

User's Guide

Agilent Technologies

8510C Network Analyzer Introductory

This manual provides documentation for the 8510C Network Analyzers.



Manufacturing Part Number: 08510-90290

Printed in USA

February 1994

© Copyright 1991, 1994, 2001 Agilent Technologies

Notice

The information contained in this document is subject to change without notice.

Agilent Technologies makes no warranty of any kind with regard to this material, including but not limited to, the implied warranties of merchantability and fitness for a particular purpose. Agilent Technologies shall not be liable for errors contained herein or for incidental or consequential damages in connection with the furnishing, performance, or use of this material.

Safety Information

The following safety symbols are used throughout this manual. Familiarize yourself with the symbols and their meaning before operating this instrument.

WARNING

Warning denotes a hazard. It calls attention to a procedure which, if not correctly performed or adhered to, could result in injury or loss of life. Do not proceed beyond a warning note until the indicated conditions are fully understood and met.

CAUTION

Caution denotes a hazard. It calls attention to a procedure that, if not correctly performed or adhered to, could result in damage to or destruction of the instrument. Do not proceed beyond a caution sign until the indicated conditions are fully understood and met.

NOTE

Note calls out special information for the user's attention. It provides operational information or additional instructions of which the user should be aware.



The instruction documentation symbol. The product is marked with this symbol when it is necessary for the user to refer to the instructions in the documentation.



This symbol is used to mark the on position of the power line switch.



This symbol is used to mark the standby position of the power line switch.



This symbol indicates that the input power required is AC.

WARNING **This is a Safety Class 1 Product (provided with a protective earth ground incorporated in the power cord). The mains plug shall be inserted only in a socket outlet provided with a protected earth contact. Any interruption of the protective conductor inside or outside of the product is likely to make the product dangerous. Intentional interruption is prohibited.**

WARNING **No operator serviceable parts inside. Refer servicing to qualified personnel. To prevent electrical shock do not remove covers.**

WARNING **If this product is not used as specified, the protection provided by the equipment could be impaired. This product must be used in a normal condition (in which all means for protection are intact) only.**

CAUTION Always use the three-prong AC power cord supplied with this product. Failure to ensure adequate grounding may cause product damage.

Warranty

This Agilent Technologies instrument product is warranted against defects in material and workmanship for a period of three years from date of shipment. During the warranty period, Agilent Technologies will, at its option, either repair or replace products which prove to be defective.

For warranty service or repair, this product must be returned to a service facility designated by Agilent Technologies. Buyer shall prepay shipping charges to Agilent Technologies and Agilent Technologies shall pay shipping charges to return the product to Buyer. However, Buyer shall pay all shipping charges, duties, and taxes for products returned to Agilent Technologies from another country.

Agilent Technologies warrants that its software and firmware designated by Agilent Technologies for use with an instrument will execute its programming instructions when properly installed on that instrument. Agilent Technologies does not warrant that the operation of the instrument, or software, or firmware will be uninterrupted or error-free.

LIMITATION OF WARRANTY

The foregoing warranty shall not apply to defects resulting from improper or inadequate maintenance by Buyer, Buyer-supplied software or interfacing, unauthorized modification or misuse, operation outside of the environmental specifications for the product, or improper site preparation or maintenance.

NO OTHER WARRANTY IS EXPRESSED OR IMPLIED. AGILENT TECHNOLOGIES SPECIFICALLY DISCLAIMS THE IMPLIED WARRANTIES OF MERCHANTABILITY AND FITNESS FOR A PARTICULAR PURPOSE.

EXCLUSIVE REMEDIES

THE REMEDIES PROVIDED HEREIN ARE BUYER'S SOLE AND EXCLUSIVE REMEDIES. AGILENT TECHNOLOGIES SHALL NOT BE LIABLE FOR ANY DIRECT, INDIRECT, SPECIAL, INCIDENTAL, OR CONSEQUENTIAL DAMAGES, WHETHER BASED ON CONTRACT, TORT, OR ANY OTHER LEGAL THEORY.

Notice

Hewlett-Packard to Agilent Technologies Transition

This documentation supports a product that previously shipped under the Hewlett-Packard company brand name. The brand name has now been changed to Agilent Technologies. The two products are functionally identical, only our name has changed. The document still includes references to Hewlett-Packard products, some of which have been transitioned to Agilent Technologies.



Agilent Technologies

Contents

Chapter 1	Operating the HP 8510	2
	Getting Acquainted	
	The Network Analyzer System	
	Turn On System Power	
	General Measurement Sequence	
	Step 1: PRESET or RECALL Instrument State	
	Step 2: Test Setup Connections	
	Step 3: System Control Settings	
	Step 4: Perform Measurement Calibration	
	Step 5: Save Instrument State	
	Step 6: Measure Device Under Test	
	Step 7: Read Measured Value	
	Step 8: Output Measurement Results	
Chapter 2	Reflection Measurements	19
	Overview	
	General Setup	
	Multi-Port Devices	
	Measuring Return Loss	
	Measuring Reflection Coefficient Magnitude	
	Measuring Standing Wave Ratio	
	Measuring S-Parameters	
	Measuring Impedance	
Chapter 3	Transmission Measurements	22
	Overview	
	General Setup	
	Measuring Insertion Loss and Gain	
	3 dB Bandwidth	
	Out of Band Rejection	
	Passband Flatness	
	Measuring Insertion Phase	
	Measuring Electrical Length	
	Measuring Phase Distortion	
Chapter 4	Time Domain Measurements	27
	Reflection Measurements	
	Transmission Measurements	
	Time Domain Gating	
Chapter 5	Measurement Enhancements	31
	Single Channel and Dual Channel Measurements	
	Single Channel, Single Parameter	
	Single Channel, Four Parameter	
	Dual Channel	
	Coupled and Uncoupled Channels	
	Preset Instrument State	
	Pulse and Waveguide Systems	

What's in this Guide?

This User's Guide provides an introduction to the HP 8510 Network Analyzer, showing how the instrument is used to characterize the frequency and time domain performance of network components. Rather than being a formal text on measurement theory and techniques, this guide is intended to help you get hands-on experience with the network analyzer, using example procedures to illustrate network analyzer operating sequences in actual measurement situations. This helps you to get started making network measurements using the HP 8510 and demonstrates the ease with which accurate results can be obtained.

Chapter 1 The reader who has limited prior experience with network analysis techniques or the HP 8510 will find Chapter 1 helpful. It overviews the system hardware then presents a general procedure for making network measurements using the HP 8510. This procedure is followed throughout the rest of the guide.

Chapters 2 and 3 These chapters illustrate the HP 8510 at work making a variety of reflection and transmission measurements. The examples have been chosen to demonstrate many of the operating modes for the instrument. The examples should help you adapt these techniques to measurement of your particular device.

Chapter 4 The HP 8510 can optionally present measured data in the Time Domain. This valuable feature permits analysis of impedance and length characteristics of a signal path with respect to time or distance.

Chapter 5 This chapter, Measurement Enhancements, describes additional features of the HP 8510 that you can use to make the measurement easier and more productive.

Other HP 8510 Learning Products

Operating and Programming Manual

The HP 8510 Operating and Programming Manual has more complete operating information for both manual and automatic measurements. Refer there for further information on any topic in this User's Guide as well as topics not described here.

Installation and Service

It is assumed that the network analyzer system is installed and ready for use. If not, refer to the Installation manual for installation and checkout instructions. The Service manual contains specifications, replaceable parts lists, and other pertinent maintenance information.

Keyword Dictionary

The HP 8510 Keyword Dictionary provides a very detailed description for each of the manual and remote functions of the system. Use the Keyword Dictionary when the tutorial presentations here and in the Operating and Programming manual do not provide sufficient information for your application.

Pocket Guide

The HP 8510 pocket-size Operating and Programming Quick Reference provides memory aids for the user who is familiar with the HP 8510.

Chapter 1

Operating the HP 8510

Getting Acquainted

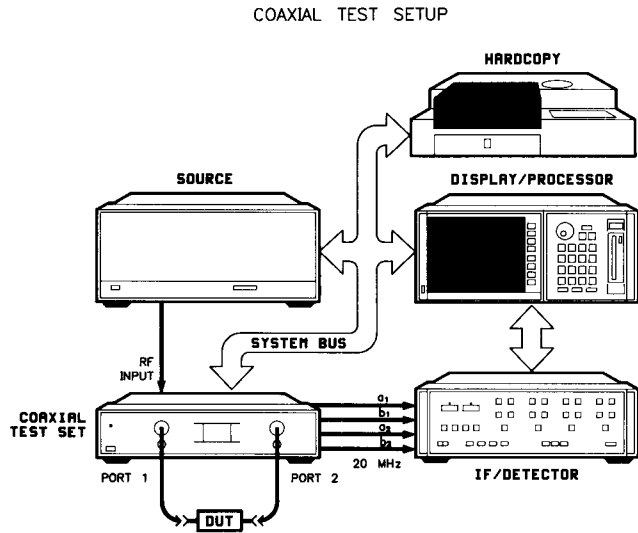

The minimum network analyzer measurement system consists of the source, the test set, the vector signal processor, and the display. Together these comprise a complete stimulus/response test system which provides stimulus to the device under test and measures the signal transmitted through the device or reflected from its input. The system then detects and processes the data to provide various displays showing the magnitude and phase of these responses. Accuracy enhancement techniques permit measurement calibration at the interface to the device under test, minimizing the effect of systematic measurement errors.

The Network Analyzer System. A representative HP 8510 network analyzer system is shown here. It consists of: the sweeper or synthesizer to provide the RF stimulus; the test set which provides signal separation and the first frequency conversion stage; and the HP 8510 which consists of two instruments, the IF/Detector and the Display/Processor. The HP 8510 controls the system instruments via a dedicated HP-IB called the 8510 system bus. This direct control allows the HP 8510 to take full advantage of the capabilities of the various system instruments.

A test set provides the points at which the device under test is connected, signal separation devices to measure the four S-parameters, and the first frequency conversion stage of the receiver. The device to be tested is connected between the test set Port 1 and Port 2. Several different test sets are used with the HP 8510, and the system may include up to four test sets. From the operator's point of view, except for the frequency range and different connection techniques for coaxial and waveguide, operation of the HP 8510 is the same regardless of the test set used.

From 45 MHz to 50 GHz the system uses coaxial test sets; there are versions covering different frequency ranges. These coaxial test sets contain all signal separation components and the internal Local Oscillator (LO).

Above 50 GHz, the system uses the waveguide millimeter-wave (mm-wave) test set. This consists of the band-independent test set controller and two test set modules for the specific frequency band. The test set modules contain the signal separation and first frequency conversion stages. This configuration requires two sources, one for the stimulus RF and one for the LO.

System setups and measurement-related data may be stored and loaded using the HP 8510 front panel disk mass storage unit or any external HP-IB compatible mass storage unit.

The HP 8510C can control hardcopy output devices such as a line printer, graphics printer, and graphics plotter using HP-IB or RS-232 protocol. These devices may be connected to the HP 8510 system interface bus, or to either of the two RS-232 ports on the rear panel of the display/processor.

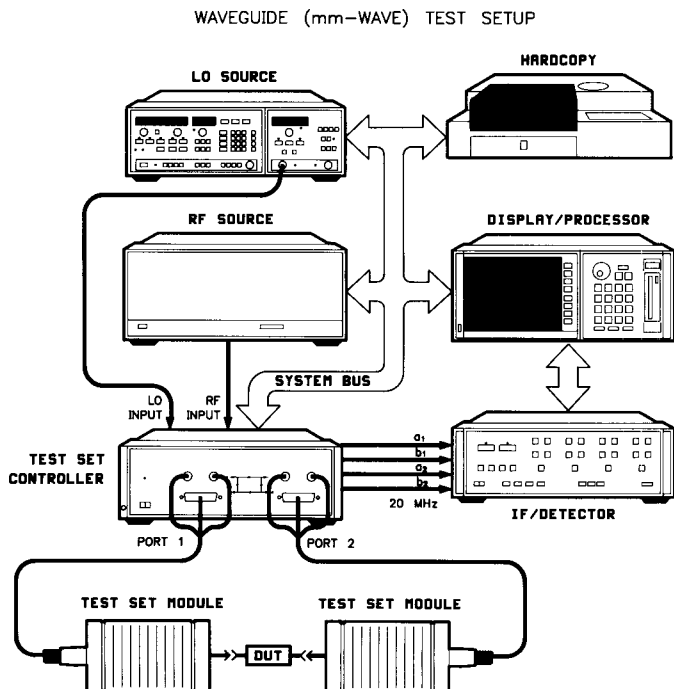

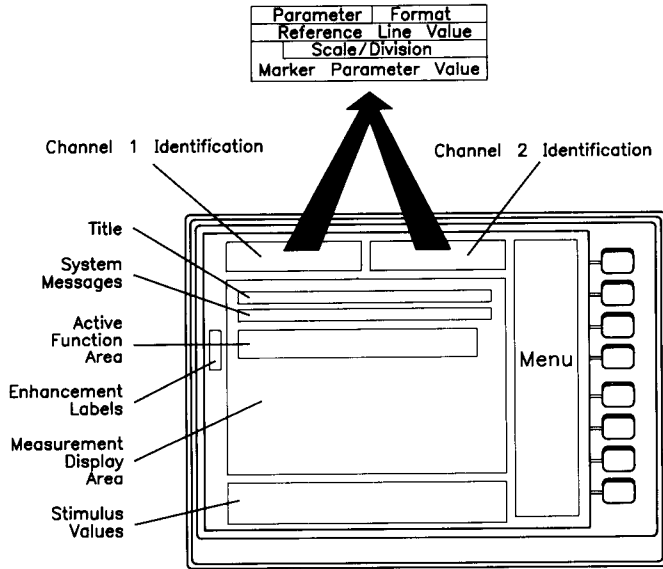

CRT Display. The front panel of the network analyzer is relatively simple. It is shown in full by the foldout at the end of this document. First, there is the CRT which presents the measurement results. This illustration shows the general areas for the measurement trace and for the various annotations which communicate to the operator.

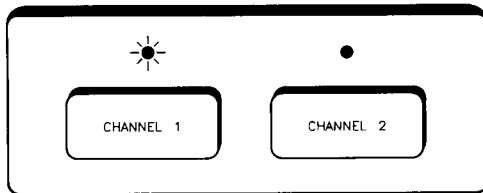

Channel Selection. The HP 8510 has two separate, identical measurement channels. To select the channel for display, press **CHANNEL 1** or **CHANNEL 2**. An indicator above the keys lights to show the current selected channel.

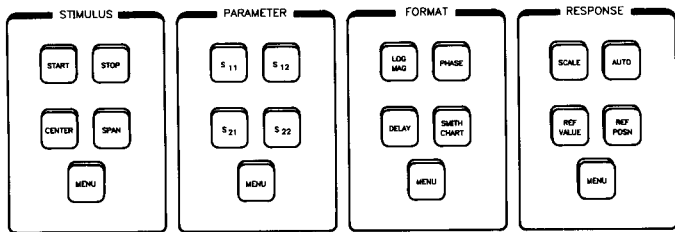

Basic Measurement Functions - S/P/F/R. Next, there are groups of keys for the measurement setup, measurement calibration, data presentation, and data output functions. The basic measurement and display functions are specified using keys in the STIMULUS, PARAMETER, FORMAT, and RESPONSE blocks.

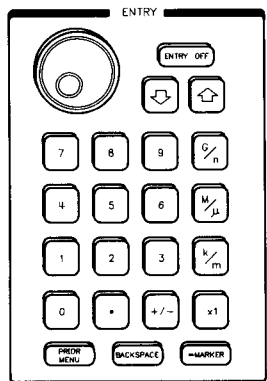

Knob and Numeric Entry. The value of the active function is changed using the ENTRY controls. The knob changes the function value in steps related to the current function value and the speed of the knob. The STEP keys change the active function value by a proportional increment each time the key is pressed. Enter a numeric value using the numeric, the decimal, and the (+/-) toggle, then pressing the appropriate units key.

The **(G/n)**, **(M/μ)**, and **(k/m)** keys are general purpose terminators having values of $10^9/10^{-9}$, $10^6/10^{-6}$, and $10^3/10^{-3}$, respectively, and the x1 key is used to specify the basic units for the quantity, for example Hz. To specify the Start frequency of 3 GHz, press **(START)**, **(3)**, then **(G/n)**. Press **(ENTRY OFF)** to clear the active function area.

Entry Area Terminators

Key Name	Frequency	Power	Power Slope	Time	Voltage
G/n	GHz	—	—	ns	—
M/μ	MHz	—	—	μs	μV
k/m	kHz	—	—	ms	mV
x1	Hz	dBm	dB/GHz	s	V

x1 Always Basic Units for Current Active Function

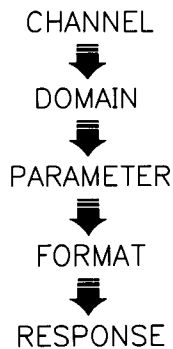

P/F/R Memory. This diagram shows that the HP 8510 internal memory provides what is called the "Channel/Domain/P/F/R Limited Instrument State". Functionally, this feature allows you to select the format and response settings most appropriate for viewing the parameter, then when you switch between the different parameters, the previous format and response settings are automatically recalled.

Active Function. Pressing one of the function keys in these groups either changes the instrument state immediately, such as selecting one of the parameters, or, for keys such as **(START)**, makes that function the "active" function and its current value is shown in a specific area of the CRT.

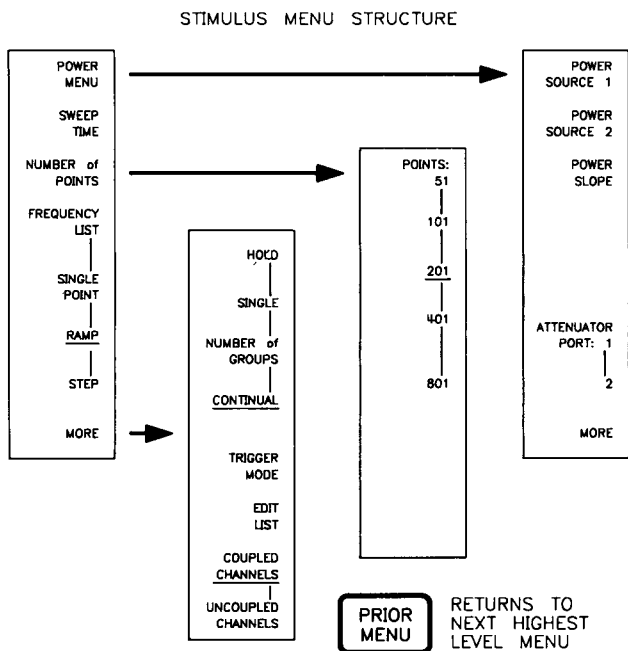
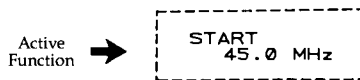

Softkey Menus. Choices in each of the function groups are extended using CRT-displayed "menus". Pressing a **(MENU)** key presents a selection of additional function key labels on the CRT. This is called a "softkey menu". Each "menu" lists the possible choices for a particular function, with each choice corresponding to one of the eight "softkeys" located to the right of the CRT. Press the softkey to the right of the function label to activate the function.

Every key, when pressed, either activates the function, possibly changing the state of the system, or presents the next level softkey menu. For example, pressing the **(MARKER)** key makes a trace marker the active function and also presents the first level marker menu to allow selection of other marker functions. You may press any key at any time, in any sequence, without fear of damaging the system although the measurement result may not always be meaningful.

Turn on System Power

First turn on power to the source, test set, and other peripherals connected to the HP 8510. Now turn on power to the HP 8510 by setting the LINE rocker switch on the IF/Detector to ON, then depressing the LINE pushbutton switch on the Display/Processor. It is recommended that the network analyzer Display /Processor be turned on last to allow all other instruments on the 8510 system bus to go through their start-up cycle, then the HP 8510 can gain control.

Power-On Sequence. As soon as power is applied, the network analyzer performs a self-test sequence that tests internal operation as well as operation of the other system instruments.

If the HP 8510 system configuration has not changed since it was last turned off, and if the system does not include multiple test sets, the network analyzer will begin making measurements. The actual measurement after power-up will vary according to the actual instrument state stored in the HP 8510 Instrument State number 8. This state is very close to the standard Preset state unless it has been changed by the user. However, all properly functioning systems will display the operating system firmware issue in the active function area.

Warm-Up Time. In a typical environment, the system will be ready to make measurements immediately, with about 30 to 90 minutes warmup required to meet all system performance specifications. When you are finished with the system, power can be left applied to the test set and the source (source in STANDBY) in order to minimize warmup time.

Multiple Test Sets. If multiple test sets are included in the system, look at each of the test sets front panel Active indicators to determine which of the test sets is active (ACTIVE indicator lighted). If two or more of the test sets show the Active indication, it will be necessary to manually initialize the system for the measurement by using the HP-IB Addresses menu.

Press the **(LOCAL)** key to display the HP-IB Addresses menu. Now press **[ADDRESS of TEST SET]**. The Active Function area should display an address between 20 and 23. Initialize by selecting each test set in turn. Depending upon how many test sets are in the system, first, enter **(20)** then press **(x1)**, then **(21)**, **(x1)**, **(22)**, **(x1)**, **(23)**, **(x1)** to select each test set in turn. With each address entry the selected test set Active indicator will light, then extinguish when the next test set is selected. Finally, enter the address of the test set to be used.

mm-Wave Test Set. If the mm-wave test set modules have been changed to a different frequency band, the HP 8510 will display an error message and a beeper may sound. Do not be alarmed. You may disable the beeper by pressing **(SYSTEM)** then **[BEEPER OFF]**. If line power is applied to all instruments and all cables are connected properly, this error means that it is necessary to configure the HP 8510 Hardware State memory for the new frequency band. This memory is loaded from a System Disk supplied with the HP 8510.

System Disk. Multiple source systems are supplied with a system disk which contains several files for the different coaxial and mm-wave hardware configurations. To load HP 8510 memory with the correct hardware configuration, proceed as follows:

- Insert the System Disk in the HP 8510 front panel disk drive.
- Press:
(DISC)
[DIRECTORY]

Read the displayed directory to find the correct file for your current hardware configuration. The file names will be MD_COAX, for a coaxial test set, or MD_WR-15SYN for a mm-wave test set covering 50 to 75 GHz with an HP 83xx synthesizer as the LO.

- Load the appropriate file by pressing:
[LOAD] [MORE]
[MACHINE DUMP]
Use the knob to position the box around the file you wish to load
Press:
[LOAD FILE]

The file will be loaded and the system should begin to measure normally.

General Measurement Sequence

Even with its wide range of capabilities, the HP 8510 is easy to operate. Common measurements can be set up with only a few front panel selections. The following sequence is used throughout the HP 8510 user documentation to illustrate the use of the HP 8510 in its various operating modes.

User Preset or Factory Preset

The green **(USER PRESET)** key can be pressed at any time to return the HP 8510C to a user-defined state. The User Preset function performs all necessary internal HP 8510C initialization then recalls Instrument State 8.

If you wish to set the HP 8510 instrument state to a fully known factory-defined configuration, press:

**(RECALL) [MORE],
[FACTORY PRESET]**

which always initializes all system instrument state functions to the same default conditions, except for the frequency range, which depends upon the capabilities of the source and the test set. **[FACTORY PRESET]** sends an instrument preset to all instruments on the HP 8510 system bus, then recalls the HP 8510 factory-defined instrument state. A table at the end of this document shows a partial list of important Factory Preset conditions. Because an instrument preset is sent to all instruments connected to the HP 8510 system bus, the time required for this operation to complete depends upon the equipment connected to the system bus.

Connections

Set up the test port cables and connectors for your particular device under test requirements

Controls

Set up the network analyzer instrument state in these steps:

- Use the STIMULUS keys to set the desired start and stop frequencies, number of measured points, and other characteristics of the frequency sweep.
- Use the PARAMETER keys to select the parameter to be measured and displayed.
- Use the FORMAT keys to select the type of graticule for display of the measured data.
- Use the RESPONSE keys to position the trace for viewing.

Measurement Calibration

Use the keys under **(CAL)** and connect appropriate calibration standards where the device under test will be connected in order to improve the accuracy of the measurement.

Save Instrument State

Use the **(SAVE)** keys to store the current control settings in internal non-volatile memory, and the **(RECALL)** keys to recall previously saved instrument states.

Measurement

With error correction on, when the device under test is connected its response will be displayed on the CRT.

Read Values

Use the **(MARKER)** keys and the knob to position the measurement marker(s) to points of interest on the trace.

Output Results

Use the **(COPY)** keys to select data output to printer and/or plotter. Use the **(DISC)** key to direct measurement result and instrument state files to the HP 8510 internal disk drive or to external mass storage.

These steps are discussed in detail in the following paragraphs.

Step 1: USER PRESET

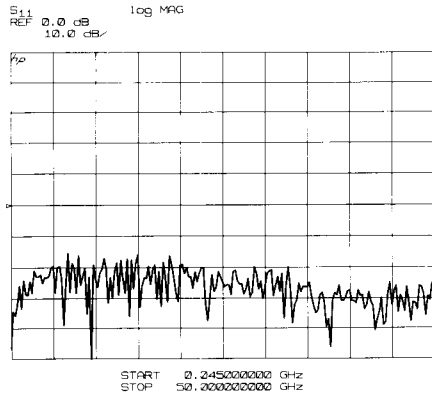

Pressing the green **USER PRESET** key initializes all HP 8510 internal functions, then recalls Instrument State 8. An instrument preset command is not sent to other instruments connected to the HP 8510 system bus. Unless the user has changed the contents of Instrument State 8, the CRT will appear as shown here, with the current S11 measurement displayed in the logarithmic magnitude format. The appearance of the trace will depend upon the actual connection to PORT 1 of the test set.

Note: HP 8510C Preset operation is changed from the HP 8510B. The fact that HP 8510C **USER PRESET** only presets the HP 8510, does not issue an instrument preset to the source and other instruments on the HP 8510 system bus, then recalls instrument state 8 allows you to define the instrument state recalled after you press **USER PRESET**. Simply set all desired instrument state functions to the settings you wish then press **SAVE**, **[INST. STATE 8]**. If you wish to define instrument state 8 to the factory preset instrument state, press **RECALL**, **[MORE]**, **[FACTORY PRESET]**, **SAVE**, **[USER PRESET 8]**.

Step 2: Test Setup Connections

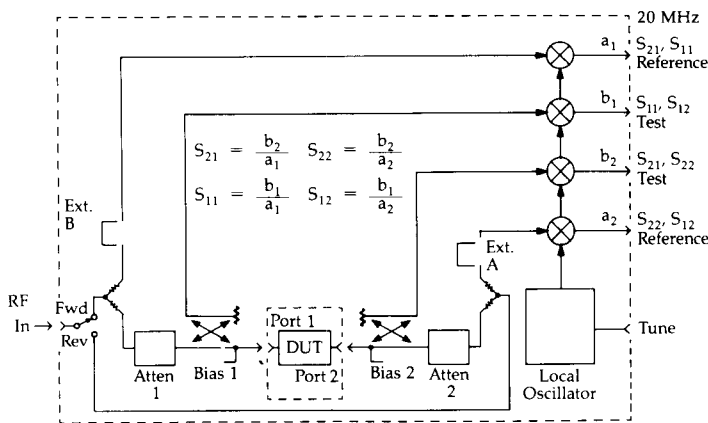

The point(s) at which the device under test is connected to the test set is called the Reference Plane(s). If cables are used to extend the test set port out to the device under test, the end of the cable is defined as the Port 1 and Port 2 reference plane. All measurements are made with respect to the reference plane(s).

Here is a signal flow diagram of a typical S-Parameter test set. It is called a two-path test set because the stimulus signal can be applied to either test set PORT 1 or PORT 2, thus allowing all four parameters of a two-port test device to be measured without the need to manually disconnect and reverse the device.

Control of the signal path is accomplished using keys in the PARAMETER block. An illustration on the test set front panel shows the signal flowgraph, and lighted indicators show whether the stimulus is incident at Port 1 or Port 2.

Various cables and adapters are used to connect the device to be tested to the network analyzer. If the device is a one-port device, connect the DUT directly to the test port, using an adapter if required. If the device has two or more ports, either use the two test port extension cables and the necessary adapters to achieve a symmetrical setup, or connect the DUT directly to Port 1 and use a single cable to connect Port 2 of the device to test set Port 2.

In order to minimize the connect/disconnect cycles on the relatively expensive test set or cable connectors, it is always good practice to use a consumable high quality adapter, or "connector saver". Connect this connector saver to the test setup before doing the measurement calibration.

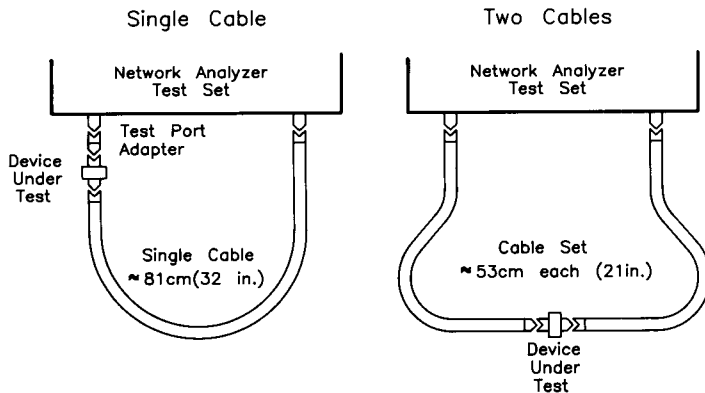

Step 3: System Control Settings

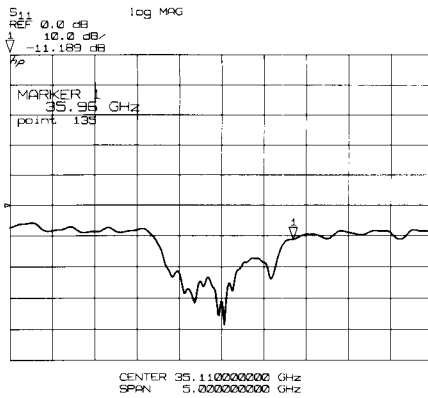

STIMULUS

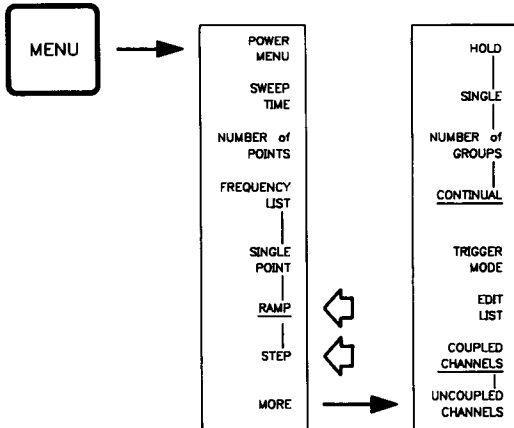

Use the STIMULUS, PARAMETER, FORMAT, and RESPONSE controls to configure the network analyzer for the measurement.

Set Stimulus. Controls in the STIMULUS block and the menus allow you to set the frequency sweep, source power level, sweep time, number of frequency points to be measured, and other related characteristics of the incident signal.

The **(START)** and **(STOP)** keys and the **(CENTER)** and **(SPAN)** keys are used to set the limits of the frequency sweep. Notice that the stimulus annotation at the bottom of the CRT shows the current frequency sweep in terms of Start/Stop or Center/Span depending upon which of the keys has been pressed last.

Press the STIMULUS **(MENU)** key to present the first level Stimulus menu. Now press the **[NUMBER of POINTS]** softkey. The Number of Points menu provides selection of the number of points to be measured over the frequency sweep. Press **[POINTS:51]**, **[101]**, **[201]**, **[401]**, or **[801]** depending on the number of points you wish to measure. Because you can reduce the number of points after calibration, you may wish to calibrate using more points than actually required for the measurement then reduce the number of points later.

Sweep Modes. The **[RAMP]**, **[STEP]**, and **[FREQUENCY LIST]** softkeys select the sweep mode. **[RAMP]** and **[FREQUENCY LIST]** can be used with any source, and **[STEP]** may be used when the source is a synthesized sweeper such as the HP 834x- or 836x- series sources.

Factory Preset always selects Ramp sweep, in which the source is swept from the lowest frequency to the highest frequency in a continuous sweep. Measured data is sampled at the selected frequency points without stopping the sweep.

Because you can select either Ramp or Step after calibration, you may wish to choose Step for the calibration then switch to Ramp for tuning or other DUT adjustments during the measurement, then switch back to Step for the final data acquisition.

Frequency List is used to specify arbitrary frequency points for measurement. Pressing **[FREQUENCY LIST]** presents a menu structure that allow you to specify unrelated single frequencies or segments. For example, in the application where the same number of points are measured over adjacent octaves, use the key sequence shown here.

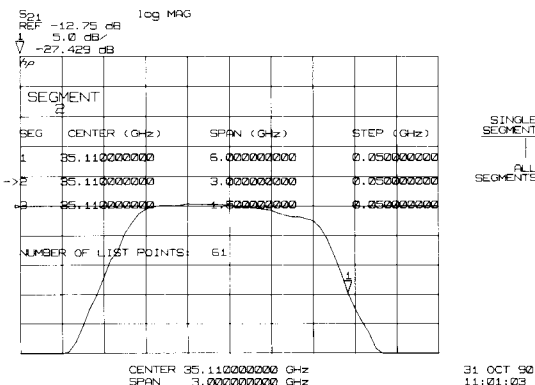

STIMULUS **(MENU)** **[MORE]**,
[EDIT LIST]
[ADD]
[START] **(2)** **(G/n)** **[STOP]** **(4)** **(G/n)**
[STEP SIZE] **(100)** **(M/μ)**
[DONE]
[ADD]
[START] **(4)** **(G/n)** **[STOP]** **(8)** **(G/n)**
[STEP SIZE] **(200)** **(M/μ)**
[DONE]
[DUPLICATE POINTS]
[DUPLICATES DELETED]
[DONE]
[FREQUENCY LIST]

When you press **[FREQUENCY LIST]** with more than one segment defined, the menu allows selection of either **[ALL SEGMENTS]** or **[SINGLE SEGMENT]**. Pressing **[SINGLE SEGMENT]** causes only the current selected segment to be measured. Use the STEP keys, knob, or numeric entry to select the segment.

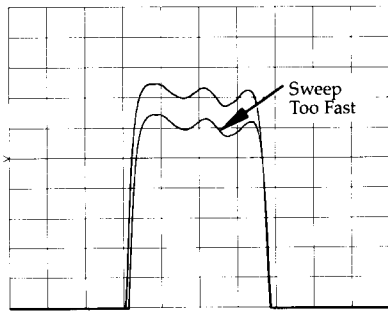

What are the Speed and Accuracy Differences Between RAMP and STEP?

Sweep Time. In the Ramp sweep mode, the Sweep Time is an important consideration when testing narrowband devices. Factory Preset always selects the fastest sweep time appropriate for the HP 8510 data acquisition process. The optimum sweep time for a particular measurement is as fast as possible while allowing time for the device under test to respond. A practical method for determining this optimum sweep time is to connect the device under test then slow the sweep as necessary until the device response does not change. Too fast a sweep time will be indicated by smoothing of narrow responses. Press STIMULUS (MENU) then the [SWEEP TIME] softkey and use the knob or STEP keys to adjust the sweep time.

In the Step and Frequency List sweep modes, the sweep time function label changes to DWELL TIME, allowing you to set the dwell time between when the source is locked to the measurement frequency and the measurement is actually made. This feature allows you to control the measurement process so that the device can respond to the new frequency before the measurement is made. Dwell time is set in the same way as sweep time.

In general, the time to accomplish a single 201 point Step sweep is about 100 times greater than the time required for a single Ramp sweep. Averaging does not slow the Step sweep appreciably with fewer than about 32 averages. Thus, a Ramp sweep measurement using 32 averages takes about the same time as a Step sweep with 32 averages. If a greater number of averages is used, the time for Ramp sweep increases faster than for a Step sweep.

For an HP 8510 using firmware revision 6.0 or greater along with an HP 836x-family source, Ramp sweep frequency accuracy is much improved over systems with HP 835x- or 834x-family sources due to the source/network analyzer measurement trigger interface. This interface lets the source control the HP 8510 by signalling when the source is at the desired measurement frequency. Using this interface, the HP 8510 Trim Sweep function is disabled.

The Step sweep mode is used when maximum frequency accuracy and repeatability are required. In the Step mode the synthesized sweeper is phase locked at each frequency point before the measured data is read. The tradeoff is measurement speed and frequency accuracy (better frequency accuracy produces better measurement accuracy). Because you can select either Ramp or Step after calibration, you may wish to choose Step for the calibration then switch to Ramp for tuning or other DUT adjustments during the measurement, then switch back to Step for the final data acquisition.

Source Power Level. The power level of the stimulus signal is preset to an appropriate value for measurement of most passive device and devices with less than about 20 dB of gain. In order to be absolutely certain of the RF power level available at the test port, measure it using a power meter connected to Port 1 or Port 2. The [SOURCE POWER] function may be used to change the power available at the test port. Messages will be displayed if the source power is set too high or too low.

Select Parameter

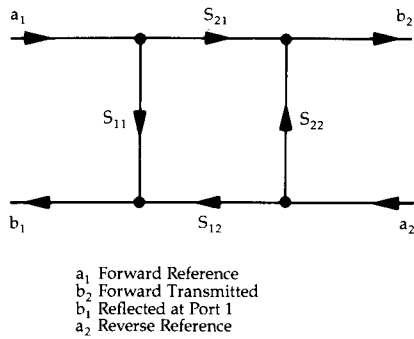

Keys in the PARAMETER block allow you to select the S-parameter to be measured and displayed. Recall that S-parameters are always defined as a ratio and they are represented by the notation S_{outin} where out represents the emerging signal and in represents the incident signal. Therefore, S_{11} is the ratio of the signal emerging from port 1 to the signal incident at port 1, or as shown in the signal flow diagram, the ratio b_1/a_1 . After Preset, Channel 1 displays S_{11} and Channel 2 displays S_{21} , if selected.

Select Format for Display

FORMAT	MARKER Basic Units
LOG MAG	dB
PHASE	degrees
DELAY	seconds
SMITH CHART	$R \pm jX$
SWR	
LINEAR MAGNITUDE	ρ (reflection) τ (transmission)
LIN mkr on POLAR	$\rho \angle \phi^\circ$ $\tau \angle \theta^\circ$
LOG mkr on POLAR	dB $\angle \phi^\circ$
Re/Im mkr on POLAR	$x \pm jy$
INVERTED SMITH	$G \pm jB$
REAL	x
IMAGINARY	jy (unitless)

Twelve different display formats provide a comprehensive selection of useful presentations. The keys in the FORMAT block and displayed by FORMAT (MENU) also select the marker units shown by the active marker. This list shows the trace value and marker units for each of the standard format selections. Examples of how these formats are used for various reflection and transmission measurements are discussed in later chapters.

Notice that the Parameter and Format keys are associated such that when a parameter is selected, the measurement is displayed in the format last selected for that parameter.

For example, press (S11) then (SMITH CHART). This measurement can show the actual complex impedance of the device under test. Now select S_{21} and (DELAY), a measurement of the transit time for the transmitted signal.

Switching between the parameters with each parameter keeping its preferred format is accomplished without additional keystrokes. This may seem like a minor feature but it is an example of how the HP 8510 is designed to provide maximum convenience to the user.

Position Response for Viewing

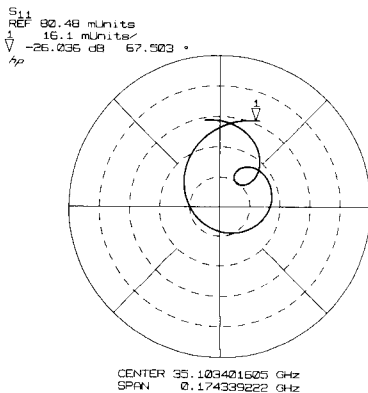
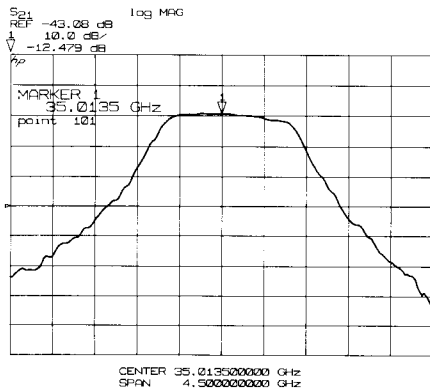

Press (AUTO) to automatically scale the selected format for display of the complete measurement trace. The (SCALE), (REF VALUE), and (REF POSN) keys, along with the ENTRY block, control the display presentation. The trace is always positioned on the graticule according to its value with respect to the value of the graticule reference position line.

For Cartesian displays such as (LOG MAG) and (DELAY) the reference position can be any horizontal line.

For Polar formats, such as [LOG mkr on POLAR] and [LIN mkr on POLAR], the reference position is the outer circle for magnitude and zero degrees for phase. For consistency, the SMITH format uses Polar conventions.

For an example showing linkage of the Channel, Parameter, and Format keys select:

(CHANNEL 1) (S11) (LOG MAG) (AUTO)
 (CHANNEL 2) (S11)
 (MARKER) (REF VALUE) (=MARKER)
 (SCALE) (0.1) (x1).

Switch between Channel 1 and Channel 2 and between parameters and formats on both channels to learn about this Channel/Domain/P/F/R association. Of course, all settings are saved when you use the save instrument state function.

Averaging

Probably the most frequently used feature to improve the data presentation is averaging. Press RESPONSE (MENU), then [AVERAGING ON/restart]. The active function is now the averaging factor applied to the measurement.

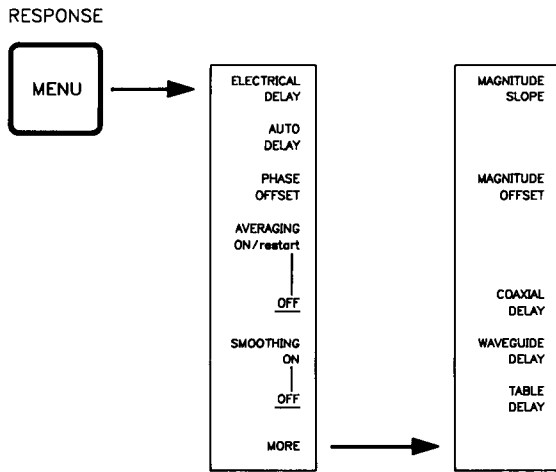

Averaging is used to extend the effective dynamic range of the measurement and thus improve accuracy and resolution. Although averaging is performed on the digitized data by the HP 8510 central processing unit, it operates like a variable bandwidth IF filter to reduce the effect of random noise and other time variant errors on the displayed trace.

In the Ramp sweep mode, averaging is accomplished on a sweep-by-sweep basis by averaging the newly acquired data with the current displayed data using the weighted exponential running average technique. Using this process, the new data has relatively little effect on the existing data and $n + 1$ sweeps, where n is the averaging factor, are required to produce fully averaged data. The proper procedure is, then, if you select an averaging factor of 16, allow 17 sweeps until using the data. You may use the Number of Groups function on the Stimulus menu to keep track of the sweeps by pressing STIMULUS (MENU), [MORE], [NUMBER of GROUPS], then (17), (x1). When the H (Hold) annotation appears on the screen the sweep stops and data is ready.

In the Step sweep mode, each data point is averaged as it is measured by taking $n + 1$ measurements of that point. Thus, for Step sweep, only one sweep is required to produce fully averaged data. Select [SINGLE] or [NUMBER OF GROUPS] (1) (x1) to acquire the data.

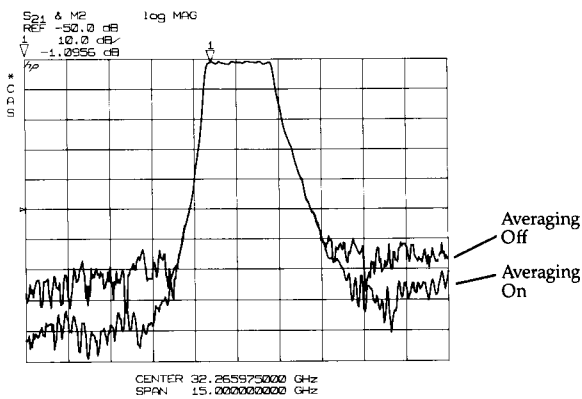

Step 4: Perform Measurement Calibration

Accuracy in network measurements is greatly influenced by factors external to the network analyzer frequency conversion and signal processing steps. Parts of the measurement setup such as interconnecting cables and test sets all introduce variations in magnitude and phase that can distort the actual performance of the DUT. Because the magnitude and phase of the error is unknown, each error is assumed to have a cumulative effect of increasing the uncertainty of the measured data.

Errors that are repeatable and have effects that can be predicted are called "systematic" errors. The measurement calibration step seeks to remove the effects of these systematic errors from the measurement of the device under test. There are three categories of these systematic errors:

- Frequency Response (Tracking)
- Leakages
- Mismatches

Any of several calibration types can be used to measure and compensate for these test system imperfections. Each method removes one or more of the systematic errors using a specific error model. In the process of measurement calibration the user connects and measures one or more precisely known standards at the point at which the test device will be connected. In principle, the difference between the precisely known response of each calibration standard and the actual measured response is used to determine the magnitude and phase value of one of the errors. Later, when the device under test is connected, the effects of these errors are mathematically removed and the device response is displayed with much reduced measurement uncertainty.

The accuracy of error-corrected measurements depends on the quality of the standards used for calibration. This is one of the HP 8510 calibration kits. It contains standards for measurement calibration at a 7mm reference plane. Since the calibration standards are very precise, great accuracy enhancement is achieved. Please also refer to the operating manual for the calibration kit you will be using.

These are two measurements of a 1-Port device made without accuracy enhancement and with 1-Port accuracy enhancement. The uncorrected measurement uses no error correction and includes the effects of all systematic errors. The second example shows results of the same measurement with frequency response, directivity, and source mismatch errors reduced by accuracy enhancement.

Four of the calibration choices are discussed in the following paragraphs, starting with the simplest (frequency response) and ending with the most complete (2-port). When the calibration procedure is complete, store the results in Cal Set storage location 1 through 8. When you wish to recall the stimulus settings used for the calibration, simply press CAL, CORRECTION ON, then select the Cal Set.

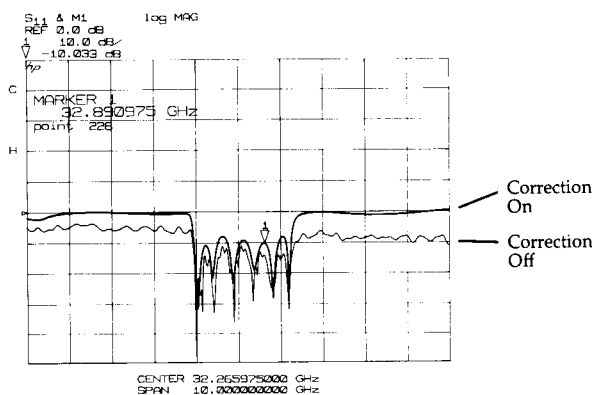
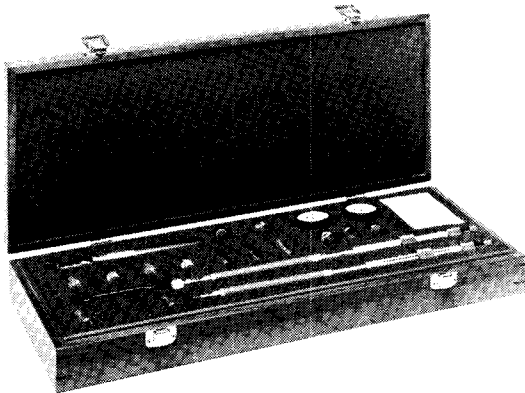

General Calibration Procedure

- Set Stimulus Values
(Frequency, Points, Power, Averages)
 - Select Calibration Kit
(**CAL**), then [**CAL1**] or [**CAL2**])
 - Select Calibration Type
(Response, 1-Port, 2-Port)
 - Connect and Measure Calibration Standards
(Press key on Standard Selection menu;
standard name is underlined when measured)
 - Save Calibration Coefficients
(**CAL SET 1**) or any other)
- C appears when correction is applied to current parameter.
* symbol disappears when data acquisition is complete.

Frequency Response/ Reflection or Transmission Calibration

- Simple Procedure
- Requires only a "thru" for transmission measurements, or,
- Requires a short circuit or open circuit for reflection measurements
- Applies only to current parameter
- Each parameter can have a different Response Cal Set

The frequency response calibration removes the magnitude and phase frequency response errors of the selected signal path by normalizing the response of the device under test to the ideal response of the selected calibration standard. For S_{21} and S_{12} measurements, the thru connection is substituted for the DUT to establish a 0 dB and 0 degrees reference. The thru connection is accomplished by connecting together the points at which the DUT will be connected. For S_{11} and S_{22} measurements, either a short circuit or an open circuit is connected to the point at which the DUT will be connected, to establish the reference response.

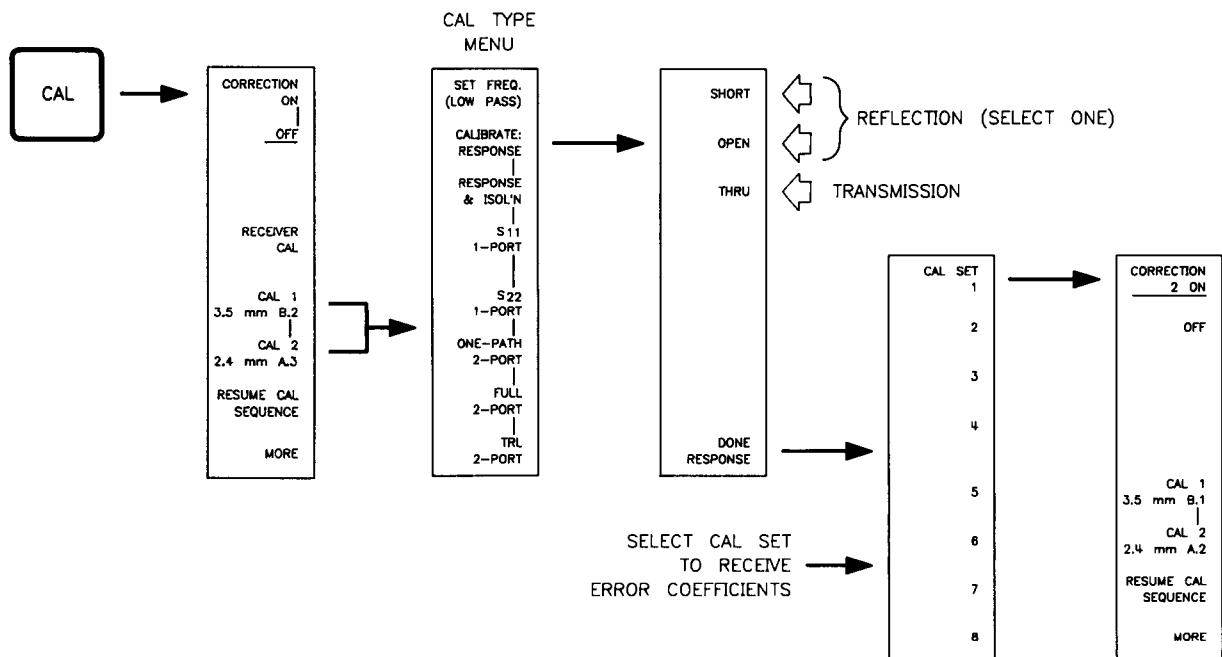

How Often do I need to Calibrate?

This can be a complicated question, but the actual answer is: The calibration remains valid as long as nothing changes. This means no changes to the uncorrected leakages (directivity and isolation), mismatches (source match and load match), and frequency response of the system. The network analyzer is designed with stability as a prime consideration so, given adequate warm-up time and a constant temperature, drift of the system instruments is typically not a problem over the term of 6-8 hours. In practice, changes in the environment (especially temperature) between calibration and measurement is the major cause in drift. The major effect is a change in the physical length of external and internal cables. Another important factor is dirt or damage of the test port connectors. If the connectors become dirty or damaged, repeatability is affected.

Fortunately, it is relatively easy to evaluate the general validity of the calibration. To test repeatability, remeasure one of the calibration standards. If you cannot obtain repeatable measurements from your calibration standards, maintenance needs to be performed on the test port connectors or cables. Also, maintain at least one sample of the device under test as your reference device. After calibration, measure this reference device and note its responses. Periodically remeasure this device and note any changes in its corrected response which can be attributed to the test system. With experience you will be able to see changes in the reference responses that indicate a need to perform the measurement calibration again.

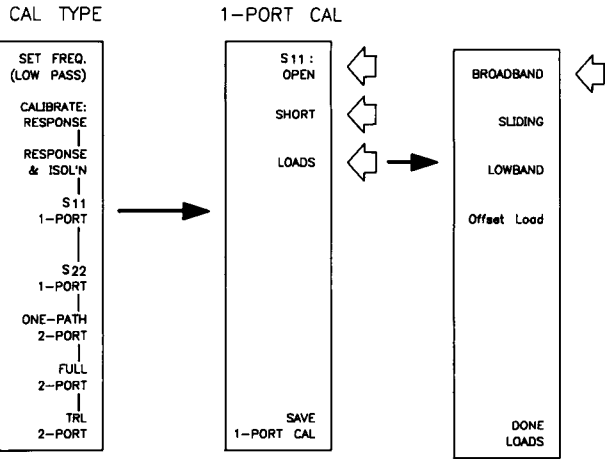

1-Port Reflection Calibration

- Most accurate for 1-Port devices
- Good choice for measurements of small or large reflections.
- Requires three terminations (open, short, load)
- Applies only to S_{11} or S_{22}

This calibration routine removes all three of the systematic error terms for a reflection measurement of a one-port DUT. These are Directivity, Source Match and Reflection Signal Path Frequency Response. It is best applied to measurement of a one-port device because it does not remove the mismatch effects seen from the output port of a 2-port DUT. These output mismatch effects are negligible if either the reflected signal from Port 1 is large or if the DUT greatly attenuates the mismatch signals seen from the output port.

For best accuracy, the Lowband load is used below 2 GHz and the Sliding or the Offset load is used above 2 GHz.

2-Port Calibration

- Most accurate for measurement of 2-Port DUT
- Measures 12 error terms
- Best applied using S-Parameter Test Set

The HP 8510 offers two calibration choices to achieve 2-Port error correction: FULL 2-PORT and TRL 2-PORT. Both of these calibration types use all 12 error terms and use the same accuracy enhancement mathematics to correct the measured data. The difference between them is the calibration standards used and the technique used to quantify the error terms.

This is the most complete calibration procedure for measurement of transmission and reflection characteristics of 2-port devices. Twelve systematic errors are quantified, six for the forward S-parameters and six for the reverse S-parameters. These are: Directivity, Source Match and Frequency Response for both Port 1 and Port 2 reflection signal paths; and Isolation (crosstalk), Load Match, and Frequency Response for the forward and reverse transmission signal paths. In order to accomplish error correction for a two-port DUT, all four DUT S-parameters must be measured.

FULL 2-PORT calibration uses Opens, Shorts, and Loads at each port in exactly the same way as the 1-Port calibration to measure reflection error terms, a thru to measure transmission tracking and load match, and an open transmission signal path to measure isolation. Almost any Cal Kit may be used to accomplish this calibration.

Select FULL 2-PORT from the Cal Type selection menu, then press REFLECT'N. The correct parameter for the calibration step is selected automatically. Proceed by connecting the calibration standards at Port 1 (S_{11}) and at Port 2 (S_{22}) in any order.

Next select TRANSMISSION, connect the thru, and press each of the softkeys in turn, then press TRANS. DONE.

On the Isolation menu, choose OMIT ISOLATION except when you are measuring devices with very high insertion loss. For high dynamic range measurements, connect loads to Port 1 and Port 2, choose an averaging factor of 128 or greater (use RESUME CAL on the Cal Menu) and select FWD. ISOL'N then REV. ISOL'N.

After pressing SAVE 2-PORT CAL, then selecting a cal set, the HP 8510 will turn correction on and switch the stimulus between Port 1 and Port 2 for fully calibrated measurements of all four S-Parameters.

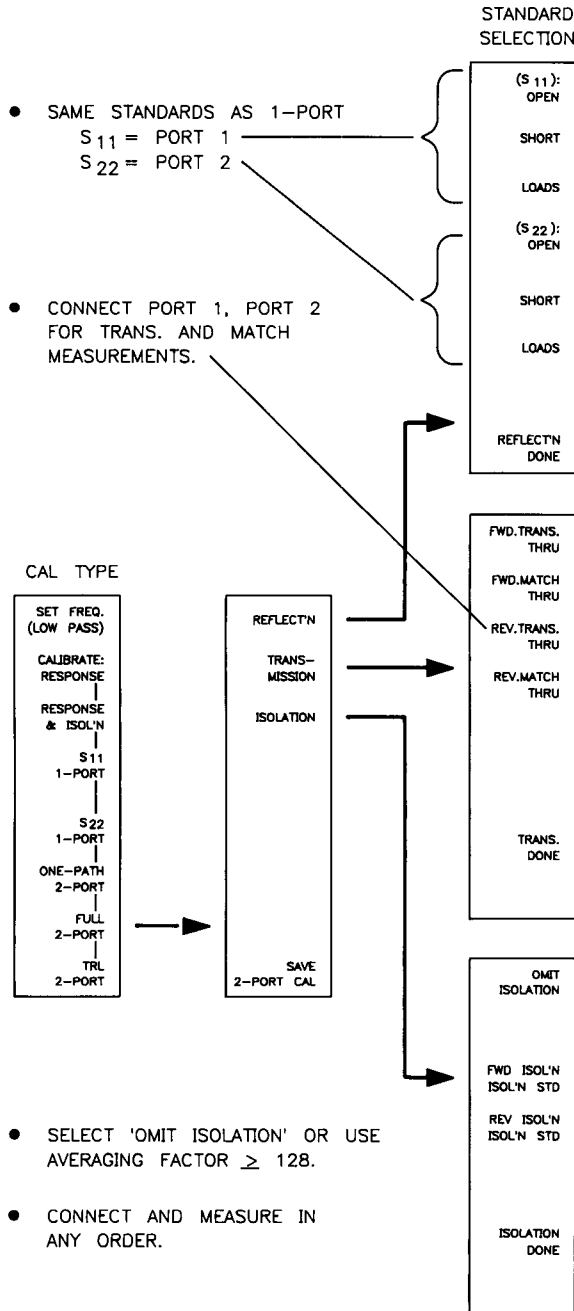

CAL TYPE

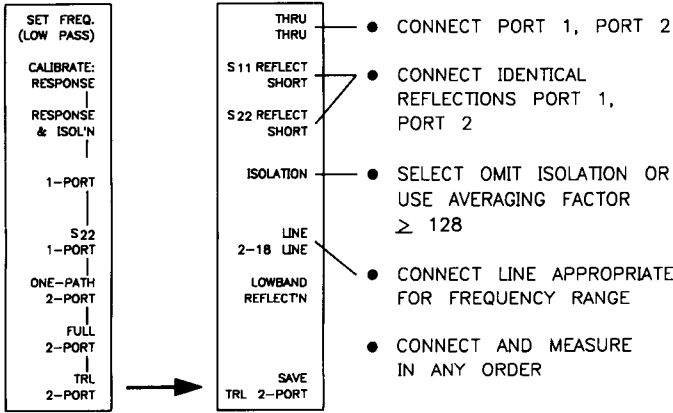

TRL 2-PORT calibration type uses multiple measurements of the thru connection, identical reflection standards at each port, and a transmission line of appropriate length and impedance to measure the error terms. If proper standards are available, this is the preferred technique due to fewer connections required and the potential for more accurate characterization of the error terms. More details of this calibration procedure are contained in other documentation supplied with the HP 8510 system.

What is a Cal Set?

A cal set contains the error coefficients for each frequency measured during the calibration sequence. After correction is turned on, the measurement at each frequency is used with the error coefficient(s) for that frequency in the error model equation to obtain and plot the corrected value.

Cal Set Limited Instrument State Contents

- Parameter(s)
- Frequency Range
- Number of Points
- Source Power
- Sweep Time
- Power Slope
- Sweep Mode (Ramp/Step/Single Point/Frequency List)
- Trim Sweep

Along with the error coefficients, a cal set also contains a subset of the complete instrument state that includes important instrument settings used for the calibration. The contents of this "Cal Set Limited Instrument State" are listed here.

If one of the instrument settings in the cal set limited instrument state is changed, the HP 8510 either displays a caution message and turns correction off, or simply displays a caution message. Note that some instrument changes to the instrument state make the cal set invalid. Other changes do not cause correction to be turned off but leave it to the user to decide whether or not the corrected data remains valid.

CAL SET RULES

Parameters	Will not turn On if current parameter not included. Turns Off if new parameter selection not included.
Frequency Range	Turns Off if changed.
Number of Points	In Ramp, Step, Single Point – Number of Points may be reduced.
Source Power Sweep Time Power Slope Ramp/Step Trim Sweep	Message CAUTION: CORRECTION MAY BE INVALID Displayed if changed. You must determine if the change invalidates the calibration.

Also note that turning on correction automatically recalls the cal set limited instrument state, placing the HP 8510 stimulus functions to the same values as during the measurement calibration. To see this feature operate, change the Start and Stop frequencies for the current cal set. The message is displayed and correction is turned off. Now press **(CAL)**, **[CORRECTION ON]**, then specify the previous cal set. Note that the sweep frequencies are changed back to those which apply to the specific cal set. This feature makes it convenient to calibrate several different frequency ranges, then when measuring the device, change frequency ranges by simply selecting a different cal set.

After calibration in the Ramp, Step, or Single Point sweep modes the number of points can be reduced, but not increased. Thus, after calibration using 401 points, either 401, 201, 101, or 51 points can be selected. If a number of points greater than the original calibration is selected, a caution message is displayed and correction is turned off. When fewer points are selected, the instrument skips alternate frequency points. For example, when the number of points is reduced from 201 to 101, every other point is measured.

Step 5. Save Instrument State

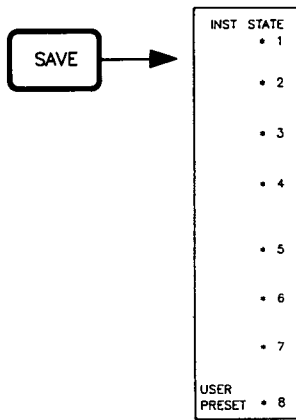

Press **(SAVE)**, then select one of the eight instrument state registers to save the current instrument state. All control settings, including the P/F/R limited instrument state for each channel, are saved. Please note that the contents of the cal set are not saved, only the reference to any cal sets that are turned on.

Press **RECALL**, then select one of the eight instrument state registers to recall a previously saved instrument state. If the recalled instrument state was saved with cal sets turned on, then the HP 8510 will turn on the cal sets so that corrected measurements are displayed. Remember that instrument state 8 is recalled when power is turned On, or when **(USER PRESET)** is pressed, allowing you to define the power-up state.

Step 6. Measure Device Under Test

After the test setup is calibrated, connect the device under test and make your measurements. Chapters 2 and 3 give examples of various reflection and transmission measurements.

Step 7. Read Measured Value

Use the measurement markers to read the trace value at any point on the trace.

The measurement markers are controlled using the **(MARKER)** key, the Marker menu structure, and the knob or numeric entries. Pressing **(MARKER)** turns on one of the markers (actually the last selected marker or, after Preset, Marker 1) and also displays the Marker menu.

When you press **(PRIOR MENU)**, the Marker menu is replaced by the Marker Values List, which displays the values of all On markers in the units of the current format. Use the knob or entry keys to control the marker position. To return to the Marker menu, press **(PRIOR MENU)** or the **(MARKER)** key.

Note that the Marker menu has softkeys for each of the five measurement markers. The current active marker number is underlined. When you turn on another marker, it becomes the active marker, the previous marker inverts but does not disappear from the screen. To clear the markers from the trace, press **[ALL OFF]**.

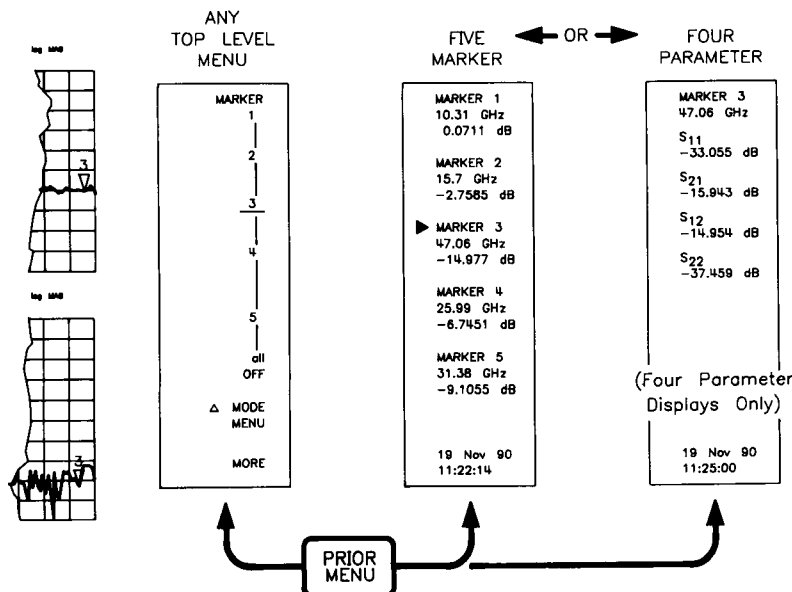

The five marker list can be selected for any display mode. The four parameter marker list can only be selected with a four parameter display.

Step 8. Output Measurement Results

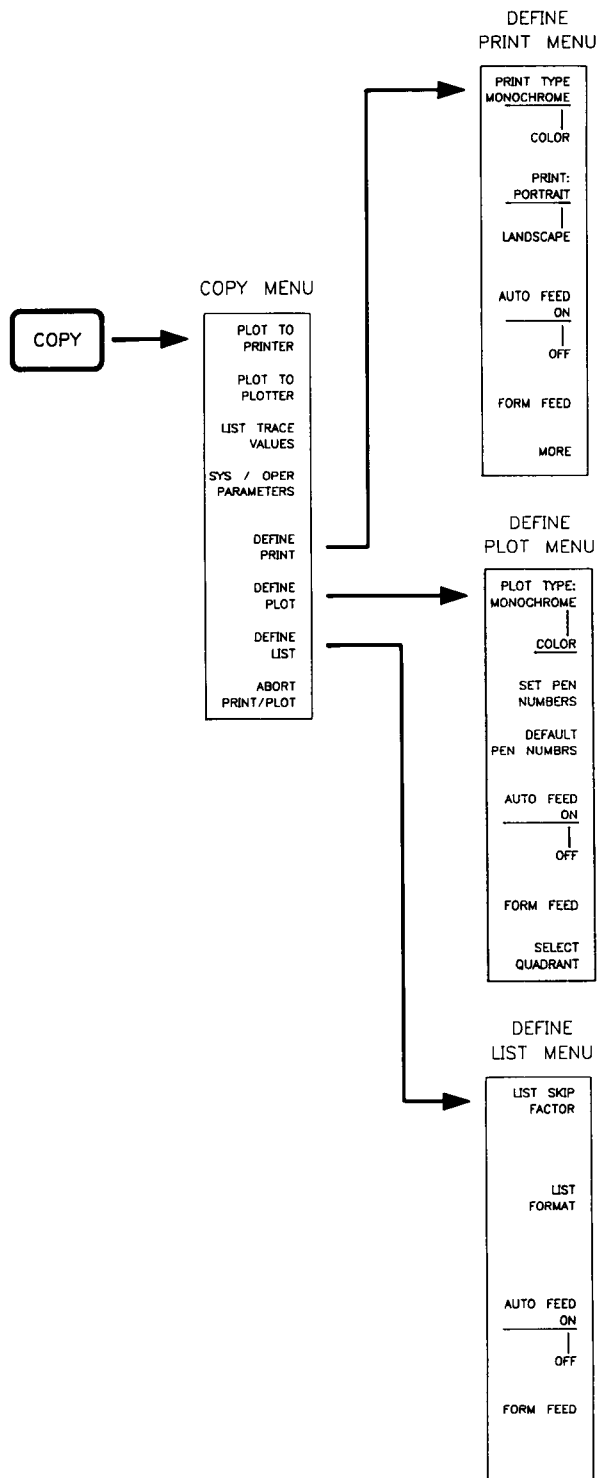

Measurement results can be output to a graphics printer, digital plotter, or a line printer using selections in the **(COPY)** menu structure. The HP 8510C adds two RS-232 ports for connection of hardcopy output devices. Moving the output devices from the 8510 system bus to the RS-232 ports may improve measurement throughput because since the RS-232 ports are fully buffered, the measurement can continue while the plot is being produced.

Use the **(DISC)** menus to store the actual measured data to the front panel disk or to a disk-type mass storage unit on the 8510 system bus.

Select Graphics or List. The selections allow choice of plots to a graphics printer or to a digital plotter, or output a tabular list of trace values to a line printer. Pressing **[PLOT TO PRINTER]**, **[PLOT TO PLOTTER]**, or **[LIST TRACE VALUES]** outputs the current measurement data to the selected device according to the output definition. The system and operating parameters are lists describing the current measurement configuration.

Define the Output. **(USER PRESET)** restores the standard plot and list definitions. In general, this means that a full-size plot or complete list of data will be output. The Define Plot menu allows selection of the parts of the CRT display that will be plotted. Use the Define Print menu to specify details about how the plot should appear on a graphics plotter.

For lists, the skip factor is used to specify the actual number of data points to be listed, and other keys are used to specify other details of the frequency and data presentation. The results are listed in units of the current format, the same as the marker.

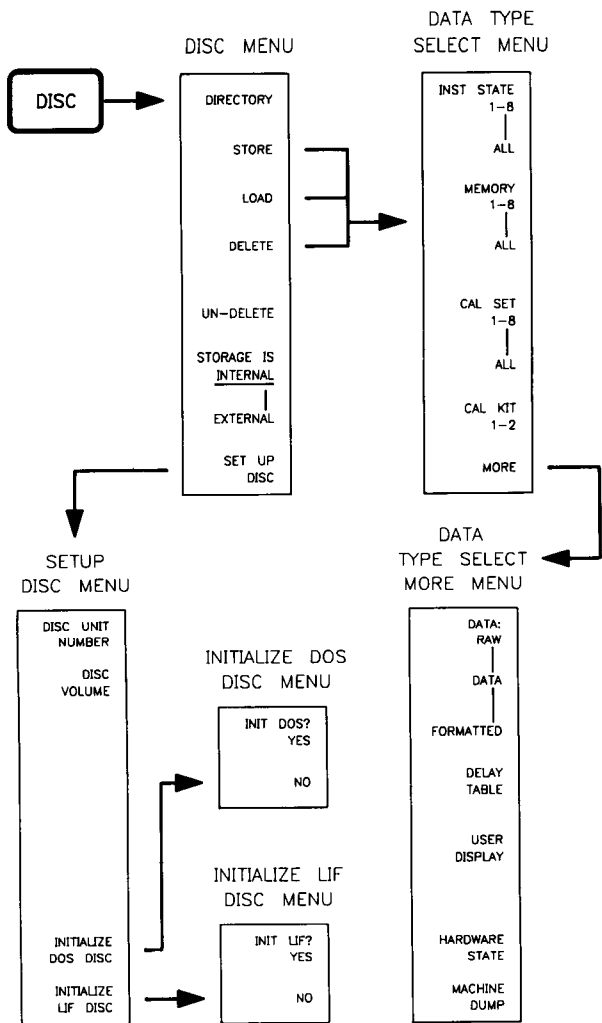

Store to Disc. **[DISC]** is used to select data output to or retrieval from a disc mass storage device. Press **[DISC]**, then **[STORAGE IS INTERNAL]** to select the front panel disc drive, or **[STORAGE IS EXTERNAL]** to select a disc drive on the HP 8510 System Bus.

To initialize the disc, press **[SET UP DISC]** then choose either **[INITIALIZE DOS DISC]** or **[INITIALIZE LIF DISC]**. The term DOS refers to the Disc Operating System format used by most personal computers using the MS-DOS® operating system. The HP 8510 can only initialize using DOS format on the Internal disc drive. The term LIF refers to the Logical Interchange Format which is the standard disc format used by HP Series 200/300 computers. After making this selection, press either **[INIT DOS? YES]** or **[INIT LIF? YES]** to start the disc initialization process.

The HP 8510 can store files to and load files from any standard DOS or LIF format disc on either the internal or external drive. To determine whether the HP 8510 can use a disc not initialized by the HP 8510, install the disc in the internal or external drive, select **[STORAGE IS INTERNAL]** or **[STORAGE IS EXTERNAL]**, then press **[DIRECTORY]**. A complete directory will appear.

Press **[STORE]** and specify the type of file to be recorded, then enter the file name and store the file. To load previously recorded data from storage into HP 8510 memory, press **[LOAD]** then specify the file type and file name.

Measurement results are stored in the CITIFile format which allows easy transfer to data processing applications. These files consist of ASCII characters defining the frequency range and the data at each measurement frequency. If 2-Port correction is On, data for all four basic parameters are saved. This CITIFile format is described in other documents supplied with the HP 8510.

Create a Frequency Subset

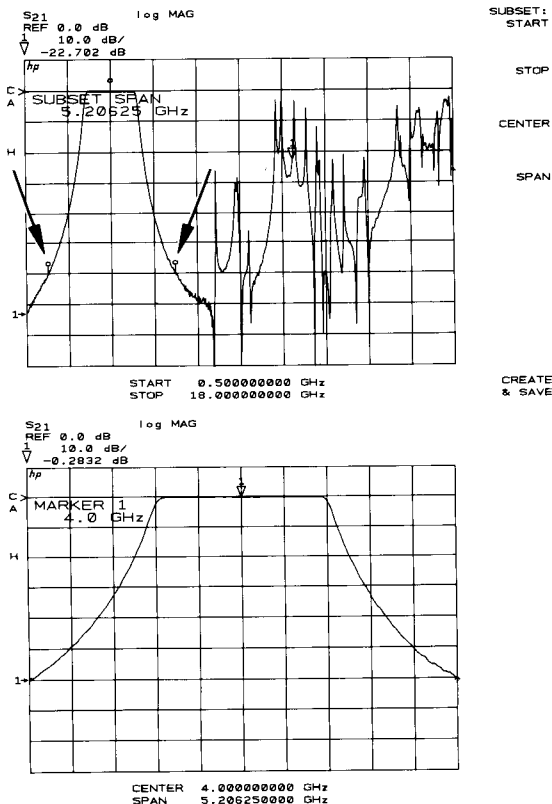

The HP 8510 allows you to measure a subset of the current frequency range without recalibration. After calibration, new Start/Stop or Center/Span frequencies can be stored in a different cal set.

With correction On, perform this sequence.

- [MORE]**
- [MODIFY CAL SET],**
- [FREQUENCY SUBSET]**
- Position markers using
- [SUBSET: START] [STOP]**
- [CENTER: SPAN]**
- [CREATE & SAVE]**
- [CAL SET n] (1-8)** (cal set for subset)

As shown here, markers appear on the trace to show you the current center and endpoints of the frequency subset. Position these markers by pressing **[SUBSET: START]**, **[STOP]**, **[CENTER]**, or **[SPAN]** softkeys then using the knob, STEP keys, or numeric entry.

When the markers are positioned correctly, press **[CREATE & SAVE]**, then select a cal set. A frequency list is created, error coefficients for all frequency points in the selected range are transferred to the new cal set, and corrected data for the subset is displayed. To measure the original range, recall the original cal set.

Chapter 2

Reflection Measurements

Overview

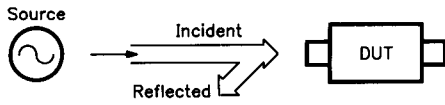

The next three chapters of this User's Guide demonstrate the many kinds of network measurements that can be made with the HP 8510. For each example a complete measurement setup is given, following the same general measurement sequence described in Chapter 1. The examples used represent typical network measurements using an S-parameter test set. The DUT used in most of these examples is a bandpass filter but you can use any device. For simplicity while learning the instrument, connect 7 mm adapters to your device and consider the adapters as part of the device.

The following paragraphs describe reflection measurements of Return Loss, SWR, Reflection Coefficient, and Impedance.

General Setup

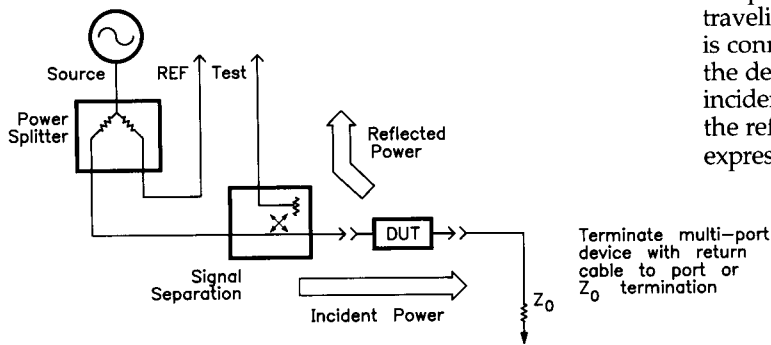

Reflection measurements require a directional device, such as a directional coupler or directional bridge, in the measurement setup. This signal separator provides a sample of the power traveling in one direction only. For reflection measurements it is connected as shown here allowing the power reflected from the device to be separated and measured independently of the incident power. The ratio of these two signals, the incident and the reflected, is the reflection coefficient of the DUT, or, when expressed in decibels, the Return Loss.

Multi-Port Devices

Reflection measurements determine how much energy is reflected from the device input port. When the device has more than one port, care must be taken to terminate the unused port(s) in the system characteristic impedance. If this is not done, reflections from the unused ports may appear at the test port causing measurement errors. With the S-parameter test set, measurement port 2 provides this termination.

In any case, the signal reflected from the device is most often measured as a ratio with the incident signal and can be expressed as return loss or reflection coefficient. These measurements are mathematically expressed as:

$$\begin{aligned} \text{reflection coefficient} &= \text{reflected/incident} \\ &= \Gamma = \rho \angle \phi^\circ \end{aligned}$$

(linear magnitude ratio and angle)

$$\text{Return Loss} = 20 \log \rho$$

$$\text{SWR} = (1 + \rho)/(1 - \rho)$$

Thus, the reflection coefficient consists of a linear magnitude ratio and the angle of the reflected signal, Return Loss is the difference in dB between the reflected and the incident signal, and SWR is a computed value.

Setup Stimulus (START) (STOP) and [NUMBER of POINTS] as required

Parameter (S11)

Format (LOG MAG)

Response as required

Calibrate (CAL)
[CAL 1]
[CALIBRATE: RESPONSE]
Connect Short at Port 1.
[SHORT]
[DONE RESPONSE]
[CAL SET 1]

Measure Connect test device
Select Format
(AUTO)
(MARKER), then position measurement marker to read measured value.

Measuring Return Loss

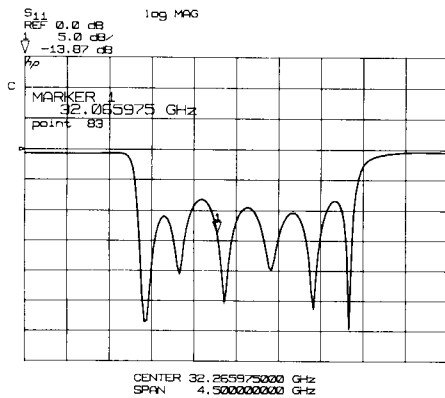

This figure shows the return loss of a filter in the LOG MAG format. A typical filter has a poor match (near 0 dB) outside the passband and a good match (large numerical) inside the passband. A large numerical value for return loss, for example -40 dB, corresponds to a small reflected signal (the reflected signal is 40 dB below the incident signal) just as a large value for insertion loss corresponds to a small transmitted signal.

Measuring Reflection Coefficient Magnitude

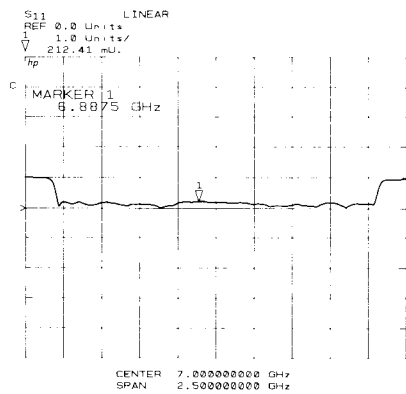

This figure shows the reflected signal viewed using the [LINEAR MAGNITUDE] cartesian format. In this format a reflection coefficient of 1.00 means that 100 percent of the signal is reflected. Inside the passband a value of 0.7 means that 70 percent of the signal is reflected.

Measuring SWR

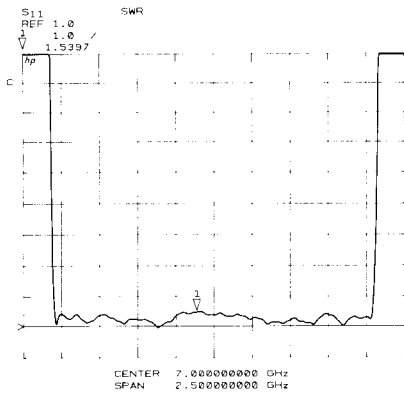

This figure shows the reflection measurement in terms of standing wave ratio, a unitless ratio of reflected to incident signal. SWR equal to one means that none of the incident signal is reflected.

Measuring S-Parameters

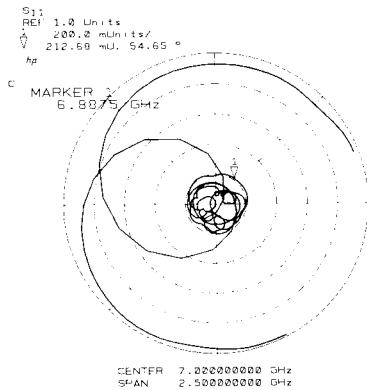

The S-parameters are measured in exactly the same way as described above. An S-parameter is always a complex coefficient consisting of a linear magnitude ratio and a phase angle, defined with the DUT embedded in a known characteristic impedance, usually 50 ohms. These figures show the reflection measurement viewed using the **[LIN mkr on POLAR]** format. The marker reads out the S-parameter directly.

The center of the circle represents a reflection coefficient magnitude of zero, no reflected signal, meaning that the device input exhibits a perfect match and all energy is transferred into the device. The outermost circle represents unity reflection, meaning that all incident energy is reflected. The radial lines show phase angle with the 3 o'clock position corresponding to 0 degrees, that is the reflected signal has the exact same phase angle as the incident signal.

Measuring Impedance

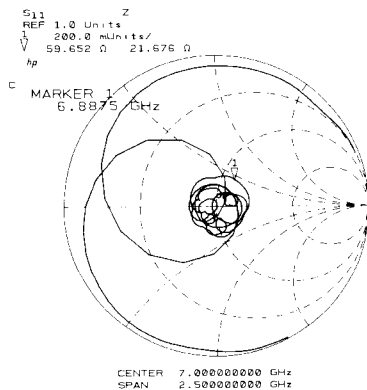

The amount of power reflected from a device is directly related to the difference in impedance of the device under test and the impedance of the port which delivers the incident energy. In fact, each value of the reflection coefficient uniquely defines a device impedance; $\Gamma = 0$ only occurs when the device and the test set impedance are exactly the same. The ideal short circuit has a reflection coefficient of $1 \angle \pm 180^\circ$. Every other value for Γ also corresponds uniquely to a complex device impedance according to the equation:

$$Z_n = (1 + \Gamma) / (1 - \Gamma)$$

where Z_n is the device impedance normalized to (i.e. divided by) the measuring system characteristic impedance. After Preset, the system characteristic impedance, Z_0 , is set to 50 ohms. Thus, the center of the Smith chart is 50 ohms. When you select **(SMITH CHART)**, the current system Z_0 , the **[SET Z_0]** function in the Cal menu, is the center of the chart and the marker reads the impedance data in $R \pm jX$ format where R is the resistive component of the impedance and jX is the reactive component of the impedance.

This display shows the complex impedance of the DUT. Select **(MARKER)**, then use the knob to read the complex impedance at any point on the trace. Note that the marker annotation tells that the complex impedance is capacitive in the bottom half of the chart and inductive in the top half of the chart.

Chapter 3 Transmission Measurements

Overview

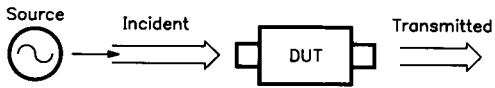

The reflection measurements discussed in Chapter 2 are only part of the network measurements picture. Measuring the transmission insertion loss and phase characteristics completes the device characterization, and provides a basis for computing parameters such as electrical length and group delay.

The following paragraphs describe transmission measurements of insertion loss, insertion phase, electrical length, and group delay.

General Setup

Insertion Loss and Gain are ratios of the output signal to the input signal. When set up as shown below, the results can be read directly in decibels.

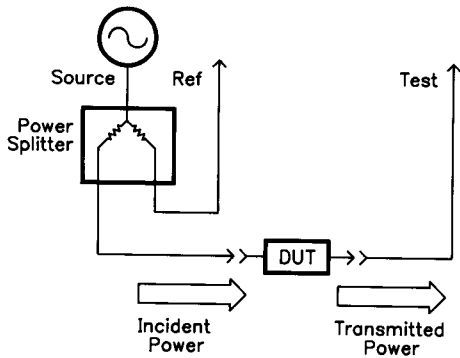

Setup

Stimulus **START** **STOP** and **[NUMBER of POINTS]** as required

Parameter **S21**

Format **LOG MAG**

Response **REF POSN**, **10**, **x1**

Calibrate

CAL

[CAL 1]

[CALIBRATE: RESPONSE]

Connect Thru

[THRU]

[DONE RESPONSE]

[CAL SET 2]

Connect test device

Select Format

AUTO

MARKER, then position measurement marker to read measured value.

Measure

Measuring Insertion Loss and Gain

Calibration for insertion loss and gain sets the magnitude ratio to zero dB at all frequency points with the thru connection. After connecting the test device, a negative measured value indicates loss; a positive measured value indicates gain. This figure shows the insertion loss of a bandpass filter.

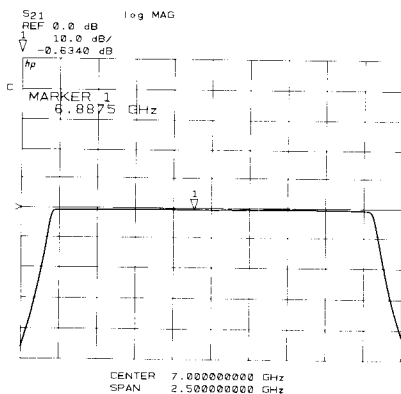

3 dB Bandwidth

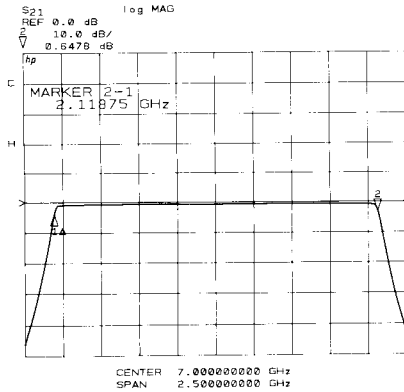

The marker search functions can be used to read the 3 dB bandwidth as follows:

```

STIMULUS (MENU) [MORE] [HOLD]
(MARKER)
[MARKER 1] [MORE] [MARKER to MAXIMUM]
(PRIOR MENU)
[MARKER 2] [MORE] [MARKER to MAXIMUM]
(PRIOR MENU)
[Δ MODE MENU] [Δ REF = 1]
[MORE]
[TARGET VALUE] (-3) (x1)
[MARKER to TARGET]
(PRIOR MENU)
[MARKER 1] [MORE] [SEARCH LEFT]
(PRIOR MENU)
[MARKER 2]
    
```

The markers are now at the -3 dB frequencies and the 3 dB bandwidth is displayed in the active function area.

Out-of-Band Rejection

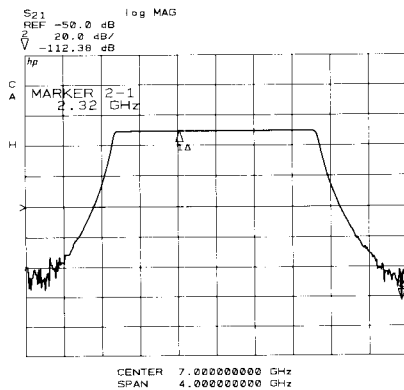

The wide dynamic range of the HP 8510 allows it to measure stopband rejection over 100 dB below the passband response. Maximum dynamic range requires proper selection of input power level.

```

(MARKER)
[MARKER 1] [MORE] [MARKER to MAXIMUM],
(PRIOR MENU)
[Δ MODE MENU] [Δ REF = 1],
[MARKER 2] [MORE] [MARKER to MINIMUM].
    
```

The marker automatically moves to the minimum point on the trace. The marker value shows the difference between the markers.

Passband Flatness

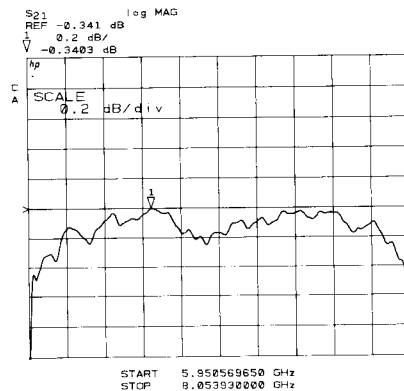

To measure passband flatness at high resolution, select:

```

(MARKER) [MORE] [MARKER to MAXIMUM]
(REF POSN) (5) (x1)
(REF VALUE) (= MARKER)
(SCALE) (0.01) (x1)
    
```

The trace is moved to the center graticule then the scale/division is set to view the passband flatness at high resolution.

Measuring Insertion Phase

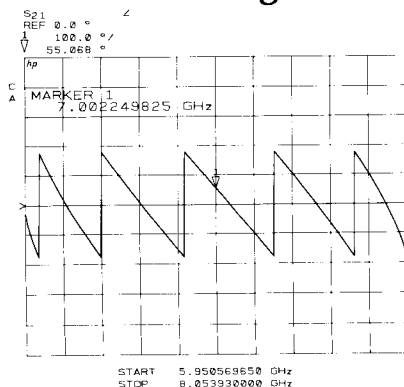

The measurement can also provide information about the phase shift, or insertion phase, of a network.

Since measurement calibration for any parameter applies to all format selections for that parameter, unless the frequency range is changed, this measurement can be made using the previous calibration.

Calibration for insertion phase sets the phase to zero degrees at all frequency points with the thru connection. After connecting the test device, select (PHASE) to display the relative phase shift between the output signal and the input signal.

This figure shows the insertion phase of a bandpass filter. The HP 8510 phase measurement range is -180 degrees to +180 degrees, and the vertical trace represents the transition between these values. Thus, the trace between any two of these transition lines represents 360 degrees of phase shift.

Measuring Electrical Length

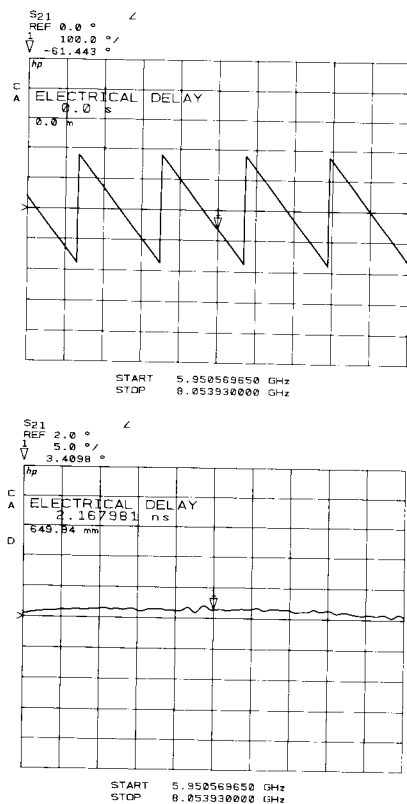

The HP 8510 electronically implements a function similar to the mechanical "line stretcher" of earlier analyzers. This feature simulates a variable length lossless transmission line, which is effectively added to or removed from the reference signal path to compensate for electrical length in the test signal path.

As shown in this example of measurements on a length of coaxial cable, this feature can be used to easily determine the electrical length of the test device. After measurement calibration, insert the test device, a cable in this example, and select **PHASE**.

Place the marker at an appropriate point on the trace (usually the center of the frequency span). Press **RESPONSE** (**MENU**), then **AUTO DELAY**. The HP 8510 automatically adds the electrical delay necessary to flatten the phase response at the marker position. Press **ELECTRICAL DELAY**, then use the knob or numeric entry to add or subtract electrical delay with the objective of flattening the trace to zero degrees over the frequency range of interest. When the phase trace is flat, the active function shows the electrical length of the test device relative to the speed of light in free space.

Thus, the physical length of the device is related to this value by the propagation velocity in the medium of the device.

Measuring Phase Distortion

For many networks, the amount of insertion phase is not nearly as important as the deviation from ideal phase shift over a frequency range of special interest, such as the pass-band of a filter. The HP 8510 measures the phase response and can express it in two different ways: directly, as deviation from ideal phase, or as group delay, a derived value.

Deviation from Ideal Phase. For coaxial devices, insertion phase consists of two components, linear phase, which is characteristic of coaxial media, and non-linear phase shift which can cause unwanted distortion. For waveguide components, insertion phase consists of the characteristic dispersion of the waveguide media and the non-ideal phase shift which can cause unwanted distortion. Deviation from ideal phase is a measure of the non-characteristic phase shift included in the insertion phase. By compensating for the ideal insertion phase, the deviation from ideal phase over the frequency sweep can be measured directly.

Compared to group delay, deviation from ideal phase is a fundamental measurement because group delay is the derivative of phase change with frequency. Also, greater phase sensitivity allows a greater dynamic range than group delay measurements, and deviation from ideal phase will produce greater detail in areas where the phase response changes rapidly over a small frequency range.

This figure shows how introducing linear insertion phase using coaxial electrical delay allows determination of non-linear insertion phase. You may change the scale/division to view the phase response at very high resolution. Note that if you are testing waveguide devices, select RESPONSE (MENU), [MORE], [WAVEGUIDE DELAY], enter the cutoff frequency of the particular waveguide media under test, then press [ELECTRICAL DELAY].

This measurement shows the phase response of a coaxial filter between the 3 dB points. Even if the network must be specified in terms of group delay, the deviation from ideal phase measurement serves as a good check of the actual phase response. Using the dual channel capability, press (DISPLAY), [DISPLAY MODE], [DUAL CHAN SPLIT], then compare deviation from linear phase with the group delay measurement described next.

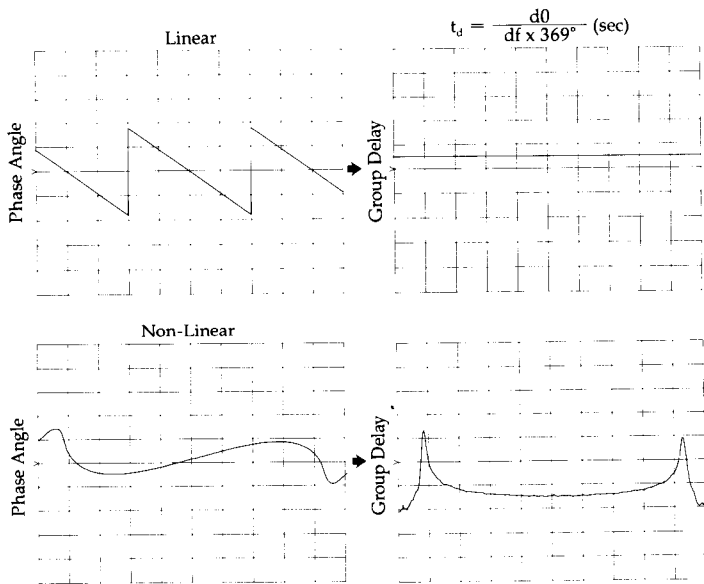
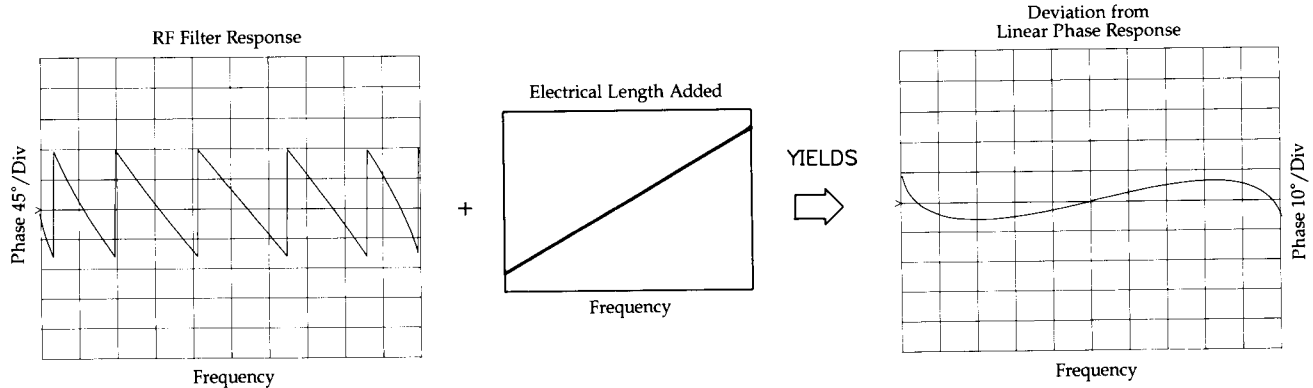

Group Delay. The phase linearity of many devices is specified in terms of group or envelope delay. This is especially true of telecommunications components and systems. After calibration, select (DELAY) to view the group delay of the DUT.

A coaxial device with no phase distortion presents a linear phase characteristic. The group delay will thus appear as a flat line. This figure shows that the group delay varies as a function of frequency when the test device exhibits deviation from linear phase.

Thus, group delay is the transit time through the DUT as a function of frequency. Mathematically it is the derivative of the phase response with respect to frequency, where $\Delta\phi$ is the difference in phase at two frequencies separated by Δf . The quantity Δf is commonly called the "aperture" of the measurement.

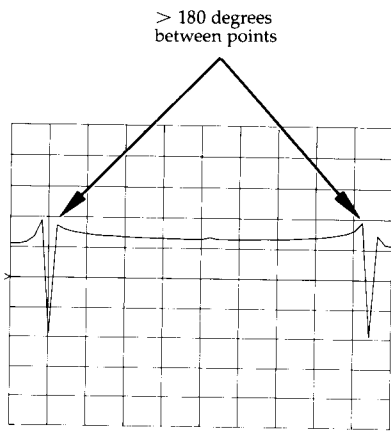

Group Delay Aperture. The minimum aperture is the frequency step between the phase measurements. You must choose this aperture when you set the frequency range and number of points so that there is no more than 180 degrees of phase shift between any of the frequency points. If there is more than 180 degrees of phase shift, the group delay trace will show a sudden discontinuity.

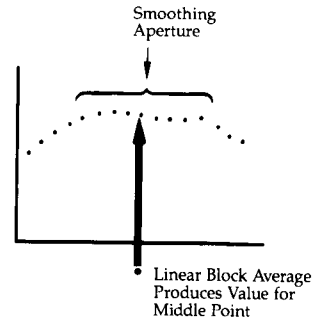

End Points Duplicated As Necessary

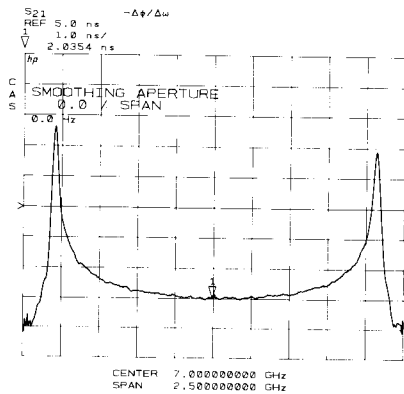

After selecting the minimum aperture, you may increase the effective aperture of the measurement using the smoothing function. Press RESPONSE (MENU), then [SMOOTHING ON]. Use the knob or numeric entry to set the effective aperture. Note that increasing the aperture smooths the group delay trace, removing fine grain variations from the response. This is why, when comparing group delay measurements, the aperture must be specified.

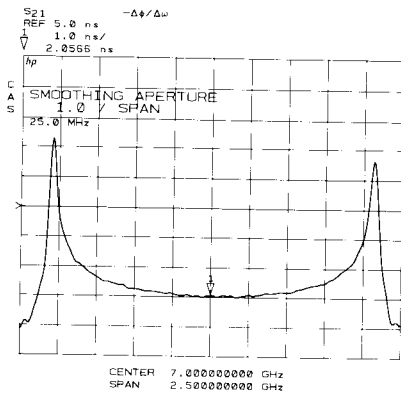

Chapter 4

Time Domain Measurements

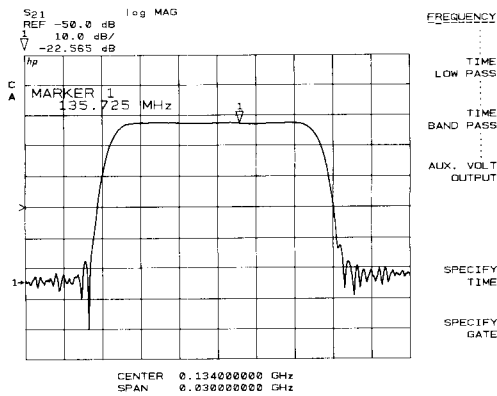

$$\Downarrow \mathcal{F}^{-1}$$

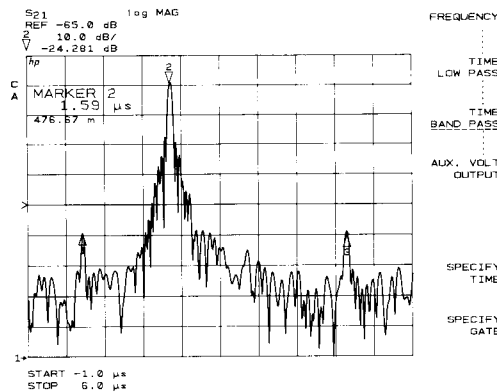

The HP 8510 with optional Time Domain analysis capability can display the time domain response of the DUT. Time domain analysis is useful for isolating a problem in the DUT in time or in distance. Time and distance are related by the speed of light and the relative velocity of propagation in the medium of the DUT. By setting the actual velocity of propagation using the [VELOCITY FACTOR] function on the (CAL) menu, the conversion to distance is displayed. The HP 8510 measures the transmission or reflection frequency domain response of the DUT and uses an inverse Fourier transform to convert the data to the time domain.

To begin familiarizing yourself with the time domain controls, press (DOMAIN) and look at the Domain menu. Notice that [FREQUENCY] is underlined. All previous measurements have used the Frequency domain. The two keys of interest here are

[TIME LOW PASS]
[TIME BAND PASS]

that select two different time domain modes. There are several considerations for use of each mode, but the simple guideline is to use TIME LOW PASS for devices which have adequate low frequency responses (or at least down to about 100 MHz), or use TIME BAND PASS for devices which are band limited. For example, when measuring a coaxial cable, the Low Pass mode is probably the best choice. When measuring a filter, the Band Pass mode is probably better. If you use Time Low Pass for a device which does not have sufficient low end frequency response, the time domain measurement will be very noisy and it will be necessary to use averaging.

Since the frequency domain data is used to develop the time domain response, the first step is to perform an appropriate measurement calibration.

As examples, we first use time domain analysis to locate and analyze points of reflection at connectors and bends along a coaxial transmission line, comparing responses in both the Band Pass and the Low Pass modes. Then (using the Band Pass mode) separate the individual main, leakage, and triple travel transmission paths through a surface acoustic wave (SAW) filter. This example also shows the Time Domain Gate capability. The HP 8510 time domain lets you perform "what if" analysis by mathematically removing selected reflections and seeing the effect back in the frequency domain.

Reflection Measurements

The time domain response of a reflection measurement is often compared with the familiar time domain reflectometry (TDR) measurements. Like the TDR measurement, it measures the size of the reflections versus time (or distance). Unlike the classical TDR, the HP 8510 time domain capability allows you to choose the frequency range over which you would like to make the measurement. In this example, we measure over the full range of the example test set, 45 MHz to 50 GHz, comparing the responses.

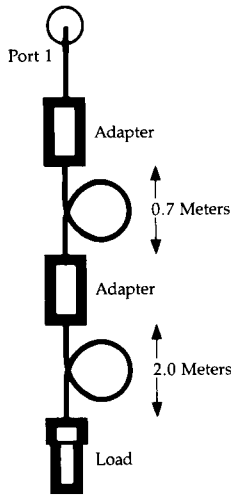

The test device is a pair of test cables shown in the figure, connected by one or two adapters to make things interesting. Terminate the end of the cable with a fixed load. Proceed as follows to measure this device.

Setup

Domain **[FREQUENCY]**
 Stimulus **(START)/(STOP)** and **[NUMBER of POINTS]** as required
 Parameter **(S11)**
 Format **(LOG MAG)**
 Response as required

Calibrate

(CAL)
[CAL 1]
[SET FREQ. (LOW PASS)]
[CALIBRATE: RESPONSE]
 Connect Short at Port 1.
[SHORT]
[DONE RESPONSE],
[CAL SET 1].

Notice that when you pressed SET FREQ. (LOW PASS) the frequency range may have changed. This is done because we will show both the Low Pass and the Band Pass responses, although it is not required when viewing only the Band Pass response. The frequency range is automatically set to meet the harmonic frequency step requirements of the Low Pass mode.

Measure

Domain **(DOMAIN)**
[TIME BAND PASS]
 Marker **(MARKER) [MORE]**
[MARKER to MAXIMUM]

After calibration, with the short circuit still connected, view the Time Band Pass response. Measurement calibration with a short circuit sets the reference plane to a reflection coefficient of 1 and ± 180 degrees at zero seconds. If the short circuit is not offset (like the 7 mm short) the time domain response should show a response of 1.00 at zero seconds. The Band Pass trace shows the response of the device as if it had been stimulated by an impulse of RF energy with bandwidth of the frequency span. Since the short circuit reflects totally, the response shows the shape of the stimulus impulse.

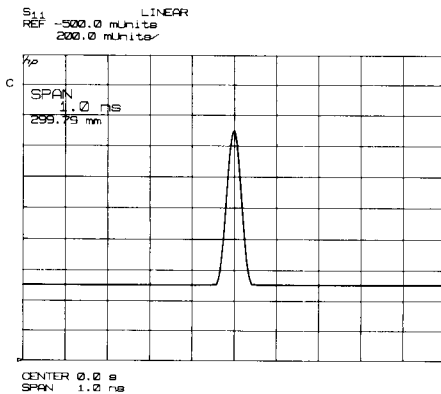

Domain **(DOMAIN)**
[TIME LOW PASS]
[SET FREQ. (LOW PASS)]
[SPECIFY TIME]
[IMPULSE]

This is the Time Low Pass Impulse response of the short circuit. Here, the trace also shows the effect of stimulating the device with a broadband impulse of microwave energy. The trace goes negative because the short circuit inverts the phase of the pulse. As you remove the short circuit, notice that the impulse becomes positive because the open circuit does not invert the phase of the impulse. With the short removed, select **[TIME BAND PASS]** and notice that the impulse is approximately the same whether a short or an open is connected.

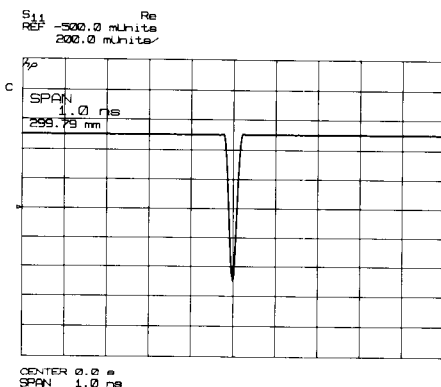

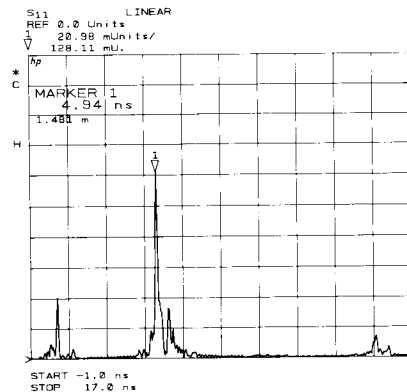
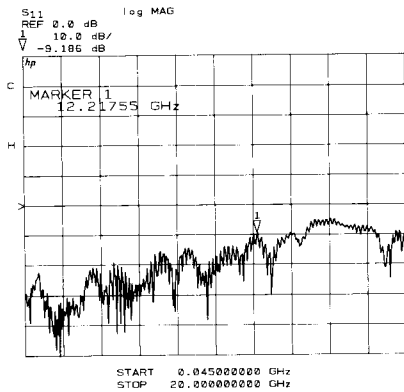

Transmission Measurements

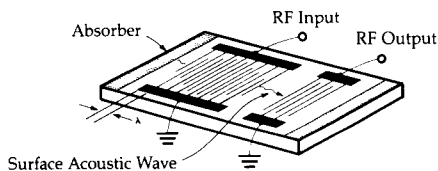

Setup

Stimulus (START)/(STOP) and [NUMBER of POINTS] as required
 Parameter (S21)
 Format (LOG MAG)
 Response

Calibrate

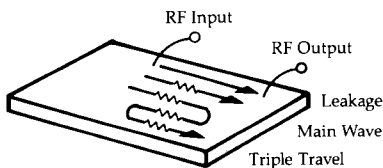

Measure

(CAL)
 [CAL 1]
 [CALIBRATE: RESPONSE]
 Connect Thru
 (connect Port 1 and Port 2 together)
 [THRU]
 [DONE RESPONSE]
 [CAL SET 1]

(DOMAIN)
 [TIME BAND PASS]

Now connect the cables. These figures show the frequency domain response and the time domain response of the cables under test. The complex ripple pattern in the frequency domain is caused by reflections from the adapters interacting with each other. By transforming this data to the time domain, you can determine the magnitude of each reflection versus distance along the cable.

As an experiment, loosen the adapters connecting the two cables and observe the responses. You can change the start and stop time using the STIMULUS (START) and (STOP) controls to zoom in on the response of interest, and you can select any FORMAT, although the [LINEAR MAGNITUDE] and the [LOG MAG] formats are most useful.

A good rule of thumb is that the energy travels about 1 foot per nanosecond, or about 0.3 meter per nanosecond, in free space. Most coaxial cables have a relative velocity of about 2/3 the propagation velocity in free space, about 10 nanoseconds per meter. Since you are measuring the round trip distance, from the test port to the reflection and back to the test port, you will see the response at double the actual distance from the port to the reflection. Thus, to view an entire cable of about 1 meter in length, enter a stop time of about 40 nanoseconds.

(START) (4) (G/n)

To adjust the distance readout of the marker, press:

(CAL) [MORE] [PORT EXTENSIONS]
 [VELOCITY FACTOR] (0.666) (x1)
 (MARKER)

With the velocity factor equal to 1, the distance display shows the equivalent electrical length of the signal path relative to the speed of light in free space. Changing the function to 0.666 sets the time to distance conversion to 2/3 of the speed of light in free space, thereby adjusting the marker distance readout.

In this example, we will measure the transmission response of a SAW filter. We will use the Time Band Pass mode, not because it is simpler, but because the DUT is band limited.

Measurement calibration with a thru sets the reference plane, the point connecting Port 1 and Port 2, to a transmission coefficient of 1 and 0 degrees at zero seconds. The time domain response should show a response magnitude of 1.00 at zero seconds.

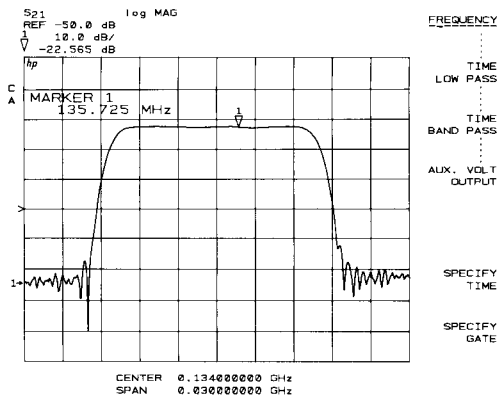

Now connect the SAW filter. These figures show the frequency domain response and the time domain response of this device. Note the three components of the transmission time domain response: RF leakage, at near zero time, the main travel path through the device (about 1.6 microseconds), and the "triple travel" path (about 4.5 microseconds travel time). Each of these signal paths is shown in the measurement.

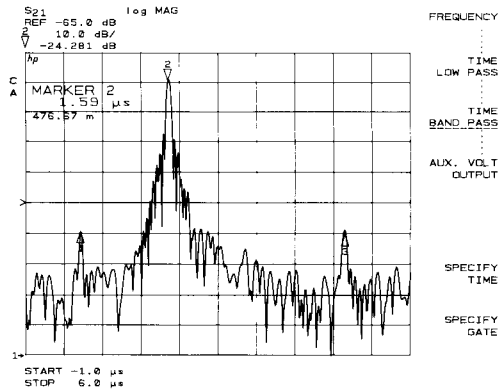

Time Domain Gating

Time domain analysis also lets you remove individual parts of the time domain response to see the effect of potential design changes. We do this by mathematically "gating" out the undesired responses. In this example we see the effect of removing the leakage and triple travel responses using the gating feature. Press

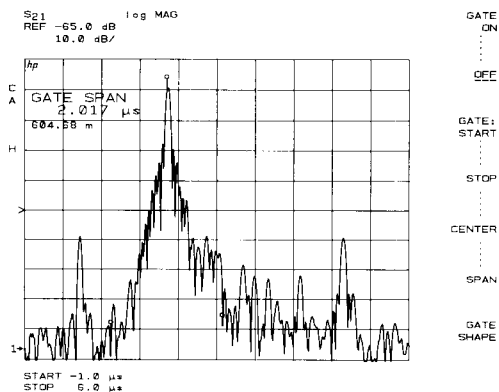

DOMAIN

[SPECIFY GATE]

[GATE CENTER]

Use the knob to center the gate on the main path response.

[GATE SPAN]

Use the knob to adjust the gate span to enclose the main path response.

[GATE ON]

Only the responses inside the gate are retained. You have selected the center time and span time of a signal processing algorithm that works like a temporal (time) bandpass filter. Return to the frequency domain and see that this change yields better out-of-band rejection for this device.

Please refer to the Time Domain Measurements section of the HP 8510 Operating and Programming manual for a complete description of all of the time domain operating modes and features.

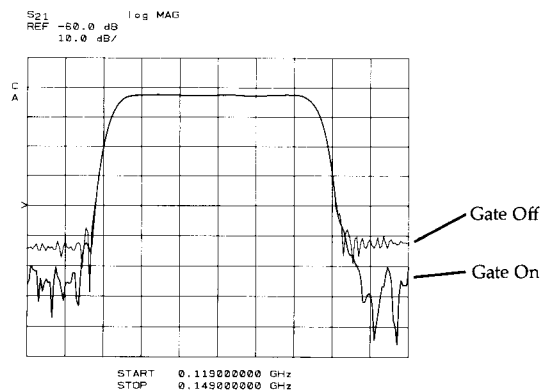

Chapter 5

Measurement Enhancements

Single Channel and Dual Channel Measurements

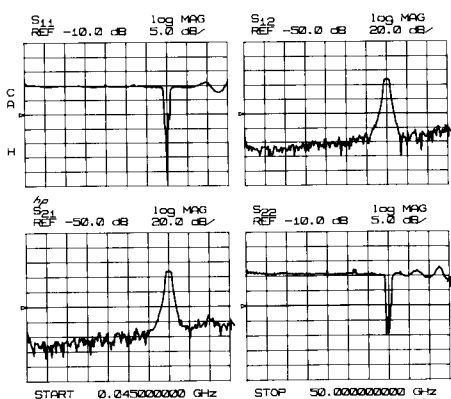

In the split display, the parameters are plotted in the same relative position as the PARAMETER keys. To change the FORMAT and RESPONSE settings for an individual parameter, first press a PARAMETER key, then change the FORMAT and/or RESPONSE settings.

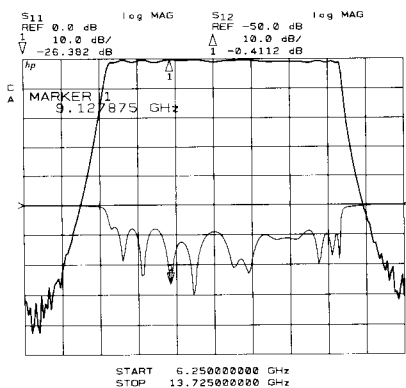

The HP 8510 network analyzer provides many features that add to convenience and accuracy. These paragraphs describe the single and dual channel display modes. The versatility of the single and dual channel modes of the HP 8510C gives the user many choices for the display of the measured data.

The HP 8510 uses two identical, independent measurement channels to acquire and display data. The instrument can operate in either a single channel or a dual channel data acquisition and display mode.

Single Channel, Single Parameter. In the Single Channel mode, either a single parameter or all four of the basic S-parameters can be selected for display. Preset selects the single channel, single parameter display.

Single Channel, Four Parameter. To choose the four parameter display, press

DISPLAY
[DISPLAY MODE]
[FOUR PARAM OVERLAY] or
[FOUR PARAM SPLIT]

Now all four of the basic parameters, S_{11} , S_{21} , S_{12} , and S_{22} of the current channel are displayed. Averaging Factor and Electrical Delay type (Coaxial, Waveguide, or Table) will be the same for all parameters (always coupled to channel); all other Response functions (Electrical Delay, and trace slope and offsets) are part of the P/F/R memory and apply only to the current selected parameter on the current channel. The data acquisition process continues and the traces are updated as the data becomes available.

Notice that the DOMAIN is the same for all displayed parameters (also always coupled to channel). Press **DOMAIN**, **[TIME BAND PASS]**, then switch between Channel 1 and Channel 2.

Press **MARKER**, then select a marker. Using the Four Parameter display, the value of the current selected marker for each of the S-parameters appears in the marker value display area.

Dual Channel. The HP 8510 Dual Channel mode allows display of one parameter from each measurement channel. Press:

DISPLAY
[DISPLAY MODE]
[DUAL CHAN OVERLAY] or
[DUAL CHAN SPLIT]

Notice that the Channel Identification annotations for both Channel 1 and Channel 2 are displayed. To make changes in the control settings for a channel, first select the channel by pressing either **CHANNEL 1** or **CHANNEL 2**, then make the change. For example, select the same parameter on both channels, then select the Frequency Domain for Channel 1 and the Time Domain for Channel 2.

Coupled and Uncoupled Channels

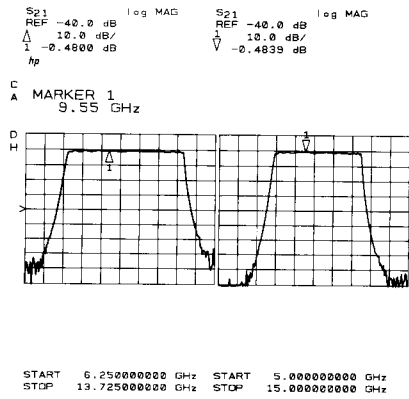

In the Dual Channel displays, as you make changes to the instrument state, notice that some settings are Coupled, meaning that the setting always applies to both channels, and others are Uncoupled, meaning that the setting applies only to the current selected channel. An example of the a function that is always coupled is Number of Points, on the Stimulus menu. An example of a function that is always uncoupled is Averaging, on the Response menu.

There is a subset of the Stimulus functions which may be uncoupled by selecting STIMULUS **(MENU)** **[MORE]** **[UNCOUPLED CHANNELS]**.

Now the stimulus values are listed individually for each channel. Select **(CHANNEL 1)** or **(CHANNEL 2)** then select a function and change its value. For example change the Start and the Stop frequency on one channel to achieve an alternate sweep of the two frequency ranges.

Factory Preset Instrument State

Selected Channel = 1, no menu displayed
SAVE/RECALL Instrument States 1 through 8 not changed
Correction Off, Cal Sets not changed

Stimulus

Maximum sweep range of source and test set
NUMBER OF POINTS = 201
Source power = depends upon source
Test set attenuation = 0 dB
SWEEP TIME = 100 ms
RAMP SWEEP, CONTINUAL
Flatness Off
Coupled Channels

Parameter

Channel 1 = S_{11}
Channel 2 = S_{21}

Format

Channel 1 = LOG MAG
Channel 2 = LOG MAG

Response

SCALE = 10 dB/division
REF VALUE = 0 dB
REF POSN = 5
COAXIAL DELAY
ELECTRICAL DELAY = 0 seconds
AVERAGING = OFF
SMOOTHING = OFF
PHASE OFFSET = 0 degrees
MAGNITUDE OFFSET = 0 dB
MAGNITUDE SLOPE = 0 dB/GHz

Cal

CORRECTION OFF
 $Z_0 = 50$ ohms
PORT EXTENSIONS 1 and 2 = 0s
TRIM SWEEP = 0
CAL SETS 1 through 8 = not changed
VELOCITY FACTOR = 1

Domain

FREQUENCY DOMAIN
GATE OFF

Display

SINGLE CHANNEL, SINGLE PARAMETER, DATA
Trace Memories 1 through 8 not changed
MKR List On
LIMITS OFF

Marker

all OFF
 Δ OFF

System

HP-IB addresses not changed
CRT ON
IF GAIN = AUTO

Copy

PLOT ALL = FULL PAGE
LIST ALL POINTS

Disc

STORAGE is INTERNAL
SAVE USING BINARY
FORMAT is LIF

Pulse and Waveguide Systems

After Factory Preset, you should Recall a correct instrument state, or manually set these functions:

Sweep Mode = STEP

SET $Z_0 = 1$

WAVEGUIDE DELAY

WAVEGUIDE CUTOFF = Depends upon band

SOURCE #1 POWER = Depends upon band

SOURCE #2 POWER = Depends upon band

MULTIPLE SOURCE = ON

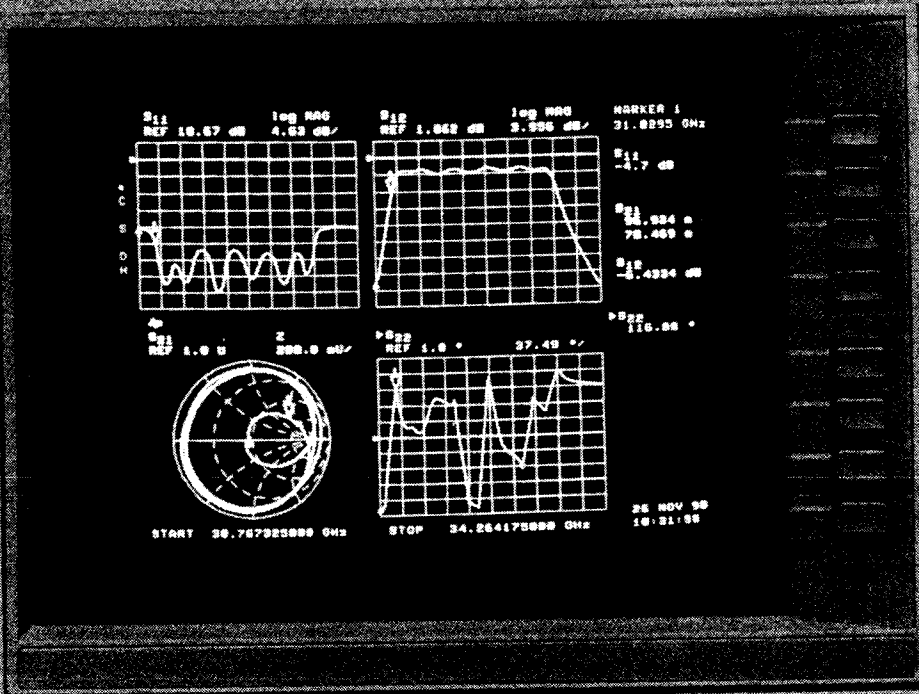
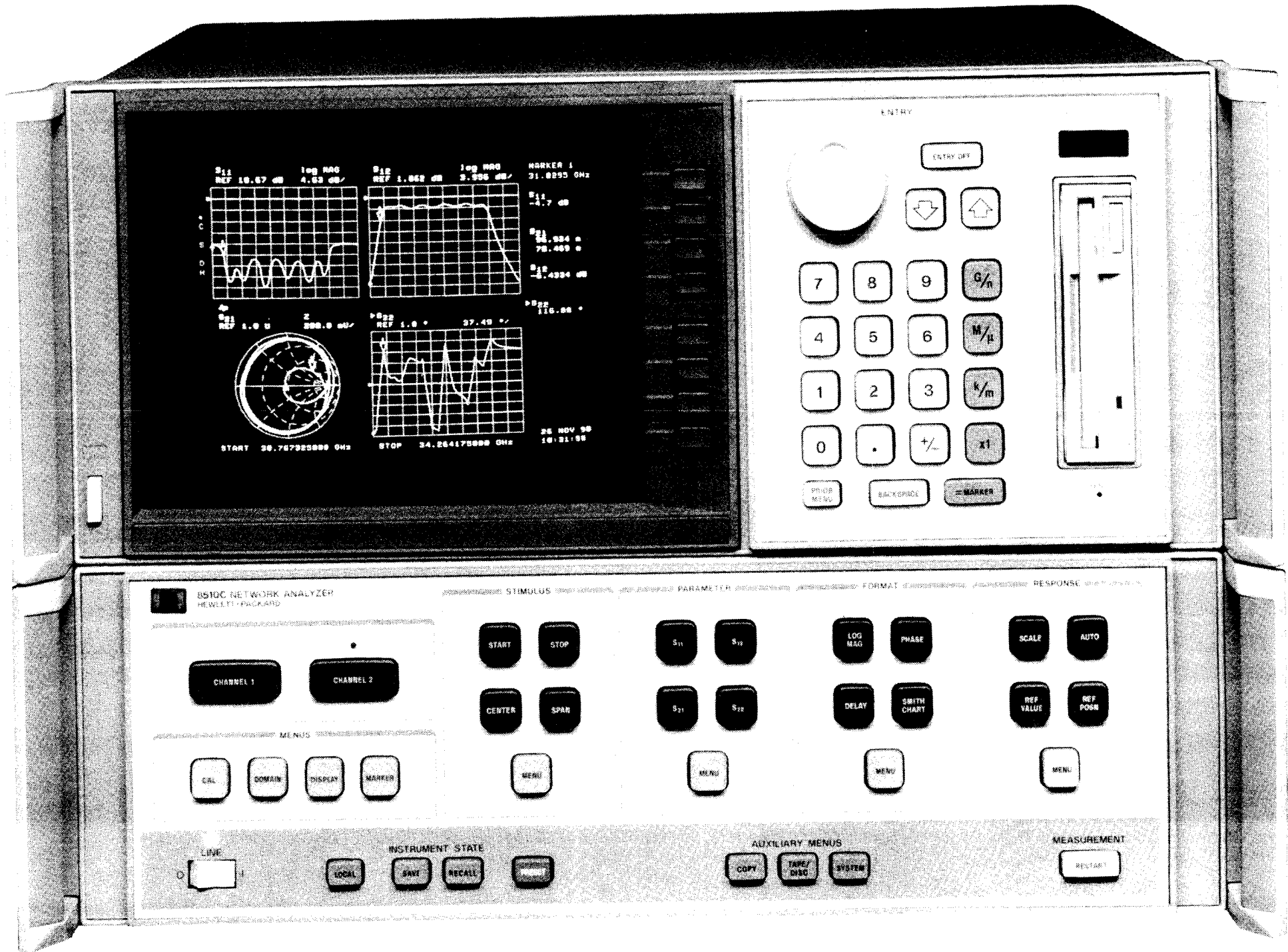

ENTRY

ENTRY OFF

7 8 9 %/h

4 5 6 M/u

1 2 3 k/m

0 . +/- x1

PH-OB MESS BACKSPACE MARKER

8510C NETWORK ANALYZER HEWLETT-PACKARD

STIMULUS PARAMETER FORMAT RESPONSE

CHANNEL 1 CHANNEL 2

START STOP S11 S22 LOG MAG PHASE SCALE AUTO

CENTER SPAN S21 S22 DELAY SMITH CHART REF VALUE REF POSN

MENUS

CAL DOMAIN DISPLAY MARKER MENU MENU MENU MENU

LIVE INSTRUMENT STATE AUXILIARY MENU MEASUREMENT

LOCAL SAVE RECALL COPY TAPE/DISC SYSTEM RESTART

By internet, phone, or fax, get assistance with all your test and measurement needs.

Table 1-1 Contacting Agilent

Online assistance: www.agilent.com/find/assist

United States
(tel) 1 800 452 4844

Latin America
(tel) (305) 269 7500
(fax) (305) 269 7599

Canada
(tel) 1 877 894 4414
(fax) (905) 282-6495

Europe
(tel) (+31) 20 547 2323
(fax) (+31) 20 547 2390

New Zealand
(tel) 0 800 738 378
(fax) (+64) 4 495 8950

Japan
(tel) (+81) 426 56 7832
(fax) (+81) 426 56 7840

Australia
(tel) 1 800 629 485
(fax) (+61) 3 9210 5947

Asia Call Center Numbers

Country	Phone Number	Fax Number
Singapore	1-800-375-8100	(65) 836-0252
Malaysia	1-800-828-848	1-800-801664
Philippines	(632) 8426802 1-800-16510170 (PLDT Subscriber Only)	(632) 8426809 1-800-16510288 (PLDT Subscriber Only)
Thailand	(088) 226-008 (outside Bangkok) (662) 661-3999 (within Bangkok)	(66) 1-661-3714
Hong Kong	800-930-871	(852) 2506 9233
Taiwan	0800-047-866	(886) 2 25456723
People's Republic of China	800-810-0189 (preferred) 10800-650-0021	10800-650-0121
India	1-600-11-2929	000-800-650-1101