

HEWLETT-PACKARD

**HP 8561A and HP 8562A/B Spectrum Analyzer
Quick Reference Guide**

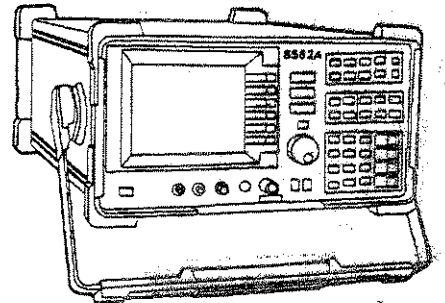

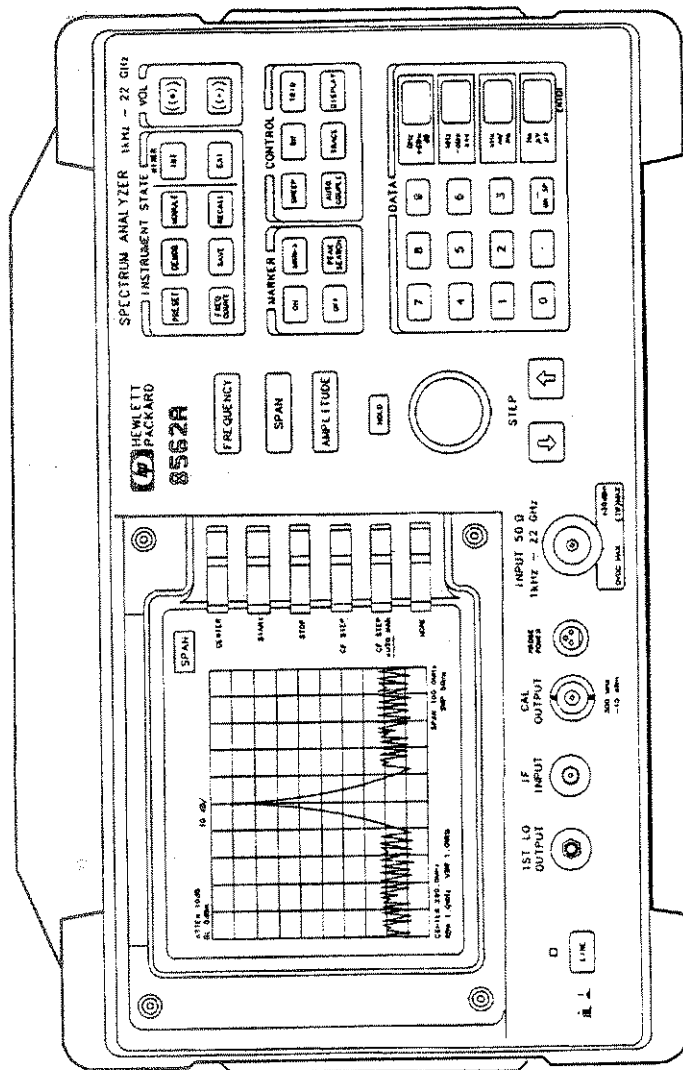

**HP 8561A and HP 8562A/B Spectrum Analyzer
Quick Reference Guide**



Manual Part Number: 08562-90089
Microfiche Part Number: 08562-90090
Printed in the USA August 1989

Copyright © 1989 by Hewlett-Packard Company
1212 Valley House Drive, Rohnert Park, CA 94928-4999

Introduction

This guide provides a quick reference for experienced spectrum analyzer users.

The HP 8560A/8561B Quick Reference Guide is a convenient reference for both manual and automated measurements. Chapter 1 gives an overview of front-panel keys and connectors, rear-panel connectors, and display annotation. Chapter 2 leads you through a simple procedure that demonstrates some general-purpose measurement techniques. Chapters 3 and 4 document softkey functions and HP-IB commands. The appendixes list error messages and cross references to front-panel functions and programming commands. Menu trees and simplified block diagrams can be found at the end of the guide.

For additional instrument information, consult the *HP 8560A/8561B Operating and Programming Manual*, the *HP 8560A Installation and Verification Manual*, or the *HP 8561B Installation and Verification Manual*.

Contents

1. Manual Operation	
Input and Output Connectors	1-2
Front Panel	1-2
Rear Panel	1-4
Screen Annotations	1-6
Making a First Measurement	1-8
Calibration Routines	1-13
Analyzer Functions	1-15
2. Programming	
Notation Conventions	2-2
Syntax Conventions	2-3
Command Summary	2-5
Amplitude Control	2-5
Bandwidth Control	2-5
Coupling Control	2-5
Demodulation	2-6
Display Control	2-6
External Mixing	2-6
Frequency Control	2-7
Information and Service Diagnostics	2-7
Instrument State Control	2-7
Marker Control	2-8
Plotter Output	2-8
Preselector Control	2-9
Printer Output	2-9
Service Request	2-9
Sweep and Trigger Control	2-10
Synchronization	2-10
Trace Functions	2-10

Processing	2-10
Math	2-10
Other	2-11
Operator Entry	2-11
Output Format Control	2-11
Programming Codes	2-12
Secondary Key Word Summary	2-35

- A. Locating a Softkey
- B. Programming Command to Key
- C. Key to Programming Command
- D. HP-IB Errors
- E. Softkey Menus

Index

Figures

1-1. HP 8562A Front Panel	1-2
1-2. Display Annotation	1-6
1-3. Center Frequency Set to 300 MHz	1-9
1-4. Frequency Span Reduced to 20 MHz	1-10
1-5. Signal Peak Set to Reference Level	1-11
1-6. Activated Normal Marker	1-12
1-7. Frequency, Span, and Amplitude Set for Calibration	1-13
1-8. Signal Peak Calibrated to the Reference Level	1-14

Tables

1-1. Front-Panel Connector Data	1-4
1-2. Conversion-Loss Flatness Data	1-18
1-3. External Frequency Bands and Recommended Harmonics	1-21
2-1. Status Byte Definition	2-9
A-1. Softkey Locations	A-1
B-1. Programming Command to Key	B-1
C-1. Key to Programming Command	C-1
D-1. Error Codes	D-1

Manual Operation

This chapter contains a brief explanation of some of the operating features of the HP 8561A and HP 8562A/B Spectrum Analyzers. For more information, refer to the *HP 8561A and HP 8562A/B Operation and Programming Manual*.

Input and Output Connectors	1-2
Front Panel	1-2
Rear Panel	1-4
Screen Annotations	1-6
Making a First Measurement	1-8
Calibration Routines	1-13
Analyzer Functions	1-15

Caution  The maximum RF INPUT level is +30 dBm with a minimum of 10 dB input attenuation. Maximum dc voltage to the RF input is 0 V. Exceeding either of these levels can damage the input attenuator and the input mixer.

Caution  To prevent damage to the instrument, be sure to set the rear-panel voltage selector to the appropriate value for your local line-voltage output. For more information, refer to the *Installation and Verification Manual*. The LINE input operates at nominally 115 V (47—440 Hz) or at nominally 230 V (47—66 Hz).

Note  In this manual the frequency range of HP 8562A/B instruments is listed as 9 kHz to 22 GHz (Option 026: 26.5 GHz). However, the frequency range of HP 8562A/B instruments serial prefixed below 2929A is 1 kHz to 22 GHz.

Input and Output Connectors

Front Panel

Front panel connections provide an RF input, active-probe power, 300 MHz calibrator signal, 310.7 MHz IF input, and a first LO output. See Figure 1-1. These connections are described in the following text and in Table 1-1. The **LINE** key turns on the spectrum analyzer. The LED above the key indicates whether or not ac power is applied to the spectrum analyzer.

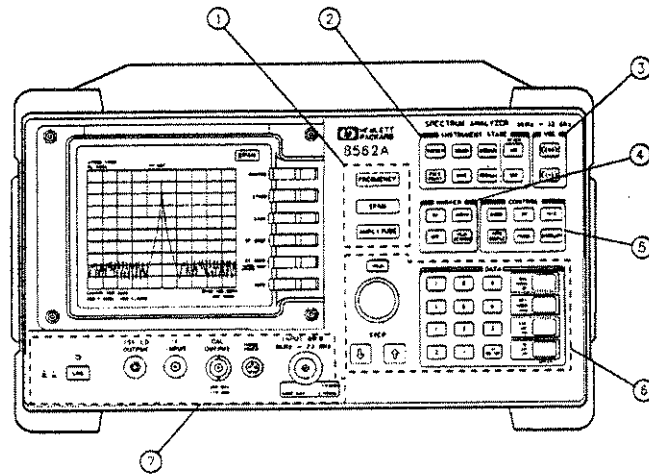

Figure 1-1. HP 8562A Front Panel

1. FREQUENCY, SPAN, and AMPLITUDE are the fundamental functions for most measurements.

1-2 Manual Operation

2. INSTRUMENT STATE functions generally affect the state of the entire spectrum analyzer, not just of a single function.
3. VOL functions control the volume of the speaker in the spectrum analyzer. **VOL** increases volume, **VOI** decreases it.
4. MARKER functions read out frequencies and amplitudes along the spectrum analyzer trace, allow you to make relative measurements, automatically locate the signal of highest amplitude on a trace, and tune the analyzer to track a signal automatically.
5. CONTROL functions allow you to adjust the resolution and video bandwidths, the sweep time, and the display, and to vary other functions that control spectrum analyzer measurement capabilities.
6. Data keys, step keys, and the knob allow you to change the numeric value of an active function. Use the data keys to enter an exact value or to move quickly from one end of the frequency range to the other. The step keys vary a value in predefined increments or, for some functions, in increments that you choose. The knob allows you to fine-tune most numeric values. The **HOLD** key freezes the active function and holds it at a set value until the function key is pressed again. **HOLD** also blanks the key menu.
7. The signal connections provide an RF input, active-probe power, a 300 MHz calibrator signal, a 310.7 MHz IF input, and a first LO output. These functions are described more fully in Table 1-1. The **LINE** button turns on the spectrum analyzer. The LED above indicates whether or not ac power is applied to the spectrum analyzer.

Table 1-1. Front-Panel Connector Data

Connector	Frequency Range	Amplitude/ Voltage Limits
INPUT 50Ω	HP 8561A: 1 kHz to 6.5 GHz HP 8562A/B: 9 kHz to 22 GHz (External mixers supported)	+10 dBm Max. 0 V dc Max.
PROBE POWER	— —	+15 V (150 mA max.) -12.6 V (150 mA max.)
CAL OUTPUT	300 MHz	-10 dBm
IF INPUT (for use with external mixers)	310.7 MHz	0 V dc max.
1ST LO OUTPUT	3.0 GHz to 6.81 GHz	+16.5 dBm ±2.0 dB

Rear Panel

- J1 provides a 4Ω impedance earphone jack.
- J2 is the Hewlett-Packard Interface Bus (IIP-IB) connector.
- J3 allows you to connect optional modules, such as the HP 85629B Test and Adjustment Module or the HP 85620A Mass Memory Module.
- J4 provides a detected video output that is proportional to the vertical deflection of the CRT trace. The output range is 0 V to 1 V when terminated in 50Ω, and can only be used in 10 dB/div mode.
- J5 provides an external trigger input. The input signal range is 0–5 V (TTL). When the trigger is in external mode, the instrument sweep triggers on the rising, positive edge of the signal (about 1.5 V).
- J6 provides a blanking output from 0–5 V (TTL) that is low (0 V) during spectrum analyzer sweeps. The output is used when operating the spectrum analyzer with a tracking generator such as an HP 85640A. The output is high (5 V) when the instrument is relocking between bands in multiband sweeps. Use this output for pen lift when plotting

1-4 Manual Operation

with nondigital plotters. This output is also useful for synchronizing instruments.

J8 provides a 0—10 V ramp corresponding to the sweep ramp that tunes the local oscillator or provides a sweeping dc output having the following value:

HP 8562A/B: 0.5 V/GHz from 0—22 GHz
HP 8562A/B (Option 026): 0.5 V/GHz from 0—26.5 GHz
HP 8561A: 0.5 V/GHz from 0—6.5 GHz

The output can be selected from the keys **0** → **10 V/LO SWP** and **5 V/GHz (FAV)**, respectively, which are under the **(SWEEP)** menu.

J9 provides a 10 MHz, 0 dBm minimum, time-base reference signal. This connector can be switched to an input, in order to connect an external reference. An external reference must be 10 MHz \pm 100 Hz at a nominal amplitude of 0 dBm (-2 to +10 dBm). To select the external reference mode, use the key **10 MHz EXT. INT** under the **(FREQUENCY)** menu.

X POSN, Y POSN, and TRACE ALIGN allow you to align the spectrum analyzer CRT using a special CRT pattern. Refer to **CRT ADJ PATTERN** in this chapter, or consult the *Installation and Verification Manual*.

Screen Annotations

Figure 1-2 illustrates the display annotation.

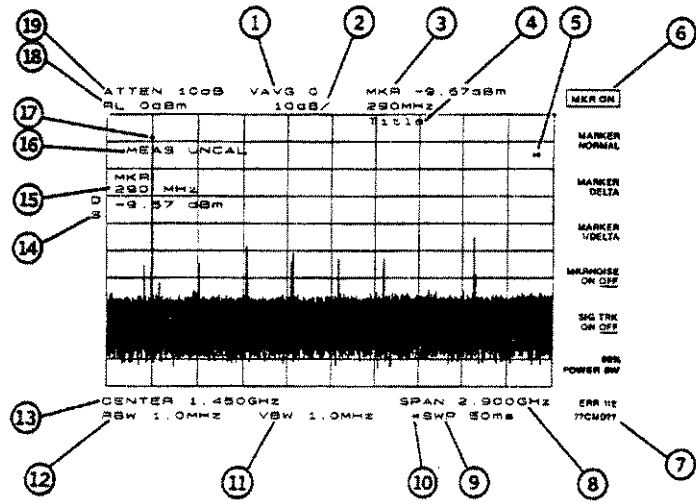

Figure 1-2. Display Annotation

1. Number of video averages.
2. Logarithmic or linear amplitude scale.
3. Marker amplitude and frequency.
4. Title area.
5. Data invalid indicator, displayed when analyzer settings are changed before completion of a sweep.

6. Menu title and key menu.
7. Error code.
8. Frequency span or stop frequency.
9. Sweep time.
10. Indicator of uncoupled function such as sweep time, resolution bandwidth, video bandwidth, or input attenuation.
11. Video bandwidth
12. Resolution bandwidth.
13. Center or start frequency.
14. Active special functions:

T = Trigger mode set to line, video, or external
D = Detector mode set to sample, negative peak, or positive peak
S = Single-sweep mode
F = Frequency Offset \neq 0 Hz
X = External Frequency Reference Active
R = Reference level offset \neq 0 dB
A = IF adjust turned OFF
K = Signal track is ON
M = Trace math is ON
+ = Positive External Mixer Bias On (>0 mA)
- = Negative External Mixer Bias On (<0 mA)

15. Active function area.
16. Measurement uncalibrated message.
17. Marker indicator.
18. Reference level.
19. Input attenuation or conversion loss.

Making a First Measurement

A basic measurement involves tuning the spectrum analyzer to place a signal on the screen, then measuring the frequency and amplitude of the signal with a marker.

You can measure an input signal in four simple steps.

1. Set the center frequency.
2. Set the frequency span.
3. Set the amplitude.
4. Activate the marker.

As an example, measure the 300 MHz calibration signal. First, power on the spectrum analyzer (for maximum accuracy, allow for a 5-minute warm-up). Next, connect the CAL OUT output to the INPUT 50 Ω connector and complete the four steps as described below.

1. Set the center frequency. Press **FREQUENCY**. This activates the center frequency function, indicated by **CENTER** appearing in the active function block on the left side of the display (see Figure 1-3). To set the center frequency to 300 MHz, use the keys in the data section of the front panel and press 300 **MHz**. These data keys allow you to select the exact numeric value of the active function, which in this case is the center frequency. The step keys and knob also allow you to select function values.

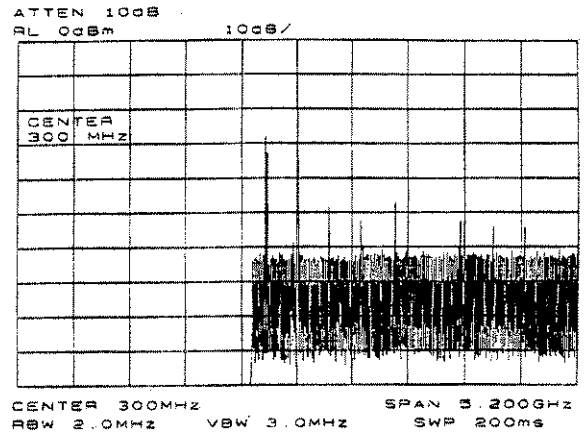

Figure 1-3. Center Frequency Set to 300 MHz

2. Set the frequency span. Press **SPAN**. Note that SPAN is now displayed in the active function block, identifying it as the current active function. To reduce the frequency span—for example, to 20 MHz—either key in 20 **MHz** or use the step down-arrow key to “step down” to this value. (Like data keys, step keys can also be used to change the numeric value of the active function.) The resulting display is shown in Figure 1-4. Note that the resolution and video bandwidths are coupled to the frequency span; they are automatically adjusted to appropriate values for a given span. Sweep time is also a coupled function.

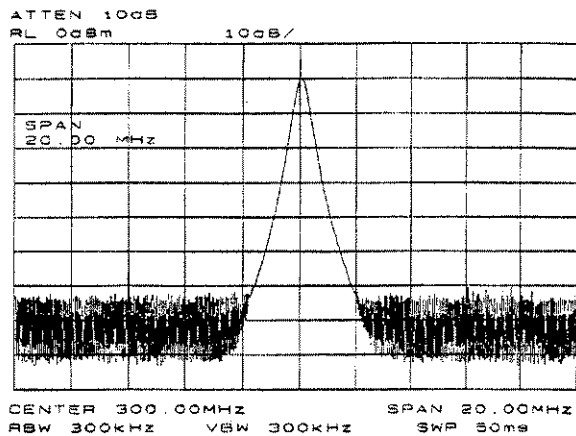

Figure 1-4. Frequency Span Reduced to 20 MHz

Note



The low band of the HP 8562A/B ranges from 9 kHz to 2.9 GHz. The upper band ranges from 2.75 GHz to 22 GHz. The frequency span cannot be set to overlap both bands at the same time in continuous sweep. For example, to sweep a range from 2.0 GHz to 3.5 GHz, use the low band to sweep from 2.0 GHz to 2.9 GHz and use the upper band to sweep from 2.75 GHz to 3.5 GHz. The frequency span can be set to overlap both bands in single sweep mode.

3. Set the amplitude. Generally, placing the signal peak at the reference level provides the best measurement accuracy. To adjust the signal peak to the reference level (Figure 1-5), press **AMPLITUDE**, then key in 10 **dBm**, or use either the step keys or the knob. Using the knob is the easiest way of fine-tuning the signal peak to the reference level, which is at the top of the screen.

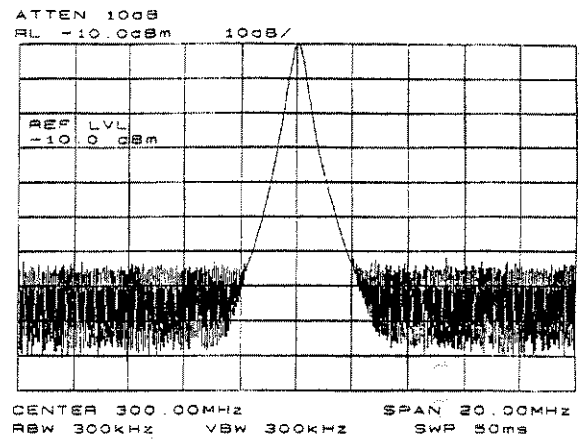

Figure 1-5. Signal Peak Set to Reference Level

4. Activate the marker. Press **ON** which is located in the MARKER section of the front panel. This places a marker at the center of the trace (in this case, at the peak of the signal) and completes the measurement. The marker reads both the frequency and the amplitude and displays these values in the active function block. In this case, the marker reads 300.00 MHz and -10.00 dBm, as shown in Figure 1-6.

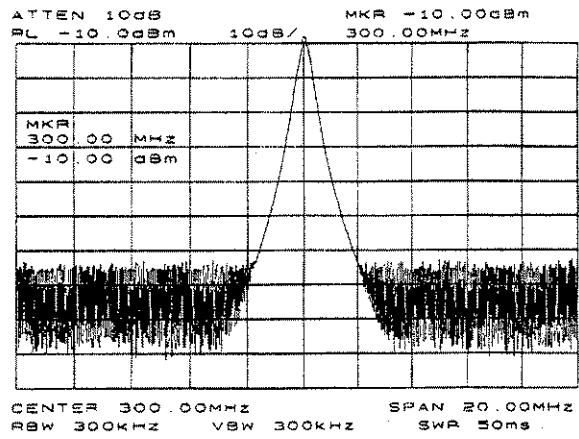

Figure 1-6. Activated Normal Marker

Many measurements require only these four steps. To return the instrument to its initial power-on state, press **PRESET**.

Calibration Routines

Note If the spectrum analyzer has just powered on, allow for a 5-minute warm-up before calibration.



The spectrum analyzer's reference-level-calibration function is stored under the key **REF LVL CAL** in the **AMPLITUDE** menu. To calibrate the instrument, perform the following steps.

1. Use a short BNC cable to connect the front panel's CAL OUT and INPUT 50Ω connectors.
2. Set the center frequency to 300 MHz, the span to 20 MHz, and the reference level to -10 dBm. See Figure 1-7.

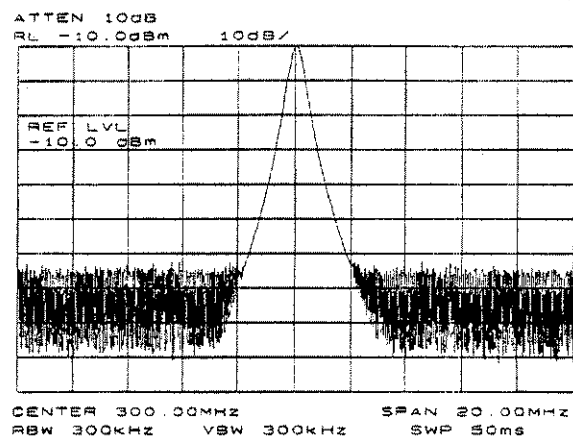

Figure 1-7. Frequency, Span, and Amplitude Set for Calibration

3. Press **AMPLITUDE**, **MORE**, and then **REF LVL CAL**.
4. Using the front-panel knob, adjust the peak of the signal to the reference level as shown in Figure 1-8. Note the number that appears in the active function block. This number, which ranges from -33 to 33, is a relative number indicating how much amplitude correction was required to calibrate the spectrum analyzer. The number is usually around 0.
5. To store the value, press **STORE REF LVL**.

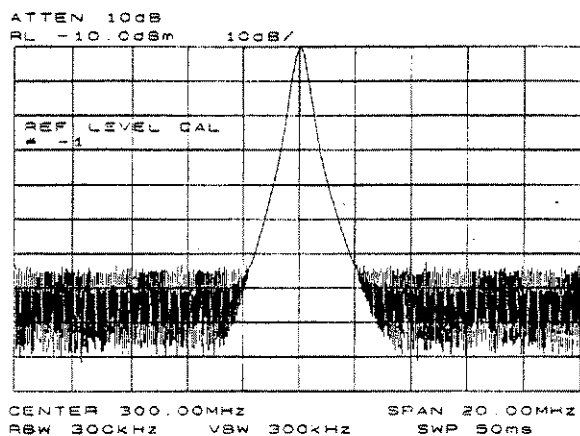

Figure 1-8. Signal Peak Calibrated to the Reference Level

Note



Recalibrating the reference level is usually necessary only when the ambient temperature changes more than 10 degrees Celsius. Because the HP 8561A and HP 8562A/B continually monitor and reduce any IF errors, executing the IF calibration is seldom necessary.

Analyzer Functions

This section lists the HP 8561A and 8562A/B front-panel functions in alphabetical order. Next to each key is a brief description of its operation. For detailed descriptions, refer to the *HP 8561A and HP 8562A/B Portable Spectrum Analyzers Operating and Programming Manual*.

0-10 VLO SWP

Selects as output for J8 (on the rear panel) the 0 to 10 V ramp corresponding to the sweep ramp that tunes the local oscillator.

0.5 V/GHZ (FAV)

Specifies a 0.5 V per GHz sweep output (the "frequency-analog voltage") at the rear-panel sweep output J8; primarily used with external tracking generators.

LO REF: EXT INT

Selects an external (EXT) or internal (INT) frequency reference. When external mode is selected an X appears on the left side of the display.

99% POWER BW

Integrates the power displayed and returns the bandwidth containing 99% of the total displayed power.

A+B→A

Adds the contents of trace A with those of trace B and places the result in trace A.

A-B→A ON OFF

When it is ON, this function continuously subtracts the contents of trace B from those of trace A, and places the result in trace A. An M appears on the left side of the display when this function is on.

A-B+DL→A ON OFF

When it is ON, this function subtracts the contents of trace B from those of trace A, adds the display line to the result, then places the result in trace A. An M appears on the left side of the display when this function is on.

ADJ STATE

Adjusts various parameters in the IF bandwidth currently in use, producing optimum amplitude accuracy.

A EXCH B	Exchanges the contents of trace A with those of trace B, then places traces A and B in view mode.
AGC ON OFF	Switches automatic gain control on or off and keeps the volume relatively constant during AM demodulation.
ALL	Couples all AUTO functions: resolution bandwidth, video bandwidth, sweep time, input attenuation, center frequency step-size, and amplitude units.
AM DEMOD ON OFF	Turns AM demodulation on and off.
DEMOD	Accesses functions for AM or FM demodulation.
AMPLITUDE	Activates the reference level function and accesses a menu of amplitude related functions.
AMPTD CORRECT	Accesses functions that set conversion loss and flatness data for external mixer measurements.
UNITS	Accesses a menu of amplitude units.
ANNOT ON OFF	Switches the display annotation on and off.
ATTEN	Activates the attenuation level.
ATTEN=AUTO=MAN	Adjusts the spectrum analyzer input attenuator, which is either coupled to the reference level (AUTO) or adjusted manually (MAN).
AUTO COUPLE	Accesses a menu of couple-mode functions.
AVERAGE CONV LOSS	Displays the mean conversion loss for the current harmonic and allows you to enter new conversion loss data. Any change to the average conversion loss also affects flatness data.
B-DL-B	Subtracts the display-line value from the contents of trace B, then places the result in trace B.
BACK SPACE	Deletes the last character placed in the current title.
BIAS	Displays a menu of functions for selecting external-mixer bias.

BIAS OFF

Turns external-mixer bias off.

BLANK A

Blanks the contents of trace A from the display.

BLANK B

Blanks the contents of trace B from the display.

BW

Activates the resolution bandwidth and accesses a menu of bandwidth related functions.

CENTER FREQ

Activates the center frequency function and sets the spectrum analyzer to center frequency/span mode.

CF STEP

Adjusts the center frequency step-size so that when a STEP key is pressed, the center frequency shifts by the selected step size.

CF STEP AUTO MAN

Adjusts the center frequency step-size so that when a STEP key is pressed, the center frequency shifts by the selected step size. This function may be coupled to the frequency span function (AUTO), or set manually (MAN).

CHAR SET 1 2

Accesses character sets used for creating titles.

CLR WRT A

Clears trace A and sets it to accept and display new input-signal data continuously.

CLR WRT B

Clears trace B and sets it to accept and display new input-signal data continuously.

CONV LOSS VS FREQ

Displays the conversion loss for a specific frequency in the current band. For use with external mixers; see Table 1-2.

Table 1-2. Conversion-Loss Flatness Data

Band	Frequency Range	Number of Flatness Points	Point Spacing	Conversion Loss
6 (K)	18.6 — 26.5 GHz	6	2 GHz	30 dB
7 (A)	26.5 — 40.0 GHz	8	2 GHz	30 dB
8 (Q)	33.0 — 50.0 GHz	7	3 GHz	30 dB
9 (U)	40.0 — 60.0 GHz	6	4 GHz	30 dB
10 (V)	50.0 — 75.0 GHz	6	5 GHz	30 dB
11 (E)	60.0 — 90.0 GHz	7	5 GHz	30 dB
12 (W)	75.5 — 110.0 GHz	8	5 GHz	30 dB
13 (F)	90.0 — 140.0 GHz	6	10 GHz	30 dB
14 (D)	110.0 — 170.0 GHz	7	10 GHz	30 dB
15 (G)	140.0 — 220.0 GHz	9	10 GHz	30 dB
16 (Y)	170.0 — 260.0 GHz	7	15 GHz	30 dB
17 (J)	220.0 — 325.0 GHz	8	15 GHz	30 dB

COLOR

Selects the HP PaintJet or similar color printer configuration for use with **COPY**.

COLOR PRINT

Prints entire contents of display (except menus and error codes) in color on an HP 3630A PaintJet printer.

CONT

Activates continuous-sweep mode.

COUNTER ON OFF

Switches the precision frequency counter ON and OFF (activating a marker if none is present), and displays counter results when the counter is on.

COUNTER RES

Adjusts the resolution of the frequency counter readout.

COUPLING AC DC

Selects ac or dc coupling to the input; ac coupling protects the input of the analyzer from damaging dc signals. When dc coupling is selected, a C appears on the left edge of the display. *HP 3561A only.*

CRT ADJ PATTERN

Displays an alignment pattern which is used in conjunction with X POSN, Y POSN, and TRACE ALIGN adjustments (located on the rear panel).

dBm	Selects absolute decibels relative to 1 milliwatt as the amplitude units.
dBmV	Selects absolute decibels relative to 1 millivolt as the amplitude units.
dBµV	Selects absolute decibels relative to 1 microvolt as the amplitude units.
DEMOD TIME	Selects the duration of demodulation between successive sweeps.
DETECTOR MODES	Accesses a menu of detector modes.
DETECTOR NEG PEAK	Selects negative-peak detection of the video signal and places a D on the left side of the display.
DETECTOR NORMAL	The normal-detector mode alternately displays positive and negative-peaks when the presence of noise is detected, and displays positive peaks otherwise.
DETECTOR POS PEAK	Selects positive-peak detection of the video signal and places a D on the left side of the display.
DETECTOR SAMPLE	Samples the video signal and places a D on the left side of the display.
DISPLAY	Accesses a menu of display-related functions.
DISPLAY LINE	Activates the display line. Adjust the display line using the data keys, step keys, or front-panel knob.
DSPL LIN ON OFF	Switches the display line on and off.
ELAPSED TIME	Displays the cumulative operating time of the spectrum analyzer.
ERASE TITLE	Erases the current title from the display.
EXT	Accesses a menu of external-mixer functions.
EXTERNAL	Sets the trigger to external mode; connect external trigger sources to J5 (EXT TRIG INPUT) on the rear panel. When this mode is selected a T appears on the left side of the display.

FACTORY PRSEL PK	Restores the factory preselector-peaking data as the current preselector data.
FFT	Performs a discrete Fourier transform on the input signal, converting zero-span information into the frequency domain.
FM DEMOD ON OFF	Switches FM demodulation ON and OFF.
FOCUS	Permits focusing of the display using the data keys, the step keys, or the knob.
FREE RUN	Sets the trigger to free-run mode; sweep triggers occur as rapidly as the spectrum analyzer will allow.
FREQ COUNT	Turns on the frequency counter (and a marker if none is present) and accesses a menu of counter and marker functions.
FREQ DIAGNOSE	Accesses a menu of diagnostic functions which allow various internal parameters to be retrieved.
FREQ DSP OFF	Turns off all frequency related annotation.
FREQ OFFSET	Adds an offset value to displayed frequency values, including marker frequency values. The range of the sweep (that is, the span) is not affected. When this function is active, an F appears on the left edge of the display.
FREQUENCY	Activates the center frequency (or the start frequency) and accesses a menu of frequency functions.
FULL BAND	Selects commonly-used frequency bands above 18 GHz and activates the harmonic-lock function. See Table 1-3.

Table 1-3.
External Frequency Bands and Recommended Harmonics

Band	Frequency Range	Mixing Harmonic	Conversion Loss
6 (K)	18.6 — 26.5 GHz	8— (External)	30 dB
7 (A)	26.5 — 40.0 GHz	8— (External)	30 dB
8 (Q)	33.0 — 50.0 GHz	10— (External)	30 dB
9 (U)	40.0 — 60.0 GHz	10— (External)	30 dB
10 (V)	50.0 — 75.0 GHz	14— (External)	30 dB
11 (E)	60.0 — 90.0 GHz	16— (External)	30 dB
12 (W)	75.5 — 110.0 GHz	18— (External)	30 dB
13 (F)	90.0 — 140.0 GHz	24— (External)	30 dB
14 (D)	110.0 — 170.0 GHz	30— (External)	30 dB
15 (G)	140.0 — 220.0 GHz	36— (External)	30 dB
16 (Y)	170.0 — 260.0 GHz	44— (External)	30 dB
17 (J)	220.0 — 325.0 GHz	54— (External)	30 dB

- FULL IF ADJ** Executes a complete adjustment of the IF system for optimum measurement accuracy.
- FULL SPAN** Sets the spectrum analyzer span to its maximum frequency range.
- GRAT ON OFF** Turns the display graticule ON and OFF.
- HOLD** Holds the active function to its present value, blanks the softkeys from the display, and expands the remaining display.
- HP-IB ADDRESS** Displays the current HP-IB address of the spectrum analyzer, which can be changed, entered, and then stored using **STORE HP-IB**.
- IF ADJUST** Activates the automatic IF adjustment. Various IF parameters are adjusted during retrace to ensure amplitude accuracy within specifications.

IF ADJ ON/OFF	Switches the automatic IF adjustment ON and OFF. When it is ON, various IF parameters are adjusted during retrace to ensure amplitude accuracy within specifications. If this function is turned off an A appears on the left side of the display.
INTEN	Permits changing the display intensity using the data keys, step keys, or the knob.
INT	Accesses a menu of signal-identification functions or returns the spectrum analyzer from external-mixer mode to its internal frequency coverage.
LAST SPAN	Sets the spectrum analyzer to the previously-selected span.
LAST STATE	Recalls the state that existed before preset was pressed or power was turned off.
LINE	Sets the trigger to line mode; sweep triggers occur at intervals synchronized to the line frequency. When this mode is selected a T appears on the left side of the display.
LINEAR	Selects the linear amplitude scale.
LOCK HARMONIC	Displays the number of the harmonic currently used to sweep the selected frequency band. Only frequencies and spans that fall within the frequency band of the current harmonic may be entered. See Table 1-3.
LOCK ON/OFF	Turns the harmonic lock on and off. When it is on, it performs the same function as LOCK HARMONIC .
LO FREQ	Displays the first local-oscillator frequency corresponding to the current start frequency.
LOG dB/DIV	Selects a 1, 2, 5, or 10 dB logarithmic amplitude scale.
MAIN ROLLER	Displays the main-roller-oscillator frequency corresponding to the current start frequency.

MARKER→CF	Sets the center frequency equal to the marker frequency.
MKRA→CF	Sets the center frequency equal to the delta frequency value.
MARKER→CF STEP	Sets the center frequency step-size equal to the marker frequency; the step keys change the center frequency in increments equal to the delta value.
MKRA→CF STEP	Sets the center frequency step-size equal to the delta frequency value.
MARKER DELTA	Reads the difference in amplitude and in frequency (or time when the span equals 0 Hz) and displays these values.
MARKER 1/A	Sets the marker readout to a frequency equal to the reciprocal of the delta value. For use with zero-span mode.
MARKER NORMAL	Activates a single marker and places it at the center of the trace.
MARKER→REF LVL	Sets the reference level equal to the amplitude of the marker.
OFF	Turns all markers off, blanks the softkey menu, and expands the display.
MKRA→SPAN	Sets the frequency span equal to the delta frequency value.
MAX HOLD A	Displays and holds the maximum responses of the input signal in trace A.
MAX HOLD B	Displays and holds the maximum responses of the input signal in trace B.
MAX MXR LEVEL	Selects the maximum mixer level seen at the input mixer for signals at or below the reference level.
MAX NO VID AVGS	Selects the number of sweeps used in video averaging. Range is from 1 through 999. Turn video averaging on with VID AVG ON OFF .

MKR→

Activates a marker and accesses a menu of marker functions.

MKR=1/Δ=CF

Sets the center frequency equal to the reciprocal of the delta value. For use in zero-span mode.

MKR=1/Δ=CF STEP

Sets the center frequency step-size equal to the reciprocal of the delta value. For use in zero span mode.

MKRNOISE ON/OFF

Turns the marker noise function on or off. When it is on, it normalizes the equivalent amplitude of the measured noise to a 1 Hz bandwidth. Not for use with tracking generators.

MODULE

Accesses the functions of an optional, rear panel module when it is present.

MORE

Displays next page of current menu.

MORE TRC MATH

Accesses a menu of additional trace math functions.

NEGATIVE BIAS

Selects negative bias for an external mixer. When this function is selected a - appears on the left side of the display.

NEXT PEAK

Moves the active marker to the next-highest trace peak relative the current marker position.

NEXT PK LEFT

Finds the next peak to the left of the current marker position.

NEXT PK RIGHT

Finds the next peak to the right of the current marker position.

OFFSET ROLLER

Displays the offset-roller-oscillator frequency corresponding to the start frequency.

ON

Activates a marker and accesses a menu of marker functions.

PEAK EXCURSN

Defines what constitutes a peak on a trace. The selected value specifies the amount that a trace must increase monotonically then decrease monotonically in order to be a peak.

PEAK SEARCH

Places a marker at the highest point on a trace and accesses a menu of marker functions.

PEAK SEARCH

Places a marker on the highest point on a trace and displays the marker frequency and amplitude.

PEAK THRESHLD

Sets the minimum amplitude level from which a peak on a trace can be detected.

PLOT

Plots the entire contents of the display except for menus and error codes.

PLOT ANNOT

Plots only the display annotation. To halt plotting before it is complete, press **STOP ANNOT**.

PLOT GRATICUL

Plots only the graticule. To halt plotting before it is complete, press **STOP GRAT**.

PLOT ORG DSP GRAT

Selects either the display (DSP) or the graticule area (GRAT) for plotting. In either case, the plot fills the entire area defined by the P1 and P2 plot parameters.

PLOT TRACE A

Plots only the contents of trace A and any markers associated with the trace. To halt plotting before it is complete, press **STOP TRACE A**.

PLOT TRACE B

Plots only the contents of trace B and any markers associated with the trace. To halt plotting before it is complete, press **STOP TRACE B**.

POSITIVE BIAS

Selects positive mixer bias for an external mixer. When this function is selected a + appears on the left side of the display.

PRESEL AUTO PK

Automatically peaks the preselector for the desired signal on a trace.

PRESEL MAN ADJ

Permits manual adjustment of the preselector. Peak the preselector using the data keys, the step keys, or the knob.

PRESET

Presets the spectrum analyzer.

<u>PREV MENU</u>	Displays previous menu level.
<u>PRINT</u>	Prints entire contents of display except for menus and error codes.
<u>PRINT PLOT</u>	Accesses a menu for printing and plotting the display.
<u>PWR ON STATE</u>	Saves the current state in the power-on register; the spectrum analyzer is set to this state whenever <u>LINE</u> is turned on or when <u>POWER ON</u> is pressed.
<u>RBW SPAN</u>	Displays the current coupling ratio between the resolution bandwidth and the frequency span.
<u>REALIGN LO & IF</u>	Activates the LO and IF alignment routines for a complete LO and IF alignment.
<u>RECALL</u>	Accesses a menu of functions that recall instrument data.
<u>RECALL ERRORS</u>	Displays the last error that has occurred. Use the step keys to cycle through accumulated errors.
<u>RECALL PRESEL PK</u>	Recalls the preselector data initially stored in the user table using <u>SAVE PRESEL PK</u> .
<u>RECALL STATE</u>	Displays a menu of 10 registers from which instrument states can be recalled and displayed.
<u>RECALL TO TR A</u>	Displays a menu of 8 registers from which data can be recalled and placed in trace A.
<u>RECALL TO TR B</u>	Displays a menu of 8 registers from which data can be recalled and placed in trace B.
<u>REAR PNL CAL</u>	Accesses a menu for selecting the signal available at J8 (LO SWP 0.5V/GHz OUTPUT) and at J9 (10 MHz REF IN/OUT).
<u>RECALL PWR ON</u>	Sets the instrument state to the same state that occurred when <u>LINE</u> was switched on. Initially set by <u>PWR ON STATE</u> .
<u>REF LVL</u>	Activates the reference-level function.

REF LVL ADJ	Permits adjusting the spectrum analyzer's internal gain so that when the calibrator signal is connected to the input, the reference level at top-screen equals the calibrator amplitude.
REF LVL OFFSET	Introduces an offset to all amplitude readouts, but does not change the position of the on-screen trace. When this function is active, an R appears on the left side of the display.
RES BW	Activates the resolution bandwidth of the spectrum analyzer.
RES BW AUTO MAN	Adjusts the resolution bandwidth of the spectrum analyzer. The resolution bandwidth may be coupled to other functions (AUTO) or adjusted manually (MAN).
SAMPLER FREQ	Displays the sampling-oscillator frequency corresponding to the current start frequency.
SAMPLER HARMONIC	Displays the sampler harmonic number corresponding to the current start frequency.
SAVE	Accesses a menu for storing instrument data.
SAVELOCK ON/OFF	When this function is on, the data in the state and trace registers cannot be erased or overwritten; no new data may be entered into the registers until this function is turned off.
SAVE PRESEL PK	Saves the current preselector-peak data in a user data table.
SAVE STATE	Displays a menu of ten registers for storing the current instrument state.
SAVE TRACE A	Displays a menu of nine registers for storing trace contents.
SAVE TRACE B	Displays a menu of nine registers for storing trace contents.
SCREEN TITLE	Accesses a menu of functions for creating on-screen titles.

<u>SELECT CHAR</u>	Causes the currently selected character in the active block to appear in the next available position of the title.
<u>SIG ID AT MKR</u>	Locates the frequency and harmonic number of the mixer response where a marker has been positioned.
<u>SIG ID CF</u>	Sets the center frequency to the frequency obtained from executing <u>SIG ID AT MKR</u> .
<u>SIG ID ON OFF</u>	Switches manual signal identification on and off. Signals that are correct for the selected band are shifted less than 50 kHz. Limit frequency spans to less than 20 MHz for best performance.
<u>SIGNAL IDENT</u>	Accesses a menu of signal-identification functions.
<u>SIG TRK ON OFF</u>	Switches the signal-tracking function ON and OFF. When it is ON, it keeps the active marker on the peak of the signal where it was initially placed and sets the center frequency to the marker value. A K appears on the left side of the display to indicate this function is active.
<u>SINGLE</u>	Activates the single-sweep mode. Pressing <u>SINGLE</u> initiates one sweep. When this function is active, an S appears on the left side of the display.
<u>SPACE</u>	Places a blank space in the next available character position in the title.
<u>SPAN</u>	Activates the frequency span, sets the spectrum analyzer to center-frequency/span mode, and accesses a menu of span-related functions.
<u>SPAN WIDTH</u>	Activates the span-width function and sets the spectrum analyzer to center-frequency/span mode.
<u>SQUELCH</u>	Adjusts the squelch level for demodulation.
<u>SQUELCH ON OFF</u>	Switches the squelch function for demodulation ON and OFF.

START FREQ	Activates the start frequency and sets the spectrum analyzer to start/stop mode.
STATE #	Selects one of 10 registers used to store instrument states.
STOP FREQ	Activates the stop frequency and sets the spectrum analyzer to start/stop mode.
STORE REF LVL	Stores amplitude constant set with REF LVL CAL function.
(SWEEP)	Activates the sweep-time function and accesses a menu of sweep-related functions.
SWEEP TIME	Activates the sweep-time function.
SWP TIME AUTO MAN	Adjusts the sweep time of the spectrum analyzer. The sweep time may be coupled to bandwidth and span settings (AUTO) or adjusted manually (MAN).
THRESHLD	Adjusts the threshold that determines the lower limit of an active trace. Adjust the threshold using the data keys, step keys, or front-panel knob.
THRESHLD ON OFF	Sets a threshold that determines the lower limit of an active trace. Adjust the threshold using the data keys, the step keys, or the knob. Turns the threshold ON and OFF .
TITLE DONE	Freezes the current title.
(TRACE)	Accesses a menu of trace functions.
TRACE A	Accesses trace-related functions for traces A.
TRACE B	Accesses trace-related functions for traces B.
TRACE #	Selects one of 8 registers used to store traces.
TRANSFER ROLLER	Displays the transfer-roller oscillator frequency corresponding to the start frequency.
(TRIG)	Accesses a menu of trigger functions.

UNITS-AUTO-MAN

Accesses a menu of amplitude units. AUTO indicated default units for the amplitude scale are in use; MAN indicates other units have been selected.

VBW-RBW

Displays the coupling ratio between the video bandwidth and the resolution bandwidth.

VID AVG ON OFF

Turns video averaging on and off. It smoothes the trace by averaging successive traces with each other.

VIDEO

Sets the trigger to video modem. Sweep triggers occur whenever the input signal passes through, with a positive slope, the video trigger level. When this mode is selected, a T appears on the left side of the display.

VIDEO BW

Activates the video bandwidth of the spectrum analyzer.

VIDEO BW-AUTO-MAN

Adjusts the video bandwidth of the spectrum analyzer. The video bandwidth may be coupled to other functions (AUTO) or adjusted manually (MAN).

VOLTS

Selects volts as amplitude units.

VOLUME

Adjusts the volume of the demodulated signal. Use the VOL keys (located in the upper-right corner of the front panel) to lower or raise the volume.

WATTS

Selects watts as amplitude units.

Programming

The following pages are a compilation of all current IIP 8561A and HP 8562A/B programming codes. More detailed information on each operation can be found in the *HP 8561A and HP 8562A/B Operation and Programming Manual*.

Notation Conventions	2-2
Syntax Conventions	2-3
Command Summary	2-5
Programming Codes	2-12
Secondary Key Word Summary	2-35

This reference is intended for use by the experienced spectrum analyzer programmer. To find a programming code which performs a particular function, first refer to the "Command Summary" section which shows the programming codes grouped according to similar function. A brief definition of each code is provided. Once the desired programming code is found, refer to the alphabetical listing of the programming codes for further key word definition and syntax information. An example of how to use each command is also given. The examples are partial IIP BASIC programs for the HP 9000 series 200/300 computers.

For further information on syntax, refer to the "Notation Conventions" and "Syntax Conventions" sections. Secondary key words are parameters appearing in capital letters within the argument of key words. Their definitions can be found the "Secondary Key Word Summary" section.

Notation Conventions

The following symbols and type styles found in this guide denote the following:

BOLD TYPE	All characters appearing in bold type are key words and must appear exactly as shown.
CAPITAL LETTERS	All characters that are capital letters are secondary key words and appear within the key word syntax. They must appear exactly as shown and their meanings can be found in the "Secondary Key Word Summary" section.
< >	Characters appearing in angular brackets are considered to be elements of the language being defined. Their meanings can be found in the section on syntax conventions unless otherwise specified with the key word definition.
[]	Square brackets indicate that whatever occurs within the brackets is optional.
	"Or" indicates a choice of exactly one element from a list (for example, <a> indicates <a> or but not both).
()	Parentheses are used to clarify which elements are to be chosen from.
-	"Underscore" indicates a space must be placed at that location (for example, A.<a> indicates there must be a space between the key word, A, and the element, <a>).
::=	"Is defined as" (for example, <a>::=<c> indicates that <a> can be replaced by the series of elements, <c> in any statement where <a> occurs).
{ }	Integers appearing in braces indicate that the integer is transmitted to the analyzer as a single 8-bit byte.

Syntax Conventions

<A-block data field> ::= #A<length><command list><LF & END>
(use when the length of the command list is known)

<A-block data format> ::= #A<length><command list><LF & END>

<amplitude unit> ::= DB|DM|DBM|DBMV|DBUV|V|MV|UV|W|MW

<block data field> ::= <A-block data field>|<I-block data field>

<command list> ::= one or more spectrum analyzer commands

<CR> ::= ASCII 13 (carriage return)

<delimiter> ::= <CR>|<LF>|,|;

<END> ::= end of data transmission

<frequency unit> ::= HZ|KZ|KHZ|MZ|MHZ|GZ|GHZ

<I-block data field> ::= #I<command list>END; (use when the length of the command list is not known)

<integer> ::= positive or negative integer number in the range of -32768 through +32767

<length> ::= two 8-bit bytes specifying the length of the command list

<LF> ::= ASCII 10 (line feed)

<numeric data format> ::= <real><LF><EOI>

<real> ::= positive or negative real number

<string data field> ::= <string delimiter><text><string delimiter>

<string delimiter> ::= :|"|\$|%|&|_|/|:|=|@|{|}|"

<terminator> ::= <amplitude unit>|<time unit>|<frequency unit>|<delimiter>

<time unit> ::= S|SC|SEC|MS|MSEC|US

Command Summary

Alternate commands common to the HP 8566A/8568A are shown in parentheses.

Amplitude Control

AT	Specifies input attenuation.
AT AUTO	Couples input attenuation (CA).
AUNITS	Specifies amplitude units for input, output, and display.
COUPLE	HP 8561A only. Selects ac or dc coupling of input attenuator.
LG	Selects log scale.
LN	Selects linear scale.
MKRL	Moves active marker amplitude to reference level (E4).
ML	Specifies mixer level.
RL	Specifies reference level.
RLCAL	Calibrates reference level.
ROFFSET	Specifies reference level offset.

Bandwidth Control

RB	Specifies resolution bandwidth.
RB AUTO	Couples resolution bandwidth (CR).
RBR	Specifies coupling ratio of resolution bandwidth and frequency span.
VB	Specifies video bandwidth.
VB AUTO	Couples video bandwidth (CV).
VBR	Specifies coupling ratio of video bandwidth and resolution bandwidth.

Coupling Control

AUTOCP	Auto couple all controls.
AT AUTO	Auto couple the input attenuator (CA).
RB AUTO	Auto couple resolution bandwidth (CR).
SS AUTO	Auto couple center frequency step size (CS).
ST AUTO	Auto couple sweep time (CT).
VB AUTO	Auto couple video bandwidth (CV).

RBR Specifies coupling ratio of resolution bandwidth and frequency span.
VBR Specifies coupling ratio of video bandwidth and resolution bandwidth.

Demodulation

DEM0D Demodulation.
DEM0DAGC Demodulation automatic gain control.
DEM0DT Demodulation time.
SQUELCH Squelch control for demodulation.
VOL Sets speaker volume.

Display Control

ANNOT Turns annotation on or off.
AUNITS Specifies amplitude units for input, output, and display.
DL Specifies display line level in dBm.
DLE Turns display line on and off (L0).
FDSP Turns all frequency display annotation off.
GRAT Turns graticule on or off.
LG Selects log scale.
LN Selects linear scale.
TH Specifies display threshold value.

External Mixing

CNVLOSS Sets reference level offset to compensate for external mixer conversion loss.
FULBAND Sets start and stop frequencies for full waveguide bands.
HNLOCK Locks to specified harmonic number.
HNUNLK Unlocks the specified harmonic number.
IDCF Sets center frequency to frequency of SIGID.
IDFREQ Returns frequency of identified signal.
MBIAS Specifies the bias level for external mixers.
MKPX Specifies minimum excursion for peak identification.
MXRMODE Specifies either internal or external mixing.
SIGID Identifies signals for external mixing frequency bands.

Frequency Control

CF	Specifies center frequency.
SS AUTO	Couples center frequency step size (CS).
FA	Specifies start frequency.
FB	Specifies stop frequency.
FOFFSET	Specifies frequency offset.
FREF	Specifies the frequency reference source.
FS	Specifies full frequency span as defined by instrument state.
FULBAND	Sets the start and stop frequency for full waveguide band (external mixing only).
MKFCR	Specifies resolution of frequency counter.
SP	Specifies frequency span.
SS	Specifies center frequency step size.

Information and Service Diagnostics

ADJALL	Initiates power-on adjustment sequence.
ADJCRT	Initiates CRT adjustment patterns.
ADJIF	Initiates IF adjustment sequence.
ERR?	Returns list of instrument error codes.
ET?	Elapsed time.
FDIAG	Returns frequency of specified oscillator.
ID?	Returns the HP model number of analyzer used.
FSDAC	Returns preselector DAC setting at frequency of marker.
REV?	Returns analyzer revision number.
RLCAL	Used to calibrate reference level.
RQS	Returns decimal weighting of status byte bits which are enabled during service request.
SER?	Returns analyzer serial number.

Instrument State Control

IP	Sets instrument parameters to preset values.
RCLS	Recalls previously saved state (RC).
PSTATE	Protect saved states (save lock).
SAVES	Saves current state of the analyzer in the specified register (SV).

Marker Control

MKA	Amplitude of active marker (MA).
MKCF	Enter marker frequency into center frequency (E2).
MKD	Moves delta marker to specified frequency (M3).
MKDR	Marker delta reciprocal, readout in time.
MKF	Frequency of active marker (MF).
MKFC	Counts marker frequency for greater accuracy.
MKFCR	Specifies resolution of marker frequency counter.
MKMIN	Moves marker to minimum signal detected.
MKN	Moves marker to specified frequency or center screen (M2).
MKNOISE	Returns average noise value at marker, normalized to 1 Hz bandwidth.
MKOFF	Turns the active marker off (M1).
MKPK	Moves marker to signal peak (E1).
MKPT	Specifies marker peak threshold.
MKPX	Moves marker to signal peak (E1).
MKRL	Moves active marker to reference level (E4).
MKSP	Moves marker delta frequency into span.
MKSS	Moves marker frequency to center frequency step size (E3).
MKSWP	Marker sweep.
MKT	Positions marker at point corresponding to the time from beginning of sweep.
MKTRACE	Moves marker to same position on another trace.
MKTRACK	Turns marker signal track on (MT1) or off (MT0).

Plotter Output

OP	Returns P1 and P2 in display units.
PLOT	Sends analyzer display to a plotter.
PLOTORG	Scaling points for plot.
PLOTSRC	Specifies plot source.

Preselector Control

PP Peaks preselector.
PSDAC Preselector peak data.

Printer Output

PRINT Sends the analyzer display to a printer.

Service Request

RQS Specifies the decimal weighting of status byte bits which are allowed during service request. Set to 0 with powerup or device clear.
SRQ Sets service request if operand bits are allowed by RQS.
STB Returns the decimal equivalent of the bits set in the status byte. Refer to Table 2-1.

Table 2-1. Status Byte Definition

Bit	Decimal	Definition
7	—	Not used
6	64	Request service
5	32	Error present in error register
4	16	Command complete
3	—	Not used
2	4	End of sweep
1	2	Message occurred
0	0	Cleared

Sweep and Trigger Control

CONTS	Selects continuous sweep mode (S1).
ST	Specifies sweep time.
ST AUTO	Couples sweep time.
SNGLS	Selects single sweep mode (S2).
TM	Selects trigger mode: free run (T1), video (T4), line (T2), external (T3).
TS	Takes a sweep.
VTL	Video trigger level.

Synchronization

TS	Takes a sweep.
DONE?	Returns a 1 when task has been completed.

Trace Functions

Processing

BLANK	Stores and blanks specified trace register (A4/B4).
CLRW	Clear-writes specified trace register (A1/B1).
MINH	Holds the minimum trace register values.
MXMH	Max holds the specified trace register (A2/B2).
RCLT	Recall specified trace data.
SAVET	Save specified trace data.
TRA	Input/output trace A.
TRB	Input/output trace B.
VIEW	Views specified trace register (A3/B3).

Math

AMB	A-B into A (C1/C2).
AMBPL	A-B+DL into A.
APB	A+B into A.
AXB	Exchanges A and B (EX).
BML	B-DL into B (BL).
FFT	Performs a fast fourier transform.
TWNDOW	Selects window for FFT function.

VAVG Turns video averaging on or off.

Other

AUNITS Specifies amplitude units for input, output, and display.
DET Specifies detector mode.
TITLE Writes specified ASCII characters in title block area of display.
PWRBW Computes trace power bandwidth.

Operator Entry

HD Holds or disables data entry and blanks active function CRT readout.

Output Format Control

AUNITS Specifies amplitude units for input, output, and display.
MKA? Returns marker amplitude (MA).
MKF? Returns marker frequency (MF).
SWPOUT Specifies the sweep output.
TRA? Outputs trace A (TA).
TRB? Outputs trace B (TB).
TDF Selects trace data output as binary (B) or real numbers (P) in Hz, volts, dB, or watts. Preset is P.

Programming Codes

ADJALL;
Initiates power-on adjustments.
OUTPUT 718;"ADJALL;IP;"

ADJCRT;
Turns on CRT adjustment pattern. Use IP to exit from adjustment.patter.
OUTPUT 718;"ADJCRT;"
Corresponding key: CRT ADJ PATTERN

ADJIF_ON|OFF|1|0|FULL|CURR|?;
Activate constant IF adjustment sequence.
Default is on.
OUTPUT 718;"ADJIF OFF;"
Query response: 1|0
OUTPUT 718;"ADJIF?;"
ENTER 718;Adjif
Corresponding key: FULL IF ADJ

AMB_ON|OFF|1|0|?;
Subtracts trace B from trace A and sends the result to trace A.
OUTPUT 718;"VIEW TRA;CLRWB TRB;TS;VIEW TRB;AMB ON;"
Query response: 1|0
OUTPUT 718;"AMB?;"
ENTER 718;Amb
Corresponding key: A-B--A ON OFF

AMBPL_ON|OFF|1|0|?;
Subtracts trace B from trace A, adds the display line value to the difference, and sends the result to trace A.
OUTPUT 718;"VIEW TRA;CLRWB TRB;TS;VIEW TRB;DL -500BM;"
OUTPUT 718;"AMBL ON;"
Query response: 1|0
OUTPUT 718;"AMBPL?;"
ENTER 718;Ambpl
Corresponding key: A-B+DL--A ON OFF

ANNOT_ON|OFF|1|0|?;
Turns the display annotation on or off. IP turns on the annotation.
OUTPUT 718;"ANNOT OFF;"
Query response: 1|0
OUTPUT 718;"ANNOT?;"

ENTER 718;Annot
 Corresponding key: ANNOT ON OFF
APB;
 Adds trace A and trace B and sends the result to trace A.
 OUTPUT 718;"VIEW TRA;CLRW TRB;TS;VIEW TRB;"
 OUTPUT 718;"APB;"
 Corresponding key: A+B→A
AT.<integer>[DB]]UP|DN|EP|MAN|AUTO|?;
 Specifies the RF input attenuation. Default units are dB.
 <integer>::=0|10|20|30|40|50|60|70
 UP/DN increment::=10 dB
 OUTPUT 718;"AT 30 DB;"
 OUTPUT 718;"AT UP;"
 Query response: <numeric data format>
 OUTPUT 718;"AT AUTO;"
 OUTPUT 718;"AT?;"
ENTER 718;Atten
 Corresponding keys: ATTEN, ATTEN AUTO MAN
AUNITS.<amplitude units> |AUTO|MAN|?;
 Specifies the amplitude units for input, output and display.
 OUTPUT 718;"AUNITS DBUV;"
 OUTPUT 718;"AUNITS AUTO;"
 Query response: <amplitude units>
 OUTPUT 718;"AUNITS?;"
ENTER 718;Units\$
 Corresponding key: UNITS
AUTOCPPL;
 Auto couple all controls.
 OUTPUT 718;"AUTOCPPL;"
 Corresponding key: ALL
AXB;
 Exchanges trace A and trace B.
 OUTPUT 718;"AXB;"
 Corresponding key: A EXCH B
BLANK.TRA|TRB;
 Stores and blanks the specified trace register.
 OUTPUT 718;"BLANK TRB;"
 Corresponding keys: BLANK A, BLANK B

BML;
 Subtracts the display line from trace B and sends the result to trace B.
 OUTPUT 718;"DL -30 DBM;CLRW TRB;TS;"
 OUTPUT 718;"BML;"
 Corresponding key: B-DL-B

CF_(<real>[frequency units])[UP|DN|EP]?
 Specifies the center frequency. Default units are Hz.
 UP/DN increment::=10% of Span or Step Size
 OUTPUT 718;"CF 2.750 GHZ;"
 OUTPUT 718;"CF DN;"
 Query response: <numeric data format>
 OUTPUT 718;"CF?;"
 ENTER 718;Freq
 Corresponding key: FREQUENCY, CENTER FREQUENCY

CLRW_TRA|TRB;
 Clear-writes the specified trace register.
 OUTPUT 718;"CLRW TRA;"
 Corresponding keys: CLR-WRT A, CLR-WRT B

CNVLOSS_(<real>[DB])[UP|DN|EP]?
 Specifies the average conversion loss of an external millimeter mixer.
 UP/DN increment::=0.1 dB
 OUTPUT 718;"CNVLOSS 24.5 DB;"
 OUTPUT 718;"CNVLOSS DN;"
 Query response: <real>
 OUTPUT 718;"CNVLOSS?;"
 ENTER 718;Mixer_loss
 Corresponding key: CNV LOSS VS FREQ

CONTS;
 Selects continuous sweep mode. Selected with IP.
 OUTPUT 718;"SP 10 MHZ;CONTS;"
 Corresponding key: CONT

COUPLE_AC|DC|OA]?
 Selects HP 8561A's input coupling to input attenuator. Select either ac or dc. Preset state is ac.
 OUTPUT 718;"COUPLE AC;"
 Query response: AC|DC
 OUTPUT 718;"COUPLE?;"
 ENTER 718; Couple\$

Corresponding key: COUPLING AC DC

DEMODO_FM|AM|OFF|?;
 Select either FM or AM demod.
 OUTPUT 718;"DEMODO FM;"
 OUTPUT 718;"DEMODO OFF;"
 Query response: FM|AM|OFF
 OUTPUT 718;"DEMODO?;"
 ENTER 718;Demod\$

Corresponding keys: AM DEMODO ON OFF, FM DEMODO ON OFF

DEMODOAGC_ON|OFF|1|0|?;
 Turns the demodulation automatic gain control (AGC) on or off. IP turns AGC off.
 OUTPUT 718;"DEMODOAGC ON;"
 Query response: 1|0
 OUTPUT 718;"DEMODOAGC?;"
 ENTER 718;Demodagc

DEMODO_T|<real>[time units]|UP|DN|EP|?;
 Selects the time that the sweep pauses at the marker for signal demodulation.
 UP/DN increment::=1,2,5 sequence
 OUTPUT 718;"DEMODO_T 10 SC;"
 Query response: <real>
 OUTPUT 718;"DEMODO_T?;"
 ENTER 718;Delay

Corresponding key: DEMODO TIME

DET_POS|NEG|NRM|SMP|?;
 Selects the specified analyzer detector mode. Default is normal detector mode.
 OUTPUT 718;"DET POS;"
 Query response: POS|NEG|NRM|SMP
 OUTPUT 718;"DET?;"
 ENTER 718;Det\$

Corresponding key: DETECTOR MODES

DL_(<real>[amplitude units])UP|DN|ON|OFF|EP|?;
 Specifies a display line level that is displayed on the CRT. Default is 0 dBm.
 UP/DN increment::= 1 Vertical division
 OUTPUT 718;"DL -25 DBM;"
 Query response: <numeric data format>
 OUTPUT 718;"DL?;"
 ENTER 718;Line
 Corresponding key: DISP LIN OF OFF

[TS;]<command list>;DONE[_]?;
 This command is a synchronizing function that sends a 1 to the controller after the command list has been executed. If a TS (take sweep) precedes the command list, execution of the command list begins after the sweep is completed.
 OUTPUT 718;"TS;SP 100 MHZ;DONE?;"
 ENTER 718;Done

ERR?;
 Returns to a controller a list of error numbers. Positive numbers are error codes. An error code of 0 means there are no errors.
 Query response: <block data format>
 OUTPUT 718;"ERR?;"
 REPEAT
 ENTER 718 USING &"#,4A";Err\$
 Err_num=VAL(Err\$)
 PRINT Err_num
 UNTIL NUM(Err\$[4])=10

ET?;
 Returns the elapsed time of operation in hours.
 Query response: <numeric data field>
 OUTPUT 718;"ET?;"
 ENTER 718;Time
 Corresponding key: ELAPSED TIME

FA_(<real>[frequency units])UP|DN|EP|?;
 Specifies the start frequency. Default units are Hz.
 UP/DN increment::=10% of Span
 OUTPUT 718;"FA 150 KHZ;"
 Query response: <numeric data format>
 OUTPUT 718;"FA?"

ENTER 718;Startfreq
 Corresponding key: START FREQ
FB_(<real>[frequency units])|UP|DN|EP|?;
 Specifies the stop frequency. Default units are Hz.
 UP/DN increment::=10% of Span
OUTPUT 718;"FB 540 MHZ;"
 Query response: <numeric data format>
OUTPUT 718;"FB?;"
ENTER 718;Stopfreq
 Corresponding key: STOP FREQ
FDIAG_HARM|LO|MROLL|OROLL|SMP|XROLL,?;
 Frequency diagnostic routine. Returns the frequency of the specified oscillator.
OUTPUT 718;"FDIAG LO ?;"
ENTER 718;Lo_freq
 Corresponding key: FREQ DIAGNOSE
FDSP.OFF|?;
 Turns all frequency related annotation off. Power-on reset is the only way to turn frequency annotation back on and no last state is saved under this condition.
OUTPUT 718;"FDSP OFF;CF 12.25 GHZ;"
 Corresponding key: FREQ DSP OFF
FFT_(TRA|TRB),(TRA|TRB),(TRA|TRB);
 Performs discrete Fourier transform on source trace array and stores result in destination.
OUTPUT 718;"FFT TRA,TRB,TRA;"
 Corresponding key: FFT
FOFFSET_(<real>[frequency units])|UP|DN|EP|?;
 Specifies the frequency offset for all absolute frequency readouts such as center frequency. Default units are Hz.
 UP/DN increment::=20% of Span
OUTPUT 718;"FOFFSET 25 MHZ;
 Query response: <numeric data format>
OUTPUT 718;"FOFFSET?;"
ENTER 718;Offset
 Corresponding key: FREQ OFFSET

FREF|INT|EXT|?;

Specifies the frequency reference source.

OUTPUT 718; "FREF INT; "

Query response: INT|EXT

OUTPUT 718; "FREF ?; "

ENTER 718; Freqref

Corresponding key: 10 MHz INT EXT

FS;

Selects the full frequency span as defined by the instrument.

OUTPUT 718; "IP; CF 300MHZ; SP 1MHZ; FS; "

Corresponding key: FULL SPAN

FULBAND_K|A|Q|U|V|E|W|F|D|G|Y|J;

Selects the full frequency span for the external mixing frequency band the analyzer is currently tuned to (that is, 26.5 to 40.0 GHz band A.) Refer to Table 2-2.

OUTPUT 718; "MXRMODE EXT; FULBAND V; "

Corresponding key: FULL BAND

External Mixing Bands

BAND	FREQUENCY RANGE	MIXING HARMONIC
6 (K)	18.6—28.5 GHz	6— (External)
7 (A)	26.5—40.0 GHz	8— (External)
8 (Q)	33.0—50.0 GHz	10— (External)
9 (U)	40.0—60.0 GHz	10— (External)
10 (V)	50.0—75.0 GHz	14— (External)
11 (E)	60.0—90.0 GHz	16— (External)
12 (W)	75.5—110 GHz	18— (External)
13 (F)	90.0—140 GHz	24— (External)
14 (D)	110—170 GHz	30— (External)
15 (G)	140—220 GHz	36— (External)
16 (Y)	170—260 GHz	44— (External)
17 (J)	220—325 GHz	54— (External)

GRAT.ON|OFF|1|0|?;

Turns the graticule on or off. IP turns on the graticule.

OUTPUT 718; "GRAT OFF; "

Query response: 1|0

```

OUTPUT 718;"GRAT?;"
ENTER 718;Grat
Corresponding key: GRAT ON OFF
HD;
Holds or disables data entry and blanks the active function CRT readout.
Selected with IP.
OUTPUT 718;"CF 14 GHZ;TS;HD;"
Corresponding key: HOLD
HNLOCK_<integer> |ON|OFF|UP|DN|EP|?;
Locks the specified harmonic number to prevent multi-harmonic sweeps.
<integer>::=value 1 through 50
UP/DN increment::=1
OUTPUT 718;"MXRMODE EXT;HNLOCK 8;"
Query response: <integer>
OUTPUT 718;"HNLOCK ?;"
ENTER 718;Harmonic_Lock
Corresponding key: LOCK ON OFF
HNUNLK;
Unlocks the harmonic number.
OUTPUT 718;"HNUNLK;CF 65 GHZ;HNLOCK ON;"
Corresponding key: LOCK ON OFF
ID[.];?
Returns the HP model number of the analyzer being used (HP 8562A/B)
and any options installed.
DIM ID$[50]
OUTPUT 718;"ID?;"
ENTER 718;ID$
IDCF;
Sets the center frequency (CF) to the frequency of the signal identified by
the SIG ID function.
OUTPUT 718;"MKPK HI;SIGID AUTO;IDCF;"
Corresponding key: SIGID—CF
IDFREQ[.];?
Returns to the controller the frequency of the identified signal.
Returns 0 if invalid signal identification.
OUTPUT 718;"SIGID AUTO;IDFREQ?;"
ENTER 718;Sig_freq

```

IP;
 Sets instrument parameters to their preset values.
 OUTPUT 718;"IP;CF 100MHZ;SP 1MHZ;TS;"
 Corresponding keys: PRESET, RECALL PWR ON
LG_(<integer>[DB])|UP|DN|EP|?;
 Specifies the scale of the logarithmic display, 10, 5, 2, or 1 dB/div. Default units are dB. 10 dB per division is selected with IP.
 <integer>::=1|2|5|10
 UP/DN increment::=1 Step
 OUTPUT 718;"LG 2 DB;"
 OUTPUT 718;"IP;LG DN DN;"
 Query response::=<numeric data format>
 A query response of zero indicates a linear scale.
 OUTPUT 718;"LG ?;"
 ENTER 718;Log_scale
 Corresponding key: LOG dB/DIV
LN;
 Selects the linear scale.
 OUTPUT 718;"RL -30 DBM;LN;"
 Corresponding key: LINEAR
MBIAS_(<real>[A|MA|UA])|ON|OFF|UP|DN|EP|?;
 Select the bias level for external mixers which require diode bias for efficient mixer operation.
 UP/DN increment::=0.01 mA
 OUTPUT 718;"MXRMODE EXT;HNLOCK A;MBIAS 20 MA;"
 Query response: <real>
 OUTPUT 718;"MBIAS ?;"
 ENTER 718;Mixer_bias
 Corresponding key: BIAS
MINH_TRA|TRB;
 Similar to MAX HOLD except that the minimum trace values are stored.
 OUTPUT 718;"CLRW TRA;MINH TRA;"
MKA[.]?;
 Returns the amplitude of the active marker. Default units are dBm.
 Query response: <numeric data format>
 OUTPUT 718;"SNGLS;TS;MKPK HI;MKA?;"
 ENTER 718;Amptd

MKCF;

Moves the active marker to the center frequency.

OUTPUT 718;"CF 600 MHZ;SP 1 GHZ;"

OUTPUT 718;"TS;MKPK HI;MKCF;TS;"

Corresponding key: MARKER←CF

MKD.<real>[frequency units]]UP|DN|EP|?;

Places a second marker the specified frequency from the active marker.

Frequency may be positive or negative. Default units are Hz. In zero frequency span the units are time.

UP/DN increment::=10% of Span

OUTPUT 718;"CF 450 MHZ;SP 400 MHZ;"

OUTPUT 718;"TS;MKPK HI;MKD 300 MHZ;"

Query response: <numeric data format>

OUTPUT 718;"MKPK HI;MKD;MKPK NH:MKD?;"

ENTER 718;Marker_del

Corresponding key: MARKER DELTA

MKDR.<real>[time units]]EP|?;

Reciprocal marker delta, readout is in time period between markers. In zero frequency span the units are frequency.

OUTPUT 718;"TS;MKPK HI;MKD;MKPK NH;MKDR;"

Query response: <numeric data format>

OUTPUT 718;"TS;MKPK HI;MKD;MKPK NH;MKDR?;"

ENTER 718;Period

Corresponding key: MARKER 1/DELTA

MKF.<real>[frequency units]]EP|?;

Specifies the frequency of the active marker. Default units are Hz.

OUTPUT 718;"CF 450 MHZ;SP 400 MHZ;MKF 600 MHZ;"

Query response: <numeric data format>

OUTPUT 718;"TS;MKPK HI;MKF?;"

ENTER 718;Mfreq

MKFC.ON|OFF;

Counts the marker frequency for a more accurate readout of the marker frequency. The accuracy is determined in part by the counter resolution.

OUTPUT 718;"TS;MKPK HI;MKFC ON;MKF?;"

ENTER 718;Freq_count

Corresponding key: COUNTER ON OFF

MKFCR_{<real>[frequency units]}|EP|?;
 Specifies the resolution of the marker frequency counter.
OUTPUT 718;"MKFCR 100 HZ;MKFC ON;"
 Query response: <numeric data format>
OUTPUT 718;"MKFCR ?;"
ENTER 718;Count_res
 Corresponding key: COUNTER RES
MKMIN;
 Moves the active marker to the minimum signal detected.
OUTPUT 718;"TS'MKPK HI;MKD;MKMIN;"
MKN_{<real>[frequency units]}|UP|DN|EP|?;
 Moves the active marker to the specified frequency. Default units are Hz.
 UP/DN increment::=10% of Span
OUTPUT 718;"CF 100 MHZ;SP 100 MHZ;TS;MKN 75 MHZ;"
 Query response: <numeric data format>
OUTPUT 718;"MKPK HI;MKN?;"
ENTER 718;Marker
 Corresponding key: MARKER NORMAL
MKNOISE_ON|OFF|1|0|?;
 Returns the average value at the marker, normalized to a 1 Hz bandwidth,
 after correction for resolution bandwidth and detection mode (log or
 linear).
OUTPUT 718;"TS;MKMIN;MKNOISE ON;MKA?;"
ENTER 718;Amptd
 Query response: 1|0
OUTPUT 718;"MKNOISE?;"
ENTER 718;Mknoise
 Corresponding key: MKNOISE ON OFF
MKOFF[_ALL];
 Turns the active marker off.
OUTPUT 718;"MKOFF;"
 Corresponding key: OFF

MKPK_HI|NH|NR|NL;
 Moves the active marker to the maximum signal detected or to the next highest, next right, or next left signal detected. Marker defaults to maximum signal detected.
 OUTPUT 718;"TS;MKPK HI;"
 OUTPUT 718;"TS;MKPK HI;MKPK NL;"
 OUTPUT 718;"TS;MKPK;"
 Corresponding key: PEAK SEARCH

MKPT_(<real>[amplitude units])|UP|DN|EP|?;
 Specifies the marker peak threshold. Default value is -120 dBm.
 UP/DN increment::=10 dB
 OUTPUT 718;"MKPT -95 DBM;"
 OUTPUT 718;"AUNITS DBUV;MKPT UP;"
 Query response: <real number>
 OUTPUT 718;"MKPT?;"
 ENTER 718;Peak_thresh

MKPX_(<real>[DB])|UP|DN|EP|?;
 Specifies the minimum excursion for peak identification. Default units are dB. (IP selects 6 dB for minimum excursion.)
 <real>::=values 0.0 through 30.0
 UP/DN increment::=10 dB
 OUTPUT 718;"MKPX 3DB;TS;MKPK HI;"
 Query response: <numeric data format>
 OUTPUT 718;"MKPX?;"
 ENTER 718;Peak_ex

Corresponding key: PEAK EXCURSN

MKRL;
 Moves the active marker to the reference level.
 OUTPUT 718;"TS;MKPK HI;MKRL;TS;"
 Corresponding key: MARKER→REF LVL

MKSP;
 Moves the marker delta frequency into the frequency span.
 OUTPUT 718;"TS;MKPK HI;MKD;MKPK NH;MKSP;TS;"
 Corresponding key: MKRΔ→SPAN

MKSS;
 Moves the marker frequency into the center frequency step size.
 OUTPUT 718;"TS;MKPK HI;MKSS;CF UP UP;"
 Corresponding key: MARKER→CF STEP

```

MKT.<real>[time units]?;
Sets the Marker to the position corresponding to the sweep time from the
beginning of sweep.
OUTPUT 718;"ST 2 SEC;MKT 1.6 SEC;"
Query response: <real>
OUTPUT 718;"MKT ?;"
ENTER 718;Mkr_time
Corresponding key: MARKER 1/DELTA
MKTRACE_TRA|TRB?;
Moves the active marker to the corresponding position on another trace.
OUTPUT 718;"CLRW TRA;TS;VIEW TRA;MKPK HI;"
OUTPUT 718;"MKD;CLRW TRB;MKTRACE TRB;"
Query response: TRA|TRB
OUTPUT 718;"MKTRACE?;"
ENTER 718;Mkr_trace$
MKTRACK_ON|OFF?;
Turns the marker signal track ON|OFF.
OUTPUT 718;"CF 300 MHZ;SP 100 MHZ;"
OUTPUT 718;"MKPK HI;MKTRACK ON;"
OUTPUT 718;"SP 100 KHZ;MKTRACK OFF;"
Query response: 1|0
OUTPUT 718;"MKTRACK ?;"
ENTER 718;Track$
Corresponding key: SIG TRK ON OFF
ML.<integer>[amplitude units] [UP|DN|EP]?;
Specifies the mixer level. Default units are dBm.
<integer>::=-10|-20|-30|-40|-50|-60|-70|-80
UP/DN increment::=10 dB
OUTPUT 718;"ML - 40 DBM;"
OUTPUT 718;"ML 60 DBUV;"
OUTPUT 718;"ML 10 DBMV;"
Query response: <integer>
OUTPUT 718;"ML?;"
ENTER 718;Mixer_lvl
Corresponding key: MAX MXR LEVEL
MXMH_TRA|TRB;
Updates each trace element with the maximum level detected.
OUTPUT 718;"CLRW TRA;CLRW TRB;MXMH TRA;"

```

Corresponding keys: MAX HOLD A, MAX HOLD B

MXRMODE|INT|EXT;
 Specifies the mixer mode.
OUTPUT 718;"MXRMODE INT;"

OA
 Queries a function. Used the same as (?).
OUTPUT 718;"RL OA;"
ENTER 718;Reflvl

OP?;
 Returns the parameters which represent the dimensions of the lower left and upper right vertices of the analyzer display in plotter units.
 Response = "P1x, P1y, P2x, P2y;"
 Default is "0, 0, 800, 800;"
OUTPUT 718;"OP?;"
ENTER 718;P1x,P1y,P2x,P2y

PLOT[_P1x,P1y,P2x,P2y];
 Plots the CRT display on any HP-IB plotter.
 P1x and P1y::=plotter dependent values that specify the lower left plotter dimension.
 P2x and P2y::=plotter dependent values that specify the upper right plotter dimension.
 Default is current plotter P1, P2 settings.
OUTPUT 718;"PLOT 80,320,10080,7520;"
ENTER 718 USING "#,-K;Plot_str\$
 Corresponding key: PLOT

PLOTORG|DSP|GRT|?;
 Specifies whether plotter P1, P2 settings are the origin for the graticule or the entire spectrum analyzer display. Allows plotting trace data on paper with preprinted graticule lines.
OUTPUT 718;"PLOTORG GRT;PLOT;"
SEND Sel.code;UNT UNL LISTEN Pit.addr\$ TALK Sa.addr\$ DATA"

PLOTSRC|ALL|TRA|TRB|GRT|ANNT|?;
 Specifies the source for PLOT. Default is ALL.
OUTPUT 718;"PLOTORG GRT;PLOTSRC ANNT;PLOTSRC TRB;"
 Query response: ALL|TRA|TRB|GRT|ANNT
OUTPUT 718;"PLOTSRC?;"
ENTER 718;Plotsrc

PP;
 Peaks the preselector.
 OUTPUT 718;"CF 12 GHZ;SP 100 MHZ;
 OUTPUT 718;"TS;MKPK HI;MKCF;SP 10 MHZ;TS;PP;"
 Corresponding key: PRESEL AUTO PK

PRINT_0[1];
 Prints screen data in HP raster graphics format.
 0::= Monochrome (default);
 1::= Color
 OUTPUT 718;"PRINT;"
 SEND Sel_code; UNL LISTEN Prt_addr TALK Sa_addr DATA
 Corresponding keys: PRINT, COLOR PRINT

PSDAC_<integer>|UP|DN|EP|?
 Specifies the preselector peak DAC setting.
 <integer>::=0 through 255
 UP/DN increment::=1
 OUTPUT 718;"PSDAC 35;"
 Query response: <integer>
 OUTPUT 718;"PSDAC?;"
 ENTER 718;Prese1_dac

PSTATE_ON|OFF|1|0|?
 Protect state (Save lock.)
 OUTPUT 718;"SAVES 2;PSTATE ON;"
 OUTPUT 718;"PSTATE OFF;SAVES 4;"
 Query response: 1 = ON, 0 = OFF
 OUTPUT 718;"PSTATE ?;"
 ENTER 718;Pstate
 Corresponding key: SAVELOCK ON OFF

PWRBW_(TRA|TRB),<integer>?;
 Computes bandwidth equal to specified percentage of the total displayed power.
 OUTPUT 718;"PWRBW TRA, 50.0;"
 Query response: <integer>
 OUTPUT 718;"PWRBW?"
 Corresponding key: 99% POWER BW

RB_(<real>[frequency units])|UP|DN|EP|AUTO|MAN|?;
 Specifies the resolution bandwidth.
 <real>::=10 kHz to 2 MHz in 1, 3, 10 sequence.
 UP/DN increment::= 1, 3, 10 sequence
 OUTPUT 718;"SP 1 MHZ;RB 1 MHZ;TS;"
 Query response: <numeric data format>
 OUTPUT 718;"RB UP UP;RB?;"
 ENTER 718;Res_bw
 Corresponding key: RES BW AUTO MAN

RBR_(<real>)|UP|DN|EP|?;
 Specifies the ratio between the resolution bandwidth and the frequency span. If span changed, RBW changes to maintain ratio.
 <real>::=.002 to .10 in a 2, 5, 10 sequence
 UP/DN increment::= 2, 5, 10 Sequence
 OUTPUT 718;"RBR .3;SP 100KHZ;TS;"
 Query response: <real>
 OUTPUT 718;"RBR DN DN DN;RBR ?;"
 ENTER 718;Rbw_ratio
 Corresponding key: RBW:SPAN

RCLS_<integer>|LAST|PWRON;
 Recalls the previously saved state stored in registers 0 through 9, the last state, or the power-on state.
 <integer>::=0 through 9
 OUTPUT 718;"IP;RCLS 2;"
 OUTPUT 718;"CF 10MHZ;SP 1MHZ;TS;IP;RCLS LAST;"
 Corresponding key: RECALL STATE

RCLT_(TRA|TRB),<integer>;
 Recalls the previously saved trace stored in registers 0 through 7.
 <integer>::= 0 through 7
 OUTPUT 718;"CLRW TRA;VIEW TRB;"
 OUTPUT 718;"RCLT TRB,4;"
 Corresponding keys: RECALL TO TRA, RECALL TO TRB

REV_?
 Returns the firmware revision number of the analyzer being used. Number returned is in the date format of "YYMMDD".
 Query response: <real>
 OUTPUT 718;"REV ?;"
 ENTER 718;Revision

RL_(*<real>*{amplitude units}) [UP|DN|EP]?;
 Specifies the reference level. Default units are dBm.
 UP/DN increment::= Log scale/div or 10 dB in Linear scale
 OUTPUT 718;"CF 300MHZ;SP 1MHZ;RL -10DBM;TS;"
 Query response: <numeric data format>
 OUTPUT 718;"TS;MKPK HI;MKRL;TS;"
 ENTER 718;Ref_lvl
 Corresponding key: AMPLITUDE, REF LVL
RLCAL_*<integer>*?;
 Calibrates reference level.
<integer>::= -30 through +30
 OUTPUT 718;"RLCAL ";Rl_cal
 Query response: <integer>
 OUTPUT 718;"RLCAL ?;"
 ENTER 718;Rl_cal
 Corresponding key: REF LVL CAL
ROFFSET_(*<real>*[DB]) [UP|DN|EP]?;
 Specifies the reference level offset. Default units are dBm.
 UP/DN increment::= Log scale/div or 10 dB in Linear scale
 OUTPUT 718;"ROFFSET -20DBM;"
 Query response: <numeric data format>
 OUTPUT 718;"ROFFSET?;"
 ENTER 718;Ref_offset
 Corresponding key: REF LVL OFFSET
RQS_*<integer>*?;
 Specifies a mask which allows the bits that are not masked for service request.
<integer>::= 0 through 255
 OUTPUT 718;"RQS 16;"
 OUTPUT 718;"RQS 4;"
 OUTPUT 718;"RQS 20;"
 Query response: returns the decimal weighting of the status byte bits which are enabled during a service request.
 OUTPUT 718;"RQS?;"
 ENTER 718;Rqs

SAVES.<integer>|PWRON;
 Saves the current state of the analyzer in the specified state register.
 <integer>::= 0 through 9
 OUTPUT 718;"CF 20MHZ;SAVES 3;IP;"
 Corresponding key: SAVE STATE

SAVET.(TRA|TRB),<integer>;
 Saves the current trace of the analyzer in the specified trace register.
 <integer>::= 0 through 7
 OUTPUT 718;"CLR TRB;TS;SAVET TRB,4;"
 Corresponding keys: SAVE TRACE A, SAVE TRACE B

SER?;
 Returns the serial number of the spectrum analyzer to the controller.
 OUTPUT 718;"SER?;"
 ENTER 718;Serial_number\$

SIGID_AUTO|MAN|OFF?;
 Identifies signals for the external mixing frequency bands.
 OUTPUT 718;"TS;MKPK HI;MKAL;SIGID AUTO;"
 Query response: 0 = OFF, 1 = MAN
 OUTPUT 718;"SIGID?;"
 ENTER 718;Status
 Corresponding key: SIG ID ON OFF

SNGLS;
 Selects single sweep mode.
 OUTPUT 718;"IP;CF 100MHZ;SP 1MHZ;SNGLS;TS;"
 Corresponding key: SINGLE

SP_(<real>[amplitude units])|UP|DN|FULL|ZERO|EP|?;
 Specifies the frequency span. Default units are Hz.
 UP/DN increment::=1,2,5 Sequence
 OUTPUT 718;"CF 10MHZ;SP DN DN;"
 OUTPUT 718;"TS;MKPK HI;MKTRACK ON;SP 100KHZ;TS;MKTRACK OFF;"
 Query response: <numeric data format>
 OUTPUT 718;"SP UP UP;SP?;"
 ENTER 718;Span
 Corresponding key: SPAN

SQUELCH_(<real>[amplitude units]) [ON|OFF|UP|DN|EP]?;
 Squelch for demodulation.
 UP/DN increment::= Log scale/div or 10 dB in Linear scale
 OUTPUT 718;"DEM0D AM;SQUELCH -80 DBM;"
 Query response: <numeric data format>
 OUTPUT 718;"SQUELCH?;"
 ENTER 718;Squelch
 Corresponding key: SQUELCH

SRQ_(integer);
 Sets a service request if the operand bits are allowed by RQS.
 <integer>::= 0 through 255
 OUTPUT 718;"RQS 4;SRQ 4;"

SS_(<real>[frequency units]) [UP|DN|AUTO|MAN|EP]?;
 Specifies the center frequency step size.
 Default units are Hz.
 UP/DN increment::= 1,2,5 Sequence
 OUTPUT 718;"CF 100MHZ;SS 100MHZ;"
 Query response: <numeric data format>
 OUTPUT 718;"TS;MKPK HI;MKSS;SS?;"
 ENTER 718;Step_size
 Corresponding key: CF STEP AUTO MAN

ST_(<real>[time units]) [UP|DN|EP|AUTO|MAN]?;
 Specifies the sweep time.
 Default units are seconds.
 UP/DN increment::= 1,2,5 Sequence
 OUTPUT 718;"CF 20MHZ;SP 10MHZ;ST UP UP;"
 OUTPUT 718;"ST 5SEC;"
 Query response: <numeric data format>
 OUTPUT 718;"SP 100KHZ;ST?;"
 ENTER 718;Sweep_time
 Corresponding key: SWP TIME AUTO MAN

STB?;
 Status byte query, returns to the controller the decimal equivalent of the bits set in the status byte.
 OUTPUT 718;"RQS 20;SRQ 20;"
 Repeat: !
 OUTPUT 718;"STB?"
 ENTER 718;Status

```

IF Status < > 20 THEN GOTO Repeat
SWPOUT_RAMP|FAV|?;
Sweep output.
RAMP::= sweep ramp 0 to 10 volts
FAV::= frequency analog voltage 0.5 volt/GHz.
OUTPUT 718:"SWPOUT RAMP;";
Query response: 0 = RAMP, 1 = FAV
OUTPUT 718;"SWPOUT ?;";
ENTER 718;Sweep
Corresponding key: REAR PNL OUTPUT
TDF_P|B|A|M|?;
Formats trace information for return to controller. IP selects P.
P::= enables output format as real numbers in Hz, volts, watts, dBm,
dBuV, dBmV, dBW, or seconds.
B::= enables binary format.
OUTPUT 718;"TS;VIEW TRA;TDF P:TRA?;";
Query response: P|B
OUTPUT 718;"TDF?;";
ENTER 718;Format$
TH_(<real>[amplitude units])|ON|OFF|UP|DN|EP|?;
Blanks signal responses below the specified threshold level. Default units,
zre dBm. Default level is 9 divisions below the reference level.
UP/DN increment::= Log scale/div or 10 dB in Linear scale
OUTPUT 718;"TH -75DBM;";
OUTPUT 718;"TH OFF: ";
Query response: <numeric data format>
OUTPUT 718;"TH?;";
ENTER 718;Threshold
TITLE_<string data field>;
Sets the analyzer to title mode where characters called from the analyzer
character set are displayed near the upper right-hand corner of the CRT.
Up to two 16 character lines can be displayed.
OUTPUT 718;"TITLE %This is a sample";
OUTPUT 718;"title, two lines%";
Corresponding key: SCREEN TITLE

```

```

TM_FREE|VID|LINE|EXT|?;
Selects the trigger mode.
OUTPUT 718;"TM LINE;"
OUTPUT 718;"TM FREE;"
Query response: FREE|VID|LINE|EXT
OUTPUT 718;"TM ?;"
ENTER 718;Trigger$
Corresponding key: TRIG
TRA_<block data field>|?;
Input or output 601 data points to/from trace A. (See TDF.) Places trace
A in view mode before trace data transfer.
DIM A(0:600)
OUTPUT 718;"TDF P;TRA";
FOR I=0 TO 599
OUTPUT 718;A(I);"DBM,";
NEXT I
OUTPUT 718;A(600);"DBM;"
Query response: <block data field>
DIM B(0:600)
OUTPUT 718;:"TDF P;TRA?;"
ENTER 718;B(*)
TRB_<block data field>|?;
Input or output 601 data points to/from trace B. (See TDF.) Places trace
B in view mode before trace data transfer.
INTEGER A(0:600)
OUTPUT 718;"TS;TDF B;TRB;"
OUTPUT 718 USING "#,W";A(*)
Query response: <block data field>
INTEGER A(0:600)
OUTPUT 718;"TDF B;TRB?;"
ENTER 718 using "#,W";A(*)
OUTPUT 718;"RL?;"
ENTER 718;Ref_lvl
OUTPUT 718;"LG ?;"
ENTER 718;Scale
FOR X=0 TO 600
A(X)=Ref_lvl+Scale*(A(X)/60-10)
NEXT X

```

TS;
 Takes a sweep.
OUTPUT 718;"SNGLS;CF 10MHZ;SP 1MHZ;TS;"
TWNDOW_(TRA|TRB),(UNIFORM|HANNING|FLATTOP);
 Creates window trace array for FFT command.
OUTPUT 718;"TWNDOW TRA, UNIFORM;"
VAVG.<average length>|ON|OFF|UP|DN|EP|?>;
 Turns the video averaging on or off.
 <average length>::=[NT and represents the maximum number of sweeps
 executed for averaging. Default length is 100.
 UP/DN increment::=1
OUTPUT 718;"VAVG 10;"
 Query response: <numeric data format>|NO-BUG
OUTPUT 718;"VAVG ?;"
ENTER 718;Vid_avg
 Corresponding key: VID AVG ON OFF
VB_(<real>[frequency units])|UP|DN|AUTO|MAN|EP|?;
 Specifies the video bandwidth. Default units are Hz.
 <real>::= 1 Hz to 3 MHz, 1,3 Sequence
 UP/DN increment::= 1,3 Sequence
OUTPUT 718;"RB 10KHZ;VB DN;"
OUTPUT 718;"VB 1HZ;"
 Query response: <numeric data format>
OUTPUT 718;"RB 100KHZ;VB UP UP;VB?;"
ENTER 718;Video_bw
 Corresponding key: VIDEO BW AUTO MAN
VBR_([+<real>)]|UP|DN|EP|?;
 Specifies the ratio between the video bandwidth and the resolution
 bandwidth. For example, an entry of .3 sets the video bandwidth one
 bandwidth step lower than the resolution bandwidth.
 <real>::= .003 to 3.00, 1, 3 Sequence
 UP/DN increment::= 1,3 Sequence
OUTPUT 718;"VBR 3;RB 10KHZ;"
 Query response: <numeric data format>
OUTPUT 718;"VBR DN DN;VBR?;"
ENTER 718;"Video_ratio
 Corresponding key: VBW:RBW

VIEW_TRA|TRB;
Stores and views the specified trace.
OUTPUT 718;"CLRW TRA;TS;VIEW TRA;"
Corresponding keys: VIEW A, VIEW B

VOL_<integer>|?;
Sets speaker volume. A value of 0 turns speaker off, a value of 255 turns speaker on full volume.
OUTPUT 718;"DEM0D FM;VOL 156;"
Query response: <integer>::= 0 through 255
OUTPUT 718;"VOL?;"
ENTER 718;Volume
Corresponding key: VOLUME

VTL_<real>[amplitude units] [UP|DN|EP]?;
Sets the level for video trigger.
UP/DN increment::=Log scale/div or 10 dB in Linear scale
OUTPUT 718;"TM VID;VTL -55 DBM;"
Query response: <real>
OUTPUT 718;"VTL ?;"
ENTER 718;Trig_lvl
Corresponding key: VIDEO

Secondary Key Word Summary

A	ampere (unit); A-block data format.
ALL	All.
AM	amplitude modulation (DEMOD).
ANNT	annotation
AUTO	Auto couple.
B	8-bit byte.
CURR	current (IF adjustment)
DB	Decibel (unit).
DBM	Absolute decibel milliwatt (unit).
DBMV	Decibel millivolt (unit).
DBUV	Decibel microvolt (unit).
DM	absolute decibel milliwatt (unit).
DN	Decreases parameter one step size
DSP	display.
EP	enable parameter for front panel operator entry while in remote mode.
EXT	External trigger.
FAV	frequency analog voltage (sweep output).
FM	frequency modulation (DEMOD).
FREE	Free run.
FULL	full band span width.
GHZ	Gigahertz (unit).
GRT	graticule.
GZ	Gigahertz (unit).
HARM	harmonic number (frequency diagnostic).

HI	Highest.
HZ	Hertz (unit).
I	I-block data format.
INT	internal (reference, mixer mode).
K	external mixer frequency band.
KHZ	Kilohertz (unit).
KZ	Kilohertz (unit).
LAST	previous state before a change.
LAST SPAN	previous span before a change.
LINE	Line trigger.
LO	local oscillator (frequency diagnostic).
M	ASCII display data output format.
MA	milliamp (unit).
MAN	manual operation.
MHZ	Megahertz (unit).
MROLL	main roller oscillator (frequency diagnostic).
MS	Millisecond (unit).
MSEC	millisecond (unit).
MV	Millivolts (unit).
MW	milliwatt (unit).
MZ	Megahertz (unit).
NEG	Negative.
NH	Next highest peak.
NL	Next peak left.
NRM	Normal.
NR	Next peak right.

OA	function query (same as ?).
OFF	Turn function off.
ON	Turn function on.
OROLL	offset roller oscillator (frequency diagnostic).
P	real number output format.
POS	Positive.
PWRON	sets same state as turning power on.
RAMP	sweep ramp voltage (sweep output)
S	second (unit)
SC	Seconds (unit).
SEC	second (unit).
SMP	Sample detection mode.
TRA	Trace A.
TRB	Trace B.
UA	microamp (unit).
UP	Increases the parameter one step size.
US	Microseconds (unit).
UV	Microvolts (unit).
V	Volts (unit).
VID	Video trigger.
W	Word (for MDS command).
XROLL	transfer roller oscillator (frequency diagnostic).
ZERO	zero span.
;	Semicolon (ASCII code 59).
,	Comma (ASCII code 44).
0	Off. Command argument.

1

On. Command argument.

?

Returns a query response containing the value or state of the associated parameter. The query response is followed by a carriage-return/line-feed.

Locating a Softkey

Use this appendix to locate a softkey. For each softkey listed, a corresponding front panel key is listed. Pressing this key presents the menu containing the desired softkey.

Table A-1. Softkey Locations

Softkey	Located Under this Hardkey
0→10V/LD SWP	(SWEEP)
5 V/GHz (FAV)	(SWEEP)
10 MHz IN EXT	(FREQUENCY)
99% POWER BW	(ON)
A	
ADJ CURR IE STATE	(AMPLITUDE)
A EXCH B	(TRACE)
AGC ON OFF	(DEMOD)
ALL	(AUTO COUPLE)
AM DEMOD ON OFF	(DEMOD)
AMPTD CORRECT	(EXT)
ANNOT ON OFF	(DISPLAY)
ATTEN	(AMPLITUDE)
ATTEN AUTO MAN	(AMPLITUDE)

Table A-1. Softkey Locations (continued)

Softkey	Located Under this Hardkey
AVERAGE CVV LOSS	EXT
A+B-A	TRACE
A-B-A ON/OFF	TRACE
A-B-DL-A OFF/OFF	TRACE
B	
BACK SPACE	DISPLAY
BIAS	EXT
BIAS OFF	EXT
BLANK A	TRACE
BLANK B	TRACE
B-DL-B	TRACE
C	
CENTER FREQ	FREQUENCY
CF STEP	FREQUENCY
CF STEP AUTO MAN	FREQUENCY
CHAR SET 1 2	TRACE
CLR-WRT A	TRACE
CLR-WRT B	TRACE
CVV LOSS VS FREQ	EXT
COLOR PRINT	DISPLAY
CONT	SWEEP, TRIG

A-2 Locating a Softkey

Table A-1. Softkey Locations (continued)

Softkey	Located Under this Hardkey
COUNTER ON OFF	FREQ COUNT
COUNTER RES	FREQ COUNT
CRT ADJ PATTERN	RECALL
D	
dBm	AMPLITUDE
dBmV	AMPLITUDE
dBuV	AMPLITUDE
DEMOD TIME	DEMOD
DETECTOR MODES	TRACE
DETECTOR NEG PEAK	TRACE
DETECTOR NORMAL	TRACE
DETECTOR POS PEAK	TRACE
DETECTOR SAMPLE	TRACE
DISPLAY LINE	DISPLAY
DISP LIN ON OFF	DISPLAY
E	
ELAPSED TIME	RECALL
ERASE TITLE	DISPLAY
EXTERNAL	TRIG
F	
FACTORY PRSEL PK	RECALL

Table A-1. Softkey Locations (continued)

Softkey	Located Under this Hardkey
FEL	TRACE
FREMOD ON/OFF	DEMOD
FOCUS	DISPLAY
FREE RUN	TRIG
FREQ DIAGNOSE	RECALL
FREQ DSP OFF	DISPLAY
FREQ OFFSET	FREQUENCY
FULL BAND	EXT
FULL IF ADJ	AMPLITUDE
FULL SPAN	SPAN
G	
GRAT. ON. OFF.	DISPLAY
H	
HP-IB ADDRESS	PRESET
I	
IF ADJ ON/OFF	AMPLITUDE
IF ADJUST	AMPLITUDE
INTEN	DISPLAY
L	
LAST SPAN	SPAN

Table A-1. Softkey Locations (continued)

Softkey	Located Under this Hardkey
LAST STATE	PRESET
LINE	TRIG
LINEAR	AMPLITUDE
LOCK HARMONIC	EXT
LOCK ON OFF	EXT
LO FREQ	RECALL
LOG dB/DIV	AMPLITUDE
M	
MAIN ROLLER	RECALL
MARKER DELTA	FREQ COUNT, MKR→, ON, PEAK SEARCH
MARKER NORMAL	DEMOD, FREQ COUNT, ON, MKR→, EXT
MARKER→CF	MKR→, PEAK SEARCH
MARKER→CF STEP	MKR→
MARKER→REF LVL	MKR→
MARKER 1/DELTA	ON
MAX HOLD A	TRACE
MAX HOLD B	TRACE
MAX MXR LEVEL	AMPLITUDE, AUTO COUPLE
MAX NO. VID AVGS	BW
MKRNOISE ON OFF	ON, PEAK SEARCH
MKRA→CF	MKR→
MKRA→CF STEP	MKR→

Table A-1. Softkey Locations (continued)

Softkey	Located Under this Hardkey
MKR→SPAN	(MKR→)
MKR 1/A→CF	(MKR→)
MKR 1/A→CF STEP	(MKR→)
WORE TRC MATH	(TRACE)
N	
NEGATIVE BIAS	(EXT)
NEXT PEAK	(DEMOD), (FREQ COUNT), (PEAK SEARCH), (EXT)
NEXT PEAK LEFT	(PEAK SEARCH)
NEXT PEAK RIGHT	(PEAK SEARCH)
O	
OFFSET ROLLER	(RECALL)
P	
PEAK EXCURSN	(PEAK SEARCH)
PEAK SEARCH	(DEMOD), (FREQ COUNT), (MKR→), (EXT)
PEAK THRSBLD	(PEAK SEARCH)
PLOT	(DISPLAY)
PLOT ANNOT	(DISPLAY)
PLOT GRATICUL	(DISPLAY)
PLOT OPTIONS	(DISPLAY)
PLOT ORG DSP GRAT	(DISPLAY)
PLOT TRACE A	(DISPLAY)

Table A-1. Softkey Locations (continued)

Softkey	Located Under this Hardkey
PLOT TRACE B	DISPLAY
POSITIVE BIAS	EXT
PRESEL AUTO PK	INT
PRESEL MAN ADJ	INT
PRINT	DISPLAY
PRINT PLOT	DISPLAY
PWR DN STATE	SAVE
R	
RBW:SPAN	AUTO COUPLE
REALIGN LO & IP	PRESET
REAR PNL OUTPUT	SWEEP
RECALL ERRORS	RECALL
RECALL PRESEL PK	RECALL
RECALL PWR DN	PRESET
RECALL STATE	RECALL
RECALL TO TRA	RECALL
RECALL TO TRB	RECALL
REF LVL	AMPLITUDE
REF LVL CAL	AMPLITUDE
REF LVL OFFSET	AMPLITUDE
RES BW	BW
RES BW AUTO MAN	BW

Table A-1. Softkey Locations (continued)

Softkey	Located Under this Hardkey
S	
SAMPLER FREQ	RECALL
SAMPLER HARMONIC	RECALL
SAVE LOCK ON OFF	SAVE
SAVE PRSEL PK	SAVE
SAVE STATE	SAVE
SAVE TRACE A	SAVE
SAVE TRACE B	SAVE
SCREEN TITLE	DISPLAY
SELECT CHAR	DISPLAY
SIG ID AT MKR	EXT, INT
SIG ID ON OFF	EXT, INT
SIGID CP	EXT, INT
SIGNAL IDENT	EXT
SIG TRK ON OFF	ON, PEAK SEARCH
SINGLE	SWEEP, TRIG
SPACE	DISPLAY
SPAN WIDTH	SPAN
SQUELCH	DEMOD
SQUELCH ON OFF	DEMOD
START FREQ	FREQUENCY
STATE #	RECALL, SAVE

Table A-1. Softkey Locations (continued)

Softkey	Located Under this Hardkey
STOP FREQ	FREQUENCY
SWEEP TIME	SPAN, SWEEP
SWP TIME AUTO MAN	SPAN, SWEEP
T	
THRESHLD	DISPLAY
THRESHLD ON OFF	DISPLAY
TITLE DONE	DISPLAY
TRACE A	TRACE
TRACE B	TRACE
TRANSFER ROLLER	RECALL
U	
UNITS	AMPLITUDE
UNITS AUTO MAN	AMPLITUDE
V	
VBW:RBW	AUTO COUPLE
VIDEO AVG ON OFF	BW
VIDEO	TRIG
VIDEO BW	BW
VIDEO BW AUTO MAN	BW
VIEW A	TRACE
VIEW B	TRACE

Table A-1. Softkey Locations (continued)

Softkey	Located Under this Hardkey
VOLTS VOLUME	AMPLITUDE DEMODE
W WATTS	AMPLITUDE
Z ZERO SPAN	SPAN

Programming Command to Key

Table B-1. Programming Command to Key

Command	Name	Key
ADJALL	Execute Turn-on Adjustments	
ADJCRT	CRT Adjustment Pattern	CRT ADJ PATTERN
ADJIF	Execute IF Adjustments	FULL IF ADJ
AMB	Trace A Minus Trace B	A-B → A ON OFF
AMBPL	Trace A Minus Trace B Plus Display Line	A-B+DL → A ON OFF
ANNOT	Annotation On/Off	ANNOT ON OFF
APB	Trace A Plus Trace B	A+B → A
AT	Input Attenuator	ATTEN ATTEN AUTO MAN
AUNITS	Absolute Amplitude Units	UNITS
AUTOCP	Autocouple All "AUTO" Functions	ALL
AXB	Trace A Exchange Trace B	A EXCH B
BLANK	Blank Trace	BLANK A BLANK B
BML	Trace A Minus Display Line	B-DL → B
CF	Center Frequency	FREQUENCY CENTER FREQ
CLRW	Clear/Write Trace	CLR-WRT A CLR-WRT B

Table B-1. Programming Command to Key (continued)

Command	Name	Key
CNVLOSS	External Mixer Conversion Loss	CONV LOSS VS FREQ
CONTS	Continuous Sweep	CONT
COUPLE	HP 8561A. Couple ac or dc input	COUPLING AC DC
DEMODO	Demodulation	AM DEMOD ON OFF FM DEMOD ON OFF
DEMODAGC	Demodulation Automatic Gain Control	
DEMODT	Demodulation Time	DEMOD TIME
DET	Detection Mode	DETECTOR MODES
DL	Display Line	DISP LYM ON OFF
DONE	Done	
ERR	Command Error	
ET	Elapsed Time	ELAPSED TIME
FA	Start Frequency	START FREQ
FB	Stop Frequency	STOP FREQ
FDIAG	Frequency Diagnostics	FREQ DIAGNOSE
FDSP	Frequency Display	FREQ DSP OFF
FFT	Fast Fourier Transform	FFT
FOFFSET	Frequency Offset	FREQ OFFSET
FREF	Frequency Reference	10 MHz INT EXT
FS	Full Span	FULL SPAN
FULBAND	Full Band	FULL BAND

B-2 Programming Command to Key

Table B-1. Programming Command to Key (continued)

Command	Name	Key
GRAT	Graticule On/Off	GRAT ON OFF
HD	Hold	HOLD
HNLOCK	Harmonic Number Lock	LOCK ON OFF
HNUNLK	Unlock Harmonic Number	LOCK ON OFF
ID	Output Identification	
IDCF	Signal Identification Frequency to Center Frequency	SIGID--CF
IDFREQ	Signal Identification to Frequency Found	
IP	Instrument Preset	PRESET RECALL PWR ON
LG	Logarithmic Display Scale	LOG dB/DIV
LN	Linear Display Scale	LINEAR
MBIAS	Mixer Bias	BIAS
MINH	Minimum Trace Hold	
MKA	Marker Amplitude	
MKCF	Marker to Center Frequency	MARKER--CF
MKD	Marker Delta	MARKER DELTA
MKDR	Marker Delta Reciprocal	MARKER 1/DELTA
MKF	Marker Frequency	
MKFC	Marker Frequency Count	COUNTER ON OFF
MKFCR	Marker Frequency Count Resolution	COUNTER RES
MKMIN	Marker to Minimum	

Table B-1. Programming Command to Key (continued)

Command	Name	Key
MKN	Marker Normal	MARKER NORMAL
MKNOISE	Marker Noise	MARKER NOISE ON OFF
MKOFF	Marker Off	OFF
MKPK	Marker Peak Search	PEAK SEARCH PEAK SEARCH
MKPX	Marker Peak Excursion	PEAK EXCURSE
MKREAD	Marker Readout	
MKRL	Marker to Reference Level	MARKER REF LVL
MKSP	Marker Delta to Span	MARKER Δ SPAN
MKSS	Marker to Center Frequency Step Size	MARKER Δ CF STEP
MKT	Marker Time	MARKER Δ DELTA (when span > 0 Hz)
MKTRACK	Marker Signal Track	SIG TRK ON OFF
ML	Mixer Level	MAX MIX LEVEL
MXMH	Maximum Hold	MAX HOLD A MAX HOLD B
OP	Output Display Parameters	
PLOT	Plot Display	PLOT
PP	Preselector Peak	PRESEL AUTO PK
PRESEL	Preselector Data	RECALL PRESEL PK FACTORY PRESEL PK
PRINT	Print display	PRINT COLOR PRINT
PSTATE	Protect State	SAVELOCK ON OFF
PWRBW	Trace Power Bandwidth	99% POWER BW

B-4 Programming Command to Key

Table B-1. Programming Command to Key (continued)

Command	Name	Key
RB	Resolution Bandwidth	RES BW AUTO MAN
RBR	Resolution Bandwidth to Span Ratio	RBW:SPAN
RCLS	Recall State Register	RECALL STATE
RCLT	Recall Trace Register	RECALL TO TRA RECALL TO TRB
REV	Output Revision Number	
RL	Reference Level	(AMPLITUDE) REF LVL
RLCAL	Reference Level Calibration	REF LVL CAL
ROFFSET	Reference Level Offset	REF LVL OFFSET
RQS	Request Service Conditions	
SAVES	Save State	SAVE STATE
SAVET	Save Trace	SAVE TRACE A SAVE TRACE B
SER	Serial Number	
SIGDEL	Signal Amplitude Delta	
SIGID	Signal Identify	SIG ID ON OFF
SNGLS	Single Sweep	SINGLE
SP	Frequency Span	(SPAN)
SQUELCH	Squelch for Demodulation	SQUELCH
SRQ	Service Request	
SS	Center Frequency Step Size	CF STEP AUTO MAN
ST	Sweep Time	SWP TIME AUTO MAN
STB	Status Byte Query	

Table B-1. Programming Command to Key (continued)

Command	Name	Key
SWPOUT	Sweep Output	REAR PNL OUTPUT
TDF	Trace Data Format (Parameter Units ASCII or Binary)	
TITLE	Title Entry	SCREEN TITLE
TM	Trigger Mode	(TRIG)
TRA	Trace A Data Input/Output	
TRB	Trace B Data Input/Output	
TS	Take Sweep	
TWNDOW	Trace window	
VAVG	Video Average	VID AVG ON/OFF
VB	Video Bandwidth	VIDEO BW AUTO/MAN
VBR	Video Bandwidth Resolution Bandwidth Ratio	VBW/RSW
VIEW	View Trace	VIEW A VIEW B
VOL	Volume	(()) VOLUME
VTL	Video Trigger Level	VIDEO

Key to Programming Command

Table C-1. Key to Programming Command

Key	Name	Command
	Execute Turn-on Adjustments	ADJALL
CRT ADJ PATTERN	CRT Adjustment Pattern	ADJCRT
FULL IF ADJ	Execute IF Adjustments	ADJIF
A-B → A ON OFF	Trace A Minus Trace B	AMB
A-B+DL → A ON OFF	Trace A Minus Trace B Plus Display Line	AMBPL
ANNOT ON OFF	Annotation On/Off	ANNOT
A+B → A	Trace A Plus Trace B	APB
ATTEN ATEN AUTO MAN	Input Attenuator	AT
UNITS	Absolute Amplitude Units	AUNITS
ALL	Autocouple All "AUTO" Functions	AUTOCP
A EXCH B	Trace A Exchange Trace B	AXB
BLANK A BLANK B	Blank Trace	BLANK
B-DL → B	Trace A Minus Display Line	BML
(FREQUENCY) CENTER FREQ	Center Frequency	CF
CLR-WRT A CLR-WRT B	Clear/Write Trace	CLRW

Key to Programming Command C-

Table C-1. Key to Programming Command (continued)

Key	Name	Command
CNV LOSS VS FREQ	External Mixer Conversion Loss	CNVLOSS
CONT	Continuous Sweep	CONTS
COUPLING AC DC	HP 8561A. Couple ac or dc input	COUPLE
AM DEMOD ON OFF FM DEMOD ON OFF	Demodulation	DEMOMOD
	Demodulation Automatic Gain Control	DEMOMODAGC
DEMOMOD TIME	Demodulation Time	DEMOMODT
DETECTOR MODES	Detection Mode	DET
DISP LIN ON OFF	Display Line	DL
	Done	DONE
	Command Error	ERR
ELAPSED TIME	Elapsed Time	ET
START FREQ	Start Frequency	FA
STOP FREQ	Stop Frequency	FB
FREQ DIAGNOSE	Frequency Diagnostics	FEDIAG
FREQ DSP OFF	Frequency Display	FEDSP
FFT	Fast Fourier Transform	FFT
FREQ OFFSET	Frequency Offset	FOFFSET
10 MHz INT EXT	Frequency Reference	FREF
FULL SPAN	Full Span	FS
FULL BAND	Full Band	FULBAND

C-2 Key to Programming Command

Table C-1. Key to Programming Command (continued)

Key	Name	Command
GRAT ON OFF	Graticule On/Off	GRAT
HOLD	Hold	HD
LOCK ON OFF	Harmonic Number Lock	HNLOCK
LOCK ON OFF	Unlock Harmonic Number	HNUNLK
	Output Identification	ID
SIGID → CF	Signal Identification Frequency to Center Frequency	IDCF
	Signal Identification to Frequency Found	IDFREQ
PRESET RECALL PWR ON	Instrument Preset	IP
LOG dB/DIV	Logarithmic Display Scale	LG
LINEAR	Linear Display Scale	LN
BIAS	Mixer Bias	MBIAS
	Minimum Trace Hold	MINH
	Marker Amplitude	MKA
MARKER → CF	Marker to Center Frequency	MKCF
MARKER DELTA	Marker Delta	MKD
MARKER 1/DELTA	Marker Delta Reciprocal	MKDR
	Marker Frequency	MKF
COUNTER ON OFF	Marker Frequency Count	MKFC
COUNTER RES	Marker Frequency Count Resolution	MKFCR
	Marker to Minimum	MKMIN

Table C-1. Key to Programming Command (continued)

Key	Name	Command
MARKER NORMAL	Marker Normal	MKN
MKNOISE ON OFF	Marker Noise	MKNOISE
OFF	Marker Off	MKOFF
PEAK SEARCH PEAK SEARCH	Marker Peak Search	MKPK
PEAK EXCURSION	Marker Peak Excursion	MKPX
	Marker Readout	MKREAD
MARKER REF LVL	Marker to Reference Level	MKRL
MKDA SPAN	Marker Delta to Span	MKSP
MARKER CF STEP	Marker to Center Frequency Step Size	MKSS
MARKER 1/DELTA (when span > 0 Hz)	Marker Time	MKT
SIG TRK ON OFF	Marker Signal Track	MKTRACK
MAX MIX LEVEL	Mixer Level	ML
MAX HOLD A MAX HOLD B	Maximum Hold	MXMH
	Output Display Parameters	OP
PLOT	Plot Display	PLOT
PRESEL AUTO PK	Preselector Peak	PP
RECALL PRESEL PK	Preselector Data	PRESEL
FACTORY PRESEL PK		
PRINT COLOR PRINT	Print display	PRINT
SAVELOCK ON OFF	Protect State	PSTATE
90% POWER BW	Trace Power Bandwidth	PWRBW
RES BW AUTO MAN	Resolution Bandwidth	RB

C-4 Key to Programming Command

Table C-1. Key to Programming Command (continued)

Key	Name	Command
RBW:SPAN	Resolution Bandwidth to Span Ratio	RBR
RECALL STATE	Recall State Register	RCLS
RECALL TO TRA RECALL TO TRB	Recall Trace Register	RCLT
	Output Revision Number	REV
(AMPLITUDE) REF LVL	Reference Level	RL
REF LVL CAL	Reference Level Calibration	RLCAL
REF LVL OFFSET	Reference Level Offset	ROFFSET
	Request Service Conditions	RQS
SAVE STATE	Save State	SAVES
SAVE TRACE A SAVE TRACE B	Save Trace	SAVET
	Serial Number	SER
	Signal Amplitude Delta	SIGDEL
SIG-ID ON OFF	Signal Identify	SIGID
SINGLE	Single Sweep	SINGLS
(SPAN)	Frequency Span	SP
SQUELCH	Squelch for Demodulation	SQUELCH
	Service Request	SRQ
CF STEP AUTO MAN	Center Frequency Step Size	SS
SWP TIME AUTO MAN	Sweep Time	ST
	Status Byte Query	STB

Key to Programming Command C-

Table C-1. Key to Programming Command (continued)

Key	Name	Command
REAR PNL OUTPUT	Sweep Output	SWPOUT
	Trace Data Format (Parameter Units ASCII or Binary)	TDF
SCREEN TITLE	Title Entry	TITLE
TRIG	Trigger Mode	TM
	Trace A Data Input/Output	TRA
	Trace B Data Input/Output	TRB
	Take Sweep	TS
	Trace window	TWNDOW
VID AVG ON OFF	Video Average	VAVG
VIDEO BW AUTO MAN	Video Bandwidth	VB
VBW:RBW	Video Bandwidth Resolution Bandwidth Ratio	VBR
VIEW A VIEW B	View Trace	VIEW
(VOLUME)	Volume	VOL
VIDEO	Video Trigger Level	VTL

HP-IB Errors

This appendix contains the possible error messages that can appear in the lower-right corner of the display during remote operation. Another aid for determining programming errors is the **ERRORS** softkey. If an HP-IB error is generated in the analyzer during remote operation, **ERRORS** appears on the analyzer screen. Press this key to read the errors. The cause of the error appears in the active function block. After reviewing the errors, press **RECALL** or **EXIT** to return the previous spectrum analyzer display.

Table D-1. Error Codes

Error Code	Error	Probable Cause
100	NO PWRON	Power-on state not valid; a default state was loaded instead
101	NO STATE	Recalled state not valid or not saved
106	ABORTED!	Aborted operation
107	HELLO ??	NO HP-IB listener on bus
108	TIME OUT	Controller time out
109	CTRLFAIL	Take control of HP-IB failed
110	NOT CTRL	Not a controller
111	# ARGMTS	Command does not have enough arguments
112	??CMD??	Command not recognized
113	FREQ NO!	Command cannot have frequency units
114	TIME NO!	Command cannot have time units
115	AMPL NO!	Command cannot have amplitude units
116	UNITS??	Units not recognized
117	NOP NUM	Command cannot have numeric units
118	NOP EP	Enable parameter cannot be used
119	NOP UPDN	Up/down are not valid arguments for the command
120	NOP ONOF	On/off are not valid arguments for the command
121	NOP ARG	Auto/man are not valid arguments for the command

Table D-1. Error Codes (continued)

Error Code	Error	Probable Cause
122	NOP TRC	Trace register not valid for the command
123	NOP ABLK	A-block not valid for the command
124	NOP IBLK	I-block not valid for the command
125	NO STRNG	Strings are not valid for the command
126	NO ?	Query is not allowed for the command
127	BAD DTMD	Detector mode is not valid
128	PK WHAT?	Peak-search parameter is not valid
129	PRE TERM	Premature termination
130	BAD TDF	Arguments are valid only for the TDF command
131	?? AM/FM	AM/FM are not valid arguments for the command
132	FAV/RMP	FAV/RAMP are not valid arguments for the command
133	INT/EXT	INT/EXT are not valid arguments for the command
134	??? ZERO	ZERO is not a valid argument for the command
135	??? CURR	CURR is not a valid argument for the command
136	??? FULL	FULL is not a valid argument for the command
137	??? LAST	LAST is not a valid argument for the command
138	GRT/DSP	GRT/DDSP is not a valid argument for the command
139	PLOTONLY	Use argument only with the PLOT command
140	??PWRON	PWRON is not a valid argument for the command
141	BAD ARG	Argument is valid only for the FDIAG command
142	BAD ARG	Query is expected for the FDIAG command
143	NO PRESL	Preselector hardware is required
144	NEXT 44	Next error space

Softkey Menus

The following menus appear on the display when the indicated front-panel keys are pressed.

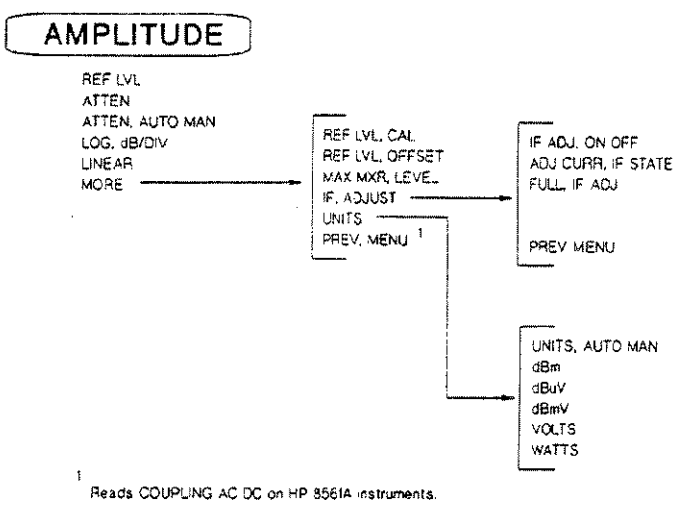

**AUTO
COUPLE**

ALL
VBW:RBW
RBW:SPAN
MAX MXR, LEVEL

BW

RES BW
RES BW, AUTO MAN
VIDEO BW
VIDEO BW, AUTO MAN
MAX. NO., VID AVGS
VID AVG, ON OFF

DEMODO

AM DEMOD. ON OFF
FM DEMOD. ON OFF
MARKER. NORMAL ¹
PEAK. SEARCH
NEXT. PEAK
MORE

DEMOD. TIME
VOLUME
SCUELCH
SCUELCH. ON OFF
AGC. ON OFF
PREV. MENU

¹ Reads "MARKER DELTA" when two markers are active or "CENTER FREQ" when SPAN = 0.

DISPLAY

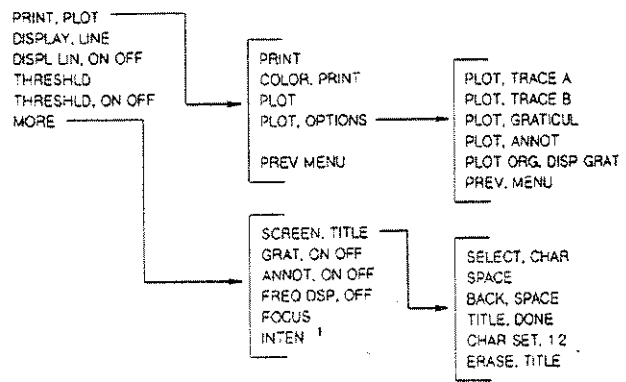

¹ For outdoor use, maximum intensity is 255.
For indoor use, keep intensity around 80.

EXT

FULL BAND
LOCK HARMONIC
LOCK, ON OFF
AMPTD. CORRECT
SIGNAL IDENT
BIAS

AVERAGE, CNV LOSS
CNV LOSS, VS FREQ

PREV MENU

SIG ID, AT MKR
SIG ID, \rightarrow CF
SIG ID, ON OFF
MARKER, NORMAL
PEAK, SEARCH
NEXT, PEAK 1

BIAS, OFF
POSITIVE, BIAS
NEGATIVE, BIAS

PREV, MENU

¹ Active when marker is on.

FREQUENCY

CENTER, FREQ
START, FREQ
STOP, FREQ
CF STEP
CF STEP, AUTO MAN
MORE

FREQ. OFFSET
10 MHz, EXT INT

PREV, MENU

FREQ COUNT

COUNTER, ON OFF
COUNTER, RES
MARKER, NORMAL
MARKER DELTA
PEAK, SEARCH
NEXT, PEAK

INT

PRESEL, MAN ADJ
PRESEL, AUTO PK
SIG ID, AT MKR
SIG ID, ← CF
SIG ID, ON OFF

MKR →

(Single Marker Active)

MARKER, NORMAL
MARKER, DELTA
PEAK, SEARCH
MARKER →, REF LVL
MARKER →, CF¹
MARKER →, CF STEP¹

MKR →

(Marker Delta Active)

MARKER, NORMAL
MARKER, DELTA
PEAK, SEARCH
MKR Δ →, SPAN¹
MKR Δ →, CF²
MKR Δ →, CF STEP²

¹ Active when SPAN > 0 Hz.

² * Δ * changes to *1/Δ* when SPAN = 0 Hz

ON

MARKER, NORMAL
MARKER, DELTA
MARKER, 1/DELTA
MKRNOISE, ON OFF
SIG TRK, ON OFF
99%, POWER SW

PEAK SEARCH

MARKER \rightarrow CF ¹
MARKER, DELTA
NEXT, PEAK
MKRNOISE, ON OFF
SIG TRK, ON OFF
MORE \rightarrow

NEXT PK, RIGHT
NEXT PK, LEFT
PEAK, EXCURSN
PEAK, THRESHLD
PREV, MENU

¹ Active when SPAN > 0 Hz. Reads
MARKER NORMAL when SPAN = 0 Hz.

PRESET

RECALL, PWR ON
LAST, STATE
REALIGN, LO & IF
HP-IB, ADDRESS

RECALL

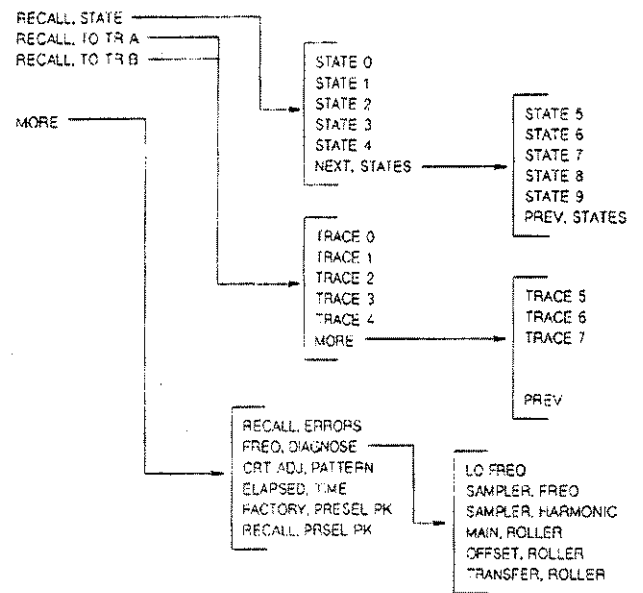

For states and traces stored from titled displays, "STATE", "TRACE", and numbers are replaced with the first 16 characters of the title.

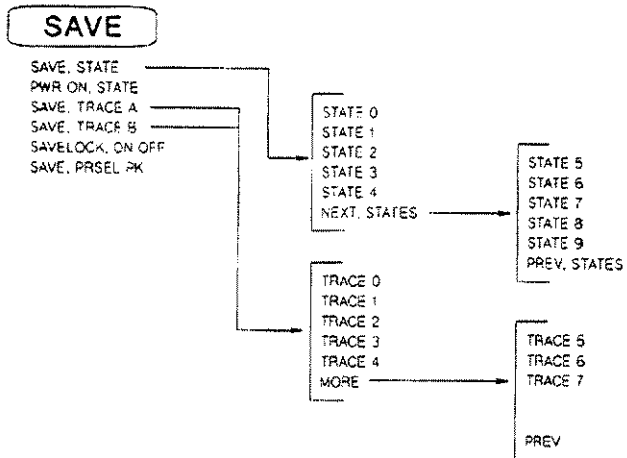

For states and traces stored from titled displays, "STATE", "TRACE", and numbers are replaced with the first 16 characters of the title.

SPAN

SPAN, WIDTH
 FULL, SPAN
 ZERO, SPAN
 LAST, SPAN
 SWEEP, TIME
 SWP TIME, AUTO MAN

SWEEP

CONT
SINGLE
SWEEP, TIME
SWP TIME, AUTO MAN
REAR PNL, OUTPUT

0 → 10V. LO SWP
.5V/GHz, FAV
PREV. MENU

TRACE

CLR-WRT, A
MAX HOLD, A
VIEW, A
BLANK, A
TRACE, B
MORE

CLR-WRT, B
MAX HOLD, B
VIEW, B
BLANK, B
TRACE, A¹
MORE

A-B → A, ON OFF
A-B+DL → A, ON OFF
MORE TRC MATH
DETECTOR, MODES
FF?
PREV MENU

A+B → A
A EXCH B
B-DL → B
PREV. MENU

DETECTOR, NORMAL
DETECTOR, SAMPLE
DETECTOR, POS PEAK
DETECTOR, NEG PEAK
PREV MENU

¹ TRACE A returns to TRACE A menu.

TRIG

- CONT
- SINGLE
- FREE RUN
- VIDEO
- LINE
- EXTERNAL

Index

- 0
- 0.5 V/GHz (FAV) function, 1-15
- 0→10V LO SWP function, 1-15
- 1
- 10 MHz connector, 1-5
- 10 MHz EXT INT function, 1-15
- 9
- 99% POWER BW function, 1-15
- A
- A+B→A function, 1-15
- ADJALL command, 2-7, 2-12
- ADJCRT command, 2-7, 2-12
- ADJ CURR IF STATE function, 1-15
- ADJIF command, 2-7, 2-12
- A EXCH B function, 1-16
- AGC ON OFF function, 1-16
- ALL function, 1-16
- AMB command, 2-10, 2-12
- AMBPL command, 2-10, 2-12
- AM DEMOD ON OFF function, 1-16
- A→B→A ON OFF function, 1-15
- amplitude, 1-2
 - control, 2-5
- AMPLITUDE
 - function, 1-16
 - menu, E-1
- AMPTD CORRECT function, 1-16
- annotation
 - +, 1-7
 - A, 1-7
 - D, 1-7
 - F, 1-7
 - K, 1-7
 - M, 1-7
 - R, 1-7
 - S, 1-7
 - T, 1-7
 - X, 1-7
- ANNO command, 2-6, 2-12
- ANNO ON OFF function, 1-16
- APB command, 2-10, 2-13
- AT AUTO command, 2-5
- AT command, 2-5, 2-13
- ATTEN AUTO MAN function, 1-16
- ATTEN function, 1-16
- AUNITS command, 2-5-6, 2-11, 2-13
- AUTO COUPLE
 - function, 1-16
 - menu, E-2
- AUTOCP command, 2-5, 2-13
- AVERAGE CNV LOSS function, 1-16
- AXB command, 2-10, 2-13
- B
- BACK SPACE function, 1-16
- bandwidth control, 2-5
- BIAS function, 1-16
- BIAS OFF function, 1-17
- BLANK A function, 1-17
- BLANK B function, 1-17
- BLANK command, 2-10, 2-13

B-DL-B function, 1-16
BML command, 2-10, 2-14
BW
function, 1-17
menu, E-2

C

calibration, 1-13
caution
maximum input level, 1-1
voltage selection, 1-1
CENTER FREQ function, 1-17
CF command, 2-7, 2-14
CF STEP AUTO MAN function, 1-17
CF STEP function, 1-17
CHAR SET 1 2 function, 1-17
CLR W command, 2-10, 2-14
CLR WRT A function, 1-17
CLR WRT B function, 1-17
CNVLOSS command, 2-6, 2-14
CNV LOSS VS FREQ function, 1-17
COLOR function, 1-18
COLOR PRINT function, 1-18
CONT function, 1-18
control, 1-3
CONTS command, 2-10, 2-14
COUNTER ON OFF function, 1-18
COUNTER RES function, 1-18
COUPLE command, 2-5, 2-14
COUPLING AC DC function, 1-18
coupling control, 2-5
CRT ADJ PATTERN function, 1-18
CRT alignment, 1-5

D

data keys, 1-3
dBm function, 1-19
dB μ V function, 1-19
dBmV function, 1-19
DEMOD
command, 2-6, 2-15

function, 1-16
menu, E-3
DEMODAGC command, 2-6, 2-15
DEMOT command, 2-6, 2-15
DEMOT TIME function, 1-19
demodulation, 2-6
DET command, 2-11, 2-15
DETECTOR MODES function, 1-19
display
annotation, 1-6
control, 2-6
DISPLAY
function, 1-19
menu, E-4
DISPLAY LINE function, 1-19
DL command, 2-6, 2-16
DLE command, 2-6
DONE? command, 2-10
DSPL LIN ON OFF function, 1-19

E

earphone jack, 1-4
ELAPSED TIME function, 1-19
ERASE TITLE function, 1-19
ERR? command, 2-7, 2-16
error messages, D-1
ET? command, 2-7, 2-16
EXT
function, 1-19
menu, E-5
EXTERNAL function, 1-19
external mixer
commands, 2-6
external reference, 1-5

F

FA command, 2-7, 2-16
FACTORY PRSEL PK function, 1-20
FAV, 1-5
FB command, 2-7, 2-17
FDIAG command, 2-7, 2-17

FDSP command, 2-6, 2-17
 FFT
 command, 2-10, 2-17
 function, 1-20
 FM DEMOD ON OFF function, 1-20
 FOCUS function, 1-20
 FOFFSET command, 2-7, 2-17
 FREE RUN function, 1-20
 FREF command, 2-7, 2-18
 FREQ COUNT
 function, 1-20
 menu, E-6
 FREQ DIAGNOSE function, 1-20
 FREQ DSP OFF function, 1-20
 FREQ OFFSET function, 1-20
 frequency, 1-2
 band overlap, 1-10
 control, 2-7
 range, 1-1
 FREQUENCY
 function, 1-20
 menu, E-6
 FS command, 2-7, 2-18
 FULBAND command, 2-6-7, 2-18
 FULL BAND function, 1-20
 FULL IF ADJ function, 1-21
 FULL SPAN function, 1-21

G
 GRAT command, 2-6, 2-18
 GRAT ON OFF function, 1-21

H
 HD command, 2-11, 2-19
 HNLOCK command, 2-6, 2-19
 HNUNLK command, 2-6, 2-19
 HOLD function, 1-21
 HP-IB
 connector, 1-4
 errors, D-1
 HP-IB ADDRESS function, 1-21

I
 IDCF command, 2-6, 2-19
 ID? command, 2-7, 2-19
 IDFREQ command, 2-6, 2-19
 IF ADJ ON OFF function, 1-22
 IF ADJUST function, 1-21
 input connectors
 CAL OUTPUT, 1-4
 IF INPUT, 1-4
 INPUT 50Ω, 1-4
 PROBE POWER, 1-4
 instrument state, 1-3
 control, 2-7
 INT
 function, 1-22
 menu, E-6
 INTEN function, 1-22
 IP command, 2-7, 2-20

J
 J1, 1-4
 J2, 1-4
 J3, 1-4
 J4, 1-4
 J5, 1-4
 J6, 1-5
 J8, 1-5
 J9, 1-5

L
 LAST SPAN function, 1-22
 LAST STATE function, 1-22
 LG command, 2-5-6, 2-20
 LINEAR function, 1-22
 LINE function, 1-22
 line input voltage, 1-1
 LN command, 2-5-6, 2-20
 LOCK HARMONIC function, 1-22
 LOCK ON OFF function, 1-22
 LO FREQ function, 1-22

LOG dB/DIV function, 1-22

M

MAIN ROLLER function, 1-22

marker, 1-3

commands, 2-8

MARKER 1/ Δ function, 1-23

MARKER DELTA function, 1-23

MARKER NORMAL function, 1-23

MARKER—CF function, 1-22

MARKER—CF STEP function, 1-23

MARKER—REF LVL function, 1-23

MAX HOLD A function, 1-23

MAX HOLD B function, 1-23

MAX MXR LEVEL function, 1-23

MAX. NO. VID AVGS function, 1-23

MBIAS command, 2-6, 2-20

measurement

basic technique, 1-8

MINH command, 2-10, 2-20

MKA? command, 2-11

MKA command, 2-8, 2-20

MKCF command, 2-8, 2-21

MKD command, 2-8

MKDR command, 2-8, 2-21

MKFC command, 2-8, 2-21

MKF command, 2-8, 2-11, 2-21

MKPCR command, 2-7-8, 2-22

MKMIN command, 2-8, 2-22

MKN command, 2-8, 2-22

MKNOISE command, 2-8, 2-22

MKOFF command, 2-8, 2-22

MKPK command, 2-8, 2-23

MKPT command, 2-8, 2-23

MKPX command, 2-6, 2-8, 2-23

MKR

menu, E-7

MKR 1/ Δ —CF function, 1-24

MKR 1/ Δ —CF STEP function, 1-24

MKRL command, 2-5, 2-8, 2-23

MKRNOISE ON OFF function, 1-24

MKR— function, 1-24

MKRA—CF function, 1-23

MKRA—CF STEP; function, 1-23

MKRA—SPAN function, 1-23

MKSP command, 2-8, 2-23

MKSS command, 2-8, 2-23

MKSWP command, 2-8

MKT command, 2-8, 2-24

MKTRACE command, 2-8, 2-24

MKTRACK command, 2-8, 2-24

ML command, 2-5, 2-24

MODULE function, 1-24

MORE function, 1-24

MORE TRC MATH function, 1-24

MXMH command, 2-10, 2-24

MXRMODE command, 2-6, 2-25

N

NEGATIVE BIAS function, 1-24

NEXT PEAK function, 1-24

NEXT PK LEFT function, 1-24

NEXT PK RIGHT function, 1-24

notation conventions, 2-2

note

band overlap, 1-10

frequency range, 1-1

reference level calibration, 1-14

warm-up time, 1-13

O

OA command, 2-25

OFF function, 1-23

OFFSET ROLLER function, 1-24

ON

menu, E-7

ON function, 1-24

OP command, 2-8, 2-25

operator entry, 2-11

output format commands, 2-11

Index-4

P

PEAK EXCURSN function, 1-24
PEAK SEARCH
function, 1-25
menu, E-8
PEAK THRESHLD function, 1-25
PLOT
command, 2-8, 2-25
function, 1-25
PLOT ANNOT function, 1-25
plot commands, 2-8
PLOT GRATICUL function, 1-25
PLOTORG command, 2-8, 2-25
PLOT ORG DSP GRAT function, 1-25
PLOTSRC command, 2-8, 2-25
PLOT TRACE A function, 1-25
PLOT TRACE B function, 1-25
POSITIVE BIAS function, 1-25
PP command, 2-9, 2-26
PRESEL AUTO PK function, 1-25
preselector commands, 2-9
PRESEL MAN ADJ function, 1-25
PRESET
function, 1-25
menu, E-8
PREV MENU function, 1-26
PRINT
command, 2-9
function, 1-26
print commands, 2-9
PRINT PLOT function, 1-26
PSDAC command, 2-7, 2-9, 2-26
PSTATE command, 2-7, 2-26
PWRBW command, 2-11, 2-26
PWR ON STATE function, 1-26

R
RB AUTO command, 2-5
RB command, 2-5, 2-27
RBR command, 2-5-6, 2-27
RBW

SPAN function, 1-26
RCLS command, 2-7, 2-27
RCLT command, 2-10, 2-27
REALIGN LO & IF function, 1-26
REAR PNL CAL function, 1-26
RECALL
function, 1-26
menu, E-9
RECALL ERRORS function, 1-26
RECALL PRSEL PK function, 1-26
RECALL STATE function, 1-26
RECALL TO TR A function, 1-26
RECALL TO TR B function, 1-26
reference level calibration, 1-13
REF LVL ADJ function, 1-27
REF LVL function, 1-26
REF LVL OFFSET function, 1-27
RES BW AUTO MAN function, 1-27
RES BW function, 1-27
REV? command, 2-7
REV command, 2-27
RLCAL command, 2-5, 2-7, 2-28
RL command, 2-5, 2-28
ROFFSET command, 2-5, 2-28
RQS command, 2-7, 2-9, 2-28

S

SAMPLER FREQ function, 1-27
SAMPLER HARMONIC function, 1-27
SAVE
function, 1-27
menu, E-10
SAVELOCK ON OFF function, 1-27
SAVE PRSEL PK function, 1-27
SAVES command, 2-7, 2-29
SAVE STATE function, 1-27
SAVET command, 2-10, 2-29
SAVE TRACE A function, 1-27
SAVE TRACE B function, 1-27
SCREEN TITLE function, 1-27

secondary key words, 2-35
 SELECT CHAR function, 1-28
 SER command, 2-7, 2-29
 service diagnostics, 2-7
 service request, 2-9
 SIG ID AT MKR function, 1-28
 SIGID command, 2-6, 2-29
 SIG ID ON OFF function, 1-28
 SIG ID→CF function, 1-28
 signal connections, 1-2
 SIGNAL IDENT function, 1-28
 SIG TRK ON OFF function, 1-28
 SINGLE function, 1-28
 SNGLS command, 2-10, 2-29
 SPACE function, 1-28
 span, 1-2
 SPAN
 function, 1-28
 menu, E-10
 SPAN WIDTH function, 1-28
 SP command, 2-7
 SQUELCH
 command, 2-6, 2-30
 function, 1-28
 SQUELCH ON OFF function, 1-28
 SRQ command, 2-9, 2-30
 SS command, 2-5, 2-7, 2-30
 START FREQ function, 1-29
 STATE # function, 1-29
 ST AUTO command, 2-5, 2-10
 STB command, 2-9, 2-30
 ST command, 2-10, 2-30
 STOP FREQ function, 1-29
 STORE REF LVL function, 1-29
 sweep
 commands, 2-10
 SWEEP
 function, 1-29
 menu, E-11
 SWEEP TIME function, 1-29
 SWPOUT command, 2-11, 2-31

SWP TIME AUTO MAN function, 1-29
 synchronization commands, 2-10
 syntax conventions, 2-3

T

TDF command, 2-11, 2-31
 TH command, 2-6, 2-31
 THRESHLD function, 1-29
 TITLE command, 2-11, 2-31
 TITLE DONE function, 1-29
 TM command, 2-10, 2-32
 TRACE
 menu, E-12
 TRACE A function, 1-29
 TRACE ALIGN, 1-5
 TRACE B function, 1-29
 trace commands, 2-10
 TRACE # function, 1-29
 TRACE function, 1-29
 TRA command, 2-10-11, 2-32
 TRANSFER ROLLER function, 1-29
 TRB command, 2-10-11, 2-32
 TRIG
 function, 1-29
 menu, E-13
 trigger
 commands, 2-10
 TS command, 2-10, 2-33
 TWINDOW command, 2-10, 2-33

U

UNITS AUTO MAN function, 1-30
 UNITS function, 1-16

V

VAVG command, 2-11, 2-33
 VB AUTO command, 2-5
 VB command, 2-5, 2-33
 VBR command, 2-5-6, 2-33
 VBW
 RBW function, 1-30

VID AVG ON OFF function, 1-30
VIDEO BW AUTO MAN function, 1-30
VIDEO BW function, 1-30
VIDEO function, 1-30
VIEW command, 2-10, 2-34
vol, 1-3
VOL command, 2-6, 2-34
VOLTS function, 1-30
VOLUME function, 1-30
VTL command, 2-10, 2-34

W
WATTS function, 1-30

X
X POSN, 1-5

Y
Y POSN, 1-5

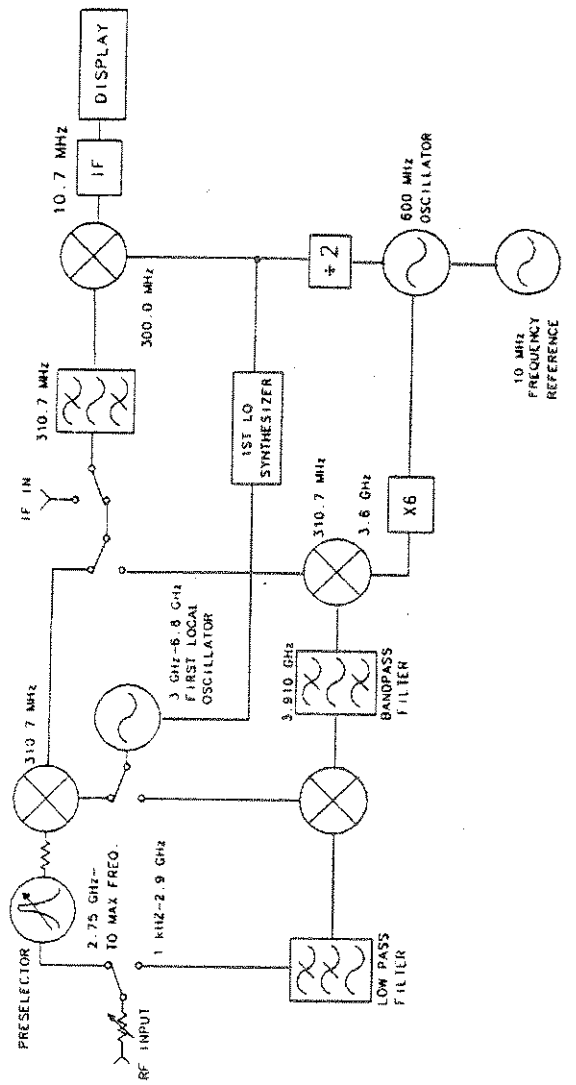



HEWLETT
PACKARD

Manual Part Number: 08562-90089

Printed in USA