

Notice

Hewlett-Packard to Agilent Technologies Transition

This documentation supports a product that previously shipped under the Hewlett-Packard company brand name. The brand name has now been changed to Agilent Technologies. The two products are functionally identical, only our name has changed. The document still includes references to Hewlett-Packard products, some of which have been transitioned to Agilent Technologies.

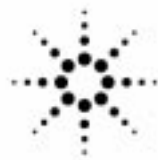

Agilent Technologies



**HEWLETT
PACKARD**

OPERATING AND PROGRAMMING MANUAL

**8566B
SPECTRUM ANALYZER
100 Hz – 2.5 GHz/2 – 22 GHz**

SERIAL NUMBERS

This manual applies directly to Model 8566B RF
Sections with serial numbers prefixed 2410A and IF-
Display Sections with serial numbers prefixed 2403A.

© Copyright HEWLETT-PACKARD COMPANY 1984
1212 VALLEY HOUSE DRIVE, ROHNERT PARK, CALIFORNIA.94928. U.S.A.

MANUAL PART NO. 08566-90040
Microfiche Part No. 08566-90044

Printed: March 1984

CERTIFICATION

*Hewlett-Packard Company certifies that **this** product met its published specifications at the time of shipment from the factory. Hewlett-Packard further certifies that its calibration measurements are traceable to the United States National Bureau of Standards, to the extent allowed by the Bureau's calibration facility, and to the calibration facilities of other International Standards Organization members.*

WARRANTY

This Hewlett-Packard instrument product is warranted against defects in material and workmanship for a period of one year from date of shipment. During the warranty period, Hewlett-Packard Company will, at its option, either repair or replace products which prove to be defective.

For warranty service or repair, this product must be returned to a service facility designated by HP. Buyer shall prepay shipping charges to HP and HP shall pay shipping charges to return the product to Buyer. However, Buyer shall pay all shipping charges, duties, and taxes for products returned to HP from another country.

HP warrants that its software and firmware designated by HP for use with an instrument will execute its programming instructions when properly **installed** on that instrument. HP does not warrant that the operation of the instrument, or software, or firmware will be uninterrupted or error free.

LIMITATION OF WARRANTY

The foregoing warranty shall not apply to defects resulting from improper or inadequate maintenance by Buyer, Buyer-supplied software or interfacing, unauthorized modification or misuse, operation outside of the environmental specifications for the product, or improper site preparation or maintenance.

NO OTHER WARRANTY IS EXPRESSED OR IMPLIED. HP SPECIFICALLY DISCLAIMS THE IMPLIED WARRANTIES OF MERCHANTABILITY AND FITNESS FOR A PARTICULAR PURPOSE.

EXCLUSIVE REMEDIES

THE REMEDIES PROVIDED HEREIN ARE BUYER'S SOLE AND EXCLUSIVE REMEDIES. HP SHALL NOT BE LIABLE FOR ANY DIRECT, INDIRECT, SPECIAL, INCIDENTAL, OR CONSEQUENTIAL DAMAGES, WHETHER BASED ON CONTRACT, TORT, OR ANY OTHER LEGAL THEORY

ASSISTANCE

Product maintenance agreements and other customer assistance agreements are available for Hewlett-Packard products.

For any assistance, contact your nearest Hewlett-Packard Sales and Service Office. Addresses are provided at the back of this manual.

Section I

Manual Operation

Chapter 1 – GETTING STARTED

Chapter 2 – DATA

Chapter 3 – FUNCTION

Chapter 4 – CRT DISPLAY

Chapter 5 – TRACE

Chapter 6 – MARKER

Chapter 7 – SCALE AND REFERENCE LINE

Chapter 8 – COUPLED FUNCTION

Chapter 9 – SWEEP AND TRIGGER

Chapter 10 – INSTRUMENT STATE

Chapter 11 – SHIFT KEY FUNCTIONS

Chapter 12 – USER DEFINED KEYS

Chapter 13 – PLOTTER OUTPUT

GENERAL INFORMATION

The HP 8566B is a high-performance spectrum analyzer which operates from 100 Hz to 2.5 GHz in the low frequency band and 2 – 22 GHz in the preselected microwave band. It uses a synthesized LO to provide accurate frequency tuning and an internal micro-computer to automate controls and provide useful operating features.

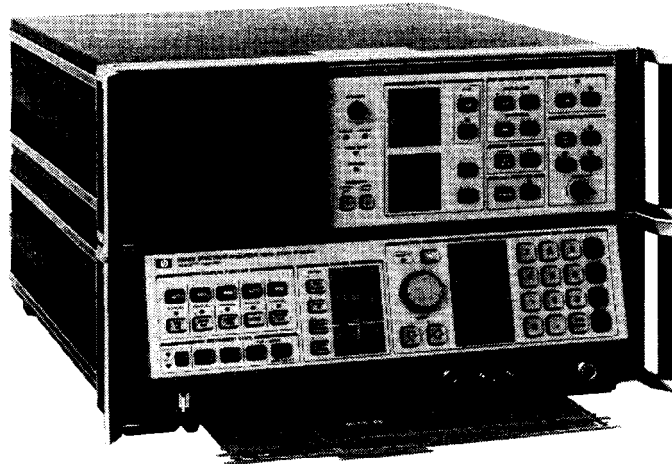

HP 8566B SPECTRUM ANALYZER

The HP 8566B consists of an 85662A Display Section and an 85660B RF Section. Connect the two sections along with the inter-connection cables as shown in the illustration below.

Connect interconnection cables as shown:

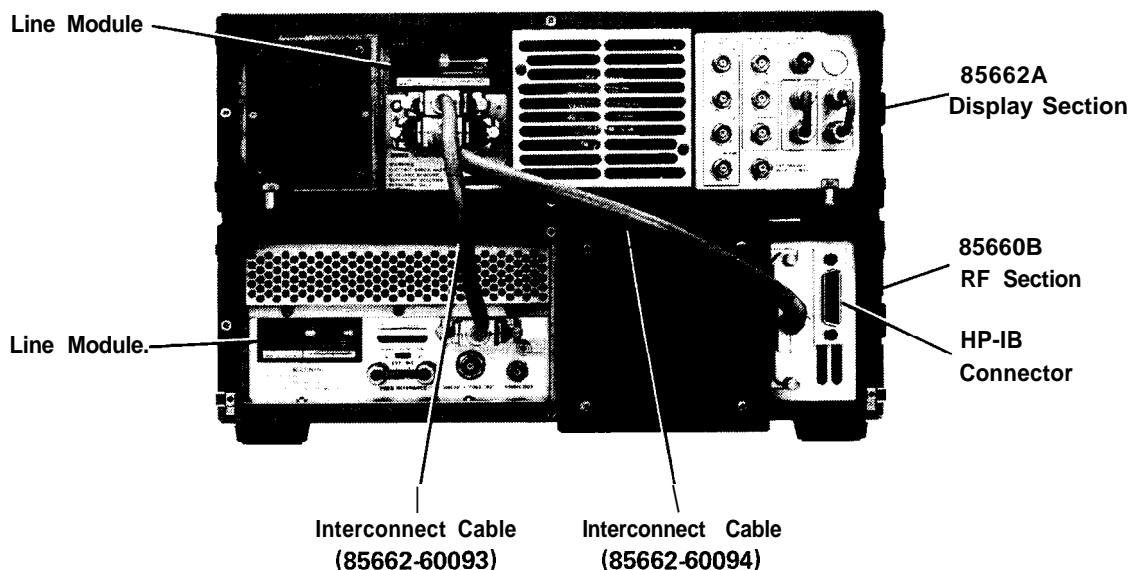

REAR PANEL CONNECTIONS

CAUTION

Before connecting the line power cords, make sure the appropriate line voltage and line fuse have been selected for both the RF and Display sections of the analyzer. For complete information on line voltage and fuse selection, refer to the HP 8566B Operator's Handbook. For information on line power cords for a specific country, contact the nearest Hewlett-Packard office.

INITIAL POWER ON

After making the AC power line connections, the STANDBY lights of both the RF and Display section should be on. As long as the instrument is operating (LINE ON) or in STANDBY, the accuracy specifications of the internal frequency standard will be met. After a cold start, such as on-receipt of instrument, the analyzer requires 24 hours to stabilize prior to meeting specified performance.

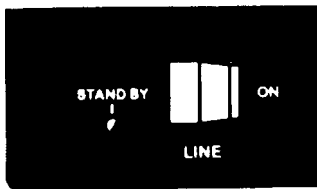

LINE ON AND STANDBY



INSTR CHECK LED

Upon LINE ON, the instrument will perform an automatic internal instrument check. If one or both of the red instrument check lights (INST CHECK I and II) remain on after this brief check routine, refer to the chart below to localize the problem.

LED On	Problem	Solution
I	Digital Storage failure in 85662A	Check bus interconnect cable (85662-60094)
II	Interface Failure	Check bus interconnect cable (85662-60094) and check if A12 board is connected tightly
I & II	Controller (A15)	Check if A15 is connected tightly in 85660B and that contacts are clean.

Calibration

In order to meet specified frequency and amplitude accuracy, the analyzer's calibration must be checked periodically to ensure the highest performance.

RF INPUT

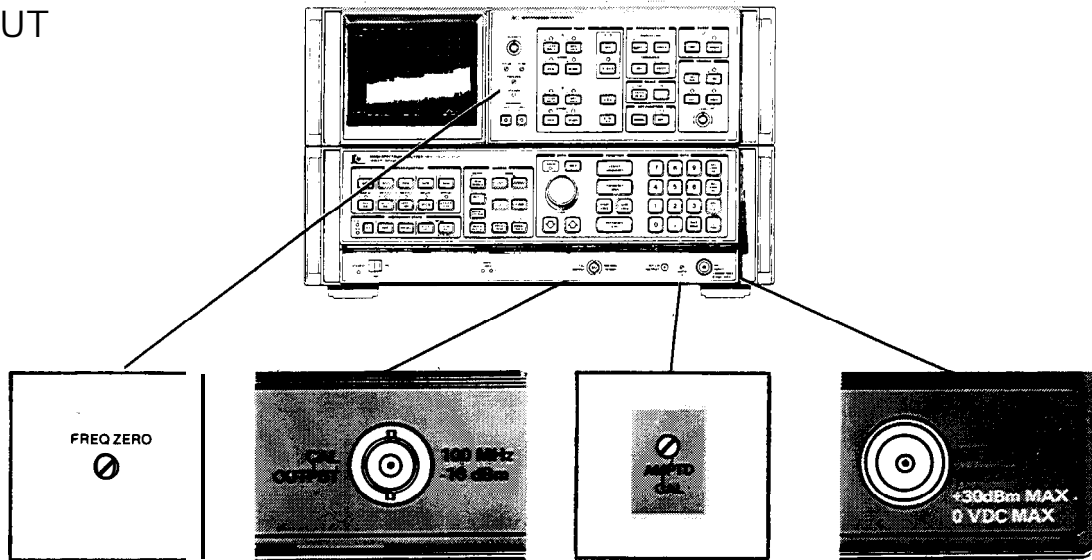

Connect cable from CAL OUTPUT signal to RF input to perform initial calibration.

CAUTION

Excessive signal input power will damage the input attenuator and the input mixer. The spectrum analyzer total RF power must not exceed + 30 dBm (1 watt).

DC Precaution: The HP 8566B cannot accept DC voltages in 0 dB ATTEN. With 10 dB or greater input attenuation, a maximum of $\pm 7V$ DC can be accepted without damage. A blocking capacitor is recommended at the input when DC is present with an RF signal.

Manual Calibration Procedure

1. After instrument has stabilized, press **2-37 0M**.
2. Press **RECALL** 8; this recalls the following stored control settings from the analyzer's internal memory:
 - Center Frequency = 100 MHz
 - Frequency Span = 2 MHz
 - Reference Level = - 7 dBm
 - Res BW = 1 MHz
 - Scale = 1 dB/Div
 - Marker = Normal
3. Adjust AMPTD CAL for a marker amplitude of - 10 dBm. *
4. Press **RECALL** 9; this recalls the following:
 - Center Frequency = 100 MHz
 - Frequency Span = 0 Hz
 - Reference Level = - 7 dBm
 - Res BW = 30 Hz
 - Scale = 1 dB/Div
 - Sweep Time = 10 Sec.

* If connection cable has significant loss, it must be accounted for separately.

- Maximize amplitude response with **FREQ ZERO** adjustment.

Error Correction Routine

A 30 second internal error correction routine minimizes uncertainties due to control changes in the analyzer. To start the routine, press **SHIFT** **W** **FREQUENCY SPAN**.

A "CORR'D" readout will appear on the left edge of the CRT upon completion of this routine. If the message "Adjust AMPTD CAL" appears in the display, repeat the manual calibration before running the error correction routine again.

CRT DISPLAY

The analyzer's CRT display presents the signal response trace and all pertinent measurement data. The active function area names the function under DATA control and shows the function values as they are changed. All the information necessary to scale and reference the graticule is provided.

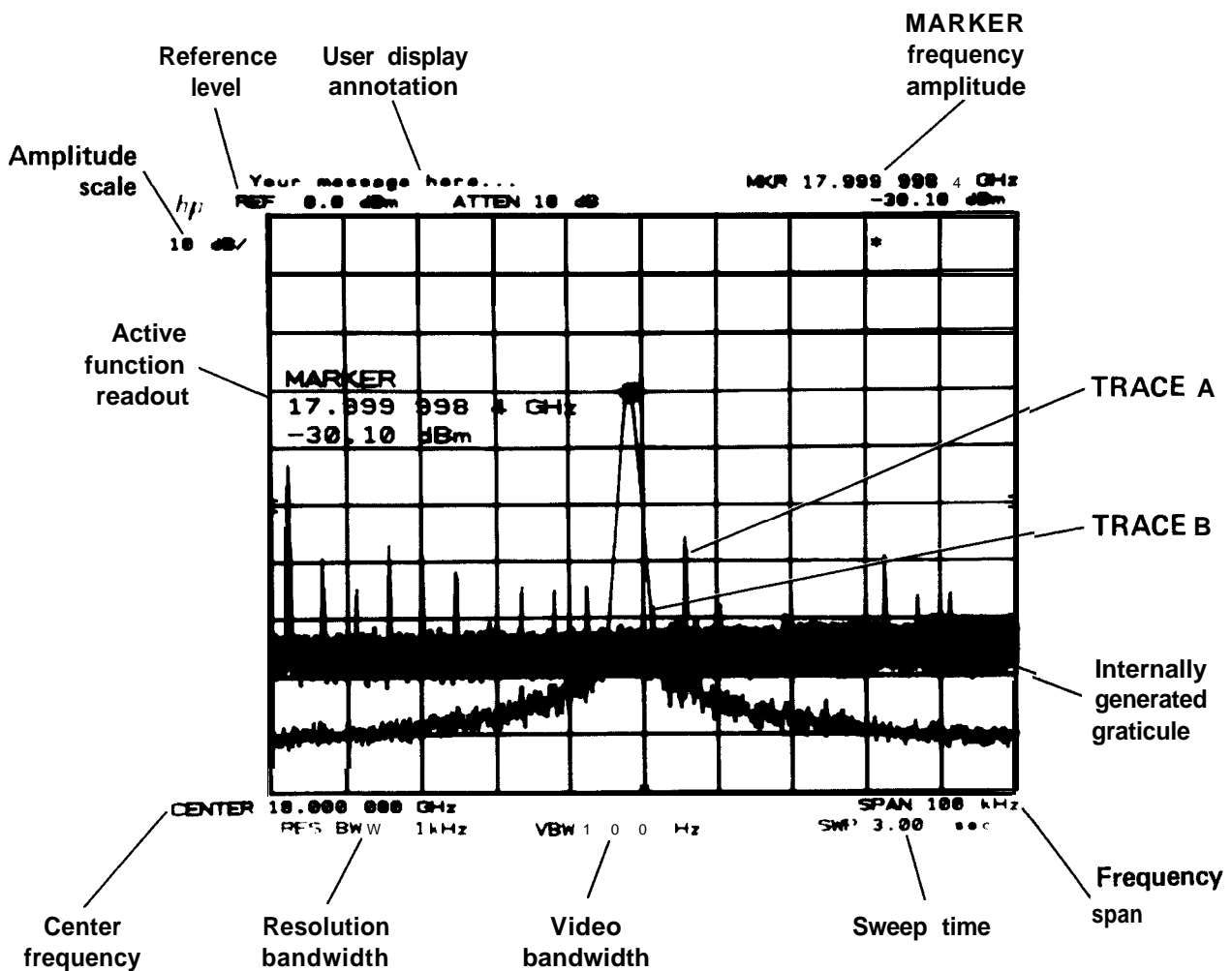

PLOTTER OUTPUT

The trace data, graticule, and annotation on the analyzer's screen can be directly output via HP-IB to a Hewlett-Packard plotter (such as the HP 7245A/B, 7240A, 7470A, or 9872C) by pressing the LOWER LEFT key on the front panel of the analyzer.

FRONT PANEL OVERVIEW

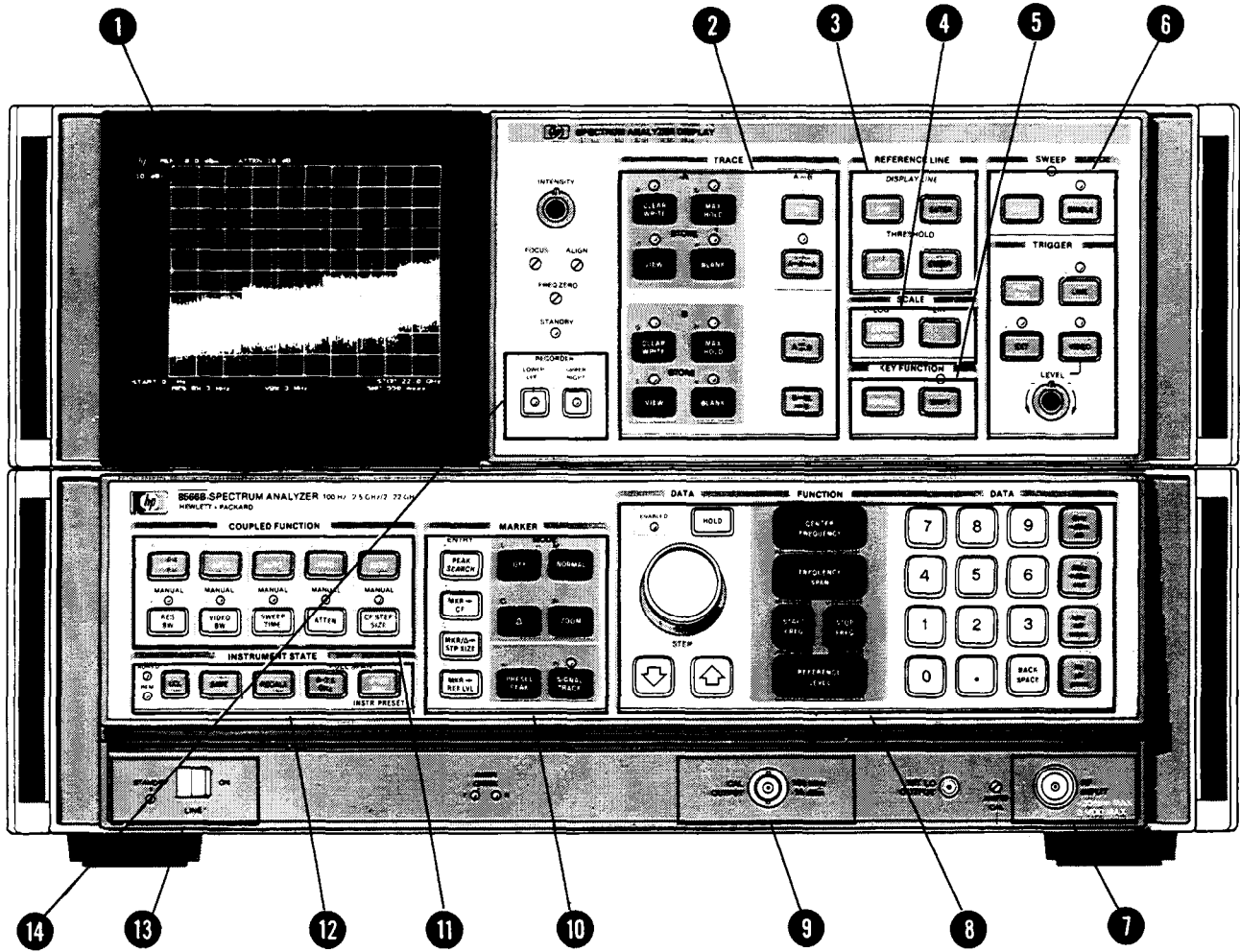

Control Groups



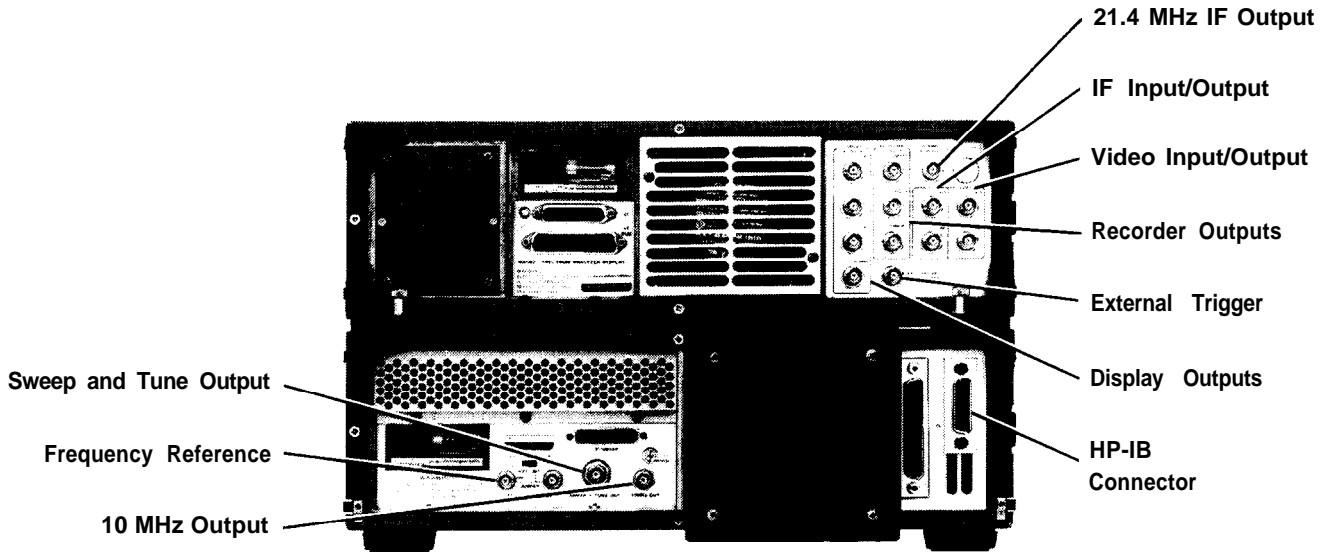

- | | |
|--|---|
| <ul style="list-style-type: none"> 1 CRT DISPLAY: 2 TRACE: 3 REFERENCE LINE: 4 SCALE: 5 KEY FUNCTION: 6 SWEEP and TRIGGER: 7 RF INPUT: 8 DATA/FUNCTION: 9 CAL OUTPUT: 10 MARKER: 11 COUPLED FUNCTION: 12 INSTRUMENT STATE: 13 LINE ON &STANDBY: 14 REORDER/PLOTTER FUNCTIONS: | <ul style="list-style-type: none"> Signal response and analyzer settings Control of signal response display Measurement and display aids Selects logarithmic or linear amplitude scale Access to special functions Selects trace update trigger 100 Hz to 22 GHz (+ 30 dBm max. power) Fundamental analyzer control Calibration signal Movable bright dot markers for direct frequency and amplitude readout Maintenance of absolute amplitude and frequency calibration by automatically selecting certain analyzer control settings Local (lcl) select key, SAVE and RECALL keys and FULL SPAN keys Powers instrument and performs instrument check Controls output to recorder or HP-IB controlled plotter |
|--|---|

REAR PANEL OUTPUTS







Display Outputs

Display outputs allow all the CRT information to be displayed on an auxiliary CRT display such as the HP 1310A Large Screen Display.

Display Outputs	output
 X  Y	<75 nsec rise times. 1V full deflection.
 Z	
 BLANK	<30 nsec rise time. Intensity: - 1V blank, 0 to 1V intensity modulation. TTL level >2.4V for blanking. Compatible with most oscilloscopes.

Recorder Outputs

The recorder outputs allow the x-y plot of trace data with x-y plotters using positive penlift coils or TTL penlift input. The front panel keys enable outputs for the calibration of x-y plotter reference points:

Recorder outputs	RECORDER LOWER LEFT UPPER RIGHT  		RECORDER Outputs when keys or HP-IB commands are enabled	
			Lower Left	Upper Right
 SWEEP	A voltage proportional to the horizontal sweep of the CRT trace that ranges from 0V for the left edge and to +10V for the right edge.		0V left	10V right
 VIDEO	Detected video output (before A-D conversion) proportional to vertical deflection of the CRT trace. Output increases 100 mV/div from 0 to 1V.		0 v lower	+ 1V upper
 PENLIFT	A blanking output, 15V, occurs during CRT retrace; otherwise output is low at 0V (pen down).		+ 15v	+ 15V

21.4 MHz IF Output

21.4 MHz IF Output	output
 21.4 MHz IF OUTPUT	A 50Ω, 21.4 MHz output related to the RF input to the analyzer. In log scales, the IF output is logarithmically related to the RF input signal; in linear, the output is linearly related. The output is nominally - 20 dBm for a signal at the reference level. The analyzer's resolution bandwidth setting controls the bandwidth. The input attenuator and IF step gain positions control the amplitude.

Sweep Plus **Tune Output**

Sweep Plus Tune Output	Output
 SWEEP + TUNE OUT	- 1.0V per GHz of tune frequency, ≥ 10 kΩ load. Accuracy: - 1V/GHz ± 2% ± 10 mV.

10 MHz **Output**

10 MHz Output	output
 10 MHz OUT	> - 5 dBm, 50Ω output impedance

Frequency Reference Input/Output

To lock the spectrum analyzer to an external frequency reference, set the **FREQ REFERENCE** switch to **EXT**. Analyzer performance will be degraded unless frequency reference phase noise and spurious signals are < -140 dBc single sideband (1 Hz) referred to 10 MHz at a 100 Hz to 10 kHz offset. To lock another spectrum analyzer to the spectrum analyzer internal frequency reference, set the **FREQ REFERENCE** switch to **INT**.

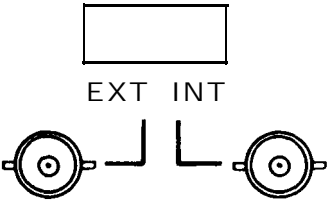
Frequency Reference Input/Output	Input/Output
 <p>The diagram shows a rectangular box representing the frequency reference section. Below the box is a switch with two positions labeled 'EXT' and 'INT'. Below the switch are two BNC connectors, one on the left and one on the right, connected to the switch terminals.</p>	<p>External Frequency Reference Requirements:</p> <p>Frequency: 5 MHz \pm 50 Hz or 10 MHz \pm 100 Hz Power: 0 to 10 dBm Input Impedance: 50Ω nominal</p> <p>Internal Frequency Reference Characteristics.</p> <p>Frequency: 10 MHz Power: 0 dBm Output Impedance: 50Ω</p>

HP-IB Input Output Connector



The Hewlett-Packard Interface Bus allows remote operation of the analyzer as well as input and output of measurement data. See Section II of this manual.



IF and Video Connectors

The IF and Video connectors allow the 85650A Quasi-Peak Adapter to be used with the analyzer for EMI measurements

NOTE

When the Quasi-Peak Adapter is disconnected from the analyzer, make sure the IF INP connector connects to the IF OUT connector with one short BNC cable, and VIDEO INP connector connects to the VIDEO OUT connector with the other short BNC cable. Failure to connect the BNC cables will result in a loss of signal.

IF and Video Connectors		Input
	IF INP	21.4 MHz input. Input is nominally - 11 dBm (with spectrum analyzer input attenuator set to 10 dB). 50Ω input impedance.
	VIDEO INP	0 - 2V. 139Ω input impedance.

IF and Video Connectors		Output
	IF OUT	21.4 MHz output. Output is nominally - 11 dBm (with spectrum analyzer input attenuator set to 10 dB). 50Ω output impedance.
	VIDEO OUT	0 - 2V. Output impedance < 10 kΩ.

External Sweep Trigger Input

The External Sweep Trigger input allows the analyzer's internal sweep source to be triggered by an external voltage.

External Sweep Trigger Input		Input
	EXT TRIGGER	Must be >2.4V (10V max) . 1 kΩ nominal input impedance.

Chapter 1 GETTING STARTED

GENERAL DESCRIPTION

This chapter is intended to provide you with a quick overview of the use and capability of the HP 8566B Spectrum Analyzer. The chapters following provide the details on each aspect of operation.

FRONT PANEL CONCEPT

The basic controls on the HP 8566B front panel consist of FUNCTION keys and DATA control keys. Functions are activated by pressing the appropriate key; its value is then changed via the DATA control knob, step keys or numeric keyboard. The activated FUNCTION will appear on the CRT as well as its current value.

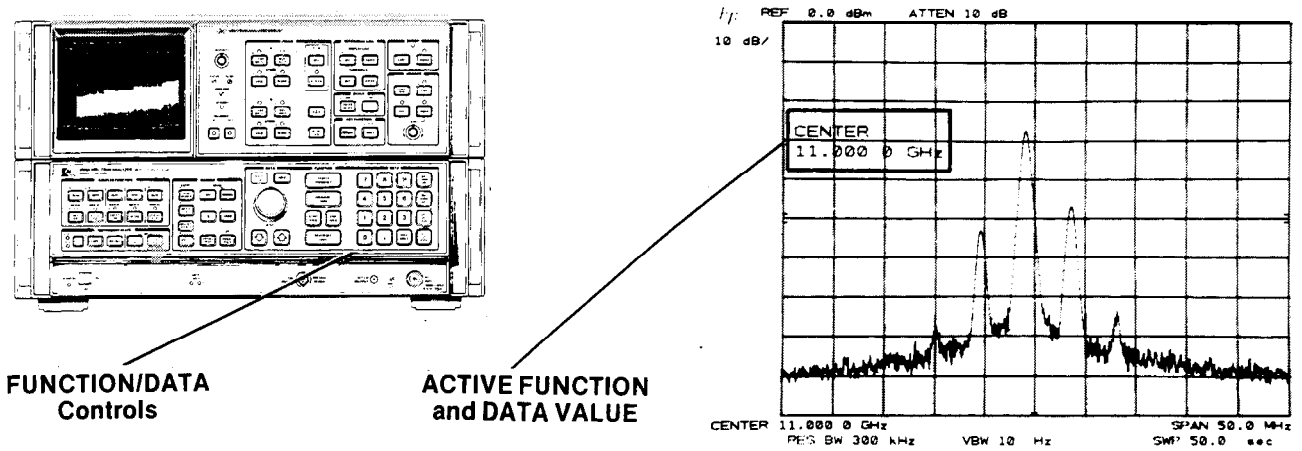

The front panel controls are grouped by function. The majority of measurements can be made with only the FUNCTION/DATA group illustrated. The major FUNCTION controls are CENTER FREQUENCY FREQUENCY SPAN (or START/STOP FREQ), and REFERENCE LEVEL. The value of the activated FUNCTION can be changed continuously with the knob, incrementally with STEP KEYS or exactly with the numeric keyboard.

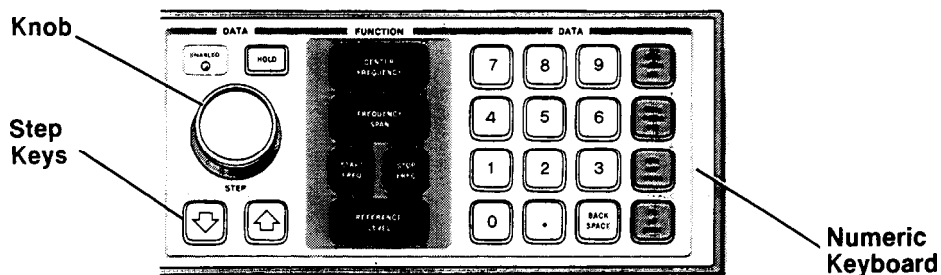

MAKING A MEASUREMENT

Two FULL SPAN keys allow you to select a wide



0- 2.5 GHz or 2 -22 GHz* frequency span. Both keys preset all the analyzer functions to automatically maintain a calibrated display during the course of the measurement.

Example

Connect the CAL OUTPUT signal to RF INPUT

Press **0-2.5 GHz**

This presets the analyzer to a full 0- 2.5 GHz span with 0 dBm Reference level and automatically couples all secondary receiver functions.

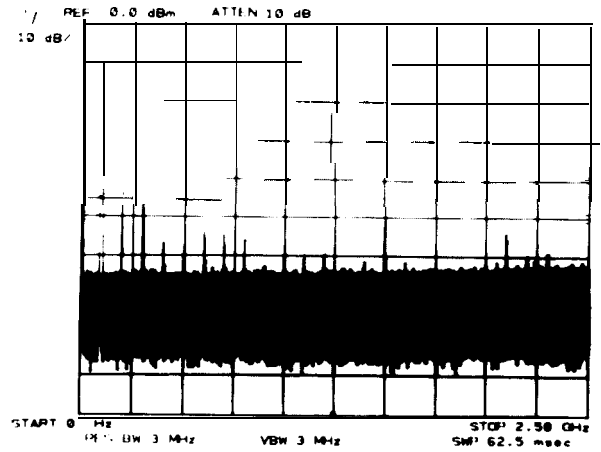

Press **CENTER FREQUENCY** and use the knob step keys or the numeric keyboard to tune the center frequency to 100 MHz. Note that the activated FUNCTION (CENTER FREQUENCY) appears on the CRT graticule field.

CENTER FREQUENCY

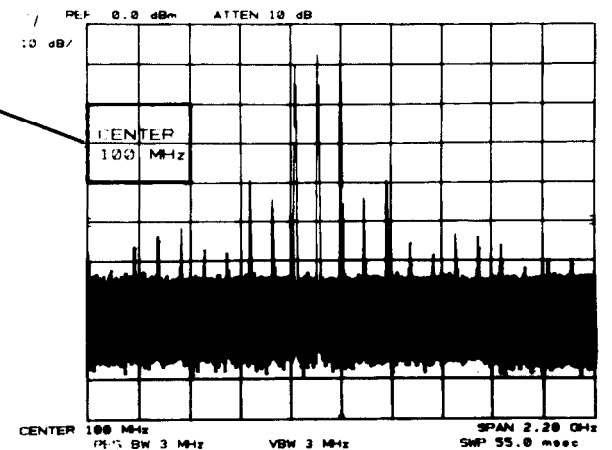

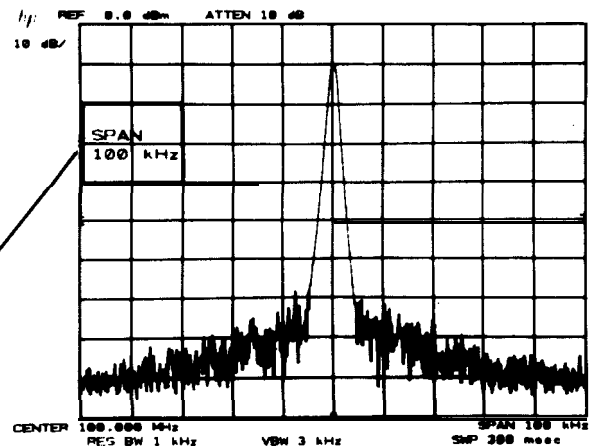

Press **FREQUENCY SPAN** and use the knob , step keys or numeric keyboard to reduce the frequency span to 100 kHz.

FREQUENCY SPAN



*The **2-22 GHz** key is also activated with LINE ON.

GETTING STARTED

Press **REFERENCE LEVEL** and use the knob , step keys  or numeric keyboard to position the peak of the signal on the top graticule line.

DIRECT FREQUENCY AND AMPLITUDE READOUT

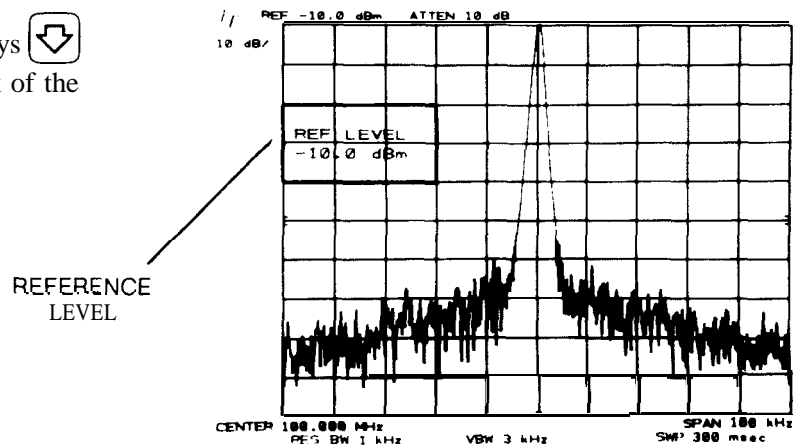

The frequency and amplitude of the signal are read out from the graticule border. All secondary analyzer functions (resolution bandwidth, video bandwidth, sweep time, and attenuation) were automatically adjusted to maintain a fully calibrated display. The coupled functions can also be uncoupled to allow manual operation.

For instance, to manually control the resolution bandwidth, press **RES BW** and change bandwidth with any combination of DATA control. The above also applies to **FREQ**, **SWEEP TIME**, **ATTEN**, or **CF STEP SIZE**.

DIRECT FREQUENCY AND AMPLITUDE READOUT

Markers can be used to quickly identify signal frequency and amplitudes – delta (Δ) markers are available to measure signal separation or amplitude differences.



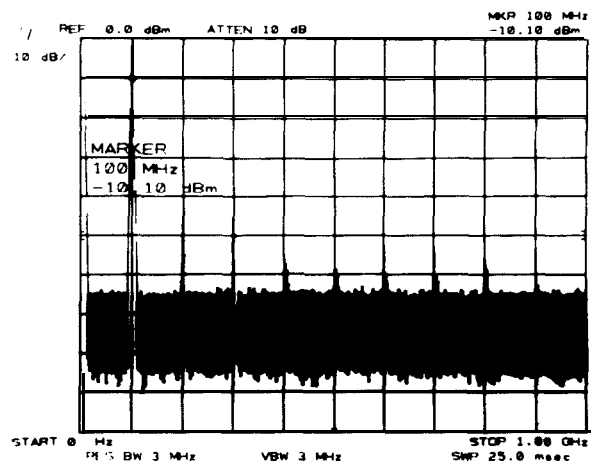

Activate a marker on the display with **NORMAL**. Tune marker with . The frequency and amplitude of the signal are read out with the marker.

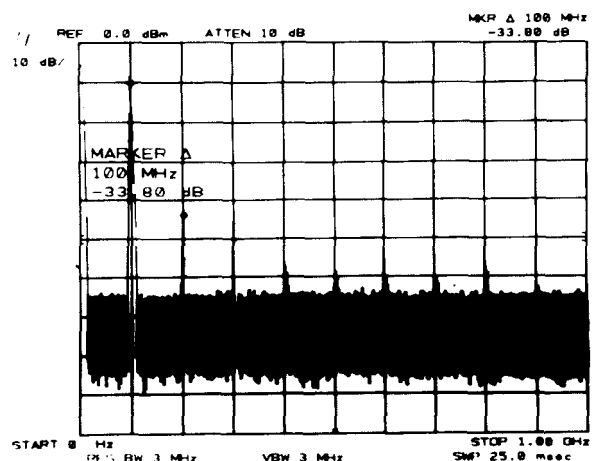

To measure the harmonic(s) of the signal, press **A** and tune the second marker to the signal's harmonic. The frequency separation and amplitude difference are read out.



SAVE/RECALL

The HP 8566B instrument control settings can be saved in an internal memory and later recalled to make a measurement.  /   to  provide access to the six internal storage registers.

SHIFT KEYS

In addition to the front panel functions listed on the keys, another set of functions can be assigned to the same keys by pressing the blue  key prior to activating a front panel key. These will be covered in more detail in Chapter 11.

AUTOMATIC MEASUREMENTS

The HP 8566B is fully programmable via the Hewlett-Packard Interface Bus (HP-IB) -HP's implementation of IEEE STD 488-1975. Internationally, HP-IB is in concert with the IEC main interface document.

A computing controller/calculator can be used with the HP 8566B to configure an automatic measurement system. Just as the analyzer's front panel is keyed manually to control functions and change values, simple program codes are transmitted via the HP-IB with a controller to make measurements automatically. These program codes are listed in the Remote Operation section of the instrument pull-cards.

Detailed information on remote operation is found in Section II of this manual.

CHAPTER 2 DATA

GENERAL DESCRIPTION

DATA controls are used to change function values for functions such as center frequency, start frequency, resolution bandwidth, or marker position.

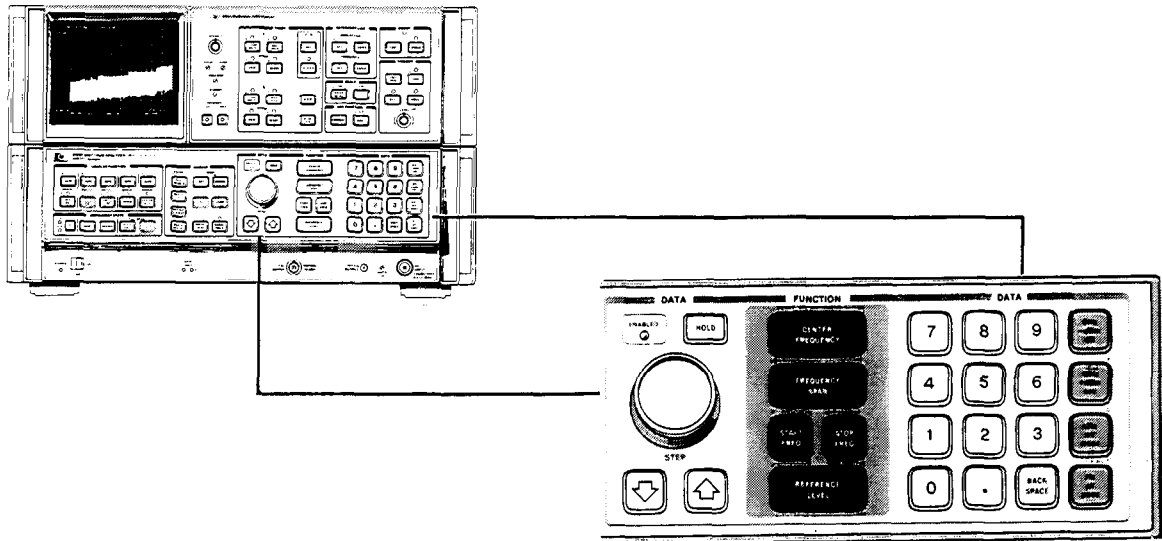





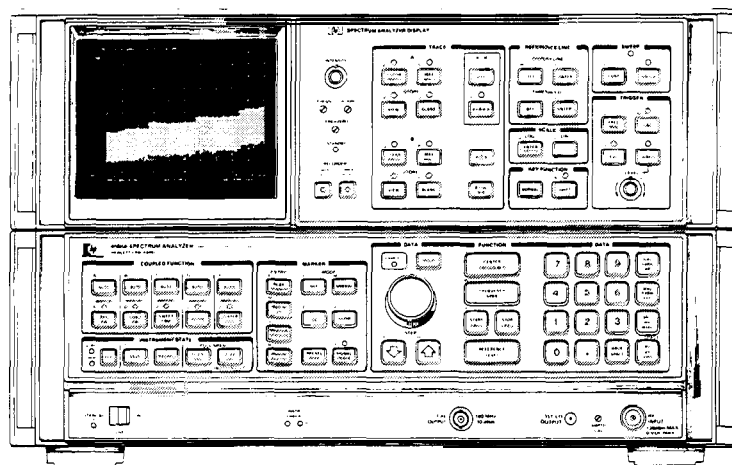



DATA CONTROLS

The DATA controls are clustered about the FUNCTION keys which “call up” or activate the most frequently used spectrum analyzer control functions: center frequency, frequency span (or start/stop frequency), and reference level. The other functions that accept DATA control are shown below:



FRONT PANEL FUNCTIONS USING DATA CONTROLS

To the left of the FUNCTION Keys are the Data knob  and the DATA STEP keys  , which are used to make incremental changes to the activated function. To the right of the FUNCTION keys is the DATA number/units keyboard which allows changes to an exact value.

The DATA controls will change the activated function in a manner prescribed by that function. For example, center frequency can be changed continuously with the DATA knob , or in steps proportional to the frequency span with the DATA STEP keys  , or set exactly with the DATA number/units keyboard. Resolution bandwidth, which can be set only to discrete values, can still be changed with any of the DATA controls. The DATA knob  and DATA STEP keys   increment the setting from one bandwidth to the next. An entry from the number/units keyboard which may not coincide with an allowable bandwidth will select the nearest bandwidth.

DATA ENTRY READOUT

DATA entries are read from the CRT display as they are changed.

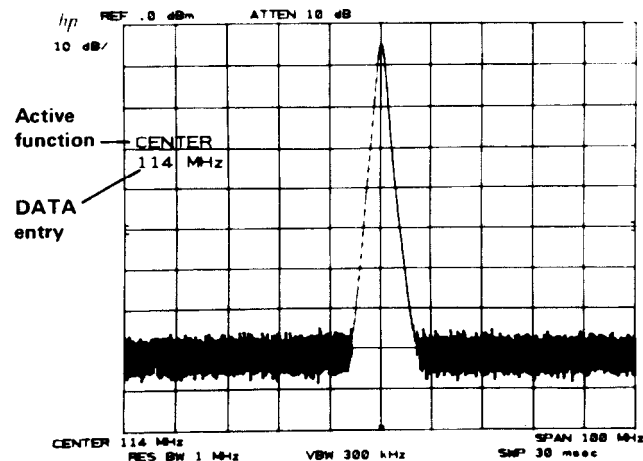

PREVENTING DATA ENTRY







A function can be deactivated by pressing . The active function readout is blanked and the ENABLED light goes out, indicating no DATA entry can be made. Pressing a function key re-enables the DATA controls.

DATA KNOB

The DATA knob  allows the continuous change of center frequency, frequency span (or start/stop frequencies), reference level, marker positions, display line, and threshold. It can also change the function values which are only incremented.

Clockwise rotation of the DATA knob will increase the function value. For continuous changes, the knob's sensitivity is determined by the measurement range and the speed at which the knob is turned. For example, when the center frequency is activated,  increases the value of the center frequency one horizontal division of span per one quarter turn.



DATA STEP KEYS

The DATA STEP keys allow rapid increase  or decrease  of the active function value. The step size is dependent either upon the analyzer's measurements range, on a preset amount, or, for those parameters with fixed values, the next value in a sequence. Examples: Activate center frequency and  will increase the center frequency value by an amount equal to one division of the frequency span (one tenth of the frequency span). If the center frequency step size  has been preset,  will increase the center frequency by that preset amount. If frequency span were activated,  would change the span to the next lower value in predetermined sequence. Activate resolution bandwidth and  will select the next widest bandwidth. Each press results in a single step,

DATA NUMBER/UNITS KEYBOARD

The DATA number/units keyboard (or DATA keyboard) allows exact value entries to center frequency, frequency span (or start/stop frequency), reference level, log scale, marker positions, display line, threshold, and the COUPLED FUNCTIONS.

An activated parameter is changed by entering the number (with the CRT display providing a readout) then selecting the appropriate units key. The value is not changed (entered) until the units key is pressed.

The number portion of the entry may include a decimal, . If not, the decimal is understood at the end of the number. Corrections to number entries are made with , which erases the last digit for each press.

Example: With center frequency activated,

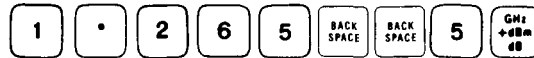







will set the center frequency to 1.250 GHz.

- If the units key were pressed without a number entry, 1 is entered (except in zero frequency span).

Negative DATA Entry

Negative entries from the number units keyboard can be made for power and frequency but not time and voltage.

Negative power entries can be made using . The “- dBm” key will enter - dBm, - dBmV, or - dB μ V. For example, in reference level, with the dBmV units, an entry of    will enter - 50 dBmV.

Negative frequency entries can be made using  

as a prefix to the frequency entry. For example, to enter a negative start frequency, press

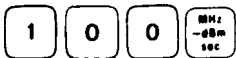

. This enters the frequency value as - 100 MHz.



Not all functions will accept negative entries (the sign will be ignored).

MULTIPLE DATA CHANGES

A function, once activated, may be changed as often as necessary without reactivating that function (see Chapter 3, FUNCTION). Any of the DATA controls can be used in any order. .

It is not always necessary to make a DATA entry. For example, start and stop frequency may be activated simply to allow readout of the left and right display reference frequencies as start/stop frequencies.

- Exceptions are the SHIFT KEY FUNCTIONS which use only DATA number/units keyboard. See Chapter 11.

CHAPTER 3 FUNCTION

GENERAL DESCRIPTION

This chapter describes the use of the major function block- CENTER FREQUENCY FREQUENCY SPAN (or START/STOP FREQUENCY), and REFERENCE LEVEL.

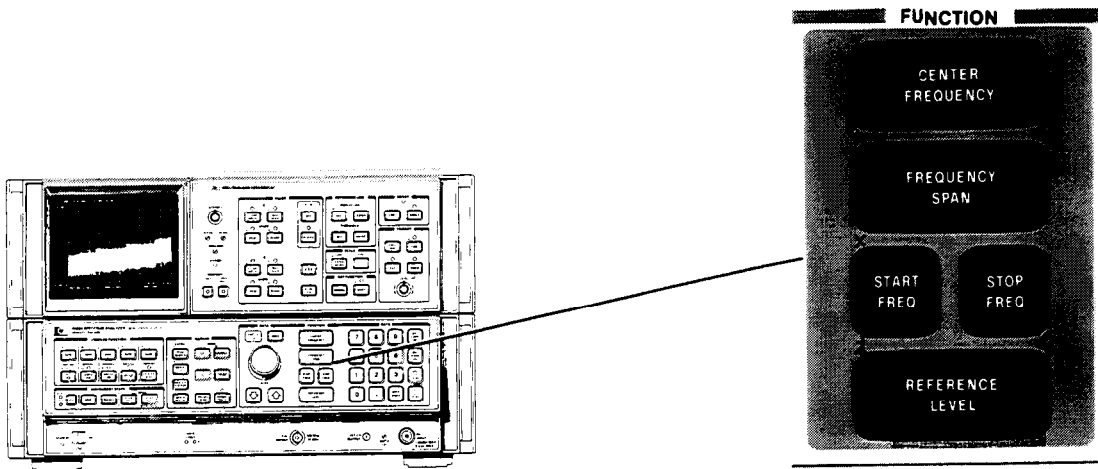

A FUNCTION is enabled by pressing the desired FUNCTION key. Once enabled, the function, along with its current data value, is displayed in the active graticule area of the CRT as well as outside the graticule border. To change the value of the active function, use either the DATA knob, step keys, numeric keyboard, or a combination of all three. The HOLD key above the DATA knob can be used to retain the present instrument state and prevent any inadvertent entry of DATA. HOLD clears the active function area of the CRT as well as de-activates any function.

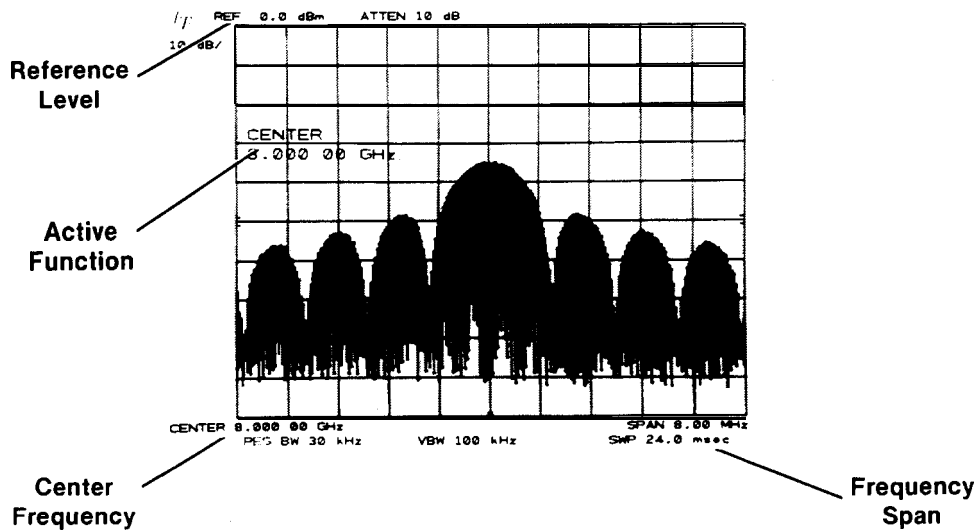



CENTER FREQUENCY

The center frequency can be tuned continuously from 0 to 22 GHz using any combination of DATA controls. Additional band overlap enables the center frequency to tune up to 24 GHz and below to - 1 GHz.

The center frequency can be set with 1 Hz resolution. Readout resolution is 1% of the frequency span, hence the highest readout resolution is obtained with narrow frequency spans. Data entered, however, is always accurate to 1 Hz even though the center frequency readout may display less resolution.

During band crossings (from 0 – 2.5 GHz low band to 2 – 22 GHz microwave band) or at band edges (below 0 Hz or above 22 GHz), the frequency span may change to enable the desired center frequency to be set. (See Appendix for detailed information.)

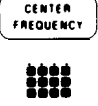

DATA Entry with CENTER FREQUENCY

	Changes the center frequency by about one half the total frequency span each full turn.
	Changes the center frequency by one tenth of the frequency span, i.e., by one division. COUPLED FUNCTION  can be used to change this step size.
	Allows direct center frequency entry. The analyzer will accept a center frequency entry with 1 Hz resolution. Even though the readout may show a fewer number of digits (due to wide frequency span), as the span is narrowed the full entry will be read out. Abbreviated readouts are not rounded.

Example

Once a signal response is placed at the center of the display, the frequency of the signal can be read out from CENTER FREQUENCY. The input signal is a 9 GHz synthesized source.

Press  for a full span display.

Tune signal to center of display with  .

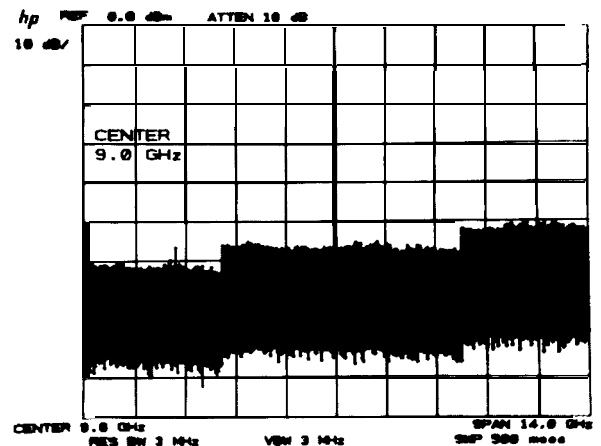
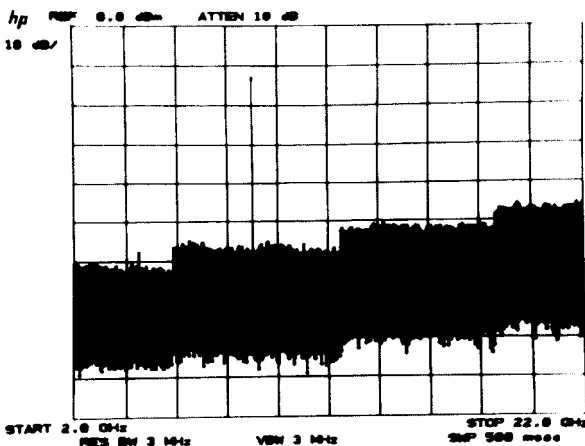

Reducing the frequency span will increase the center frequency readout resolution.

Press **FREQUENCY SPAN**  

then **CENTER FREQUENCY**

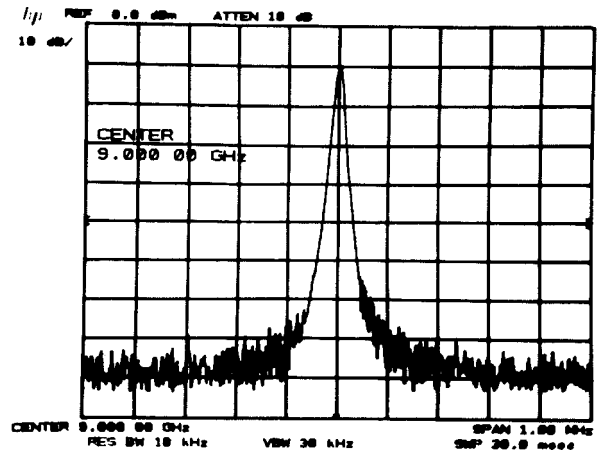







FREQUENCY SPAN

The frequency span changes the total display frequency range symmetrically about the center frequency. Note that the frequency span readout refers to the total display frequency range; to determine frequency span per division, divide by 10.

As the frequency span is changed, resolution bandwidth and video bandwidth automatically change to provide a predetermined level of resolution and noise averaging, respectively. Sweep time also changes automatically to maintain a calibrated display.

The analyzer can be adjusted to span a maximum of 2.5 GHz in the low band and 22 GHz (2 to 24 GHz range) in the microwave band. A minimum span of 100 Hz is allowed in both bands as well as 0 Hz (zero span) which enables the analyzer to function as a fixed-tune receiver. In zero span, the analyzer can display modulation waveforms in the time domain.

DATA Entry with FREQUENCY SPAN

 	Changes the frequency span continuously.
  	Changes the frequency span to the next value in a 1, 2, 5, 10 sequence.
 	Enters an exact value up to three digits, depending on span. Additional digits will be deleted without rounding.

Example

Use FREQUENCY SPAN to zoom in on signals.

Connect CAL OUTPUT to RF INPUT press **0-2.5 GHz**
 This selects a convenient full span display from 0 to 2.5 GHz.

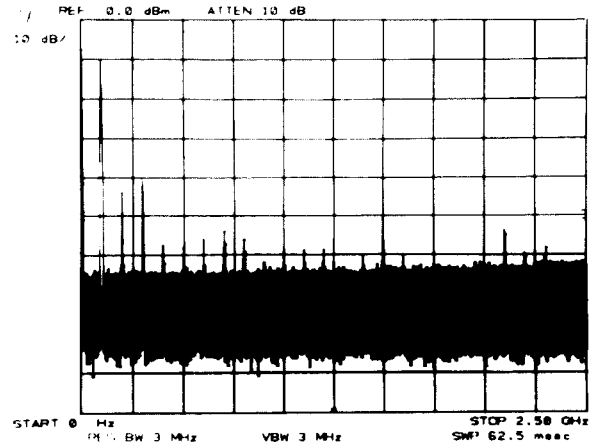

Tune center frequency to 100 MHz with: **CENTER FREQUENCY**
 100 MHz.

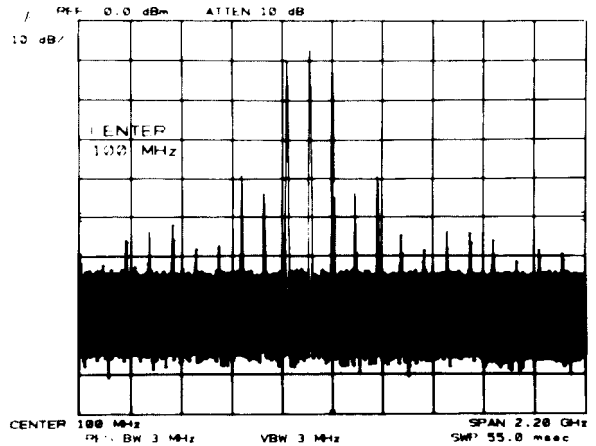

Reduce span with: **FREQUENCY SPAN**, **↓**, **↓** or **⊙**

The desired span can also be selected with the numeric keyboard. Note that narrow frequency spans provide increased center frequency resolution.

In the microwave band, pressing **2-20 GHz** enables a 20 GHz full span.

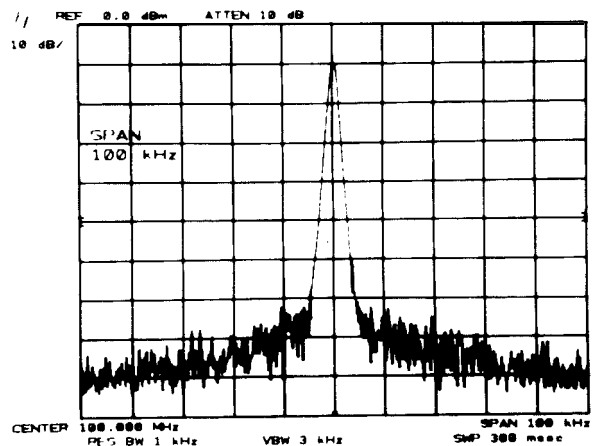

Example

Operating the spectrum analyzer in zero span. The modulation waveform of an AM signal can be displayed in the time domain.

In the frequency domain, we can accurately determine the modulation frequency and level.

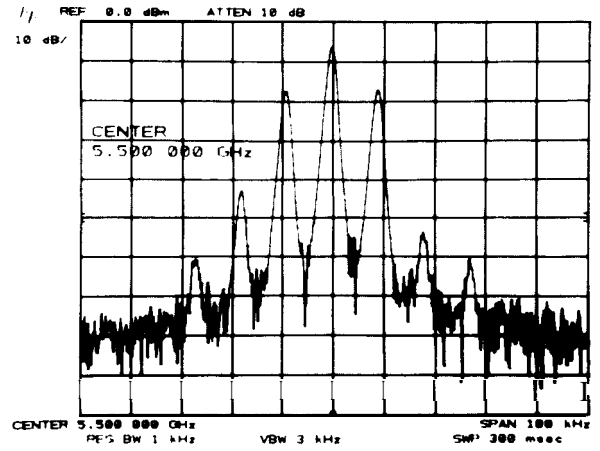

To demodulate the AM, increase the resolution bandwidth to include both sidebands with the IF passband.

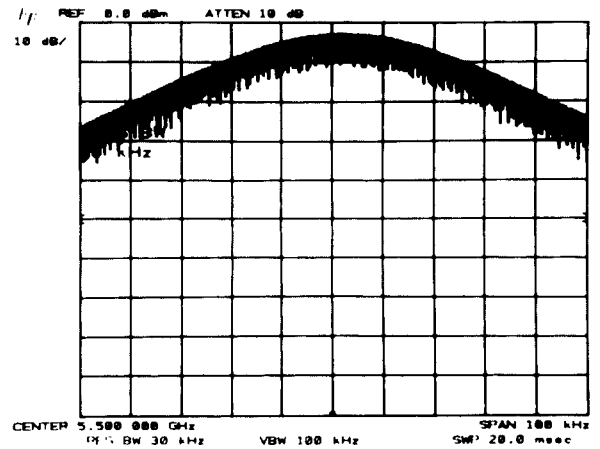

Position the signal at the reference level and select a linear voltage display



LINEAR SCALE.

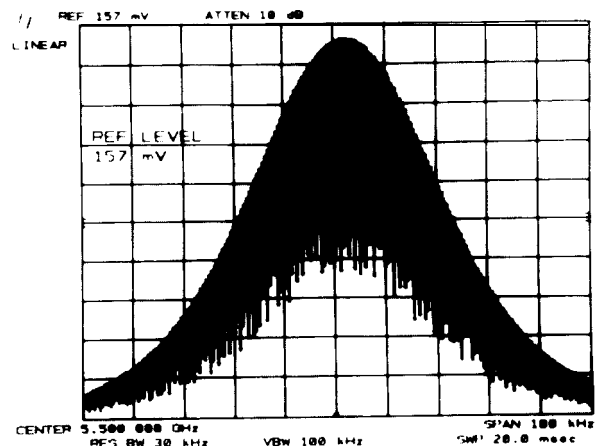

To select zero span, press **FREQUENCY SPAN** **0** **Hz** **μV** **mV** **dB**.
 Video trigger can be used to trigger on the waveform.
 The sweep time control can be adjusted to change the horizontal scale.

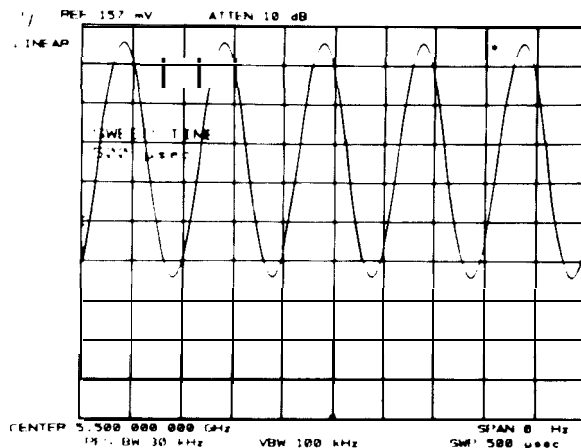



START/STOP FREQUENCY

Another way to adjust the frequency range is by using START/STOP FREQUENCY instead of CENTER FREQUENCY and FREQUENCY SPAN. Activating START FREQ or STOP FREQ causes both to read out in place of CENTER FREQUENCY and SPAN on the CRT. START FREQ sets the left graticule frequency and STOP FREQ sets the right graticule frequency; both are mutually exclusive with CENTER FREQUENCY and FREQUENCY SPAN.

The INSTRUMENT STATE keys, **0-2.5 GHz** and **2-22 GHz**, select a start/stop frequency from 0 to 2.5 GHz and 2 to 22 GHz, respectively. Additional over-range allows start frequency setting of -1 GHz and stop frequency of 24 GHz. The maximum start/stop frequency span allowable is 22 GHz; the minimum span is 100 Hz and zero span (START FREQ = STOP FREQ).

Start/Stop frequency readout resolution is 1% of the span (span = stop frequency - start frequency). Both start or stop frequencies can be entered with 1 Hz resolution.

DATA Entry with START/STOP Frequency

<p>START FREQ OR STOP FREQ</p> 	<p>Changes the start or stop frequency. The amount of change per turn is a constant percentage of the frequency span.</p>
<p>START FREQ OR STOP FREQ</p> 	<p>Changes the frequency by one tenth of the total frequency span.</p>
<p>START FREQ OR STOP FREQ</p> 	<p>Exact start or stop frequencies can be entered. The number of digits read out depends upon the frequency span.</p>

Example

Set start/stop frequency to monitor FM broadcast band

Press: 0-25 GHz
START FREQ 8 8 MHz -dBm sec
STOP FREQ 1 0 8 MHz -dBm sec

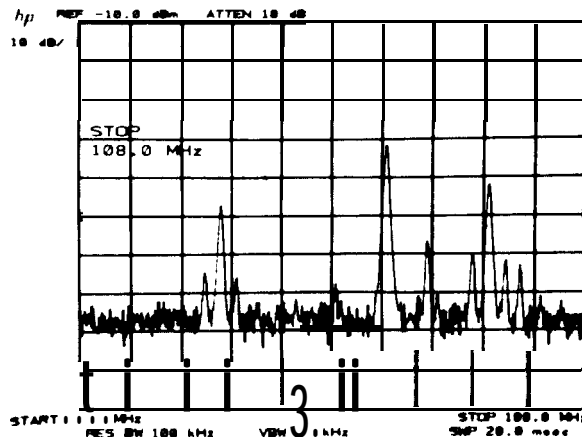

Press CENTER FREQUENCY. Note that horizontal scaling is unchanged, although the START/STOP frequency readouts are replaced by center frequency and span (108 - 88 = 20 MHz).

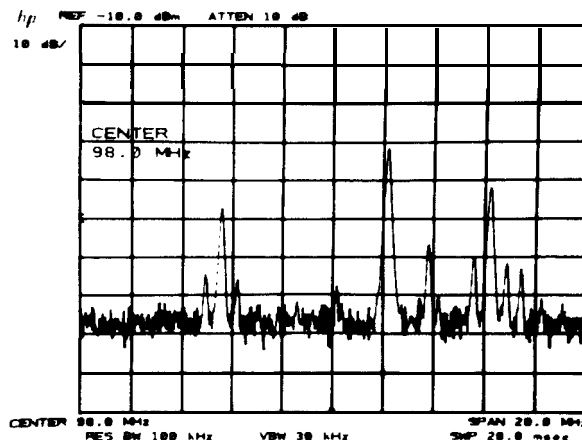



REFERENCE LEVEL

The REFERENCE LEVEL function changes the absolute amplitude level of the top graticule line. The vertical scale (amplitude units per division) is selected from the SCALE control group. To measure signal level, the peak of the signal's response is positioned on the top graticule line and its amplitude is read out from REF LEVEL.



The reference level can be adjusted from - 89.9 dBm to + 30 dBm (- 139.9 dBm to + 60 dBm with extended range) with 0.1 dB resolution. The input attenuator is automatically coupled with the reference level to prevent gain compression; signals which are above the gain compression point will be displayed above the reference level line. Different mixer input levels as well as amplitude units can be selected (see SHIFT FUNCTIONS Chapter 11).

DATA Entry with REFERENCE LEVEL

	<p>In logarithmic scale, the changes are in 0.1 dB steps: in linear scale, the changes are made to the least significant digit.</p>
	<p>In logarithmic scale, changes the reference level in steps according to dB/division scale. In linear scale, changes the reference level in 1 dB steps.</p>
	<p>Allows entry of exact reference levels. Digits entered beyond the displayed number of digits are deleted.</p>

Example

Measure amplitude of calibration signal.



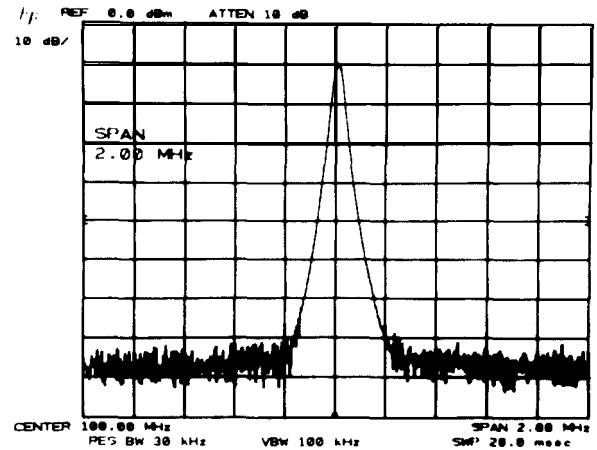



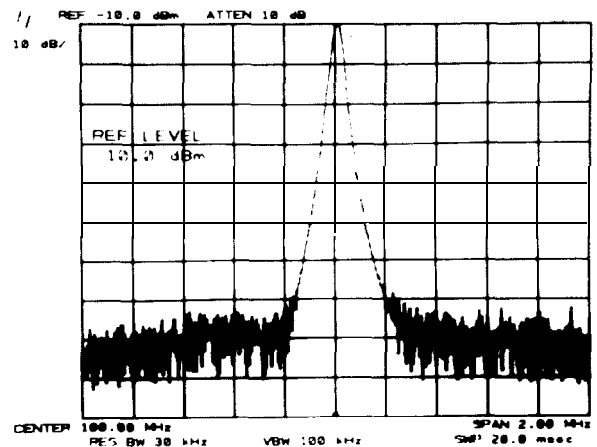





Press 
 100 MHz
 2 MHz



To measure signal amplitude, press  position signal peak to top graticule line. Read amplitude from REF LEVEL.



FUNCTION/DATA SUMMARY

FUNCTION DATA	CENTER FREQUENCY	FREQUENCY SPAN	START/STOP FREQUENCY	REFERENCE LEVEL
KNOB 	Change continuously with up to 1 Hz resolution in narrow spans.		Change continuously with n x 2 Hz resolution *	Continuous with 0.1 dB tuning resolution.
STEP KEYS  	Change frequency in one division steps (i.e., 10% of frequency span).		Change span in 1, 2, 5, 10 sequence.	Incremental change in accordance with log scale. In linear, changes incrementally in 1 dB steps.
NUMERIC KEYBOARD 	Enter exact frequency with up to 1 Hz resolution.		Enter exact frequency with n x 2 Hz resolution *	Enter exact reference level. Digits entered beyond last displayed digit are deleted.
ADJUSTMENT RANGE	- 1.00000000 GHz to 23.99999995 GHz.	 - 1 to 2.5 GHz  2 to 24 GHz	 100 Hz to 22 GHz and zero span.  100 Hz to 2.5 GHz and zero span.	- 139.9 dBm to +60 dBm.
READOUT RESOLUTION	1% of SPAN (Up to 1 Hz in narrow span).			0.1 dB in log; 4 significant digits in linear.

* where n = harmonic number

CHAPTER 4 CRT DISPLAY

GENERAL DESCRIPTION

This chapter describes the CRT display adjustments, readouts, and graphics.

ADJUSTMENT OF THE **DISPLAY**

The adjustments for intensity, focus, and alignment simultaneously affect all the lines and characters on the display.

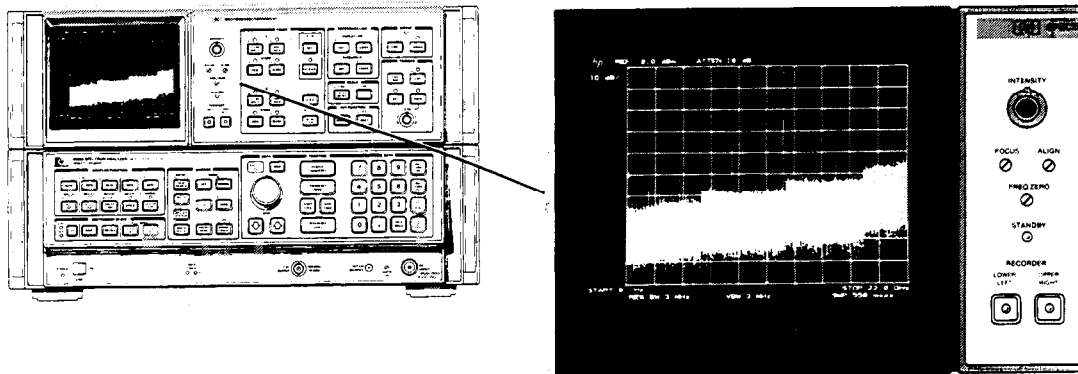

CRT Display and Adjustments



INTENSITY
Controls intensity for all the CRT writing.



FOCUS
A screwdriver adjustment which focuses all the CRT writing. Focusing any one element on the CRT focuses all the writing.



ALIGN
A screwdriver adjustment which tilts all the displayed CRT information.

DISPLAY SECTION LINE POWER



STANDBY
The light indicates power condition of the Spectrum Analyzer Display section as dictated by the LINE power switch on the 85660B RF section.

CRT DISPLAY OVERVIEW

The cathode ray tube of the Spectrum Analyzer Display section displays:

- active function name and value
- graticule
- traces of the signal response
- values that calibrate the frequency, time, and amplitude axes
- values for the spectrum analyzer receiver parameters -that is, COUPLED FUNCTIONS.
- operator originated labels and graphics

Active Function

The function which has been activated for DATA entry is read out in the graticule area shown.

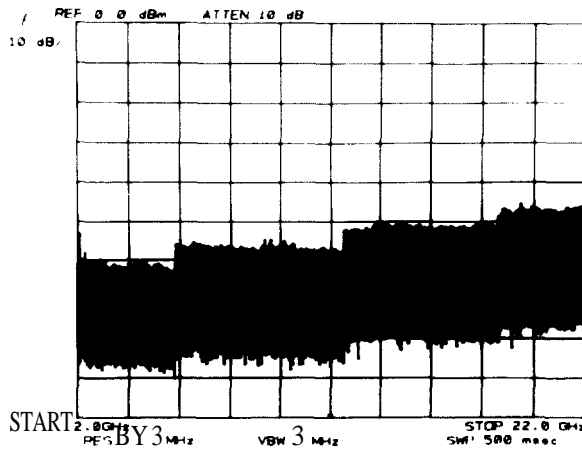

Activating a function immediately writes its name in the active function area along with its present value. The following summarizes the names and readout formats for the front panel designated active functions after an INSTRUMENT PRESET

Function	Examples of Active Function Readout	Function	Examples of Active Function Readout
FUNCTION		MARKER	
CENTER FREQUENCY	CENTER 12.0 GHz	NORMAL	MARKER 12.0 GHz 19.8 dBm
FREQUENCY SPAN	SPAN 20 GHz	Δ	MARKER A 20.0 MHz - 12.4 dB
START FREQ	START 2 GHz	ZOOM	MARKER ZOOM 12.0 GHz - 32.8 dBm
STOP FREQ	STOP 22 GHz	NORMAL SHIFT M	MARKER 12.0 GHz - 140.4 dBm (1 Hz)
REFERENCE LEVEL	REF LEVEL .0dBm		
COUPLED FUNCTION		REFERENCE LINE	
RES BW	RES BW 3 MHz	ENTER	DISPLAY LINE - 45.0 dBm
VIDEO BW	VIDEO BW 3 MHz	ENTER	THRESHOLD - 90.0 dBm
SWEEP TIME	SWEEP TIME 500 msec		
ATTEN	RF ATTEN 10 dB	SCALE	
CF STEP SIZE	CF STEP 100 MHz	ENTER dB/DIV	LOG 10 dB/
HOLD deactivates the active function and blanks the active readout.		KEY FUNCTION	
		(See SHIFT KEY FUNCTIONS, Chapter 11.)	

Graticule

The display graticule is an internally generated 10 division by 10 division rectangle for referencing frequency, time, and amplitude measurements. Double markings at the left, right, and bottom designate the center axes.

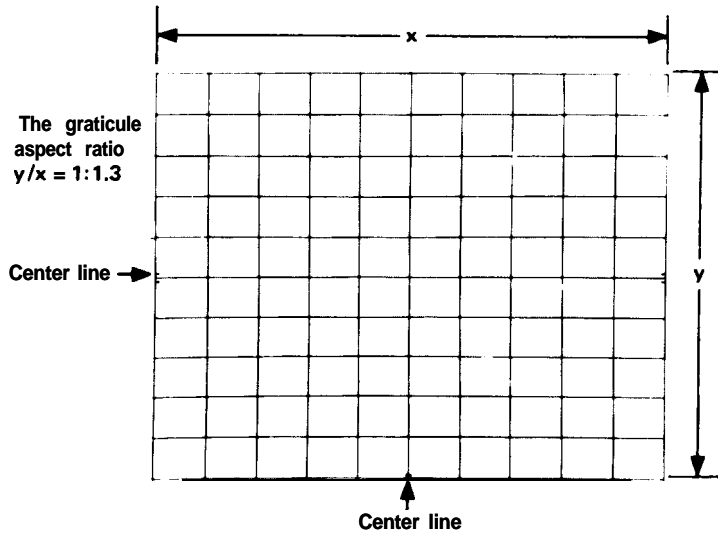

The graticule may be blanked from the display with KEY FUNCTION **SHIFT** m and restored with **SHIFT** n.

For CRT photography, the graticule may be intensified independent of the annotation and trace by pressing the following sequence:

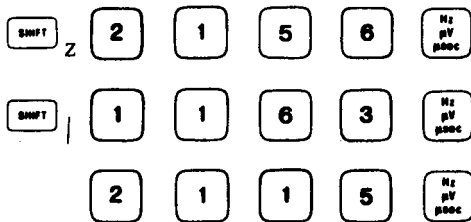

For more intensity, repeat the last two number entries, 1163 Hz and 2115 Hz. **3-22** returns the graticule to normal.

Traces

Three separate traces, A, B, and C, can be written onto the display. Each trace consists of 1000 separate straight-line elements drawn between 1001 fixed points across the CRT X and Y axis coordinates designate the particular points between which the elements are drawn. Terms used to describe trace composition are defined as follows:

Point A "point" in the context of this manual is a fixed location on the CRT display. There are 1,001 points along the X (horizontal) axis of the CRT graticule, numbered from 0 on the far left graticule line to 1000 on the far right graticule line. Similarly, there are 1,001 points along the Y (vertical) axis of the CRT graticule, numbered from 0 on the bottom graticule line to 1000 on the top graticule line. An additional 22 points of overrange available above the top graticule line provide the Y axis with a total of 1,023 points.

Display Unit One display unit is the distance between two points (see above) along an X or Y axis. The distance along the X axis between the far left graticule line and the far right graticule line is 1000 display units. The Y axis length between the bottom graticule line and the top graticule line is also 1000 display units. Although the Y axis can be extended another 22 display units above the top graticule line, the extended area is not calibrated.

X, Y coordinates to a particular point on the display are given in display units relative to X, Y coordinates 0,0 at the junction of the far left and bottom graticule lines.

Element An element is a distinct portion of the trace drawn on the CRT. It comprises a point and the visible straight line drawn to it from the preceding point. An element drawn parallel with a vertical or horizontal graticule line is one display unit long. An element drawn at an angle to the graticule lines is longer, its actual length depending on the angle.

Vector A vector is identical with an element, except that it can be either visible or blanked.

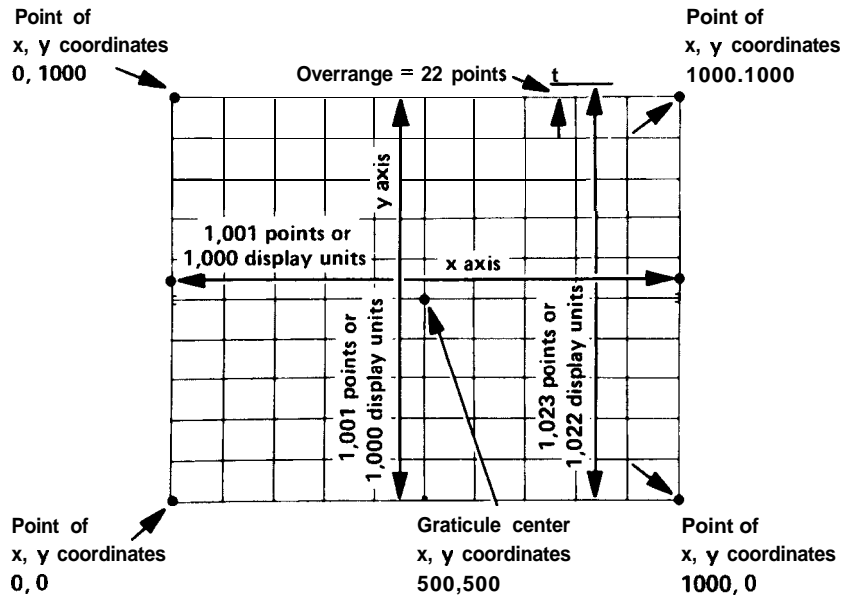

TRACE DISPLAY TERMS

NOTE

When the analyzer is operated manually (i.e., with its front-panel controls), the display size remains constant and the above definitions are fully applicable. When it is operated remotely with a controller, however, three additional larger display sizes are available through the display-size programming commands. For these larger-than-normal display sizes the lower left reference coordinates and the upper right trace limit expand beyond the CRT's outer graticule lines. For further information on remotely-controlled (i.e., programmed) display sizes, refer to commands D1, D2, and D3 under Programming Commands in Section II of this manual.

Locations of Permanent Readouts

The vertical and horizontal graticule axes are scaled by these readouts:

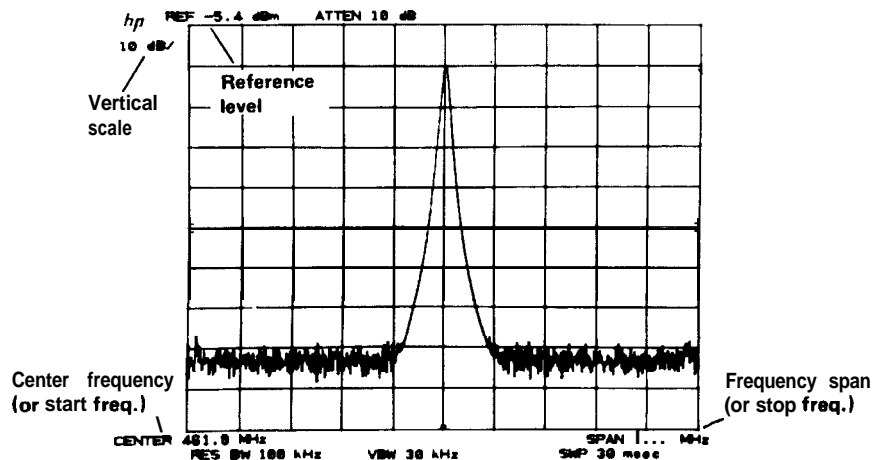

The COUPLED FUNCTIONS that describe the swept receiver characteristics of the spectrum analyzer are:

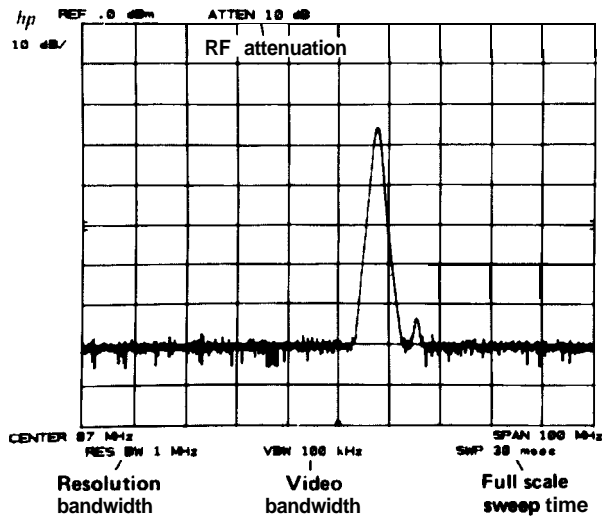

To blank all the character readouts, press KEY FUNCTION o. To restore, press p.

Other Readouts

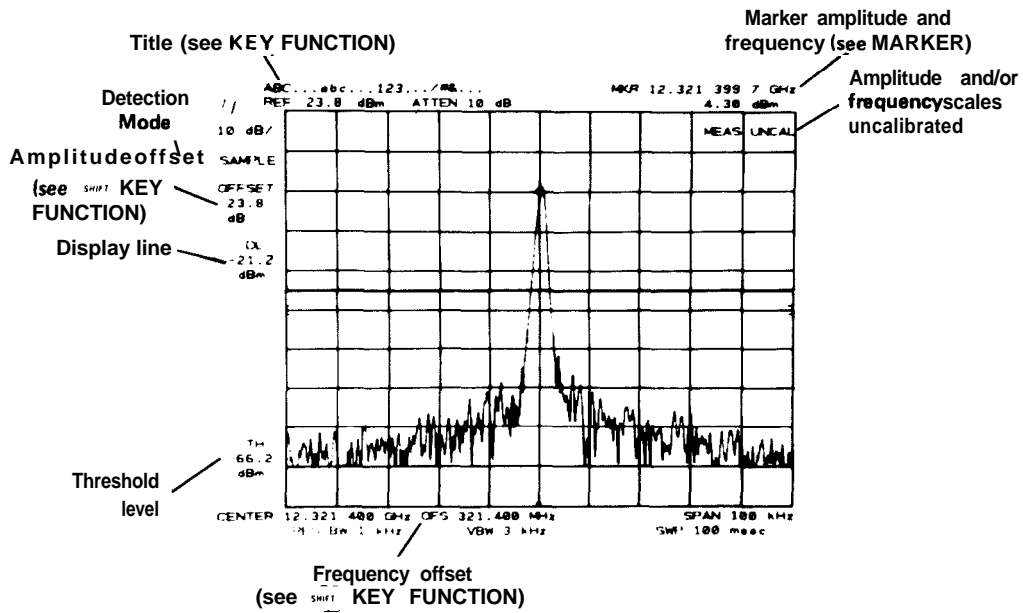

A number of other special function readouts can be activated. These are covered in Chapter 11.

CHAPTER 5 TRACE

GENERAL DESCRIPTION

This chapter describes the use of the TRACE functions for writing, storing, and manipulating trace data.

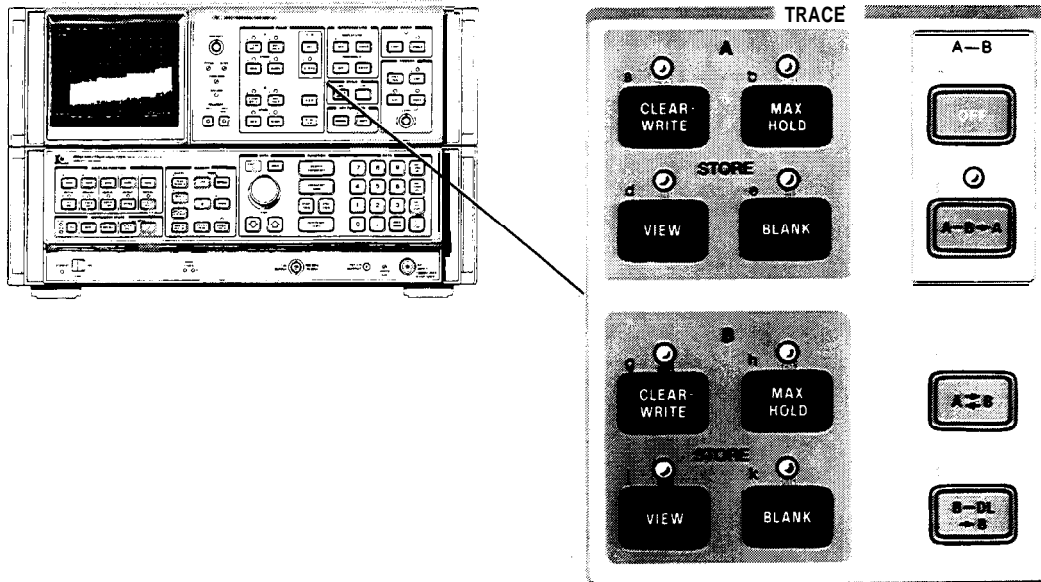

TRACE Controls

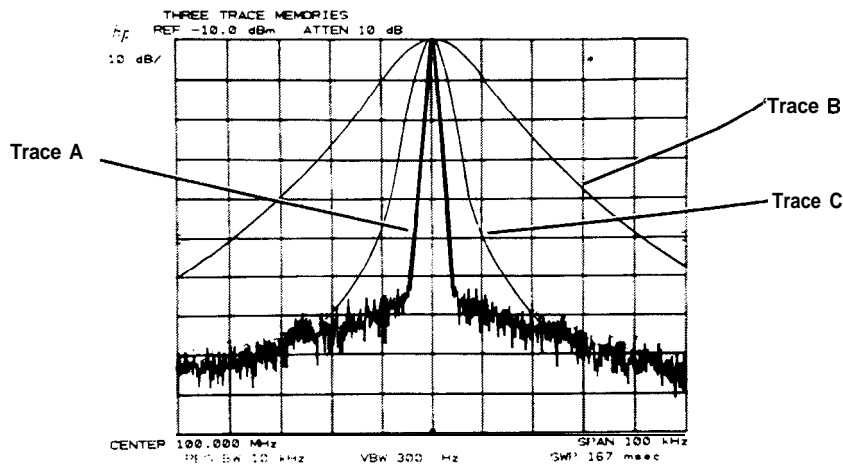

TRACE IDENTIFICATION

Traces are differentiated by intensity. Trace A is bright, trace B and trace C are dim. **VIEW** and **BLANK** allow positive identification.

TRACE MODES

Four mutually exclusive functions or modes for trace A and trace B determine the manner in which the traces are displayed. Indicator lights by the keys show the current modes.

WRITE Modes (sweeping):

- Displays the input signal response in trace selected.
- Displays and holds the maximum responses of the input signal in trace selected.

STORE Modes (not sweeping):

- Stores the current trace and displays it on the CRT display.
- Stores the current trace and blanks it from the CRT display.

Trace Memory

An understanding of the TRACE modes requires a description of the trace memory and trace data transfer within the analyzer.

Display traces are not written onto the CRT directly from the spectrum analyzer's IF section. Instead, the analog signal response is converted to digital information and stored in one trace memory which can then be transferred to the CRT display. The way in which the information is displayed depends upon the TRACE mode selected.

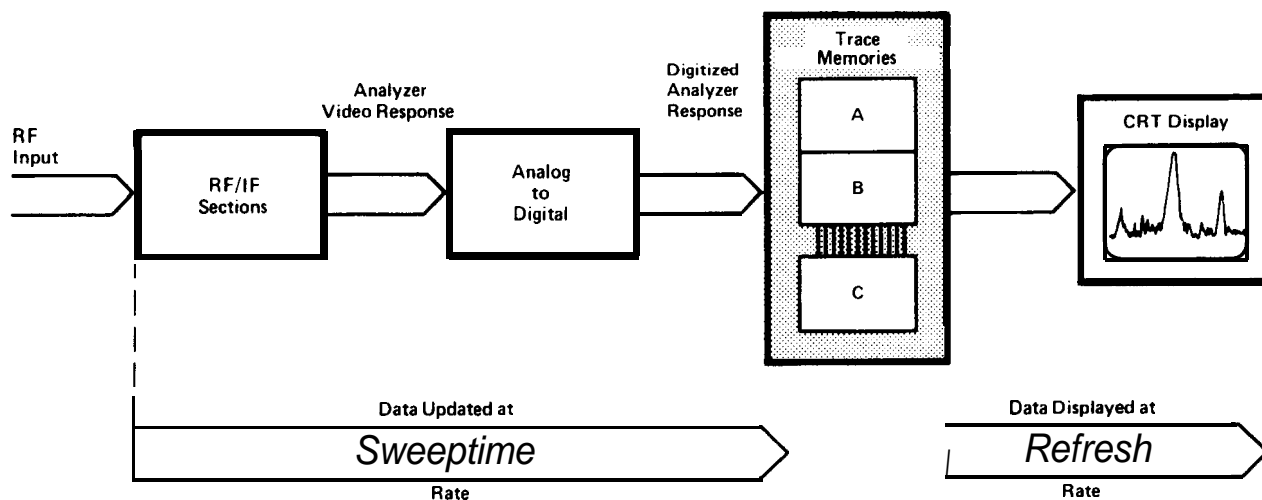

**TRACE MODES DETERMINE HOW DATA IS ENTERED INTO
AND DISPLAYED FROM TRACE MEMORIES**

The analyzer's response is transferred into the trace memory at the sweep rate of the analyzer; that is, its sweep time. The trace memory is written onto the CRT display at a refresh rate of about 50 Hz, rapid enough to prevent flickering of the trace on the CRT. Trace intensities remain constant as analyzer sweep times are changed.

NOTE

It is important to understand the difference between sweep and refresh.

Sweep refers to the spectrum analyzer sweeping from a start frequency to a stop frequency and storing measured amplitude data into a trace memory.

Refresh refers to the transfer of display memory data to the CRT display.

WRITE Modes

For the write modes, the analyzer signal response is written into trace memory during the sweep and the memory contents are displayed on the CRT

A(B) Sets all the values in the trace memory A(B) to zero when first activated (bottom line graticule) , then displays the signal response.

A(B) Latest signal response is written into the trace A(B) memory only at the horizontal positions where the response is greater than the stored response.

When both A and B modes are selected, the analyzer writes into (sweeps) A and B alternately.

STORE Modes

In the STORE modes, no updating of the trace memory is made. The current memory data is saved.

A(B) The trace A(B) data are displayed on the CRT (that is, the refresh is enabled).

A(B) The trace A(B) data are not displayed on the CRT (that is, the refresh is disabled).

Example

With TRACE modes, signals can be observed as the analyzer sweeps, can be stored for comparison, erased, or monitored for frequency drift.

Center and zoom in on a 20 MHz signal:

Press

Since has set A and B, only A is displayed.

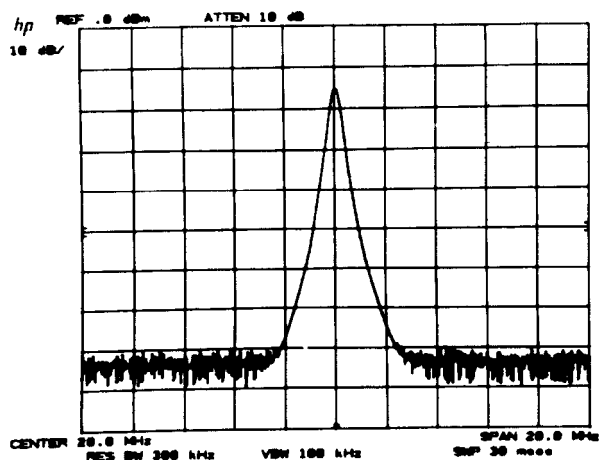

TRACE

TRACE MODES

This response can be stored:

Press **VIEW** A.

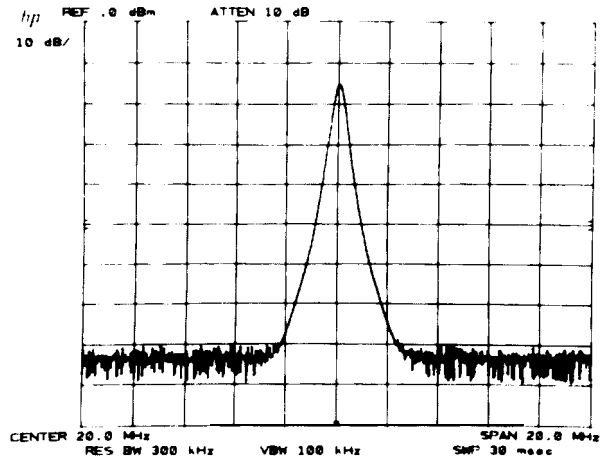

Write the same signal with B and change its position relative to trace A:

Press **CLEAR-WRITE** B.

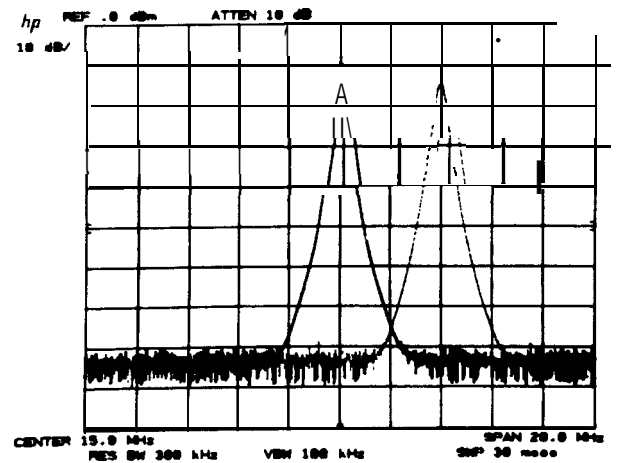

Blank trace A;

Press **BLANK** A.

This trace can be recalled with **VIEW** A as long as

CLEAR-WRITE A or **MAX HOLD** A is not used first.

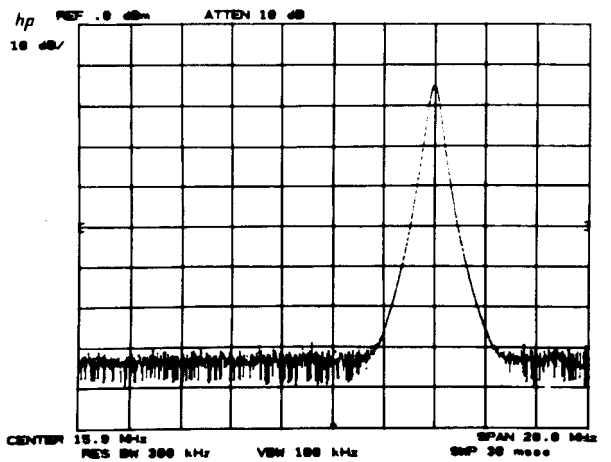

NOTE

The . on the top right corner of the CRT indicates that the CRT readouts may not correspond to the trace(s). In this case, the readouts apply only to TRACE B and not TRACE A.

TRACE

TRACE EXCHANGE

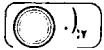
To display the drift of a signal, press **MAX HOLD** **A**.
 (Simulate frequency drift with )

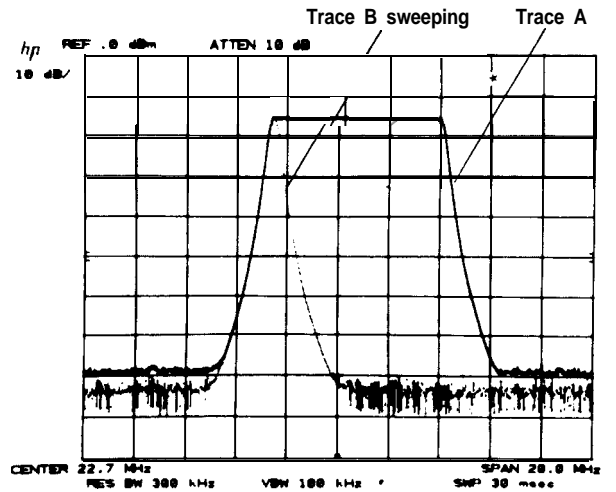

TRACE EXCHANGE

A ↔ B exchanges trace A and B, changing their relative intensities and storage memory locations and enables A and B **VIEW**. For example, in the trace display above, the modes and display appear.

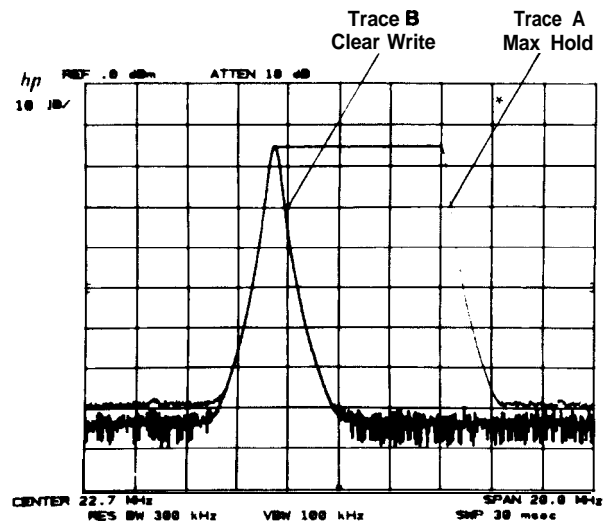
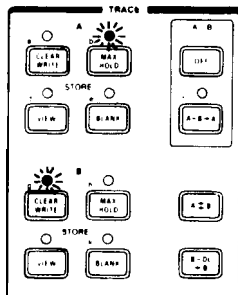

Press **A ↔ B**

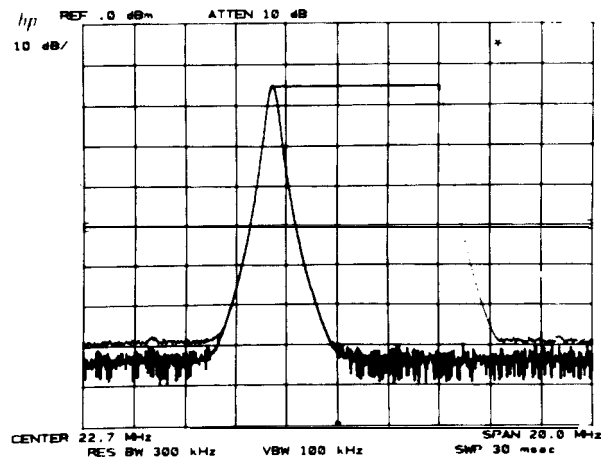
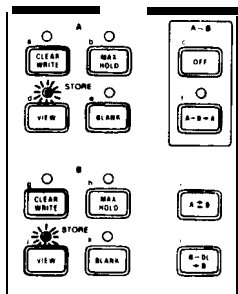

TRACE C MODES

A third trace, C, can be used to store a signal response. Trace C is not swept from the analyzer IF section as are traces A and B, but is input using a trace B into C function (B → C) or a B and C exchange function (B ↔ C).

Access to the trace C modes is through KEY FUNCTION **SHIFT**. The modes are:

- View C: **SHIFT** j Displays trace C.
- Blank C: **SHIFT** k Blanks trace C from CRT display.
- B → C: **SHIFT** l Writes trace B into trace C. Trace A and B modes are not changed. If trace C is not displayed, it remains undisplayed.
- B ↔ C: **SHIFT** i Exchanges traces B and C. If trace B is displayed before the exchange, trace C is now displayed. If trace B is not displayed before the exchange, trace C is not displayed.

TRACE ARITHMETIC

TRACE arithmetic allows one trace to be modified by another trace or a display line position.

- A-B **A-B-A** Trace B amplitude (measured in divisions from the bottom graticule) is subtracted from trace A and the result written into trace A from sweep to sweep. Trace B is placed or kept in a STORE mode.
- A-B **OFF** Turns **A-B-A** off.
- B-DL** **-B** Subtracts the amplitude of the display line from trace B and writes the result into trace B. Trace B is placed or kept in **VIEW**. Details on display line are in Chapter 7, REFERENCE LINE.

Example

Trace arithmetic with the display line can be used to correct for the frequency response characteristics (flatness) of a swept measurement system typified by this setup:

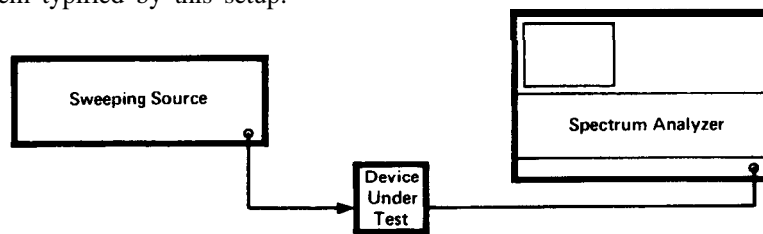

where the device under test is to be characterized for insertion loss over a specific frequency range.

The analyzer and source are set to the proper amplitude level and frequency span with the source output connected directly to the analyzer input.

- HAL HOLD** B, sweep source then
- VIEW** B.

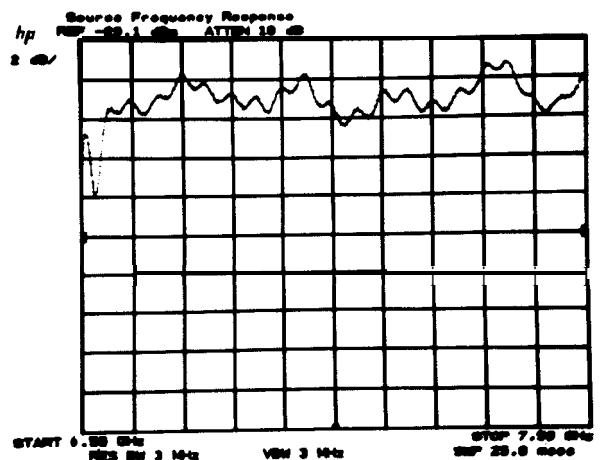

TRACE

TRACE ARITHMETIC

The display line is activated and set below the source/ analyzer response.

DL  

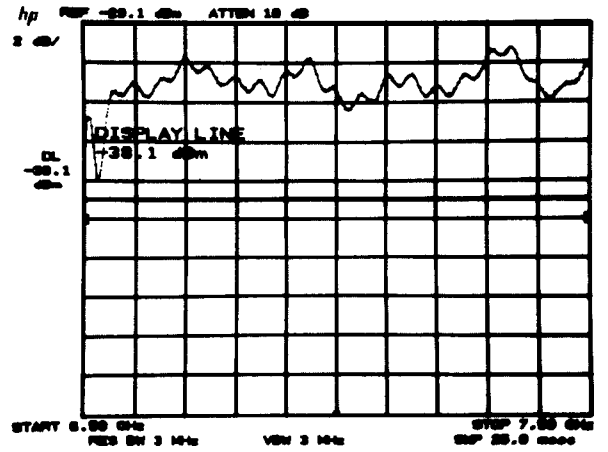

The difference between the display line (in display units) and the source/analyzer response is stored in trace B with I'::

Negative values of the  line are stored even though not displayed.

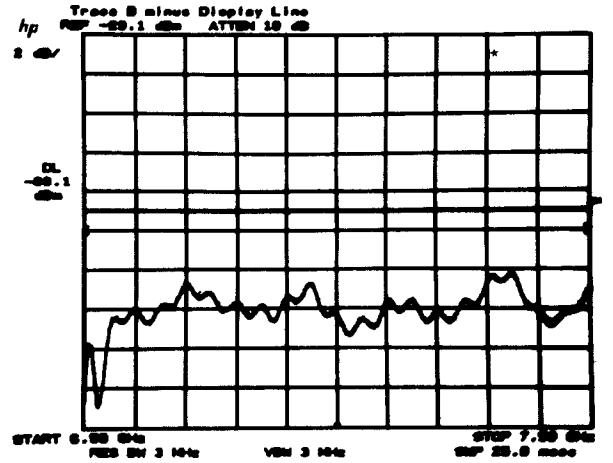





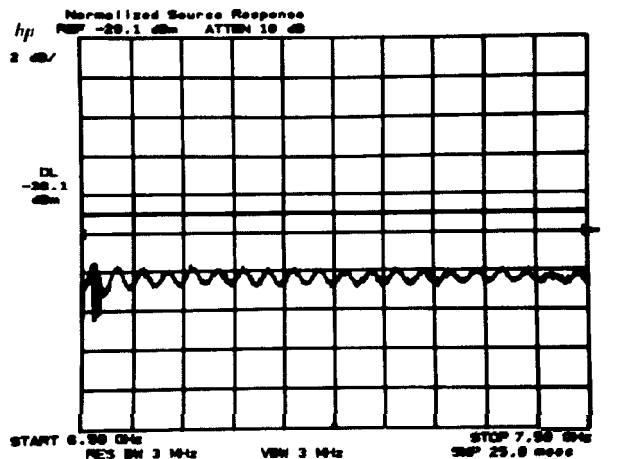



Now the device under test is connected between source and analyzer and its response is corrected for source flatness uncertainty by using

 A 



TRACE PRIORITY

Functions which act upon a trace always act upon the highest priority trace. Priority is defined by the trace modes as follows:

Highest priority	 A or  A
	 B or  B
	 A
	 B
	view C
a	 A
	 B
Lowest priority	blank C

Marker functions, for example, use trace priority to decide which trace to mark. See Chapter 6.

Chapter 6 MARKER

GENERAL DESCRIPTION

This chapter describes the use of the MARKER and DATA controls for making many measurements faster and with greater accuracy. Markers can be displayed only on TRACE A and TRACE B.

Two types of functions make up the MARKER group; MARKER MODES, which enable or disable markers and their related functions; and MARKER ENTRY functions, which allow the scaling of the display frequency and amplitude using marker information.

Markers are bright spots which lie directly on the display trace. The horizontal position of an activated marker is controlled by the DATA controls. The marker can be positioned at a specific frequency with the DATA number/units keyboard.

Readout of marker amplitude and frequency appears in the upper right of the display outside the **graticule**. When a MARKER MODE is active, its amplitude and frequency readout also appears in the active function area of the

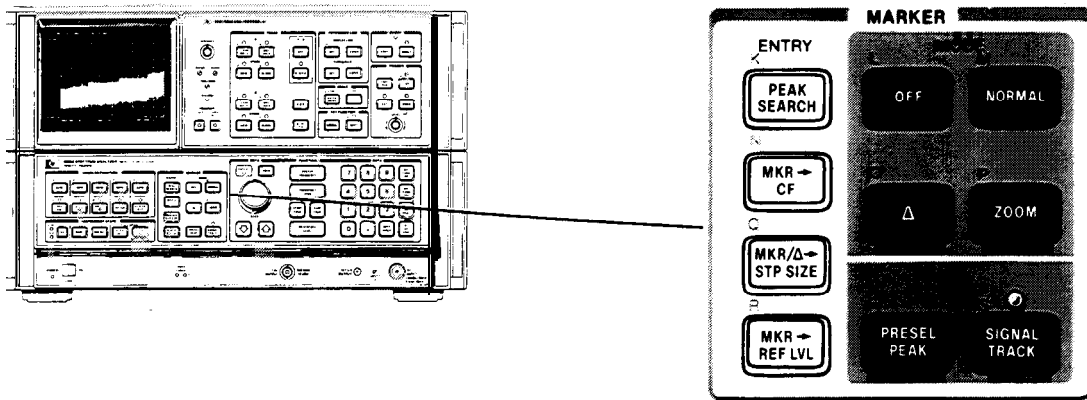

MARKER CONTROLS

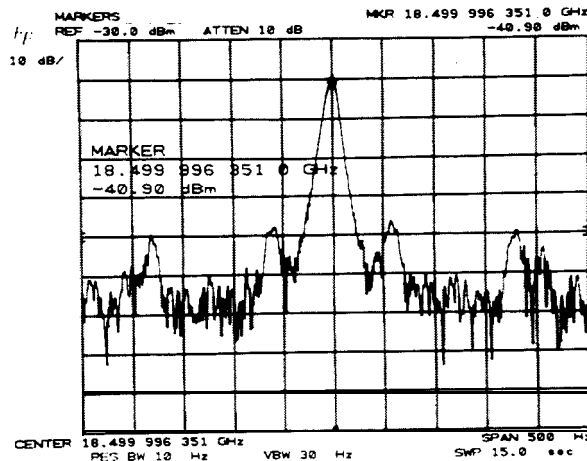

MARKER READOUT LOCATIONS

MARKER OVERVIEW

- Direct readout of the amplitude and frequency of a point along the trace.
- Direct readout of amplitude and frequency differences between points on the trace.
- Expansion of a span about a specific frequency.
- Placing a single marker at the highest response.
- Automatic peaking of preselector.
- Direct noise level readout.
- Analysis of stored traces.
- Amplitude and frequency display scaling.

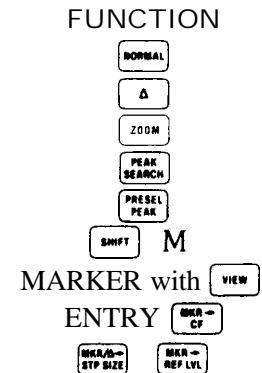

MARKER ON BUT NOT ACTIVE

An activated marker mode can be deactivated by activating another function, such as display line, or by DATA **HOLD**. This does not erase the marker itself nor the upper right display readout. If the marker mode is reactivated, DATA control and active function readout will continue from its last position.

If a marker mode is deactivated by a function (other than MARKER ENTRY) where a value change of the new function results in a **rescaling** of the amplitude or frequency axes, the marker will not stay on the trace. Reactivating the marker will start it at the display center.

MARKER OFF

OFF disables any marker mode, and blanks the marker readout from the CRT display. DATA controls are disabled if the marker was active.

MARKER IN VIEW

MARKER **NORMAL** and **Δ** may be used on traces A or B in the view mode. This allows detailed analysis of responses which are nonperiodic or unstable.

The markers will be placed on a viewed trace according to the priority defined in Chapter 5, TRACE PRIORITY





SINGLE MARKER — NORMAL

NORMAL activates a single marker at the center of the display on the trace of highest priority. Trace priority is defined in Chapter 5. The marker will not activate on the TRACE modes **BLANK** A, **BLANK** B, view C or blank C.

Measurement and Readout Range



Marker frequency has one digit more resolution than center frequency, and marker amplitude has one digit more resolution than reference level.

DATA Entry

	<p>Moves the marker continuously along the trace at about 5 horizontal divisions each full turn. The marker moves in display unit increments.</p>
	<p>Moves the marker along the trace one tenth of the total width per step.  moves marker to the right.</p>
	<p>Places the marker at the frequency entered. An out-of-range entry results in placement of the marker at a graticule edge.</p>

Example

Reading frequencies and amplitudes of signals is greatly simplified using MARKER  .

For a given display, activate the single marker with  then tune the marker with  to position it at the signal peak.

The frequency and amplitude is read out in two display areas.

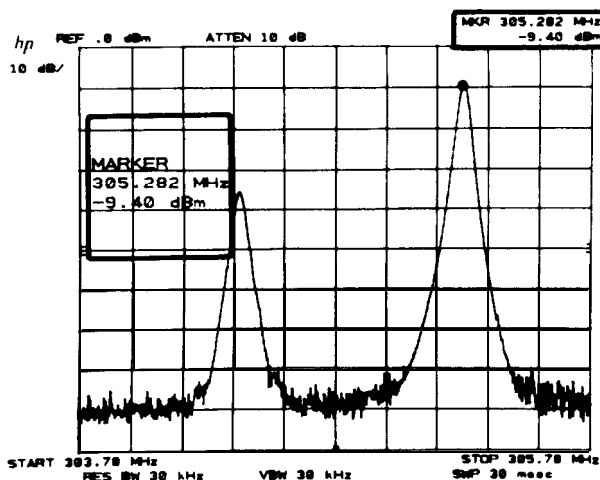

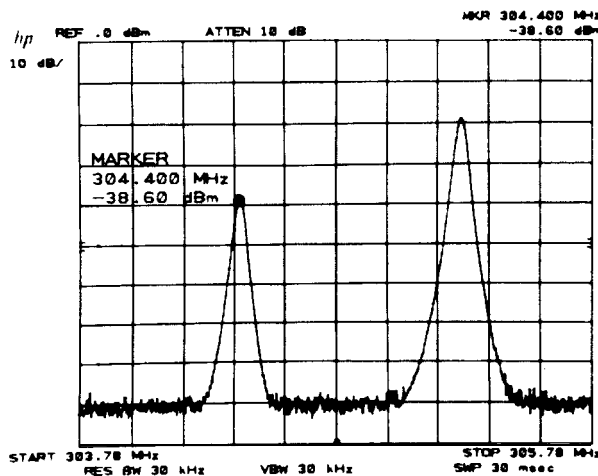

To read the left-hand signal's parameters, move the marker to the signal peak with  .

The signal's amplitude and frequency is read out directly.



DIFFERENTIAL MARKERS – A

 activates a second marker at the position of a single marker already on the trace. (If no single marker has been activated,  places two markers at the center of the display.) The first marker's position is fixed. The second marker's position is under DATA control.



The display readout shows the difference in frequency and amplitude.

Example

Measuring the differences between two signals on the same display.

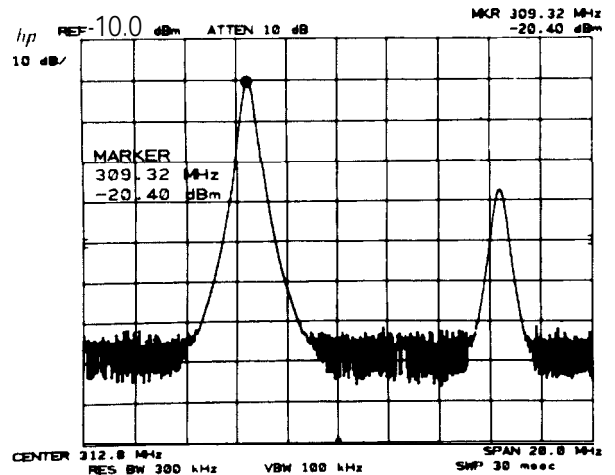
First set the marker on one of the signal peaks with



Activate , move the second marker to the other signal peak with , and read their differences directly.

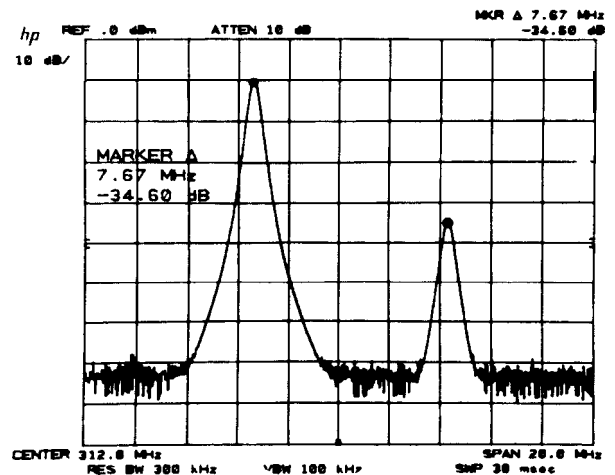

Fractional Differences

When the reference level is calibrated in voltage, marker  amplitudes are given as a fraction, the voltage ratio of two levels.

With logarithmic amplitude scale and the reference level in voltage, the fraction is based on the equation:

$$\text{fraction} = 10^{-\left(\frac{\text{dB difference}}{20}\right)}$$

Since this equation yields the harmonic distortion due to a single harmonic, its distortion contribution can be read directly from the display.

MARKER

DIFFERENTIAL MARKERS-A

Example

Set up  on the peaks of a fundamental (left) and its harmonic (right).

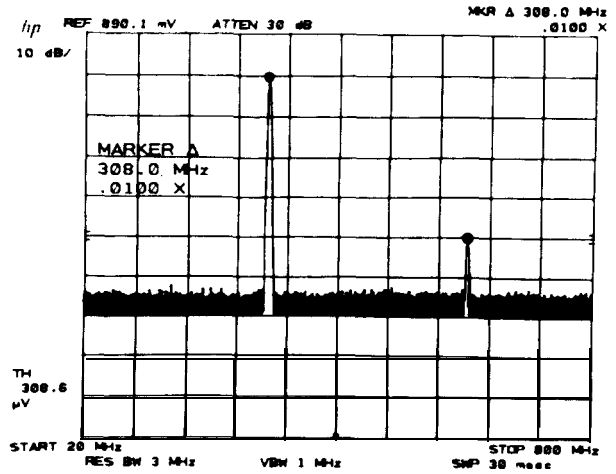

With the display referenced and scaled as shown, the readout “.0100X” designates the fractional harmonic content. Percent is calculated as $100 \times (.0100) = 1.0\%$.

With a linear amplitude scale and a reference level calibrated in voltage, the fractional amplitude readout is the simple linear ratio of the two markers.



Example

To measure % AM modulation from a spectral display, calibrate the display with the reference level in voltage and the amplitude scale in voltage.

Place the single marker on the carrier peak,  , and the second marker on one of the side-band peaks,  . The fractional amplitude readout gives one half the modulation index .283.

$$\%AM = 100 \times 2 \times .28 = 56\%.$$

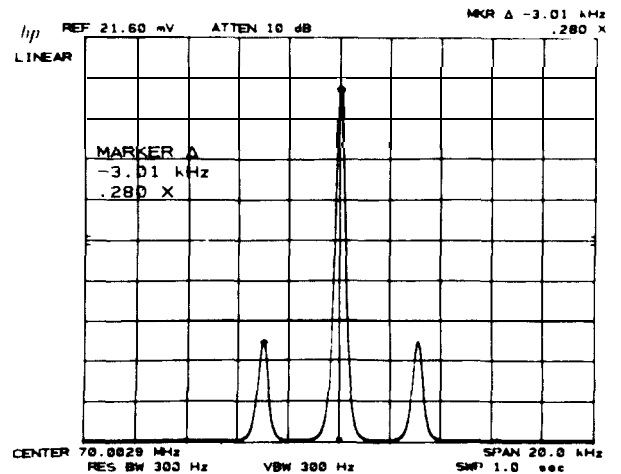



Measurement and Readout Range

The  function formats the amplitude readout according to reference level units and scale.

Reference Level Units	SCALE Logarithmic	SCALE Linear
dBm dBmV dBμV	Amplitude in dB	Amplitude in dB
Voltage	Amplitude ratio $10^{-\left(\frac{\text{dB difference}}{20}\right)}$	Ratio of marker amplitudes

AMPLITUDE READOUT FORMAT FOR MARKER 







The frequency readout for all MARKER  conditions has up to 4 significant digits, depending upon the portion of span measured.

The amplitude readout in dB has a resolution of $\pm .01$ dB for linear scale. The resolution for logarithmic scale depends upon the LOG  value:

LOG SCALE dB PER DIV	RESOLUTION
10	± 0.1 dB
5	± 0.05 dB
2	± 0.02 dB
1	± 0.01 dB

DATA Entry

The minimum incremental change for  frequency is 0.1% of the frequency span.

	<p>One full turn moves the active marker about one tenth of the horizontal span.</p>
	<p>One step moves the marker one tenth of the horizontal span.</p>
	<p>Positive entry places marker higher in frequency than the stationary marker, negative entry places marker lower in frequency. Larger entries than allowable will place the marker on the adjacent graticule border,</p> <p>Negative frequencies can be entered using a   prefix as the minus sign. For example, to set a  span of 10 MHz with the second marker positioned to the left of the first, press</p> 

MARKER ZOOM

 activates a single marker on the trace of highest priority (see TRACE PRIORITY, Chapter 5).

In , the DATA knob and STEP keys change the values of different *functions*.

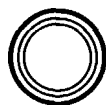

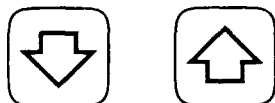

Positions Marker



Changes FREQUENCY SPAN and sets CENTER FREQUENCY equal to MARKER frequency

DATA Control Use for 



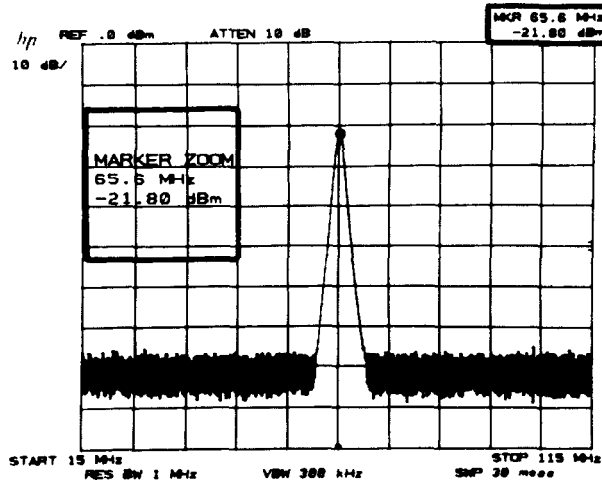



The marker can be moved along the trace with the DATA knob  , and the frequency span can be changed about the marker with DATA step  and  . Each step also sets center frequency equal to the marker frequency.



Measurement and Readout Range

The measurement and readout range for marker zoom is the same as marker  .

DATA Entry

 	Moves the marker continuously along the trace. Rate dependent on speed of rotation. The marker moves in display unit increments.
  	Changes the frequency span to the next value in the sequence and sets the center frequency equal to the marker frequency.
 	Places the marker at the frequency entered. An out-of-range entry places the marker at a graticule border.

Example

In wide frequency spans, it is often necessary to expand a portion of the frequency span about a specific signal in order to resolve modulation sidebands or track frequency drift.

From a full span, select a signal using the marker with

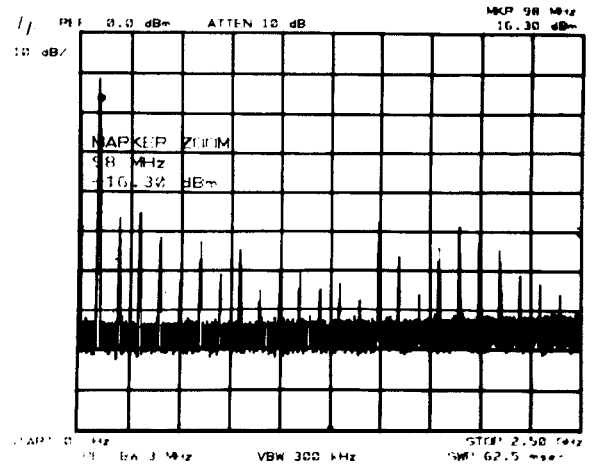

To center the marker and signal and expand the frequency span in one step, press

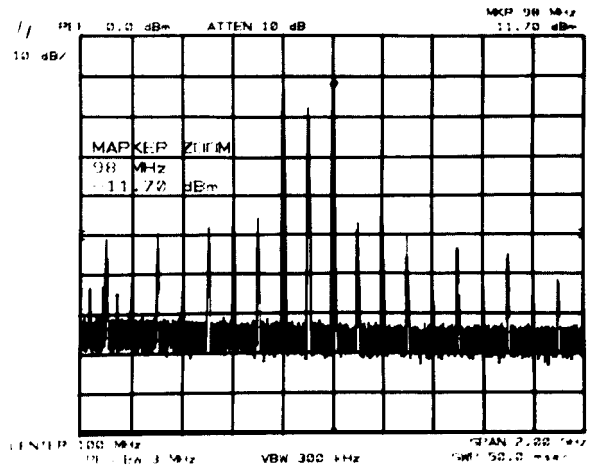

Expanding twice more with shows that the marker requires recentering on the signal.

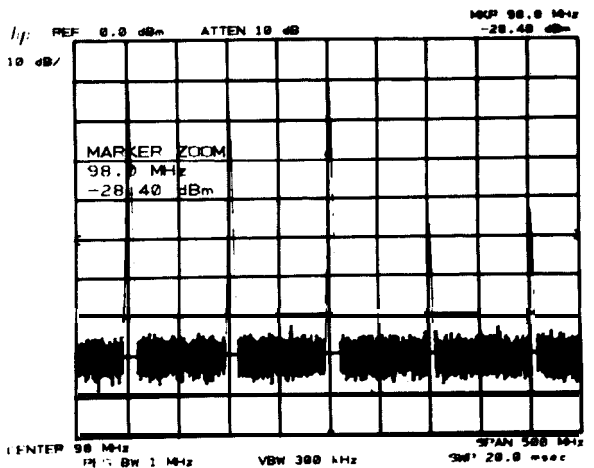

Recenter with 

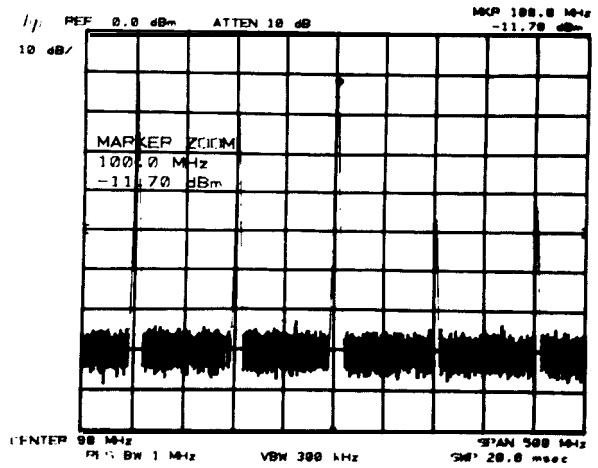



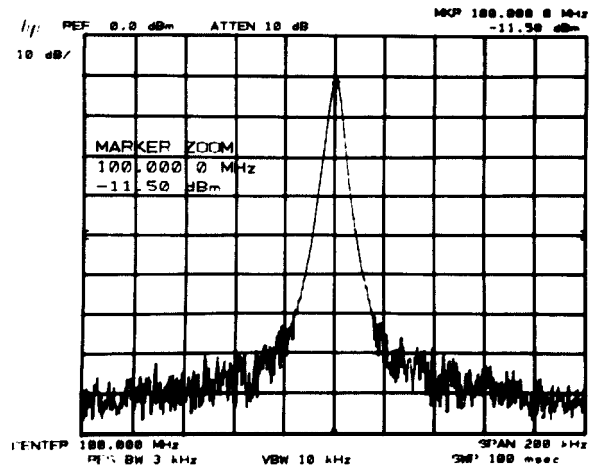

Continue using  (and recentering the marker on the signal when necessary) until the desired resolution is achieved.



AUTOMATIC ZOOM

The analyzer can automatically zoom in on a signal specified by a marker. The desired frequency span is input from the DATA number/units keyboard.

To use the automatic zoom function:

- Use   to identify the signal to be zoomed in on.
- Press   and enter the desired span with the DATA number/units keyboard.

When the units key is pressed, the zooming process will begin.

Example

A single carrier needs to be examined in a 200 kHz span to see the sidebands. Because the SIGNAL TRACK function automatically maintains the signal on the center of the CRT you can zoom automatically from a very wide span to a narrow span to look close-in at the signal.

PEAK SEARCH

MARKER

Place a marker on the carrier with **NORMAL** 

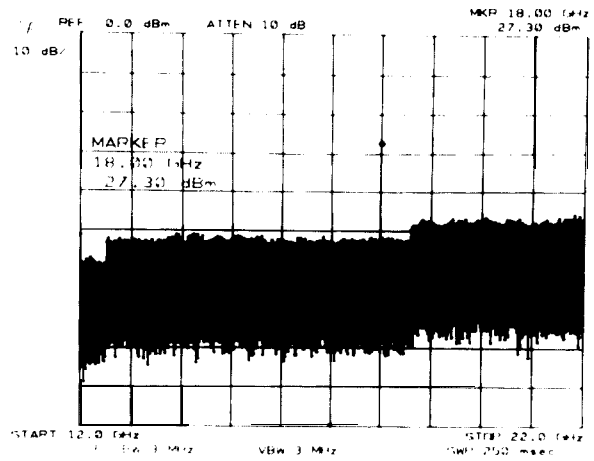

Press **SIGNAL TRACK** **FREQUENCY SPAN**.

Enter the span.

Press **2** **0** **0** **kHz mV msec**, and auto zoom will be completed

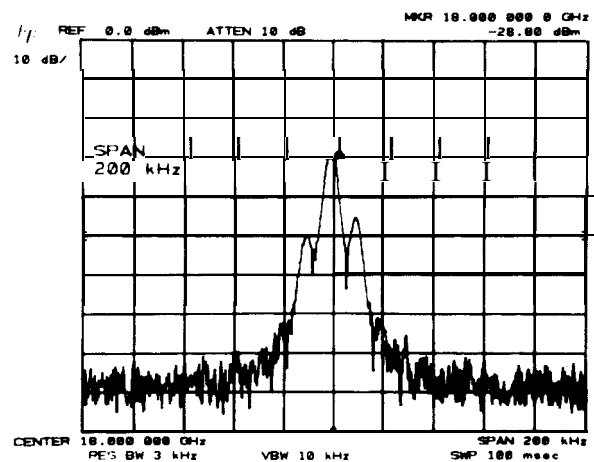

PEAK SEARCH

Peak Search

Peak search places a single marker at the highest trace position of the highest priority trace. The active function is not changed.

Example

Use PEAK SEARCH to position the marker at the peak of the signal response.

In a narrow span, the marker may be placed at the signal peak.

Press **PEAK SEARCH**.

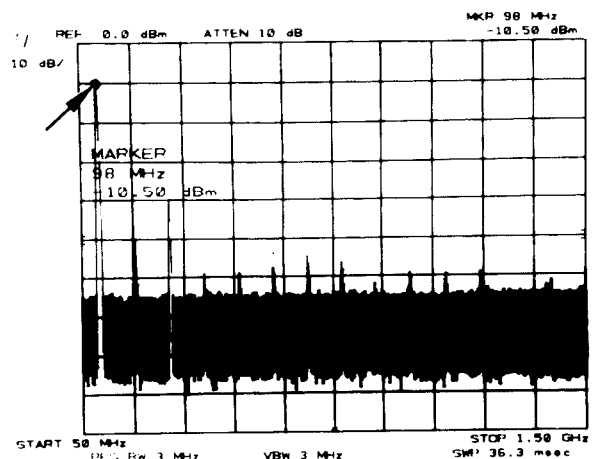

MARKER

MARKER ENTRY

Note that the marker seeks the maximum trace response, no matter what the cause of the response. A larger signal, or the local oscillator feedthrough, would have attracted the marker.

MARKER to Next Peak

The marker can also find the next highest peaks by successively pressing **SHIFT** **K** **PEAK SEARCH**

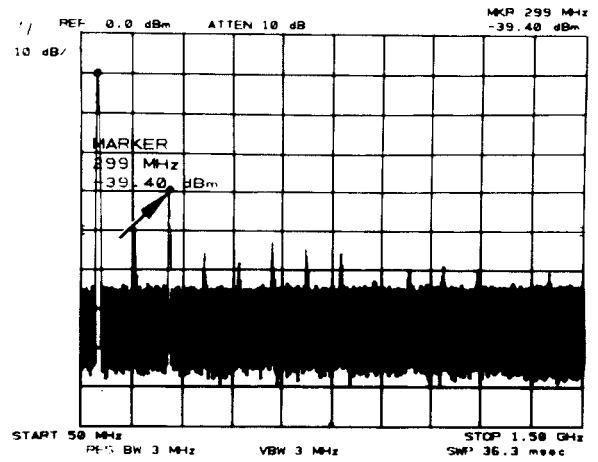

Marker to Minimum

The minimum trace value can be located by pressing **SHIFT** **N**.

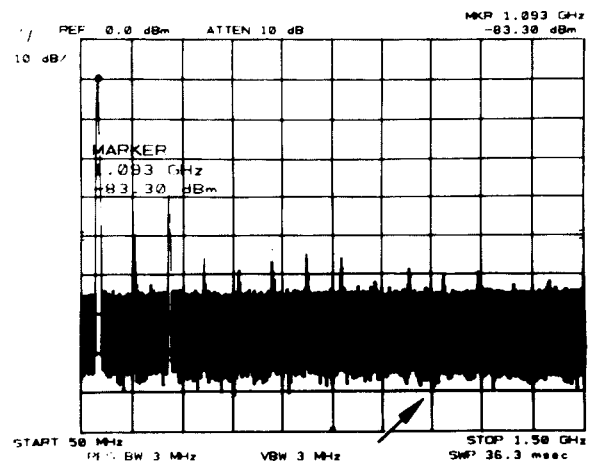

MARKER ENTRY

MARKER → CF, **MARKER → REF LVL** and marker **Δ** into span. Immediately set the corresponding FUNCTION value equal to the readout of the active marker or markers:

ENTRY	RESULT
<p>MARKER → CF</p> <p>SHIFT Δ</p> <p>MARKER → REF LVL</p>	<p>marker frequency into CENTER FREQUENCY</p> <p>marker Δ frequency into FREQUENCY SPAN OR START FREQ / STOP FREQ</p> <p>marker amplitude into REFERENCE LEVEL</p>

MARKER → STEP SIZE immediately records the single or the differential marker frequency in COUPLED FUNCTION **CF STEP SIZE** for use with **CENTER FREQUENCY** DATA **↑** **↓**

MARKER ENTRY

MARKER

A marker entry can be made any time a marker is on the trace. (with only one marker displayed takes 0 Hz as the lower frequency.) The active function will not be changed.

Example

One of the fastest, most convenient ways to bring a signal to the center of the display is by using .

Activate a single marker and tune it to the desired signal: .

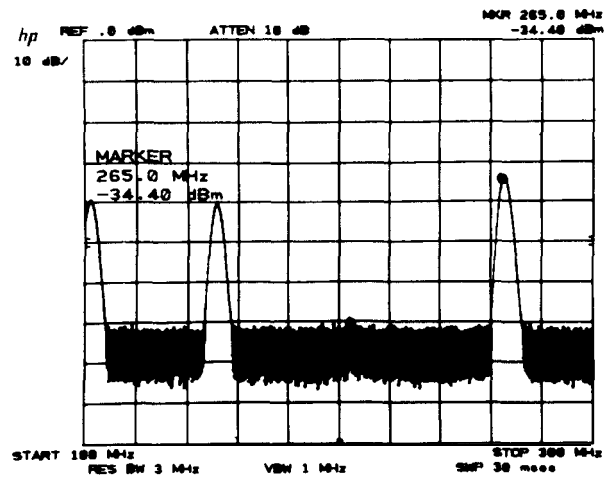

Change the center frequency to the marker frequency.

will also work if start/stop frequencies are read out.

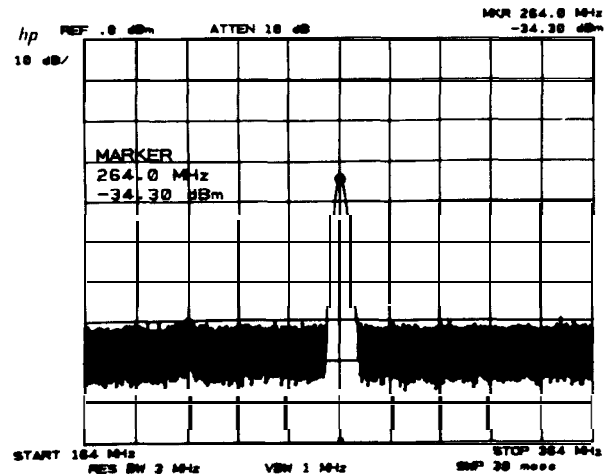

Example

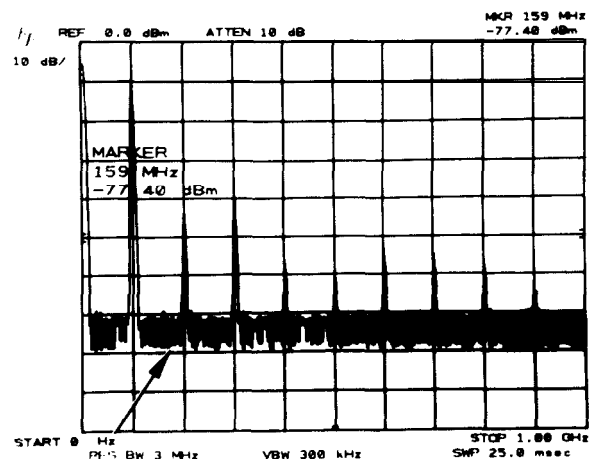

One way to tune to a particular portion of a spectrum being displayed is to use the A → span function.

Activate the single marker and place it at either end of the desired frequency span with .





MARKER

MARKER ENTRY

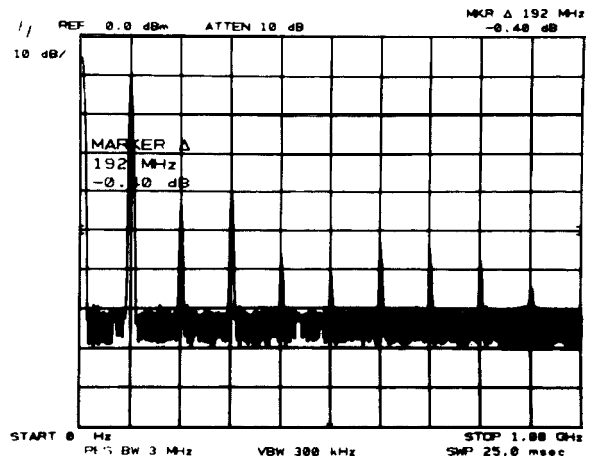
Activate the second marker and place it at the other end of the span with  



Set the start and stop frequencies equal to the left and right marker frequencies with  

Marker  is activated.

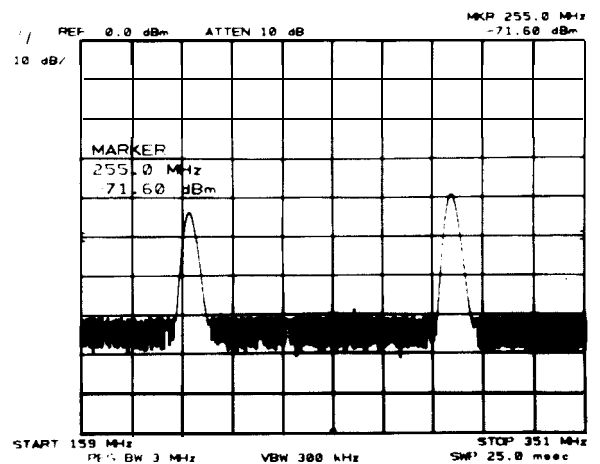



A → span will work the same with start/stop frequency readout. Note that the markers can be placed at either end of the span.

Example

Here is a technique for viewing a fundamental and its harmonics (or any evenly spaced portions of the spectrum) with high resolution.

Narrow the span about the fundamental as necessary with , centering the carrier.

Set the center frequency step size with 

Now enable center frequency. With each , successive harmonics will be displayed.

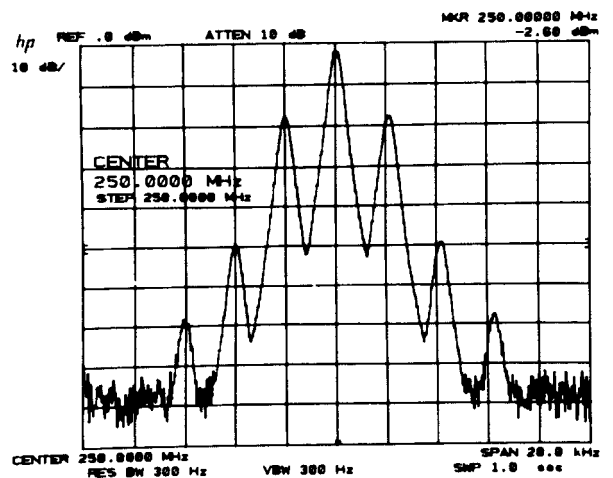

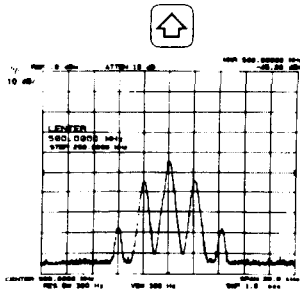

SECOND HARMONIC

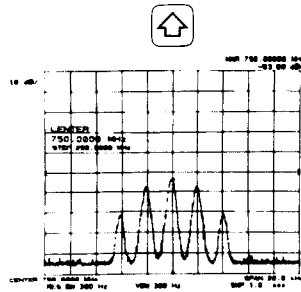

THIRD HARMONIC

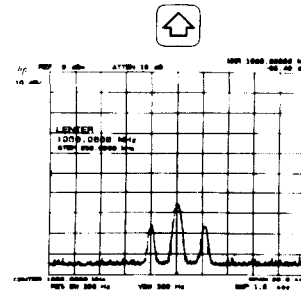

FOURTH HARMONIC

Similar stepping can be accomplished using marker Δ into step size for intermodulation products or other evenly spaced signals such as communication channels.

SIGNAL TRACK – AUTOMATIC FREQUENCY CONTROL

The analyzer is capable of automatically maintaining a drifting signal at the center of the display. To operate SIGNAL TRACK:

Press **NORMAL**, and place the marker on the signal to be tracked with \odot .

Press **SIGNAL TRACK** to initiate the tracking. The light above the key indicates tracking. (Press again to turn off.)

As the signal drifts, the center frequency will automatically change to bring the signal, and marker to the center of the display.

MARKER **OFF**, any other MARKER mode or the instrument preset turns the tracking function off.

The upper sideband of a transmitter is to be monitored as the carrier frequency is tuned.

Locate the sideband with **NORMAL** \odot .

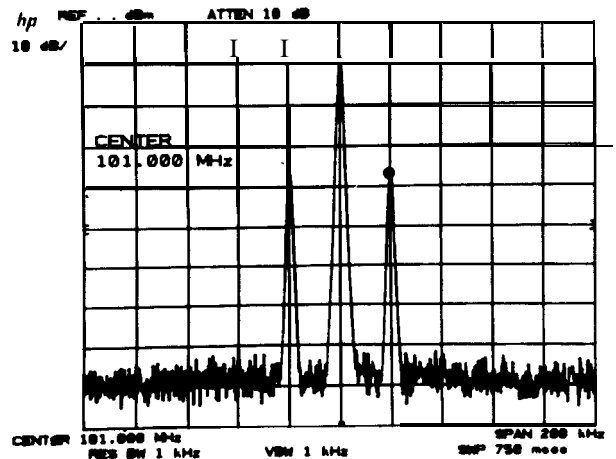

MARKER

PRESELECTOR PEAK

The upper carrier sideband is tracked with **SIGNAL TRACK** then zoomed in with **FREQUENCY SPAN** **1** **0** **kHz** **mV** **msec**.

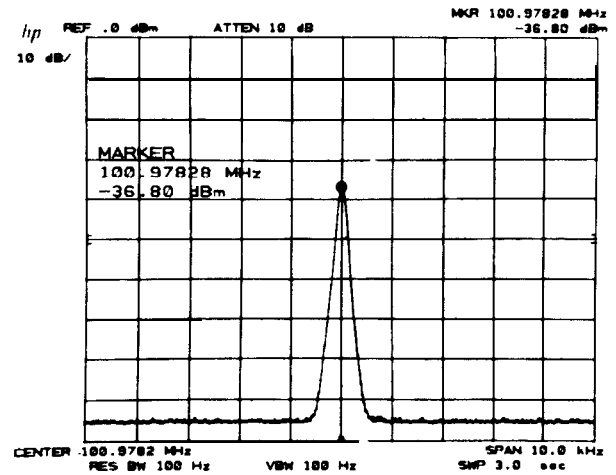

As the carrier frequency is changed, the sideband response will tend to remain in the center of the display. The center frequency and marker frequency reads out the sideband's frequency.

A combination of **SIGNAL TRACK** and **Δ** allows the “real time” signal frequency drift to be read on the display.

PRESELECTOR PEAK

Preselector peak automatically adjusts the preselector tracking to peak the signal at the active marker. When the marker is tuned to a signal and **PRESEL PEAK** is pressed, an internal routine searches for the peak response of the preselector and adjusts the tracking accordingly. Using preselector peak prior to measuring a signal yields the most accurate amplitude reading.

Preselector peak operates with the **NORMAL**, **ZOOM**, or **Δ** markers. If the marker is OFF pressing **PRESEL PEAK** will initiate a peak search routine and then peak the response at that marker. A “PEAKING!” message appears on the active graticule area to indicate operation of the peaking routine. PRESELECTOR PEAK only operates in the 2 – 22 GHz preselected band.

Example

Peak the signal for accurate amplitude measurement.

Tune marker to signal of interest.

Press **NORMAL** .

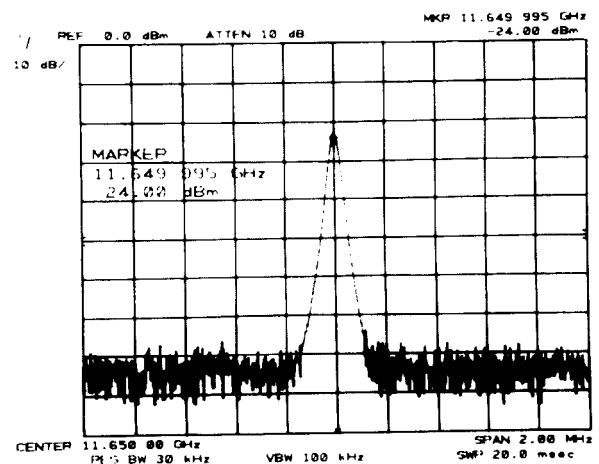

Press **PRESEL PEAK** to peak preselector tracking. Measure amplitude by reading marker.

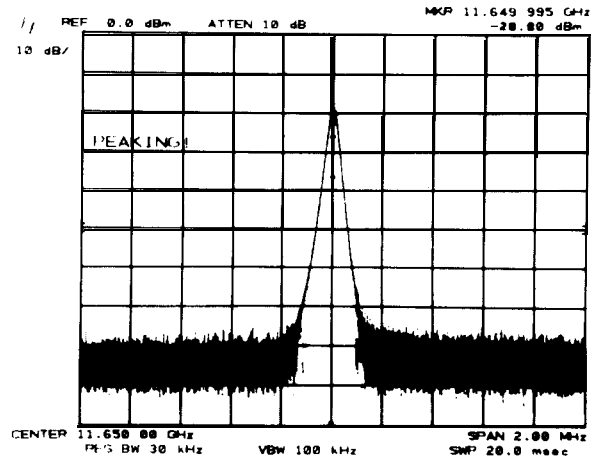

The specific preselector correction factor applied in the example above is stored. A **2-22 GHz** INSTRUMENT PRESET will not erase the correction factor; however, another PEAKING routine in the same band will store a new correction factor in that band.

The factory set preselector tracking can be recalled with **SHIFT** = **PRESEL PEAK**. The preselector can be manually adjusted by pressing **SHIFT** / **GHz +dBm dB** (See Chapter 11.)

How It Works

The internal preselector peaking routine automatically searches and sets the peak response of the YIG filter at the marker frequency. Each peaking operation only affects the frequency band in which the signal is located (four possible bands). A correction factor, representing the tracking offset, is stored in memory for that particular band each time the peaking routine is used. Correction factors (one per band) remain in memory unless a new peaking routine is initiated that may result in a different number. The last **PRESEL PEAK** correction factors are saved along with control settings in the internal storage registers upon execution of a **SAVE** followed by a number from 1 to 6. Thus, up to six correction factors could be saved for any of the frequency ranges listed in the chart below:

BAND	FREQUENCY RANGE
1	2.0 – 5.8 GHz
2	5.8 – 12.5 GHz
3	12.5 – 18.6 GHz
4	18.6 – 22 GHz

NOISE LEVEL MEASUREMENT

When noise level is activated and the marker is placed in the noise, the rms noise level is read out normalized to a 1 Hz noise power bandwidth.

MARKER

NOISE LEVEL MEASUREMENT

Noise level enabled:
 Noise level disabled:

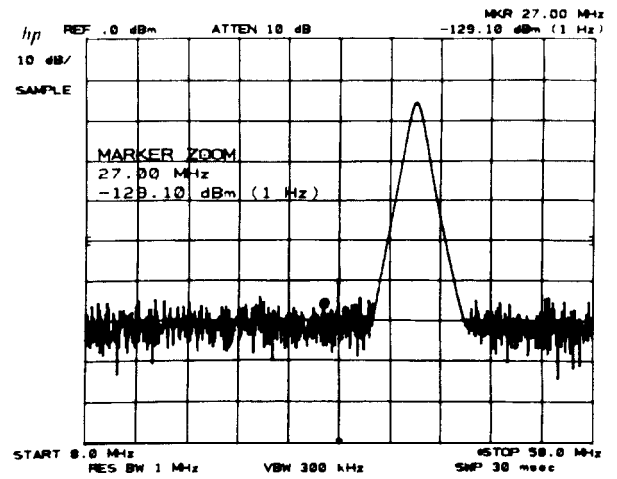

The noise level measurement readout is corrected for the analyzer’s log amplifier response, and the detector response. The value is also normalized to a 1 Hz bandwidth.

Measurement and Readout Range

Noise level measures noise accurately down to 10 dB above the spectrum analyzer’s noise level. The readout resolution is in steps of ± 0.1 dB.

DATA Entry

See MARKER , , and .

Example

In a communication system, the baseband noise level as well as signal to noise ratio measurements are required.

Select a frequency in the baseband spectrum clear of signals with a single marker. Press .

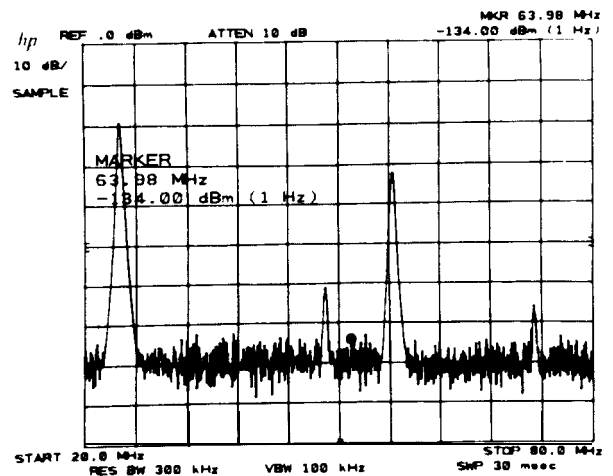

Read the noise at the marker by pressing

The noise at 64 MHz is -134 dBm in a 1 Hz bandwidth. This corresponds to $-134 \text{ dBm} + 36 \text{ dB}/4 \text{ kHz} = -98 \text{ dBm}$ in 4 kHz voice channel bandwidth.

Signal to noise measurements require the measurement of the noise level, as the example above, and the measurement of the absolute signal level. *

Measure the power level of the adjacent signal. To turn the noise level off, press and read the power level.

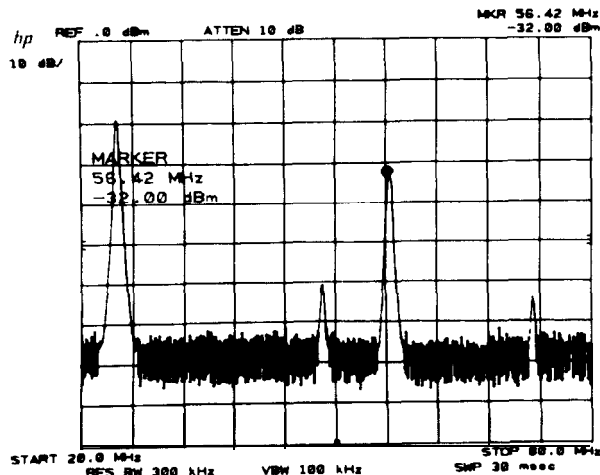

The signal to noise ratio referenced to 4 kHz bandwidth is $-32 \text{ dBm} - (-98 \text{ dBm}) = 66 \text{ dB}$.

*Normalization to a desired bandwidth uses the equation $10 \log_{10} \left(\frac{\text{desired BW}}{1 \text{ Hz}} \right)$

Chapter 7 SCALE AND REFERENCE LINE

GENERAL DESCRIPTION

This chapter describes the use of SCALE and REFERENCE LINE control groups for setting the amplitude scale, and for making amplitude level measurements more conveniently.

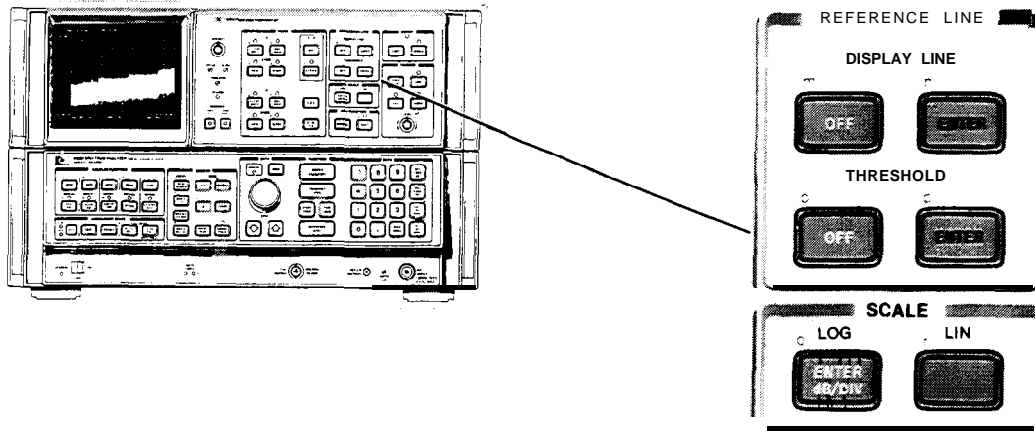

SCALE

SCALE keys allow the scaling of the vertical graticule divisions in logarithmic or linear units without changing the reference level value.

LOG.

ENTER dB/DIV (DATA entry) scales the amplitude to 1 dB, 2 dB, 5 dB, or 10 dB per division.

If **ENTER dB/DIV** is pressed when the scale is linear, 10 dB per division will be automatically entered. The subsequent (DATA), if any, will then replace the automatic 10 dB/div.

Press: **LOG** **ENTER dB/DIV** **5** **GHz +dBm dB**

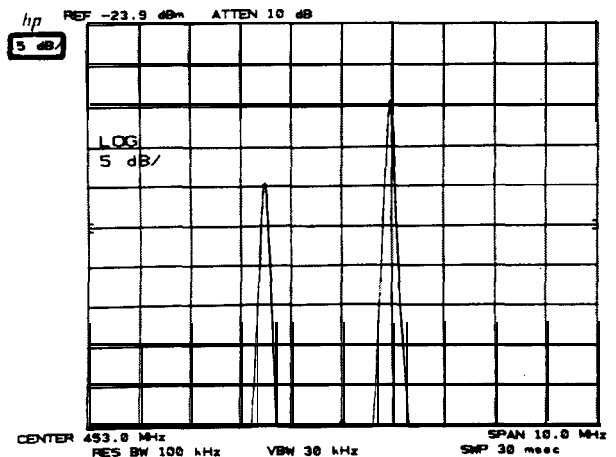

LIN

immediately scales the amplitude proportional to input voltage. The top graticule remains the reference level, the bottom graticule becomes zero voltage. Reference level, and all other amplitudes, are read out in voltage. However, other units may be selected. See AMPLITUDE UNITS SELECTION, Chapter 11.

If is pressed when the scale is linear, 10 dB per division will be automatically entered.

Press LIN

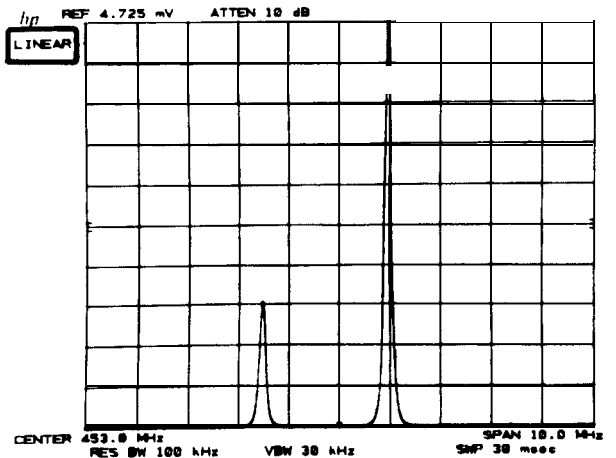

In LINEAR, a specific voltage per division scale can be set by entering a voltage reference level value. For example, to set the scale to 3 mV/division, key in 30 mV reference level, (Voltage entries are rounded to the nearest 0.1 dB, so the 30 mV entry becomes 30.16 mV, which equals -17.4 dBm.)

DATA Entry

	<p>Changes scale in allowable increments (1, 2, 5, or 10 dB per division).</p>
	<p>Enables direct scale selection of allowed values. Other entries are rounded to an adjacent value.</p>

No DATA entry will be accepted with the linear SCALE selection key, LIN

Example

It is convenient to observe AM sidebands in linear as well as logarithmic scales for analysis of both modulation percentages and distortion products.

6.2 Manual Operation

Modulated AM signal displayed in the 10 dB/division scale shows the carrier, its sidebands, and distortion products.

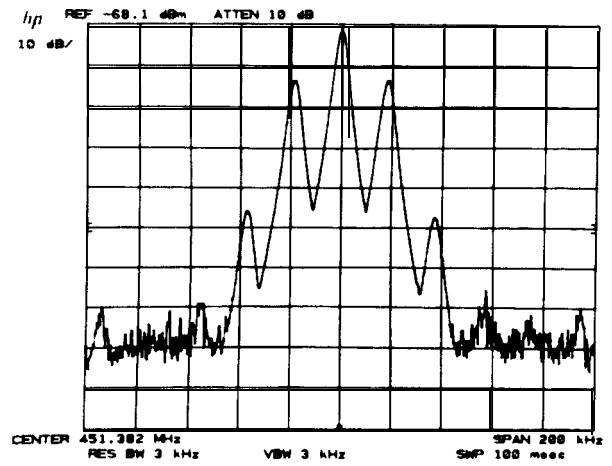

Linear scaling enables the observation of the sidebands proportional to the carrier.

Press LIN

As in the MARKER Δ example, Chapter 6, a direct readout of the percent modulation can be made.

The fractional readout is one-half the modulation index (only one sideband is measured).

$$\%AM = 2(.25) \times 100 = 50\%.$$

Note that the carrier signal need not be placed at the reference level for an index ratio measurement.

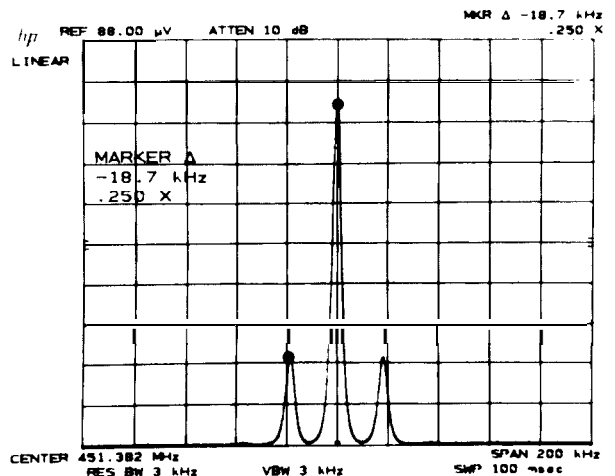

LOG

Change to a logarithmic scale with ENTER dB/DIV and change the dB/division with ↓ ↓ .

The sidebands are 12 dB down from the carrier, verifying the earlier measurement results.

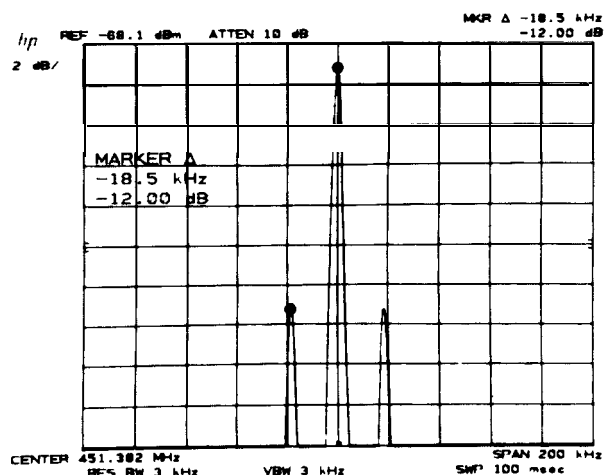

REFERENCE LINE

SCALE AND REFERENCE LINE

Harmonic distortion of the modulating signal can be measured as in MARKER , Chapter 6.

The modulation frequency is 18.8 kHz and the distortion caused by the second harmonic is 2.4% (read out as .024X).

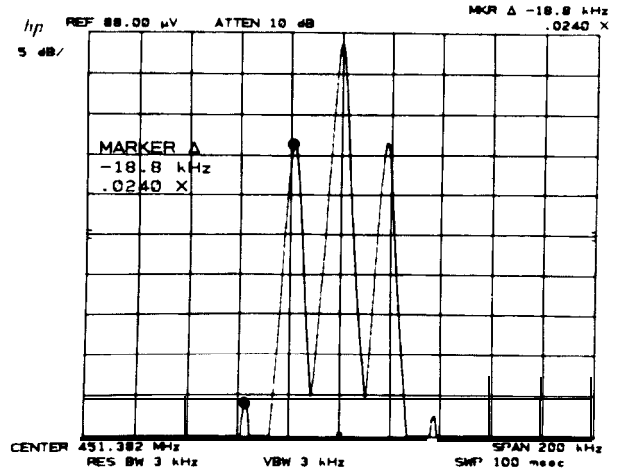

REFERENCE LINE

The reference line functions, DISPLAY LINE (DL) and THRESHOLD (TH), place horizontal reference lines on the display. Their levels are read out in absolute amplitude units.

DISPLAY LINE uses

- measure signal levels with direct readout.
- establish a standard for go/no-go test comparisons.
- eliminate or reduce amplitude errors due to system frequency response uncertainty

THRESHOLD provides:



- a base line clipper whose level is read out.
- a minimum threshold level that can be set.

DISPLAY LINE

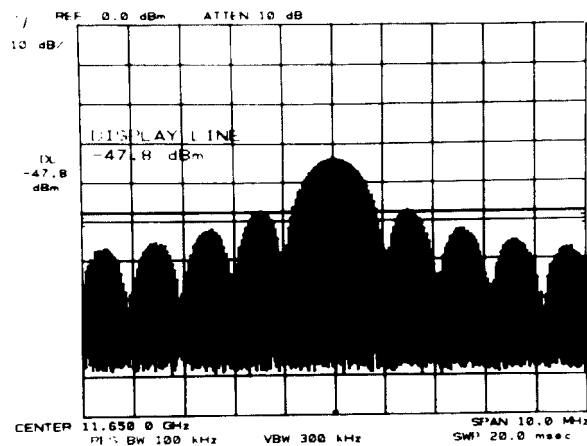
DISPLAY LINE (DATA entry) places a horizontal reference line at any level on the graticule. The line's amplitude, in reference level units, is read out on the left-hand side of the CRT display.









The DISPLAY LINE can be positioned anywhere within the graticule. When activated after LINE power ON or  , the display line is placed 4.5 divisions down from the reference level.

DISPLAY LINE  erases the line and readout from the CRT display but does not reset the last position. If the display line is activated again before LINE power ON or  , it will return to its last position.

DISPLAY LINE position is always accessible for HP-IB and TRACE  , even if never activated. See Chapter 5, TRACE ARITHMETIC.

The DISPLAY LINE readout has the same number of significant digits as reference level.

DATA Entry

 	Moves the line about one division for each full turn. The line moves in display unit increments.
  	Moves the line one-tenth of the total amplitude scale per step.
 	Positions the line to the exact entry level. Entry may be in mV, μ V, \pm dBm, \pm dBmV, or \pm dB μ V, depending upon which units are selected.

Example

When the amplitude of a number of signals in the same span require a quick readout, the DISPLAY LINE can be used.

Activate the DISPLAY LINE with 

With  , place the line through the peak of a signal and read out its absolute amplitude level.

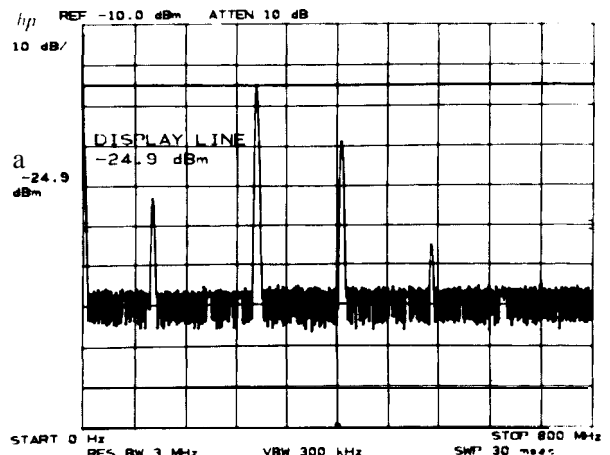

Moving the DISPLAY LINE to each signal reads out its amplitude.

THRESHOLD

THRESHOLD (DATA entry) moves a lower boundary to the trace, similar to a base line clipper on direct-writing CRT spectrum analyzers. The boundary's absolute amplitude level, in reference level units, is read out on

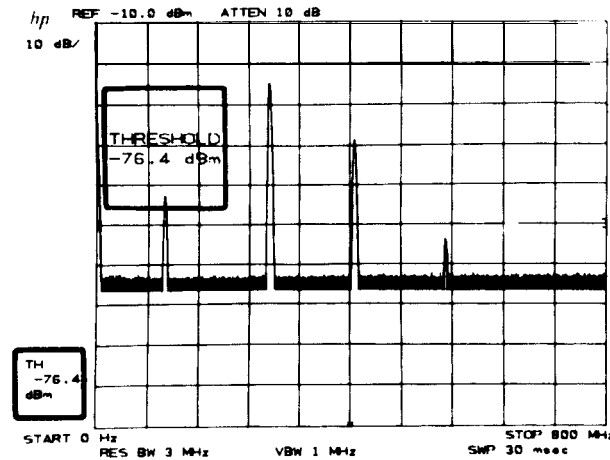





The THRESHOLD can be positioned anywhere within the graticule. It operates on TRACE , , or for TRACES A, B, and C simultaneously. When activated after LINE power ON or , the THRESHOLD is

The THRESHOLD level does not influence the trace memory; that is, the threshold level is not a lower boundary for trace information stored and output from the trace memories through the HP-IB. TH removes the THRESHOLD boundary and readout from the CRT display but does not reset the position. If threshold is activated again before LINE power ON or I'd:], it will resume at its last level.

The THRESHOLD readout has the same number of significant digits as reference level.

DATA Entry

<input type="button" value="ENTER"/> 	Moves the THRESHOLD about one division per rotation. The line moves in
<input type="button" value="ENTER"/>  	Moves the THRESHOLD one-tenth of the total amplitude scale per step.
<input type="button" value="ENTER"/> 	Positions the THRESHOLD to the exact entry level. Entry may be in mV, ± dBm, ± dBmV, or ± dBμV, depending upon units selected.

Example

The THRESHOLD can be used as a go/no-go test limit.

A series of signals can be tested for a specific THRESHOLD level by placing the THRESHOLD at the test level.

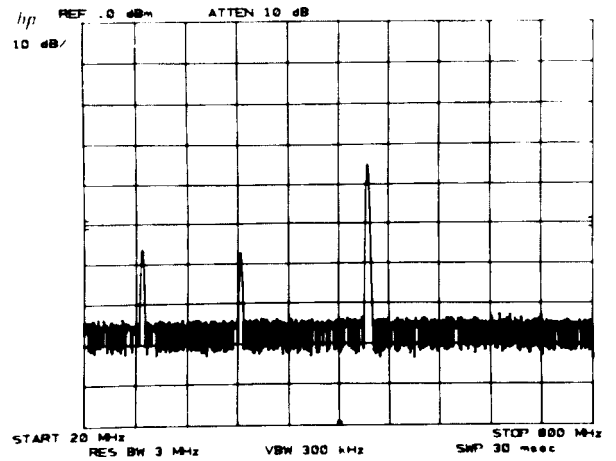

Press THRESHOLD 55.2 dBm. Only those signals > -55.2 dBm will be displayed.

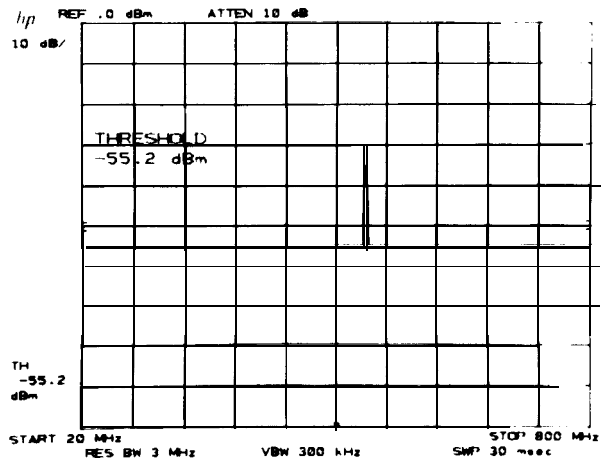

Chapter 8 COUPLED FUNCTION

GENERAL DESCRIPTION

This chapter describes the COUPLED FUNCTION group and its use in various measurements. The COUPLED FUNCTIONS control the receiver characteristics of the spectrum analyzer.

The values of the COUPLED FUNCTION are automatically selected by the analyzer to keep absolute amplitude and frequency calibration as frequency span and reference level are changed. * The functions are all coupled with LINE power ON, a 2-22 GHz or I";(:) FULL SPAN key, or when their individual AUTO is activated.

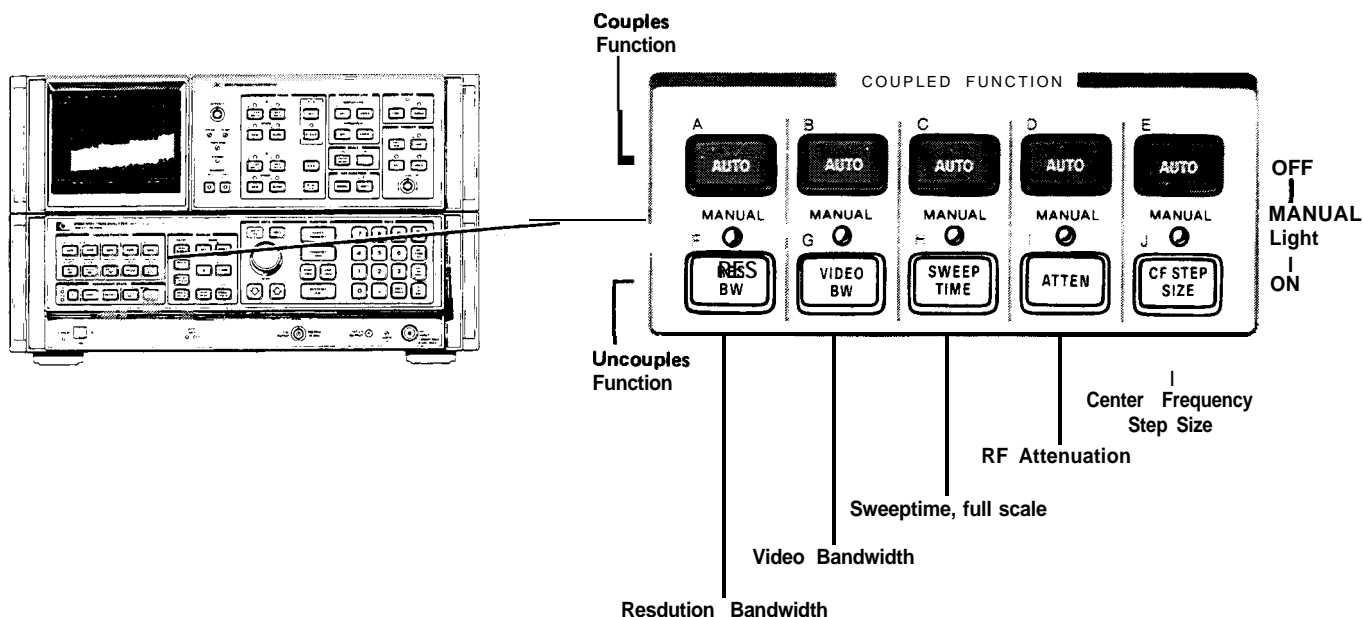

For each COUPLED FUNCTION:



Sets the function to the preset value dictated by the analyzer's current state. The function is coupled.



Function value will not change with instrument state. DATA entry changes value. The MANUAL light goes on and stays on until the function is placed in AUTO once again.

In most cases, the AUTO coupled functions will change values to maintain amplitude calibration when one or more of the others are manually set. If the amplitude or frequency becomes uncalibrated, "MEAS UNCAL" appears in the right-hand side of the graticule.

*Center frequency step size does not affect amplitude or frequency calibration.

Coupled Function

Selects

- 3 dB resolution bandwidth (IF filter) which largely determines the ability of the analyzer to resolve signals close together in frequency.
- 3 dB bandwidth of the post detection low pass filter that averages noise appearing on the trace.
- The total time for the analyzer to sweep through the displayed frequency span or display a detected signal in zero frequency span.
- The setting of the input RF attenuator which controls signal level at the input mixer.
- Selects center frequency change for each DATA when is activated.

DATA ENTRY FOR COUPLED FUNCTIONS

Discrete values are entered for , , , and . The DATA entry from DATA and selects these values sequentially from the current value. A DATA entry from the keyboard which is not exactly equal to an allowable value will select an adjacent value. For example, will select 30 kHz bandwidth, the next higher IF bandwidth.

RESOLUTION BANDWIDTH

(DATA entry) sets bandwidth selection to MANUAL and changes the analyzer's IF bandwidth. The bandwidths that can be selected are 10 Hz, 30 Hz, 100 Hz, 300 Hz, 1 kHz, 3 kHz, 10 kHz, 30 kHz, 100 kHz, 300 kHz, 1 MHz, and 3 MHz.

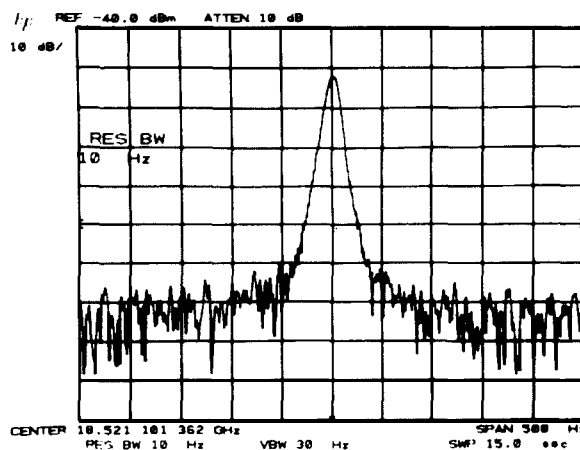

Example

A measurement requiring manual resolution bandwidth selection is the zero span (time domain) observation of modulation waveforms. An example can be found in Chapter 3, ZERO FREQUENCY SPAN -- FIXED TUNED RECEIVER OPERATION.

Another use of manual resolution bandwidth is for better sensitivity over a given frequency span.

The low level intermodulation products of a signal needs to be measured. With the functions coupled, the analyzer noise may mask the distortion products.

Reduction of the noise level by 10 dB (increased sensitivity) is achieved by decreasing the bandwidth by a factor of 10.



(THRESHOLD has been activated to clarify the display.)

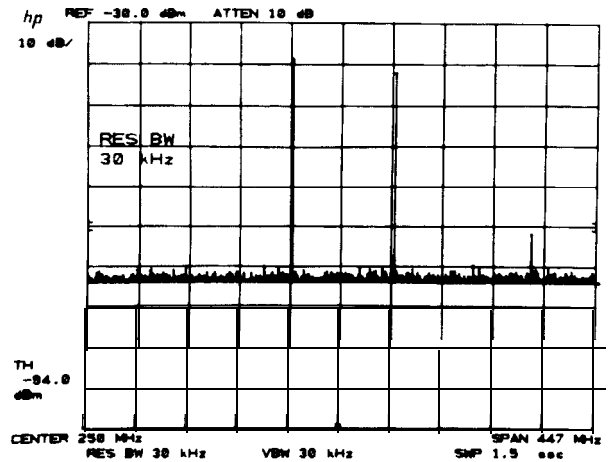
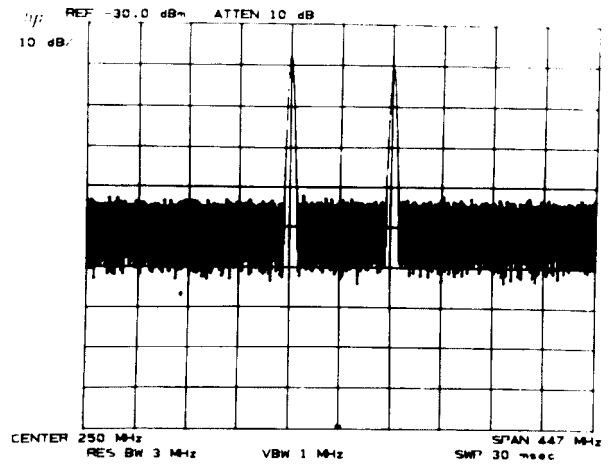

The sweep time automatically slows to maintain absolute amplitude calibration if **SWEEP TIME** is coupled.

VIDEO BANDWIDTH

VIDEO BW (DATA entry) sets the video bandwidth selection to manual and changes the analyzer's post detection filter bandwidth. The bandwidths that can be selected are 1 Hz, 3 Hz, 10 Hz, 30 Hz, 100 Hz, 300 Hz, 1 kHz, 3 kHz, 10 kHz, 30 kHz, 100 kHz, 300 kHz, 1 MHz, and 3 MHz.

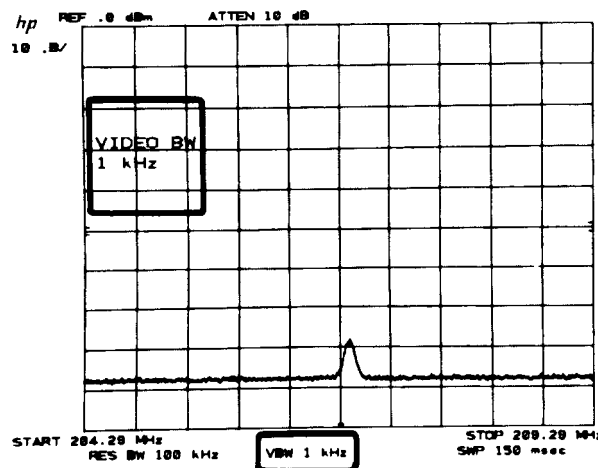

Example

Signal responses near the noise level of the analyzer will be visually masked by the noise. The video filter can be narrowed to smooth this noise.

A low level signal at this center frequency can just be discerned from the noise.

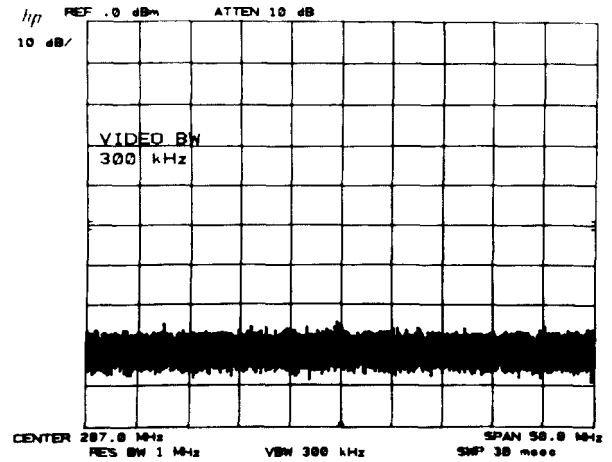

Narrowing the video bandwidth clarifies the signal and allows its amplitude measurement.

Press     

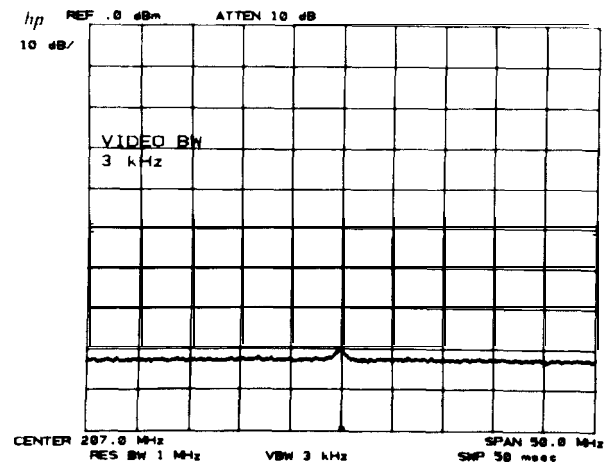

The sweep time will increase to maintain amplitude calibration.

NOTE

The video bandwidth must be set wider or equal to the resolution bandwidth when measuring pulsed RF or impulse noise levels.

Video Averaging

Narrowing the video filter requires a slower sweep time to keep amplitude calibration, since the narrower filter must have sufficient time to respond to each signal response. Video averaging is an internal routine which *digitally* averages a number of sweeps, allowing a more instantaneous display of spectral changes due to center frequency, frequency span, or reference level changes. See Chapter 11.

SWEEP TIME

SWEEP TIME (DATA entry) sets the sweep time selection to manual and changes the rate at which the analyzer sweeps the displayed frequency or time span.

The sweep times that can be selected are:

	SWEEP TIME	SEQUENCE
FREQUENCY SPAN (≥ 100 Hz)	20 msec to 1500 sec	continuously
ZERO FREQUENCY SPAN (0 Hz)	1 μ sec to 10 msec	1, 2, 5, and 10
	20 msec to 1500 sec	continuously

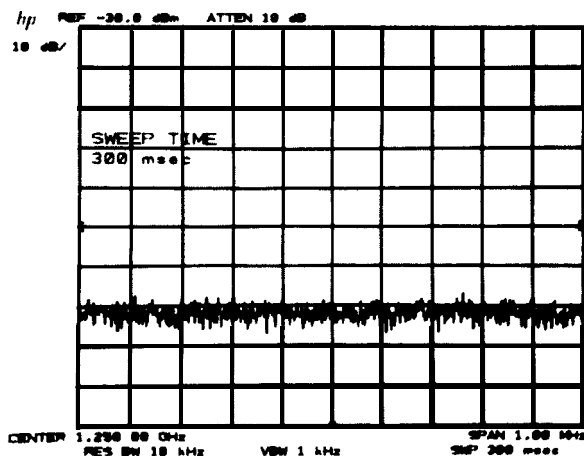

Example

To identify signals quickly in a very narrow frequency span (where the resolution bandwidth would be narrow), the sweep time can be temporarily reduced (e.g., speed up sweep rate).

A frequency span of 10 kHz will have a selected resolution bandwidth of 100 Hz and a sweep time of 3 seconds.

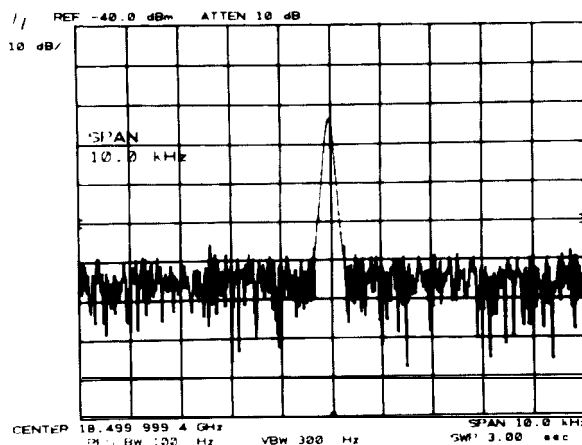

INPUT ATTENUATION

To quickly see signals present in the span, press **SWEEP TIME** and **↓** several times. When the sweep completes its span, couple sweep time again with **AUTO**.

Note that the **MEAS UNCAL** message appears automatically as the faster sweep time causes some distortion of the spectral response.

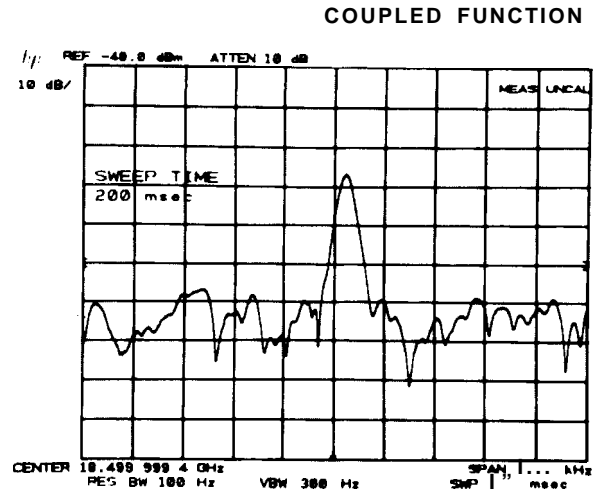

INPUT ATTENUATION

ATTEN (DATA entry) sets the attenuation function to **MANUAL** and changes the analyzer's RF input attenuation. The levels of attenuation that can be selected are 10 dB to 70 dB in 10 dB steps, or 0 dB under special conditions. Generally, the reference level does not change with attenuator settings.

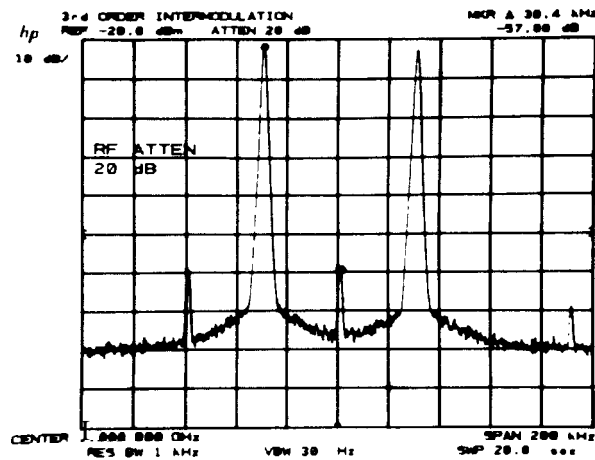

When the RF input attenuator function is coupled (**AUTO**), the value selected assures that the level at the input mixer is less than -10 dBm (the 1 dB compression point) for on-screen signals. For example, if the reference level is $+28$ dBm, the input attenuator will be set to 40 dB: $+28$ dBm $-$ 40 dB = -12 dBm at the mixer.

The input mixer level can be changed to assure maximum dynamic range. See **EFFECTIVE MIXER LEVEL**, Chapter 11.

CAUTION

Greater than $+30$ dBm total input power will damage the input attenuator and the input mixer.

Zero Attenuation

As a precaution to protect the spectrum analyzer's input mixer, 0 dB RF attenuation can only be selected from the number/units keyboard, press **ATTEN** **0** **GHz +dBm dB**.

Reference Levels ≤ -100 **dBm** and $> +30$ **dBm**

Reference levels ≤ -100 **dBm** or between $+30$ **dBm** and $+60$ **dBm** can be called when the reference level extended range is activated. Low reference level limits depend upon resolution bandwidth and scale.

Press **SHIFT** **ATTEN** to extend the reference level range.

See Chapter 3, **FUNCTION** **REFERENCE LEVEL**, and Chapter 11, **SHIFT** **KEY FUNCTIONS**.

Determining Distortion Products

If the total power to the analyzer is overloading the input mixer, distortion products of the input signals can be displayed as real signals. The RF attenuator can be used to determine which signals, if any, are internally generated distortion products.

Example

The two main signals shown are producing intermodulation products because the analyzer's input mixer is overloaded.

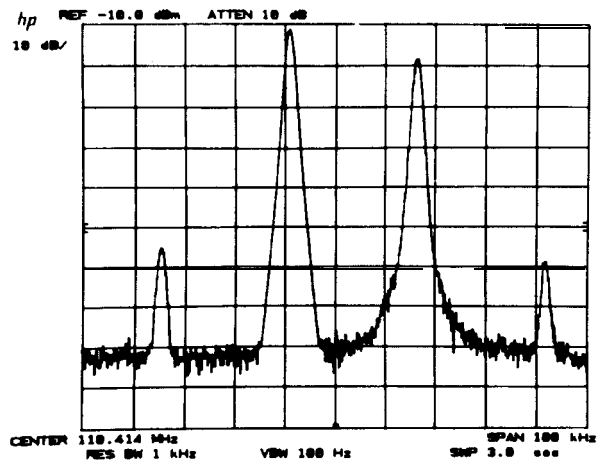

To determine whether these intermod products are generated by the analyzer, first save the spectrum displayed in B with **CLEAN-WHITE** **B** **VIEW** **B**.

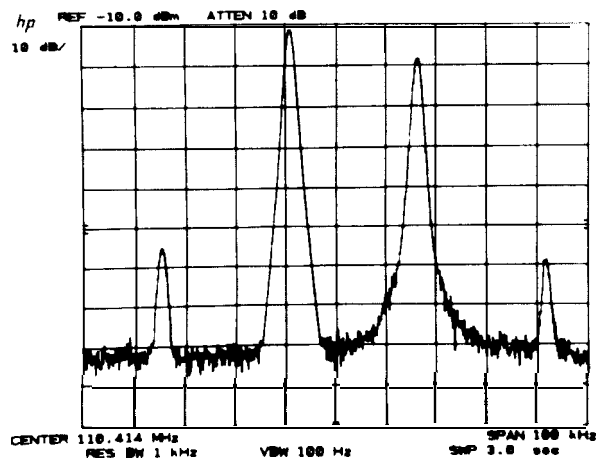

Increase the RF attenuation by 10 dB. Press **ATTEN** 
 (If the reference level changes, it will be necessary to return it back to its original value.)

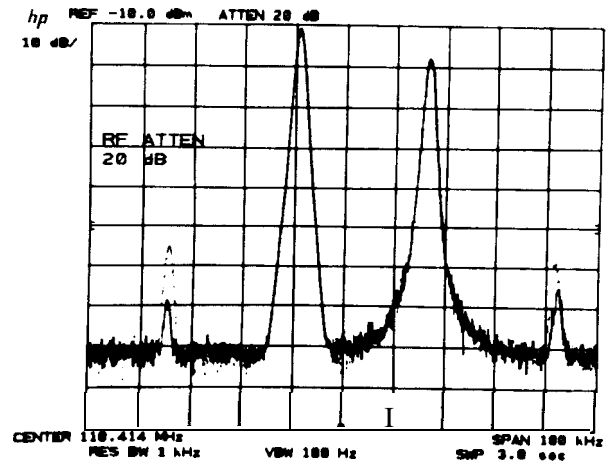

Since some of the signal responses decrease as the attenuation increases (by comparing the response in A with the stored trace in B), distortion products are caused by an overloaded input mixer. The high level signals causing the overload conditions must be attenuated to eliminate this condition.

CENTER FREQUENCY STEP SIZE

CF STEP SIZE (DATA entry) sets step size to MANUAL, changes and stores the step size entered into a register. While **CF STEP SIZE** is in MANUAL, **CENTER FREQUENCY** and  change center frequency by the step size value stored in the register. Several functions can be used to enter step size value to the register. When a CF STEP SIZE is AUTO, the center frequency steps will be 10% of the frequency span, even though the CF STEP SIZE register contains another value.

	Entry Value	CF STEP SIZE State
step size AUTO , 2-22 GHz FULL SPAN or LINE power ON	100 MHz	coupled (AUTO)
CF STEP SIZE (DATA entry)	DATA entry value	uncoupled (MANUAL)
MARKER MKR/Δ-STP SIZE	marker frequency readout	uncoupled (MANUAL)

The step size can be varied from 0 Hz to greater than 20 GHz with 1 Hz resolution. It is displayed with the same resolution as center frequency.

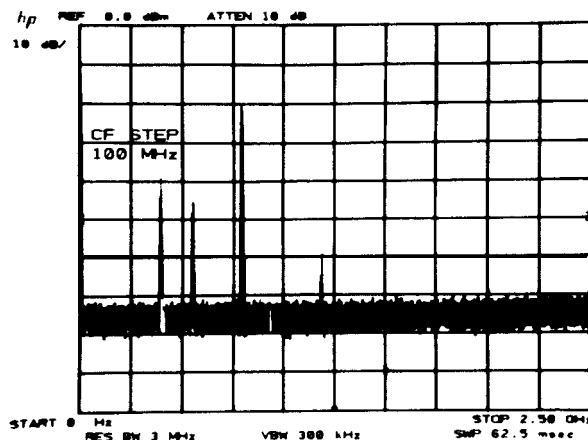

When the center frequency is activated with step size in MANUAL, the active function readout includes both the center frequency and the step size value.

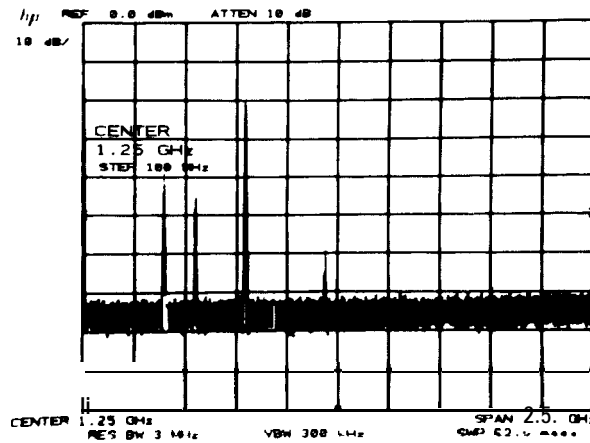

DATA Entry

	<p>Changes the step size in display unit increments.</p>
	<p>Changes the step size in steps equal to one-tenth of the frequency span.</p>
	<p>Selects a specific step size to a resolution equal to the current center frequency readout.</p>

Example

Surveillance of a wide frequency span sometimes requires high resolution. One fast way to achieve this is to take the span in sequential pieces using a tailored center frequency step. This example looks from 0 Hz to 2.5 GHz in 50 MHz spans.

First set the span and center frequency: For a span of 50 MHz, press **FREQUENCY SPAN** **5** **0** **MHz -60m sec**. Set the center frequency to 25 MHz with **CENTER FREQUENCY** **2** **5** **MHz -60m sec**.

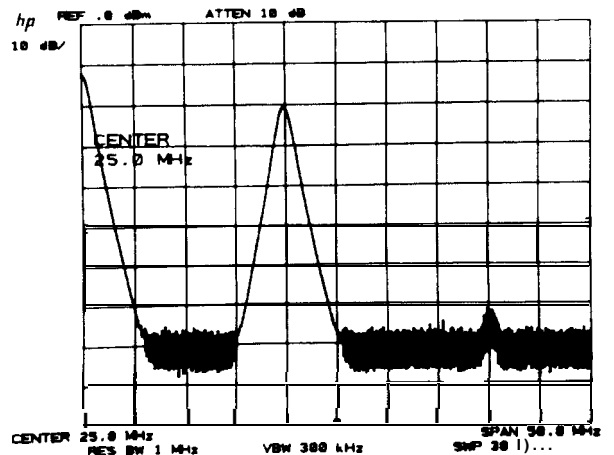

CENTER FREQUENCY STEP SIZE

COUPLED FUNCTION

Set the step size to 50 MHz, **CF STEP SIZE** **5** **0** **MHz** ;
reactivate center frequency with **CENTER FREQUENCY** and step to 225 MHz.

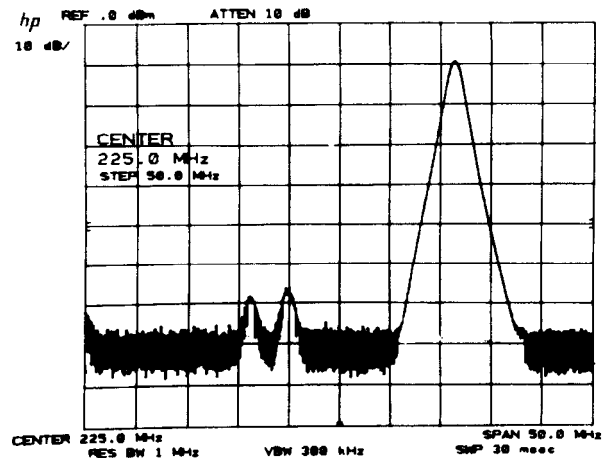

Now each **↑** sets the center frequency to the next 50 MHz span for a span by span surveillance of the spectrum. (Center frequency = 25 MHz, 75 MHz, 125 MHz, etc.) Center frequency step size can also be defined by the marker. See the MARKER ENTRY portion of Chapter 6.

Chapter 9

SWEEP AND TRIGGER

This chapter describes the use of SWEEP and TRIGGER control functions.

SWEEP controls enable:

- CONT** continuous, or repetitive sweeping (sweep time ≥ 20 msec) .
- SINGLE** a single sweep which will repeat only on demand (sweep time ≥ 20 msec) .

TRIGGER controls select the function which will begin a sweep:

- FREE RUN** as soon as possible,
- LINE** line voltage passes through zero on a positive swing,
- EXT** an external signal voltage passes through $\sim 1.5V$ on a positive swing.
- VIDEO** the level of a detected RF envelope reaches up to the level on the CRT display determined by the LEVEL knob.

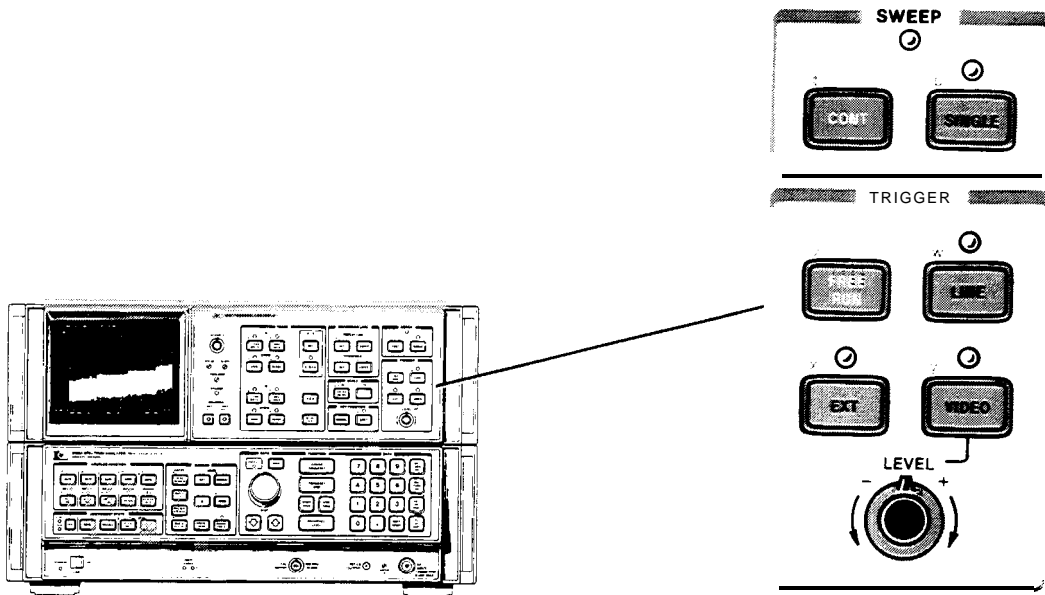

SWEEP AND TRIGGER CONTROLS

SWEEP

The spectrum analyzer frequency sweep (sweep times ≥ 20 msec), once triggered, continues at a uniform rate from the start frequency to the stop frequency unless new data entries are made to the analyzer from the front panel or the HP-IB. With faster sweeps, changes to center frequency, for example, appear continuous. With long sweep times, a change in center frequency noticeably suspends the sweep while the analyzer updates its state and readout, then the sweep continues from where it was, tracing out the new spectrum.

The SWEEP light indicates that a sweep is in progress. The light is out between sweeps and during data entry. (The light is out for sweep times ≤ 10 msec.)

After a sweep, the next sweep will be initiated only if:

- continuous sweep mode is selected or a single sweep demand is made,
- the trigger conditions are met,
- data is not entered continuously from the front panel DATA controls or the HP-IB.

Continuous Sweep

CONT enables the continuous sweep mode. Provided the trigger and data entry conditions are met, one sweep will follow another as soon as triggered. Pressing **CONT** initiates a new sweep.

Single Sweep

SINGLE enables the single sweep mode. Each time **SINGLE** is pressed, including when the SWEEP mode is changed from continuous, one sweep is initiated provided that the trigger and data entry conditions are met. A sweep in progress will be terminated and restarted upon **SINGLE**.

Zero Frequency Span Sweep

In zero frequency span, sweep times from 1 μ sec to 10 msec are also available. In these sweep times, the SWEEP **CONT**, **SINGLE** are disabled. The video signal response is not digitally stored (trace modes also disabled), but multiplexed directly onto the display along with the graticule and readouts. The graticule and readouts are refreshed following each fast sweep.

To avoid flicker of the display when external or video triggers are less frequent than 25 msec, the analyzer will trigger internally. If triggers dependent only on external or video trigger are required, press

SHIFT **X** **EXT** disables "auto" external trigger feature
or **SHIFT** **Y** **VIDEO** disables "auto" video trigger feature

NOTE

For zero frequency span sweep times ≤ 10 msec and **SHIFT** **X** or **SHIFT** **Y**, the CRT display graticule and readout depend upon triggering. If no trigger is present, the CRT display will be blank.

TRIGGER

The analyzer sweep is triggered by one of four modes selected.

- **FRE. RUN** allows the next sweep to start as soon as possible after the last sweep.
- **LINE** allows the next sweep to start when the line voltage passes through zero, going positive.
- **EXT** allows the next sweep to start when an external voltage level passes through $\approx 1.5V$, going positive.

The external trigger signal level must be between 0V and +5V.

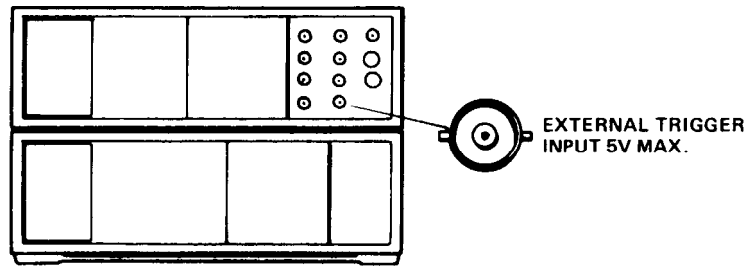

EXTERNAL TRIGGER INPUT

- VIDEO allows the next sweep to start if the detected RF envelope voltage rises to a level set by the LEVEL knob. The LEVEL corresponds to detected levels displayed on the CRT between the bottom graticule (full CCW) and the top graticule (full CW).

An RF envelope will trigger the sweep only if it is capable of being traced on the CRT display—that is, the resolution bandwidth and video bandwidth are wide enough to pass the modulation waveform of an input signal.

Example

A zero span display of this video waveform will trigger for all LEVEL knob settings.

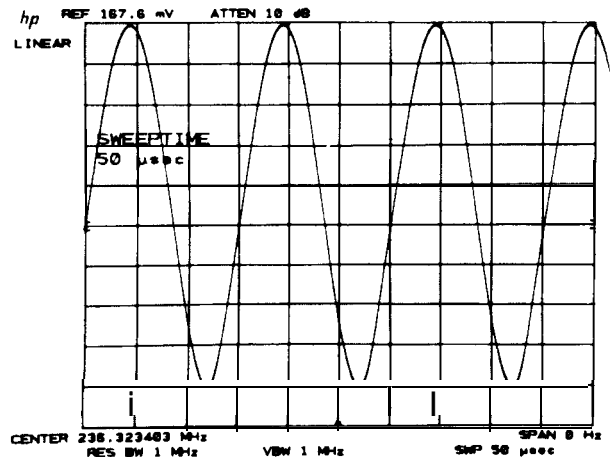
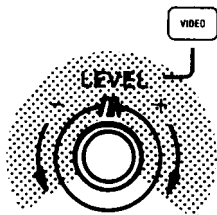

If the video signal lowers on the display, the LEVEL must be set towards the minus side.

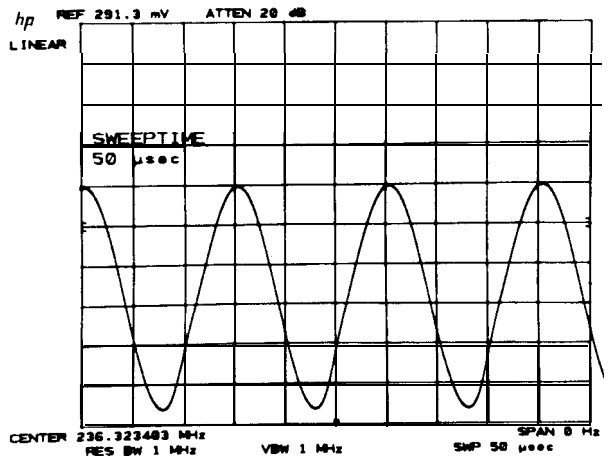
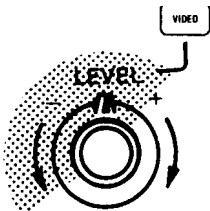

If the level does not cause a trigger within 25 msec, the sweep will be triggered anyway to ensure a display. Note that this is true only for sweep times ≤ 10 msec.

Chaper 10 INSTRUMENT STATE

GENERAL DESCRIPTION

This chapter describes the INSTRUMENT STATE keys. Each key allows access to or activation of a specific set of functions and their values. Some of the sets are built into the analyzer and some are user defined.

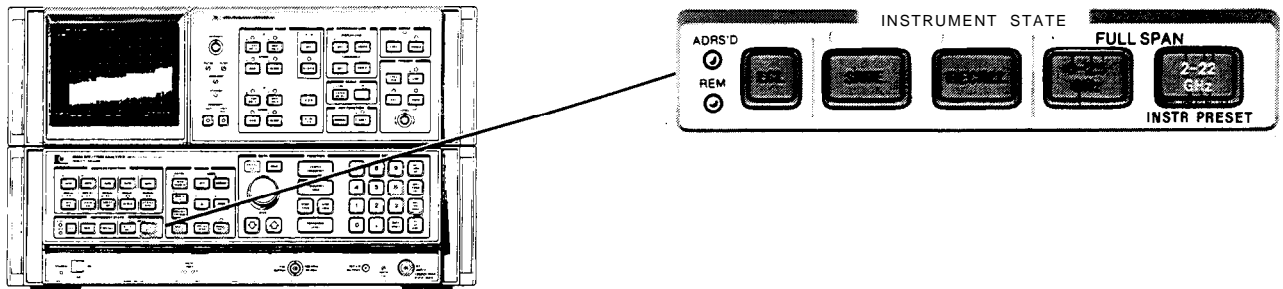

Instrument states that can be selected:

FULL SPAN



A full 2-22 GHz span with coupled operation and all the functions set to known states and values.

FULL SPAN



A full 0 Hz to 2.5 GHz span with coupled operation and all the functions set to known states and values.



Saves the complete set of current front panel function states and values for later recall. Registers 1 through 6 are available for storage.



Recalls the complete instrument state saved in the register called.



Calls for front panel control after the analyzer has been placed in a remote state by an HP-IB controller.

FULL SPAN INSTRUMENT PRESET (2 – 22 GHz)

provides a convenient starting point for making most measurements. That is, it calls for a full 2 – 22 GHz span, coupled functions, and a 0 dBm reference level, to name a few. LINE power ON automatically calls for an instrument preset.

The states that are set include all the functions and values of

- front panel functions, and
- KEY FUNCTIONS, and
- functions accessible only by the HP-IB.

Front Panel Preset

2-22 GHz enables all the front panel functions designated by keys with white lettering. It will save a trace response in TRACE B, but not A or C.

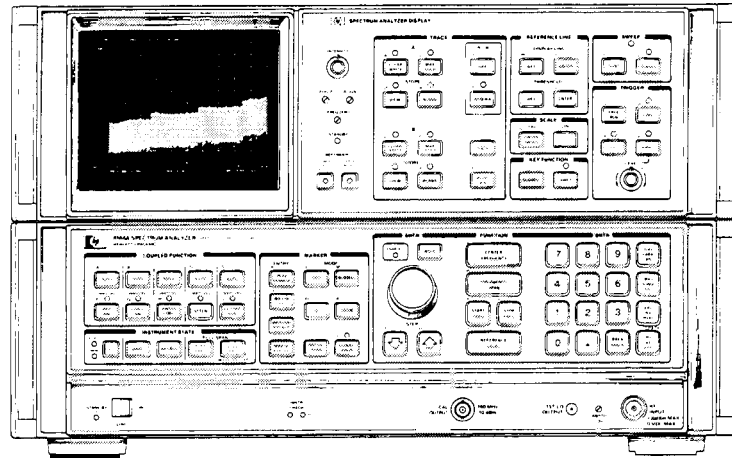

FUNCTIONS ACTIVATED WITH FULL SPAN KEY

To be precise:

- FUNCTION: Start Frequency 2 GHz
- Stop Frequency 22 GHz
- Reference Level 0 dBm

- DATA: Hold

- COUPLED FUNCTION: All set to **AUTO** which corresponds to the following values:
 - Resolution Bandwidth 3 MHz
 - Video Bandwidth 1 MHz
 - Sweep Time 500 msec full scale
 - Attenuator 10 dB, coupled to maintain < - 10 dBm at input mixer

 - Center Frequency Step Size 100 MHz entered in register

- TRACE: A Clear-Write
- B Blanked, but information in memory saved
- A - B off

- MARKER: off

- INSTRUMENT STATE
- SAVE and RECALL** : States are saved including the current state. See **RECALL 7** below.

- SCALE: Logarithmic, 10 dB/division

- REFERENCE LINE: Display line off 5.5 divisions up
- Threshold off 1.0 divisions up

SWEEP:	Continuous	
TRIGGER:	Free run	
INSTR CHECK:	An internal instrument check is made. If the check is false, lights will stay on.	
KEY FUNCTION:	Normal	
[auto] FUNCTIONS:	Chapter 11, SHIFT KEY FUNCTIONS, discusses the implications of activating instrument preset during SHIFT FUNCTION use. If the key is activated (shift light on), 2-22 GHz unshifts the key. This is equivalent to pressing NORMAL .	
HP-IB FUNCTIONS:	“D1” “EM” “03” “PD” “DA”	Display size-normal Erase trace C memory Output format ASCII absolute Pen down Display address set to 3072 Graphic information or control language written into the analyzer memory by HP-IB functions such as graph (GR) , plot (PA), label (LB), or display write (DW) will be erased unless stored in trace memory B. Instrument preset also rewrites all the display graticule and character readouts into the appropriate section of the display memory.

FULL SPAN 0 – 2.5 GHz

The 0 – 2.5 GHz FULL SPAN key selects a start/stop frequency of 0 Hz and 2.5 GHz respectively, a reference level of 0 dBm, and sets all the COUPLED FUNCTIONS to AUTO. Basically, **0-2.5 GHz** is the equivalent of an instrument preset in the low band. It presets everything that **2-22 GHz** does except that **0-2.5 GHz** will not execute the instrument check sequence.

SAVING AND RECALLING INSTRUMENT STATES

SAVE (DATA keyboard entry) and **RECALL** (DATA keyboard entry) save and recall complete sets of user-defined front panel function values. The DATA entry from the keyboard names the register which stores the instrument state. Six registers, **1** through **6**, can be saved and recalled. Only another **SAVE** will erase a saved register. The registers contain their last states even with a loss of line power (power failure). The registers are maintained with an internal battery supply for about a 30-day period after line power failure.

RECALL **7** is a special recall function which recalls the instrument state prior to the last instrument preset or single function value change, whichever has most recently occurred. It aids in recovering from inadvertent entries.

Registers 8 and 9 contain preset control settings that are used for calibration purposes. (See Calibration procedure under GENERAL INFORMATION at the beginning of this section.) Register 0 restores the current state of the analyzer, which is useful for servicing.

The current instrument state, if the POWER switch is turned to STANDBY (or a short-term loss of ac line power), can be recovered at POWER ON if **SHIFT** is activated previous to a power loss.

Some **SHIFT** KEY FUNCTION values or states cannot be saved. Neither can information in the display memories, such as a title or trace.

Example

When a test sequence is used over and over, the instrument states can be set up in the registers prior to testing for recall during the procedure.

Keying in a specific state: **0-2.5 GHz**

CENTER FREQUENCY **8** **8** **MMHz -dBm SEC**
FREQUENCY SPAN **2** **0** **0** **kHz MV msec**
RES BW **↓**

LIN SCALE
 Then save with **SAVE** **1**

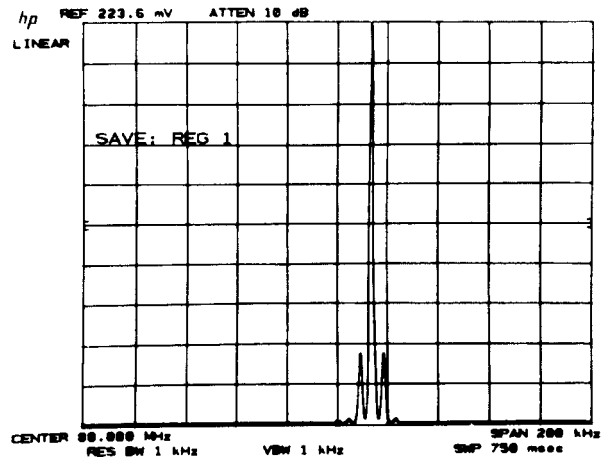

Press **0-2.5 GHz**

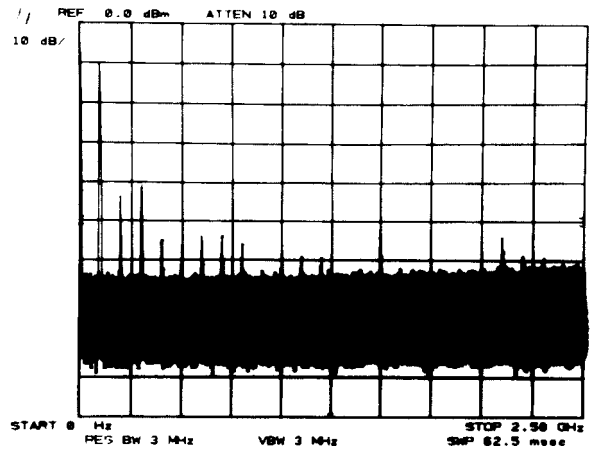

And recall the last state with **RECALL** **[1]** Once the state has been recalled, any function can be used for more detailed measurements.



Note that in this case, the state could also have been recalled by **RECALL** **[1]**.

Registers 1 – 6 can also be locked to prevent any loss or change in the contents of the storage registers.

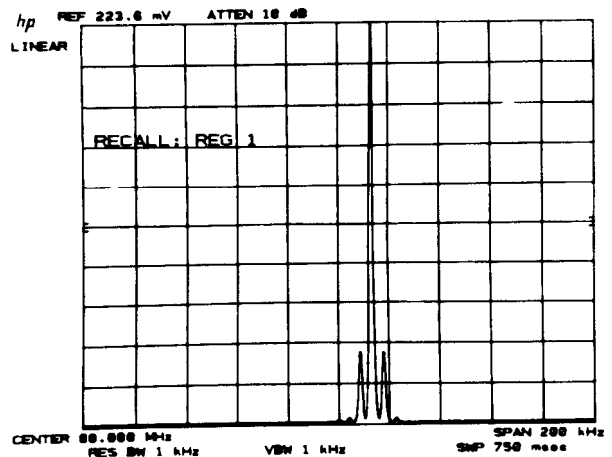
SHIFT **SAVE** locks the registers and **SHIFT** **RECALL** unlocks the registers.



LOCAL OPERATION

 enables front panel control after an HP-IB remote LISTEN or TALK command has been executed. An HP-IB local lockout will disable  until an HP-IB return to local command is executed or the LINE power is turned to STANDBY, then ON again.

Indicates instrument has been addressed through HP-IB.

Indicates instrument is in remote operation.

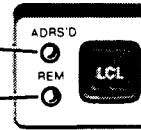

The addressed light remains on until an HP-IB device clear command or any unlisten command is executed.

Chapter 11

SHIFT KEY FUNCTIONS

GENERAL DESCRIPTION

This chapter describes access and use of the SHIFT KEY FUNCTION.

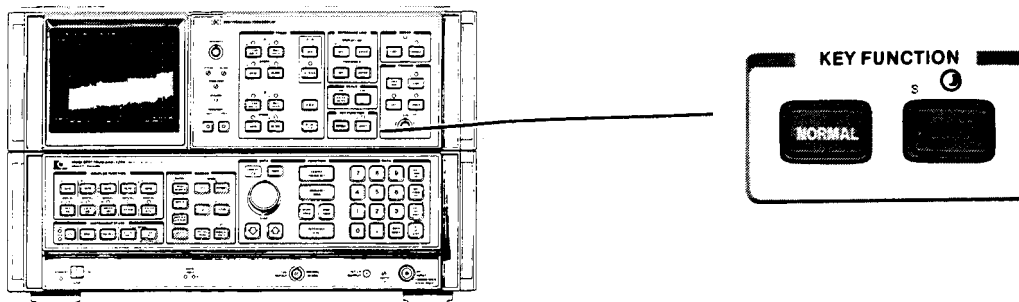

Shift functions supplement a front panel function or provide unique measurement capabilities. The SHIFT functions are not named on the front panel but are coded by the blue characters beside the keys. For example, the frequency offset function is designated by the code V. On the front panel the code V is found in the FUNCTION section :







The shift functions are activated by pressing SHIFT and then the front panel key with the appropriate blue code. A complete summary of shift FUNCTIONS is in this chapter under FUNCTION SUMMARY There is an index to all shift functions at the end of this chapter.

Example

Activate the shift function V (frequency offset) with

press  shift light on



press   shift light off and offset function activated

The shift light can always be turned off with , which returns the front panel keys to their designated function.  does not disable the selected shift function (except for title).



DATA Entry

An active shift function value is read out and identified in the active function area of the display the same as any other function using DATA entry Once the data has been entered, any other function can be activated. The shift function will retain its last value until the  key is pressed, or the LINE switch is switched to STANDBY

FUNCTION SUMMARY

<p>General</p> <p>r HP-IB Service request P Enter HP-IB address f Power on in last state z Display Address Display Write</p> <p>Amplitude</p> <p>Z Amplitude offset A Units: dBm B dBmV C dBμV D voltage I Extended reference level range - Negative entry , Mixer level</p> <p>Marker</p> <p>K Marker to next peak N Marker to minimum 0 Enter Δ→ span M Noise level on L Noise level off u Stop single sweep at marker = Factory preselector setting / Manual preselector setting</p>	<p>Display</p> <p>o Annotation blanked p Annotation on w Display correction data g CRT beam off h CRT beam on m Graticule blanked n Graticule on E Title</p> <p>Trace</p> <p>c A + B → A</p> <p>Detection:</p> <p>a normal b positive peak d negative peak e sampling</p> <p>Trace C:</p> <p>k blank trace C i B ⇌ C l B - C j view trace C G Video averaging on H Video averaging off</p> <p>Trigger-Zero Span</p> <p>x  without 25 msec triggering y  without 25 msec triggering</p>	<p>Instrument State</p> <p>(Save registers locked) Save registers unlocked T Fast preset 2 – 22 GHz U Fast preset external mixer S Fast HP-IB operation t Band lock Q Band unlock</p> <p>Error Correction</p> <p>W Execute routine X Use correction data Y Do not use correction data w Display correction data</p> <p>Diagnostics</p> <p>w Display correction data q Disable step gain R Frequency diagnostic on F YTO pretest mode J Manual DACS control # Turns off YTX self-heating correction</p> <p>Frequency</p> <p>V Frequency offset - Negative entry v Signal identifier ext. mixer</p>
--	---	---

ALPHABETICAL KEY CODE SUMMARY

<p>*A Amplitude in dBm B Amplitude in dBmV C Amplitude in dBμV D Amplitude in voltage E Title F Removes IF Offset for YTO preset G Video averaging on . H Video averaging off I Extended reference level range J Manual DACS control K Marker to next peak . L Noise level off M Noise level on N Marker to minimum 0 Enter A → span P Set HP-IB address * Q Band unlock R Frequency diagnostic on S Fast HP-IB operation</p>	<p>T Fast preset 2 – 22 GHz U Fast preset external mixer V Frequency offset W Execute error correction routine X Use correction data *Y Do not use correction data Z Amplitude offset *a Normal detection b Positive peak detection c A + B → A d Negative peak detection e Sample detection f Power on in last state g CRT beam off *h CRT beam on i B ⇌ C j View trace C *k Blank trace C l B - C m Graticule blanked</p>	<p>*n Graticule on o Annotation blanked *p Annotation on q Disable step gain r HP-IB service request t Band lock u Stop single sweep at marker v Signal identifier ext. mixer w Display correction data x  without 25 msec triggering y  without 25 msec triggering z Display address - Negative entry = Factory preselector setting / Manual preselector setting (Save registers locked) Save registers, unlocked I Display write , Mixer level # Turns off YTX self-heating correction</p>
---	--	---

*These functions selected with  INSTRUMENT PRESET

DATA entries to shift functions are made only from the number/units keyboard. The ENABLED light remains off even though data may be entered.

Data is entered (that is, changes the instrument state) only when a units key is pressed. If the entry has no units (an address, for example), use the **Hz** key as the terminator.

NEGATIVE DATA KEYBOARD ENTRY

Entering negative data from the DATA keyboard requires the use of a negative symbol prefix on the number entry.

Negative entry: **SHIFT** **HOLD**

For example, to enter a negative 100 MHz offset frequency:

Press **SHIFT** **CENTER FREQUENCY** to activate frequency offset.

Press **SHIFT** (-) **1** **0** **0** **MHz -dBm sec** to enter a negative frequency.

Not all values can be entered with a negative prefix. For example, a negative entry to a voltage reference level will result in entering the positive value.

Negative entries in dB can be made with the -dBm units key or the negative prefix with the +dBm units key. If both negative prefix and **MHz -dBm sec** are used, the value will be entered as positive.

FREQUENCY AND AMPLITUDE OFFSET

The CRT display amplitude and frequency readout can be offset. Entering an offset does not affect the trace.

Frequency offset: **SHIFT** **CENTER FREQUENCY** (DATA keyboard entry)

Amplitude offset: **SHIFT** **CENTER FREQUENCY** (DATA keyboard entry)

Offset entries are added to all the frequency or amplitude readouts on the CRT display, including marker, display line, threshold, start frequency, and stop frequency.

FUNCTION

To eliminate an offset, activate the offset and enter zero. A FULL SPAN key also sets the offsets to zero.

Offsets are stored with the **SAVE** functions for recall with **RECALL**.

When an offset is entered, its value is displayed on the CRT

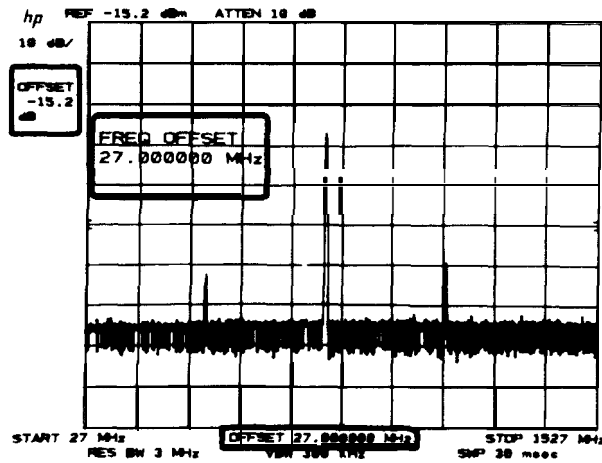

DATA entry from the keyboard can be in Hz, kHz, MHz, or GHz for frequency and dB, - dB, mV, and μ V for amplitude. The amplitude offset readout is always in dB. An entry in voltage can be made and will be converted to dB offset.

The offset range for frequency is - 99.999999990 to + 99.999999999 GHz in 1 Hz steps. The amplitude offset range is greater than ± 100 dB in 0.1 dB steps. Least significant digits will be truncated for frequency and amplitude offset entries.

Example

An 102.6 MHz up converter with 12.7 dB attenuation is placed between a signal source and the spectrum analyzer. The offsets can be set so that the CRT display shows the trace referenced to the signal as input to the converter.

Amplitude offset is entered as a positive value to compensate (offset) the loss of the converter.

Press SHIFT Z REFERENCE LEVEL 1 2 . 7 GHz +dBm dB

Note that the original REF LEVEL of 0 dBm is now changed to 12.7 dBm also.

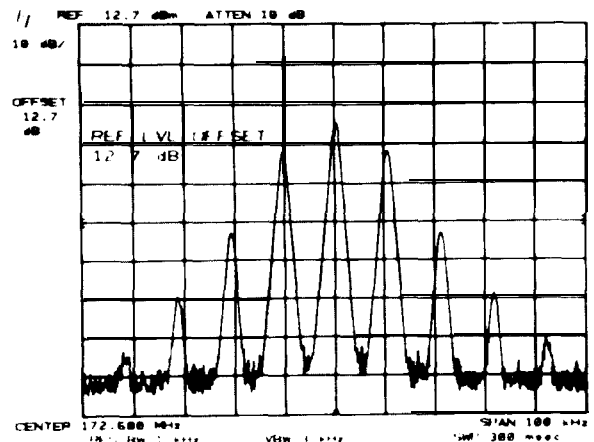

Frequency offset is entered as a negative value since the input frequency to the converter is lower than the output.

Press SHIFT V CENTER FREQUENCY

SHIFT HOLD 1 0 2 . 6 MHz -dBm SEC

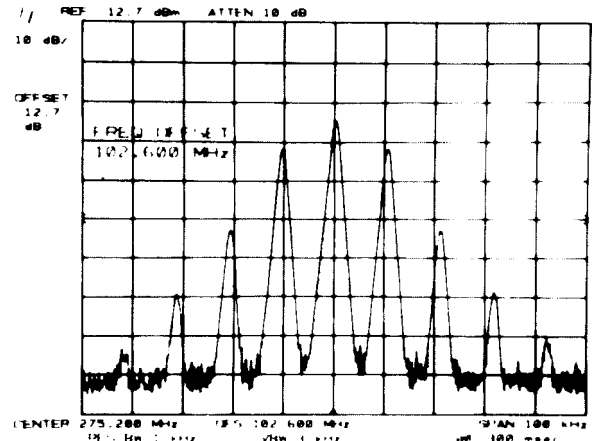

EFFECTIVE MIXER LEVEL

The effective mixer level is equal to the REFERENCE LEVEL minus the INPUT ATTENUATOR setting. It specifies the maximum signal level that will be applied to the input mixer for a signal that is equal to or below the REFERENCE LEVEL. A FULL SPAN key (0 – 2.5 GHz or 2 – 22 GHz) sets the mixer level to – 10 dBm, which is 5 dB below the analyzer’s 1 dB compression point. The effective mixer level can be manually set from – 10 dBm* to – 70 dBm in 10 dB steps by pressing SHIFT, (comma sign) and entering the desired level through the numeric keyboard. For instance, to set a mixer level at -40 dBm, press: SHIFT, 4 0 MHz -dBm SEC. As the analyzer’s REFERENCE LEVEL is changed, the coupled input attenuator will automatically change to limit the maximum signal at the mixer to – 40 dBm for signals ≤ REFERENCE LEVEL.

AMPLITUDE UNITS

The following shift key codes immediately select the corresponding units for all the amplitude readouts: reference level, marker, display line, and threshold.

When a units change is made, all readouts are converted so as to preserve the absolute power levels of all the readouts. For example, a 0 dBm threshold level converts to 47.0 dBmV (50 ohm input) when dBmV units are called.

SHIFT KEY FUNCTION	AMPLITUDE UNITS
SHIFT A (or FULL SPAN key)	dBm
SHIFT B	dBmV
SHIFT C	dBμV
SHIFT D	volts

The keys for these functions are located in the COUPLED FUNCTION group.

*In the Extended Reference Level Range (Shift I, under EXTEND REFERENCE LEVEL RANGE in this chapter), the effective mixer level can be set to 0 dBm.

EXTEND REFERENCE LEVEL RANGE

Normally, the reference level can be set from -89.9 dBm to $+30.0$ dBm in coupled operation. The limits of the range can be extended to a maximum of -139.9 dBm and $+60$ dBm.

Press **SHIFT** **ATTEN**

The lower limit of reference level depends upon resolution bandwidth and scale.

Scale	Resolution Bandwidth	Minimum reference level with extended reference level	
		10 dB attenuation	0 dB attenuation
log	≤ 1 kHz	-129.9 dBm	-139.9 dBm
log	≥ 3 kHz	-109.9 dBm	-119.9 dBm
linear	≤ 1 kHz	-109.9 dBm	-119.9 dBm
linear	≥ 3 kHz	-89.9 dBm	-99.9 dBm

When the reference level is set at a minimum, the level may change if either scale or resolution bandwidth is changed. The extended range is disabled with instrument preset.

FACTORY PRESELECTOR SETTING

Activating **SHIFT** = will reset the internal preselector to a factory set 2 – 22 GHz tracking range. The factory setting provides a preset adjustment for each of the four frequency bands in the 2 – 22 GHz range. These preset adjustments optimize the preselector tracking over the full 2 – 22 GHz frequency range. The tracking can be optimized at any single frequency with the **PRESEL PEAK** key. A **PRESEL PEAK** adjustment in one band will not affect the preselector tracking in the other three bands. (See Chapter 6 for more information.)

MANUAL PRESELECTOR TRACKING

The internal preselector can be manually adjusted for a peak response in the 2-22 GHz band. **SHIFT** / **GHz +dBm dB** enables manual entry of a DAC number from 0 – 63 with the DATA knob, step keys, or numeric keyboard. The DAC reading corresponds to a voltage which sets a particular preselector tracking offset. The location of the MARKER determines the band (four independently adjustable bands) to be adjusted.

The Manual Preselector Tracking function is useful for peaking the preselector at locations where a stable CW signal is absent. For instance, drifting signals or pulse modulated signals do not easily lend themselves to the use of **PRESEL PEAK**. The automatic preselector peak routine depends on a stable CW signal. In this situation, a means for manually tracking the preselector may provide a more reliable setting.

MARKER SWEEPS

Stop Sweep at Marker, TALK after Marker

To stop the sweep at the marker,
 press MARKER **NORMAL** and
 press **SHIFT** u

A marker must be activated to enter this sweep function.

Each time a sweep is triggered, it will stop at the marker, even if the marker has been moved. A marker being moved when the sweep passes may not stop the sweep.

To disable the stop sweep at marker functions
 press MARKER **OFF** or **2-27 GHz**.

In remote operation, the analyzer will not TALK until the trace sweep stops at the marker. TALK is suspended by keeping the HP-IB Data Valid line not true until the marker is placed.

MARKER TO NEXT PEAK/MARKER TO MINIMUM

Successive peaks can be identified by continuously using **SHIFT** K. If a trace displays many different signal levels, a **PEAK SEARCH** can be used to find the largest signal. Then **SHIFT** K can be used successively to find the next largest signal.

Example

Press **PEAK SEARCH** to find largest signal.

SHIFT K to find next largest signal.

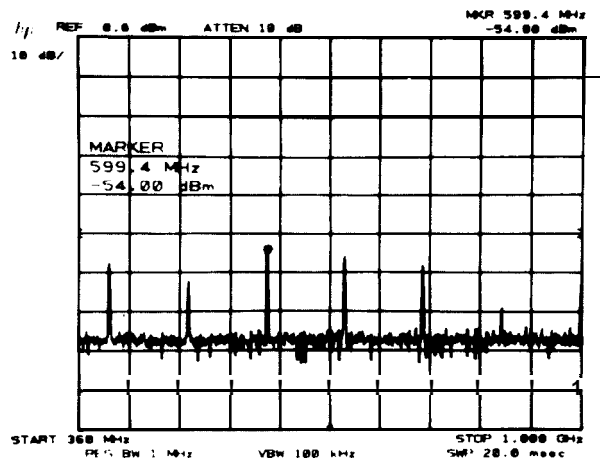

Marker to Minimum

The minimum data value in a trace can be quickly located with **SHIFT** N.

GRATICULE AND ANNOTATION ON/OFF

The graticule and character readouts can be selectively blanked with key functions. This is valuable when alternative graphics are drawn on the CRT through the HP-IB.

Graticule

Blank: press SHIFT m

On: press SHIFT n

Annotation

Blank: press SHIFT o

On: press SHIFT p

CRT BEAM ON/OFF

The CRT beam power supply can be turned off to avoid unnecessary wear of the CRT if the analyzer is operated unattended. **Reducing intensity** or **blanking** the traces does **not** reduce wear on the CRT

Beam off: press SHIFT g

Beam on: press SHIFT h

CRT beam power off does not affect HP-IB input/output of instrument function values or trace information.

DISPLAY CORRECTION DATA

The correction data generated from the error correction routine can be displayed.

Display correction data: press SHIFT w

Do not display correction data: press 2-22 0Hz

The readout is detailed in this chapter under ERROR CORRECTION ROUTINE.

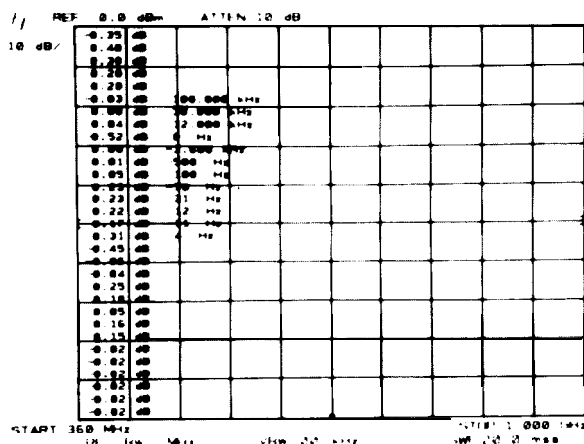

CORRECTION DATA DISPLAYED

TITLE

The user can write a message in the top CRT display line. When the title is activated, the front panel blue characters, number keyboard numbers, decimal, backspace, and space can be typed onto the top line starting at the left of the display. The full width of the display can be used (total of 58 characters); however, marker readout may interfere with the last 16 characters of the title.

Activate title: SHIFT E (shift light on)
 Enter text: abcdefghijklmnopqrstuvwxyz
 ABCDEFGHIJKLMNOPQRSTUVWXYZ
 /#&=(),><
 0123456789. [space]
 To end a title: press NORMAL (shift light off)

A title will remain on the display until the title function is activated again, **2-27 GHz** is pressed, or an instrument state is recalled with **RECALL**.

To erase a title without changing the instrument state, end the title function if still active, then press **SHIFT E NORMAL**.

A + B → A

A + B → A enables the restoration of the original trace A after a **A-B→A** has been activated. A + B → A is executed with both Trace A and Trace B in **VIEW**:

press **SHIFT c**.

When executed, **A-B→A** is turned off and the amplitude in trace B is added to the amplitude in trace A (in display units) and the result is written into trace A.

Additional A + B → A executions will each add another trace B response to the cumulative trace A

TRACE DETECTION MODES

One of four detection techniques can be selected for displaying trace information.

Mode	Access	Use
normal	FULL SPAN key or SHIFT a	<ul style="list-style-type: none"> Most measurements
sample	SHIFT e	<ul style="list-style-type: none"> Noise Level measurements Zero frequency span waveforms for sweep times ≥ 20 msec Video averaging
positive peak negative peak	SHIFT b SHIFT d	<ul style="list-style-type: none"> Diagnostic aids for servicing

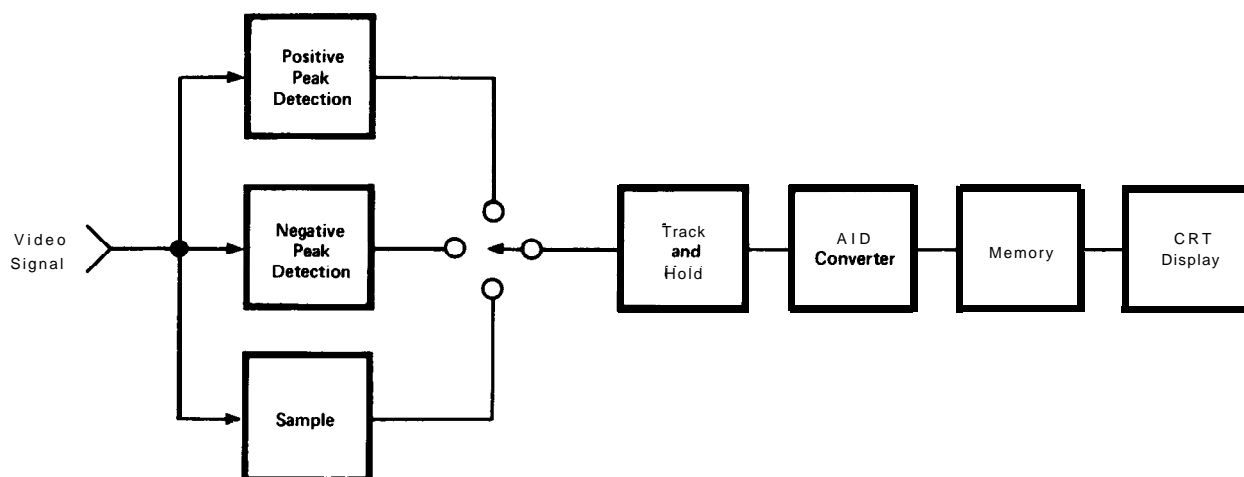

During a sweep, only a specified amount of time is available for writing data into each of the 1001 trace memory addresses. In two of these time periods, the positive and negative peak detectors obtain the maximum and minimum video signal excursions, respectively, and store these values in *alternate* trace memory addresses. This technique allows a graphic presentation of noise on the CRT display.

Normal Mode

In normal mode, a detection algorithm selectively chooses between the positive and negative peak values to be displayed. The choice is made dependent upon the type of video signal present.

Data from the positive peak detector (signal maximums) will **always** be displayed in the odd-addressed trace memories (1, 3, . . . 1001). If, within the time period following the storage of a value in an odd-addressed memory, there is no change in video signal level, the positive peak detector value will also be stored in the even address. In other words, the even-addressed memory will also contain positive peak detection data if the signal during that time period is monotonic. Negative peak detector data (video signal minimum) will be stored in the **even**-addressed trace memory if the signal has a point of inflection during the time period.

Normal mode is selected with instrument preset.

Sample Mode

In the sample mode, the **instantaneous** signal value of the final analog-to-digital conversion for the time period is placed in memory. (As sweeptime increases, many analog-to-digital conversions occur in each time period, but only the final, single value can be stored.)

Sample mode is selected automatically for video averaging and noise level.

Positive and Negative Peak Modes

Positive and negative peak modes store signal maximums and minimums, respectively, in all trace memories.

Readout

Here, the same signal response is displayed with each trace detection mode.

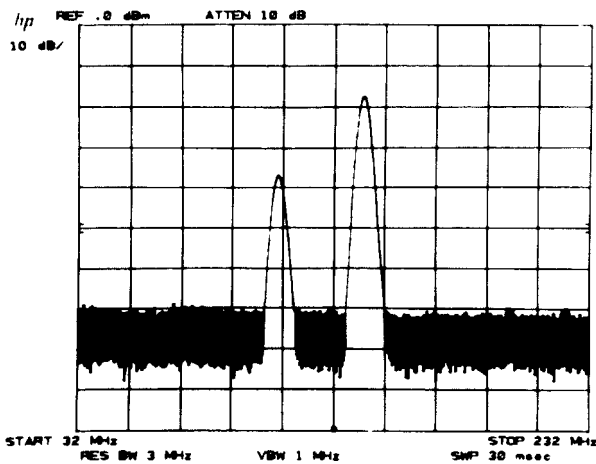

NORMAL

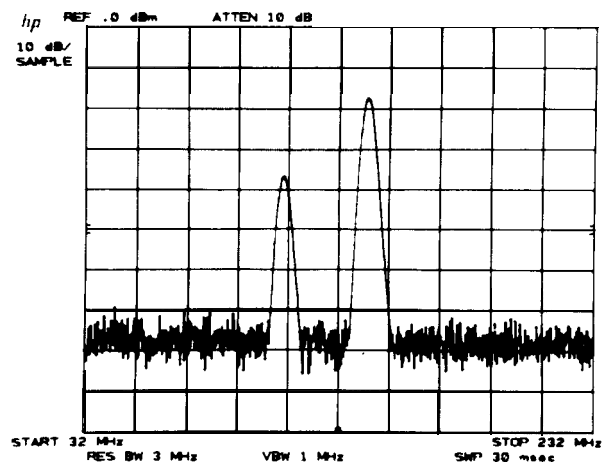

SAMPLE

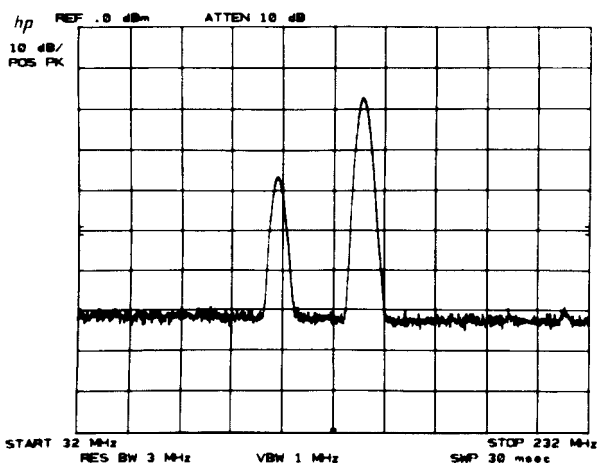

POSITIVE PEAK

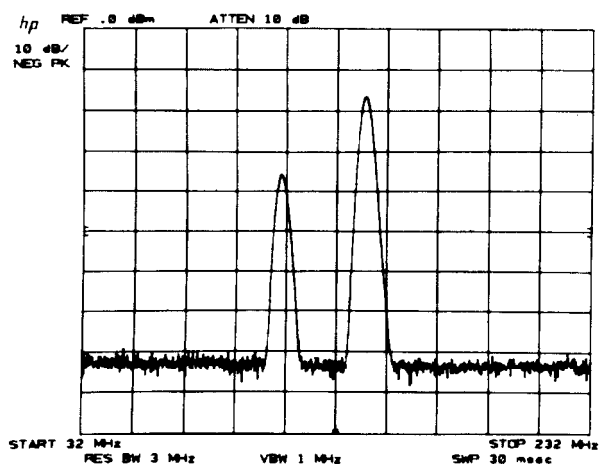

NEGATIVE PEAK

TRACE C

A third trace memory is available for the storage and display of trace information. Only the storage modes (view and blank) can be used.

View C: SHIFT j

Blank C: SHIFT k

These are analogous to the TRACE A and B modes discussed in Chapter 5.

Trace C cannot be written into directly from the analyzer except when video averaging is used.

Trace information from B can be transferred to C. To transfer from TRACE B to TRACE C, use

B → C: SHIFT B-DL → C

The sweep will be suspended, the trace in memory B will be read and written into trace C from left to right in about 20 msec. Trace C is viewed. Sweeping will then resume from where suspended. The trace information in B is not changed.

To exchange traces B and C

B ⇌ C: SHIFT i

The trace information in B and C is interchanged point for point from left to right in about 20 msec. If trace B is not displayed, it remains undisplayed. If trace C is not displayed, it remains undisplayed.

To store TRACE A into trace C. the trace A data must first be transferred into trace B:

press A⇌B SHIFT 1 (which also erases last trace C)
 or press A⇌B SHIFT i (which also saves last trace C in B)

Example

Comparisons of up to three different signal traces can be made simultaneously using traces A, B, and C. In this example, the modulation level of a signal will be changed for each trace. To start, clear the display with BLANK A and BLANK B.

The signal with the desired level of modulation will be stored in trace C:

Press CLEAR-WRITE B and allow one sweep.

Press SHIFT 1 which writes the trace from B into C.

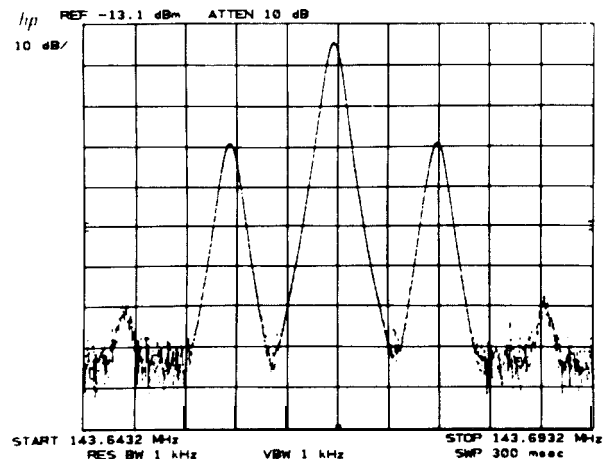

Change the modulation level, allow one sweep and store in B with VIEW B.

To view C, press SHIFT j.

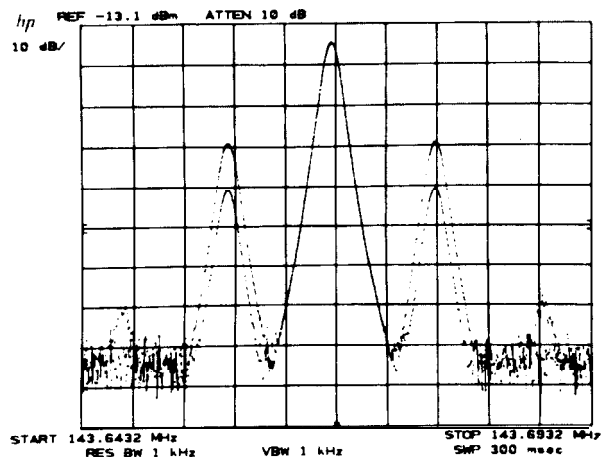

Change the modulation level again and press **CLEAR-WRITE** A, and store with **VIEW** A. The three traces are differentiated by intensity.

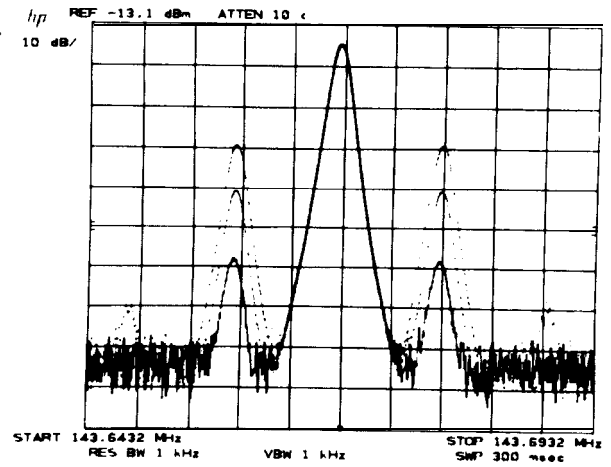

VIDEO AVERAGING

Video averaging is a trace display routine that averages trace responses from sweep to sweep without requiring a narrow video bandwidth. (Averaging with the video bandwidth is discussed in Chapter 8, COUPLED FUNCTION **VIDEO BW**.) Both video averaging and reducing video bandwidth are primarily used to improve the analyzer's ability to measure low-level signals by smoothing the noise response.

To activate video averaging (and sample detection mode),

press **SHIFT** **VIDEO BW** (DATA keyboard entry)

To disable video averaging, press **SHIFT** **SWEEP TIME**

CAUTION

Video averaging may result in an uncalibrated amplitude display when

$$\frac{\text{frequency span}}{\text{Resolution Bandwidth}} > 1000$$

Readout in the active function display area is "VID AVG 100". The number represents the maximum number of samples (or sweeps) for complete averaging. The DATA entry can be used to change the maximum sample number in integers from 0 to 1000. A unity sample limit allows direct writing of analyzer response into Trace C (see Trace C below). A 100 sample limit is selected upon instrument preset. The higher the sample limit, the more smoothing possible. Averaging with high sample limits can provide more smoothing than the 1 Hz video bandwidth.

During video averaging, the current sample being taken is read out at the left of the display.

The advantage of video averaging over narrowing the video filter is the ability of the user to see changes made to the amplitude or frequency scaling of the display while smoothing the noise response. For example, when a 100 Hz video bandwidth is used with a 200 kHz frequency span, the sweeptime is 2 sec. Almost a full sweeptime duration would have to pass before any center frequency change effect on the trace could be seen. If video averaging is used instead of the narrow video bandwidth, any change to center frequency will be seen immediately, even though full averaging will take roughly 6 sec. (Any change to control settings such as CENTER FREQUENCY FREQUENCY SPAN, etc., will cause the video averaging process to be restarted.)

Example

To display very low-level signal responses, very narrow resolution and video bandwidths are required. The accompanying increase in sweep time can make measurements cumbersome. Video averaging allows the display of low-level signals without the long sweep time.

Viewing a low-level signal with a video bandwidth of 1 Hz requires a 150-second sweep.

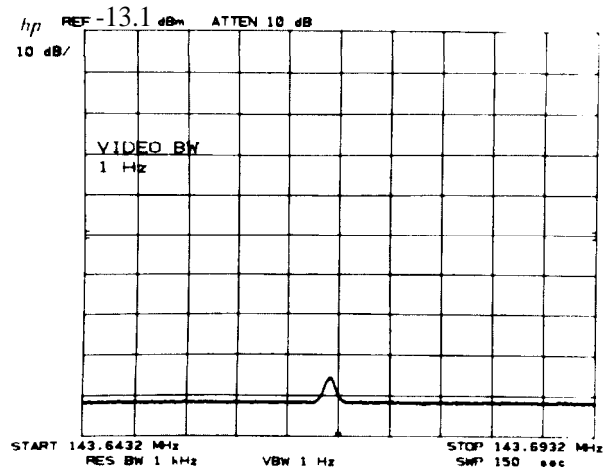

Disable the narrow video filter by pressing the **AUTO** key that is above the **VIDEO BW** key.

Start video averaging by pressing **SHIFT** **G** **VIDEO BW**.

Now the low-level signals begin to show quickly. Changes to the frequency range or amplitude scale will restart the sampling to show the signals quickly, without having to wait 150 seconds. In fact, the video averaging shown took 42 x 300 msec = 12.6 sec.

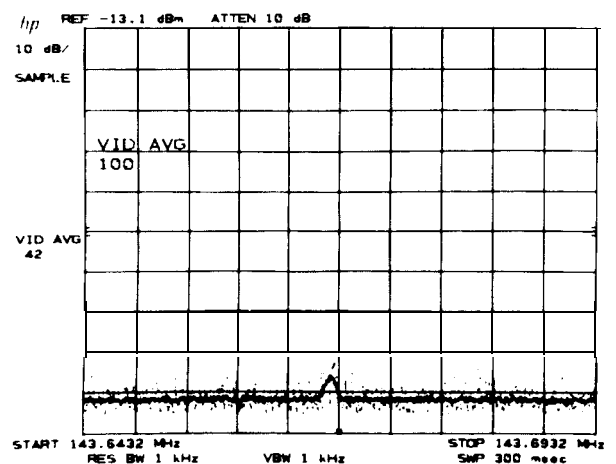

Video Averaging Algorithm

The averaging of each amplitude point depends upon the number of samples already taken and last average amplitude.

$$\bar{y}_n = \frac{n-1}{n} \times \bar{y}_{(n-1)} + \frac{1}{n} y_n$$

where \overline{y}_n latest average amplitude value in display units
 n current sample number

\overline{y}_{n-1} last average amplitude in trace memory (TRACE A or B)
 y_n new amplitude entry from analyzer (Trace C)

The new amplitude value, \overline{y}_n , is weighted more heavily by the last average amplitude \overline{y}_{n-1} than the new amplitude entry, y_n .

When n equals the limit set (e.g. 100, the preset limit), the last average amplitude is gradually replaced with new data. Thus, the average will follow a slowly changing signal response, particularly if the sample limit is small.

Trace C

Video averaging requires the use of trace memory C. When video averaging is activated, the input signal response is written into trace C, the averaging algorithm is applied to these amplitudes and the results written into TRACE A. Thus, two traces are displayed: the input signal in C and the averaged signal in A.

Trace C may be blanked without affecting the operation of video averaging.

Press **SHIFT** k

Trace C may be written into as traces A and B if a video average sample limit of one is selected.

Press **SHIFT** **G** **VIDEO SW** **1** **Hz**
μV
mSEC

If either trace A or B is in a write trace mode, the analyzer response will also be written into trace C.

EXTERNAL AND VIDEO TRIGGER

The front panel **EXT** and **VIDEO** trigger modes automatically keep the display refreshed in zero frequency spans for sweeptimes less than 20 msec. To eliminate the automatic refresh feature:

For external triggering: Press **SHIFT** **EXT**^x

For video triggering: Press **SHIFT** **VIDEO**^y

LOCKING SAVE REGISTERS

After saving instrument states in one or more of the six registers, 1 through 6, the registers can be secured from being written over and destroyed. The recall function is not affected.

Lock: **SHIFT** **SAVE**
 Unlocked: **SHIFT** **RECALL**

When locked, an attempt to **SAVE** will write "SAVE LOCK" on the CRT and no DATA entry can be made.

ERROR CORRECTION ROUTINE

A built-in analyzer routine measures and records the amplitude and frequency error factors due to a number of parameters, then corrects the display for them. The routine takes about 30 seconds to run. When complete, instrument preset will be called and the correction factors applied.

Connect CAL OUT to RF INPUT

Execute the routine: SHIFT W

Use correction factors: SHIFT X

Do not use correction factors: SHIFT Y

Display correction factors: SHIFT w

If "ADJUST AMP'TD CAL" appears on the CRT manual calibration adjustment is necessary before the routine can be successfully run. See GENERAL INFORMATION for the manual calibration procedure.

Indicates that the routine has been run and the display is corrected.

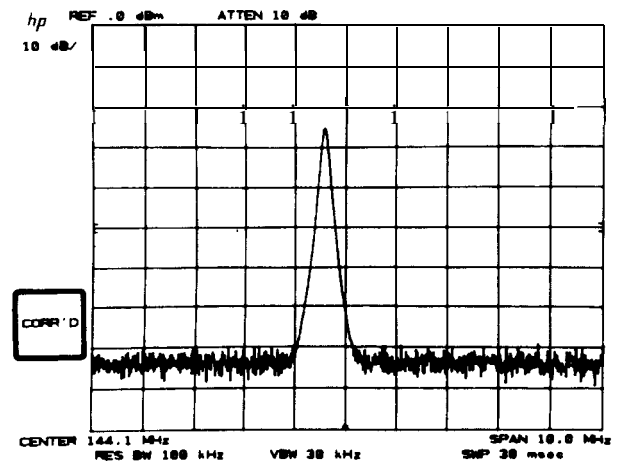

Correction can be turned on or off using SHIFT X and SHIFT Y after the routine has been successfully completed. See DISPLAY CORRECTION DATA in this chapter.

For more information on accuracy, see the 8566B Spectrum Analyzer Data Sheet.

The readout of the correction factors is as follows:

Line	Parameter	Correction Values Displayed
1	LOG and LIN scale (Res BW \geq 100 kHz)	Amplitude offset error between log and linear scale. Reference at 1 dB log.
2	10 dB/	Amplitude errors due to changing log scale. Reference to - 10 dBm CAL OUTPUT signal.
3	5 dB/	
4	2 dB/	
5	1 dB/	
	LOG SCALE	
6	3 MHz	Amplitude errors due to switching bandwidths. Reference to 1 MHz resolution bandwidth.
7	1 MHz	
8	300 kHz	
9	100 kHz	
10	30 kHz	
11	10 kHz	
12	3 kHz	
13	1 kHz	
14	300 Hz	
15	100 Hz	
16	30 Hz	Frequency offset errors due to center frequency tuning inaccuracies of resolution bandwidth.
17	10 Hz	
	RESOLUTION BANDWIDTH	
18	LOG and LIN scale (RES BW <100 kHz)	Same as line 1.
19	A20	Amplitude error due to changing IF step gain. Reference to - 10 dBm REFERENCE LEVEL.
20	A10	
21	SG 20-2	
22	SG 20-1	
23	SG 10	
24	LG 20	
25	LG 10	
	STEP GAINS	
26	20 dB	Amplitude error due to switching attenuator. Reference to 10 dB Attenuator position.
27	30 dB	
28	40 dB	
29	50 dB	
30	60 dB	
31	70 dB	
	INPUT ATTENUATOR	

The total amplitude correction value composed of linear/log scale offsets, bandwidth errors, and attenuator errors can be output to a computer/controller with KS91. This error can then be corrected with software to yield a more accurate amplitude measurement.

Correction values are stored in memory for a 30-day period in the event of power-line failure.

FASTPRESET/HP-IB

A partial instrument preset can be initiated with SHIFT T or SHIFT U. These key functions operate essentially the same as the 2-22 GHz instrument preset in that a specific full span is set, functions automatically coupled, and shift functions turned off. The difference is that the fast presets do not exercise the instrument's internal self-test routine, which controls the two check LEDs and, as a result, can be executed much faster.

Fast preset 2 – 22 GHz: press SHIFT T
 Fast preset external mixer: press SHIFT U

Under remote operation, an HP-IB operation mode can be set which allows the analyzer to operate faster than normal. The Fast HP-IB mode is enabled with a SHIFT S. A 2-22 GHz instrument preset will disable the Fast HP-IB mode, whereas the Fast presets will not disable the Fast HP-IB mode.

Fast HP-IB: press SHIFT S

BAND LOCK

If desired, the analyzer can be locked on a selected frequency band (local oscillator harmonic number). In normal operation, pressing the CENTER FREQUENCY key enables the analyzer to be tuned with one of the tuning controls from 0 to 22 GHz (– 1 to 24 GHz over-range). Executing a band lock limits the analyzer's tuning range to the selected harmonic number.

To execute band lock, SHIFT R (Diagnostics On) and the tuning controls can be used to display the harmonic numbers. SHIFT t locks the frequency range to the desired harmonic number.

Band lock: SHIFT t

Band unlock: SHIFT Q or FULL SPAN key



EXTERNAL MIXER

Two shift functions are available to specific usage with an external mixer. Shift U selects an LO tuning range for external mixer operation. Shift v enables a signal identifier routine which uses the marker to automatically identify the signal under observation.

Fast preset external mixer: SHIFT U
 Signal identifier external mixer: SHIFT v

SHIFT FUNCTION Index

All the shift functions are listed below. (DATA) indicates the functions that use a number and unit entry.

	CODE	PAGE			
GENERAL			Annotation on	P	96
Display Address (DATA)	z	*	CRT beam off	g	96
Display Write (DATA)		*	CRT beam on	h	96
HP-IB service request	r	*	Graticule blanked	m	96
HP-IB address (DATA)	P	*	Graticule on	n	96
Fast HP-IB operation	S	106	Title	E	97
Power on in last state	f	85	TRACE		
Mixer input level	,	93	A + B - A	c	97
FREQUENCY AND AMPLITUDE			Detection Modes:		
Amplitude offset	Z	91	normal	a	97
Amplitude units selection			positive peak	b	97
dBm	A	93	negative peak	d	97
dBmV	B	93	sample	e	97
dBμV	C	93	Trace C		
voltage	D	93	blank C	k	99
Removes IF Offset for	F	App. H	B ⇌ C		100
YTO pretest			B - C	l	99
Extended reference level	I	94	view C	j	99
range (DATA)			Video averaging on	G	101
Frequency offset (DATA)	V	91	Video averaging off	H	101
Signal identifier external	v	106	TRIGGER. ZERO SPAN. SWEEP <20 msec		
mixer			 without 25 msec trigger	x	103
Mixer level	,	93	 without 25 msec trigger	Y	103
Negative entry (DATA)	-	91	INSTRUMENT STATE		
MARKER			Save Registers locked	(103
Marker to next peak	K	95	Save Registers unlocked)	103
Marker to minimum	N	95	Fast preset 2 - 22 GHz	T	106
Enter A → Span	0	53	Fast preset external mixer	U	106
Noise Level on	M	58	Band lock	t	106
Noise Level off	L	58	Band unlock	Q	106
Stop single sweep at marker	u	95	ERROR CORRECTION		
Factory preselector setting	=	94	Execute Routine	W	104
Manual preselector setting	/	94	Use data (display corrected)	X	104
DISPLAY			Do not use data (display	Y	104
Annotation blanked	o	96	not corrected)		
			Display correction data	W	104
			on CRT		

DIAGNOSTIC AIDS

To aid in servicing the spectrum analyzer, there are a number of diagnostic shift functions. These functions

are listed here. Their operation and use are covered in the HP 8566B Service Manual.

CODE

Frequency diagnostic on	R
Disable step gain	q
Manual DACS control	J
Display correction data	w
Turns off YTX self-heating	#
correction	

. See Section II of this manual

Chapter 12 USER DEFINED KEYS

GENERAL DESCRIPTION

This chapter describes the procedure for defining a numeric key(s) to allow the storage and execution of a list of commands. The procedure for remote storage and execution of command lists is contained in Section II of this manual.

ENTERING A COMMAND LIST

The title mode must be activated to enter a command list. When the title mode is activated, the front panel blue characters, numeric keys, decimal, backspace, and space can be entered onto the top line starting at the upper left corner of the display. The full width of the display can be used (58 characters total).

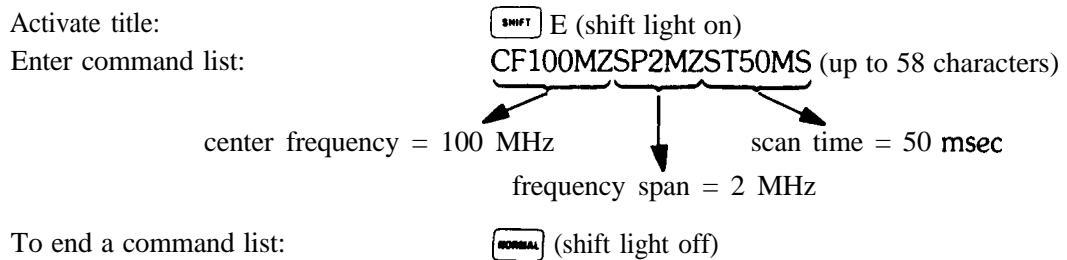

KEY DEFINITION

After a command list is entered into the title block, it is stored under a defined numeric key(s).

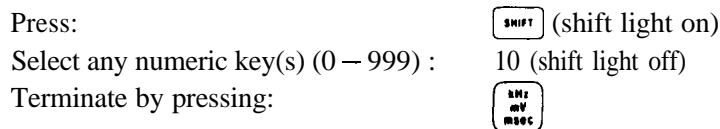



NOTE

The kHz
mV
msec key must be pressed to terminate the key definition procedure. If it is not, the command list will not be stored under the numeric **key(s)**.

EXECUTING A SOFT KEY

After a command list is stored under a numeric key(s), it can be executed

Press:	 (shift light on)
Enter defined numeric key(s) :	10 (shift light off)
Terminate by pressing:	

NOTE

The  key must be pressed to terminate this execution procedure. If it is not, the command list will not be executed.

Chapter 13 PLOTTER OUTPUT

GENERAL DESCRIPTION

This chapter describes the procedure for executing the PLOTTER OUTPUT function, and provides information for preventing problems that may arise while attempting to execute it.

EXECUTING PLOTTER OUTPUT

Connect an HP plotter via HP-IB to the spectrum analyzer:



Set the HP-IB address on the plotter to address 5:

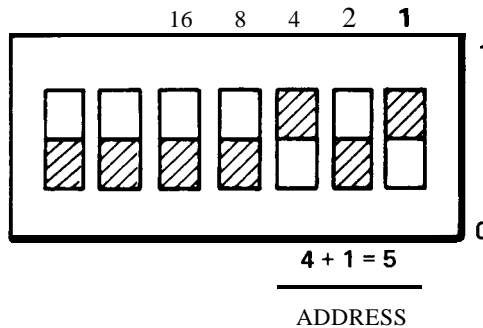

If the address switch on the plotter cannot be located, refer to the plotter's operation manual.

Press the lower left recorder key  to execute the PLOTTER OUTPUT function.

The function plots everything that is displayed on the CRT. If desired, traces A, B, and C, the annotation and the graticule can be individually blanked from the CRT using front-panel functions (refer to Chapters 5 and 11).

You can also blank the HP logo from the display. To do this from a computer, execute:

```
OUTPUT 718; "DA 2174; DW 32;32;"
```

Or, to execute it from the front panel, press:

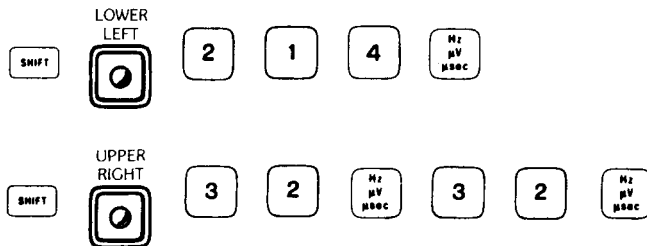

PLOTTER PENS

Traces A, B, and C, and the annotation and graticule are individually plotted with four different pens, provided there are four pen locations in the plotter. Pens 1, 2, and 4 plot traces A, B, and C, respectively, and pen 3 plots the annotation and graticule. For a two-pen plotter, pens 1 and 2 take the place of pens 3 and 4, respectively.

NOTE

There are certain types of equipment that prevent the PLOTTER OUTPUT function from being executed correctly. They are discussed in the next two sections.

CONTROLLER

The analyzer should not be connected via HP-IB to an active controller while attempting to execute the PLOTTER OUTPUT function from the front panel. This is because the analyzer will abort any attempts to execute the function from the front panel when an active controller is on the bus.

PLOTTER

The 7245A/B, 7240A, 9872C, and 7550 Graphics Plotters work readily for executing the PLOTTER OUTPUT function. However, the HP 7570A, 7585, 7470A, and 7475A plotters require special operating instructions. The HP 7570 and 7585 plotters work only in EMULATE MODE. For more information on EMULATE MODE, refer to the plotter's operating manual. On the HP 7470A plotter, set the US/A4 rocker switch to the US position. For the HP 7475 plotter, the US/MET and A4/A3 rocker switches must be set to the US and A4 positions.

Section II

Programming

FUNCTIONAL INDEX
PROGRAMMING COMMANDS
PROGRAMMING NOTES

This section describes remote operation of the spectrum analyzer.

The Functional Index contains all the remote commands arranged by functions.

The Programming Command section describes operation of the commands, which are listed in alphabetical order.

The appendixes at the end of this section contain useful information:

Appendix A describes the contents of the spectrum analyzer display memory.

Appendix B contains programming techniques for custom graphics.

Appendix C lists the learn string contents.

Appendix D describes the service request commands and their use.

Appendix E explains how to increase execution speed of analyzer programs.

Appendix F contains a graph of the analyzer tuning curves.

Appendix G describes how the spanwidth is automatically adjusted when the analyzer is tuned near the edge of its band.

Appendix H explains how to use the first LO output as a tunable microwave source.

Appendix I describes some differences of operation between the HP 8566A and HP 8566B.

Appendix J lists new HP 8566B commands and original HP 8566A commands that function identically.

REMOTE OPERATION OVERVIEW

The standard HP 8566B Spectrum Analyzer with an HP-IB controller allows:

Remote operation of the analyzer front panel functions, including the shift key functions.

Output of any analyzer function value or trace amplitude. See individual commands, including OL. See Appendix C.

Input of special CRT display labels and graphics. See TRGRPH, LB, GR, TEXT, KSE, and DSPLY commands.

Interrupt of controller for service or data transfer. See Appendix D.

Creation of custom soft key functions. See KEYDEF, KEYEXC, FUNCDEF, IF, KSC, and REPEAT commands.

Creation of custom command language using flow-of-control commands. See FUNCDEF, IF, and REPEAT commands.

Creation of user-defined variables. See VARDEF command.

To set the center frequency to 4.621 GHz and the span to 10 MHz:

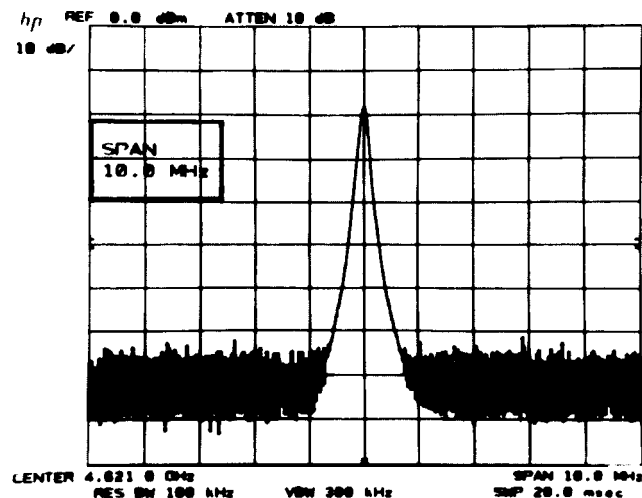
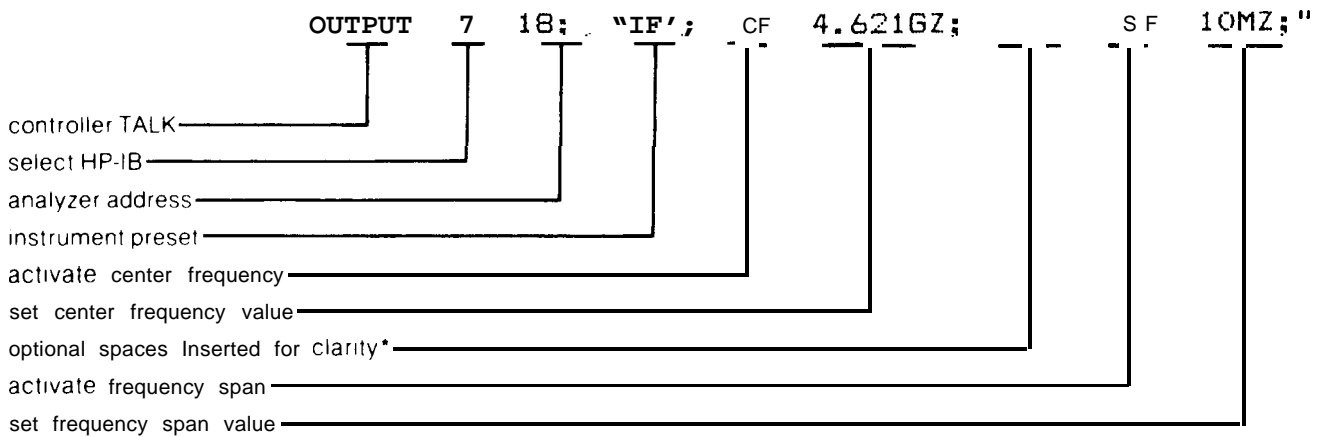

Output Value or Amplitude

To return the center frequency to the controller as variable F, enable the output of the active parameter.

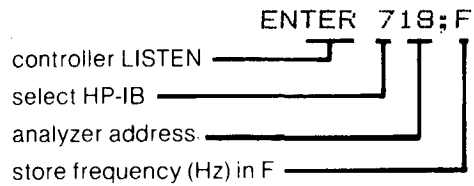
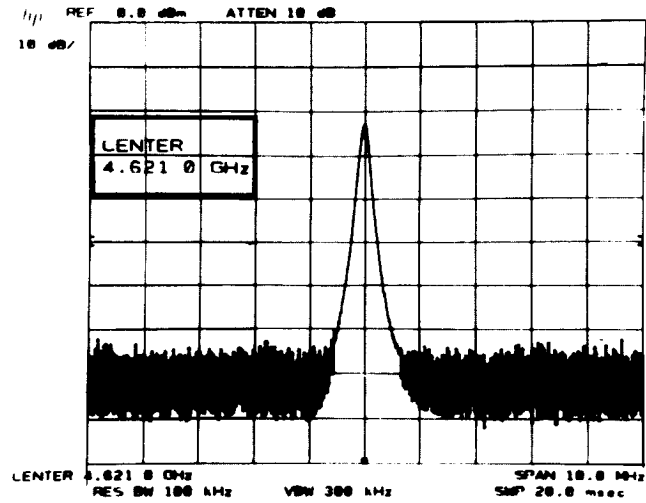
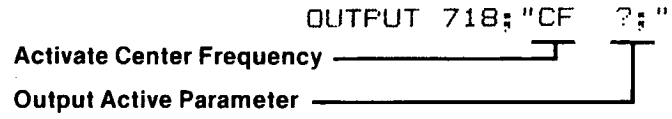

Input CRT Labels and Graphics

To write "Center Frequency" in the top center of the graticule area:

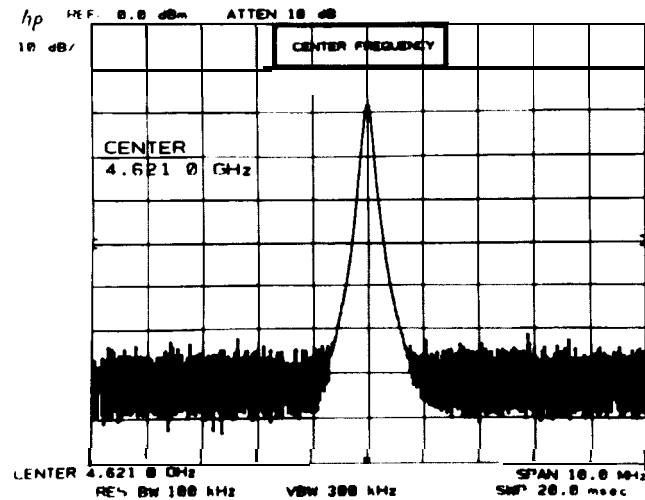
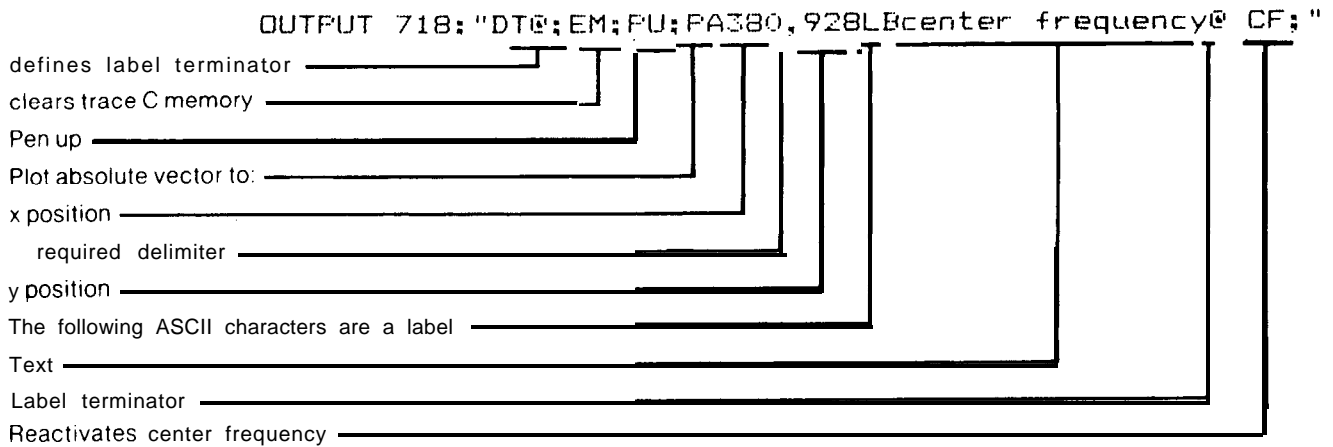

HP-IB Controller

Any HP-IB compatible controller can be used to operate the HP 8566B. The overall system measurement speed and capability depend to a large extent on the computing, storage, and interrupt capabilities of the controller.

The HP Series 200 Desktop Computers, HP Models 16, 26, and 36, are the computing controllers in this manual.

Addressing the Spectrum Analyzer

Communications between instruments via HP-IB require that a unique address be assigned to each instrument. The analyzer address, preset at the factory to 18, appears on the CRT display when the LINE power is turned from STANDBY to ON.

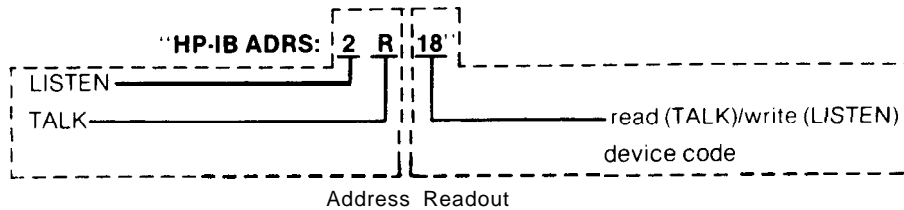
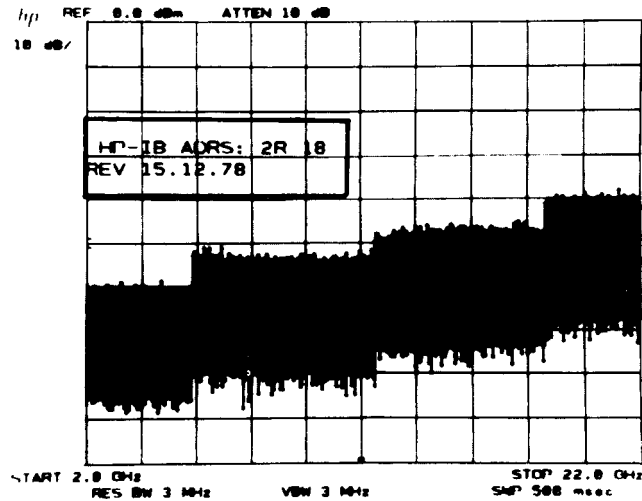





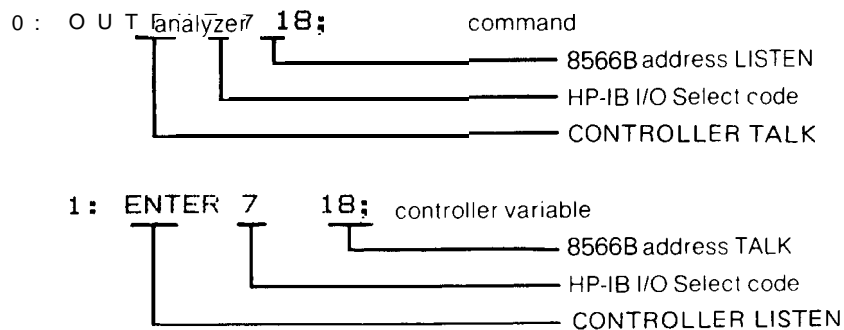



Two formats are available for addressing an HP-IB instrument or device. One command format uses separate addresses for TALK (“R”) and LISTEN (“2”). The other uses only a bus address (“18”) to designate the recipient of the command.

In all examples, the preset address of the HP computing controller is HP-IB SELECT CODE “7”



The read/write address of the HP 8566B can be changed from the front panel or via HP-IB by using the shift function I?

Pressing      sets the address to 18.

To set the address to 8, press    .

From the controller, the address can be set to 8 via HP-IB:

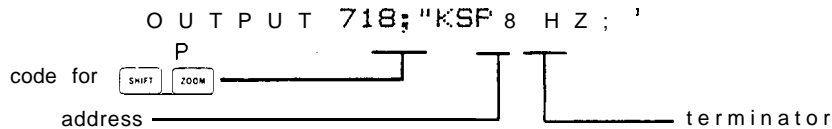

As long as the analyzer internal battery has power, the analyzer address remains unchanged. (Battery lasts one year.)

In addition to these features, an internal switch can be set which changes the default address at Power Up.

Call your nearest HP service office for more information.

Remote/Local Operation

If the controller has addressed the analyzer to TALK or LISTEN, the ADRS'D indicator lights. When the analyzer is addressed with an HP-IB device command, the analyzer will go to remote, and the REM indicator also lights.

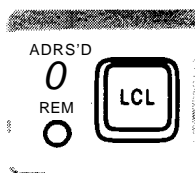

Remote operation generally prevents front panel control of the analyzer except by those functions not programmable: LINE power, calibration and display adjustment, and video trigger level.

Return to front panel, or local control by pressing , or executing a local device command from the controller such as

LOCAL 718.

CAUTION

An HP-IB transmission may be disrupted if the analyzer LINE power is cycled. An analyzer should be connected to an operating HP-IB only with POWER ON.

Similar HP-IB disruption may result from pressing **LOC** when the HP-IB is active. Thus, a local lockout is recommended during HP 8566B automatic operation.

After analyzer power-on, wait 5 seconds before addressing it.

Shift Function Codes

Programming a shift function requires a code sequence similar to the manual procedure for activating a shift function; that is, press **SHIFT**, then press the key with the function's code (the front panel blue character).

For example, to select the video averaging shift function, blue code G, execute

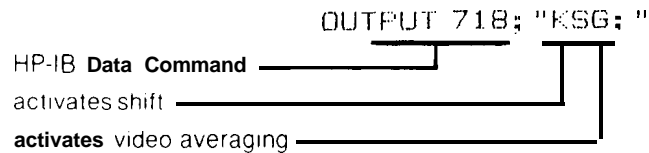

About half of the shift key function codes require ASCII lower case letters or symbols. Spaces are not allowed between the shift command, "KS" and the shift function, in this case "G".

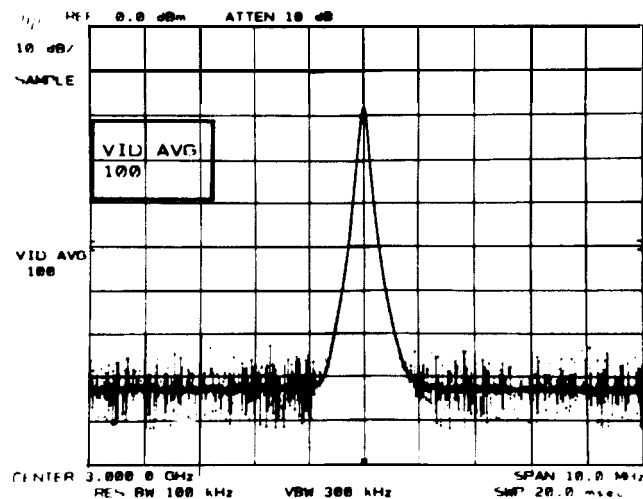

Data Entry Via HP-IB

A data entry through the HP-IB must meet the same requirements as a front panel DATA entry. It must have a number (value) and a message that terminates the entry, signaling the analyzer to assign the function value.

The number code within the quote field must be a string of (ASCII) decimal numbers plus an optional decimal point. It may be preceded by a minus or plus sign. If the decimal is not included in the entry, the decimal point is assumed to be at the end of the number. Either fixed or floating point notation may be used to make number entries. For example, the entries "12.3E6", "12.3e6" and "12300000" each enters the same number. Exercise caution when using the "E" exponent format, since several marker command mnemonics also begin with E.

The number of significant digits accepted and stored by the analyzer is dependent upon which function is active. For example, an entry of 11 significant digits for center frequency can be stored in the analyzer's center frequency register.

If no number is entered, a "1" is assumed.

Terminating the Data Entry

The units code is the most common data entry terminator. It sets the value units and enters the function value.

UNIT CODES

Frequency	Code	Power	Code	Voltage	Code	Time	Code
Hz	HZ	dBm	DM	mV	MV	sec	SC
kHz	KZ	-dBm	-DM	μ V	UV	msec	MS
MHz	MZ	dB	DB			μ sec	US
GHz	GZ						

Other than the units codes, some ASCII codes can be used to terminate a data entry.

ASCII Codes Which Terminate a Numeric Data Entry

Symbol	Name	Decimal Equivalent (ASCII)
,	comma	44
CR	carriage return	13
LF	line feed	10
;	semi-colon	59
ETX	end of text	3

These non-unit code terminators originate in the controller's language.

A terminated entry without a units code defaults to the fundamental units for the function activated. The default units of power depend upon the amplitude readout units selected.

Default Units

Frequency	HZ
Power	dBm, dBmV, dB μ V, or dB
Voltage	volts
Time	seconds

Front-Panel Data Entry During Remote Control



Data may also be entered from the front panel when the analyzer is in remote control. This is done by following the analyzer command with the secondary keyword, EP. The syntax diagrams show which commands can be followed by EI? EP pauses program operation until data is entered from the front panel and terminated with one of the units keys listed in the Units Code table. Program operation then resumes. EP is especially useful when it is part of a programming routine that is stored in a soft key.

Custom Soft key Functions

The spectrum analyzer has soft keys that can be loaded into up to 16K bytes of memory, with or without a controller. These soft keys remain in nonvolatile memory for the life of the internal battery, which lasts for one year.

The functions of the soft keys are defined with the KEYDEF command. The original contents of a soft key are erased when the key is defined a second time with the KEYDEF command, or when the DISPOSE command is executed.

The soft keys can be executed four ways. To execute a soft key remotely, execute the KEYEXC command, or define the soft key as part of a user-defined function. Then, whenever the function name is encountered, the soft key is executed. (See FUNCDEF command.) Soft keys can also be nested inside another soft key. Thus, executing one key actually can cause the execution of several keys.

To manually execute a soft key from the front panel, press , the key number, and then press .

FUNCTIONAL INDEX

FREQUENCY CONTROL

CF	Specifies center frequency
CS	Couples step size
*FA	Specifies start frequency
*FB	Specifies stop frequency
FOFFSET	Specifies frequency offset
FS	Specifies full frequency span as defined by instrument
KSQ	Unlocks frequency band
KSV	Specifies frequency offset
KSt	Locks frequency band
SP	Specifies frequency span
SS	Specifies center frequency step size

INSTRUMENT STATE CONTROL

IP	Sets instrument parameters to preset values
KST	Performs fast present 2 – 22 GHz
KSU	Performs external mixer preset
KS(Locks save registers
KS)	Unlocks save registers
LF	Presets 0 – 2.5 GHz
RC	Recalls previously saved state
RCLS	Recalls previously saved state
SAVES	Saves current state of the analyzer in the specified register
sv	Saves current state of analyzer in specified register
USTATE	Configures or returns configuration of user-defined states: ONEOS, ONSWP, TRMATH, VARDEF, FUNCDEF, TRDEF

AMPLITUDE CONTROL

AT	Specifies input attenuation
AUNITS	Specifies amplitude units for input, output and display
*CA	Couples input attenuation
E4	Moves active marker to reference level
*KSA	Selects dBm as amplitude units
KSB	Selects dBmV as amplitude units
KSC	Selects dBuV as amplitude units
KSD	Selects voltage as amplitude units
KSI	Extends reference level range
KSW	Performs amplitude error correction routine
KSX	Incorporates correction data in amplitude readouts
KSY	Does not incorporate correction data in amplitude readouts
KSZ	Specifies reference level offset
KSq	Decouples IF gain and input attenuation
KSw	Displays correction data
KS,	Sets mixer level
LG	Selects log scale
LN	Selects linear scale
MKRL	Moves active marker to reference level
ML	Specifies mixer level
RL	Specifies reference level
ROFFSET	Specifies reference level offset

BANDWIDTH CONTROL

*CR	Couples resolution bandwidth
*CV	Couples video bandwidth
RB	Specifies resolution bandwidth

*Selected with instrument preset (IP)

VB Specifies video bandwidth
VBO Specifies coupling ratio of video bandwidth and resolution bandwidth

SWEEP AND TRIGGER CONTROL

***CONTS** Selects continuous sweep mode
***CT** Couples sweep time
KS_t Continues sweep from marker
KS_u Stops sweep at active marker
KS_x Sets external trigger (eliminates auto-refresh)
KS_y Sets video trigger (eliminates auto-refresh)
ST Specifies sweep time
SNGLS Selects single sweep mode
***S1** Selects continuous sweep mode
S2 Selects single sweep mode
TM Selects trigger mode: free run, video, line, external
TS Takes a sweep
***T1** Sets trigger mode to free run
T2 Sets trigger mode to line
T3 Sets trigger mode to external
T4 Sets trigger mode to video

MARKER CONTROL

E1 Moves active marker to maximum signal detected
E2 Moves marker frequency into center frequency
E3 Moves marker or delta frequency into step size
E4 Moves active marker to reference level
KSK Moves active marker to next highest peak
KSL Turns off average noise level marker
KSM Returns average value at marker, normalized to 1 Hz bandwidth
KSN Moves active marker to minimum value detected
KSO Moves marker delta frequency into span
KS_u Stops sweep at active marker
KS{92} Enters DL, TH, M2, M3 in display units
MA Returns marker amplitude
MF Returns marker frequency
MKA Specifies amplitude of active marker
MKACT Specifies active marker: 1, 2, 3, or 4
MKCF Enters marker frequency into center frequency
MKCONT Continues sweep from marker
MKD Moves delta marker to specified frequency
MKF Specifies frequency of active marker
MKMIN Moves active marker to minimum signal detected
MKN Moves active marker to specified frequency or center screen
MKNOISE Returns average value at marker, normalized to 1 Hz bandwidth
MKOFF Turns all markers, or the active marker off
MKP Specifies marker position horizontally, in display units
MKPAUSE Pauses sweep at marker for duration of specified delay time (in seconds)
MKPK Moves active marker to maximum signal detected, or to adjacent signal peaks
***MKPX** Specifies minimum excursion for peak identification. Preset value is 6 dB
MKREAD Specifies marker readout mode
MKRL Moves active marker to reference level
MKSP Moves marker delta frequency into span
MKSS Moves marker frequency to center frequency step size
MKSTOP Stops sweep at active marker
MKTRACE Moves active marker to corresponding position on another specified trace
MKTRACK Turns marker signal track on or off

*Selected with instrument preset (IP)

MKTYPE	Sets marker type
*MT0	Turns off marker signal track
MT1	Turns on marker signal track
*M1	Turns off active marker
M2	Turns on active marker and moves it to center screen
M3	Turns on delta marker
M4	Turns on marker zoom

COUPLING CONTROL

'CA	Couples input attenuation
*CR	Couples resolution bandwidth
*c s	Couples step size
*CT	Couples sweep time
*c v	Couples video bandwidth
*VBO	Specifies coupling ratio of video bandwidth and resolution bandwidth

PRESELECTOR CONTROL

FPKA	Performs fast preselector peak and returns measured value of active marker
KSJ	Allows manual control of DAC
KS#	Turns off YTX self-heating correction
KS/	Allows manual peaking of preselector
KS=	Selects factory preselector setting
PP	Peaks preselector

EXTERNAL MIXING COMMANDS

CNVLOSS	Selects the reference level offset to amplitude calibrate the display for a mixer with a given conversion loss. Default units are dB .
EXTMXR	Performs an external mixing preset. Start frequency 18 GHz; Stop frequency 26.5 GHz.
FULBAND	Sets the start and stop frequencies for full waveguide bands.
HNLOCK	Locks to the specified harmonic number to prevent multi-harmonic sweeps and to prevent tuning past the 2 to 6.2 GHz L.O. tuning range.
HNUNLK	Turns off the harmonic lock (see HNLOCK) allowing tuning over the entire analyzer input range.
IDSTAT	Returns the completion status of the signal identifier. Query response : 1 signal found 0 no signal found -1 signal found but cannot be reached on locked harmonic
KSQ	Turns off the harmonic lock (see HNLOCK) allowing tuning over the entire analyzer input range.
KSt	Locks to the specified harmonic number to prevent multi-harmonic sweeps and to prevent tuning past the 2 GHz to 6.2 GHz L.O. tuning range.
KSU	Performs an external mixer preset. Start frequency 18 GHz; Stop frequency 26.5 GHz.
KSv	Identifies signals for the external mixing frequency bands.
NSTART	Specifies the start harmonic for signal identification.
NSTOP	Specifies the stop harmonic for signal identification.
SIGDEL	Specifies the maximum amplitude difference allowed between a signal and its image for the pair to be recognized by the signal identification routine. Default units are dB .
SIGID	Identifies signals for external mixing frequency bands.

*Selected with instrument preset (IP)

DISPLAY CONTROL

*ANNOT	Turns annotation on or off. Preset condition is on.
AUNITS	Specifies amplitude units for input, output, and display
DL	Specifies display line level in dBm
DLE	Turns display line on and off
*GRAT	Turns graticule on or off. Preset condition is on.
KSg	Turns off CRT beam
*KSh	Turns on CRT beam
KSm	Turns off graticule
*KSn	Turns on graticule
KSo	Turns off annotation
*KSp	Turns on annotation
*LG	Selects log scale
LN	Selects linear scale
*LØ	Turns off display line
TH	Specifies display threshold value
THE	Turns threshold on or off
*TØ	Turns off threshold
TRGRPH	Dimensions and graphs a trace

READING AND WRITING DISPLAY MEMORY

*DA	Specifies display address
DD	Writes to display (binary) and advances address by 1
DR	Reads display and advances address by 1
DSPLY	Displays the value of a variable on the analyzer screen
DT	Defines a character for label termination
DW	Writes to display and advances address by 1
*D1	Sets display to normal size
D2	Sets display to full CRT size
D3	Sets display to expanded size
*EM	Erases trace C memory
GR	Graphs specified y values on CRT
*HD	Holds or disables data entry and blanks active function CRT readout
IB	Inputs trace B in binary units
KSE	Sets title mode
KS{39}	Writes to display memory in fast binary
KS{125}	Writes to display memory in binary
KS{127}	Prepares analyzer to accept binary display write commands
LB	Writes specified characters on CRT
OP	Returns lower left and upper right vertices of display window
PA	Draws vectors to specified x and y positions
*PD	Turns on beam to view vector
PR	Draws vector from last absolute position
PS	Skips to next display page
PU	Turns off beam, blanking vector
SW	Skips to next control instruction
TEXT	Writes text string to screen at current pen location

TRACE PROCESSING

*A1	Clear-writes trace A
A2	Max holds trace A
A3	Stores and views trace A
A4	Stores and blanks trace A
B1	Clear-writes trace B
B2	Max holds trace B
B3	Stores and views trace B
*B4	Stores and blanks trace B
BLANK	Stores and blanks specified trace register

*Selected with instrument preset (IP)

CLRW	Clear-writes specified trace register
KSj	Stores and views trace C
KSk	Stores and blanks trace C
KS{39}	Writes to display memory in fast binary
KS{123}	Reads display in binary units
KS{125}	Writes to display memory in binary units
KS{126}	Outputs every nth value of trace
MOV	Moves source to the destination
MXMH	Max holds the specified trace register
TA	Outputs trace A
TB	Outputs trace B
TRDSP	Turns specified trace on or off, but continues taking information
VIEW	Views specified trace register

TRACE MATH

AMB	A - B into A
AMBPL	(A - B) + DL into A
APB	A + B into A
AXB	Exchanges A and B
BL	B - DL into B
BML	B - DL into B
BTC	B into C
BXC	Exchanges B and C
*C1	A - B off
C2	A - B into A
Ex	Exchanges A and B
KSG	Turns on video averaging
*KSH	Turns off video averaging
KSc	A + B into A
KSi	Exchanges B and C
KSI	B into C
TRMATH	Executes trace math or user-operator commands at end of sweep
VAVG	Turns video averaging on or off

OTHER TRACE FUNCTIONS

AUNITS	Specifies amplitude units for input, output, and display
COMPRESS	Compresses trace source to fit trace destination
CONCAT	Concatenates operands and sends new trace to destination
DET	Specifies input detector type
FFT	Performs a forward fast fourier transform
*KSa	Selects normal detection
KSb	Selects position peak detection
KSd	Selects negative peak detection
KSe	Selects sample detection
MEAN	Returns trace mean
ONEOS	Executes specified command(s) at end of sweep
ONSWP	Executes specified command(s) at start of sweep
PDA	Returns probability density of amplitude
PDF	Returns probability density of frequency
PEAKS	Returns number of peak signals
PWRBW	Returns bandwidth of specified percent of total power
RMS	Returns RMS value of trace in display units
SMOOTH	Smooths trace over specified number of points
STDEV	Returns standard deviation of trace amplitude in display units
SUM	Returns sum of trace element amplitudes in display units
SUMSQR	Squares trace element amplitudes and returns their sum
TRDEF	Defines user-defined trace
TRGRPH	Dimensions and graphs a trace

*Selected with instrument preset (IP)

TRPRST	Sets trace operations to preset values
TRSTAT	Returns current trace operations
TWVNDW	Formats trace information for fast fourier analysis (FFT)
VARIANCE	Returns amplitude variance of trace

USER-DEFINED COMMANDS

*DISPOSE	Frees memory previously allocated by userdefined functions. Instrument preset disposes ONEOS, ONSWP, and TRMATH functions.
FUNCDEF	Assigns specified program to function label
KEYDEF	Assigns function label or command list to softkey number (See FUNCDEF)
KEYEXC	Executes specified softkey
MEM	Returns amount of allocatable memory available for user-defined commands
ONEOS	Executes specified command(s) at end of sweep
ONSWP	Executes specified command(s) at start of sweep
TRDEF	Defines userdefined trace name and length
TRMATH	Executes specified trace math or user-operator commands at end of sweep
USTATE	Configures or returns configuration of user-defined state: ONEOS, ONSWP, TRMATH, VARDEF, FUNCDEF, TRDEF
*VARDEF	Defines variable name and assigns real value to it. Preset reassigns initial value to variable identifier.

PROGRAM FLOW CONTROL

IF	Compares two specified operands. If condition is true, executes commands until next ELSE or ENDIF statements are countered
THEN	No-operation function
ELSE	Delimits alternate condition of IF command
ENDIF	Delimits end of IF command
REPEAT	Delimits the top of the REPEAT UNTIL looping construct
UNTIL	Compares two specified operands. If condition is true, commands are executed following this command. If condition is false operands are executed following the previous REPEAT command.

MATH FUNCTIONS

ADD	Operand 1 + operand 2 into destination
AVG	Operand is averaged into destination
CONCAT	Concatenates two operands and sends new trace to destination
CTA	Converts operand values from display units to vertical measurement units
CTM	Converts operand values from vertical measurement units to display units
DIV	Operand 1 / operand 2 into destination
EXP	Operand is divided by specified scaling factor before being raised as a power of IO
LOG	LOG of operand is taken and multiplied by specified scaling factor
MIN	Minimum between operands is stored in destination
MOV	Source is moved to destination
MPY	Operand 1 x operand 2 into destination
MXM	Maximum between operands is stored in destination
SQR	Square root of operand is stored in destination
SUB	Operand 1 - operand 2 into destination
XCH	Contents of the two destinations are exchanged

Operations on specific traces (A, B, and C) can be found in the Trace Math section.

*Selected with instrument preset (IP)

INFORMATION AND SERVICE DIAGNOSTICS COMMANDS

BRD	Reads data word at analyzer's internal input/output bus
BWR	Writes data word to analyzer's internal input/output bus
ERR	Returns results of processor test
ID	Returns the HP model number of analyzer used (HP 85668 or HP 8568B)
KSF	Shifts YTO by intermediate frequency
KSJ	Allows manual control of DAC
KSQ	Unlocks frequency band
KSR	Turns frequency diagnostics on
KSf	Recovers last instrument state at power on
KSq	De-couples IF gain and input attenuation
KSr	Sets service request 102
KSt	Locks frequency band
KSu	Stops sweep at active marker
KSw	Displays correction data
KS =	Selects factory preselector setting
KS#	Turns off YTX self-heating correction
KS/	Selects manual preselector peak
MBRD	Reads specified number of bytes starting at specified address and returns to controller
MBWR	Writes specified block data field into analyzer's memory starting at specified address
MRD	Reads two-byte word starting at specified analyzer memory address and returns word to controller
MRDB	Reads 8-bit byte contained in specified address and returns byte to controller
MWR	Writes two-byte word to specified analyzer memory address
MWRB	Writes one-byte message to specified analyzer memory address
REV	Returns analyzer revision number
RQS	Returns decimal weighting of status byte bits which are enabled during service request

OUTPUT FORMAT CONTROL

DR	Reads display and increments address
DSPLY	Displays value of variable on analyzer screen
EE	Enables front panel number entry
KSJ	Allows manual control of DAC
KSP	Sets HP-IB address
KSS	Sets fast HP-IB
KS{91}	Returns amplitude error
KS{94}	Returns code for harmonic number in binary
KS{123}	Reads display in binary units
KS{126}	Returns every nth value of trace
LL	Provides lower left x-y recorder output voltage at rear panel
MA	Returns marker amplitude
*MDS	Specifies measurement data size to byte or word. Preset condition is word.
MDU	Returns values of CRT baseline and reference level
MF	Returns marker frequency
OA	Returns active function
OL	Returns learn string
OT	Returns display annotation
O1	Selects output format as integers (ASCII) representing display units or display memory instruction words
02	Selects output format as two 8-bit bytes
*O3	Selects output format as real numbers (ASCII) in Hz, volts, dBm, or seconds
04	Selects output format as one 8-bit byte
TA	Outputs trace A

*Selected with instrument preset (IP)

TB Outputs trace B
***TDF** Selects trace data output format as O1, O2, O3, O4, A-block data field, or I-block data field. Preset format is O3.
UR Provides upper right x-y recorder output voltage at rear panel

SYNCHRONIZATION

DONE Sends message to controller after preceding commands are executed
TS Takes a sweep

SERVICE REQUEST

KSr Allows service request 102
KS{43} Allows service request 140 and 102
RQS Returns decimal weighting of status byte bits which are enabled during service request
R1 Resets service request 140
R2 Allows service request 140 and 104
***R3** Allows service request 140 and 1 IO
R4 Allows service request 140 and 102
SRQ Sets service request is operand bits are allowed by RQS

SRQ	COMMAND	BIT	DEFINITION
102	R4	1	units key pressed
102	KS{43}	1	frequency limit exceeded
104	R2	2	end of sweep
110	R3	3	hardware broken
120	RQS	4	command complete input buffer empty
140	all	5	illegal command
1xx		6	universal HP-IB service

PLOTTER OUTPUT

LL Provides lower left x-y recorder output voltage at rear panel
PLOT Plots CRT Scaling points, P1 and P2 must be specified and must be compatible with plotter.
P1x Represents first x-axis scaling point to be specified in PLOT command
P1y Represents first y-axis scaling point to be specified in PLOT command
P2x Represents second x-axis scaling point to be specified in PLOT command
P2y Represents second y-axis scaling point to be specified in PLOT command
UR Provides upper right x-y recorder output voltage at rear panel

MEMORY INFORMATION

***EM** Erases trace C memory
KSz Sets display storage address
KSj Writes to display storage
MEM Returns amount of allocatable memory available for user-defined commands, in bytes

OPERATOR ENTRY

EE Enables front panel data number entry
EK Enables DATA knob
EP Enables manual entry into specified command
***HD** Holds or disables data entry and blanks active function CRT readout
KS Shifts front panel keys

*Selected with instrument preset (IP)

PROGRAMMING COMMANDS

All the commands in this section are immediately executed.

Command syntax is represented pictorially. All characters enclosed by a rounded envelope must be entered exactly as shown.

Words enclosed by a rectangular box are names of items also used in the command statement. These items are described in the table below, and are also described in the tables below the syntax diagrams for each command. Statement elements are connected by lines. Each line can be followed in only one direction, as indicated by the arrow at the end of the line. Any combination of statement elements that can be generated by following the lines in the proper direction is syntactically correct. An element is optional if there is a path around it. Optional items usually have default values. The table or text following the diagram specifies the default value that is used when an optional item is not included in a statement.

In the diagrams, narrow ovals surround command names. Circles and wide ovals surround secondary keywords, or special numbers and characters.

Command Statement Elements Enclosed in Rectangular Boxes

A-Block Data Field	Absolute block data field consisting of #, A, Length, and Command List.
Average Count	Integer representing counter value. Default value is current counter value.
Average Length	Integer representing maximum number of sweeps executed for computing average.
Carriage Return	Asserts carriage return. (ASCII code 13.)
Character	Represents text displayed on screen. (ASCII codes 32 through 126.)
Command List	Alphanumeric character comprising any spectrum analyzer command. (ASCII characters 0 through 255.)
Data Bytes	8-bit bytes representing command list.
Display Address	Integer signifying 1 of 1008 elements (display units) of trace A, B, or C. Trace A comprises addresses 0 through 1023. Trace B comprises addresses 1024 through 2047. Trace C comprises addresses 3072 through 4095.
END	Ends program.
ETX	Marks end of text. (ASCII code 3.)

Function Label	User-defined label declared in FUNCDEF statement. Alpha character of 2 to 12 characters: AA through ZZ and “_” (ASCII character 95). Recommend “_”
I-Block Data Field	Indefinite block data field consisting of #, I Command List, and END.
Key Number	Integer (Ø to 999) representing number of user-defined key declared in KEYDEF statement.
Length	Two 8-bit bytes specifying length of command list in A-Block Data Field, in 8-bit bytes. The most significant byte is first: MSB LSB.
Line Feed	Asserts line feed. (ASCII code 10.)
Local	Returns spectrum analyzer to local control. Controller dependent.
Marker Number	Integer (1, 2, 3, or 4) specifying 1 of 4 markers.
Measurement-Variable Identifier	Alpha characters representing instrument identifiers, such as CF or MA.
Number of Points	Integer representing number of points for running average in SMOOTH command.
P1X and P1Y	Integer representing plotter-dependent values that specify lower-left plotter dimension.
P2X and P2Y	Integer representing plotter-dependent values that specify upper-right plotter dimension.
Real	The range of real numbers is $-1.797\ 693\ 134\ 862\ 315\ E + 308$ through $-2.225\ 073\ 858\ 507\ 202\ E-308$, Ø, and $+2.225\ 073\ 858\ 507\ 202\ E-308$ through $+1.797\ 693\ 134\ 862\ 315E + 308$.
String Delimiter	!” \$ % & ’ / : = @ \ ~ (ASCII characters 33, 39, 47, 58, 64, 92, and 126, respectively).
Terminator	Character defined with DT command that marks end of text. (ASCII codes Ø – 255).
Trace Element	Any element (point) of trace A, B, or C, or a user-defined trace.
Trace Label	User-defined label declared in TRDEF statement. Alpha character of 2 to 12 characters: AA through ZZ and “_” (ASCII character 95). Recommend “_” as second character.
Trace Length	Integer determining number of elements (display units or points) in user-defined trace array, declared in TRDEF statement. Range is 1 to 1008. Default is 1001.
User-Defined Identifier	User-defined label declared in VARDEF statement. Alpha character of 2 to 12 characters: AA through ZZ and “_” (ASCII character 95). Recommend “_” as second character.

Variable Identifier	<p>User-Defined Identifier declared in VARDEF statement. Alpha character of 2 to 12 characters: AA through ZZ and “_” (ASCII character 95). Recommend “_” as second character.</p> <p>or</p> <p>Measurement-Variable Identifier Alpha characters representing instrument identifiers: AT, FB, KS/, MA, RL, VB, CF, KSv, MF, SP, DA, KSZ, OA, ST DL, RB, TH, FA, KSP, LG</p> <p>Trace Element</p>
X Position	Integer value, in display units, that shifts trace position to right of specified Display Address. (See TRGRPH .)
Y Position	<p>Integer value, in display units, that shifts trace position above specified Display Address. (See TRGRPH.)</p> <p>Alphanumeric character comprising any spectrum analyzer command.</p>

Secondary Keywords Enclosed in Circles

ALL	all
AMP	amplitude
AVG	average detection
B	8-bit byte
DB	decibel (unit)
DBM	absolute decibel milliwatt (unit)
DBMV	decibel millivolt
DBUV	decibel microvolt
DELTA	delta
DM	absolute decibel milliwatt (unit)
DN	decreases the parameter one step size
EP	pauses program operation for data entry from front panel
EQ	equal
EXT	external
FFT	fast fourier transform (MKREAD command only)
FIXED	fixed
FREE	free run
FRQ	frequency
GE	greater than or equal
GT	greater than
GZ	gigahertz (unit)
HI	highest
HZ	hertz
IST	inverse sweep time
Kz	kilohertz (unit)
LE	less than or equal
LINE	line, as in power line
LT	less than
MS	millisecond (unit)
MV	millivolts (unit)
MZ	megahertz (unit)
NE	not equal to
NEG	negative peak detection
NH	next highest
NL	next left
NR	next right
NRM	normal Rosenfell detection
OA	output active. Returns the value of the associated parameter.
OFF	turn function off

ON	turn function on
PER	period
PK-PIT	peak-to-peak average detection
PK-AVG	peak minus average detection
POS	positive peak detection
PSN	position
SC	seconds (unit)
SMP	sample detection
SWT	sweep time
TRA	trace A
TRB	trace B
TRC	trace C
UP	increases the parameter one step size
u v	microvolts (unit)
u s	microseconds (unit)
V	volts (unit)
VID	video
W	2-byte word
?	returns a query response containing the value or state of the associated parameter

ADD

Add

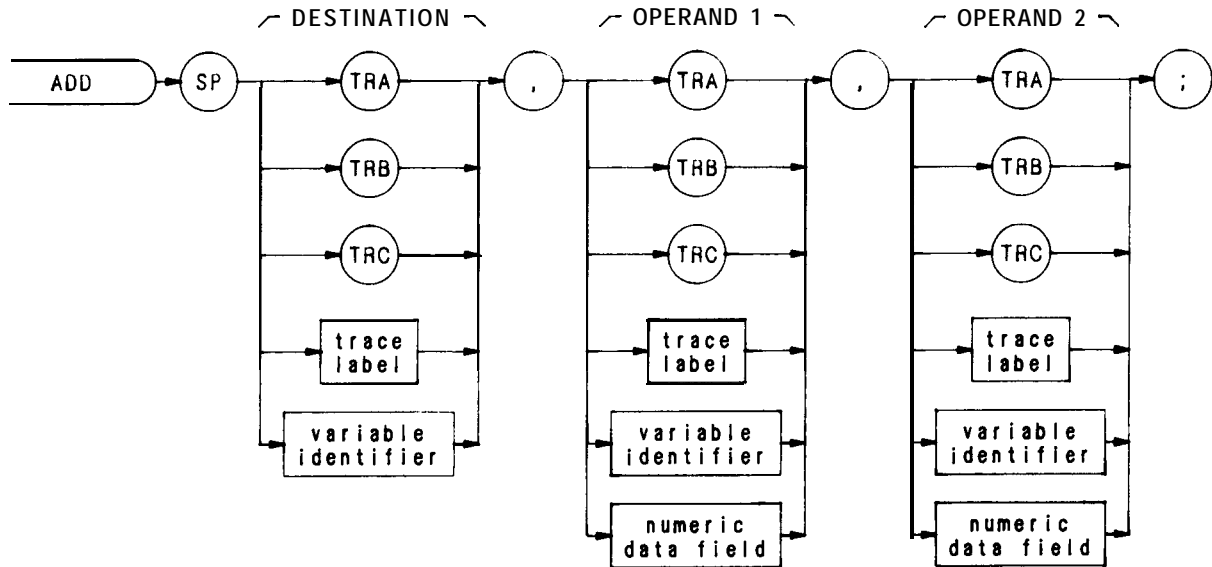

Item	Description/Default	Range Restriction
TRACE LABEL	Alpha character. User-defined label declared in TRDEF statement.	AA-ZZ and ___ 2-12 characters required.
VARIABLE IDENTIFIER	Alpha character. User-defined identifier declared in VARDEF statement. or Alpha character. Measurement-variable identifier, such as CF or MA. Trace element, such as TRA	AA-ZZ and ___ 2-12 characters required.
NUMERIC DATA FIELD	Real	

The ADD command adds the operands, point by point, and sends the sum to the destination.

$$\text{operand 1} + \text{operand 2} \rightarrow \text{destination}$$

The operands and destination may be different lengths. The trace operands (TRA, TRB, TRC, and trace label) range from 1 to 1008 elements in length. A variable identifier or numeric data field is 1 element long. When operands differ in length, the last element of the shorter operand is repeated for the addition process. When the operands are longer than the destination, they are truncated to fit.

The following program demonstrates the ADD command.

```
10 OUTPUT 718;"SNGLS;"
20 OUTPUT 718;"VARDEF COUNT,0:VARDEF SCORE,0;"
30 OUTPUT 718;"FUNCDEF C-LOP,"""
40 OUTPUT 718;"REPEAT TS;"
50 OUTPUT 718;"ADD COUNT,COUNT,1;"
60 OUTPUT 718;"UNTIL COUNT,EQ,3;""""
70 OUTPUT 718;"REPEAT;"
80 OUTPUT 718;"C__LOP;"
90 OUTPUT 718;"ADD SCORE,SCORE,1;"
100 OUTPUT 718;"UNTIL SCORE,EQ,4;"
```

The operands and results of trace math are truncated if they are not within certain limits. If operating on traces A, B, or C, results must be within 1023. If operating on user-defined traces, results must be within 32,767.

AMB

A-B→A
(C2)

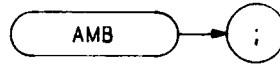

The AMB command subtracts trace B from trace A, point by point, and sends the difference to trace A

A - B - > A

The functions of the command AMB, the command C2, and front panel  key are identical.

See C1 and C2. Also refer to Chapter 5 in Section I.

OUTPUT 718;“AMB;”

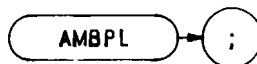

The AMBPL command subtracts trace B from trace A, point by point, adds the display line value to the difference, and sends the result to trace A, as demonstrated in the program below.

$A - B + \text{display line} \rightarrow A$

```
10 OUTPUT 718;"IP;SNGLS;TS;A3;"
20 OUTPUT 718;"RL -5ODM;TS;B3;"
30 OUTPUT 718;"DL-70;"
40 OUTPUT 718; "AMBPL;"
50 LOCAL 718
60 END
```

ANNOT

Annotation

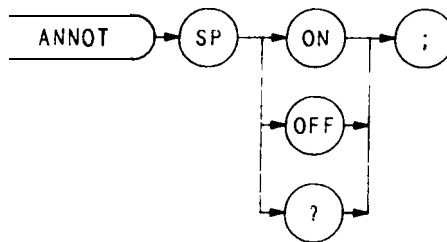

The ANNOT command turns the annotation on or off.

```
OUTPUT 718;"ANNOT ON;"
```

When queried (?), ANNOT returns the annotation state: on or off. The state is followed by carriage-return/line-feed (ASCII codes 13, 10). The end-of-identity state (EOI) is asserted with line feed.

(See KSo and KSp.)

APB

A + B → A
(KSc)

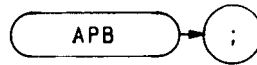

The APB command adds trace A and trace B, point by point, and sends the result to trace A. Thus, APB can restore the original trace after an A-minus-B function (AMB) is executed.

A + B → A

To successfully add all trace elements, place trace A in VIEW or BLANK display mode before executing APB. The sample program below has both traces in STORE mode.

```
10 ASSIGN @Sa TO 718
20 OUTPUT @Sa;"IP;LF;"
30 OUTPUT @Sa;"CF100MZ;SP2MZ;"
40 OUTPUT @Sa;"A3;"
50 OUTPUT @Sa;"B1;CF100MZ;"
80 OUTPUT @Sa;"B3;"
70 OUTPUT @Sa;"APB;"
80 END
```

Line 20: Presets the instrument.
Line 30: Sets trace A to 100 MHz center frequency with 2 MHz frequency span.
Line 40: Views trace A.
Line 50: Selects trace B and sets center frequency to 200 MHz.
Line 60: Views trace B .
Line 70: Combines the amplitude of trace B with trace A and displays this combination as trace A.

The functions of the APB and KSc commands are identical.

AT

Attenuation

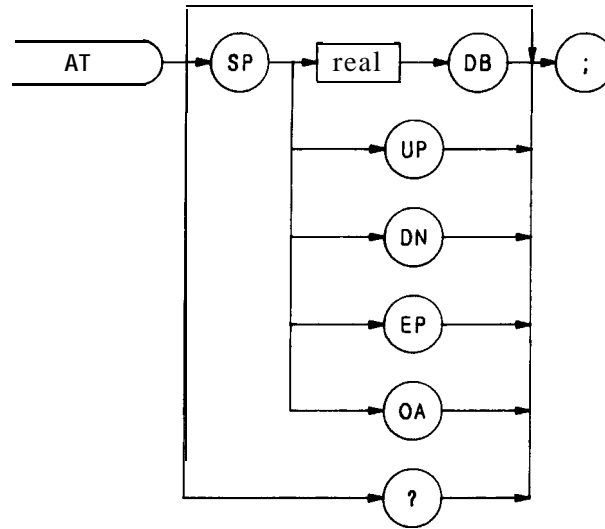

The AT command specifies the RF input attenuation from 0 to 70 dB, in 10 dB steps.

The input attenuator is coupled to the reference level. This coupling keeps the mixer input level at or below a threshold, when a continuous wave signal is displayed on the spectrum analyzer screen with its peak at the reference level. Instrument preset (IP) sets the threshold value to -10 dBm. (See KS, and ML.)

The AT command allows less than the threshold value at the mixer input. Executing CA (couple attenuator) resets the attenuation value so that a continuous wave signal displayed at the reference level yields -10 dBm (or the specified threshold value) at the mixer input.

When the attenuation is changed with the AT command, the reference level does not change. Likewise, when the reference level is changed with the RL command, the input attenuation changes to maintain a constant signal level on screen.

The following program lines illustrate proper syntax:

```
10 OUTPUT 718;"AT 60;"  
20 OUTPUT 718;"AT UP;"
```

Line 10: Sets attenuation to 60 dB.

Line 20: Sets attenuation to 70 dB.

When queried (OA or ?), AT returns the attenuation value as a real number, followed by a carriage-return/line-feed (ASCII codes 13, 10). The end-or-identify state (EOI) is asserted with line feed.

Refer to Chapter 8 in Section I.

AUNITS

Amplitude Units

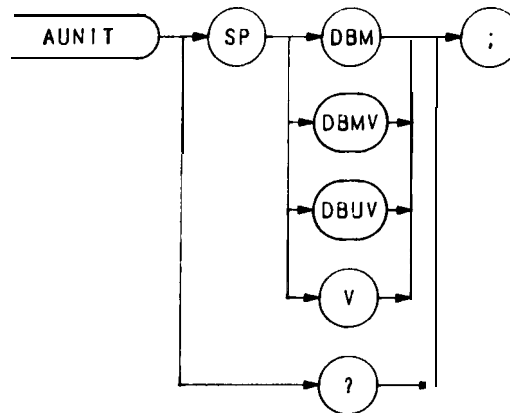

The **AUNITS** command sets the amplitude readouts (reference level, marker, display line, and threshold) to the specified units. (See KSA, KSB, KSC, and KSD.)

AVG

Average

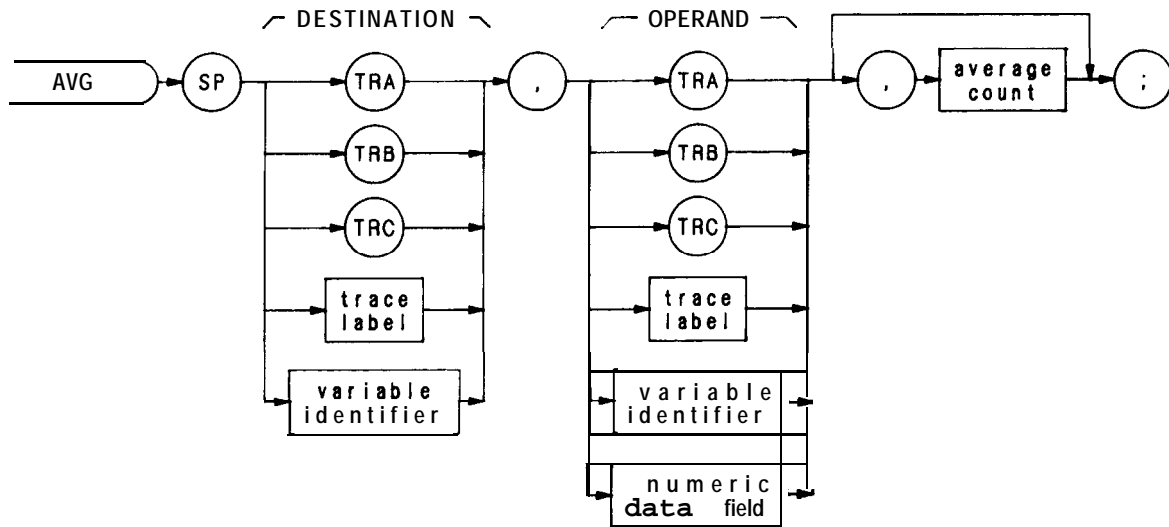

Item	Description/Default	Range Restriction
TRACE LABEL	Alpha character. User-defined label declared in TRDEF statement.	AA-ZZ and <u> </u> 2-12 characters required.
VARIABLE IDENTIFIER	Alpha character. User-defined identifier declared in VARDEF statement.	AA-ZZ and <u> </u> 2-12 characters required.
	Alpha character. Measurement- variable identifier, such as CF or MA.	
	Trace element, such as TRA	
NUMERIC DATA FIELD	Real	
AVERAGE COUNT	Selects counter value. Default is current counter value.	

The AVG command averages the operand and the destination according to the following algorithm.

$$\text{Average} = (\text{average count} - 1) \cdot (\text{destination/average count}) + (1 / (\text{average count})) \cdot \text{OPERAND}$$

The average counter may be set to 1 with the CLAVG command.

```
10 OUTPUT 718;"SNGLS;A1;TS;RL; -50;B1;TS;"
20 For I = 1 TO 100
30 OUTPUT 718;"AVG TRB,TRA,1E10"
40 NEXT I
50 END
```

AXB

Exchange A and B
(EX)

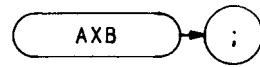

The AXB command exchanges trace A and B, point by point.

The functions of the AXB and EX commands are identical. (Refer to Chapter 5 in Section I.)

OUTPUT 718;"AXB;"

Only trace information in display addresses 1 through 1001 and 1025 through 2025 is exchanged.

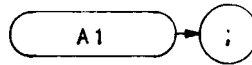

The A1 command enables the clear-write mode, which continuously displays any signals present at the spectrum analyzer input.

OUTPUT 718; "A1;"

The A1 command initially clears trace A, setting all trace A elements to a zero amplitude level. The sweep trigger then signals the start of the sweep, and trace A is continuously updated as the sweep progresses.



In addition, subsequent sweeps send new amplitude information to display memory addresses 1 through 1001. A1 also writes instruction word 1040* into address 0. Therefore, any information stored in memory address 0 is always lost whenever A1 is executed.

If you have used address 0 for a graphics program or label, you may wish to save the contents of address 0 before **executing** A1. For additional information, refer to Appendix A. The functions of the A1 command and front panel  key are identical. (See CLRW and B1.)

* 1040 is a machine instruction word that causes the analyzer to set address 1 through 1023 to zero, and draw trace A.

A2

Maximum Hold A

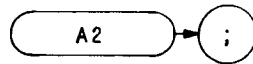

The A2 command updates each trace element with the maximum level detected, while the trace is active and displayed. The functions of the MXMH and A2 commands, and front panel  key are identical.

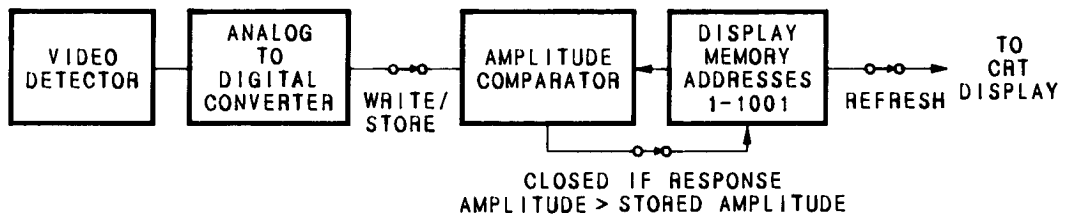

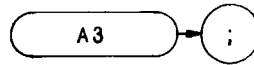

The A3 command displays trace A and stops the sweep. Thus, trace A is not updated.

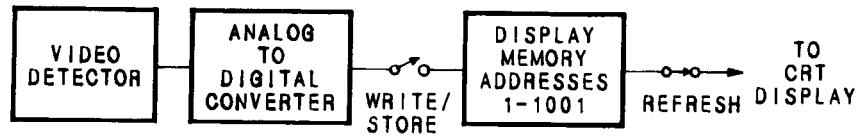

When A3 is executed, the contents of trace are stored in display memory addresses 1 through 1001. A3 writes instruction word 1040' into address 0. Therefore, any information stored in memory address 0 is always lost whenever A3 is executed.

If you have used address 0 for a graphics program or label, you may wish to save its contents before executing A3.

For additional information, refer to Appendix A. The functions of the A3 command and front panel ^dVIEW key are identical. (See B3, VIEW, and TRSTAT.)

OUTPUT; "A3;"

- 1040 is a machine instruction word that causes the analyzer to set addresses 1 through 1023 to zero, and draws trace A.

A4

Blank A

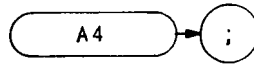

The A4 command blanks trace A and stops the sweep; the trace is not updated.

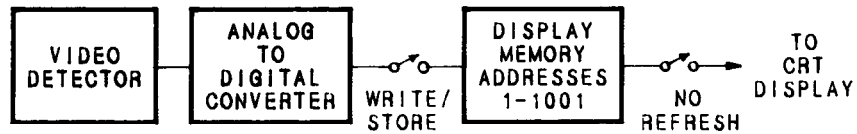

When A4 is executed, the contents of trace A are stored in display memory addresses 1 through 1001. A4 writes instruction word 1072' into address 0. Therefore, any information stored in address 0 is lost when A4 is executed.

If you have used address 0 for a graphics program or label, you may wish to save its contents before executing A4.

For additional information, refer to Appendix A. The functions of the A4 command and front panel  key are identical. (See BLANK, B4, and TRSTAT)

OUTPUT 718; "A4;"

* 1072 is a machine instruction word that sets addresses 1 through 1023 to zero, and then skips to the next page of memory.

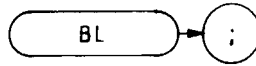

The BL command subtracts the display line from trace B and sends the difference to trace B.

B – display line → B

The functions of the BL and BML commands, and the front panel  key are identical. (Refer to Chapter 7 in Section I.)

The following program demonstrates the BL command.

```
10 OUTPUT 718;"IP;A4;S2;"
20 OUTPUT 718;"DL -8SDM;"
30 OUTPUT 718;"B1;TS;BL;"
40 END
```

BLANK

Blank

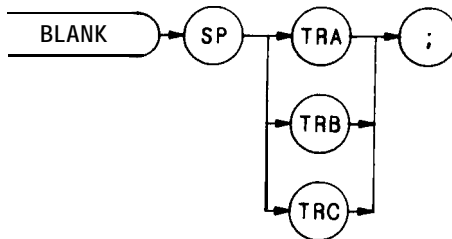

The BLANK command blanks trace A, B, or C and stops the sweep; the trace is not updated.

Trace A and C are discussed below. For detailed information about trace B, see B4 in this section.

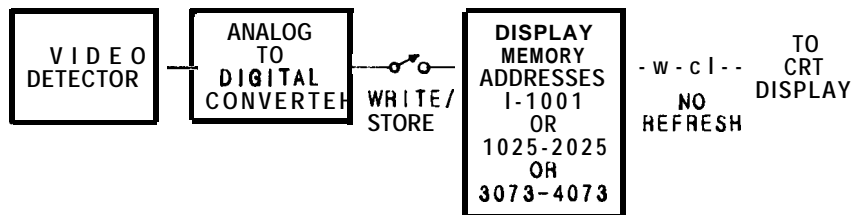

When BLANK TRA is executed, the contents of trace A are stored in display memory addresses 1 through 1023. Address 0 is reserved for the instruction word 1072'. Similarly, when BLANK TRB is executed, trace C contents are stored in addresses 3073 through 4095. Again, address 3072 is reserved for instruction word 1072'. Therefore, any information stored in address 0 is lost when BLANK TRA is executed. Likewise, the contents of address 3072 are lost when BLANK TRC is executed.

If you have used address 0 or 3072 for a graphics program or label, you may wish to save their contents before executing BLANK.

OUTPUT 718; "BLANK TRA;"

For additional information, refer to Appendix A. (See A4, B4, KSk, and TRSTAT.)

- 1072 is a machine instruction word that sets addresses 1 through 1023 (BLANK TRA) or 3073 through 4095 (BLANK TRC) to zero, and then skips to the next page memory.

B-display line → B

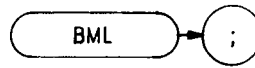

The BML command subtracts the display line from trace B, point by point, and sends the difference to trace B.

BML – display → B

The functions of the BML and BL commands, and the front panel  key are identical. (Refer to Chapter 5 in Section I.)

The following program demonstrates the BML command.

```
10 OUTPUT 718;"IP;A4;S2;"
20 OUTPUT 718;"DL -85DM;"
30 OUTPUT 718;"B1;TS;BML;"
40 E N D
```

BRD

Bus Read

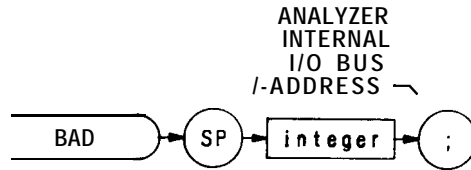

Item	Description/Default	Range	Restriction
INTEGER	ASCII decimal number representing analyzer internal I/O bus address.		

The BRD command reads a two-byte word at the internal input/output bus of the spectrum analyzer, at the indicated address. BRD is a service diagnostic function only.

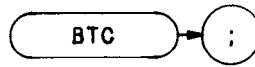

The BTC command transfers trace B to trace C.

Note that trace C is not a swept, active function. Therefore, transfer trace information to trace C as follows:

1. Select single sweep mode (S2).
2. Select desired analyzer settings.
3. Take one complete sweep (TS) .
4. Transfer data

This procedure ensures that the current settings of the analyzer are reflected in the transferred data.

```
10 OUTPUT 718;"IP;TS;SNGLS;A3;"
20 OUTPUT 718;"B1;CF 20MZ;TS;B4;"
30 OUTPUT 718;"BTC;KSj"
31 LOCAL 718
40 END
```

When transferring trace data from one trace to another, only the trace information from 1001 display memory addresses is transferred out of the total 1024 available display memory addresses. Information in address 1024 and addresses 2026 through 2047 is not transferred. (Addresses 2026 through 2047 are usually used for custom graphics.)

The functions of the BTC and KS1 commands are identical.

BWR

Bus Write Word

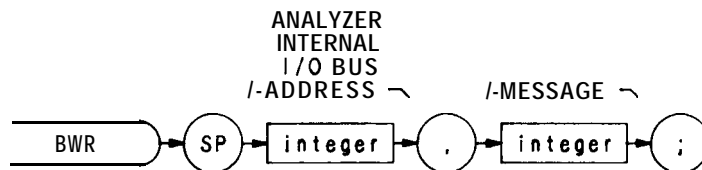

Item	Description/Default	Range Restriction
INTEGER	ASCII decimal number representing analyzer internal I/O bus address.	
INTEGER	ASCII decimal number representing two-byte word.	

The BWR command writes a two-byte word to the spectrum analyzer internal input/output bus, at the indicated address. BWR is a service diagnostic command.

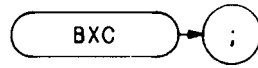

The BXC command exchanges traces C and B, point by point.

Note that trace C is not a swept, active function. Therefore, exchange traces C and B as follows:

1. Select single sweep mode (SNGLS) .
2. Select desired analyzer settings.
3. Take one complete sweep (TS) .
4. Exchange data.

This procedure ensures that the current settings of the analyzer are reflected in the transferred data.

When transferring data from one trace to another, only amplitude information is exchanged, located in display memory addresses 1025 through 2025 and 2049 through 3049.

The functions of the BXC and KSi commands are identical.

B1

Clear-Write B1

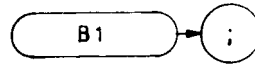

The **B1** command enables the clear-write mode, which continuously displays any signals present at the spectrum analyzer input.

OUTPUT 718; "B1;"

The **B1** command initially clears trace B, setting all trace B elements to a zero amplitude level. The sweep trigger then signals the start of the sweep, and trace B is continuously updated as the sweep progresses.

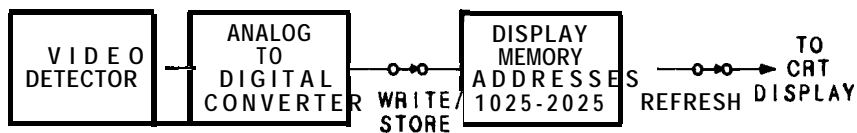

In addition, subsequent sweeps send new amplitude information to display memory addresses 1025 through 2025. **B1** writes the instruction word 1048' to address 1024. Therefore, any information stored in memory address 1024 is always lost when **B1** is executed.

If you have used address 1024 for a graphics program or label, you may wish to save its contents before executing **B1**.

For additional information, refer to Appendix A. The functions of the **B1** command and front panel ^g key are identical. (See CLRW and A1 .)

. 1048 is a machine instruction word that sets addresses 1025 through 2047 to zero, and draws trace B dimly.

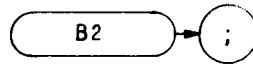

The B2 command updates each trace B element with the maximum level detected, while the trace is active and displayed.

OUTPUT 718; "B2;"

See MXMH.

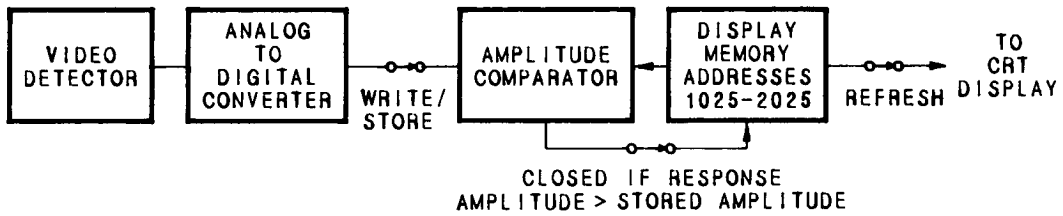

B3

View B

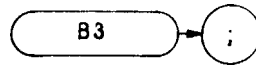

The B3 command displays trace B and stops the sweep. Thus, the trace is not updated.

OUTPUT 718; "B3;"

When B3 is executed, the contents of trace B are stored in display memory addresses 1025 through 2025. B3 writes the instruction word 1048* to address 1024. Therefore, any information stored in address 1024 is lost when B3 is executed.



If you have used address 1024 for a graphics program or label, you may wish to save its contents before executing B3.

For additional information, refer to Appendix A. The functions of the B3 command and front panel ^jVIEW key are identical. (See VIEW, A3, KS^j, and TRSTAT.)

* 1048 is a machine instruction word that sets addresses 1025 through 2047 to zero, and draws trace B dimly.

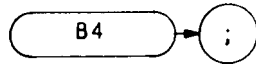

The B4 command blanks trace B and stops the sweep; the trace is not updated.



When **B4** is executed, the contents of trace B are stored in display memory addresses 1025 through 2025. B4 writes the instruction word 1072 *
B4 is executed.

used or label, you may wish to save its contents before executing B4.

For additional information, refer to Appendix A. The functions of the B4 command and front panel ^k **BLANK** key are identical. (See BLANK, A4, KSk, and TRSTAT.)

OUTPUT 718; "B4;"

. 1072 is a machine instruction word that sets addresses 1025 through 2047, and then skips to the next page of memory.

CA

Couple Attenuation

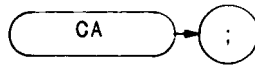

During normal operation, the spectrum analyzer is coupled to the reference level. This coupling keeps the mixer input level at or below a threshold, when a continuous wave signal is displayed on the spectrum analyzer screen so that its peak is at the reference level.

The CA command sets the threshold to -10 dBm (or a value specified by KS or ML). The counterpart to the CA command, the AT command, allows levels less than the threshold value at the mixer input.

OUTPUT 718; "CA;"

The functions of the CA command and the front panel  key are identical.

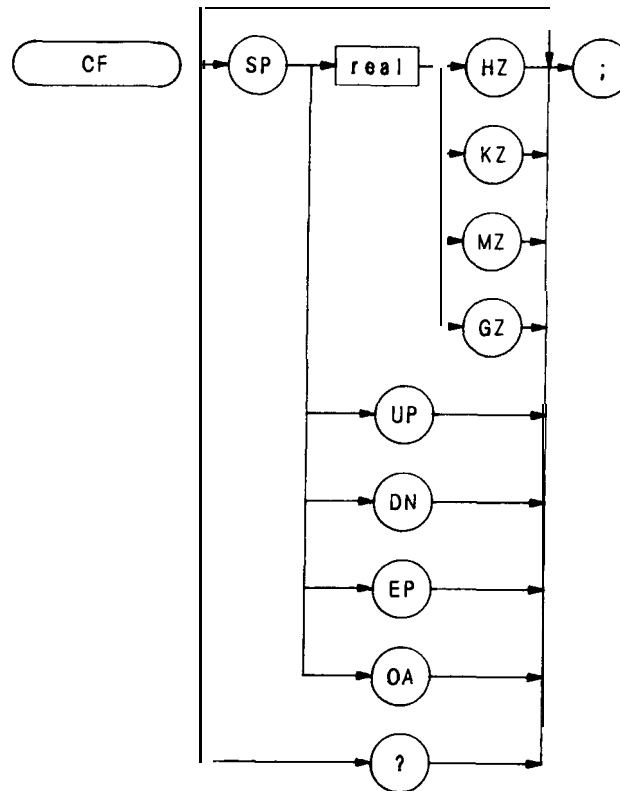

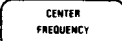
The **CF** command specifies the value of the center frequency, performing the same function as the front panel  key. (Refer to Chapter 3 in Section I.)

When queried (OA or ?), CF returns the center frequency value as a real number, followed by **carriage-return/line-feed** (ASCII codes 13, 10). The end-of-identity state (EOI) is asserted with line feed.

The following program returns a center frequency value of 350 MHz. The program displays the center frequency on the controller screen,

```

1  OUTPUT 718;"IP;LF;01;"
10 OUTPUT 718;"CF 200MZ;"
20 OUTPUT 718;"CF UP;"
30 OUTPUT 718;"CF?;"
40 ENTER 718;N
50 PRINT N
60 END

```

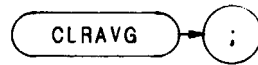

CLRAVG

Clear Average

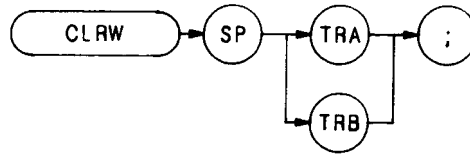

The CLRAVG command sets the average counter to 1. The average counter is active during execution of the AVG command.

OUTPUT 718; "CLRAVG;"



The CLR W command enables the clear-write mode, which continuously displays any signals present at the spectrum analyzer input.

The CLR W command operates on either trace A or trace B. Trace A is discussed below. For detailed information about the clear-write mode and trace B, see B1 in this section.

The CLR W command initially clears trace A, setting all trace A elements to a zero amplitude level. The sweep trigger then signals the start of the sweep, and trace A is continuously updated as the sweep progresses.

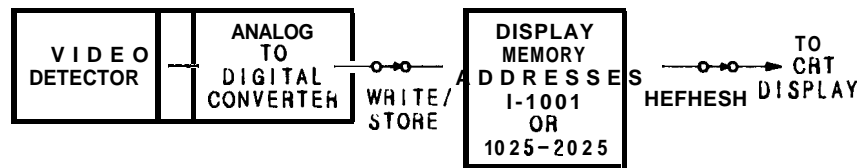

In addition, subsequent sweeps send new amplitude information to display memory addresses 1 through 1023. Address 0 is reserved for the instruction word, 1040'. Therefore, any information stored in memory address 0 is always lost when CLR W is executed.

If you have used address 0 for a graphics program or label, you may wish to save its contents before executing CLR W

OUTPUT 718: "CLR W TRA;"

For additional information, refer to Appendix A. The functions of the CLR W command and front panel  are identical. (See B1 and A1.)

instruction word that

CNVLOSS

Conversion Loss

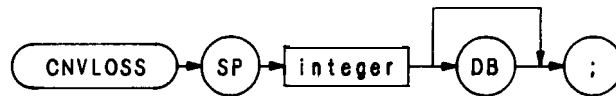

Item	Description/Default	Range Restriction
INTEGER	Selects reference level offset to compensate for conversion loss.	0 – 60

The CNVLOSS command offsets the reference level. The reference level is calibrated when the analyzer is in external mixing mode by compensating for the conversion loss of an external mixer with the CNVLOSS offset.

If a harmonic of the analyzer LO is not locked before the CNVLOSS command is executed, the message “NOT HARMONIC LOCKED” is displayed on the CRT and the CNVLOSS command is ignored.

The analyzer stores the value of the offset entered with the CNVLOSS command. One offset value is stored for each of the external mixing bands. The offset value remains as long as the band is locked. The offset value is erased whenever the band is unlocked. (See HNUNLK or KSQ.)

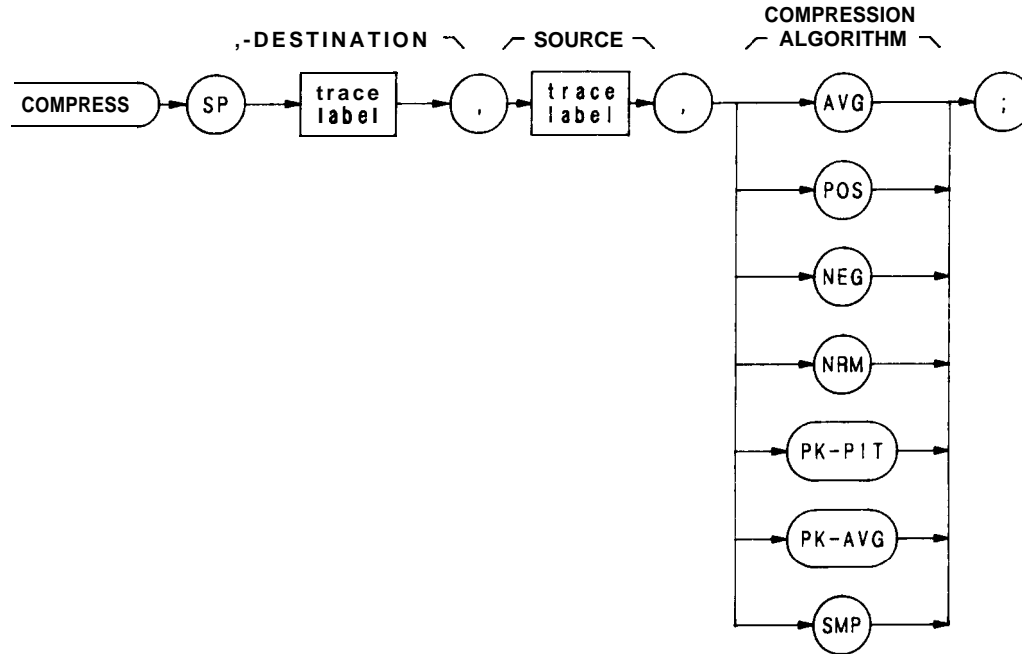

Item	Description/Default	Range Restriction
TRACE LABEL	Alpha character. User-defined label in TRDEF statement.	AA-ZZ and _ 2- 12 characters required.

The COMPRESS command compresses the source trace to fit the destination trace, according to the compression algorithm, and ratio of source and destination trace sizes.

The source trace must be longer than the destination trace. The ratio of source trace length to destination trace length, in display units, equals K.

$$\text{source trace length} / \text{destination trace length} = K$$

$$\text{number of points in interval} = K$$

COMPRESS divides the source trace into intervals, and computes a compressed value for each interval. The compressed values become the amplitude values for all of the points in the destination trace. For example, if the source trace is 1000 points long, and the destination trace is 100 points long, K equals 10. COMPRESS divides the source trace into 100 intervals of 10 points each, and computes a compressed value for each interval. The 10 points are operated on by the compression algorithm, and the compressed value for the first interval becomes the amplitude of the first point in the destination trace. The 99 remaining compressed values determine the amplitude of the last 99 points of the destination trace.

COMPRESS (Continued)

The compression algorithms determine how the compressed values are computed.

Specifying AVG (average) computes the average value of the points in the interval as the compressed value.

Specifying POS (positive) selects the highest point in the interval as the compressed value.

Specifying NEG (negative) selects the lowest point in the interval as the compressed value.

Specifying NRM (normal) computes the compressed value of the interval using the Rosenfell algorithm, which chooses between negative and positive peak values.

Specifying PK-PIT (peak-pit) computes the greatest peak-to-peak deviation within the interval as the compressed value.

Specifying PK-AVG (peak average) selects the difference of the peak and average value of the interval as the compressed value.

Specifying SMP (sample) selects the last point in the interval as the compressed value.

The program below compresses a full sweep to one-fifth its size. The result is moved to trace A for display.

```
14 OUTPUT 71a;"DISPOSE ALL;IP;A1;EM;S2;TS;"
21 OUTPUT 718;"TRDEF NEW__A,200;"
22 OUTPUT 71a;"FUNCDEF C__P, ! "
24 OUTPUT 718;"S2;TS;"
26 OUTPUT 718;"COMPRESS NEW__A,TRA,AVG;"
27 OUTPUT 718;"MOV TRA,NEW__A;"
28 OUTPUT 718;"!"
31 OUTPUT 718;"C__P;"
35 END
```

CONCAT

Concatenate

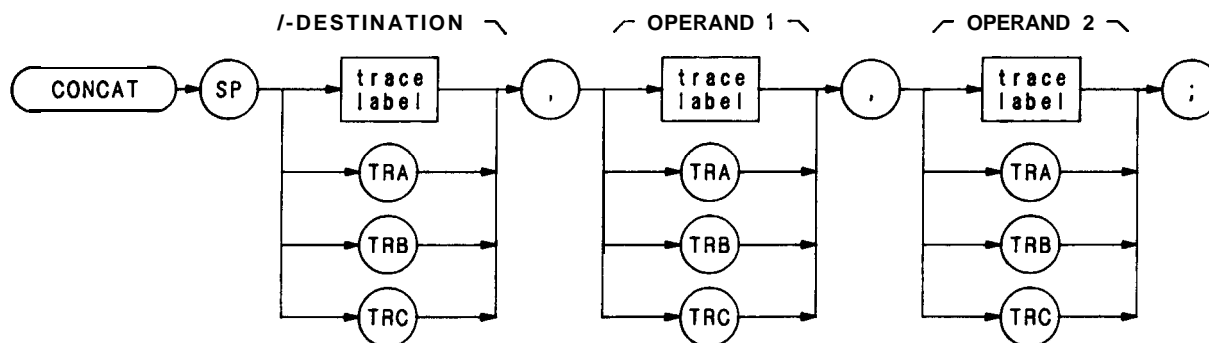

Item	Description/Default	Range Restriction
TRACE LABEL	Alpha character. User-defined label declared in TRDEF statement.	AA-ZZ and __ 2- 12 characters required.

The **CONCAT** command concatenates the operands and sends the new trace array to the destination.

The size of the destination varies from 1 to 1008 elements. Traces A, B, and C each contain 1001 elements. If necessary, use the **COMPRESS** command to reduce the length of the operands. Otherwise, the concatenated arrays may not fit in the destination, and trace information is lost.

```
10 OUTPUT 718;"IP;S2;B1;TS;B3;RL -3ODM;TS;A3;"
20 |
30 OUTPUT 718;"TRDEF XXX,500;"
40 OUTPUT 718;"COMPRESS XXX,TRA,AVG;"
50 |
60 OUTPUT 718;"EX;"
70 OUTPUT 718;"TRDEF 222,500;"
80 OUTPUT 718;"COMPRESS ZZZ,TRA,AVG;"
90 |
100 OUTPUT 718;"B3;"
110 OUTPUT 718;"CONCAT TRB,XXX,ZZZ;"
120 |
130 END
```

CONTS

Continuous Sweep
(S1)



The CONTS command sets the analyzer to continuous sweep mode. In the continuous sweep mode, the analyzer continues to sweep (sweep times ≥ 20 ms) at a uniform rate from the start frequency to the stop frequency, unless new data entries are made from the front panel or via HP-IB. If the trigger and data entry conditions are met, the sweep is continuous.

The sweep light indicates that a sweep is in progress. The light is out between sweeps, during data entry, and for sweep times ≤ 10 ms.

OUTPUT 718: "CONTS;"

The functions of the CONTS and S1 commands, and front panel  key are identical.



The CR command couples the resolution bandwidth with the video bandwidth and sweep time. The counterpart to the CR command, the RB command, breaks coupling. Use CR to reestablish coupling after RB has been executed.

OUTPUT 718; "CR;"

The functions of the CR command and the front panel key ^A are identical

CS

Couple Step Size



The CS command couples the center frequency step size to the span width, so that step size equals 10 percent of the span width, or one major **graticule** division. The counterpart to the CS command, the SS command, breaks coupling. Use CS to reestablish coupling after SS has been executed.

OUTPUT 718; "CS;"

The functions of the CS command and the front panel  key are identical.

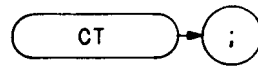

The CT command couples the sweep time with the resolution and video bandwidths. The counterpart to the CT command, the ST command, breaks coupling. Use CT to reestablish coupling after ST has been executed.

OUTPUT 718; "CT;"

The functions of the CT command and the front panel  key are identical.

CTA

Convert to Absolute Units

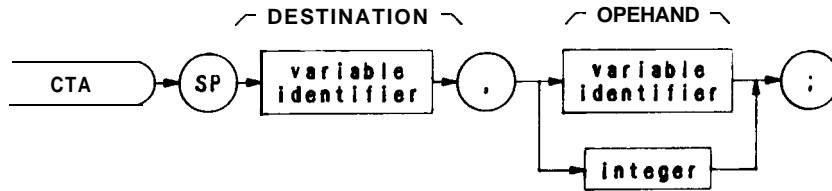

Item	Description/Default	Range Restriction
VARIABLE IDENTIFIER	Alpha character. User-defined identifier declared in VARDEF statement.	AA-ZZ and <u> </u> 2- 12 characters required.
NUMERIC DATA FIELD	Alpha character. Measurement- variable identifier representing amplitude value, such as MKA.	
	Real	

The CTA command converts the operand values from display units to the current absolute amplitude units.

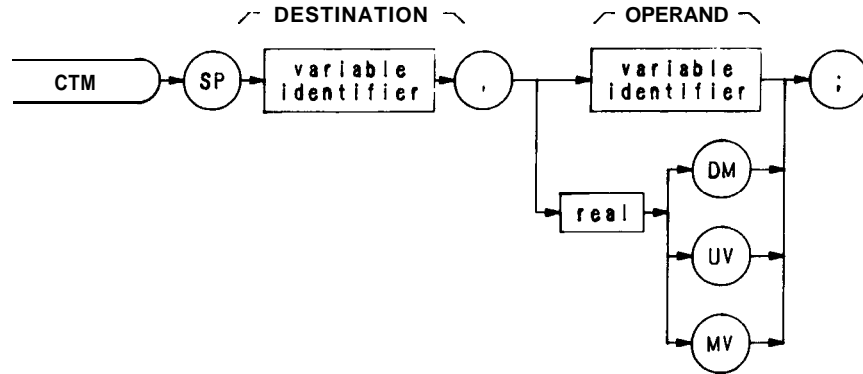

Item	Description/Default	Range Restriction
VARIABLE IDENTIFIER	Alpha character. User-defined identifier declared in VARDEF statement.	AA-ZZ and <u> </u> 2- 12 characters required.
NUMERIC DATA FIELD	Alpha character. Measurement-variable identifier representing amplitude value, such as MKA.	
	Real	

The CTM command converts the operand values to vertical display units.

```
OUTPUT 718; "VARDEF XXX,1; CTM XXX,12; DSPL XXX,13.5;"
```

CV

Couple Video Bandwidth

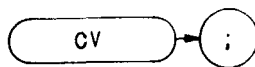

The CV command couples the video bandwidth with the resolution bandwidth and sweep time. The counterpart to the CV command, the VB command, breaks coupling. Use CV to reestablish coupling after VB has been executed.

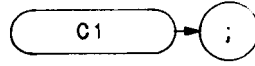

OUTPUT 718; "CV;"

The functions of the CV command and the front panel  key are identical.



The C1 command turns off the A-minus-B mode.

OUTPUT 718;"C1;"

The functions of the C1 command and the front panel  key, located above the  key, are identical. (Refer to Chapter 5 in Section I. Also see AMB and C2.)

c 2

A-B→A
(AMB)

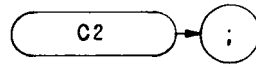

The C2 command subtracts trace B from trace A, point by point, and sends the difference to trace A.

$$A - B \rightarrow A$$

OUTPUT 718; "C2;"

The A-minus-B mode is turned off with the C1 command. The function of C2 is identical with that of the command AMB, and the front panel  key. (Refer to Chapter 5 in Section I.)

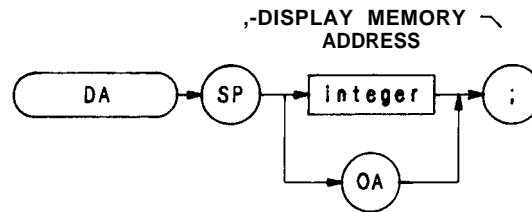

Item	Description/Default	Range Restriction
INTEGER	Represents analyzer display memory address.	0 – 4095

The DA command selects a specified display memory address to be the initial current (in-use) register. The display address register can then be accessed and advanced one address at a time with the DW, DD, and DR commands. Refer to Appendix B for additional information on the DA command.

A typical use of the DA command is shown in the sample program below.

```

10 OUTPUT 718;"01;DA;1024;"
20 FOR I= 1 TO 5
30 OUTPUT 718;"DA;OA;"
40 ENTER 718;A
50 OUTPUT 718;"DR;"
60 ENTER 718;W
70 OUTPUT 718;A,W
80 NEXT I
90 END
  
```

- Line 10: Addresses the analyzer, formats the output in decimal display units, and selects the first address to be read.
- Line 20-80: Reads and prints five successive display program addresses and their contents. The address is automatically advanced one address for each DR execution.
- Line 30: Activates the output of each display address.
- Line 50: Activates the output of each current display address.

Each display address contains twelve bits of information.

DD

Display Write Binary

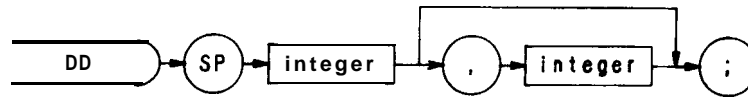

Item	Description/Default	Range Restriction
INTEGER	Represents 16-bit binary byte that is transmitted as two 8-bit bytes.	0 – 4095

The DD command writes two 8-bit bytes into the current or specified (with DA command) display memory address, and advances the address selection to the next higher address. If the DD command is followed by more than one pair of bytes, DD loads the pairs into consecutive display addresses. The display address is always advanced after a number is loaded into an address. (Each display address contains twelve bits.)

The bytes represent data or a display instruction.

Use the DD command in conjunction with the DR and DA commands to draw on the spectrum analyzer CRT. The functions of the DD and DW commands are identical, except that the controller must send instructions or data in binary form instead of decimal form. This difference is illustrated in the program below. The program tells the analyzer, in four different ways, to dim trace A. The number 1048 is an instruction word that means “dim trace.”

```
10 OUTPUT 718;“A1;S2;TS;”
20 OUTPUT 718;“DA 0; DW 1048;”
30 PAUSE
40 OUTPUT 718;“A1;S2;TS;”
50 OUTPUT 718 USING “#,K,W”;“DA 0;DD”;1048
60 PAUSE
70 OUTPUT 718;“A1;S2;TS;”
80 OUTPUT 718 USING “#,K,B,B”;“DA 1;DD”,4,24
90 PAUSE
100 OUTPUT 718;“A1;S2;TS;”
110 A$ = CHR$(4)&CHR$(24)
120 OUTPUT 718 USING “#,K”;“DA 0 DD”,A$
130 END
```

- Lines 10, 40, 70, 100: Sweeps trace and displays trace A once.
- Line 20: Transmits instruction word 1048, in decimal form, to display address 0.
- Line 50: Suppresses carriage-return/line-feed (#), transmits instruction word 1048 as one word (W for word, or 16 bits).
- Line 80: Suppresses carriage-return/line-feed (#), transmits instruction word 1048 as two 8-bit bytes (B,B for byte,byte).
- Line 110: Declares A4 equal to CHR\$(4) plus CHR\$(24).
- Line 120: Transmits instruction word 1048, as A\$.

Refer to Appendix B for additional information about instruction words and display programming. The Consolidated Coding table in Appendix B is especially useful.

DET

Input Detector

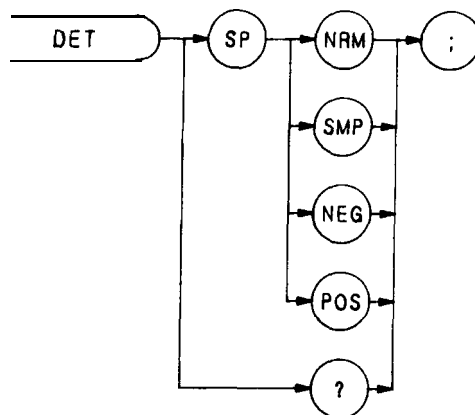

The DET command selects the kind of spectrum analyzer input detection: normal, sample, positive peak, or negative peak.

Normal (NRM) enables the Rosenfell detection algorithm that selectively chooses between positive and negative peak values. The IP command (instrument preset) also activates normal detection.

Sample (SMP) displays the instantaneous signal value detected at the analog-to-digital converter output. Video averaging and a noise-level marker, when active, also activate sample detection. (See MKNOISE, VAVG, or KSe.)

Positive peak detection (POS) displays the maximum signal value detected during the conversion period.

Negative peak detection (NEG) displays the minimum signal value detected during the conversion period. The program line below selects the negative peak detection.

```
OUTPUT 718; "DET NEG;"
```

When queried (?), DET returns the detection type to the controller (NRM, SMP, NEG, or POS) followed by carriage-return/line-feed (ASCII codes 13, 10). The line feed asserts the end-of-identify state (EOI).

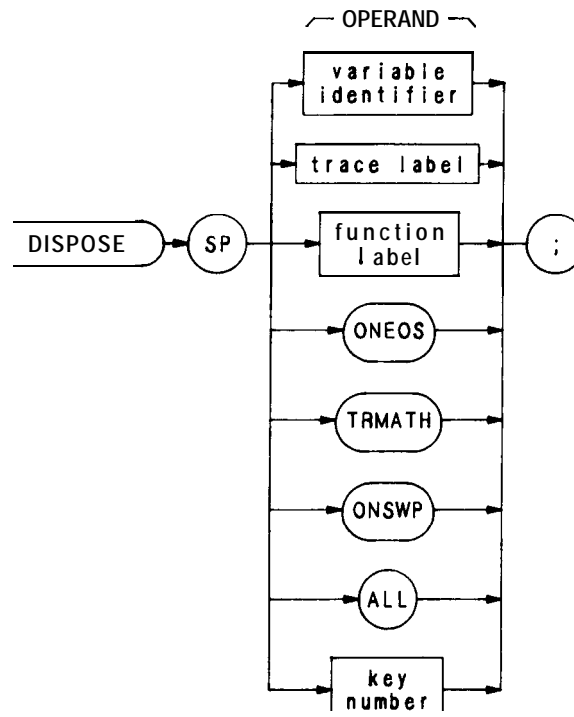

Item	Description/Default	Range Restriction
TRACE LABEL	Alpha character. User-defined label declared in TRDEF statement.	AA-ZZ and __ 2-12 characters required.
VARIABLE IDENTIFIER	Alpha character. User-defined VARDEF statement. Alpha character. Measurement-variable identifier, such as Trace element, such as TRA [10]	AA-22 and __ 2-12 characters required.
FUNCTION IDENTIFIER	Alpha character. User-defined label declared in FUNCDEF statement.	AA-ZZ and __ 2-
KEY NUMBER	Integer representing number of KEYDEF statement.	0-999

The DISPOSE command clears any operand listed above. DISPOSE ALL clears all operands. The program line below disposes all command lists declared with a TRMATH command.

OUTPUT 7 18; "DISPOSE TRMATH; "

DISPOSE (Continued)

If the analyzer remains locked up- that is, it does not respond to remote commands but does respond to front panel commands – and interface clear (shift reset) does not free up the analyzer, then execute the following lines:

```
Send 7; LISTEN CMD 12  
Clear 718
```

This forces DISPOSE ALL.

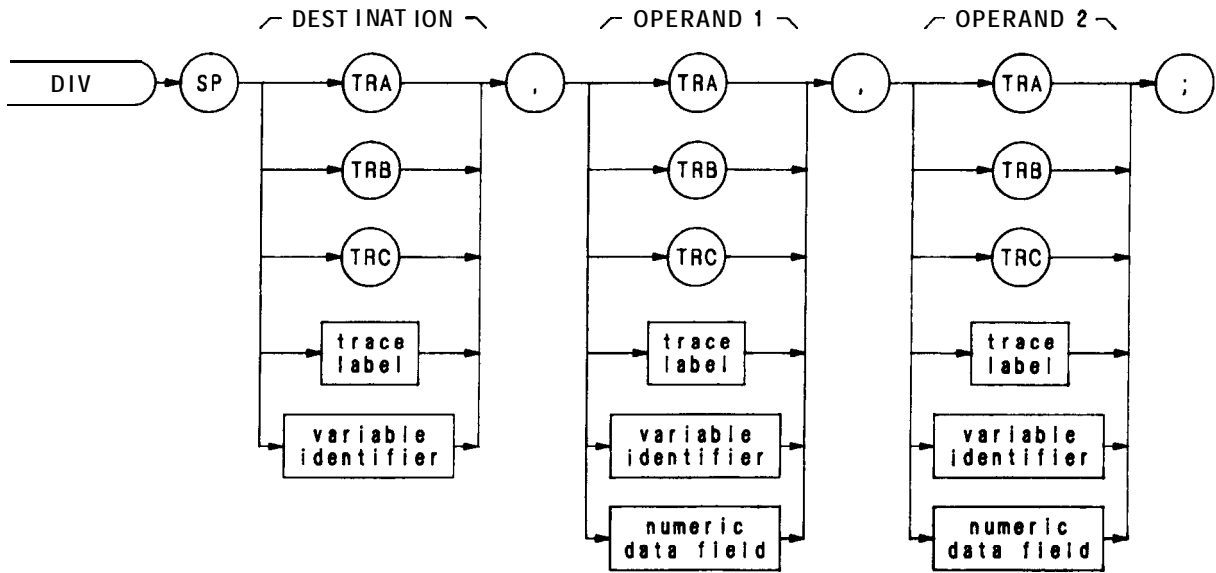

Item	Description/Default	Range Restriction
TRACE LABEL	Alpha character. User-defined label declared in TRDEF statement.	AA-ZZ and <u> </u> 2-12 characters required.
VARIABLE IDENTIFIER	Alpha character. User-defined identifier declared in VARDEF statement.	AA-ZZ and <u> </u> 2- 12 characters required.
	Alpha character. Measurement- variable identifier, such as CF or MA.	
	Trace element, such as TRA [10]	
NUMERIC DATA FIELD	Real	

The DIV command divides operand 1 by operand 2, point by point, and sends the difference to the destination.

$$\text{operand 1} / \text{operand 2} \rightarrow \text{destination}$$

The operands and destination may be of different length. The trace operands (**TRA**, **TRB**, **TRC**, and trace label) range from 1 to 1008 elements in length. A variable identifier or numeric data field is 1 element long. When operands are of different lengths, the last element of the shorter operand is repeated for operations with the remaining elements of the longer element. When the operands are longer than the destination, they are truncated to fit.

DIV (Continued)

The operands and results of trace math are truncated if they are not within certain limits. If operating on traces A, B, or C, results must be within 1023. If operating on user-defined traces, results must be within 32,767.

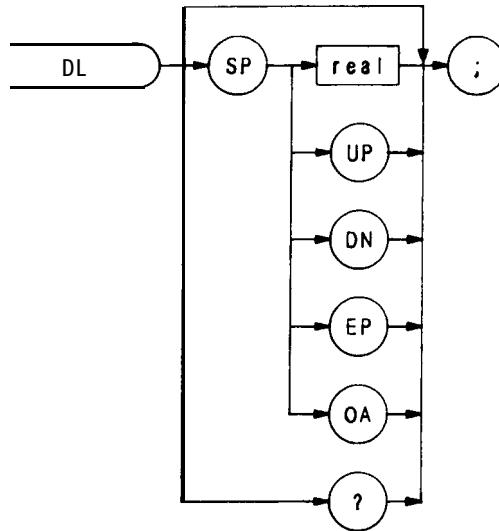

Item	Description/Default	Range Restriction
VARIABLE	Alpha character. User-defined identifier declared in VARDEF statement.	AA-ZZ and <u> </u> 2-12 characters required.
	Alpha character. Measurement-variable identifier, such as CF or MA.	
	Trace element, such as TRA [10]	

The DL command defines a display line level and displays it on the CRT. The level is in **dBm** and can be used in arithmetic functions, such as DIV or MXM.

The functions of the DL command and the front panel reference level  key are identical. The display line also can be turned on or off by the DLE and LØ commands.

The following program lines compare a display line level of -10 **dBm** to the largest signal detected. If the display line level is greater than the signal level, the display line is lowered.

```

10 OUTPUT 718;"IP;DL -10DM;TS;MKPK;MA OA;"
20 ENTER 718;N
30 OUTPUT 718;"IF DL,GT,N THEN DL DN ENDIF;"
40 OUTPUT 718;50
50 END

```

DL (Continued)

When queried (? or OA), DL returns the display line level as a real number, followed by carriage-return/line-feed (ASCII codes 13, 10). The end-of-identify state (EOI) is asserted with line feed. (See DLE.)

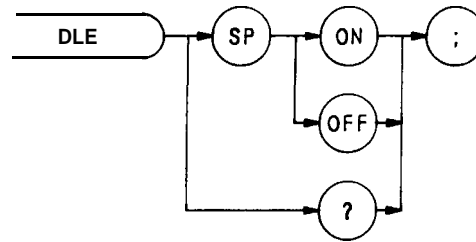

The DLE command enables or disables the display line.

The function of this command is similar to that of the DL and LØ commands, and the display line ^m OFF and ⁿ ENTER keys on the front panel.

When queried (?), DLE returns the display line state, ON or OFF followed by carriage-return/line-feed (ASCII codes 13, 10). The line feed asserts the end-or-identify state (EOI) .

```

10 OUTPUT 718;"IP;DLE ?;"
20 ENTER 718;A$
30 PRINT 718;A$
  
```

Since IP deactivates the display line, the query in the above program returns "OFF" to the controller.

DONE

Done

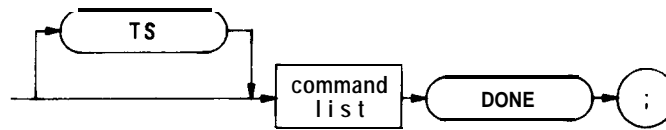

Item	Description/Default	Range Restriction
COMMAND LIST	Any spectrum analyzer commands from this Remote section	

The DONE command is a synchronizing function. When DONE follows a command list, it sends the controller a 1 after the command list is executed. The TS command may also be a synchronizing function. If TS precedes the command list, list execution begins after the sweep is completed.



The DR command sends the contents of the current display address to the controller. Thus, the controller “reads” the contents of the display memory address. Use the DA command to specify the display memory address when executing DR for the **first** time. After DR is executed, the display address is automatically advanced to the next higher address. Thus, the DA command is only needed to specify the first address, because subsequent DR commands read consecutive addresses.

```
10 OUTPUT 718;“DA 501 DR”  
20 ENTER 718;A  
30 OUTPUT 718;“DA 1525 DR;”  
40 ENTER 718; B  
50 OUTPUT 718; “DR”  
60 ENTER 718; C
```

Line 10:

Line 30: Reads contents of address 1525.

Reads contents of address 1526.

Lines 20, 40, and 60: Assigns address contents to variables A, B, and C.

DSPLY

Display

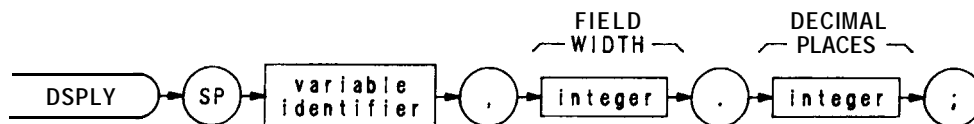

Item	Description/Default	Range Restriction
INTEGER	Specifies number of digits decimal point.	
INTEGER	Specifies number of digits to	0 to 9
VARIABLE IDENTIFIER	Alpha character. User-defined statement. Measurement- variable identifier, such as CF or MA. Trace element, such as TRA [10]	AA-22 and ___ 2-12 characters required.

The DSPLY command displays the value of a variable anywhere on the spectrum analyzer display.

Field width specifies the number of digits displayed, including sign and decimal point. Places to the right of the decimal point are limited by decimal places. For example, the number 123.45 has a field of 7, and 2 decimal places.

Use the DA, PU, PD, and PA commands to position the variable on the screen.



Item	Description/Default	Range Restriction
TERMINATOR	Marks end of text.	ASCII codes 0 – 255

In the sample program below, the @ symbol is defined as a terminator by the DT command immediately preceding it. In line 30, @ separates the command string “RL -50DM” from the title string “CAL OUT 2ND HARMONIC.” Without the @ symbol, “RL -50DM” would be written on the analyzer’s CRT as part of the title instead of

```

10 OUTPTJT 718;“DT@”
20 OTJTPUT 718; “CF 200MZ”
30 OUTPUT 718;“KSE CAL OUT 2ND HARMONIC@RL -50DM”
40 END
  
```

DW

Display Write

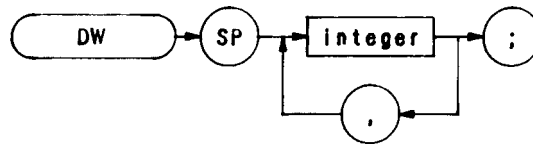

Item	Description/Default	Range Restriction
INTEGER	Integers representing display memory values or instruction words.	0 – 4095

The DW command sends a decimal number from the controller to the current or specified (with the DA command) display memory address, and advances the address selection to the next higher address. If the DW command is followed by more than one number, they are all loaded into consecutive display addresses. The display address is always advanced by one after a number is loaded into an address. (Each display address contains 12 bits. See DA.)

The decimal number represents data, or is an ASCII representation of a display instruction.

Use the DW command in conjunction with the DR and DA commands to draw on the spectrum analyzer CRT when the 03 or 01 output format is active. Refer to Appendix B for additional information about display memory instructions and display programming. The Consolidated Coding table and Data Word Summary in Appendix B are especially useful.

The program line below contains an instruction word, 1026, followed by data, 500 and 600. The DW command writes the numbers 1026, 500, and 600 into display addresses 1024, 1025, and 1026, respectively. The DA command specifies 1024 as the first address.

```
OUTPUT 718;"DA 1024; DW 1026,500,600;"
```

The instruction word (1026) causes the analyzer to draw a vector from the current position to the X-Y coordinates 500,600. (See Chapter 4 in Section I for a description of display unit coordinates.)

- D 1 Display Size Normal
- D 2 Display Size Full CRT
- D 3 Display Size Expand

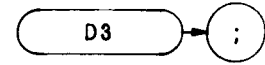
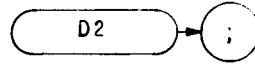
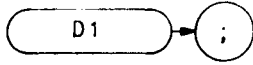

Display size commands D1, D2, and D3 set the display size for CRT graphics. BEX is a fourth display size that can only be accessed by a display control instruction: graph, label, or vector mode. 256 (big expand) must be added to the control word, i.e., graph (1024 + 256). Once a code is selected, it remains in effect until changed.

Positions on the CRT display are referenced in display units as *x*, some horizontal position, and *y*, some vertical position. The coordinates (*x*,*y*) represent distance from the lower left-hand corner of the graticule (0,0), which is also the origin. The upper right-hand corner is the (1000, 1000) point.

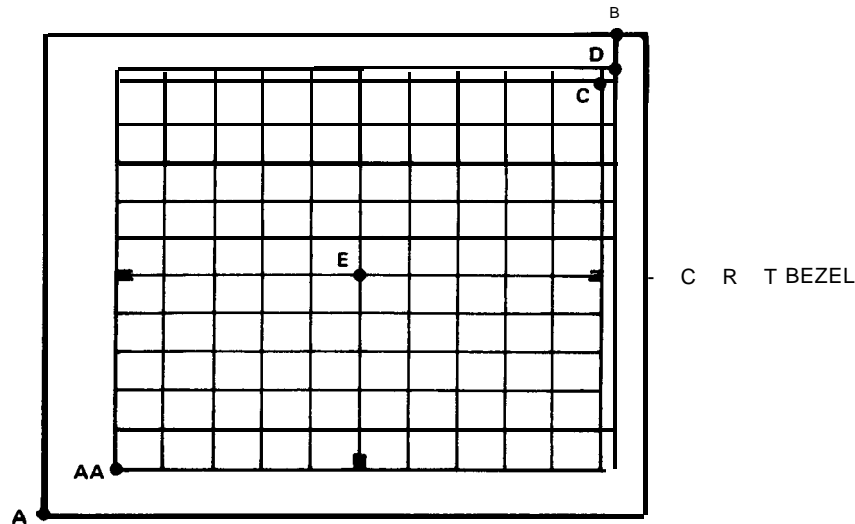

SIZE	(0,0)	AA	B	C	D	E
D1	AA	(0,0)	·	(1000,1000)	(1023,1023)	(500,500)
D2	A	(120,73)	(1023,1023)	(1005,957)	(785,978)	(562,515)
D3	A	(81,49)	(689,689)	(676,645)	(690,658)	(379,347)
Display size 4 cannot be accessed by the command code D4						
bex	AA	(0,0)	*	(671,671)	(686,686)	(336,336)

*No writing outside boundary marked by AA, D

D1, D2, D3 (Continued)

Display size 4 can only be accessed by a display control instruction such as graph, label, or vector mode. Big expand (256) must be added to the word selected (i.e., label is 1025 + 256).

A display program word can be a value from 0 to 4095. The value is stored as a 12-bit binary word. The bits define the type of word. Graphic representations used are defined as follows:

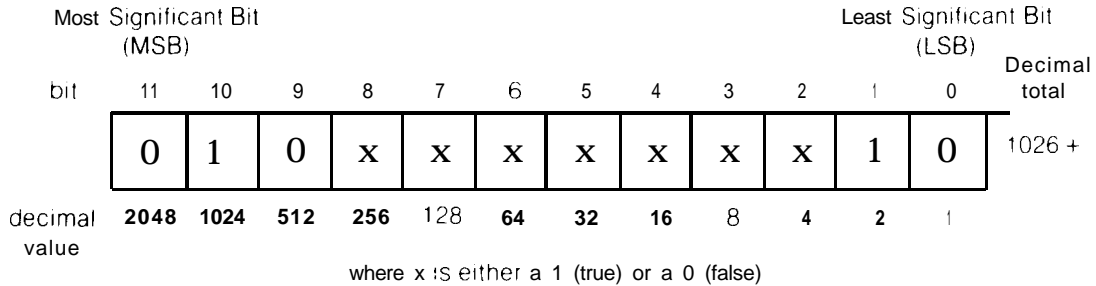

Changing the display size and beam intensity are controlled by setting various bits along with the control instructions and data words. These functions are called auxiliary functions to the instruction.

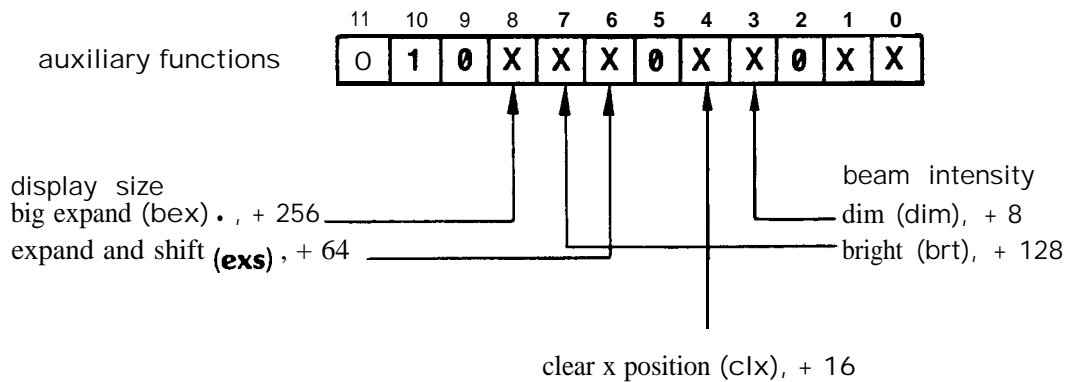

- clear x position (clx) : Resets the axis display position to the far left (0, y).
- big expand (bex) : Amplifies the x and y CRT beam deflection by a 1.49 factor.
- expand and shift (exs) : Amplifies the x and y CRT beam deflection by a 1.13 factor (expand) and shifts the (0,0) reference point to the lower left of the CRT screen.
- dim (dim): Sets the CRT beam intensity below the normal level.
- bright (brt) : Sets the CRT beam intensity to the maximum level.

* Abbreviations within the parentheses are useful as a shorthand notation for writing display programs. They are not programming codes.

The display size commands combine the size instructions as follows:

Display Size	Consolidated Coding Instructions	Ratio to D1	Origin Shifted
D1	none	1.00	no
D2	exs	1.13	yes
D3	bex and exs	1.68	yes
big expand	bex	1.49	no

The display size determines the position and number of rows and columns for characters on the CRT display. This can be an important consideration when labeling graph lines or points.

D1 Display Size

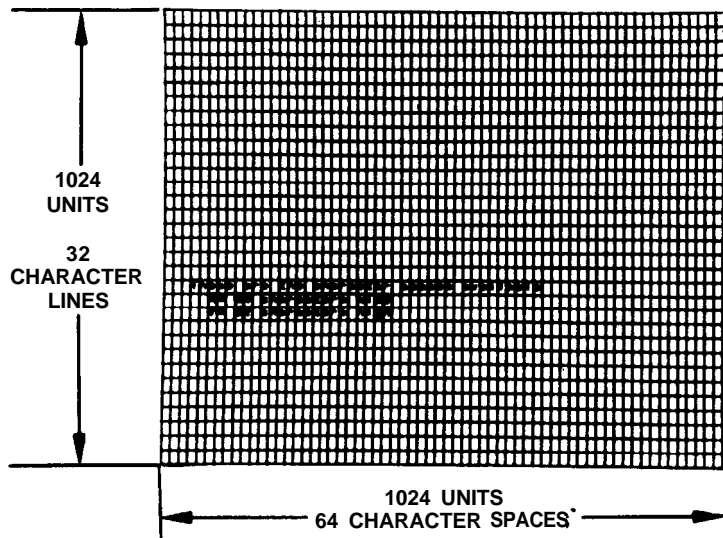

D2 Display Size

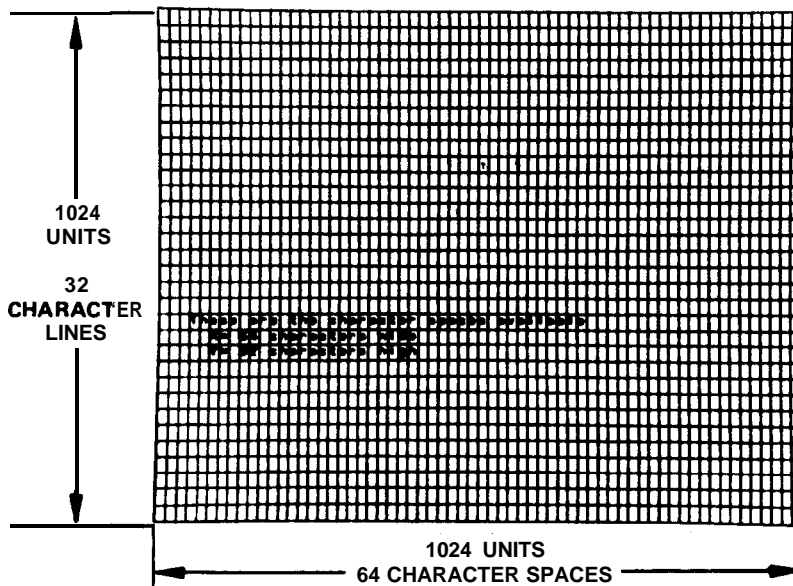

D1, D2, D3 (Continued)

Display memory is set up to contain 64 character spaces per line with respect to display size 1. When using the third and fourth display sizes, a label can only be a maximum of 44 characters. The remaining 20 characters of the label will be stored in display memory, but will not show up on the CRT display due to the expansion of D3 and bex. At character space 65, an automatic carriage-return and line-feed will occur, at which point labeling will continue to be written on the CRT display.

The automatic carriage-return and line-feed occur only when character space 65 is reached. Thus, in the third and fourth display sizes, the characters from the 44th character space through the 64th character space will not appear on the CRT display. Therefore, labeling with display size 3 and bex needs appropriate placement of characters because of the limited number of character spaces for these display sizes.

D3 Display Size

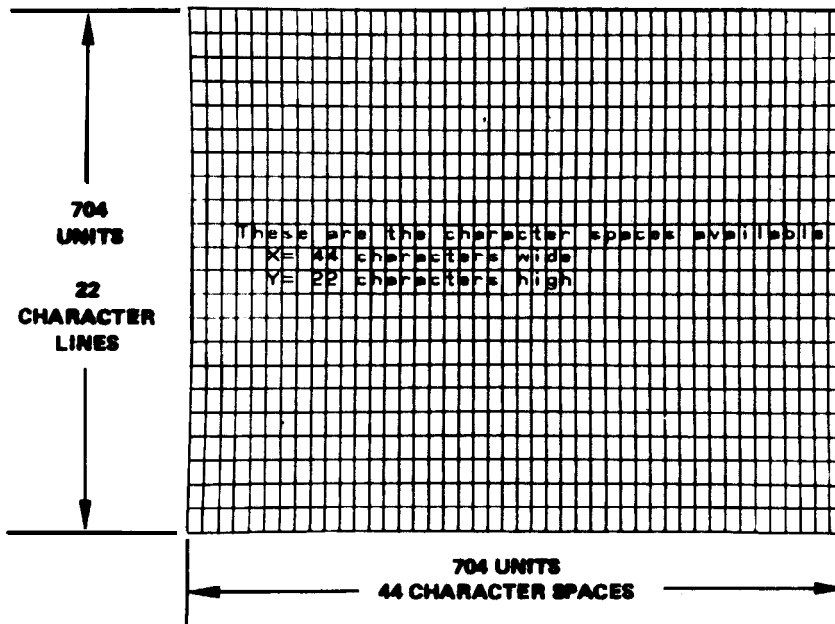

Big Expand (bex)

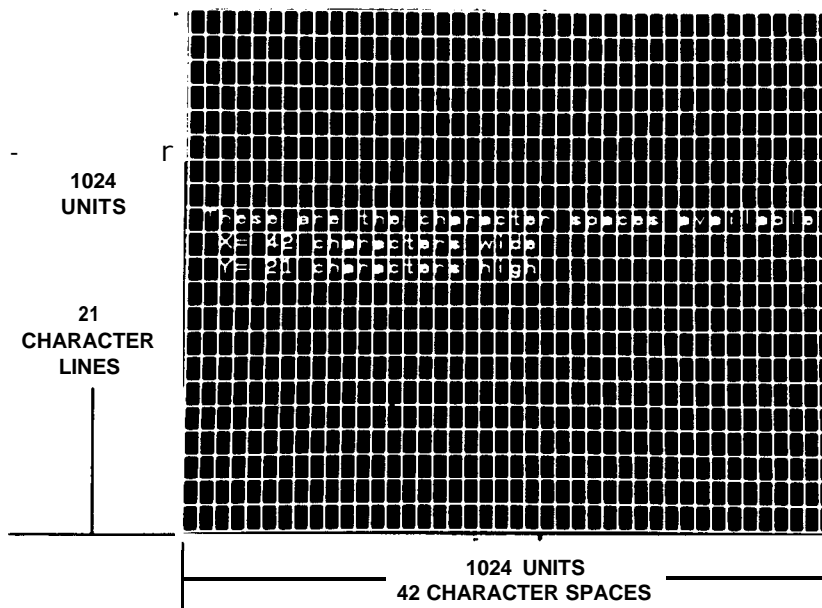

OUTPUT 718; "D2;"

The above program line selects display size 2 for the CRT display of the analyzer.

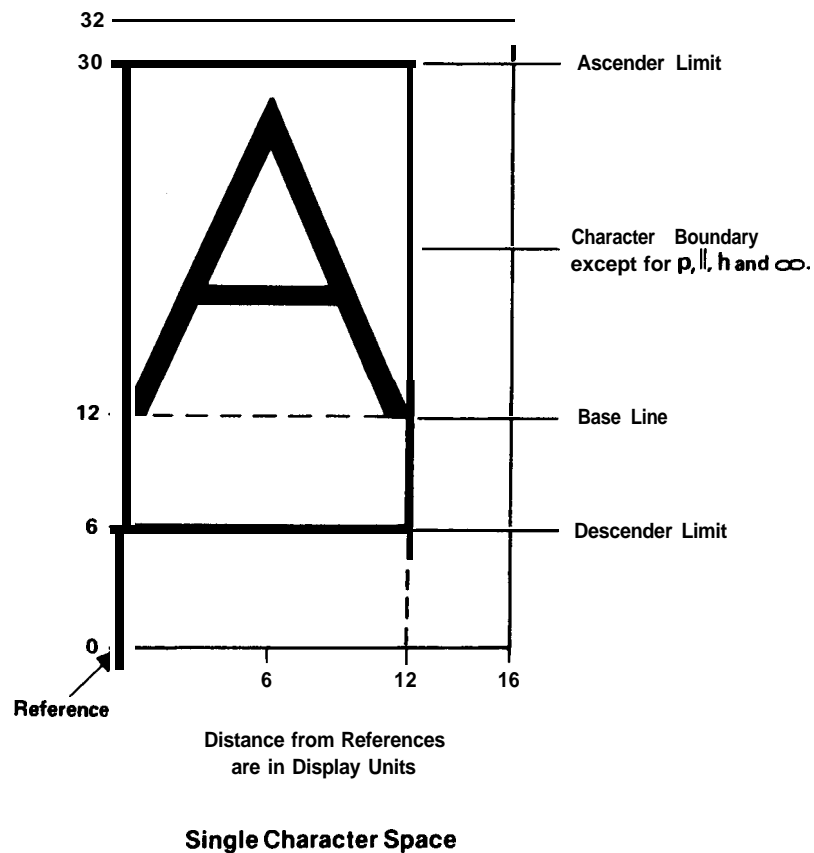

A single character space (see above) has an absolute outside limit of 16 (x) by 32 (y) units in any display size. A character position is referenced from the lower left corner of each character space. The actual “character boundary” is designated by the ascender and descender limits.

From the center of the character space, x may be changed as many as ± 7 units and y by as many as ± 15 units before the text begins at the next x and y character. If a plot absolute statement calls a position anywhere in the character space, the character will be placed within the “character boundary.” If two characters are labeled into the same character space, they will be superimposed over one another.

Example :

To begin labeling text 6 characters up from the bottom and 24 characters from the left (in any display size), the plot absolute vector values are calculated for the center of the character location as follows:

$$\begin{aligned} x &= (\text{character spaces}) (16) - 8 \\ &= (24) (16) - 8 = 376 \end{aligned}$$

$$\begin{aligned} y &= (\text{character spaces}) (32) - 16 \\ &= (6) (32) - 16 = 176 \\ &\text{"PA 376,176 LB <text>"} \end{aligned}$$

D1 , D2, D3 (Continued)

The first character of text will be positioned as shown:

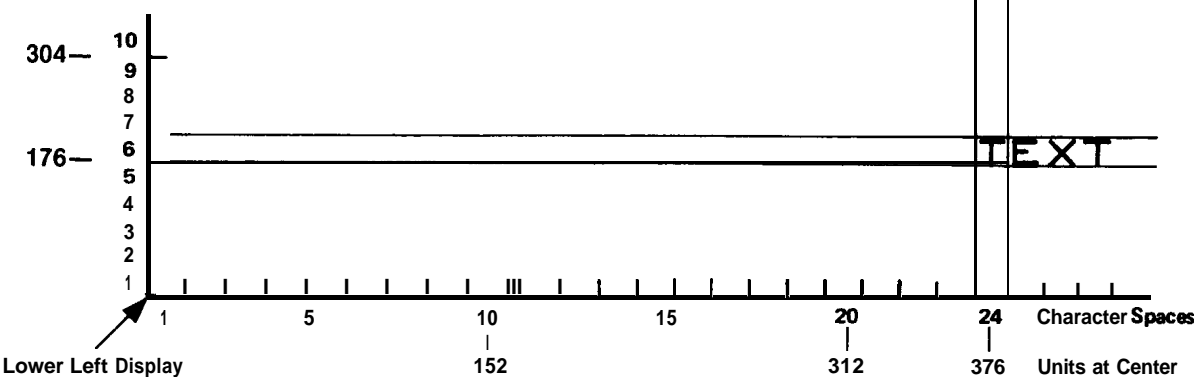



The EE command sends values entered by the operator on the analyzer DATA keyboard to the controller. Generally, the sequence of programmed events is as follows:

1. A program loop prevents the controller from using the entered value until the operator signals that the entry is complete.
2. The operator makes a DATA entry, which is stored in the analyzer internal data register.
3. The operator signals completion of the entry.
4. The controller reads the value of the entry and continues to the next program step.

Depending on the type of DATA entry required, one of two different methods is used. The first method does not require the use of service requests and is used only for entering positive single digits, the second is for entering positive integers from 0 to $[10(12) - 1]$.

Method 1: Testing for a non-zero entry.

```

10  OUTPUT 718;"EE;"
20  REPEAT
30    OUTPUT 718;"OA;"
40    ENTER 718;N
50  UNTIL N>0
60  P R I N T E R I S
70  PRINT N
80  END

```

Line 10: Allows data to be entered with the analyzer DATA keys and presets the entry to 0 (default value). The OA command transfers this value to the analyzer.

Lines 20 to 50: Forms a program loop that is exited when a single digit entry between 1 and 9 is made.

Line 20: Reads the current value of the DATA keys into the variable N.

Lines 60 to 70: Prints the entered number on a printer whose address is 701.

EE (Continued)

Using this program, the outputs printed by pressing particular DATA keys are as follows:

DATA Entry	Output	DATA Entry	Output
1	1.00	GHz +20= dB	1000000000.00
5	5.00	MHz -20= dBc	1000000.00
9	9.00	MHz dB msec	1000.00
		Hz dB µsec	1.00

(There is no response to pressing DATA [0] .)

Method 2: Testing when an entry has been completed, and then exiting the program loop with a service request.



```

10 OUTPUT 718;"R1;R4;EE;"
20 REPEAT
30   A = SPOLL(718)
40   UNTIL BIT (A,1)>0
50   OUTPUT 718;"OA;"
60   ENTER 718;N
70   PRINTER IS
80   PRINTN
90   END

```

- Line 10: Contains an EE command preceded by two service-request format commands. The **R1** command clears the service request modes of the analyzer. The **R4** command calls for a service request if a units key is pressed to signify the completion of an entry.
- Line 30: Reads the serial poll byte and sets it equal to variable A. The first bit of this byte denotes the status of the service request.
- Line 40: Forms the conditional statement of the program loop (lines **20-40**). The BIT statement compares the first bit of variable A with **0**. If the first bit of variable A is **0**, indicating the units key has not been pressed, the program continues at line 30. If it is 1, indicating a units key has been pressed, the program continues at line 50.
- Line 50: Transfers the value of the active function to the controller. In this case, the active function contains the DATA keys entry
- Line 60: Takes the DATA keys entry and sets it equal to the variable N.
- Lines 70 to 80: Prints the value of N on a printer whose address is 701.

Some DATA entries and the corresponding printed outputs, as executed by this program, are shown in the following table.

DATA Entry	Output
	1.00
	123450.00
	123.00

EK

Enable Knob

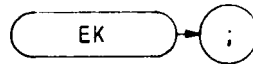

The EK command allows data entry with the front panel data knob when the analyzer is under remote control. The front panel ENABLED indicator lights, indicating the data knob is functional, but other front panel functions remain inoperative.

The following program requests the operator to position a marker on a signal that needs further analysis, while the program is paused.

```
10 OUTPUT 718:"M2;EK;"
20 PRINT "USE DATA KNOB TO PLACE MARKER ON SIGNAL. PRESS CONTINUE"
30 PAUSE
40 ! Analysis program here
50 END
```

The program above is continued by pressing the  key on the controller keyboard

Be sure to pause program operation after executing EK. This gives the operator time to turn the data knob.

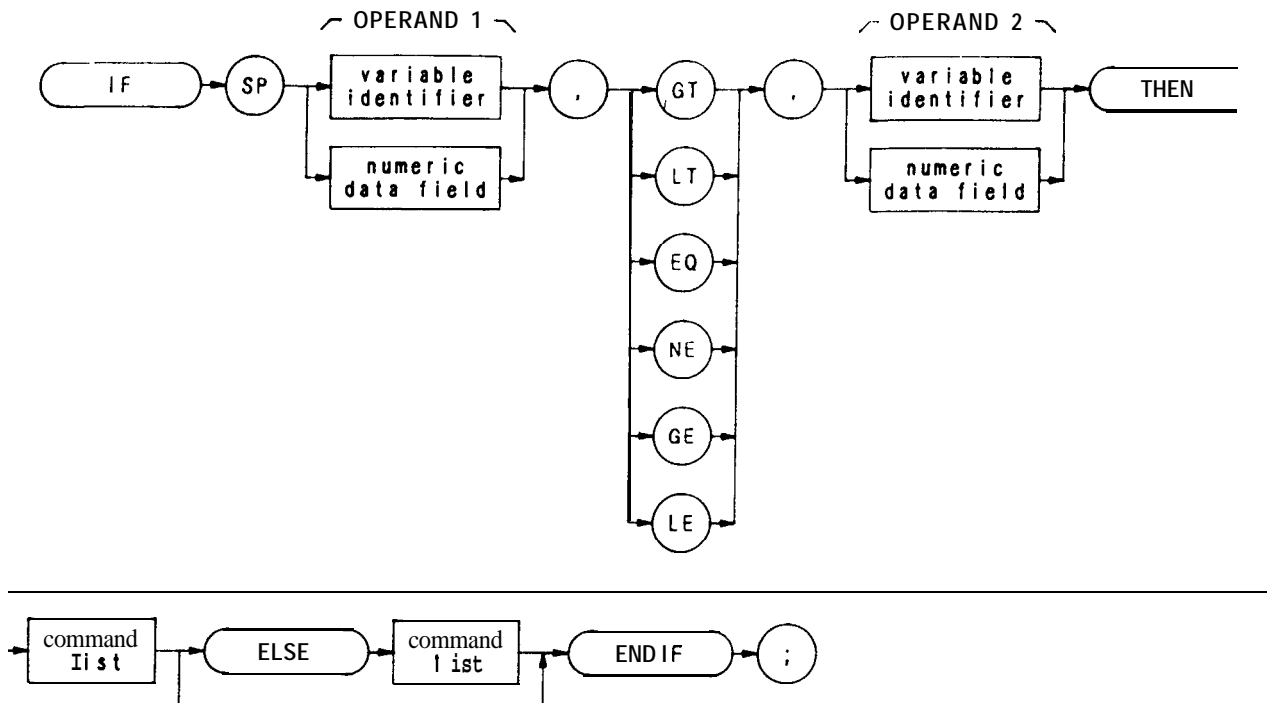

Item	Description/Default	Range Restriction
COMMAND LIST	Alphanumeric character. Any spectrum analyzer command from this section	
VARIABLE IDENTIFIER	Alpha character. User-defined identifier declared in VARDEF statement.	AA-ZZ and _ 2— 12 characters required.
	Alpha character. Measurement-variable identifier, such as CF or MA.	
	Trace element, such as TRA[10].	
NUMERIC DATA FIELD	Real	

The IF-THEN-ELSE-ENDIF commands form a decision and looping construct. They compare operand 1 to operand 2. If the condition is true, the command list is executed. Otherwise, commands following ELSE or ENDIF are executed.

The IF command must be delimited with the ENDIF command.

IF THEN ELSE ENDIF (Continued)

The following program uses the IF THEN ELSE ENDIF command to place a marker on the largest signal that is greater than the threshold level.

```
10 OUTPUT 718;"IP;LF;TH -35DM;"
20 OUTPUT 718;"TS;MKPK HI;MA;"
30 OUTPUT 718;"IF MA,GT,TH"
40 OUTPUT 718;"THEN CF 20MZ;"
50 OUTPUT 718;"ELSE CF 100MZ;TS;MKPK HI;"
60 OUTPUT 718;"ENDIF;"
70 END
```

The program below does not incorporate the ELSE branch of the IF THEN ELSE ENDIF command. The program lowers any signal positioned about (off) the analyzer screen.

```
10 OUTPUT 718;"S2;TS;E1; "
20 OUTPUT 718;"IF MA,GT,RL THEN"
30 OUTPUT 718;"REPEAT RL UP;TS;E1; "
40 OUTPUT 718;"UNTIL MA,LE,RL "
50 OUTPUT 718;"ENDIF S1;" " "
60 END
```

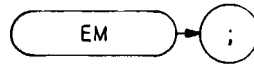

The EM command clears display memory addresses 3072 through 4095, which contain instruction words and amplitude information for trace C. The EM command loads the instruction word 1044 into addresses 3072 through 4095, and then establishes address 3072 as the current (in-use) address, placing this address in the display address register. (See Appendix A for more information about trace C.)

The EM command is often incorporated in a routine that blanks the spectrum analyzer screen in preparation for the display of custom graphics. Execute the following program line to blank the analyzer screen;

```
OUTF'UT 718; "EM;BLANK TRA;BLANK TRB; GRAT OFF; KSo; DLE OFF;"
```

The line above clears trace C memory, and blanks the graticule, characters, display line, and traces A and B. Though the display can be blanked with the **KSg** command, which turns off the CRT beam, the above program line is advantageous. It clears the display faster than **KSg**. In addition, the contents of traces A and B are saved, the instrument state is not altered, and the beginning of trace C memory, address 3072, is established as the current address.

To reinstate the analyzer display, execute the following program line:

```
OUTF'UT 718;"EM;CLRW TRA;CLRW TRB; GRAT ON; KSp;DLE ON;"
```

IF THEN ELSE ENDIF

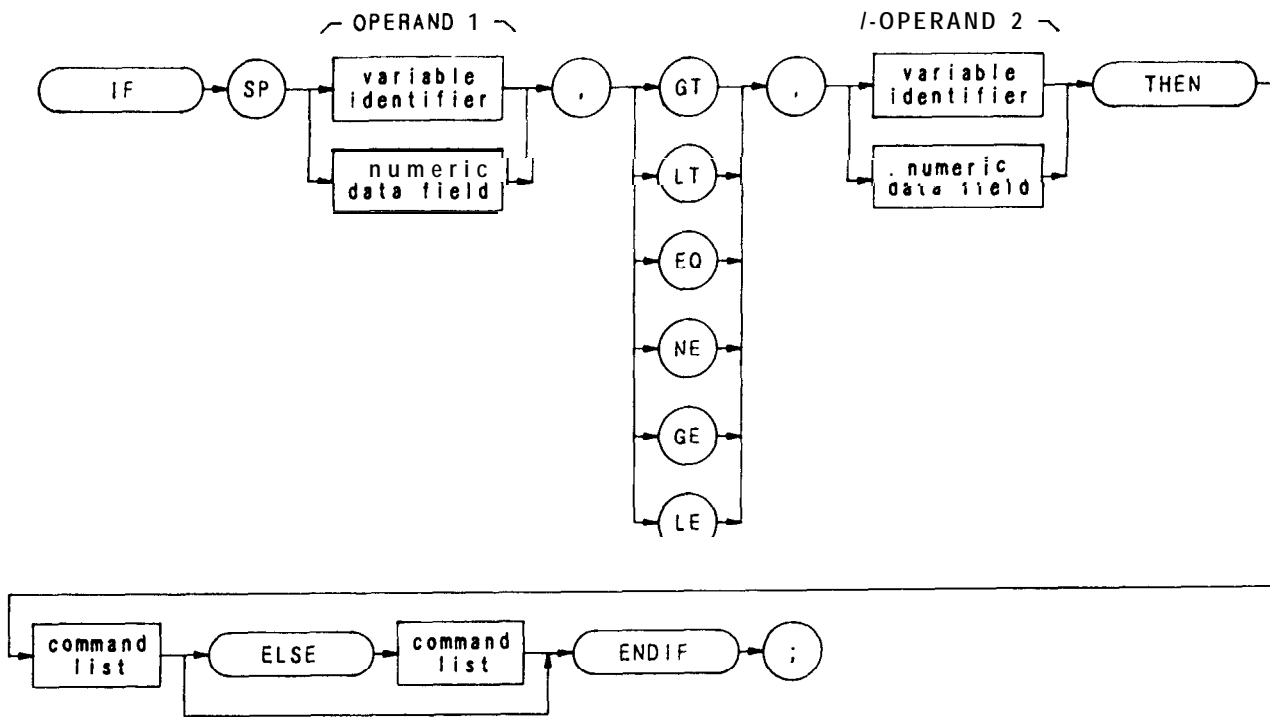

Item	Description/Default	Range Restriction
COMMAND LIST	Alphanumeric character. Any spectrum analyzer command from this section.	
VARIABLE IDENTIFIER	Alpha character. User-defined identifier declared in VARDEF statement.	AA-22 and _ 2— 12 characters required.
	Alpha character. Measurement-variable identifier, such as CF or MA.	
	Trace element, such as TRA[10].	
NUMERIC DATA FIELD	Real	

The IF-THEN-ELSE-ENDIF commands form a decision and looping construct. They compare operand 1 to operand 2. If the condition is true, the command list is executed. Otherwise, commands following ELSE or ENDIF are executed.

The IF command must be delimited with the ENDIF command.

IF THEN ELSE ENDIF (Continued)

The following program uses the IF THEN ELSE ENDIF command to place a marker on the largest signal that is greater than the threshold level.

```
10 OUTPUT 718;"IP;LF;TH -35DM;"
20 OUTPUT 718;"TS;MKPK HI;MA;"
30 OUTPUT 718;"IF MA,GT,TH"
40 OUTPUT 718;"THEN CF 20MZ;"
80 OUTPUT 718;"ELSE CF 100MZ;TS;MKPK HI;"
80 OUTPUT 718;"ENDIF;"
70 END
```

The program below does not incorporate the ELSE branch of the IF THEN ELSE ENDIF command. The program lowers any signal positioned above (off) the analyzer screen.

```
10 OUTPUT 718;"S2;TS;E1; "
20 OUTPUT 718;"If MA,GT,RL THEN"
30 OUTPUT 718;"REPEAT RL UP;TS;E1; "
40 OUTPUT 718;"UNTIL MA,LE,RL "
50 OUTPUT 718;"ENDIF S1; " " "
80 END
```

EX

Exchange A and B
(AXB)

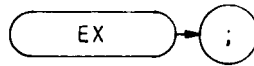

The EX command exchanges traces A and B, point by point.

```
OUTPUT 718;`EX;`
```

The functions of the AXB and EX commands are identical. (Refer to Chapter 5 in Section I.)

EXP

Exponential

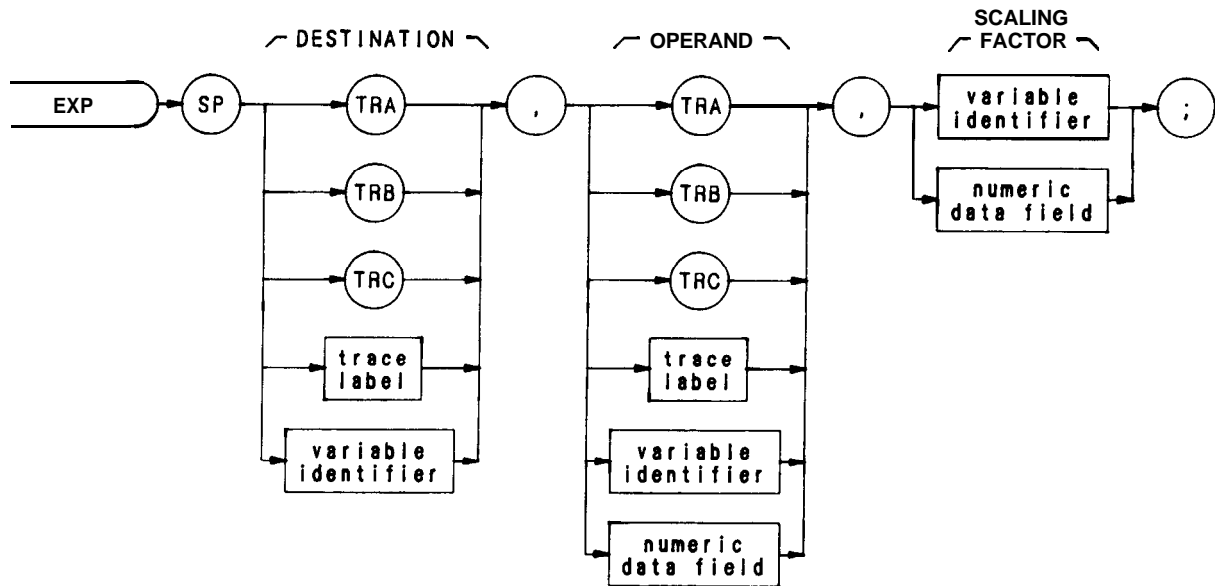

Item	Description/Default	Range Restriction
TRACE LABEL	Alpha character. User-defined label declared in TRDEF statement.	AA- ZZ and _ 2— 12 characters required.
VARIABLE IDENTIFIER	Alpha character. User-defined identifier declared in VARDEF statement.	AA— ZZ and _ 2— 12 characters required.
	Alpha character. Measurement-variable identifier, such as CF or MA.	
	Trace element, such as TRA[10].	
NUMERIC DATA FIELD	Real	

The EXP command processes the operand as follows:

$$10^{\text{operand/scaling factor}} \rightarrow \text{destination}$$

The operand and scaling factor are shown in the syntax chart above.

EXTMXR

External Mixing Mode
(KSU)



The EXTMXR command presets the external mixing mode, setting the frequency range from 18.0 GHz to 26.5 GHz. The frequency range is derived from the sixth harmonic of the analyzer local oscillator (LO).

The preset conditions are as follows:

Specifies the fifth LO harmonic as the start harmonic for the signal identification routine. (See NSTART)

Specifies forty-second harmonic as the stop harmonic for the signal identification routine. (See NSTOI?)

Specifies 10 dB as the maximum amplitude difference between a signal and its image. (See SIGDEL.)



On execution of EXTMXR, the active function readout displays the following:

FULLBAND
6(k)

The 6 represents the current LO harmonic. The K represents the frequency band to which the analyzer is tuned.

If a harmonic lock is in effect (KSt or HNLOCK), an "L" is displayed above the graticule next to the harmonic number. The conversion loss offset value is annotated to the left of the graticule.

Changing the frequency range with the start and stop frequencies automatically changes the harmonic used for tuning.

The functions of the EXTMXR and KSU commands, and   keys are identical. See NSTART, NSTOP, SIGDEL, HNLOCK, and CNVLOSS.

```
10 ASSIGN @Sa TO 718
20 OUTPUT @Sa; "IP; "
30 OUTPUT @Sa; "FA6.0GZ;"
40 OUTPUT @Sa; "S2;TS;"
50 OUTPUT @ Sa; "HNLOCK; "
60 OUTPUT @Sa; "S1;"
70 OUTPUT @Sa; "FA5.0GZ;FB12.5GZ;"
80 END
```

EXTMXR (Continued)

- Line 20: Presets the instrument.
- Line 30: Sets a start frequency of 6.0 GHz which automatically selects the second harmonic.
- Line 40: Sets the analyzer to single sweep mode and takes one complete sweep of the current display.
- Line 50: Locks the second harmonic of the local oscillator.
- Line 60: Resets the analyzer to continuous sweep mode.
- Line 70: Sets the frequency range of the second harmonic.

The functions of the HNLOCK and KSt commands are identical.

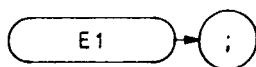

The E1 command positions the marker at the signal peak. See MKPK

OUTPUT 718;“E1;”

E2

Marker to Center Frequency
(MKCF)

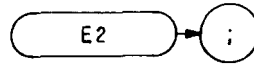

The E2 command centers the active marker on the analyzer screen, moving the marker to the center frequency.

```
OUTP'UT 718; "E2;"
```

The functions of the E2 and MKCF commands, and the front panel  key are identical.

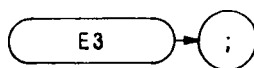

The E3 command establishes the center frequency step size as the frequency difference between the delta and active markers. (See M3 or MKD.)

OUTPUT 718; "E3;"

The functions of the MKSS and E3 commands are identical.

E4

Marker to Reference Level
(MKRL)

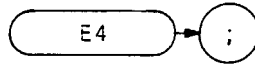

The E4 command moves the active marker to the reference level.

OUTPUT 718; "E4;"

The functions of the E4 and MKRL commands, and the front panel  key are identical.

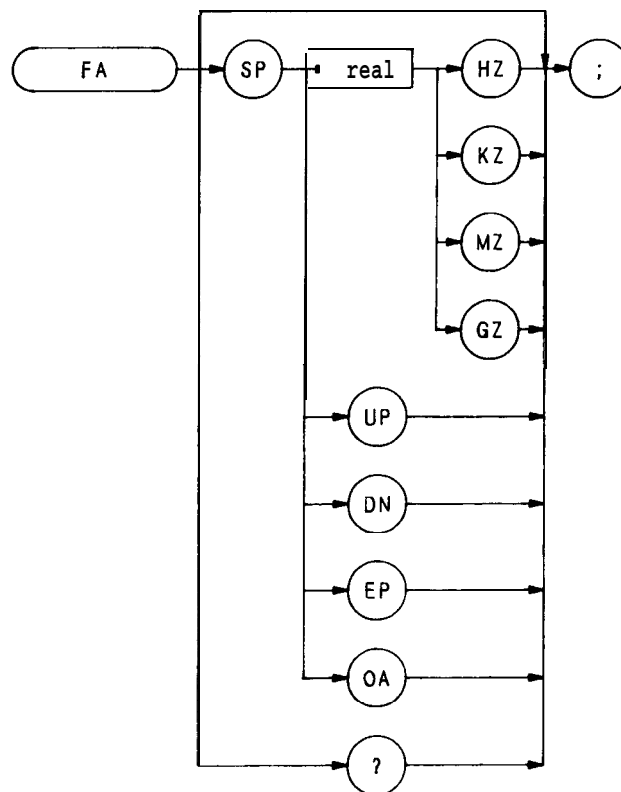

The FA command specifies the start frequency value. The function is identical with that of the front panel  key. The program line below illustrates command syntax.

OUTPUT 718; "FA 88MZ;"

When queried (? or OA), FA returns the start frequency value, a real number, followed by **carriage-return/line-feed** (ASCII codes 13, 10). The end-or-identify state (EOI) is asserted with line feed.

FB

Stop Frequency

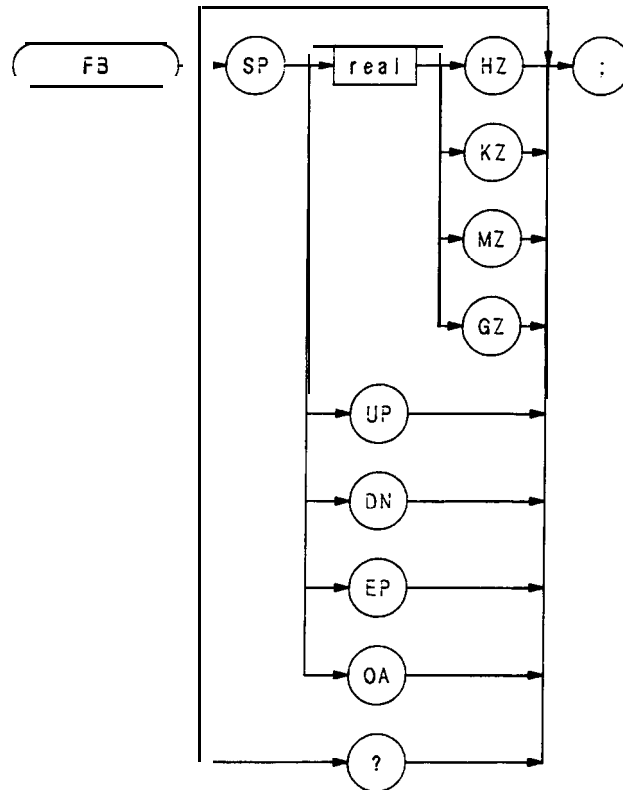

The FB command specifies the stop frequency value. The function is identical with that of the front panel key The program below illustrates command syntax.



```
OUTPUT 718;"FB 88MZ;"
```

When queried (? or OA), FB returns the stop frequency value, a real number, followed by carriage-return/line-feed (ASCII codes 13, 10). The end-or-identify state (EOI) is asserted with line feed.

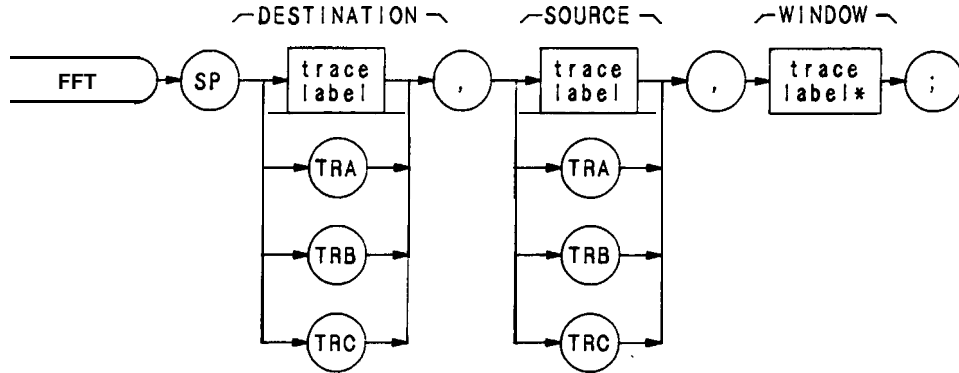

Item	Description/Default	Range Restriction
TRACE LABEL	Alpha character. User-defined label declared in TRDEF statement. For window, TRACE LABEL is also defined by TWINDOW.	AA-ZZ and _ 2— 12 characters required. Trace length must be 1008.

The FFT command performs a forward fast fourier transform on a trace array. The results of the transform contain logged magnitude components only.

The FFT algorithm assumes the source trace array is one period of an infinitely long string of concatenated, duplicate arrays. Thus, in order to avoid discontinuities when the source trace is concatenated, the beginning and end elements of the source trace array must gradually diminish to the same amplitude value. If the endpoints of the original trace array were of different amplitudes, the discontinuities in the resulting array series would introduce false frequency components into the fourier transform. This is illustrated in the following figure.

FFT (Continued)

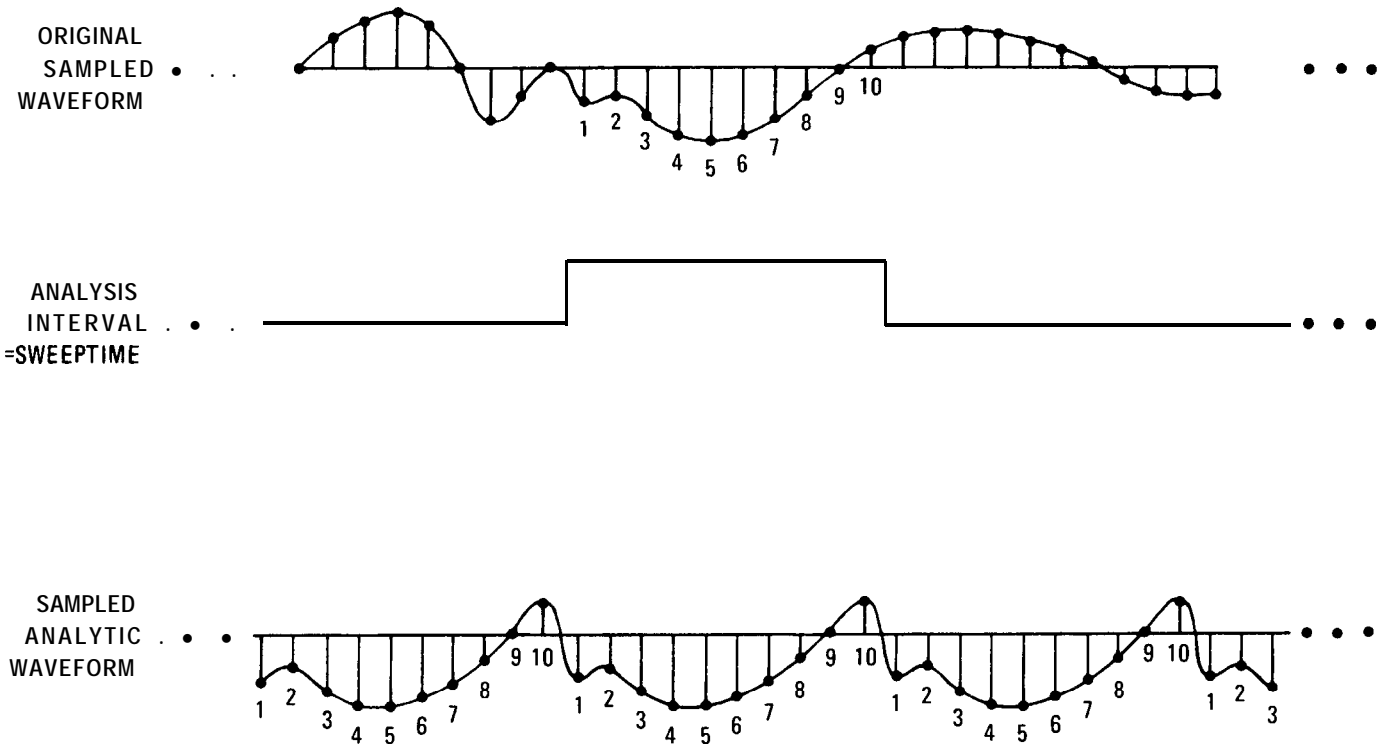

The TWNDOW command allows the source trace array to be modified so the amplitude of the trace endpoints gradually diminish to zero.

The TWNDOW command formats trace arrays with one of three built-in “window” algorithms: HANNING, UNIFORM, and FLATTOI? Each simulates a series of equally spaced filters (see figure below). The detected, spectral line traces the top of the passband while moving from $N\Delta f$ to $(N + 1)\Delta f$.

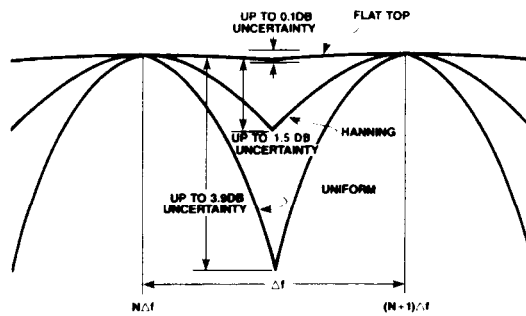

The amplitude and frequency uncertainty of the FFT display depends on the choice of the window, and the analyzer sweep time. Amplitude uncertainty is maximum when the spectral component falls midway between the filter shapes. Passbands that are flatter in shape, like the **FLATTOP** filter, contribute less amplitude uncertainty, but frequency resolution and sensitivity are compromised (see **TWNDOW**)

Of the three algorithms, the **FLATTOP** has the least amplitude uncertainty and greatest frequency uncertainty. Worst-case accuracy is -0.1 dB. Use this passband when transforming periodic signals.

The **UNIFORM** algorithm has the least frequency uncertainty and greatest amplitude uncertainty. Worst-case amplitude uncertainty is 3.9 dB and its 3 dB resolution bandwidth is 60% of the **HANNING** bandwidth. The **UNIFORM** algorithm contains no time domain window weighting. Use it for transforming noise signals or transients that fully decay within one sweep time period.

The **HANNING** algorithm is a traditional passband window found in most real time analyzers. It offers a compromise between the **FLATTOP** and **UNIFORM** shapes. Its amplitude uncertainty is -1.5 dB, and its 3 dB bandwidth is 40% of the **FLATTOP** bandwidth.

The FFT results are displayed on the spectrum analyzer in logarithmic scale. For the X dimension, the frequency at the left side of the graph is 0 Hz, and at the right side is F_{max} . F_{max} can be calculated using a few simple equations and the sweep time of the analyzer.

The sweep time divided by the number of trace array elements containing amplitude information (in this case, 1000) is equal to the sampling period. The inverse of the sampling period is the sampling rate. The sampling rate divided by two yields F_{max} . For example, let the sweep time of the analyzer be 20 msec. 20 msec divided by 1000 equals $20 \mu\text{sec}$, the value of the sampling period. The sampling rate is $1/20 \mu\text{sec}$. F_{max} equals $1/20 \mu\text{sec}$ divided by 2, or 25 kHz.

The Fourier transforms of the window functions are shown in the following figure. Use these graphs to estimate resolution and amplitude uncertainty of a Fourier transform display. Each horizontal division of the graphs equals $1/\text{sweep time}$ or $F_{max}/500$ (which can be calculated from the previous equations), and represents two trace array elements.

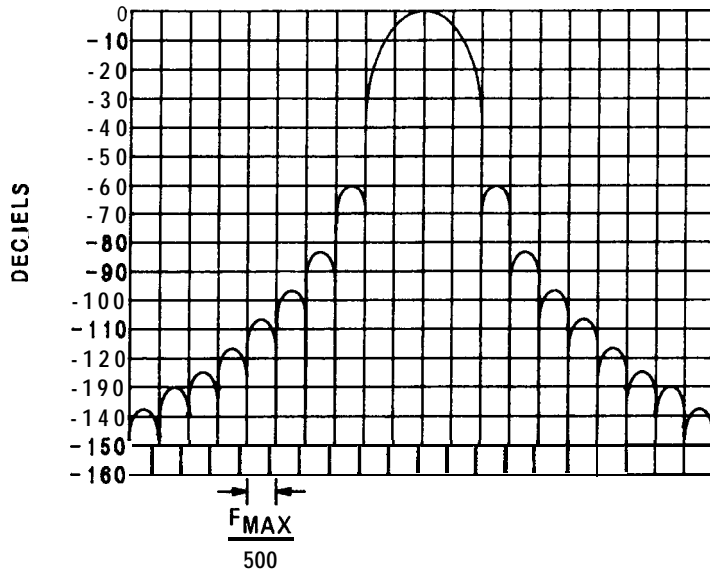

HANNING FILTER WINDOW

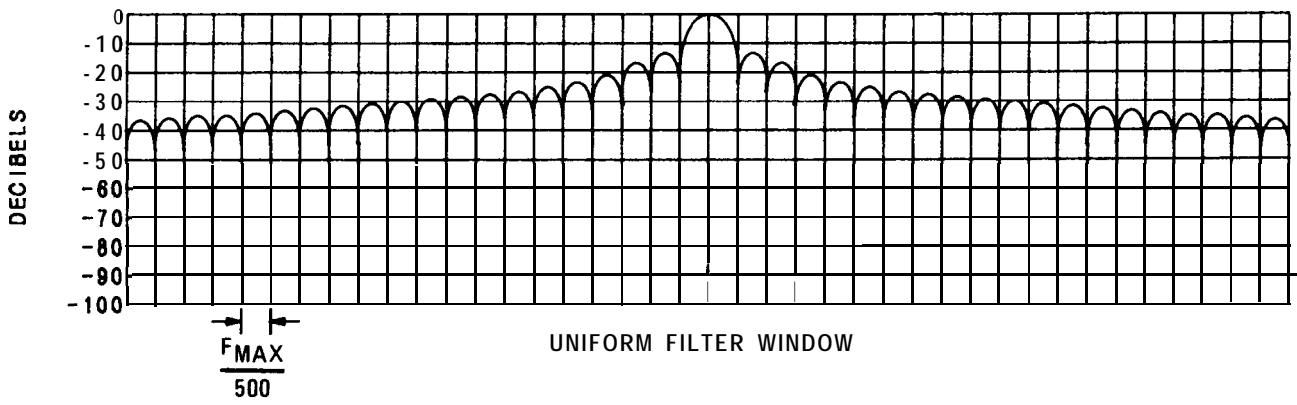

UNIFORM FILTER WINDOW

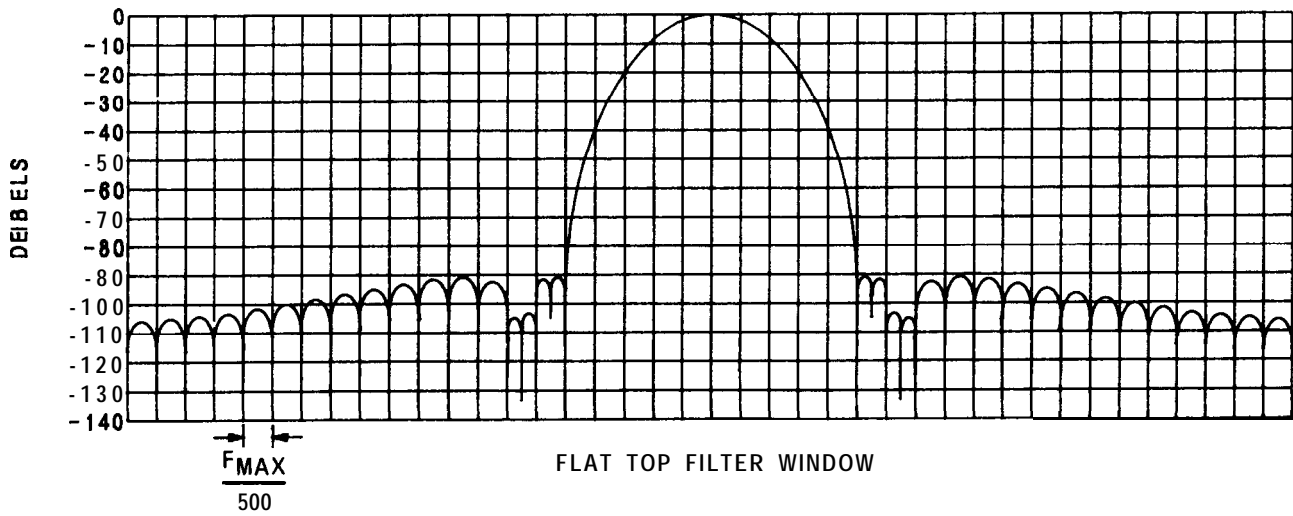

FLAT TOP FILTER WINDOW

In summary, keep the following in mind when executing FFT:

Perform fourier transforms on trace A, B, or C, or user-defined traces containing 1008 elements only. (FFT automatically creates a 1008 point array from trace A, B, or C.)

FFT is designed to be used in transforming zero span information into the frequency domain. Performing FFT on a frequency sweep will result in inaccurate FFT data.

Define a trace window with the TWNDOW command before performing an FFT on a trace.

It is possible to get numbers outside the boundaries of the screen (0 – 1023) after executing an FFT. If the destination trace is trace A, then the results are automatically clipped. For traces B, C, and user-defined traces, the results are not automatically clipped. When using these traces, avoid writing in locations outside the boundaries of the screen.

To get an FFT frequency readout on the FFT trace, use the Marker Read command (MKREAD FFT;).

The following is an example of an FFT program.

```

10  OUTPUT 718; "TRDEF W__INDOW,1008;"
20  OUTPUT 718; "TWNDOW W__INDOW,HANNING;"
21
30  OUTPUT 718; "FFT TRB,TRA,W__INDOW;"
31
40  END

```

- Line 10: A trace array of 1008 points is defined as W__INDOW.
- Line 20: The trace array is formatted according to the HANNING algorithm.
- Line 30: An FFT is performed on trace A and the results are stored in trace B.

FOFFSET

Frequency Offset

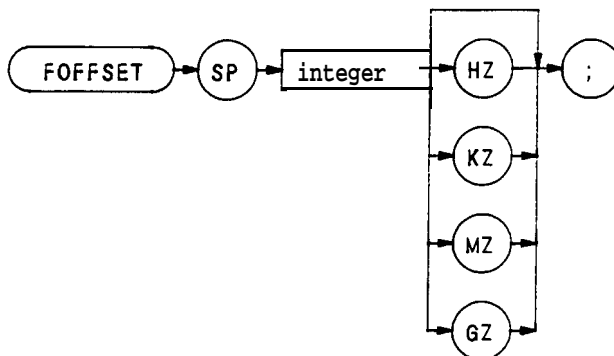

Item	Description/Default	Range Restrictions
INTEGER	Default is hertz.	

The FOFFSET command selects a value that offsets the frequency scale for all absolute frequency readouts, such as center frequency. Relative values, like span, and delta marker, are not offset.

After execution, the FOFFSET command displays the frequency offset in the active function readout. The offset value is **always** displayed beneath the CRT graticule line, as long as the offset is in effect.

The following program returns an offset value of 100 MHz to the controller and prints it on the controller screen.

```
10 OUTPUT 718;"FOFFSET 100MZ;FOFFSET?;"  
20 ENTER 718;N  
30 PRINTN  
40 END
```

When queried (?), FOFFSET returns the offset value as a real number, followed by carriage-return/line-feed (ASCII codes 13, 10). The end-or-identify state (EOI) is asserted with the line feed.

FORMAT STATEMENTS
01, 02, 03, 04

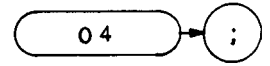
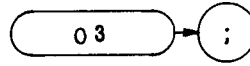
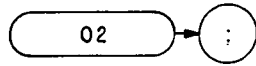
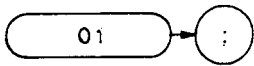

The spectrum analyzer outputs must be formatted appropriately for the controller and measurement requirements. The spectrum analyzer transmits decimal or binary values, via the Hewlett-Packard Interface Bus (HP-IB), to a controller or other HP-IB device, such as a printer. The decimal and binary values represent trace information or instructions.

The format characteristics are summarized in the table below.

Analyzer Output	Format	Output Example of Marker Amplitude. Marker is at — 10 dBm Command reference level.
Sends trace information only as a decimal value in Hz, dB, dBm, volts, or seconds.	03	— 10.00
Sends trace amplitude and position information, or instruction word as decimal values ranging from 0 to 4095: 0 to 1023 represent positive, unblanked amplitudes in display units. 1024 to 2047 are instruction words (analyzer machine language). 2048 to 3071 represent positive, blanked amplitudes in display units. 3072 to 4095 represent negative, blanked amplitudes in display units,	01	1001
Sends trace amplitude and position information, or instruction word as binary values in two 8-bit bytes, sending the most significant bit first. The four most significant bits are zeroes.	02	<pre> o o o o x x x x x x x x x x x x (3) (231) values 0 to 4095 </pre>
Sends trace amplitude information only as binary value in one 8-bit byte, composed from the 02 output bytes: <pre> o o o o x x x x x x x x x x x x 0 2 1 1 // // // // x x x x x x x x 0 4 </pre>	04	<pre> x x x x x x x x (250) values 0 to 255 (full scale) </pre>

FORMATSTATEMENTS (Continued)

03 Format

The 03 format transmits trace amplitude information only, in measurement units: Hz, dBm,dB, volts, or seconds. The 03 format cannot transmit instruction words.

A carriage-return/line-feed (ASCII codes 13, 10) always follows any data output. The end-or-identify state (EOI) is asserted with line feed.

Instrument preset (IP) automatically selects the 03 format.

01 Format

The 01 format transmits trace amplitude information as decimal values in display units. (See Chapter 4 in Section I for a description of display units.)

Trace amplitude values can be positive and unblanked, positive and blanked, or negative and blanked. Positive, unblanked values (0 to 1023) cover the visible amplitude range on the spectrum analyzer CRT

Negative trace values (3072 to 4095) usually result from trace arithmetic, and are not displayed because they are off (below) the screen. Negative values are represented by the 12-bit two's complement of the negative number, that is, $4096 - |\text{negative value}|$. For example, a -300 value is an output of 3796.

$$4096 - |-300| = 3796$$

Positive, blanked values (2048 to 3071) are those responses immediately ahead of the updated, sweeping trace. These values form the blank-ahead marker, and represent the amplitude responses of the previous sweep, plus 2048. Thus, they are off (above) the screen. (See Appendix B.)

The 01 format also transmits instruction words as decimal values. See the Instruction and Data Word Summary in Appendix B

A carriage-return/line-feed (ASCII codes 13, 10) always follows any data output in the 01 format. The end-or-identify state (EOI) is asserted with line feed.

02 Format

The 02 format transmits trace information or instruction words as two 8-bit binary numbers. The most significant bit is sent first. The four most significant bits are always zeroes.

Most Significant Byte	Least Significant Byte
0 0 0 0 x x x x	x x x x x x x x

Refer to the Consolidated Coding table in Appendix B for instruction word information.

Note that the 02 format sends the same kind of information that the 01 format sends, except that 02 transmits the information in binary numbers instead of decimal numbers. Also, the end of transmission is not marked by carriage-return/line-feed (ASCII codes 13, 10) in the 02 format.

04 Format

The 04 format transmits trace amplitude information only as a binary number. The binary number is one 8-bit byte composed from the bytes established with the 02 format.

```

0 0 0 0 X X X X X X X X X X X X X X X X 0 2
      11 // // // //
      X X X X X X X X X X X X X X X X    0 4

```

The 04 output is the fastest way to transmit trace data from the spectrum analyzer to the HP-IB bus. However, sign information is lost. Keep this in mind when transmitting delta marker information (MKD). The end of data transmission is NOT marked by a carriage-return/line-feed.

Format Statements and the HP-IB Bus

The table below shows a transmission sequence on the HP-IB bus for each of the four formats. Each format is transmitting the amplitude of a marker positioned at the -10 dBm reference line.

Format	0 3	0 1	0 2	0 4
Byte	NUM (-)	NUM ("1")	(3)	(250)
Byte	NUM (1)	NUM ("0")	(231)	
Byte	NUM (0)	NUM ("0")		
Byte	NUM ()	NUM ("1")		
Byte	NUM (0)	13		
Byte	NUM (0)	10		
Carriage Return	13			
Line Feed (EOI asserted)	10			

Though the spectrum analyzer transmits either binary or digital information on the HP-IB bus, a decimal number is always returned to the controller display. This is illustrated in the program below, which reads the instruction word 1040 at display address 0, the first memory location of trace A. The program reads the instruction word, using each of the formats, and the DR command.

```

1  ASSIGN @Sa TO 7 18
2  PRINTER IS 701
4  OUTPUT @Sa;"A1;S2;TS;"
10 OUTPUT @Sa;"DA 0 01 DR"
20 ENTER @Sa;Dr1
30 OUTPUT @Sa;" DA 0 02 DR"
40 ENTER @Sa USING "# W":Dr2

```

FORMATSTATEMENTS (Continued)

```

50 OUTPUT @Sa;" DA 0 03 DR "
60 ENTER @Sa;Dr3
70 OUTPUT @Sa;" DA 0 04 DR"
80 ENTER @Sa USING "#,B";Dr4
90 PRINT Dr1,Dr2,Dr3,Dr4
100 END

```

Running the program above produces the following responses on the controller display. Note that all the responses are decimal numbers. Also note that the 03 and 04 formats do not return the correct data. (As mentioned above, 03 and 04 do not transmit instruction words.)

```

01 FORMAT response: 1040
02 FORMAT response: 1040
03 FORMAT response : — 200.8
04 FORMAT response: 4

```

Controller Formats

The format of the controller must be compatible with the output format of the analyzer.

Analyzer Format	Controller Format	
	Requirements	Example Statement and Analyzer Response
01	free field	ENTER 718; PK-AMPLITUDE Response: 1001
03	field size dependent on output, use free field format	ENTER 718; PK-AMPLITUDE Response: — 10.0
02	binary, read twice for each value	ENTER 7 18 USING "#, W" Response: 1001
04	binary, read once for each value	ENTER 718 USING "#,B" Response: 250

NOTE

The 0 in O1, O2, O3, and O4 is the letter 0 and not the number zero.

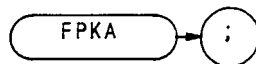

The FPKA command automatically adjusts the preselector frequency to yield the greatest signal level at the active marker. The FPKA command peaks the preselector faster than the preselector-peak command, **PP**.

Although this command can be executed in all frequency spans, it performs best when the instrument is in zero span. Use the standard preselector peak for all other frequency spans.

FS

Full Span

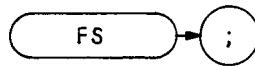

The FS command selects the full frequency span of 0 – 2.5 GHz.

OUTPUT 718; "FS; "

The functions of the commands FS and LF, and the front-panel  function, are identical.

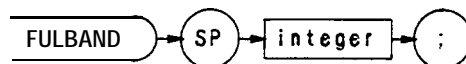

Item	Description/Default	Range Restriction
INTEGER	Specifies waveguide band.	6to 17

Band	Frequency Range	Mixing Harmonic
6 (K)	18.0— 26.5 GHz	6+
7 (A)	26.5-40.0	8+
8 (Q)	33.0— 50.0	10+
9 (U)	40.0— 60.0	10+
10 (V)	50.0— 75.0	14+
11 (E)	60.0— 90.0	16+
12 (W)	75.0— 110.0	18+
13 (F)	90.0— 140.0	24+
14 (D)	110.0— 170.0	30+
15 (G)	140.0— 220.0	36+
16 (Y)	170.0— 260.0	44+
17 (J)	220.0— 325.0	54+

The FULBAND command sets the start and stop frequencies for the analyzer external mixing bands. In the table above, the start and stop frequencies for each band are shown in the Frequency Range column. On execution of the FULBAND command, a harmonic lock (HNLOCK) is automatically executed. (See HNLOCK.)

FUNCDEF

Function Define

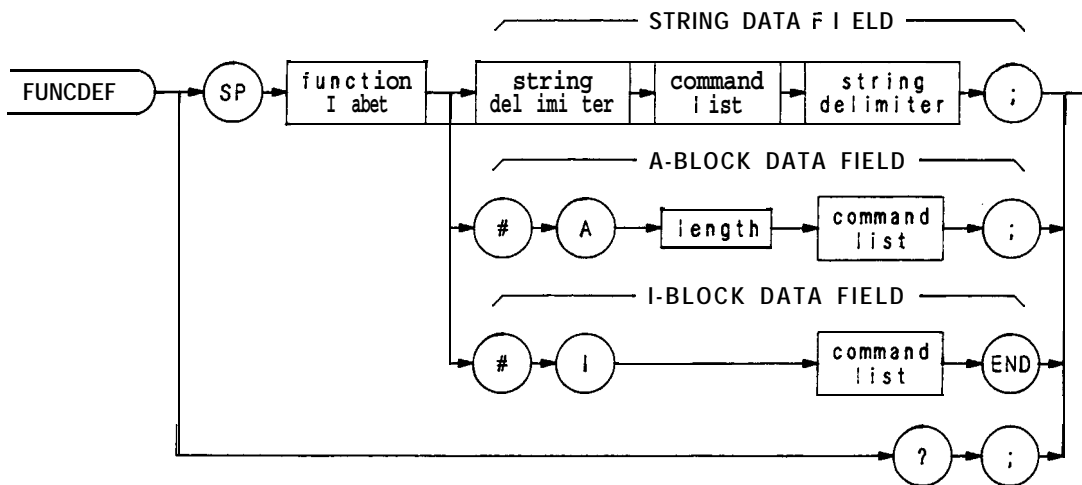

Item	Description/Default	Range Restriction
COMMAND LIST	Any spectrum analyzer commands from this Remote section.	Command list length is limited to 2015 characters, including carriage return (CR) and line feed (LF).
LENGTH	Two 8-bit bytes specifying length of command list, in 8-bit bytes. The most significant byte is first: MSB LSB	
STRING DELIMITER	Must match. Marks beginning and end of command list.	! " \$ % & ' / : = @ \ ~ ;

The FUNCDEF command defines a program routine as a function label. After FUNCDEF is executed, the command **list** is executed whenever the function label is encountered.

Once the function label is defined, it can be loaded into a **softkey** which can be executed remotely, or locally from the front panel.

When queried (?), FUNCDEF returns the command list in an A-block data format.

(See KEYDEF and KEYEXC.)

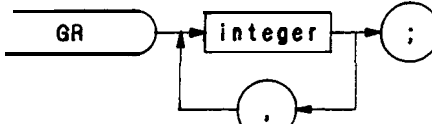

Item	Description/Default	Range Restriction
INTEGER	Represents display memory Y-axis values.	0— 4095

The GR command, in the trace modes of operation only, plots HP-IB inputs as graphs on the analyzer CRT. It is also used with auxiliary function codes to modify the appearance on the CRT of stored trace data (highlighting a portion of the trace, for example). Following the GR command, HP-IB inputs in y (amplitude) display units are entered on the CRT, starting at the far left side of the display. For each y display unit added to the trace, the x (horizontal) coordinate is automatically advanced one display unit to the right.

Execution of the GR command tells the analyzer to start plotting a graph at the amplitude point indicated by the next y (amplitude) coordinate received from the HP-IB input. This first amplitude point, y_1 , appears at the left of the display; successive points are then plotted, and the lines connecting them are drawn from left to right within the display area limits. (The display area size is established with display size command D1, D2, or D3, or the box programming instruction.)

A sample program using the GR command is shown below.

```

10 ASSIGN @Sa TO 718;FORMAT ON
20 OUTPUT @Sa;"IP;LF;FA200KZ;FB5MZ;S2;GR"
30 FOR N = 1 TO 400
40 OUTPUT @Sa;400— (3.5/4)*N
50 NEXT N
60 FOR N = 401 TO 1000
70 OUTPUT @Sa;300
80 NEXT N
90 OUTPUT @Sa;"KSi;TS;KSk;B3;C2;TS;"
100 OUTPUT @Sa;"HD;EM;KSo;DT@";
110 FOR N = 1 to 11 STEP 2
120 OUTPUT @Sa;"D2;PU;PA 50";(90*N)— 20;"LB";(10*N)— 10;"@"
130 NEXT N
140 OUTPUT @Sa;"B4"
150 OUTPUT @Sa USING "K,B,B,K";"D3;PU;PA 0,600 LBdB";10,13;OUT OF SPEC@"
160 OUTPUT @Sa;"D3;PA 100,500 LB RADIATED INTERFERENCE, 200kHz— 5MHz@"
170 END

```

- Line 20: Initiates the graph mode. The IP insures that the graphing starts at the beginning of trace C.
- Lines 30 to 80: Writes test limit values into the trace C memory.
- Line 90: Sends graph data to trace B memory and enables A- B- >A.
- Line 200: Clears the active function readout (HD), prepares trace C for input (EM), clears the display annotation (KSo), and sets the label terminator to @.
- Lines 110 to 160: Labels the graticule.

GRAT

Graticule

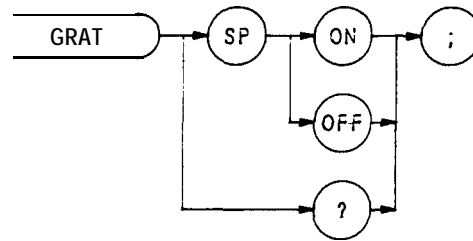

The GRAT command turns the graticule on and off.

`OUTPUT 718; "GRAT;"`

When queried (?), GRAT returns the graticule state: ON or OFF.

(See also `KSn` and `KSm`.)

HD

Hold Data Entry

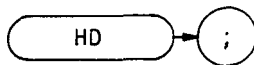

The HD command disables data entry via the front panel DATA keyboard and blanks the active function readout.

```
OUTPUT 718; "HD; "
```

HNLOCK

Harmonic Lock
(KSt)

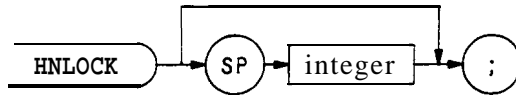

Item	Description/Default	Range Restriction
INTEGER	Real number representing an LO harmonic.	1 - 64

The HNLOCK command prevents the analyzer from tuning with other than the specified LO harmonic. This command also restricts the tuning range of the LO to 6.2 GHz.

If the harmonic specified with the HNLOCK command is not compatible with the current START and STOP frequency settings, these settings are automatically changed. When this happens, the CENTER FREQUENCY setting is retained, if possible (i.e., the START and STOP frequencies are set closer together). If the CENTER FREQUENCY setting can not be retained, another external mixing band is selected that is compatible with the specified harmonic. The HNLOCK command can not be used to switch between the internal and external mixer bands.

If no harmonic number is specified with the HNLOCK command, the analyzer tunes with the current harmonic.

When executing a harmonic lock, use the following method to ensure the desired harmonic is selected:

1. Select desired harmonic by setting a start frequency within the desired band. (See Tuning Curves in Appendix F for frequency range of each harmonic.)
2. Set analyzer to single sweep mode. Single sweep ensures the desired harmonic is selected when executing a bank lock.
3. Execute **KSt** to lock the desired harmonic.
4. Set analyzer to continuous sweep mode.
5. Reset desired start and stop frequencies.

Remember, before you can change the frequency range to another harmonic, you must unlock the band with the **KSQ** (harmonic unlock) command.

KSR (Diagnostics On) can be activated, at any time, to display the local oscillator harmonic number in the upper left corner of the CRT display.

```
10 ASSIGN @Sa TO 718
20 OUTPUT @Sa; "IP;"
30 OUTPUT @Sa; "FA6.0GZ;"
40 OUTPUT @Sa; "S2;TS;"
50 OUTPUT @Sa; "HNLOCK;"
60 OUTPUT @Sa; "S1;"
70 OUTPUT @Sa; "FA5.0GZ;FB12.5GZ;"
80 END
```

Line 20: Presets the instrument.
Line 30: Sets a start frequency of 6.0 GHz which automatically selects the second harmonic.
Line 40: Sets the analyzer to single sweep mode and takes one complete sweep of the current display.
Line 50: Locks the second harmonic of the local oscillator.
Line 60: Resets the analyzer to continuous sweep mode.
Line 70: Sets the frequency range of the second harmonic.

The functions of the HNLOCK and KSt commands are identical.

HNUNLK

Harmonic Bank Unlock
(KSQ)



The HNUNLK command removes the harmonic lock established with the HNLOCK command, thus allowing the analyzer to tune over the whole input frequency range.

The functions of the HNUNLK and KSQ commands are identical.

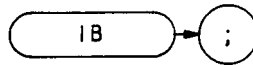

The IB command transmits the contents of an array, located in the controller to trace B memory. Use IB with the O2 format, which formats data in two 8-bit bytes.

The IB command cannot be executed when it is followed by a carriage-return/line-feed. Two examples of terminating the IB command are shown below:

```
OUTPUT 718;"IB;"
```

```
OUTPUT 718 USING "#, k";"IB;"
```

The program below demonstrates the use of IB.

```
10 ASSIGN @Sa TO 718;FORMAT ON
20 ASSIGN @Sa_bin TO 718;FORMAT OFF
30 INTEGER B200( 1: 1001)
40 OUTPUT @Sa;"CF200MZ B1;A4;RB30KZ;SP2MZ;S2;TS;"
50 OUTPUT @Sa;"O2TB"
60 ENTER @Sa_bin;B200( *)
70 OUTPUT @Sa;"CF100MZ;RB30KZ;SP1MZ;TS;"
80 PAUSE
90 OUTPUT @Sa;"IB";
100 OUTPUT @Sa_bin;B200( *)
110 END
```

Line 30: Declares, dimensions, and reserves memory for array B200.

Line 40: Blanks trace A and sets the analyzer to 200 MHz center frequency. Selects single sweep mode, and sweeps trace B.

Lines 50 and

60: Stores trace B (in binary) in controller array.

Line 70: Sets analyzer to 100 MHz center frequency. Sweeps trace B with new data.

Line 90: Prepares analyzer to receive previous trace B data.

Line 100: Sends trace B data to analyzer.

ID

Identify

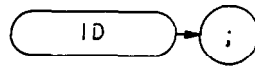

The ID command returns the instrument identity to the controller: HP 8568B or HP 8566B.

OUTPUT 718;"ID;"



The IDSTAT command returns a 1, 0, or - 1, representing the completion status of the signal identifier routine, to the controller.

The 1 means the signal was found, indicating signal identification routine identifies signal and moves signal to center screen. The 0 means signal was not found, analyzer recalled register 7. The - 1 means the signal was found, indicating signal identification routine found signal but did not move signal to center screen because of a harmonic lock (see HNLOCK) .

```
10 OUTPUT 718;"IDSTAT?;"  
20 ENTER 718;N  
30 PRINT N  
40 END
```

See SIGID or KSv.

IF THENELSEENDIF

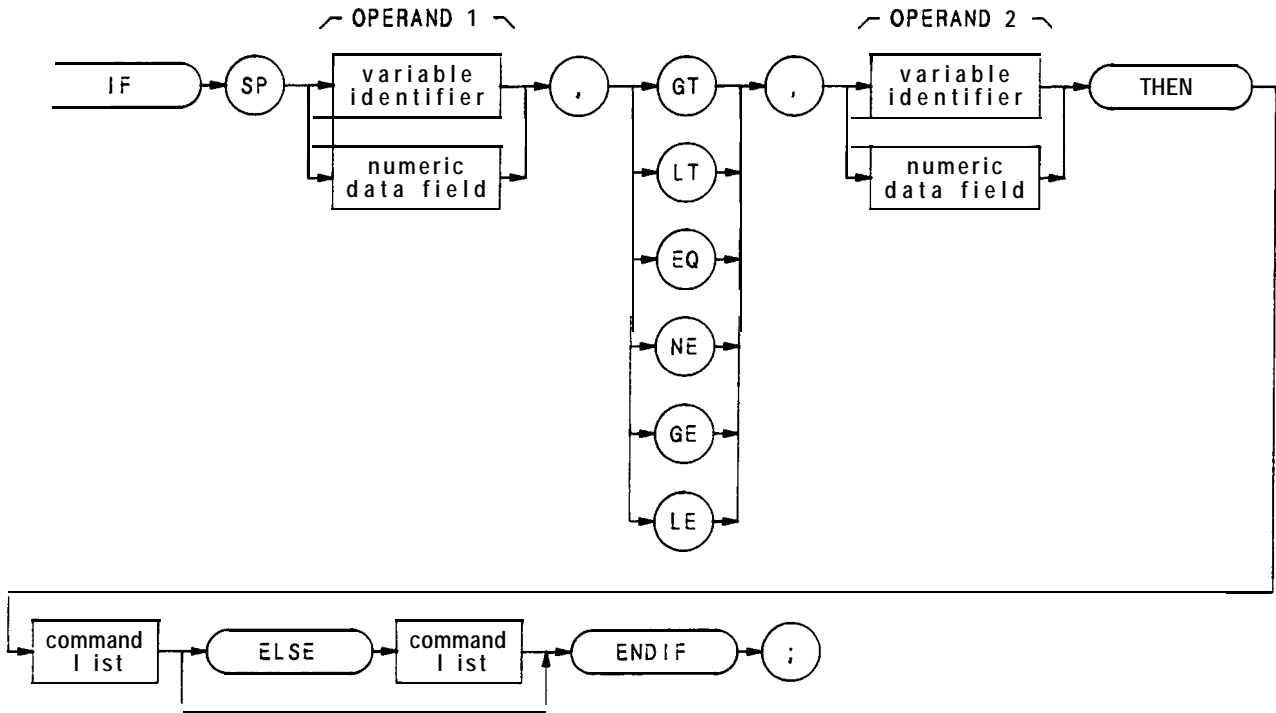

Item	Description/Default	Range Restriction
COMMAND LIST	Alphanumeric character. Any spectrum analyzer command from this section.	
VARIABLE IDENTIFIER	Alpha character. User-defined identifier declared in VARDEF statement. Alpha character. Measurement-variable identifier, such as CF or MA. Trace element, such as TRA[10].	AA-22 and __ 2— 12 characters required.
NUMERIC DATA FIELD	Real	

The IF-THEN-ELSE-ENDIF commands form a decision and looping construct. They compare operand 1 to operand 2. If the condition is true, the command list is executed. Otherwise, commands following ELSE or ENDIF are executed.

The IF command must be delimited with the ENDIF command.

The following program uses the IF THEN ELSE ENDIF command to place a marker on the largest signal that is greater than the threshold level.

```
10 OUTPUT 718;"IP;LF;TH -35DM;"
20 OUTPUT 718;"TS;MKPK HI;MA;"
30 OUTPUT 718;"IF MA,GT,TH"
40 OUTPUT 718;"THEN CF 20MZ;"
50 OUTPUT 718;"ELSE CF 100MZ;TS;MKPK HI;"
60 OUTPUT 718;"ENDIF;"
70 END
```

The program below does not incorporate the ELSE branch of the IF THEN ELSE ENDIF command. The program lowers any signal positioned above (off) the analyzer screen.

```
10 OUTPUT 718;"S2;TS;E1; "
20 OUTPUT 718;"IF MA,GT,RL THEN"
30 OUTPUT 718;"REPEAT RL UP;TS;E1; "
40 OUTPUT 718;"UNTIL MA,LE,RL "
50 OUTPUT 718;"ENDIF S1;" " "
60 END
```

IP

Instrument Preset

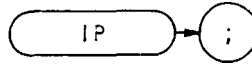

The instrument preset command, **IP**, executes the following commands:

CLRW A (A1)	Clears and writes trace A.
BLANK B (B4)	Blanks trace B .
CR	Couples resolution bandwidth.
CA	Couples input attenuation.
c s	Couples step size.
CT	Couples sweep time.
c v	Couples video bandwidth.
AMB OFF (C1)	Turns off A-B mode.
FA	Sets start frequency
FB	Sets top frequency.
HD	Hold
AUNITS DBM (KSA)	Selects dBm amplitude units.
VAVG OFF (KSH)	Turns off video averaging.
DET NRM (KSa)	Selects normal detection mode.
MKNOISE OFF (KSL)	Turns off noise markers.
DET NRM (KSa)	Selects normal detection mode.
GRAT ON (KSn)	Turns on graticule .
KSp	Turns on characters.
LG	Selects 10dB/DIV log scale.
MKTRACK OFF (MTØ)	Turns off marker tracking.
MKOFF (MI)	Turns off markers.
CONTS (S1)	Selects continuous sweep mode.
THE OFF (TØ)	Turns off threshold.
TM FREE (T1)	Selects free run trigger.
TDF P (03)	Selects 03 output format.
DA	Selects 3072 as the current address.
D1	Selects normal display size.
PD	Puts pen down at current address.
R3	Allows SRQ 110.
MKPZ 6dB	
MDS W	Selects data size of one word, which is two 8-bit bytes.
DISPOSE ONEOS	Erases command list associated with the end of the sweep. (See ONEOS.)
DISPOSE ONSWP	Erases command list associated with the beginning of the sweep. (See ONSWP.)
DISPOSE TRMATH	Erases command list associated with the end of the sweep. (See TRMATH.)
MKPAUSE OFF	Turns off marker pause mode.

In addition, IP re-assigns user-defined variables **to** their initial values, specified by the VARDEF command.

Instrument preset automatically occurs when you turn on the analyzer, and is a good starting point for many measurement processes, especially when followed by the TS command. (When IP is executed remotely, the analyzer does not necessarily execute a complete sweep.)

OTJTF/UT 718; "IP;TS;"

KEYDEF

Key Define

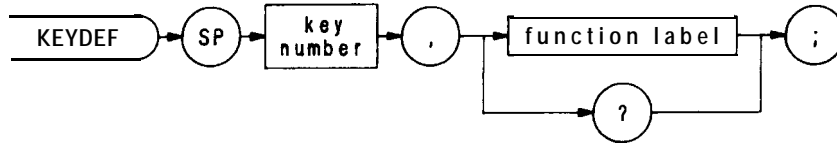

Item	Description/Default	Range Restriction
KEY NUMBER	Integer	Ø through 999
FUNCTION LABEL	Alpha character. User-defined label declared in FUNCDEF statement.	AA—ZZ and _ 2— 12 characters required.

The KEYDEF command associates a numbered key with a programming routine, which can be executed remotely or from the front panel.

The program below stores a routine in key 999. The program, contained in lines 20 through 70, increases the reference level until the signal peak is below the reference level. The routine is assigned a name with the FUNCDEF command, and then assigned to key 999. Note that the program is delimited with single quotation marks.

```
10 OUTPUT 718;"FUNCDEF ROUTINE," ""
20 OTJTPTT 718;"S2;TS;E1;"
30 OUTPUT 718;"IF MA,GT,RL THEN"
40 OUTPUT 718;"REPEAT RL UP;TS;E1;"
50 OUTPUT 718;"UNTIL MA,LE,RL"
60 OUTPUT 718;"ENDIF S1;" ""
70 OUTPUT 718;"KEYDEF 999,ROUTINE;"
80 END
```

- Line 10: Assign ROUTINE as the name of the routine in lines 20 – 70.
- Lines 20 through 70: Execute a peak search. If the marker amplitude is greater than the reference level, increase the reference level until it is greater than the marker amplitude.
- Line 70: Store the routine in the analyzer, and assign it to key 999.

To execute key 999 remotely, use the KEYEXC command:

```
OUTPUT 718; "KEYEXC 999"
```

To execute key 999 from the front panel, press these front panel keys:



Once a key is defined, the routine is saved, even when the analyzer loses power or is preset. Use the DISPOSE command to clear a user-defined key

When queried, KEYDEF returns the command list in a A-block data format. (See DISPOSE, KEYEXC, and FUNCDEE)

- When quotation marks are nested, use two quotes (") for the inner marks, and one quote (") for the outer mark, as shown in lines 10 and 60.

KEYEXC

Key Execute

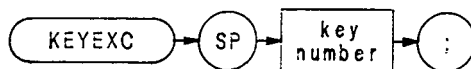

Item	Description/Default	Range Restriction
KEY NUMBER	INTEGER. User-defined key number declared in KEYDEF statement.	0 to 999

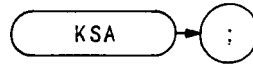

The KEYEXC command executes the specified defined key. The program below executes key 2, which contains a programming routine called M_AIN. The routine consists of several user-defined functions, declared with the FUNCDEF command, which sweep the analyzer over different frequency ranges.

```
1  OUTPUT 718;"FUNCDEF M_AIN," "PRESET;TS;FIRST;TS;SECOND;TS;THIRD;TS;" " "
10 OUTPUT 718;"FUNCDEF PRESET," "IP;LF;S2;" " "
20 OUTPUT 718;"FUNCDEF FIRST," "FA100MZ;FB300MZ;" " "
30 OUTPUT 718;"FUNCDEF SECOND," "FA500MZ;FB700MZ;" " "
40 OUTPUT 718;"FUNCDEF THIRD," "FA800MZ;FB1000MZ;" " "
50 OUTPUT 718;"KEYDEF 2,M_AIN;"
50  END
```



The KSA command sets the amplitude readouts (reference level, marker, display line, and threshold) to dBm units.

OUTPUT 718; "KSA;"

The KSA command is identical to manual operation of the front panel   keys, (See AUNITS.)

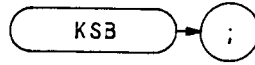

KSB

Amplitude in dBmV



The KSB command sets the amplitude readouts (reference level, marker, display line, and threshold) to dBmV units.

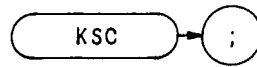

OUTPUT 718; "KSB;"

The KSB command is identical to manual operation of the front panel   keys. (See AUNITS.)



The KSC command sets the amplitude readouts (reference level, marker, display line, and threshold) to dBuV units.

```
OUTPUT 718; "KSC;"
```

The KSC command is identical to manual operation of the front panel   keys. (See AUNITS.)

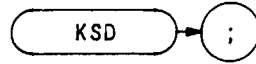

KSD

Amplitude in volts



The KSD command sets the amplitude readouts (reference level, marker, display line, and threshold) to V units.

OUTPUT 718; 'KSD;'

The KSD command is identical to manual operation of the front panel   keys. (See AUNITS.)

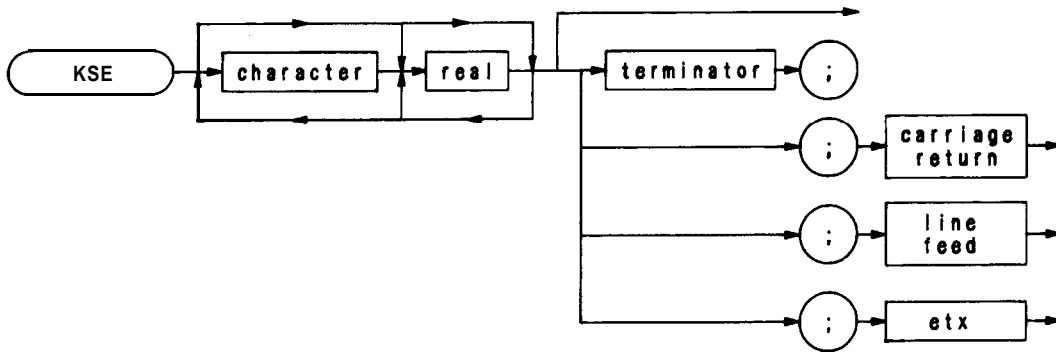

Item	Description/Default	Range Restriction
Character	Represents text displayed on screen.	ASCII codes 32 through 126.
REAL	Represents text displayed on screen.	
Terminator	Character defined in OT command that terminates text.	ASCII codes Ø through 255
Carriage Return	Terminates text.	ASCII code 13
Line Feed	Terminates text.	ASCII code 10
etx	Terminates text. (End-of-text)	

The KSE command activates the title mode. This function writes a message in the top CRT display line.

Any character on the controller keyboard can be written. The full width of the display is available for writing a maximum of 58 characters. However, the marker readout may interfere with the last sixteen characters of the title.

The message must be terminated. Terminate the message with one of the following:

- A terminator defined with the DT command.
- Carriage-return (ASCII 13).
- Line-feed (ASCII 10).
- End-of-text command (controller dependent).

KSE (Continued)

To erase the message, execute instrument preset (IP) or recall an instrument state with the RCLS or RC command. The message can also be erased by executing a KSE command that does not contain a message, as in the program below.



Line 10: Instrument preset.
Line 20: Activates the title mode and writes "Adjust Antenna" in the top CRT display line.
Line 30: Pauses program until CONTINUE is pressed on the HP series 200 controller.
Line 40: Prints a blank message on the screen; thus blanking the "Adjust Antenna" message.

The HP series 200 computers execute a carriage-return/line-feed whenever the ENTER key is pressed. Thus, lines 20 and 40 of the program above terminate the message this way. The same program is shown below, but the KSE command message is terminated with a terminator defined by the DT command.

```
10 OUTPUT 718;"DT@";  
20 OUTPUT 718;"KSEAdjust Antenna@";  
30 PAUSE  
40 OUTPUT 718; "KSE"  
50 END
```

Line 20 can also be terminated with a carriage-return this way:

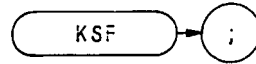

```
20 OUTPUT 718;"KSEAdjust Antenna";CHR$(13)
```

The functions of the KSE command and the   keys are identical.



The KSF command is a diagnostic aid used for servicing the spectrum analyzer.

The KSF command removes the IF offset from the YIG-tuned oscillator so that the start frequency can be tuned directly from the front panel.

The functions of the KSF command and the   keys are identical.

KSG

Video Averaging On

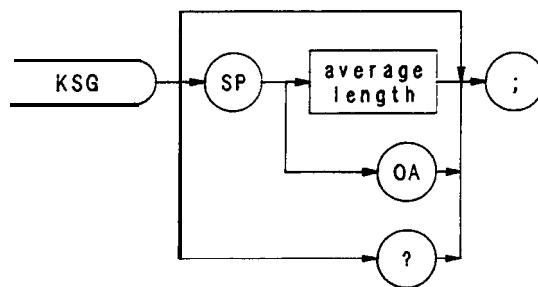



The KSG command enables video averaging. During video averaging, two traces are displayed simultaneously. Trace C contains signal responses as seen at the input detector. Trace A or B contains the same responses digitally averaged. The digital reduces the noise floor level, but does not affect the sweep time, bandwidth, or any other analog characteristics of the analyzer.

Before executing KSG, select trace A or B as the active trace (CLR W) and blank the remaining trace.

The active function readout indicates the number of sweeps averaged; the default is 100 unless otherwise specified. Increasing the number of sweeps averaged increases the amount of averaging.

Use KSG to view low level signals without slowing the sweep time. Video averaging can lower the noise floor more than a 1 Hz video bandwidth can, if a large number of sweeps is specified for averaging. Video average may also be used to monitor instrument state changes (such as changing bandwidths or center frequencies) while maintaining a low noise level. (See Chapter 11 in Section I. Also see KSH and VAVG .)

OUTPUT 718;"KSG;"

The functions of the KSG command and the   keys are identical.

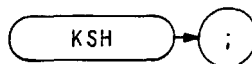

The KSH command disables the video averaging function of the analyzer. The KSH command is identical with manual operation of the (, . I,  keys.



```
OTJTPUT 718;"KSH;"
```

(See KSG and VAVG .)

KSI

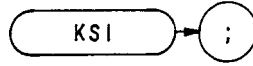
Reference Level Range (Extended)



The **KSI** command extends the analyzer reference level range to maximum limits of -139.9 dBm and $+60$ dBm. The functions of the **KSI** command and the   keys are identical.

The lower limit of the reference level depends on resolution bandwidth and scale selection, log or linear. When the reference level is set at minimum, the level may change if either resolution bandwidth or scale selection is changed. The table below shows the relationship between the scale and/or the resolution bandwidth, and the reference level range.

The extended reference level range is disabled with an instrument preset (II?)

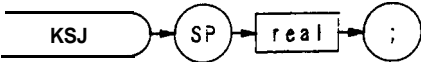

Scale	Resolution Bandwidth	Minimum reference level with extended reference level	
		10 dB attenuation	0 dB attenuation
log	≤ 1 kHz	-129.9 dBm	-139.9 dBm
log	≥ 3 kHz	-109.9 dBm	-119.9 dBm
linear	≤ 1 kHz	-109.9 dBm	-119.9 dBm
linear	≥ 3 kHz	-89.9 dBm	-99.9 dBm



Item	Description/Default	Range Restriction
Carriage Return	Sets all DACs to the specified value.	ASCII code 13
Line Feed	Sets all DACs to the specified value.	ASCII code 10
etx	Asserts end of text.	

The KSJ command is a diagnostic aid used for servicing the spectrum analyzer.

The KSJ command allows the DACs on the A16 Scan Generator and the A19 Digital-Analog Converter to be manually controlled from the front panel.

The functions of the KSJ command and the   keys are identical.

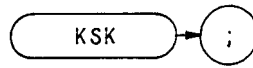

KSK

Marker to Next Peak



If an active marker is on screen, KSK moves the marker to the next signal peak of lower amplitude.

See MKPK.

The functions of the KSK command and the   keys are identical.

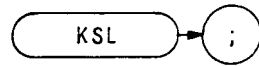

The KSL command disables the noise level function which displays the RMS noise level at the marker. (See MKNOISE or KSM.)



KSL does not blank the marker. Use MKOFF or M1 to blank the marker. (Because MKOFF and M2 remove the marker from the screen, they also disable the noise level mode.)

```

10 OUTPUT 718; "MKF 50 MZ;"
20 OUTPUT 718; "KSM;"
30 OUTPUT 718; "KSL;"
40 OUTPUT 718; "M1;"
50 END

```

Line 10: Positions marker at 50 MHz.
 Line 20: Selects noise level mode.
 Line 30: Turns off noise level mode.
 Line 40: Blanks marker.

The functions of the KSL command and   keys are identical."/>

KSM

Marker Noise On

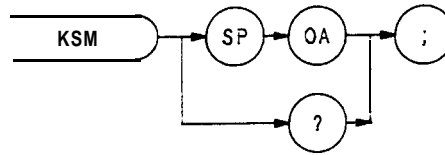



The KSM command displays the RMS noise level at the marker. The RMS value is normalized to a 1 Hz bandwidth.

The KSM command averages the amplitude of 32 elements about the location of the marker, in the frequency or time scale. The average value is converted to the current reference level unit (dBm, dBmV, dBuV, or volts).

The noise level function measures accurately to within 10 dB of the analyzer's own internal noise level. The readout resolution is + — 0.1 dB.

OUTPUT 718; "KSM;"

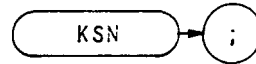

The functions of the KSM command and the   keys are identical. See also MKNOISE and KSO.



The KSN command moves the active marker to the minimum value detected. (See also MKMIN.)

OUTPUT 718; "KSN; "

The functions of the KSN and MKN commands are identical. See MKPK.

The functions of the KSN command and the   keys are identical.

KSO

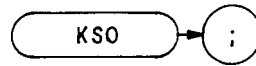

Marker Span
(MKSP)



The **KSO** command operates only when the delta marker is on. (See MKD or M3.) When the delta marker is on, and **KSO** is executed, the delta marker and active marker specifies start frequency, and the right marker specifies stop frequency. If delta marker is off, there is no operation.



OUTPUT 718;"KSO;"

The functions of the MKSP and **KSO** command are identical.

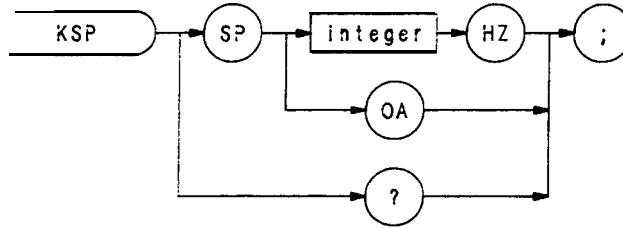
The functions of the **KSO** command and the   keys are identical.



Item	Description/Default	Range Restriction
Integer		Ø thru 30



The KSP command enables the user to display or change the current read/write HP-IB address of the analyzer. The KSP command is identical with manual operation of the front panel    keys.

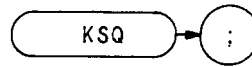

OUTPUT 718; "KSP 15HZ;"

KSQ

Band Unlock



The KSQ command unlocks the analyzer from a specific band (harmonic number). The functions of the KSQ command and the front panel   keys are identical.

Either one of the full span keys,  or , will also unlock a preselected band.

OUTPUT 718; "KSQ;"

The functions of the KSQ and HNUNLK commands are identical.

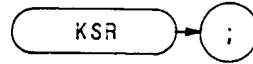

The KSR command is a diagnostic aid used for servicing the spectrum analyzer.

The KSR command displays specific internal frequency control parameters in the upper left corner of the CRT display. These parameters are the programmed values determined by the Controller Assembly, A15.

The following is a sample of what might appear when KSR is executed.



```
(1)      400 000
(2)      000
(3)     1 25 13
(4)    180.769 231
( 5 )  150.000 000
(6)    160.00 000
```

- Line -1: Displays the YIG-tuned oscillator (YTO) start frequency in GHz.
- Line 2: Displays the 20/30 loops frequency.
- Line 3: Displays the band number, M phase-lock-loop divide number, and N phase-lock-loop divide number.
- Line 4: Displays the M/N loop frequency.
- Line 5: Displays the phase-lock-loop 2 (PLL2) voltage-controlled oscillator (VCO) frequency.
- Line 6: Displays the phase-lock-loop 3 (PLL3) voltage-controlled oscillator (VCO) frequency.

NOTE

In line 6, an asterisk (*) appears in front of the VCO frequency when the span width is greater than the LO harmonic number times 100 kHz, or the span width is less than or equal to the LO harmonic number times 5 MHz.

The asterisk indicates that the VCO frequency is not used to determine the 20/30 loop frequency

The functions of the KSR command and the   keys are identical.

KSS

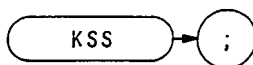

Fast HP-IB Remote Operation







The KSS command enables fast HP-IB operation that allows the analyzer to operate faster than normal under remote operation.

Fast HP-IB operation (KSS) remains in effect until deactivated by one of the following commands: **IP**, **LF**, **KSU**, **KST**, **RCLS**, or a local message (e.g. **LOCAL 718**).

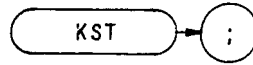
For further information on the KSS command, refer to Appendix E.

The functions of the KSS command and the   keys are identical.





The KST command enables a fast preset (2-22 GHz), similar to an instrument preset (IP) except that the internal bus check is not performed. The functions of the KST command and the front panel    keys are identical.

For additional information on fast operation, refer to Appendix E.

KSU

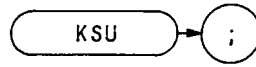
Fast Preset External Mixer



The KSU command presets the external mixer mode by setting the frequency range to 18.0-26.5 GHz. This frequency range is derived from the 6th harmonic of the analyzer local oscillator. The functions of the KSU command and the front panel   keys are identical.

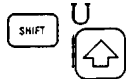

When KSU is executed, the analyzer does a fast preset (similar to KST) and readies the analyzer for external mixing by locking the frequency range to the 6th harmonic. The current harmonic number is displayed above the graticule, and the current conversion loss is displayed to the left of the graticule.

If a harmonic lock (such as KSt) is in effect, an "L" is also displayed following the current harmonic number.

Changing the frequency range with start and stop frequencies automatically changes the local oscillator frequency to the corresponding harmonic.

OUTPUT 718; "KSU;"

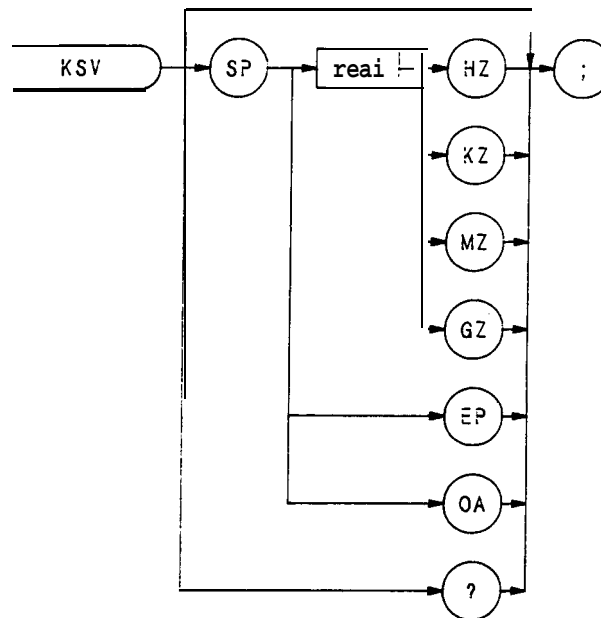

The KSV command selects a value that offsets the frequency scale for all absolute frequency readouts, such as center frequency. Relative values, like span and delta marker, are not offset.

After execution, the KSV command displays the frequency offset in the active function readout. The offset value is always displayed beneath the CRT graticule line, as long as the offset is in effect.

```

10 OUTPUT 718;"KSV 100MZ;"
20 ENTER 718;N
30 PRINTN
40 END

```

When queried(?), KSV returns the offset value as a real number, followed by carriage-return/line-feed (ASCII codes 13, 10). The end-or-identify (EOI) is asserted with the line feed.

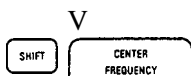
The functions of the KSV command and the  keys are identical.

KSW

Error Correction Routine

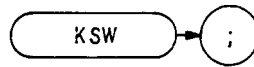

The KSW command executes a built-in error correction routine. This routine takes approximately 30 seconds to run and when completed, the instrument returns to its previous state. The functions of the KSW command and the front panel  keys are identical.

The error correction routine measures and records the amplitude and frequency error factors with reference to the 100 MHz calibration output (CAL OUT) signal, the 1 MHz resolution bandwidth, the 10 dB input attenuator, and the step gains. The "CORR'D" message to the left of the graticule indicates the routine has been run and the display has been corrected.

Use the error correction routine to ensure data has been corrected to the most recent calibration.

Before executing KSW, recall registers 8 and 9, follow the calibration procedure described in the introduction in Section I.

```
10  OTJTPUT 718;"RCLS 8;"
20  PAUSE
30  OUTPUT 718; "RCLS 9;"
40  PAUSE
50  OUTPUT 718;"KSW;"
```

When the routine is completed, the error correction data can be displayed on the CRT with the KSw (display correction data) command. (See KSw.)

Accuracy of an amplitude measurement can be improved by taking advantage of the correction data stored in the analyzer by the KSW command. For additional information on improving the amplitude accuracy, see the KS91 command.

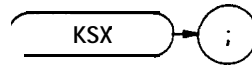

The K SX command automatically incorporates the error correction factors into measurements taken by the analyzer. The CRT readout values are automatically offset by the error correction value. The functions of the K SX command and the front panel [,,I,  keys are identical.

The error correction factors are generated by an error correction routine. Use the K SW command to run the routine. (To view the correction factors, execute K SW.)



For additional information on amplitude accuracy, see K S91, K SW, K S w, and K SY.

```
OUTF'UT 718; "K SX;"
```

KSY

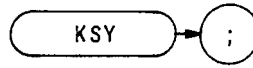
Correction Factors Off



The KSY command prevents the error correction factors from being used in measurements taken by the analyzer. The functions of the KSY command and the front panel   keys are identical.



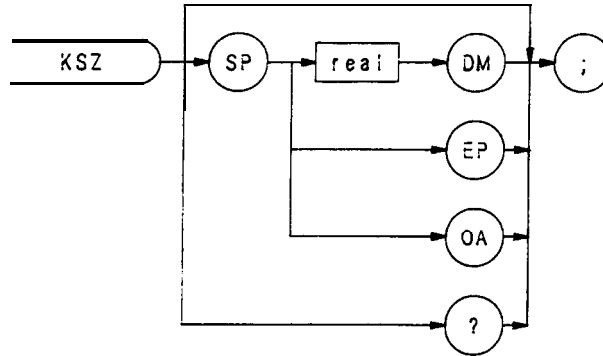

OUTPUT 718; "KSY;"

S KSW, KSw, and KSX.



Item	Description/Default	Range Restriction
REAL	Default value for units is dBm (DM)	+ – 300 dB

The KSZ command offsets all amplitude readouts on the CRT display without affecting the trace. The functions of the KSZ command and the front panel   keys are identical.

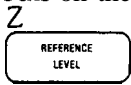

Once activated, the KSZ command displays the amplitude offset in the active function block. And, as long as the offset is in effect while doing other functions, the offset is displayed to the left of the graticule.

OUTPUT 718; “KSZ — 12DM;”

The functions of the KSZ and ROFFSET commands are identical.

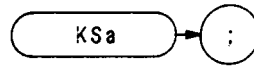

KSa

Normal Detection



The **KSa** command selects normal input detection for displaying trace information. This enables a detection algorithm called the Rosenfell detection, which selectively chooses between positive and negative peak values. The choice depends on the type of video signal present.

OUTPUT 718; "KSa;"

The **KSa** function and the front panel function   are identical. (See DET.)

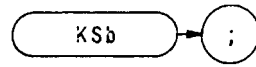

The **KSb** command selects positive-peak input detection for displaying trace information. During this mode, the trace elements are updated only when the detected signal level is greater than the previous signal level. (See DET.)

OUTPUT 718; "KSb;"

The **KSb** function and the front-panel   function are identical.

KSc

A + B → A
(APB)

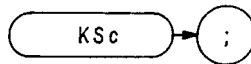

The KSc command adds trace A to trace B, point by point, and sends the result to trace A. Thus, KSc can restore the original trace after an A ← minus – B function (AMB) is executed.



A + B - > A

To successfully add all trace elements, place trace A in VIEW or BLANK display mode before executing KSc.

```
10 ASSIGN @Sa TO 718
20 OUTPUT @Sa; "IP;LF;"
30 OUTPUT @Sa; "CF100MZ;SP2MZ;"
40 OUTPUT @Sa; "A4; "
50 OUTPUT @Sa; "B1;CF200MZ;"
60 OUTPUT @Sa; "B4;"
70 OUTPUT @Sa; "A3;B3;"
80 OUTPUT @Sa; "KSc;"
90 END
```

Line 20: Presets the instrument.
Line 30: Sets trace A to 100 MHz center frequency with 2 MHz frequency span.
Line 40: Blanks trace A.
Line 50: Selects trace B and sets center frequency to 200 MHz.
Line 60: Blanks trace B.
Line 70: Views trace A and trace B.
Line 80: Combines the amplitude of trace B with trace A and displays this combination as trace A.

The functions of the KSc and APB commands are identical.

The KSc function and the front-panel   OFF are identical.

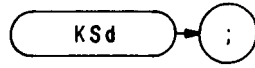



The **KSd** command selects negative-peak input detection for displaying trace information. During this mode, the trace elements are updated only when the detected signal level is less than the previous signal level. (See DET)

The functions of the **KSd** command and the I,] ^dVIEW keys are identical.

KSe

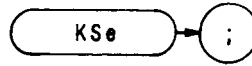
Sample Detection



The **KSe** command selects the sample detection **mode** for displaying trace information. The **KSe** command is identical with manual operation of the front panel  I-] keys.

In sample mode, the instantaneous signal value of the final analog-to-digital conversion for the sample period is stored in trace memory. As sweep time increases, many analog-to-digital conversions occur in each period, but only the final signal value is stored and displayed.

Sample detection mode is automatically selected for video averaging and noise level measurements.

OUTPUT 718; "KSe;"

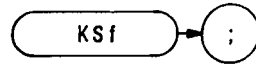

The above program line selects the sample detection mode of the analyzer.



Use the **KSf** command to recall any instrument configuration in the event of power loss.

If **KSf** is the last command executed, and the analyzer loses power, the instrument state at the time of power loss is restored when power returns.

If any spectrum analyzer command is executed, or any front panel key is pressed after **KSf** is executed, the analyzer configuration can not be regained if power is lost.

The functions of the **KSf** command and the   keys are identical.

KSg

CRT Beam Off

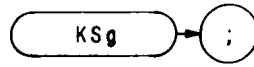

The **KSg** command turns off the CRT beam power supply to avoid unnecessary wear of the CRT in cases where the analyzer is in unattended operation. The **KSg** command is identical with manual operation of the front panel

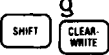

 keys.

The **KSg** command does not affect HP-IB input/output of instrument function values or trace information.

OUTPUT 718; "KSg;"

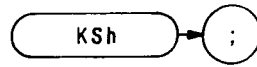
The above program line turns the CRT beam power supply off.



The **KSh** command turns the CRT beam on and is activated automatically with an instrument preset. The **KSh** command is identical with manual operating of the front panel   keys.

OUTPUT 718;"KSh;"

The above program line activates the CRT beam power supply of the analyzer.

KS*i*

Exchange B and C
(BXC)

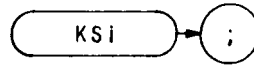

The **KS*i*** command exchanges traces C and B, point by point.



Note trace C is not a swept, active function. Therefore, exchange traces C and B as follows:

1. Select single sweep mode (SNGLS) .
2. Select desired analyzer settings.
3. Take one complete sweep (TS) .
4. Exchange data.

This procedure ensures that the current settings of the analyzer are reflected in the transferred data.

When transferring data from one trace to another, only amplitude information is exchanged, located in display memory addresses 1025 through 2025 and 2049 through 3049.

The functions of the **KS*i*** and BXC commands are identical.

The functions of the **KS*i*** command and the   keys are identical.

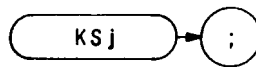

The **KSj** command displays trace C. Amplitude information for trace C is contained in display memory addresses 3073 through 4073. The **KSj** command displays this trace information on the analyzer display.

KSj also sends the instruction word, 1048 . , to address 3072. Therefore, any information stored in address 3072 is lost when **KSj** is executed. If you have used address 3072 for a graphics program or a label, you may wish to save its contents before executing **KSj**.

Trace C is not a swept, active trace, as are traces A and B. **send** data to trace C with these commands:

BTC or KS1 transfers trace B amplitude information to trace C.
 BXC or **KSj** exchanges trace B and trace C amplitude information.
 DW or KS125 sends trace information to trace C.

Transfer trace amplitude information as follows:

1. Select single sweep mode (SNGLS or S2).
2. Select desired analyzer settings.
3. Sweep analyzer (TS) .
4. Transfer data.

The program below demonstrates **KSj** .

```

10  ASSIGN @Sa TO 718
20  OUTPUT @Sa; "IP;LF;"
30  OUTPUT @Sa; "A4;S2;"
40  OUTPUT @Sa; "B1;CF200MZ;SP2MZ;TS;"
50  OUTPUT @Sa "KS1;"
60  OUTPUT @Sa; "B4;"
70  OUTPUT @Sa; "KSj;"
50  END

```

Line 20: Presets the instrument.

Line 30: Stores and blanks trace A. Selects single sweep mode (S2).

Line 40: Selects trace B. Sets the analyzer to 200 MHz center frequency with a 2 MHz frequency span.
 Takes one complete sweep of trace B at the current settings (TS) .

KSj (Continued)

Line 50: Exchanges trace B and trace C. Trace C (containing no trace data) now appears on the display as trace B. The asterisk (*) in the top right corner of the analyzer does not agree with the current display.

Line 60: Stores and blanks trace B (containing no trace data and an asterisk in the top right corner).

Line 70: Views trace C .

Commands BTC, **KS1**, BXC, and **KSj** manipulate trace amplitude information in display memory addresses 3074 through 4073. They do not manipulate data in the remaining display addresses that are allocated to trace C: addresses 4073 through 4095, and 3072. These addresses are available, in addition to address 3073 and 4074, for custom graphics programming or labels. (See Appendix B.)

The functions of the **KSj** command and   keys are identical. (See VIEW and BLANK.)

. 1048 is a machine instruction word that sets addresses 3073 through 4073 to zero and draws the trace dimly.

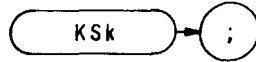

The **KSk** command blanks trace C. Amplitude information for trace C is contained in display memory addresses 3073 through 4073. The **KSk** command blanks trace C but does not alter the information stored in these addresses.

KSk also sends the instruction word, **1044***, to address 3072. Therefore, any information stored in address 3072 is lost when **KSk** is executed. If you have used address 3072 for a graphics program, or label, you may wish to save its contents before executing **KSk**.

The functions of the **KSk** command and   keys are identical. (See **KSj**, VIEW and BLANK.)

* **1044** is a machine instruction word that sets addresses 3073 through 4073 to zero and  to the next page memory.

KSI

Transfer B to C
(BTC)

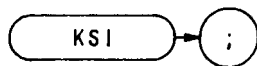

The **KSI** command transfers trace B to trace C.

Note trace C is not a swept, active function. Therefore, transfer trace information to trace C as follows:



1. Select single sweep mode (**S2**).
2. Select desired analyzer settings.
3. Take one complete sweep (TS) .
4. Transfer data.

This procedure ensures that the current settings of the analyzer are reflected in the transferred data.

```
10 OUTPUT 718;"IP;LF;TS;SNGLS;A3;"
20 OUTPUT 718;"B1;CF 20MZ;TS;B4;"
30 OUTPUT 718;"KS1;KSj"
31 LOCAL718
40 END
```

When transferring trace data from one trace to another, only the trace information from **1001** display memory addresses is transferred out of the total 1024 available display memory addresses. Information in address 1024 and addresses 2026 through 2047 is not transferred. (Addresses 2026 through 2047 are usually used for custom graphics.)

The functions of the **KSI** and BTC commands are identical.

The functions of the KSI command and the   keys are identical." data-bbox="73 720 620 751"/>

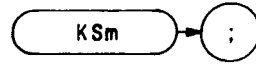

The **KSm** command blanks the graticule on the analyzer display. The **KSm** command is identical with manual operation of the front panel **SHIFT** **m** **OFF** keys.



```
OUTPUT 718; "KSm;"
```

See also **GRAT**.

KS_n

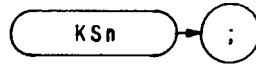
Graticule On



The **KS_n** command turns on the graticule of the analyzer display. The **KS_n** command is identical with manual operation of the front panel    keys.



OUTPUT 718;“KS_n;”

See GRAT and **KS_m** .

KSo

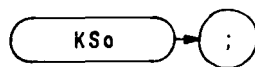
Characters Off



The **KSo** command blanks the annotation on the analyzer display. The functions of the **KSo** command and the front panel   keys are identical.



OUTPUT 718; "KSo;"

See **ANNOT** and **KSp**.

KSp

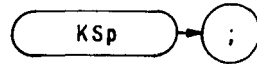
Characters On



The **KSp** command turns on all annotation on the analyzer display. The functions of the **KSp** command and the front panel    keys are identical.

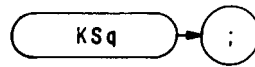

OUTPUT 718; "KSp;"

See **KSo** and **ANNOT**.



The **KSq** command is a diagnostic aid used for servicing the spectrum analyzer.

The **KSq** command uncouples the step gain amplifiers (from attenuator changes) of the IF section (**A4A5** Step Gain and **A4A8** Attenuator-Bandwidth Filter).

The functions of the **KSq** command and the   key are identical.

KSr

Service Request 102

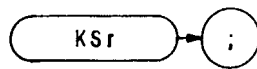

The **KSr** command sends service request 102 to the controller, notifying the controller that the operator has requested service. See Appendix D.

The functions of the **KSr** command and the (,,I,  keys are identical.

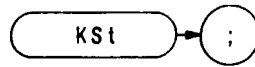

The **KSt** command (harmonic lock) limits the tuning range of the analyzer to a specific harmonic of the local oscillator as selected by start and stop frequencies. The functions of the **KSt** command and the front panel  keys are identical.

When executing a harmonic lock, use the following method to ensure the desired harmonic is selected:

1. Select desired harmonic by setting a start frequency within the desired band. (See Tuning Curves in Appendix F for frequency range of each harmonic.)
2. Set analyzer to single sweep mode. Single sweep ensures the desired harmonic is selected when executing a bank lock.
3. Execute **KSt** to lock the desired harmonic.
4. Set analyzer to continuous sweep mode.
5. Reset desired start and stop frequencies.

Remember, before you can change the frequency range to another harmonic, you must unlock the band with the **KSQ** (harmonic unlock) command.

KSR (Diagnostics On) can be activated, at any time, to display the local oscillator harmonic number in the upper left corner of the CRT display

```

10  ASSIGN @Sa TO 718
20  OUTPUT @Sa;"IP;"
30  OUTPUT @Sa;"FA6.0GZ;"
40  OUTPUT @Sa;"S2;TS;"
80  OUTPUT @Sa;"KSt;"
80  OUTPUT @Sa;"S1;"
70  OUTPUT @Sa;"FA5.0GZ;FB12.5GZ;"
80  END

```



- Line 20: Presets the instrument.
- Line 30: Sets a start frequency of 6.0 **GHz** which automatically selects the second harmonic.
- Line 40: Sets the analyzer to single sweep mode and takes one complete sweep of the current display
- Line 50: Locks the second harmonic of the local oscillator.
- Line 60: Resets the analyzer to continuous sweep mode.
- Line 70: Sets the frequency range of the second harmonic.

KSu

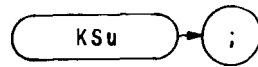
Marker Stop



The **KSu** command stops the sweep at the active marker. (See also **MKSTOP**.)

The functions of the **KSu** command and the   keys are identical.

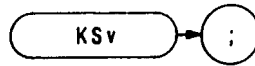



The **KSv** command enables a signal identifier routine that use the active marker to automatically identify the signal under observation in the external mixing mode.

OUTPUT 718; "KSv;"

If a marker is present on screen when **KSv** is executed, **KSv** determines the frequency and mixing harmonic of the signal at the marker. If a marker is not on screen, **KSv** fit places a marker at the highest peak on screen, and then determines the frequency and mixing harmonic of that signal. If no identification can be made, the original state, prior to executing the **KSv** command, is automatically restored. If this should occur, change the harmonics and amplitude delta values used by the signal identification routine, and then reexecute **KSv**. (See **SIGDEL**, **NSTART**, and **NSTOI?**)

If a harmonic lock (**KSt**) is in effect when the **KSv** command is executed, the lock is restored when the identification process is finished.

The functions of the **SIGID** and **KSv** commands are identical.

The functions of the **KSv** command and the   keys are identical.

KSw

View Correction Data

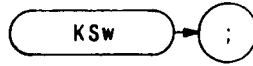

The **KSw** command displays the correction data of the error correction routine of the analyzer. **KSw** executes the correction routine. (See **KSW**.) The functions of the **KSw** command and the front panel  **W**, **[,I.,** keys are identical.

Correction data can also be transferred to the controller **by** executing the **KSw** (display correction routine) command. The correction data is transferred in sequence as a series of 43 strings using the following program:

```
10 DIM A$(1:43)[80]
20 OUTPUT 718;"KSw;"
30 FOR N = 1 TO 43
40 ENTER 718;A$(N)
80 NEXT N
```

Line 10: Dimensions string array storage (in the controller memory) for correction data.
Line 20: Sends correction data to controller.
Line 30 to 50: Sequentially stores correction data in array.

The content of each string is the error in **dB** or Hz for a specific control setting relative to a set of standard settings determined at the factory. Strings 6 through 29 contain the amplitude and frequency errors displayed on CRT lines 6 through 17. Data in strings 1 through 5 correspond to CRT lines 1 through 5, and data in strings 30 through 43 correspond to lines 18 through 31. The errors listed should be within the specification listed on the Error Correction Routine Table.

For additional information on the error correction routine, see Error Correction Routine in Chapter 11 of Section I.

Error Correction Table

Parameter	Specification
LOG and LIN scale, BW <100 kHz	± 1 dB typical
LOG 10 dB/	} $\pm (0.5$ dB — 1 dB reading)
LOG 5 dB/	
LOG 2 dB/	
LOG 1 dB/	
RES BW = 3 MHz	± 0.5 dB
1 MHz	± 1 dB*
300 kHz	.
100 kHz	} ± 0.5 dB*
30 kHz	
10 kHz	
3 kHz	
1 kHz	
300 Hz	
100 Hz	
30 Hz	
10 Hz	± 1 dB*
LOG and LIN scale, BW \geq 100 kHz	± 1 dB typical
Step Gains = A20	± 0.6 dB
A10	t
SG20-2	} ± 1.0 dB
SG20-1	
SG10	
LG20	} ± 1.0 dB typical
LG10	
RF ATTENUATOR = 20 dB	} ± 0.2 dB typical
20 dB	
30 dB	
40 dB	
50 dB	
60 dB	
70 dB	
. Specifications for all Resolution Bandwidths are referenced to the 1 MHz Resolution Bandwidth. The frequency error terms are for error correction only.	

KSx

External Trigger

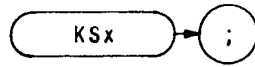

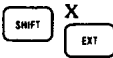

The **KSx** command activates the normal external trigger mode, but eliminates the automatic refresh for **swept**-mes less than 20 msec. (The T3 and TM commands do not inhibit the automatic refresh.) The functions of the **KSx** command and the front panel  keys are identical.

When the **KSx** command is executed, the RF input signal is displayed only when the external trigger signal exceeds the threshold of the trigger level.

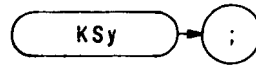
OUTPUT 718; "KSx;"



The **KSy** command activates the normal video trigger mode, **but** eliminates the automatic refresh for sweeptimes less than 20 msc. (The T4 and TM commands do not inhibit the automatic refresh.) The functions of the **KSy** command and the front panel  ^y  Trigger keys are identical.



When the **KSy** command is executed, the RF input signal is displayed only when the video trigger signal, which is internally triggered off the input signal, exceeds the threshold of the trigger level.

OTJTPUT 718;“KSy;”

KSz

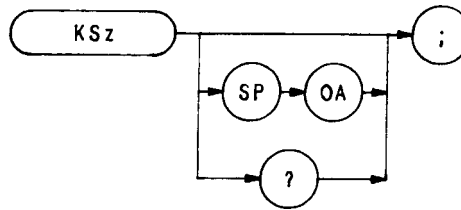
Storage Address



The **KSz** command displays the specified display memory address of the analyzer from \emptyset to 4095. If an address is not specified, the analyzer displays the current address. The functions of the **KSz** command and the front panel   keys are identical.

The **KSz** command has the same function as the DA command.

OUTPUT 718; "KSz;"

For additional information on the **KSz** command, see DA.

**KS,
Mixer Level
(ML)**

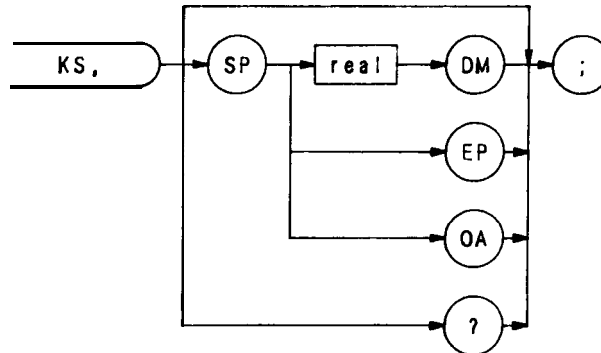



The KS, command specifies the maximum signal level that is applied to the input mixer for a signal that is equal to or below the reference level.

The effective mixer level is equal to the reference level minus the input attenuator setting. When KS, is activated, the effective mixer level can be set from -10 dBm^* to -70 dBm in 10 dB steps. Instrument preset (IP) selects -10 dBm .

The program line below sets the mixer level to -40 dBm

OUTPUT 718; "KS, - 40DM;"

As the reference level is changed, the coupled input attenuator automatically changes to limit the maximum signal at the mixer input to -40 dBm for signals less than or equal to the reference level.

The functions of the KS, and ML commands, and the   keys are identical. See also AT

. In the extended reference level range, the effective mixer level can be set to 0 dBm .

KS=

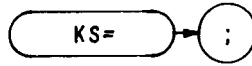

Automatic Preselector Tracking



Use the KS= command to reinstate automatic preselector tracking after KS/ has been executed. Normally, the center of the preselector filter automatically tracks signal responses in the four frequency bands of the 2 to 22 GHz range.

The KS/ command allows manual adjustment of the preselector tracking. The PP command automatically optimizes preselector tracking at any one frequency.

OUTPUT 718; "KS = ;"

The functions of the KS = command and the   keys are identical.

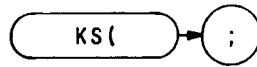

(See KS/ and PP.)





The **KS(** command secures the contents of registers one through six. When the registers are secured, the SV and SAVE commands cannot save more instrument states in the registers, but instead write “SAVE LOCK” on the analyzer display. To save an instrument state in a locked register, first execute KS) to unlock the registers.

The recall function of the analyzer is not affected by this function.

OUTPUT 718;“KS(;



The functions of the **KS(** command and the   keys are identical.

The **KS(** command also protects the contents of any user-defined **softkeys** when the analyzer is under manual operation. During manual operation, **softkeys** are loaded by pressing the  key. Loading a **softkey** with new information erases the original contents of the **softkey**. If **KS(** has been executed, pressing  does not load a **softkey**. Thus, existing **softkey** contents cannot be altered. Execute **KS)** to **unsecure** the **softkeys**.

KS)

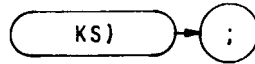
Unlock Registers



The KS) command unlocks the registers where instrument states are stored with SV and SAVE commands. The functions of the KS) command and the front panel   keys are identical.

When the registers are unlocked, new instrument states can be saved in registers one through six. Each time new states are stored, the original register contents are erased.

The recall function of the analyzer is not affected by this function.

```
OUTF'UT 718; "KS);"
```

The KS) command also unlocks user-defined softkeys, which are locked during manual operation only, by the KS(command.

See KS(.

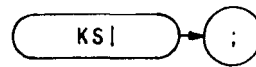

The **KS|** command writes the instruction word or data value into the specified display memory address. The functions of the **KS|** command, the front panel  keys, and the DW command are all identical.



The sample program lines below demonstrate how to format the **KS|** command.

```

10 OUTPTJT 718;"KS|;"
20 OUTPUT 718;"KS";CHR$(124)
30 OUTPUT718 USING "K,B";"KS",124

```

For additional information on display write, refer to the DW command.

KS#

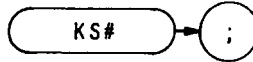

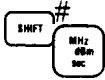
The **KS#** command turns off the **YIG-tuned** mixed (**YTX**) self-heating correction factor. The functions of the **KS#** command and the front panel  keys are identical.

Normally, preselector tracking is controlled by the preselector digital-to-analog converter (DAC) , and the thermal correction factor determined by the microprocessor. When **KS#** is executed, the thermal correction factor is not applied to the preselector tracking. Therefore, a DAC value is the only condition affecting preselector tracking.

Executing an instrument preset (IP) is the only way to re-enable the YTX self-heating correction factor.

OUTPUT 718; "KS#;"

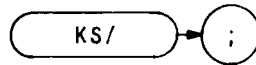



Use the KS/ command to manually adjust the internal preselector tracking. Normally, preselector tracking is automatically adjusted. (See PP and KS = .) However, the KS/ function is useful for adjusting preselector tracking of unstable signals, such as drifting signals or pulse modulated signals.

To manually adjust tracking, execute KS/ and then use the spectrum analyzer data knob to peak the signal response at the marker position. If no marker is on screen, KS/ automatically places a marker at the signal with greatest amplitude.

When KS/ is executed, the active function readout displays a number, from 0 to 63, which corresponds to the preselector frequency. Changing the active function readout by 1, shifts the preselector tuning by 1.13 MHz.

Once the preselector tracking is altered with the data knob, tracking is no longer automatically adjusted. Executing KS = is the only way to re-enable automatic preselector tracking.

OTJTPTJT718;“KS/;”

The functions of the KSE command and the   keys are identical.

(See KS = and PI?)

Write to Display Memory

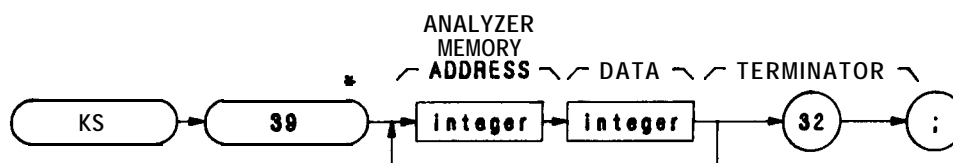

Item	Description/Default	Range Restriction
INTEGER	Represents the analyzer display memory address. Must be sent to analyzer as two 8-bit bytes.	1 to 4095
INTEGER	Represents amplitude data. Each data value must be sent to analyzer as two 8-bit bytes.	0 to 1022 Number of addresses between starting address and 4095.

KS39 is the general purpose command for writing data into the analyzer display memory. Any starting display address is allowed with KS39. Up to 4096 display memory values can be sent in one operation. Data sent with KS39 must be in 2-byte binary format, 02, and be terminated with a single binary byte value of 32. The number of bytes sent to the analyzer is limited by the number of addresses between the starting address and address 4095, the last display memory address. The display address must be sent to the analyzer in the 2-byte binary format.

KS123 and KS39 are often used together to read and write the contents of display memory. The following program demonstrates this.

```

10 OPTION BASE 1
20 DIM M$(8)[1024]
30 OUTPUT 718;"02;"
40 Da=0
50 !
60 FOR I=1 TO 8
70   OUTPUT 718;"DA";Da;"KS";CHR$(123)
80   ENTER 718 USING "#,1024A";M$(I)
90   Da = Da + 512
100 NEXT I
110 !
120 OUTPUT 718;"A3;B3;M1;L0;KSm;KSo;"
130 OUTPUT 718;"EM;KSi;EM; EX;KSi;EM;"
140 PRINT "OBSERVE BLANK SCREEN;PRESS CONTINUE"
150 PAUSE
160 !
170 OUTPUT 718 USING "#,K,B,W,";"KS";39;0
180 OUTPUT 718 USING "8(K),B";M$(*);32
190 OUTPUT 718;"A1;"
200 END
  
```

- Lines 10 to 100: Sends the content of trace memory to the controller. Refer to the description of the KS123 mnemonic for a complete explanation of these lines.
- Lines 120 to 150: Erases trace A, B, and C memories and blanks the annotation and graticule.
- Line 170: Sends the KS39 command and the display memory address to the analyzer. The USING part of the OUTPUT statement formats the controller to send the KS as a compact field, the 39 as a single binary byte, and the Ø (display address) as a two byte binary word, the # sign suppresses the trailing CR/LF so it will not be send as part of the display memory data.
- Line 180: Sends the display memory data contained in array M\$ to the analyzer and terminates the KS39 command with a 32. The USING part of the OUTPUT statement formats the controller to end the contents of the array as eight strings and the 32 as a single binary byte.
- Line 190: AI sets trace A to the clear-write mode. HD clears the active function block of the display, which contained a display address.

The KS39 command cannot be executed from the front panel.

. This is the decimal ASCII equivalent and is transmitted to the analyzer as a single 8-bit byte.

KS43

Frequency Limit SRQ

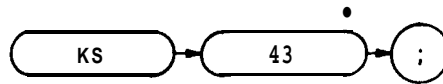

The KS43 command tells the analyzer to send the service request (SRQ) called “102” to the controller, if the analyzer current frequency band has been exceeded. In effect, KS43 lets the controller determine if the analyzer (because of commands given by the controller which exceed the analyzer frequency band) has automatically readjusted the start or stop frequency to keep it in the current band, or changed bands.

When the controller gives a command that exceeds the frequency range of the current band, the analyzer status byte is set to 66, which is equivalent to an octal 102. The analyzer then notifies the controller that a service request is ready. It does this by setting the HP-IB SRQ line true. To determine which service request the analyzer is indicating, the controller must do a serial poll of the analyzer status byte.

Note that service request 140 (illegal command) is always allowed by the analyzer. If the analyzer receives an illegal command from the controller, it set its status byte to 96 (octal 140).

The following program demonstrates the KS43 command. Note that the 43 in KS43 must be sent to the analyzer as a single binary byte.

```
10 OUTPUT 718;“IP;LF;”
20 OUTPUT 718 USING “K,B”;“KS”;43
30 OUTPUT 718;“CF 100MZ”
40 OUTPUT 718;“FA10MZ;FB3GZ”
50 ! NOTE “SRQ 102” message on analyzer’s CRT
60 END
```

The **FB3GZ** command exceeds the frequency range of the 0-2.5 GHz band. This causes the analyzer to display the SRQ 102 message. Note that when this program is run, the analyzer automatically changes the stop frequency (FB) to 2 GHz, instead of 3 GHz.

The KS43 command cannot be executed from the front panel.

. This is the decimal ASCII equivalent and is transmitted to the analyzer as a single 8-bit byte.

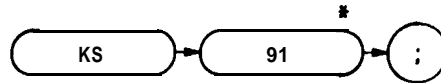

KS91 sends an amplitude correction value to the controller. This correction value improves measurement accuracy when it is subtracted from the amplitude measured by the analyzer.

The analyzer compiles the KS91 correction value from calibration data stored in its memory by the KSW command, the error correction routine. When the KS91 command is executed, the correction value is compiled from those parts of the KSW data that apply to the present instrument state. Execute KSW before KS91 to ensure the correction value is based on recent KSW data. Execute KS91 immediately after making your amplitude measurement to ensure the correction value is based on the right instrument settings.

The KSX (Use Correction Data) command puts the analyzer into a “corrected” mode. In this mode the analyzer automatically corrects its measurements with the data collected by the KSW command. The KSX command makes amplitude corrections by adjusting the IF gain. Because of the inaccuracies inherent in changing the IF gain, the correction mode established by the KSX command is up to 0.4 dB less accurate than the external mathematical correction made with the KS91 correction value.

The following program gives a sample readout of the KS91 correction value.

```

10 OUTPUT 718;"KSW;"
20 !
30 ! Any amplitude measurement routine
40 !
50 OWTJT 718 USING "K,B";"KS";91
60 ENTER 718;E
70 PRINT "AMPLITUDE ERROR IS ";E;" dB"
80 END

```

The correction value stored in variable E improves the amplitude measurement accuracy when it is subtracted from the measured amplitude.

The KS91 command cannot be executed from the front panel

. This is the decimal ASCII equivalent and is transmitted to the analyzer as a single 8-bit byte.

KS92

Write in Display Units

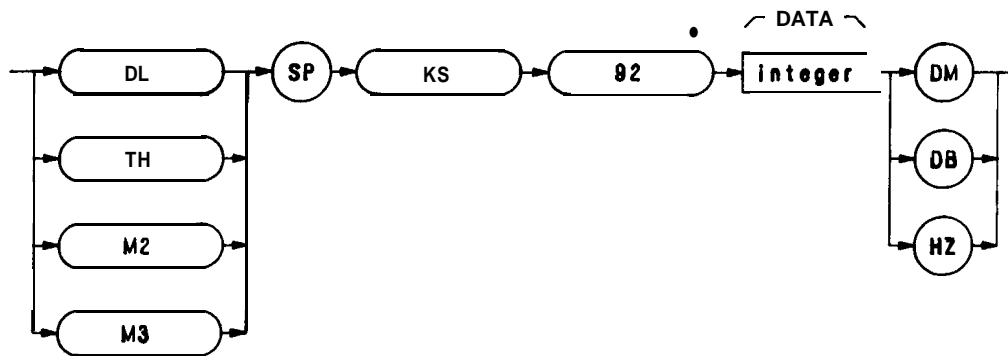

Item	Description/Default	Range Restriction
INTEGER	Represents display line, threshold, active marker, or delta marker amplitude in display units.	1 to 1022

The KS92 command tells the analyzer to receive the display line (DL), threshold line (TH), marker normal (M2), or delta marker (M3) position in display units. The program line below shows the KS92 syntax.

```
OWTJT 718 USING "K,B,K";"DL KS";92;"300HZ;"
```

The HZ keyword is this line functions as a terminator for the DL command. Without the HZ keyword, the DL command will not work. When used with KS92, the DL, TH, M2, and M3 commands must be terminated with one of the following keyword terminators: DM, DB, or HZ.

The KS92 command cannot be executed from the front panel.

. This is the decimal ASCII equivalent and is transmitted to the analyzer as a single 8-bit byte.

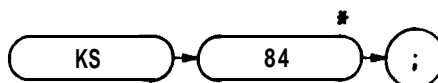

The KS94 command reads the analyzer current LO harmonic number. On execution of KS94, the analyzer sends a binary code to the controller, which represents the LO harmonic number. The decimal equivalent of this binary code represents the LO harmonic number such that 0 represents the 1st harmonic, 1 represents the 2nd harmonic, 2 represents the 3rd harmonic, and so forth.

The analyzer binary code is not followed by a terminator, Therefore, the controller must terminate its own ENTER command, which it uses to read the binary code. This is the function of the # sign in line 20 of the following program. This program reads the current LO harmonic number and prints it on the controller CRT

```

10 OUTPUT 718 USING "K,B";"KS";94
20 ENTER 718 USING "B,#";H
30 PRINTH
40 END

```

The KS94 command cannot be executed from the front panel.

. This is the decimal ASCII equivalent and is transmitted to the analyzer as a single 8-bit byte.

Read Display Memory

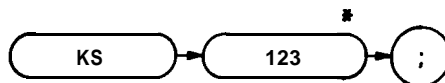

The KS123 command sends the contents of display memory to the controller. Thus, the controller “reads” display memory.

Starting at a designated address, KS123 sends 1001 of the 4096 analyzer display memory values to the controller. The analyzer output format and display memory address must be specified before executing KS123.

Follow the three steps listed below to send any section (up to 1001 addresses long) of display memory.

1. Specify the first display memory address of the section to be read.
2. Format a string or string array in the controller to store the exact number of values you need.
3. Terminate the KS123 command with a LOCAL 718 or an OUTPUT statement.

The KS123 command **tells** the analyzer to “wait” until 1001 memory values are read. If the **controller** does not read all 1001 memory values, the program must terminate this “wait” mode with step 3. The sample program below reads 10 memory values, starting at the center of trace A.

```

10  OPTION BASE 1
20  INTEGER A(10)
30  !
40  OUTPUT 718 USING "K,B";"01;DA 500;KS";123
50  ENTER 718;A(*)
60  OWUT 718;";"
70  LOCAL718
80  !
90  FOR I = 1 to 10
100  PRINTA(1)
110  NEXT I
120  END
  
```

If KS123 is used with DA1 or DA1025, it imitates the TA and TB commands; however, TA and TB are slightly faster and therefore preferable. The only efficient way to read the entire contents of trace C memory, however, is with KS123. This is done by executing a DA3073 before the KS123 command, and dimensioning enough controller memory for 1001 display values. To read individual values of trace data, use the DR command.

KS123 can **also** send all display memory contents (4096 values) to the controller. This is done with a program loop that advances the display address by one and executes subsequent KS123 commands. The program below is an example of this application.

```

10 OPTIONBASE 1
20 DIM M$(B)[ 1024]
30 OUTPUT 718;"02;"
40 Da=0
80 !
60 FOR I=1 TO 8
70   OUTPUT 718;"DA";Da;"KS";CHR$(123)
80   ENTER 718 USING "#,1024A";M$(I)
90   Da = Da + 512
100 NEXT I
110 !
120 OUTPUT 718;"A3;B3;M1;L0;KSm;KSo;"
130 OUTPUT 718;"EM;KSi;EM; EX;KSi;EM;"
140 PRINT "OBSERVE BLANK SCREEN;PRESS CONTINUE"
180 PAUSE
160 !
170 OUTPUT 718 USING "#,K,B,W";"KS";39;0
180 OUTPUT 718 USING "8(K),B,K";M$( *);32;";"
190 OUTPUT 718;"A1 HD"
200 END

```

- Line 20: Dimensions enough memory in **M\$** to contain all 4096 values of display memory. (8192 bytes or 2 times 4096 .)
- Line 30: Sets the analyzer output format to 2-byte binary. The KS39 command used in line 170 requires this format.
- Line 40: Sets the display address variable, **Da**, equal to the first address.
- Line 60: Defines the program loop. Eight cycles are necessary. The total number of display memory values (4096) is not evenly divisible by **1001**, which is the number of **values read by** KS123. The next smallest number by which 4096 is evenly divisible is 512. **4096/512 = 8**.
- Line 70: Sets the display address and executes KS123. The 123 must be sent as a single binary byte.
- Line 80: Enters the display memory data into the string array **M\$**. (1024 or 2 times 512 bytes are entered.)
- Line 100: Continues the program at line 70. Line 70 readdresses the analyzer, clearing the "wait" mode. This "wait" mode is a result of using KS 123 to read less than 1001 display memory values.
- Lines 120 to 150: Erases trace A, B, and C memories and blanks the annotation and graticule.
- Line 170 to 190: Restores the analyzer display by writing the contents of M4 back into display memory.

The KS123 command cannot be executed from the front panel.

. This is the decimal ASCII equivalent and is transmitted to the analyzer as a single 8-bit byte.

Write to Display Memory

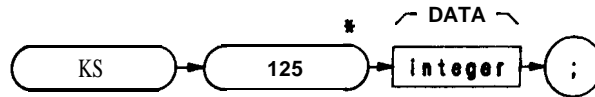

Item	Description/Default	Range Restriction
INTEGER	Represents amplitude data. Each trace data value must be sent as two 8-bit bytes. Up to 2002 bytes (1001 values) can be sent.	0— 1022

The KS125 command writes data, which is formatted in 2-byte binary, into the analyzer display memory. The KS125 syntax requires a specified starting address that immediately precedes KS125. Specify the address with the DA command. Up to 1001 display memory values are written with each execution of KS125.

The following program first uses KS123 to send the contents of trace B memory to the controller array. The program then writes the contents of the array back to the analyzer trace B memory.

```

10 OPTION BASE 1
20 INTEGER B_store( 1001)
30 !
40 OUTPUT 718;"A4;B1;TS;B3;"
50 OUTPUT 718 USING "K,B,#";"O2;DA1024;KS";123
60 ENTER 718 USING "W";B_store(*)
70 !
80 OUTPUT 718;"S1;A1;B1;"
90 LOCAL718
100 PRINT "CHANGE ANALYZER DISPLAYPRESS CONTINUE"
110 PAUSE
120 !
130 OUTPUT 718;"B3;"
140 OUTPUT 718; "DA 1024;"
150 OUTPUT 718 USING "K,B,#";"KS";125
160 OUTPUT 718 USING "W";B_store(*)
170 OUTPUT 718;";"
180 END
    
```

Line 20: Dimensions enough memory to store the contents of trace B memory. The INTEGER statement automatically dimensions 2 bytes for each element of string B-store (1001 elements).

Lines 40 to 60: Sweeps trace B and then sets it to the view mode. The analyzer is then set to the 2-byte binary display-units output format. Next, the contents of trace B are read by the controller and stored in string B-store.

Lines 80 to 110: Clears trace B, places the analyzer in the LOCAL mode, and tells the operator to change the analyzer display (trace B display) and continue the program.

- Line 130: Places trace B in the view mode. This is necessary to prevent the analyzer from writing over the data placed back into trace B by KS125.
- Lines 40 to 150: Sets the analyzer display address to 1024 with the DA command and sends the KS125 command to the analyzer. The “125” in KS125 is sent as a single binary byte.
- Line 160: Writes the integer string B-store, which contains the display memory values for the original trace B display, into the analyzer trace B memory, restoring the original trace B display.

The KS125 command cannot be executed from the front panel.

. This is the decimal ASCII equivalent and is transmitted to the analyzer as a single 8-bit byte.

KS126

Read Every Nth Value

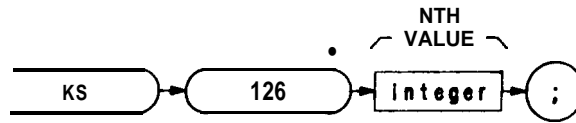

Item	Description/Default	Range Restriction
INTEGER	Represents every Nth value of trace A, B, or C display memory.	0–1022

KS126 sends every Nth **value in** display memory to the controller. This is useful when more trace data than required are available. For example, when displaying noise data in zero span, a small number of points can be sampled and averaged without a significant loss of data. Another example is when the resolution bandwidth is wide enough relative to the spanwidth so that only minimum display resolution is required.

Before executing the KS126 command, the analyzer output format and starting display memory address must be specified. All trace memories must be in a store mode (VIEW or BLANK) when they are read by KS126. Immediately following the command, the variable N must be specified as follows:

$$N = \text{point interval and is described by the formula } N = 1000 / (M - 1).$$

$$M = \text{the number of points to be read and is described by the formula } M = (1000 / N) - 1.$$

The value of N must be an integer and must be sent to the analyzer as a single binary byte. The resulting value of M dimensions memory in the controller.

The following program is an example of reading 11 values of trace B with KS126.

```

10 OPTION BASE 1
20 INTEGER A( 11)
30 OUTPUT 718 USING "K,B,K";"01;DA1025;KS";126;"100;"
40 FOR I= 1 TO 11
50 ENTER 718;A(I)
60 PRINT A(1)
70 NEXT I
80 END

```

The KS126 command cannot be executed from the front panel.

. This is the decimal ASCII equivalent and is transmitted to the analyzer as a single 8-bit byte

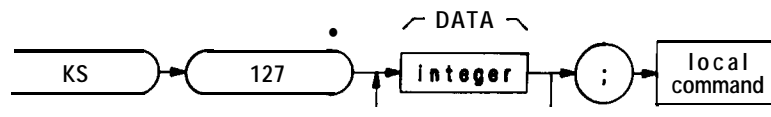

Item	Description/Default	Range Restriction
INTEGER	Represents amplitude data.	0 to 1022
LOCAL COMMAND	Return spectrum analyzer to local control. Controller dependent.	

The KS127 command sends data, formatted in 2-byte binary, to the analyzer display memory. All of the display memory addresses can be written to with a single execution of KS127. The syntax of the KS127 command requires a specified starting address that immediately precedes KS127. Specify the starting address with the DA command.

If the controller is instructed to write to more addresses than there are between the specified starting address and the last address in display memory, 4095, then a “wrap around” occurs, and the remaining display memory values are sent to successive addresses starting at address 0.

```

10 OPTION BASE 1
20 INTEGER B_store(1001)
30 !
40 OUTPUT 718;"A4;B1;TS;B3;"
50 OUTPUT 718 USING "K,B,#";"02;DA 1024;KS";123
60 ENTER 718 USING "W";B_store(*)
70 OUTPUT 718;"A1;B1;"
80 LOCAL 718
90 PRINT "CHANGE ANALYZER DISPLAY;PRESS CONTINUE"
100 PAUSE
110 !
120 OUTPUT 718;"B3;"
130 OUTPUT 718;"DA 1024;"
140 OUTPUT 718 USING "K,B,#";"KS";127
160 OUTPUT 718 USING "W,K";B_store(*)";";
160 LOCAL 718
170 END

```

The KS127 command cannot be executed from the front panel.

. This is the decimal ASCII equivalent and is transmitted to the analyzer as a single 8-bit byte.

LB

Label

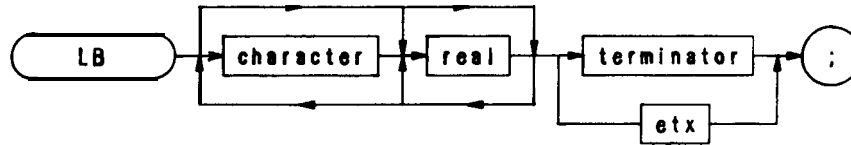

Item	Description/Default	Range Restriction
CHARACTER	Represents text displayed on screen.	ASCII codes 32— 126
REAL	Represents text displayed on screen.	
TERMINATOR	Terminates text. Character defined in DT command.	ASCII codes 0— 255
ETX	End of text.	ASCII code 3

The LB command writes text (label) on the CRT display with alphanumeric characters specified in the program. The text characters are each specified by 8 bits in a 12-bit data word which immediately follows the LB command. (The 4 most significant bits in the data word are set to 0.) The decimal equivalent of the binary number formed by the 12-bit data word corresponds to a particular one of the available alphanumeric characters. Decimal numbers 0 through 255 and their corresponding characters are shown in the Character Set Table at the end of this command description.

Characters generated for the LB command are aligned on the CRT in the same manner as typeset characters on a printed page (that is, in rows and columns). This alignment is important when you are labeling graph lines or points.

The display size specified by the display size command (D1, D2, D3), or the “big expand (bex)” instruction, determines the position of the text on the CRT, the number of rows and columns, and the size of the characters.

A typical use of the LB command is shown in the sample program below.

```
10  OTJTPUT 718;"IP;"
20  OUTPUT 718;"A4;KS0;D3;"
30  OUTPUT 718;"DT@";
40  OUTPUT 718;"PU PA 75,650 LB LABEL@";
50  END
```

Line 20: Blanks display and selects display size.

Line 30: Establishes a character (@) to terminate label text.

Line 40: Positions start of label text, writes text, and terminates label mode.

When using LB, the end of the text must be terminated. If the text is not terminated, instructions and other text following the actual label statement are displayed on the CRT. The label mode can be terminated with an ASCII end-of-text code (decimal code **3**), or with a character specified by the DT command. The label terminator command, **DT**, **suffix**ed with the character selected as the terminator (see line 30 above), must precede the label. The terminator character itself must immediately follow the label.

The character codes listed below provide special label functions. Instructions for a particular function are normally given in the function's decimal code.

Code .	Function . .
Ø	null
8	back space (BS)
10	line feed
11	vertical tab (opposite of line feed) (VT)
12	form feed (move beam to Ø,Ø) (FMFD)
13	carriage return (CR)
17	blink on (bkon)
18	blink off (bkof)
32	space (SP)
145	skip to next higher block of 16 addresses (sk 16)
146	skip to third higher block of 16 addresses (sk 16)
147	skip to fifth higher block of 16 addresses (sk 64)

* Character codes can be used with both the label instruction code (1025 +) and the LB command.

* . Abbreviations within the parenthesis are shorthand notation for writing display programs. They are not programming codes.

A blink-on instruction causes the label statement to blink until a subsequent blink-off or end-of-text instruction in the program is executed.

For the skip-to-next-block instructions, the 4096 addresses in the **display** memory are hypothetically divided into 256 blocks of 16 addresses each. Execution of a skip instruction causes the program to skip to the **first** address in the next higher block of 16 addresses (code **145**), to skip over the next two higher blocks to the **first** address in the third higher block (code **146**), or to skip over four blocks to the first address in the fifth higher block (code 147).

For example, if the program is at any address from Ø through 15 (the **first** block of 16 addresses) and a skip-to-next-16-b&k is executed, the program skips to address 16 (the **first** address in the second block of 16 addresses). Similarly, if the program is at address **84** in the sixth block of 16 addresses, and a skip-to-next-32-block is executed, the program skips over two blocks of 16 addresses to address 128 (the **first** address in the ninth block). Again, if the program is at address 84 in the sixth block, but the instruction this time is for a skip-to-next&1-block, the program skips over four blocks to address 160 in the eleventh block of 16 addresses.

LB (Continued)

A **sample program** using the blink-on and blink-off codes is shown below.

```
20 ASSIGN @Sa TO 718
30 OUTPUT @Sa; "IP;"
40 OUTPUT @Sa; "A4;KSo;D3;"
80 OUTPUT @Sa; "PU;PA 344,656;LB";CHR$(17);"LABEL";CHR$(18);CHR$(3);
60 END
```

For a binary format, line 50 can be written as follows:

```
50 OUTPUT @Sa USING "K,B,K,B,B";"PU;PA 344,656;LB";17;"LABEL";18.3;
```

Line 30: Presets the instrument.
Line 40: Blank trace A and characters and selects display size 3.
Line 50: Positions the beginning of the label, blinks the label, and terminates the label.

Character Set

The character set for the label command is the same as the ASCII set. There are **86** additional characters available.

Cod	Chair	Code	Chr	Code	Cha	Cod	Chi	Cod	Chr	Cod	Char	Code	Chs	Code	Char
0	(NLLI)	32	SP	64	@	96	,	128		160	A	191	∠	224	Ψ
		33	!	65	A	97	a	129		161	∨	191	∆	225	Ω
2		34	"	66	B	98	b	130		162		191	∫	226	Β
3		35	#	67	C	99	c	131		163	≠	195	ϕ	227	Χ
4		36	\$	68	D	100	d	132		164	£	196	∇	228	Ϟ
5		37	%	69	E	101	e	133		165	⊗	197		229	ϙ
6		38	&	70	F	102	f	134		166	⊕	198		230	Ϡ
7		39	'	71	G	103	g	135		167	.	198	g	231	Υ
8	(BS)	40	<	72	H	104	h	136		168	↑	200	h	232	η
9		41	>	73	I	105	i	137		169	→	201	i	233	ι
10	(LF)	42	*	74	J	106	j	138		170	∞	202		234	ζ
11	(VT)	43	+	75	K	107	k	139		171	±	203		235	κ
12	(FMFI)	44	,	76	L	108	l	140		172	↓	204		236	λ
13	(CR)	45	-	77	M	109	m	141		173		205	π	237	μ
14		46	.	78	N	110	n	142		174	.	206	π	238	ν
15		47	/	79	O	111	o	143		175	∓	207	o	239	ο
16		48	0	80	P	112	p	144		176	o	208	ρ	240	Ϡ
17	(BKON)	49	1	81	Q	113	q	145	5K16	177	-	209	ρ	241	θ
18	(BKOF)	50	2	82	R	114	r	146	5K32	178	≠	210	r	242	Ϡ
19		51	3	83	S	115	s	147	5K64	179	≠	211	s	243	α
20		52	4	84	T	116	t	148		180	≠	212	t	244	τ
21		53	5	85	U	117	u	149		181	≠	213	a	245	υ
22		54	6	86	V	118	v	150		182	≠	214	∨	246	ϛ
23		55	7	87	W	119	w	151		183	√	215		247	ϙ
24		56	8	88	X	120	x	152		184	~	216		248	Ϡ
25		57	9	89	Y	121	y	153		185	ℝ	217	∥	249	Δ
26		58	:	90	Z	122	z	154		186	∥	218	∥	250	Ω
27		59	;	91	[123	{	155		187	∴	219	∏	251	Μ
28		60	<	92	\	124		156		188	∞	220	⊕	252	Δ
29		61	≡	93	_	25	~	157		89	≡	221	⊕	253	ϙ
30		62	∨	94	↑	26	~	158		90	∨	222	⊕	254	∏
31		63	∩	95		27	~	159		91	>	223		255	

LABEL COMMAND CHARACTER SET

Blank codes are either unassigned or character pieces. () indicates display machine language word. See Appendix B.

LF

Preset 0 – 2.5 GHz

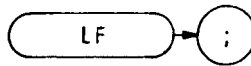

The LF command selects start/stop frequencies of 0 Hz and 2.5 GHz (in full span), a reference level of 0 dBm, and sets all the coupled functions to automatic. The functions of the LF command and the front panel FULL SPAN  key are identical.

The Full Span 0 – 2.5 GHz function provides a convenient starting point for making measurements in the low band because it presets the analyzer functions to known states and values. (See II?)

OUTPUT 718;“LF;”

The above program line enables the full 0 – 2.5 GHz span with coupled operation functions.

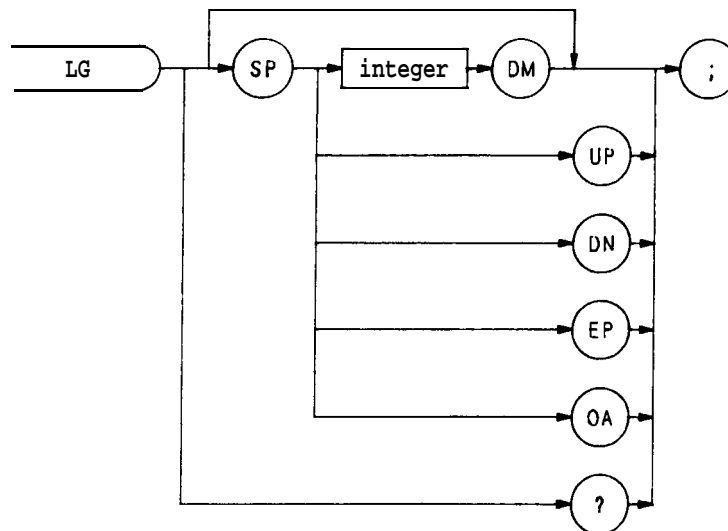

Item	Description/Default	Range Restriction
INTEGER		1, 2, 5, 10

The LG command specifies the vertical graticule divisions as logarithmic units without changing the reference level. The vertical scale may be specified as **1, 2, 5, or 10 dB** per major division. If no value is specified, as shown below, the logarithmic scale is **10 dB** per division.

OUTPUT 718;“LG;”

The functions of the LG command, and the front panel  key are identical.

When queried (? or OA) , LG returns the current log scale as a real number, followed by a carriage-return/line-feed (ASCII codes 13, 10). The end-or-identify state (EOI) is asserted with line feed.

LL

Lower Left

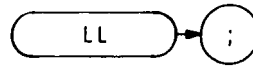

The LL command sends a voltage to the rear panel RECORDER OUTPUTS. The voltage level remains until a different command is executed. Use the LL command to calibrate the lower left dimension of a recorder. The LL command is illustrated in the sample program below.

```
10 OUTPUT 718;"LL;"  
20 PRINT "ALIGN PLOTTER PEN LOWER LEFT CORNER OF PAPER: PRESS CONTINUE."  
30 END
```

The functions of the LL command and front panel  key are identical. (See Introduction in Section I.)

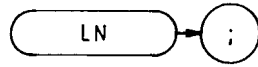

The LN command scales the amplitude (vertical graticule divisions) proportional to input voltage, without changing the reference level. The bottom graticule line represents a signal level of zero volts.

The LN command selects **V**, **mV**, or **uV** as the vertical scale, depending on the vertical scale before LN **is executed**.

Units other than **V/DIV**, **MV/DIV**, or **uV/DIV** can be selected **by** changing the reference level after executing LN. For example, to set the scale to **3 mV/DIV**, specify a reference level of **30 mV**.

OUTPUT 718; "LN; RL 30mV;"

Note that voltage entries are rounded to the nearest 0.1 **dB**. Thus, 30 **mV** becomes 30.16 **mV**, which equals -17.4 **dBm**.

The functions of the LN command and front panel  key are identical. (See also KSB, KSC, and KSD.)

LOG

Logarithm

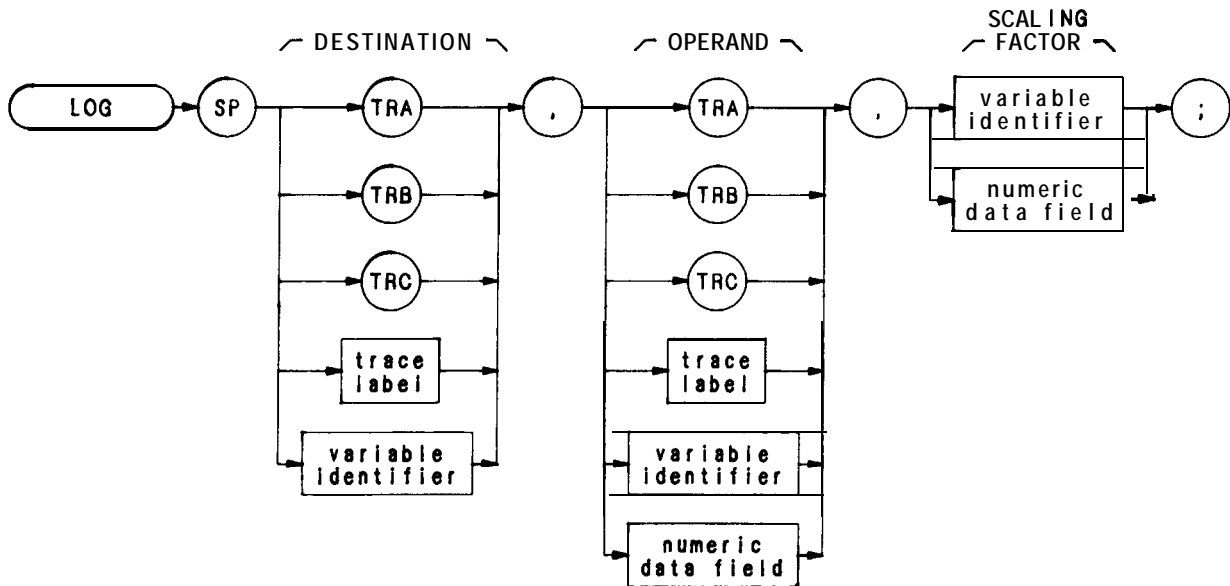

Item	Description/Default	Range Restriction
TRACE LABEL	Alpha character. User-defined label declared in TRDEF statement.	AA-22 and _ 2— 12 characters required.
VARIABLE IDENTIFIER	Alpha character. User-defined identifier declared in VARDEF statement.	AA-Z? and _ 2— 12 characters required.
	Alpha character. Measurement-variable identifier, such as CF or MA.	
	Trace element, such as TRA [10].	
NUMERIC DATA FIELD	Real	

The LOG command modifies the operand:

LOG operand 1 x scaling factor → destination

The operands and destination may be different lengths. The trace operands (**TRA**, **TRB**, **TRC**, and trace label) range from 1 to 1008 elements in length; a variable identifier or numeric data field is one element long. When

operands differ in length, the last element of the shorter operand is repeated for processing. When the operands are longer than the destination, they are truncated to fit.

OUTPUT 718;“LOG TRC,TRA 10;”

LØ

Display Line Off

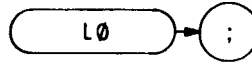

The **LØ** command disables the display line.

The functions of the **LØ** command and the front panel, reference line key are identical. The display line also can be turned on or off by the DLE and DL commands.

OUTPUT 718; "LØ;"

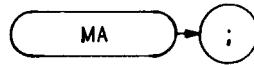

The MA command returns the amplitude level of the active marker to the controller, if the marker is on screen. If both the delta marker and active marker are on screen, MA returns the amplitude difference between the two markers. (See MKDELTA and M3.) The amplitude is also displayed in the upper right-hand corner of the analyzer display.

The output can be formatted in any of the four output formats. (Refer to FORMAT commands, O1, O2, O3, O4.) However, do not use output format 04 for marker delta output, because sign information is lost.

A typical use of the MA command is shown in the sample program below.

```

10  ASSIGN @Sa TO 718
20  P R I N T E R I S
30  OUTPUT @Sa;"FA 80MZ; FB 120MZ;"
40  OUTPUT @Sa;"M2;E1;"
50  OUTPUT @Sa;"MA;"
60  ENTER @Sa;A
70  PRINT A
80  END

```

Line 30: Selects start and stop frequencies.
Line 40: Activates a normal marker and peak search.
Line 50: Returns the amplitude to the controller.
Line 60: Assigns the amplitude to variable A.
Line 70: Prints the marker amplitude.

An ENTER command must follow each output command, or output data is lost. For example, the following program assigns only the marker amplitude to variable F, and the marker frequency value is lost.

```

OUTPUT 718;"MF;MA;"
OUTPUT 718;F,A

```

MBRD

Processor Memory Block Read

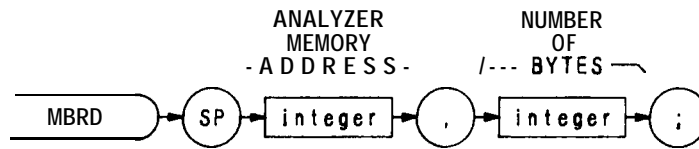

Item	Description/Default	Range Restriction
INTEGER	ASCII decimal number representing analyzer memory address.	
INTEGER	ASCII decimal number indicating number of bytes to read.	
NUMERIC DATA FIELD	Real	

The MBRD command reads an indicated number of bytes, beginning at the specified microprocessor address, and returns the bytes to the controller.

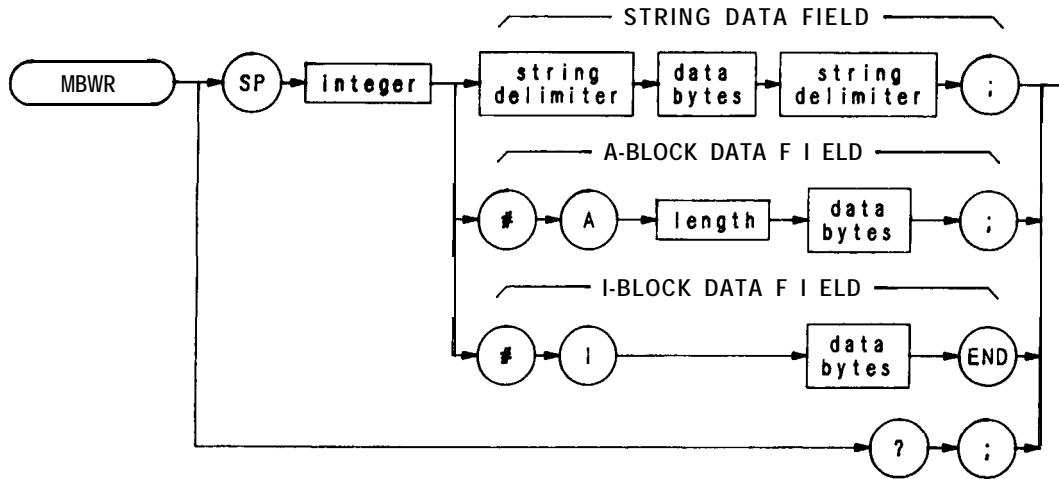

Item	Description/Default	Range Restriction
STRING DELIMITER	Mark beginning and end of command string. End and beginning delimiter must be identical.	!"\$%&'/:=@\~
LENGTH	Two 8-bit bytes specifying length of command list, in 8-bit bytes. The most significant byte is first: MSB LSB.	
DATA BYTES	8-bit bytes of data representing command list.	
INTEGER	ASCII decimal number representing analyzer memory address.	

The MBWR command writes a block message to analyzer memory, starting at specified address.

MDS

Measurement Data Size

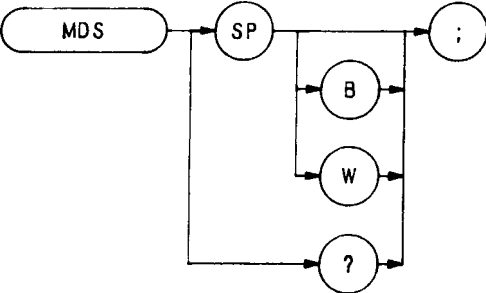

The MDS command formats binary measurement:

B selects a data size of one **8-bit** byte.

W selects a data size of one word, which is two 8-bit bytes.

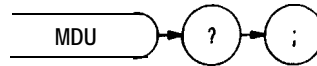

The MDU command returns values for the CRT base line and reference level, in display units and measurement units.

For example, the program below returns the following to the controller:

```
0      1000      -110      -10
```

This means the vertical scale spans \emptyset to 1000 display units, or 100 dB, and the reference level is -10 dBm.

```
10  OUTPUT 718;"IP;03;"
20  OUTPUT 718;"RL -10DM;"
100 OUTPUT 718;"MDU?;"
140 ENTER 718;A,B,C,D
150 PRINT A,B,C,D
160 END
```

MEAN

Mean

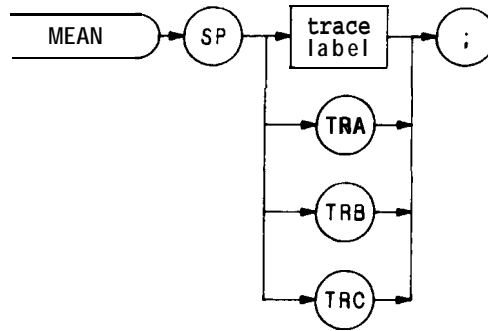

Item	Description/Default	Range Restriction
TRACE LABEL	Alpha character. User-defined label declared in TRDEF statement.	AA—ZZ and _ 2—12 characters required.

The MEAN command returns the mean value of the trace, in display units. Note that the value must be moved into a variable to be accessed.

```
OUTPTJT 718; "TRDEF TEST; 1008; VARDEF DESTINATION, 0;"  
OUTPTJT 718; "MOV DESTINATION, MEAN TEST;"
```



The MEM command returns the amount of unused memory available for user-defined functions. These functions include **TRDEF**, **VARDEF**, **FUNCDEF**, **ONSWP**, **ONEOS**, and **TRMATH**.

The MEM command returns the number of available bytes to the controller followed by a carriage-return/line-feed (ASCII codes 13, 10). The end-of-identify state (EOI) is asserted with line feed.

```
10  OUTF'UT 718; "MEM?;"  
20  ENTER 718;How_much_memory  
30  PRINT  How-much-memory  
40  END
```

MF

Marker Frequency Output

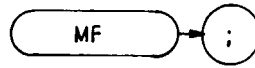

The MF command returns the frequency level of the active marker to the controller, if the marker is on screen. If both the delta marker and active marker are on screen, MF returns the frequency difference between the two markers. (See MKDELTA and M3.)

The output can be formatted in any one of the four output formats. (Refer to FORMAT command, 01, 02, 03, and 04.) However, do not use output format 04 for marker delta output, because sign information is lost.

A typical use of the MF command is shown in the sample program below.

```
10 ASSIGN @Sa to 718
20 PRINTER IS 701
30 OUTPUT @Sa;"FA 80MZ;FB 120MZ;"
40 OUTPUT @Sa;"M2;E1;"
50 OUTPTJT @Sa;"MF;"
60 ENTER @Sa;A
70 PRINT A
80 END
```

Line 30: Selects start and stop frequencies.
Line 40: Activates a normal marker and peak search.
Line 50: Returns the frequency to the controller.
Line 60: Assigns the frequency to variable A.
Line 70: Prints the frequency amplitude.

An ENTER command must follow each output command, or output data **is lost**. For **example, the following program assigns only the marker amplitude to variable F, and the marker frequency value is lost.**

```
OUTPUT 718;"MF;MA;"
OUTPUT 718;F,A
```

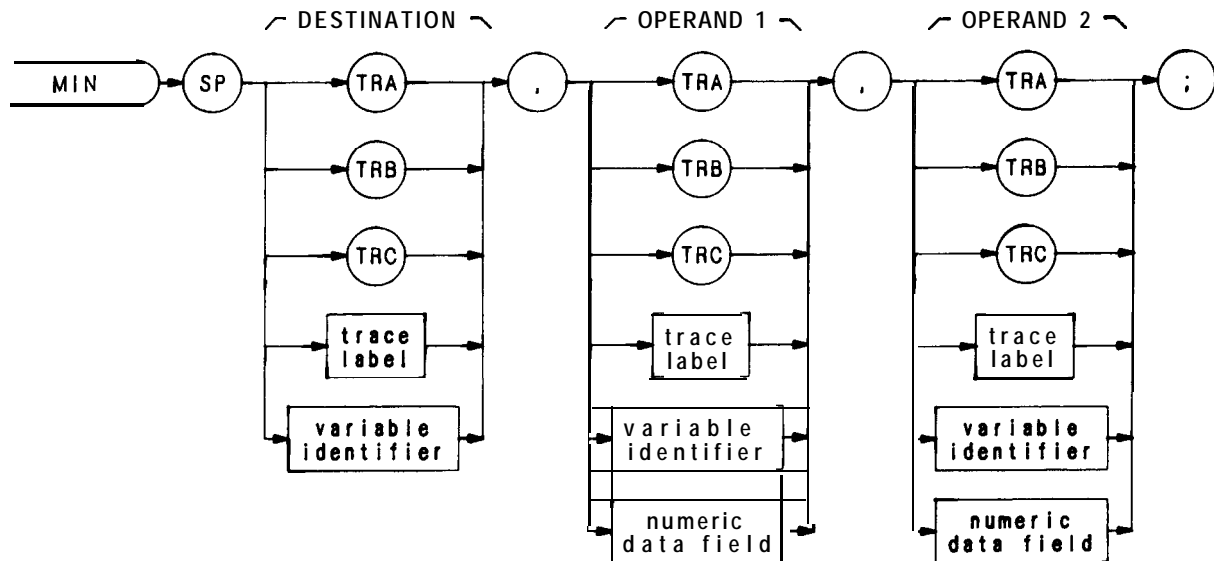

Item	Description/Default	Range Restriction
TRACE LABEL	Alpha character. User-defined label declared in TRDEF statement.	AA- ZZ and _ 2— 12 characters required.
VARIABLE IDENTIFIER	Alpha character. User-defined identifier declared in VARDEF statement.	AA-22 and _ 2— 12 characters required.
	Alpha character. Measurement-variable identifier, such as CF or MA.	
	Trace element, such as TRA [10].	
NUMERIC DATA FIELD	Real	

The MIN command compares operand 1 and operand 2, point by point, sending the lesser values of each comparison to the destination.

If one of the operands is a single value, it acts as a threshold, and all values equal to or less than the threshold pass to the destination.

OUTPUT 718; "MIN TRB,TRC,TRB;"

MKA

Marker Amplitude

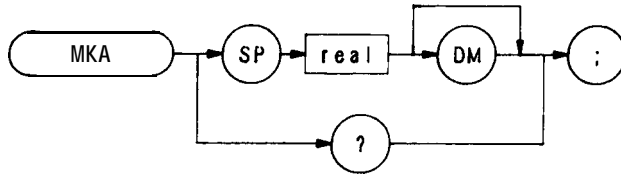

Item	Description/Default	Range Restriction
REAL		Amplitude range of analyzer screen.

The MKA command specifies the amplitude of the active marker in **dBm**, when the active marker is the **fixed** or amplitude type. (Instrument preset (IP) selects an amplitude marker. See MKTYPE.)

When queried (?), MKA returns the marker amplitude, a real number, followed by a carriage-return/line-feed (ASCII codes 13, 10). The end-or-identify state (EOI) is asserted with line feed.

OUTPUT 718; "**MKA -20DM;**"

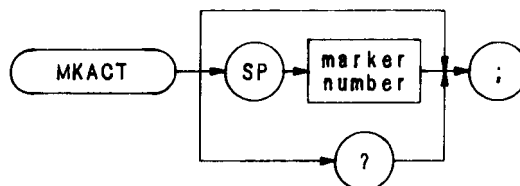

Item	Description/Default	Range Restriction
MARKER NUMBER	Integer. Default is 1.	1, 2, 3, 4

The MKACT command establishes the active marker. There can be four different numbered markers, but only one marker can be active at any time.

A variety of commands listed in this remote section operate on the active marker. Most of them begin with the letters "MK."

When MKACT is executed, the display readout indicates the active marker state.

OUTPUT 718; "MKACT 3;"

When queried (?), MKACT returns the number of the current active marker, followed by carriage-return/line-feed (ASCII codes 13, 10). The end-of-identify state (EOI) is asserted with line feed.

MKCF

Marker to Center Frequency
(E2)

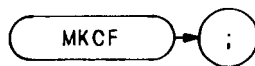

The MKCF command centers the active marker on the analyzer screen, moving the marker to the center **f**requency.

```
OUTPUT 718; "MKCF;"
```

The functions of the MKCF and E2 commands, and the front panel  key are identical.

MKCONT

Marker Continue
(KSt)

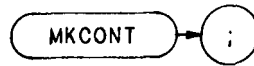

The MKCONT command resumes the sweep after execution of a MKSTOP or **KSu** command. Execute **MK-CONT** after MKSTOP or **KSu** .

The functions of the MKCONT and **KSt** commands are identical.

MKD

Marker Delta
(M3)

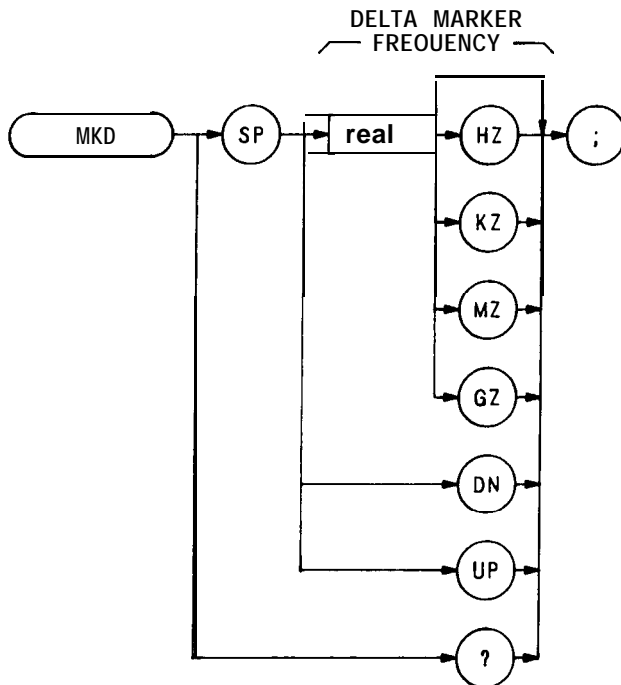

Item	Description/Default	Range Restriction
REAL	Selects delta marker frequency. Default units is HZ.	

The MKD command computes the frequency and amplitude difference of the active marker and a special marker, called the delta or differential marker. These values are displayed in the display readout.

$$\text{Differential value} = \text{active marker frequency} - \text{delta marker frequency}$$

$$\text{Differential value} = \text{active marker amplitude} - \text{delta marker amplitude}$$

If a delta marker is not on screen, MKD places one at the specified frequency, or at the right side of the CRT if an active marker is not on screen, MKD positions an active marker at center screen. (The active marker is the number 1 marker, unless otherwise specified with the MKACT command.)

OUTPUT 718; "MKD 120MZ;"

The MKD command function is identical with that of the M3 command, and similar to that of the front panel Δ key

When queried(?), MKD returns the frequency difference between the delta and active markers. The frequency difference is returned as a real number, followed by a carriage-return/line-feed (ASCII codes 13, 10). The end-or-identify state (EOI) is asserted with line feed.

MKF

Marker Frequency

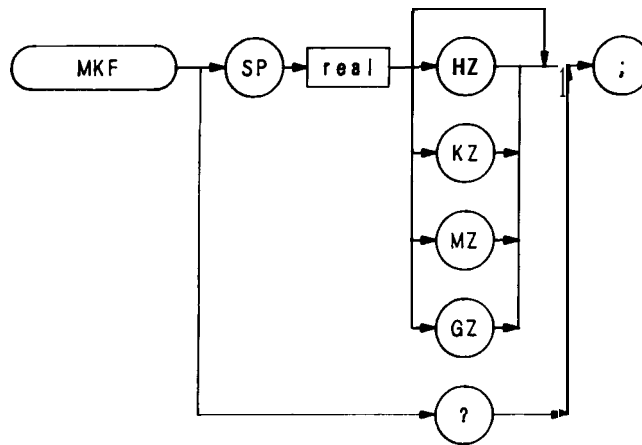

Item	Description/Default	Range Restriction
REAL	Represents marker frequency. Default value for units is Hz.	Marker frequency limited to frequency range of spectrum analyzer display.

The MKF command specifies the frequency value of the active marker.

OUTPUT 718; "MKF 100MZ;"

When queried (?), MKF returns the active marker frequency as a real number followed by a carriage-return/line-feed (ASCII codes 13, 10). The end-of-identify state (EOI) is asserted with line feed.

MKMIN

Marker Minimum
(KSN)



The MKMIN command moves the active marker to the minimum value detected. (See also KSN.)

OUTPUT 718; "MKMIN;"

MKN

Marker Normal
(M2)

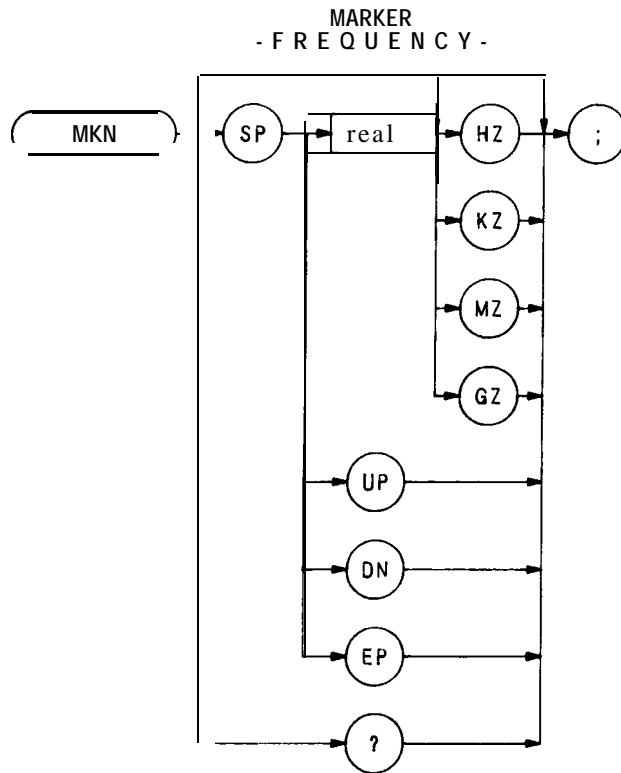

Item	Description/Default	Range Restriction
REAL	Default value for units is Hz.	

The MKN command moves the active marker to the marker frequency. If the active marker is not declared with **MKACT**, the active marker number is 1.

OTJTPUT 718;“MKN;”

The functions of the MKN and **M2** commands are identical.

MKNOISE

Marker Noise
(KSM)

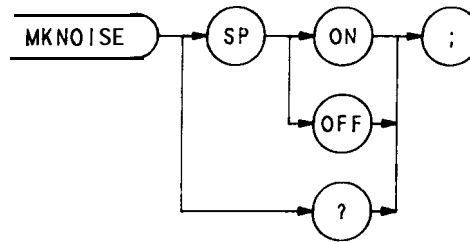

The MKNOISE command displays the RMS noise level at the marker. The RMS value is normalized to a 1 Hz bandwidth.

```
10 OUTPUT 718;"IP;O3;"
20 OUTPUT 718;"MKACT 1;"
30 OUTPUT 718;"MKF 3GZ;"
40 OUTPUT 718;"MKNOISE ON;"
50 OUTPUT 718;"MKNOISE?;"
60 ENTER 718;A$
70 PRINT A$
80 END
```

When queried (?), MKNOISE returns ON or OFF, followed by a carriage-return/line-feed (ASCII codes 13, 10). The end-or-identify state (EOI) is asserted with line feed.

The functions of the MKNOISE and KSM commands are identical.

MKOFF

Marker Off

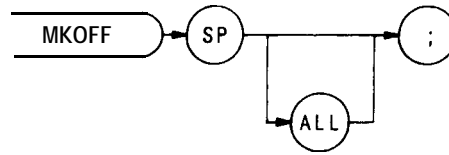

The MKOFF command turns off either the active or all markers displayed on the CRT Up to four markers can be displayed at one time.

```
OTJTPJT718;“MKOFF;”
```

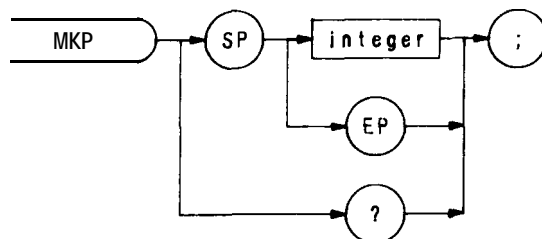

item	Description/Default	Range Restriction
INTEGER		1 to 1001

The MKP command specifies the marker position horizontally, in display units.

The program line below positions the marker at the first major graticule line

OUTPUT 7 18; "MKP 100;"

When queried (?), MKP returns the active marker frequency as a real number followed by a carriage-return/line-feed (ASCII codes 13, 10). The end-or-identify state (EOI) state is asserted with line feed.

MKPAUSE

Marker Pause

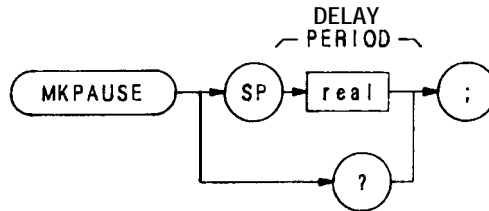

Item	Description/Default	Range Restriction
REAL	Delay time in seconds.	0 to 1000 seconds.

The MKPAUSE command pauses the sweep at the active marker for the duration of the delay period.

```
OUTPUT 718;"MKPAUSE 100;"
```

When queried (?), MKPAUSE returns the value of the delay period as a real number followed by a carriage-return/line-feed (ASCII codes 13, 10). The end-or-identify state (EOI) is asserted with line feed.

To turn pause off, turn off markers.

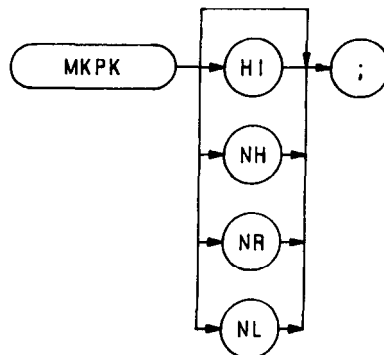

The MKPK command positions on the active marker on signal peaks.

OUTPUT 718; "MKPK NR;"

Executing MKPK HI, or simply MKPK, positions the active marker at the highest signal detected.

If an active marker is onscreen, NH, NR, and NL move the marker accordingly:

Specifying NH moves the active marker to the next signal peak of lower amplitude.

Specifying NR moves the active marker to the next signal peak of higher frequency.

Specifying NL moves the active marker to the next signal peak of lower frequency.

(See also KSK and El .)

MKPX

Marker Peak Excursion

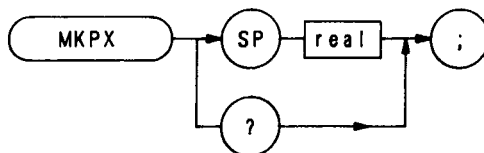

The MKPX command specifies the minimum signal excursion for the analyzer internal signal-identification routine.

The default value is 6 dB. In this case, any signal with an excursion of less than 6 dB on either side is not identified. If MKPK HI (peak search) were executed on such a signal, the analyzer would not place a marker at the signal peak.

OUTPUT 718; "MKPX 8dB;"

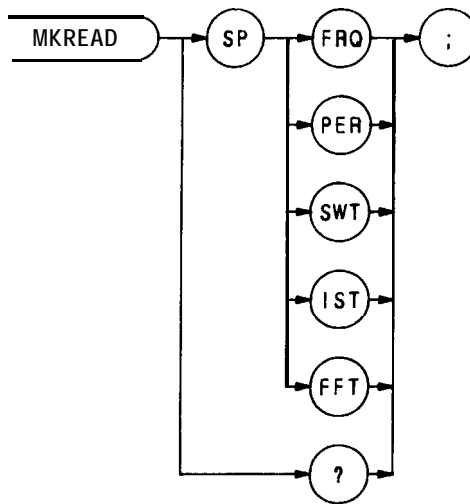

The MKREAD command selects the type of active trace information displayed by the analyzer marker readout: marker frequency, period, sweep time, inverse sweep time, or fast fourier transform readout.

When queried (?), MKREAD returns the marker readout type, followed by carriage-return/line-feed (ASCII codes 13, 10). The end-of-identify state (EOI) is asserted with line feed. The program prints "FFT" on the computer screen.

```

10 OUTPUT 718;"MKREAD FFT;"
20 OUTPUT 718;"MKREAD?;"
30 ENTER 718;A$
40 PRINT A$
50 END
  
```

MKRL

Marker to Reference Level
(E4)



The MKRL command moves the active marker to the reference level.

OUTPUT 718; "MKRL;"

The functions of the MKRL and E4 commands, and the front panel  key are identical.

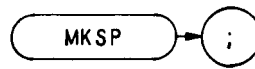

The MKSP command operates only when the delta marker is on. (See MKD or M3.) When the delta marker is on and MKSP is executed, the delta marker and active marker determine the start and stop frequencies. The left marker specifies start frequency, and the right marker specifies stop frequency. If marker delta is off, there is no operation.

OUTPUT 718;MKSP;

The functions of the MKSP and KSO commands are identical.

MKSS

Delta Marker Step Size
(E3)

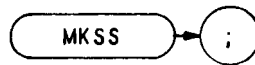

The MKSS command establishes the center frequency step size as the frequency difference between the delta and active markers. (See M3 or MKD.)

OUTPUT 718; "MKSS;"

The functions of the MKSS and E3 commands are identical.

MKSTOP

Marker Stop
(KSu)

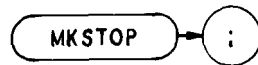

The MKSTOP command stops the sweep at the active marker. (See also **KSu**.)

OUTPUT 718; "MKSTOP;"

MKTRACE

Marker Trace

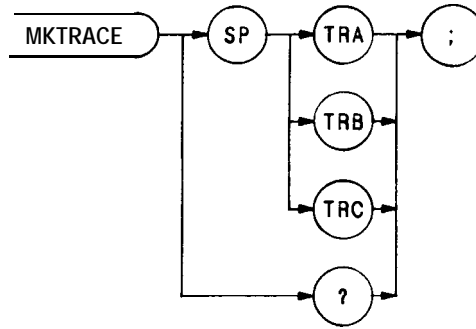

The MKTRACE command moves the active marker to a corresponding position in trace A, B, or C.

OUTPUT 718; "MKTRACE TRB;"

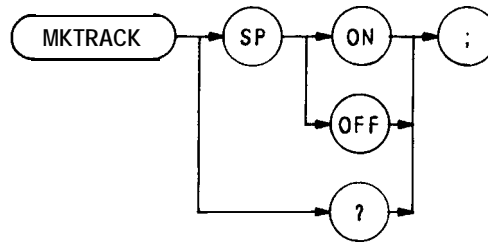

The MKTRACK command keeps the active marker at the center of the display. To keep a drifting signal at center screen, place the active marker at the desired signal before executing MKTRACK. (See MT1 and **MT0**. Also see  key in Section I.)

OUTPUT 718; "MKTRACK ON;"

MKTYPE

Marker Type

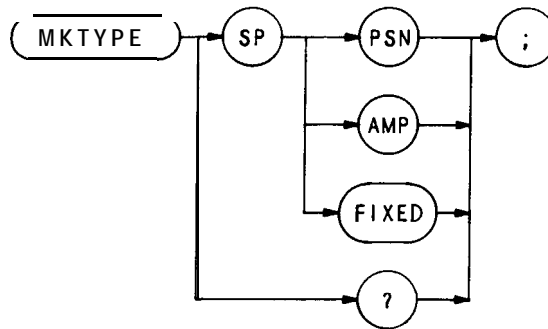

The MKTYPE command specifies the kind of marker,

Specifying MKTYPE AMP allows markers to be positioned according to amplitude, as shown in the line below, which positions a marker on a signal response at the -3 dBm level.

```
OUTPUT 718;"TS; MKTYPE AMP; MKA-3;"
```

The program line below returns the 3-dB bandwidth to the controller.

```
10 OUTPUT 718;"TS;MKPK HI; MKD;"
20 OUTPUT 718;"MKTYPE AMP;MKA-3;"
30 OUTPUT 718;" MKD; MF?"
40 END
```

Line 10 executes a sweep, places a reference marker at the signal peak, and enables the delta marker mode.

Line 20 searches for an amplitude that is 3 dB below the reference marker at the signal peak, because the delta marker mode is active.

The MKD in line 30 establishes the marker that is 3 dB below the peak as the new reference marker. However, since the amplitude and reference markers cannot occupy the same position, the analyzer searches again for an amplitude 3 dB below the signal peak and places another marker there. The MF? command returns the frequency difference between the markers.

Specifying MKTYPE PSN allows markers to be positioned according to a horizontal position in display units. The program line below positions a marker on the third major graticule.

```
OUTPUT 718;"MKTYPE PSN; MKP 300;"
```

Specifying MKTYPE FIXED allows a marker to be placed at any fixed point on the CRT

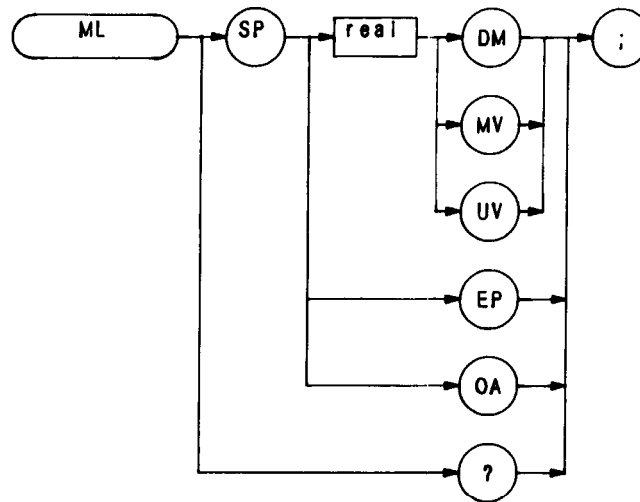



The ML command specifies the maximum signal level that is applied to the input mixer for a signal that is equal to or below the reference level.

The effective mixer level is equal to the reference level minus the input attenuator setting. When ML is activated, the effective mixer level can be set from -10 dBm^* to -70 dBm in 10 dB steps. Instrument preset (IP) selects -10 dBm .

The program line below sets the mixer level to -40 dBm .

```
OUTPUT 718;"ML - 40DM;"
```

As the reference level is changed, the coupled input attenuator automatically changes to limit the maximum signal at the mixer input to -40 dBm for signals less than or equal to the reference level.

The functions of the ML and KS, commands, and the   keys are identical. See also AT

* In the extended reference level range, the effective mixer level can be set to 0 dBm .

MOV

Move

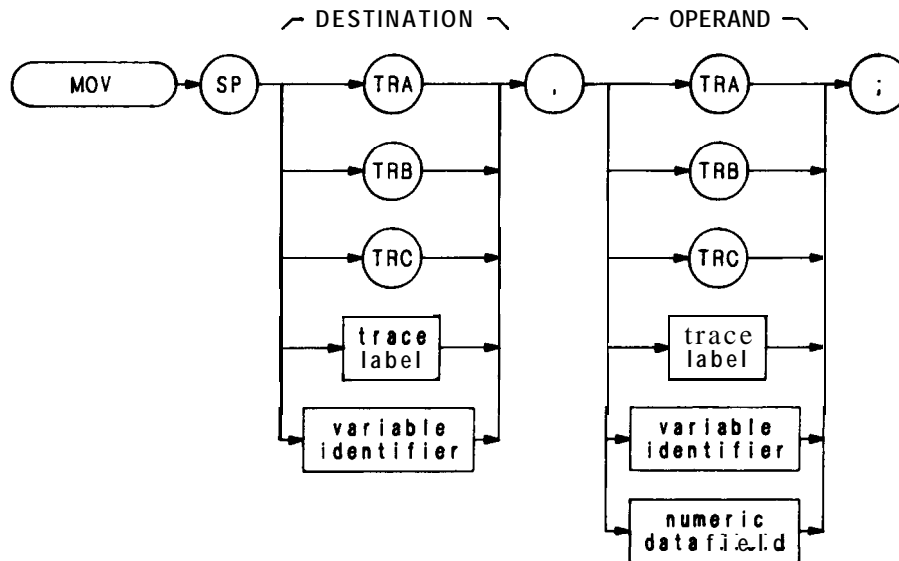

Item	Description/Default	Range Restriction
TRACE LABEL	Alpha character. User-defined label declared in TRDEF statement.	AA- ZZ and _ 2— 12 characters required.
VARIABLE IDENTIFIER	Alpha character. User-defined identifier declared in VARDEF statement.	AA-22 and _ 2— 12 characters required.
	Alpha character. Measurement-variable identifier. such as CF or MA.	
	Trace element, such as TRA[10] .	
NUMERIC DATA FIELD	Real	

The MOV command moves the operand to the destination.

The operand and destination may be of different length: the trace operands (TRA, TRB, TRC, and trace label) range from 1 to 1008 elements in length, and a variable identifier or numeric data field is 1 element long. When the operand is longer than the destination, it is truncated to fit. When the operand is shorter than the destination, the last element is repeated to fill the destination.

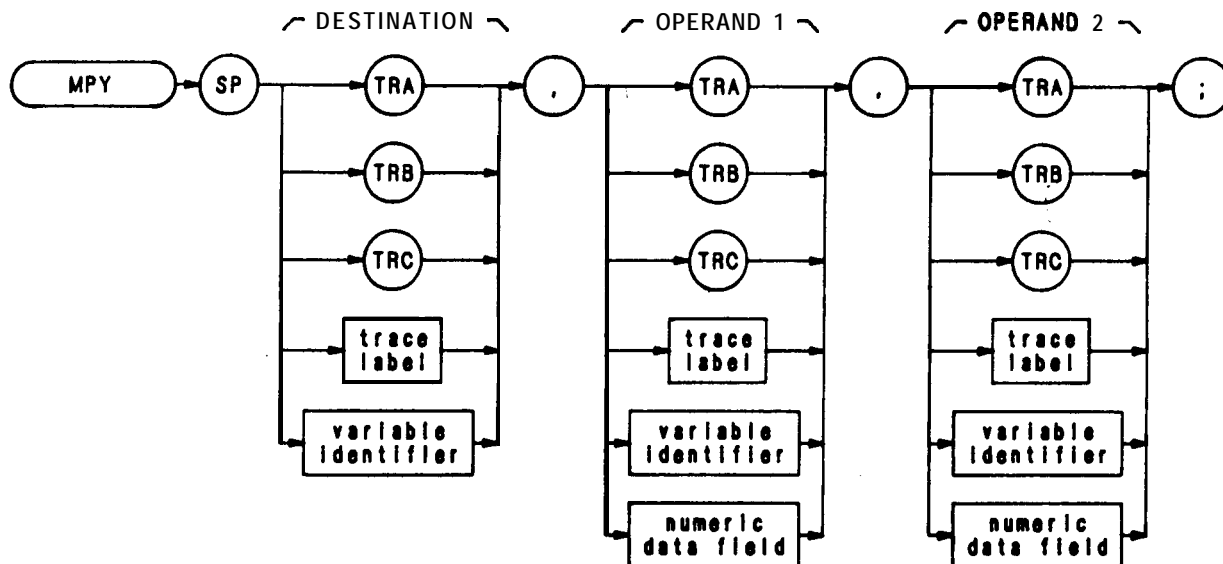

Item	Description/Default	Range Restriction
TRACE LABEL	Alpha character. User-defined label declared in TRDEF statement.	AA- ZZ and _ 2— 12 characters required.
VARIABLE IDENTIFIER	Alpha character. User-defined identifier declared in VARDEF statement.	AA-22 and _ 2— 12 characters required.
	Alpha character. Measurement-variable identifier, such as CF or MA.	
	Trace element, such as TRA[10].	
NUMERIC DATA FIELD	Real	

The MPY command multiplies the operands, point by point, and places the result(s) in the destination.

$$\text{operand 1} \times \text{operand 2} \rightarrow \text{destination}$$

The operands and destination may be of different length: the trace operands (TRA, TRB, TRC, and trace label) range from 1 to 1008 elements in length; and a variable identifier or numeric data field is 1 element long. When operands are of different lengths, the last element of the shorter operand is repeated and multiplied with the remaining elements of the longer element. When the operands are longer than the destination, they are truncated to fit.

MPY Continued

The results and operands of trace math are truncated if they are not within certain limits. If operating on traces A, B, or C, results must be within 1023. If operating on user-defined traces, results must be within 32,767.

OUTPUT 718; "MPY TRA,TRC,TRB;"

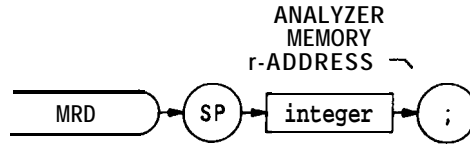

Item	Description/Default	Range Restriction
INTEGER	ASCII decimal number representing analyzer memory address.	Must be even.

The MRD command reads two bytes, starting at the indicated spectrum analyzer memory address, and returns the word to the controller.

MRDB

Memory Read Byte

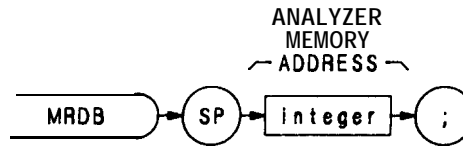

Item	Description/Default	Range Restriction
INTEGER	ASCII decimal number representing analyzer memory address.	

The MRDB command reads the 8-bit byte at the analyzer memory address, and returns the byte to the controller, as ASCII code.

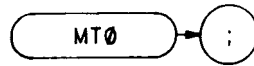



The **MTO** command disables the marker tracking mode. (See MKTRACK and MT1 . Also see  key in Section I.)

OUTPUT 718; "MTO;"

MT1

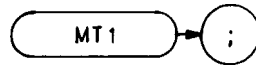
Marker Track On



The MT1 command keeps the active marker at the center of the display. To keep a drifting signal at center screen, place the active marker at the desired signal before executing **MT1**. (See MKTRACK and **MT0**. Also see  key in Section I.)

OUTPUT 718; "MT1;"

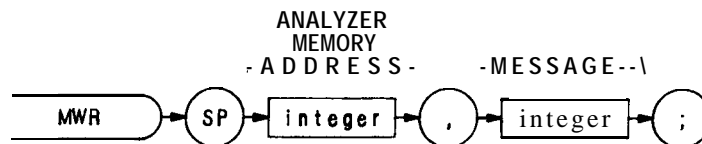

Item	Description/Default	Range Restriction
INTEGER	ASCII decimal number representing analyzer memory address.	Must be even number.
INTEGER	ASCII decimal number indicating number of bytes to read.	

The MWR command writes a two-byte message to spectrum analyzer memory, starting at the indicated address.

MWRB

Memory Write Byte

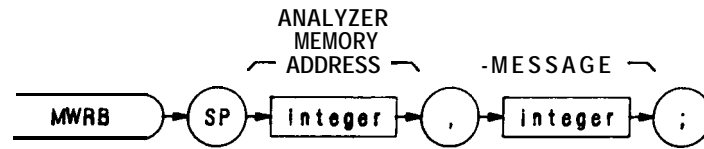

Item	Description/Default	Range Restriction
INTEGER	ASCII decimal number representing analyzer memory address.	
INTEGER	ASCII decimal number representing one 8-bit byte.	

The MWRB command writes a one-byte message to a memory address in the analyzer.

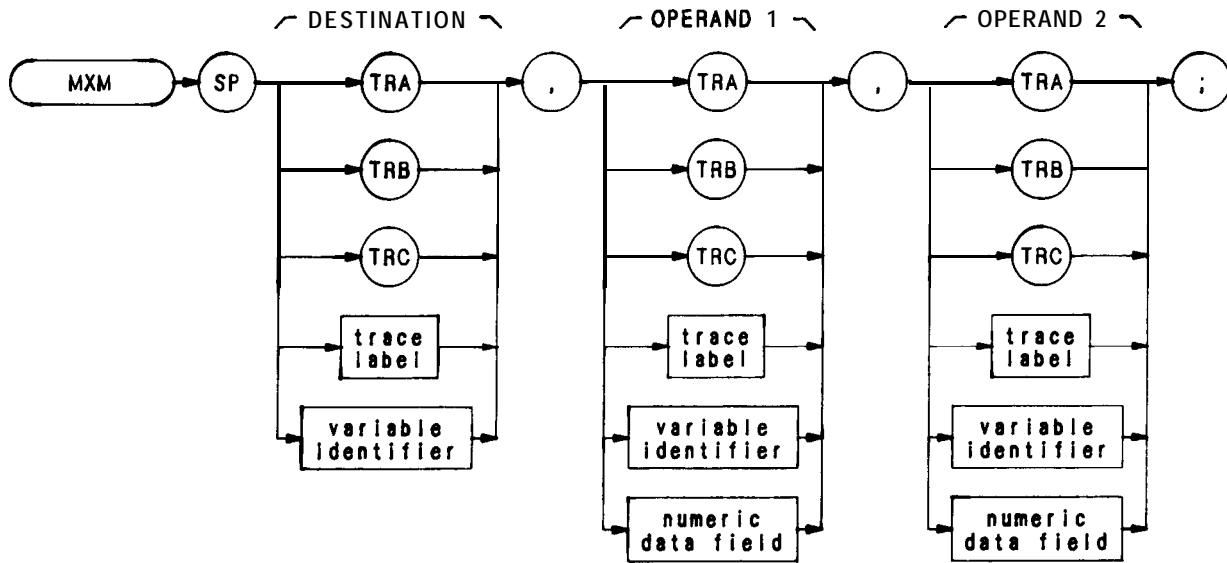

Item	Description/Default	Range Restriction
TRACE LABEL	Alpha character. User-defined label declared in TRDEF statement.	AA–ZZ and _ 2– 12 characters required.
VARIABLE IDENTIFIER	Alpha character. User-defined identifier declared in VARDEF statement.	AA-22 and _ 2– 12 characters required.
	Alpha character. Measurement-variable identifier, such as CF or MA.	
	Trace element, such as TRA[101.	
NUMERIC DATA FIELD	Real	

The MXM command compares operand 1 and operand 2, point by point, sending the greater value of each comparison to the destination.

If one of the operands is a single value, it acts as a threshold, and all values equal to or greater than the threshold pass to the destination.

The operands and destination may be of different length. However, the destination must be as long as the largest operand. The trace operands (TRA, TRB, and TRC, and trace label) range from 1 to 1008 elements in length, and a variable identifier or numeric data field is 1 element long.

MXM (Continued)

The operands are truncated if they are not within certain limits. The limit for operands other than trace A, B, or C, is 32,767.

OUTPUT 718; "MXM TRA,TRC,TRB;"

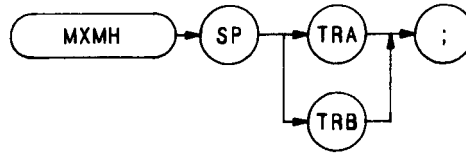

The MXMH command updates each trace element with the maximum level detected, while the trace is active and displayed. The functions of the MXMH and A2 commands, and front panel  key are identical.

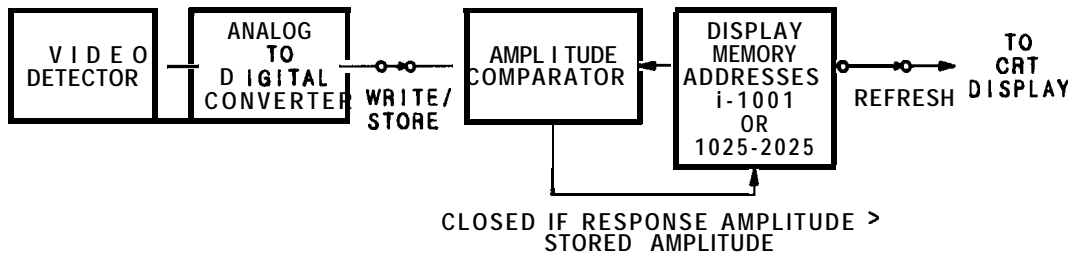

M1

Marker Off

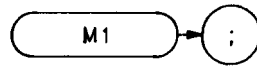

The M1 command blanks any markers present on the CRT (See also M2, MKOFF, and MKN.)

OUTPUT 718;“M1;”

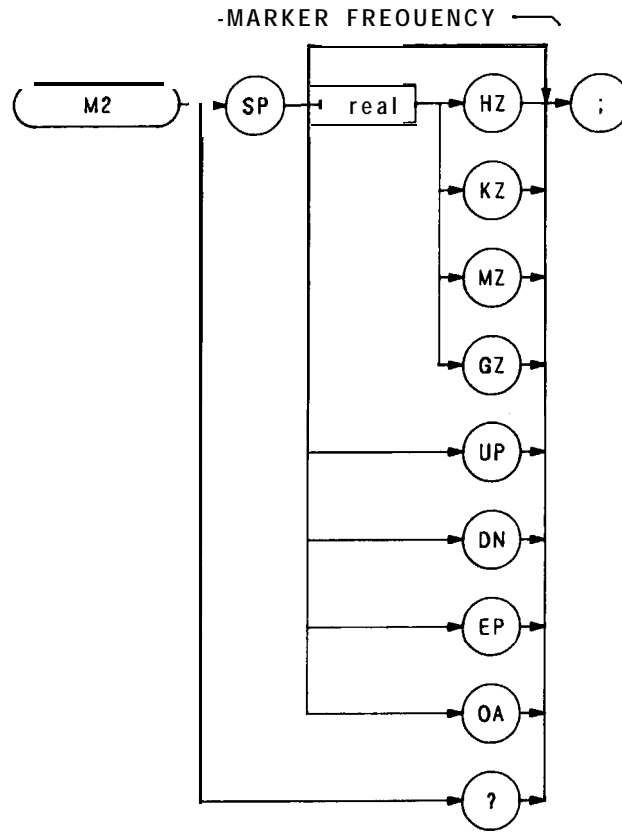

Item	Description/Default	Range Restriction
Real	Default value for units is Hz.	

The M2 command moves the active marker to the marker frequency. If the active marker is not declared with MKACT, the active marker number is 1.

OUTPUT 718; "M2;"

The functions of the M2 and MKN commands are identical.

M3

Delta Marker
(MKD)

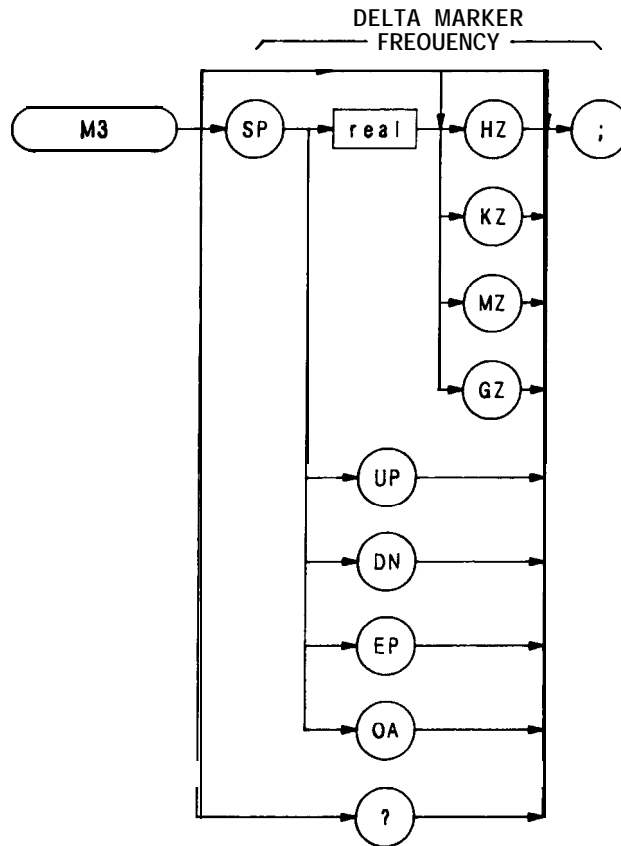

Item	Description/Default	Range Restriction
REAL	Selects delta marker frequency. Default value for units is Hz.	

The M3 command computes the frequency and amplitude difference of the active marker and a special marker, called the delta or differential marker. These values are displayed in the display readout.

$$\text{Differential value} = \text{active marker frequency} - \text{delta marker frequency}$$

$$\text{Differential value} = \text{active marker amplitude} - \text{delta marker amplitude}$$

If a delta marker is not on screen, MKD places one at the specified frequency, or at the right side of the CRT if an active marker is not on screen, MKD positions an active marker at center screen. (The active marker is the number 1 marker, unless otherwise specified with the MKACT command.)

OUTPUT 718; "M3 120MZ;"

The M3 command function is identical with that of the MKD command, and similar to that of the front panel  key.

M4

Marker Zoom

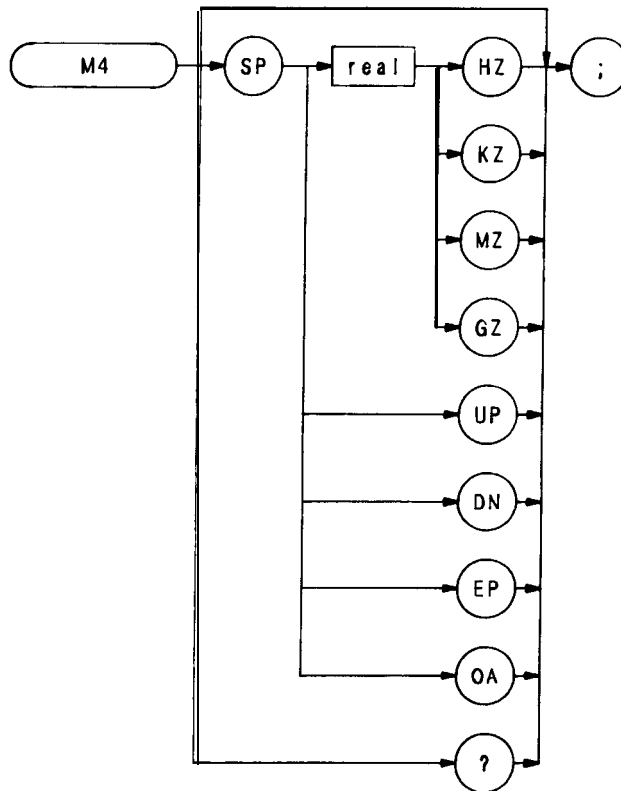

The M4 command activates a single marker at center frequency, the DATA knob changes the position of the marker and the STEP keys change the frequency span and sets the center frequency equal to the marker frequency. The functions of the M4 command and the front panel Marker Mode **ZOOM** key are identical.

Once a single marker is positioned anywhere on the display, executing the M4 command immediately positions the marker at center frequency.

OUTPUT 718; "M4;"

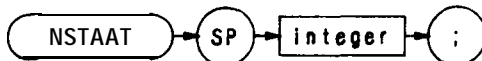

Item	Description/Default	Range Restriction
INTEGER	Real number representing analyzer LO harmonic.	4—63

The NSTART command specifies the start harmonic for the signal identification (**SIGID**) routine. The signal identification routine searches with all harmonics between the start harmonic (NSTART) and the stop harmonic (NSTOP).

NSTOP

Stop harmonic

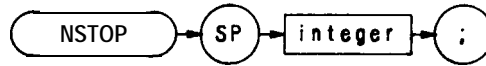

Item	Description/Default	Range Restriction
INTEGER	Real number representing analyzer LO harmonic.	4-63

The NSTOP command specifies the stop harmonic for the signal identification (SIGID) routine. The signal identification routine searches with all harmonics between the start harmonic (NSTART) and the stop harmonic (NSTOP) .

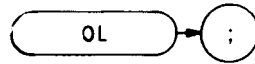

The OL command transmits information to the controller that describes the state of the analyzer when the OL command is executed. This information is called the learn string. The learn string can be sent from the controller memory back to the analyzer to restore the analyzer to its original state.

A list of the learn string contents and coding, and the control settings restored when the learn string is sent to the analyzer is provided in Appendix C. Note that the trace data and the state of some analyzer functions are not contained in the learn string.

The learn string requires 80 bytes of storage space. The program below sends the value of the resolution bandwidth to the controller.

```

10 DIM A$(80)
20 PRINTER IS 701
30 !
40 OUTPUT 718;"OL;"
50 ENTER 718 USING "80A";A$
60 Bandwidth = NUM(A${27,27})
70 PRINT SHIFT(Bandwidth,4)
80 !
90 END

```

Line 10: Dimensions enough storage to contain the 80-byte learn string.

Lines 40 to 50: Reads and stores the contents of the learn string.

Lines 60 to 70: Prints the numerical equivalent of bits 4 through 7 of byte 27.

When this program is run, the printer prints the code for the current bandwidth. The instrument state is not affected. Interpreting the codes of some function values, such as resolution bandwidth, requires additional program lines that equate these codes to specific function values.

Use OL command to return the state of most instrument functions to the controller simultaneously. Use a query (?) to return the state of a single instrument function. Below, a query returns the value of the input attenuation to the controller.

```

10 OUTPUT 718;"AT?;"
20 ENTER 718;N
30 END

```

The OL command and "?" do not alter the state of the spectrum analyzer, and for this reason, are the best way to send the states of the analyzer functions to the controller. An analyzer state may be returned to the controller with "OA", but this sometimes necessitates changing the analyzer state. For example, the program below changes the attenuation from the coupled state to the uncoupled state when the attenuation value is queried with OA.

```

10 OUTPUT 718;"AT; OA;"
20 ENTER 718;N
30 END

```

ONEOS

On end of sweep

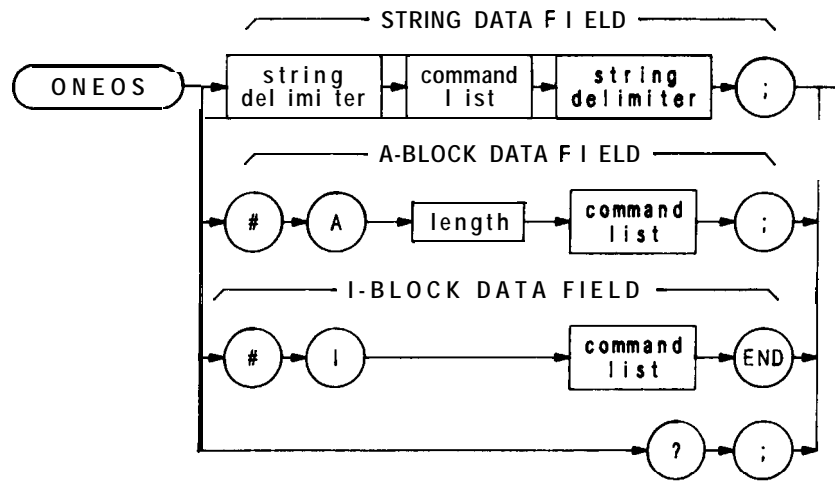

Item	Description/Default	Range Restriction
COMMAND LIST	Alphanumeric character. Any spectrum analyzer command from this section.	
STRING DELIMITER	Mark beginning and end of command string. End and beginning delimiters must be identical.	!"\$%&'{:=\~
COMMAND LIST	Any spectrum analyzer command from this section, except TS, ONSWP , or ONEOS.	
LENGTH	Two 8-bit bytes specifying length of command list, in 8-bit bytes. The most significant byte is first: MSB LSB.	

At the end of the sweep, the ONEOS command executes the contents of the data field.

OUTPUT 718;“ONEOS”“CF 100MZ;” ” ”

When queried (?) , ONEOS returns the command list.

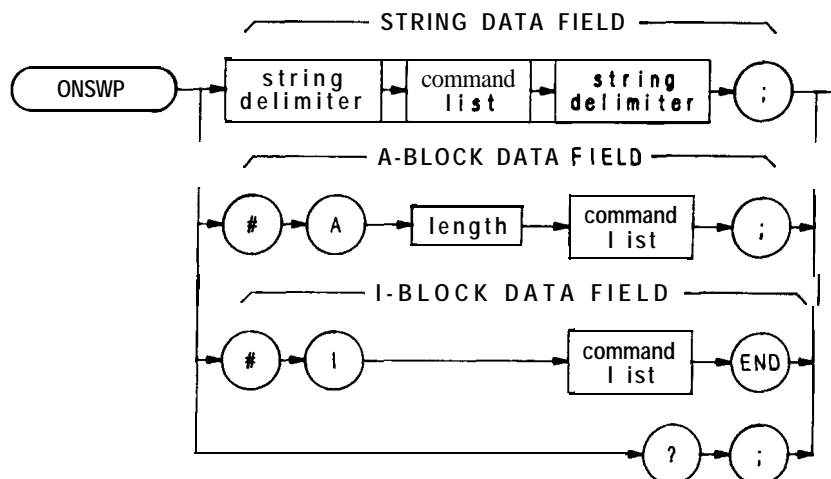

Item	Description/Default	Range Restriction
COMMAND LIST	Alphanumeric character. Any spectrum analyzer command from this section.	
STRING DELIMITER	Mark beginning and end of command string. End and beginning delimiters must be identical.	!"\$%&'{: = \~
COMMAND LIST	Any spectrum analyzer command from this section.	
LENGTH	Two 8-bit bytes specifying length of command list, in 8-bit bytes. The most significant byte is first: MSB LSB.	

At the beginning of the sweep, the ONSWP command executes the command list.

OUTPUT 718;“ONSWP”“CF 100MZ;”””

When queried (?) , ONSWP returns the command list.

OP

Output Parameter

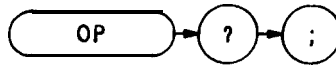

The OP command returns parameter values, P1 and P2, which represent the dimensions of the lower left, and upper right analyzer display. The values returned represent X and Y in display units.

A typical response to OP is 0,0,1023,1023;

0,	0,	1023,	1023
/	/	\	\
P1X	P1Y	P2X	P2Y

OUTPUT 718; "OP?;"

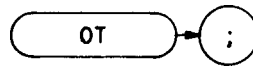

The output annotations command sends 32 character-strings, each up to 64 characters long, to the controller. These character strings contain all the CRT annotations except annotations written with the label command, LB, the title mode, KSE, or the text command, TEXT. The controller must read all 32 strings to successfully execute the command. The strings, listed below in the order they are sent, contain the following information:

String	Readout
1	"BATTERY"
2	"CORR'D"
3	resolution bandwidth
4	video bandwidth
5	sweep time
6	attenuation
7	reference level
8	scale
9	trace detection
10	center frequency or start frequency
11	span or stop frequency
12	reference level offset
13	display line
14	threshold
15	marker frequency
16	marker amplitude
17	frequency offset
18	video averaging
19	title
20	"PL1 UNLOCK"
21	"PL2 UNLOCK"
22	"Y-I-0 UNLOCK"
23	"HET UNLOCK"
24	"M/N UNLOCK"
25	"REFUNLOCK"
26	"EXT/OVEN"
27	"MEASUNCAL"***
28	frequency diagnostics
29	
30	"SRQ"
31	center frequency "STEP"
32	active function

The following program stores all the CRT annotations in the string array, A\$:

```

10 DIM A$(32)(64)
20 PRINTERS
30 !

```

OT (Continued)

```
40 OUTPUT 718;"OT"  
50 FOR N = 1 TO 32  
60 ENTER 718;A$(N)  
70 NEXT N  
80 !  
90 FOR N = 1 TO 32  
100 PRINT A$(N)  
110 NEXT N  
120 END
```

After turning line power on, an OT command and print routine print the following string array contents:

```
1  
2  
3     RES BW 3 MHz  
4     VBW 3 MHz  
5     SWP 500 msec  
6     ATTEN 10 dB  
7     REF 0.0 dBm  
8     10 dB/  
9  
10    START 2.0 GHz  
11    STOP 22.0 GHz  
12  
13  
14  
15  
16  
17  
18  
19  
20  
21  
22  
23  
24  
25  
26  
27  
28  
29  
30  
31  
32    HP-IB ADRS:
```

All blank lines represent empty strings.



The spectrum analyzer outputs must be formatted appropriately for the controller and measurement requirements. The spectrum analyzer transmits decimal or binary values, via the Hewlett-Packard Interface Bus (HP-IB), to a controller or other HP-IB device, such as a printer. The decimal and binary values represent trace information or instructions.

The format characteristics are summarized in the table below.

Analyzer Output	Format Command	Output Example of Marker Amplitude. Marker is at — 10 dBm reference level.
Sends trace information only as a decimal value in Hz, dB, dBm, volts, or seconds.	0 3	— 10.00
Sends trace amplitude and position information, or instruction word as decimal values ranging from 0 to 4095:	0 1	1001
0 to 1023 represent positive, unblanked amplitudes in display units.		
1024 to 2047 are instruction words (analyzer machine language).		
2048 to 3071 represent positive, blanked amplitudes in display units.		
3072 to 4095 represent negative, blanked amplitudes in display units.		
Sends trace amplitude and position information, or instruction word as binary values in two 8-bit bytes, sending the most significant bit first. The four most significant bits are zeroes.	0 2	0000 xxxx xxxxxxxx (3) (231) values 0 to 4095
Sends trace amplitude information only as binary value in one 8-bit byte, composed from the 02 output bytes:	0 4	xxxxxxx (250) values 0 to 255 (full scale)
<pre> o o o o x x x x x x x x x x x x 0 2 11 // // // // x x x x x x x x 0 4 </pre>		

01, 02, 03, 04 (Continued)

03 Format

The 03 format transmits trace amplitude information only, in measure units: Hz, **dBm**, **dB**, volts, or seconds. The 03 format cannot transmit instruction words.

A carriage-return/line-feed (ASCII codes 13, 10) always follows any data output. The end-or-identify state (EOI) is asserted with line feed.

Instrument preset (**IP**) automatically selects the 03 format.

01 Format

The 01 format transmits trace amplitude information as decimal values in display units. (See Chapter 4 in Section I for a description of display units.)

Trace amplitude values can be positive and unblanked, positive and blanked, or negative and blanked. Positive, unblanked values (**0** to 1023) cover the visible amplitude range on the spectrum analyzer CRT

Negative trace values (3072 to 4095) usually result from trace arithmetic, and are not displayed because they are off (below) the screen. Negative values are represented by the **12-bit** two's complement of the negative number, that is, **4096—**(negative **value**). For example, a **— 300** values is an output of 3796.

$$4096 - | - 300 | = 3796$$

Positive, blanked values (2048 to 3071) are those responses immediately ahead of the updated, sweeping trace. These values form the blank-ahead marker, and represent the amplitude responses of the previous sweep, plus 2048. Thus, they are off (above) the screen (See Appendix B.)

The 01 format also transmits instruction words as decimal values. See the Instruction and Data Word Summary in Appendix B.

A carriage-return/line-feed (ASCII codes 13, 10) always follows any data output in the 01 format. The end-or-identify state (EOI) is asserted with line feed.

02 Format

The 02 format transmits trace information or instruction words as two 8-bit binary numbers. The most significant bit is sent first. The four most significant bits are always zeroes.

Most Significant Byte

Least Significant Byte

0000 xxxx

xxxxxxxx

Refer to the Consolidated Coding table in Appendix B for instruction word information.

Note that the 02 format sends the same kind of information that the 01 format sends, except that 02 transmits the information in binary numbers instead of decimal numbers. Also, the end of transmission is not marked by carriage-return/line-feed (ASCII codes 13, 10) in the 02 format.

04 Format

The 04 format transmits trace amplitude information only as a binary number. The binary number is one 8-bit byte composed from the bytes established with the 02 format.

```

0000  xxxx  xxxxxxxxxx  02
      11  //
      xxxxxxxxxx          04

```

The 04 output is the fastest way to transmit trace data from the spectrum analyzer to the HP-IB bus. However, sign information is lost. Keep this in mind when transmitting delta marker information (MKD) . The end of data transmission is NOT marked by a carriage-return/line-feed.

Format Statements and the HP-IB Bus

The table below shows a transmission sequence on the HP-IB bus for each of the four formats. Each format is transmitting the amplitude of a marker positioned at the -10 dBm reference line.

Format	03	01	02	04
Byte	NUM (—)	NUM ("1")	(3)	(250)
Byte	NUM (1)	NUM ("Ø")	(231)	
Byte	NUM (Ø)	NUM ("Ø")		
Byte	NUM (.)	NUM ("1")		
Byte	NUM(0)	13		
Byte	NUM(0)	10		
Carriage Return	13			
Line Feed (EOI asserted)	10			

Though the spectrum analyzer transmits either binary or digital information on the HP-IB bus, a decimal number is always returned to the controller display. This is illustrated in the program below, which reads the instruction word **1040** at display address **Ø**, the **first** memory location of trace A. The program reads the instruction word, using each of the formats, and the DR command.

```

1  ASSIGN @Sa TO 718
2  PRINTER IS
4  OUTPUT @Sa,"A1;S2;TS;"
10 OUTPUT @Sa,"DA Ø 01 DR"
20 ENTER @Sa;Dr1
30 OUTPUT @Sa;" DA Ø 02 DR"

```

01, 02, 03, 04 (Continued)

```

40 ENTER @Sa USING "# W":Dr2
50 OUTPUT @Sa;" DA 0 03 DR
50 ENTER @Sa;Dr3
70 OUTPUT @Sa;" DA 0 04 DR"
80 ENTER @Sa USING "#,B";Dr4
90 PRINT Dr1,Dr2,Dr3,Dr4
100 EN-D

```

Running the program above produces the following responses on the controller display Note that all the responses are decimal numbers. Also note that the 03 and 04 formats do not return the correct data. (As mentioned above, 03 and 04 do not transmit instruction words.)

```

01 FORMAT response: 1040
02 FORMAT response: 1040
03 FORMAT response: — 200.8
04 FORMAT response: 4

```

Controller Formats

The format of the controller must be compatible with the output format of the analyzer.

Analyzer Format	Controller Format	
	Requirements	Example Statement and Analyzer Response
01	free field	ENTER 7 18; PK-AMPLITUDE Response: 1001
03	field size dependent on output, use free field format	ENTER 7 18; PK-AMPLITUDE Response: — 10.0
02	binary, read twice for each value	ENTER 7 18 USING "#,W" Response: 1001
04	binary, read once for each value	ENTER 7 18 USING "#,B" Response: 250

NOTE

The 0 in O1, O2, O3, and O4 is the letter 0 and not the number zero.

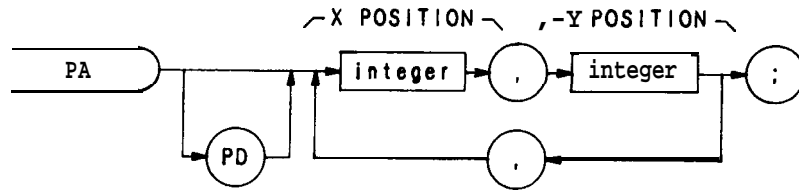

Item	Description/Default	Range Restriction
INTEGER	Represents x,y coordinates of vector endpoint(s), in display units.	0— 1022

The PA command specifies in display units a vector location on the CRT relative to display reference coordinates 0,0. (See also display size commands D1, D2, and D3.) The vector is drawn on the CRT if the pen-down (PD) command is in effect. If the pen-up (PU) command is in effect, the vector does not appear of the CRT A sample program using the PA command is shown below.

```

10 ASSIGN @Sa TO718
20 OUTPUT @Sa;"IP;A4;KSm;KSo;"
30 OUTPUT @Sa;"D2;PU;"
40 OUTPUT @Sa;"PA 700,500;PD 900,500;"
50 OUTPUT @Sa;"900,300,700,300,700,500;"
80 END
    
```

- Line 20: Presets the analyzer and clears the display
- Line 30: Specifies the full CRT display size. The pen-up command prevents the initial vector (to point 700,500) from being drawn.
- Line 40: Specifies the starting point of the rectangle to be drawn by the program (coordinates 700,500). The PD (pen-down) command causes a vector to be drawn on the CRT from the starting point coordinates to the next set of coordinates (900,500) specified in the program.
- Line 50: Plots the remainder of the rectangle on the CRT The pen-down command remains in effect.

PD

Pen Down

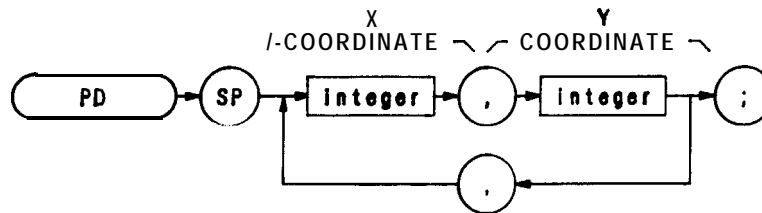

Item	Description/Default	Range Restriction
INTEGER	Represents x,y coordinates of vector endpoint(s), in display units.	0– 1022

The PD command draws one or more vectors on the analyzer screen. The PA command, plot absolute, may be used to mark the starting point of the vector.

```
10 ASSIGN @Sa to 718
20 OUTPUT @Sa; "IP;A4;KSm;KSo;"
30 OUTPUT @Sa; "D3;PU;"
40 OUTPTJT @Sa; "PA 300, 500;PD 450,250;"
50 OUTPTJT@Sa; "150,250,300,500;"
60 END
```

- Line 20: Presets the instrument and clears the display.
- Line 30: Specifies the expanded CRT display size. The pen-up command ensures that the initial vector to point (300,500) is not drawn.
- Line 40: Plot absolute command and the starting point of the triangle. The following pen-down command draws the vector from (300,500) to (450,250).
- Line 50: Plots the remainder of the triangle on the CRT The pen-down condition is still in effect.

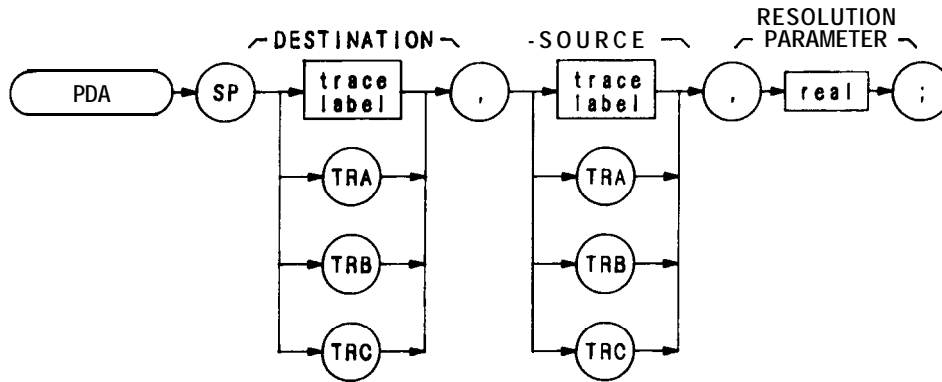

Item	Description/Default	Range Restriction
REAL TRACE LABEL	Default is dBm . Alpha character. User-defined label declared in TRDEF statement.	AA—ZZ and _ 2— 12 characters required.

The PDA command loads the destination trace according to the pattern of amplitude values in the source trace. Thus, the destination trace represents the amplitude probability function of the source trace.

The assumption is that the source trace is taken from the display. Hence, the values of the source trace are in **dBm** (or **dBmV** or **dBμV**) when the display is in the log mode, or in display units when the display is in the linear mode. The resolution parameter determines how the screen is divided vertically to create the probability function.

If the display is in the 10 dB/div log mode and the resolution parameter is specified as 5, then the screen is divided into twenty **5-dB** increments. Each value of the source trace is tested in turn and the appropriate element of the destination trace is incremented by one. For example, if the first point of the source trace is 12 **dB** below the reference level (and thus falls in the eighteenth **5-dB** increment from the bottom of the screen), then the 18th element of the destination trace is incremented. Note that the destination trace must have an appropriate number of points (in this case, 20).

If the display mode is linear, then the resolution parameter divides the screen into increments that are a percentage of the total number of display units within the graticule (1000). For example, if the resolution parameter is 5, the screen is divided into twenty 50-display-unit increments (5% of 1000 is 50). Otherwise, the procedure is the same as above.

The data need not be taken from the screen. PDA can be used on an array of calculated data. However, the resolution parameter must be chosen as if the data were in display units. For example, if the array values vary from 0 to 200, and you want to divide it into twenty increments (1 — 10, 11 — 20, **21** — 30, etc.), then the resolution parameter must be 1.0 (1.0% of 1000 is **10**).

PDF

Probability Distribution in Frequency

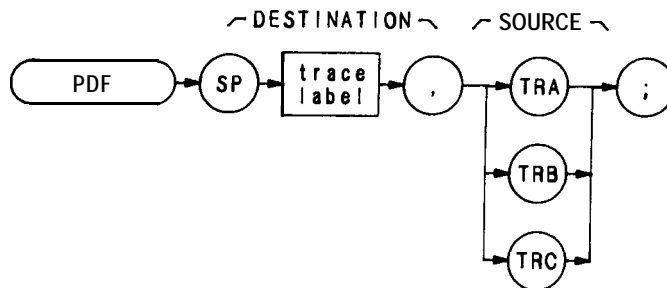

Item	Description/Default	Range Restriction
TRACE LABEL	Alpha character. User-defined label declared in TRDEF statement.	AA- ZZ and _ 2— 12 characters required.

When the PDF command is executed, elements of the source trace that are above the threshold value cause corresponding elements in the destination trace to be increased in amplitude by one display unit. The threshold value may be specified by the TH command. Otherwise, its default value is nine major divisions below the reference level.

```

OUTPUT 718; "TRDEF S__AMPLE,50;"
OUTPUT 718; "PDF S__AMPLE,TRA;"
    
```

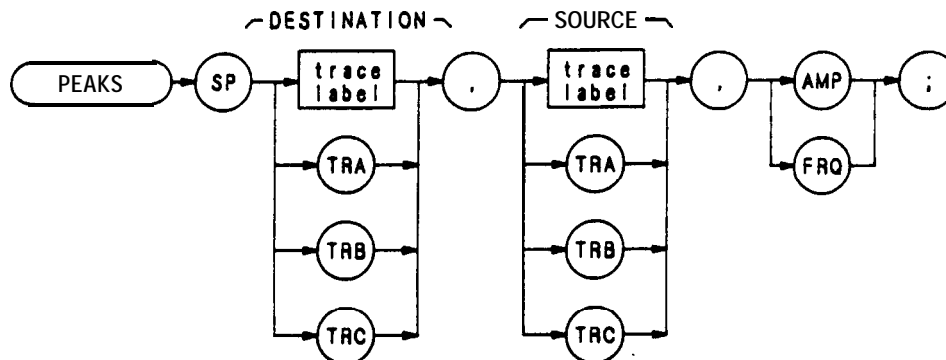

Item	Description/Default	Range Restriction
TRACE LABEL	Alpha character. User-defined label declared in TRDEF statement.	AA- ZZ and _ 2— 12 characters required.

The PEAKS command sorts signal peaks **by** frequency or amplitude. PEAKS sorts the source trace and sends sorted results to the destination trace.

```

10 OUTPUT 718; "IP;"
20 OUTPUT 718; "TRDEF FREQ;"
30 OUTPUT 718; "TS;MOV FREQ,TRA;"
40 OUTPUT 718; "PEAKS TRC,FREQ,FRQ;"
80 END

```

When sorting by frequency, PEAKS first computes, in display units, the horizontal position of all peaks. These values are consecutively loaded into the destination trace, the lowest **value** occupying the first element. Thus, signal horizontal positions, from low to high, determine the amplitude of the destination trace from left to right. To obtain results in frequency units, scale the destination trace from display units to frequency units using either the center frequency and frequency span, or the start and stop frequencies.

When sorting by amplitude, PEAKS first computes the amplitudes of all peaks in the source trace. The horizontal position corresponding to each signal peak is loaded, in display units, into the destination trace. The horizontal position corresponding to the signal with the highest amplitude is loaded into the first element of the destination trace. The horizontal position corresponding to the signal with the second highest amplitude is loaded into the second element of the destination trace, and so on. It is in this manner that the horizontal positions corresponding to signals ranging from the highest amplitude to the lowest amplitude determine, from left to right, the amplitude of the destination trace.

PEAKS only sorts signals that are above the threshold value; to change the threshold, use the TH command before PEAKS is executed.

If necessary, the last sorted value is repeated to fill remaining elements of the destination trace.

PEAKS (Continued)

PEAKS also returns the number of signal peaks found. To access this value, **execute**

```
ENTER 718;N  
PRINT N
```

after line 40 of the example program.

To access the data in the destination trace once PEAKS is executed, move the indexed trace data into a variable and display the variable on the screen, or return it to the controller by querying the variable. The following program example displays the first value of the destination trace, TRC, on the analyzer screen at the analyzer's current pen location.

```
10 OUTPUT 718;"VARDEF FIRST,0;"  
20 OUTPUT 718;"MOV FIRST,TRC[1];"  
30 OUTPUT 718;"DSPLY FIRST,4.5;"  
40 END
```



Item	Description/Default	Range Restriction
P1X P1Y	Plotter-dependent values that specify lower left plotter dimension.	Plotter dependent
P2X P2Y	Plotter-dependent values that specify upper right plotter dimension.	Plotter dependent

The trace data, graticule, and annotation of the analyzer's screen can be directly transferred via HP-IB to a Hewlett-Packard plotter such as the 7245A/B, 7240A, 7470A, 9872C, or 7550 using the PLOT command.

Before executing a program, set the HP-IB on the plotter to address 5:

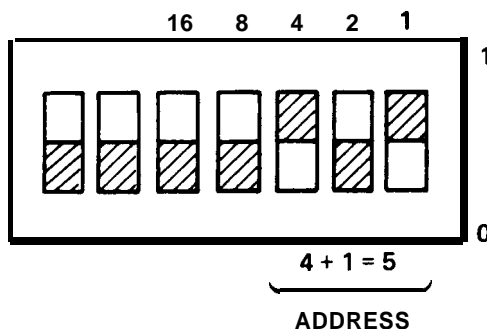

If the address switch on the plotter cannot be located, refer to the plotter's operation manual.

When using the PLOT command, the scaling points (P1x, P1y; P2x, P2y) must be specified. These scaling points specify the x,y coordinates which determine the size of the plot. (For more scaling point information, refer to the plotter's operation manual.)

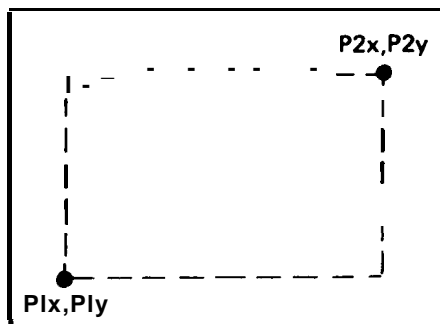

PP

Preselector Peak

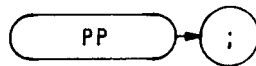

The PP command optimizes preselector tracking to peak the amplitude of a signal at the active marker. If a marker is not on screen, PP places a marker at the highest signal level, and optimizes preselector tracking at that frequency.

Normally, preselector tracking is automatically maintained so that the center of the preselector filter tracks the sweep. The PP command monitors the signal amplitude at the marker while the preselector frequency is adjusted to yield the maximum level of the signal response, provided the signal is a stable continuous wave signal. Use the KS/ command to manually adjust the preselector frequency when measuring unstable signals.

OUTPUT 718; "PP;"

The functions of the PP command and the  key are identical. (See KS/ and KS = .)

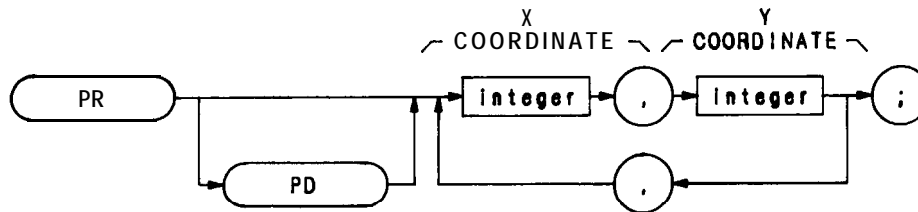

Item	Description/Default	Range Restriction
INTEGER	Represents CRT beam x and y coordinates, in display units, relative to the last beam position.	0— 1022

The PR command specifies a plot location on the CRT relative to the last plot point coordinates. Vector coordinate sets (x,y pairs) following the PR command can be either positive or negative, depending on the direction the individual vectors are to be drawn. PU (pen-up) and PD (pen-down) commands tell the analyzer to draw or not draw the vectors on the CRT display.

A typical use of the PR command is shown in the sample program below.

```

10 ASSIGN @Sa TO 718
20 OUTPTJT@Sa;"IP;A4;KSm;KSo;"
30 FOR X = 200 TO 800 STEP 200
40 OUTPUT @Sa;"PU PA",X,1,1*X
50 GOSUB Rectangle
60 NEXT X
70 STOP
80 Rectangle: !
90 OUTPUT @Sa;"PD PR 300,0,0—200,—300,0,0,200"
100 RETURN
110 END

```

Line 20: Presets the analyzer and clears the display.

Line 40: PA (plot absolute) command defines the starting point for the three rectangles to be drawn on the CRT display.

Line 90: PD (pen-down) command tells the analyzer to display the vectors drawn in accordance with the vector coordinates (x,y pairs) that follow the PR command. Vectors are then drawn to the four corners of the current rectangle.

PS

Skip Page

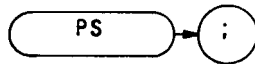

The PS command causes the address pointer to skip over the addresses in the remaining portion of the display memory page in use, and go to the first address at the beginning of the next display memory page. Display control work 1056 (DW 1056) can be substituted for the PS command.

If PS is executed when the address pointer is at an address in the fourth and **last** page (Trace **C**) of display memory, the pointer skips to address \emptyset in page 1. Because the program does not wait for a new refresh cycle to begin before executing the next instruction, the skip may cause an increase in trace intensity as new data is written over the old. Increased trace intensity occurs only when the time span of the program is less than the default refresh rate. End-of-display control instruction word 1028 in the trace C page normally makes sure a refresh cycle occurs.

A typical use of the PS command is shown in the sample program below.

```
10 ASSIGN @Sa to 718
20 OUTPUT @Sa;"IP; S2; TS; DA100; PS;"
30 END
```

In the sample program above, the analyzer is preset (IP), put in the single-sweep mode (**S1**), instructed to take a single sweep (TS), and then, from address 100 (**DA100**) in display memory page 1 (trace A), skip over (PS) the remainder of the page 1 addresses to the first address in display memory page 2 (trace B) .

(See Appendix B.)

• (Refresh means to update the display from the display memory. Refresh cycles occur at a rate of approximately 50 Hz

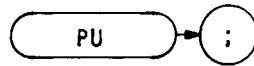

The **PU** command blanks the CRT beam to prevent plot vectors from being displayed on the CRT.

A typical use of the **PU** command is shown in the sample program below.

```

10  ASSIGN @Sa TO 718
20  OUTPUT @Sa;"IP; A4; KSm; KSo;"
30  OUTPUT @Sa;"D2; PU;"
40  OUTPUT @Sa;"PA 700,500 PD 900,500"
50  OUTPUT @Sa;"900,300,700,300,700,500"
60  END

```

- Line 20: Presets the instrument and clears the display.
- Line 30: Specifies display size D2 and, with the **PU** command, instructs the analyzer not to display the vector to the initial point specified by x,y coordinates 900,500.
- Line 40: PA (plot absolute) command establishes the starting point of the rectangle to be drawn on the CRT The following PD (pen-down) command instructs the analyzer to display the vector to coordinates 700,500.
- Line 50: Plots and displays the remainder of the rectangle on the CRT

PWRBW

Power Bandwidth

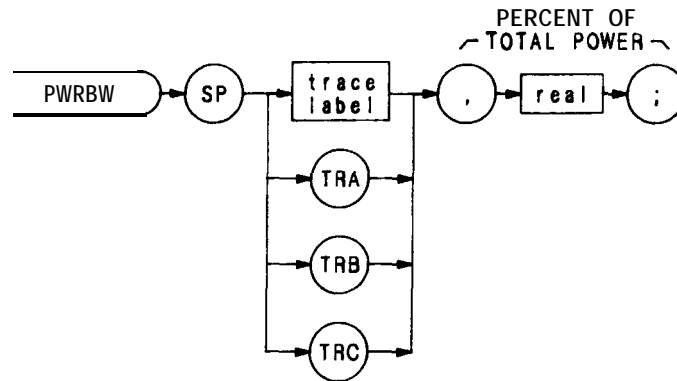

Item	Description/Default	Range Restriction
TRACE LABEL	Alpha character. User-defined label declared in TRDEF statement.	AA- ZZ and _ 2— 12 characters required.
REAL		Ø to 100

The PWRBW command first computes the combined power of all **signal responses contained in a trace array**. The command then computes the bandwidth equal to a percentage of the total power, and returns this value to the controller.

For example, if the percent of total power is specified as **100%**, the power bandwidth **equals the frequency range** of the CRT display, which is 100 MHz if the frequency span per division is 10 MHz. If 50% is specified, trace elements are eliminated from either end of the array until the combined power of the remaining signal responses equals half of the original power computed. The frequency span of these remaining trace elements is the power bandwidth returned to the controller.

The following example computes the power bandwidth of a trace, and returns 99% of the total power.

```

10 OUTPUT 718;"VARDEF P__BW,0;"
20 OUTPUT 718;"MOV P__BW,PWRBW TRA,99.0;"
30 OUTPUT 718;"DIV P__BW,P__BW,1E6;"
40 OUTPUT 718;"D2;EM;PU;PA380,1000;"
45 OUTPUT 718;"TEXT @99% POWER BANDWIDTH = @;DSPLY P__BW,6.3;"
46 OUTPUT 718;"TEXT @ MHZ@;HD;"
50 END

```

- Line 10: Define a variable, **P__BW**, to store the power bandwidth.
- Line 20: Find the power bandwidth and move it into **P__BW**.
- Line 30: Convert **P__BW** to MHz.
- Line 40: Set display size to D2, erase trace C memory (which sets the display address to 3072), and set pen position to x = 380, y = 1000.
- Lines 45 and 46: Write the results on the analyzer screen.

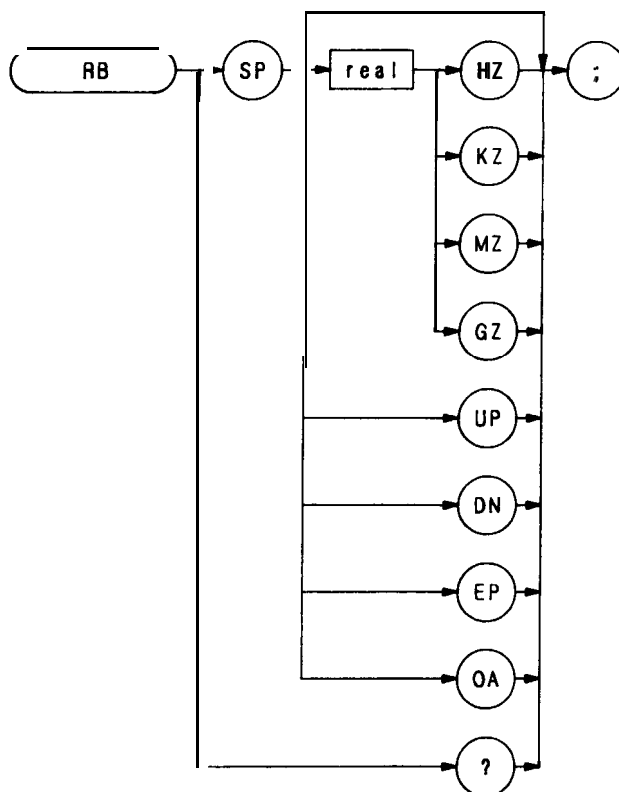

The RB command specifies the resolution bandwidth. Available bandwidths are 10 Hz, 30 Hz, 300 Hz, 1 kHz, 3 kHz, 30 kHz, 100 kHz, 300 kHz, 1 MHz, and 3 MHz. The resolution bandwidths, video bandwidths, and sweep time are normally coupled. Executing RB decouples them. Execute CR to reestablish coupling.

OUTPUT 718; "RB 1KZ;"

The execution of the RB command, and the  key is identical.

RC

Recall Last State
(RCLS)

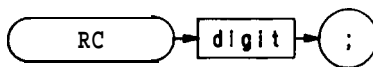

Item	Description/Default	Range Restriction
DIGIT	Specifies analyzer register.	1 through 9

The RC command recalls registers containing a set of instrument states. Registers one through six are reserved for the user, and contain instrument states (such as front panel configuration) sorted with the SAVES or SV commands.

Register 7 is a special register that contains the instrument state prior to the last instrument preset (IP) or single function change. Use the contents of register 7 to recover from inadvertent entries:

OUTPUT 718; "RC 7;"

Registers 8 and 9 recall factory-selected control settings for calibration purposes.

The functions of the RCLS and RC commands, and front-panel RECALL key are identical. (Also see SAVES or SV.)

RCLS

Recall State Register
(RC)

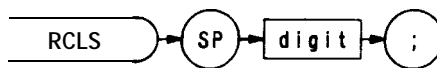

Item	Description/Default	Range Restriction
DIGIT	Specifies analyzer register.	1 through 9

The RCLS command recalls registers containing a set of instrument states. Registers one through six are reserved for the user, and contain instrument states (such as front panel configuration) stored with the SAVES or SV commands.

Register 7 is a special register that contains the instrument state prior to the last instrument preset (IP) or single function change. Use the contents of register 7 to recover from inadvertent entries:

OUTPUT 718; “RCLS 7;”

Register 8 and 9 recall factory-selected control settings for calibration purposes.

The functions of the RCLS and RC commands, and front-panel  key are identical. (Also see SAVES or SV.)

REPEAT UNTIL

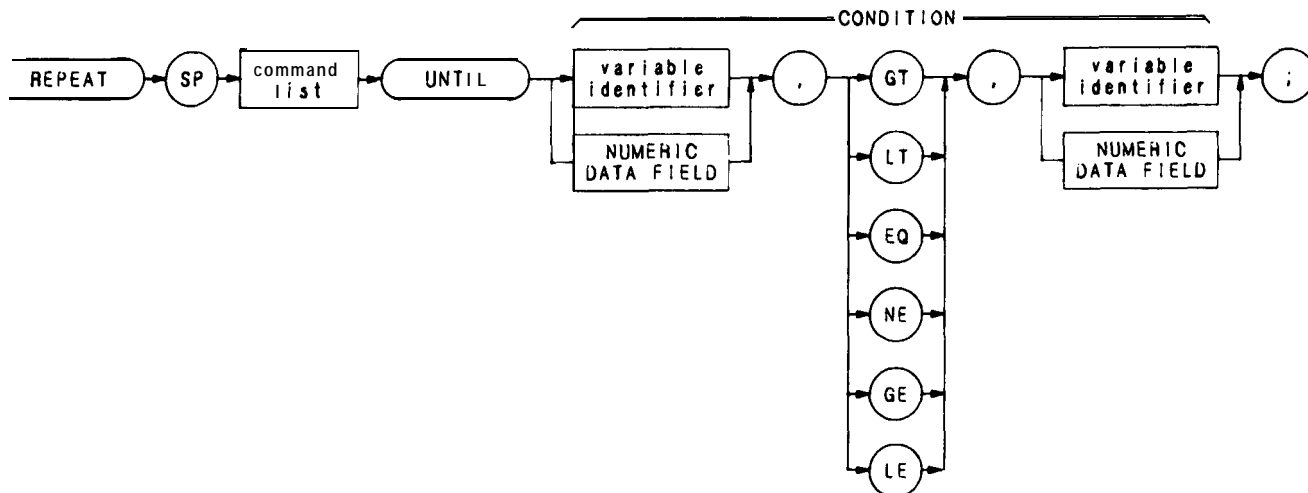

Item	Description/Default	Range Restriction
VARIABLE IDENTIFIER	Alpha character. User-defined identifier declared in VARDEF statement. Do not follow identifier with semicolon.	AA-U and _ 2— 12 characters required.
	Alpha character. Measurement-variable identifier, such as CF or MA. Do not follow identifier with semicolon.	
	Trace element, such as TRA[10].	
NUMERIC DATA FIELD	Real	
COMMAND LIST	Any commands from this remote section.	

REPEAT and UNTIL commands form a looping construct. The command list is repeated until condition is true.

The following program lowers any off-screen signal.

```

10 OUTPUT 718;"S2;TS;E1;"
20 OUTPUT 718;"IF MA,GT,RL THEN"
30 OUTPUT 718;"REPEAT RL UP;TS;E1;"
40 OUTPUT 718;"UNTIL MA,LE,RL"
50 OUTPUT 718;"ENDIF S2;" ""
60 END

```

Use the FUNCDEF command to nest a REPEAT UNTIL command within another REPEAT UNTIL looping construct. The program below defines “C-LOP” as a looping construct in lines 30 through 60. The construct is then nested into the REPEAT UNTIL command in line 80.

```

10 OUTPUT 718;"SNGLS;"
20 OUTPUT 718;"VARDEF COUNT,0;VARDEF SCORE,0;"
30 OUTPUT 718;"FUNCDEF C_LOP," " "
40 OUTPUT 718;"REPEAT TS;"
50 OUTPUT 718;"ADD COUNT,COUNT,1;"
80 OUTPUT 718;"UNTIL COUNT,EQ,3;" " "
70 OUTPUT 718;"REPEAT;"
80 OUTPUT 718;"C_LOP;"
90 OUTPUT 718;"ADD SCORE,SCORE,1;"
100 OUTPUT 718;"UNTIL SCORE,EQ,4;"

```

The program below does not work because the REPEAT UNTIL commands are nested without the use of the FUNCDEF command.

```

10 OUTPUT 718;"SNGLS;"
20 OUTPUT 718;"VARDEF COUNT,0;VARDEF SCORE,0;"
30 OUTPUT 718;"REPEAT;"
40 OUTPUT 718;"REPEAT;"
50 OUTPUT 718;"TS;"
80 OUTPUT 718;"ADD COUNT,COUNT,1;"
70 OUTPUT 718;"UNTIL COUNT,EQ,3;"
80 OUTPUT 718;"ADD SCORE,SCORE,1;"
90 OUTPUT 718;"UNTIL SCORE,EQ,4;"
100 END

```

REV

Revision



The REV command returns the firmware revision number and HP date code.

OUTPUT 718;“REV;”

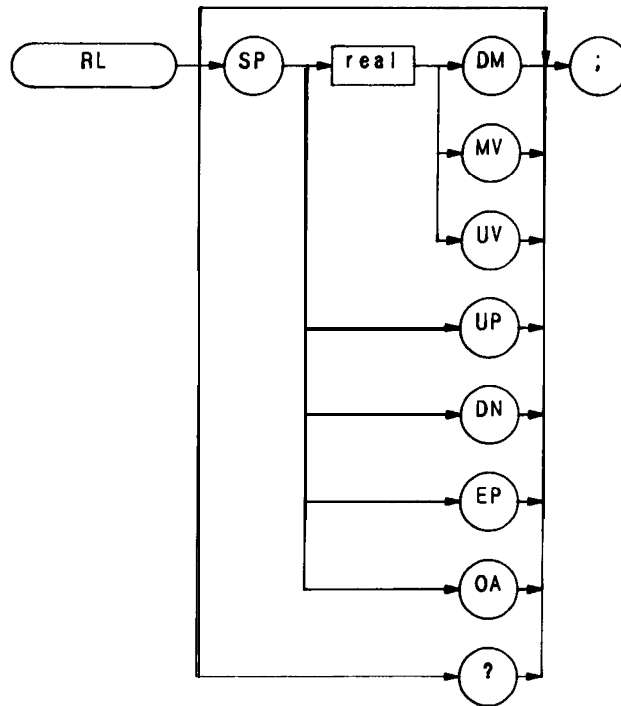

The RL command specifies the amplitude value of the top CRT graticule line, which is called the reference level. The reference level can be specified from -89.9 dBm to $+30 \text{ dBm}$ with 0.1 dB resolution.

The reference level and input attenuator are coupled to prevent gain compression. Any signals with peaks at or below the reference level are not affected by gain compression.

The reference level range can be extended from -129.9 dBm to $+60 \text{ dBm}$ with the KSI command. When the reference level range is extended, and the mixer level commands, KSI or ML, are used to change the threshold of the mixer input to values greater than -10 dBm , signals on the spectrum analyzer screen may be affected by gain compression. (See AT and ML.)

OUTPUT 718; "RL -10DM;"

The functions of the RL command and the REFERENCE
LEVEL key are identical.

RMS

Root Mean Square

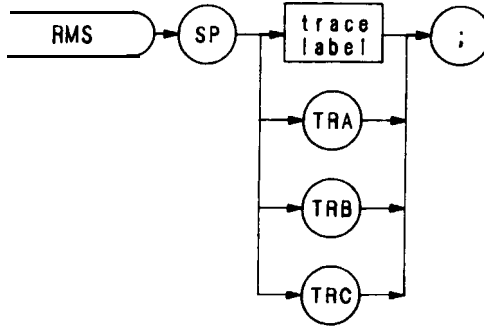

Item	Description/Default	Range Restriction
TRACE LABEL	Alpha character. User-defined label declared in TRDEF statement.	AA- ZZ and _ 2— 12 characters required.

The RMS command returns the RMS value of the trace, in display units. Note that the value must be moved into a variable to be accessed.

```
OUTPUT 718;"VARDEF DESTINATION, 0;"  
OUTPUT 718;"MOV DESTINATION,RMS TRC;"
```

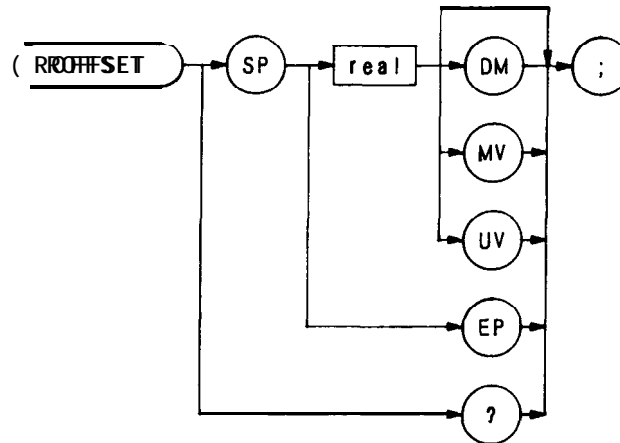

Item	Description/Default	Range Restriction
REAL	Default value for units is dBm (DM) .	+ – 300 dB

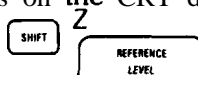
The ROFFSET command offsets all amplitude readouts on the CRT display without affecting the trace. The functions of the ROFFSET command and the front panel  keys are identical.

Once activated, the ROFFSET command displays the amplitude offset in the active function block. And, as long as the offset is in effect while doing other functions, the offset is displayed to the left of the graticule.

Entering a zero with ROFFSET activated eliminates any amplitude offset.

OUTPUT 718;“ROFFSET -12DM;”

The functions of the ROFFSET and KSZ commands are identical.

RQS

SRQ Mask

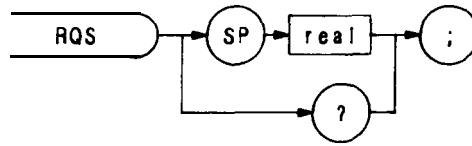

Item	Description/Default	Range Restriction
INTEGER	Integer representing a bit mask for service requests (SRQ).	0— 255

The RQS command sets a bit mask for service requests (SRQ command).

On execution of a SRQ command, the analyzer logically **ANDs** the RQS mask with the binary equivalent of the SRQ operand. When the result of this AND operation is a non-zero number, the analyzer sends a service request to the HP-IB controller.

A query for the RQS command returns the RQS operand.

See also SRQ and Appendix D.

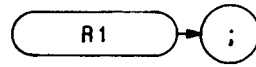

The **R1** command deactivates all analyzer service requests (**SRQs**) except SRQ140, the illegal-command service request.

See Appendix D for more information on the **R1** command

R2

End-of-Sweep SRQ

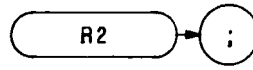

The **R2** command activates the end-of-sweep and illegal-command service requests.

See Appendix D for more information on the R2 command.

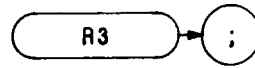

The R3 command activates the hardware-broken and illegal-command service requests.

See Appendix D for more information on the R3 command.

R4

Units-Key-Pressed SRQ

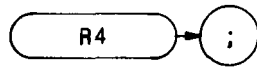

The R4 command activates the units-key-pressed and illegal-command service requests.

See Appendix D for more information on the R4 command.

SAVES

Save State
(SV)

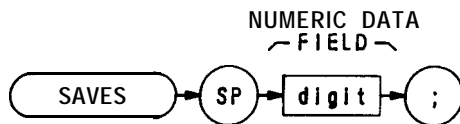

Item	Description/Default	Range Restriction
DIGIT	Specifies register for storage of instrument states.	1 - 6

The SAVES command saves the current spectrum analyzer state in any of registers one through six. Register contents are not affected by power loss, but previously saved data is erased when new data is saved in the same register.

The functions of the SAVES and SV commands, and front-panel  key are identical.

OUTPUT 718; "SAVES 5;"

SIGDEL

Signal Identification Delta Value

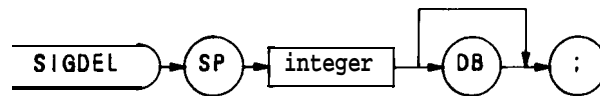

Item	Description/Default	Range Restriction
INTEGER	Specifies maximum difference allowed between the amplitude of a signal and its image, in dB.	0, 5, 10, 15, 20, 25, 30, and 35.

The SIGDEL command specifies the maximum difference allowed between the amplitude of a signal and its image for the internal signal identification routine, used for external mixing bands.

Execute the signal identification routine with the SIGID command.



The SIGID command enables a signal identifier routine that uses the normal marker to automatically identify the signal under observation in the external mixing mode. The functions of the SIGID and **Ksv** commands, and the front panel  keys, are identical.

A normal marker must be activated prior to executing the SIGID (external mixer signal identifier) command. The SIGID command determines the true frequency and mixing harmonic of the signal that the marker is on.

When signal identification is complete, the CENTER FREQUENCY is changed to match the frequency of the true signal, and CENTER FREQUENCY is left as the active function. If no identification can be made, the state before the SIGID command was executed is automatically restored with the “RECALL 7” function. When this happens, changing the harmonics and amplitude delta used by the signal identification routine may give better results. See SIGDEL, NSTART, and NSTOI?

If a harmonic lock is in effect when the SIGID command is executed, it is restored on completion of the SIGID command unless the identified signal cannot be tuned to with the “locked” harmonic. In this case, the original state, prior to executing the SIGID command, is automatically restored with the “RECALL 7” function, and the message “IDENTIFIED OUT OF BAND” appears on the CRT

If no marker is activated prior to executing SIGID, a peak search is done looking for the highest peak.

The SIGID command syntax is shown in the sample program line below.

```
OUTPUT 718;“SIGID;”
```

SMOOTH

Smooth

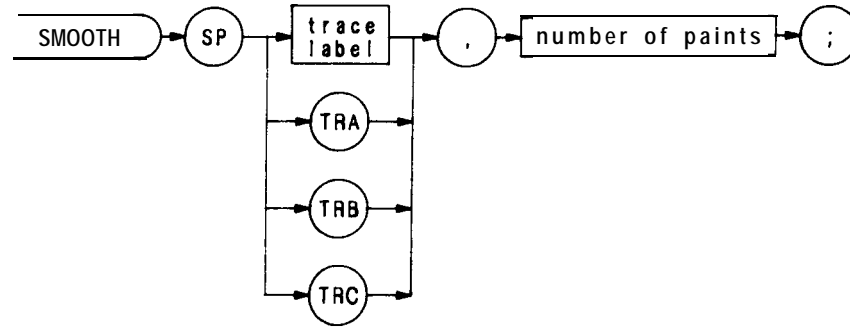

Item	Description/Default	Range Restriction
TRACE LABEL	Alpha character, User-defined label declared in TRDEF statement.	AA-22 and _ 2— 12 characters required.
NUMBER OF POINTS	Integer representing number of points for running average.	1 < number of points < 39 Must be odd number.

The SMOOTH command smooths the **trace** according to the number of points specified for the running average. Increasing the number of points increases smoothing.

OUTPUT 718; “SMOOTH **TRA** 23;”

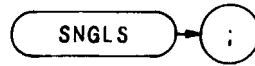

The SNGLS command sets the analyzer to single sweep mode. Each time single sweep is pressed, one sweep is initiated if the trigger and data entry conditions are met. The functions of the SNGLS and S2 commands, and front-panel  key are identical.

OUTPUT 718;“SNGLS;”

SP

Frequency Span

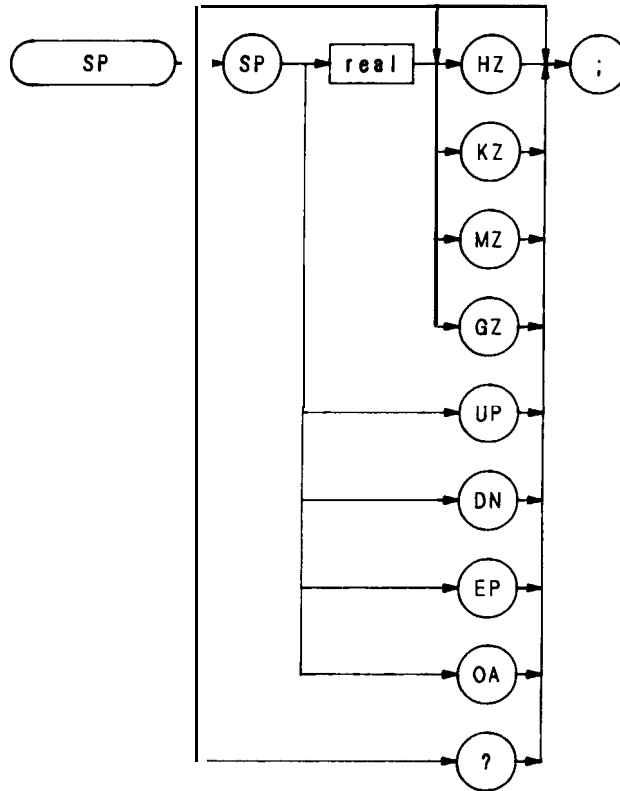

The SP command changes the total display frequency range symmetrically about the center frequency. The frequency span readout displays the total display frequency range. Divide the readout by ten to determine the frequency span per division.

Specifying 0 Hz enables zero span mode, which configures the analyzer as a fix-tuned receiver. Otherwise, the minimum span width is 100 Hz. Maximum span width is 2.5 GHz in the low band, and 22 GHz (2 to 24 GHz) in the microwave band.

The functions of the SP command and the front panel  key are identical. Thus, if span width is coupled to the resolution and video bandwidths, the bandwidths change with the span width to provide a predetermined level of resolution and noise averaging. Likewise, sweep time changes to maintain a calibrated display, if coupled. All of these functions are normally coupled, unless RB, VB, or ST have been executed. (See CR, CV, or CT)

OUTPUT 718; "SP 10MZ;"

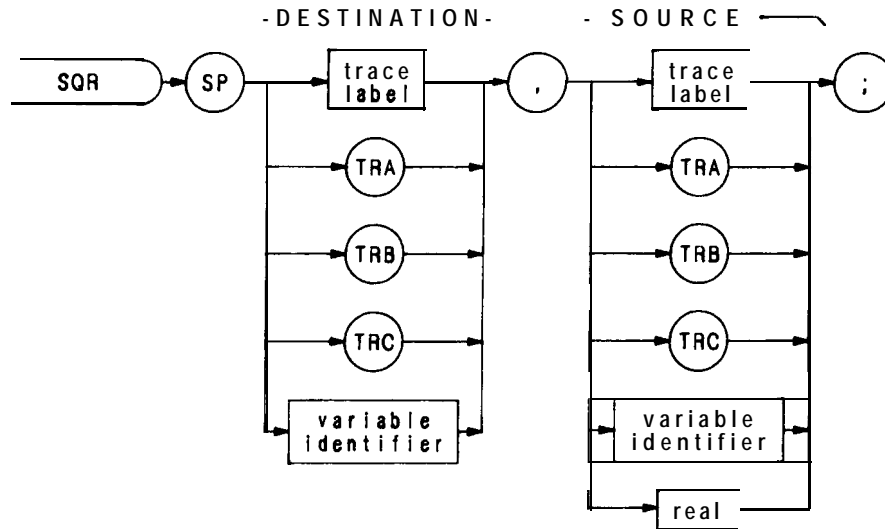

Item	Description/Default	Range Restriction
TRACE LABEL	Alpha character. User-defined label declared in TRDEF statement.	AA-ZZ and __ 2- 12 characters required.
VARIABLE IDENTIFIER	Alpha character. User-defined label declared in VARDEF statement.	AA-22 and __ 2-12 characters required.
	Alpha character. Measurement-variable identifier, such as CF or MA.	
	Trace element, such as TRA [10].	

The SQR command computes the square root of the source trace amplitude, point-by-point. The results go to the destination trace.

OUTPUT 718;“SQR TRC,TRB;”

SRQ

User-defined SRQ

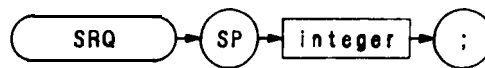

Item	Description/Default	Range	Restriction
INTEGER	Integer representing a service request.	0– 255	

The SRQ command sends a service request to the controller when the SRQ operand fits the mask specified with the RQS command.

On execution of a SRQ command, the analyzer logically **ANDs** the RQS mask with the binary equivalent of the SRQ operand. When the result of this AND operation is a non-zero number, the analyzer sends a service request to the HP-IB controller.

See also RQS and Appendix D.

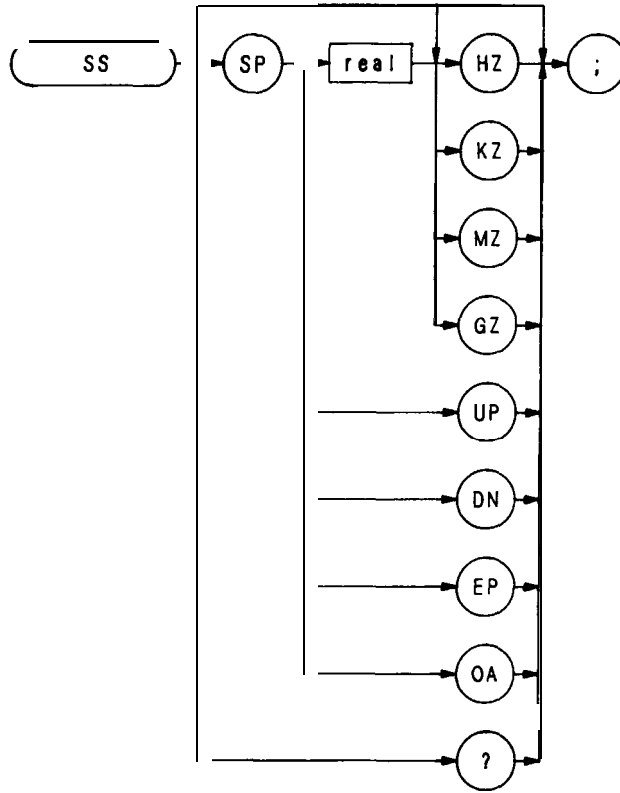

Item	Description/Default	Range Restriction
REAL	Default is Hz.	

The SS command specifies center frequency step size, and is the same function as the  key.

OUTPUT 718;“SS 10MZ;CF UP;”

The above program line changes center frequency by 10 MHz.

ST

Sweep Time

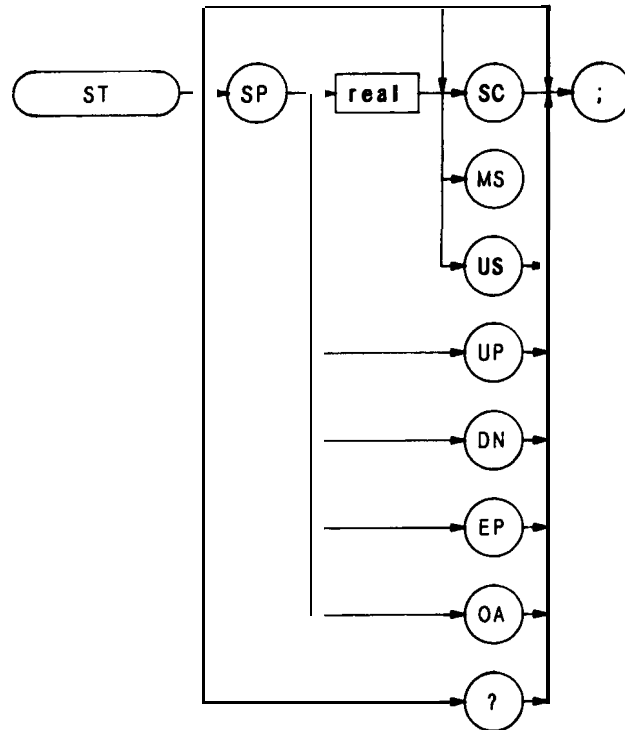

The ST command specifies the rate at which the analyzer sweeps the displayed frequency or time span.

The sweep times available are shown below.

	SWEEP TIME	SEQUENCY
FREQUENCY SPAN (> = 100 Hz)	20 ms to 1500 sec	continuously
ZERO FREQUENCY SPAN (0 Hz)	1 us to 10 ms	1, 2, 5, and 10
	20 ms to 1500 sec	continuously

OUTPUT 718; "ST **100MS**;"

The above program line sets the sweep time of the analyzer to 100 milliseconds.

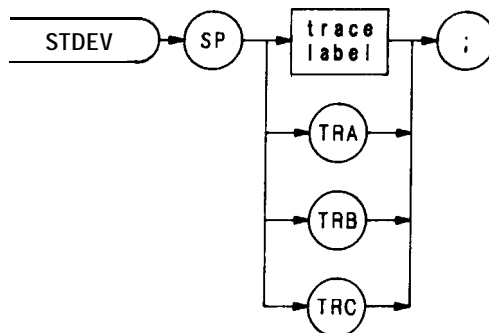

Item	Description/Default	Range Restriction
TRACE LABEL	Alpha character. User-defined label declared in TRDEF statement.	AA-ZZ and _ 2– 12 characters required.

The STDEV command returns to the controller the standard deviation of the trace amplitude in display units.

```

OUTPUT 718;"IP;TS;STDEV TRA;"
ENTER 718;N
PRINT N
END
  
```

SUB

Subtract

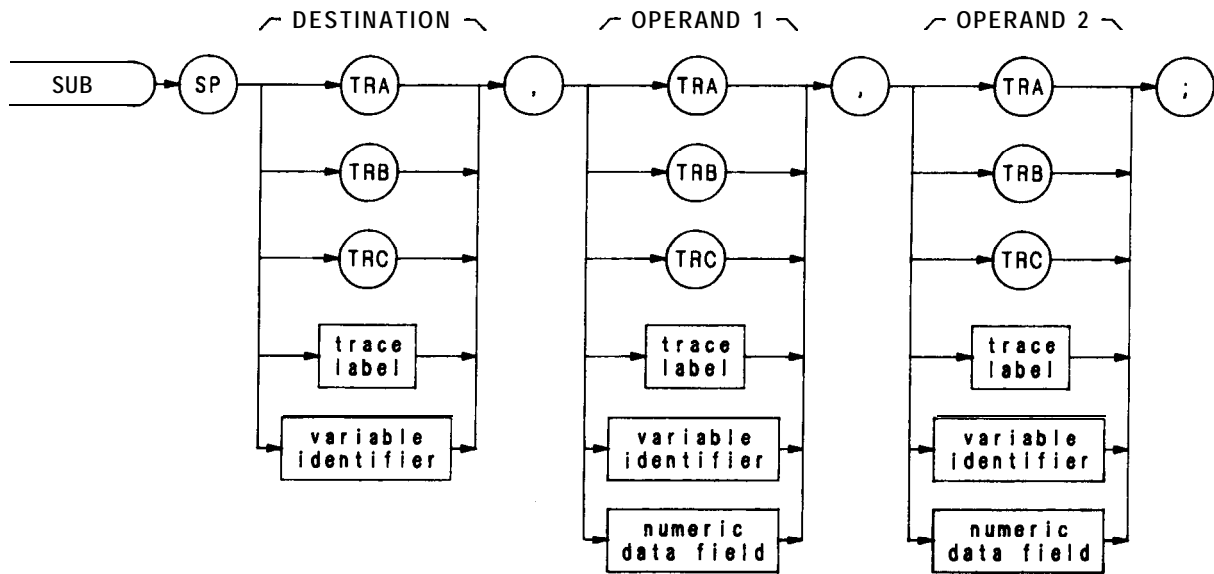

Item	Description/Default	Range Restriction
TRACE LABEL	Alpha character. User-defined label declared in TRDEF statement.	AA-22 and _ 2— 12 characters required.
VARIABLE IDENTIFIER	Alpha character. User-defined identifier declared in VARDEF statement.	AA-ZZ and _ 2— 12 characters required.
	Alpha character. Measurement-variable identifier, such as CF or MA.	
	Trace element, such as TRA [10].	
NUMERIC DATA FIELD	Real	

The SUB command subtracts operand 2 from operand 1, point by point, and send the difference to the destination.

$$\text{operand 1} - \text{operand 2} \rightarrow \text{destination}$$

The operands and destination may be different lengths. The trace operands (**TRA**, **TRB**, **TRC**, and **trace label**) range from 1 to 1008 elements in length. A variable identifier or numeric data field is one element long. When operands differ in length, the last element of the shorter operand is repeated for the subtraction process. When the operands are longer than the destination, they are truncated to fit.

The results and operands of trace math are truncated if they are not within certain limits. If operating on traces A, B, or C, results must be within 1023. If operating on user-defined traces, results must be within 32,767.

See TRMATH .

SUM

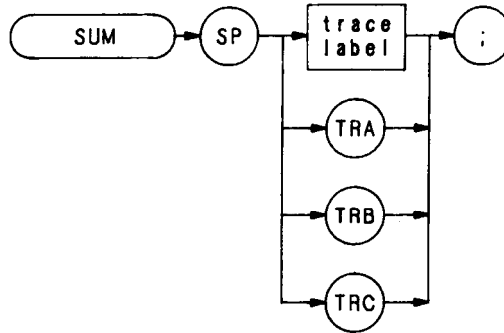

Item	Description/Default	Range Restriction
TRACE LABEL	Alpha character. User-defined label declared in TRDEF statement.	AA-22 and _ 2— 12 characters required.

The SUM command sums the amplitudes of the trace elements, and returns the sum to the controller.

```
10 OUTPUT 718;"IP; SNGLS; CLRW TRA; TS;"
20 OUTPUT 718;"SUM TRA;"
30 ENTER 718;N
40 PRINT N
50 END
```

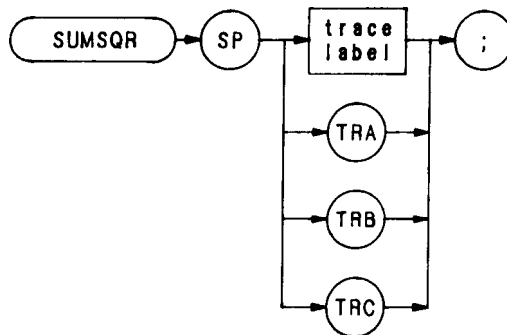

Item	Description/Default	Range Restriction
TRACE LABEL	Alpha character. User-defined label declared in TRDEF statement.	AA-ZZ and _ 2— 12 characters required.

The SUMSQR command squares the amplitude of each trace element, and returns the sum of the squares to the controller.

```

10 OUTPUT 718;"IP; SNGLS; CLRW TRA; TS;"
20 OUTPUT 718;"SUMSQR TRA;"
30 ENTER 718;N
40 PRINTN
50 END

```

SV

Save State
(SAVES)

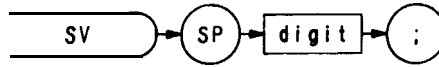

Item	Description/Default	Range Restriction
DIGIT	Specifies register for storage of instrument states.	1 - 6

The SV command saves the current spectrum analyzer state in any of registers one through six. Register contents are not affected by power loss, but previously saved data is erased when new data is saved in the same register.

The functions of the SAVES and SV command, and front panel  key are identical.

OUTPTJT 718; "SV 5;"

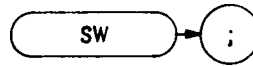

The skip-to-next-control-instruction command, SW, instructs the display to skip to the next control word from the present display memory address. Use SW to omit labels, markers, etc. from the display. Display control word 1027 (DW 1027) can be substituted for programming command SW

```
10  ASSIGN @Sa TO 718
20  OTJTPUT @Sa; "DA 2073 SW,"
30  END
```

In the example above, display memory address 2073 contains the label control word that places the center frequency “|” mark on the CRT. However, this marker is omitted from the display because the SW command has been added to the address.

(See Appendix B.)

S1

Continuous Sweep
(CONT)

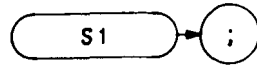

The **S1** command sets the analyzer to continuous sweep mode. In the continuous sweep mode, the analyzer continues to sweep (sweep time ≥ 20 ms) at a uniform rate, from the start frequency to the stop frequency, unless new data entries are made from the front panel or via HP-IB. If the trigger and data entry conditions are met, the sweep is continuous.

The sweep light indicates a sweep is in progress. The light is out between sweeps, during data entry, and for sweep times ≤ 10 ms.

OUTPUT 718: "S1;"

The functions of the **S1** and **CONT** commands and the front panel  key are identical.

S2

Single Sweep
(SNGLS)

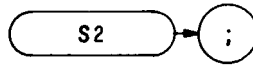

The S2 command sets the analyzer to single sweep mode. Each time single sweep is pressed, one sweep is initiated if the trigger and data entry conditions are met.

OUTPUT 718; "S2;"

The functions of the S2 and SNGLS commands and the front panel  key are identical.

TA

Transfer A

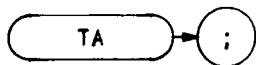

The TA command transfers trace A amplitude values, in display units, from the analyzer to the controller. The display unit values are transferred in sequential order (from left to right) as seen on the CRT display. Display unit values that are stored in the display memory can be transferred to the controller in any one of the four output formats of the analyzer (01, 02, 03, or 04).

Transfer of trace amplitude data should only be done as follows:

1. Select single sweep mode (S2).
2. Select desired analyzer settings.
3. Take one complete sweep (TS) .
4. Transfer data.

This procedure ensures that the current settings of the analyzer are reflected in the transferred data.

When the TA command is executed, and the analyzer is in continuous sweep mode, the blank-ahead marker is **also** transferred as amplitude values in the 01 and 02 format. The blank-ahead marker is not transferred in the 03 and 04 formats.

The blank-ahead marker is composed of positive, blanked amplitude values and is immediately ahead of the updated, sweeping trace. These values represent the amplitude responses of the previous sweep, plus 2048. Thus, they are off (above) the screen.

The blank-ahead marker is eight display units wide and is transferred as such. For example, if an amplitude value of 100 **falls** within the blank-ahead marker area when the sweep is transferred, the amplitude value becomes 2148 (amplitude value 100 + data word 2048, in which bit number 11 of graph data is positive blanked). For further information on data word coding see Consolidated Coding Data in Appendix B.

When transferring amplitude data, only the data words from 1001 display memory addresses are transferred out of the total of 1024 available display memory addresses. Each of the 1024 display memory addresses contains a single data word. The 23 data words not transferred are at address 0 (used for the control instruction word) and at addresses 1002 through 1024 (not used by the analyzer for trace data, but available for programming custom graphics or labels).

The sample program below demonstrates how to store a trace similar to the one in the following illustration.

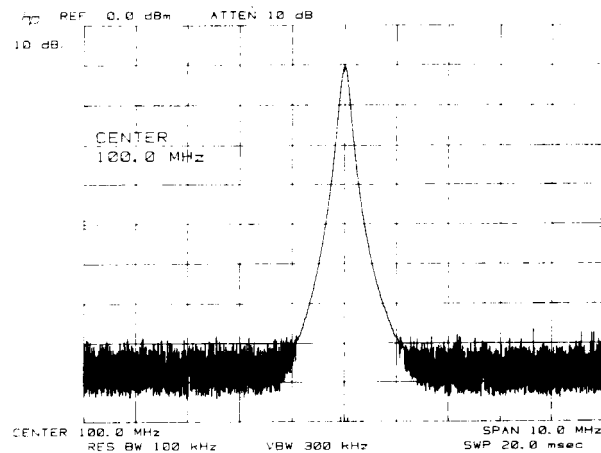

```

10 ASSIGN @Sa TO 718
20 PRINTER IS 701
30 DIM A( 1001)
40 |
50 OUTPUT @Sa; "IP;LF;"
60 OUTPUT @Sa; "CF100MZ;SP2MZ;S2;TS;"
70 OUTPUT @Sa; "O1;TA;"
80   FOR N = 1 TO 1001
90     ENTER @Sa;A(N)
100    NEXTN
110 |
120   FOR N = 490 TO 510
130     PRINT A(N)
140   NEXTN
180 END

```

Line 30: Reserves controller memory for 1001 amplitude values.

Line 50: Presets the instrument.

Line 60: Sets analyzer to 100 MHz center frequency with 2 MHz frequency span. Selects **single sweep mode** and takes one complete sweep of the trace (graph) data.

Line 70: Selects analyzer output to be in O1 format and commands the analyzer to transfer **trace A** amplitude values to the controller.

Lines 80 to 100: Sequentially reads all 1001 trace A amplitude values into A(N) of the controller.

Lines 120 to 140: Prints out trace A amplitude values at all 20 points between x-axis coordinates 490 and 510.

T B

Transfer B

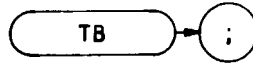

The TB command transfers trace B amplitude values, in display units, from the analyzer to the controller. The display unit values are transferred in sequential order (from left to right) as seen on the CRT display. Display unit values that are stored in the display memory can be transferred to the controller in any one of the four output formats of the analyzer (01, 02, 03, or 04).

Transfer of trace amplitude data should only be done as follows:

1. Select single sweep mode (S2).
2. Select desired analyzer settings.
3. Take one complete sweep (TS) .
4. Transfer data.

This procedure ensures that the current settings of the analyzer are reflected in the transferred data.

When the TB command is executed, and the analyzer is in continuous sweep mode, the blank-ahead marker is also transferred as amplitude values in the 01 and 02 format. The blank-ahead marker is not transferred in the 03 and 04 formats.

The blank-ahead marker is composed of positive, blanked amplitude values and is immediately ahead of the updated, sweeping trace. These values represent the amplitude responses of the previous sweep, plus 2048. Thus, they are off (above) the screen.

The blank-ahead marker is eight **display** units wide and is transferred as such. For example, if an amplitude value of 100 falls within the blank-ahead marker area when the sweep is transferred, the amplitude value becomes 2148 (amplitude value 100 + data word 2048, in which bit number 11 of graph data is positive blanked). For further information on data word coding see Consolidated Coding Data in Appendix B.

When transferring amplitude data, only the data words from 1001 display memory addresses are transferred out of the total of 1024 available display memory addresses. Each of the 1024 **display** memory addresses contains a single data word. The 23 data words not transferred are at address 0 (used for the control instruction word) and at addresses 1002 through 1024 (not used by the analyzer for trace data, but available for programming custom graphics or labels).

The sample program below demonstrates how to store a trace similar to the one in the following illustration.

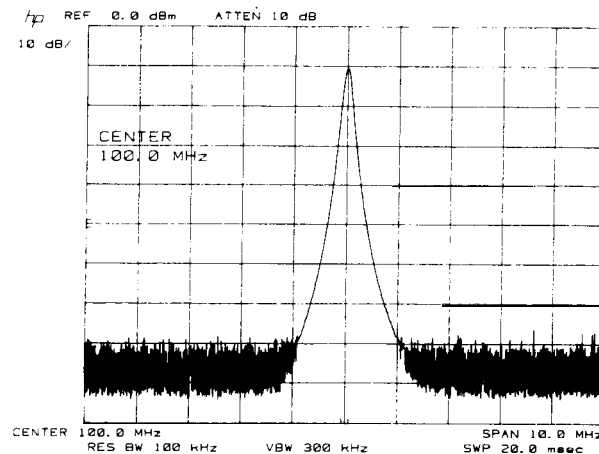

```

10 ASSIGN @Sa TO 718
20 PRINTER IS 701
30 DIM A(1001)
40 |
80 OUTPUT @Sa;"IP;LF;"
60 OUTPUT @Sa;"CF100MZ;SP2MZ;S2,TS;"
70 OUTPUT @Sa;"O1;TB;"
80   FOR N = 1 TO 1001
90     ENTER @Sa;A(N)
100  NEXT N
110 |
120  FOR N = 490 TO 510
130    PRINT A(N)
140  NEXT N
180 END

```

Line 30: Reserves controller memory for 1001 amplitude values.

Line 50: Presets the instrument.

Line 60: Sets analyzer to 100 MHz center **frequency** with 2 MHz frequency span. Selects single sweep mode and takes one complete sweep of the trace (graph) data.

Line 70: Selects analyzer output to be in 01 format and commands the analyzer to transfer trace B amplitude values to the controller.

Lines 80 to 100: Sequentially reads all 1001 trace B amplitude values into A(N) of the controller.

Lines 120 to 140: Prints out trace B amplitude values at all 20 points between **x-axis** coordinates 490 and 510.

TDF

Trace Data Format

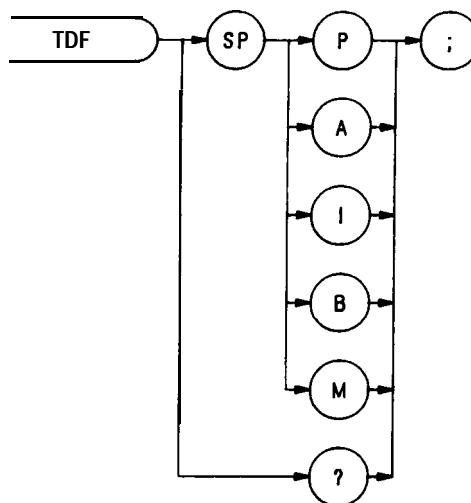

The TDF command formats trace information for return to the controller.

OUTPUT 718; "TDF **B**;"

Specifying M enables the 01 format and returns values in display units, from 0 to 1001.

Specifying P enables the 03 format and returns absolute measurement values, such as **dBm** or Hz.

Specifying A returns data as an A-block data field. The MDS command determines whether data comprises one or two **8-bit** bytes. (See MDS.)

Specifying I returns data as an I-block data field. The MDS command determines whether data comprises one or two **8-bit** bytes. (See MDS .)

Specifying B enables the 02 or 04 format. The MDS command determines whether data comprises one or two **8-bit** bytes.

See the **01**, **02**, **03**, and **04** FORMAT commands.

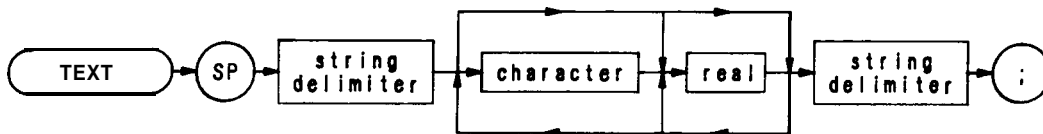

Item	Description/Default	Range Restriction
STRING DELIMITER	Must match. Marks beginning and end of command list.	!"\$%&'/:=@\~
Characters	Alphanumeric characters.	ASCII character 32 through 126.

The TEXT command writes text on the spectrum analyzer screen at the current pen position.

OUTPUT 718; "TEXT ""CONNECT ANTENNA." ";"

TH

Threshold

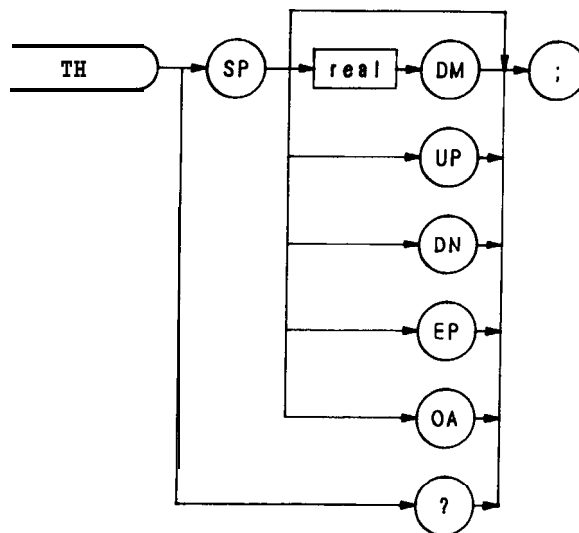

Item	Description/Default	Range Restriction
	Threshold value defaults to nine major divisions below reference level.	
	UP or DN to step threshold by 10 dB.	

The TH command blanks signal responses below the threshold level, similar to a base line clipper. The threshold level is nine major divisions below the reference level, unless otherwise specified. The **UP** and **DN** commands move the threshold 10 **dB**.

The threshold level is annotated in reference level units at the lower left-hand side of the CRT display. (See **TØ** and **THE**.)

The threshold can also be used as a variable. The program below places a marker on the largest signal that is greater than the threshold level.

```
10 OUTPUT 718;"IP;LF;TH -35DM;"
20 OUTPUT 718;"TS;MKPK HI;MA;"
30 OUTPUT 718;"IF MA,GT,TH "
40 OUTPUT 718;"THEN CF 20MZ;"
50 OUTPUT 718;"ELSE CF 100MZ;TS;MKPK HI;"
60 OUTPUT 718;"ENDIF;"
70 END
```

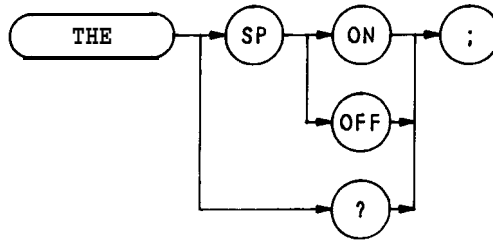

The THE command disables or enables the threshold level. The threshold level is specified by the TH command.

OUTPUT 718: "THE OFF;"

When queried (? or OA), TH returns the threshold line state, followed by carriage-return/line-feed (ASCII codes 13, 10). The end-of-identify state (EOI) is asserted with line feed.

IF THEN ELSE ENDIF

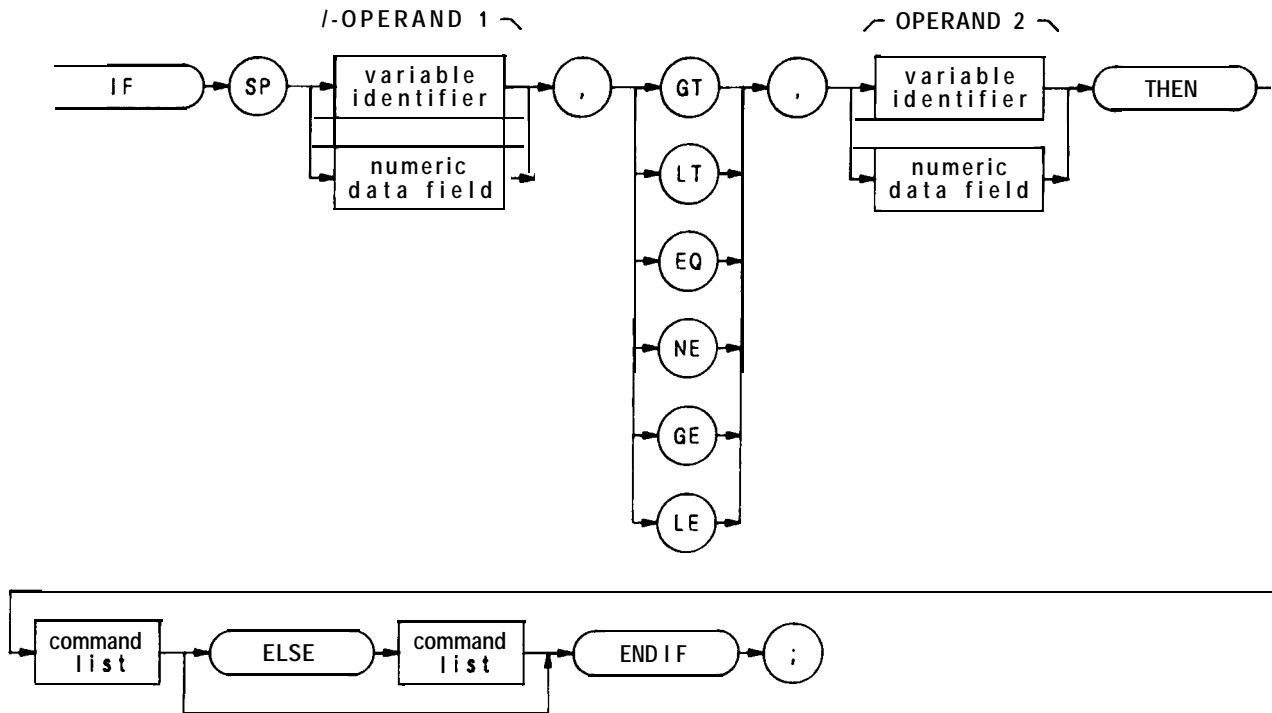

Item	Description/Default	Range Restriction
COMMAND LIST	Alphanumeric character. Any spectrum analyzer command from this section.	
VARIABLE IDENTIFIER	Alpha character. User-defined identifier declared in VARDEF statement. Alpha character. Measurement-variable identifier. such as CF or MA. Trace element, such as TRA [10].	AA-ZZ and _ 2—12 characters required.
NUMERIC DATA FIELD	Real	

The IF-THEN-ELSE-ENDIF commands form a decision and looping construct. They compare operand 1 to operand 2. If the condition is true, the command list is executed. Otherwise, commands following ELSE or ENDIF are executed.

The IF command must be delimited with the ENDIF command.

The following program uses the IF THEN ELSE ENDIF command to place a marker on the largest signal that is greater than the threshold level.

```
10 OUTPUT 718;"IP;LF;TH -35DM;"
20 OUTPUT 718;"TS;MKPK HI;MA;"
30 OUTPUT 718;"IF MA,GT,TH"
40 OUTPUT 718;"THEN CF 20MZ;"
50 OUTPUT 718;"ELSE CF 100MZ;TS;MKPK HI;"
60 OUTPUT 718;"ENDIF;"
70 END
```

The program below does not incorporate the ELSE branch of the IF THEN ELSE ENDIF command. The program lowers any signal positioned above (off) the analyzer screen.

```
10 OUTPUT 718;"S2;TS;E1; "
20 OUTPUT 718;"IF MA,GT,RL THEN"
30 OUTPUT 718;"REPEAT RL UP;TS;E1 "
40 OUTPUT 718;"UNTIL MA,LE,RL "
50 OUTPUT 718;"ENDIF S1;" " "
60 END
```

TM

Trigger Mode

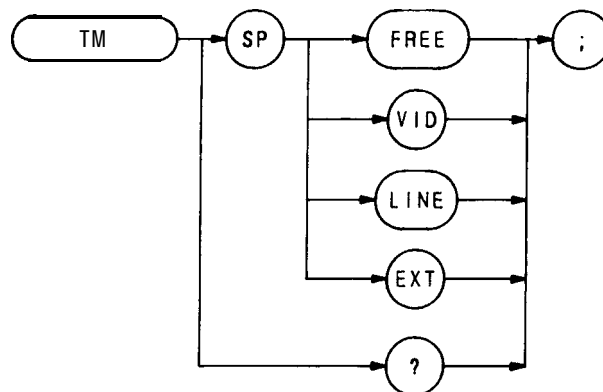

The TM command selects trigger mode: free, video, line, or external trigger. See T1, T2, T3, and T4.

The query response return the trigger mode.

```
OUTPUT 718;"TM EXT;"
```

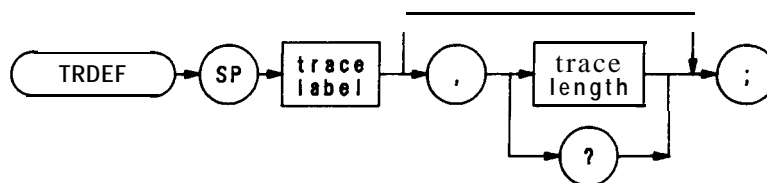

Item	Description/Default	Range Restriction
Trace Label	Alpha character. User-defined label declared in TRDEF statement.	AA- ZZ and __ 2– 12 characters required.
TRACE LENGTH	Determines the number of elements (points) in a trace. Default is 1001. INTEGER.	0 to 1008

The TRDEF statement establishes the length and name of a user-defined trace. User-defined traces form the operand of many remote functions in this section. These functions show “TRACE LABEL.” as an operand in their syntax diagrams. Following are some of the functions that operate on user-defined traces.

MOV, MPY, XCH, TRACE, TRGRPH, NEG, DIV, AVG, BLANK, ADD, MXM, SCALE, MXMH, SUB, MIN, TWNDOW

If two traces have different lengths, the largest length is used for the specified span. The shorter length accepts data until filled.

When a trace of a greater length is operated on and stored in a trace of lesser length, the trace is truncated to fit. Conversely, when a shorter trace is operated on and stored in a trace of longer length, the last trace element is extended for operations with the longer length. Thus, a single element trace acts like a display **line** in trace operations.

TRDSP

Trace Display

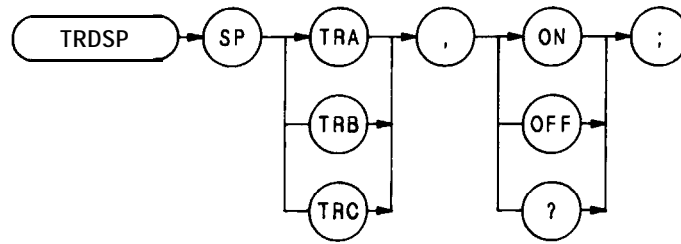

The TRDSP command displays a trace or turns it off. The command does not affect any other trace operations.

OUTPUT 718; "TRDSP TRC,ON;"

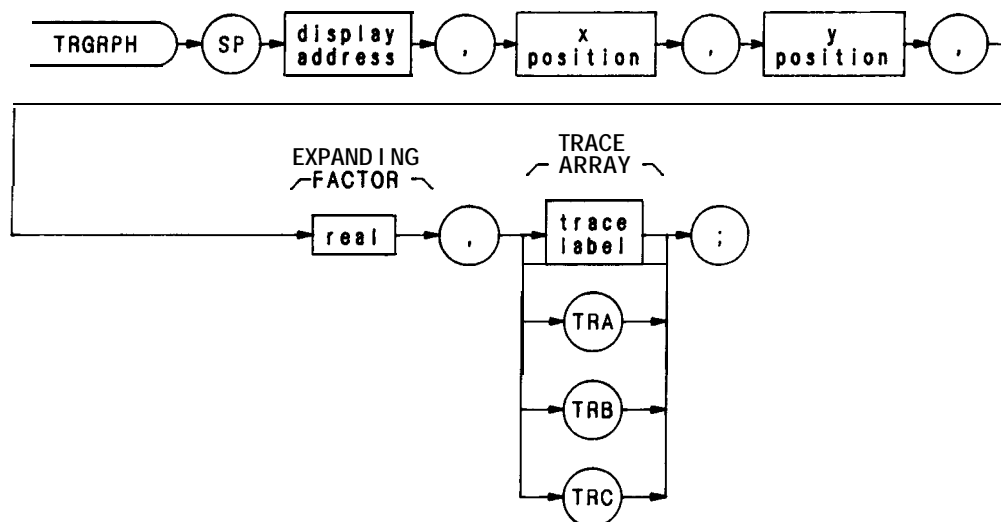

The TRGRPH command displays a trace A, B, or C, or a user-defined trace anywhere on the spectrum analyzer display. The X and Y positions orient the trace above and to the right of a point on the CRT specified by the display address. The trace can be expanded, according to the scale determined by the expanding factor.

For example, the following command would display a user-defined trace named TEST occupying the length of the CRT at the base line, if TEST was originally full-scale, and was compressed by 10 with the COMPRESS command:

```
TRGRPH 0,0,0,10 TEST;
```

Note that the above TRGRPH command **fills** display addresses 0 through 1000 with the amplitude information of the TEST trace array. Thus, any original trace A information is lost.

The program below moves trace A data into a user-defined trace array, called TEST then positions TEST 100 display units above the CRT baseline.

```

10 OUTPUT 718;"IP;LF;CF 100MZ;SP 20MZ;A1;S2;TS;"
20 OUTPUT 718;"TRDEF TEST, 1001;"
30 OUTPUT 718;"MOV TEST, TRA;"
40 OUTPUT 718"TRGRPH 0,0,100,1,TEST;"
50 END

```

Line 10: Sets up an active trace.

Line 20: Defines user-defined trace array.

Line 30: Moves trace A into array

Line 40: Display array, filling display addresses allocated for trace A.

To reposition traces A, B, and C without the use of a user-defined trace array, substitute the letter I for the display address.

TRMATH

Trace Math

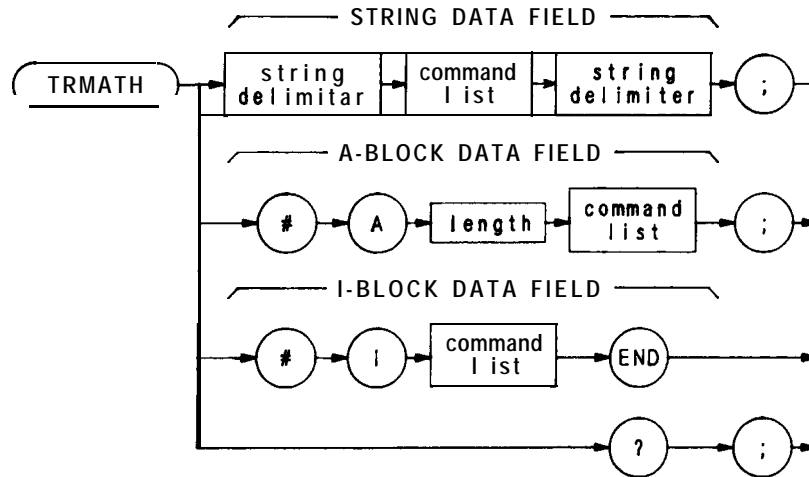

Item	Description/Default	Range Restriction
COMMAND LIST	Any spectrum analyzer commands from this Remote section.	
LENGTH	Two 8-bit bytes specifying length of command list, in 8-bit bytes. The most significant byte is first: MSB LSB.	
STRING DELIMITER	Must match. Marks beginning and end of command list.	!"\$%&'/:=@\~

The TRMATH command executes a command list at the end of a sweep. Compose the command Iii with any of the following commands only.

Trace Math Commands:

AMB, AMBPL, APB, AXB, BL, BML, BTC, BXC, CI, **C2**, EX, KSG, KSH, **KSc**, **KSi**, KSI, VAVG

User-Operator Functions:

MOV, SUB, ADD, **MPY**, DIV, LOG, **EXP**, MXM, MIN, XCH, SQR, **CONCAT**, CTM, CTA, AVG

If an on-end-of-sweep command is encountered, it is executed after the contents of the TRMATH command are executed.

The operands and **results** of trace math are truncated if they are not within certain limits. If operating on traces A, B, or C, results must be within 1023. If operating on user-defined traces, results must be within 32,767.

The program below halves the amplitude of trace A and moves it to trace B. If trace A is in log mode, this is equivalent to the square root of trace A.

```
10 OUTPUT 718;"A1;B3;"
12 OUTPUT 718;"DISPOSE TRMATH;"
20 OUTPUT 718;"TRMATH! DIV TRB,TRA,2! ;"
30 END
```

See DISPOSE.

TRPST

Trace Preset



The TRPST command executes the following commands:

A1
B4
C1
KSK
EM
TØ
LØ
DISPOSE ONEOS
DISPOSE TRMATH
DISPOSE ONSWP

TRSTAT

Trace State



The TRSTAT command returns trace states to the controller: clear-write, off, view, or blank.

	Trace Is Swept and Updated	Trace Is Displayed
Trace Clear/Write CLRW	X	X
Trace Off TRDSP	X	
Trace View VIEW		X
Trace Blank BLANK		

TS

Take Sweep

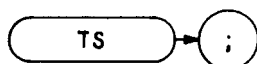

The take sweep command, TS, starts and completes one full sweep before the next command is executed. One TS command is required for each sweep in the single mode.

The function, marker, trace, coupled function, preselector peak, automatic zoom and video average commands, and a number of the shii functions require one complete sweep to update the display and trace memory. This is to avoid losing information for the output of measurement data on either the CRT display or through the HP-IB interface.

OUTPUT 718;“IP;CF 11.105GZ;SP20KZ;VIEW;”

In the example above, the command sequence does not allow sufficient time for a full sweep of the specified span, before VIEW is executed. Therefore, only the span set by the instrument preset is displayed in trace A.

A TS command inserted before VIEW, as shown in the program line below, makes the analyzer take one complete sweep before displaying trace A. This allows the analyzer sufficient time to respond to each command in the sequence.

OUTPUT 718;“IP;CF 11.105GZ;SP20KZ;TS;VIEW;”

A TS command is also recommended before HP-IB transmission of marker data (amplitude, frequency) on the HP-IB bus, and before marker operations (peak search, preselector peak). This is because the active marker is repositioned at the end of each sweep.

The TS command guarantees that the HP-IB bus transmission and CRT display contain marker position information that is relative to the current trace response.

When the analyzer receives a TS command, it is not ready to receive any more data via HP-IB until one full sweep has been completed. However, when slow sweep speeds are being used, the controller can be programmed to perform computations or to address other instruments on the HP-IB bus while the analyzer is completing its sweep.

In normal programming practice, a semicolon terminates each command statement. By using the semicolon as a terminator, an automatic carriage-return/line-feed is performed by the controller. However, the controller can perform computations or address other instruments while the analyzer is executing TS, if the **carriage-return/line-feed** is suppressed.

In the program line below, the semicolon at the end of the line (outside the quotation marks) suppresses the carriage-return/line-feed. The controller is now available to proceed to the next program line while the analyzer is completing its sweep.

OUTPUT 718;“ST5SC;R2;TS”;

The R2 command in the program line above enables the end-of-sweep service request when the analyzer is finished sweeping. This service request interrupts the controller program to allow subsequent addressing of the analyzer. Refer to Appendix D for a complete description of the R2 Service Request.

T0

Threshold Off

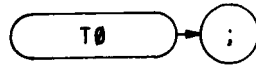

The **T0** command removes the threshold boundary and its readout from the CRT display.

`OUTPUT 718;"T0;"`

The function of the **T0** command and the THRESHOLD ⁰ key are identical.

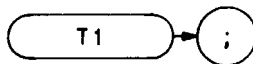

The **T1** command sets the analyzer sweep to free run trigger mode. The functions of the **T1** command and front panel  key are identical.

See TM.

OUTPUT 718;T1;"

T2

Line Trigger

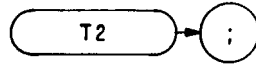

The T2 command sets the analyzer sweep to line trigger mode. This function triggers the analyzer sweep when the line voltage passes through zero in a positive direction. The functions of the T2 command and front panel  key are identical. (See TM.)

OUTPUT 718;“T2;”

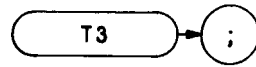

The T3 command sets the analyzer to external trigger mode. This function triggers the analyzer sweep when an external voltage passes through approximately 1.5 volts in a positive direction. The **external trigger signal level** must be between 0 and 5 volts.

The functions of the T3 command and front panel  trigger are identical. (See TM.)

OUTPUT 718; "T3;"

T4

Video Trigger

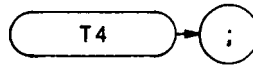

The T4 command sets the analyzer sweep to video trigger mode. This function triggers the analyzer sweep when the voltage level of a detected RF envelope reaches the level set by the trigger LEVEL knob. The level (set by the LEVEL knob) corresponds to detected levels displayed on the CRT between the bottom graticule (full CCW) and the top graticule (full CW) .

The functions of the T4 command and front panel  trigger key are identical. (See TM.)

OUTPUT 718; "T4;"

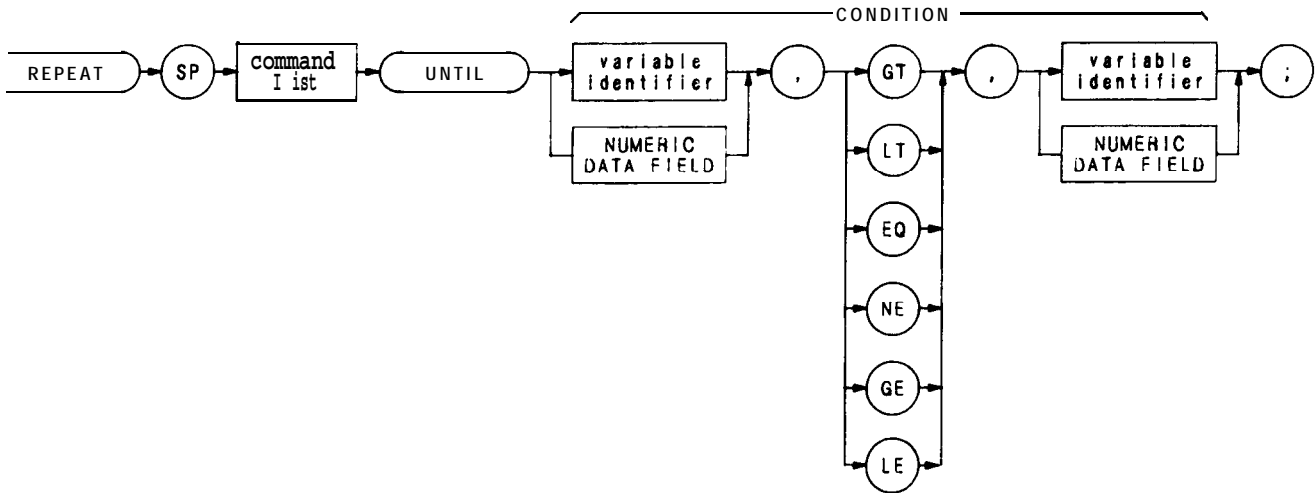

Item	Description/Default	Range Restriction
VARIABLE IDENTIFIER	Alpha character. User-defined identifier declared in VARDEF statement. Do not follow identifier with semicolon.	AA-ZZ and _ 2– 12 characters required.
	Alpha character. Measurement-variable identifier, such as CF or MA. Do not follow identifier with semicolon.	
	Trace element, such as TRA[10]	
NUMERIC DATA FIELD	Real	
COMMAND LIST	Any commands from this remote section.	

The REPEAT and UNTIL commands form a looping construct. The command list is repeated until the condition is true.

The following program lowers any off screen-signal.

```

10 OUTPUT 718;"S2;TS;E1;"
20 OUTPUT 718;"IF MA,GT,RL THEN"
30 OUTPUT 718;"REPEATRL UP;TS;E1; "
40 OUTPUT 718;"UNTIL MA,LE,RL"
50 OUTPUT 718;"ENDIF S1;" ""
60 END

```

REPEAT UNTIL (Continued)

Use the FUNCDEF command to nest a REPEAT UNTIL command within another REPEAT UNTIL looping construct. The program below defines "C-LOP" as a looping construct in lines 30 through 60. The construct is then nested into the REPEAT UNTIL command in line 80.

```
10 OUTPUT 718;"SNGLS;"
20 OUTPUT 718;"VARDEF COUNT,0;VARDEF SCORE,0;"
30 OUTPUT 718;"FUNCDEF C-LOP," " " "
40 OUTPUT 718;"REPEAT TS;"
50 OUTPUT 718;"ADD COUNT,COUNT,1;"
80 OUTPUT 718;"UNTIL COUNT,EQ,3;" " "
70 OUTPUT 718;"REPEAT;"
80 OUTPUT 718;"C_LOP;"
90 OUTPUT 718;"ADD SCORE,SCORE,1;"
100 OUTPUT 718;"UNTIL SCORE,EQ,4;"
```

The program below does not work because the REPEAT UNTIL commands are nested without the use of the FUNCDEF command.

```
10 OUTPUT 718;"SNGLS;"
20 OUTPUT 718;"VARDEF COUNT,0;VARDEF SCORE,0;"
30 OUTPUT 718;"REPEAT;"
40 OUTPUT 718;"REPEAT;"
50 OUTPUT 718;"TS;"
50 OUTPUT 718;"ADD COUNT,COUNT,1;"
70 OUTPUT 718;"UNTIL COUNT,EQ,3;"
80 OUTPUT 718;"ADD SCORE,SCORE,1;"
90 OUTPUT 718;"UNTIL SCORE,EQ,4;"
100 END
```



The UR command sends a voltage to the rear panel RECORDER OUTPUTS. The voltage level remains until a different command is executed. Use the UR command to calibrate the upper right dimension of a recorder.

OUTPUT 718; "U-R; "

UPPER
RIGHT

The functions of the UR command and front panel  key are identical (See Introduction in Section I.)

USTATE

State

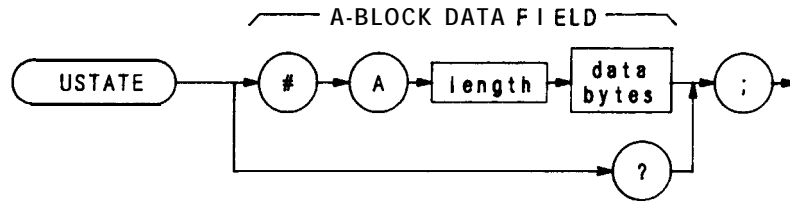

Item	Description/Default	Range Restriction
LENGTH	Two 8-bit bytes specifying length of command list, in 8-bit bytes. The most significant byte is first: MSB LSB.	
DATA BYTES	8-bit bytes of data representing command list.	ASCII characters 0 to 255.

The USTATE command configures or returns configuration of user-defined states defined by these commands:

- ONEOS
- ONSWP
- KEYDEF
- FUNCDEF
- TRDEF
- TRMATH

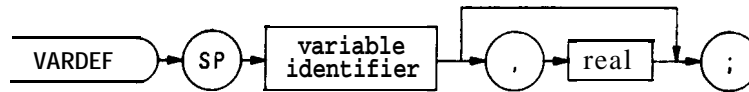

Item	Description/Default	Range Restriction
VARIABLE IDENTIFIER	User-defined identifier. Alphanumeric character.	AA-ZZ and _ 2— 12 characters required.

The VARDEF command assigns a real value to a variable. The value is assigned immediately after VARDEF execution and reassigned during any instrument preset.

The following program demonstrates the VARDEF command.

```

10 OUTPUT 718;"SNGLS;"
20 OUTPUT 718;"VARDEF COUNT,0;VARDEF SCOR,0;"
30 OUTPUT 718; "FUNCDEF C-LOP;" " "
40 OUTPUT 718; "REPEAT TS;"
50 OUTPUT 718; "ADD COUNT,COUNT,1;"
80 OUTPUT 718;"UNTIL COUNT,EQ,3;" " "
70 OUTPUT 718;"REPEAT;"
80 OUTPUT 718;"C_LOP;"
90 OUTPUT 718;"ADD SCORE,SCORE,1;"
100 OUTPUT 718;"UNTIL SCORE,EQ,4;"
  
```

VARIANCE

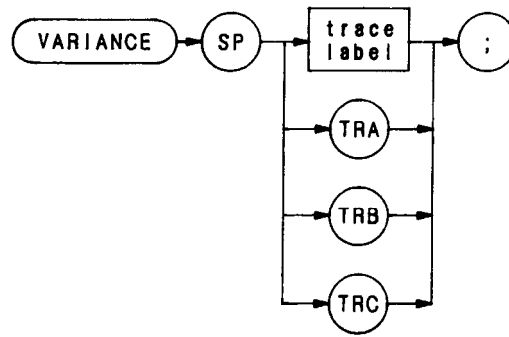

Item	Description/Default	Range Restriction
TRACE LABEL	Alpha character. User-defined label declared in TRDEF statement.	AA-22 and _ 2— 12 characters required.

The VARIANCE command returns to the controller the amplitude variance of the specified trace, in display units.

```
10 OUTPUT 718;"VARIANCE TRC;"
20 ENTER 718;N
30 PRINTN
40 END
```

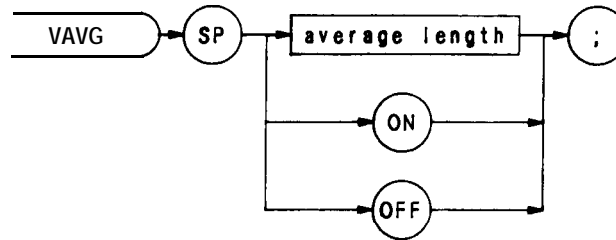

Item	Description/Default	Range Restriction
AVERAGE LENGTH	Real. Default is 100.	Represents maximum number of sweeps executed for averaging.

The VAVG command enables video averaging. During video averaging, two traces are displayed simultaneously. Trace C contains signal responses as seen at the input detector. Trace A or B contains the same responses digitally averaged. The digital reduces the noise floor level, but does not affect the sweep time, bandwidth, or any other analog characteristics of the analyzer.

Before executing VAVG, select trace A or B as the active trace (CLRW) and blank the remaining trace.

The active function readout indicates the number of sweeps averaged; the default is 100 unless otherwise specified. Increasing the number of sweeps averaged increases the amount of averaging.

Use VAVG to view low level signals without slowing the sweep time. Video averaging can lower the noise floor more than a 1 Hz video bandwidth, if a large number of sweeps is specified for averaging. Video average may **also** be used to monitor instrument state changes (changing bandwidths, center frequencies, etc.) while maintaining a low noise floor. (See Chapter 11 in Section I. **Also** see KSG and KSH.)

OUTPUT 718; "VAVG 125;"

VB

Video Bandwidth

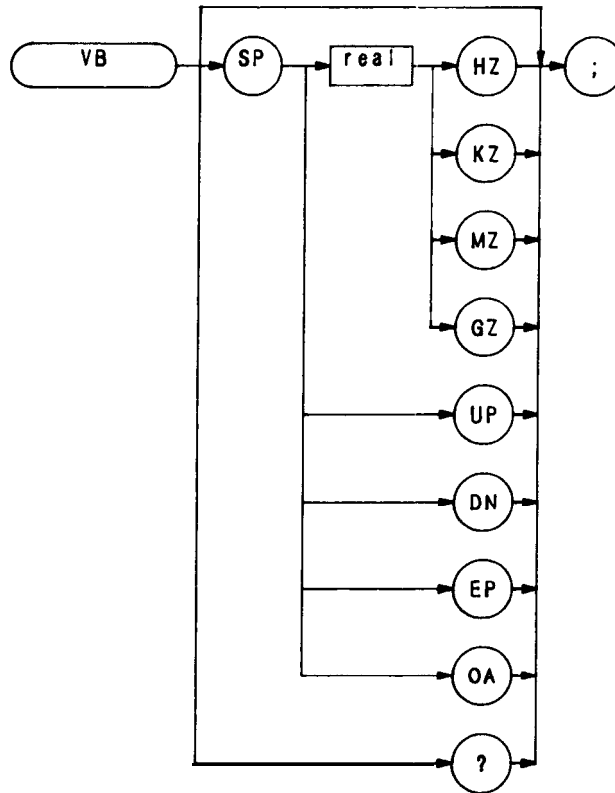

The VB command specifies the video filter bandwidth, which is a post-detection filter. Available bandwidths are 1 Hz, 3 Hz, 10 Hz, 30 Hz, 100 Hz, 300 Hz, 1 kHz, 3 kHz, 10 kHz, 30 kHz, 100 kHz, 1 MHz, and 3 MHz.

The program line below sets the video bandwidth to 10 kHz.

```
OUTPUT 718;"VB 10KZ;"
```

The functions of the VB command and front panel  key are identical.

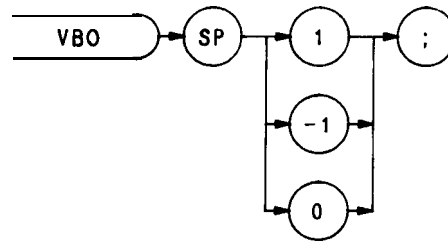

The VBO command specifies the relation between the video and resolution bandwidths that is maintained when these bandwidths are coupled. The bandwidths are usually coupled, unless the RB or VB commands have been executed.

Selecting \emptyset sets the ratio to one, that is, the resolution and video bandwidths are always equal.

Selecting 1 sets the video bandwidth one step wider than the resolution bandwidth:

Resolution Bandwidth	Video Bandwidth
3 MHz	3MHz
1 kHz	1 MHz
100 kHz	300 kHz
30 kHz	100 kHz
10 kHz	30 kHz
3 kHz	10 kHz
1 kHz	3 kHz
300 Hz	1 Hz
100 Hz	300 Hz
30 Hz	100 Hz
10 Hz	30 Hz

Selecting -1 sets the video bandwidth 1 step narrower than the resolution bandwidth.

Resolution Bandwidth	Video Bandwidth
3 MHz	3 MHz
1 MHz	1 kHz
300 kHz	100 kHz
100 kHz	30 kHz
30 kHz	10 kHz
10 kHz	3 kHz
3 kHz	1 kHz
1 Hz	300 Hz
300 Hz	100 Hz
100 Hz	30 Hz
30 Hz	10 Hz

VIEW

View

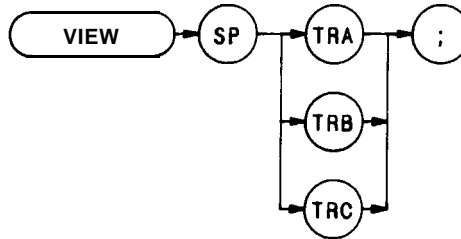

The VIEW command displays trace A, B, or C, and stops the sweep. Thus, the trace is not updated. Trace A and C are discussed below. For detailed information about trace B, see B3 in this section.

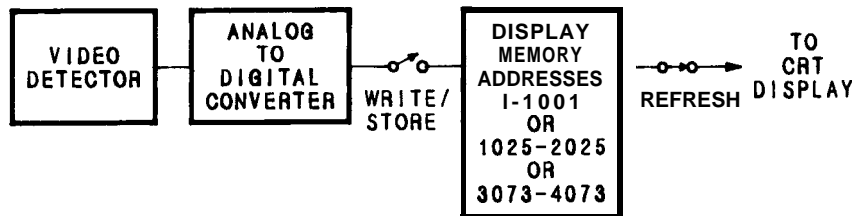

When VIEW TRA is executed, the contents of trace A are stored in display memory addresses 1 through 1023. Address 0 is reserved for the instruction word 1040'. Similarly, when VIEW TRC is executed, the contents of trace C are stored in display memory addresses 3073 through 4095, and address 3072 is reserved for the instruction work 1048*. Therefore, any information stored in address 0 is lost when VIEW TRA is executed. Likewise, the contents of address 3072 are lost when VIEW TRC is executed.

If you have used address 0 or 3072 for a graphics program, or label, you may wish to save their contents before executing VIEW.

OUTPUT 718; "VIEW TRC;"

For additional information, refer to Appendix A. (See B3, A3, KSj, and TRSTAT.)

. 1040 and 1048 are machine instruction words. 1040 sets addresses 1 through 1023 to zero, and draws trace A. 1048 does the same, but draws the trace dimly.

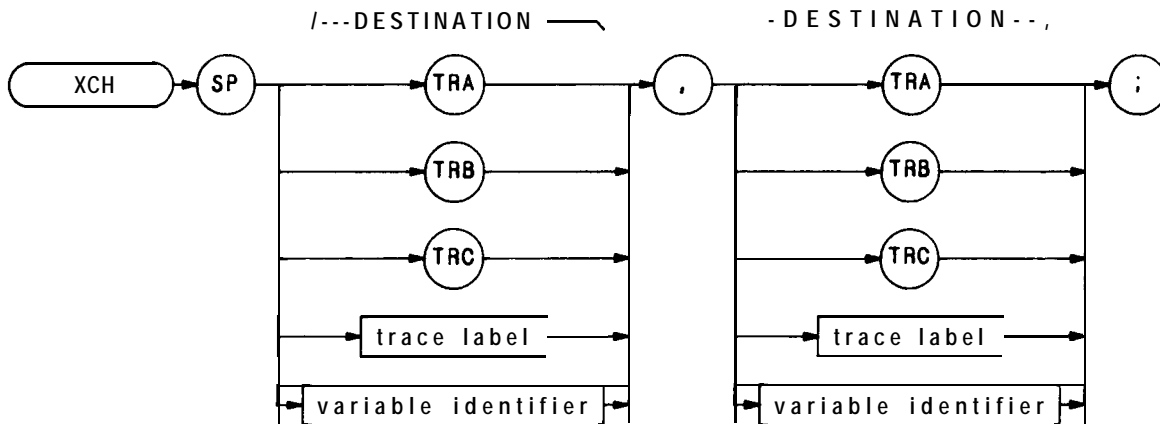

Item	Description/Default	Range Restriction
TRACE LABEL	Alpha character. User-defined label declared in TRDEF statement.	AA-Z.7 and _ 2— 12 characters required.
VARIABLE IDENTIFIER	Alpha character. User-defined identifier declared in VARDEF statement.	AA-22 and _ 2— 12 characters required.
	Alpha character. Measurement-variable identifier, such as CF or MA.	
	Trace element, such as TRA[101.	

The XCH command exchanges the contents of the destinations. The destinations may be different lengths, as trace operands (TRA, TRB, TRC, and trace label) range from 1 to 1008 elements in length, and a variable identifier is 1 element long. During execution of the XCH command, the longer destination is truncated to fit the shorter destination.

Section III

Appendixes

Appendix A – DISPLAY MEMORY STRUCTURE

Appendix B – ADVANCED DISPLAY PROGRAMMING

Appendix C – LEARN STRING CONTENT

Appendix D – SERVICE REQUESTS

**Appendix E – FAST REMOTE OPERATION
(KSS AND KST)**

Appendix F – TUNING CURVES

**Appendix G – CENTER FREQUENCY/SPAN
TUNING CHARACTERISTICS**

Appendix H – 1ST LO OUTPUT

Appendix I – OPERATING DIFFERENCES

**Appendix J – EQUIVALENT HP 8566B AND HP 8566A
COMMANDS**

Appendix A DISPLAY MEMORY STRUCTURE

This appendix describes the spectrum analyzer display memory. A summary of trace data manipulation by the trace mode functions is also included.

The display memory is defined as the digital storage allocated in the spectrum analyzer for the information that is presented on the CRT display. It comprises four different memories: three trace memories and one annotation memory. Addresses are assigned as follows:

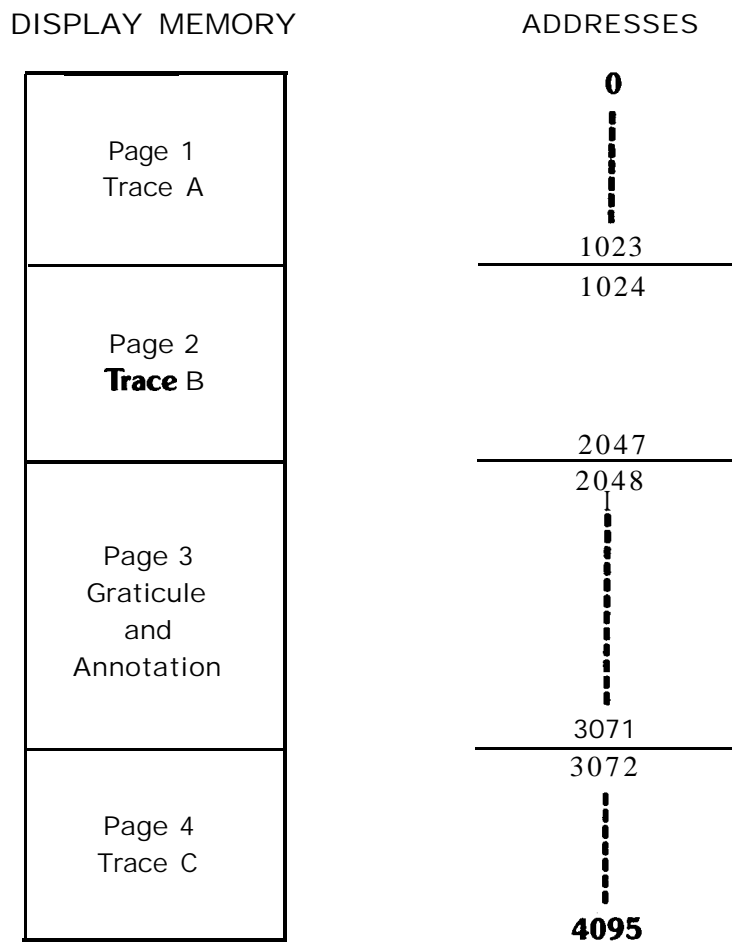

TRACES

The trace pages are used primarily to store analyzer response data to be displayed. Use is not restricted to the storage of trace data. Operator defined graphics and annotation can also be written into the memory for display on the CRT.

Each trace address may contain an integer from 0 to 4095. When drawing, trace values from 0 to 1023 are plotted on the CRT display as amplitude y position, in display units. Appendix B discusses these values in detail.

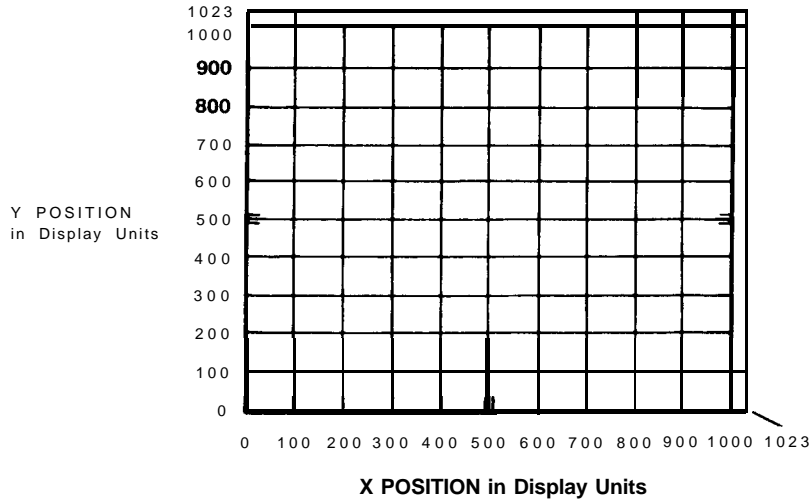

For each trace, A, B, or C, the display width on the CRT is determined by the instruction word in the first address for that trace. In the example below, the first address is 1024 and the instruction word is 1040.

Address	Amplitude Value, Y	(x,y) Position on CRT
1024	1040	Display Instruction
1025	622	(0,622)
1026	531	(1,531)
⋮	⋮	⋮
2023	181	(998,181)
2024	162	(999,162)
2025	185	(1000,185)
2026	1072	} Over-range Addresses (Blanked)
2027	1072	
⋮	⋮	
2046	1072	

Addresses 2023 and 2024 describe one trace line drawn from x,y coordinates (998,181) to x,y coordinates (999,162). The 1072 values shown for the overrange addresses tell the analyzer to blank these values instead of interpreting them as coordinates.

ANNOTATION AND GRATICULE

Page 3 of the display memory fills with instructions on instrument preset. These instructions draw the graticule and annotation on the displays.

The display memory in page 3 contains the information necessary to position and display (or blank) labels, graticule lines, and markers. A brief description of the contents of page 3 is given on the next page. The first

addresses on each line are those of the instructions for each readout.

Address	Contents *
2048 – 2049, 2060 – 2064	controls marker, display line, threshold annotation and graticule on/off functions
2050 – 2054	marker dot 1
2055 – 2059	marker dot 2
2065 – 2084	center line marks
2085 – 2099	marker symbols
2100-2114	display line
2115 – 2154, 2165 – 2167	graticule
2155 – 2159	marker dot 3
2160 – 2164	marker dot 4
2168-2175	“hp”
2176 – 2191	“BA-I-I-ERY”
2192 – 2207	“CORR’D”
2208 – 2239	“RES BW”
2240 – 2271	“VBW”
2272 – 2303	“ S W
2304 – 2335	“ATTEN”
2336 – 2367	“REF”
2368 – 2383	“dB/”, “LINEAR”
2384-2399	trace detection mode: “SAMPLE”, “POS PK”, “NEG PK”
2401 – 2431	“START” or “CENTER”
2432 – 2463	“STOP” or “SPAN”
2464-2495	“OFFSET” for amplitude
2496 – 2527	“DL’
2528 – 2559	“TH ”
2560 – 2623	“MKR” or “MKR A”
2624 – 2655	“OFFSET” for frequency
2656 – 2687	“VID AVG”
2688 – 2751	title
2752 – 2767	“YTO UNLOCK”
2768 – 2783	“249 UNLOCK”
2784 – 2799	“275 UNLOCK”
2800 – 2815	“OVEN COLD”
2816 – 2831	“EXT. REE”
2832 – 2847	“VTO UNCAL’
2848 – 2863	“Y-I-0 ERROR”
2864 – 2879	“MEAS UNCAL” or “. ”
2880 – 2943	frequency diagnostics
2944-2959	“2ND L.O.“, “↑”, “↑”
2960 – 2975	“SRQ” number
2976 – 3007	center frequency “STEP”
3008 – 3071	active function readout

* indicates the CRT annotation stored, values included where applicable.

DATA TRANSFER

The trace functions dictate the way in which data is entered into and extracted from the trace page.

This section describes each TRACE function in terms of the interactions of the analyzer response, trace page and CRT display. The events are listed in chronological order, starting from when the trace function is activated. In each case, the analyzer accepts the function command immediately.

Clear-Write A1 B1

1. Sweep is stopped.
2. Zero is written into each trace address and displayed in one refresh of the CRT.
3. On the next sweep trigger, the sweep is started and the trace amplitudes are written into memory.

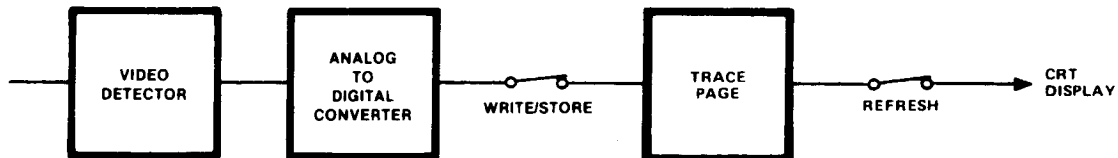

Max Hold A2 B2

1. Sweep is stopped, but restarts from the left on the next trigger.
2. During each subsequent refresh, the amplitude stored at each trace memory address is compared with the corresponding current analyzer response. The larger of the two is stored at the trace address.

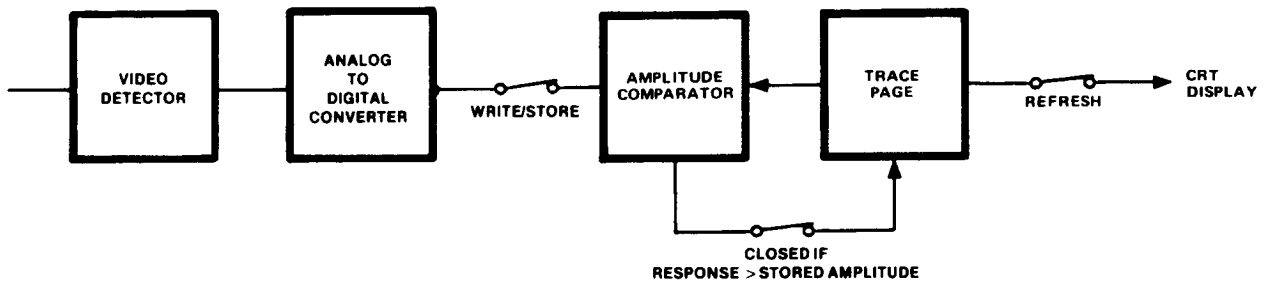

View A3 B3

1. The sweep is stopped and the trace is displayed on the CRT.

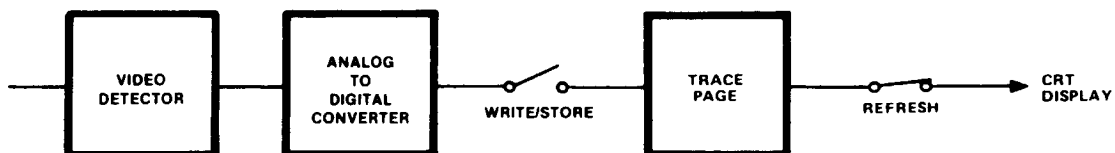

Blank A4 B4

1. The sweep is stopped and the trace is not displayed.

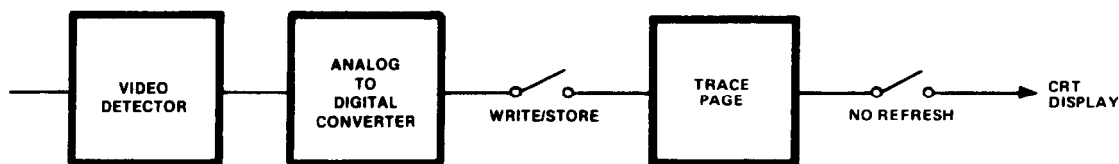

Exchange A and B EX

1. The sweep is stopped. If either trace is in a CLEAR WRITE or MAX HOLD mode, it is placed in VIEW.
2. The contents of traces A and B are exchanged.

A – B → A On C 2

1. The sweep is stopped and trace B is placed in VIEW mode.
2. A is replaced with A – B (A minus B).
3. The sweep is continued from the left. Each new analyzer response point is reduced by the amount stored in the corresponding address of trace B, and the result is stored in trace A. This process continues at the sweep rate.
4. Subsequent sweeps continue the process.

A – B → A Off C 1

1. Subsequent analyzer responses are written directly into trace A. Trace B and its mode are not changed.
2. The amplitude stored in the display line register is subtracted from the contents in each trace B address and the result is stored at the same trace B address.

B – DL → B BL

1. Trace B is placed in view. Trace A is not changed.
2. The amplitude stored in the display line register is subtracted from the contents in each trace B address. The result is stored at the same trace B address.

Appendix B

ADVANCED DISPLAY PROGRAMMING

This appendix describes CRT display programming with the analyzer display language.

A display program increases the CRT graphics capability of the spectrum analyzer. Explicit display programming generally uses less display memory, allowing more efficient use of the 4,096 display addresses available.

Appendix A, Display Memory Structure, provides background material for information in this appendix.

DISPLAY PROGRAM DEFINED

A display program consists of a specific set of display commands which are followed by instructions and/or data words written into the display memory.

Use these commands to write display programs into memory.

DA	Display Address puts the address into the display memory address register (referred to as the current address).
DW	Instruction or Data Write writes the instruction or data word into the current display address. The current display address pointer is then automatically advanced to the next higher address.
DD	Binary Instruction or Data Word writes two 8-bit binary words into the current address. *
DR	Display Read places the contents of the current address on the HP-IB data lines. These contents are then read by the HP-IB controller according to the current Output format (01 to 04). Execution of each DR concludes by advancing the current address by one (1).

Instruction Words dictate the operating mode of the CRT circuitry, such as label, graph, or plot. The data words contain amplitude or position information.

Instruction and data words are written into memory when the above commands are used. For example, the code "PA 500,600" writes into the display memory the instruction word for vector, 1026, followed by the x and y data values 500 and 600. This same "plot absolute" command could also be done as a display program by writing "1026,500,600" into the display memory. The display program is "executed" each time the CRT is refreshed from memory.

LOADING AND READING A DISPLAY PROGRAM

Instruction and data words are loaded directly into the analyzer display memory by, first, specifying the beginning address of the program, then writing in the instructions and data serially. To write the "1026,500,600" program beginning at address 1024 (the first address of trace B), execute

```
O U T P U T 718; "DA 1024;DW 1026,500,600;"
```

This program instructs the display to draw a vector to the position (500,600) on the CRT

*The first byte contains the four most significant bits, the second contains eight least significant bits of the 12-bit instruction or data word. DD must be executed for every 2 bytes input into the analyzer.

To read and print out the program, run:

```

10  PRINTER IS 701
20  !
30  OUTPUT 718;"01;DA 1024;"
40  FOR I=1 TO 3
50    OUTPUT 718;"DA OA;"
60    ENTER 718;A
70    OUTPUT 718;"DR"
80    ENTER 718;W
90    PRINT A,W
100 NEXT I
110 END
    
```

Address	Contents
1024	1026
1025	500
1026	600

- Line 30:** Sets format to decimal word values, and sets the address to 1024.
- Line 40 to 100:** Read and print three successive display program addresses and their contents. The address is automatically incremented by one after the execution of each DR command.
- Line 50:** Sends the display address to the controller.
- Line 5:** Reads the content of the current display address.

INSTRUCTION WORDS AND DATA WORDS

Instruction words and data words can be any value from 0 to 4095. The value is stored as a 12-bit binary word, and several of the bits define the type of word. Graphic representations used in this appendix are defined as follows:

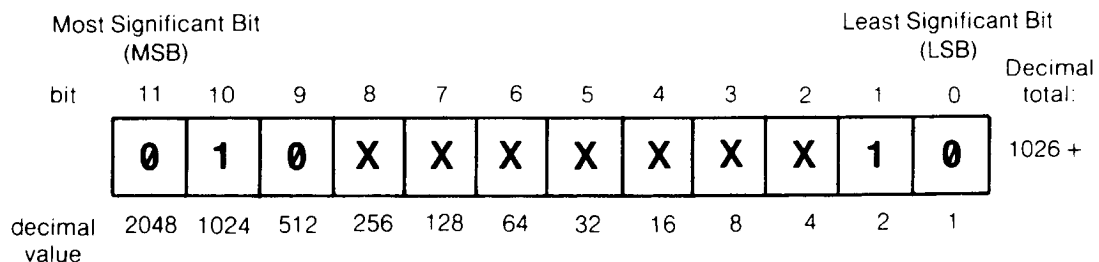

where x is either a 1 (true) or a 0 (false).

The sample word displayed is $1024 + 2 = 1026$, the instruction control word for vector used in the previous examples.

INSTRUCTION WORDS

There are three kinds of instruction words:

1: Display control	11 10 9 8 7 6 5 4 3 2 1 0	0 1 0 X X X X X X 0 X X	1024 +
2: Program control including end of display		0 1 0 X X X X X X X 0 1 1	1027 +
		0 1 0 X X X X X X 1 X X	1028 +
3: Count/Threshold		0 1 1 X X X X X X X X X	1536 +

Display Control Instruction Words. The display control instruction words tell the CRT circuitry how to use the subsequent data words to direct the CRT beam. Instruction word 1026 **vector** is an example. Data values in a display program following 1026 direct the CRT beam to x,y positions. The two other display control instruction words are **label**, which writes characters on the CRT, and **graph**, which displays traces.

vector (vtr)*	11 10 9 8 7 6 5 4 3 2 1 0	0 1 0 X X X 0 X X 0 1 0	1026 +
label (lbl)		0 1 0 X X X 0 X X 0 0 1	1025 +
graph (gra)		0 1 0 X X X 0 X X 0 0 0	1024 +

The syntax of vector, label, and graph are counterparts of commands PA, PR, LB, and GR. Pen up/down, display size, and beam intensity are controlled by setting various bits along with the instruction and data words. These functions are called auxiliary functions to the instruction.

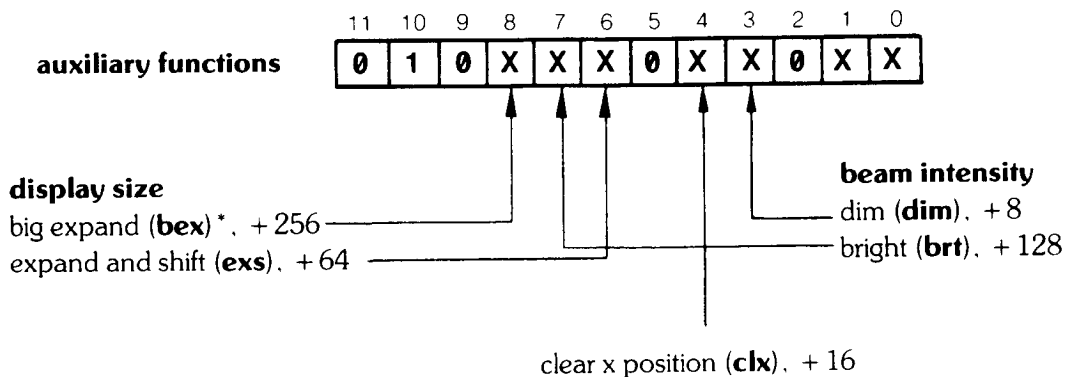

* Abbreviations within the parentheses are short hand notation for writing display programs. They are not programming codes.

- clear x position (**clx**) : Reset the x axis display position to the far left (0,y).
- big expand (**bex**) : Amplify the x and y CRT beam deflection by a 1.9 factor.¹
- expand and shift (**exs**) : Amplify the x and y CRT beam deflection by a 1.13 factor (expand) and shifts the (zero,zero) reference point to the lower left of the CRT screen.¹
- dim (dim): Set the CRT beam intensity below the normal level.²
- bright (brt) : Set the CRT beam intensity to the maximum level.*

Flow-of-Control Instruction Words. The CRT refresh program normally executes the contents of memory starting with address 0 and working one address at a time to address 4095. Flow-of-control instruction words alter the normal flow of a refresh program by allowing program execution to be transferred anywhere in memory. They allow jumps to specific display addresses (imp), jumps to a display program subroutine (jsb), returns (ret), skips to the next control instruction (skc), and a word that simulates a “for...next” loop, the **decrement-and-skip-on-zero** (dsz). Control instructions contain 0 1 0 in bits 11, 10, and 9, respectively.

	11 10 9 8 7 6 5 4 3 2 1 0													
jump (jmp)	<table border="1" style="border-collapse: collapse; width: 100%; height: 100%; text-align: center;"> <tr><td>0</td><td>1</td><td>0</td><td>X</td><td>0</td><td>0</td><td>0</td><td>X</td><td>1</td><td>0</td><td>1</td><td>1</td></tr> </table>	0	1	0	X	0	0	0	X	1	0	1	1	1035
0	1	0	X	0	0	0	X	1	0	1	1			
jump to subroutine (jsb)	<table border="1" style="border-collapse: collapse; width: 100%; height: 100%; text-align: center;"> <tr><td>0</td><td>1</td><td>0</td><td>X</td><td>1</td><td>0</td><td>0</td><td>X</td><td>1</td><td>0</td><td>1</td><td>1</td></tr> </table>	0	1	0	X	1	0	0	X	1	0	1	1	1163
0	1	0	X	1	0	0	X	1	0	1	1			
return (ret)	<table border="1" style="border-collapse: collapse; width: 100%; height: 100%; text-align: center;"> <tr><td>0</td><td>1</td><td>0</td><td>X</td><td>1</td><td>1</td><td>0</td><td>X</td><td>1</td><td>0</td><td>1</td><td>1</td></tr> </table>	0	1	0	X	1	1	0	X	1	0	1	1	1227
0	1	0	X	1	1	0	X	1	0	1	1			
skip to next control instruction (skc)	<table border="1" style="border-collapse: collapse; width: 100%; height: 100%; text-align: center;"> <tr><td>0</td><td>1</td><td>0</td><td>X</td><td>X</td><td>X</td><td>0</td><td>X</td><td>0</td><td>0</td><td>1</td><td>1</td></tr> </table>	0	1	0	X	X	X	0	X	0	0	1	1	1027
0	1	0	X	X	X	0	X	0	0	1	1			
skip to next memory page (skp)	<table border="1" style="border-collapse: collapse; width: 100%; height: 100%; text-align: center;"> <tr><td>0</td><td>1</td><td>0</td><td>X</td><td>X</td><td>X</td><td>1</td><td>X</td><td>0</td><td>0</td><td>0</td><td>0</td></tr> </table>	0	1	0	X	X	X	1	X	0	0	0	0	1056
0	1	0	X	X	X	1	X	0	0	0	0			
end of display (end)	<table border="1" style="border-collapse: collapse; width: 100%; height: 100%; text-align: center;"> <tr><td>0</td><td>1</td><td>0</td><td>X</td><td>X</td><td>X</td><td>X</td><td>X</td><td>X</td><td>1</td><td>X</td><td>X</td></tr> </table>	0	1	0	X	X	X	X	X	X	1	X	X	1028 +
0	1	0	X	X	X	X	X	X	1	X	X			
decrement and skip on zero (dsz)	<table border="1" style="border-collapse: collapse; width: 100%; height: 100%; text-align: center;"> <tr><td>0</td><td>1</td><td>0</td><td>X</td><td>0</td><td>1</td><td>0</td><td>X</td><td>1</td><td>0</td><td>1</td><td>1</td></tr> </table>	0	1	0	X	0	1	0	X	1	0	1	1	1099
0	1	0	X	0	1	0	X	1	0	1	1			

The address to be jumped to is the contents of the memory word following the jmp or jsb instruction. For example, “1035,2048” causes program execution to jump to address 2048. The address given should contain a control instruction. (If the address does not contain a control instruction, the program will go to the first control instruction following the specified address.) A return (ret) causes the program execution to return to the first control instruction following the jsb instruction that sent it to the subroutine.

*The display size commands combine these size instructions as follows:

	instructions	ratio to D 1	origin shifted
D1	none	1.00	no
D2	exs	1.13	yes
D3	bex and exs	1.68	yes
—	bex	1.49	no

²The intensity of the beam is also dependent upon line length. Lines longer than a preset length will be brighter because beam writing rate is slowed.

NOTE

Subroutines must not contain label or graph control words. A subroutine may not call another subroutine.

The skip-to-next control instruction (SKC) causes program execution to go to the next instruction in memory. The skip-to-next page (SKP) instruction causes program execution to go to the next address that is an integer multiple of 1024. (An instruction that combines SKP and SKC, $1056 + 3 = 1059$, executes as if it were a SKP followed by a **skc**.)

The decrement and skip-on-zero (DSZ) instruction decrements an internal count register then tests the contents for zero. If the contents are not zero, the program goes to the next control instruction. If the contents equal zero, the program will skip the next two addresses then go to the next control instruction. For example, “1099, 1035, 1532, 1026” causes the program to skip to the control word 1026 if the counter register is zero; otherwise it executes the 1035, 1532, which is a jump to address 1532. See Load Counter and Threshold Instructions below.

The auxiliary control function clear x position (CLX) can be added to any of the program control instructions.

Another method of causing skips in program execution is with the label mode (either LB or lbl). This is discussed under Data Words.

End of Display Instruction. When executed, the end of display instruction terminates execution of the display program. The next execution of the program then begins at display address zero on the next display refresh trigger (note that refresh trigger and sweep trigger are not the same).

The end of display instruction bit supersedes all other coding in the instruction except the auxiliary function clear x position, CLX (bit 4), which may be added. The end instruction causes a default-to-graph mode at the beginning of the next program execution if no display control instruction is at address zero.

Since fast sweeps (direct display of video and sweep for sweep times less than 20 msec) are displayed between program executions, an end instruction is required for proper operation of the fast sweep display.

An end-of-display in trace C is changed to a skip-to-next memory page, 1056, when a B \rightleftharpoons C exchange is executed.

Load-Counter and Load-Threshold Instructions. The load-counter instruction loads an internal count register with a value determined by bits 0 through 8 of the instruction. The internal register is used in either of two ways. In the graph (gra) mode, the display program interprets the register contents as the display THRESHOLD

position. The second use is the count register for the decrement and skip-on-zero (dsz) instruction. The interpretation for these two uses is shown below:

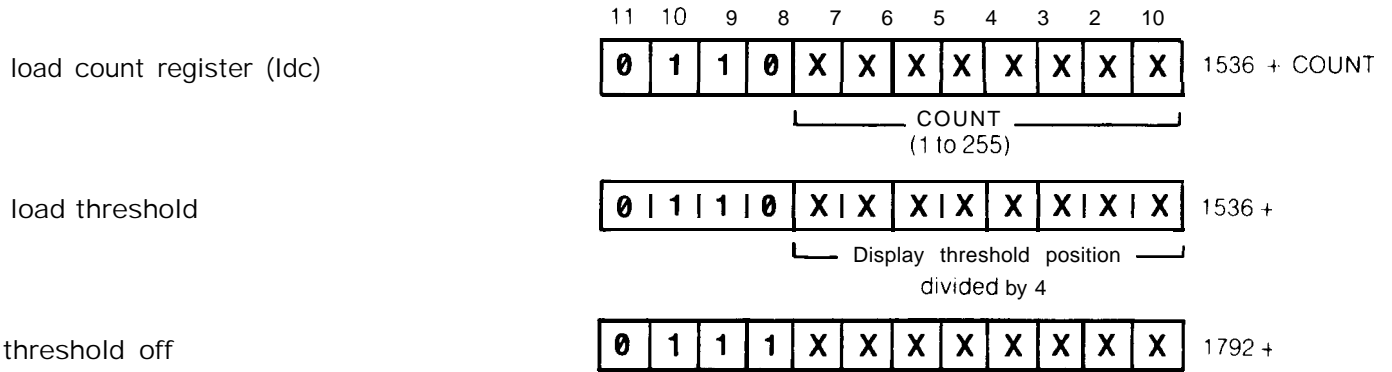

NOTE

The ldc and **dsz** instructions use the THRESHOLD level register. Therefore, load threshold instruction 1536 must be executed after all uses of ldc and dsz, and before the next graph command is executed. If the load threshold is not executed, the threshold may not function correctly.

DATA WORDS

Data words are differentiated from instruction words by the two most significant bits, bits 11 and 10. The following words are data words:

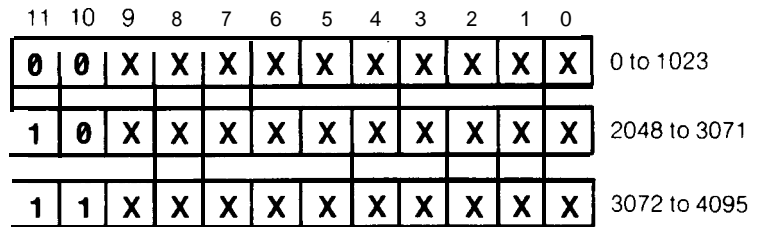

Interpretation of these data word formats by the CRT refresh program depends entirely on the preceding instruction word.

Graph. Each data word following a graph instruction is interpreted as an absolute y position. Y position values follow the general rule shown below:

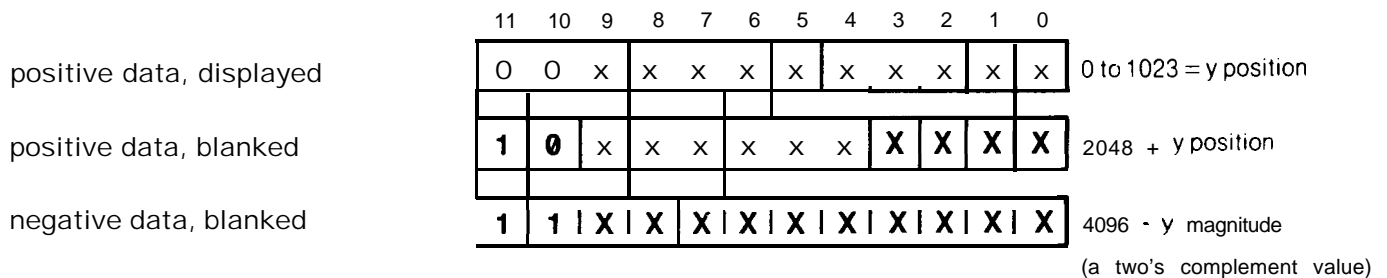

With negative data, the CRT beam goes to $y = 0$. Note that negative data can result from trace arithmetic functions $A - B \rightarrow A$ and $B - DL \rightarrow B$.

Vector. Data words following a vector (**vtr**) instruction are interpreted as x,y pairs. The data value determines whether the vector is blanked or displayed, absolute or relative. The x position data sets the absolute/relative auxiliary function; the y position data sets the blank/unblank auxiliary function.

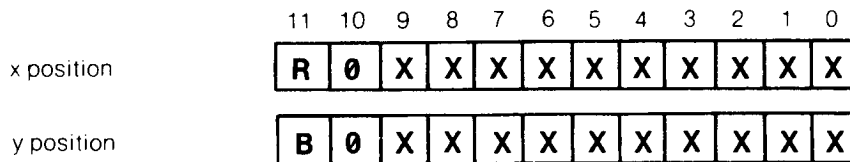

- when R = 1 (x position + 2048) vector is relative (both x and y are relative)
- R = 0 (x position + 0) vector is absolute (both x and y are absolute)
- B = 1 (y position + 2048) vector is blanked (pen up)
- B = 0 (y position + 0) vector is displayed (pen down)

Negative values for the plot relative x and y positions are entered as complementary values of 1024 to the ten least significant bits of the data word. For example, a plot relative -300 of x position is written in the data word as $(1024 - 300) = 724$. The actual plot "wraps around" the display to find the -300 position.

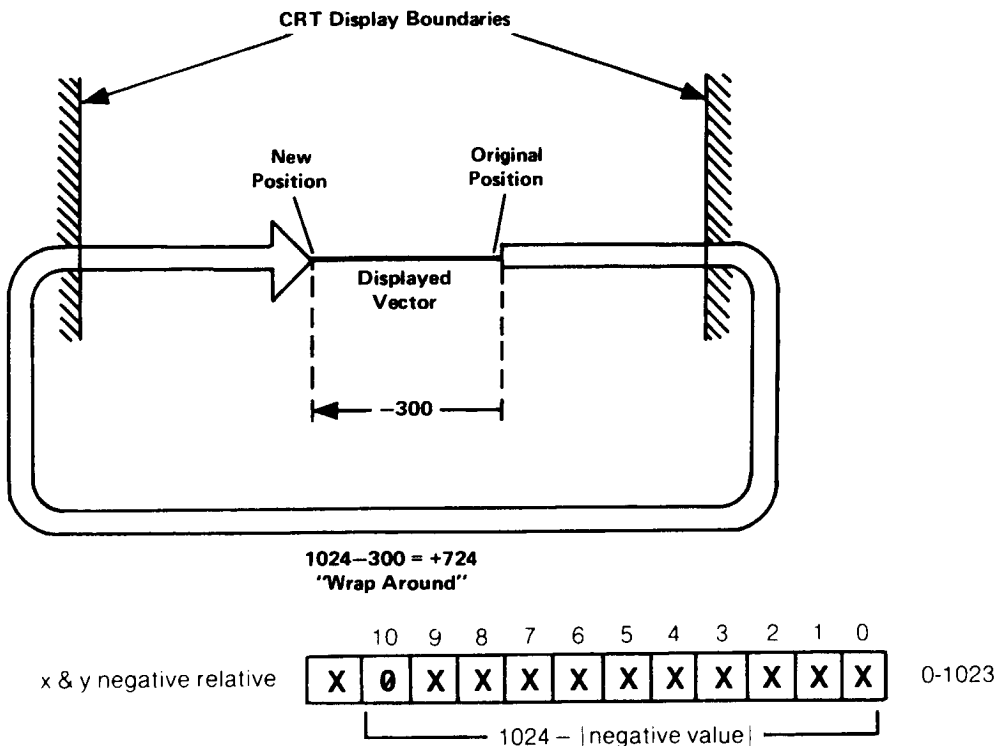

A specific set of character codes provide special label functions:

	Code
null	0
back space (BS)	8
line feed (LF)	10
vertical tab (opposite of line feed) (VT)	11
form feed (move beam to (0,0)) (FMFD)	12

carriage return (CR)	13
blink on (bkon)	17
blink off (bkof)	18
space (SP)	32
skip to next 16 block (sk16)	145
skip to next 32 block (sk32)	146
skip to next 64 block (sk64)	147

A blink on (bkon) will cause blinking of everything drawn on the display until a subsequent blink off (bkof) or an end of display (end) instruction is encountered with program execution.

A skip 16, 32, or 64 will cause program execution to go to the next address that is an integer multiple of 16, 32, or 64, respectively.

Note that these functions will work for both the **lbl** instruction code (1025 +) or the LB command.

PROGRAMMING WITH DISPLAY CONTROL INSTRUCTION WORDS

These examples illustrate the use of display control instructions and data words. The display memory commands described at the start of this appendix are used for loading and reading.

Vector (vtr)

Instructions can be used to draw lines on the CRT display. The data words each determine whether the data is plotted absolute/relative or **blanked/unblanked** (pen up/pen down). The auxiliary functions apply to the vector instructions.

For example, a line is to be plotted on the display with plot relative instructions in trace C memory beginning at address 3072.

address	description	program	word
3072	vector	vtr	1026
3073	x = 450 absolute	450 + 0	450
3074	y = 450 blanked	450 + 2048	2498
3075	x = - 100 relative	(1024 - 100) + 2048	2972
3076	y = + 100 relative pen down	100 + 0	100

The load program is:

```
OUTPUT 718;"DA 3072;DW 1026,450,2498,2972,100;"
```

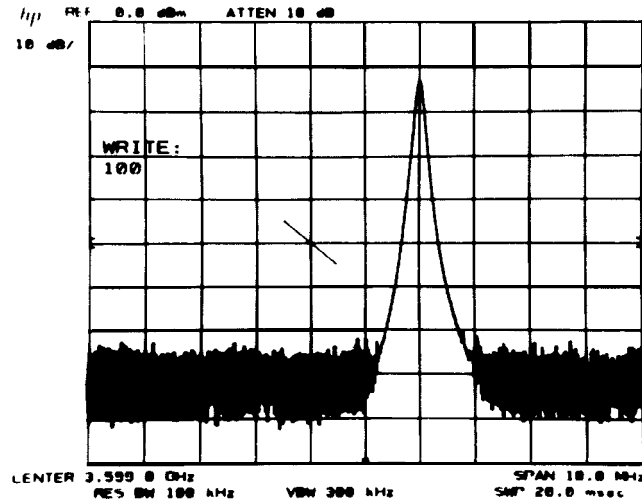

Vector and Label (vtr and **lbl**). To demonstrate the display instructions, a simple block diagram is drawn and labelled. Then the control words are modified with some of the auxiliary functions to demonstrate their use.

First a graphics plan is drawn:

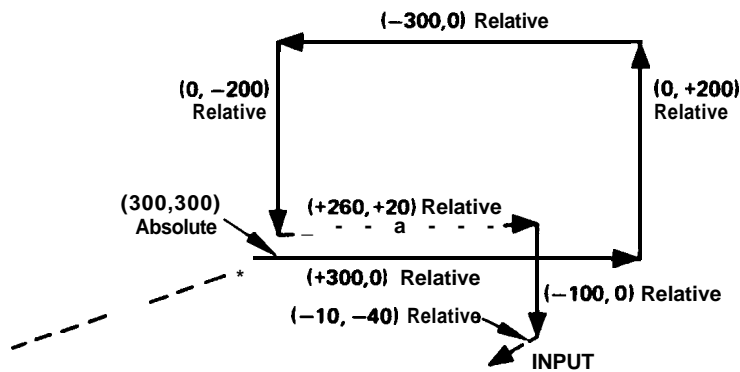

Graphics Plan

The vectors with + and - signs are relative vectors, the others are absolute points. Dashed lines are to be blanked.

address	description	program	word
3072	vector absolute	vtr	1026
3073	x = 300 absolute	300 + 0	300
3074	y = 300 pen up	300 + 2048	2348
3075	x = + 300 relative	300 + 2048	2348
3076	y = 0 pen down	0 + 0	0
3077	x = 0 relative	0 + 2048	2048
3078	y = + 200 pen down	200 + 0	200
3079	x = - 300 relative	(1024-300) -t2048	2772
3080	Y = 0 pen down	0	0
3081	x = 0 relative	0 + 2048	2048
3082	y = - 200 pen down	(1024-200) + 0	824
3083	x = + 260 relative	260 + 2048	2308
3084	y = + 20 pen up	20 + 2048	2068
3085	x = 0 relative	0 + 2048	2048
3086	y = - 100 pen down	(1024-100) + 0	924
3087	x = - 10 relative	(1024-10) +2048	3062
3088	y = - 40 pen up	(1024-40) +2048	3032
3089	label	lbl	1025
3090		I	73
3091	the word	N	78
3092	"INPUT"	P	80
3093		U	85
3094		T	84
3095	end of display	end	1028

The above plan can then be programmed and run.

```

10  OUTPUT 718;"IP;KSo;KSm;A4;"
20  OUTPUT 718;"DA 3072;DW 1026,300,2348,"
30  OUTPUT 718;"2348, 0, 2048, 200,"
40  OUTPUT 718;"2772, 0, 2048, 824,"
50  OUTPUT 718;"2308, 2068, 2048, 924,"
60  OUTPUT 718;"3062, 3032,"
70  OUTPUT 718;"1025, 73, 78, 80, 85, 84, 1028;"
80  END

```

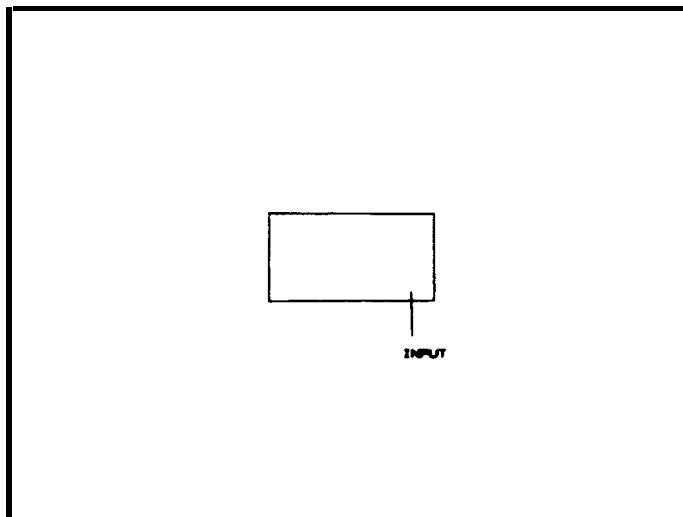

The display can now be modified by adding various auxiliary functions to the existing control words.

Brighten the "INPUT" term by adding 128 (brt) to the label address 3089 (1025 + 128 = 1153).

```
70 OUTPUT 718;"1153, 73, 78, 80, 85, 84, 1028;"
```

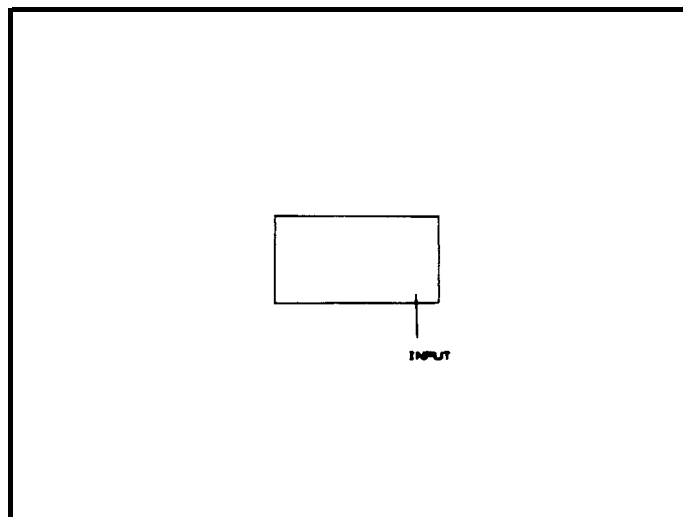

The label "INPUT" can be made to blink by adding blink on (bk on) and blink off (bk of) words before and after the "INPUT" label.

```
70 OUTPUT 718;"1025,17, 73, 78, 80' 85, 84' 18, 1028;"
```

Alternately, line 7 could have been replaced with the following lines:

```
61 OUTPUT 718;"DT@"  
70 OUTPUT 718 USING "K,B,K,B,K";"LB"; 17;"INPUT;18;"@DW 1028"
```

Note that a write binary (wtb) is used to transmit a mix of characters and non-character codes.

PROGRAMMING WITH PROGRAM CONTROL INSTRUCTION WORDS

These examples use both the commands listed in Section II and instruction words.

End-of-Display (end) and Skip-to-Next-Memory-Page (skp) Instruction Words. To end the display after the first 100 points of trace A, write "DW 1028" into address 100.

```
OUTPUT 718;"IP;S2;TS;DA 100;DW 1028:"
```



In this example, all display memory information beyond address 100 is ignored, including the annotation. Note that the analyzer is in single sweep, **S2**, to prevent signal response data from writing over the control word.

Skip control words allow certain portions of the display to be omitted. There are two kinds of skip control words. The **first** enables a skip over the remainder of the present memory page to the beginning of the next memory page, the second enables a skip to the next control word.

The skip-page and skip-to-next-control-word have been assigned two command codes, PS and SW, respectively

In the example, the annotation was blanked because of the end-of-display written into address 100. If a skip had been written instead, the rest of the display memory would have been displayed, but the remainder of trace A would have been omitted.

OUTPUT 718;"IP;S2;TS;DA 100;DW 1056;"

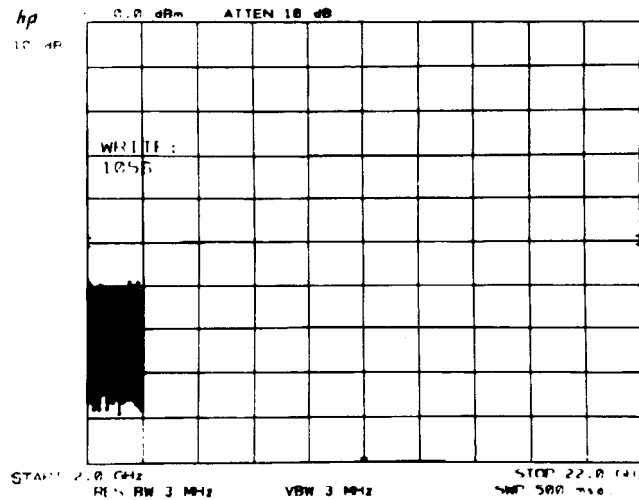

(Note that programming code PS can be substituted for DW 1056.)

A *skp* written into the trace C page skips the refresh pointer to DA 0 (trace A). This may cause an increase in the trace intensity because the program does not wait for a refresh trigger before beginning the next execution of the program. An end of display, 1028, is normally used in the Trace C page. This instruction allows a new refresh cycle to begin.

Skip-to-Next-Control-Instruction (*skc*). Program control is transferred to the next control instruction.

For example, address 2073 of the annotation memory page contains the label control word that places the center frequency “|” mark on the CRT. To omit this marker from the display, the label word is replaced by a *skc* word.

OUTPUT 718;"DA 2073;DW 1027;"

OR

OUTPUT 718;"DA 2073:DW SW;"

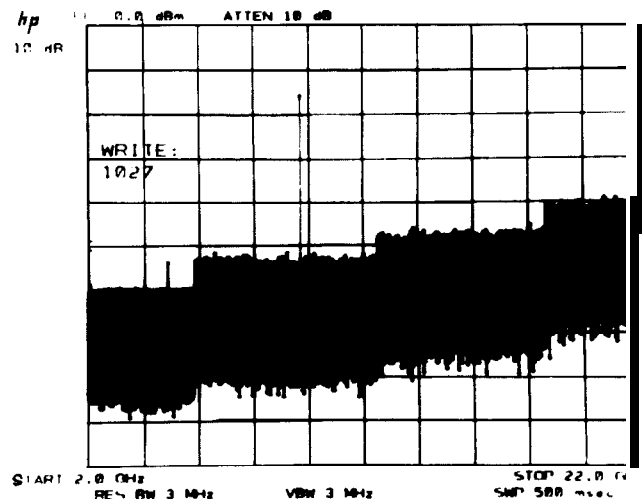

(Note that programming code SW can be used for DW 1027.)

Jump (*imp*). The example demonstrates *jmp* by jumping over the data in addresses 100 to 500 in trace A. Since the jump should be made to a control word, *gra* is first written into DA 500.

Before the program is loaded the display might look like this:

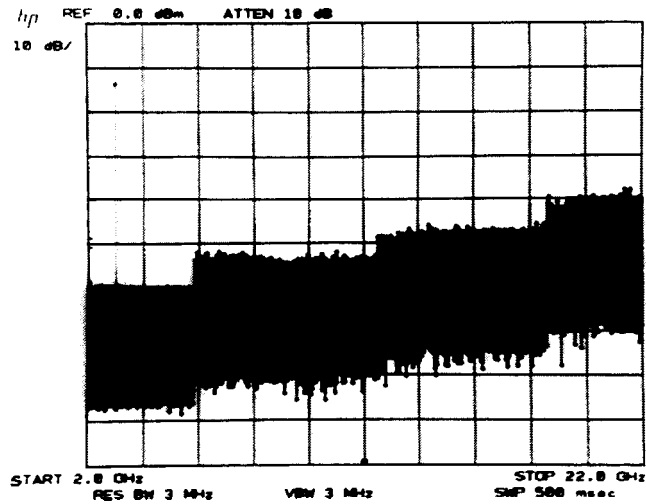

After the following lines are executed the CRT would appear like this:

```

10 OUTPUT 718;"IP;S2;TS;DA500;DW1024;"
11 OUTPUT 718;"DA 100:DW 1035, 500;"
13 END
    
```

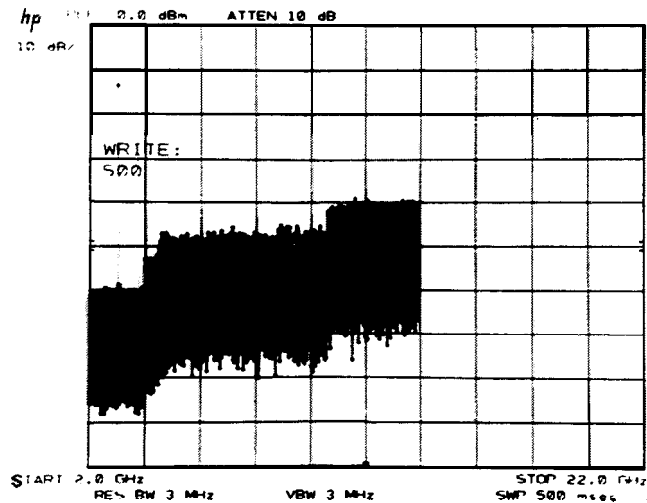

The trace data that would have been shown between display addresses 100 and 500 is omitted and the data for addresses 501 – 1001 is displayed at x positions 100 through 600.

Jump Subroutine (**jsb**) and Return (**rtn**). The jsb instruction transfers program control to the address specified. If the address does not contain a control word, the program skips to the next control word after that address. The rtn instruction transfers program control to the first control word following the jsb instruction.

The flow of the program is as follows:

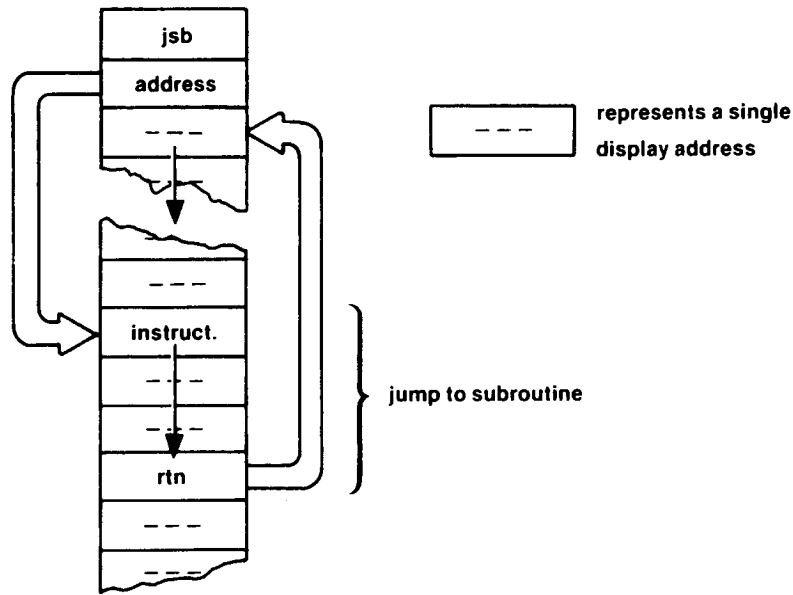

To demonstrate jsb/rtn, this example substitutes a new symbol for the preprogrammed marker symbol.

The marker symbol (a small diamond) is written as a subroutine in the annotation memory at address 2085. Substitution of the diamond symbol can be made by calling for and writing a new jsb routine with this program. The address for the marker subroutine call is located at display address 2054.

```

10  OUTPUT 718;"DA 2054;DW 3080;"
11  OUTPUT 718;"DA 3080;DW 1154,2148,100,"
12  OUTPUT 718;"1227;M2;"
14  END
    
```

- Line 10:** Writes a new subroutine address, 3080, in place of the old one.
- Line 11:** Writes the new symbol vector subroutine starting at address 3080 (trace C).
- Line 12:** Return.

After running this program, the display memory contains the following:

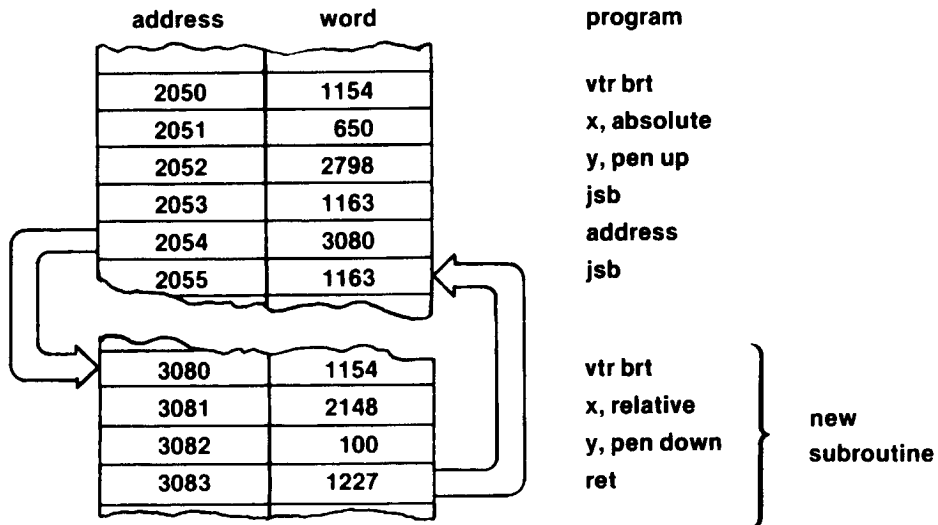

The display would appear similar to this:

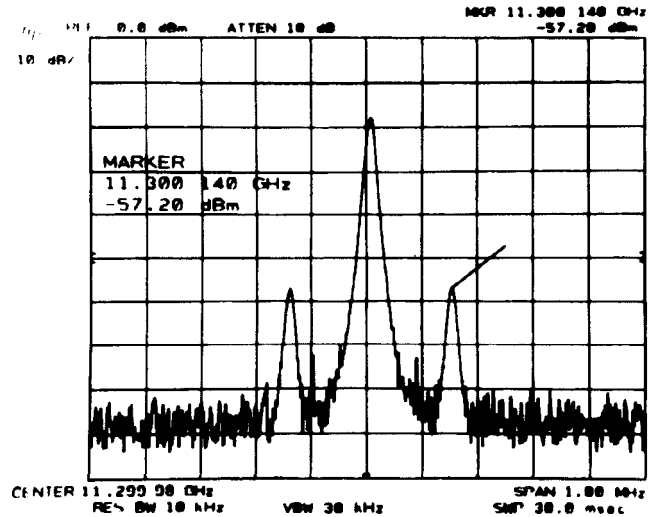

Once a subroutine is written in a given location, care must be exercised that it is not accidentally changed. For example, storing a trace in trace C would destroy the subroutine beginning at DA 3080.

LOOP INSTRUCTIONS

Load Counter Register (ldc) and Decrement and Skip on Zero (dsz). In the following example, looping is used to draw a grid in two places on the CRT display on refresh. The trace C page is programmed to contain the graphics.

	address	description	program	word
positioning vector	3072	plot absolute	vtr	1026
	3073	x = 600 (PA)	600	600
	3074	y = 300 (PU)	300 + 2048	2348
	3075	jump to subroutine	jsb	1163
	3076	at address	address	3199
	3077	plot absolute	vtr	1026
	3078	x = 100 (PA)	100	100
	3079	y = 300 (PU)	300 + 2048	2348
	3080	jump to subroutine	jsb	1163
	3081	at address	address	3199
	3082	end of display	end	1028
looping subroutine	3199	vector	vtr	1026
	3200	repeat 10 times	ldc + 10	1546
	3201	plot relative	vtr	1026
	3202	x = 0 (PR)	0 + 2048	2048
	3203	y = +25 (PU)	25 + 2048	2073
	3204	x = +300 (PR)	300 + 2048	2348
	3205	y = 0 (PD)	0	0
	3206	x = 0 (PR)	0 + 2048	2048
	3207	y = +25 (PU)	25 + 2048	2073
	3208	x = -300 (PR)	1024-300 + 2048	2772
	3209	y = 0 (PD)	0	0
	3210	decrement	dsz	1099
	3211	jump to	jmp	1035
	3212	start	address	3201
3213	return	rtn	1227	

The program can then be written, loading the words sequentially as listed in the prior plan.

```

10  OUTPUT 718;"IP;KSo;KSm:A4;"
20  OUTPUT 718;"DA 3072:DW 1026,600,2348,"
30  OUTPUT 718;"1163,3199,1026,100,2348,1163,"
40  OUTPUT 718;"3199,1028;"
50  OUTPUT 718;"DA 3199;DW 1026,1546,1026,"
60  OUTPUT 718;"2048,2073,2348,0,2048,2073,"
70  OUTPUT 718;"2772,0,1099."
80  OUTPUT 718;"1035,3201,"
90  OUTPUT 718;"1227:HD;"
100 END

```

- Line 10: Blanks the analyzer display
- Lines 20 to 30: Contain the positioning vectors.
- Line 40: An end of memory instruction (1028) insures that the following loop (DA 3199) is not executed unless called from addresses 3075 and 3080, the jsb words.
- Lines 50 to 90: Contain the grid subroutine.

Running the program results in the following display:

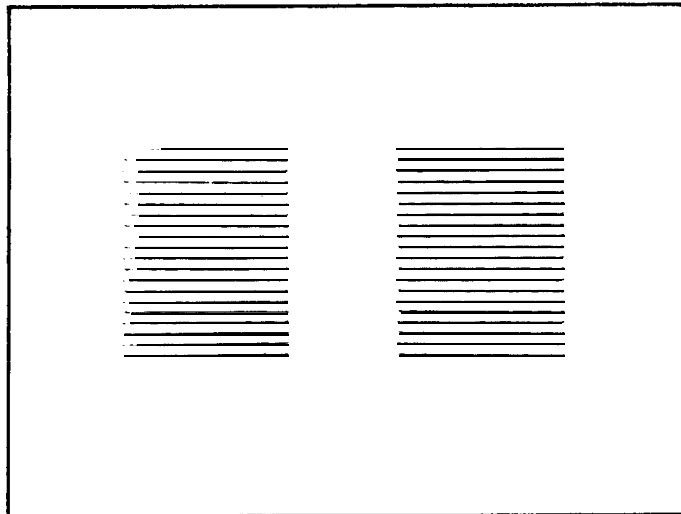

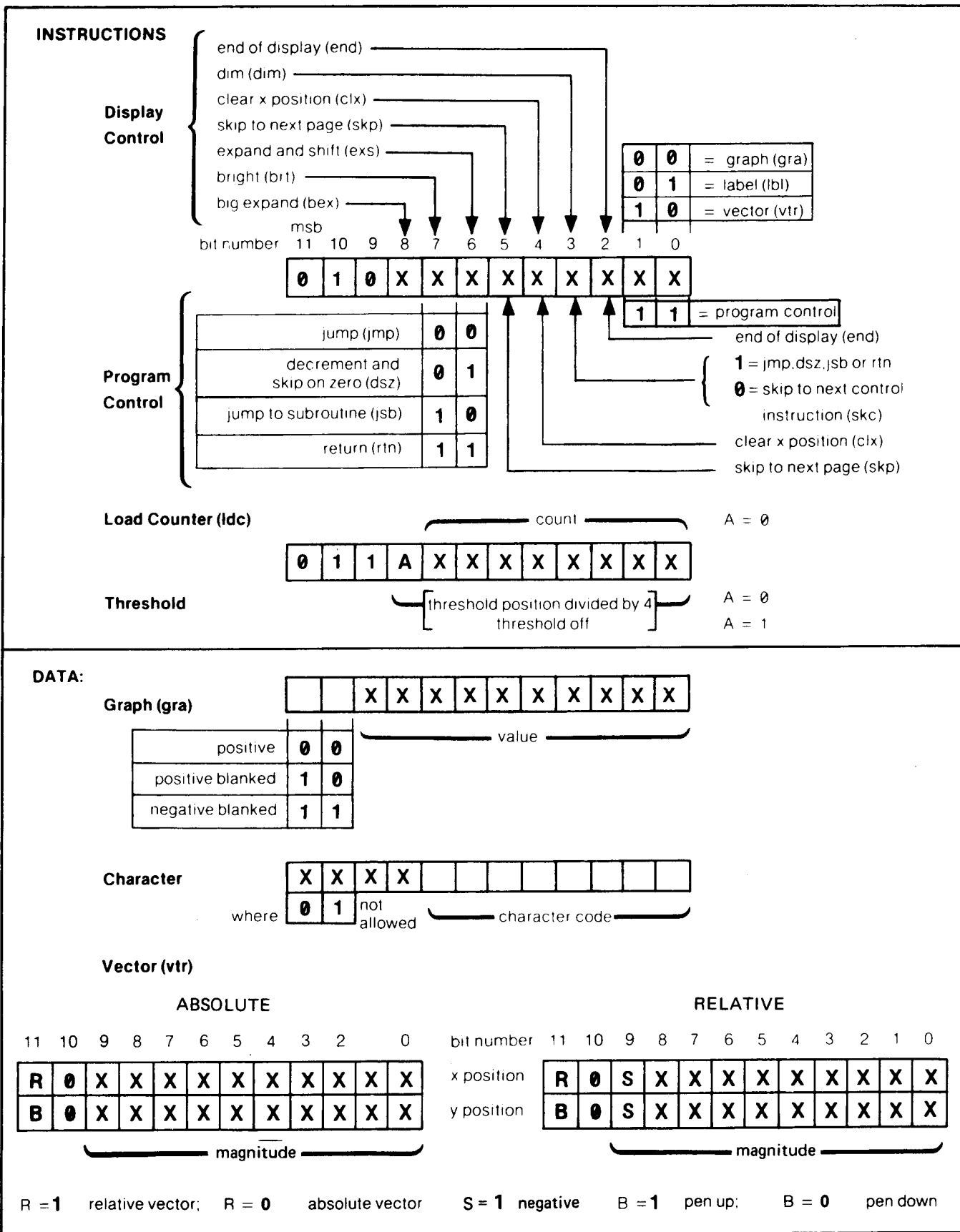

INSTRUCTION AND DATA WORD SUMMARY

Display Control Instruction	Data	Word
graph (gra)	amplitude: position unblanked position blanked negative blanked	1024 Y y + 2048 4096- y
label (lbl)	character blink on (bkon) . blink off (bkof) . skip to next 16 block (sk16) * skip to next 32 block (sk32) . skip to next 64 block (sk64) .	1025 ASCII or special character code (≤ 255) 17 18 145 146 147
vector	x position y position absolute vectors relative vectors pen down pen up (blanked)	1026 data in display units data in display units x + 0 x + 2048 y + 0 y + 2048
Auxiliary to gra, lbl, and vtr instruction word: big expand (bex) expand and shift (exs) bright (brt) dim (dim) clear x position		word + 256 word + 64 word + 128 word + 8 word + 16
Program Control Instruction	Data	Word
end of display (end) skip to next memory page (skp) skip to next control word ⁽¹⁾ (skc) jump⁽¹⁾ (jmp) jump to subroutine ⁽²⁾ ⁽³⁾ (jsb) return⁽¹⁾ ⁽³⁾ (ret)	address address	1028 1056 or "PS" 1027 or "SW" 1035 0 to 4096 1163 0 to 4096 1227
decrement and skip two addresses on zero ⁽¹⁾ ⁽²⁾ (dsz)		1099
load counter (THRESHOLD position) ⁽²⁾ (ldc)		1536 + (count)
<p>• These can also be accessed using the LB command. These functions can be initiated any time the label mode is active.</p> <p>(1) Jumps and skips will skip to an address containing a control word.</p> <p>(2) Loop should use only lbl and vtr control words. Ldc is not a control word.</p> <p>(3) Subroutines may use only vtr control words.</p>		

Appendix C
LEARN STRING CONTENT

The following table describes the learn string contents and coding, and the control settings restored when the learn string command, OL, is executed. (See OL.)

HP 8566B LEARN STRING DECODING (1 OF 6)

BYTE NUMBEF	BIT USAGE BY EXAMPLE 7 6 5 4 3 2 1 0	EXAMPLE	DESCRIPTION
1	0 0 0 1 1 1 1 1	31 (decimal)	Notifies analyzer that a learn string follows
2			Unused
3	- - - - - 0	+ (plus sign)	Sign of center frequency: I= + , 1 = -
4	0 0 0 0 0 0 0 0	0 0	Center frequency (CRT annotation is rounded from this value) BCD MSD: Byte 4, bits 4 through 7 For this example, the Center frequency is 1234567896 Hz.
5	0 0 0 1 0 0 1 0	1 2	
6	0 0 1 1 0 1 0 0	3 4	
7	0 1 0 1 0 1 1 0	5 6	
8	0 1 1 1 1 0 0 0	7 8	
9	1 0 0 1 0 0 0 0	9 0	
10	0 - - - - - - -		Bit 7 set to 1 if in zero span mode.
	- - - - - - 0 0	03	Output Format 0 =03, 1=01, 2=04, 3=02
11	1 - - - - - - -	Band lock	Band Lock 0 = unlock (IP, KSQ) 1 = band lock (KSt)
	- - - 0 0 1 0 0	4th Harmonic	Harmonic mode in use, 0, 1, 2..., where 0 is fundamental mixing 0-2.5 GHz.
12	0 0 0 0 0 0 0 0	0 0	Frequency span in Hz (CRT annotation is rounded from this value) BCD MSD: Byte 12, bits 4 thru 7 For this example: 10001 (Hz)
13	0 0 0 0 0 0 0 0	0 0	
14	0 0 0 0 0 0 0 0	0 0	
15	0 0 0 0 0 0 0 1	0 1	
16	0 0 0 0 0 0 0 0	0 0	
17	0 0 0 0 0 0 0 1	0 1	
18	i v - - - - - - -	Enabled	0 = DATA HOLD (HD) 1 = DATA Enabled
	- 1 - - - - - - -	On	SIGNAL TRACK 0 = Off 1 = On
	- - - 1 - - - - -	On	Instr Check I LED 0 = Off 1 = On
	- - - - 1 - - - -	On	Instr Check II LED 0 = Off 1 = On
	- - - - - 0 - - -	Coupled	CF STEP SIZE 0 = Coupled 1 = Uncoupled
	- - - - - - 0 - -	Coupled	ATTEN 0 = Coupled 1 = Uncoupled
	- - - - - - - 0	Coupled	SWEEP TIME 0 = Coupled 1 = Uncoupled
19	- - - - - - -	Uncoupled	VIDEO BW 0 = Coupled 1 = Uncoupled
	- I - - - - - - -	Uncoupled	RES BW 0 = Coupled 1 = Uncoupled
	- - - - - - - -	On	THRESHOLD 0 = Off 1 = On
	- - - 1 - - - - -	On	DISPLAY LINE 0 = Off 1 = On
	- - - - I - - - -	On	Noise Marker (KSM) 0 = Off 1 = On
	- - - - - - -	Start-Stop	Frequency display mode 0 = CF, SP 1 = start-stop

HP 8566B LEARN STRING DECODING (2 OF 6)

BYTE NUMBER	BIT USAGE BY EXAMPLE 7 6 5 4 3 2 1 0	EXAMPLE	DESCRIPTION
20	1 0 - - - - -	UR	Recorder Output 1 =Off 1=LL 2=UR
	- - 0 - - - -	Off	Sweep TRIGGER
	- - - 0 - - -	Off	VIDEO O=Off 1 = On
	- - - - 0 - -	Off	EXT O=Off 1 = On
	- - - - - 0 - -	Off	LINE O=Off 1 = On
		Example shown is FREE RUN	
	- - - - - 1 - -	Single	SWEEP Mode 0 = Continuous 1 = Single
	- - - - - - 0	Off	CLEAR-WRITE B O=Off 1 = On
21	1 - - - - -	On	TRACE Display Modes O=Off 1 = On
	- 0 - - - - -	Off	CLEAR WRITE A
	- - 1 - - - -	On	A-B→A
	- - - 0 - - -	Off	BLANK B
	- - - - 0 - -	Off	VIEW B
	- - - - - 0 - -	Off	MAX HOLD B
	- - - - - - 0 -	Off	BLANK A
- - - - - - - 0	Off	VIEW A	
- - - - - - - - 0	Off	MAX HOLD A	
22			Internal Flag
23	1 1 1 - - - -	- 10 dBm	Input Mixer Level (KS,) 9 = - 70 dBm 13 = - 30 dBm 10 = -60dBm 14 = - 20 dBm 11 = - 50 dBm 15 = - 10 dBm 12 = -40dBm 0 = - 0 dBm (only with KSI)
	- - - - - 0 1 1	30 dB	Input attenuator setting (dB)/ 10
24	01 1 0 - - - - - - - - 01 10	a=6 β=6	Reference Level in dBm RL= 10(10α + β - 64) + γ + δ/10
25	1 0 0 1 - - - - - - - - 0 0 1 0	γ=9 δ=2	Example: RL= 10(10(6) + 6 - 64) + 9 + 2/10 = 29.2 dBm Range is - 640.0 dBm to + 359.9 dBm
26	1 - - - - -	LOG	Amplitude Scaling 0 = linear (LIN) 1 = LOG
	- 1 1 - - - -	1dB/	Log scale factor in 0 = 10 dB/div 2 = 2 dB/div 1 = 5 dB/div 3 = 1 dB/div
	- - - 1 0 - - -	UR	XY Recorder Calibrated Output 0 = Off, normal operation 2 = Output for upper right 3 = Output for lower left
	- - - - - 0 - -	ON	CRT Beam O=On 1 = Off (KSG)

HP 8566B LEARN STRING DECODING (3 OF 6)

BYTE NUMBER	BIT USAGE BY EXAMPLE 7 6 5 4 3 2 1 0	EXAMPLE	DESCRIPTION
27	1 1 1 1 - - - -	3 MHz	Resolution Bandwidth (RES BW) 15 = 3 MHz 6 = 1 kHz 14 = 1 MHz 5 = 300 Hz 13 = 300 kHz 4 = 100 Hz 12 = 100 kHz 3 = 30 Hz 11 = 30 kHz 2 = 10 Hz 10 = 10 kHz 9 = 3 kHz
	- - - - 0 1 0 1	300 Hz	Video Bandwidth (VIDEO BW) Coding is same as Resolution Bandwidth with the addition of: 1 = 3 Hz 0 = 1 Hz
28			Internal Flag
29	- - 0 1 0 - - -	Sample	Trace Detection Mode 0 = Negative peak (KSd) 1 = Positive peak (KSb) 2 = Sample (KSe) 4 = Normal (KSa)
	- - - - - 0 1 0	Max Hold B	TRACE display modes 0 = CLEAR-WRITE A 1 = CLEAR-WRITE B 2 = MAX HOLD A 3 = MAX HOLD A, CLEAR-WRITE B 4 = MAX HOLD B 5 = MAX HOLD B, CLEAR-WRITE A 6 = Write A-B 7 = Max Hold A-B
30	- - - - 0 1 - - -	EXT	TRIGGER Mode 0 = FREE RUN 1 = EXT 2 = LINE 3 = VIDEO
31			Unused
32 33	- - - - - 1 1 1 1 1 0 1 0 0 0	1000	DISPLAY LINE position in display units thru 100 given by 16 bits of bytes 32 and 33 where bit 7 byte 32 is the MSB
34 35	0 0 0 0 0 0 0 1 1 1 1 1 0 1 0 0	500	THRESHOLD in display units. Coded the same as Display Line bytes 32 and 33 (bit 7 of byte 34 is MSB).

HP 8566B LEARN STRING DECODING (4 OF 6)

BYTE NUMBER	BIT USAGE BY EXAMPLE 76543210	EXAMPLE	DESCRIPTION
36	0 - - - - -	Positive	REF LEVEL Offset (KSZ), Sign 0 = + 1 = -
37	- 0 0 0 0 0 0 1 0 0 1 0 1 1 0	150	REF LEVEL Offset (KSZ), in dB Where bit 6 Byte 36 is MSB and bit 0 byte 37 is LSB of a 15 bit binary value. If sign bit is 0 (pos) offset is decimal equivalent of binary value/10. If sign bit is 1 (neg) offset is two's complement of binary value/10 .
38			Unused
39	- - - - - 1	Negative	FREQUENCY OFFSET (KSV). Sign 0 = + 1 = -
40 41 42 43 44 45	0 0 0 1 0 0 1 0 0 0 1 1 0 1 0 0 0 1 0 1 0 1 1 0 0 1 1 1 1 0 0 0 1 0 0 1 0 0 0 0 0 0 0 1 0 0 1 0	1 2 3 4 5 6 7 8 9 0 1 2	FREQUENCY OFFSET (KSV), in Hz BCD MSD: Byte 40 , bits 4 thru 7 Example: 1 2 3 4 5 6 7 8 9 0 1 2 Hz
46 47	- - - - - 1 0 1 1 1 0 1 0 0 0 -	1000	Video Averaging Limit (KSG) Binary MSB: Byte 46, bit 2
48 49 50 51 52 53	0 0 0 0 0 0 0 1 0 0 1 0 0 0 1 1 0 1 0 0 0 1 0 1 0 1 1 0 0 1 1 1 1 0 0 0 1 0 0 1 0 0 0 0 0 0 0 1	0 1 2 3 4 5 6 7 8 9 0 1	Center Frequency STEP SIZE (SS) BCD MSD: Byte 48 bits 4 thru 7 Range: 0 to 24 GHz Example: 1 2 3 4 5 6 7 8 9 0 1 Hz
54 55	0 0 0 0 0 0 0 1 1 1 1 1 0 1 0 0	500	Reference Marker X-axis position Binary MSB: Byte 54, bit 7 Range: 1 to 1001
56 57	0 0 0 0 0 0 0 1 0 1 0 1 0 0 0 1	337	Reference Marker Y-axis position Binary MSB: Byte 56 bit 7 Range: 1 to 1023
58 59	0 0 0 0 0 0 1 0 0 1 0 1 1 0 0 0	600	Active Marker X-axis position Binary MSB: Byte 58 bit 7 Range: 1 to 1001

HP 8566B LEARN STRING DECODING (5 OF 6)

BYTE NUMBER	BIT USAGE BY EXAMPLE 7 6 5 4 3 2 1 0	EXAMPLE	DESCRIPTION
60 61	0000000 1 00101100	300	Active Marker Y-axis position Binary MSB: Byte 60 bit 7 Range: 1 to 1023
62			Unused
63	00010100	ZOOM	MARKER mode 0=Off 18 = NORMAL 19 = A' 20 = ZOOM
64	0 1 - - - - -	dBmV	Reference Level units which will be used when the LOG scale is chosen. 0 = dBm , 1 = dBmV , 2 = dBμV , 3 = Volts
	- - - 0 - - - -	Off	Stop Sweep at marker (KSu) 0=Off, 1 =On
	- - - - - 0 - -	On	*SRQ on Unlock or Hardware Broken, Activated only by R3 or IF commands, 0 = On, 1 = Off
	- - - - - 0 -	Off	*SRQ at End of Sweep. Activated only by R2 command; 0=Off, 1 =On
	- - - - - 0	Off	* SRQ when Units key pressed. Activated only by R4 command; 0=Off, 1 =On
6 5	0 - - - - -	Internal	*Input Mixer 0 = Internal 1 = External
	- 0 - - - - -	Disabled	*Frequency SRQ, KS < 43 >; 0 = Off, 1 = On
	- - 1 - - - - -	"CORR'D"	Use CAL data 0 = No 1 = Yes
	- - - 1 - - - -	Cal'd	*Calibration routine correction data has been stored 0 = No 1 = Yes
	- - - - 1 0 - -	dBμV	Reference Level units which will be used when the LIN scale is chosen. 0 = dBm , 1 = dBmV , 2 = dBμV , 3 = Volts
	- - - - - 1 -	View C	View trace C 0=Off 1 = On

These settings are recorded by the Learn String but not restored if the string is output to the analyzer (as with RECALL).

HP 85668 LEARN STRING DECODING (6 OF 6)

BYTE NUMBER	BIT USAGE BY EXAMPLE 76543210	EXAMPLE	DESCRIPTION
66	00000000	0 0	SWEEP TIME in μsec . BCD MSD: Byte 66, bits 4 thru 7 Example: 500000 μsec .
67	00000000	0 0	
68	00000000	0 0	
69	01010000	5 0	
70	00000000	0 0	
71	00000000	0 0	
72			Internal Flag
73	- 1 - - - - -	Yes	*Power on in last state. This will be activated by KSf command. 0 = No 1 = Yes
	- - - 0 - - - -	No	Extended Reference Level allowed (KSI). 0 = No 1 = Yes
	- - - - - 1 - -	On	Video Averaging (KSG) 0 = Off 1 = On
	- - - - - 0 -	Off	Fast HP-IB (KSS) 0 = Off 1 = On
74	- - 0 1 1 0 1 0	26	Preselector tracking offset DAC settings: B Band (2.0 - 5.8 GHz) C Band (5.8 - 12.5 GHz) D Band (12.5 - 18.6 GHz) E Band (18.6 - 24 GHz)
75	- - 0 1 0 1 1 0	22	
76	- - 1 0 0 0 1 1	35	
77	- - 0 1 1 1 0 0	28	
78	1 0 1 0 1 - - -	500 μsec	Fast SWEEP TIME's (< 20 msec) 0 = greater than 10 ms 16 = 10 ms 23 = 100 μs 17 = 5 ms 25 = 50 μs 18 = 2 ms 26 = 20 μs 19 = 1 ms 27 = 10 μs 21 = 500 μs 29 = 5 μs 22 = 200 μs 30 = 2 μs 31 = 1 μs
79			Unused
80	1 0 1 0 0 0 1 0		Identifies the end of the 8566A Learn String.

These settings are recorded by the Learn String but not restored if the string is output to the analyzer (as with RECALL).

Appendix D

SERVICE REQUESTS

This appendix describes the analyzer service request (SRQ) capability and the use of service requests to interrupt an HP-IB controller to obtain service. A service request is an analyzer output that tells the controller a specific event has taken place in the analyzer. Service requests enable the analyzer to interrupt the controller program sequence, causing the program to branch to a subroutine.

For example, by using service requests, the controller can perform other operations while the analyzer is sweeping, and then service the analyzer when the sweep is completed. The analyzer sends its service request to the controller, which triggers the controller to take action, such as changing the instrument state or reading data from the display memory.

When making a service request, the analyzer places the HP-IB SRQ line true and the analyzer CRT display reads out "SRQ" with a number. Setting the SRQ line true announces to the HP-IB controller that the analyzer requires attention. The controller can then command the analyzer to send its "status byte". The status byte indicates the type of service request.

NOTE

If the CRT display annotation has been blanked, the service request notation will not appear.

DISPLAY DURING A SERVICE REQUEST

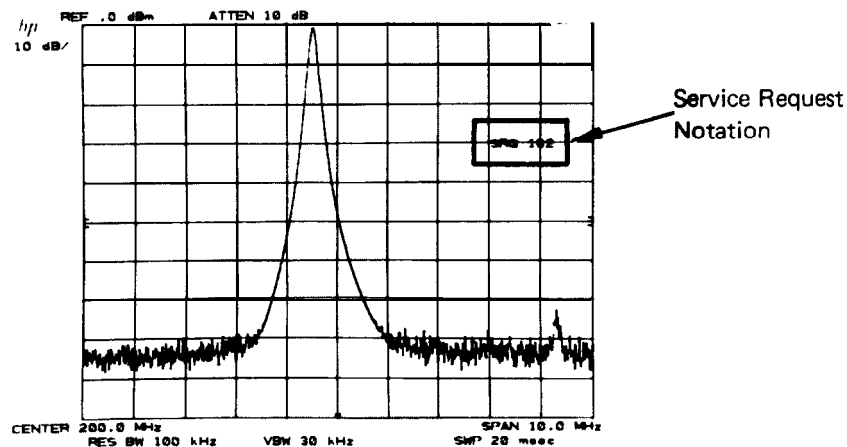

NOTE

A serial polling technique must be used by the HP-IB controller to test for service requests. The analyzer does not respond to HP-IB parallel polling.

INTERRUPT WITH SERVICE REQUEST

The HP-IB controller response to a service request depends on the controller. The operating manuals for each controller discuss that **controller's** reaction to setting the SRQ line true. Series 200 computers have a sequence of commands which enable a response to a service request. These commands allow monitoring the SRQ line and reading, interpreting, and then clearing the status byte. This sequence of commands and a subroutine, selected according to the type of service request, form a service routine. A general setup is given below.

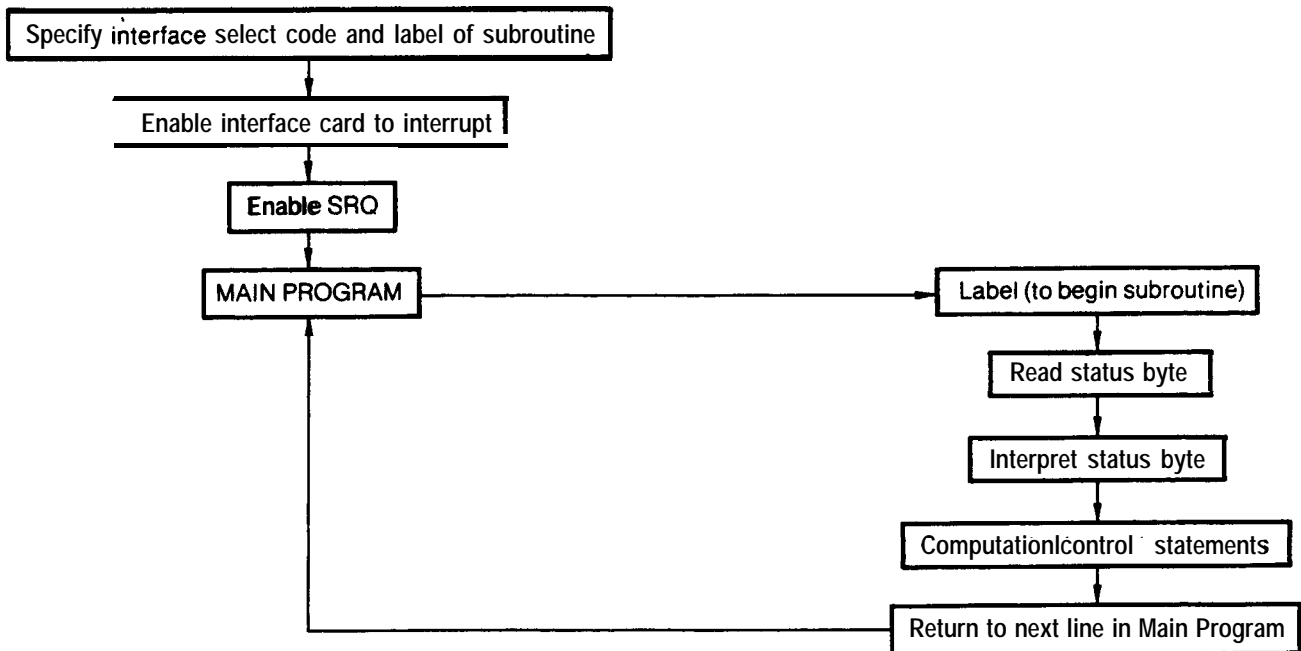

BASIC 2.0 SERVICE ROUTINE COMMANDS

Interrupt Statements	Example	Comments
ON INTR	ON INTR 7 GOSUB Shutoff	Declares the name of the service routine where program execution branches on interrupt from the peripheral specified by select code 7.
ENABLE INTR	ENABLE INTR 7;2	Enables the calculator to accept an SRQ interrupt from select code 7;2 (the HP-IB).
RETURN	RETURN	Signals the end of an interrupt service routine. While executing the service routine, the interrupt for the peripheral being serviced must be disabled to prevent cascading of interrupts.
SUBEXIT	SUBEXIT	Signals the end of an interrupt service subprogram.
Bit Functions		
SROLL	A = SROLL (718)	Reads the analyzer status byte, assigns its decimal value to A and clears the SRQ line.
BIT	BIT (A, N)	Returns the value of the Nth bit in A (0 or 1).

STATUS BYTE DEFINITION

The status byte sent by the analyzer in response to the controller SROLL command determines the nature of the service request. The meaning of each bit of the status byte is explained in the following chart.

Bit	Message	CRT Display Message
0 (LSB)	Unused.	—
1	Unit Key,  r pressed or frequency limit exceeded.	“SRQ 102”
2	End of sweep.	“SRQ 104”
3	Hardware broken.	“SRQ 110”
4	Unused.	—
5	Illegal analyzer command.	“SRQ 140”
6	Universal HP-IB service request. HP-IB RQS Bit	—
7	Unused.	—

The CRT SRQ number is an octal number based on the binary value of the status byte. This octal number always begins with a “1” since this is translated from bit 6, the universal HP-IB service request bit. For example, the status byte for an illegal analyzer command (SRQ 140) is as follows:

bit number	7	6	5	4	3	2	1	0
status byte	0	1	1	0	0	0	0	0

The CRT displays the octal equivalent of the status byte binary number:

“SRQ 140”

The octal equivalent is based on the whole binary number:

$$01100000 \text{ (binary)} = 140 \text{ (octal)}$$

One simple way to determine the octal equivalent of the binary number is to partition the binary number 3 bits at a time from the least significant bit, and treat each part as a single binary number:

binary	0 1	1 0 0	0 0 0
octal	1	4	0

The decimal equivalent of the octal number is determined as follows: $140 \text{ (octal)} = 1 \cdot (8) + 4 \cdot (8) + 0 \cdot (8) = 96 \text{ (decimal)}$.

More than one service request can be sent at the same time. For example, if an illegal analyzer command and the end of a sweep occurred at the same time, “SRQ 144” appears on the CRT display.

bit number	7 6	5 4 3	2 1 0	= “SRQ 144”
status byte	0 1	1 0 0	1 0 0	
octal value	1	4	4	

Note if bit 1 is set, it has one of three meanings, depending on how SRQ 102 was activated. These meanings are explained in the following section.

SERVICE REQUEST ACTIVATING COMMANDS

Service requests do not occur unless the appropriate activating command has been given, except for two service requests: illegal command, SRQ 140, and [SHIFT r] command, SRQ 102 (local operation only). The following chart summarizes the service request activating commands.

Message	SRQ Activating Command	SRQ(s) Allowed	Cancelled By	Comments
Illegal Command	R1	140 only	None	Always activated, R1 disables all SRQ's but SRQ 140.
End of Sweep	R2	104 & 140	R1	Also gives SRQ on completion of CAL routine, video averaging, preselector peak, and auto-zoom.
Hardware Broken	R3 & IP	110 & 140	R1	
Units Key Pressed	R4	102 & 140	R1, pressing units key, or whenever SRQ is cleared.	R4 must be reactivated whenever it is used.
Front Panel SRQ shift r	Local Operation	102, 140	Remote Operation	Always activated when in local (manual) operation.

Note that R2, R3, and R4 can be activated simultaneously, allowing all the SRQ's.

Examples

This program interprets the SRQ status byte and prints its message

```

10  OUTPUT 718;"R1;R3;R4;"
20  ON INTR 7 GOSUB Interpret-srq
30  ENABLE INTR 7;2
40  PRINT "Push Hz key on analyzer."
50  PRINT "Press S on controller to stop program. '*
60  !
70  Idle:REPEAT
80      ON KBD ALL GOSUB Stop
90      UNTIL Idle
100 Stop:OUTPUT 718;"R1;"
110 STOP
120 !
130 Interpret-srq:OFF INTR 7
140  Status_byte=SPOLL (718)
150  IF BIT(Status_byte,3)=1 THEN PRINT "HARDWARE BROKEN'
160  IF BIT(Status_byte,1)=1 THEN PRINT "UNITS KEY PRESSED'
170  WAIT .1
180  ON INTR 7 GOSUB Interpret-srq
190  OUTPUT 718;"R4;"
200  RETURN
210  END

```

Line 10: Enables all but the end of sweep SRQ. R1 clears former SRQ commands.

Line 20: Executes the "Interpret__srq" subroutine when an interrupt at select code 7 occurs.

Line 30: Enables the controller interrupt capability.

Lines 70 to 100: Any main program. These lines form a program loop that is interrupted when the analyzer requests service.

Lines 130 to 200:	The "Interpret__srq" subroutine.
Line 130:	Turns off further interrupts from the HP-IB. This prevents the cascading of interrupts generated by another service request from the analyzer.
Line 140:	Assigns the status byte to the variable "Status__byte". This clears the analyzer's SRQ (i.e., the status byte is reset).
Lines 150 to 160:	Compares the status byte to two analyzer SRQ codes, and prints the name of the SRQ.
Line 180:	Turns on the controller interrupt capability.
Line 190:	Re-enables the units-key-pressed SRQ.
Line 200:	Returns program execution to the main program.

In the following program, the analyzer sweeps to measure a signal. The controller continues to run its main program while the analyzer sweeps. An end-of-sweep service request **tells** the controller when the sweep is completed. The controller then re-addresses the analyzer and records the measurement data. This procedure ensures that test data is complete, and improves program execution speed when slow sweeps are used.

```

10  OPTION BASE 1
20  ON INTR 7 GOSUB Record-data
30  ENABLE INTR 7;2
40  !
50  OUTPUT 718;"IP;S2;FA1MZ;FB150MZ;"
60  OUTPUT 718;"ST3SC;R2;TS";
70  BEEP
80  !
90  Idle: REPEAT
100 PRINT "WORKING! "
110   Idle=Idle+1
120   WAIT 1
130 UNTIL Idle=7
140 PRINT "DONE"
150 BEEP
160 STOP
170 !
180 Record-data:OFF INTR 7
190 OUTPUT 718;"R1;"
200   Is_data_ready=SPOLL(718)
210   IF BIT(Is_data_ready,2)=1 THEN
220     OUTPUT 718;"E1;03;MF;"
230     ENTER 718;Freq
240     OUTPUT 718;"MA;"
250     ENTER 718;Ampl
260     PRINT "FREQUENCY = ";Freq;"Hz"
270     PRINT "AMPLITUDE = ";Ampl;"dBm"
280   ELSE
290     PRINT " Illegal analyzer command?*"
300   BEEP
310   END IF
320   RETURN
330   !
340   END

```

Lines 20 and 30:	Executes the "Record_data" subroutine when an interrupt at select code 7 occurs. Enables interrupts from the HP-IB interface card.
Lines 50 and 60:	Sets the analyzer for the measurement. The TS command (take sweep) is the last command sent to the analyzer, and the controller CR/LF is suppressed with a semicolon terminator. This is necessary; otherwise, the next program line is not executed until the sweep is complete. (Refer to the description of the TS mnemonic for a detailed explanation of line 60.)
Lines 90 to 150:	Any main program.
Line 180:	"Record-data" subroutine. Turns off interrupts from the HP-IB. This prevents interrupts from cascading.
Line 190:	Clears the end-of-sweep SRQ. This prevents the SRQ from interrupting the program at the next sweep.
Line 200:	Reads the status byte and clears the SRQ.
Line 210 to 310:	Record data if end-of-sweep SRQ was sent.
Line 320:	Returns program execution to the main program.

The following program signals the controller when an operator has completed a data entry. With this information, the controller can read the data entry or branch to a subprogram.

```

10  ENABLE INTR 7;2
20  ON INTR 7 GOSUB Read-entry
30  OUTPUT 718;"R1;R4;EE;"
40  PRINT "Enter center frequency on analyzer's keyboard.**
50  PRINT "Press S on controller to stop program."
60  !
70  Idle:REPEAT
80      ON KBD ALL GOSUB Stop
90  UNTIL Idle
100 Stop:OUTPUT 718;"R1;"
110  STOP
120  !
130 Read-entry:OFF INTR 7
140  Is_entry_ready=SPOLL(718)
150  IF BIT(Is_entry_ready,1)=1 THEN
160      OUTPUT 718;"OA;"
170      ENTER 718;Center_freq
180      PRINT "YOU ENTERED"; Center_freq; "Hz"
190      OUTPUT 718;"R4;EE;"
200      ON INTR 7 GOSUB Read-entry
210  ELSE
220      PRINT "ILLEGAL ANALYZER COMMAND?"
230      BEEP
240  END IF
250  RETURN
260  END

```



Lines 10 and 20:	Executes the “Read-entry” subroutine when an interrupt at select code 7 occurs. Enables interrupts from the HP-IB interface card.
Lines 70 to 90:	Any main program.
Line 100:	Disables the R4 service request.
Lines 130 to ZOO:	Forms a subroutine that records the operator’s entry.
Line 130:	Turns off interrupts from the HP-IB interface.
Line 140:	Clears the end-of-sweep SRQ and reads the status byte.
Line 150:	Checks the status byte to verify that the interrupt was caused by the units-key-pressed SRQ. If this is not the case, the program continues at line 220.
Lines 160 to 180:	Reads the operator’s entry and displays it.
Lines 200 and 210:	Re-enables operator entry, units-key-pressed SRQ, and the controller interrupt capability.
Lines 220 to 250:	Notifies the operator if the illegal analyzer command SRQ triggered the interrupt.

SERVICE REQUEST FROM THE FRONT PANEL

When the spectrum analyzer is in local operation mode (unaddressed), the operator can call for service from a controller by pressing front panel key [SHIFT r]. This front panel request for service sends SRQ 102, the units-key-pressed SRQ. The SRQ command, R4, need not be enabled in order to use the front panel service request.

Example

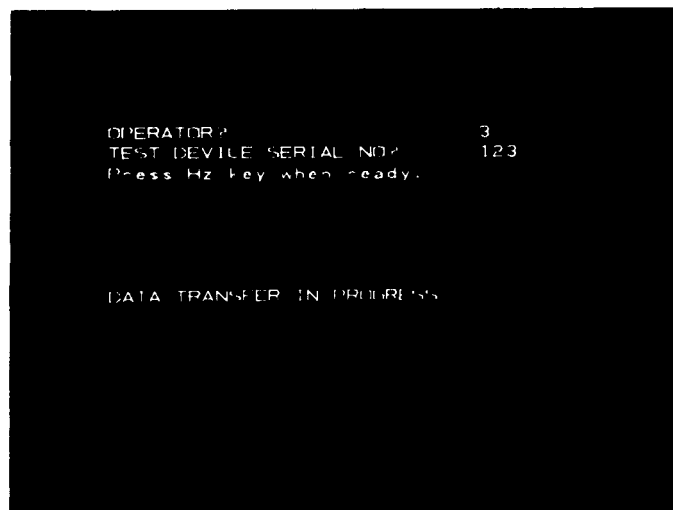
The front panel service request can summon a controller for assistance. The following example shows one way to do this. During the data transfer, beginning at line 430, the CRT display appears as shown below, with the “DATA TRANSFER” message blinking.



Several analyzers, each with a different HP-IB address, can call for individual service. This requires serial polling at the beginning of the service subroutine.

```

10  DIM A(1001)
20  DIM A$(20)
30  ENABLE INTR 7;2
40  PRINT "Pressing S on the controller stops program when data is received."
50  LOCAL 718
60  !
70  Idle:REPEAT
80      ON INTR 7 GOSUB Which-inst
90      ON KBD ALL GOSUB Stop
100  UNTIL Idle
110 Stop:STOP
120  !
130 !*****
140 Which_inst:OFF INTR 7
150 !*****
160 Analyzer_a=SPOLL(718)
170 IF BIT(Analyzer_a,1)>0 THEN
180     GOSUB Record_data
190 END IF
200 RETURN
210 !
220 !*****
230 Record_data: !
240 !*****
250 OUTPUT 718;"SV1;EM;O1;KSm;KSo;A4;DT:"
260 OUTPUT 718;"D3;PU;PA64,544;LBOPERATOR NO.?:"
270 REPEAT
280     OUTPUT 718;"EE;OA;"
290     ENTER 718;Operator
300 UNTIL Operator>0
310 OUTPUT 718;"D3PU;PA512,544;LB";Operator;":"
320 !
330 OUTPUT 718;"D3PU;PA64,512;LBTEST DEVICE SERIAL NO?:"
340 OUTPUT 718;"D3 PU;PA64,490;LBPress Hz key when ready.:"
350 OUTPUT 718;"R1;R4;EE;"
360 REPEAT
370     Hz_key_pressed=SPOLL(718)
380 UNTIL BIT(Hz_key_pressed,1)>0
390 OUTPUT 718;"OA"
400 ENTER 718;Serial_number
410 OUTPUT 718;"PU;PA512,512;LB";Serial_number;":"
420 !
430 OUTPUT 718 USING "K,B,K,B,B";PU;PA64,312;LB";17;"DATA TRANSFER IN
PROGRESS";18;3
440 OUTPUT 718;"TB;"
450 FOR N=1 TO 1001
460     ENTER 718;A(N)
470 NEXT N
480 OUTPUT 718;"EM;RC1;KSn;KSp;HD;"
490 LOCAL 718
500 RETURN
510 END

```

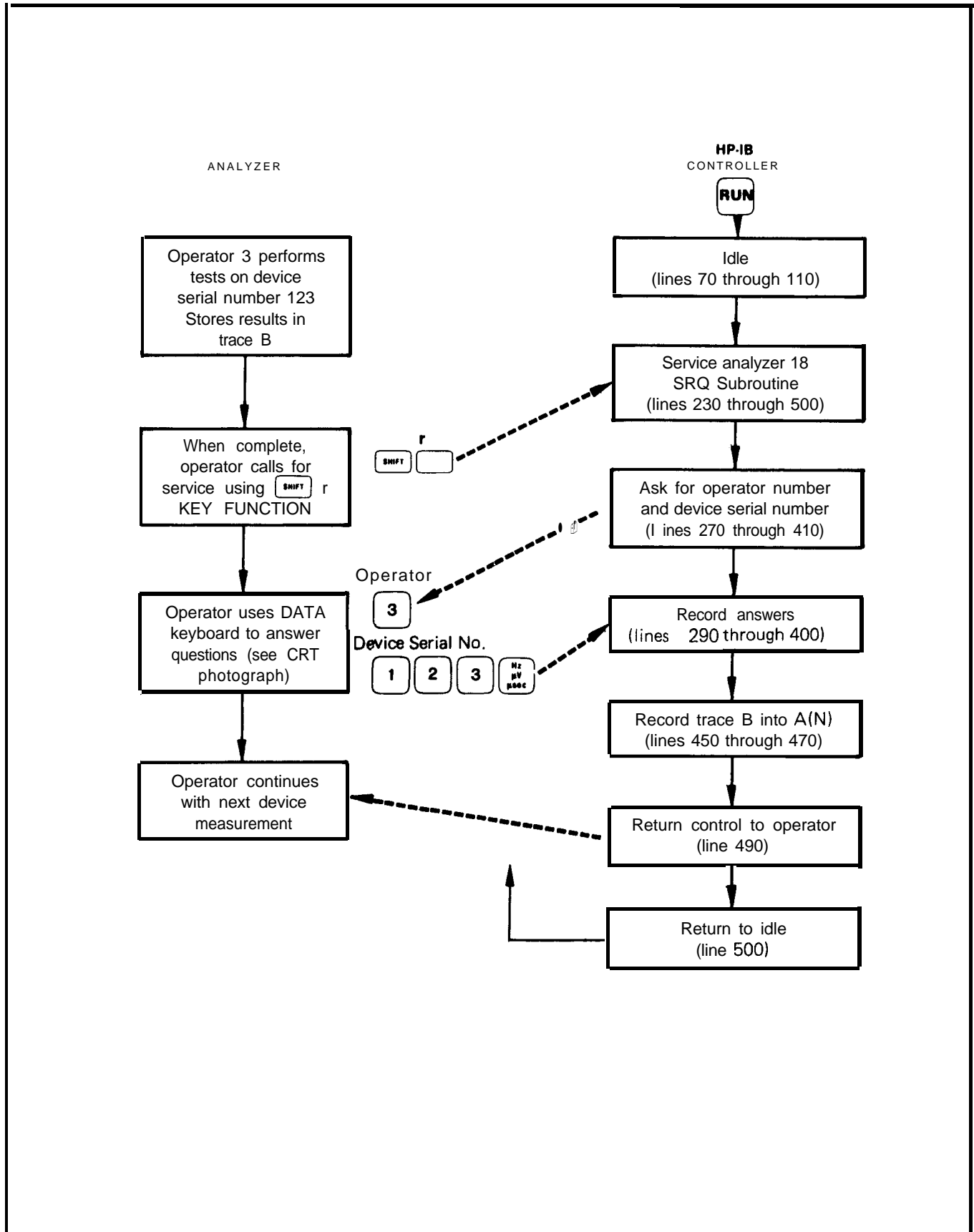

Appendix E

FAST REMOTE OPERATION (KSS AND KST)

This section describes the execution time reduction for commonly used commands that involve sweeping, tuning, or active functions (for example — TS, CF, or EI).

NORMAL OPERATION

During normal operation, the analyzer repeats a specific cycle of operations each time it sweeps. If a single sweep mode command (**S2** or TS) is used, the following sequence of operations occurs once the trigger conditions are met:

1. Phase lock to the start frequency.
2. Begin and complete sweep.
3. Perform computations for the CRT annotations.
4. Write annotations on the CRT
5. Reset sweep ramp and phase lock to the start frequency.

The analyzer repeats this cycle each time a single sweep command is executed.

In most cases, the remote operation mode does not require operation 4, updating of CRT annotation; and until another single sweep command is executed, operation 5 is not needed either. Therefore, eliminating operations 4 and 5 does not sacrifice any information or accuracy. Depending on the current instrument state, eliminating operations 4 and 5 saves between 20 and several hundred milliseconds for each single sweep command execution. This is important, because the execution of subsequent analyzer commands must wait for the completion of the sweep cycle. Reducing the required sweep time and eliminating unnecessary operations significantly reduces the command execution time.

FAST OPERATION (**KSS**)

The KSS command saves execution time by eliminating operation 4, the internal CRT annotation routine, and operation 5, the second phase lock. KSS is activated with a controller, not from the front panel, and remains in effect until deactivated by **IP**, **LF**, **KSU**, **KST**, **RC**, or a local command such as BASIC command lcl. If a single sweep is executed when KSS is activated, only the first three operations of the sweep cycle are performed; the analyzer is left tuned to the stop frequency. While KSS is activated, the analyzer is in the single sweep mode; therefore, a new sweep does not begin until another single sweep command is given. When KSS is deactivated, the analyzer returns to the sweep mode that was in effect when KSS was activated.

Because KSS removes operation 4 and part of operation 5 from the sweep cycle, it reduces the execution time of commands involving a sweep cycle, tuning, or annotation. The following commands are some of those that execute faster with KSS: TS, CR, EI, RB, SF?

If a command does not require a sweep, or fetches information directly from the analyzer memory, its execution time is not affected by KSS. This kind of command includes OL, RC, R1, and KS94.

The following program illustrates how the KSS command saves time.

```

10  DIM A(100),B(100)
20  !
30  OUTPUT 718;"IP;SP1MZ;M2;S2;"
40  FOR N=1 TO 100
50    OUTPUT 718;"CF4GZ;TS;E1;MA;"
60    ENTER 718;A(N)
70    OUTPUT 718;"CF6GZ;TS;E1;MA;"
80    ENTER 718;B(N)
90  NEXT N
100 END

```

The program above stores the amplitude of the largest signal within a 1 MHz band centered about a frequency that alternates between 4 and 6 GHz. This program takes approximately 40 seconds to run. The program takes only 25 seconds to run if line 20 is changed to read as follows:

```
OUTPUT 718;"IP KSS SP1MZ MS S2"
```

When the program has finished running, the CRT display is as shown in the following illustration.

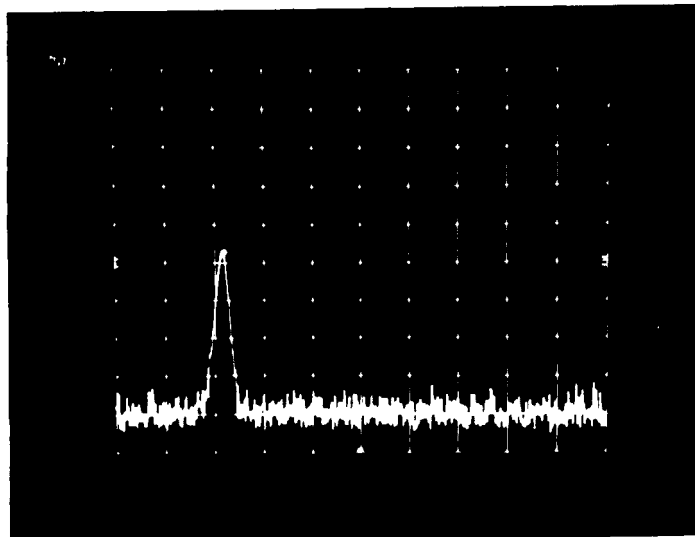

To deactivate KSS and leave the analyzer in the same state, execute this command:

OUTPUT 718;"RCØ"

NOTE

The Ø in "RCO" is a zero and not the letter O.

FAST PRESET (**KST**)

The instrument preset command, **IP**, initiates a cycle of operations similar to the five steps outlined before, but with the addition of an internal bus check. If this check detects any faults, one or both of the INSTR CHECK LEDs remain on. Fast preset is identical with instrument preset command **IP**, except that it does not perform the internal bus check. In practice, the instrument bus check routine is not needed every time the instrument is preset; therefore, the analyzer can be preset with the fast preset command, **KST**. **KST** takes approximately 0.2 seconds to execute; **IP** takes 0.8 seconds.

Appendix F TUNING CURVES

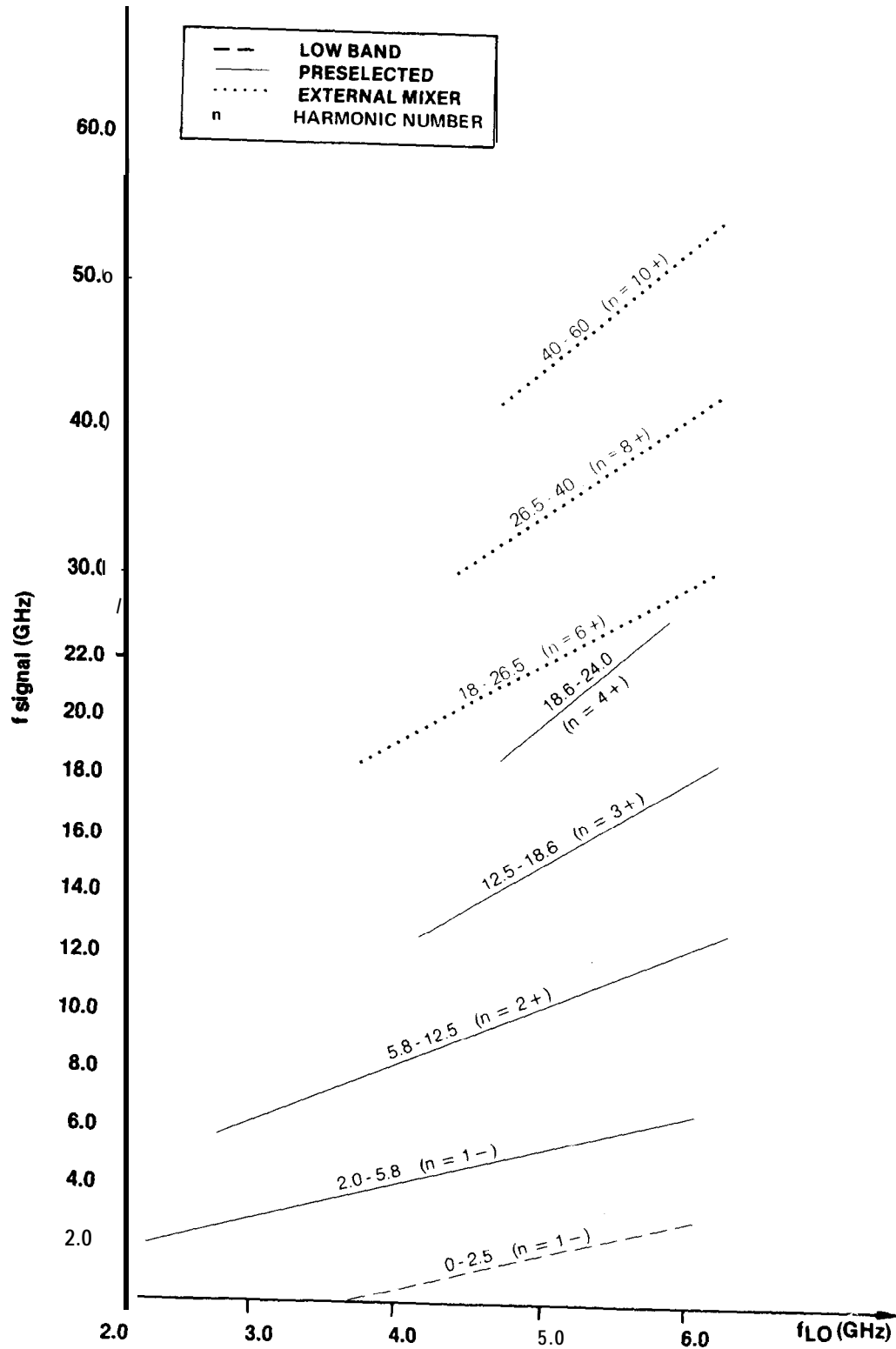

Appendix G CENTER FREQUENCY/SPAN TUNING CHARACTERISTICS

At the location of the band overlap (2.0–2.5 GHz) or on band edges (–1.0 GHz and 24 GHz), the frequency span may change as center frequency is tuned near the above locations. This situation occurs when the frequency span is such that the equivalent start/stop frequency exceeds the tuning range of the analyzer.

Example

Analyzer Settings: 0 – 2.5 GHz Band
 FREQUENCY SPAN = 1 GHz
 CENTER FREQUENCY = 2 GHz

Note that the equivalent start/stop frequencies are 1.5 GHz and 2.5 GHz.

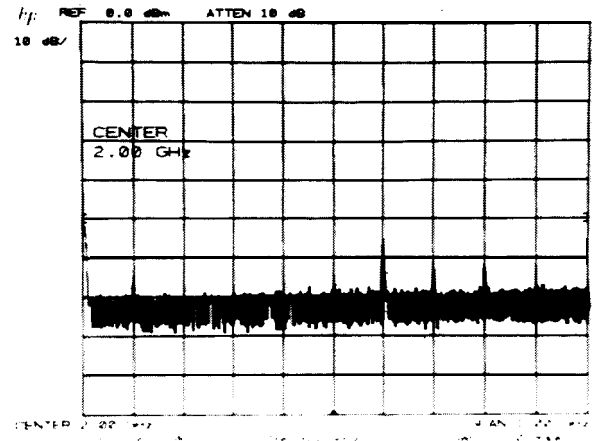

Now tune to 2.2 GHz.

CENTER FREQUENCY 2.2 GHz.

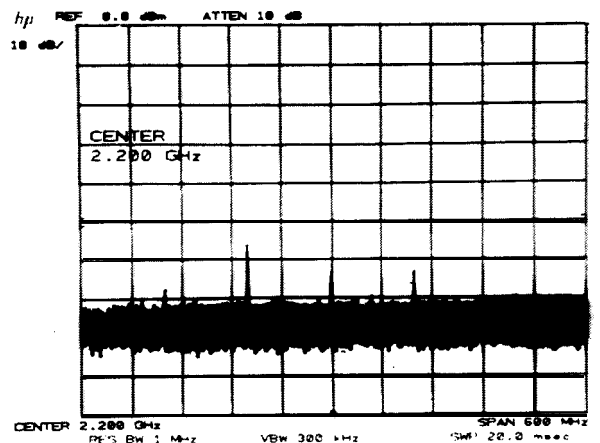

Since the maximum stop frequency in low band is 2.5 GHz, the analyzer will reduce the span by changing the START FREQ in order to enable the center frequency to be tuned to 2.2 GHz. Hence, the equivalent START/STOP FREQ is now 1.9 GHz/2.5 GHz, which yields a 600 MHz span. If the CENTER FREQUENCY is tuned to 2.25 GHz, the SPAN will be reduced to 500 MHz, a CENTER FREQUENCY greater than 2.25 GHz will automatically switch the analyzer to the microwave (2 – 22 GHz) band while maintaining a 500 MHz span.

The CENTER FREQUENCY/SPAN TUNING CHART below graphically illustrates the aforementioned tuning characteristics.

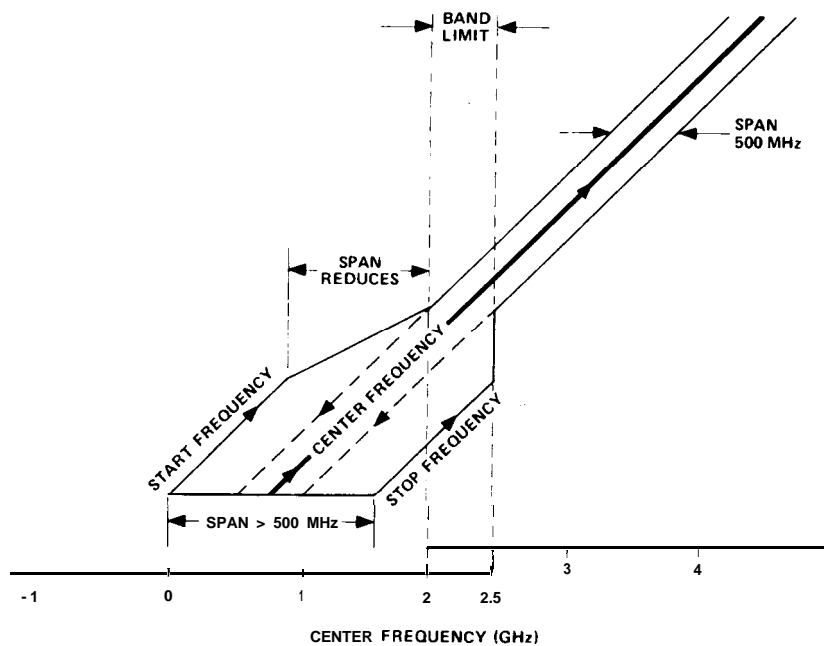

Appendix H 1ST LO OUTPUT

The 1st LO OUTPUT provides a nominal + 5 dBm signal that is tunable from 2.3214-6.1214 GHz. Since the HP 8566B is synthesized, the 1st LO can be used as a precise tunable microwave source.

Example

Using the 1st LO OUTPUT as a precision source; connect equipment as shown:

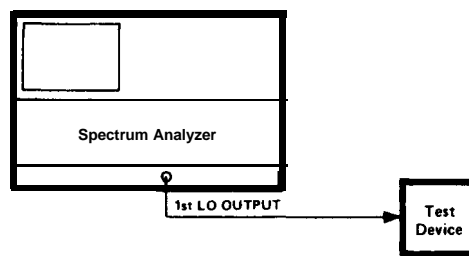

Instrument Preset: **3-32 GHz**

Select zero span with: **FREQUENCY SPAN 0** Hz

Offset IF with: **SHIFT 1** F. This removes the 321.4 MHz IF offset.

By pressing **CENTER FREQUENCY**, you now have a precision source that can be tuned from 2.3214-6.1214 GHz with 1 Hz resolution.

Example

Using the 1st LO OUTPUT as a tracking signal source from 2 – 5.8 GHz; connect equipment as shown:

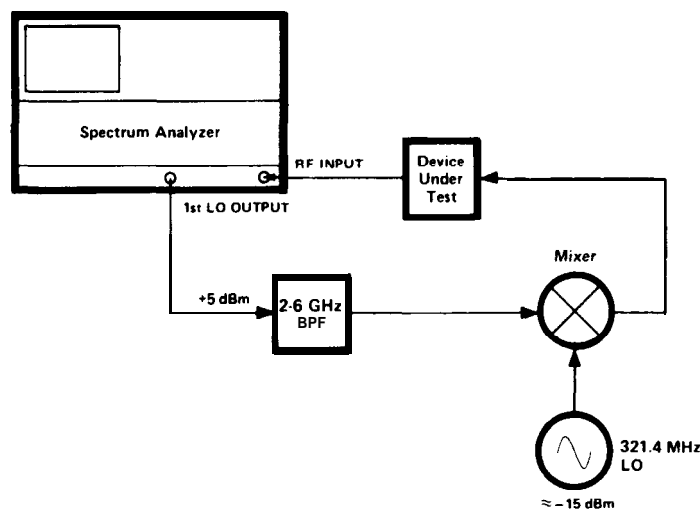

Instrument Preset: **3-32 GHz**

Set START/STOP FREQ: **START FREQ 2 GHz**, **STOP FREQ 5.8 GHz**.

The dynamic range will depend on the conversion loss and isolation characteristics of the mixer. Flatness variations can be normalized through trace arithmetic.

Appendix I

OPERATING DIFFERENCES

Because of the faster processing speed, the addition of new commands, the slight modification of some old commands, and the input buffering capability of the HP 8566B, there are a few minor operating differences between the HP 8566B and its predecessor, the HP 8566A. If you intend to use the HP 8566A and HP 8566B interchangeably, become familiar with the following differences.

EXPONENTIAL FORMAT

With the HP 8566B, any command that specifies the display address (e.g., DA, DR, DW), and which is given in the exponential format (i.e., with notation E1, E2, E3, etc.), executes its prescribed functions as described in this manual. The HP 8566A, however, interprets the exponential notation as an analyzer command. For example, the E1 notation is interpreted as a peak search command, the E2 notation as a marker-into-center-frequency command, etc.

RESETTING THE INPUT BUFFER AND INSTRUMENT PRESET

The HP 8566A does not have an input buffer, and the HP-IB can be reset with an interface clear (IFC). To reset the input buffer in the HP 8566B, use a device clear (CLEAR 718). This way, any commands in the input buffer of the HP 8566B are executed before instrument preset (IP) occurs. However, if device clear (CLEAR 718) is preceded by interface clear (ABORT 7), an instrument preset (IP) occurs and clears the input buffer immediately. Thus, all commands in the buffer are lost and not executed.

REMOTE INSTRUMENT PRESET

Execution of a remote Instrument Preset (IP) causes the HP 8566B merely to preset its controls. The same command causes the HP 8566A to preset its controls and run a check of its IO bus and memory.

RELOCK

In the HP 8566A, the local oscillator (LO) is phase-locked to the reference oscillator after every data entry. In the HP 8566B, the relock does not occur until the analyzer needs to relock for taking data readings. Because the relock occurs less often in the HP 8566B than in the HP 8566A, the HP 8566B operates faster than the HP 8566A.

TIMING

The HP 8566B processes data faster than the HP 8566A (see RELOCK, above). Therefore, if you attempt to use HP 8566A software with the HP 8566B, timing problems may occur.

ACTIVE FUNCTION

Occasionally, a two-letter command to the HP 8566B might not activate the specified function. The reason is that the command mnemonic has been interpreted by the analyzer as the first two letters of a longer command mnemonic that starts with the same two letters. For example, the command ST for Sweep Time could be interpreted by the analyzer as the first two letters of **STDEV**, the command for Standard Deviation. In this situation, the analyzer simply waits for another character before activating the function. To prevent this problem, insert a space or a terminator immediately after the two-letter command.

SWEEP + TUNEOUTPUT

The Tuning Algorithm in the HP 8566B causes large pulses to appear at the end of a sweep or at a band crossing. These pulses do not appear on the HP 8566A.

BAND CROSSING

In the HP 8566A, a band crossing can occur within the last ten display units of a sweep. In the HP 8566B, a band crossing cannot occur within the last ten display units of a sweep.

SOFTWARE INCOMPATIBILITY

If there are no spaces or semicolons between two-letter commands in HP 8566A software, **certain "A"** commands might be misinterpreted by the HP 8566B analyzers.

The following is a list of examples where "A" commands might be misinterpreted by the HP 8566B:

"A" SOFTWARE EXAMPLE	"B" MISINTERPRETATION
CTA1 (Couple Sweeptime, View Trace A)	CTA (Convert to dBm)
CTMT1 (Couple Sweeptime, Signal Track On)	CTM (Convert to Display Units)
DLE1 (Activate Display Line, Peak Search)	DLE (Enable Display Line)
GRAT (Graph, Set Attenuator)	GRAT (Gaticule on or off)
PDA4 (Pen Down, Blank Trace A)	PDA (Probability Distribution in Amplitude)
PDFA (Pen Down, Start Frequency)	PDF (Probability Distribution in Frequency)
THE1 (Activate Threshold, Peak Search)	THE (Enable Threshold)
VBOA (Activate Video Bandwidth, Output Active Function)	VBO (Set Video Bandwidth and Resolution Bandwidth Ratio)

Examples that are least likely to occur are **GRAT**, PDA4, and PDFA because, in these sets of commands, the second command will not typically follow the first command. However, all examples have the potential to cause problems, because they don't follow "**B**" syntax requirements. The HP 8566B interprets "A" software written like the above examples as invalid commands. As a result, the commands are not executed and an HP-IB command error should appear on the analyzer CRT. Fortunately, this command error can be used as a method of finding software errors.

Appendix J

EQUIVALENT HP 8566B AND 8566A COMMANDS

The following list shows combinations of 8566B commands and secondary keywords that are equivalent to other 8566B commands common to the HP 8566A. The commands are interchangeable when programming the 8566B.

Alphabetical Listing of 8566B Commands	Equivalent Commands Common to the 8566A	Alphabetical Listing of 8566B Commands	Equivalent Command5 Common to the 8566A
AMB ON	c 2	MKNOISE OFF	KSL
AMB Off	C1	MKPK	E1
ANNOT ON	KSp	MKPK HI	E1
ANNOT OFF	KSo	MKPK NH	KSK
APB	KSc	MKRL	E4
AUNITS DBM	KSA	MKSP	KSO
AUNITS DBMV	KSB	MKSS	E3
AUNITS DBUV	KSC	MKSTOP	KSu
AUNITS V	KSD	MKTRACK ON	MT1
AXB	EX	MKTRACK OFF	MT0
BLANK TRA	A4	ML	KS,
BLANK TRB	B4	MOV TRC, TRB	KSI
BLANKTRC	KSk	MXMH TRA	A2
BML	BL	MXMH TRB	B2
BTC	KSI	RCLS	RC
BXC	KSi	ROFFSET	KSZ
CLRW TRA	A1	SAVES	s v
CLRW TRB	B1	SIGID	KSv
CONTS	S1	SNGLS	S2
DET NRM	KSa	TDF M	O1
DET SMP	KSe	TDF P	0 3
DET POS	K Sb	TDF B	02 or 04
DET NEG	K Sd	THE ON	TH
DLE OFF	L0	THE OFF	TO
EXTMXR	KSU	TM FREE	T1
FOFFSET	KSV	TM LINE	T2
GRAT ON	KSn	TM EXT	T3
GRAT OFF	KSm	TM VID	T4
HNLOCK	KSt	VAVG	KSG
HNUNLK	KSQ	VAVG ON	KSG
MKA?	MA	VAVG OFF	KSH
MKCF	E2	VIEW TRA	A3
MKD	M3	VIEW TRB	B3
MKF?	MF	VIEW TRC	KSj
MKMIN	KSN	XCH TRA, TRB	EX
MKN	M2	XCH TRB, TRC	KS i
MKNOISE ON	KSM		

Alphabetical Listing of Commands Common to the 8566A	Equivalent 8566B Command	Alphabetical Listing of Commands Common to the 8566A	Equivalent 8566B Command
A1	CLRWTRA	KSd	DETNEG
A2	MXMH TRA	KSe	DETSMP
A3	VIEWTRA	KSj	XCHTRB, TRCorBXC
A4	BLANKTRA	KSj	VIEWTRC
B1	CLRWTRB	KSj	BLANKTRC
B2	MXMHTRB	KSj	BTC or MOV TRC, TRE
B3	VIEWTRB	KSj	GRATOFF
B4	BLANKTRB	KSj	GRATON
BL	BML	KSj	ANNOTOFF
C1	AMBOFF	KSj	ANNOTON
C2	AMBON	KSj	HNLOCK
EX	XCHTRA, TRB or AXB	KSj	MKSTOP
E1	MKPK or MKPK HI	KSj	SIGID
E2	MKCF	KSj	ML
E3	MKSS	KSj	DLEOFF
E4	MKRL	KSj	MKA?
KSA	AUNITSDBM	KSj	MKF?
KSB	AJNITSDBMV	KSj	MKTRACKOFF
KSC	AUNITSDBUV	KSj	MKTRACKON
KSD	AUNITS V	KSj	MKN
KSG	VAVG or VAVG ON	KSj	MKD
KSH	VAVGOFF	KSj	TDFM
KSK	MKPKNH	KSj	TDFP
KSL	MKNOISEOFF	KSj	TDFB
KSM	MKNOISEON	KSj	RCLS
KSN	MKMIN	KSj	CONTS
KSO	MKSP	KSj	SNGLS
KSQ	HNUNLK	KSj	SAVES
KSU	EXTMXR	KSj	THE ON
KSV	FOFFSET	KSj	THE OFF
KSZ	ROFFSET	KSj	TMFREE
KSa	DETNRM	KSj	TMLINE
KSb	DETPOS	KSj	TMEXT
KSc	APB	KSj	TMVID

Section IV

INDEX

INDEX

A

A – B → A, **40, 41**
A – B → A OFF, **40**
A + B → A (KSc), **97**
A ⇌ B, **39**
Active function, 30
ADD, 24 – 25
Addressing the spectrum analyzer, 5
Advanced display programming, App B
ALIGN, 29
Alphabetical **keycode** summary, 90
AMB, 26
AMBPL, 27
Amplitude calibration, 3
Amplitude offset (KSZ), **91**
Amplitude units (KSA, KSB, KSC, KSD), **93**
AMPTD CAL, **3, 4**
ANNOT, 28
Annotation off/on (KSo,KSp), 96
APB, 29
AT, 30
Attenuation (ATTEN), 74 – 76
AUNITS, 31
AUTO (coupled functions), 69
Automatic spectrum analyzer, 14
Automatic zoom, 51
(see **also** zoom to marker)
AVG, 32 – 33
AXB, 34
A1, 35
A2, 36
A3, **37**
A4, **38**

B

BACKSPACE, 17
Band lock (KSQ, KSt), 106
Baseline clipper (see **also** Threshold), 66
B – DL → B, **40, 41**
BL, 39
BLANK, **36, 40**
Blank annotation (KSo), **96**
Blank display(CRT) (KSg), **96**
Blank graticule (KSm), **96**
Blank output, 6
Blue front panel characters, 89
BML, 41
BRD, 42
BTC, 43

BWR, 44
BXC, 45
B1, 46
B2, **47**
B3, **48**
B4, **49**

C

C (TRACE) (see also Trace C modes), 99, 103
CA, 50
CAL OUTPUT 3
Calibration procedures, **3, 4**, 104
CENTER FREQUENCY 12, 20
Center frequency/span tuning characteristics, App. G
Center frequency step size (CF STEP SIZE), 76
CF, 51
CLEAR-WRITE, 36
CLRAVG, 52
CLRW, 53
CNVLOSS, 54
Command **list**
 enter, 109
 execute, 110
Command statement elements, 19 – 2 1
COMPRESS, 55 – 56
CONCAT, 57
Continuous sweep (**CONT**), **79, 80**
Controller, **112, 4**
CONTS, 58
CORR'D, 4,104
Correction data (KSX, KSY), 104
Correction data displayed (**KSw**), **96, 104**
Coupled functions (see **also** specific functions), 69-70
CR, 59
CRT, 29
CRT display, **4,29**
CRT adjustments, 29
CRT beam off/on (**KSG, KSh**), 96
CRT photography,31
CRT refresh rate, 36
CS, 60
CT, 61
CTA, 62
CTM, 63
Custom **softkey** functions, 9
CV, 64
C1, 65
C2, **66**

NOTE: Page numbers in regular typeface refer to Section I, Manual Operation. Page numbers in bold typeface refer to Section II, Programming.

D

DA, 67

Data

CONTROLS, 15, 16

entries, 16, 17

entry, via HP-IB, 8

entry, via front panel, under remote control, 9

entry, terminating, 8 – 9

keys, 11, 16

knob, 11, 12, 15, 16

number/units keyboard, 11, 15, 17

step keys, 11, 12, 15, 16

dBm (KSA), 93

dBmV (KSB), 93

dB μ V (KSC), 93

DC precaution, 3

DD, 68-69

Deactivate function (HOLD), 16

DET, 70

Detection modes (**KSa**, **KSb**, **KSc**, **KSd**), 97

Diagnostic aids, 107

Differential (DELTA) marker, 13, 46

Display correction data (**KSw**), 96

Display, CRT, 4

DISPLAY LINE, 41, 64 – 65

Display memory structure, App. A

Display outputs, 6

Display unit, 32

Display terms, 32

Display titling (**KSE**), 97

DISPOSE, 71 – 72

DIV, 73 - 74

DL, 75 – 76

DLE, 77

DONE, 78

DR, 79

DSPLY, 80

DT, 81

DW, 82

D1, **D2**, **D3**, 83 – 88

E

EE, 89-91

Effective mixer level (**KS**);, 93

EK, 92

Element, 32

ELSE, IF THEN, **ENDIF**, 93 – 94

EM, 95

Enabled LED, 16

ENDIF, IF THEN ELSE, 96 – 97

Entering a command list, 109

Equivalent HP 8566B and HP 8566A commands,
App. J

Error correction routine (**KSW**), 4, 104 – 105

EX, 99

Excessive input power, 3

Exchange trace B and C (**KSi**), 100

Executing a **softkey**, 110

Executing plotter output, 111

EXP, 100

Extend reference level (**KSI**), 94

External frequency reference, 8

External mixer, 106

External trigger (**EXT**), 80, 103

External trigger input, 9

EXTMXR, 101 – 102

EI, 103

E2, 104

E3, 105

E4, 106

F

FA, 107

Factory preselector setting (**KS** =), 94

Fast HP-IB (**KSS**), 106

Fast preset (**KST**), 106

Fast remote operation, App. E

FB, 108

FFT, 109 – 113

Fit LO output, App. H

Focus, 29

FOFFSET, 114

Format statements, **O1**, **O2**, **O3**, **O4**, 115 – 118

FPKA, 119

FREE RUN (trigger), 79, 80

Freq reference input/output, 8

Frequency calibration, 3, 4

Frequency drift compensation (SIGNAL TRACK), 56

Frequency offset (**KSV**), 91

Frequency response measurement (example), 40 – 41

FREQUENCY SPAN, 12, 21 – 24

FREQ ZERO, 3

Front panel data entry under remote control, 9

Front panel overview, 5, 11

FS, 120

FULBAND, 12 1

FULL SPAN, 11

0 – 2.5 GHz, 12, 85

2 – 22 GHz, 12, 83 – 85

FUNCDEE 122

NOTE: Page numbers in regular typeface refer to Section I, Manual Operation. Page numbers in bold typeface refer to Section II, Programming.

Functional index, 11 – 18
FUNCTION keys, 11, 19
Function summary, 90
Function/data summary, 27

G

General Information, 1
GR, 123
GRAT, 124
Graticule, 31
 off/on (**KSm, KSn**), 96

H

Harmonic distortion (example), 47
Hewlett-Packard Interface Bus (HP-IB), 8, 14
 Fast HP-IB (**KSS**), 106
 via, data entry, 8
HD, 125
HNLOCK, 126 – 127
HNUNLK, 128
HOLD, 16

IB, 129
ID, 130
IDSTAT, 131
IF input connector, 8, 9
IF output connector, 8, 9
IF output, 21.4 MHz, 7
IF THEN ELSE **ENDIF, 132 – 133**
Ineterrupt, App. D
Input attenuation, 74 – 76
Input CRT **labels** and graphics, 4
Input mixer level (**KS**), 93
INPUT, RF, 3, 7
Internal frequency reference, 8
INSTR CHECK, 2
INSTRUMENT PRESET, 12, 83
INSTRUMENT STATE, 83
 FULL SPAN, 0 – 2.5 **GHz**, 85
 INSTRUMENT PRESET, 83
 LOCAL OPERATION (LCL), 87
 SAVE and RECALL, 85 – 86
IP, 134 – 135
Intensity, CRT 29

K

KEYDEF, 136 – 137
Key definition, 109
KEYEXC, 138
Knob, 11 – 13, 15 – 16
KSA (amplitude in **dBm**), 93, 139
KSa (normal detection), 97, 166
KSB (amplitude in **dBmv**), 93, 140
KSb (positive peak detection), 97, 167
KSC (amplitude in **dBuv**), 93, 141
KSc (A + B → A), 97, 168
KSD (amplitude in voltage), 93, 142
KSD (negative peak detection), 97, 169
KSE (title mode), 97, 143 – 144
KSe (sample detection), 97, 170
KSF (remove IF offset for YTO preset), 145, App. H
KSf (power on in last state), 85, 171
KSG (video averaging on), 101, 146
KSg (CRT beam off), 96, 172
KSH (video averaging off), 101, 147
KSh (CRT beam on), 101, 178
KSI (extended reference level range), 75, 94, 148
KSi (exchange traces B and C), 40, 100, 174
KSJ (manual **DACs** control), 107, 149
KSj (view trace C), 40, 99, 175 – 176
KSK, 53, 95, 150
KSk, 177
KSL (noise level off), 58 – 60, 151
KSI (B → C), 40, 99, 178
KSM (noise level on), 58 – 60, 152
KSm (graticule blanked), 96, 179
KSN (marker to minimum), 95, 153
KSn (**graticule** on), 96, 180
KSO (enter A → span), 53, 154
KSo (annotation blanked), 96, 181
KSP (set HP-IB address), 155
KSp (annotation on), 96, 182
KSQ (band unlock), 106, 156
KSq (disable step gain), 107, 183
KSR (frequency diagnostic on), 106, 107, 157
KSr (HP-IB service request), 184
KSS (fast HP-IB operation), 106, 158, App. E
KST (fast preset 2 – 22 **GHz**), 106, 159
KSt (band lock), 106, 185
KSU (fast preset external mixer), 106, 160
KSu (stop single sweep at marker), 95, 186
KSV (frequency offset), 91, 161
Ksv (signal identifier external mixer), 106, 187
KSW (execute error correction routine), 104, 162
KSw (display correction data), 96, 107, 188 – 189
KSX (use correction data), 104, 163

NOTE: Page numbers in regular typeface refer to Section I, Manual Operation. Page numbers in bold typeface refer to Section II, Programming.

KSx (remove external trigger automatic refresh), 80,
 103, 190
KSY (do not use correction data), 104, 164
KSy (remove video trigger automatic refresh), 80, 103,
 191
KSZ (amplitude offset), 91, 165
KSz (display address), 192
KS- (negative data entry), 91
KS = (factory preselector setting), **58, 94**, 194
KS/ (manual preselector setting), **58, 94**, 199
KS((lock SAVE registers), 103, 195
KS) (unlock SAVE registers), 103, 196
KSI, 197
KS, (mixer level), 93, 193
KS# (turn off YTX self-heating correction), 107, 198
KS39, **200** – 201
KS43, **202**
KS91, **203**
KS94, **205**
KS123, **206** – 207
KS125, **208** – 209
KS126, **210**
KS127, **211**

L

LB, 212-215
 Learn string content, App. C
LF, **216**
LG, 217
 Linear scale (LIN), **63**
 LINE TRIGGER, 79
LL, 218
LN, 219
 Local operation (LCL), **87, 6** – 7
 Lock SAVE registers (**KS()**), 103
LOG, 61, 220 – 221
LØ, 222

M

MA, 223
 Manual calibration procedure, 3
MARKER, **13, 43, 44**
 active, 43
 differential (DELTA), 46 – 48
 entry, 53 – 56
 in view, 44
 to center frequency (MKR → CF), 53
 to step size (MKR → STEP SIZE), 53
 to minimum (KSN), **95**

 to next peak (**KSK**), 95
 noise level measurement, 58 – 60
NORMAL, 44 – 45
OFF, **44**
 on, 44
PEAK SEARCH, 52 – 53
PRESEL PEAK, 57 – 58
 readout, 13
 to reference level (MKR → REF LVL), 53
SIGNAL TRACK, 56 – 57
 stop sweep (**KSu**), 95
ZOOM, 48 – 51
 zoom, **automatic**, 51 – 52
 Marker sweeps, 95
MAX HOLD, 36
MBRD, 224
MBWR, 225
MDS, 226
MDU, 227
MEAN, 228
MEM, 229
MF, 230
MIN, 231
 Mixer level, 93
MKA, **232**
MKACT, **233**
MKCF, **234**
MKCONT, **235**
MKD, 236 – 237
MKF, **238**
MKMIN, 239
MKN, 240
MKNOISE, 241
MKOFF, **242**
MKP, **243**
MKPAUSE, 244
MKPK, 245
MKPX, **246**
MKREAD, 247
MKRL, 248
MKSP, 249
MKSS, **250**
MKSTOP, 251
MKTRACE, 252
MKTRACK, 253
MKTYPE, 254
ML, 255
MOV, 256
MPY, 257 – 258
MRD, 259
MRDB, 260
MTØ, 261

NOTE: Page numbers in regular typeface refer to Section I, Manual Operation. Page numbers in bold typeface refer to Section II, Programming.

MT1, 262
MWR, 263
MWRB, 264
MXM, 265 – 266
MXMH, 267
M1, 268
M2, 269
M3, **270** – 271
M4, **272**

N

Negative data entry (KS-), 17, 91
Negative peak detection (**KSd**), **97**
Noise level measurements (KSM, KSL), **58**
NORMAL
 shift key function, 89
 MARKER, **13, 44**
NSTART, 273
NSTOP, 274

O

Offsets
 amplitude (KSZ), 91
 frequency (KSV), **91**
 function, **91 – 93**
OL, 275
ONEOS, 276
ONSWP, 277
OP, 278
Operating differences, App. I
Operating precautions, **2,3**
OT, 279 – 280
outputs
 blank, 6
 display (x, y, and z), 6
 HP-IB, 8
 PENLIFT, 7
 plotter, 4
 rear panel, 6
 RECORDER, 6
 SWEEP 7
 SWEEP + TUNE **OUT**, 7
 VIDEO, **7, 9**
 10 MHz, 7
 21.4 MHz IF Output, 7
Output amplitude and value, 3
O1, O2, O3, O4, Format statements, **281 – 284**

P

PA, 285
PD, 286
PDA, 287
PDF, 288
Peak detection modes (**KSa, KSb**), **97 – 99**
PEAKS, 289 – 290
PEAK SEARCH, 52
Performance, 1
PLOT 291
Plotter addresses, 112
Plotter output, 4, 111 – 112
Plotter pens, 112
Positive peak detection (**KSb**), **97**
Power ON, 2
PP, 292
PR, 293
Preselector
 factory setting (KS =), **94**
 PEAK, **57, 94**
 tracking (KS/), 94
Programming commands, general information, 19
Programming, general information, 1
PS, 294
PU, 295
PWRBW, 296

Q

Quasi-Peak Adapter, 8

R

RB, 297
RC, 298
RCLS, 299
Readouts, 33 – 34
Rear panel
 connections, 1
 outputs, **6, 7**
RECALL INSTRUMENT STATE, 14
Recorder outputs, 6
REFERENCE LEVEL, **13, 25 – 26**
Reference level, extended range (KSI), **25 – 26, 94**
Reference lines, 64
 display line, 64
 threshold line, 66
Refresh display, 36
Remote operation, **14, 87, 6 – 7**

NOTE: Page numbers in regular typeface refer to Section I, Manual Operation. Page numbers in bold typeface refer to Section II, Programming.

Remote operation overview, 2 – 9
 Resolution bandwidth (RES BW) , 70 – 71
 REPEAT UNTIL, 300 – 301
 Resolution of markers, 44
 REV 302
 RF attenuation, 74
 RF INPUT, 37
 RL, 303
 RMS, 304
ROFFSET, 305
 RQS, 306
R1, 307
R2, **308**
R3, **309**
R4, **310**

S

Sample detection mode (**KSe**) , 97
 SAVE INSTRUMENT STATE, 14
 locking registers (KS ()), 103
 unlocking registers (KS)), 103
 SAVES, 311
 Scale, 61
 linear (LIN), 63
 logarithmic (LOG), 63
 Secondary keywords, 22 – 23
 Service requests, App. D
 SHIFT key, 14
 alphabetical key code summary, 90
 function index, 107
 functions, 89
 (see also specific shift key function or KS code)
 Shift function codes, 7
 SIGDEL, 312
 SIGID, 313
 SIGNAL TRACK, **51**, **56**
 SMOOTH, 314
 SNGLS, 313
Softkey functions, custom, 9
SP, **316**
 SPAN, **21** – 24
 SQR, 317
 SRQ, 318
 ss, 319
 ST, 320
STANDBY, 2
 START FREQUENCY; 24
STDEV, 321
 Step keys
 down, **11** – **13**, **15** – **16**
 up, **11** – **13**, **15** – **16**

Step size, center frequency, 76
 Step size, marker, 53
 STOP FREQUENCY 24
 Stop sweep at marker (**KSu**) , 95
 STORE modes, 36
 SUB, 322 – 323
 SUM, 324
SUMSQR, **325**
SV, 326
 SW, 327
 Sweep, **36**, **79** – 80
 continuous (CONT) , 80
 SINGLE, 80
 Sweep and trigger, 79
 Sweep time, 73
 SWEEP + TUNE OUT, 7
 Swept measurement (example), 40 – 41
S1, 328
S2, **329**

T

TA, 330 – 331
 TB, 332 – 333
 TDF, 334
 Terminating data entry, 8 – 9
 TEXT, 335
 TH, 336
 THE, 337
 THEN, **IF**, **ELSE ENDIF**, 338 – 339
 Threshold, **64**, **66** – 67
 Title mode (KSE), 97
 TM, 340
 Trace, 35
 A ⇌ B, 39
 A – B → A, 40, 41
 A – B → A OFF, 40
 A + B → A, 97
 arithmetic, 40 – 42
 BLANK, 35, 36, 37
 B – DL → B, 41
 C, modes (**KS_i**, **KS_j**, **KS_k**, **KS_l**), 40, 99 – 101, 103
 CLEAR-WRITE, 36, 37
 detection modes (**KS_a**, **KS_b**, **KS_c**, **KS_d**) , 97
 exchange trace A and B, 39
 exchange trace B and C (**KS_i**) , 100
 functions, 35
 identification, 35
 MAXHOLD, 36, 37
 memory, 37
 memory structure, 36
 modes, 36

NOTE: Page numbers in regular typeface refer to Section I, Manual Operation. Page numbers in bold typeface refer to Section II, Programming.

priority, 42
 store mode, 37 – 39
 transfer trace B to C (KSI), **99**
 VIEW, **35, 36, 37**
 write modes, **36, 37**
 Traces, **31 – 32**
TRDEF, 341
TRDSP, 342
 TRGRPH, 343
 Trigger, **79, 80 – 81**
 automatic, zero span, 80
 EXT (external), 80, 103
 FREE RUN, 79
 LINE, 79
 VIDEO, 79, 103
 VIDEO LEVEL, 81
 TRMATH, 344 – 345
TRPST, 346
 TRSTAT, 347
 TS, 348
 Tuning curves, App. F
 TWINDOW, 349
T0, 350
T1, 351
T2, **352**
T3, **353**
T4, **354**

U

Uncoupled functions, 13
 Units, 93
 (KSA, KSB, KSC, KSD)
 Unlock SAVE registers (KS), 103
 UNTIL, REPEAT 355 – 356
 UR, 357
 User-defined keys, 109
 USTATE, 358

V

VARDEE 359
 VARIANCE, 360
 VAVG, 361
 VB, 362
 VBO, 363
 Vector, 32
 Video
 averaging (**KSG, KSH**), **72, 101 – 103**
 bandwidth (VIDEO BW), **71 – 72**
 connectors, **8, 9**
 INP connector, 9
 OUT connector, 9
 trigger, 79, 103
 trigger level, 81
 VIEW, **36, 37, 364**
 Voltage scale (LINEAR), 63
Volts (KSD), 93

W

WRITE modes, 36

X

XCH, 365

Z

Zero frequency span, **23, 80**
 Zero span, automatic trigger, 80
 Zoom, automatic, zero span, **51, 52**
 Zoom to marker, 48

NOTE: Page numbers in regular typeface refer to Section I, Manual Operation. Page numbers in bold typeface refer to Section II, Programming.

HEWLETT-PACKARD SALES AND SERVICE OFFICES

To obtain servicing information or to order replacement parts, contact the nearest Hewlett-Packard Sales and Service Office listed in the HP Catalog, or contact the nearest regional office listed below:

IN THE UNITED STATES

CALIFORNIA
PO. Box 4230
1421 South Manhattan Avenue
Fullerton 9263 1

GEORGIA
P.O. Box 105005
2000 South Park Place
Atlanta 30339

ILLINOIS
5201 Tollview Drive
Rolling Meadows 60008

NEW JERSEY
W. 120 Century Road
Paramus 07652

IN CANADA

Hewlett-Packard (Canada) Ltd.
17500 South Service Road
Trans-Canada Highway
Kirkland, Quebec H9J 2M5

IN FRANCE

Hewlett-Packard France
F-91 947 Les Ulis Cedex
Orsay

IN GERMAN FEDERAL REPUBLIC

Hewlett-Packard GmbH
Vertriebszentrale Frankfurt
Berner Strasse 117
Postfach 560 140
D-6000 Frankfurt 56

IN GREAT BRITAIN

Hewlett-Packard Ltd.
King Street Lane
Winnersh, Wokingham
Berkshire RG 11 5AR

IN OTHER EUROPEAN COUNTRIES

SWITZERLAND
Hewlett-Packard (Schweiz) AG
29 Chemin Chateau Bloc
CH- 12 19 LeLignon-Geneva

IN ALL OTHER LOCATIONS

Hewlett-Packard Inter-Americas
3200 Hillview Avenue
Palo Alto, California 94304

