



HEWLETT
PACKARD

OPERATOR'S HANDBOOK

8566B SPECTRUM ANALYZER

Includes Options 010, 400, 908, and 913

SERIAL NUMBERS

This manual applies directly to Model 8566B RF Sections with serial numbers prefixed 2410A and IF-Display Sections with serial numbers prefixed 2403A.

Copyright © 1984, HEWLETT-PACKARD COMPANY.
1212 VALLEY HOUSE DRIVE
ROHNERT PARK, CALIFORNIA 94928, U.S.A.

MANUAL PART NO. 08566-90045

Microfiche No. 08566-90049

Printed: MARCH 1984



OPERATION VERIFICATION

8566B SPECTRUM ANALYZER

Includes Option 400

SERIAL NUMBERS

This manual applies directly to Model 8566B RF Sections with serial numbers prefixed 2410A and IF-Display Sections with serial numbers prefixed 2403A.

Copyright © 1984, HEWLETT-PACKARD COMPANY
1212 VALLEY HOUSE DRIVE
ROHNERT PARK, CALIFORNIA 94928, U.S.A.

HP Part Number	Description
08566-90078	Manual
08566-90083	Microfiche
08566-60008	Manual with discs

Printed: OCTOBER 1985

TABLE OF CONTENTS

Topic	Page
Introduction	1
Test System Configuration	4
Equipment Connections	4
Program Loading	6
Program Operation	7
HP-IB Addresses	8
Error Messages	9
Test Descriptions	9
1. Input Attenuator Switching Check	9
2. IF Gain Uncertainty	10
3. Scale Fidelity (Log)	10
4. Scale Fidelity (Linear)	11
5. Log Scale Switching Uncertainty	11
6. Resolution Bandwidths	12
7. Line Related Sidebands	13
8. Average Noise Level	13
9. Residual Responses	14
10. SWEEP + TUNE OUT Accuracy	15
11. Second Harmonic Distortion	16
12. Frequency Span Accuracy	16
13. Gain Compression	17
14. Frequency Response	17
15. Third Order Intermodulation Distortion	18
16. Calibrator Output Amplitude Accuracy	19
17. 1st LO Output Power	19

OPERATION VERIFICATION

INTRODUCTION

Operation Verification is an automatic performance test designed to give a high confidence level in the operation of the HP Model 8566B Spectrum Analyzer in a reasonable time. It performs 80% to 85% of the manual performance tests in approximately 60 minutes and is designed to test an instrument operating within a temperature range of 20° to 30° C. Refer to Table 1 for a list of tests performed.

Passing Operation Verification assures that the spectrum analyzer is performing within the specifications tested. Other results indicate the need to perform the related manual test located in the Tests and Adjustments Manual (HP part number 08566-90051).

Operation Verification can be used to test the majority of the manual performance tests for a performance verification. Listed in Table 2 are the tests not covered.

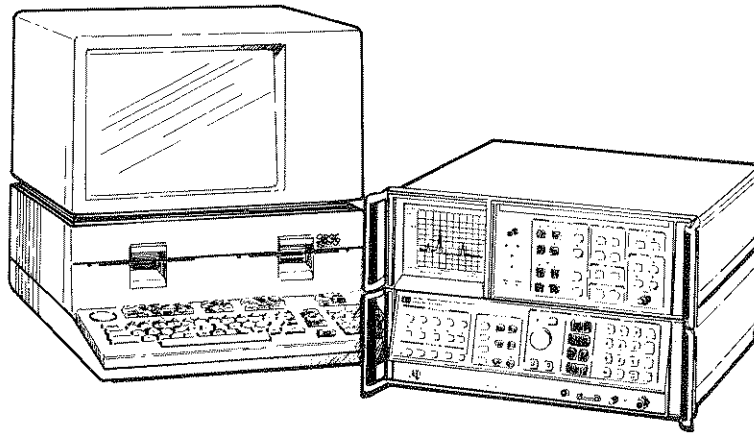

TABLE 1. TESTS PERFORMED

Test Number and Name	Equipment Required
1. Input Attenuator Switching Check	HP 3335A
2. IF Gain Uncertainty	HP 3335A
3. Scale Fidelity (Log)	HP 3335A
4. Scale Fidelity (Linear)	HP 3335A
5. Log Scale Switching Uncertainty	HP 3335A
6. Resolution Bandwidths	none
7. Line Related Sidebands	none
8. Average Noise Level	HP 909A, Option 012
9. Residual Responses	HP 909A, Option 012
10. Sweep + Tune Out Accuracy	HP 3456A or HP 3455A
11. Second Harmonic Distortion	HP 3335A 50 MHz Low Pass Filter
12. Frequency Span Accuracy	HP 8340A HP 8120-3124 or HP 5061-5458
13. Gain Compression	HP 8340A HP 8902A or HP 436A or HP 438A HP 8485A or HP 8481A HP 11667 (A or B) HP 8120-3124 or HP 5061-5458
14. Frequency Response	HP 3335A HP 8340A HP 8902A or HP 436A or HP 438A HP 8485A or HP 8481A HP 11667A (DC to 18 GHz) HP 11667B (DC to 26.5 GHz) HP 8120-3124 or HP 5061-5458
15. Third Order Intermodulation	HP 3335A HP 8340A HP 8721A HP 8120-3124 or HP 5061-5458 50 MHz Low Pass Filters
16. Cal Output Amplitude Accuracy	HP 8902A or HP 436A or HP 438A HP 8485A or HP 8481A
17. First LO Output Power	HP 8902A or HP 436A or HP 438A HP 8485A or HP 8481A

TABLE 2. TESTS NOT PERFORMED

Frequency Reference Error Test
Center Frequency Readout Accuracy Test
Sweep Time Accuracy Test
Noise Sidebands Test
Harmonic and Intermodulation Test
Image, Multiple, and Out-of-Band Responses Test

TABLE 3. EQUIPMENT SUMMARY

HP Part Number	Equipment
HP 9816, HP 9826, or HP 9836S	Controller*
HP 3335A	Frequency Synthesizer
HP 3455A or HP 3456A	System DVM
HP 8340A or HP 8341A	Synthesized Sweeper
HP 8902A	Measuring Receiver
HP 436A or HP 438A	Power Meter
HP 8485A or HP 8481A (18 GHz)	Power Sensor
HP 909A Option 012	50 Ohm Termination
HP 8721A	Coaxial Directional Bridge
HP 11667A or HP 11667B	Power Splitter
HP 0955-0306	50 MHz Low Pass Filter (2 needed)
HP 8120-3124	High Frequency Test Cable (22 GHz)
HP-IB Printer	
Miscellaneous Cables and Adapters	

* HP 98624A HP-IB Interface is needed with the MTS.
 * 300K of free memory is required for the test program.

TEST SYSTEM CONFIGURATION

The Operation Verification program requires an HP Model 9816, Model 9826, or a Model 9836S computer with HP BASIC 2.0 and Extensions 2.1 or BASIC 3.0. The program operates on either a single or dual bus configuration; the dual bus system is used with the Microwave Test Set (MTS). The HP 9816 operates only on the single bus, while the HP 9826 and 9836S operate on either single or dual bus systems. For a dual bus system it is also necessary to have an HP Model 98624A HP-IB Interface to connect the test instrument to the HP 9826 or 9836S (as shown in Figure 1).

The Operation Verification software is designed to operate on the dual bus (MTS) system. In this configuration the bus with the test equipment has a select code of 7, while the bus with the unit under test has a select code of 8. The software will adapt itself to a single bus system if a 98624A HP-IB Interface at select code 8 is not present.

The equipment needed to perform the HP 8566B Operation Verification is listed in both Tables 1 and 3. Table 1 includes a test-by-test listing of the equipment needed and Table 3 a test equipment summary. To obtain a permanent record of the test results an HP-IB printer is required. The HP 8566B CRT display may be selected to display the test results if a permanent test record is not desired.

NOTE

As a change of the results for each test is expected over a period of time, Hewlett-Packard warrants only the specification range and not the repeatability of the data for any given specification.

EQUIPMENT CONNECTIONS

Set up the HP 9816, 9826, or the 9836S Computer following the instructions in Chapter 1, "Computer Installation", in the BASIC Operating Manual (HP Part Number 09826-90000).

For the Dual Bus configuration (MTS) connect the test equipment connect as shown in Figure 1. The instrument under test is connected to the HP 98624A Interface card.

For a single bus system connect the HP-IB by attaching one end of an HP-IB cable to the connector on the rear panel of the computer and the other end of the cable to the connector on the rear panel of the HP 8566B (refer to Figure 2). Connect the other listed test equipment to the HP-IB using additional cables as necessary.

Turn the HP 8566B line power on and allow a two-hour warm-up. Also, allow sufficient warm-up time for the other test equipment as indicated in the individual operating and service manuals.

NOTE

When connecting signals from the Synthesized Sweeper (HP 8340A) to the test setup, it is necessary to use a high frequency cable with minimum attenuation to 22 GHz.

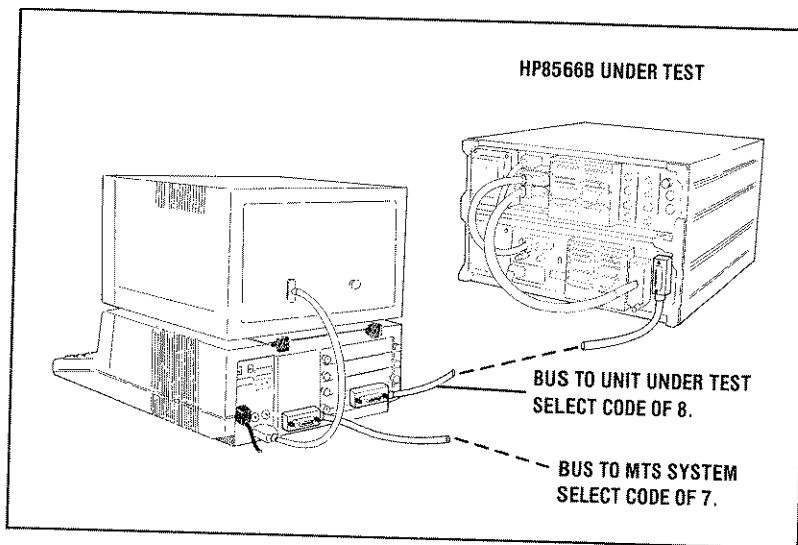

FIGURE 1. DUAL BUS (MTS) SYSTEM CONNECTION

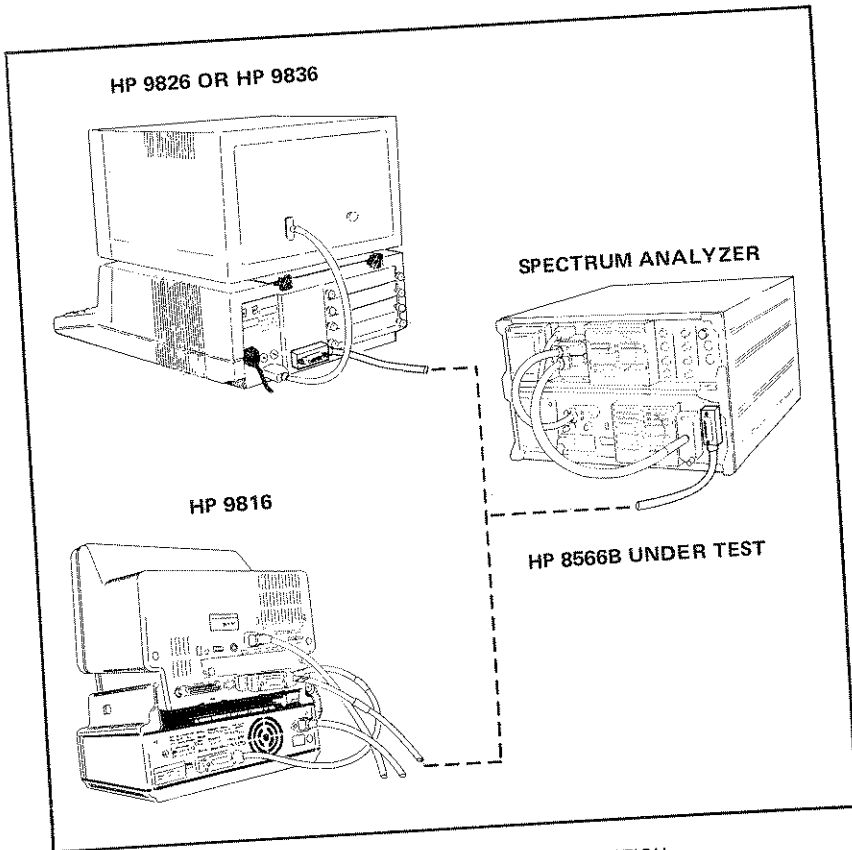

FIGURE 2. SINGLE BUS SYSTEM CONNECTION

PROGRAM LOADING

Load the BASIC language into the computer. Possible language options are:

- BASIC 2.0 and Extensions 2.1
- BASIC 3.0 which must include the following binaries:
 - MAT 3.0
 - IO 3.0
 - GRAPH 3.0
 - PDEV 3.0
 - HPIB 3.0

For configuration instructions, refer to the BASIC Operating Manual. Next, insert the disc containing the Operation Verification software and type:

LOAD "VERIFY_66",1

and press the EXECUTE key. The software will load and begin to run.

PROGRAM OPERATION

The initial displays are designed to assist you in configuring the software to meet your needs. Each display lists the various options and the appropriate responses. The LIST OF DEFAULTS display deserves special mention because it is here that the choice of power meters must be made. If the power meter listed in the display does not match your configuration, enter the model number on the

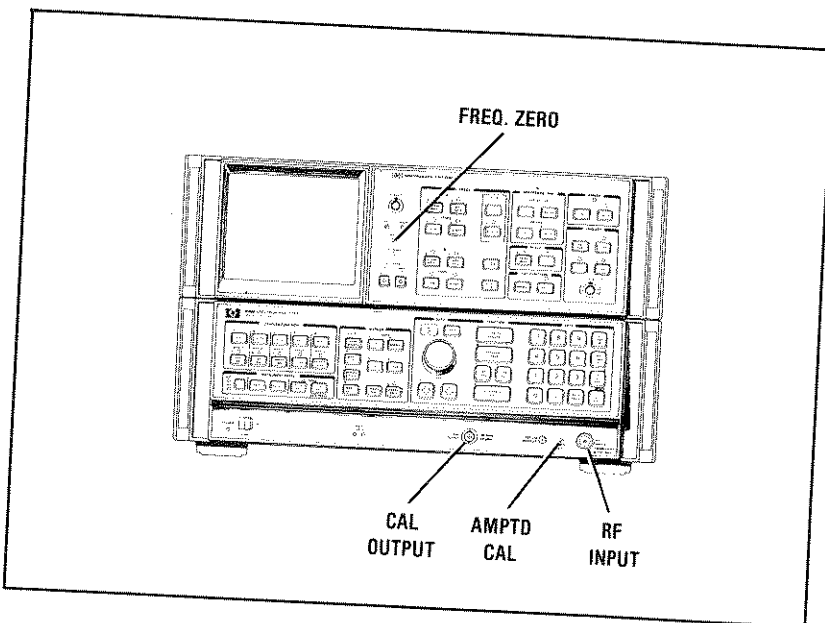

FIGURE 3. RF INPUT AND CALIBRATION CONTROLS

correct line and software will use this throughout Operation Verification. This display is also the entry screen for HP-IB addresses. If the test equipment on the bus does not agree with the addresses shown, the software will allow the user to return to this display and change the addresses.

HP-IB ADDRESSES

Table 4 lists the assigned addresses of the test equipment on the HP-IB. For dual bus configuration the select code for the test equipment is 7 and the select code for the instrument under test is 8. (The address for the HP 8566B under test is 818.)

In the single bus configuration the select code for the test equipment is 7, and the select code for the instrument under test is 7.

TABLE 4. HP-IB ADDRESSES

Equipment	HP Model	Address
Controller	HP 9816 or HP 9836S	21
Frequency Synthesizer	HP 3335A	04
Systems DVM	HP 3456A	22
Synthesized Sweeper	HP 8340A	19
Measuring Receiver	HP 8902A	14
HP-IB Printer	HP 82906A (Recommended)	01

ERROR MESSAGES

Self-explanatory error messages are incorporated into the Operation Verification program to assist you in identifying errors.

TEST DESCRIPTIONS

The following test descriptions list the Specifications, Related Performance Test, and Test Description for each test performed by the Operation Verification program. The specifications listed below are those of each Operation Verification test and are uncorrected (where applicable). Operation Verification is designed to test an instrument operating within a temperature range of 20° to 30° C.

1. INPUT ATTENUATOR SWITCHING CHECK

Specification:

None

Related Performance Test:

None

Description:

This is included as an aid to verify operation only and to assist in troubleshooting.

A signal source of known amplitude is connected to the spectrum analyzer and the analyzer is adjusted for a reference. The input attenuator is stepped down from 10 dB to 70 dB, while the reference level and the signal source are stepped up. This maintains the signal peak at the same approximate location on the CRT display. The amplitude of the signal is measured at each step using the marker function on the spectrum analyzer.

2. IF GAIN UNCERTAINTY

Specification:

0.0 dBm to -55.9 dBm; ± 0.6 dB
-56.0 dBm to -129.9 dBm; ± 1.0 dB

Related Performance Test:

IF GAIN UNCERTAINTY TEST

Description:

A signal source of known amplitude is connected to the spectrum analyzer and the analyzer is adjusted for a reference level. The amplitude of the signal peak is measured in 0.1 dB steps from -0.1 dB to -1.9 dB, in 2 dB steps from -1.9 dB to -9.9 dB, and in 10 steps from -10 dB to -120 dB.

3. SCALE FIDELITY (Log)

Specification:

$\leq \pm 1.0$ dB max over 0 to 80 dB display
 $\leq \pm 1.5$ dB max over 0 to 90 dB display

Related Performance Test:

SCALE FIDELITY TEST

Description:

The specification listed is for cumulative error. Only cumulative error is measured in this procedure.

A signal source of known amplitude is connected to the spectrum analyzer and the analyzer is adjusted for a reference. The signal source is stepped down in 1 dB steps and the displayed signal amplitude on the spectrum analyzer measured at each step. This measurement is performed in both the 3 kHz and 300 kHz bandwidths.

4. SCALE FIDELITY (Linear)

Specification:

$\pm 3\%$ of Reference Level

Related Performance Test:

SCALE FIDELITY TEST

Description:

A signal source of known amplitude is connected to the spectrum analyzer and the analyzer is adjusted for a reference. The signal source is stepped down from -10 dB to -30 dB in 10 dB steps and the amplitude of the displayed signal measured using the marker function. This measured value is used to calculate the percent error from the reference level established.

5. LOG SCALE SWITCHING UNCERTAINTY

Specification:

± 0.5 dB (uncorrected)

Related Performance Test:

LOG SWITCHING UNCERTAINTY TEST

Description:

A signal source of known amplitude is connected to the spectrum analyzer and the analyzer is adjusted for a reference in the 1 dB per division log scale. The spectrum analyzer is then switched to each of the other LOG scales (2 dB, 5 dB, and 10 dB) and the LINEAR scaler. The amplitude of the signal peak is measured at each setting.

6. RESOLUTION BANDWIDTHS

Specification:

Bandwidth: 10 Hz to 3 MHz; $\pm 20\%$
3 kHz to 1 MHz; $\pm 10\%$

Amplitude: 3 MHz to 10 Hz; ± 1.0 dB
1 MHz to 30 Hz; ± 0.5 dB
30 Hz; ± 0.8 dB
10 Hz; ± 2.0 dB

Selectivity: (60 dB/3 dB Ratio)
3 MHz to 100 kHz; $<15:1$
30 kHz to 10 kHz; $<13:1$
3 kHz to 30 Hz; $<11:1$
10 Hz; <100 Hz separation of 60 dB points

Related Performance Tests:

RESOLUTION BANDWIDTH ACCURACY TEST
RESOLUTION BANDWIDTH SELECTIVITY TEST
RESOLUTION BANDWIDTH SWITCHING UNCERTAINTY TEST

Description:

A signal source is connected to the spectrum analyzer input. The analyzer steps through the bandwidths from 3 MHz to 10 Hz, centers the signal, sets signal peak near the Reference Level, and measures the frequency of the 3 dB points for each bandwidth. The 3 dB bandwidth is then calculated by determining the difference in frequency between the 3 dB points.

Next the spectrum analyzer steps through the bandwidths and measures the frequency of the 60 dB points of each bandwidth. The 60 dB bandwidth is then calculated by determining the frequency difference between the 60 dB points.

The shape factors are calculated by dividing the 60 dB bandwidths by the 3 dB bandwidths.

7. LINE RELATED SIDEBANDS

Specification:

For a Line Frequency of 60 Hz:

Offset from Carrier	Sideband Level
<360 Hz	- 70 dBc

For a Line Frequency of 400 Hz:

<2 kHz	- 55 dBc
--------	----------

Related Performance Test:

LINE RELATED SIDEBANDS TEST

Description:

A signal source is connected to the spectrum analyzer input and the necessary front panel control settings made for the test. The harmonics of the line frequency are calculated, the front panel controls to view the frequencies, and measure the amplitude of the signal at each of the frequencies.

8. AVERAGE NOISE LEVEL

Specification:

Non-Preselected

Level	Tuning Range
< -95 dBm	100 Hz to 50 kHz
< -112 dBm	50 kHz to 1.0 MHz
< -134 dBm	1.0 MHz to 2.5 GHz

Preselected

Level	Tuning Range
< -132 dBm	2.0 GHz to 5.8 GHz
< -125 dBm	5.8 GHz to 12.5 GHz
< -119 dBm	12.5 GHz to 18.6 GHz
< -114 dBm	18.6 GHz to 22.0 GHz

Related Performance Test:

AVERAGE NOISE LEVEL

Description:

The RF INPUT of the spectrum analyzer is terminated with a 50 ohm load or the synthesizer and the analyzer attenuator. The necessary front-panel control settings are made and the average noise level measured at four non-preselected and four preselected frequencies.

9. RESIDUAL RESPONSES

Specification:

- 100 dBm, 100 Hz to 5.8 GHz
- 95 dBm, 5.8 Hz to 12.5 GHz
- 85 dBm, 12.5 GHz to 18.6 GHz
- 80 dBm, 18.6 GHz to 22.0 GHz

Related Performance Test:

RESIDUAL RESPONSES TEST

Description:

The RF Input of the spectrum analyzer is terminated with a 50 ohm load or the synthesizer and the analyzer attenuator. The peak amplitude of the noise or responses is measured at various frequencies associated with residual responses caused by harmonics and mixing products of the First, Second, and Third local oscillator, the internal reference, and the HP-IB and digital storage clocks.

10. SWEEP + TUNE OUT ACCURACY**Specification:**

-1V/GHz $\pm 2\%$ ± 10 mV.

Related Performance Test:**SWEEP + TUNE OUT ACCURACY TEST****Description:**

A digital voltmeter is used to monitor the rear-panel SWEEP + TUNE OUT voltage while the spectrum analyzer center frequency is set to nine arbitrary values. The output voltage for each center frequency setting is checked against the specification.

11. SECOND HARMONIC DISTORTION

Specification: (For mixer level ≤ -40 dBm)
 < -70 dBc, 100 Hz to 2.5 GHz (non-preselected)

Related Performance Test:

HARMONIC AND INTERMODULATION DISTORTION

Description:

A 40 MHz signal is applied to the analyzer RF INPUT through a 50 MHz Low Pass Filter. The spectrum analyzer is adjusted to measure the second harmonic at 80 MHz.

12. FREQUENCY SPAN ACCURACY

Specification: (where N is the harmonic mixing number)

For span/n > 5 MHz; $\pm 3\%$ of indicated frequency separation
For span/n ≤ 5 MHz; $\pm 1\%$ of indicated frequency separation

Related Performance Test:

FREQUENCY SPAN ACCURACY

Description:

A stable signal source is connected to the spectrum analyzer and the center frequency and span are set to measure spans from 100 kHz to 10 GHz in a 1,2,5 sequence.

13. GAIN COMPRESSION

Specification:

<1.0 dB, 100 Hz to 22 GHz with ≤ -5 dBm at input mixer

Related Performance Test:

GAIN COMPRESSION TEST

Description:

Gain compression is measured by changing the power level at the input mixer from -15 dBm to -5 dBm and measuring the change in display level using the spectrum analyzer marker function. This is done at two frequencies: 100 MHz and 2.2 GHz to check both the First Mixer and YIG Tuned Mixer, respectively.

14. FREQUENCY RESPONSE

Specification:

Center Frequency	Flatness
200 Hz to 2.5 GHz non-preselected band	± 0.6 dB (1.2 dB)
2.0 GHz to 5.8 GHz preselected band	± 1.7 dB (3.4 dB)
5.8 GHz to 12.5 GHz preselected band	± 1.7 dB (3.4 dB)
2.5 GHz to 18.6 GHz preselected band	± 2.2 dB (4.4 dB)
18.6 GHz to 20.0 GHz preselected band	± 2.2 dB (4.4 dB)
20.0 GHz to 22.0 GHz preselected band	± 3.0 dB (6.0 dB)

Cumulative Flatness
200 Hz to 22 GHz 6.0 dB

Related Performance Test:

FREQUENCY RESPONSE TEST

Description:

If this test is individually selected, a menu of the testable bands is displayed. For all bands, the test consists of 100 data points taken across the selected band. For the 200 Hz to 22 GHz test, six bands are tested (600 data points). First the sweeper is used to test from 20 MHz to 22 GHz and then the synthesizer is used to test from 200 Hz to 20 MHz. The levels at 20 MHz are matched to guarantee continuity. If the Frequency Response test is entered from the ALL TESTS Mode, then the 200 Hz to 22 GHz is selected automatically.

15. THIRD ORDER INTERMODULATION DISTORTION

Specification:

Intercept is greater than +7.0 dBm from 5 MHz to 5.8 GHz

Related Performance Test:

HARMONIC AND INTERMODULATION DISTORTION TEST

Description:

Two signals with 1 MHz separation are applied to the First Mixer. The frequencies of third order intermodulation products is calculated and the spectrum analyzer is set to measure the amplitude of these responses. The third order intercept is calculated from the measurements.

16. CALIBRATOR OUTPUT AMPLITUDE ACCURACY

Specification:

+10 dBm \pm 0.3 dB

Related Performance Test:

CALIBRATOR AMPLITUDE ACCURACY TEST

Description:

The power sensor is connected to the spectrum analyzer CAL OUTPUT and the power is measured.

17. FIRST LO OUTPUT POWER

Specification:

Greater than +8 dBm

Related Performance Test:

1ST LO OUTPUT AMPLITUDE

Description:

The power sensor is connected to the spectrum analyzer 1ST LO OUTPUT and the output power is measured as the LO is stepped from 2.3 GHz to 6.2 GHz in 100 MHz steps.

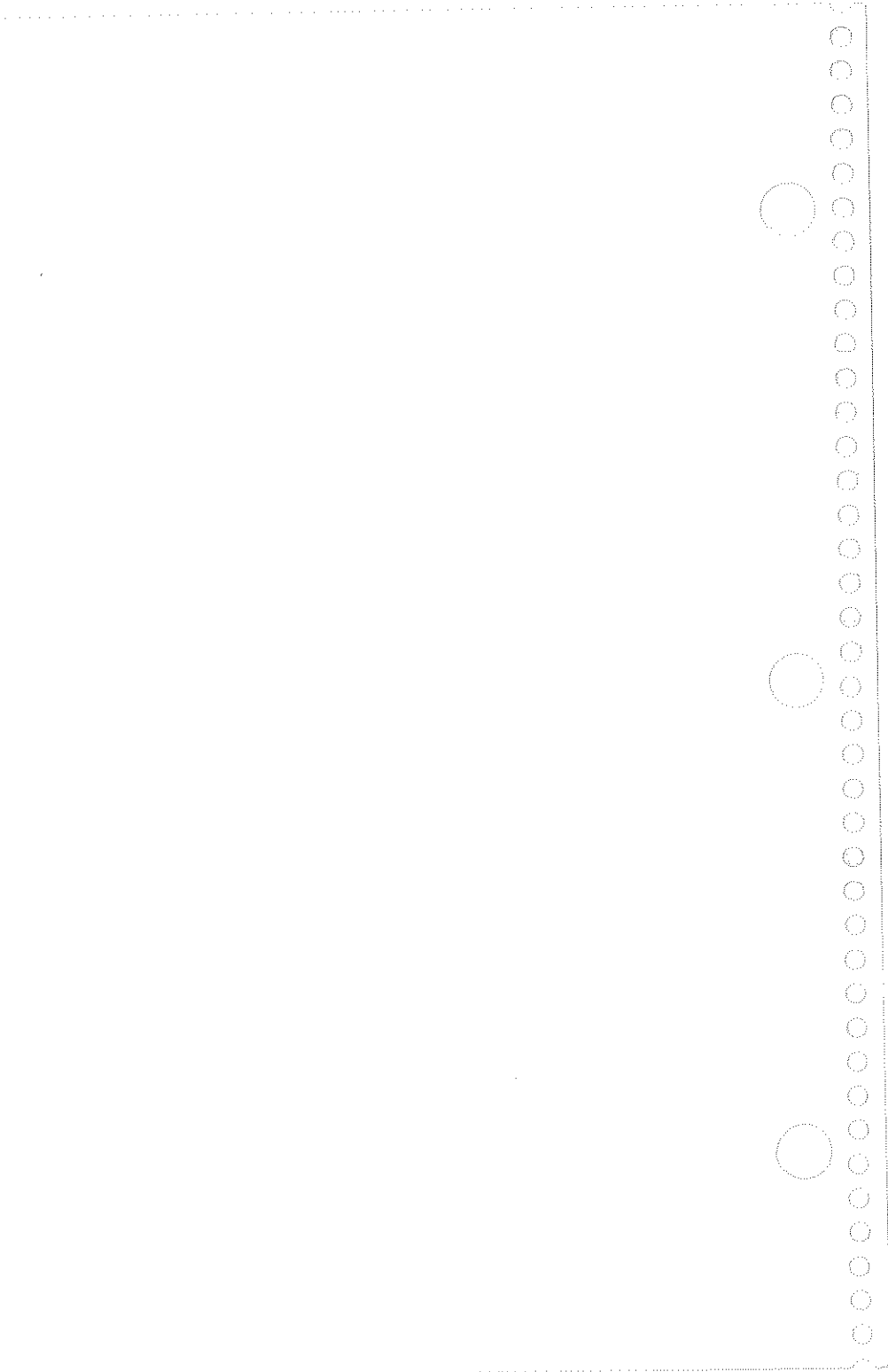

.....

.....

.....

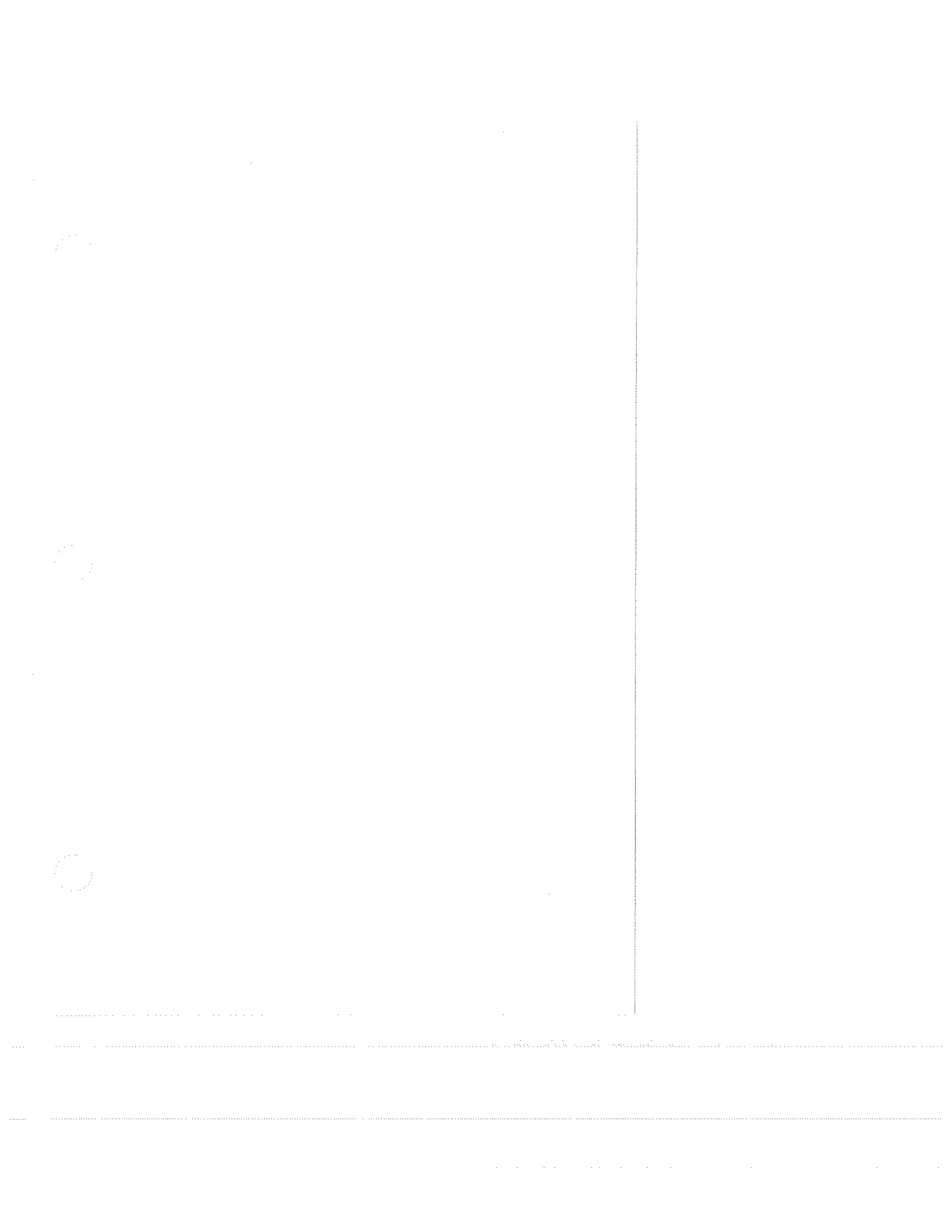

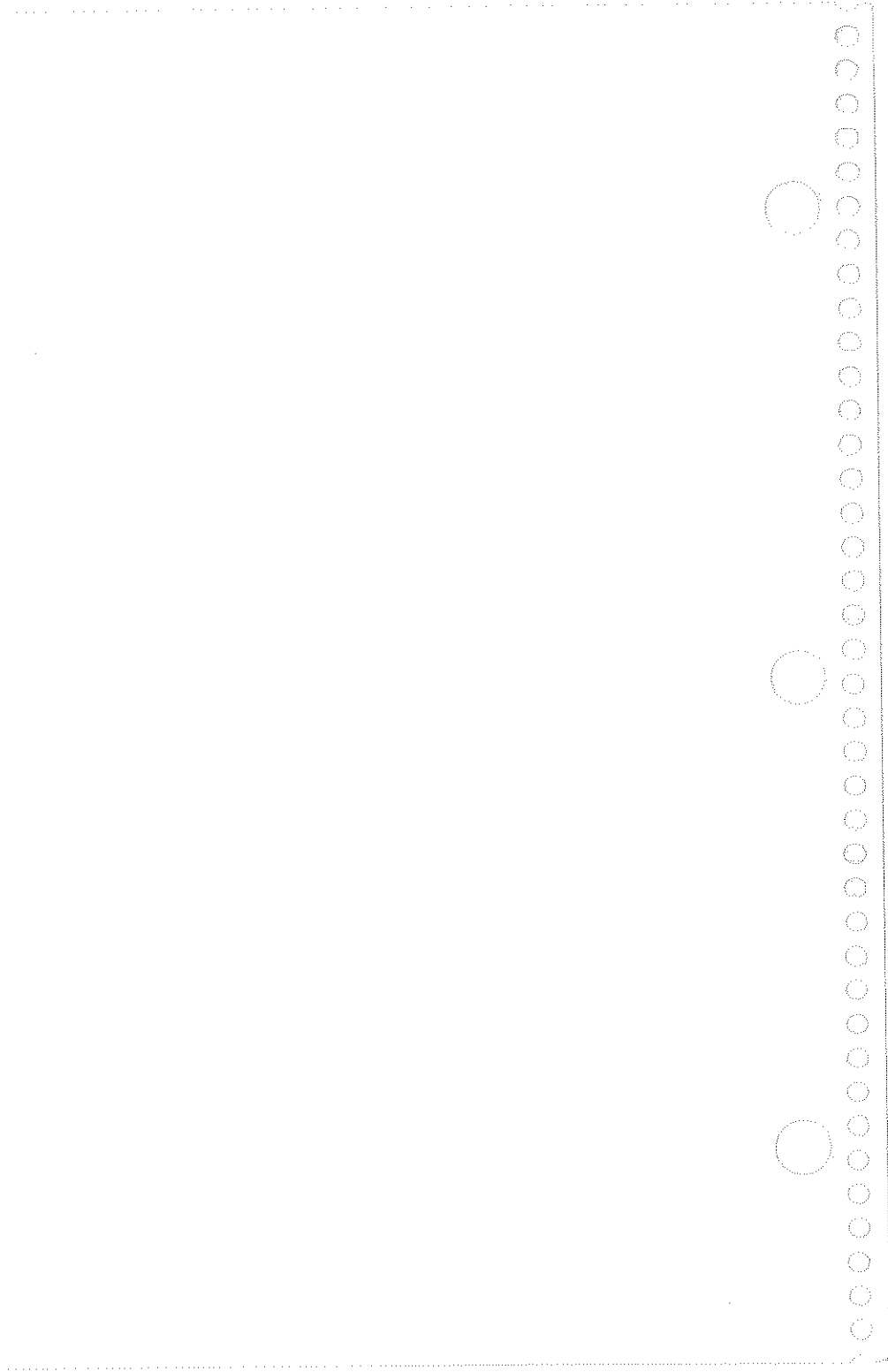

SAFETY SYMBOLS

The following safety symbols are used throughout this manual and in the instrument. Familiarize yourself with each of the symbols and its meaning before operating this instrument.



Instruction manual symbol. The instrument will be marked with this symbol when it is necessary for the user to refer to the instruction manual in order to protect the instrument against damage. Location of pertinent information within the manual is indicated by use of this symbol in the table of contents.



Indicates dangerous voltages are present. Be extremely careful.

CAUTION

The CAUTION sign denotes a hazard. It calls attention to a procedure which, if not correctly performed or adhered to, could result in damage to or destruction of the instrument. Do not proceed beyond a CAUTION sign until the indicated conditions are fully understood and met.

WARNING

The WARNING sign denotes a hazard. It calls attention to a procedure which, if not correctly performed or adhered to, could result in injury or loss of life. Do not proceed beyond a WARNING sign until the indicated conditions are fully understood and met.

GENERAL SAFETY CONSIDERATIONS

WARNING

BEFORE THIS INSTRUMENT IS SWITCHED ON, make sure it has been properly grounded through the protective conductor of the ac power cable to a socket outlet provided with protective earth contact. Any interruption of the protective (grounding) conductor, inside or outside the instrument, or disconnection of the protective earth terminal can result in personal injury.

WARNING

There are voltages at many points in the instrument which can, if contacted, cause personal injury. Be extremely careful. Any adjustments or service procedures that require operation of the instrument with protective covers removed should be performed only by trained service personnel.

CAUTION

BEFORE THIS INSTRUMENT IS SWITCHED ON, make sure its primary power circuitry has been adapted to the voltage of the ac power source. Failure to set the ac power input to the correct voltage could cause damage to the instrument when the ac power cable is plugged in.

LOCATING OPERATING INFORMATION

Included with the HP Model 8566B Spectrum Analyzer are three manuals: the Operator's Handbook, the Operating and Programming Manual, and the Tests and Adjustments Manual. Not included with the instrument, but available at no charge upon return of the enclosed order card, is the two volume Troubleshooting and Repair Manual.

OPERATOR'S HANDBOOK (HP part number 08566-90045)

Contents:

General Information, Installation, Quick Reference, Specifications, and Operation Verification. Available as separate publications are the Specifications (HP part number 08566-90046), Operation Verification (HP part number 08566-60008), and a pocket sized version of the Quick Reference Guide.

OPERATING AND PROGRAMMING MANUAL (HP part number 08566-90040)

Contents:

Manual and remote operation, including complete syntax and command description. Accompanying this manual is the separate, pocket sized Quick Reference Guide (HP part number 5955-8970).

TESTS AND ADJUSTMENTS MANUAL (HP part number 08566-90051)

Contents:

Electrical performance testing and adjustment procedures.

TROUBLESHOOTING AND REPAIR MANUAL (HP part number 08566-90042)

Contents:

IF-Display Section and RF Section service information.

SUMMARY OF OPERATOR'S HANDBOOK

General Information

 General information regarding safety, German x-ray radiation notice and license, instrument identification, manual updating, and a listing of available accessories and options.

Installation

 Information regarding initial inspection, preparation for use, power selection, mating connector guide, and installation procedures.

Quick Reference

Information to allow the experienced operator to find the specific program codes either alphabetically or by function. Also available as a pocket sized booklet (HP part number 5955-8970).

Specifications

 A listing of the spectrum analyzer specifications. Also available separately (HP part number 08566-90046).

Operation Verification

The program disc and operating information for running the automatic Operation Verification. Also available separately (HP part number 08566-60008).



GENERAL INFORMATION

INTRODUCTION

This HP 8566B Operator's Handbook contains the following five sections: General Information, Installation, Quick Reference, Specifications, and Operation Verification. The Operation Verification, Specifications, and Quick Reference Guide (pocket size) are also available as separate publications.

SAFETY

Before operating this instrument, you should familiarize yourself with the safety markings on the instrument and the safety instructions in the manuals. The instrument has been manufactured and tested in accordance with international safety standards. However, to ensure safe operation of the instrument and personal safety of the user, the cautions and warnings in the manuals must be followed. Refer to the summary of the safety information located near the front of this handbook.

INSTRUMENT IDENTIFICATION

Attached to the rear of each section of your instrument is a serial number plate. The serial number is in two parts. The first four digits and letter are the serial number prefix; the last five digits are the suffix. The prefix is the same for all identical instruments; it changes only when a production change is made to the instrument. The suffix, however, is assigned sequentially and differs for each instrument. The contents of the manuals for the HP 8566B apply to instruments with the serial number prefix(es) listed under SERIAL NUMBERS on the title page.

MANUAL UPDATING

An instrument manufactured after the printing of one of the manuals may have a serial number prefix not listed on the title page. An unlisted serial number prefix indicates the instrument differs from those described in the manual. The manual for the newer instrument is accompanied by a manual updating changes supplement.

To keep the manuals as current and accurate as possible, Hewlett-Packard recommends you periodically request the latest Manual Updating Changes supplement. Each manual has a separate supplement identified by the manual print date and part number. Copies of the supplements are available at no cost from any Hewlett-Packard office.

EQUIPMENT AND ACCESSORIES AVAILABLE

Computers

The HP 8566B is fully HP-IB programmable. Consult your local HP Field Engineer for recommended controllers and available software. For a list of equipment required for Operation Verification, refer to the Operation Verification Manual.

HP 85650A Quasi-Peak Adapter

The HP 85650A adds to the spectrum analyzer the resolution bandwidth filters and quasi-peak detection capability specified by CISPR. Together the quasi-peak adapter and the spectrum analyzer provide many of the elements needed for an EMI receiver system.

External Mixer Set

The frequency range of the spectrum analyzer may be extended to 60 GHz with the use of the HP 11970 series external mixers.

Troubleshooting and Repair Manual

Service information for the HP 8566B is available in this manual (HP part number 08566-90042). It includes schematic diagrams, block diagrams, component location illustrations, circuit descriptions, repair procedures, and troubleshooting information.

Service Kits

Service accessories packages for the HP 8566B are available for convenience in troubleshooting and instrument alignment. These kits include a test cable and extender boards.

Service Kit for HP 8566B: HP part number 08566-60001
Service Kit for HP 8566B and HP 8568B: HP part number
08566-60005

OPTIONS

Electrical

400 400 Hz Power Line Frequency Operation

Documentation

080 Information Cards in Japanese
081 Information Cards in French

Rack Mounting Kits

908 Rack Mount Flange Kit (to mount without handles)
913 Rack Mount Flanges with Handles (handles already provided)
010 Rack Mount with Slides (with or without handles)

X-RAY RADIATION NOTICE

ACHTUNG

Model 85662A

WARNING

Während des Betriebs erzeugt dieses Gerät Röntgenstrahlung. Das Gerät ist so abgeschirmt, daß die Dosisleistung weniger als 36 pA/kg (0,5 mR/h) in 5cm Abstand von der Oberfläche der Katodenstrahlröhre beträgt. Somit sind die Sicherheitsbestimmungen verschiedener Länder, u.A. der deutschen Röntgenverordnung eingehalten.

Die Stärke der Röntgenstrahlung hängt im Wesentlichen von der Bauart der Katodenstrahlröhre ab, sowie von den Spannungen, welche an dieser anliegen. Um einen sicheren Betrieb zu gewährleisten, dürfen die Einstellungen der Niederspannungs- und des Hochspannungsnetzteils nur nach der Anleitung des Handbuchs vorgenommen werden.

Die Katodenstrahlröhre darf nur durch die gleiche Type ersetzt werden.

Das Gerät ist in Deutschland zugelassen unter der Nummer: BW/50/79/RÖ

When operating, this instrument emits x-rays; however, it is well shielded and meets safety and health requirements of various countries, such as the X-ray Radiation Act of Germany.

Radiation emitted by this instrument is less than 0.5 mR/hr at a distance of five (5) centimeters from the surface of the cathode-ray tube. The x-ray radiation primarily depends on the characteristics of the cathode-ray tube and its associated low-voltage and high-voltage circuitry. To ensure safe operation of the instrument, adjust both the low-voltage and high-voltage power supplies as outlined in the Tests and Adjustments manual (if applicable).

Replace the cathode-ray tube with an identical CRT only.

Number of German License: BW/50/79/RÖ

FIGURE 1. X-RAY RADIATION NOTICE



MINISTERIUM
FÜR ARBEIT, GESUNDHEIT UND SOZIALORDNUNG
BADEN-WÜRTTEMBERG

Ministerium für Arbeit, Gesundheit und Sozialordnung Baden-Württemberg
Postfach 10000 - 7000 Stuttgart 1

Firma
Hewlett-Packard GmbH
Herrenberger Str. 110

7030 Böblingen



Stuttgart, den 22. Januar 1981

P am Eingang 8
im Innenhof

Fernsprecher
Durchwahl (07 11) 66 73- 7357

Aktenzeichen: VII/6-3400.2.2/7/
(Bitte bei Antwort angeben) Fa. Hewlett-
Packard; Böbl./80

Betr.: Durchführung der Röntgenverordnung (RöV)

Bezug: Ihr Antrag vom 20. November 1978 - US/iw -

Zulassungsschein Nr. BW/50/79/Rö

Hiermit wird Ihnen gemäß § 7 Abs. 2 der Röntgenverordnung
vom 1. März 1973 (BGBI. I S. 173) die Zulassung der Bauart
des nachstehend beschriebenen Störstrahlers erteilt:

Gegenstand:	Sichtgerät für Spektrumanalysator
Firmenbezeichnung:	Typ 85662 A
Kathodenstrahlröhre :	Hewlett Packard Typ 5083-5791
Hersteller:	Hewlett Packard, Santa Rosa Div., 1400 Fountain Grove Parkway, Santa Rosa, California 95404, USA
Betriebsbedingungen:	Hochspannung: max. 24,4 kV Strahlstrom: max. 7,5 μ A

Dienstgebäude: Rotchöhlplatz 30 (Ref. Gruppe III R - Sicherheit in der Kerntechnik - Lange Straße 4 A)
Fernsprecher Vermittlung (07 11) 66 73-0 · Telex (07 11) 61 81 13 · Telex 722 548

Bauartunterlagen: Bauartzeichnungen:
Nr. B-5083-5700-3 Rev. A vom 15. Dez. 1977,
Nr. B-5061-0195-1 Rev. F vom 8. Sept. 1977,
Nr. C-2000-0105-1 Rev. D vom 18. April 1977,
Nr. A-5060-9708-1 Rev. C vom 22. Juli 1975.

Operating and Service Manual
Nr. 08568-90005 vom Juni 1976

Materialangaben vom 3. Juli 1979

Prüfungsschein: Physikalisch-Technische Bundesanstalt
Braunschweig
Nr. 6.32-5 80 vom 18. September 1979

Die Zulassung wird befristet bis 22. Januar 1991. Auf § 8 Abs. 2 RöV wird hingewiesen.

Für den Strahlenschutz wesentliche Merkmale

1. Die Art und Qualität der Kathodenstrahlröhre,
2. die der Hochspannungserzeugung und -stabilisierung dienenden Bauelemente.

Auflagen:

Die Zulassung wird gemäß § 8 Abs. 1 der RöV mit folgenden Auflagen verbunden:

1. Die Geräte sind einer Stückprüfung daraufhin zu unterziehen, ob sie bezüglich der für den Strahlenschutz wesentlichen Merkmale der Bauartzulassung entsprechen. Die Prüfung muß umfassen:
 - a) Kontrolle der Hochspannung an jedem einzelnen Gerät
 - b) Dosisleistung nach näherer Angabe der Zulassungsbehörde.

Die Ergebnisse der Dosisleistungsmessung sind, den Herstellungsnummern der Geräte zugeordnet, aufzuzeichnen, 3 Jahre aufzubewahren und der Zulassungsbehörde auf Verlangen einzusenden.

Die Zulassungsbehörde ist berechtigt, einzelne Geräte nach eigener Auswahl anzufordern, um das Vorliegen der für den Strahlenschutz wesentlichen Merkmale zu überprüfen oder überprüfen zu lassen. Die Geräte sind auf Verlangen im Originalzustand anzuliefern und angemessene Zeit zur Verfügung zu stellen.

2. Die Herstellung und die Stückprüfung sind durch einen von der Zulassungsbehörde bestimmten Sachverständigen überwachen zu lassen.
3. Die Geräte sind deutlich sichtbar und dauerhaft mit dem Kennzeichen

BW/50/79/Rö

zu versehen sowie mit einem Hinweis folgenden Mindestinhalts:

"Die in diesem Gerät entstehende Röntgenstrahlung ist ausreichend abgeschirmt. Beschleunigungsspannung maximal 24,4 kV."

4. Jedem Erwerber eines Geräts ist ein Abdruck des Zulassungsscheins auszuhändigen, auf dem das Ergebnis der Stückprüfung (Auflage 1) bestätigt sein muß.

Jedem Gerät ist ferner ein Betriebsanleitung beizufügen, in der auf den in Auflage 3 genannten Hinweis aufmerksam gemacht wird und die die für die Durchführung von Reparatur- und Wartungsarbeiten notwendigen Sicherheitsmaßnahmen bezüglich des Strahlenschutzes enthält:

Hinweis für den Benutzer des Geräts:

Unsachgemäße Eingriffe, insbesondere Verändern der Hochspannung oder Auswechseln der Kathodenstrahlröhre, können dazu führen, daß Röntgenstrahlung in erheblicher Stärke auftritt. Ein so verändertes Gerät entspricht nicht mehr dieser Zulassung und darf infolgedessen nicht betrieben werden.



Detting
Dr. Detting

Dieses Gerät wurde nach den Auflagen der Zulassungsbehörde einer Stückprüfung unterzogen und entspricht in den für den Strahlenschutz wesentlichen Merkmalen der Bauartzulassung. Die Beschleunigungsspannung beträgt maximal 24,4kV.

NOTE

Relevant information previously contained in the Operating and Service Manual is now contained in the Tests and Adjustments Manual (HP part number 08566-90051) and the Troubleshooting and Repair Manual (HP part number 08566-90042).

Hewlett-Packard Company
Signal Analysis Division
1212 Valley House Drive
Rohnert Park, CA 94928

INSTALLATION

INITIAL INSPECTION

Inspect the shipping containers and the cushioning materials for damage. If there is any, they should be kept until the contents of the shipment have been checked mechanically and electrically. If there is any damage or defect to the instrument sections or accessories, report it to the nearest Hewlett-Packard office. The HP office will arrange for repair or replacement without waiting for claim settlement. Keep the shipping materials for inspection by the carrier.

In the shipping containers is an accessory package. This contains two power cords, two fuses, and two instrument interconnect cables. Also included (already attached to the instrument) are cables W15, W37, and W38.

NOTE

Cable W15 is normally connected between the **FREQ REFERENCE EXT and **INT BNC** ports, providing the HP 8566B with its own internal 10 MHz frequency reference. W15 is removed when an external frequency reference is used. Cables W37 and W38 are only removed for connection of the **IF** and **VIDEO** ports to the HP Model 85650A Quasi-Peak Adapter. If the analyzer is used without the HP 85650A Quasi-Peak Adapter, W37 and W38 must be connected for the analyzer to operate.**

PREPARATION FOR USE

Operating Conditions

The instrument may be operated in temperatures from 0°C to +55°C, at altitudes up to 4,572 meters (15,000 ft.).

Physical Specifications

Figure 1 shows the dimensions of the combined instrument sections. Allow an additional 100 mm (4 inches) clearance at the rear of the instrument for the interconnect cables.

As the combined weight of the instrument sections is approximately 112 pounds, use appropriate caution when moving or installing.

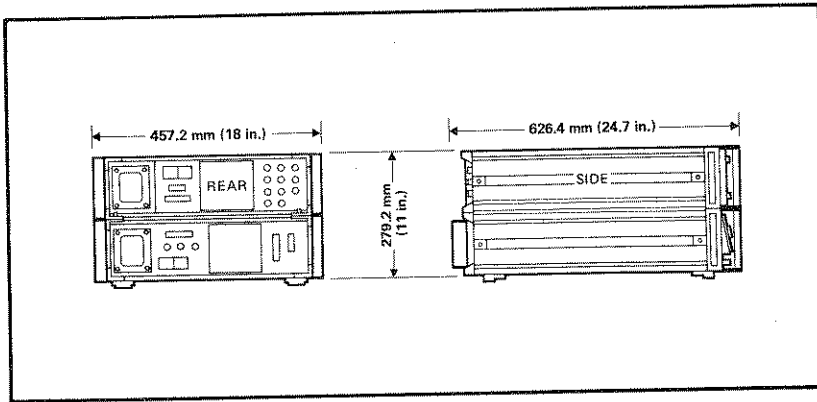

FIGURE 1. PHYSICAL DIMENSIONS WITH HANDLES

Interconnection of Sections

Place the RF Section right side up on a level work surface. Place the IF-Display Section on top of the RF Section, offset far enough forward to allow the RF Section hooks to engage the IF-Display Section frame when slid back. When the rear panel lock feet line up, tighten both lock foot thumb screws. (If the instrument is to be rack mounted with slides, the left slide panel should be changed before the interconnection – see the instructions for rack mounting with slides in this guide.)

Cable Connections

As shown in Figure 2, connect cable W30 between IF-Display Section J1 and RF Section J1. Connect cable W31 between IF-Display Section J2 and RF Section J4.

Power Requirements

The HP 8568B requires a power source of 100, 120, 220, or 240 Vac + 5% - 10%, 50-60 Hz. Power consumption for each instrument section is less than 250 volt-amperes.

Line Voltage and Fuse Selection

WARNING

BEFORE SWITCHING ON THIS INSTRUMENT, make sure it has been properly grounded through the protective conductor of the ac power cable to a socket outlet provided with protective earth contact. Any interruption of the protective (grounding) conductor inside or outside the instrument, or disconnection of the protective earth terminal, can result in personal injury.

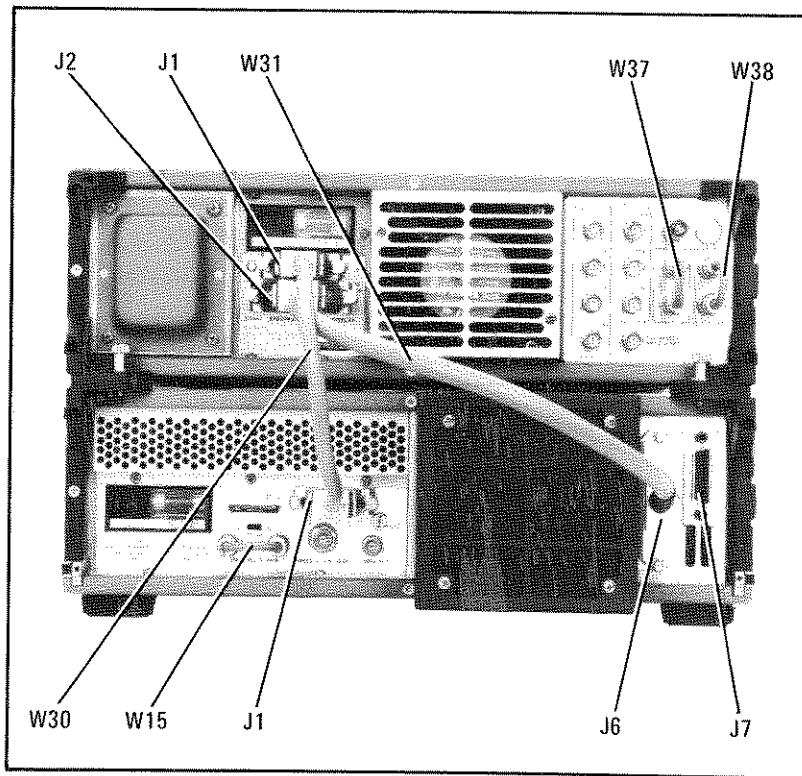

FIGURE 2. REAR PANEL WITH INTERCONNECT CABLES INSTALLED

CAUTION

BEFORE SWITCHING ON THIS INSTRUMENT, make sure it is adapted to the voltage of the ac power source. Failure to set the ac power input to the correct voltage could cause damage to the instrument when the ac power cable is plugged in.

Select the line voltage and fuses as follows:

1. Determine the ac line voltage to be used.
2. Position the power line module PC Selector board (on the rear panel of each instrument section) as shown in Figure 3. If the line voltage is not within the instrument requirements, you must use an autotransformer between the ac source and the HP 8566B.
3. Check that the required fuses are installed (in both instrument sections) as follows:

Voltage	IF-Display Section	RF Section
100/120	2 amperes FAST BLO	4 amperes FAST BLO
220/240	1 ampere SLOW BLO	2 amperes SLOW BLO

WARNING

Power is still applied to this instrument with the LINE switch in STANDBY. There is no OFF position of the LINE switch. To remove power from the instrument, it is necessary to remove the power cable from the rear of each of the instrument sections.

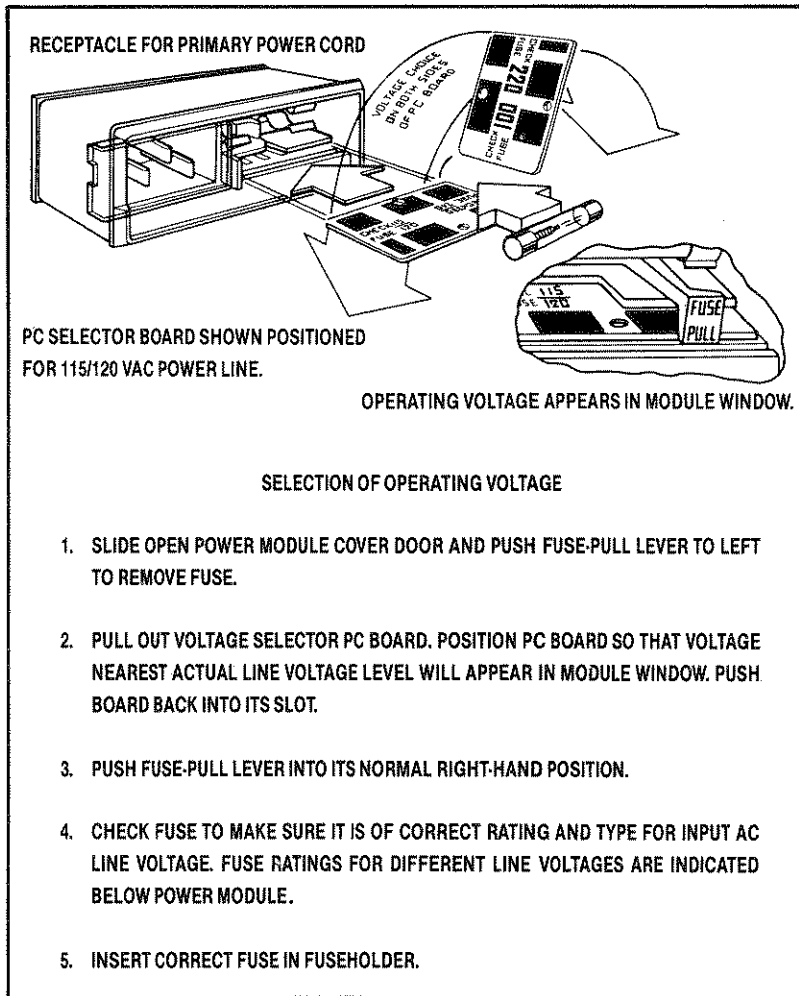

FIGURE 3. VOLTAGE SELECTION WITH POWER MODULE PC BOARD

Mating Connectors

A list of connectors on the front and rear panels of the HP 8566B is given in Table 1. The HP part number, industry identification, and alternate source for the mating connector is given for each connector on the instrument.

TABLE 1. HP 8566B MATING CONNECTORS

	Mating Connector			
	Industry Identification	HP Part Number	C D	Alternate Source
RF Section				
A6J1 CAL OUTPUT	Type BNC, male connector	1250-0061	5	Bendix 056-1
A6J2 1ST LO OUTPUT	Type SMA, male connector	1250-1544	1	Sealectro 55-628-9141-31
A6J3 RF INPUT	Type N, male connector	1250-0882	8	Specialty connector 25 P117-2
J1 IF/SWEEP	Series D, male connector	1251-4955	6	ITT Cannon DBM 5W5D
J2 EXT FREQ REFERENCE	Type BNC, male connector	1250-0061	5	Bendix 056-1
J3 INT FREQ REFERENCE	Type BNC, male connector	1250-0061	5	Bendix 056-1
J4 SWEEP + TUNE OUT	Type BNC, male connector	1250-0061	5	Bendix 056-1
J5 10 MHz OUT	Type BNC, male connector	1250-0061	5	Bendix 056-1
J6 (Analyzer Bus)	Series D, male connector 50 contact, 2 rows	1251-4400	6	Amphenol 57-30500-15
J7 (HP-IB)	Series D, male connector 24 contact, 2 rows	10833 A/B/C/D (Cables)		None
IF-Display Section				
J1	Series D, male connector	1251-4955	6	ITT Cannon DBM 5W5D
J2	Series D, male connector	1251-2245	3	TRW DDM-50P
J3-J11	Type BNC, male connector	1250-0061	5	Bendix 056-1

6 Installation

WARNING

If this instrument is to be energized through an autotransformer, make sure the common terminal of the autotransformer is connected to the protective earth contact of the power source outlet socket.

Power Cables

In accordance with international safety standards, both sections of this instrument are equipped with three wire AC power cables. If additional cables are needed, refer to the list of replaceable parts in the Service manual.

HP-IB

The instrument is shipped with the HP-IB address switch preset to 18 (ASCII 2R). If it is necessary to change the HP-IB address, refer to the Operating and Programming Manual for instructions. The HP-IB connector is J7 on the RF Section (see Figure 2).

Bench Operation

The instrument has plastic feet and foldaway tilt stands for convenience in bench operation. The plastic feet are shaped to make full width modular instruments self-aligning when stacked. The instrument is shipped with front handles attached for ease of moving.

Front Handle Removal

To install some instrument options, the front handles need to be removed. See Figure 4 for instructions. When installing an option or replacing the handles be sure that the correct size screw (as indicated in the illustrations) is used to prevent damage to the instrument.

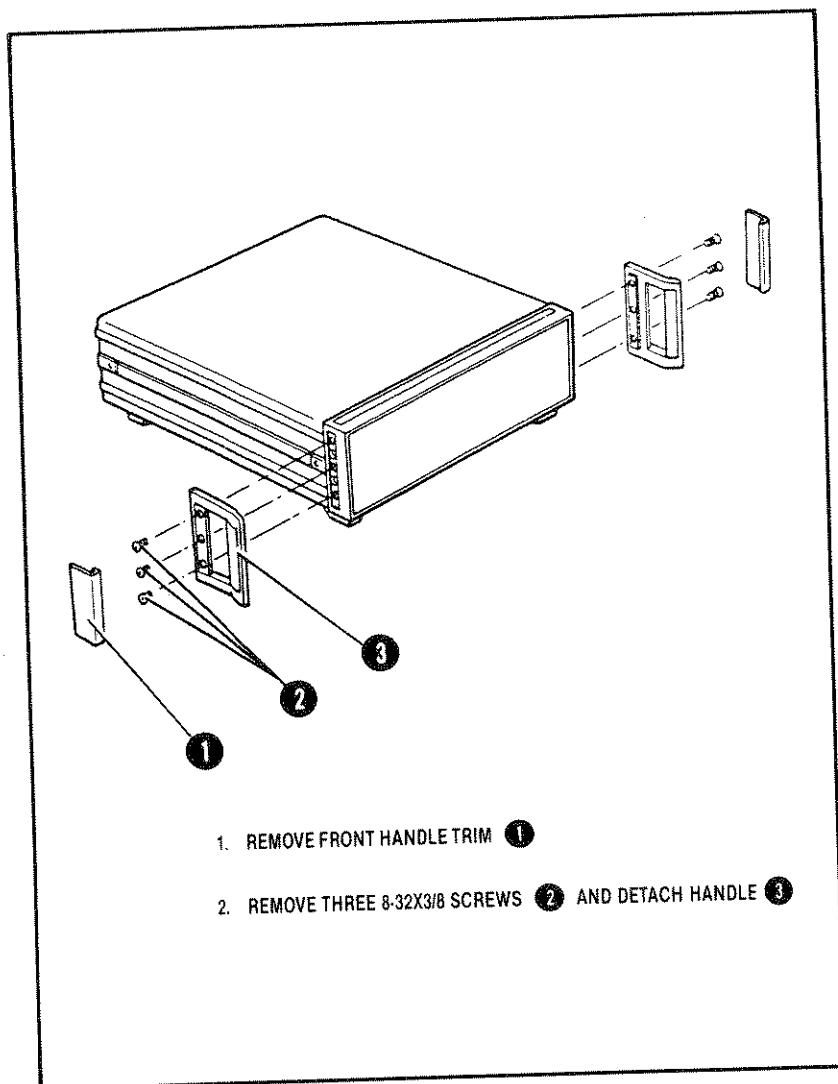

FIGURE 4. REMOVING FRONT HANDLES

Rack Mounting (Options 908 and 913)

Instrument options 908 and 913 contain the necessary hardware to mount the HP 8566B in a rack of 482.6 mm (19 inches) spacing. Option 908 is for mounting without handles (see Figure 5) and option 913 is for mounting with handles (see Figure 6).

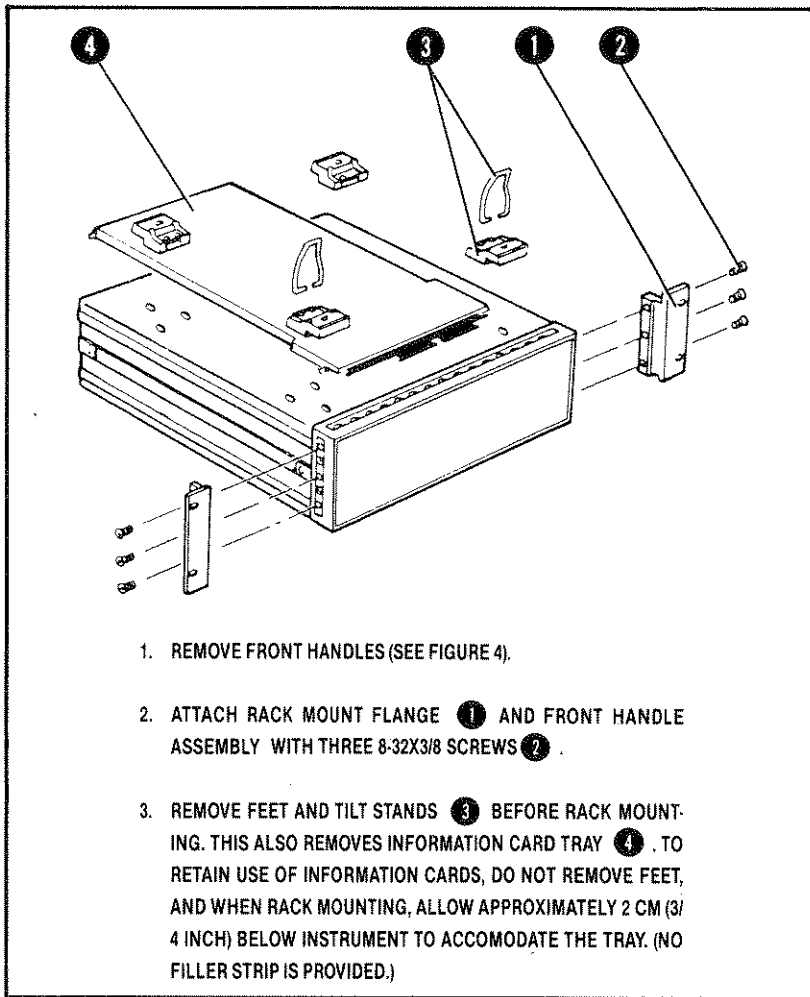

FIGURE 5. OPTION 908 ATTACHING RACK MOUNT FLANGES WITHOUT HANDLES

Rack Mounting with Slides (Option 010)

Instrument Option 010 contains the necessary hardware to mount the HP 8566B with slides in a rack of 482.6mm (19 inches) spacing. The kit also contains adapters for mounting in non-HP racks. The slides provide extra support at the sides of the instrument in the rack and, because of the weight of the instrument, are recommended. Refer to Figure 7 and the following instructions to install the slides.

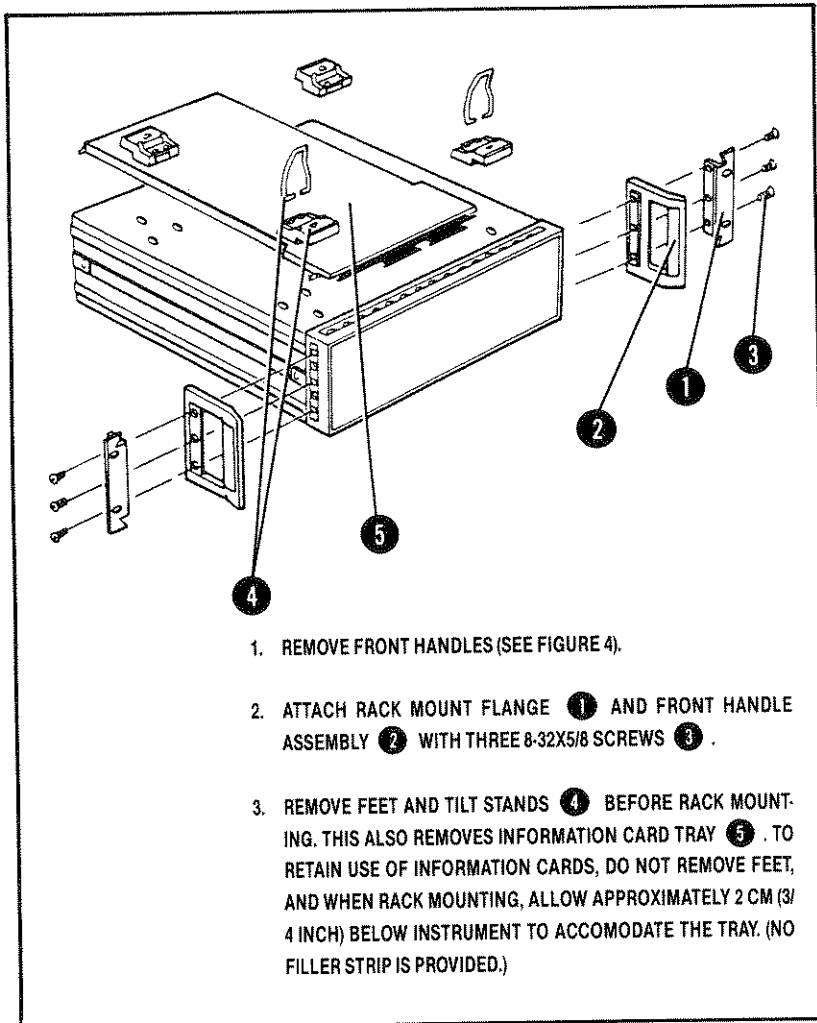

FIGURE 6. OPTION 010 ATTACHING RACK MOUNT FLANGES WITH HANDLES

1. To gain access to the slide mount holes (in the IF-Display Section), first remove the strap handle on the right side panel. Next, remove the left rear lock foot and slide the left side cover off to rear. Replace it with the panel included in the kit. (If the instrument sections are combined, move the lock foot enough for the side cover to clear, but still support the IF-Display Section.)

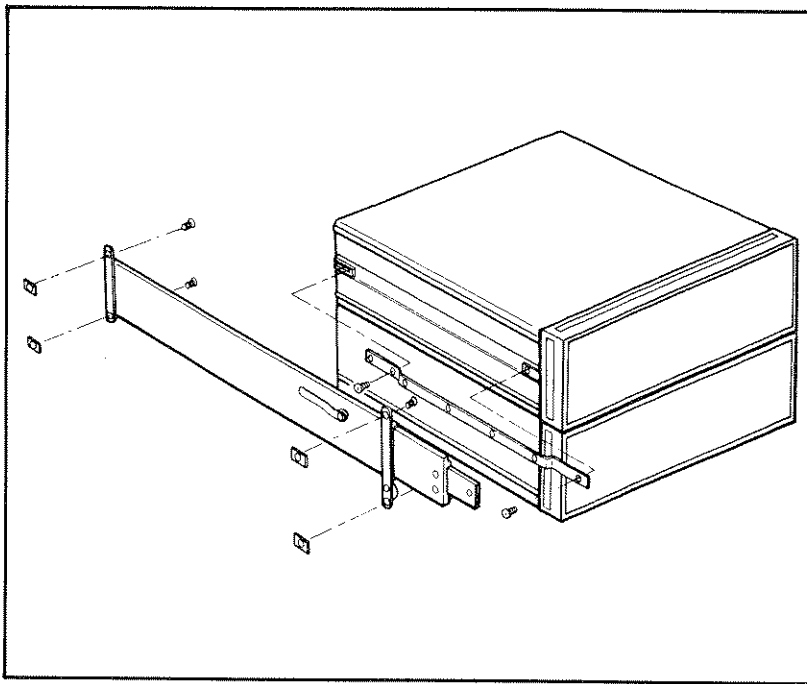

FIGURE 7. OPTION 010 ATTACHING RACK MOUNT SLIDES

2. Remove the front handles on both instrument sections and replace with the 10 1/2 inch handles and/or the 10 1/2 inch rack mount brackets supplied with the kit. (Refer to Figure 4, 5, and 6.)
3. Attach one slide inner member bracket to each side of the instrument using two 10-32 3/8-inch pan head screws per side. Attach the brackets to the inner members of the slides with four 10-32 3/8-inch flat head screws per side.
4. Insert two Unistrut Nuts into each of the four vertical columns of the enclosure and attach the slide outer members with four 10-32 7/16-inch pan head screws per side. Install the instrument by aligning the inner members (attached to instrument) with the outer members (attached to enclosure). If there is any binding, adjust the slides by supporting the instrument and loosening the screws to the Unistrut Nuts at each side of the enclosure. Adjust the slides slightly until they operate freely.



QUICK REFERENCE

INTRODUCTION

The following pages are a compilation of all current HP 8566B/8568B programming codes. More information on each operation can be found in the HP 8566B/8568B Operating and Programming Manual. For comprehensive training in the remote operation of these analyzers, the HP 8566B + 24D/8568B + 24D Spectrum Analyzer Operation Course is offered at selected HP training centers.

How to Use This Reference

This reference is intended for use by the experienced spectrum analyzer programmer.

To find a programming code which performs a particular function, first refer to the functional index which shows the programming codes grouped according to similar function. The key word and brief definition of each code are shown in this index. Once the desired key word is found, refer to the alphabetical listing of the programming codes for further key word definition and syntax information.

For further information on syntax, refer to the Notation Conventions and Syntax Conventions sections. Secondary key words are parameters appearing in capital letters within the argument of key words. Their definitions can be found in the Secondary Key Word Summary.

Notation Conventions

The following symbols and type styles found in this guide denote the following:

BOLD TYPE	All characters appearing in bold type are key words and must appear exactly as shown.
CAPITAL LETTERS	All characters which are capital letters are secondary key words and appear within the key word syntax. They must appear exactly as shown and their meanings can be found in the Secondary Key Word Summary.
< >	Characters appearing in angular brackets are considered to be elements of the language being defined. Their meanings can be found in the section on syntax conventions unless otherwise specified with the keyword definition.
[]	Square brackets indicate that whatever occurs within the brackets is optional
	“or”: Indicates a choice of exactly one element from a list (e.g. <a> indicates <a> or but not both).
()	Parentheses are used to clarify which elements are to be chosen from.
—	Indicates a space must be placed at the indicated location (e.g. A_ <a> indicates there must be a space between the key word, A , and the element, <a>).
:: =	“Is defined as” (e.g. <a>:: = <c> indicates that <a> can be replaced by the series of elements, <c> in any statement where <a> occurs).
{ }	Integers appearing in braces indicate that the integer is transmitted to the analyzer as a single 8-bit byte.
●	Indicates that the programming code applies to the HP 8566B only.
■	Indicates that the programming code applies to the HP 8568B only.

Syntax Conventions

- <A-block data field>:: =
#A<length><command list>; (use when the length of the command list is known)
- <A-block data format>:: =
#A<length><command list>
- <analyzer internal I/O bus>:: =
ASCII decimal number from 0 to 63
- <analyzer memory address>:: =
ASCII decimal number from 0 to 17,700
- <block data field>:: =
<A-block data field>|<I-block data field>
- <command list>:: = any spectrum analyzer command
- <CR>:: = {13} (ASCII carriage return)
- <delimiter>:: = <CR>|<LF>|<ETX>|,|;
- <destination>:: =
<trace label>|<variable identifier>|TRA|TRB|TRC
- <display memory address>:: =
ASCII decimal number from 0 to 4095
- <EOI>:: = end or identify
- <ETX>:: = {3} (ASCII end of text)
- <flow operand 1>:: =
<variable identifier>|<numeric data field>
- <flow operand 2>:: =
<variable identifier>|numeric data field>
- <function label>:: =
2 – 12 ASCII characters defined in the FUNCDEF statement
- <I-block data field>:: =
#I<command list>END; (use when the length of the command list is not known)
- <integer>:: = integer number

<key number>:: =
 integer 1 – 999 defined in KEYDEF statement

<length>:: = two 8-bit bytes specifying the length of the command list

<LF>:: = {10} (ASCII line feed)

<message>:: = ASCII decimal number

<numeric data field>:: = <real>

<numeric data format>:: =
 <real><CR><LF><EOI>

<operand 1>:: =
 <trace label>|<variable identifier>|<numeric data field>|TRA|TRB|TRC

<operand 2>:: =
 <trace label>|<variable identifier>|<numeric data field>|TRA|TRB|TRC

<real>:: = positive or negative real number

<string data field>:: =
 <string delimiter><command list><string delimiter>

<string delimiter>:: =
 !|”|\$|%|&|’|/|:|=|@|\|~|^

<terminator>:: =
 DM|–DM|DB|HZ|KZ|MZ|GZ|MV|UV|SC|MS|US|<delimiter>

<trace destination>:: = <trace label>|TRA|TRB|TRC

<trace label>:: =
 2 – 12 ASCII characters defined in the TRDEF statement

<trace source>:: = <trace label>|TRA|TRB|TRC

<variable identifier>:: =
 2 – 12 ASCII characters defined in the VARDEF statement

FUNCTIONAL INDEX

FREQUENCY CONTROL

CF	Specifies center frequency
CS	Couples step size
*FA	Specifies start frequency
*FB	Specifies stop frequency
FOFFSET	Specifies frequency offset
FS	Specifies full frequency span as defined by instrument
● KSQ	Unlocks frequency band
KSV	Specifies frequency offset
● KSt	Locks frequency band
■ KS =	Specifies resolution of frequency counter
■ MKFCR	Specifies resolution of frequency counter
SP	Specifies frequency span
SS	Specifies center frequency step size

INSTRUMENT STATE CONTROL

IP	Sets instrument parameters to preset values
● KST	Performs fast present 2 – 22 GHz
● KSU	Performs external mixer preset
KS(Locks save registers
KS)	Unlocks save registers
● LF	Presets 0 – 2.5 GHz
RC	Recalls previously saved state
RCLS	Recalls previously saved state
SAVES	Saves current state of the analyzer in the specified register
SV	Saves current state of analyzer in specified register
USTATE	Configures or returns configuration of user-defined states: ONEOS, ONSWP, TRMATH, VARDEF, FUNCDEF, TRDEF

AMPLITUDE CONTROL

AT	Specifies input attenuation
AUNITS	Specifies amplitude units for input, output and display
*CA	Couples input attenuation
E4	Moves active marker to reference level
*KSA	Selects dBm as amplitude units
KSB	Selects dBmV as amplitude units
KSC	Selects dBuV as amplitude units
KSD	Selects voltage as amplitude units
KSI	Extends reference level range
KSW	Performs amplitude error correction routine
KSX	Incorporates correction data in amplitude readouts

*Selected with instrument preset (IP)

KSY	Does not incorporate correction data in amplitude readouts
KSZ	Specifies reference level offset
KSq	Decouples IF gain and input attenuation
KSw	Displays correction data
KS,	Sets mixer level
LG	Selects log scale
LN	Selects linear scale
MKRL	Moves active marker to reference level
ML	Specifies mixer level
RL	Specifies reference level
ROFFSET	Specifies reference level offset

BANDWIDTH CONTROL

*CR	Couples resolution bandwidth
*CV	Couples video bandwidth
RB	Specifies resolution bandwidth
VB	Specifies video bandwidth
VBO	Specifies coupling ratio of video bandwidth and resolution bandwidth

SWEEP AND TRIGGER CONTROL

*CONTS	Selects continuous sweep mode
*CT	Couples sweep time
■ KSF	Measures sweep time
KSt	Continues sweep from marker
KSu	Stops sweep at active marker
KSx	Sets external trigger (eliminates auto-refresh)
KSy	Sets video trigger (eliminates auto-refresh)
ST	Specifies sweep time
SNGLS	Selects single sweep mode
*S1	Selects continuous sweep mode
S2	Selects single sweep mode
TM	Selects trigger mode: free run, video, line, external
TS	Takes a sweep
*T1	Sets trigger mode to free run
T2	Sets trigger mode to line
T3	Sets trigger mode to external
T4	Sets trigger mode to video

MARKER CONTROL

E1	Moves active marker to maximum signal detected
E2	Moves marker frequency into center frequency
E3	Moves marker or delta frequency into step size
E4	Moves active marker to reference level
● KSK	Moves active marker to next highest peak

*Selected with instrument preset (IP)

KSL	Turns off average noise level marker
KSM	Returns average value at marker, normalized to 1 Hz bandwidth
● KSN	Moves active marker to minimum value detected
KSO	Moves marker delta frequency into span
■ KSt	Continues sweep from marker
KSu	Stops sweep at active marker
■ KS =	Specifies resolution of marker frequency counter
KS{92}	Enters DL, TH, M2, M3 in display units
MA	Returns marker amplitude
■ *MCO	Turns off marker frequency count
■ MCI	Turns on marker frequency count
MF	Returns marker frequency
MKA	Specifies amplitude of active marker
MKACT	Specifies active marker: 1, 2, 3, or 4
MKCF	Enters marker frequency into center frequency
MKCONT	Continues sweep from marker
MKD	Moves delta marker to specified frequency
MKF	Specifies frequency of active marker
■ MKFC	Counts marker frequency for greater resolution (See MKFCR)
■ MKFCR	Specifies resolution of marker frequency counter
MKMIN	Moves active marker to minimum signal detected
MKN	Moves active marker to specified frequency or center screen
MKNOISE	Returns average value at marker, normalized to 1 Hz bandwidth
MKOFF	Turns all markers, or the active marker off
MKP	Specifies marker position horizontally, in display units
MKPAUSE	Pauses sweep at marker for duration of specified delay time (in seconds)
MKPK	Moves active marker to maximum signal detected, or to adjacent signal peaks
* MKPX	Specifies minimum excursion for peak identification. Preset value is 6 dB
MKREAD	Specifies marker readout mode
MKRL	Moves active marker to reference level
MKSP	Moves marker delta frequency into span
MKSS	Moves marker frequency to center frequency step size
MKSTOP	Stops sweep at active marker
MKTRACE	Moves active marker to corresponding position on another specified trace
MKTRACK	Turns marker signal track on or off
MKTYPE	Sets marker type
* MT0	Turns off marker signal track
MT1	Turns on marker signal track
* M1	Turns off active marker
M2	Turns on active marker and moves it to center screen
M3	Turns on delta marker
M4	Turns on marker zoom

*Selected with instrument preset (IP)

COUPLING CONTROL

- *CA Couples input attenuation
- *CR Couples resolution bandwidth
- *CS Couples step size
- *CT Couples sweep time
- *CV Couples video bandwidth
- *VBO Specifies coupling ratio of video bandwidth and resolution bandwidth

PRESELECTOR CONTROL

- FPKA Performs fast preselector peak and returns measured value of active marker
- KSJ Allows manual control of DAC
- KS# Turns off YTX self-heating correction
- KS/ Allows manual peaking of preselector
- KS= Selects factory preselector setting
- PP Peaks preselector

RF INPUT CONTROL

- I1 Enables left RF input
- *I2 Enables right RF input

EXTERNAL MIXING COMMANDS

- KSU Performs external mixer preset
- KSv Identifies signals for external mixing frequency bands

Additional external mixing commands can be found on page 41.

DISPLAY CONTROL

- *ANNOT Turns annotation on or off. Preset condition is on.
- AUNITS Specifies amplitude units for input, output, and display
- DL Specifies display line level in dBm
- DLE Turns display line on and off
- *GRAT Turns graticule on or off. Preset condition is on.
- KSg Turns off CRT beam
- *KSh Turns on CRT beam
- KSm Turns off graticule
- *KSn Turns on graticule
- KSo Turns off annotation
- *KSp Turns on annotation
- *LG Selects log scale
- LN Selects linear scale
- *LO Turns off display line
- TH Specifies display threshold value
- THE Turns threshold on or off
- *TO Turns off threshold
- TRGRPH Dimensions and graphs a trace

*Selected with instrument preset (IP)

READING AND WRITING DISPLAY MEMORY

*DA	Specifies display address
DD	Writes to display
DR	Reads display and increments address
DSPLY	Displays the value of a variable on the analyzer screen
DT	Defines a character for label termination
DW	Writes to display and increments address
*D1	Sets display to normal size
D2	Sets display to full CRT size
D3	Sets display to expanded size
*EM	Erases trace C memory
GR	Graphs specified y values on CRT
*HD	Holds or disables data entry and blanks active function CRT readout
IB	Inputs trace B in binary units
KSE	Sets title mode
KS{39}	Writes to display memory in fast binary
KS{125}	Writes to display memory in binary
KS{127}	Prepares analyzer to accept binary display write commands
LB	Writes specified characters on CRT
OP	Returns lower left and upper right vertices of display window
PA	Draws vectors to specified x and y positions
*PD	Turns on beam to view vector
PR	Draws vector from last absolute position
PS	Skips to next display page
PU	Turns off beam, blanking vector
SW	Skips to next control instruction
TEXT	Writes text string to screen at current pen location

TRACE PROCESSING

*A1	Clear-writes trace A
A2	Max holds trace A
A3	Stores and views trace A
A4	Stores and blanks trace A
B1	Clear-writes trace B
B2	Max holds trace B
B3	Stores and views trace B
*B4	Stores and blanks trace B
BLANK	Stores and blanks specified trace register
CLRW	Clear-writes specified trace register
KSj	Stores and views trace C
KSk	Stores and blanks trace C
KS{39}	Writes to display memory in fast binary
KS{123}	Reads display in binary units

*Selected with instrument preset (IP)

KS{125}	Writes to display memory in binary units
KS{126}	Outputs every nth value of trace
MOV	Moves source to the destination
MXMH	Max holds the specified trace register
TA	Outputs trace A
TB	Outputs trace B
TRDSP	Turns specified trace on or off, but continues taking information
VIEW	Views specified trace register

TRACE MATH

AMB	A - B into A
AMBPL	(A - B) + DL into A
APB	A + B into A
AXB	Exchanges A and B
BL	B - DL into B
BML	B - DL into B
BTC	B into C
BXC	Exchanges B and C
*C1	A - B off
C2	A - B into A
EX	Exchanges A and B
KSG	Turns on video averaging
*KSH	Turns off video averaging
KSc	A + B into A
KSi	Exchanges B and C
KSI	B into C
TRMATH	Executes trace math or user-operator commands at end of sweep
VAVG	Turns video averaging on or off

OTHER TRACE FUNCTIONS

AUNITS	Specifies amplitude units for input, output, and display
COMPRESS	Compresses trace source to fit trace destination
CONCAT	Concatenates operands and sends new trace to destination
DET	Specifies input detector type
FFT	Performs a forward fast fourier transform
*KSa	Selects normal detection
KSb	Selects position peak detection
KSc	Selects negative peak detection
KSe	Selects sample detection
MEAN	Returns trace mean
ONEOS	Executes specified command(s) at end of sweep
ONSWP	Executes specified command(s) at start of sweep
PDA	Returns probability density of amplitude
PDF	Returns probability density of frequency
PEAKS	Returns number of peak signals

*Selected with instrument preset (IP)

PWRBW	Returns bandwidth of specified percent of total power
RMS	Returns RMS value of trace in display units
SMOOTH	Smooths trace over specified number of points
STDEV	Returns standard deviation of trace amplitude in display units
SUM	Returns sum of trace element amplitudes in display units
SUMSQR	Squares trace element amplitudes and returns their sum
TRDEF	Defines user-defined trace
TRGRPH	Dimensions and graphs a trace
TRPRST	Sets trace operations to preset values
TRSTAT	Returns current trace operations
TWNDOW	Formats trace information for fast fourier analysis (FFT)
VARIANCE	Returns amplitude variance of trace

USER-DEFINED COMMANDS

*DISPOSE	Frees memory previously allocated by user defined functions. Instrument preset disposes ONEOS, ONSWP, and TRMATH functions.
FUNCDEF	Assigns specified program to function label
KEYDEF	Assigns function label to softkey number (See FUNCDEF)
KEYEXC	Executes specified softkey
MEM	Returns amount of allocatable memory available for user-defined commands
ONEOS	Executes specified command(s) at end of sweep
ONSWP	Executes specified command(s) at start of sweep
TRDEF	Defines user-defined trace
TRMATH	Executes specified trace math or user-operator commands at end of sweep
USTATE	Configures or returns configuration of user-defined state: ONEOS, ONSWP, TRMATH, VARDEF, FUNCDEF, TRDEF
*VARDEF	Defines variable name and assigns real value to it. Preset reassigns initial value to variable identifier.

PROGRAM FLOW CONTROL

IF	Compares two specified operands. If condition is true, executes commands until next ELSE or ENDIF statements are countered
THEN	No-operation function
ELSE	Delimits alternate condition of IF command
ENDIF	Delimits end of IF command
REPEAT	Delimits the top of the REPEAT UNTIL looping construct
UNTIL	Compares two specified operands. If condition is true, commands are executed following this command. If condition is false operands are executed following the previous REPEAT command.

*Selected with instrument preset (IP)

MATH FUNCTIONS

ADD	Operand 1 + operand 2 into destination
AVG	Operand is averaged into destination
CONCAT	Concatenates two operands and sends new trace to destination
CTA	Converts operand values from display units to measurement units
CTM	Converts operand values from measurement units to display units
DIV	Operand 1 / operand 2 into destination
EXP	Operand is divided by specified scaling factor before being raised as a power of 10
LOG	LOG of operand is taken and multiplied by specified scaling factor
MIN	Minimum between operands is stored in destination
MOV	Source is moved to destination
MPY	Operand 1 * operand 2 into destination
MXM	Maximum between operands is stored in destination
SQR	Square root of operand is stored in destination
SUB	Operand 1 - operand 2 into destination
XCH	Contents of the two destinations are exchanged

Operations on specific traces (A, B, and C) can be found in the Trace Math section.

INFORMATION AND SERVICE DIAGNOSTICS COMMANDS

BRD	Reads data word at analyzer's internal input/output bus
BWR	Writes data word to analyzer's internal input/output bus
ERR	Returns results of processor test
ID	Returns the HP model number of analyzer used (HP 8566B or HP 8568B)
● KSF	Shifts YTO by intermediate frequency
■ KSF	Measures sweep time
■ KSJ	Allows manual control of DAC
■ KSK	Counts pilot IF at marker
■ KSN	Counts voltage-controlled oscillator at marker
● KSQ	Unlocks frequency band
■ KSQ	Counts signal IF
KSR	Turns frequency diagnostics on
■ *KSS	Second LO frequency is determined automatically
■ KST	Shifts second LO down
■ KSU	Shifts second LO up
KSf	Recovers last instrument state at power on
KSq	De-couples IF gain and input attenuation
KSr	Sets service request 102

*Selected with instrument preset (IP)

● KS_t	Locks frequency band
■ KS_i	Continues sweep from marker
KS_u	Stops sweep at active marker
■ KS_v	Inhibits phase lock
KS_w	Displays correction data
■ KS =	Specifies resolution of frequency counter
● KS =	Selects factory preselector setting
■ KS >	Specifies preamp gain for signal input 1
■ KS <	Specifies preamp gain for signal input 2
● KS #	Turns off YTX self-heating correction
● KS /	Selects manual preselector peak
MBRD	Reads specified number of bytes starting at specified address and returns to controller
MBWR	Writes specified block data field into analyzer's memory starting at specified address
MRD	Reads two-byte word starting at specified analyzer memory address and returns word to controller
MRDB	Reads 8-bit byte contained in specified address and returns byte to controller
MWR	Writes two-byte word to specified analyzer memory address
MWRB	Writes one-byte message to specified analyzer memory address
REV	Returns analyzer revision number
RQS	Returns decimal weighting of status byte bits which are enabled during service request

OUTPUT FORMAT CONTROL

DR	Reads display and increments address
DSPLY	Displays value of variable on analyzer screen
EE	Enables front panel number entry
KSJ	Allows manual control of DAC
KSP	Sets HP-IB address
● KSS	Sets fast HP-IB
KS{91}	Returns amplitude error
● KS{94}	Returns code for harmonic number in binary
KS{123}	Reads display in binary units
KS{126}	Returns every nth value of trace
LL	Provides lower left x-y recorder output voltage at rear panel
MA	Returns marker amplitude
* MDS	Specifies measurement data size to byte or word. Preset condition is word.
MDU	Returns values of CRT baseline and reference level
MF	Returns marker frequency
OA	Returns active function
OL	Returns learn string
OT	Returns display annotation

*Selected with instrument preset (IP)

- O1** Selects output format as integers (ASCII) representing display units or display memory instruction words
- O2** Selects output format as two 8-bit bytes
- *O3** Selects output format as real numbers (ASCII) in Hz, volts, dBm, or seconds
- O4** Selects output format as one 8-bit byte
- TA** Outputs trace A
- TB** Outputs trace B
- *TDF** Selects trace data output format as O1, O2, O3, O4, A-block data field, or I-block data field. Preset format is O3.
- UR** Provides upper right x-y recorder output voltage at rear panel

SYNCHRONIZATION

- DONE** Sends message to controller after preceding commands are executed
- TS** Takes a sweep

SERVICE REQUEST

- KSr** Allows service request 102
- KS{43}** Allows service request 140 and 102
- RQS** Returns decimal weighting of status byte bits which are enabled during service request
- R1** Resets service request 140
- R2** Allows service request 140 and 104
- *R3** Allows service request 140 and 110
- R4** Allows service request 140 and 102
- SRQ** Sets service request is operand bits are allowed by RQS

SRQ	COMMAND	BIT	DEFINITION
102	R4	1	units key pressed
102	● KS{43}	1	frequency limit exceeded
104	R2	2	end of sweep
110	R3	3	hardware broken
120	RQS	4	command complete – input buffer empty
140	all	5	illegal command
1xx	–	6	universal HP-IB service

*Selected with instrument preset (IP)

PLOTTER OUTPUT

LL	Provides lower left x-y recorder output voltage at rear panel
PLOT	Plots CRT. Scaling points, P1 and P2 must be specified and must be compatible with plotter.
P1x	Represents first x-axis scaling point to be specified in PLOT command
P1y	Represents first y-axis scaling point to be specified in PLOT command
P2x	Represents second x-axis scaling point to be specified in PLOT command
P2y	Represents second y-axis scaling point to be specified in PLOT command
UR	Provides upper right x-y recorder output voltage at rear panel

MEMORY INFORMATION

*EM	Erases trace C memory
KSz	Sets display storage address
KS 	Writes to display storage
MEM	Returns amount of allocatable memory available for user-defined commands, in bytes

TRACKING GENERATOR APPLICATION

■ *KSS	Second LO frequency is determined automatically
■ KST	Shifts second LO down (necessary for HP 8444A-059 operation in spans <1 MHz)
■ KSU	Shifts second LO up

OPERATOR ENTRY

EE	Enables front panel data number entry
EK	Enables DATA knob
EP	Enables manual entry into specified command
*HD	Holds or disables data entry and blanks active function CRT readout
KS	Shifts front panel keys

*Selected with instrument preset (IP)

Programming Codes

A

ADD_<destination>,<operand 1>,<operand 2>;
Adds the operands and sends the sum to the destination.

AMB;
Subtracts trace B from trace A and sends the result to trace A.

AMBPL;
Subtracts trace B from trace A, adds the display line value to the difference, and sends the result to trace A.

ANNOT_ON|OFF|?
Turns the display annotation on or off. IP turns on the annotation.
Query response: ON|OFF

APB;
Adds trace A and trace B and sends the result to trace A.

AT_(<real>[DB])|UP|DN|EP|?;
Specifies the RF input attenuation. Default units are DB.
Query response: <numeric data format>

AUNITS_V|DBM|DBMV|DBUV|?;
Specifies the amplitude units for input, output and display.

AVG_<destination>,<operand 1>,<average count>;
Computes the average value of the operand and the destination according to the following algorithm:
$$\frac{(N - 1)\langle \text{destination} \rangle + \langle \text{operand 1} \rangle}{N}$$

where N is the specified average count
<average count>:: = integer which selects the counter value

AXB;
Exchanges trace A and trace B.

A1;
Clear-writes trace A. Selected with IP.

A2;
Updates each element of trace A with the maximum level detected.

A3;
Stores and views trace A.

A4;
Stores and blanks trace A.

B

- BL;**
Subtracts the display line from trace B and sends the result to trace B.
- BLANK_(TRA|TRB|TRC);**
Stores and blanks the specified trace register.
- BML;**
Subtracts the display line from trace B and sends the result to trace B.
- BRD_<analyzer memory address>;**
Reads the two-byte word at the analyzer's internal input/output bus, at the specified address.
- BTC;**
Transfers trace B to trace C.
- BWR_<analyzer internal I/O bus>,<message>;**
Writes a two-byte word to the analyzer's internal input/output bus, at the specified address.
<message>:: = ASCII decimal number representing a two-byte word
- BXC;**
Exchanges trace B and trace C.
- B1;**
Clear-writes trace B.
- B2;**
Updates each element of trace B with the maximum level detected.
- B3;**
Stores and views trace B.
- B4;**
Stores and blanks trace B. Selected with IP.

C

- CA;**
Couples the RF input attenuator. Selected with IP.
- CF_(<real>[HZ|KZ|MZ|GZ])|UP|DN|EP|?);**
Specifies the center frequency. Default units are Hz.
Query response: <numeric data format>
- CLRAVG;**
Sets the average counter to 1.

CLRW_(TRA|TRB);

Clear-writes the specified trace register.

COMPRESS_<destination>,<source>,(AVG|POS|NEG|NRM|PK-PIT|PK-AVG|SMP)

Compresses the trace source to fit the trace destination according to the specified compression algorithm.

<destination>:: = <trace label>

<source>:: = <trace label>

CONCAT_<trace destination>,<trace operand>,<trace operand>;

Concatenates the trace operands and sends the new trace array to the destination.

<trace operand>:: = <trace label>|TRA|TRB|TRC

CONTS;

Selects continuous sweep mode. Selected with IP.

CR;

Couples the resolution bandwidth. Selected with IP.

CS;

Couples the center frequency step size. Selected with IP.

CT;

Couples the sweep time. Selected with IP.

CTA_<destination>,<operand>;

Converts the operand values from display units to dBm.

<destination>:: = <variable identifier>

<operand>:: = <variable identifier>

CTM_<destination>,<operand>;

Converts the operand values from dBm units to display units.

<destination>:: = <variable identifier>

<operand>:: = <variable identifier>

CV;

Couples the video bandwidth. Selected with IP.

C1;

Turns off the A – B into A function. Selected with IP.

C2;

Subtracts trace B from trace A and sends the result to trace A.

D

DA<display memory address>;

Specifies the analyzer display memory address.

[DA<display memory address>;**DD**<binary value><binary value>

Writes the specified 8-bit-binary bytes into the specified analyzer display memory address.

<binary value>::8-bit binary number

DET_POS|NEG|NRM|SMP|?;

Selects the specified analyzer input detection.

Query response: POS|NEG|NRM|SMP

DISPOSE_<operand>;

Frees memory previously allocated by the specified operand. DISPOSE ALL clears all operands. IP disposes ONEOS, ONSWP, and TRMATH functions.

<operand>:: = <variable identifier>|<trace label>|<function label>|ONEOS|ONSWP|TRMATH|<key number>|ALL

DIV_<destination>,<operand 1>,<operand 2>;

Divides operand 1 by operand 2 and sends the result to the destination.

DL_(<real>[DM|MV|UV])|UP|DN|EP|?];

Specifies a display line level that is displayed on the CRT. Default units are dBm.

Query response: <numeric data format>

DLE_ON|OFF|?;

Turns the display line on or off.

Query response: ON|OFF

[TS;]<command list>;**DONE**;

This command is a synchronizing function that sends a 1 to the controller after the command list has been executed. If a TS (take sweep) precedes the command list, execution of the command list begins after the sweep is completed.

[O1|O2|O3|O4;][**DA**<display memory address>;**DR**;

Returns the contents of the specified analyzer display memory address.

The contents are formatted and each DR increments the display address by 1.

DSPLY_<variable identifier>,<field width>.<decimal places>;

Displays the current value of a variable on the analyzer screen.

<field width>:: = integer specifying the total number of characters displayed

<decimal places>:: = integer specifying the number of digits to the right of the decimal point

DT<character>;
Establishes a character for label termination or for title (KSE) entry termination.
<character>:: = any ASCII character

[DA<display memory address>;**DW**[<real><terminator>]
Writes the value in the entry to the specified display memory address and increments the address by 1. This operation can also be done via the front panel using KS|.

D1;
Sets the display to normal size. Selected with IP.

D2;
Sets the display to full CRT size.

D3;
Sets the display to expanded size.

E

EE;
Allows the operator to make an entry to the DATA buffer with the DATA number/units front panel keyboard.

EK;
Allows the operator to change the active function value with the front panel DATA knob.

IF_<flow operand 1>,(GT|LT|EQ|NE|GE|LE),<flow operand 2>**[THEN]**
<command list>**[ELSE**<command list>**]ENDIF**;
Compares flow operand 1 to flow operand 2. If the condition is true, the command list is executed. Otherwise, commands following the next ELSE or ENDIF statements are executed.

EM;
Replaces trace C memory (3073-4095) with an end of memory word, 1044, and resets the display address to 3072. Selected with IP.

IF_<flow operand 1>,(GT|LT|EQ|NE|GE|LE),<flow operand 2>**[THEN-**
<command list>**[ELSE**<command list>**]ENDIF**;
Compares flow operand 1 to flow operand 2. If the condition is true, the command list is executed. Otherwise, commands following the next ELSE or ENDIF statements are executed.

ERR?;
Queries the results of the processor test (which is performed during instrument turn-on) and returns a list of integer numbers to the controller.

EX;
Exchanges trace A and trace B.

EXP_<destination>,<operand 1>,<scaling factor>;

The operand is divided by the specified scaling factor before being raised as a power of 10.

<scaling factor>:: = <variable identifier>|<numeric data field>

E1;

Moves the active marker to the maximum signal detected.

E2;

Moves the active marker frequency into the center frequency.

E3;

Moves the active marker frequency or the delta marker frequency into the center frequency step size.

E4;

Moves the active marker to the reference level.

F

FA_(<real>[HZ|KZ|MZ|GZ])|UP|DN|EP|?);

Specifies the start frequency. Default units are Hz. Selected with IP.

Query response: <numeric data format>

FB_(<real>[HZ|KZ|MZ|GZ])|UP|DN|EP|?);

Specifies the stop frequency. Default units are Hz. Selected with IP.

Query response: <numeric data format>

FFT_<trace destination>,<trace source>,<window>;

Performs a forward fast fourier transform on the source trace and sends the results to the destination trace. Before executing FFT, a trace window must be defined with the TWINDOW command, for proper formatting. (See TWINDOW.)

<window>:: = <trace label>

FOFFSET_(<real>[HZ|KZ|MZ|GZ])|EP|?);

Specifies the frequency offset for all absolute frequency readouts such as center frequency. Default units are Hz.

Query response: <numeric data format>

● **FPKA;**

Performs a fast preselector peak and returns the measured value at the active marker.

FS;

Selects the full frequency span as defined by the instrument.

FUNCDEF_<function label>,<string data field>|<block data field>|?);

Assigns the specified program to the function label. After FUNCDEF is executed, the program is executed whenever the function label is encountered.

Query response: <A-block data format>

[D1|D2|D3];[DA<display memory address>];GR<y-value>;

Graphs successive y-values as amplitudes on the CRT, incrementing horizontal positions by 1 from left to right for each y-value specified. Trace starts at x = 0 position.

<y-value>:: = <integer><delimiter>[y-value]

GRAT_ON|OFF|?;

Turns the graticule on or off. IP turns on the graticule.

Query response: ON|OFF

HD;

Holds or disables data entry and blanks the active function CRT readout.

Selected with IP.

IB<entry>;

Sends the specified entry into trace B beginning at display address 1025.

<entry>:: = exactly 2002, 8-bit binary bytes

ID;

Returns the HP model number of the analyzer being used (HP 8566B or HP 8568B)

**IF_<flow operand 1>,(GT|LT|EQ|NE|GE|LE),<flow operand 2>[THEN]
<command list>[ELSE]<command list>ENDIF;**

Compares flow operand 1 to flow operand 2. If the condition is true, the command list is executed. Otherwise, commands following the next ELSE or ENDIF statements are executed.

IP;

Sets instrument parameters to their preset values.

■ I1;

Enables the left RF input.

■ I2;

Enables the right RF input. Selected with IP.

KEYDEF_<key number>,(<function label>|?);

Assigns the previously defined function label (see FUNCDEF) to the specified softkey number. Once this command is executed, the command list assigned to the function label can be executed by pressing SHIFT, the key number, and the Hz on the front panel.

Query response: <A-block data format>

KEYEXC_<key number>;

Executes the previously assigned softkey number. (See KEYDEF.)

KS;

Shifts the front panel key functions.

KSA;

Selects dBm as amplitude units. Selected with IP.

KSB;

Selects dBmV as amplitude units.

KSC;

Selects dB μ V as amplitude units.

KSD;

Selects voltage as amplitude units.

KSE;

Sets the analyzer to title mode where characters called from the analyzer character set are displayed on the top line of the CRT. Up to 64 characters can be displayed.

●KSF;

Shifts the YTO by the intermediate frequency.

■KSF;

Measures the sweep time.

KSG[<average length>];

Turns on the video averaging.

<average length>:: = real number representing the maximum number of sweeps executed for averaging. Default length is 100.

KSH;

Turns off the video averaging. Selected with IP.

KSI;

Allows the reference level to be extended up to +60 dBm.

●KSJ_<real><delimiter>

Allows manual control of the DACs. All delimiters set the following DACs to the same specified value:

- PLL 2 pre-tune
- span attenuator
- scan time
- auxilliary offset
- YTX DAC
- YTX pre-tune DAC

■KSJ_<real>(HZ|KZ|MZ|GZ|UP|DN|<CR>|<LF>|<ETX>|;|,)

Allows manual control of the DACs.

The terminators specify which DAC is to be set to the specified value:

- HZ sets value of L.S. YTO DAC
- KZ sets value of M.S. YTO DAC
- MZ sets value of YTO DAC
- GZ sets value of SCAN ATTEN
- UP and DN step all DACs by power of 2
- <CR>|<LF>|<ETX>|;|, set all DACs to the specified value.

- **KSK;**
Moves the active marker to the next highest peak.
- **KSK;**
Counts the pilot IF at the marker.
- KSL;**
Turns off the average noise level marker. Selected with IP.
- KSM;**
Returns the average value at the marker, normalized to a 1 Hz bandwidth.
- **KSN;**
Moves the active marker to the minimum value detected.
- **KSN;**
Counts the voltage-controlled oscillator at the marker.
- KSO;**
Moves the marker delta frequency into the frequency span.
- KSP<integer>HZ;**
Sets the analyzer's HP-IB address.
- **KSQ;**
Unlocks the frequency band.
- **KSQ;**
Counts the signal intermediate frequency.
- KSR;**
Turns the frequency diagnostics on.
- **KSS;**
Selects fast HP-IB I/O format.
- **KSS;**
Automatically determines the second LO frequency. Selected with IP.
- **KST;**
Performs a fast preset, 2 – 22 GHz.
- **KST;**
Shifts the second LO down.
- **KSU;**
Performs an external mixer preset.
- **KSU;**
Shifts the second LO up.

KSV[_(<real>[HZ|KZ|MZ|GZ])|EP|?];
Specifies the frequency offset for all absolute frequency readouts such as center frequency. Default units are Hz.
Query response: <numeric data format>

KSW;
Performs an amplitude error correction routine.

KSX;
Incorporates the correction data (see KSW) in amplitude readouts.

KSY;
Does not incorporate the correction data in amplitude readouts.

KSZ[_(<real>[DM|MV|UV|])|EP|?];
Specifies the reference level offset. Default units are dB.
Query response: <numeric data format>

KSa;
Selects normal detection. Selected with IP.

KSb;
Selects positive peak detection.

KSc;
Adds trace A and trace B and sends the result to trace A.

KSd;
Selects negative peak detection.

KSe;
Selects sample detection.

KSf;
Recovers the last instrument state at power on.

KSg;
Turns off the CRT beam.

KSh;
Turns on the CRT beam.

KSi;
Exchanges trace B and trace C.

KSj;
Views trace C.

KSk;
Blanks trace C.

KSl;
Moves trace B into trace C.

KSm;
Turns off the graticule.

KSn;
Turns on the graticule. Selected with IP.

KSo;
Turns off the annotation.

KSp;
Turns on the annotation. Selected with IP.

KSq;
Decouples the IF gain and the RF input attenuation.

KSr;
Sets service request 102.

● **KSt;**
Locks the frequency band.

■ **KSt;**
Continues sweeping from the marker.

KSu;
Stops the sweep at the active marker when the analyzer is in single sweep mode. (See S1 or SINGLS.)

● **KSv;**
Identifies signals for external mixing frequency bands.

■ **KSv;**
Inhibits the phase lock.

KSw;
Displays the amplitude error correction data.

KSx;
Sets the trigger mode to external, but eliminates the auto-refresh.

KSy;
Sets the trigger mode to video, but eliminates the auto-refresh.

KSz;
Sets the display storage address.

KS[_(<real>[DM|MV|UV])|EP|?];
Specifies the mixer level. Default units are dBm.
<real>:: = integer multiple of 10.
Query response: <numeric data format>

●**KS** = ;
Selects the factory preselector setting.

■**KS** = [_(<real>[HZ|KZ|MZ|GZ])|EP|?];
Specifies the resolution of the marker frequency counter. Default units are Hz.
Query response: <numeric data format>

KS (;
Locks the save registers.

KS);
Unlocks the save registers.

KS | ;
See DW.

■**KS** > [_(<real>[DB])|EP|?];
Specifies the preamp gain for signal input 2. Default units are dB.
Query response: <numeric data format>

■**KS** < [_(<real>[DB])|EP|?];
Specifies the preamp gain for signal input 1. Default units are dB.
Query response: <numeric data format>

●**KS** # ;
Turns off the YTX self-heating correction.

●**KS** / ;
Allows the preselector to be peaked manually.

KS {39} <display memory address> <display write commands> <terminator>
Writes to display memory in fast binary.
<display memory address>:: = two 8-bit binary bytes
<display write commands>:: = two 8-bit binary bytes

●**KS** {43} <terminator>
Sets SRQ 102 when the frequency limit is exceeded.

KS {91} ;
Returns the amplitude error.

(DL|TH|M2|M3); **KS** {92} <value> <terminator>
Specifies the value of the display line, threshold, active marker, or the delta marker in display units.
<value>:: = integer in display units

●**KS{94};**

Returns the code for the harmonic number in binary.

(O1|O2|O3|O4);DA<display memory address>;KS{123};

Returns up to 1001 words of display memory beginning at the address specified.

DA<display memory address>;KS{125}<entry>;

Writes up to 1001 display memory words (two bytes per word), beginning at the address specified.

<entry>:: = up to 2002 eight bit binary bytes

(O1|O2|O3|O4);DA<display memory address>;KS{126}<N>;

Returns every Nth value of a trace.

<N>:: = integer from 1 to 1001

DA<display memory address>;KS{127}<entry>;

Prepares the analyzer to accept binary display write commands, input as a part of 2 eight bit bytes.

<entry>:: = the number of pairs of bytes to be sent as a pair of 2 eight bit bytes.

L

LB<character string><label terminator>;

Writes the specified characters on the CRT display. The first character appears at the current CRT beam position. (See PA and PR.)

<character string>:: = any ASCII character

<label terminator>:: = <ETX>|<character specified in DT command>

●**LF;**

Presets the analyzer 0 – 2.5 GHz.

LG__{[(<integer>[DB])|UP|DN|EP|?];}

Specifies the scale of the logarithmic display. Default units are dB. 10 dB per division is selected with IP.

Query response:: = <numeric data format>

A query response of zero indicates a linear scale.

LL;

Provides the lower left recorder output voltage at the rear panel.

LN;

Selects the linear scale.

LOG__{<destination>,<operand 1>,<scaling factor>}

The log of the operand is taken, multiplied by the specified scaling factor and the result is sent to the destination.

<scaling factor>:: = <variable identifier>|<numeric data field>;

LO;

Turns off the display line.

M

[O1|O2|O3|O4;]MA;

Returns the amplitude of the active marker.

MBRD_<analyzer memory address>,<number of bytes>

Reads the specified number of bytes starting at the specified address and returns the bytes to the controller.

<number of bytes>:: = ASCII decimal number indicating the number of bytes to be read

MBWR_<analyzer memory address>(<string data field>|<block data field>);

Writes the specified data field into the analyzer's memory starting at the specified address.

■ **MC0;**

Turns off the marker frequency counter. Selected with IP.

■ **MC1;**

Turns on the marker frequency counter.

MDS_B|W?;

Formats binary measurements by selecting the measurement data size as an 8-bit byte or a two-byte word. IP sets the data size to word.

Query response: B|W

MDU?;

Returns the values of the CRT base line and reference level, in display units and measurement units.

MEAN_<trace label>|TRA|TRB|TRC;

Returns the mean value of a trace in display units.

MEM?;

Returns the amount of allocatable memory available for user-defined commands in bytes. These commands include TRDEF, VARDEF, FUNCDEF, ONEOS, ONSWP, and TRMATH.

[O1|O2|O3|O4;]MF;

Returns the frequency of the active marker.

MIN_<destination>,<operand 1>,<operand 2>;

Compares operand 1 and operand 2, point by point, and sends the lesser value of each comparison to the destination.

MKA[_(<real>[DM])|EP|?];

Specifies the amplitude of the active marker. Default units are dBm.

Query response: <numeric data format>

MKACT[_1|2|3|4]?;

Establishes the number of the active marker. Up to four markers can be displayed at one time but only one marker can be active at any time.
Query response: 1|2|3|4

MKCF;

Moves the active marker to the center frequency.

MKCONT;

Continues sweeping from the marker after the marker has been stopped.
(See MKSTOP.)

MKD[_(<real>[HZ|KZ|MZ|GZ])|UP|DN|EP]?;

Places a second marker the specified frequency from the active marker. Frequency may be positive or negative. Default units are Hz.
Query response: <numeric data format>

MKF[_(<real>[HZ|KZ|MZ|GZ])|EP]?;

Specifies the frequency of the active marker. Default units are Hz.
Query response: <numeric data format>

■ MKFC_ON|OFF;

Counts the marker frequency for a more accurate readout of the marker frequency. The accuracy is determined by the MKFCR command.

■ MKFCR[_(<real>[HZ|KZ|MZ|GZ])|EP]?;

Specifies the resolution of the marker frequency counter.
Query response: <numeric data format>

MKMIN;

Moves the active marker to the minimum signal detected.

MKN[_(<real>[HZ|KZ|MZ|GZ])|UP|DN|EP]?;

Moves the active marker to the specified frequency. Default units are Hz.
Query response: <numeric data format>

MKNOISE_ON|OFF?;

Returns the average value at the marker, normalized to a 1 Hz bandwidth.
Query response: ON|OFF

MKOFF[_ALL];

Turns all markers or the active marker off. Up to four markers can be displayed at one time. (See MKACT.)

MKP_<integer>|EP?;

Specifies the horizontal position of the marker, in display units.
<integer>:: = integer number from 0 to 1001.
Query response: <integer>

- MKPAUSE_<delay time>|?;**
 Pauses the sweep at the active marker for the duration of the delay time, in seconds.
 <delay time>:: = real number from 0 to 1000 seconds
 Query response: <delay time>
- MKPK[HI|NH|NR|NL];**
 Moves the active marker to the maximum signal detected or to the next highest, next right, or next left signal detected. Marker defaults to maximum signal detected.
- MKPX_(<real>[DB])|EP|?;**
 Specifies the minimum excursion for peak identification. Default units are dB. IP selects 6 dB for minimum excursion.
 Query response: <numeric data format>
- MKREAD_FRQ|PER|SWT|IST|FFT|?;**
 Specifies the marker readout mode.
 Query response: FRQ|PER|SWT|IST|FFT
- MKRL;**
 Moves the active marker to the reference level.
- MKSP;**
 Moves the marker delta frequency into the frequency span.
- MKSS;**
 Moves the marker frequency into the center frequency step size.
- MKSTOP;**
 Stops the sweep at the active marker.
- MKTRACE_TRA|TRB|TRC|?;**
 Moves the active marker to the corresponding position on another trace.
 Query response: TRA|TRB|TRC
- MKTRACK_ON|OFF|?;**
 Turns the marker signal track on or off.
 Query response: ON|OFF
- MKTYPE_PSN|FIXED|AMP|?;**
 Specifies the type of active marker to be used.
 Query response: PSN|FIXED|AMP
- ML_(<real>[DM|MV|UV])|EP|?;**
 Specifies the mixer level. Default units are dBm.
 <real>:: = integer multiple of 10
 Query response: <numeric data format>
- MOV_<destination>,<operand 1>;**
 Moves the operand to the destination.

MPY_<destination>,<operand 1>,<operand 2>;
Multiplies the operands, point by point, and sends the result to the destination.

MRD_<analyzer memory address>;
Reads the two-byte word at the specified memory address and returns it to the controller. The address must be an even number.

MRDB_<analyzer memory address>;
Reads the 8-bit byte at the specified memory address and returns its ASCII equivalent to the controller.

MT0;
Turns off the marker signal track. Selected with IP.

MT1;
Turns on the marker signal track.

MWR_<analyzer memory address>,<message>;
Writes a two-byte message, starting at the specified memory address.
<message>:: = ASCII decimal number representing two-byte word.

MWRB_<analyzer memory address>,<message>;
Writes a one-byte message to the specified memory address.
<message>:: = ASCII decimal number representing one 8-bit byte

MXM_<destination>,<operand 1>,<operand 2>;
Compares operand 1 and operand 2, point by point, and sends the greater value of each comparison to the destination.

MXMH_TRA|TRB;
Updates each trace element with the maximum level detected.

M1;
Turns off all markers. Selected with IP.

M2_(<real>[HZ|KZ|MZ|GZ])|UP|DN|EP|?);
Moves the active marker to the specified frequency. Default units are Hz.
Query response: <numeric data format>

M3_(<real>[HZ|KZ|MZ|GZ])|UP|DN|EP|?);
Places a second marker the specified frequency from the active marker. Frequency may be positive or negative. If no frequency is specified, the marker is placed on the active marker. Default units are Hz.
Query response: <numeric data format>

M4_(<real>[HZ|KZ|MZ|GZ])|UP|DN|EP|?);
Moves the active marker to the specified frequency. Stepping up or down changes the frequency span. Default units are Hz.
Query response: <numeric data format>

O

OA;

Returns the active function value.

OL;

Returns the coded instrument state information to the controller in 80 8-bit binary bytes.

ONEOS<string data field>|<block data field>|?;

Executes the specified command(s) at the end of every sweep.

Query response: <A-block data format>

ONSWP<string data field>|<block data field>|?;

Executes the specified command(s) at the start of every sweep.

Query response: <A-block data format>

OP?;

Returns the parameters which represent the dimensions of the lower left and upper right vertices of the analyzer display, in display units.

OT;

Returns all CRT annotation as 32 strings. The strings are from 0 (null) to 64 characters long. Each string is terminated with a <CR><LF> and the last string is terminated with an EOI upon <LF>.

O1;

Selects the output format as ASCII integers representing display units or display memory instruction words.

O2;

Selects the output format as two 8-bit binary bytes.

O3;

Selects the output format as real numbers in Hz, volts, dBm, or seconds. Selected with IP.

O4;

Selects the output format as one 8-bit binary byte.

P

[D1|D2|D3;]DA<display memory address>;PA[PU|PD]<x position>,<y position>;

Draws vectors to the specified x and y positions. PU and PD determine whether the vector(s) are displayed or blanked. As many x-y position pairs as desired may be entered.

<x position>:: = positive integer in display units

<y position>:: = positive integer in display units

PD;
Turns on the beam to display the vector. (See PA.) Selected with IP.

PDA_<trace label>,<trace source>,<resolution>;
Finds the probability density in amplitude of the specified trace source and sends the result to the destination which is a trace label.
<resolution>:: = real number in dB specifying the resolution of each trace point in the destination trace. If a linear scale is used, specify the resolution as the percent of the total trace elements.

PDF_<trace label>,<trace source>;
Finds the probability density in frequency of the specified trace source and sends the result to the destination which is a trace label. The TH command may be previously set to specify the minimum signal level of interest.

PEAKS_<trace destination>,<trace source>,(AMP|FRQ);
Sorts the signal peaks in the source trace by amplitude or frequency and returns the number of peaks found to the controller. It also sends the sorted results to the destination trace.

PLOT_P1x,P1y,P2x,P2y;
Plots the CRT display on any HP-IB plotter.
P1x and P1y:: = plotter dependent values that specify the lower left plotter dimension.
P2x and P2y:: = plotter dependent values that specify the upper right plotter dimension.

●PP;
Peaks the preselector.

[D1|D2|D3];]DA<display memory address>;PR[PU|PD]<x position>,<y position>;
Draws vectors relative from the last absolute position. (See PA.) As many x-y position pairs as desired may be entered.
<x position>:: = positive or negative integer in display units
<y position>:: = positive or negative integer in display units

[DA<display memory address>;]PS;
Skips the display program from the specified address to the next page of display memory.

PU;
Turns off the CRT beam to blank a vector(s).

PWRBW_(<trace label>|TRA|TRB|TRC),<percent of total power>;
Computes the combined power of all signal responses in the specified trace and returns the bandwidth of the specified percentage of the total power.
<percent of total power>:: = real number from 0 to 100

R

- RB**[_(<real>[HZ|KZ|MZ|GZ])|UP|DN|EP|?];
Specifies the resolution bandwidth. Default units are Hz.
Query response: <numeric data format>
- RC**_<digit>;
Recalls the previously saved state stored in registers 0 through 9.
<digit>:: = 0|1|2|3|4|5|6|7|8|9
- RCLS**_<digit>;
Recalls the previously saved state stored in registers 0 through 9.
<digit>:: = 0|1|2|3|4|5|6|7|8|9
- REPEAT**_<command list>**UNTIL**<flow operand 1>,(GT|LT|EQ|NE|GE|LE),<flow operand 2>;
Delimits the top of the REPEAT UNTIL looping construct. (See UNTIL.)
- REV**;
Returns the firmware revision number of the analyzer being used.
- RL**[_(<real>[DM|MV|UV])|UP|DN|EP|?];
Specifies the reference level. Default units are dBm.
Query response: <numeric data format>
- RMS**_(<trace label>|TRA|TRB|TRC);
Returns the RMS value of a trace, in display units.
- ROFFSET**[_(<real>[DM|MV|UV])|EP|?];
Specifies the reference level offset. Default units are dBm.
Query response: <numeric data format>
- RQS**_<integer>|?;
Specifies a mask which allows the bits that are not masked for service request.
<integer>:: = ACHII decimal number, 0 – 255
Query response: returns the decimal weighting of the status byte bits which are enabled during a service request.
- R1**;
Resets service request 140 (illegal command).
- R2**;
Allows service requests 140 (illegal command) and 104 (end of sweep).
- R3**;
Allows service requests 140 (illegal command) and 110 (hardware broken).
Selected with IP.
- R4**;
Allows service requests 140 (illegal command) and 102 (units key pressed or, for HP 8566B, frequency limit exceeded).

S

SAVES_<digit>;

Saves the current state of the analyzer in the specified state register.

<digit>:: = 1|2|3|4|5|6

SMOOTH_(<trace label>|TRA|TRB|TRC),<number of points>;

Smooths the specified trace according to the number of points specified for the running average.

<number of points>:: = integer between 0 and the trace length of the specified trace

SNGLS;

Selects single sweep mode.

SP_(<real>[HZ|KZ|MZ|GZ])|UP|DN|EP?];

Specifies the frequency span. Default units are Hz.

Query response: <numeric data format>

SQR_<trace destination>,<trace source>;

Computes the square root of the source and sends the result to the destination.

SRQ_<operand>;

Sets a service request if the operand bits are allowed by RQS.

<operand>:: = integer from 0 to 255

SS_(<real>[HZ|KZ|MZ|GZ])|UP|DN|EP?];

Specifies the center frequency step size. Default units are Hz.

Query response: <numeric data format>

ST_(<real>[SC|MS|US])|UP|DN|EP?];

Specifies the sweep time per division. Default units are seconds per division.

Query response: <numeric data format>

STDEV_<trace label>|TRA|TRB|TRC;

Returns the standard deviation of the specified trace amplitude, in display units.

SUB_<destination>,<operand 1>,<operand 2>;

Subtracts operand 2 from operand 1, point by point, and sends the result to the destination.

SUM_<trace label>|TRA|TRB|TRC;

Sums the amplitude of each trace element, and returns the sum to the controller.

SUMSQR_(<trace label>|TRA|TRB|TRC);

Squares the amplitude of each trace element, and returns the sum of the squares to the controller.

SV_<digit>;

Saves the current state of the analyzer in the specified state register.

<digit>:: = 1|2|3|4|5|6

[DA<display memory address>;]SW;

Skips from the current address or the specified address to the next control word.

S1;

Selects continuous sweep mode. Selected with IP.

S2;

Selects single sweep mode.

T

[O1|O2|O3|O4;]TA;

Returns 1001 trace amplitude values for trace A, beginning with the trace point most to the left.

[O1|O2|O3|O4;]TB;

Returns 1001 trace amplitude values for trace B, beginning with the trace point most to the left.

TDF_A|B|I|M|P?;

Formats trace information for return to the controller. IP selects O3 format.

A:: = returns data as an A-block data field

B:: = enables O2 or O4 format. See MDS for data size determination.

I:: = returns data as an I-block data field

M:: = enables O1 format

P:: = enables O3 format

Query response: A|B|I|M|P

TEXT_<string delimiter><text><string delimiter>;

Writes text on the spectrum analyzer screen at the current pen location.

<string delimiter>:: = !|"|\$|%|' | / |:|=|@|\|~|^

(must match at beginning and end of text)

<text>:: = alphanumeric ASCII characters 32 through 126

TH_(<real>[DM|MV|UV])|UP|DN|EP?];

Blanks signal responses below the specified threshold level. Default units are dBm. Default level is 9 major divisions below the reference level.

Query response: <numeric data format>

THE_ON|OFF?;

Turns the threshold on or off.

Query response: ON|OFF

IF_<flow operand 1>,(GT|LT|EQ|NE|GE|LE),<flow operand 2>**[THEN]**
<command list>**[ELSE**<command list>**ENDIF;**

Compares flow operand 1 to flow operand 2. If the condition is true, the command list is executed. Otherwise, commands following the next ELSE or ENDIF statements are executed.

TM_FREE|VID|LINE|EXT|?;

Selects the trigger mode.

Query response: FREE|VID|LINE|EXT

TRDEF_<trace label>[,(<trace length>|?)];

Defines the name and length of a user-defined trace. Default trace length is 1001.

<trace length>:: = integer from 0 to 1008

Query response: <trace length>

TRDSP_(TRA|TRB|TRC), (ON|OFF|?);

Turns the specified trace on or off but continues taking information.

Query response: (TRA|TRB|TRC)(ON|OFF)

TRGRPH_<display address>,<x position>,<y position>,<expanding factor>,(<trace label>|TRA|TRB|TRC);

Displays a compressed (see COMPRESS) trace anywhere on the spectrum analyzer display. The x and y positions orient the trace positions.

<x position>:: = integer from 1 to 1008

<y position>:: = integer from 1 to 1008

<expanding factor>:: = real

TRMATH<string data field>|<block data field>|?;

Executes the specified trace math or user-operator commands at the end of a sweep.

Allowable commands in TRMATH:

AMB, AMBPL, APB, AXB, BL, BML, BTC, BXC, C1, C2, EX, KSG, KSH, KSC, KSi, KSI, MOV, MIN, SUB, XCH, ADD, SQR, MPY, CON-CAT, DIV, CTM, LOG, CTA, EXP, AVG, MXM

Query response: <A-block data format>

TRPRST;

Sets trace operations to their preset values.

TRSTAT;

Returns the current trace status to the controller: clear-write, off, view, or blank.

TS;

Takes a sweep.

TWINDOW_<trace label>(UNIFORM|HANNING|FLATTOP);

Formats trace information for fast fourier analysis (FFT). This trace label should be used as the <window> in the FFT command.

UNIFORM: for FFT of transient signals and random noise. This window has the least frequency uncertainty.

HANNING: offers a compromise between the UNIFORM window and the FLATTOP window.

FLATTOP: for FFT of periodic signals. This window has the least amplitude uncertainty.

T0;

Turns the threshold level off. Selected with IP.

T1;

Sets the trigger mode to free run. Selected with IP.

T2;

Sets the trigger mode to line.

T3;

Sets the trigger mode to external.

T4;

Sets the trigger mode to video.

U

REPEAT_<command list>**UNTIL**<flow operand 1>,(GT|LT|EQ|NE|GE|LE),<flow operand 2>;

Compares the operands and repeats the command list until the condition on the operands is true.

UR;

Provides the upper right x-y recorder output voltage at the rear panel.

USTATE_<A-block data field>|?;

Configures or returns the configuration of the user-defined trace: ONEOS, ONSWP, TRMATH, VARDEF, FUNCDEF, TRDEF.

Query response: <A-block data format>

V

VARDEF_<variable identifier>,<initial value>;

Defines a variable name and assigns an initial value to it. IP reassigns the initial value to the variable name.

<initial value>:: = <real>

VAVG_<average length>|ON|OFF;

Turns the video averaging on or off.

<average length>:: = real and represents the maximum number of sweeps executed for averaging. Default length is 100.

VB_(<real>[HZ|KZ|MZ|GZ])|UP|DN|EP|?];

Specifies the video bandwidth. Default units are Hz.
Query response: <numeric data format>

VBO_(+|-)<integer>;

Specifies the ratio between the video bandwidth and the resolution bandwidth. For example, an entry of +1 sets the video bandwidth one bandwidth step higher than the resolution bandwidth.

VARIANCE_(<trace label>|TRA|TRB|TRC);

Returns the amplitude variance of the specified trace.

VIEW_TRA|TRB|TRC;

Stores and views the specified trace.

X

XCH_<destination>,<destination>;

Exchanges the contents of the destinations.

Programming Codes Developed Too Late for Itemized Listings

● **CNVLOSS_<real>[DB];**

Selects the reference level offset to amplitude calibrate the display for a mixer with a given conversion loss. Default units are dB.
<real>:: = real number from 0 to 60

● **EXTMXR;**

Performs an external mixer preset. Start frequency 18 GHz; Stop frequency 26.5 GHz.

● **FULBAND_<digit>;**

Sets the start and stop frequencies for full waveguide bands as in
<digit>:: = integer from 6 to 17 indicating the following:

Band	Frequency Range	Mixing Harmonic
6 (K)	18.0 – 26.5 GHz	6+
7 (A)	25.5 – 40.0	8+
8 (Q)	33.0 – 50.0	10+
9 (U)	40.0 – 60.0	10+
10 (V)	50.0 – 75.0	14+
11 (E)	60.0 – 90.0	16+
12 (W)	75.0 – 110.0	18+
13 (F)	90.0 – 140.0	24+
14 (D)	110.0 – 170.0	30+
15 (G)	140.0 – 220.0	36+
16 (Y)	170.0 – 260.0	44+
17 (J)	220.0 – 325.0	54+

● **HNLOCK[<digit>];**

Locks to the specified harmonic number to prevent multi-harmonic sweeps and to prevent tuning past the 2 GHz to 6.2 GHz L.O. tuning range.
<digit>:: = integer from 1 to 64

● **HNLOCK0;**

Turns off the harmonic lock (see HNLOCK) allowing tuning over the entire analyzer input range.

● **IDSTAT?;**

Returns the completion status of the signal identifier.

Query response: 1 signal found

0 no signal found

– 1 signal found but cannot be reached on locked harmonic

● **NSTART_<digit>;**

Specifies the start harmonic for signal identification.

<digit>:: = integer from 5 to 64

- **NSTOP_<digit>;**
Specifies the stop harmonic for signal identification.
<digit>:: = integer from 5 to 64
- **SIGDEL_<integer>[DB];**
Specifies the maximum amplitude difference allowed between a signal and its image for the pair to be recognized by the signal identification routine.
Default units are dB.
<integer>:: = integer from 0 to 35 in steps of 5.
- **SIGID;**
Identifies signals for external mixing frequency bands.

Secondary Keyword Summary

ALL	all
AMP	amplitude
AVG	average detection
B	8-bit byte
DB	decibel (unit)
DBM	absolute decibel milliwatt unit
DBMV	decibel millivolt
DBUV	decibel microvolt
DELTA	delta
DM	absolute decibel milliwatt unit
DN	decrement the parameter
EP	enable parameter for front panel operator entry
EQ	equal
EXT	external
FFT	fast fourier transform
FIXED	fixed
FREE	free run
FRQ	frequency
GE	greater than or equal
GT	greater than
GZ	gigahertz (unit)
HI	highest
HZ	hertz
IST	inverse sweep time
KZ	kilohertz (unit)
LE	less than or equal
LINE	line, as in power line
LT	less than
MS	millisecond (unit)
MV	millivolts (unit)
MZ	megahertz (unit)
NE	not equal to
NEG	negative peak detection

NH	next highest
NL	next left
NR	next right
NRM	normal rosenfell detection
OFF	turn function off
ON	turn function on
PER	period
PK-PIT	peak-to-peak average detection
PK-AVG	peak minus average detection
POS	positive peak detection
PSN	position
SC	seconds (unit)
SMP	sample detection
SWT	sweep time
TRA	trace A
TRB	trace B
TRC	trace C
UP	increment the parameter
UV	microvolts (unit)
US	microseconds (unit)
V	volts (unit)
VID	video
W	2-byte word
?	returns a query response containing the value or state of the associated parameter

APPENDIX A

CONSOLIDATED CODING FOR DISPLAY PROGRAMMING

INSTRUCTIONS

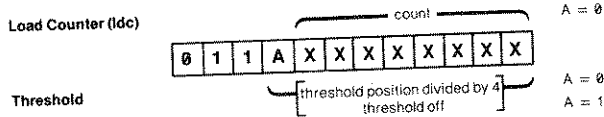
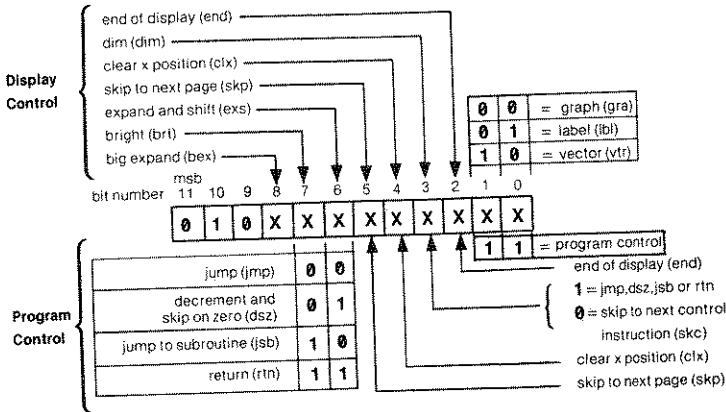

DATA:

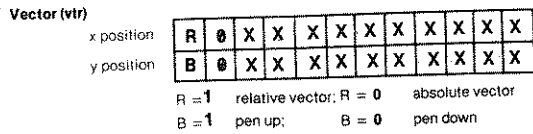
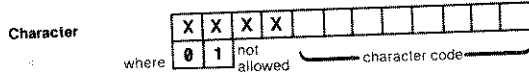
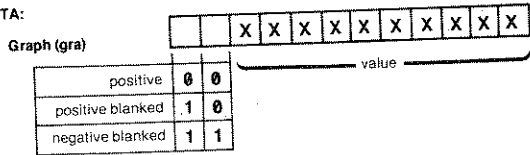



**HEWLETT
PACKARD**

SPECIFICATIONS

8566B SPECTRUM ANALYZER

Includes Option 400

SERIAL NUMBERS

This manual applies directly to Model 8566B RF Sections with serial numbers prefixed 2410A and IF-Display Sections with serial numbers prefixed 2403A.

**Copyright © 1984, HEWLETT-PACKARD COMPANY
1212 VALLEY HOUSE DRIVE
ROHNERT PARK, CALIFORNIA 94928, U.S.A.**

MANUAL PART NO. 08566-90046

Microfiche No. 08566-90050

Printed: MARCH 1984

TABLE OF CONTENTS
SPECIFICATIONS

Topic	Page
Frequency	1
Amplitude	4
Log Uncertainty	9
Marker	12
Sweep	12
Inputs	12
Outputs	14
Options	15
General	16

PERFORMANCE CHARACTERISTICS

Topic	Page
Frequency	18
Amplitude	21
Inputs	23
Outputs	24

SPECIFICATIONS

INTRODUCTION

Unless noted, all specifications are for AUTO COUPLED FUNCTION operation and are with the preselector tracking optimized using the MARKER PRESELECTOR PEAK function. Where specifications are subject to minimization with the error correction routine, corrected limits are given unless noted.

SPECIFICATIONS

FREQUENCY

MEASUREMENT RANGE

100 Hz to 22 GHz, dc coupled input

DISPLAYED VALUES

Frequency Reference Error

Aging Rate

$<1 \times 10^{-9}/\text{day}$

$(2.5 \times 10^{-7}/\text{yr})$

Temperature Stability

$<7 \times 10^{-9} 0^\circ \text{ to } 55^\circ\text{C}$

Center Frequency

0 Hz to 22 GHz

Readout Accuracy

Spans $\leq n \times 5 \text{ MHz}$

$\pm(2\%$ of frequency span + frequency reference error x center frequency + 10 Hz)

Spans $>n \times 5 \text{ MHz}$

$\pm(2\%$ of frequency span + $n \times 100 \text{ kHz}$ + frequency reference error x center frequency) where n is the harmonic mixing number, depending upon center frequency:

n center frequency

1 100 Hz to 5.8 GHz

2 5.8 GHz to 12.5 GHz

3 12.5 GHz to 18.6 GHz

4 $>18.6 \text{ GHz}$

Zero Span

\pm frequency reference error x center frequency

SPECIFICATIONS

FREQUENCY (Cont'd)

Frequency Span

0 Hz, 100 Hz to 22 GHz over 10 divisions CRT horizontal axis; variable in approximately 1% increments.

Full Span

0 – 2.5 GHz and 2 – 22 GHz

Readout Accuracy

Spans $\leq n \times 5$ MHz: $\pm 1\%$ of indicated frequency separation

Spans > 5 MHz: $\pm 3\%$ of indicated frequency separation

Start/Stop Frequency

Readout Accuracy

Same as Center Frequency

RESOLUTION

Resolution Bandwidth

3 dB bandwidths of 10 Hz to 3 MHz in a 1, 3, 10 sequence. Bandwidth may be selected manually or coupled to frequency span (AUTO mode).

Bandwidth Accuracy¹

3 dB bandwidths calibrated to
 $\pm 20\%$, 10 Hz to 3 MHz filters
 $\pm 10\%$, 3 kHz to 1 MHz filters

Bandwidth Selectivity

60 dB/3 dB bandwidth ratio:

<15:1 3 MHz to 100 kHz

<13:1 30 kHz to 10 kHz

<11:1 3 kHz to 30 Hz

60 dB points on 10 Hz bandwidth are separated by <100 Hz.

Bandwidth Shape

Synchronously tuned, 5 pole filters for 10 Hz to 30 kHz bandwidths; 4 poles, 100 kHz to 3 MHz bandwidth. Approximate Gaussian shape optimized for minimum sweep time and smooth pulse response with calibrated display.

¹30 kHz and 100 kHz bandwidth accuracy figures only applicable $\leq 90\%$ relative humidity.

SPECIFICATIONS

FREQUENCY (Cont'd)

SPECTRAL PURITY

Noise Sidebands

For Frequency Span ≤ 25 kHz (except 100 kHz offset) and Center Frequency from 100 Hz to 5.8 GHz.

Offset from Carrier Sideband Level

320 Hz	- 80 dBc/Hz
1 kHz	- 85 dBc/Hz
10 kHz	- 90 dBc/Hz
100 kHz	- 105 dBc/Hz

Power Line Related Sidebands

For line conditions specified in Power Requirements section.

Offset from Carrier	Center Frequency	
	≤ 100 MHz	> 100 MHz to 5.8 GHz
< 360 Hz	-70 dBc	-60 dBc
360 Hz to 2 kHz	-75 dBc	

SPECIFICATIONS

AMPLITUDE

MEASUREMENT RANGE

Measurement range is the total amplitude range over which the analyzer can measure signal responses. The low value is determined by sensitivity (10 Hz resolution bandwidth and 0 dB RF input attenuation) and the high value by damage level.

Range	Tuned Frequency
	non-preselected
-95 dBm to +30 dBm	100 Hz to 50 kHz
-112 dBm to +30 dBm	50 kHz to 1 MHz
-134 dBm to +30 dBm	1 MHz to 2.5 GHz
	preselected
-132 dBm to +30 dBm	2.0 GHz to 5.8 GHz
-125 dBm to +30 dBm	5.8 GHz to 12.5 GHz
-119 dBm to +30 dBm	12.5 GHz to 18.6 GHz
-114 dBm to +30 dBm	18.6 GHz to 22 GHz

DISPLAYED VALUES

Scale

Over a 10 division CRT vertical axis with the Reference Level (0 dB) at the top graticule line.

Calibration

Log: 10 dB/div for 90 dB display from Reference Level.

5 dB/div for 50 dB display	expanded from
2 dB/div for 20 dB display	Reference Level
1 dB/div for 10 dB display	

Linear: 10% of Reference Level/div when calibrated in voltage

SPECIFICATIONS

AMPLITUDE (Cont'd)

Fidelity

Log:

Incremental	Cumulative
± 0.1 dB/dB over 0 to 80 dB display	$\leq \pm 1.0$ dB max over 0 to 80 dB display, 20° – 30°C
	$\leq \pm 1.5$ dB max over 0 to 90 dB display
10 Hz Res BW	$\leq \pm 2.1$ dB max over 0 to 90 dB display

Linear: $\pm 3\%$ of Reference Level for top 9 1/2 divisions of display.

Reference Level

Range

Log: +30.0 to -99.9 dBm or equivalent in dBmV, dB μ V, Volts.

Readout expandable to +60.0¹ to -119.9 dBm (-139.9 dBm for ≤ 1 kHz resolution bandwidth) using SHIFT I.

Linear: 7.07 volts to 2.2 μ volts full scale.

Readout expandable to 223.6¹ volts to 2.2 μ volts (0.22 μ volts for < 1 kHz resolution bandwidth) using SHIFT I.

Accuracy

The sum of several factors, listed in Log Uncertainty, determines the accuracy of the reference level readout. Refer to pages 9 through 11.

REFERENCE LINES

Accuracy

Equals the sum of reference level accuracy plus the scale fidelity between the reference level and the reference line level.

¹Maximum total input power not to exceed +30 dBm damage level.

SPECIFICATIONS

AMPLITUDE (Cont'd)

DYNAMIC RANGE

Spurious Responses (signals generated by the analyzer due to input signals). For total signal power ≤ -40 dBm at the input mixer, all harmonic and intermodulation distortion >70 dB below input signal.

Second Harmonic Distortion

- < -80 dBc, 50 MHz to 700 MHz (non-preselected)
- < -70 dBc, 100 Hz to 2.5 GHz (non-preselected)
- For mixer levels ≤ -10 dBm:
 - < -100 dBc, 2 to 22 GHz (preselected)

Third Order Intermodulation Distortion^{1, 2}

Third Order Intercept (TOI):

- $> +5$ dBm, 100 Hz to 5 MHz
- $> +7$ dBm, 5 MHz to 5.8 GHz
- $> +5$ dBm, 5.8 GHz to 18.6 GHz

See Figure 4 in PERFORMANCE CHARACTERISTICS for typical second and third order distortion characteristics.

Image Responses (due to the mixing of signals two times the IF frequency, 2×321.4 MHz, above or below the tuned frequency).

- < -70 dBc, 100 Hz to 18.6 GHz
- < -60 dBc, 18.6 GHz to 20 GHz
- < -50 dBc, 20 GHz to 22 GHz

Multiple Responses (due to the input signal mixing with more than one local oscillator harmonic.)

- < -70 dBc, 100 Hz to 22 GHz

¹Dynamic range due to TOI and noise level can be calculated from $2/3$ [TOI - displayed average noise level]. For example, at 18 GHz the analyzer's specified dynamic range when using the 10 Hz resolution BW is:
 $2/3[+5 \text{ dBm} - (-120 \text{ dBm})] = 2/3(125) = 83 \text{ dB}$.

²Two tone intermodulation distortion products can be calculated from $2(\text{TOI} - \text{signal level})$. For example, for two tones at -33 dBm, the IM products for a $+5$ dBm TOI will be
 $2[+5 \text{ dBm} - (-33)] = 76 \text{ dB down}$

SPECIFICATIONS

AMPLITUDE (Cont'd)

Out-of-band Responses (due to the mixing of input signals outside the preselector's frequency span):

< -60 dBc, 2 to 22 GHz

Residual Responses (signals generated by the analyzer independent of input signals). With 0 dB input attenuation and no input signal:

< -100 dBm, 100 Hz to 5.8 GHz

< -95 dBm, 5.8 GHz to 12.5 GHz

< -85 dBm, 12.5 GHz to 18.6 GHz

< -80 dBm, 18.6 GHz to 22 GHz

Gain Compression

<1.0 dB, 100 Hz to 22 GHz with ≤ -5 dBm at input mixer.

Displayed Average Noise Level (Sensitivity)

0 dB input attenuation and 10 Hz resolution bandwidth.

Level	Tuning Range
	Non-Preselected
< -95 dBm	100 Hz to 50 kHz
< -112 dBm	50 kHz to 1.0 MHz
< -134 dBm	1.0 MHz to 2.5 GHz
	Preselected
< -132 dBm	2.0 GHz to 5.8 GHz
< -125 dBm	5.8 GHz to 12.5 GHz
< -119 dBm	12.5 GHz to 18.6 GHz
< -114 dBm	18.6 GHz to 22 GHz

SPECIFICATIONS

AMPLITUDE (Cont'd)

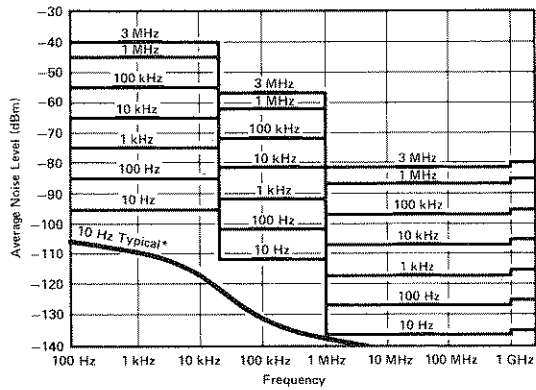

FIGURE 1. SPECIFIED AVERAGE DISPLAYED NOISE LEVEL,
100 Hz TO 2.5 GHz NON-PRESELECTED TUNING RANGE

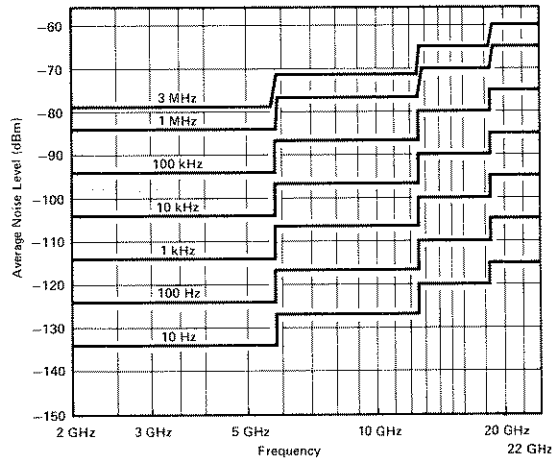

FIGURE 2. SPECIFIED AVERAGE DISPLAYED NOISE LEVEL,
2.0 GHz TO 22 GHz PRESELECTED TUNING RANGE

SPECIFICATIONS

LOG UNCERTAINTY

This table summarizes the amplitude measurement uncertainties along with their respective dependent variables (such as tuned frequency or reference level range) versus corrected and uncorrected conditions and ambient temperature ranges.

Source of Uncertainty	Dependent Variable	With Uncorrected Readout (SHIFT Y)		With Corrected Readout (SHIFT W, SHIFT X)**
		20°-30°C	0°-55°C	20°-30°C
Calibrator	None	±0.3 dB	±0.3 dB	±0.3 dB
Frequency Response (Flatness)† (input attenuation 10 dB)	Tuned Frequency: 100 Hz-2.5 GHz	±0.6 dB	±1.0 dB	±0.6 dB
	2.0 GHz-12.5 GHz	±1.7 dB	±1.7 dB	±1.7 dB
	12.5 GHz-18.6 GHz	±2.2 dB	±2.2 dB	±2.2 dB
	18.6 GHz-20.0 GHz	±2.2 dB	±3.3 dB	±2.2 dB
	20.0 GHz-22 GHz	±3.0 dB	±4.1 dB	±3.0 dB
Cumulative Cumulative	100 Hz-20 GHz	±2.2 dB	±3.3 dB	±2.2 dB
	100 Hz-22 GHz	±3.0 dB	±4.1 dB	±3.0 dB
Absolute Amplitude Calibration	Applicable when making absolute amplitude measurements	±0.6 dB	±0.6 dB	±0.6 dB
RF Gain	Tuned Frequency: 100 Hz-2.5 GHz	±0.2 dB*	±1.0 dB*	0 dB
	2.0 GHz-22.0 GHz	±0.7 dB*	±1.0 dB*	0 dB
Resolution Bandwidth Switching	Resolution BW: 10 Hz	±2.0 dB	±4.0 dB	±1.1 dB
	30 Hz	±0.8 dB	±2.3 dB	±0.4 dB
	100 Hz-1 MHz	±0.5 dB	±0.2 dB	±0.2 dB
	3 MHz	±1.0 dB	±2.0 dB	±0.2 dB
Log Scale Switching	Changing Log Scale	±0.5 dB	±1.0 dB	±0.1 dB

SPECIFICATIONS

LOG UNCERTAINTY (Cont'd)

Source of Uncertainty	Dependent Variable	With Uncorrected Readout (SHIFT Y)		With Corrected Readout (SHIFT W, SHIFT X)**
		20°-30°C	0°-55°C	20°-30°C
Log Fidelity	dB differential between calibration and measured signals	±0.1 dB/dB cumulative over 0 to 80 dB	±0.1 dB/dB cumulative over 0 to 80 dB	±0.1 dB/dB cumulative over 0 to 80 dB
	10 Hz Resolution BW	±2.1 dB over 0 to 90 dB	±2.1 dB over 0 to 90 dB	±2.1 dB over 0 to 90 dB
	≥30 Hz Resolution BW	±1.5 dB over 0 to 90 dB	±1.5 dB over 0 to 90 dB	±1.5 dB over 0 to 90 dB
		±1.0 dB over 0 to 80 dB	±1.0 dB over 0 to 80 dB	±1.0 dB over 0 to 80 dB
IF Gain ‡	Reference Level: 0 to -55.9 dBm			
	10 Hz Resolution BW	±1.6 dB	±2.0 dB	±1.0 dB
	≥30 Hz Resolution BW	±0.6 dB	±1.0 dB	0 dB
	-56.0 to -129.9 dBm			
Log Digitizing	10 Hz Resolution BW	±2.0 dB	±2.5 dB	±2.0 dB
	≥30 Hz Resolution BW	±1.0 dB	±1.5 dB	±1.0 dB
Log Digitizing	Log Scale: 10 dB	±0.2 dB	±0.2 dB	±0.2 dB
	5 dB	±0.1 dB	±0.1 dB	±0.1 dB
	2 dB	±0.04 dB	±0.04 dB	±0.04 dB
	1 dB	±0.02 dB	±0.02 dB	±0.02 dB
Error Correction	CORR'D function off or on	0	0	±0.4 dB

SPECIFICATIONS

LOG UNCERTAINTY (Cont'd)

- * Supplemental characteristic (typical, non-warranted performance parameter).
- ** Requires executing the error correction function (SHIFT W) after stabilization at new ambient temperature. Otherwise typical amplitude drift may be ± 0.3 dB/°C (at -10 dBm reference level, 10 dB input attenuation and 1 MHz resolution BW).
- † Includes input attenuator in 10 dB position, mixing mode gain variations, and assuming PRESELECTOR PEAK in current instrument state. COUPLED FUNCTION not required as long as MEAS UNCAL message is not displayed.
- ‡ Assuming calibration signal is used to calibrate the reference level at -10 dBm and the input attenuator is fixed at 10 dB.
- § When the error correction function is used, amplitude uncertainty is introduced because additional IF gain is used to offset the errors caused by resolution BW and scale switching and RF gain.

SPECIFICATIONS

MARKER

The marker is a bright dot placed upon the display trace which is positioned horizontally by the DATA controls. The marker amplitude and frequency are read out continuously.

FREQUENCY

Accuracy

Normal: same as center frequency accuracy.

Δ : same as frequency span accuracy.

AMPLITUDE

Accuracy

Normal: same as reference level accuracy plus scale fidelity between the reference level and marker position.

Δ : same as frequency response uncertainty and scale fidelity between two markers.

SWEEP

SWEEP TIME

Accuracy

$\pm 10\%$ ≤ 200 sec sweep times

$\pm 30\%$ > 200 sec sweep times

INPUTS

RF INPUT

100 Hz to 22 GHz, precision female type N connector, dc coupled.

Maximum Input Level

AC

Continuous power, +30 dBm (1 watt), from 50 ohm source. Mixer protected by diode limiter, 100 Hz to 2.5 GHz. ≤ 100 watts, 10 μ sec pulse with ≥ 50 dB RF attenuation (≤ 0 dBm peak to input mixer).

DC

< 100 mA current damage level.

SPECIFICATIONS

INPUTS (Cont'd)

Input Attenuator

0 to 70 dB in 10 dB steps. +30 dBm (1 watt) input damage level.

IF INPUT

Maximum Input Level



AC

+10 dBm, continuous power, from 50 Ω source

DC

20 volts with rise time of <1 volt/ μ sec

Sensitivity

-30 dBm at 321.4 MHz produces full-scale CRT deflection
 ± 1.0 dB when   (KSU) is executed.

EXTERNAL SWEEP TRIGGER INPUT (rear panel)

Must be >2.4 volt (10 volt max). 1 k Ω nominal input impedance.

EXTERNAL FREQUENCY REFERENCE INPUT (rear panel)

Must equal 5 MHz ± 25 Hz or 10 MHz ± 50 Hz, 0 to +10 dBm, 50 Ω nominal input impedance. Analyzer performance will be degraded unless frequency reference phase noise and spurious signals are < -140 dBc single sideband (1 Hz) referred to 10 MHz at a 100 Hz to 10 kHz offset.

QUASI-PEAK (rear panel: nominal values)

VIDEO INP: 0 - 2V. 139 Ω input impedance.

IF INP: 21.4 MHz. Input is nominally -11 dBm with 10 dB input attenuation. 50 Ω input impedance.

SPECIFICATIONS

OUTPUTS

CAL OUTPUT

100 MHz \pm (frequency reference error) x 10 x (days since calibration)
- 10 dBm \pm 0.3 dB, 50 Ω impedance

1st LO OUTPUT

2.3 to 6.1 GHz, $>$ + 5 dBm, 50 Ω output impedance (nominal)

Maximum Input Level

+ 27 dBm (1/2 watt) total power into 50 Ω impedance

IF OUTPUT

Maximum Input Level

AC

+ 10 dBm, continuous power, from 50 Ω source

DC

20 volts with rise time of $<$ 1 volt/ μ sec

SWEEP + TUNE OUT (rear panel)

- 1.0 volt per GHz of tune frequency, 10 k Ω minimum load

Accuracy

Sweep + Tune = $(-1\text{V}/\text{GHz} \times \text{Center Frequency (GHz)})$
 $\pm 2\%$ $\pm 10\text{mv}$.

QUASI-PEAK (rear panel: nominal values)

VIDEO OUT: 0 - 2V, 139 Ω input impedance.

IF OUT: 21.4 MHz. Output is nominally - 11 dBm with 10 dB input attenuation. 50 Ω output impedance.

SPECIFICATIONS

OPTIONS

400 Hz POWER LINE FREQUENCY OPERATION

Option 400

Power Line Related Sidebands

For Center Frequency from 100 Hz to 5.7 GHz

Offset from Carrier	Sideband Level
≤ 2 kHz	-55 dBc
2kHz to 5.5 kHz	-65 dBc

Power Requirements

400 Hz \pm 10% line frequency

100 or 120 volts (+5%, -10%) line voltage

Operating Temperature Range

0° to 40°C, 50-60 Hz Power Line Frequency, service only, not for extended periods

0° to 55°C, 400 Hz Power Line Frequency

SPECIFICATIONS

GENERAL

ENVIRONMENTAL

Temperature

Operation 0°C to 55°C

Increased internal temperatures may result if the rear panel air filters are not cleaned regularly.

POWER REQUIREMENTS

50 to 60 Hz; 100, 120, 220 or 240 volts (+ 5%, - 10%); approximately 650 VA (40 VA in standby).

400 Hz operation is available as Option 400.

Humidity

Operating, <95% relative humidity, 0°C to 40°C except as noted in electrical specifications.

EMI

Conducted and radiated interference is within the requirements of Class A1c, RE02 of MIL STD 461B, and within the requirements of VDE 0871 and CISPR publication 11.

WARM-UP TIME

Operation

Requires 30 minute warm-up from cold start, 0° to 55°C. Internal temperature equilibrium is reached after 2 hour warm-up at stabilized outside temperature.

Frequency Reference

Frequency reference aging rate attained after 30 days warm-up from cold start at 25°C. Frequency is within 1×10^{-8} of final stabilized frequency within 30 minutes.

WEIGHT

Total net 50 kg (112 lb): IF-Display Section, 21 kg (47 lb); RF Section, 29 kg (65 lb).

Shipping: IF-Display Section, 27 kg (60 lb); RF Section, 35 kg (78 lb).

SPECIFICATIONS

GENERAL (Cont'd)

DIMENSIONS

(Allow 100 mm, 4 inch clearance at rear panel for interconnect cables.)

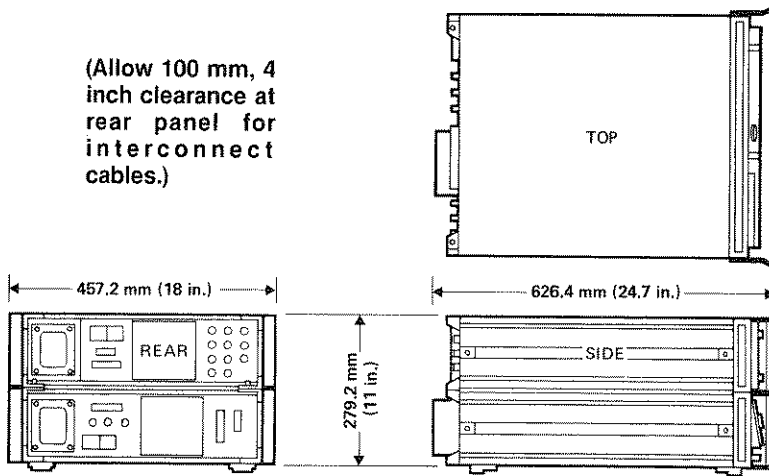

INSTRUMENT DIMENSIONS WITH HANDLES

(Allow 100 mm, 4 inch clearance at rear panel for interconnect cables.)

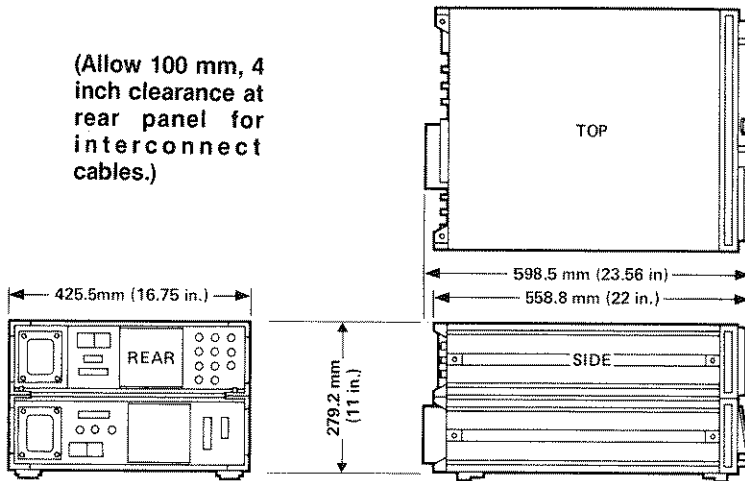

INSTRUMENT DIMENSIONS WITHOUT HANDLES

PERFORMANCE CHARACTERISTICS

NOTE

Supplemental characteristics are intended to provide information useful in applying the instrument by giving typical, non-warranted, performance parameters.

FREQUENCY

RESOLUTION

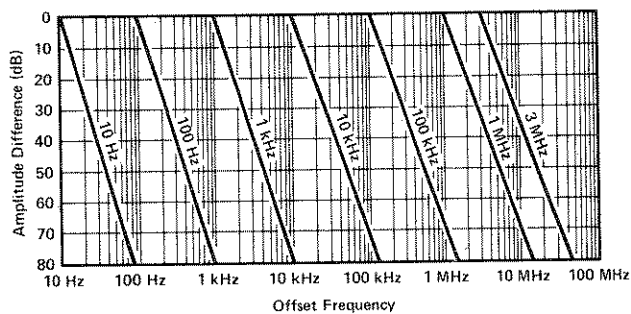

FIGURE 1. TYPICAL SPECTRUM ANALYZER RESOLUTION

SPECTRAL PURITY

Noise Sidebands

Refer to Figures 2 and 3 for typical noise sideband performance.

Power Line Related Sidebands

For line conditions specified in Power Requirements under GENERAL on page 16.

PERFORMANCE CHARACTERISTICS

FREQUENCY (Cont'd)

Offset from Carrier	Center Frequency		
	5.8 to 12.6 GHz	12.6 to 18.6 GHz	18.6 to 22 GHz
<360 Hz	-64 dBc	-60 dBc	-58 dBc
360 Hz to 2 kHz	-69 dBc	-65 dBc	-63 dBc
>2 kHz	-74 dBc	-70 dBc	-68 dBc

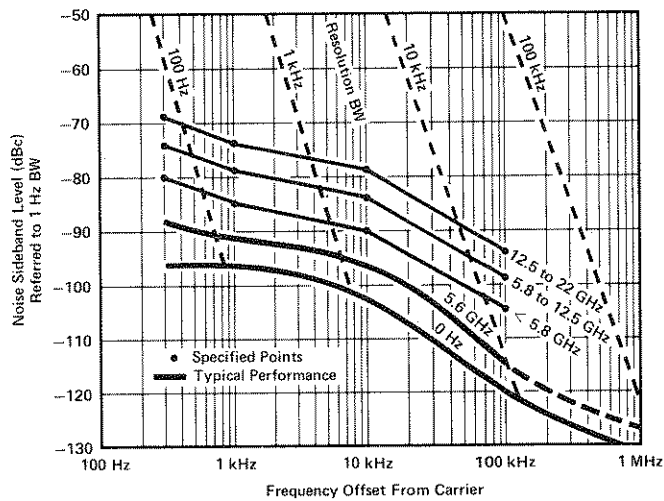

FIGURE 2. SINGLE SIDEBAND NOISE NORMALIZED TO 1 Hz BW
VS. OFFSET FROM CARRIER

PERFORMANCE CHARACTERISTICS

FREQUENCY (Cont'd)

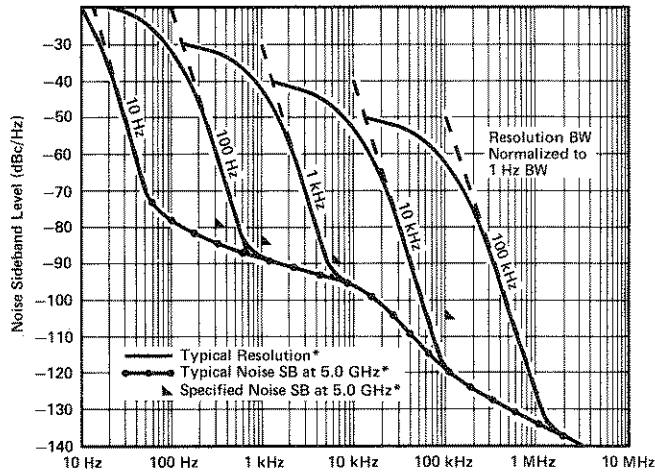

FIGURE 3. TYPICAL SSB NOISE AT 5.0 GHz CENTER FREQUENCY NORMALIZED TO 1 Hz BW VS. OFFSET FROM CARRIER AND ANALYZER RESOLUTION. MAY BE LIMITED BY AVERAGE NOISE LEVEL.

STABILITY

Residual FM

For fundamental mixing ($n = 1$)

<50 kHz peak-to-peak, frequency span >5 MHz

Drift

Typical, after 1 hour warm-up at stabilized temperature.

COUPLED FUNCTION not required.

Frequency Span	Center Frequency Drift
≤ 100 kHz	<10 Hz/minute of sweep time
100 kHz to 5 MHz	<500 Hz/minute of sweep time
≥ 5 MHz	<5 kHz/minute of sweep time

Because the analyzer is phase locked at the beginning of each sweep, drift occurs only during the time of one sweep.

PERFORMANCE CHARACTERISTICS

AMPLITUDE

DYNAMIC RANGE

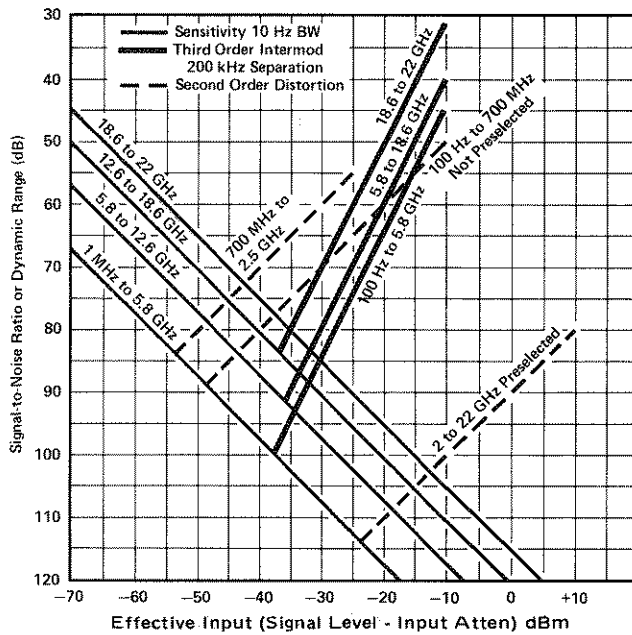

FIGURE 4. TYPICAL OPTIMUM DYNAMIC RANGE

Third Order Intermodulation Distortion¹

Third Order intercept (TOI)

> + 5 dBm (typical), 18.6 GHz to 22 GHz

> + 50 dBm (typical), 2 to 22 GHz for >100 MHz signal separation

See Figure 4 for typical second and third order distortion characteristics

Synthesis Related Spurious Sidebands

< - 90 dBc

¹Dynamic range due to TOI and noise level can be calculated from $\frac{2}{3}[\text{TOI} - \text{displayed average noise level}]$. For example, at 18 GHz the analyzer's specified dynamic range when using the 10 Hz resolution BW is:

$$\frac{2}{3}[+5 \text{ dBm} - (-120 \text{ dBm})] = \frac{2}{3}(125) = 83 \text{ dB.}$$

PERFORMANCE CHARACTERISTICS

AMPLITUDE (Cont'd)

Input Attenuator Uncertainties

Frequency Response Uncertainty (Flatness)

Attenuator Setting	Center Frequency			
	100 Hz to 2.5 GHz	2.0 GHz to 12.4 GHz	12.4 GHz to 18 GHz	18 GHz to 22 GHz
0 dB	not specified			
10	accounted for in Frequency Response Uncertainty			
20	±0.1 dB	±0.7 dB	±0.8 dB	±1.2 dB
30	±0.1 dB	±0.9 dB	±1.2 dB	±2.0 dB
40	±0.1 dB	±1.2 dB	±1.6 dB	±2.5 dB
50	±0.1 dB	±1.5 dB	±2.0 dB	±3.0 dB
60	±0.1 dB	±1.8 dB	±2.4 dB	±3.5 dB
70	±0.1 dB	±2.1 dB	±2.8 dB	±4.0 dB

10 dB Step Uncertainty

	Center Frequency			
	100 Hz to 2.5 GHz	2.0 GHz to 12.4 GHz	12.4 GHz to 18 GHz	18 GHz to 22 GHz
10 to 70 dB attenuation range	±0.2 dB	±1.0 dB	±1.0 dB	±1.5 dB

Example: In changing the attenuator from 40 to 60 dB the uncertainty of the input attenuator from 2 to 18 GHz is ±1.0 dB plus the worst case flatness up to 18 GHz for 60 dB attenuation, ±2.4 dB, a total of ±3.4 dB uncertainty.

PERFORMANCE CHARACTERISTICS

INPUTS

IF INPUT SWR

2.0 at 321.4 MHz \pm 10 MHz

RF INPUT SWR

Input Attenuation	Tune Frequency		
	100 Hz to 2.5 GHz	2 GHz to 5.8 GHz	5.8 GHz to 22 GHz
10 dB	1.2	1.5	1.9
0 dB*	2.3	3.0	3.0

*When tuned to within \pm 3 MHz of signal.

L.O. Emission

< -80 dBm when preselected, \geq 2.0 GHz
< -90 dBm when not preselected, \leq 2.5 GHz

AUXILIARY (rear panel; nominal values)

Quasi-Peak (rear panel: nominal values)

VIDEO INP: 0 – 2V, 139 Ω input impedance.

IF INP: 21.4 MHz. Input is nominally -11 dBm with 10 dB input attenuation. 50 Ω input impedance.

PERFORMANCE CHARACTERISTICS

OUTPUTS

AUXILIARY (rear panel; nominal values)

Display

X, Y and Z outputs for auxiliary CRT displays exhibiting <75 nsec rise times for X, Y and <30 nsec rise time for Z (compatible with HP 1300 series displays). X, Y: 1 volt full deflection; Z: 0 to 1V intensity modulation, -1V blank, BLANK output (TTL level >2.4V for blanking) compatible with most oscilloscopes.

Recorder

Outputs to drive all current HP X-Y recorders (using positive pencoils or TTL penlift input).

Horizontal Sweep Output (X axis): A voltage proportional to the horizontal sweep of the frequency sweep generator that ranges from 0V for the left edge to +10V for the right edge. 1.7 k Ω output impedance.

Video Output (Y axis): Detected video output (before A-D conversion) proportional to vertical deflection of the CRT trace. Output increases 100 mV/div from 0 to 1V. Output impedance $\leq 475\Omega$.

Penlift Output (Z axis): A blanking output, 15V from 10 k Ω , occurs during frequency sweep generator retrace; during sweep, output is low at 0V with 10 Ω output impedance for a normal or unblanked trace (pen down).

LOWER LEFT and UPPER RIGHT pushbuttons calibrate the recorder sweep and video outputs with 0,0 and 10,1 volts respectively, for adjusting X-Y recorders.

PERFORMANCE CHARACTERISTICS

OUTPUTS (Cont'd)

21.4 MHz IF (rear panel)

A 50 Ω , 21.4 MHz output related to the RF input to the analyzer.

In log scales, the IF output is logarithmically related to the RF input signal; in linear, the output is linearly related. The output is nominally -20 dBm for a signal at the reference level.

Bandwidth is controlled by the analyzer's resolution bandwidth setting; amplitude controlled by the input attenuator, and IF step gain positions.

Frequency Reference (rear panel)

10.000 MHz, 9 dBm; 50 Ω output impedance

10 MHz Output (rear panel)

> -5 dBm, 50 Ω output impedance

Quasi-Peak (rear panel : nominal values)

VIDEO OUT: 0 – 2V. 139 Ω input impedance.

IF OUT: 21.4 MHz. Output is nominally -11 dBm with 10 dB input attenuation. 50 Ω output impedance.

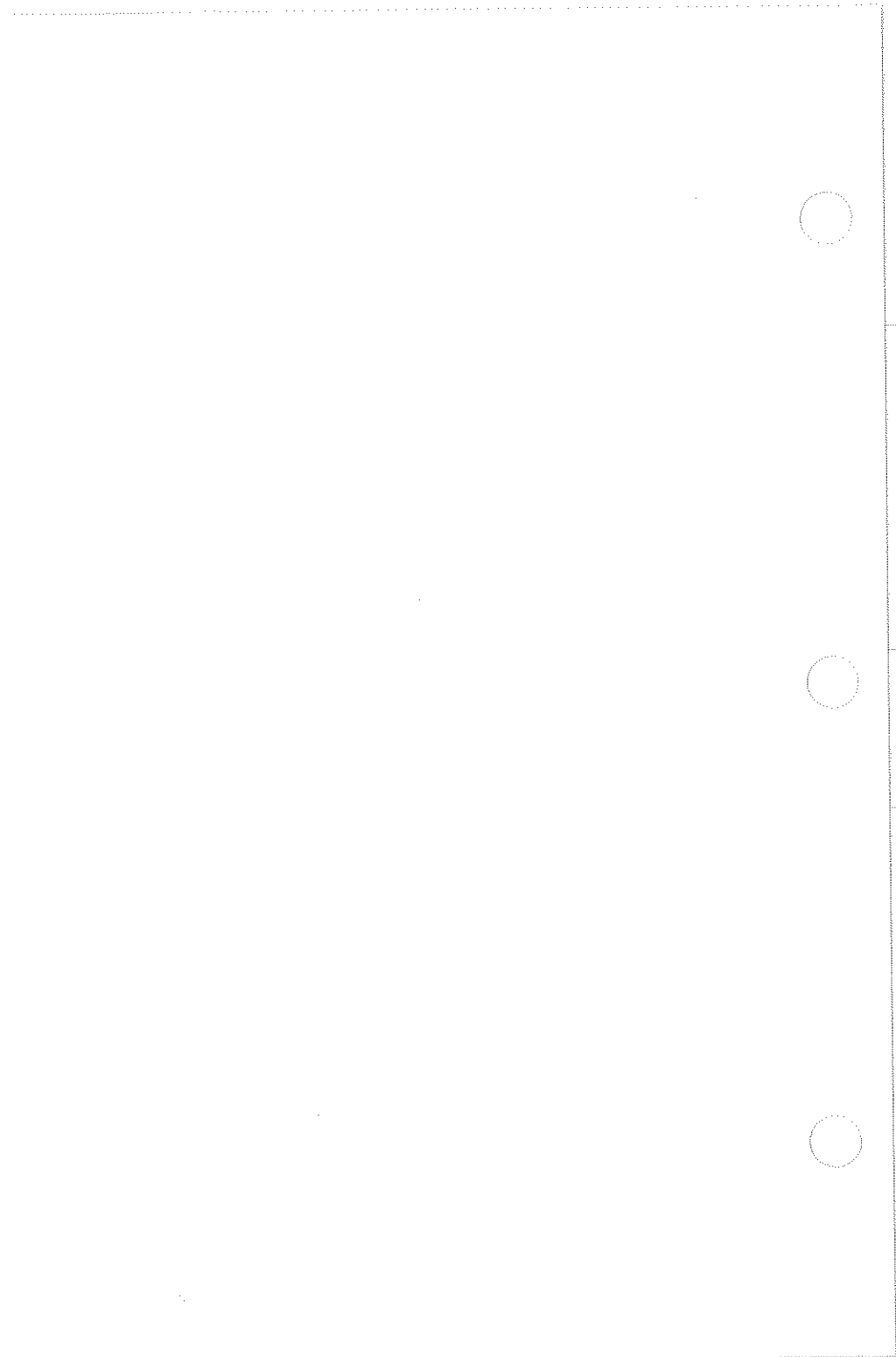



OPERATION VERIFICATION

8566B SPECTRUM ANALYZER

Includes Option 400

SERIAL NUMBERS

This manual applies directly to Model 8566B RF Sections with serial numbers prefixed 2410A and IF-Display Sections with serial numbers prefixed 2403A.

Copyright © 1984, HEWLETT-PACKARD COMPANY
1212 VALLEY HOUSE DRIVE
ROHNERT PARK, CALIFORNIA 94928, U.S.A.

HP Part Number	Description
08566-90041	Manual
08566-90047	Microfiche
08566-60008	Manual with discs

Printed: MARCH 1984

TABLE OF CONTENTS

Topic	Page
Introduction	1
Test System Configuration	4
Equipment Connections	4
Program Loading	7
Program Operation	7
HP-IB Addresses	8
Error Messages	9
Test Descriptions	9
1. Input Attenuator Switching Check	9
2. IF Gain Uncertainty	10
3. Scale Fidelity (Log)	10
4. Scale Fidelity (Linear)	11
5. Log Scale Switching Uncertainty	11
6. Resolution Bandwidths	12
7. Line Related Sidebands	13
8. Average Noise Level	13
9. Residual Responses	14
10. SWEEP + TUNE OUT Accuracy	15
11. Second Harmonic Distortion	16
12. Frequency Span Accuracy	16
13. Gain Compression	17
14. Frequency Response	17
15. Third Order Intermodulation Distortion	18
16. Calibrator Output Amplitude Accuracy	19
17. 1st LO Output Power	19

OPERATION VERIFICATION

INTRODUCTION

Operation Verification is an automatic performance test designed to give a high confidence level in the operation of the HP Model 8566B Spectrum Analyzer in a reasonable time. It performs 80% to 85% of the manual performance tests in approximately 60 minutes and is designed to test an instrument operating within a temperature range of 20° to 30° C. Refer to Table 1 for a list of tests performed.

Passing Operation Verification assures that the spectrum analyzer is performing within the specifications tested. Other results indicate the need to perform the related manual test located in the Tests and Adjustments Manual (HP part number 08566-90051).

Operation Verification can be used to test the majority of the manual performance tests for a performance verification. Listed in Table 2 are the tests not covered.

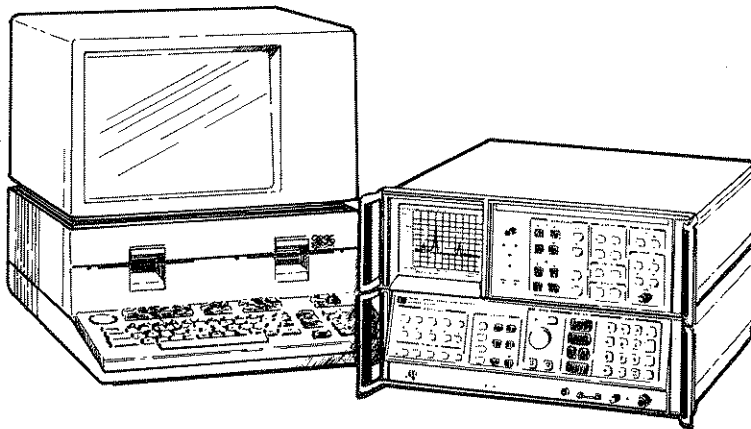

TABLE 1. TESTS PERFORMED

Test Number and Name	Equipment
1. Input Attenuator Switching Checking	HP 3335A
2. IF Gain Uncertainty	HP 3335A
3. Scale Fidelity (Log)	HP 3335A
4. Scale Fidelity (Linear)	HP 3335A
5. Log Scale Switching	HP 3335A
6. Resolution Bandwidth	None
7. Line Related Sidebands	None
8. Average Noise Level	HP 909A Option 012
9. Residual Responses	HP 909A Option 012
10. Sweep + Tune Out Accuracy	HP 3456A
11. Second Harmonic Distortion	HP 3335A 50 MHz Low Pass Filter (1)
12. Frequency Span Accuracy	HP 8340A HP 8120-1578
13. Gain Compression	HP 8340A HP 8902A HP 8485A HP 11667A HP 8120-1578
14. Frequency Response	HP 3335A HP 8340A HP 8902A HP 8485A HP 11667A HP 909A Option 012 HP 8120-1578
15. Third Order Intermodulation Distortion	HP 3335A HP 8340A HP 8721A HP 8120-1578 50 MHz Low Pass Filter (2)
16. Calibrator Output Amplitude Accuracy	HP 8902A HP 8485A
17. First LO Output Power	HP 8902A HP 8485A

2 Operation Verification

TABLE 2. TESTS NOT PERFORMED

<p>Frequency Reference Error Test</p> <p>Center Frequency Readout Accuracy Test</p> <p>Sweep Time Accuracy Test</p> <p>Noise Sidebands Test</p> <p>Harmonic and Intermodulation Test</p> <p>Image, Multiple, and Out-of-Band Responses Test</p>

TABLE 3. EQUIPMENT SUMMARY

HP Part Number	Equipment
HP 9816 or HP 9836S	Controller*
HP 3335A	Frequency Synthesizer
HP 3456A	System DVM
HP 8349A Option H01	Synthesized Sweeper
HP 8902A	Measuring Receiver
HP 8485A or HP 8481A (18 GHz)	Power Sensor
HP 909A Option 012	50 Ohm Termination
HP 8721A	Coaxial Directional Bridge
HP 11667A	Power Splitter
Cir Q Tel FLT/2-50-2/50-3A/3B	50 MHz Low Pass Filter (2 needed)
HP 8120-1578	High Frequency Test Cable (22 GHz)
HP-IB Printer	
Miscellaneous Cables and Adapters	
<p>*HP 98624A HP-IB Interface is needed with the MTS.</p> <p>*200K of free memory is required for the test program.</p>	

TEST SYSTEM CONFIGURATION

The Operation Verification program requires an HP Model 9816 or an HP Model 9836S computer with HP Basic 2.0 and Extensions 2.1. The program operates on either a single or dual bus configuration; the dual bus system is used with the Microwave Test Set (MTS). The HP 9816 operates only on the single bus, while the HP 9836S operates on either single or dual bus systems. For a dual bus system it is also necessary to have an HP Model 98624A HP-IB Interface to connect the test instrument to the HP 9836S (as shown in Figure 1).

The Operation Verification program, as it is shipped, is designed to operate on the dual bus (MTS) system. In this configuration the bus with the test equipment has a select code of 7, while the bus with the unit under test has a select code of 8. If the program is to be used on a single bus system, the necessary changes are found in the section on HP-IB addresses.

The equipment needed to perform the HP 8566B Operation Verification is listed in both Tables 1 and 3. Table 1 includes a test-by-test listing of the equipment needed and Table 3 a test equipment summary. To obtain a permanent record of the test results an HP-IB printer is required. The HP 8566B CRT display may be selected to display the test results if a permanent test record is not desired.

NOTE

As a change of the results for each test is expected over a period of time, Hewlett-Packard warrants only the specification range and not the repeatability of the data for any given specification.

EQUIPMENT CONNECTIONS

Set-up the HP 9816 or the HP 9836S Computer following the instructions in Chapter 1, "Computer Installation", in the BASIC Operating Manual (HP Part Number 09826-90000).

For the Dual Bus configuration (MTS) connect the test equipment as shown in Figure 1. The instrument under test is connected to the HP 98624A Interface card.

For a single bus system connect the HP-IB by attaching one end of an HP-IB cable to the connector on the rear panel of the computer and the other end of the cable to the connector on the rear panel of the HP 8566B (refer to Figure 2). Connect the other listed test equipment to the HP-IB using additional cables as necessary. It will be necessary to change the select code of the unit under test as explained in HP-IB ADDRESSES following Table 3.

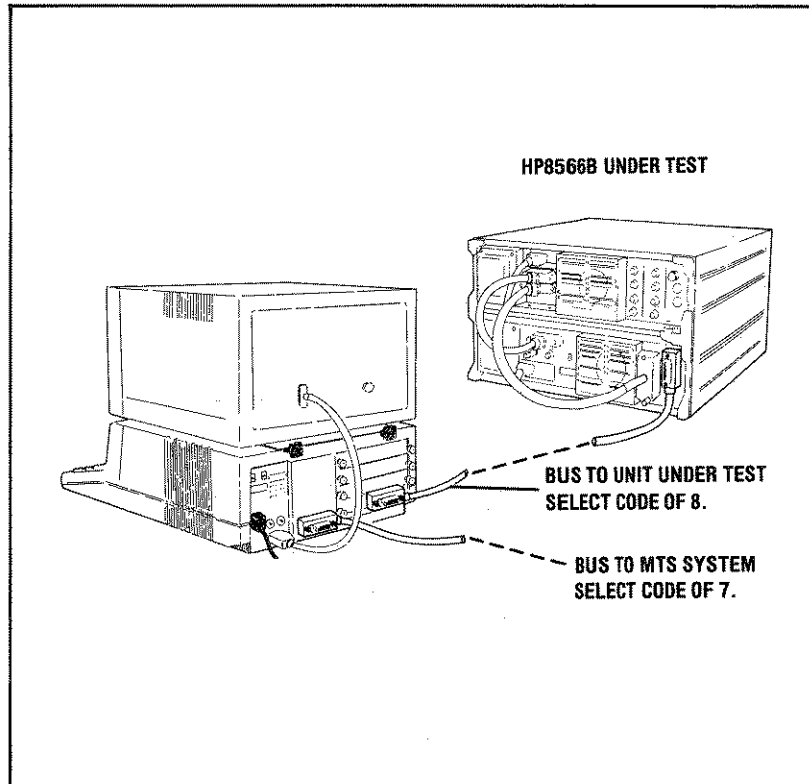

FIGURE 1. DUAL BUS (MTS) SYSTEM CONNECTION

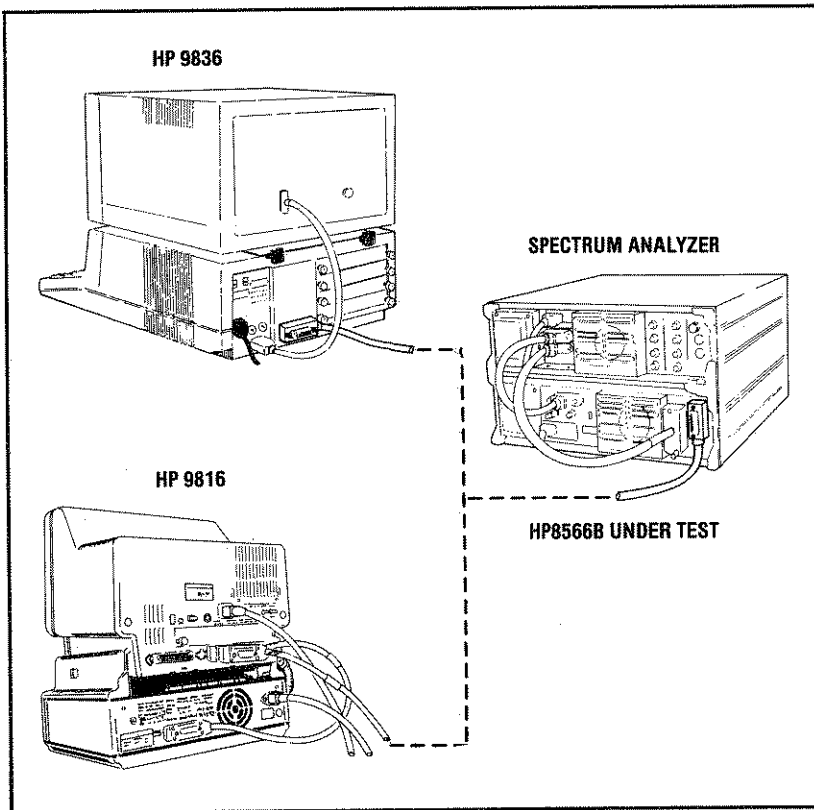

FIGURE 2. SINGLE BUS SYSTEM CONNECTION

Turn the HP 8566B line power on and allow a two-hour warm-up. Also, allow sufficient warm-up time for the other test equipment as indicated in the individual operating and service manuals.

NOTE

When connecting signals from the Synthesized Sweeper (HP 8340A Option H01) to the test set-up, it is necessary to use a high frequency cable with minimum attenuation to 22 GHz.

PROGRAM LOADING

Load Basic 2.0 and Extension 2.1 into the Computer. (Refer to the BASIC Operating Manual, Chapter 1). Next insert the disc containing the Operation Verification program and type:

LOAD "VERIFY_66",1

and push the EXECUTE key. The program will load and begin to run.

PROGRAM OPERATION

The initial displays are designed to assist you in configuring the program to meet your needs. Each display lists the program option and the appropriate responses.

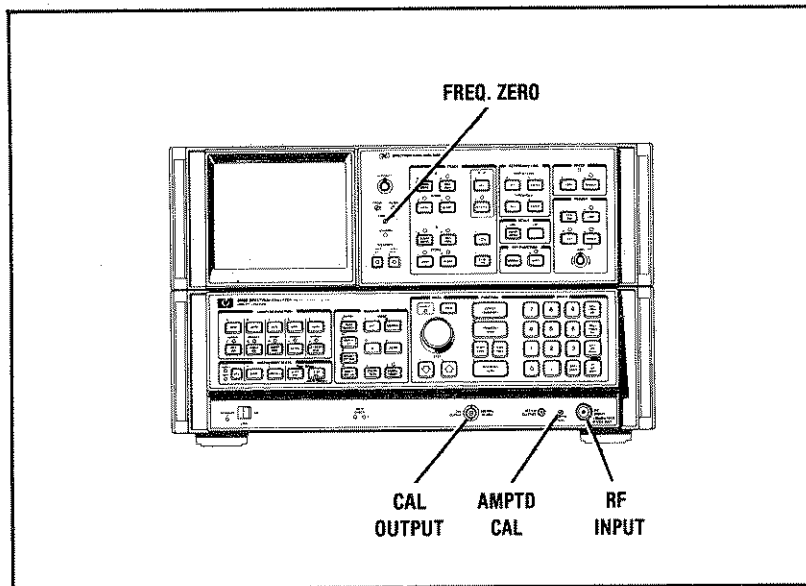

FIGURE 3. RF INPUT AND CALIBRATION CONTROLS

HP-IB ADDRESSES

Table 4 lists the assigned addresses of the test equipment on the HP-IB. For dual bus configuration the select code for the test equipment is 7 and the select code for the instrument under test is 8. (The address for the HP 8566B under test is 818.)

In the single bus configuration the select code for the test equipment is 7, and the select code for the instrument under test is 7. It will be necessary to change the value **Uut_sel_code** (near the beginning of the program under the heading **ASSIGN ADDRESSES**) from 8 to 7. (The address of the HP 8566B under test is 718.) Refer to the HP 9836S Operating Manual for instructions on storing the reconfigured program for future use.

TABLE 4. HP-IB ADDRESSES

Equipment	HP Model	Address
Controller	HP 9816 or HP 9836S	21
Frequency Synthesizer	HP 3335A	04
Systems DVM	HP 3456A	22
Synthesized Sweeper	HP 8340A	19
Measuring Receiver	HP 8902A	14
HP-IB Printer	HP 82906A (Recommended)	01

ERROR MESSAGES

Self-explanatory error messages are incorporated into the Operation Verification program to assist you in identifying errors.

TEST DESCRIPTIONS

The following test descriptions list the Specifications, Related Performance Test, and Test Description for each test performed by the Operation Verification program. The specifications listed below are those of each Operation Verification test and are uncorrected (where applicable). Operation Verification is designed to test an instrument operating within a temperature range of 20° to 30° C.

1. INPUT ATTENUATOR SWITCHING CHECK

Specification:

None

Related Performance Test:

None

Description:

This is included as an aid to verify operation only and to assist in troubleshooting.

A signal source of know amplitude is connected to the spectrum analyzer and the analyzer is adjusted for a reference. The input attenuator is stepped down from 10 dB to 70 dB, while the reference level and the signal source are stepped up. This maintains the signal peak at the same approximate location on the CRT display. The amplitude of the signal is measured at each step using the marker function on the spectrum analyzer.

2. IF GAIN UNCERTAINTY

Specification:

0.0 dBm to -55.9 dBm; ± 0.6 dB
-56.0 dBm to -129.9 dBm; ± 1.0 dB

Related Performance Test:

IF GAIN UNCERTAINTY TEST

Description:

A signal source of known amplitude is connected to the spectrum analyzer and the analyzer is adjusted for a reference level. The amplitude of the signal peak is measured in 0.1 dB steps from -0.1 dB to -1.9 dB, in 2 dB steps from -1.9 dB to -9.9 dB, and in 10 steps from -10 dB to -120 dB.

3. SCALE FIDELITY (Log)

Specification:

$\leq \pm 1.0$ dB max over 0 to 80 dB display
 $\leq \pm 1.5$ dB max over 0 to 90 dB display

Related Performance Test:

SCALE FIDELITY TEST

Description:

The specification listed is for cumulative error. Only cumulative error is measured in this procedure.

A signal source of known amplitude is connected to the spectrum analyzer and the analyzer is adjusted for a reference. The signal source is stepped down in 1 dB steps and the displayed signal amplitude on the spectrum analyzer measured at each step. This measurement is performed in both the 3 kHz and 300 kHz bandwidths.

4. SCALE FIDELITY (Linear)

Specification:

$\pm 3\%$ of Reference Level

Related Performance Test:

SCALE FIDELITY TEST

Description:

A signal source of known amplitude is connected to the spectrum analyzer and the analyzer is adjusted for a reference. The signal source is stepped down from -10 dB to -30 dB in 10 dB steps and the amplitude of the displayed signal measured using the marker function. This measured value is used to calculate the percent error from the reference level established.

5. LOG SCALE SWITCHING UNCERTAINTY

Specification:

± 0.5 dB (uncorrected)

Related Performance Test:

LOG SWITCHING UNCERTAINTY TEST

Description:

A signal source of known amplitude is connected to the spectrum analyzer and the analyzer is adjusted for a reference in the 1 dB per division log scale. The spectrum analyzer is then switched to each of the other LOG scales (2 dB, 5 dB, and 10 dB) and the amplitude of the signal peak is measured at each setting.

6. RESOLUTION BANDWIDTHS

Specification:

Bandwidth: 10 Hz to 3 MHz; $\pm 20\%$
3 kHz to 1 MHz; $\pm 10\%$

Amplitude: 3 MHz to 10 Hz; ± 1.0 dB
1 MHz to 30 Hz; ± 0.5 dB
30 Hz; ± 0.8 dB
10 Hz; ± 2.0 dB

Selectivity: (60 dB/3 dB Ratio)
3 MHz to 100 kHz; $<15:1$
30 kHz to 10 kHz; $<13:1$
3 kHz to 30 Hz; $<11:1$
10 Hz; <100 Hz separation of 60 dB points

Related Performance Tests:

RESOLUTION BANDWIDTH ACCURACY TEST
RESOLUTION BANDWIDTH SELECTIVITY TEST
RESOLUTION BANDWIDTH SWITCHING UNCERTAINTY TEST

Description:

A signal source is connected to the spectrum analyzer input. The analyzer steps through the bandwidths from 3 MHz to 10 Hz; centers the signal, sets signal peak near the Reference Level, and measures the frequency of the 3 dB points for each bandwidth. The 3 dB bandwidth is then calculated by determining the difference in frequency between the 3 dB points.

Next the spectrum analyzer steps through the bandwidths and measures the frequency of the 60 dB points of each bandwidth. The 60 dB bandwidth is then calculated by determining the frequency difference between the 60 dB points.

The shape factors are calculated by dividing the 60 dB bandwidths by the 3 dB bandwidths.

7. LINE RELATED SIDEBANDS

Specification:

For a Line Frequency of 60 Hz:

Offset from Carrier	Sideband Level
<360 Hz	- 70 dBc

For a Line Frequency of 400 Hz:

<2 kHz	- 55 dBc
--------	----------

Related Performance Test:

LINE RELATED SIDEBANDS TEST

Description:

A signal source is connected to the spectrum analyzer input and the necessary front panel control settings made for the test. The harmonics of the line frequency are calculated, the front panel controls to view the frequencies, and measure the amplitude of the signal at each of the frequencies.

8. AVERAGE NOISE LEVEL

Specification:

Non-Preselected

Level	Tuning Range
< -95 dBm	100 Hz to 50 kHz
< -112 dBm	50 kHz to 1.0 MHz
< -134 dBm	1.0 MHz to 2.5 GHz

Preselected

Level	Tuning Range
< -132 dBm	2.0 GHz to 5.8 GHz
< -125 dBm	5.8 GHz to 12.5 GHz
< -119 dBm	12.5 GHz to 18.6 GHz
< -114 dBm	18.6 GHz to 22.0 GHz

Related Performance Test:

AVERAGE NOISE LEVEL

Description:

The RF INPUT of the spectrum analyzer is terminated with a 50 ohm load or the synthesizer and the analyzer attenuator. The necessary front-panel control settings are made and the average noise level measured at four non-preselected and four preselected frequencies.

9. RESIDUAL RESPONSES

Specification:

- 100 dBm, 100 Hz to 5.8 GHz
- 95 dBm, 5.8 Hz to 12.5 GHz
- 85 dBm, 12.5 GHz to 18.6 GHz
- 80 dBm, 18.6 GHz to 22.0 GHz

Related Performance Test:

RESIDUAL RESPONSES TEST

Description:

The RF Input of the spectrum analyzer is terminated with a 50 ohm load or the synthesizer and the analyzer attenuator. The peak amplitude of the noise or responses is measured at various frequencies associated with residual responses caused by harmonics and mixing products of the First, Second, and Third local oscillator, the internal reference, and the HP-IB and digital storage clocks.

10. SWEEP + TUNE OUT ACCURACY**Specification:**

– 1V/GHz $\pm 2\%$ ± 10 mV.

Related Performance Test:**SWEEP + TUNE OUT ACCURACY TEST****Description:**

A digital voltmeter is used to monitor the rear-panel SWEEP + TUNE OUT voltage while the spectrum analyzer center frequency is set to 9 arbitrary values. The output voltage for each center frequency setting is checked against the specification.

11. SECOND HARMONIC DISTORTION

Specification: (For mixer level ≤ -40 dBm)

< -70 dBc, 100 Hz to 2.5 GHz (non-preselected)

Related Performance Test:

HARMONIC AND INTERMODULATION DISTORTION

Description:

A 40 MHz signal is applied to the analyzer RF INPUT through a 50 MHz Low Pass Filter. The spectrum analyzer is adjusted to measure the second harmonic at 80 MHz.

12. FREQUENCY SPAN ACCURACY

Specification: (where N is the harmonic mixing number)

For span/n > 5 MHz; $\pm 3\%$ of indicated frequency separation
For span/n ≤ 5 MHz; $\pm 1\%$ of indicated frequency separation

Related Performance Test:

FREQUENCY SPAN ACCURACY

Description:

A stable signal source is connected to the spectrum analyzer and the center frequency and span are set to measure spans from 100 MHz to 5 GHz in a 1,2,5 sequence.

13. GAIN COMPRESSION

Specification:

<1.0 dB, 100 Hz to 22 GHz with ≤ -5 dBm at input mixer

Related Performance Test:

GAIN COMPRESSION TEST

Description:

Gain compression is measured by changing the power level at the input mixer from -15 dBm to -5 dBm and measuring the change in display level using the spectrum analyzer marker function. This is done at two frequencies: 100 MHz and 2.2 GHz to check both the First Mixer and YIG Tuned Mixer, respectively.

14. FREQUENCY RESPONSE

Specification:

Center Frequency	Flatness
200 Hz to 2.5 GHz non-preselected band	± 0.6 dB (1.2 dB)
2.0 GHz to 5.8 GHz preselected band	± 1.7 dB (3.4 dB)
5.8 GHz to 12.5 GHz preselected band	± 1.7 dB (3.4 dB)
2.5 GHz to 18.6 GHz preselected band	± 2.2 dB (4.4 dB)
18.6 GHz to 20.0 GHz preselected band	± 2.2 dB (4.4 dB)
20.0 GHz to 22.0 GHz preselected band	± 3.0 dB (6.0 dB)

Cumulative Flatness
200 Hz to 22 GHz 6.0 dB

Related Performance Test:**FREQUENCY RESPONSE TEST****Description:**

If this test is individually selected, a menu of the testable bands is displayed. For all bands except 200 Hz to 22 GHz, the test consists of 200 data points taken across the selected band. For the 200 Hz to 22 GHz test, two bands are tested (400 data points). First the sweeper is used to test from 20 MHz to 22 GHz and then the synthesizer is used to test from 200 Hz to 20 MHz. The levels at 20 MHz are matched to guarantee continuity. If the Frequency Response test is entered from the ALL TESTS Mode, then the 200 Hz to 22 GHz is selected automatically.

15. THIRD ORDER INTERMODULATION DISTORTION**Specification:**

Intercept is greater than +7.0 dBm from 5 MHz to 5.8 GHz

Related Performance Test:**HARMONIC AND INTERMODULATION DISTORTION TEST****Description:**

Two signals with 1 MHz separation are applied to the First Mixer. The frequencies of third order intermodulation products is calculated and the spectrum analyzer is set to measure the amplitude of these responses. The third order intercept is calculated from the measurements.



OPERATOR'S HANDBOOK

8566B SPECTRUM ANALYZER

Includes Options 010, 400, 908, and 913

SERIAL NUMBERS

This manual applies directly to Model 8566B RF Sections with serial numbers prefixed 2410A and IF-Display Sections with serial numbers prefixed 2403A.

**Copyright © 1984, HEWLETT-PACKARD COMPANY.
1212 VALLEY HOUSE DRIVE
ROHNERT PARK, CALIFORNIA 94928, U.S.A.**

**MANUAL PART NO. 08566-90045
Microfiche No. 08566-90049
Printed: MARCH 1984**

