

# **HP 8935 CDMA Cellular/PCS Base Station Test Set**

## **CDMA Base Station Tests**

### **Application Guide**

**Firmware Version: A.01.00 and above**

HP Part Number E6380-90016

**Revision A**

**Printed in U.S.A.**

**November 1997**

© Copyright 1997 Hewlett-Packard Company



---

## **Notice**

Information contained in this document is subject to change without notice.

All Rights Reserved. Reproduction, adaptation, or translation without prior written permission is prohibited, except as allowed under the copyright laws.

This material may be reproduced by or for the U.S. Government pursuant to the Copyright License under the clause at DFARS 52.227-7013 (APR 1988).

---

## **Manufacturer's Declaration**

This statement is provided to comply with the requirements of the German Sound Emission Directive, from 18 January 1991.

This product has a sound pressure emission (at the operator position) < 70 dB(A).

- Sound Pressure  $L_p < 70$  dB(A).
- At Operator Position.
- Normal Operation.
- According to ISO 7779:1988/EN 27779:1991 (Type Test).

### **Herstellerbescheinigung**

Diese Information steht im Zusammenhang mit den Anforderungen der Maschinenlärminformationsverordnung vom 18 Januar 1991.

- Schalldruckpegel  $L_p < 70$  dB(A).
- Am Arbeitsplatz.
- Normaler Betrieb.
- Nach ISO 7779:1988/EN 27779:1991 (Typprüfung).

---

# Safety

## GENERAL

This product and related documentation must be reviewed for familiarization with safety markings and instructions before operation.

This product has been designed and tested in accordance with IEC Publication 1010, "Safety Requirements for Electronic Measuring Apparatus," and has been supplied in a safe condition. This instruction documentation contains information and warnings which must be followed by the user to ensure safe operation and to maintain the product in a safe condition.

## SAFETY SYMBOLS



Indicates instrument damage can occur if indicated operating limits are exceeded. Refer to the instructions in this guide.



Indicates hazardous voltages.



Indicates earth (ground) terminal

---

### WARNING

**A WARNING note denotes a hazard. It calls attention to a procedure, practice, or the like, which, if not correctly performed or adhered to, could result in personal injury. Do not proceed beyond a WARNING sign until the indicated conditions are fully understood and met.**

---

### CAUTION

A CAUTION note denotes a hazard. It calls attention to an operation procedure, practice, or the like, which, if not correctly performed or adhered to, could result in damage to or destruction of part or all of the product. Do not proceed beyond an CAUTION note until the indicated conditions are fully understood and met.

---

## Safety Considerations for this Instrument

---

WARNING



**This product is a Safety Class I instrument (provided with a protective earthing ground incorporated in the power cord). The mains plug shall only be inserted in a socket outlet provided with a protective earth contact. Any interruption of the protective conductor inside or outside of the product is likely to make the product dangerous. Intentional interruption is prohibited.**



**Do not expose to or operate this instrument in outdoor atmospheric conditions such as direct rain, hail, sleet, snow, icing, sunshine or wind. Operate this instrument only within its specified temperature humidity conditions.**



**This instrument is equipped with internal ground fault circuit interrupter class A.**

- **This device does not protect against electrical shock due to contact with both circuit conductors or a fault in supply wiring to product.**
- **Do not use extension cord to connect this product to power receptacle. Attention-ne pas utiliser de rallonge pour raccorder le detecteur-disjoncteur a la prise de courant.**
- **Replace cordset only with HP 8120 series. Attention - Remplacer uniquement par un cordon amovible numero 8120.**
- **Do not use in wet location. Ne pas utiliser dans un emplacement mouille.**

---

WARNING

**Whenever it is likely that the protection has been impaired, the instrument must be made inoperative and be secured against any unintended operation.**

**If this instrument is to be energized via an autotransformer (for voltage reduction), make sure the common terminal is connected to the earth terminal of the power source.**

**If this product is not used as specified, the protection provided by the equipment could be impaired. This product must be used in a normal condition (in which all means for protection are intact) only.**

**No operator serviceable parts in this product. Refer servicing to qualified personnel. To prevent electrical shock, do not remove covers.**

**Servicing instructions are for use by qualified personnel only. To avoid electrical shock, do not perform any servicing unless you are qualified to do so.**

**The opening of covers or removal of parts is likely to expose dangerous voltages. Disconnect the product from all voltage sources while it is being opened.**

**Adjustments described in the manual are performed with power supplied to the instrument while protective covers are removed. Energy available at many points may, if contacted, result in personal injury.**

**The power cord is connected to internal capacitors that may remain live for 5 seconds after disconnecting the plug from its power supply.**

**For Continued protection against fire hazard, replace the line fuse(s) only with 250 V fuse(s) or the same current rating and type (for example, normal blow or time delay). Do not use repaired fuses or short circuited fuseholders. FUSE: T 5.0A**

---

**CAUTION**

Always use the three-prong ac power cord supplied with this product. Failure to ensure adequate earth grounding by not using this cord may cause personal injury and/or product damage.

This product is designed for use in Installation Category II and Pollution Degree 2 per IEC 1010 and IEC 664 respectively. For indoor use only.

This product has autoranging line voltage input, be sure the supply voltage is within the specified range.

Ventilation Requirements: When installing the product in a cabinet, the convection into and out of the product must not be restricted. The ambient temperature (outside the cabinet) must be less than the maximum operating temperature of the product by 4° C for every 100 watts dissipated in the cabinet. If the total power dissipated in the cabinet is greater than 800 watts, then forced convection must be used.

---

To prevent electrical shock, disconnect instrument from mains (line) before cleaning. Use a dry cloth or one slightly dampened with water to clean the external case parts. Do not attempt to clean internally.

### **Product Markings**

CE - the CE mark is a registered trademark of the European Community. A CE mark accompanied by a year indicated the year the design was proven.

CSA - the CSA mark is a registered trademark of the Canadian Standards Association.

### **CERTIFICATION**

Hewlett-Packard Company certifies that this product met its published specifications at the time of shipment from the factory.

Hewlett-Packard further certifies that its calibration measurements are traceable to the United States National Institute of Standards and Technology, to the extent allowed by the Institute's calibration facility, and to the calibration facilities of other International Standards Organization members.

---

## **Warranty**

This Hewlett-Packard instrument product is warranted against defects in material and workmanship for a period of one year from date of shipment. During the warranty period, Hewlett-Packard Company will at its option, either repair or replace products which prove to be defective.

For warranty service or repair, this product must be returned to a service facility designated by HP. Buyer shall prepay shipping charges to HP and HP shall pay shipping charges, duties, and taxes for products returned to HP from another country.

HP warrants that its software and firmware designated by HP for use with an instrument will execute its programming instructions when properly installed on that instrument. HP does not warrant that the operation of the instrument, or software, or firmware will be uninterrupted or error free.

### **LIMITATION OF WARRANTY**

The foregoing warranty shall not apply to defects resulting from improper or inadequate maintenance by Buyer, Buyer-supplied software or interfacing, unauthorized modification or misuse, operation outside of the environmental specifications for the product, or improper site preparation or maintenance.

NO OTHER WARRANTY IS EXPRESSED OR IMPLIED. HP SPECIFICALLY DISCLAIMS THE IMPLIED WARRANTIES OF MERCHANTABILITY AND FITNESS FOR A PARTICULAR PURPOSE.

### **EXCLUSIVE REMEDIES**

THE REMEDIES PROVIDED HEREIN ARE BUYER'S SOLE AND EXCLUSIVE REMEDIES. HP SHALL NOT BE LIABLE FOR ANY DIRECT, INDIRECT, SPECIAL, INCIDENTAL, OR CONSEQUENTIAL DAMAGES, WHETHER BASE ON CONTRACT, TORT, OR ANY OTHER LEGAL THEORY.



---

## **ASSISTANCE**

### **Maintenance Agreements**

Product maintenance agreements and other customer assistance agreements are available for Hewlett-Packard products. For any assistance, contact your nearest Hewlett-Packard Sales and Service Office.

## Regional Sales Offices

**IMPORTANT**

### Regional Sales and Service Offices

<p>Eastern USA Sales Office Hewlett-Packard Company 2101 Gather Rd. Rockville, MD 20850 Tel: (301) 258-2000</p>	<p>Eastern USA Sales Office Hewlett-Packard Company 2101 Gather Rd. Rockville, MD 20850 Tel: (301) 258-2000</p>	<p>Midwestern USA Sales and Service Hewlett-Packard Company 5201 Tollview Drive Rolling Meadows, IL 60008 Tel: (708) 342-2000</p>
<p>Southern USA Sales and Service Hewlett-Packard Company 1995 North Park Place Atlanta, GA 30339 Sales Tel: (404) 955-1500 Fax: (404) 980-7292 Service Tel: (404) 850-2544 Fax: (404) 980-7292</p>	<p>Southern USA Service Center Hewlett-Packard Company 930 E. Campbell Road Richardson, TX 75081 Tel: (214) 699-4331</p>	<p>Western USA Service Center Hewlett-Packard Company 301 E. Evelyn Avenue Mountain View, CA 94041 Tel: (415) 694-2000 Fax: (415) 694-0601</p>
<p>Western USA Sales and Service Hewlett-Packard Company 24 Inverness Place East Englewood, CO 80112 Sales Tel: (303) 649-5000 Fax: (303) 649-5787 Service Tel: (303) 649-5512 Fax: (303) 649-5787</p>	<p>Western USA Sales and Service Hewlett-Packard Company 1421 South Manhattan Avenue Fullerton, CA 92631 Sales Tel: (714) 999-6700 Fax: (714) 778-3033 Service Tel: (714) 758-5490 Fax: (714) 778-3033</p>	<p>United States of America Customer Information Center Hewlett-Packard Company Tel: (800) 752-0900 6:00 am to 5:00 pm Pacific Time Parts Direct: 1-800-227-8164</p>
<p>South Eastern Europe Sales and Service Hewlett-Packard Ges. m.b.h. Liebigasse 1 P.O. Box 72 A-1222 Vienna, Austria Telephone: 43 222 2500 0 Telex: 13 4425</p>	<p>European Multicountry Region Sales and Service Hewlett-Packard S.A. P.O. Box 95 150, Route dv Nant_dl_AVRIL CH-1217 Meyrin 2 Geneva, Switzerland Telephone: (41/22) 780-8111 Fax: (41/22) 780-8542</p>	<p>Northern Europe Sales and Service Hewlett-Packard Nederland B.V. Startbaan 16 1187 XR Amstelveen, The Netherlands P.O. Box 667 Telephone: 31/20 5476911 X 6631 Fax: 31-20-6471825NL</p>

<p>Asia Sales and Service Hewlett-Packard Asia Ltd. 22-30/F Peregrine Tower Lippo Center 89 Queensway, Central Hong Kong G.P.O. Box 863 Hong Kong Telephone: 852-848-7777 Fax: 852-868-4997</p>	<p>Japan Sales and Service Yokogawa-Hewlett-Packard Ltd. 3-29-21, Takaido-Higashi Suginami-Ku, Tokyo 168 Telephone: 81 3 3331-6111 Fax: 81 3 3331-6631</p>	<p>International Sales Branch Headquarters Sales and Service Hewlett-Packard S.A. 39 Rue Veyrot P.O. Box 365 1217 Meyrin 1 Geneva, Switzerland Telephone: 41-22-780-4111 Fax: 41-22-780-4770</p>
<p>Australia, New Zealand Sales and Service Hewlett-Packard Ltd. P.O. Box 221 31-41 Joseph Street Blackburn, Victoria 3130 Telephone: (61/3) 895-2895 Fax: (61/3) 898-9257</p>	<p>Canada Sales and Service Hewlett-Packard (Canada) Ltd. 5150 Spectrum Way Mississauga, Ontario L4W 5G1 Canada Telephone: (416) 206-4725 Fax: (416) 206-4739</p>	<p>Canada Service Center Hewlett-Packard Company 17500 Transcanada Highway S. Serv Road Kirkland, Quebec H9J 2X8 Canada Telephone: (416) 206-3295</p>
<p>Canada Service Center Hewlett-Packard Ltd. 11120 178 Street Edmonton, Alberta T5S 1P2 Canada Telephone: (403) 486-6666 Fax: (403) 489-8764</p>	<p>Latin America Hewlett-Packard Company LAHQ Mexico City Col. Lomas de Virreyes 11000 Mexico D.F. Mexico Telephone: (52/5) 326-4000 Fax: (52/5) 202 7718</p>	<p>United Kingdom Sales and Service Hewlett-Packard Ltd. Cain Road Amen Corner Bracknell, Berkshire RG12 1HN United Kingdom Telephone: 44 344 360000</p>



<b>In This Manual</b> .....	<b>17</b>
<b>1. Getting Started with CDMA Test</b>	
About the Test Set .....	20
Product Description .....	20
Who Should Use this Test Set .....	21
Batteries .....	21
Getting Help .....	22
What's Included with this Test Set .....	23
Manual and Automatic Operation Modes .....	24
IBASIC programs .....	24
Maximizing the Accuracy of Your Measurements .....	25
Calibration .....	25
Temperature Compensation .....	25
When to zero the power .....	25
Display a CDMA Signal (Loopback Test) .....	26
Connections for CDMA Loopback Test .....	26
Get Started with the Test Set .....	26
Generate a CDMA Signal .....	28
Display a CDMA Signal .....	28
What to Do Next .....	28
<b>2. Testing CDMA Base Stations</b>	
Tests That You Can Perform with the Test Set .....	30
Setup and Configuration .....	31
Connections Between the Test Set and the Device Under Test (DUT)	
32	
Synchronizing Your Base Station to the Test Set .....	32
Configuring the Test Set with Your Base Station's Information .....	33
Choosing Between RF In/Out, Antenna and Duplex Ports .....	34
Saving and Recalling Instrument Setups .....	36
To Save an Instrument Setup .....	36
To Recall an Instrument Setup .....	36
To Choose the Save/Recall Location .....	36
Average Power .....	37
Prerequisites .....	37
Procedure .....	37
Results .....	38
Notes .....	39
Channel Power .....	40
Prerequisites .....	40
Channel Power Calibration Procedure .....	40
Channel Power Measurement Procedure .....	41
Results .....	42
Notes .....	42
Code Domain Testing .....	43
Prerequisites .....	43
Procedure .....	44

Results . . . . .	45
Code Domain Measurements . . . . .	45
Code Domain Power . . . . .	45
Fast Power . . . . .	46
Code Domain Phase . . . . .	46
Code Domain Timing . . . . .	46
Time Offset . . . . .	47
Frequency Error . . . . .	47
Carrier Feedthrough . . . . .	47
Code Domain Notes . . . . .	48
Rho (Modulation Quality) . . . . .	49
Prerequisites . . . . .	49
Procedure . . . . .	50
Results . . . . .	50
Transmit Spectrum . . . . .	51
Prerequisites . . . . .	52
Procedure . . . . .	52

### 3. Utility Procedures

Beeper . . . . .	54
Beeper Control . . . . .	54
Changing Between Channel Mode and Frequency Mode . . . . .	55
Procedure to Change Between Channel and Frequency Modes . . . . .	55
Measuring Insertion Losses . . . . .	56
Memory Cards . . . . .	57
Memory Cards and Initialization . . . . .	57
Initializing SRAM Cards for Save/Recall and Data Collection . . . . .	57
Oscilloscope . . . . .	58
Selecting the Oscilloscope's Input . . . . .	58
Selecting the Oscilloscope's Filters . . . . .	59
Triggering the Oscilloscope . . . . .	59
Using the Marker . . . . .	60
Online Help . . . . .	61
Help Screen Display . . . . .	61
Ports: HP-IB, Serial and Parallel . . . . .	62
HP-IB Port . . . . .	62
Controlling the HP-IB Port . . . . .	62
Serial Ports . . . . .	62
Configuring Serial Ports . . . . .	62
Using Serial Ports for Printing . . . . .	63
Configuring Serial Port 9 for IBASIC Communications . . . . .	63
Configuring Serial Ports 10 and 11 . . . . .	63
Parallel Ports . . . . .	64
Power Measurements . . . . .	65
Average Power . . . . .	65
Channel Power . . . . .	65
Code Domain Power . . . . .	65
Fast Power . . . . .	65
TX Power . . . . .	65

Printing .....	66
Configuring the Test Set for Printing .....	66
Printing a Screen .....	67
Measuring Swept Return Loss .....	68
Software: Loading .....	71
Tracking Generator .....	72
Using the Tracking Generator .....	72
User Keys .....	74
Displaying the Pre-assigned Local User Keys .....	74
Assigning a Local User Key .....	74
Assigning a Global User Key .....	74
To Release a User Key Assignment .....	75
Voltmeter .....	76
Measuring AC Level and DC Level .....	76





---

## In This Manual

This manual explains how to use the HP 8935 to manually test a CDMA Base Station.

### What is Discussed This Manual

This document presents a step-by-step approach to CDMA base station testing using the Test Set, including what you need to know before you can start testing.

### What is Not Discussed in this Manual

General operation of the Test Set, such as changing display screens and their associated controls, is discussed in the Reference Guide (HP part number E6380-90019).

Detailed operation of the Test Set's spectrum analyzer and oscilloscope. Although there are basic explanations in this manual, more detail is provided in the Reference Guide.

How to control your base station, switch system, or any other software or hardware associated with your cell site equipment. Each manufacturer and cellular service provider has their own cell site control and base station configuration procedures that go beyond the scope of this documentation.

How to perform IBASIC programming operations, such as writing, editing, copying, or cataloguing programs. Programming the Test Set is explained in the *Programming Manual* (HP part number E6380-90018), and the IBASIC language is explained in the *HP Instrument BASIC User's Handbook* (HP part number E2083-90005).

### Conventions Used in This Manual

The following conventions are used throughout this manual to help clarify instructions and reduce unnecessary text:

**Test Set** refers to the HP 8935.

Test Set keys are indicated like this: **Preset**

Test Set screen information, such as a measurement result or an error message, is shown like this: TX Channel Power -1.3 dBm

**Which Document is Required?** The following documents are part of the HP 8935 document set. Use the table to help you decide which document you need.

**Table 1 Document Navigation**

<b>Document</b>	<b>Part Number</b>	<b>Usage</b>
CDMA Application Guide	E6380-90016	Use this manual for basic CDMA measurements and for getting started with the Test Set.
AMPS Application Guide	E6380-90017	Use this manual for making AMPS base station measurements.
Reference Guide	E6380-90019	Use this manual for screen and field descriptions and general operation information about the Test Set.
Programmer's Guide	E6380-90018	Use this manual to learn HP-IB syntax and for learning how to program the Test Set.
Assembly Level Repair Guide	E6380-90015	Use this manual to perform calibration on the Test Set and for general service information.

---

# 1 Getting Started with CDMA Test

This chapter introduces you to the HP 8935 Test Set and its CDMA functions. For information on other functions in the Test Set, [see “Which Document is Required?” on page 18](#). To proceed immediately to the test procedures, [see “Tests That You Can Perform with the Test Set” on page 30](#).

## About the Test Set

### Product Description

This Test Set is a tool which will help you in testing CDMA base stations at both the cellular band and the PCS band. It also allows you to test AMPS base stations. (This guide discusses CDMA testing. For more information about AMPS testing, refer to the *Manual AMPS Base Station Tests Guide*.)

The Test Set contains a CDMA signal generator and a frequency translator which allow generation of CDMA signals at both cellular and PCS frequencies. Other tools include

- Code Domain Analyzer
- CDMA Analyzer
- CDMA Generator
- Spectrum Analyzer
- Power Meter (both wideband and channel)
- Oscilloscope

Other tools include

- AMPS Analyzer
- AC/DC Voltmeter
- Audio and RF Generators
- Built-in IBASIC controller

## Who Should Use this Test Set

If you are installing, commissioning or maintaining CDMA sites operating at either the PCS frequencies or cellular frequencies, this Test set can assist you in testing these base stations.

## Batteries

There are two methods by which the Test Set backs up its RAM. One is a set of two AA batteries mounted behind the rear panel of the Test Set. You must periodically change these batteries. The second method of RAM backup is an internal battery. It is not user serviceable.

---

**CAUTION**

Failure to take prompt action may result in loss of RAM data including IBASIC programs and SAVE / RECALL states stored in the RAM.

---

**NOTE**

Do not use rechargeable batteries.

To change the AA batteries, use the following procedure:

1. Turn off power and unplug the Test Set.
2. Remove the six screws in the rear panel using a TX-15 TORX (R) screwdriver.
3. Remove the rear cover.
4. Replace the AA batteries.
5. Replace and reconnect the rear panel. Dispose of used batteries properly.

## Getting Help

If you have problems using this Test Set, and cannot find the solution in these documents or the Help screens, please use one of the following contacts:

- Your local or regional sales office (see "[Regional Sales Offices](#)" on [page 10](#))
- U.S. Call Center: 800 542-4844
- Korea HP Direct: (82/2) 769-0800
- Canada HP Direct: (800) 387-3154
- European Call center: +31 20 547-9990
- Test and Measurement Organization on the web:  
<http://www.tmo.hp.com/>

## What's Included with this Test Set

The equipment commonly shipped with the base Test Set is listed below. Options that you order with your Test Set may change this list.

- Test Set
- Documentation
  - CDMA Applications Guide
  - CD-ROM with the above listed manual, *Manual AMPS Base Station Tests*, *Assembly Level Repair Manual*, *Programmer's Guide*, and *HP 8935 Reference Guide* in Adobe™ Acrobat Reader format (.pdf).
- Power cord
- Cover for the front panel of the Test Set

## Manual and Automatic Operation Modes

You can operate the Test Set in either of two modes: Manual or Automatic. Controlling the Test Set with the keypad is Manual Operation. Controlling the Test Set with a program is Automatic Operation.

Use Manual Mode when you want to control the Test Set with the front panel. Manual operation is described in this document.

Use Automatic Mode when you want to control the Test Set with its internal IBASIC controller. To use the Test Set in Automatic Mode, you must load an IBASIC program into the Test Set's memory.

### IBASIC programs

You can obtain an IBASIC program in two ways: either write it yourself, or purchase a software package from Hewlett-Packard. To write programs yourself, refer to the *Programmer's Guide*, included with the Test Set's documentation.

Many of HP's software packages are manufacturer-specific packages. Manufacturer-specific software packages provide automated testing of the manufacturer's base station to greatly reduce test times and provide test setup repeatability. Once configured, the software typically controls both the base station and the Test Set and prompts the user to make the required connections during testing. Test results can be printed and/or saved to a file for later use. Contact your local HP Sales Office to find out which software packages are currently available.



---

## Maximizing the Accuracy of Your Measurements

This Test Set is designed to make highly accurate measurements. However, to ensure that you have the most accurate measurements available, you can perform the following tasks:

### Calibration

You should calibrate the Test Set whenever you change a module or add a hardware option. You may want to calibrate when you upgrade firmware. See the *Assembly Level Repair Manual* for calibration procedures.

There is also a field named `Calibrate` in the CDMA ANALYZER screen. This field is used to calibrate the Channel Power measurement. See “[Channel Power](#)” on page 40. Note that cables must be removed from the Test Set’s inputs before using `Calibrate`.

### Temperature Compensation

The Test Set is internally compensated for temperature. However, you will find that on some screens a zeroing function appears. For example, in the RF ANL screen, the `TX Pwr Zero` function appears. This is a routine optimization function, and generates calibration offsets when selected. This will compensate for temperature related drift, thereby maximizing measurement accuracy.

The `Pwr Zero` function in the CDMA ANALYZER screen is the same as the `TX Pwr Zero` function. Cables do not need to be removed from the Test Set’s inputs for `Pwr Zero`. The offsets are stored in static RAM, and the Test System uses them when measuring Average Power with a DUT attached. The offsets are updated whenever you zero the power meter, and the latest values are stored for the life of the static RAM backup battery.

#### When to zero the power

By default, power zeroing is performed automatically. Automated or manual zeroing is controlled by the `Auto Zero` field.

If you choose to zero power manually, you should zero power frequently if the Test System is still warming up, about two to three times within the first two hours. You should zero power occasionally even if the Test System is on continuously. (Occasionally can mean daily, weekly or monthly, as you choose).

## Display a CDMA Signal (Loopback Test)

This section will guide you through the process of displaying a CDMA signal at a PCS frequency. It is intended to make you feel more comfortable with using the Test Set. If you are ready to begin testing, proceed to [Chapter 2, “Testing CDMA Base Stations,”](#) on page 29.

### Connections for CDMA Loopback Test

Connect the Test Set in the following manner.

**Figure 1-1** CDMA Loopback Test Connections

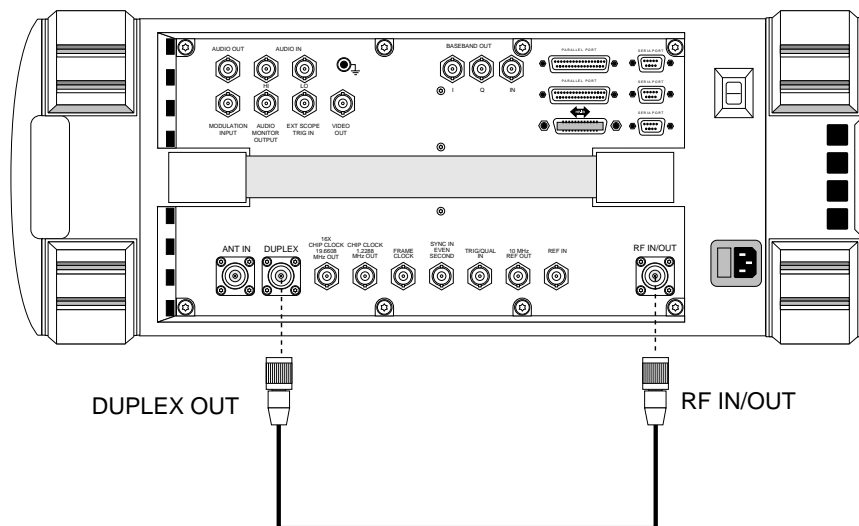

### Get Started with the Test Set

1. Plug in the Test Set.
2. Turn on the Test Set (or press **Preset**) if it is already on. The CDMA ANALYZER screen will be displayed.
3. Press the **Inst Config** key.
4. Select **RF Display**, and set the field to **Freq**.
5. Verify your connections. See [“Connections for CDMA Loopback Test”](#) on page 26.

**NOTE**

Here are some tips for selecting screens and fields:

- Rotate the knob to move the cursor around the screen. Reverse video boxes indicate fields that can be selected. Press the knob to make selections.
- A selected field has a blinking double arrow cursor >>. The arrows go away and blinking stops when the field is not selected.
- To change settings in a field on the screen, push the knob, or press the Enter key.
- The measurement screen is changed using the titlebar at the top of the screen and the cursor control knob, the GENERATOR/ANALYZER keys, or the UTILS keys.
- Use the top row of the GENERATOR/ANALYZER keys to move around in the CDMA screens.

**Figure 1-2 Using the cursor-control Knob or Screen Keys**

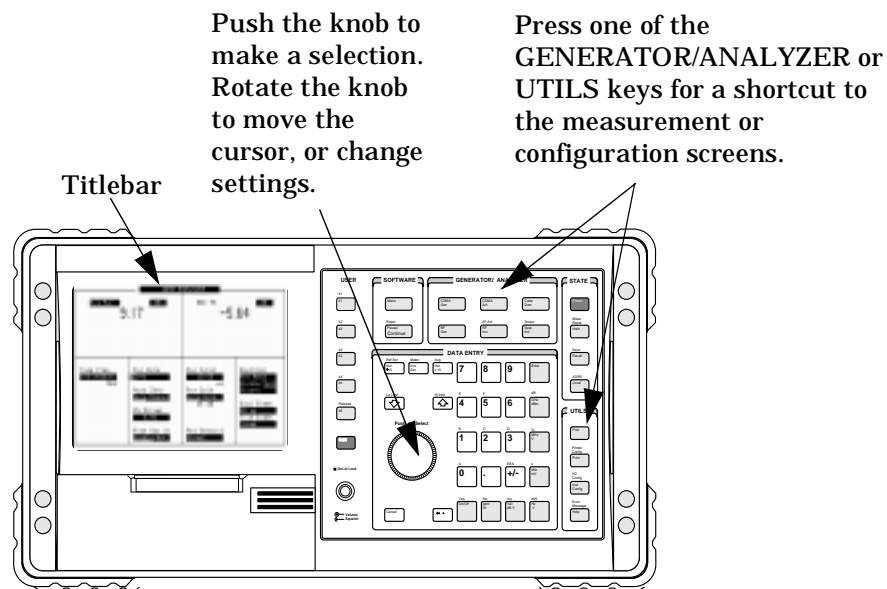

## Generate a CDMA Signal

1. Press the **CDMA Gen** key to go to the CDMA GENERATOR screen.
2. Select **RF Gen Freq** and use the keypad to set the frequency to 1881.52 MHz.
3. Select **Output Port** and verify that the port is set to Dupl.
4. Select **Amplitude** and set the amplitude to -10 dBm.
5. Select **Gen Dir** and set it to Fwd.

## Display a CDMA Signal

1. Press the **CDMA Anl** key to go to the CDMA ANALYZER screen.
2. Select **Tune Freq** and use the keypad to set the frequency to 1881.52 MHz.
3. Press the **Spec Anl** key to go to the SPECTRUM ANALYZER screen.
4. The CDMA signal should be displayed.

**Figure 1-3** CDMA Loopback Signal

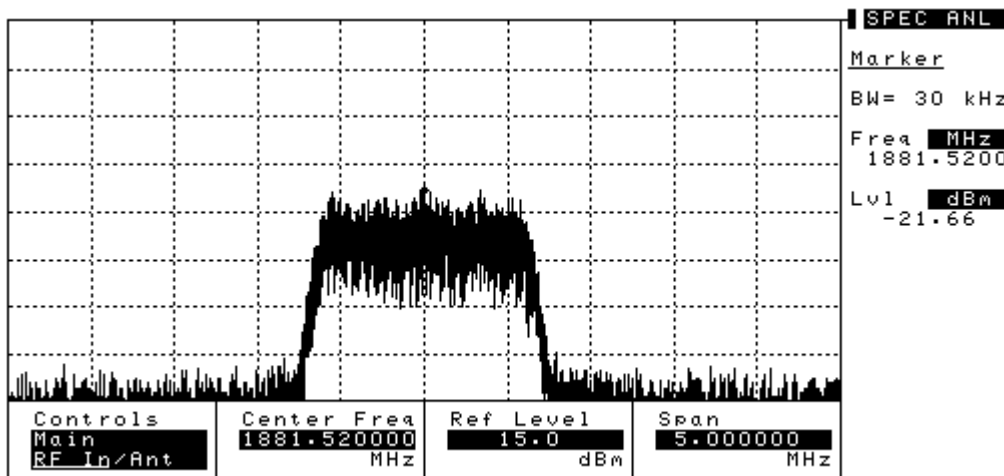

## What to Do Next

Congratulations! You are now ready to begin testing your CDMA Base Station. Proceed to [Chapter 2, "Testing CDMA Base Stations."](#)

---

## 2

# Testing CDMA Base Stations

This chapter explains how to test CDMA Base Stations with the HP 8935 Test Set. For information on performing other tasks with the Test Set, see ["Which Document is Required?" on page 18](#).

## Tests That You Can Perform with the Test Set

This Test Set is designed to perform tests you would normally use in the setup, commissioning, and maintenance of a CDMA base station. These tests are listed below. For other utility procedures of the Test Set, see [Chapter 3, "Utility Procedures," on page 53](#).

- **General**
  - ["Setup and Configuration" on page 31](#)
- **Transmitter Tests (TX tests)**
  - ["Average Power" on page 37](#)
  - ["Channel Power" on page 40](#)
  - Frequency Error: see ["Rho \(Modulation Quality\)" on page 49](#)
  - Carrier Feedthrough: see ["Rho \(Modulation Quality\)" on page 49](#)
  - Time Offset: see ["Rho \(Modulation Quality\)" on page 49](#)
  - ["Rho \(Modulation Quality\)" on page 49](#)
  - **Code Domain Phase:** see ["Code Domain Testing" on page 43](#)
  - **Code Domain Power:** see ["Code Domain Testing" on page 43](#)
  - **Code Domain Timing:** see ["Code Domain Testing" on page 43](#)
  - ["Transmit Spectrum" on page 51](#)
- **Receiver Tests (RX Tests)**

Receiver Tests typically require the Base Station to report FER (Frame Error Rate), and otherwise communicate with the Test Set. This information varies between Base Station manufacturers. Receiver Tests made with this Test Set are performed within HP software. See your local sales representative for available software for your Base Stations.

## Setup and Configuration

How you set up your Test Set will depend, of course, on the device you are testing. However, there are several parameters that are common to most setups. These are described in the following sections.

- ["Connections Between the Test Set and the Device Under Test \(DUT\)" on page 32](#)
- ["Configuring the Test Set with Your Base Station's Information" on page 33](#)
- ["Saving and Recalling Instrument Setups" on page 36](#)

## Connections Between the Test Set and the Device Under Test (DUT)

Figure 2-1 Connections for Testing a CDMA Base Station

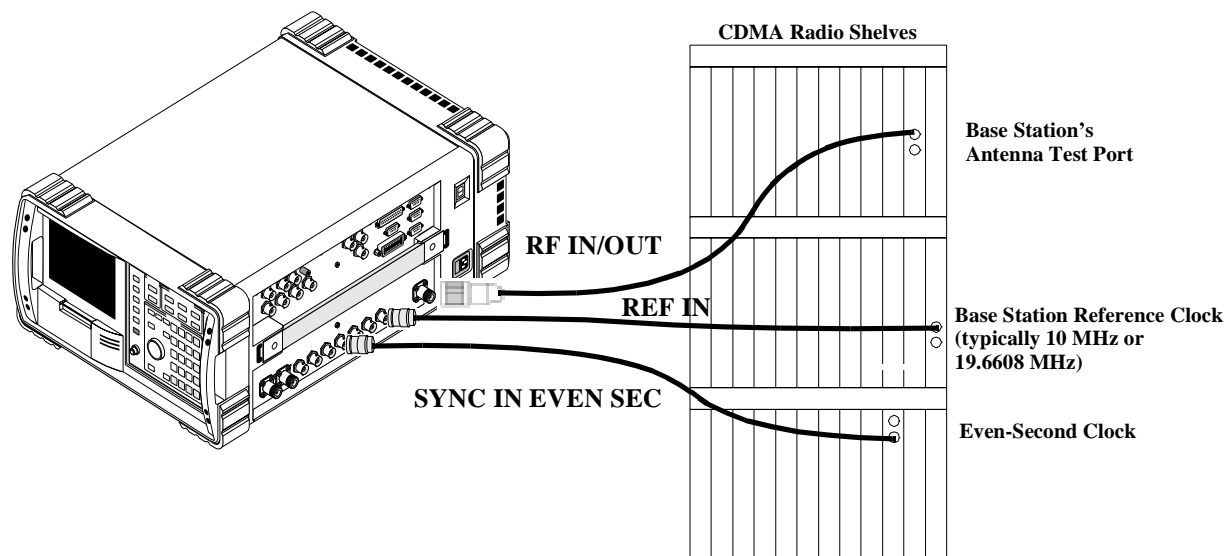

### Synchronizing Your Base Station to the Test Set

The RF signal is the signal you are testing. It typically comes from the Base Station's Antenna Test Port.

The Even-Second clock is used for the Time Offset measurement.

The REF IN is used for both the Time Offset and the Frequency Error measurements. Several different signals are available, but typically this signal is either 10 MHz or 19.6608 MHz (16x Chip Clock).



## Configuring the Test Set with Your Base Station's Information

When you are starting to test a Base Station with the Test Set, you must supply information about the Base Station to the Test Set.

1. Make connections to your Base Station as shown in [Figure 2-1, "Connections for Testing a CDMA Base Station,"](#) on page 32.  
  
If you have a low level signal, you may want to use the ANT IN port instead of the RF IN/OUT port. See ["Choosing Between RF In/Out, Antenna and Duplex Ports"](#) on page 34.
2. Press **Preset** or turn on the Test Set.
3. Select **RF Channel** in the CDMA ANALYZER screen. The RF signal can be displayed either by Channel number or Frequency. See ["Changing Between Channel Mode and Frequency Mode"](#) on page 55.
4. Enter the channel number (or frequency) of your base station.
5. Press the **Inst Config** key to go to the INSTRUMENT CONFIGURE screen.
6. Select **Ext Ref In**. This is the reference signal your Base Station provides to synchronize with the Test Set.
7. Select the reference frequency of your Base Station. Typical values are 10 MHz or 16x the chip clock (19.6608 MHz).
8. Select **Ref Select** and choose either **Auto**, **Internal** or **External**. **Auto** allows the Test Set to switch between **Internal** or **External** References, based on presence of the External signal at the **Ref In** port. **Internal** or **External** select either the internal or external reference signals.
9. Press the **Spec Anl** key to display the spectrum analyzer. This will give you a visual confirmation of your signal.

### **Choosing Between RF In/Out, Antenna and Duplex Ports**

For testing input signals, you can choose between RF IN/OUT and ANT IN. For generating signals, you can choose between RF IN/OUT and DUPLEX OUT.

The RF IN/OUT port is for measuring transmitter signals. It has the highest allowable input power. This port is also an output port for the internal signal generator.

The ANT IN port is used when the signal is very low (about 200 mV). This is an input only. It is frequently used for off-the-air measurements.

The DUPLEX OUT is the output of the signal generator. It is typically used to test receivers and as a calibration source.

The input port is chosen by selecting the `Input Port` field in the CDMA ANALYZER screen. Note that the `Input Port` cannot be selected while the Average Power measurement is displayed, since that measurement can only be made on the RF IN/OUT port.

The output port is chosen by selecting the `Output Port` field in the CDMA GENERATOR screen.

Refer to [“Block Diagram for RF, DUPLEX, and ANT Ports” on page 35](#) for more detail about the input ports.

Figure 2-2

Block Diagram for RF, DUPLEX, and ANT Ports

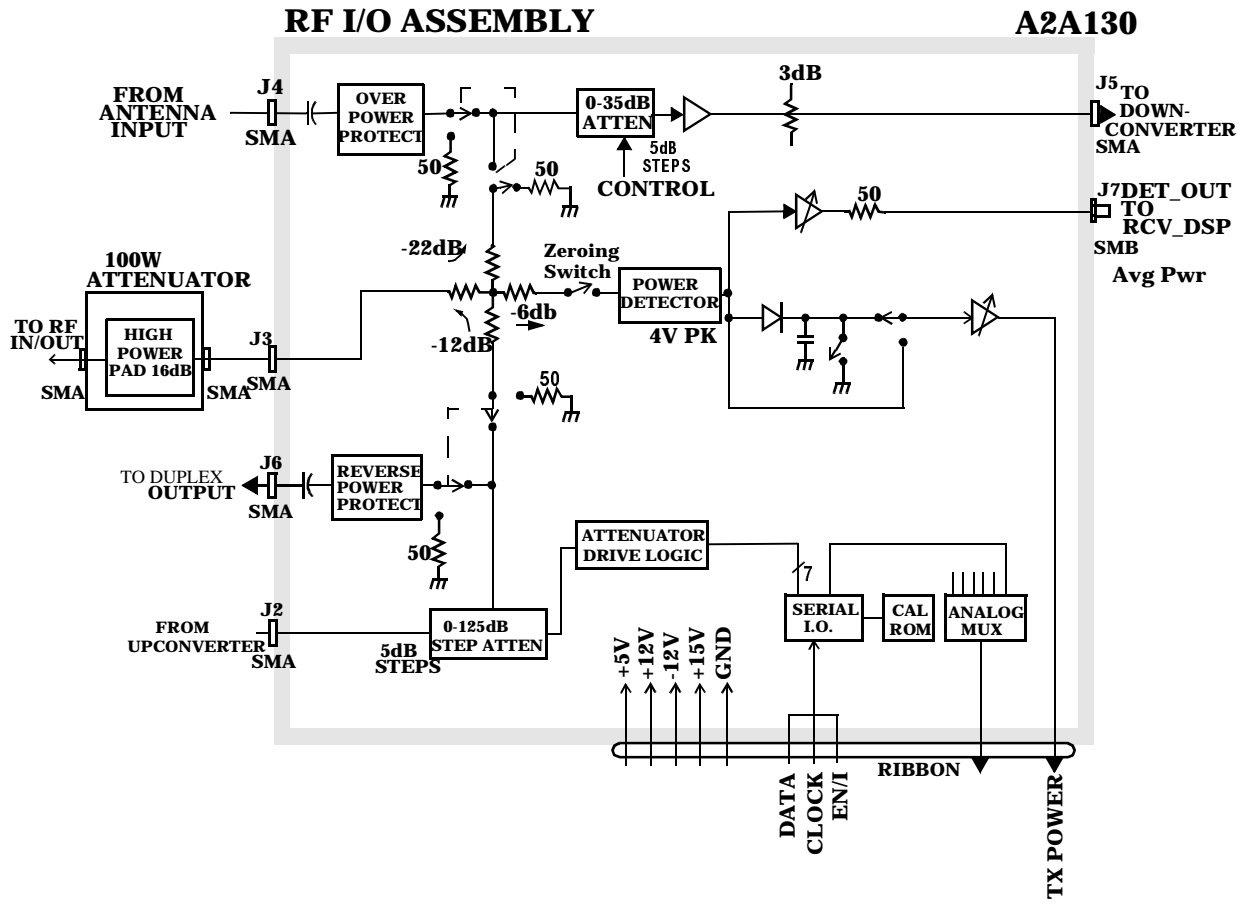

## Saving and Recalling Instrument Setups

The SAVE and RECALL functions allow you to store different instrument setups and retrieve them later, eliminating the task of re-configuring the Test Set. You can save these setups to any of the following media: Internal Memory, an External PCMCIA card, or an External RAM card.

### To Save an Instrument Setup

1. If you want to select the Save medium, see "[To Choose the Save/Recall Location](#)".
2. Make any changes to the instrument that you want to save in a register.
3. Press and release the **shift** key then the **Recall** key to access the SAVE function.
4. Use the **DATA** keys or the **Save** menu to enter the register's name.

### To Recall an Instrument Setup

1. If you want to select the Save medium, see "[To Choose the Save/Recall Location](#)".
2. Press the **Recall** key.
3. Use the knob to select the desired setup to be recalled from the **Recall** menu.

### To Choose the Save/Recall Location

1. Press and release the **shift** key then the **Inst Config** key to display the I/O CONFIGURE screen.
2. Select the **Save/Recall** field.
3. Select the desired Save medium (Internal, Card, RAM).

---

## Average Power

Average power measures the average power of full bandwidth of the received signal. To measure the power only in a single 1.23 MHz CDMA channel, see "Channel Power" on page 40.

This measurement is made only at the RF IN/OUT port. It can be measured while the Base Station is active.

### Prerequisites

You will need to do the following before measuring Average Power:

- Connect your signal to the RF IN/OUT port of the Test Set, and connect the reference signal to the REF IN port.
- Know the channel number or frequency of your transmitter.

---

#### CAUTION

Overpower Damage — Refer to the Test Set's side panel for maximum input power level. Exceeding this level can cause permanent instrument damage.

---

### Procedure

---

#### NOTE

You can zero the power meter with the `Pwr Zero` field to ensure the greatest accuracy. By default, however, the power meter is automatically zeroed.

---

1. Press the `CDMA Anl` key to go to the CDMA ANALYZER screen.
2. Zero the power meter if necessary. Select `Pwr Zero` to zero the meter.
3. Select `RF Channel` or `Tune Freq`, depending on whether your channels are selected by channel number or by frequency.
4. Enter the channel number or RF frequency of your transmitter. This ensures that you will have the correct calibration factor for the power measurement.
5. Select the measurement on the left side of the display (default is `Avg Pwr`).
6. Select `Avg Pwr` from the list of choices. Now the Average Power measurement is displayed.

**Figure 2-3 Average Power Measurement List of Choices**

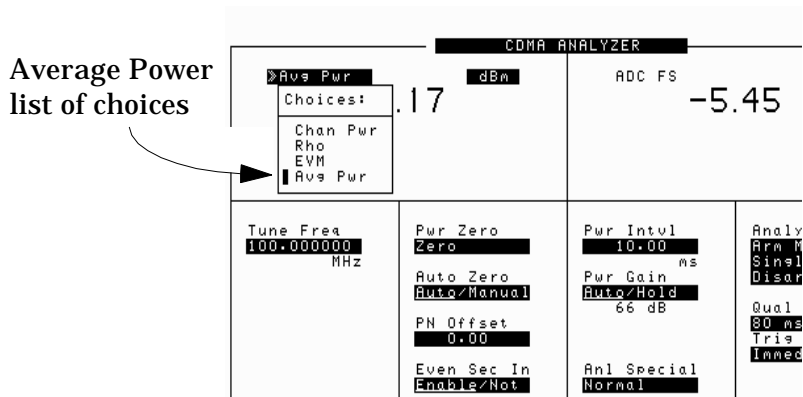

7. Set the Pwr Intvl to your desired averaging time. A higher time produces a more accurate result. Maximum value is 26.66 milliseconds.
8. The Average power should be displayed.

## Results

**Figure 2-4 Average Power Measurement Results**

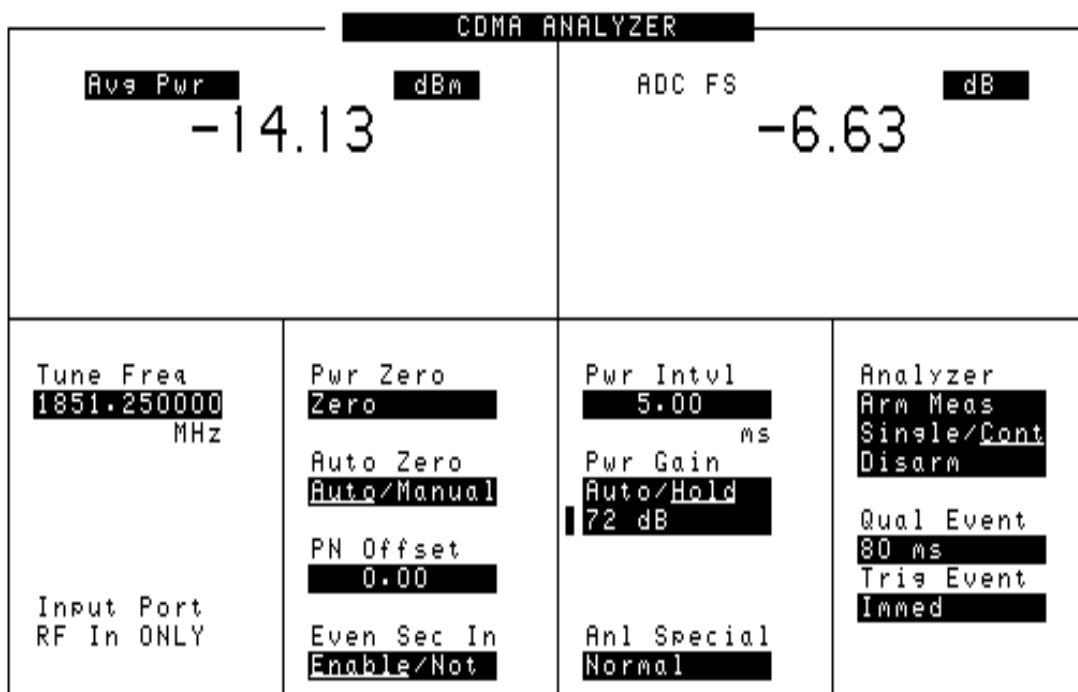

## Notes

You can control the time interval of the averaging by changing the  $Pwr_{Intvl}$ . Default is 5 milliseconds.

You should enter the channel number or center frequency of your transmitter signal, since the measurement is calibrated based on that frequency.

---

### NOTE

#### What is ADC FS?

ADC FS (Analog to Digital Converter Full Scale) is an indicator which shows how close the measured power is to the maximum allowed input power to the internal Analog-to-Digital converter (ADC).

For all measurements except Average Power, ADC FS should be in the range of  $-1$  to  $-20$  dB.

For the Average Power measurement, the range is  $-1$  to  $-10$  dB.

---

## Channel Power

Channel Power measures the power in the 1.23 MHz band of the chosen CDMA channel. This measurement can be made on an active site (if you are measuring at an RF test port). This measurement is particularly useful if you are measuring power in the presence of other signals.

### Prerequisites

You will need to do the following before measuring Channel Power:

- ❑ Know the channel number or frequency of your transmitter.
- ❑ To maximize the accuracy of the Channel Power measurement, calibrate it as needed. Conditions for calibration are:

#### Channel Power Calibration Conditions

- Whenever a 5°C ambient temperature change has occurred
- Whenever the frequency or channel number has been changed
- During or just after the 30 minute warm-up period

### Channel Power Calibration Procedure

Once the prerequisites have been met, use the following procedure to calibrate Channel Power:

1. Verify that there are no cables attached to the RF IN/OUT or Ant In ports.
2. Press the **CDMA Ant** key to go to the CDMA ANALYZER screen.
3. Select **RF Channel** or **Tune Frequency**, depending on whether your channels are selected by Channel Number or by frequency
4. Enter the channel number or frequency of your transmitter.
5. Select the measurement on the left side of the display. Select **Chan Pwr** from the list of choices.
6. Select **Calibrate** to calibrate the Channel Power measurement. The calibration may require a few seconds to finish.



## Channel Power Measurement Procedure

Once the prerequisites have been met, use the following procedure to measure Channel Power:

1. Connect your signal to the RF IN/OUT port.
2. Press the **CDMA Anl** key to go to the CDMA ANALYZER screen.
3. Select **RF Channel** or **Tune Frequency**, depending on whether your channels are selected by channel number or by frequency.
4. Enter the channel number or frequency of your transmitter.
5. Select the measurement on the left side of the display. Select **Chan Pwr** from the list of choices. Note that the fields change on the CDMA ANALYZER screen.
6. The Channel Power measurement should be displayed.

---

### NOTE

#### What is ADC FS?

ADC FS is an indicator which shows how close the measured power is to the maximum allowed input power to the internal Analog-to-Digital converter (ADC).

For all measurements except Average Power, ADC FS should be in the range of  $-1$  to  $-20$  dB.

For the Average Power measurement, the range is  $-1$  to  $-10$  dB.

---

## Results

Figure 2-5 Channel Power Measurement

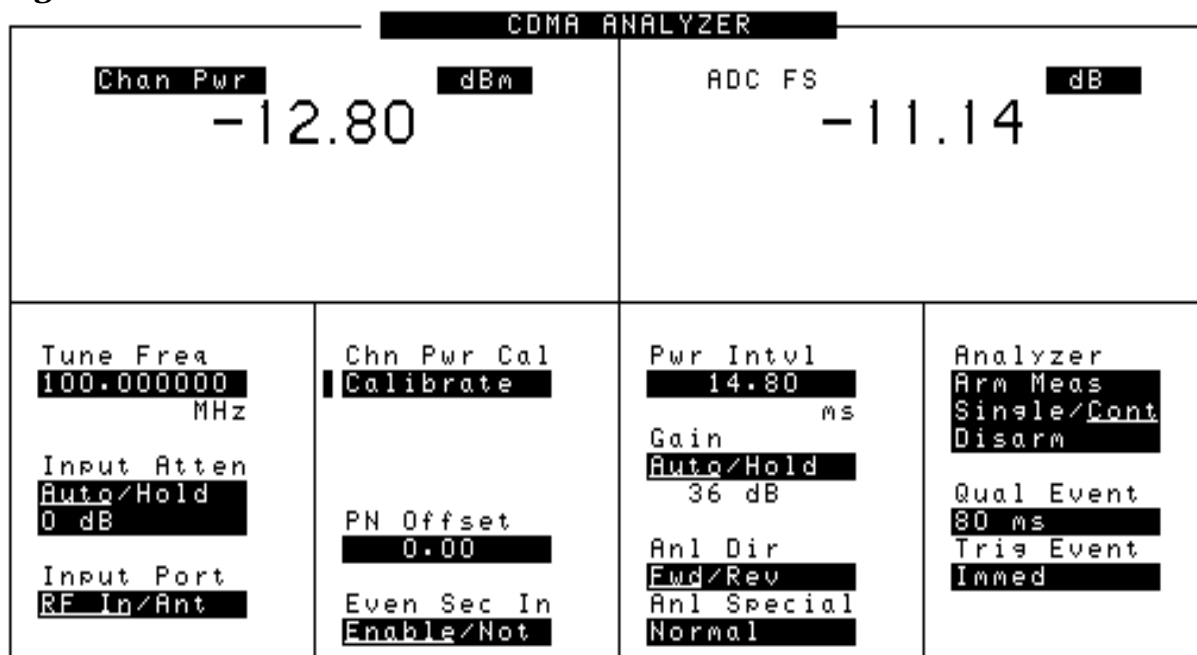

## Notes

This power measurement measures power in the 1.23 MHz bandwidth of the CDMA signal, as defined by the channel number or frequency you have chosen. For a measurement that measures over the full input bandwidth, see "Average Power" on page 37.

---

## Code Domain Testing

The Code Domain Analyzer enables you to perform a suite of measurements on your base station transmitter. These tests are intended to be made with one or more code channels turned on. Each code channel is represented by its Walsh code on this display.

For more detail about the Code Domain, See “Code Domain Notes” on page 48.

Available measurements in the CODE DOMAIN ANALYZER screen are:

- Pilot Time Tolerance (Time Offset)
- Frequency Offset (FrqOfs)
- Carrier Feedthrough (CarFT)(Pilot channel only)
- Code Domain Power (Power)
- Fast Power (Fast Pwr)
- Code Domain Timing (Timing)
- Code Domain Phase (Phase)

## Prerequisites

You will need to do the following before making Code Domain measurements:

- Connect your transmitter signal to the RF IN/OUT port of the Test Set.
- Know the channel number or frequency of your transmitter.
- Know the PN offset for the Base Station.

---

### CAUTION

Overpower Damage — Refer to the Test Set’s side panel for maximum input power level. Exceeding this level can cause permanent instrument damage.

---

## Procedure

Use these steps to select and run the Code Domain Tests:

1. Press the **Code Dom** key to go to the CODE DOMAIN ANALYZER screen.
2. Update the **RF Channel** or **Tune Freq** field for the Base Station being tested, if it is not already correct.
3. Select the **Controls** menu.
4. Select **AUX** from the list of choices. This will display the **PN Offset** field.
5. Update the **PN Offset** for the Base Station being tested, if it is not already correct.
6. **TmOfs, FrqOfs, and CarFT** should be displayed.
7. Select the **Controls** menu again, and select **Main**.
8. Select the **Measurement** field and choose from **Power, Fast Pwr, Timing, or Phase**.
9. Select the **Controls** menu again, and select **Marker**. The results for the measurement you have chosen are displayed.

## Results

Figure 2-6 The Code Domain Analyzer Display.

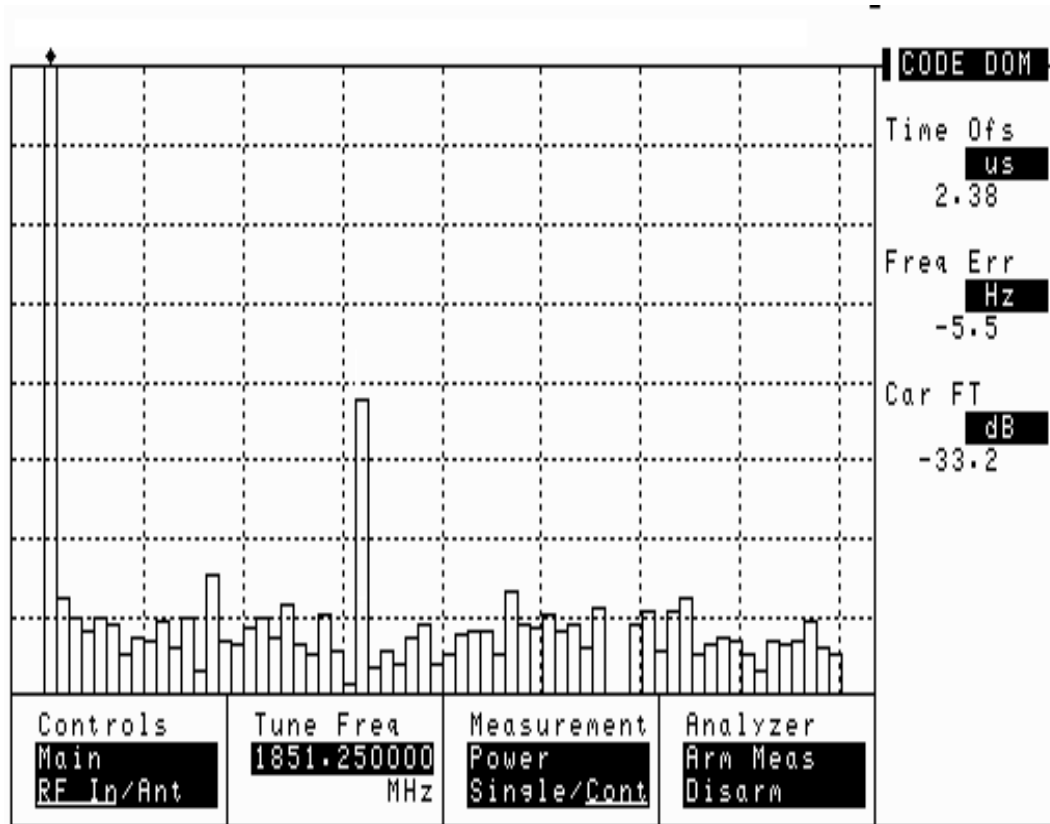

## Code Domain Measurements

Below are brief descriptions of the measurements available in the Code Domain Analyzer.

### Code Domain Power

Code Domain Power displays the power for each of the 64 Walsh Channels, relative to the total power inside a 1.23 MHz bandwidth centered at the Tune Frequency. Each Walsh Channel level is displayed as an individual vertical bar. Because this is a relative measurement, the unit of measure is always dB (not dBm or watts). This allows a comparison of signal levels between the Pilot, Sync, Paging, and Traffic channels.

## Fast Power

Fast Power is a faster method of measuring Code Domain Power. A value for Time Offset must be transferred from a non-fast power measurement before measurements begin, or when changes to the following fields occur:

- Data Rate (CDMA GENERATOR screen)
- PN Offset (CDMA ANALYZER screen)
- Opt CDMA TB (INSTRUMENT CONFIGURE screen)
- Ext Ref In (INSTRUMENT CONFIGURE screen)

To transfer the Time Offset, use the following procedure.

1. Make at least one of the following measurements:
  - Power
  - Timing
  - Phase
2. Select `FP Setup` from the Controls menu.
3. Select `Ofs Transfer`.
4. The offset is now transferred.

## Code Domain Phase

Code Domain Phase displays the phase error for each of the 64 Walsh channels relative to the Pilot channel. Displays above the zero reference in the center of the screen indicate that the Walsh channel leads the Pilot channel in phase. Displays below the zero reference in the center of the screen indicate that the Walsh channel lags the Pilot channel in phase. Move the marker to read the Phase for each individual channel.

## Code Domain Timing

Code Domain Timing displays the time offset for each of the 64 Walsh channels. This measurement is relative to the Pilot channel, which is Walsh code zero. Displays above the reference indicate that the Walsh channel is leading the Pilot channel in time. Displays below the reference indicate that the Walsh channel is lagging the Pilot channel in time. Move the marker to read the Timing for each individual channel.

**Figure 2-7 Code Domain Timing**

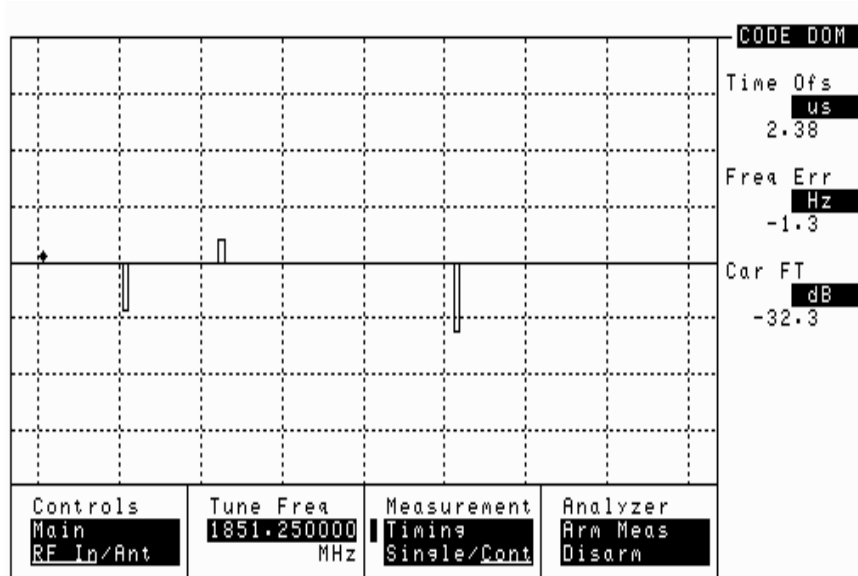

### Time Offset

Time Offset indicates how well your transmitter's signal is time-aligned to system time. The displayed value takes into account the PN Sequence Offset Index of your transmitter that is entered on the CDMA ANALYZER screen.

### Frequency Error

Frequency error is the frequency difference between your transmitter's actual center frequency and the frequency (or channel) you entered.

### Carrier Feedthrough

Used to measure performance of the I/Q modulator of your transmitter. Extremely low values indicate a very good I/Q modulator. Higher values indicate potential problems with the I/Q modulator. If Carrier Feedthrough measures more than approximately -20 dB, there may be problems with the Base Station. Unit of measure is dBc.

## Code Domain Notes

**Figure 2-8** Code Domain

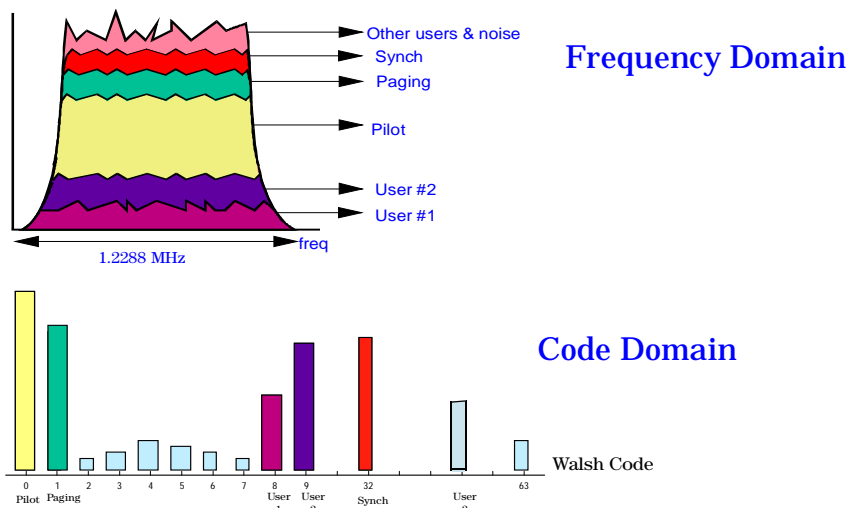

On a spectrum analyzer, you can view the 1.23 MHz forward link channel; it would appear as the envelope of the top figure. But how much of the total signal, as viewed on the spectrum analyzer, is attributed to each individual Walsh code? You cannot tell using frequency domain analysis. This, again, requires a new measurement method.

The measurement mode used is called "code domain analysis". In code domain analysis, the individual Walsh codes are decoded and displayed individually. The contribution of each Walsh channel to the total signal is measured and displayed as a bar indicating the relative power in the channel.

Figure 2-8 shows a typical display of code domain power. Note the contribution to the total signal from the pilot, sync, and paging channels. In this example, there are also three users of traffic channels on the forward link.

Inactive channels are important to measure, too. Excess power in the inactive channels means reduced capacity in the sector.



---

## Rho (Modulation Quality)

In this measurement, the modulated signal is compared to an ideal reference waveform to determine the performance of the transmitter's modulation circuitry. Rho values are in the range of 0 to 1. A value of 1 indicates perfect correlation to the reference (high modulation quality). CDMA Base Station standards require that transmitters have rho performance of 0.912 or higher.

With the Rho measurement, the following data is provided:

- Rho
- Frequency Error  
Frequency error is the frequency difference between your transmitter's actual center frequency and the frequency (or channel) you entered.
- Time Offset  
Time offset indicates how well your transmitter's signal is time-aligned to system time. The displayed value takes into account the PN Sequence Offset of your transmitter.
- Carrier Feedthrough  
Used to measure performance of the I/Q modulator of your transmitter. Extremely low values indicate a very good I/Q modulator. Higher values indicate potential problems with the I/Q modulator. If Carrier Feedthrough measures more than approximately  $-20$  dB, there may be problems with the Base Station. Unit of measure is dBc.

### Prerequisites

You will need to do the following before measuring Rho:

- Connect your transmitter signal to the RF IN/OUT port of the Test Set.
- Connect your Even Second Clock to the Even Sec/Sync In port of the Test Set. (Required only for Time Offset measurement)
- Connect your Base Station Reference signal to the REF IN port of the Test Set.
- Set up your Base Station to transmit Pilot channel only.
- Know the channel number or frequency of your transmitter.
- Know the PN offset for the Base Station.

**CAUTION** Overpower Damage — Refer to the Test Set's side panel for maximum input power level. Exceeding this level can cause permanent instrument damage.

## Procedure

1. Press the **CDMA Anl** key to go to the CDMA ANALYZER screen.
2. Select **RF Channel** or **Tune Frequency**, depending on whether your channels are selected by channel number or by frequency.
3. Enter the channel number or RF frequency of your transmitter.
4. Update the **PN Offset** for the Base Station being tested, if it is not already correct.
5. Select the measurement on the left side of the display (default is **AvG Pwr**).
6. Select **Rho** from the list of choices. Now the Rho measurement is displayed.
7. Rho, Time Offset, Frequency Error, and Carrier Feedthrough should be displayed.

## Results

**Figure 2-9 Rho measurement**

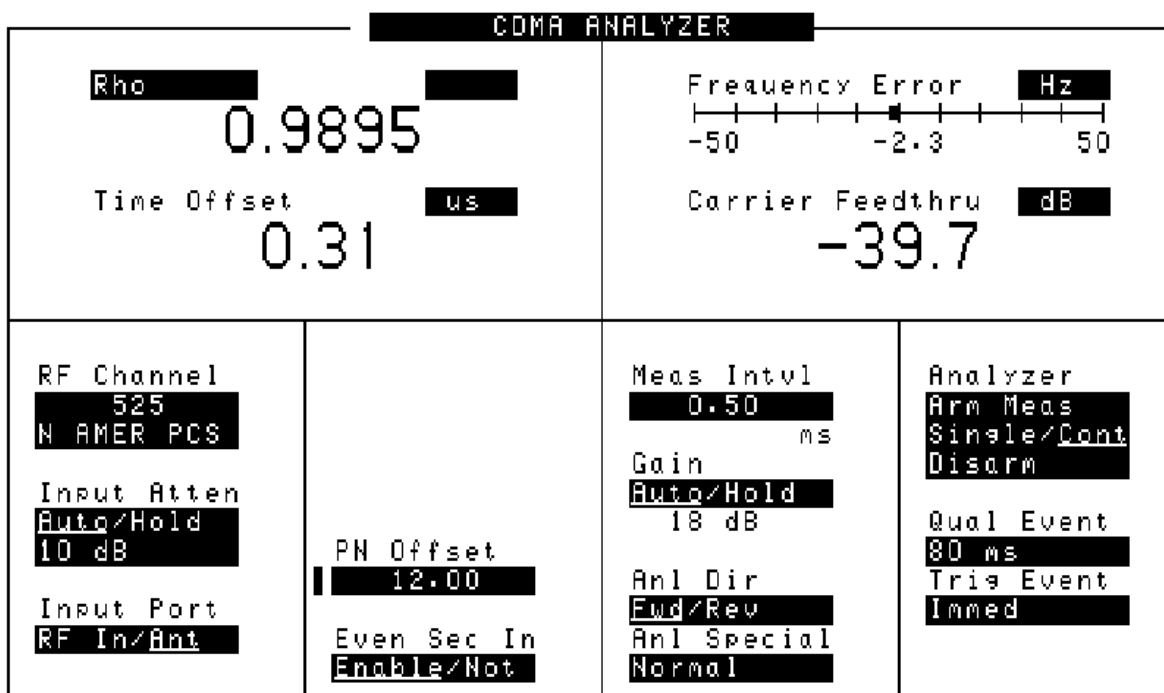

## Transmit Spectrum

Viewing the Transmit Spectrum can give you information about your CDMA signal and about other signals in the nearby frequencies.

Look for a CDMA signal that has the characteristic shape.

**Figure 2-10** Standard CDMA Signal

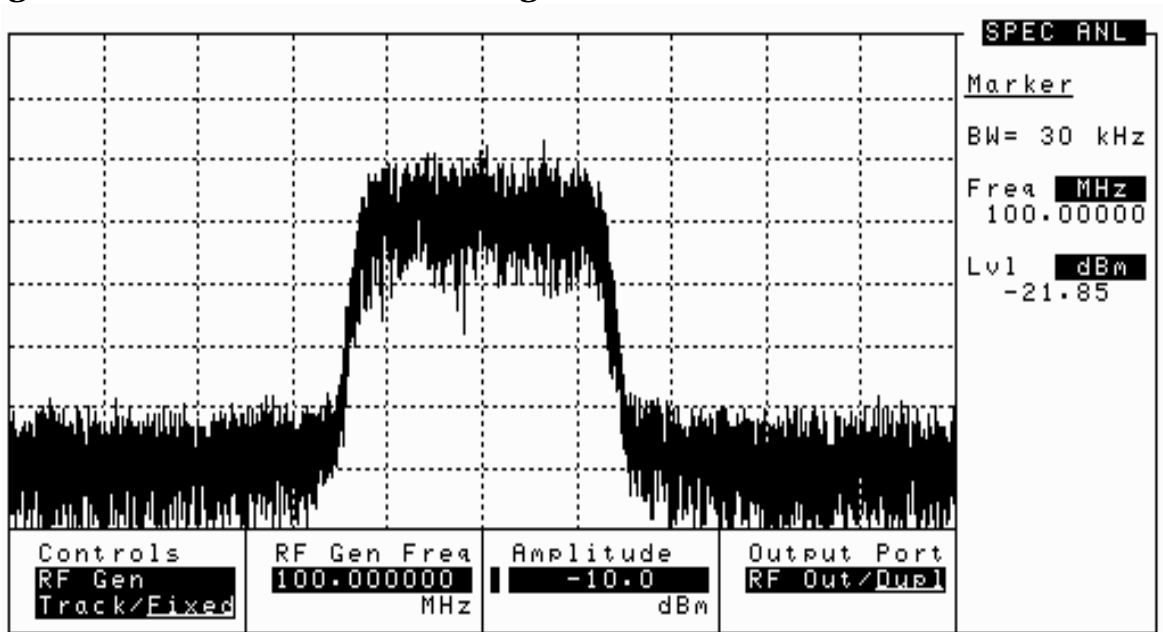

Seeing “Shoulders” on the Spectrum Analyzer display is one common distortion of the CDMA shape. This problem usually occurs when there is a problem with the power amplifier of the Base Station. The bandwidth of the “Shoulders” is usually about twice the bandwidth of the 1.2288 MHz CDMA signal.

**Figure 2-11** CDMA Signal with “Shoulders” Distortion

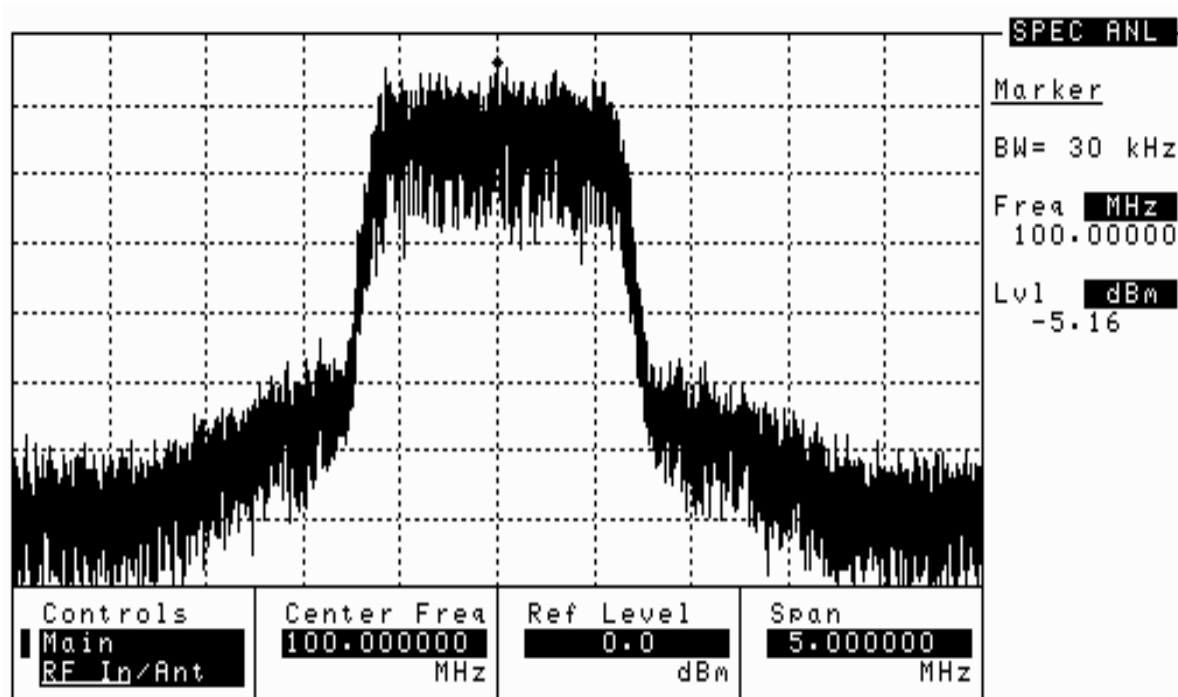

Sometimes the “Shoulders” also occur when there is an interfering signal near the CDMA signal. In this case, the “Shoulders” are usually much smaller in bandwidth.

## Prerequisites

You will need to do the following before you look at the transmit spectrum:

- ❑ Connect your transmitter signal to either the RF IN/OUT or the ANT IN port. You can also use an antenna on the ANT IN port if you want to view the signal off the air.

## Procedure

1. Press the **Spec Anl** key to go to the SPECTRUM ANALYZER screen.
2. Select **RF Channel** or **Tune Frequency**, depending on whether your desired channel is selected by channel number or by frequency.
3. Enter the channel number or frequency of your transmitter.
4. Adjust the **Ref Level** of the signal to better display your signal.
5. The spectrum of your signal should be displayed. Look for “shoulders” or interfering signals.

---

## **3 Utility Procedures**

This chapter contains procedures and instructions that will help you make the most efficient use of your Test Set.

## Beeper

The beeper notifies you when a message is displayed. Since a message may be removed from the screen before you notice it, it is better to leave the beeper on to alert you to errors during operation.

The beeper's volume setting is retained when the instrument is turned off.

## Beeper Control

1. Press the `Inst Config` key to go to the INSTRUMENT CONFIGURE screen.
2. Select `Beeper`.
3. Choose from `Off`, `Quiet`, or `Loud`.

## Changing Between Channel Mode and Frequency Mode

There are two ways to tune the Test Set's Generator and Analyzer: by channel number or by frequency. Default is channel mode, with `N AMER` PCS being the default system channel standard.

Channel mode is useful when you don't necessarily know the frequency of the channel you are testing, but you do know the channel number and the channel standard.

Frequency mode is useful when you are concerned about specific frequencies. That may be when you are searching for interfering signals, or when you want to put the Test Set in loopback mode.

- When `Chan` is selected, you enter the RF Generator's and the RF Analyzer's channel numbers directly using the keypad or knob. You can also choose a system channel standard.

Channel mode automatically sets the RF Generator's and the RF Analyzer's frequency separation according to the system's channel standard.

- When `Freq` is selected, the `RF Channel` field on all screens is replaced by frequency fields:
  - `RF Gen Freq` in the CDMA GENERATOR and RF GENERATOR screens
  - `Tune Freq` in the CDMA ANALYZER, RF ANALYZER, and CODE DOMAIN ANALYZER screens
  - `Center Freq` in the SPECTRUM ANALYZER screen

The frequency separation for frequency mode can be set in the INSTRUMENT CONFIGURE screen.

### Procedure to Change Between Channel and Frequency Modes

1. Press the `Inst Config` key to go to the INSTRUMENT CONFIGURE screen.
2. Select `RF Display`. The value toggles between `Freq` and `Chan`.
  - If you selected `Chan`, you should choose your desired channel standard from the `RF Chan Std` field.
  - If you selected `Freq`, you can turn the `RF Offset On` or `Off` in the `RF Offset` field. The frequency difference controlled by the `RF Offset` is set in the `(Gen) - (An1)` field.

## Measuring Insertion Losses

To make accurate power and receiver measurements, the signal loss through the cables or other devices used in your test setup must be known and entered into the Test Set's INSTRUMENT CONFIGURE screen to compensate for these losses.

Signal losses are measured using a built-in automated routine that runs on the Test Set's IBASIC controller. Losses can be calibrated at a discrete (single) frequency or over a frequency range. This is one routine included in a set of utility procedures called the RF TOOLS.

During the test, a calibrated signal is fed through two 6 dB attenuators/pads (such as Mini-Circuits model NAT-6-60) and a short type-N male-to-male cable to establish a known reference point. The Test Set then prompts you to connect the device under test to measure the additional loss through that device. (The pads and cable are not part of the standard equipment shipped with the Test Set.)

Figure 3-1 shows how to load and run the RFTOOLS routines and select the desired insertion loss test.

**Figure 3-1 Loading and Running the Insertion Loss Test**

The figure illustrates the navigation steps for running an insertion loss test. It consists of two main screenshots with numbered callouts:

- Top Screenshot (RFTOOLS):** Shows the 'SOFTWARE MENU' with 'RFTOOLS' selected. The menu includes options like 'Run Test', 'Continue', and 'Help'. Callouts 1, 2, and 3 point to 'ROM', 'RFTOOLS', and 'Run Test' respectively.
- Bottom Screenshot (TESTS (IBASIC Controller)):** Shows the 'Select Test (Main) Menu' with a list of choices. Callout 4 points to 'Discrete Freq Insertion Loss' and callout 5 points to 'Quit'.

When the screen below appears.....

...use the knob to move the cursor and select either **Discrete Freq Insertion Loss** or **Swept Insertion Loss**. When run, the test prompts you to enter the necessary test frequency information and displays setup diagrams. Make the indicated connections and follow instructions as you are prompted by the program.



---

## Memory Cards

The slot on the front of the Test Set is used for memory cards. The slot is used for the following:

- Storage of Save/Recall registers
- Loading of software (either HP or self-written)
- Collecting data (only when using software)
- Upgrading firmware or software

## Memory Cards and Initialization

There are several types of memory cards available, and the following cards are used with the Test Set:

- SRAM: used for Save/Recall and data storage
- Flash ROM: used when upgrading firmware
- OTP (One Time Programmable): used for HP software

Flash ROM cannot be used for collecting data and Save/Recall.

Data cannot be loaded on Flash RAM and OTP cards with the Test Set's memory card slot. SRAM can be initialized with the Test Set.

### Initializing SRAM Cards for Save/Recall and Data Collection

1. Insert the SRAM card into the slot. If the card is uninitialized, a message will appear at the top of the display.
2. Press **Shift** and **IO Config** to display the I/OCONFIGURE screen.
3. Using the knob, locate the **FORMAT CARD** field.
4. Select the **FORMAT CARD** field. A prompt will appear at the top of the display. Pressing **Yes** will erase and initialize the card.

## Oscilloscope

The built-in 50 kHz oscilloscope provides

- multiple triggering formats (internal and external)
- single-shot and pre-trigger viewing for single events
- full marker capability with automatic level and time readout

Time/division, volts/division and vertical offset are displayed and can be changed using the front-panel knob.

Input to the Oscilloscope is provided from various sources including direct inputs to the Audio Input and Modulation Input connectors. Oscilloscope functions are accessed from the AF ANI and OSCILLOSCOPE screens.

**Figure 3-2 Inputs and Filters for the Oscilloscope**

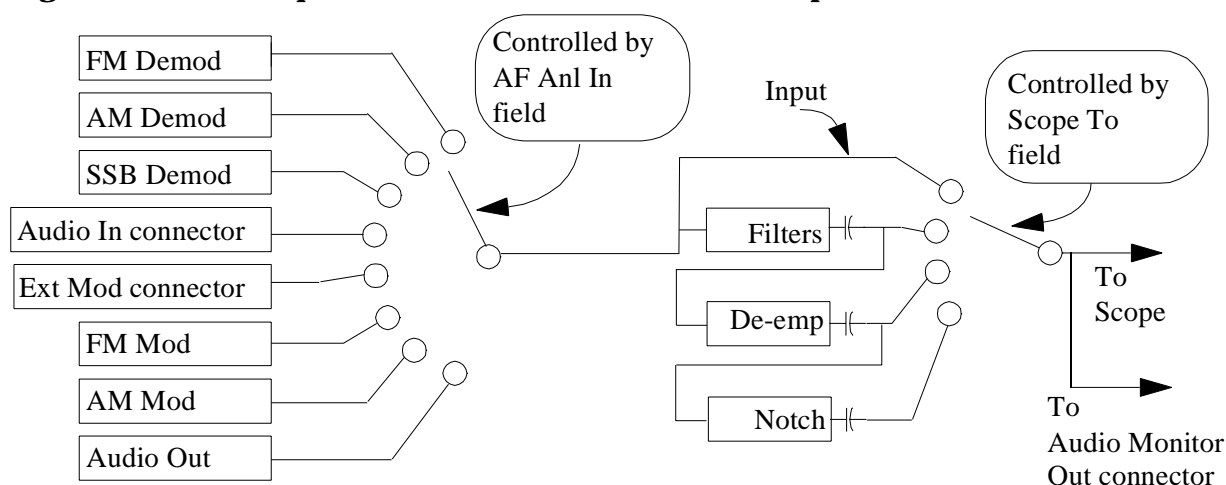

### Selecting the Oscilloscope's Input

1. Press **Shift**, then **RF Anl** to select the AF ANALYZER screen.
2. Select the **AF Anl Input** field. A list of choices should appear.
3. Select the desired input to the scope:
  - **FM Demod** for FM demodulated audio from input signals connected to the RF IN/OUT or ANT IN connectors.
  - **AM Demod** for AM demodulated audio from input signals connected to the RF IN/OUT or ANT IN connectors.
  - **SSB Demod** for SSB demodulated audio from input signals connected to the RF IN/OUT or ANT IN connectors.
  - **Audio In** for a signal connected to the AUDIO IN connector.

- Ext Mod for a signal connected to the rear panel MODULATION INPUT connector.
  - FM Mod for the FM modulated audio from the RF Gen section.
  - AM Mod for the AM modulated audio from the RF Gen section.
  - Audio Out for the signal present at the AUDIO OUT connector.
4. The input to the Scope is displayed on the SCOPE screen.

## Selecting the Oscilloscope's Filters

1. Press **Shift**, then **RF ANL** to select the AF ANALYZER screen.
2. Select the **Scope To** field. A list of choices should appear.
3. Select the desired filtering for the signal:
  - **Input** if you want no filtering (Input is DC coupled)
  - **Filters** to route the audio to the Oscilloscope after passing through Filters #1 and #2. (AC coupled)
  - **De-emp** to route the audio to the Oscilloscope after passing through Filters #1 and #2, and the De-Emphasis circuitry.(AC coupled)
  - **Notch** to route the audio to the Oscilloscope after passing through Filters #1 and #2, the De-Emphasis circuitry, and Notch circuitry.(AC coupled)

## Triggering the Oscilloscope

You can control following Triggering features of the oscilloscope:

- Trigger: external or internal
- Automated or normal triggering
- Continuous or single shot triggering
- Trigger level
- Trigger delay

The oscilloscope is triggered using the Trigger menu. Select this menu with the following procedure:

1. Press **Shift**, then **Scope** to go to the OSCILLOSCOPE screen.
2. Select the **Controls** field, then choose **Trigger** from the list of choices.

## Using the Marker

The marker is used to help you make measurements with the oscilloscope. By repositioning the marker, you can measure the level and time.

The Marker is controlled using the Marker menu. Select this menu with the following procedure:

1. Press **Shift**, then **Scope** to go to the OSCILLOSCOPE screen.
2. Select the Controls field, then choose Marker from the list of choices.

## Online Help

The Test Set contains help screens which briefly identify the most commonly used features of the Test Set.

Access the Help screens by pressing the **Help** key. Use the knob to select the Help Topic of interest.

Pressing the **Prev** key allows you to switch between the HELP screen and the previous screen you had accessed. This is particularly useful when you are following a procedure described in the HELP screen.

## Help Screen Display

**Figure 3-3 Help Screen Display**

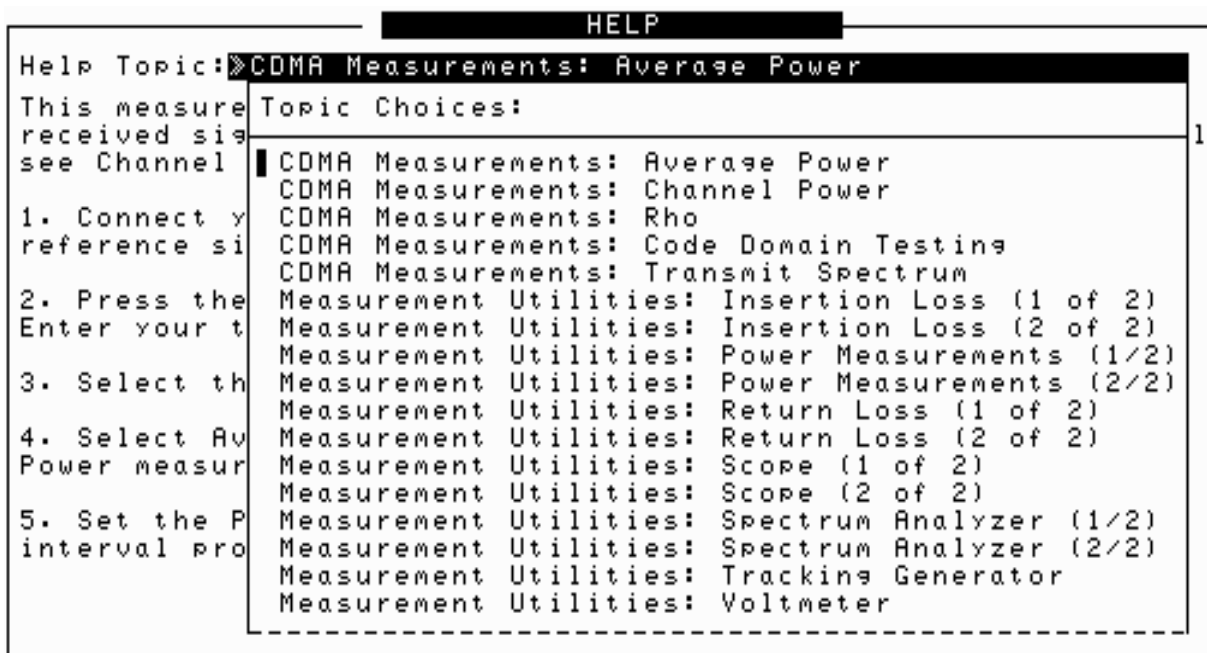

## Ports: HP-IB, Serial and Parallel

There are three types of data ports on the Test Set: HP-IB, Serial, and Parallel. They each have specific purposes.

### HP-IB Port

A special port is provided on the Test Set for IBASIC communications. It is used to control the Test Set with an external IBASIC controller.

This port can be used with an external programming device when writing programs, although it is also common to program the Test Set using a serial port.

The default address of the HP-IB port is 14. This is commonly used in IBASIC programs. An example command providing output to the port is **OUTPUT 714;"\*RST"**, which presets the Test Set.

It has two modes, which correspond to modes useful when programming the Test Set. Talk&Listn is the normal mode. Use Control only when you need to control HP-IB instruments external to the Test Set.

#### Controlling the HP-IB Port

1. Press **Shift**, then the **Inst Config** key to display the I/O CONFIGURE screen.
2. Set the address of the HP-IB port with the **HP-IB Adrs** field.
3. Use the **Mode** field to set the mode to either **Talk& Listn** or **Control**.

### Serial Ports

Three serial ports are available on the Test Set. Port 9 is used for printing, IBASIC control and data communications. Ports 10 and 11 are used only for data communications from IBASIC.

#### Configuring Serial Ports

All serial ports are configured via the I/O CONFIGURE screen. Baud Rate, Parity, Data Length, Stop Length and Flow Control are all configured in this screen. Additionally, port 9 can be configured for IBASIC control in this screen.

1. Press **Shift**, then **I/O Config** to go to the I/O CONFIGURE screen.
2. Select **Serial Port** to choose the port you want to configure.
3. Change the settings for the port as desired.

---

NOTE

Do not turn Flow Control on (set `Flow Cntl` to “Hardware” in the I/O CONFIGURE screen) for the serial port until you have a device attached to the port that can respond to the flow control communications.

Example: Assume you have a printer attached to Serial Port 9. Power is off to the printer. Before you start to run any IBASIC software (for example, the RFTOOLS program), you must make sure the printer is attached and power is on to the printer.

---

### Using Serial Ports for Printing

Serial Port 9 is the only serial port that can be used for printing. See “Printing” on page 66.

1. If you want to change the serial port configuration, see “Configuring Serial Port 9 for IBASIC Communications” on page 63. It is not necessary to change the `Serial_9 In` field.
2. Press **Shift**, then **Printer Config** to display the PRINTER CONFIGURE screen.
3. Select **Printer Port**. Choose `Serial 9` to direct the output to Serial Port 9.
4. Press **Print** to print the screen.

### Configuring Serial Port 9 for IBASIC Communications

The internal connection to Serial Port 9 is controlled in the I/O CONFIGURE screen. The port has two purposes with IBASIC:

- **Inst:** Serial Port 9 is connected to a terminal (e.g. a PC running Windows Terminal program). IBASIC commands are input from the terminal and are used to control the Test Set.
- **IBASIC:** Serial Port 9 is connected to a device that can communicate with an IBASIC program already running inside the Test Set. Typically used for input/output to a PC or other device.

1. Press **Shift**, then **I/O Config** to go to the I/O CONFIGURE screen.
2. Select `Serial_9 In` to toggle between `Inst` and `IBASIC`.

### Configuring Serial Ports 10 and 11

Serial Ports 10 and 11 are only configured via IBASIC commands. See the *Programmer's Guide* for commands which control these ports.

## Parallel Ports

There are two parallel ports on the Test Set.

Parallel Port 15 is the only parallel port that can be used for printing. It can be selected in the PRINTER CONFIGURATION screen.

Both parallel ports (Port 15 and Port 16) may be used for controlling a Base Station. The port can be put in an input or an output mode. The data is then written or read under IBASIC control. When in either of these modes, the printing function on Port 15 is disabled.



---

## Power Measurements

There are several power measurements available in this Test Set. They are listed below, along with brief descriptions.

### Average Power

CDMA ANALYZER screen. Measures the average power of the full bandwidth of the input signal (RF IN/OUT port only). The most used and the most accurate CDMA power measurement. Typically used when only one CDMA signal is present. Since this measurement measures the full bandwidth of the input signal, if more than one signal is present, the power measurement will reflect the average power of all signals. See [“Average Power” on page 37 in Chapter 2.](#)

### Channel Power

CDMA ANALYZER screen. Channel Power measures the power in the 1.23 MHz band of the chosen CDMA channel. The frequency or channel of the transmitter must first be entered in the Tune Frequency or RF Channel field. Often used with low level signals or when making measurements in the presence of interfering signals. Use this measurement when there are multiple CDMA channels at the input to the Test Set. See [“Channel Power” on page 40 in Chapter 2.](#)

### Code Domain Power

CODE DOMAIN screen. Measures the power for each of the 64 Walsh Channels relative to the total power inside a 1.23 MHz bandwidth centered at the Tune Frequency. See [“Code Domain Testing” on page 43 in Chapter 2.](#)

### Fast Power

CODE DOMAIN screen. A faster method of measuring Code Domain Power. A value for Time Offset must be transferred from a non-fast power measurement before measurements begin. See [“Code Domain Testing” on page 43 in Chapter 2.](#)

### TX Power

RF ANALYZER screen. Measures the peak power of cosine wave signals. Used for testing FM/AM radios. Choose between Peak and Sampled power. Do not use with CDMA, since this will result in erroneous readings. Refer to the [“HP 8935 CDMA Cellular/PCS Base Station Test Set AMPS Base Station Tests” Manual](#) for more information.

## Printing

You can print from the Test Set via Parallel Port 15, Serial Port 9, or the HP-IB port.

Note that data collection is not the same as printing. Data collection can only be done from a software program.

## Configuring the Test Set for Printing

1. Press **Shift**, then **Printer Config** to display the **PRINTER CONFIGURATION** screen.
2. Select the **Model** field and choose the printer that most closely matches your printer.
3. Select the **Printer Port** field and choose the port you will connect the printer to. If necessary, use the **I/O CONFIGURE** screen to set up addresses and communication modes.
  - a. **SERIAL PORT 9**: This is the uppermost serial port. Configuration defaults are 9600, none, 8, 1, Xon/Xoff.

---

### NOTE

Do not turn Flow Control on (set **Flow Cntl** to “Hardware” in the **I/O CONFIGURE** screen) for the serial port until you have a device attached to the port that can respond to the flow control communications.

Example: Assume you have a printer attached to Serial Port 9. Power is off to the printer. Before you start to run any IBASIC software (for example, the **RFTOOLS** program), you must make sure the printer is attached and power is on to the printer.

- b. **HP-IB**: The HP-IB address (**HP-IB Adrs**) is set to printer address 701. Enter this number as 01. Set **Mode** to **CONTROL**. (The default address 14 is reserved for an external controller.)
  - c. **PARALLEL PORT**: There are two ports available. Port 15 (the printer port) is the uppermost port.
4. Connect the proper cable to the connector you selected.
    - **SERIAL PORT**: Use a standard **NULL MODEM** cable.
    - **HP-IB**: HP-IB cable (such as HP 10833B)
    - **PARALLEL PORT**: Parallel cable
  5. Change **FF** (**Form Feed**) and **Lines/Page** as needed.

## Printing a Screen

1. Configure the Test Set for Printing.
2. Go to the screen you want to print.
3. Press the **Hold** key if you want to temporarily stop the measurement.  
(Optional)
4. Press the **Print** key. Data will be sent to the printer.
5. To cancel the print, go to the **PRINTER CONFIGURE** screen and select **Abort Print**.

## Measuring Swept Return Loss

This procedure measures the return loss (VSWR) of an antenna using an IBASIC program that is in the Test Set's memory. An external directional bridge must be provided (such as an Eagle RLB 150X5 Option N5A or equivalent).

Press the Menu key to access the SOFTWARE MENU screen, and follow the instructions illustrated on the following pages.

**Figure 3-4 Loading and Running the Return Loss Program**

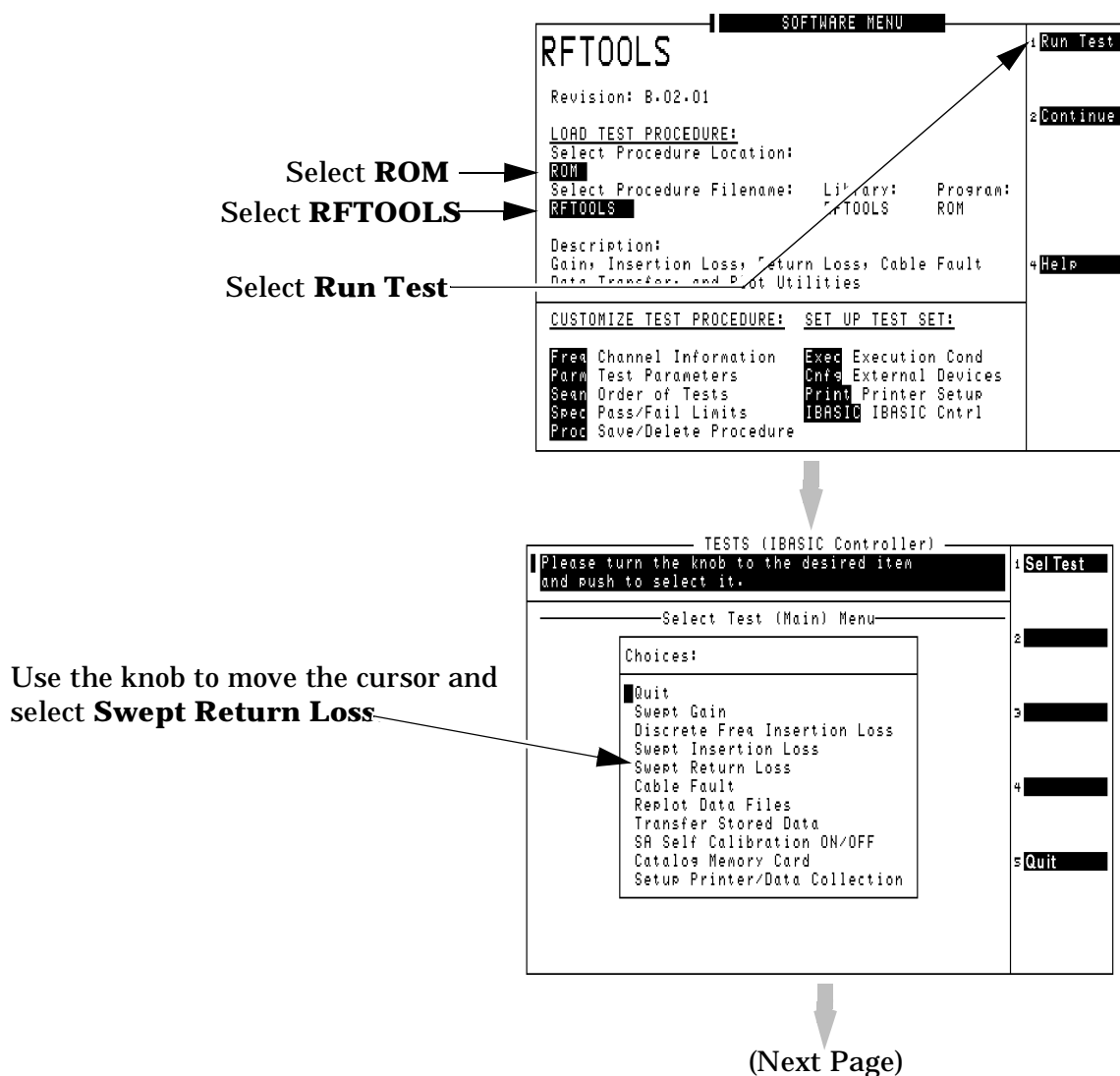
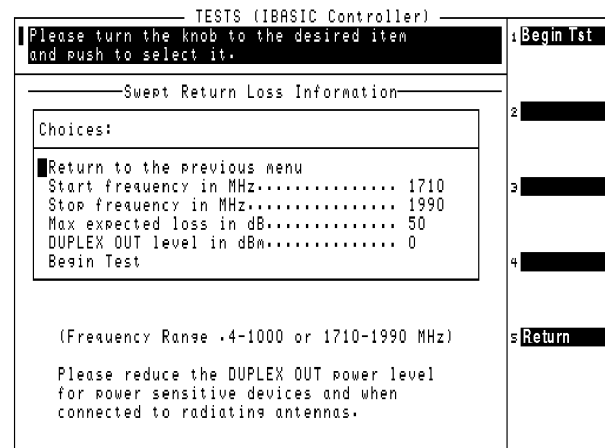

**Figure 3-5 Entering Swept Return Loss Measurement Information**

Enter the **Start** and **Stop Frequency** values for the measurement.

The **Max expected loss** value is used to determine the graphics scaling when the measurement is displayed.

The **DUPLEX OUT level** is adjustable to reduce the RF level used when measuring the loss of sensitive devices, and to minimize the amount of transmitted power during the test (if necessary).



**Figure 3-6 Swept Return Loss Measurement Connections**

Two 6 dB attenuators (pads), two short cables, and the return loss bridge are used to establish a calibration reference **without the device under test connected**. Press **Proceed(k1)** to continue.

As indicated by the NOTE on the drawing, your return loss bridge may be marked differently than shown.

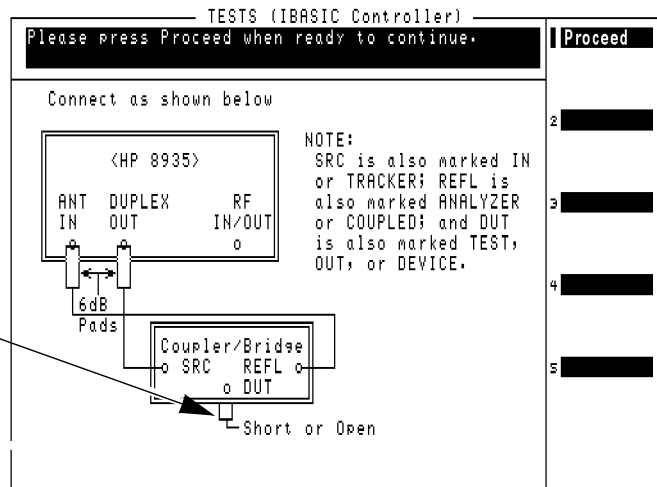

When measuring the swept return loss of a transmission line that is not terminated at an antenna, terminate the line into a 50Ω load.

After connecting your device under test, press **Proceed(k1)** to make the measurement.

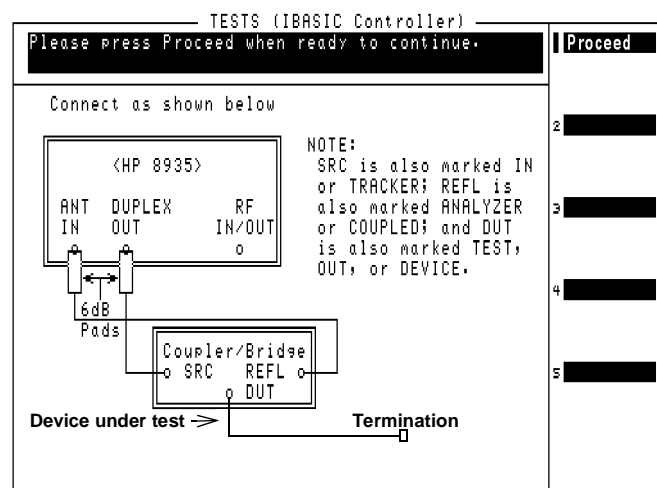

The plot in [Figure 3-7](#) is for a cellular band antenna, swept from 800 MHz to 999 MHz. The plot (and the text above it) indicates that the maximum return loss is at 885.4 MHz. This is the point where the antenna is radiating the maximum amount of signal being fed into it from the return loss bridge, and therefore the Test Set is receiving the least amount of reflected (returned) energy back.

**Figure 3-7** Swept Return Loss Measurement Results

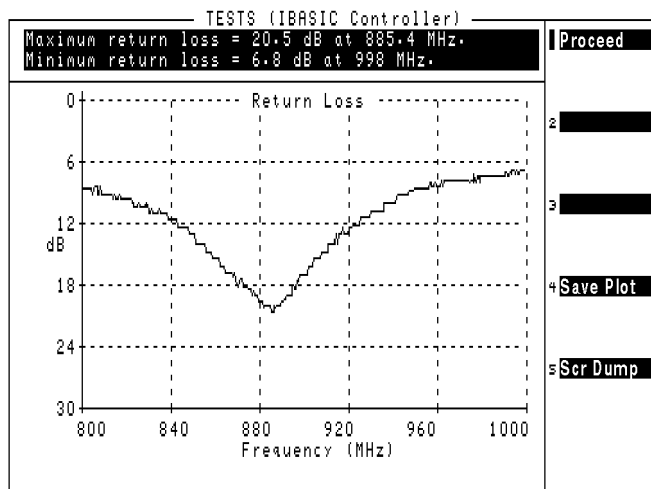

**Proceed** to the run the test again or to select a different test.

**Save Plot** to an initialized writeable PC card. (See ["Memory Cards"](#) on page 57.)

Perform a **Screen Dump** to print the screen to a connected printer. (See ["Printing"](#) on page 66.)

---

## Software: Loading

Instructions for loading software are included with the software package. Refer to the software package's User Guide for instructions on how to load the software.

## Tracking Generator

The Tracking Generator is primarily used for measuring Return Loss and Insertion Loss. It also allows for quick and accurate characterization of filters, duplexers, combiners, and RF to IF conversions. Broadband RF devices can be characterized with single sweeps due to the full-span sweep capability to 1 GHz. The tracking generator also includes amplitude and frequency offset. Output from the Tracking Generator are provided at either the side panel RF IN/OUT or DUPLEX OUT connector.

### Using the Tracking Generator

To measure Return Loss, see ["Measuring Swept Return Loss" on page 68](#). To measure Insertion Loss, see ["Measuring Insertion Losses" on page 56](#).

Features of the Tracking Generator are listed below.

- **Sweep:** the start and stop frequencies of the sweep are determined by the Spectrum Analyzer's Main Menu. The `Span` determines the band, and `Center Freq` defines the midpoint of the sweep.
- **Offset Freq:** sets the difference between the instantaneous frequency of the Tracking Generator and the center frequency of the Spectrum Analyzer. This value can be positive or negative.
- **Amplitude:** sets the amplitude of the signal.
- **Norm/Invert:** With `Norm`, the Tracking Generator sweeps from low to high frequencies. With `Invert`, it sweeps from high to low frequencies.

---

#### NOTE

The offset function is useful when looking at frequency translating devices, or anytime you need to sweep around a frequency while analyzing another. During normal operation, offset is set to "0.00".

---



**Figure 3-8**      **Spectrum Analyzer with Tracking Generator Controls Displayed**

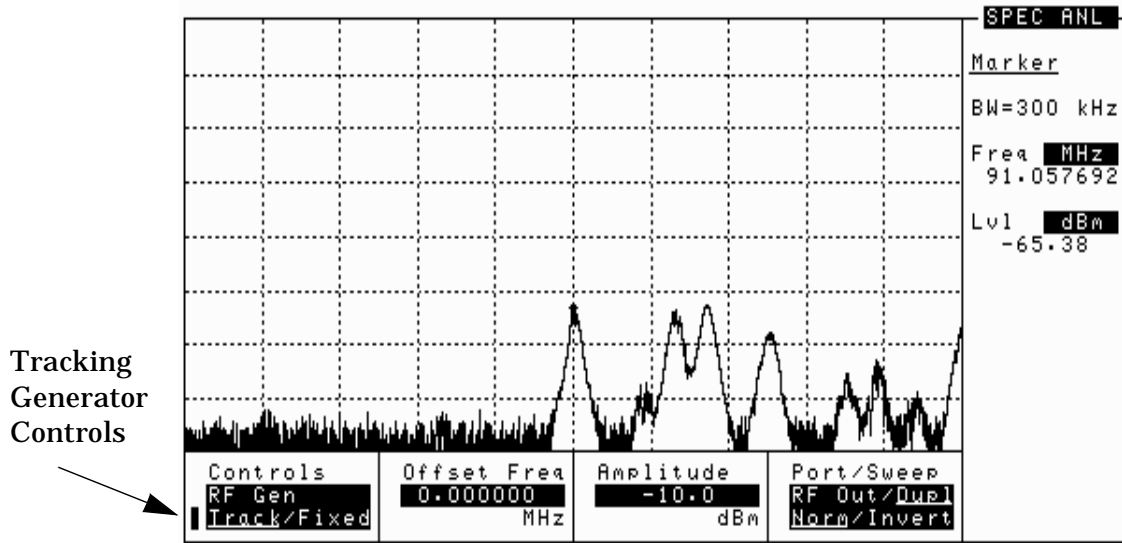

## User Keys

User keys instantly access instrument settings without using the knob. You can use user keys to move quickly between fields on the same screen, and to access field settings that are not normally available on the screen you are using. When the user key is pressed, the cursor instantly moves to, and selects, the assigned field.

Global user keys are used to access settings that are not available on the current screen. Three global user keys are available: k1', k2', and k3'. (To use one of these keys, press **Shift**, then the user key.)

Local user keys are used to move between settings on the screen that is displayed. Five local user keys are available for each screen: k1, k2, k3, k4, and k5. You can assign these keys yourself, or use the factory preset assignments.

### Displaying the Pre-assigned Local User Keys

1. Press the **Shift** key.
2. Press the **Assign** key (k4).
3. Press **Enter**. Now the factory preset keys are displayed.

### Assigning a Local User Key

1. Move the cursor to the field you want to assign to a user key.
2. Press the **Shift** key.
3. Press the **Assign** key (k4).
4. Press the user key you want to assign to the field you chose. The number of the user key will appear beside the field when you move the cursor.

### Assigning a Global User Key

1. Move the cursor to the field you want to assign to a user key.
2. Press the **Shift** key.
3. Press the **Assign** key (k4).
4. Press the **Shift** key.
5. Press the user key you want to assign to the field you chose. Global user keys are k1', k2', and k3'. The number of the user key does not appear beside the field when using global user keys.

## To Release a User Key Assignment

Perform the same procedure for assigning a key, but instead of pressing the **Assign** key (k4), press the **Release** key (k5).

## Voltmeter

The Voltmeter is available in the Test Set, and can measure low level DC or AC voltages. The input to the Voltmeter is controlled by the AF Anl In field in the AF ANALYZER screen.

---

### CAUTION

Do not exceed the rated input to the Test Set for the DC Level and AC Level measurements. Refer to the specifications for input limits.

The connector best suited to making AC Level and DC Level measurements is the Audio In port.

## Measuring AC Level and DC Level

1. Press **Shift**, then **AF Anl** to go to the AF ANALYZER screen.
2. Select **AF Anl In** and choose **Audio In**.
3. Select **Audio In Lo** and choose **Gnd**. This sets the Audio In Lo port to ground, which allows you to measure voltage at the Audio In Hi port.
4. Attach a probe (for example a 1:1 oscilloscope probe) to the Audio In Hi connector.
5. **AC Level** should be displayed. You may need to select **AF Freq**, and choose **DC Level** from the list of choices, if it is not already displayed.

---

**A**

- AC level
  - measuring, 76
- AC volts
  - measuring, 76
- ADC FS, 39
- AF Anl Input
  - field, 58
- AMPS testing, 20
- Analyzer
  - how to tune, 55
- Assembly Level Repair Manual
  - calibration, 25
- assigning global user keys, 74
- assigning local user keys, 74
- automatic operation, 24
- available power measurements,
  - 65
- average power
  - description, 65

**B**

- battery
  - replacing, 21
- beeper, 54
- bridge
  - for insertion loss, 56
  - for return loss, 68

**C**

- cable
  - measuring insertion loss, 56
  - measuring return loss, 68
- cables
  - for printing, 66
  - HP-IB, 66
  - Null Modem, 66
- Calibrate
  - Channel Power measurement
    - field, 25
- calibration
  - Assembly Level Repair Manual,
    - 25
  - Channel Power measurement,
    - 25
  - when you change a module, 25
- calibration offsets, 25
- call center
  - Europe, 22
  - U.S., 22
- Canada HP Direct, 22
- CDMA Analyzer
  - how to tune, 55
- CDMA Generator
  - channel mode, 55
  - frequency mode, 55
  - how to tune, 55
- CDMA Loopback Test
  - connections, 26
- CDMA signal
  - displaying, 26, 28
  - generating, 28
  - screen display, 28
- CD-ROM
  - documentation, 23
- Cell Band CDMA testing, 20
- change battery procedure, 21
- channel mode
  - changing to frequency mode, 55
  - when to use, 55
- channel power
  - description, 65
- channel standard, 55
- code domain power, 65
  - fast power, 65
- congratulations, 28
- connections
  - CDMA Loopback Test, 26
- conventions used in his manual,
  - 17

---

## D

DC level  
  measuring, [76](#)  
DC volts  
  measuring, [76](#)  
display  
  CDMA loopback signal, [28](#)  
display a CDMA signal, [26](#)  
displaying a CDMA signal, [28](#)

## E

Eagle bridge  
  for insertion loss, [56](#)  
  for return loss, [68](#)  
European Call Center, [22](#)

## F

fast power, [65](#)  
fields  
  selecting, [27](#)  
frequency  
  difference, [55](#)  
  setting analyzer, [55](#)  
  setting generator, [55](#)  
frequency mode  
  changing to channel mode, [55](#)  
  how to change to channel mode,  
    [55](#)  
  when to use, [55](#)

---

## G

- generating a CDMA signal, [28](#)
- Generator
  - how to tune, [55](#)
- Getting Help, [22](#)
- Getting Started, [19](#)
- global user keys, [74](#)
  - assigning, [74](#)
  - releasing, [75](#)

## H

- Help
  - how to get, [22](#)
  - online, [61](#)
  - screen display, [61](#)
- hot keys
  - setting, [74](#)
- HP Direct
  - Canada, [22](#)
  - Korea, [22](#)
- HP-IB
  - port, [62](#)
- HP-IB communications
  - via the serial port, [63](#)
- HP-IB controller
  - internal to the Test Set, [24](#)
- HP-IB port
  - controlling, [62](#)
  - modes, [62](#)

## I

- in this manual, [17](#)
- insertion loss
  - measuring, [56](#)

---

## K

k1, k2, k3, k4, k5  
  local user keys, [74](#)  
k1', k2', k3'  
  global user keys, [74](#)  
knob  
  using, [27](#)  
Korea HP Direct, [22](#)

## L

loading software, [71](#)  
local user keys, [74](#)  
  assigning, [74](#)  
  preassigned, [74](#)  
  releasing, [75](#)  
Loopback Test, [26](#)  
loss  
  measuring insertion loss, [56](#)  
  measuring return loss, [68](#)

## M

manual operation, [24](#)  
maximizing measurement  
  accuracy, [25](#)  
measurement  
  saving and recalling setups, [36](#)  
measurement accuracy  
  maximizing, [25](#)  
modes of the Test Set, [24](#)



**O**

oscilloscope, 58  
  features, 58  
  filters and inputs, 58  
  marker, 60  
  selecting the filters, 59  
  selecting the input, 58  
  triggering, 59  
overpower damage, 37, 43, 50

**P**

parallel port  
  input and output modes, 64  
  ports 15 and 16, 64  
PCMCIA card, 57  
  Flash ROM, 57  
  initializing, 57  
  OTP, 57  
  SRAM, 57  
PCS CDMA testing, 20  
port  
  HP-IB, 62  
  HP-IB, serial, parallel, 62  
  measuring AC or DC level, 76  
  printing via the serial port, 63  
  serial, 62  
power  
  average, 65  
  channel, 65  
  code domain, 65  
  measurement types, 65  
  measurements, 65  
  TX, 65  
power measurements  
  available, 65  
preassigned local user keys, 74  
printing, 66  
  and data collection, 66  
  cables, 66  
  configuring the Test Set, 66  
  FF (Form Feed), 66  
  how to print a screen, 67  
  HP-IB, 66  
  lines per page, 66  
  parallel port, 66  
  ports, 66  
  serial port 9, 66  
  via the serial port, 63  
probe  
  measuring AC or DC level, 76  
Product Description, 20  
Programmer's Guide, 24  
purchased software, 24

**R**

RAM  
  backing up, 21  
recall  
  instrument setups, 36  
  settings, 36  
Recall key  
  using, 36  
return loss, 68  
  measuring, 68  
RF Analyzer  
  how to tune, 55  
RF channel standard  
  choosing, 55  
RF Generator  
  how to tune, 55  
RF Offset  
  setting, 55  
RF Tools  
  measuring insertion loss, 56  
  measuring return loss, 68

---

## S

- sales offices, [22](#)
- save
  - instrument setups, [36](#)
  - settings, [36](#)
- SAVE key
  - using, [36](#)
- saving instrument setups, [36](#)
- saving settings, [36](#)
- screens
  - selecting, [27](#)
- serial port, [62](#)
  - configuring, [62](#)
  - configuring for HP-IB communications, [63](#)
  - port 9, configuring for HP-IB communications, [63](#)
  - port 9, configuring for printing, [63](#)
  - ports 10 and 11, [63](#)
  - using for printing, [63](#)
- settings
  - recalling, [36](#)
  - saving, [36](#)
- setups
  - recalling, [36](#)
  - saving, [36](#)
- software
  - loading, [71](#)
  - manufacturer-specific, [24](#)
  - purchased, [24](#)
  - RF Tools, [56](#), [68](#)
- SRAM card
  - initializing, [57](#)
- systems
  - AMPS, [20](#)
  - CDMA, [20](#)
  - PCS CDMA, [20](#)

## T

- temperature compensation, [25](#)
  - Pwr Zero, [25](#)
  - TX Pwr Zero, [25](#)
  - when to zero power, [25](#)
- test procedure
  - insertion loss, [56](#)
  - return loss, [68](#)
- Test Set
  - documents included, [23](#)
  - what's in the box, [23](#)
- time offset
  - and fast power, [65](#)
- tips for selecting screens and fields, [27](#)
- TMO web site, [22](#)
- tools contained in the Test Set, [20](#)
- tracking generator, [72](#)
  - controls display, [73](#)
  - offset frequency, [72](#)
  - using, [72](#)
- TX power
  - description, [65](#)

## U

- U.S. Call Center, [22](#)
- user keys
  - global, [74](#)
  - local, [74](#)
  - releasing, [75](#)
  - setting, [74](#)
- Utility Procedures, [53](#)

---

## V

- voltmeter, [76](#)
  - connector, [76](#)
  - exceeding rated input, [76](#)
- volume
  - controlling beeper, [54](#)

## W

- warm-up
  - when to zero power, [25](#)
- web site
  - TMO, [22](#)
- what to do next, [28](#)
- What's Included with this Test Set, [23](#)
- who should use this Test Set, [21](#)
- [www.tmo.hp.com](http://www.tmo.hp.com), [22](#)