

***USER'S GUIDE***  
**Multi-Cell Charger/Discharger**  
**Agilent Model E4370A**  
**Powerbus Load**  
**Agilent Model E4371A**  
**64-Channel Charger/Discharger**  
**Agilent Model E4374A**



**Agilent Technologies**

Agilent Part No. 5964-8138

Microfiche No. 5964-8139

September 2000

---

# Warranty Information

## CERTIFICATION

*Agilent Technologies certifies that this product met its published specifications at time of shipment from the factory. further certifies that its calibration measurements are traceable to the United States National Bureau of Standards, to the extent allowed by the Bureau's calibration facility, and to the calibration facilities of other International Standards Organization members.*

## WARRANTY

This Agilent Technologies hardware product is warranted against defects in material and workmanship for a period of one year from date of delivery. Agilent Technologies software and firmware products, which are designated by Agilent Technologies for use with a hardware product and when properly installed on that hardware product, are warranted not to fail to execute their programming instructions due to defects in material and workmanship for a period of 90 days from date of delivery. During the warranty period Agilent Technologies will, at its option, either repair or replace products which prove to be defective. Agilent Technologies does not warrant that the operation for the software firmware, or hardware shall be uninterrupted or error free.

For warranty service, with the exception of warranty options, this product must be returned to a service facility designated by Agilent Technologies . Customer shall prepay shipping charges by (and shall pay all duty and taxes) for products returned to Agilent Technologies for warranty service. Except for products returned to Customer from another country, Agilent Technologies shall pay for return of products to Customer.

Warranty services outside the country of initial purchase are included in Agilent Technologies' product price, only if Customer pays Agilent Technologies international prices (defined as destination local currency price, or U.S. or Geneva Export price).

If Agilent Technologies is unable, within a reasonable time to repair or replace any product to condition as warranted, the Customer shall be entitled to a refund of the purchase price upon return of the product to Agilent Technologies .

## LIMITATION OF WARRANTY

The foregoing warranty shall not apply to defects resulting from improper or inadequate maintenance by the Customer, Customer-supplied software or interfacing, unauthorized modification or misuse, operation outside of the environmental specifications for the product, or improper site preparation and maintenance. NO OTHER WARRANTY IS EXPRESSED OR IMPLIED. AGILENT TECHNOLOGIES SPECIFICALLY DISCLAIMS THE IMPLIED WARRANTIES OF MERCHANTABILITY AND FITNESS FOR A PARTICULAR PURPOSE.

## EXCLUSIVE REMEDIES

THE REMEDIES PROVIDED HEREIN ARE THE CUSTOMER'S SOLE AND EXCLUSIVE REMEDIES. AGILENT TECHNOLOGIES SHALL NOT BE LIABLE FOR ANY DIRECT, INDIRECT, SPECIAL, INCIDENTAL, OR CONSEQUENTIAL DAMAGES, WHETHER BASED ON CONTRACT, TORT, OR ANY OTHER LEGAL THEORY.

## ASSISTANCE

The above statements apply only to the standard product warranty. Warranty options, extended support contacts, product maintenance agreements and customer assistance agreements are also available. Contact your nearest Agilent Technologies Sales and Service office for further information on Agilent Technologies' full line of Support Programs.

---

# Safety Summary

*The following general safety precautions must be observed during all phases of operation of this instrument. Failure to comply with these precautions or with specific warnings elsewhere in this manual violates safety standards of design, manufacture, and intended use of the instrument. Agilent Technologies assumes no liability for the customer's failure to comply with these requirements.*

## **GENERAL**

This product is a Safety Class 1 instrument (provided with a protective earth terminal). The protective features of this product may be impaired if it is used in a manner not specified in the operation instructions.

Any LEDs used in this product are Class 1 LEDs as per IEC 825-1.

## **ENVIRONMENTAL CONDITIONS**

This instrument is intended for indoor use in an installation category II, pollution degree 2 environment. It is designed to operate at a maximum relative humidity of 95% and at altitudes of up to 2000 meters. Refer to the specifications tables for the ac mains voltage requirements and ambient operating temperature range.

## **BEFORE APPLYING POWER**

Verify that all safety precautions are taken. Note the instrument's external markings described under "Safety Symbols".

## **GROUND THE INSTRUMENT**

To minimize shock hazard, the Agilent MCCD Mainframe chassis and cover must be connected to an electrical ground. The mainframe must be connected to the ac power mains through a grounded power cable, with the ground wire firmly connected to an electrical ground (safety ground) at the power outlet. Any interruption of the protective (grounding) conductor or disconnection of the protective earth terminal will cause a potential shock hazard that could result in personal injury.

The Agilent Powerbus Load does not connect to ac mains. Connect the ground terminal of the load to the ground terminal of the external dc source. Use a #14 AWG wire as a minimum.

**ATTENTION: Un circuit de terre continu est essentiel en vue du fonctionnement sécuritaire de l'appareil. Ne jamais mettre l'appareil en marche lorsque le conducteur de mise ... la terre est d,branch,.**

## **DO NOT OPERATE IN AN EXPLOSIVE ATMOSPHERE**











Do not operate the instrument in the presence of flammable gases or fumes.

## **DO NOT REMOVE THE INSTRUMENT COVER**

Operating personnel must not remove instrument covers. Component replacement and internal adjustments must be made only by qualified service personnel.

*Instruments that appear damaged or defective should be made inoperative and secured against unintended operation until they can be repaired by qualified service personnel.*

## Safety Symbols

SAFETY SYMBOLS	
 Direct current	 Caution, risk of electric shock
 Earth (ground) terminal	 Caution, hot surface
 Protective earth (ground) terminal (Intended for connection to external protective conductor.)	 Caution (Refer to accompanying documents.)
 On - power (Indicates connection to the ac mains.)	 On - equipment (Identifies the on condition of part of the equipment.)
 Off - power (Indicates disconnection from the ac mains.)	 Off - equipment (Identifies the off condition of part of the equipment.)

---

## Document Scope

This document describes and specifies the “standard” version of the Agilent Multi-Cell Charger/Discharger System. It contains installation instructions, connection information, programming information, example programs, and specifications. Information about the Agilent MCCD User Interface is provided online. System options are described on a separate option sheet that is shipped with this manual. All information in this manual is subject to change. Updated editions will be identified by a new printing date.

## Notice

This document contains proprietary information protected by copyright. All rights are reserved. No part of this document may be photocopied, reproduced, or translated into another language without the prior consent of Agilent Technologies. The information contained in this document is subject to change without notice.

© Copyright 1999, 2000 Agilent Technologies, Inc.

---

# Table of Contents

<b>Warranty Information</b>	<b>2</b>
<b>Safety Summary</b>	<b>3</b>
<b>Document Scope</b>	<b>4</b>
Notice	4
<b>Table of Contents</b>	<b>5</b>
<b>1 - GENERAL INFORMATION</b>	<b>9</b>
<b>Agilent MCCD System Capabilities</b>	<b>9</b>
Basic Functions	10
Additional Features	10
<b>Hardware Description</b>	<b>10</b>
Agilent E4370A/E4374A MCCD	10
Agilent E4371A Powerbus Load	12
External Power Source	13
Multiple Agilent MCCD Configuration	14
<b>Measurement Capability</b>	<b>15</b>
Voltage Measurements	15
Current Measurements	15
Capacity Measurements	16
Cell Resistance	16
Probe Resistance	17
<b>Data Logging</b>	<b>17</b>
<b>Protection Features</b>	<b>18</b>
Internal Protection Functions	18
External Digital I/O Protection Functions	19
If AC Power Fails	19
<b>Remote Programming Interface</b>	<b>19</b>
Application Programming Interface (API)	20
Web Accessible Agilent MCCD User Interface	20
<b>Example of a Cell Forming Process</b>	<b>20</b>
<b>2 - INSTALLATION</b>	<b>23</b>
<b>Inspection</b>	<b>23</b>
<b>Parts and Accessories</b>	<b>23</b>
<b>Location</b>	<b>25</b>
Agilent E4370A MCCD Mainframe	25
Agilent E4371A Powerbus Load	25
<b>Channel Connections</b>	<b>25</b>
Voltage Drops and Wire Resistance	26
Remote Sense Connections	27
<b>Power Bus Connections</b>	<b>28</b>
Power Bus Wiring Information	28
<b>Digital Connections</b>	<b>31</b>
General Purpose I/O	31
Special Functions	32
Wiring Guidelines	32
<b>RS-232 Connections</b>	<b>34</b>
<b>Auxiliary Output Connection</b>	<b>35</b>
<b>Installing the API Library and Measurement Log Utility</b>	<b>36</b>
Visual C++ Configuration	36

<b>3 - CONFIGURATION</b>	<b>37</b>
<b>Configuring the LAN</b>	<b>37</b>
1. Configure the HyperTerminal program	37
2. Connect the Agilent E4370A MCCD to the COM port on the PC	38
3. Fill Out the Agilent MCCD Configuration Screens	38
Network Configuration	39
Identification Configuration	40
Miscellaneous Configuration	41
<b>Configuring the Digital I/O</b>	<b>41</b>
Mixed Configuration Example	44
<b>Accessing Calibration</b>	<b>44</b>
<b>4 - AGILENT MCCD USER INTERFACE</b>	<b>45</b>
<b>Description</b>	<b>45</b>
PC Requirements	45
Browser Settings	45
Security	45
Localization	46
Access	46
<b>Using the Interface</b>	<b>46</b>
<b>Using the Agilent MCCD Measurement Log Utility</b>	<b>47</b>
<b>5 - PROGRAMMING OVERVIEW</b>	<b>49</b>
<b>A Cell Forming Overview</b>	<b>49</b>
Cell Forming Example	50
<b>Function Call Overview</b>	<b>53</b>
Cell Grouping	53
Grouping Functions	54
Step/Test Functions	54
Sequence Control	55
Output Configuration	56
Instrument Protection	57
Power Fail Operation	58
Instrument State Storage	58
Status	59
Measurement Log	60
Time Stamp Function	61
Output Measurements	61
Direct output control	62
General Server functions	62
Selftest	63
Calibration	63
Serial port	64
Digital port	64
Probe check	65
<b>6 - LANGUAGE DICTIONARY</b>	<b>67</b>
<b>API Usage Guidelines</b>	<b>67</b>
<b>API Function Summary</b>	<b>68</b>
<b>API Function Definitions</b>	<b>70</b>
cfAbort	70
cfCal	70
cfCalStandard	70

cfCalTransfer	71
cfClose	71
cfDeleteGroup	71
cfGetCellStatus	72
cfGetCellStatusString	72
cfGetCurrent	72
cfGetDigitalConfig	73
cfGetDigitalPort	73
cfGetGroups	73
cfGetInstIdentify	74
cfGetInstStatus	74
cfGetMeasLogInterval	75
cfGetOutputConfig	75
cfGetOutputProbeTest	75
cfGetOutputState	76
cfGetRunState	76
cfGetSense	76
cfGetSenseProbeTest	77
cfGetSeqStep	77
cfGetSeqTest	77
cfGetSeqTestAnd	78
cfGetSeqTime	78
cfGetSerialConfig	78
cfGetSerialStatus	78
cfGetShutdownDelay	79
cfGetShutdownMode	79
cfGetStepNumber	79
cfGetTrigSource	79
cfGetUserIdentify	79
cfGetVoltage	80
cfInitiate	80
cfMeasACResistance	80
cfMeasCapacityAS	80
cfMeasCapacityWS	81
cfMeasCurrent	81
cfMeasDCResistance	81
cfMeasOutputProbeResistance	81
cfMeasProbeContinuity	82
cfMeasSenseProbeResistance	82
cfMeasVoltage	83
cfOpen	83
cfOpenGroup	83
cfProtect	84
cfProtectClear	84
cfReadMeasLog	84
cfReadSerial	86
cfReadTestLog	87
cfReset	87
cfResetSeq	87
cfRestart	88
cfSaveOutputConfig	88
cfSelftest	88
cfSetAutoConnect	89
cfSetCurrent	89
cfSetDigitalConfig	90

cfSetDigitalPort	92
cfSetErrorFunction	92
cfSetGroup	93
cfSetMeasLogInterval	93
cfSetOutputConfig	93
cfSetOutputProbeTest	94
cfSetOutputState	94
cfSetSense	95
cfSetSenseProbeTest	95
cfSetSeqStep	95
cfSetSeqTest	97
cfSetSeqTestAnd	99
cfSetSerialConfig	99
cfSetServerTimeout	99
cfSetShutdownDelay	100
cfSetShutdownMode	100
cfSetTimeout	100
cfSetTrigSource	100
cfSetVoltage	101
cfShutdown	101
cfStateDelete	101
cfStateList	102
cfStateRecall	102
cfStateSave	102
cfTrigger	102
cfWriteSerial	103
<b>7 - C PROGRAM EXAMPLES</b>	<b>105</b>
<b>Example 1</b>	<b>105</b>
<b>Example 2</b>	<b>107</b>
<b>Example 3</b>	<b>112</b>
<b>A - SPECIFICATIONS</b>	<b>115</b>
<b>Hardware Specifications</b>	<b>115</b>
<b>B - CALIBRATION</b>	<b>119</b>
<b>Calibration Types</b>	<b>119</b>
Full Calibration	119
Transfer Calibration	120
Mainframe Reference Calibration	120
Calibration Connections	120
<b>Accessing Calibration</b>	<b>122</b>
<b>Calibration Error Messages</b>	<b>123</b>
<b>C - DIMENSION DRAWINGS</b>	<b>125</b>
<b>D - SENSE AND POWER CONNECTOR PINOUTS</b>	<b>127</b>
<b>E - IN CASE OF TROUBLE</b>	<b>135</b>
<b>Introduction</b>	<b>135</b>
Fault LEDs (see Figure 1-2)	135
<b>Selftest Error Messages</b>	<b>136</b>
<b>INDEX</b>	<b>137</b>



## General Information

### Agilent MCCD System Capabilities

The Agilent Multi-Cell Charger/Discharger (MCCD) System has been designed to address the unique requirements and needs of lithium-ion cell manufacturing. The Agilent MCCD System can accurately charge, discharge, and measure lithium ion cells. It consists of an Agilent E4370A Multi-Cell Charger/Discharger mainframe with up to four Agilent E4374A 64-Channel Charger/Discharger cards. When fully loaded each mainframe has 256 input/output channels. Mainframes and modules can be combined in different configurations to form a low cost, high performance cell charge/discharge station in a cell manufacturing process.

The following figure is a simplified block diagram of the Agilent MCCD System. It is followed by a brief description of the system's basic as well as advanced features.

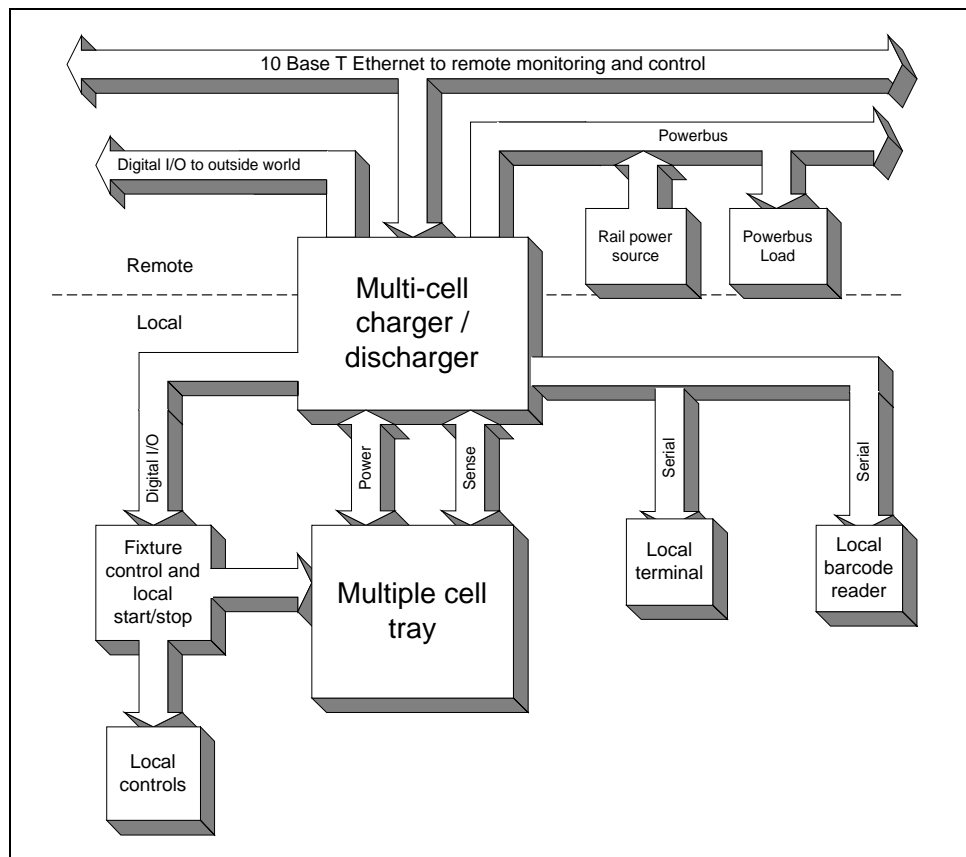

Figure 1-1. Block Diagram of Agilent MCCD System

## 1 - General Information

### Basic Functions

- ◆ **Charger** – The Agilent MCCD can deliver accurately controlled current and voltage into a cell for proper forming. Each cell is independently paced through the cell forming sequence. This means that some cells can be charging and others discharging if they are at different points in the sequence.
- ◆ **Discharger** – The Agilent MCCD can draw accurately controlled current from a cell for both forming and capacity measurement.
- ◆ **Measurement** – The Agilent MCCD can monitor several parameters of the cell while charging, discharging, and resting. Measurements include voltage, current, time, internal resistance, ampere-hours, and watt-hours. These measurements are used to adjust the cell forming sequence for safety, reliability, and or proper cell forming.
- ◆ **Digital I/O control** – The Agilent MCCD can monitor and stimulate digital I/O connected to it. This simplifies wiring, allows ease of expansion, and is more reliable than a centralized control system. Its high-speed capability is ideal for fast fault detection and system shutdown.
- ◆ **RS-232 control** – The Agilent MCCD can support peripherals connected to its serial ports for adding printers, bar code readers, local terminals, robots and other types of local additional hardware via pass-through control from the host computer.
- ◆ **Equipment Protection** – The Agilent MCCD has extensive safety features to protect both the cells under formation and the hardware from equipment failure, programming errors, cell failures and other types of external faults.

### Additional Features

- ◆ LAN 10 base-T control using a web-server graphical user interface and an application programming interface (API).
- ◆ Comprehensive data storage capability and remote data collection.
- ◆ Easily removable charger/discharger cards for minimum downtime if repair is required.
- ◆ Charge/discharge sequences that can be modified in software, allowing for simple, rapid changes to the manufacturing process without changes to system hardware.
- ◆ Define and configure groups of contiguous blocks of cells or channels. This lets you simultaneously run different sequences on groups of cells.
- ◆ Continuous calibration is performed on the programming circuits during the entire charge/discharge sequence to eliminate errors due to temperature drift.
- ◆ Bi-directional power transfer and reuse of energy by using energy from discharging cells to provide energy to charging cells.

---

## Hardware Description

### Agilent E4370A/E4374A MCCD

The Agilent E4370A MCCD mainframe is a full-width rack box that has 4 slots to hold the E4374A 64-Channel Charger/Discharger cards. The Agilent E4374A 64-Channel Charger/Discharger cards contain the circuitry that independently charges and discharges each cell at up to 5V and 2A.

---

**NOTE:** Each output channel has a maximum available compliance voltage of 5.5V. Compliance voltage is defined as the voltage required at the cell plus any fixture/wiring voltage drops. Having this higher compliance voltage allows the full 5 V to be applied directly to the cell with a maximum of 0.5 volt loss in the wiring.

---

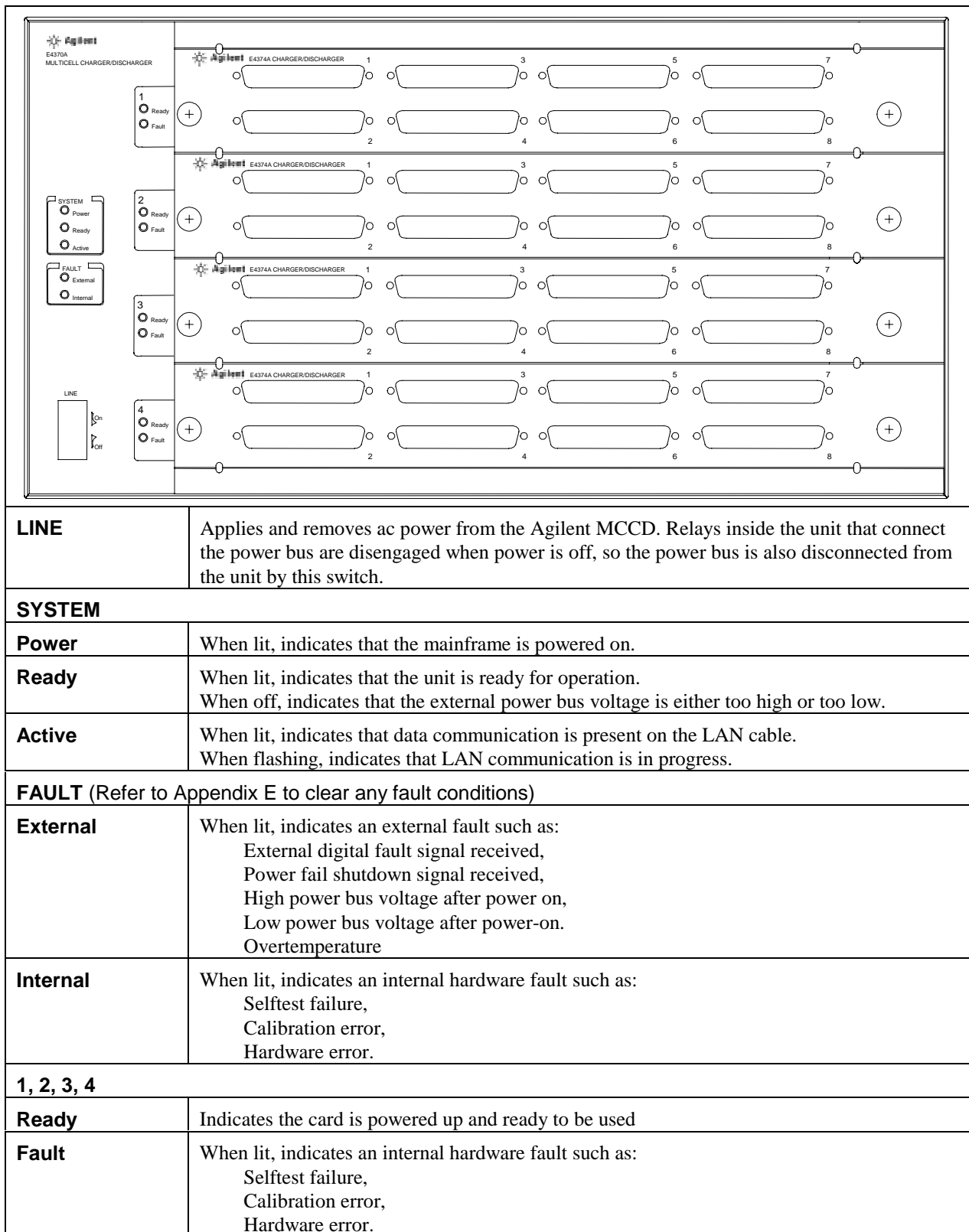
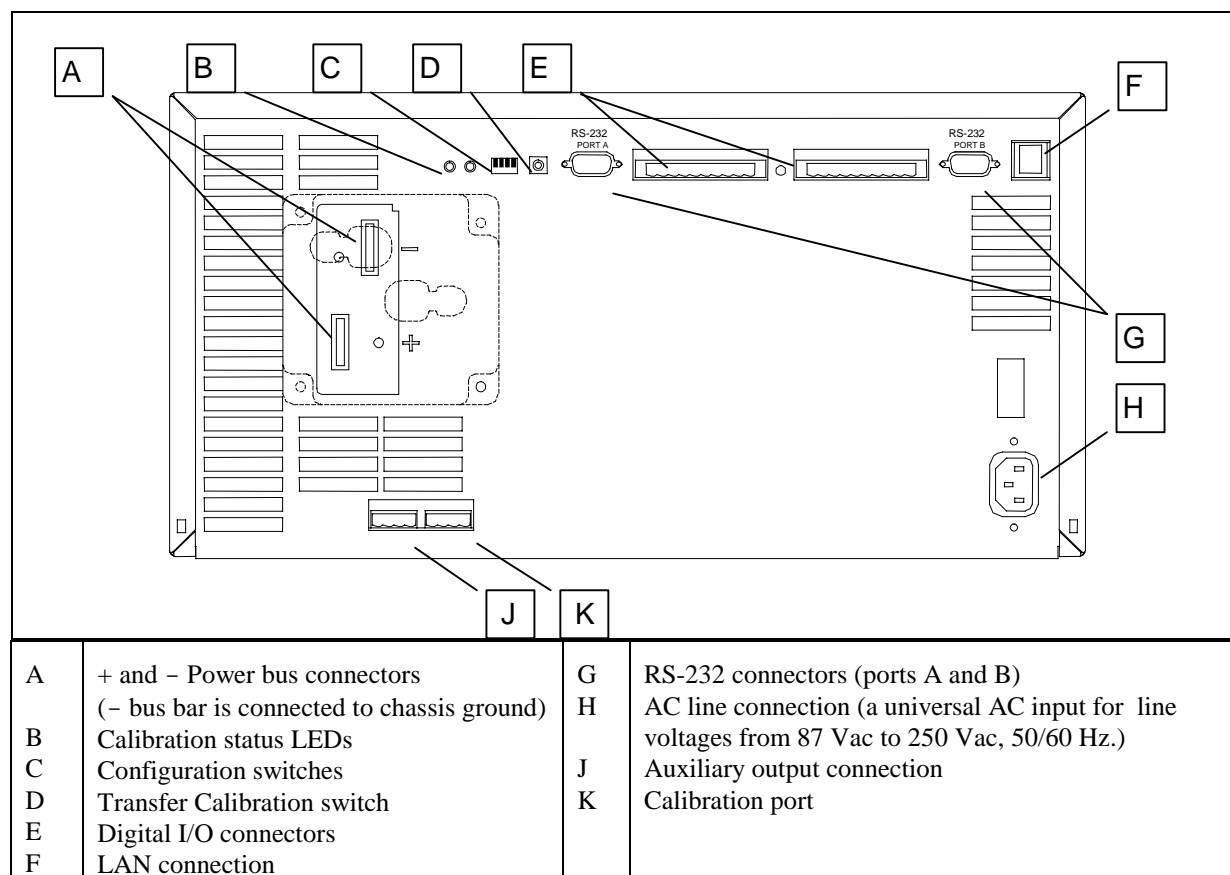

Figure 1-2. Agilent E4370A/E4374A MCCD Front Panel Controls and Indicators

## 1 - General Information



**Figure 1-3. Agilent E4370A/E4374A MCCD Rear Panel Connections**

### Agilent E4371A Powerbus Load

For the discharging cycle, an Agilent E4371A Powerbus Load is required to dissipate excess power from discharging cells. The load operates in constant voltage mode only and sequentially switches internal resistors on and off to regulate the voltage on the power bus around a midpoint of 26.75 volts. The number of load units required depends on the number of Agilent MCCD mainframes in your system. Each Agilent E4371A Powerbus Load is capable of the full power from two 256-channel Agilent E4370A MCCD mainframes.

The Agilent E4371A Powerbus Load has a + and a - power bus connector on its rear panel. There is also a ground connection. To meet safety requirements, connect the ground terminal of the Agilent Powerbus load to the ground terminal of the external dc source. The load receives its operating power from the power bus. If the dc voltage on the power bus drops below 23.8 volts, or if there is no power available on the power bus, the load will not operate. Note that the load is not programmable. It is set at the factory for the correct operating voltage and does not require calibration.

The On/Off switch on the load simply connects or disconnects the load from the power bus. Note that the internal fans draw approximately 1.5 amperes of current from the power bus.

---

**CAUTION:** When discharging its maximum rated power, the Agilent E4371A Powerbus Load becomes hot to the touch.

---

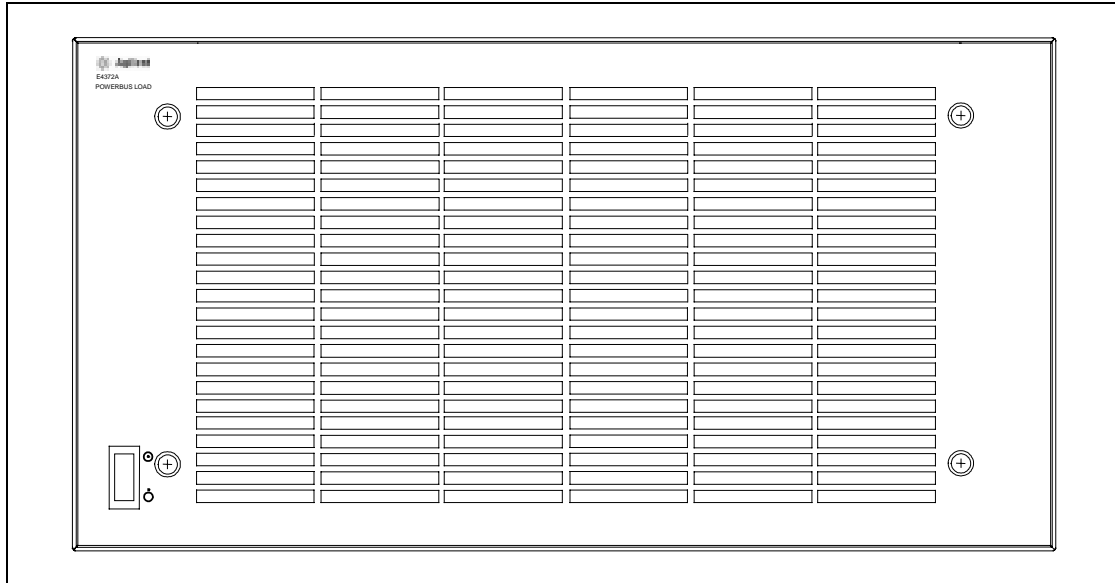

**Figure 1-4. Agilent E4371A Powerbus Load Front Panel**

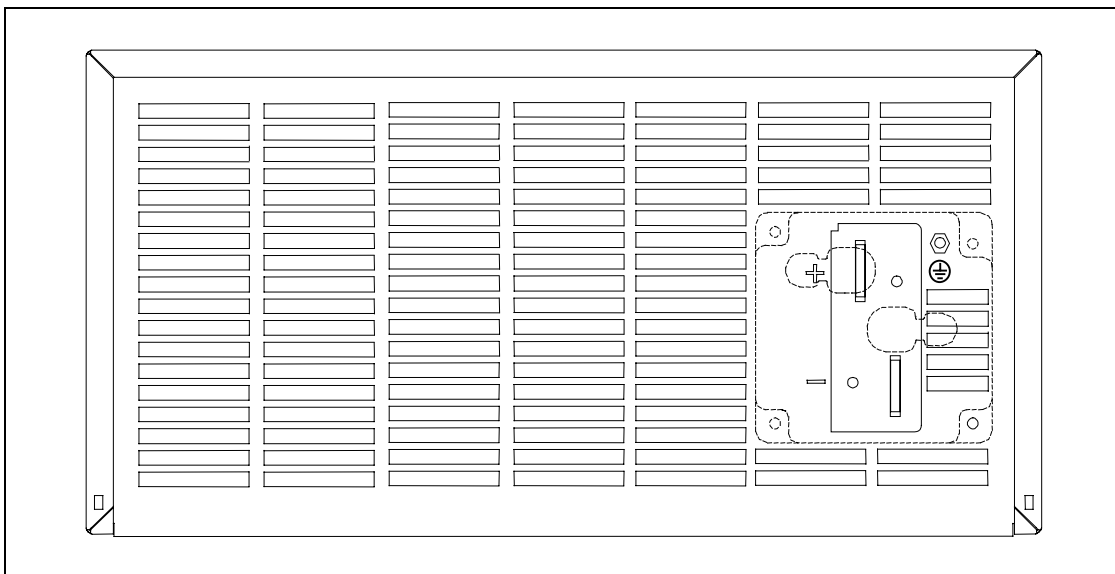

**Figure 1-5. Agilent E4371A Powerbus Load Rear Panel**

## External Power Source

For the charging cycle, each Agilent MCCD mainframe requires an external dc power source to power the cells. The external power source connects to the power bus terminals on the back of the mainframe. It must be rated at 24 volts and be able to source 125% of the required cell charging power. For example, to provide the cell charging power for a 256-channel system at 5 volts, 2 amperes per channel (or 2.56 kW), the dc power source must deliver approximately 3.2 kW to each Agilent MCCD mainframe (24 V @ 133 A).

The current rating of the power source may be reduced if the charging current is reduced accordingly. For example, to provide a maximum output current of 1 ampere per cell in the previously described system, a source rated at least 63 amperes may be used.

## 1 - General Information

Additionally, a single supply of sufficient amperage may be shared among multiple mainframes that are connected to a common power bus - provided that the total current can be supplied while meeting the voltage specification at the power bus terminals at the rear of the Agilent MCCD.

---

**NOTE:** If the external dc power source has an overvoltage protection circuit, it must be set higher than 30 volts to avoid the possibility of shutting itself down during the discharge cycle.

---

## Multiple Agilent MCCD Configuration

The following figure illustrates an Agilent E4370A MCCD system with eight fully loaded mainframes.

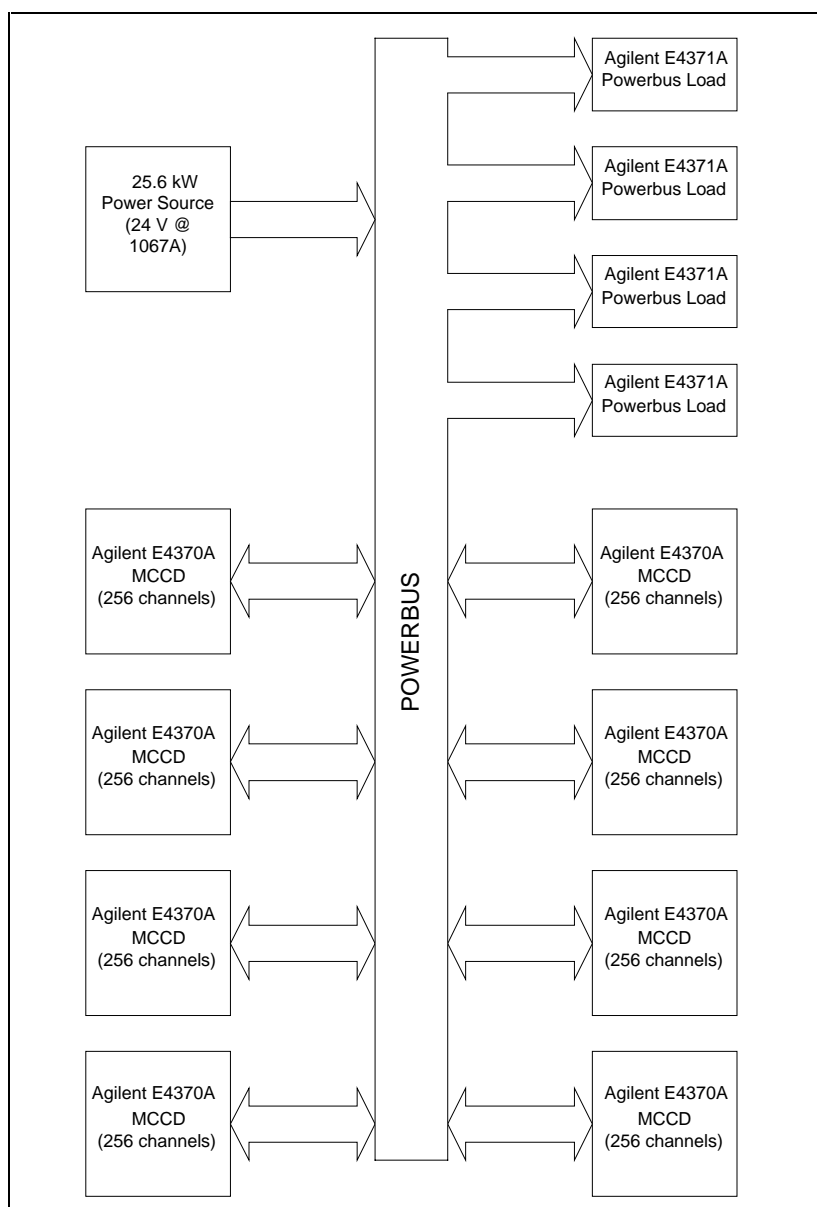

**Figure 1-6. Maximum System Block Diagram**

The maximum power required for such a system is 25.6 kilowatts. A single power source of sufficient total amperage may be shared among multiple mainframes connected to the power bus, provided the total current can be provided while meeting the 24 volt dc input requirement at the power bus terminals on the rear of each mainframe. Multiple paralleled 24 volt dc sources may be used in place of the single 24 volt, 25.6 kilowatt dc source shown in the figure.

To achieve improvements in energy efficiency, the Agilent E4370A MCCD system can re-use discharge energy to supplement the energy provided by an external power source when charging other cells in a multi-unit system. This is possible because of the bi-directional power transfer capability between charging and discharging cells when connected to a common power bus. To take advantage of this energy transfer requires that some mainframes in the system must be operating in discharge mode at the same time that others are operating in charging mode.

No special control system is required for this configuration. The regulation circuits of the 24 volt dc power source, the Agilent E4370A MCCD, and Agilent E4371A Powerbus Load will operate properly without any special hardware control lines or additional software being required.

---

**NOTE:** Adequate size power bus wiring is required to carry high currents. Refer to Table 2-5.

---

---

## Measurement Capability

The Agilent MCCD mainframe and charger/discharger cards have a high speed scanning system that makes voltage and current measurements on all channels. Refer to Appendix A for technical data about the measurement system. The following measurements are available:

### Voltage Measurements

The Agilent MCCD measures the voltage of each channel using a calibrated internal measurement circuit. In local sensing mode, the voltage measurement is made at the power connector. In remote sensing mode, the voltage is measured at the end of the remote sense leads. The advantage of remote sensing over local sensing is that when the remote sense leads are connected to the cell, the actual voltage of the cell will be measured. Any voltage drops in the load leads will not affect the measurement. Refer to chapter 2 under Remote Sensing for more information.

---

**NOTE:** If your Agilent MCCD system is configured for local sensing, the measured output voltage may not reflect the actual voltage at the cell. This is because any voltage drops in the wires due to wire resistance, probe resistance, connector resistance, etc. will reduce the available voltage at the cell.

---

### Current Measurements

The Agilent MCCD measures actual current in the output current path for each channel using a calibrated internal measurement circuit.

## 1 - General Information

### Capacity Measurements

**Amp-hour capacity** - the Agilent MCCD determines amp-hour cell capacity by making calculations based on continuous current measurements.

During charge, every time the Agilent MCCD makes a measurement, it calculates the actual incremental amp-hours put into the cell during each measurement interval by multiplying the measured current times the measurement interval. It then adds this incremental amount to the accumulated amp-hour value to determine the total amp-hours delivered into the cell. Amp-hour capacity will be positive during charge. Thus, accurate amp-hour capacity measurements can be made even when charge current is not constant, such as during constant voltage charging.

During discharge, every time the Agilent MCCD makes a measurement, it calculates the actual incremental amp-hours taken out of the cell by multiplying the measured current times the measurement interval. It then adds this incremental amount to the accumulated amp-hour value to determine the total amp-hours removed from the cell. Amp-hour capacity will be negative during discharge. Thus, accurate amp-hour capacity measurements can be made even when discharge current is not constant.

**Watt-hour capacity** - the Agilent MCCD determines watt-hour cell capacity by making calculations based on continuous current *and* voltage measurements.

During charge, every time the Agilent MCCD makes a measurement, it calculates the actual incremental watt-hours put into the cell during each measurement interval by multiplying the measured current times the measured voltage times the measurement interval. It then adds this incremental amount to the accumulated watt-hour value to determine the total watt-hours delivered into the cell. Watt-hour capacity will be positive during charge. Thus, accurate watt-hour capacity measurements can be made even when charge current and voltage is varying.

During discharge, every time the Agilent MCCD makes a measurement, it calculates the actual incremental watt-hours taken from the cell during each measurement interval by multiplying the measured current times the measured voltage times the measurement interval. It then adds this incremental amount to the accumulated watt-hour value to determine the total watt-hours taken from the cell. Watt-hour capacity will be negative during discharge. Thus, accurate watt-hour capacity measurements can be made even when discharge current and voltage is varying.

### Cell Resistance

In addition to continuous voltage, current, and capacity measurements, the Agilent MCCD can also measure ac and dc cell resistance. This measurement is available on command when a sequence is not running, or as its own step in the forming sequence.

The Agilent MCCD measures the ac cell resistance by first disconnecting the charge/discharge circuits from all cells. An ac waveform generator in the Agilent MCCD mainframe is connected sequentially to each cell. The ac waveform generator momentarily passes a small excitation current through each cell while the measurement system measures the cell's output voltage and current. By using a narrow band tuned filter and computing the magnitude and phase angle of voltage relative to current, an ac resistance measurement of the cell can be made. This method is very similar to the method used by LCR meters. Since this measurement happens sequentially for each channel, the other channels stay at rest during this test.



The Agilent MCCD measures the dc cell resistance by first disconnecting the charge/discharge circuits from all cells. A pulse generator in the Agilent MCCD mainframe is connected sequentially to each cell. The pulse generator passes a short-duration pulsed current through each cell while the measurement system digitizes the cell voltage and current using a high accuracy, high-speed A/D converter. Using proprietary algorithms to calculate the change in voltage relative to the change in pulsed current, a dc (or pulse) resistance measurement of the cell can be made. Since this measurement happens sequentially for each channel, the other channels stay at rest during this test.

## Probe Resistance

Probe resistance measurements can also be performed. The Agilent MCCD uses the remote sense to measure the resistance of both the power and sense probes. Probe resistance measurements can be made on command when a sequence is not running.

The measured probe resistance is the total resistance in the signal path, which includes wiring resistance, probe resistance, and the resistance of any connectors in the signal path. For the sense probe measurement, the resistance measurement includes the internal scanner resistance, which is typically 1000 ohms. The power and sense probe measurements return the actual measured value in ohms.

In addition to the on-command probe resistance measurements, the probes are continuously checked while the sequence is running. See chapter 5 under “Probe Check” for more information about probe check verification.

---

## Data Logging

During a charge/discharge sequence, the Agilent MCCD is constantly making voltage, current, and capacity measurements. Instead of logging each and every measurement into a data buffer, the data logging can be controlled so that only critical measurements are logged to the data buffer. This is called event-based data logging, which means that whenever an important event occurs, a data log record will be written into the data buffer. Buffer memory is used most efficiently when only critical measurements are stored.

The following events can be used to trigger critical measurements:

- |  |   |
|--|---|
| <b>Change in voltage</b><br>( $\Delta V$ ) | If the trigger is $\Delta V$ , a data log record will be written to the buffer when a user-specified voltage change is exceeded. If $\Delta V$ is set to 100 mV, then each time the voltage reading changes by more than 100 mV, a record is written to the buffer.       |
| <b>Change in current</b><br>( $\Delta I$ ) | If the trigger is $\Delta I$ , a data log record will be written to the buffer when a user-specified current change is exceeded. If $\Delta I$ is set to 100 mA, then each time the current reading changes by more than 100 mA a record is written to the buffer.        |
| <b>Change in time</b><br>( $\Delta t$ )    | If the trigger is $\Delta t$ , a data log record will be written to the buffer when a user-specified time interval is exceeded. If $\Delta t$ is set to 1 second, then every second a record is written to the buffer. $\Delta t$ is effectively a clock-driven data log. |

The acceptable range of values for  $\Delta V$ ,  $\Delta I$  and  $\Delta t$  are 0 to infinity. Setting the value to 0 or near 0 will cause all readings to be logged in the buffer, because every reading will exceed the  $\Delta V$ ,  $\Delta I$  or  $\Delta t$  value of zero. This will fill up the measurement log very quickly. Setting the value to a high number or to infinity will cause no readings to be logged in the buffer because no reading will exceed the  $\Delta V$ ,  $\Delta I$  or  $\Delta t$  value.

## 1 - General Information

The comparison test to see if the  $\Delta V$ ,  $\Delta I$ , and  $\Delta t$  values have been exceeded is done at the end of each measurement interval, so the fastest rate at which records can be written into the data buffer is the measurement rate of the Agilent MCCD. Any combination of events can be specified, so that a data log record is written into the data buffer when any of the events occur.

Each record in the data buffer contains the following information: status (including CV/CC and step number), elapsed time, voltage, current, amp-hours, and watt-hours. The total number of readings that can be stored is given in the specification table. The data log is a circular queue, which lets you continuously log data into the data buffer. When the data buffer is full, the oldest data in the buffer will be overwritten by new data. To avoid data loss, the controller must read the data from the buffer before it is overwritten. Data can be read out of the data buffer at any time during the test sequence.

---

**NOTE:** Information in the data buffer is lost when an ac power failure occurs. To prevent data loss in the event of a power failure, use the cfShutdown function to save the data in non-volatile memory. Refer to Power Fail Operation in chapter 5 for more information. To allow the Agilent E4370A to ride through temporary ac power interruptions, connect the mainframe to a 600 VA uninterruptible power supply (UPS).

---

A measurement log utility is included in the software that is provided with the Agilent E4373A Documentation package. You can use this utility to read the data log and place the information in a file on your PC. For information on how to use the Agilent MCCD Measurement Log Utility, refer to chapter 4.

---

## Protection Features

The Agilent MCCD provides extensive capability to protect both the hardware and the individual cells being formed from catastrophic damage. The Agilent MCCD can also communicate its protection status to other parts of the manufacturing system for more sophisticated forms of protection.

### Internal Protection Functions

There are internal relays between the power bus and the Agilent E4374A Charge/Discharge cards. These relays protect the Agilent MCCD from overvoltage and undervoltage conditions on the power bus. They also protect the Agilent MCCD if an external fault condition is detected. Output regulators include several features to protect the cell from failures in the hardware. Internal circuits connected in series with each channel protect the system from reverse cell polarity, cell failure, and regulator failure. Internal thermal sensors check for maximum heat rise to avoid failures due to excessive temperature excursions. A fan keeps the internal temperature at an acceptable level.

Finally, the Agilent MCCD has an extra level of safety - a built-in hardware watchdog timer. The hardware watchdog timer is independent of CPU, software, or firmware activities. If, due to some internal firmware or software fault, the CPU in the Agilent MCCD should stop functioning for more than a few seconds, the hardware watchdog timer will reset the Agilent MCCD to the power-on state. In this state, the channels outputs are disconnected from the cells.

---

**NOTE:** Overvoltage and overcurrent tests can be included as part of a test sequence to implement overvoltage and overcurrent protection (see chapter 5).

---

## External Digital I/O Protection Functions

The Digital I/O subsystem on the Agilent MCCD can be configured to provide protection capabilities. These digital I/O signals operate independently, so that if there is a problem with the computer or the LAN connection the protection functions of the Agilent MCCD are not compromised. As explained in chapter 2, the 16 digital I/O signals can be individually configured to provide one of the following protection functions:

<b>External Fault Input</b>	This function can be used to stop the cell forming sequence if an external fault condition sets the input true.
<b>External Fault Output</b>	This function can be used to signal external circuitry or another Agilent MCCD that either an external fault condition or an internal fault condition has occurred.
<b>External Interlock</b>	This function can be used to stop the cell forming sequence for reasons other than an external fault condition.
<b>External Trigger</b>	This function can be used to start a cell forming sequence.

In addition to protection capabilities, the digital I/O can also be used as general purpose I/O. When configured as a general purpose I/O, the input or output signals on the digital connector are directly controlled with API programming commands over the LAN.

## If AC Power Fails

Should the ac line fail, the CPU in the Agilent MCCD will shut down. Any charging and discharging activity will stop, and the current sequence, test data, and programmed settings will be lost.

---

**Note:** A 600 VA uninterruptible power supply (UPS) can be used to provide ac power to the Agilent E4370A MCCD mainframe to prevent any data loss during a power failure.

---

When power fails, the power bus is also disconnected from the Agilent MCCD because of the bias powered relays inside the Agilent MCCD. Thus, should a power failure occur which causes the Agilent MCCD to lose ac power, in order to provide for safety, these internal relays would be disengaged and any further charging or discharging would stop, even if the power bus were still powered and active.

Also, should a power failure occur which does not effect the Agilent MCCD but which causes the power bus to drop in voltage, this will be detected by the Agilent MCCD as a power bus undervoltage condition and the relays will open, thus preventing any further charging or discharging of connected cells.

---

## Remote Programming Interface

The remote programming interface to the Agilent MCCD is through a LAN-based TCP/IP communication protocol. The connection to the LAN is through a standard 8-pin 10Base-T connector on the rear panel, which must first be configured according to the directions in chapter 3. The LAN communication protocol is implemented in two ways:

## 1 - General Information

### Application Programming Interface (API)

The application programming interface runs under Windows 95 or Windows NT 4.0 using supplied C-language function calls. These function calls are documented in chapters 5 and 6, and provide the most comprehensive method of controlling the Agilent MCCD. The API interface is the preferred method of control when the Agilent MCCD is connected to a remote computer as part of an automated manufacturing process.

### Web Accessible Agilent MCCD User Interface

The Agilent MCCD has a built-in web server with a graphical user interface that is accessed through standard web browsers such as Netscape Navigator version 3.03 or Microsoft Internet Explorer version 3.02. This Agilent MCCD User Interface allows monitoring of individual cell state, measuring cell voltages and currents while the test is running, and also complete monitoring and control of test status. The Agilent MCCD User Interface is the preferred method of control when evaluating the test system, prototyping a process, or debugging a program.

---

## Example of a Cell Forming Process

The Agilent E4370A MCCD is designed to be the integral part of a complete cell forming process as shown in Figure 1-7. As shown in the figure, many of the previously mentioned protection and external signal capabilities of the Agilent E4370A MCCD are implemented using the digital I/O connections. The serial ports on the back of the Agilent MCCD are used to control local peripherals directly from the host computer. The remote programming interface to the Agilent MCCD lets you seamlessly integrate all of these capabilities into the cell forming process.

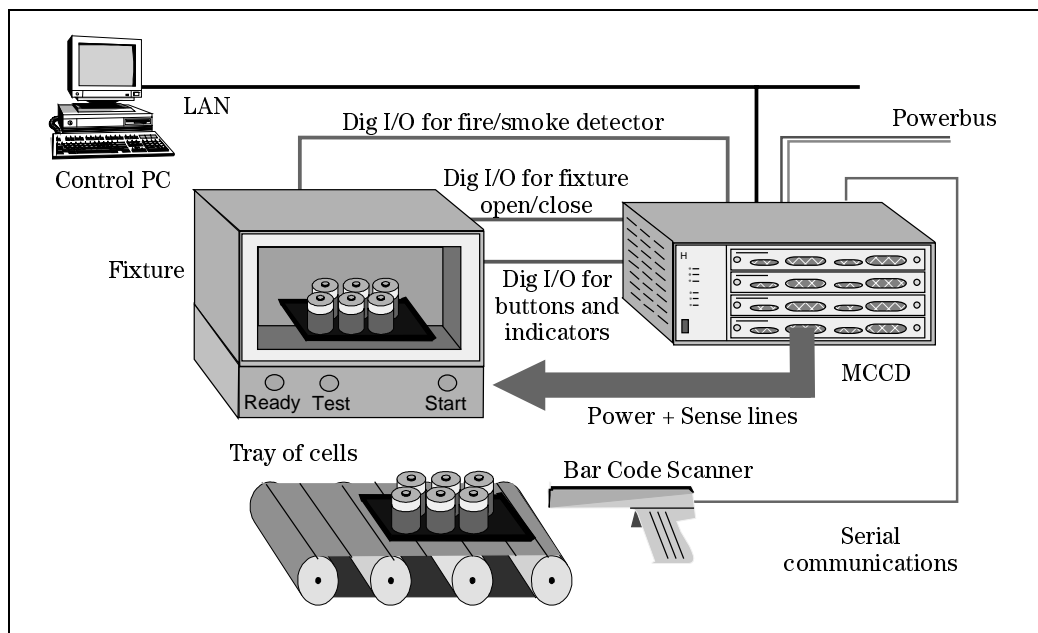

**Figure 1-7. Typical Cell Forming Station**

The following cell forming example describes how an Agilent E4370A MCCD may be used to run a semi-automated process where the only human actions required are: entering data with a barcode

scanner, loading and unloading a test fixture, and manually starting the cell forming process. Chapters 5 and 6 describe all of the function calls that are available to implement a cell forming process.

- ◆ The control PC sends a signal via the LAN to the digital I/O to turn on the Ready light on the test fixture. This tells the operator that the system is ready for another tray of cells. The control PC also begins polling for serial data on the RS-232 buffer of the Agilent MCCD.
- ◆ The operator scans the bar code on the tray of cells sitting on the conveyor belt. The operator then loads the tray into the test fixture and closes the fixture.
- ◆ After detecting that data is available on the RS-232 buffer, the control PC reads the bar code data. Based on the data, it downloads the correct forming sequence into the Agilent MCCD. It also downloads setup information such as which channel outputs to enable, probe check settings, trigger source, etc.
- ◆ The control PC then polls the digital I/O lines for the Start button.
- ◆ When the operator presses Start, the control PC detects it and polls the digital I/O lines to make sure the fixture is closed. It sends a signal to turn off the Ready light and turn on the Test light, indicating to the operator that the cell forming sequence has started.
- ◆ The control PC then sends a trigger to the Agilent MCCD to start the forming sequence. It also starts polling the instrument status for the completion of the test sequence.
- ◆ The cell forming sequence runs. The test sequence automatically applies a stimulus to the cells, monitors cell parameters to determine if a cell passes or fails, and stores the test results. During the test sequence, the Agilent MCCD monitors the dedicated digital I/O lines that are connected to the fire and smoke detectors. This allows rapid response in case of a problem.
- ◆ When the instrument status in the Agilent MCCD shows that the sequence is complete, the control PC sends commands to the Agilent MCCD to measure the internal resistance of all cells and then upload all measurement data.
- ◆ Finally, the control PC sends a signal to turn off the Test light and light the Ready light. The operator knows that it is now safe to remove the tray from the fixture and start another batch.

Chapter 7 contains several programming examples written in C. The purpose of these examples is to show you how to implement the various functions of the Agilent MCCD so that you can develop your own application programs. Program #2 matches the example described here.



## Installation

---

### Inspection

When you receive your equipment, inspect it for any obvious damage that may have occurred during shipment. If there is damage, notify the shipping carrier and the nearest Agilent Sales and Support Office immediately. The list of Agilent Technologies Sales and Support Offices is at the back of this guide. Warranty information is printed in the front of this guide.

Until you have checked out the Agilent MCCD, save the shipping carton and packing materials in case the unit has to be returned. If you return the Agilent MCCD for service, attach a tag identifying the model number, serial number, and the owner. Also include a brief description of the problem.

---

### Parts and Accessories

Table 2-1 lists items that are included with your Agilent E4370A/E4374A MCCD.

Table 2-2 lists accessory items that are not included with the Agilent E4370A/E4374A MCCD, but must be purchased separately. Except for the User's Guide, all of these items are required to make connections from the Agilent MCCD to either the computer, test fixture, or external devices that will be controlled by the Agilent MCCD.

You can either order these items by ordering the appropriate kit, or order them directly from the manufacturer. Table 2-3 lists the addresses of the manufacturers of the connector parts.

**Table 2-1. Supplied Items**

Item	Part Number	Description
Power Cord (1)	Contact your Agilent Sales and Support office	A power cord appropriate for your location.

**Table 2-2. Accessories**

Item	Manufacturer's Part Number	Description
Digital connectors (2)	Phoenix MSTB-2.5/10-STF	10-pin terminal plugs that connect to the digital connectors on the back of the unit.
Calibration connector (1) Auxiliary bias connector (1)	Phoenix MSTB-2.5/4-ST	4-pin terminal plugs that connect to the calibration and auxiliary connectors on the back of the unit.

## 2 - Installation

**Table 2-2. Accessories (continued)**

<b>Item</b>	<b>Manufacturer's Part Number</b>	<b>Description</b>
Documentation Package	Agilent E4373A	Contains user documentation, software drivers, and utility programs .
Serial cable	Agilent 34398A	RS-232 null-modem cable for port A or B. (see figure 2-4 for schematic)
37-pin D-sub connector	AMP 205210-2	Mating connector for Agilent E4374A front panel channel connectors. Eight connectors are required for each Agilent E4374A card. (Connector pins on Agilent E4374A cards are rated at 5 A maximum.)
Connector hood for 37-pin connector	AMP 749916-2	Eight connector hoods are required for each Agilent E4374A card.
Crimp style contacts for 37-pin connector	AMP 66506-9	Crimp contact for 37 pin connector 16 contacts are required for each connector. (Pins only accept wires sized 20-24 AWG.)
Crimp tool for crimp style contacts	AMP 58448-2	Hand crimp tool
Solder style contacts for 37-pin connector	AMP 66570-2	Crimp contact for 37 pin connector 16 contacts are required for each connector. No tooling is required. (Pins only accept wires sized 18 AWG.)
Front Panel Filler Panel	Agilent p/n 5002-1505	One blank filler panel is required for every empty slot in Agilent MCCD mainframes.
Rack mount Flange Kit	Agilent p/n 5062-3979	Includes 2 flanges, fasteners, and mounting screws
Rack mount Flange Kit with Handles	Agilent p/n 5062-3985	Includes 2 handles, 2 flanges, fasteners, and mounting screws

**Table 2-3. Manufacturer's Addresses**

<b>Company</b>	<b>Address</b>	<b>Contact</b>
Phoenix Contact	P.O. Box 4100 Harrisburg, PA 17111-0100	Phone:717-944-1300 Fax: 717-944-1625 <a href="http://www.phoenixcontact.com/index.html">http://www.phoenixcontact.com/index.html</a>
AMP	Harrisburg, PA 17111	<a href="http://www.amp.com/">http://www.amp.com/</a>
Agilent Technologies	See list at back of this manual	<a href="http://www.agilent.com/">http://www.agilent.com/</a>



---

## Location

### Agilent E4370A MCCD Mainframe

The outline diagrams in Appendix C give the dimensions of your Agilent MCCD mainframe. The mainframe may be installed free-standing, but must be located with sufficient space at the sides and back of the unit for adequate air circulation. You can rack mount the mainframe in standard 600 mm (23.8 in.) width system cabinets. This provides sufficient clearance for airflow. Support rails are also required when rack mounting the mainframe. These are usually ordered along with the cabinet.

A fan cools the Agilent MCCD mainframe by drawing air in on the left side of the unit and discharging it through the back and side. Minimum clearance is 9 cm (3.5 inches) along the sides. Minimum clearance behind the mainframe is 23 cm (9 inches). **Do not block the fan exhaust at the rear or the side.**

---

**NOTE:** To ensure proper cooling of the Agilent MCCD mainframe, there should be no open slots in the front of the mainframe. If an Agilent E4374A Charger/Discharger Card is either not installed or has been removed from a slot, a blank filler panel must be installed in the opening. Refer to Table 2-2.

---

### Agilent E4371A Powerbus Load

---

**CAUTION:** To ensure adequate airflow to cool the Agilent Powerbus Load requires you to leave 0.6 meters (2 feet) of open space in front of the load and directly behind the load. If you are rack-mounting the load, leave the rack door off.

When discharging its maximum rated power, the Agilent E4371A Powerbus Load becomes hot to the touch.

---

The outline diagrams in Appendix C give the dimensions of your Agilent Powerbus Load. The unit may be installed free-standing, but must be located with sufficient space at the front and back of the unit for adequate air circulation. Fans cool the unit by drawing air in on front and discharging it through the back. Maximum airflow is 10 cubic meters per minute (350 cubic feet per minute).

You can rack mount the Agilent E4371A Powerbus Load in standard 600 mm (23.8 in.) width system cabinets, provided that you remove the rear door. This provides sufficient clearance for airflow. Rack mount kits are described in Table 2-2. Support rails are required when rack mounting the unit. To meet safety requirements, connect the ground terminal of the Agilent Powerbus load to the ground terminal of the external dc source.

---

## Channel Connections

Each Agilent E4370A MCCD mainframe can control up to 256 individual charge/discharge cells when four Agilent E4374A Charger/Discharger cards are installed. Each Agilent E4374A Charger/Discharger contains 64 channels. Note that in the programming sections of this manual, channels are also referred to as outputs. When fully loaded, the 256 charge/discharge channels are configured as follows:

## 2 - Installation

**Table 2-4. Channel Configuration**

Card Number	Connector Number							
	1	2	3	4	5	6	7	8
1	1 - 8	9 - 16	17 - 24	25 - 32	33 - 40	41 - 48	49 - 56	57 - 64
2	65 - 72	73 - 80	81 - 88	89 - 96	97 - 104	105 - 112	113 - 120	121 - 128
3	129 - 136	137 - 144	145 - 152	153 - 160	161 - 168	169 - 176	177 - 184	185 - 192
4	193 - 200	201 - 208	209 - 216	217 - 224	225 - 232	233 - 240	241 - 248	249 - 256

Power connections on each Agilent E4374A card are through eight 37 pin D-subminiature connectors. These connectors allow for shielding and strain relief. Corresponding sense connections are also available on the connectors. Refer to Table 2-2 for information about ordering the mating connectors. As indicated in the table, mating connectors accept wire sizes from AWG 24 up to AWG 18, depending on the type of connector that you are using. You must wire up the mating connector to make your wire connections. Install the mating connector on the front of the Agilent E4374A card when complete. Refer to Appendix D for detailed pinout assignments of the front panel connectors.

If specific channels are not being used, you can configure them to be inactive. Inactive channels are open-circuited. Note that there are two ways to configure the channel outputs, each having different effects when the unit is powered on.

- ◆ If you configure the channel outputs using the `cfSetOutputConfig()` function (see chapter 6), the settings are NOT saved in non-volatile memory. Each time you power up the unit, you must reprogram the settings.
- ◆ If you configure the channel outputs using the Sequence setup page in the Agilent MCCD User interface (see chapter 4), the settings ARE saved in non-volatile memory. The unit will wake up with those settings when it powered up.

---

**NOTE:** If the mainframe has empty card slots, the channels that are normally reserved for those card slots will be treated as inactive channels.

---

### Voltage Drops and Wire Resistance

---

**NOTE:** Each channel has a maximum of 5.5V and 2A available at the power connector. At the rated output, the Agilent E4374A Charger/Discharger will tolerate up to a 0.5 volt drop in the load leads due to wire resistance, probe resistance, connector resistance, etc. Higher voltage drops will reduce the available voltage at the cell. Proper wiring design including using larger gauge wires and low-resistance fixture contacts can minimize voltage losses in the wiring and maximize the available voltage for charging the cells.

---

The length of the leads from the power connector to the cells is determined by how much voltage drop your system can tolerate. The voltage drop is directly determined by the wire, connector, and probe resistance (see table 2-5). Refer to Remote Sense Connections for more information.

To optimize performance and minimize the possibility of output instability and output noise, please observe the following guidelines:

- ◆ It is good engineering practice to either twist or shield the sense and power wires.
- ◆ Twist the power wires together and keep them as short as possible.
- ◆ Twist the sense wires together but do not twist them together with the power wires.
- ◆ If possible, shield the sense wires. Connect the shield to the case.
- ◆ Keep the total cable length as short as possible.
- ◆ Use low resistance fixture contacts.

## Remote Sense Connections

The sense connections provide remote sense capability at the fixture. Sense connections on each card are through the same connectors that house the power connections.

Remote sensing allows the output voltages to be sensed at the cell, thus compensating for any losses in the wiring. On the Agilent E4374A cards, the compliance voltage (the voltage that the Agilent MCCD can provide in excess of the programmable rating) can be up to 5.5 volts to compensate for any IR voltage drop in the wiring between the channel output and the cell connections. This higher compliance voltage allows the full 5 V to be applied directly to the cell with a maximum of 0.5 volt loss in the wiring. If the charging voltage at the lithium ion cell is between 4.0 and 4.1 volts, the higher compliance voltage can compensate for a maximum of 1.4 volt to 1.5 volt loss in the wiring.

The following table gives the resistance values of various wire sizes so that you can calculate the voltage drops for various wire lengths and diameters. Larger and shorter wires result in lower voltage drops. The table also gives the maximum wire that limit the voltage drop to 1.4 volts with a maximum current of 2A. (1.4 volts is the difference between the 5.5 compliance voltage available at the power connector and the 4.1 volts required to charge a typical lithium ion cell.)

**Table 2-5. Resistance of Stranded Copper Conductors**

AWG No.	mm <sup>2</sup>	Resistance (at 20 deg. C)		Maximum length in meters to limit Voltage drop to 1.4 V @ 2A (total length of + and - leads)
		Ω/m	Ω/ft	
18	0.825	0.022	0.0066	30
20	0.519	0.034	0.0105	20
22	0.324	0.055	0.0169	12
24	0.205	0.087	0.0267	8

As an example, assume that you are using AWG #24 wire for your power connections and your charging voltage is 4.1 volts at 2 amperes. Using this diameter wire and assuming a maximum current of 2 amperes, the maximum distance from the power connector to the cell is limited to about 4 meters. This is because with a total wire length of 8 meters for both the + and – power leads, the maximum voltage drop in the wiring is 1.4 volts (2A X 0.7Ω). With a charging voltage of 4.1 volts required at the cell and a compliance voltage of 5.5 volts, this is the maximum voltage drop that the Agilent MCCD can tolerate.

---

**NOTE:** This example does not account for any additional lead path resistance that may be present such as fixture contact resistance, or fixture relays. If additional resistance is present, lead length must be reduced yet further.

---

---

## Power Bus Connections

---

**CAUTION:** Observe polarity when making the power bus connections to both the Agilent MCCD mainframe and the Agilent Powerbus Load. Reversed polarity connections will result in damage to both the Agilent MCCD mainframe and the Agilent Powerbus load. **The negative (–) bus bar on the Agilent MCCD mainframe is connected to chassis ground.**

---

Connections to the power bus are made via + and – bus bars on the back of the Agilent E4370A MCCD mainframe and Agilent E4371A Powerbus Load units. These bus bars let you interconnect multiple mainframes, external power sources, and other loads. Bus bars have mounting holes that accept 7 mm diameter bolts.

---

**NOTE:** Fasten a suitable terminal lug to each power bus cable. Do not connect bare wires directly to the bus bars. Stranded cables with more and smaller diameter wires are easier to work with than cables with fewer and large diameter wires.

---

When making your power connections you can use discrete terminated wires, bus bars, or combinations of both. For proper operation all power bus configurations should have minimum loop area for low magnetic radiation and should be kept away from CRTs. The following guidelines may be helpful in deciding whether to use wires or bus bars.

### Discrete terminated wires:

- ◆ Are the better solution for connecting to individual units and the total current carrying requirements are 120 A or less.
- ◆ Have minimal alignment, insulation or routing problems.
- ◆ Are preferred for small cell charging systems.

### Bus bars:

- ◆ Are the better solution for high current carrying requirements.
  - ◆ Can be custom designed or purchased; can use standard high current building parts.
  - ◆ Use nuts and bolts or self tapped holes for connections.
  - ◆ Require careful surface preparation and cleaning at connection points.
- 

**WARNING** *ENERGY HAZARD.* If high current power bus connections touch, severe arcing may occur - resulting in burns, ignition, or welding of parts. Do not attempt to make any connections to the power bus when the power bus is live.

---

## Power Bus Wiring Information

The following table provides information about the resistance and ampacity of several standard wire sizes that may be suitable for power bus connections. This information is important because the resistance of the power bus wiring will cause a voltage drop in the power bus wires. If the voltage drop is large enough, it may prevent the Agilent E4370A MCCD mainframe from operating correctly in charging mode, or the Agilent E4371A Powerbus Load from operating correctly in discharging mode.

**Table 2-6. Ampacity and Resistance of Stranded Copper Conductors**

AWG No.	Area in mm <sup>2</sup>	Ampacity	Resistance in Ω/meter	Resistance in Ω/feet	Notes
10	5.26	40	0.00327	0.00099	1. Wire ampacities are based on 30° C ambient temperature with conductor rated at 60° C. 2. Resistance is nominal at 20° C wire temperature.
8	8.36	60	0.00206	0.00062	
6	13.3	80	0.00129	0.00039	
4	21.1	105	0.00081	0.00025	
2	33.6	140	0.00051	0.000156	
1/0	53.5	195	0.00032	0.000098	
2/0	67.4	225	0.00025	0.000078	
3/0	85.0	260	0.00020	0.000062	
4/0	107	300	0.00016	0.000049	

Figure 2-1 illustrates two typical power bus configurations consisting of two Agilent E4370A MCCD mainframes connected to one Agilent E4371A Powerbus Load and two external dc power supplies. As shown in the figure, current requirements may vary widely based on the way the equipment is connected to the power bus.

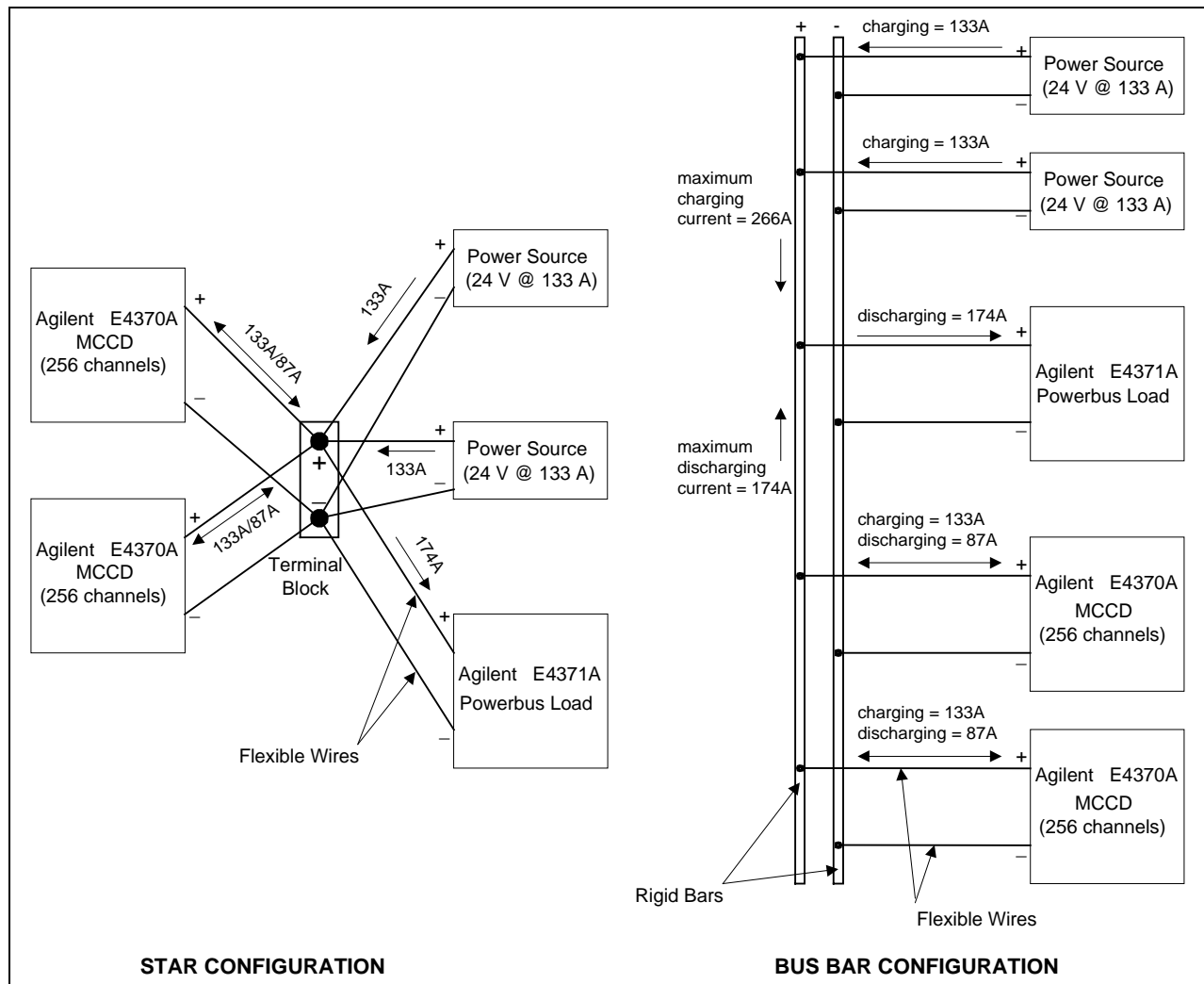

**Figure 2-1. Typical Power Bus Configurations**

## 2 - Installation

The star configuration on the left is designed so that each section of the power bus carries no more current than the rating of the equipment that it is connected to. This configuration lets you use longer lead lengths because the voltage drop in each lead is directly related to the amount of current flowing in the lead. However, this configuration requires you to run separate leads from each Agilent MCCD mainframe to the load as well as the power supply, thus increasing the total amount of wiring required.

The bus bar configuration on the right is designed to minimize the amount of wiring between the equipment. However this requires larger diameter wires or bus bars. This is because the leads from the power supplies as well as the leads to the load are required to carry the full charging and discharging current for two Agilent E4370A MCCD mainframes. Larger currents result in larger voltage drops in the wiring, which may prove unacceptable with long lead lengths.

### Charging Mode Guidelines:

Power bus wires must be capable of handling the full charging current requirements of all Agilent E4370A MCCD units connected to the power bus. In the example that follows, the calculations are for worst case current requirements. Calculate the input current requirement of one fully loaded Agilent E4370A MCCD as follows:

1. Multiply the power used by one cell times the number of cells in the Agilent MCCD. Divide the result by the efficiency of the unit to determine the total input power required for that mainframe. The efficiency of the unit in charging mode is assumed to be 80%, which is a worst-case value as far as calculating the total power required by the mainframe.

$$\frac{\# \text{ of cells} \times \text{power per cell}}{0.8} = \text{Max\_power\_in}$$

2. Divide the input power requirements of the Agilent MCCD by the minimum voltage required at the input terminals of the Agilent MCCD. The result will be the maximum charging current required by the Agilent MCCD. (Double this current if you are simultaneously charging two Agilent MCCD mainframes as illustrated in Figure 2-1.)

$$\frac{\text{Max\_power\_in}}{\text{Power\_source\_voltage}} = \text{Max\_powerbus\_current}$$

3. Determine the voltage drop that the maximum current will produce in the power bus leads using the resistance values in Table 2-6.
4. Add this voltage drop to the minimum voltage required at the input terminals of the Agilent MCCD to determine the output voltage setting of the dc power supply.
5. The voltage at the input terminals of the Agilent MCCD during charging mode must be between 25.2 and 22.8 volts. If the sum of the voltage drops in both the + and – power bus leads causes the voltage at the mainframe power terminals to drop below 22.8 volts, the Agilent E4370A MCCD will shut down due to an undervoltage condition. Use a larger size wire to reduce the voltage drop.

### Discharging Mode Guidelines:

Power bus wires must also be capable of handling the full discharging current requirements of all Agilent E4370A MCCD units connected to the power bus. In the example that follows, the calculations are also for worst case current requirements. Calculate the output current of one fully loaded Agilent E4370A MCCD as follows:

1. Multiply the power generated by one cell times the number of cells in the Agilent MCCD. Divide the result by the efficiency of the unit to determine the total output power produced by that mainframe. The efficiency of the unit in discharging mode is assumed to be 100% which is a worst-case value as far as calculating the total power that is generated by the mainframe.

$$\frac{\# \text{ of cells} \times \text{power per cell}}{1.0} = \text{Max\_power\_out}$$

2. Divide the power generated by the Agilent MCCD by the input voltage of the Agilent Powerbus Load. At an input voltage of 26.5 volts, the result will be the maximum discharging current that will be absorbed by the Agilent Powerbus Load. (Double this current if you are simultaneously discharging two Agilent MCCD mainframes as illustrated in Figure 2-5.)

$$\frac{\text{Max\_power\_out}}{26.5} = \text{Max\_powerbus\_current}$$

3. Determine the voltage drop that the maximum current will produce in the power bus leads using the resistance values in Table 2-6.
4. ***The sum of the voltage drops in both the + and – power bus leads cannot exceed 1.5V.*** If the voltage drop exceeds 1.5 volts in discharging mode, the Agilent MCCD will shut down due to an overvoltage condition at the mainframe terminals. Use a larger size wire to reduce the voltage drop.

---

## Digital Connections

Each Agilent E4370A MCCD mainframe has a 16-bit digital I/O port. Digital I/O configuration can be done with the Agilent MCCD Configuration Screens as described in chapter 3 or with the Agilent MCCD User Interface as described in chapter 4. All pins do not have to be configured the same. Some can be used as isolated outputs while others are single ended I/O. The functions can also be mixed, some pins can be general purpose I/O while others have a specific purpose. The polarity of a bit can also be configured as either high true or low true. The following list documents the types of digital I/O configurations:

### General Purpose I/O

General purpose I/O programs the digital I/O as a passthrough function that allow input or output signals on the digital connector to be directly controlled with API programming commands. These signals have no effect on the cell forming sequence.

- |                       |   |
|-----------------------|---|
| <b>Digital Output</b> | When configured as outputs, each line is driven by an internal open collector transistor. Output lines are capable of driving either TTL compatible inputs, or high power loads such as solenoids, indicator lights, and relays. These are 24 V/ 300mA compatible open-collector outputs. |
| <b>Digital Input</b>  | When configured as inputs, each line can be driven by an external source. All lines are TTL compatible inputs, with built in pull-ups to 5 V to facilitate contact and switch closure style inputs.   |
| <b>Digital InOut</b>  | When configured as in/out, each line can be used as both an input and an output. Programming the line high allows an external device to drive the line. Programming the line low drives the line low. Reading the line returns the actual state of the line.                              |

## 2 - Installation

**Isolated Output** When outputs are configured for optically isolated mode, they are open-collector outputs capable of sinking 1.6mA at 0.4V, and can be used up to 24V. Adjacent pin pairs starting with pin 0 are the plus and minus output of an optical isolator. This allows for up to 8 isolated outputs, on adjacent pin pairs 0-1, 2-3, 4-5 etc. Because these are dedicated pairs, pins 1 and 2 cannot be combined as an isolated output.

## Special Functions

**External Fault Input** When true, this signal stops the cell forming sequence due to an external fault condition. It also sets the external fault output signal true. This signal can be connected to a sensor such as a fire detector. It can also be connected to the external fault output of another Agilent MCCD so that it can respond to a fault in another mainframe.

**External Fault Output** This signal is asserted true when an external fault occurs. It can be connected to external equipment such as a fire alarm. It can also be connected to the external fault input of another mainframe so that a fault in one mainframe can shut down other mainframes. A cfProtectClear command clears this signal.

**External Interlock** When true, this signal stops the cell forming sequence, but because the stop was not due to a fault condition, it does **not** set the external fault output signal true. This level-sensitive signal can be connected to an external stop or pause switch to allow an operator or mechanical device to stop a cell forming sequence. When the signal is removed, the sequence continues.

**External Trigger** This external trigger input is used to start the cell forming sequence.

**Power Fail** Depending on how the system is configured, when true, this input signal will cause the Agilent MCCD to perform a shutdown, at which time it saves its state for a later restart. A power fail output signal is also available to indicate when the shutdown state has been saved.

## Wiring Guidelines

Connection for the 16 digital I/O signals are through two 10-pin Phoenix/Weidmuller style connectors. The connectors have screw terminals for making wire connections and are detachable. Digital I/O lines 0 through 7 are on connector 1; digital I/O lines 8 through 15 are on connector 2. There are two common terminals on each connector for ground or the return connection.

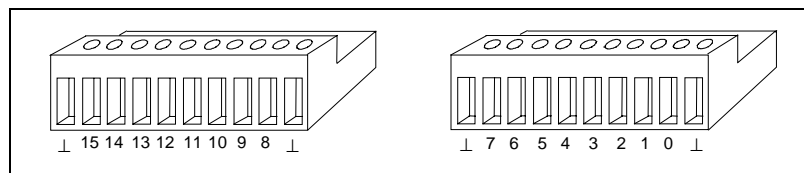

**Figure 2-2. Digital I/O Connections**

The following figure illustrates the internal circuits of the digital I/O connector. When used as a digital input (A), the external circuit connected to the digital input pin can be TTL, AS, CMOS, HC, or a simple switch that connects the digital input to the common terminal.



When used as a digital output (B) the external circuit connected to the output pin can also be TTL, AS, CMOS, HC or a warning light, provided the light has an external bias supply.

When used as isolated pairs (C), each pin pair can be connected to external circuits with the following restrictions: Only adjacent pairs can be used together. Only the even pin of each pair can be programmed to set the logic level as low true or high true. When Low True is programmed, the output is true when the pins are shorted. When High True is programmed, the output is true when the pins are open.

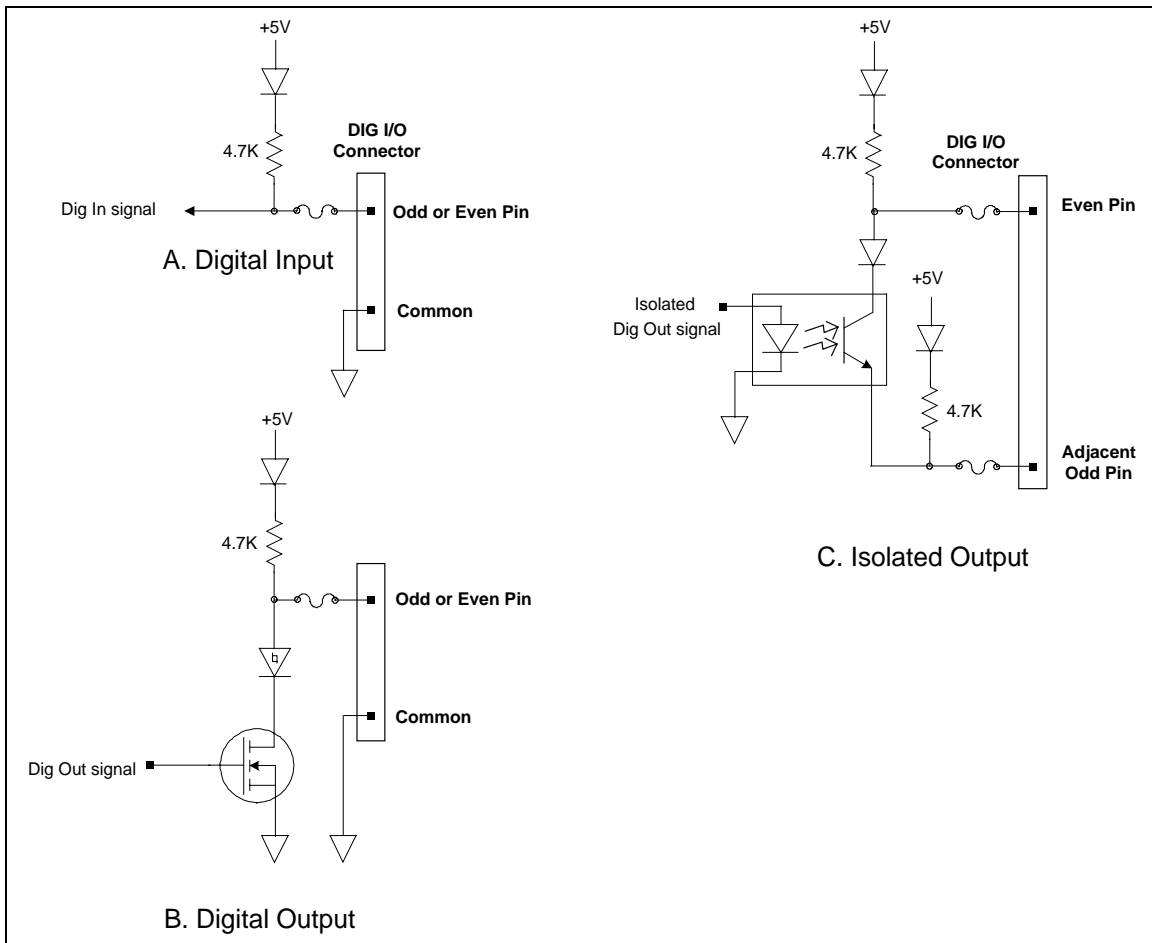

**Figure 2-3. Equivalent Digital I/O Circuits**

The following figure illustrates some typical DIO hardware connections.

## 2 - Installation

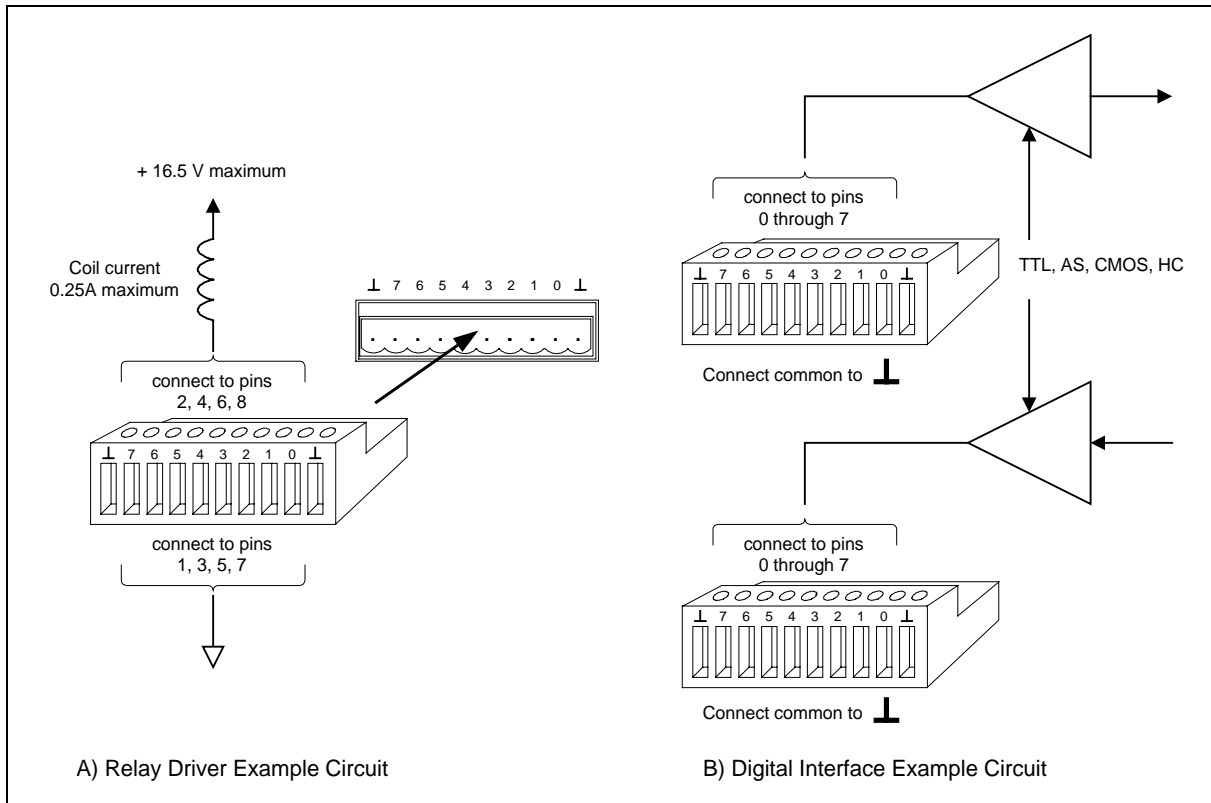

Figure 2-4. Typical Hardware Connections

## RS-232 Connections

The Agilent MCCD has two RS-232 ports for connection to local peripherals. Under normal operation both ports are available for general purpose communications and are configurable over the LAN. For initial configuration and calibration, the RS-232 ports are used as follows:

**Initial Configuration** RS-232 port B is connected to a terminal and used to access the Agilent MCCD Configuration Screens. This sets up the initial configuration.

**Calibration** RS-232 port B is connected to a terminal and used to access the Agilent MCCD Configuration Screens through which the calibration process is executed. RS-232 port A is used to connect a dedicated voltmeter for calibration.

Both ports should be configured with the same baud rate as the computer. Both ports support full hardware flow and software flow control with XON and XOFF support, and with RTS / CTS available for hardware control.

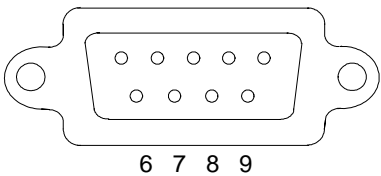
 <p>DB-9 male connector</p>	Pin	Input/Output	Description
	1		no connection
	2	Input	Receive Data (Rx)D
	3	Output	Transmit Data (Tx)D
	4		not used
	5	Common	Signal ground
	6		not used
	7	Output	Request to Send (RTS)
	8	Input	Clear to Send (CTS)
9		no connection	

**Figure 2-5. RS-232 A and B Connectors**

The following diagram describes the cable connections between the Agilent MCCD RS-232 ports and any local peripherals such as a PC or barcode scanner. Refer to table 2-2 for cable kit information.

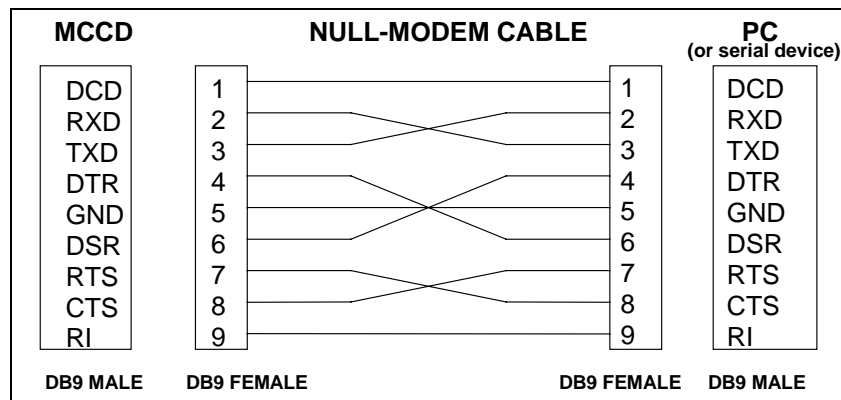

**Figure 2-6. Null-modem Cable Connections**

## Auxiliary Output Connection

An undedicated isolated auxiliary output is provided to power various actuators and circuits local to the test fixture. It can also be used as the pull-up source for any digital I/O connections that require an external pull-up source. The auxiliary output is available through a 4-pin Phoenix/Weidmuller style connector on the rear panel. The connector has screw terminals for making wire connections and is detachable.

As explained in chapter 3, the Agilent MCCD Configuration Screens let you set this output to between 5 volts and 24 volts in 0.1-volt increments. 10 Watts of total output power is available. The auxiliary output is isolated by up to 42 volts with respect to chassis common (earth ground).

---

## Installing the API Library and Measurement Log Utility

Software for the Agilent MCCD consists of the API library and a measurement utility. This software is provided with the Agilent E4373A Documentation package. You need to install this software to use the supplied C-language function calls to control the Agilent MCCD as part of a automated manufacturing process.

A setup program is provided on the disk to install the client API files and measurement utility on your PC. The setup program will create a new directory and a new windows program group. To install the software

1. Place Disk #1 in the A: drive of your computer and run A:SETUP.EXE.
2. Follow the directions on the screen to install the software. The default installation selections will install all files in the C:\hpmccd directory on your computer. It will also create an Agilent MCCD Client API and Measurement Log Utility program folder. You can change both of these default selections.

Refer to the README.TXT file installed in the \hpmccd directory for any updates. The following files are also included in the \hpmccd directory:

<b>mccdcfg.exe</b>	Lets you update the Agilent MCCD firmware from a Windows 95 or Windows NT client PC.
<b>mccdlog.exe</b>	Lets you transfer data from the Agilent MCCD's data log memory to a Windows 95 or Windows NT client PC.
<b>mccd.dll</b> <b>mccd.lib</b> <b>mccd.h</b>	Required files to develop a C programming client application.

Two example programs written in C are also installed on your PC in C:\hpmccd\c\samples.

Refer to chapter 4 for information on how to use the Agilent MCCD Measurement Log Utility.

### Visual C++ Configuration

To build an application using the Agilent MCCD API library, you must configure the Visual C++ development environment as follows:

1. Copy the mccd.dll, mccd.lib, and mccd.h files to the working project directory. (This can also be done when installing the library as previously described.)
2. In Visual C++ (4.x), you must add the mccd.lib library. To do this, in the Build menu, select Settings, then Object Modules, and then append the mccd.lib file.
3. Applications must include the mccd.h header file at the beginning of every file that contains calls to this library. To do this in your source files, #include "mccd.h".

## Configuration

---

### Configuring the LAN

The connection to the LAN is through a standard 8-pin 10Base-T connector on the rear panel, which must first be configured according to the directions in this section. Configuring the unit for LAN communications consist of three steps:

1. Configure the HyperTerminal program on your PC to communicate with the Agilent E4370A MCCD. The HyperTerminal program is provided on Windows 95 and Windows NT. Other ASCII terminals or terminal emulation programs will also work, provided that you configure the settings the same as for the HyperTerminal program.
2. Connect your PC to the RS-232 Port B connector on the back of the Agilent E4370A MCCD using a null-modem serial cable as described in Table 2-2 and Figure 2-5.
3. Fill out the screens that appear on the Agilent MCCD Configuration Screens.

---

**NOTE:** This procedure can also be used to calibrate the Agilent MCCD, configure the Digital I/O if it is not enabled over the LAN, and set the language options.

---

#### 1. Configure the HyperTerminal program

Access and configure the HyperTerminal program on your PC as follows:

<b>For Windows NT:</b>	Press the <b>Start</b> button and select : <b>Programs&gt; Accessories&gt; Hyperterminal&gt; HyperTerminal</b>
<b>For Windows 95:</b>	Press the <b>Start</b> button and select : <b>Programs&gt; Accessories&gt; Hyperterminal</b>  Next, double-click on the Hpertrm.exe icon in the HyperTerminal program group. If you are running HyperTerminal for the first time, fill in the location information. Because you are not using a modem, you do not need to enter a phone number.
In the <b>Connection Descriptions</b> box:	Type in a name and select an icon if desired. Then click OK.
In the <b>Connect To</b> box (Windows NT) or <b>Phone Number</b> box (Windows 95):	Go to the <b>Connect using</b> field and select either COM 1 or COM 2. This specifies a COM connector on the back of your computer. You will need to connect the RS-232 Port B on the back of the Agilent E4370A MCCD to the Com port that you select in this field. Then Click OK.

### 3 - Configuration

In the <b>COM Properties</b> box:	<p>select the following port settings:</p> <p>Bits per second    9600</p> <p>Data bits            8</p> <p>Parity                None</p> <p>Stop Bits            1</p> <p>Flow control        None</p> <p>Then click OK.</p>
In the <b>File</b> menu	Select the Properties command
In the <b>Properties</b> box:	<p>Select the Settings tab. Under Emulation, make sure that <b>Auto detect</b> is selected. Click the <b>ASCII Setup</b> button and make the following selections:</p> <p>Send line ends with line feeds            Not checked</p> <p>Echo Typed Characters locally            Checked</p> <p>Line delay                                    0</p> <p>Character delay                               0</p> <p>Append line feeds to incoming cone ends   Not checked</p> <p>Force incoming data to 7-bit ASCII       Not checked</p> <p>Wrap lines that exceed terminal width    Not checked</p> <p>Click OK to exit ASCII Setup.</p>
	Click OK to exit Properties

## 2. Connect the Agilent E4370A MCCD to the COM port on the PC

Connect the ac line cord to the LINE connector on the rear of the unit Agilent MCCD. This is a universal ac input that supports any line voltage from 87 Vac to 250 Vac, 50/60 Hz.

Turn on the Agilent MCCD.

If you have not already done so, connect the Agilent E4370A MCCD to the COM port on the PC. Connect the RS-232 cable from Port B on the back of the Agilent E4370A MCCD to the COM port on your computer that was specified using the HyperTerminal program.

Flip the Port B switch (#4) on the back of the Agilent E4370A down (from Normal to Configure).

Normal  
Configure



**Note:** Switches 1 through 3 must remain in the up position.

---

**NOTE:** The Agilent MCCD configuration program is active any time switch #4 is down. If you do not see the Agilent MCCD Configuration Screens on your PC, press the Enter key.

---

## 3. Fill Out the Agilent MCCD Configuration Screens

The following Agilent MCCD Configuration Screens should appear in the HyperTerminal window.

```

MCCD Configuration Screens

1) Network Configuration
2) Identification Configurations
3) Digital I/O Configuration
4) Perform Calibration
5) Miscellaneous Configuration

Type a number and press Enter

```

For now, you will only be accessing the **Network Configuration** and the **Identification Configuration** screens.

## Network Configuration

---

**NOTE:** The settings that you enter in this screen are determined by your network administrator.

---

In the Initial Screen, select 1 to configure your network. Select 1, 2, 3, or 4 to enter the IP address, Subnet Mask, Default gateway, or password.

```

Network Configuration

IP Address           000.000.000.000
Subnet Mask          000.000.000.000
Default Gateway      000.000.000.000
Network Password

1) To change IP Address
2) To change Subnet Mask
3) To change Default Gateway
4) To change Password

Type a number and press Enter or ctrl-G to return to initial screen

```

IP Address sets the IP address of the Agilent E4370A MCCD. It is in dotted decimal format.

The Subnet mask is the subnetwork that the Agilent E4370A MCCD is connected to. If it is set to 0 it is assumed that subnetting is not performed on this network.

The Default Gateway is the IP address of the gateway for the Agilent E4370A MCCD. This allows communication with a computer on a LAN other than the one to which the unit is connected.

### 3 - Configuration

The Agilent M CCD is shipped from the factory without a password being set. A network Password can be assigned to the Agilent E4370A M CCD to prevent unauthorized users from controlling the unit over the network. This is the same password that must be used when programming the Agilent M CCD using the API functions.

#### Identification Configuration

In the Initial Screen, select 2 to configure the identification of your Agilent M CCD. The information in this screen is for identification only. It is especially helpful when there are multiple Agilent M CCDs on the LAN. Fill in the Identification Configuration screen as follows:

Select 1, 2, or 3, to enter the unit name, location or other unit identification.

```
Identification Configuration
Unit Name           MyName
Unit Location       Third on left
Other ID            Identification000.000

1) To change Unit Name
2) To change Unit Location
3) To change Other ID

Type a number and press Enter or ctrl-G to return to initial screen
```

Unit Name is the network name assigned to the Agilent M CCD. The name must begin with a letter and end with either a letter or a number. Other characters in the name are limited to letters, numbers, periods, or hyphens.

Unit Location identifies the physical location of the Agilent M CCD. Only printable ASCII characters are allowed.

Other ID is any additional information that is required to identify this Agilent M CCD. Only printable ASCII characters are allowed. This could be used for the asset number, department name, production line, or other type of identification.



## Miscellaneous Configuration

In the Initial Screen, select 5 to configure the language used in the Agilent MCCD User Interface. You can choose between English and Japanese.

This screen also lets you program the auxiliary bias output on the back of the Agilent MCCD mainframe. The bias voltage can be programmed from 5 volts to 24 volts in 0.1 volt increments.

```
Miscellaneous Configuration
Web Page Language is presently ENGLISH
1) To Change Web Page language to English
2) To Change Web page language to Japanese

AUX Bias Supply voltage is 10.0000
3) Set Aux Bias Supply voltage

Type a number and press Enter or ctrl-G to return to initial screen
```

---

## Configuring the Digital I/O

Configuring the Digital I/O using Hyperterminal is provided as a convenience. You can also configure the Digital I/O using the Agilent MCCD User Interface or the API function calls over the LAN. Further information about the function of the Digital I/O lines is provided in chapter 6 under cfSetDigitalConfig.

To configure the Digital I/O using the HyperTerminal program on your PC, flip the Port B switch (#4) on the back of the Agilent E4370A down (from Normal to Configure) and run the HyperTerminal program as described in the beginning of this chapter. When the Agilent MCCD Configuration Screens appear, select 3 to configure the Digital I/O port of your Agilent MCCD mainframe.

Select 1 or 2 to either enable or disable Digital I/O configuration over the LAN. If you enable Digital I/O configuration, you will be able to configure it in the future using the web accessible Agilent MCCD User Interface or API rather than always having to run the Agilent MCCD Configuration Screens.

---

**NOTE:** One reason that you may want to disable Digital I/O access over the LAN is to prevent accidental reprogramming of any digital I/O functions if they are being used to monitor or implement safety functions in your cell forming procedure.

---

### 3 - Configuration

```
Digital I/O Configuration

Digital I/O Configuration over the LAN is    ENABLED

1)  To ENABLE Digital I/O Configuration over the LAN
2)  To DISABLE Digital I/O Configuration over the LAN
3)  To configure Digital I/O

Type a number and press Enter or ctrl-G to return to initial screen
```

To continue configuring the Digital I/O, press 3. The pin numbers of the Digital I/O connector appear on the screen. Refer to Figure 2-2 for the physical locations of the pins. Note that the two pins on each end of the connector are the Common connection for any pins that are configured as grounded outputs.

```
Digital I/O Configuration

Pin,      Function
0         General Purpose I/O,      Grounded, High True
1         General Purpose I/O,      Grounded, High True
2         General Purpose I/O,      Grounded, High True
3         General Purpose I/O,      Grounded, High True
4         General Purpose I/O,      Grounded, High True
5         General Purpose I/O,      Grounded, High True
6         General Purpose I/O,      Grounded, High True
7         General Purpose I/O,      Grounded, High True
8         General Purpose I/O,      Grounded, High True
9         General Purpose I/O,      Grounded, High True
10        General Purpose I/O,      Grounded, High True
11        General Purpose I/O,      Grounded, High True
12        General Purpose I/O,      Grounded, High True
13        General Purpose I/O,      Grounded, High True
14        General Purpose I/O,      Grounded, High True
15        General Purpose I/O,      Grounded, High True

Type a pin number and press Enter or ctrl-G to return to initial screen
```

To configure a pin, select a pin number and press Enter. The following choices appear on the screen for each pin that you select. Selections made in this screen will be shown in the previous screen.

```

Pin 0   Digital I/O Configuration

1)  Change to External Fault Input      Grounded
2)  Change to External Fault Output     Grounded
3)  Change to External Interlock        Grounded
4)  Change to General Purpose I/O       Grounded
5)  Change to General Purpose Input      Grounded
6)  Change to General Purpose Output     Grounded
7)  Change to External Trigger           Grounded
8)  Change to External Fault Output     Isolated
9)  Change to General Purpose Output     Isolated
10) Change to Power Fail Input           Grounded
11) Change to Power Fail Output          Grounded
12) Change to Power Fail Output          Isolated
13) Change to Output and not Fault In    Grounded
14) Change to Output and not Fault In    Isolated

Type a number and press Enter or ctrl-G to return to initial screen

```

All pins do not have to be configured in the same way. Some can be used as isolated outputs while others are single-ended I/O. Functions can also be mixed, with some pins being general purpose Digital I/O while others have a specific purpose. Chapter 2 under “Digital Connections” provides further information about the purpose and application of the digital I/O signals. Any pin can be configured for selections 1 through 7. The common ground pin is the return for these selections.

Selections 10 and 11 are the power fail signals. One is the input, to signal that a power failure has occurred; the other is the output, to indicate when the shutdown state has been saved. Pin 13 is a special purpose signal discussed under `cfSetDigitalConfig` in chapter 5.

Selections 8, 9, 12, and 14 are the isolated output selections, which require a dedicated pair. Dedicated pairs are located on adjacent pins (0-1, 2-3, 4-5, etc.), up to a maximum of eight pairs. For example to use the pair pin 0-1 as an isolated output, configure pin 0 to be the isolated output and do not configure pin 1. Pin 1 is the minus connector of the output. Writing to or reading pin 1 has no effect. Isolated outputs cannot be used as inputs.

After you press Enter, select whether the pin will be configured as either High True or Low True.

```

Pin 0   Digital I/O Configuration

1)  Change to High True
2)  Change to Low true

Type a number and press Enter or ctrl-G to return to initial screen

```

### 3 - Configuration

#### Mixed Configuration Example

The following example illustrates a mixed digital I/O configuration. In this example,

- ◆ Pins 0, 2, 4, and 6 are configured for External Fault Output Isolated High True (selection 11).
- ◆ Pins 1, 3, 5 and 7 the corresponding second pins of each isolated pair.
- ◆ Pins 8 through 10 are configured as General purpose I/O, high true (selection 7), referenced to the common connector.
- ◆ Pins 11 and 12 are configured as External Fault inputs, Low True (selection 2), referenced to the common connector.
- ◆ Pins 14 and 15 are configured as External Fault outputs, High True (selection 3), referenced to the common connector.

Digital I/O Configuration			
Pin,	Function		Polarity
0	External Fault Output,	Isolated,	High True
1	second pin of isolated pair		
2	External Fault Output,	Isolated,	Low True
3	second pin of isolated pair		
4	General Purpose Output,	Isolated,	High True
5	second pin of isolated pair		
6	General Purpose Output,	Isolated,	Low True
7	second pin of isolated pair		
8	General Purpose I/O,	Grounded,	High True
9	General Purpose I/O,	Grounded,	High True
10	General Purpose I/O,	Grounded,	High True
11	General Purpose I/O,	Grounded,	High True
12	External Fault Input	Grounded,	Low True
13	External Fault Input	Grounded,	Low True
14	External Fault Output	Grounded,	High True
15	External Fault Output	Grounded,	High True

Type a pin number and press Enter or ctrl-G to return to initial screen

---

## Accessing Calibration

Using the Agilent MCCD Configuration Screens to calibrate the Agilent MCCD is provided as a convenience. You can also run calibration using the Agilent MCCD User Interface or the API function calls over the LAN. For further information about how to use the Agilent MCCD Configuration Screens for calibration, refer to Appendix B.

## Agilent MCCD User Interface

---

### Description

The Agilent MCCD User Interface lets you interactively monitor and control the Agilent E4370A/E4374A MCCD System. This interface is accessed using a standard web browser on a PC located anywhere on the LAN. No special software other than the web browser needs to be installed on the PC to use this interface.

### PC Requirements

The PC must have one of the following web browsers installed:

- ◆ Netscape Navigator 3.03 or greater
- ◆ Microsoft Internet Explorer 3.02 or greater

### Browser Settings

The following browser settings are recommended when using the Agilent MCCD User Interface:

- ◆ Graphics card set to display 256 colors.
- ◆ Video resolution of 800 X 600 pixels or better.
- ◆ When using Netscape Navigator, go to View/Network Preferences/Language and enable Javascript.
- ◆ When using Microsoft Internet Explorer, go to View/Options/Security and enable Run ActiveX scripts.

---

**NOTE:** If you use the standard web browser buttons (Back, Forward, or Home) to navigate through the Agilent MCCD User Interface, you may experience unexpected results.

---

### Security

The server inside the Agilent MCCD implements the basic password authentication scheme that is supported by the Web browsers. The Agilent MCCD User Interface is shipped without password protection. You can set a password to restrict access to the Agilent MCCD using the Agilent MCCD Configuration Screens. This is done during the installation as discussed in chapter 3. The password that you set in the Agilent MCCD Configuration Screens is the same password that is used by the Agilent MCCD User Interface and must also be used when programming the Agilent MCCD using the API function calls.

## 4 - User Interface

### Localization

The user interface pages are provided in English and Japanese. You can specify the default language during installation of the Agilent MCCD. (You can also change the language from the System page once the Agilent MCCD User Interface is running.)

### Access

The user interface is accessed by starting a web browser on a LAN-connected PC and specifying the following URL:

```
http://<address>/
```

where <address> is the IP address or name of the particular Agilent MCCD unit being monitored.

---

## Using the Interface

The Agilent MCCD User Interface provides a basic level of system monitoring and control. It allows the monitoring of individual cell states, measuring cell voltage and currents while the test is running, and the monitoring and control of a complete test sequence.

The Agilent MCCD User Interface lets you control a cell-forming station independently of a computer test program. The cell forming sequence that you program using the Agilent MCCD User Interface is identical to the sequence that you construct using the API functions in a program. You can also download an existing sequence from a PC and then use the Agilent MCCD User Interface to view or modify it.

You can also use the Agilent MCCD User Interface as a learning tool to familiarize yourself with the various features of the Agilent MCCD.

Finally, the Agilent MCCD User Interface contains a Diagnostics Page that lets you directly and immediately program the individual channel outputs. This is only meant for debugging purposes. Agilent Technologies does not recommend using direct output control to run your cell forming sequence.

---

**CAUTION**     **Direct output control should not be used for charging cells. There is no protection against overcharging when using direct output control. Use this mode only for diagnostic and debugging purposes.**

---

More information on using the Agilent MCCD User Interface can be found in the online help that can be accessed from the interface. Click on the Help button.

---

## Using the Agilent M CCD Measurement Log Utility

If you are using the Agilent M CCD User Interface to create and run a cell forming sequence, you may want to transfer the data from the data log memory to your PC for analysis and storage at the completion of the cell forming sequence. Use the Agilent M CCD Measurement Utility to transfer the data from the data log memory to a file on your client PC.

---

**NOTE:** The data log memory will be cleared when you perform an Initiate function, when you exit the Agilent M CCD User Interface, or when power is removed from the unit. Transfer the data to your PC if you want to keep it.

---

To run the Agilent M CCD Measurement Log Utility, click on **Start> Programs> Agilent M CCD Client API and Measurement Log Utility> Measurement Log**

The following window will appear on your computer screen:

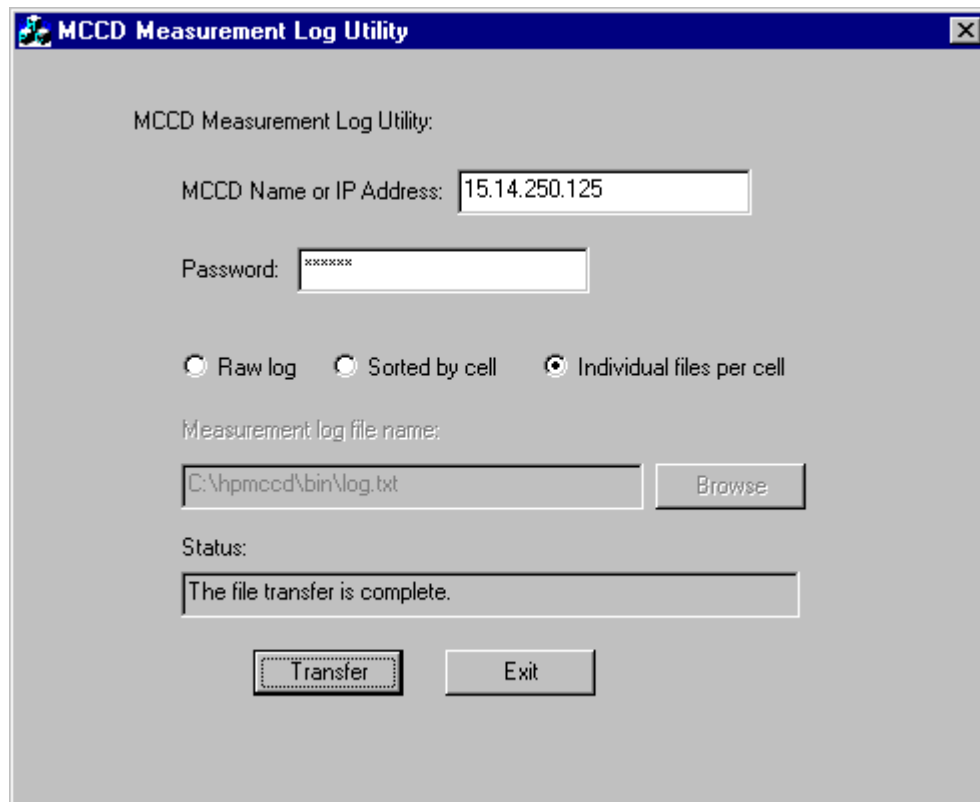

Use the measurement utility as follows:

1. Enter the M CCD name or IP Address of the unit that you are accessing in the first field.
2. If the unit has been password-protected, enter the password in the password field.
3. Select one of the following data logging formats:

## 4 - User Interface

<b>Raw log</b>	Transfers all of the logged data in the order that it was logged.
<b>Sorted by cell</b>	Transfers all of the logged data sorted by cell. Data is organized from first cell to last cell.
<b>Individual files per cell</b>	Transfers all of the logged data and creates a separate data file for each cell.

4. When you select Raw log or Sorted by cell, you must enter a filename in which to store the data. Select the Browse button to chose a directory in which to put the file. The default directory is C:\hpmccd\bin
5. When you select Individual files per cell, the utility automatically creates up to 256 data files (one for each active cell. Filenames are c001.txt through c256.txt. All files will be placed in the C:\hpmccd\bin\data directory.
6. Click Transfer to start the data transfer. The status field provides status information about the transfer.
7. Click Exit to exit the utility.

Data files that are created by the measurement log utility contain the following information:

<b>cell-number</b>	1 through 256								
<b>step-number</b>	1 through n; the total number of steps in the sequence								
<b>time</b>	Time in seconds since the forming sequence was triggered								
<b>status</b>	A value that indicates the status of the cell								
	<table><thead><tr><th><u>Value</u></th><th><u>Status</u></th></tr></thead><tbody><tr><td>1</td><td>constant voltage mode</td></tr><tr><td>2</td><td>constant current charge mode</td></tr><tr><td>4</td><td>constant current discharge mode</td></tr></tbody></table>	<u>Value</u>	<u>Status</u>	1	constant voltage mode	2	constant current charge mode	4	constant current discharge mode
<u>Value</u>	<u>Status</u>								
1	constant voltage mode								
2	constant current charge mode								
4	constant current discharge mode								
<b>entry-type</b>	One of the following: "Charge", "Discharge", "Rest", "ACR", "DCR"								
<b>volt-reading</b>	Cell voltage in volts (only for Charge, Discharge, and Rest steps)								
<b>curr-reading</b>	Cell current in amperes (only for Charge, Discharge, and Rest steps)								
<b>amp-hours</b>	Cumulative ampere-hours from the beginning of the step-number (only for Charge, Discharge, and Rest steps)								
<b>watt-hours</b>	Cumulative watt-hours from the beginning of the step-number (only for Charge, Discharge, and Rest steps)								
<b>resistance</b>	ac or dc resistance measurement in ohms (only for ACR and DCR steps)								



## Programming Overview

---

### A Cell Forming Overview

The cell forming process of the Agilent E4370A MCCD consists of a series of steps or actions that are performed on a group of cells until the process is complete. This cell forming process is here referred to as a sequence, the essence of which consists of three steps: **charging** the cell, **resting** the cell, and **discharging** the cell. These steps may be repeated a number of times and in any order within the sequence, depending on your process. The transition from one step to the next is controlled by tests within the step that specify measurement criteria that must be satisfied. You can specify at what time during the test that the measurement will be made and what action to take if the measurement criteria is met. Two additional steps, ac resistance and dc resistance, are available that are used to measure the ac or dc resistance of a cell. These measurements cannot be made while the cell is charging or discharging.

**Steps** define the voltage and current stimulus that is supplied to the cell and the length of time that a stimulus is applied. **Tests** within the step measure the cell, define measurement limits, compare the measurement to the limits, and specify an action to take based on the outcome of the comparison. Refer to the `cfSetSeqTest` function in this chapter 6 for a list of all of the tests that can be performed in a given step. Note that the ac resistance and dc resistance tests can only be performed within their respective ac resistance and dc resistance steps.

Cells may be tested before or after a specified time in the step or they may be tested once at a specific time. Cells may also be tested at the beginning of a step, before a stimulus is applied, to ensure that it is safe to charge or discharge the cell.

Depending on the outcome of a test, a cell can either bypass the remaining tests and go to the **next** step in the sequence, or get flagged as **failed** and removed from the sequence. This is illustrated in figure 5-1. When a cell is removed from the sequence, the output to that cell is turned off and no further tests are performed on it.

---

**NOTE:** There are no sequence restrictions on individual cells. What this means is that a cell can be at any point in a cell forming sequence independent of any other cell. Cells can charge, discharge, or rest at the ratings specified for the specific step that they are in. AC and DC resistance measurements are also performed on individual cells whenever they enter an ACR or DCR step. Outputs to the cells can also be turned on or off individually.

---

## 5 - Programming Overview

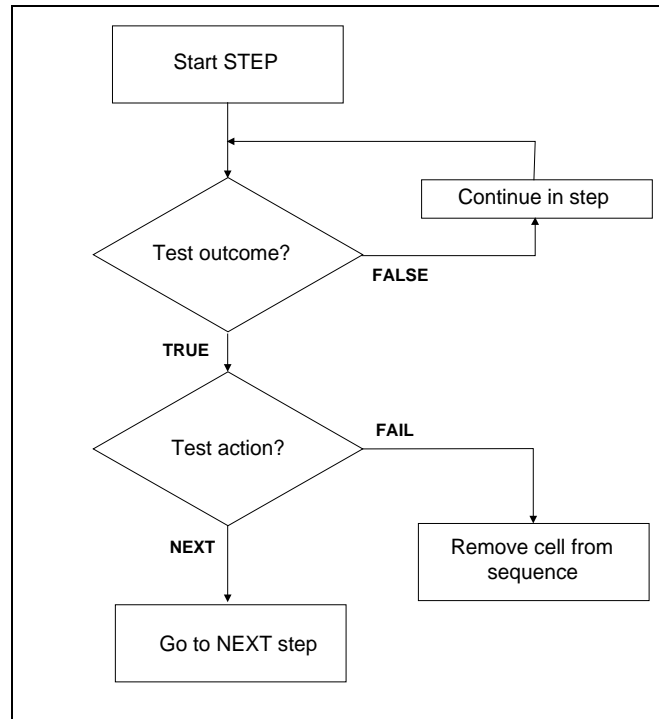

**Figure 5-1. Test Outcome Flowchart**

### Cell Forming Example

The following table documents a sequence consisting of four steps. Figure 5-2 illustrates how three of the cells behave as the sequence is running. Each step in the sequence is performed on all cells simultaneously. Sequence steps and actions are as follows. Refer to Chapter 7 for the C programming code for this example.

Function	Step	Step Action/ Test Type	Voltage	Current	Time	Test Outcome
Set Seq Step	1	Charge at	4.2 V	0.295 A	For 20 min.	
Set Seq Test	1	Voltage $\geq$	3.8 V		Before 5 min.	Fail (cell removed from sequence)
Set Seq Test	1	Current $\leq$		0.02 A	After 5 min.	Next (cell goes to step 2, rest)
Set Seq Step	2	Rest			For 10 min.	
Set Seq Step	3	Discharge at	3.0 V	0.295 A	For 15 min.	
Set Seq Test	3	Voltage $\leq$	3.0 V		Before 5 min.	Fail (cell removed from sequence)
Set Seq Test	3	Voltage $\leq$	3.0 V		After 5 min.	Next (cell goes to step 4, rest)
Set Seq Test	3	Voltage $\geq$	3.0 V		At 15 min.	Fail (cell removed from sequence)
Set Seq Step	4	Rest			For 5 min.	

**Step 1**

In Step 1, all cells are set to charge at a constant current of 0.295 amperes until the voltage reaches 4.2 volts. It continues charging at the 4.2 volt limit, however the charging current now starts decreasing from its 0.295 ampere limit setting. The cell continues charging until the cell current falls to 0.02 amperes. When this occurs, the cell goes to the next step, the resting state. This is shown occurring for cell 1 and cell 2 in Figure 5-2. Because the current test was never true for cell 3, it remained in the charging step for the maximum charging time of 20 minutes.

A cell fails the test if it reaches the 3.8 volt setting in less than 5 minutes. This indicates that the cell is charging too rapidly.

**Step 2**

In Step 2, all cells rest for at least 10 minutes with no stimulus applied to their outputs. The resting step can thus be used to move a cell into a resting state if you do not want the present stimulus settings to be applied to it after it has satisfied the test criteria, or if you do not want it to proceed to the next step before any of the other cells have completed the present step.

**Step 3**

In step 3, all cells are set to discharge at a constant current of 0.295 amperes until the voltage falls to 3 volts. This voltage is referred to as the end of discharge voltage or EODV. If the voltage drops to 3 volts after five minutes has elapsed, the cell goes to the resting state. This is shown for cells 1 and 2 in Figure 5-2. The maximum time limit for the discharge step is 15 minutes, however the step is completed sooner than that for cells 1 and 2.

A cell fails the test if its voltage drops to 3 volts before 5 minutes has elapsed. This is shown for cell 3 in Figure 5-2, which indicates that the cell is discharging too rapidly. A cell also fails the test if the voltage does not fall below 3 volts after 15 minutes. This indicates that the cell is discharging too slowly, due to a possible problem with the test fixture or the wiring.

**Step 4**

Step 4 is a five minute rest step, which is only included in this example as a buffer between the previous discharge step and any other step that may follow in the sequence. Because cells can be independently paced, you do not have to use rest steps in this manner.

## 5 - Programming Overview

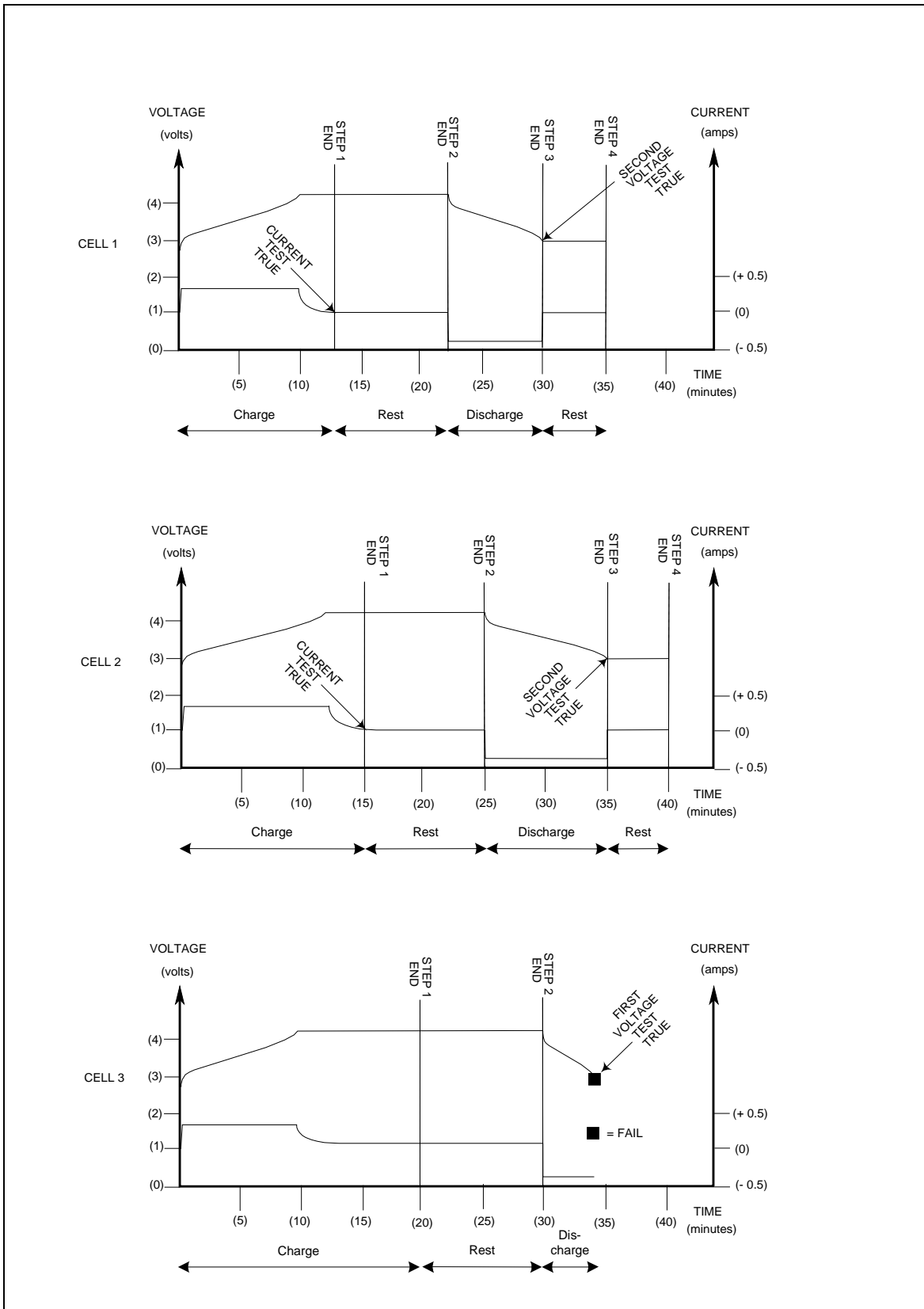

Figure 5-2. Simple Cell Forming Example

---

## Function Call Overview

The driver function calls that control the cell forming process of the Agilent E4370A MCCD are classified into the following broad categories:

- Cell Grouping functions** - configure groups of cells for independent sequence control.
- Step/Test functions** - set up and control individual steps in a cell forming sequence.
- Sequence Control functions** - control the run states of the instrument
- Protection functions** - set up the protection states of the instrument.
- Data storage functions** - control the measurement logging that occurs during a sequence.
- Direct Control functions** - program the cells when a sequence is not running.
- Server functions** - set and read communication parameters.
- Digital I/O functions** - configure and control the external digital control signals.
- Serial Port functions** - configure and control the two serial I/O ports.

The Function Definitions section in chapter 6 lists all of the cell forming (cf) functions in alphabetical order.

### Cell Grouping

The Agilent E4370A MCCD has the capability to group contiguous blocks of cells or channels. Each group of defined cells can be controlled independently of any other group of defined cells. This means that different cell forming sequences can be assigned to groups of cells connected to an Agilent E4370A MCCD mainframe. All assigned sequences can run simultaneously.

Each group is defined by a starting cell number and by the total number of cells in the group. A group can be as small as a single cell or as large as all the cells in the mainframe. A maximum number of eight groups can be defined for each mainframe of 256 channels. If no groups are defined, commands sent to the mainframe apply to all active channels in the mainframe. If one group of cells has been defined, then any remaining cells in the mainframe must also be assigned into groups in order to be controlled.

To create a group, use the command:

```
int cfSetGroup(CF_HANDLE server, char *name, int start, int size);
```

The name argument serves to identify the group. Once the group has been created, a handle must be obtained for subsequent control with API functions. This function can also be used to modify an existing group. When an existing group name is used, it overwrites that group's definition with the new data.

To obtain a group handle, use the function:

```
int cfOpenGroup(CF_HANDLE server, char *name, CF_HANDLE
*group_handle);
```

To delete an existing group, use the function:

```
cfDeleteGroup.
```

To query all defined groups, use the function:

```
int cfGetGroups(CF_HANDLE server, char
names[CF_MAX_GROUPS][CF_MAX_GROUP_NAME_LEN], int start[CF_MAX_GROUPS],
int size[CF_MAX_GROUPS]);
```

---

**NOTE:** Groups are volatile and disappear when the ac power is turned off. Also, cfReset resets all volatile settings to their power-on state, which deletes all groups.

---

## 5 - Programming Overview

### Grouping Functions

The group handle returned by `cfOpenGroup` can be used with any of the functions in the list below. These functions control or query a specific group. If a function is not in this list, it cannot be used with a group handle obtained from `cfOpenGroup`.

<code>cfAbort</code>	<code>cfGetSenseProbeTest</code>	<code>cfSetSenseProbeTest</code>
<code>fGetCurrent</code>	<code>cfGetSeqTime</code>	<code>cfSetSeqStep</code>
<code>cfGetMeasLogInterval</code>	<code>cfGetTrigSource</code>	<code>cfSetSeqTest</code>
<code>cfGetOutputProbeTest</code>	<code>cfGetVoltage</code>	<code>cfSetSeqTestAnd</code>
<code>cfGetOutputState</code>	<code>cfInitiate</code>	<code>cfSetTrigSource</code>
<code>cfGetSeqStep</code>	<code>cfReadMeasLog</code>	<code>cfSetVoltage</code>
<code>cfGetSeqTest</code>	<code>cfSetCurrent</code>	<code>cfStateRecall</code>
<code>cfGetSeqTestAnd</code>	<code>cfSetMeasLogInterval</code>	<code>cfStateSave</code>
<code>cfResetSeq</code>	<code>cfSetOutputProbeTest</code>	<code>cfTrigger</code>
<code>cfGetRunState</code>	<code>cfSetOutputState</code>	

Once one or more groups have been defined with `cfSetGroup`, the functions in the above list can only be used with a group handle obtained from `cfOpenGroup`. An error will be returned if one of these functions is called using the handle obtained from `cfOpen`. If there are no groups defined, then the handle returned from `cfOpen` can be used to control all the cells.

### Step/Test Functions

A charge-discharge sequence is a user-defined sequence of steps that the instrument or group will follow automatically. Each step applies either a charge, discharge, or no stimulus for a specified period of time. Other parameters determine what the voltage and current are set to, what number the step is in the sequence, and the length of time for the step. Steps are also used to measure ac resistance and dc resistance.

To set and query the step parameters use:

```
cfSetSeqStep();  
cfGetSeqStep();
```

To query what step is presently being executed and how long the cell has been in that step while the sequence is running, use:

```
cfGetStepNumber();
```

To program step 1 to charge at 0.295 amps, with a voltage limit of 4.2 volts for 30 minutes, and step 2 to discharge at 0.5 amps with a voltage limit of 2.0 volts for 15 minutes, use:

```
cfSetSeqStep(server, 1, CF_CHARGE, 4.2, 0.295, 30.0 *  
SECONDS_PER_MINUTE, 0.0);  
cfSetSeqStep(server, 2, CF_DISCHARGE, 2.0, 0.5, 15.0 *  
SECONDS_PER_MINUTE, 0.0);
```

Tests can be defined for each step to verify that the cells are performing properly and to control the transition to the next step based on the cell performance criteria. Each test references a step number, a measurement type (voltage, current, or ac resistance greater or less than a limit), a measurement limit, a time test type and limit, and the action to take when the test is true.

To define a test use:

```
cfSetSeqTest();
```

To read back the tests that have been defined use:

```
cfGetSeqTest();
```

To program one test to cause a cell to fail if the voltage does not exceed 4 volts within 30 minutes, and another test to cause a test to fail if the voltage reaches 4 volts in under 5 minutes use:

```
cfSetSeqTest(server, 1, CF_VOLT_LE, 4, CF_TEST_AT, 30 *
SECONDS_PER_MINUTE, CF_FAIL);
cfSetSeqTest(server, 1, CF_VOLT_GE, 4, CF_TEST_BEFORE, 5 *
SECONDS_PER_MINUTE, CF_FAIL);
```

The time test type and time limit determines when a measurement is performed. CF\_TEST\_BEFORE specifies that the measurement is performed continuously from the start of the step until the time limit. CF\_TEST\_AFTER specifies that the measurement is performed continuously from the time limit until the step is finished. CF\_TEST\_AT specifies that the measurement is performed once at the time limit.

If a test is true, NEXT causes the output to go to the next step, bypassing any remaining tests. FAIL causes that specific output to be open circuited, removed from the sequence, and tagged as having failed. If a measurement test is false, nothing happens.

### Sequence Control

The diagram below shows the various run states of the instrument or group. It wakes up at power-on in the CF\_NOT\_READY state, and stays in this state until selftest and initialization is completed and the dc power supply on the power bus is turned on. This may take a few seconds. In the CF\_NOT\_READY state, the outputs cannot be programmed on. The instrument is also in this state during calibration.

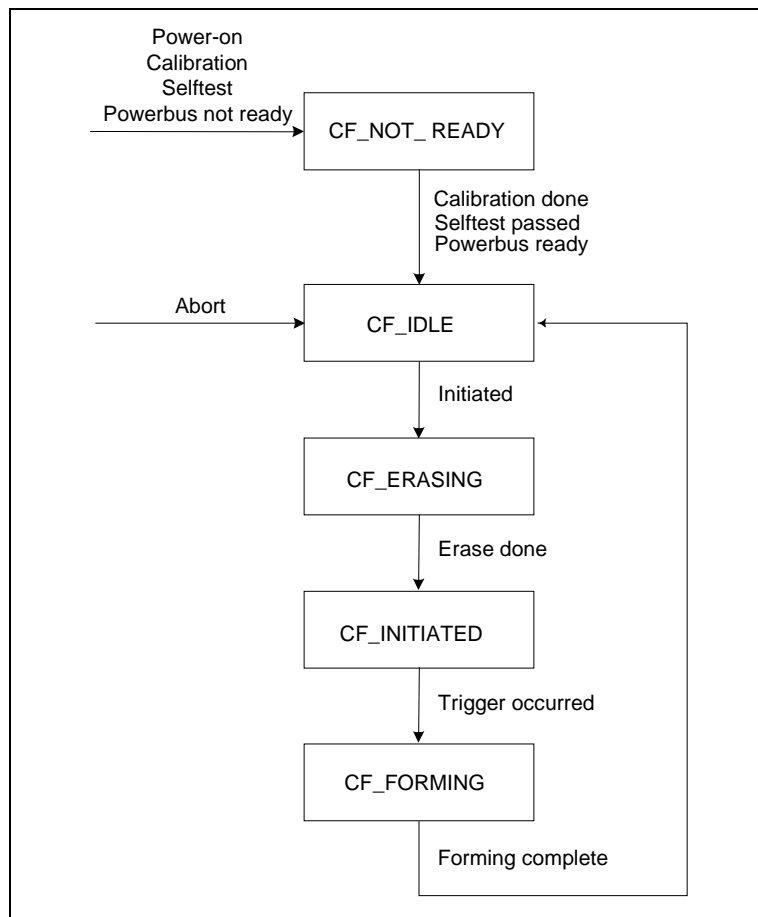

Figure 5-3. Instrument Run State

## 5 - Programming Overview

After selftest is completed and there is dc voltage on the power bus, the instrument moves to the CF\_IDLE state. In this state the instrument is waiting and ready to start a cell forming sequence. The instrument returns to the CF\_IDLE state when a cell-forming sequence completes. Note that an Abort function also places the instrument in the CF\_IDLE state. A cell forming sequence can only be defined or recalled from non-volatile memory when the Agilent MCCD is in the CF\_IDLE state.

To begin running a sequence, the initiate function must be called. This causes the instrument to check the sequence, and if it is executable, it begins erasing the memory that is used for the measurement log and moves to the CF\_ERASING state. The memory may take from 5 to 50 seconds to erase, after which the instrument moves to the CF\_INITIATED state. From here the instrument will start executing the sequence when a trigger is received. The trigger source can be either the LAN or the digital I/O port.

When the sequence completes, the instrument returns to the CF\_IDLE state, and the results can be read from the instrument. Note, because the initiate function clears the measurement log, it must be read before initiating the sequence again.

To query which state the instrument is in use:

```
cfGetRunState();
```

To check a sequence and move to the CF\_INITIATED state use:

```
cfInitiate();
```

To start a sequence use:

```
cfTrigger();
```

 or generate a trigger using a configured Digital I/O line

Set and query the trigger source use:

```
cfSetTrigSource();  
cfGetTrigSource();
```

To query the time since the trigger occurred use:

```
cfGetSeqTime();
```

To abort a sequence and return to the CF\_IDLE state use:

```
cfAbort();
```

## Output Configuration

If specific outputs are not being used, you can program them to be inactive. Outputs that are configured as inactive will remain in an off state and will not be included in the sequencing or status functions. They will not be tested during selftest and will not get calibrated during instrument calibration. Measuring inactive outputs will return the special value, CF\_NOT\_A\_NUMBER..

To set and query the output configuration use:

```
cfSetOutputConfig();  
cfGetOutputConfig();
```

---

**NOTE:** Active/inactive outputs settings that are programmed using cfSetOutputConfig() are NOT saved in non-volatile memory. Each time the unit is powered up, you must reprogram the output settings. However, the output settings that are programmed using the Agilent MCCD User Interface ARE saved in non-volatile memory. The unit will wake up with those settings when it powered up.

---



## Instrument Protection

The following diagram shows the various protection states of the instrument.

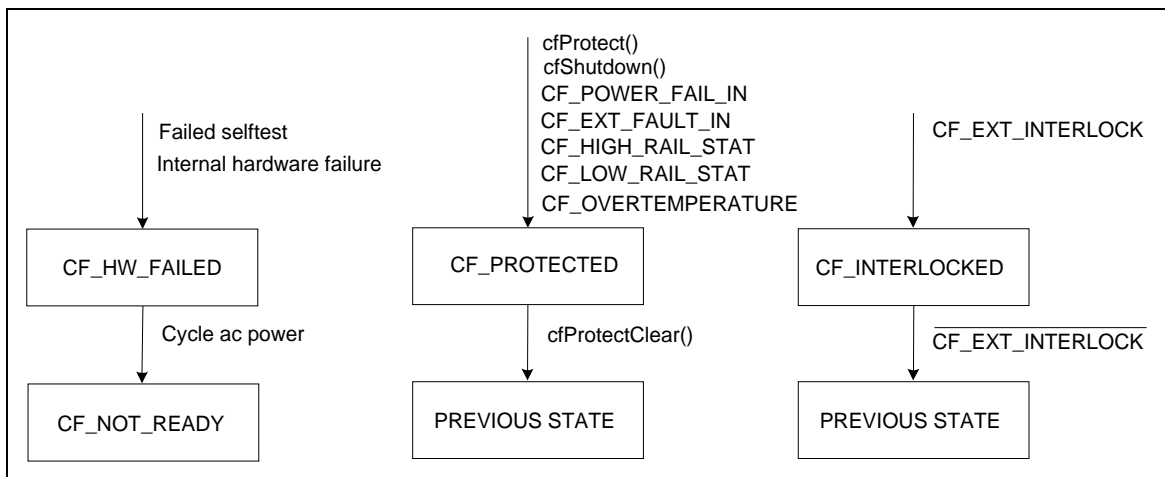

**Figure 5-4. Instrument Protect States**

After selftest is completed, and there is dc voltage on the power bus the instrument normally moves to the CF\_IDLE state. However, if a power-on selftest failed, it will instead go to the CF\_HW\_FAILED state and remain there until the ac line power is cycled or cfSelftest() passes. In the CF\_HW\_FAILED state, the outputs cannot be programmed on, but LAN communications function normally.

You can also put the instrument into a protected state in which all outputs go to open circuit. This can be done with the program command cfProtect() or by asserting a false to true edge on a digital input that was configured as CF\_EXT\_FAULT\_IN. The instrument will also go to this state if it detects an internal overtemperature condition or if the power bus voltage gets too high or too low. When the instrument goes to the CF\_PROTECTED state it remembers the state that it came from, and it will return to its previous state when the cfProtectClear() command is sent. If any faults exist when the cfProtectClear function is called, the instrument will remain in CF\_PROTECTED. If the instrument is in the CF\_FORMING state when it is sent to CF\_PROTECTED, the forming process and system timers are suspended in a manner that allows forming to be resumed from where it was interrupted.

Another protected state which is similar to CF\_PROTECTED is CF\_INTERLOCKED. The instrument goes to this state whenever the external CF\_EXT\_INTERLOCK input is true, and it returns to its previous state when CF\_EXT\_INTERLOCK goes false.

To query which state the instrument is in, use:

```
cfGetRunState();
```

To force the instrument into the CF\_PROTECTED state, use:

```
cfProtect();
```

To exit the CF\_PROTECTED state, use:

```
cfProtectClear();
```

---

**NOTE:** If the cfAbort() command is given while the instrument is in the CF\_PROTECTED state, cfProtectClear() will send the instrument to CF\_IDLE, regardless of its previous state.

---

## 5 - Programming Overview

### Power Fail Operation

The Agilent E4370A MCCD can operate in one of two power-fail shutdown modes. The mode is set by the `cfSetShutdownMode()` command. When the mode is set to `CF_AUTO`, a true signal on the `CF_POWER_FAIL_IN` digital input will cause the Agilent MCCD to perform a shutdown, at which time it saves its state in nonvolatile memory. When the mode is set to `CF_MANUAL`, an automatic shutdown is not performed (API commands such as `cfShutdown` must be used to do it manually). The `CF_POWER_FAIL_IN` digital input signal is only available if `cfShutdownMode = AUTO`.

It takes the Agilent MCCD firmware about 20 milliseconds to recognize the state of the digital `CF_POWER_FAIL_IN` signal. Additionally, a programmable delay set by the `cfSetShutdownDelay()` command determines how long the `CF_POWER_FAIL_IN` signal must be true before an automatic shutdown occurs. If the `CF_POWER_FAIL_IN` signal is true longer than the delay time set by `cfShutdownDelay`, the Agilent MCCD will shut down. If the `CF_POWER_FAIL` signal goes false before the expiration of the `cfShutdownDelay` time, no shut down occurs.

The purpose of this delay is so that the Agilent MCCD doesn't shut down every time the power fails for more than 20 ms. For example, if the Agilent MCCD is connected to a UPS that can keep it running for 5 minutes, set `cfShutdownDelay` time for 4 minutes. This way, the power must be out for 4 minutes before the Agilent MCCD shuts down. Since 4 minutes is less than the 5 minute UPS holdup time, there is no danger that power loss will occur. If the power returns (as indicated by `CF_POWER_FAIL_IN = false`) before the 4 minute delay expires, no shutdown occurs and the system has successfully handled a short ac power loss.

Use the following functions to program and control a powerfail shutdown:

```
cfSetShutdownMode();  
cfSetShutdownDelay();  
cfSetServerTimeout();  
cfSetAutoConnect();  
cfShutdown();
```

The following functions also have capabilities that apply to a powerfail shutdown:

```
cfSetDigitalConfig();  
cfGetInstStatus();  
cfSaveOutputConfig
```

To restart the instrument by recalling a saved shutdown state use:

```
cfRestart();
```

### Instrument State Storage

The instrument can store several instrument states. The entire state of the instrument, including the defined sequence steps and tests, is stored in non-volatile memory under a user defined name.

Use the following functions to control instrument states:

```
cfStateSave();  
cfStateRecall();  
cfStateList();  
cfStateDelete();
```

To reset the instrument to its power-on state:

```
cfReset();
```

The power-on and cfReset instrument settings are:

```

Output State = OFF
Output Voltage = 0 volts
Output Current = 0 amperes
Sequence Step = <all steps>
    Type = <undefined>
    Voltage = 0 volts
    Current = 0 amperes
    Time = 0 seconds
Measurement Interval = All steps
    ΔV = Infinity
    ΔI = Infinity
    Δt = Infinity
    ΔV = Infinity
Trigger Source = LAN
Digital Port = 0
Probe Test Resistance = Infinity
Sense Probe Test = Off

```

Note that power-on and cfReset() clear all test settings.

## Status

The instrument has a status register that reports various instrument conditions. To read the status register use cfGetInstStatus(). Each condition that is reported is represented by a bit in the register. These conditions are described in the following table.

CF_EXT_FAULT_IN_STAT	An input that is configured as CF_EXT_FAULT_IN was asserted.
CF_EXT_INTERLOCK_STAT	An input that is configured as a CF_EXT_INTERLOCK is true
CF_SERIALB_SWITCH_STAT	Serial port B is set as the configuration port by a hardware switch
CF_LOW_RAIL_STAT	The rail voltage was or is presently too low.
CF_HIGH_RAIL_STAT	The rail voltage was or is presently too high.
CF_OVERTEMPERATURE_STAT	The internal temperature was or is presently too high.
CF_CALIBRATING_STAT	The instrument is calibrating
CF_POWER_ON_STAT	The instrument has not finished its power-on initialization
CF_POWER_FAIL_STAT	An input that is configured as a CF_POWER_FAIL_IN is true
CF_RAIL_NOT_READY_STAT	The rail has not yet been turned on
CF_RESTART_STAT	A shutdown state has been saved
CF_SELFTEST_STAT	A selftest is in progress
CF_SELFTEST_ERROR_STAT	A selftest error has occurred
CF_SHUTDOWN_STAT	A power fail shutdown has occurred
CF_CAL_ERROR_STAT	A calibration error has occurred

To return the current state of a cell in the sequence (Pass, Fail, or in progress), use:

```
cfGetCellStatus();
```

### Measurement Log

The Agilent E4370A MCCD logs measurement data at the beginning, end, and can be programmed to log measurement data throughout each sequence step. Voltage and current for each output are continuously monitored and whenever either changes by a user-specified threshold or a when a specified time period has elapsed, a log entry is made for that output. The criteria for the voltage or current change that causes a log entry is programmable and can be different for each step in a sequence. The data logging time-period parameter can be set to intervals ranging from one second up to 596 hours. Programming the special value of CF\_INFINITY effectively turns off logging for a particular parameter.

Data saved in the Measurement log includes: the output number that this entry applies to, the step number that was being executed when the entry was made, the time measured from the beginning of the sequence, the sum of the status bits, the voltage and current measurements, and the accumulated watt- and amp-hours since the beginning of the step. For ac resistance and dc resistance steps, only the resistance measurement is entered into the log.

Data from tagged sequence step types is also entered into the measurement log. Tagged measurements include ac resistance, dc resistance, open circuit voltage, cumulative ampere hours, and cumulative watt hours. Special filters are provided for selectively reading only the tagged entries from the measurement log. Refer to `cfSetSequenceStep()` and `cfReadMeasLog()` in chapter 6 for more information about tagged measurements.

The measurement log is a circular queue large enough to hold 349,504 entries. Portions of the total available measurement log memory are allocated to groups based on the number of cells in each group. The measurement log memory is organized into 64 blocks; each block having a capacity of 5461 entries. Every group uses a minimum of four measurement blocks. For groups that are larger than 16 cells, every four cells after the first 16 cells use another memory block. Even if the number is less than four, an additional memory block is still used. For example, a group of 16 cells uses four blocks, and a group of 17, 18, 19, or 20 cells uses five memory blocks. A group of 21 cells uses six memory blocks. Refer to the "Cell Grouping" section at the beginning of this chapter for more information about groups.

---

**NOTE:** The measurement log contents are cleared when a sequence is initiated.

---

Set and query the Measurement logging voltage and current interval criteria with:

```
cfSetMeasLogInterval();  
cfGetMeasLogInterval();
```

To read the Measurement log, use:

```
cfReadMeasLog();
```

To reset the read pointer to either the beginning of the log or immediately ahead of the write pointer, use:

```
cfReset();
```

To clear the Measurement log, use:

```
cfInitiate();
```

## Time Stamp Function

The measurement log only records the time in seconds from the start of a cell forming sequence. To determine the time when the forming sequence actually starts, use the `cfGetSeqTime()` function in conjunction with the clock on your controller.

The `cfGetSeqTime()` function returns the time that has elapsed (in seconds) since a sequence was started or triggered. After your program has determined that a sequence is running, it can call this function and compute the sequence start time using the following algorithm:

$$\text{StartTime} = \text{CurrentTime} - \text{cfGetSeqTime}()$$

## Output Measurements

The instrument is capable of taking measurements at its output terminals on command. The following measurement may be made on a single output, or on all outputs.

For voltage measurements, use  
`cfMeasVoltage();`

For current measurements, use  
`cfMeasCurrent();`

The following resistance measurements may take several seconds to complete. You may need to temporarily adjust the `cfSetTimeout()` function to account for the increased execution time. If the measurement could not be completed for some reason, the special value `CF_NOT_A_NUMBER` (9.91E37) is returned.

For ac resistance measurements, use  
`cfMeasACResistance();`

For dc resistance measurements use  
`cfMeasDCResistance();`

For output probe resistance measurements, use  
`csMeasOutputProbeResistance();`

For sense probe resistance measurements, use  
`csMeasSenseProbeResistance();`

The output voltage is regulated and measured at the power output terminals unless the remote sense function is used. The Agilent M CCD can be configured to regulate and measure the voltage at either the power terminals or the sense terminals.

To set and query where the voltage is sensed, use:  
`cfSetSense();`  
`cfGetSense();`

### Direct output control

---

**CAUTION**     **Direct output control should not be used for charging cells. There is no protection against overcharging or using probe check when using direct output control. Use this mode only for diagnostic and debugging purposes.**

---

The Agilent MCCD outputs can be directly controlled for diagnostic purposes without defining a sequence of steps and tests. Direct output control commands can only be used while the Agilent MCCD is in the CF\_IDLE state. The voltage, current, and output state settings are set on all the outputs simultaneously. Whenever the Agilent MCCD system leaves the CF\_IDLE state, these settings are reset to their power-on values.

For voltage control use:

```
cfSetVoltage();  
cfGetVoltage();
```

For current control use:

```
cfSetCurrent();  
cfGetCurrent();
```

For the output on/off state use:

```
cfSetOutputState();  
cfGetOutputState();
```

### General Server functions

There are several general functions related to the instrument. Before an instrument can be controlled, the LAN connection must be made. A password is required to open this connection. The password is set with in the Agilent MCCD Configuration Screens (see chapter 3).

To open or close a LAN connection to an instrument use:

```
cfOpen();  
cfClose();
```

To set the maximum time to wait for the instrument to respond use:

```
cfSetTimeout();
```

To read the instrument identification string from the instrument use:

```
cfInstIdentify();
```

To read the identification string that was entered through the Agilent MCCD Configuration Screens use:

```
cfUserIdentify();
```

To define an optional function to be called by any other instrument function when it returns an error use:

```
cfSetErrorFunction();
```

## Selftest

The Agilent E4370A MCCD has a built in selftest capability, which is performed at power-on. This limited selftest verifies proper operation of the memory functions, serial communications functions, analog-to-digital converter functions, and the voltage programming of each output regulator. The selftest also checks for the presence of an external dc source on the power bus. The test applies no power to the cells and is performed whether or not cells are connected to the Agilent MCCD.

A more complete selftest can be done by executing the following command:

```
cfSelftest();
```

In addition to performing most of the power-on tests, cfSelftest() also tests the current measurement functions as well as the constant current charge and discharge functions of every output regulator.

---

**CAUTION:** cfSelftest() causes voltage to be applied to the outputs. Make sure that no cells are connected when executing cfSelftest().

---

Since selftest can take many seconds to complete, the cfSelftest() function does not wait for selftest to complete. It returns immediately after starting selftest. During selftest, the CF\_SELFTEST\_STAT bit is true in the status word returned by cfGetInstStatus(). When selftest is finished, CF\_SELFTEST\_STAT goes false, and a test failure is indicated by the status bit CF\_SELFTEST\_ERROR\_STAT. This means that you can poll the instrument status while selftest is running to determine if selftest is complete.

If there are any selftest errors indicated by the CF\_SELFTEST\_ERROR\_STAT bit, then the details of those errors can be obtained from the test log. The test log is read using

```
cfReadTestLog();
```

The test log retains the selftest error information until another selftest or a calibration command is given.

## Calibration

Calibration of the Agilent MCCD can be performed only when the Agilent MCCD is in the CF\_IDLE state (see Figure 5-3). Complete information on calibration is provided in Appendix B. Briefly, calibration is a two-step procedure. First the internal references are calibrated using an external DMM, and then the internal references are used to transfer calibration to each channel. You must always perform the second step when you install a new or a repaired charger/discharger card in the mainframe.

To calibrate the internal mainframe references you must connect a voltmeter to serial port A as described in appendix B. To begin mainframe reference calibration, use:

```
cfCalStandard();
```

To transfer the standard references to each channel, all external connections to the cell outputs and sense terminals must be open. The function to begin transfer calibration is:

```
cfCalTransfer();
```

The combination of cfCalStandard() and cfCalTransfer() can be performed with the single command:

```
cfCal();
```

---

**CAUTION:** Make sure that no cells are connected when executing cfCalTransfer() or cfCal().

---

## 5 - Programming Overview

Since calibration can take up to 15 minutes for an Agilent MCCD with 256 channels, calibration functions do not wait for calibration to complete. They return immediately after starting calibration. During calibration, the `CF_CALIBRATING_STAT` bit is true in the status word returned by `cfGetInstStatus()`. When calibration is finished, the `CF_CALIBRATING_STAT` bit goes false, and a calibration error is indicated by the status bit `CF_CAL_ERROR_STAT`. This means that you can poll the instrument status while calibration is running to determine if calibration is complete.

If there are any calibration errors indicated by the `CF_CAL_ERROR_STAT` bit, then the details of those errors can be obtained from the test log. To read the test log, use

```
cfReadTestLog();
```

The test log retains the calibration error information until another calibration or a selftest command is given.

### Serial port

The instrument has two serial ports, which can be used as pass-through ports from the LAN. These ports can be used for local peripherals under control of the application program. In pass-through mode, the functions that are used to read or write a string to either port have no direct effect on the instrument. There is also a function to set the configuration of the serial ports.

The functions used to access the ports are:

```
cfReadSerial();  
cfWriteSerial();
```

To set and query the serial port configuration use:

```
cfSetSerialConfig();  
cfGetSerialConfig();
```

To return the serial port status use:

```
cfGetSerialStatus();
```

Serial port B is also used as a configuration port. This is selected with a hardware switch on the instrument, as described in chapter 3. Also, during calibration, serial port A reconfigured as a dedicated communications port for an external voltmeter.

### Digital port

There is a 16 bit digital I/O port on the instrument. It can be used as general purpose I/O, or bits can be configured to have specific purposes. Each pin can be a chassis referenced input or output, or pairs of pins can be defined as one isolated output. See `cfSetDigitalConfig()` in chapter 6 for more information.

In addition to using the API functions, digital I/O configuration can be set using the Agilent MCCD Configuration Screens or the Agilent MCCD User Interface. See chapters 2 and 4 for more information.

To set or query the configuration use:

```
cfSetDigitalConfig();  
cfGetDigitalConfig();
```

To read and write the lines directly use:

```
cfSetDigitalPort();  
cfGetDigitalPort();
```



## Probe check

Probe check includes three separate functions: a continuity check, a power probe resistance check, and a sense probe resistance check. All probe check functions require a cell to be connected to the channel outputs.

The continuity check is a low-current stimulus test that should be performed prior to the power probe test, or the sense probe test. Its primary function is to identify misaligned or bad probes. If the probes pass this initial test, you can safely begin a test sequence and apply power to the cells. To perform the probe continuity test use:

```
cfMeasProbeContinuity();
```

Probe resistance checks are internal procedures that use the plus and minus output terminals in conjunction with the remote sense capability of the product to check that the resistance of both the power and sense probes are within the allowable limits. When enabled, these checks occur continuously while a sequence is running.

For the power probe resistance check, a user defined resistance limit must be specified. The power probe resistance includes the probe, fixture wiring, and connection resistance. If the defined resistance limit is ever exceeded on an individual channel, that channel fails and is removed from the forming sequence. To specify the resistance limit and enable power probe checking, use:

```
cfSetOutputProbeTest();
```

For the sense probe resistance check, an internal measurement is made and compared against the maximum allowable resistance that can be tolerated within the readback accuracy of the remote voltage sense circuits. The maximum allowable resistance includes the probe, fixture wiring, connection resistance, and an internal scanner resistance, which is typically 1000 ohms. If the maximum allowable resistance is ever exceeded on an individual channel, that channel fails and is removed from the forming sequence. To enable sense probe checking, use:

```
cfSetSenseProbeTest();
```

To measure the actual power probe resistance and sense probe resistance, use the following commands:

```
cfMeasOutputProbeResistance();
cfMeasSenseProbeResistance();
```



# Language Dictionary

---

## API Usage Guidelines

This Application Programming Interface lets you create an application program on a PC to control the operation of one or more Agilent M CCD units over a LAN. The API consists of a dynamic link library (DLL) that provides a set of driver functions that are called by the application program to access Agilent M CCD features. This section gives the syntax and parameters for all the API cell forming (cf) functions used by the Agilent M CCD.

### Operating System and Language Support

The client API library supports Windows 95 and Windows NT. It requires the TCP/IP services that are part of these operating systems to be installed and configured. This API supports only 32-bit applications. Test programs must be written in Microsoft Visual C/C++.

### Blocking Functions

All functions in this API are blocking; they do not return until the function operation is complete. Since most functions communicate over the network, they may take a relatively long time to complete. If the calling application has other tasks to perform while the network request is in progress, it should create a thread to service the network connection.

### Buffer Management

When an application calls a function, it must allocate any required buffers to pass data to the function. When the function returns, the caller is responsible for de-allocating the buffers.

### Sequential Function Calls

All API functions support multithreaded operation. If two threads each make a function call to different Agilent M CCDs, the function calls will be processed concurrently. However, if two threads make a function call to the same Agilent M CCD, the calls are serialized. The function called by the second thread will block until the call made by the first thread completes.

### Error Reporting

All functions return CF\_OK if successful or a non-zero code if an error occurred. If desired, an error handler function may be registered with the API to allow central error processing. This function will be called whenever an error occurs in any API function.

### Number of Server Connections

An Agilent M CCD server lets you connect up to three clients. All three clients have equal capability and all can monitor and control the Agilent M CCD using the API programming functions described in chapter 6. The Web-based Agilent M CCD User Interface uses a separate connection that does not count as one of the three client connections.

## Password Protection

An application program must provide a password to open a connection to a server. As shipped from the factory, the Agilent MCCD is not password protected. You may set an Agilent MCCD server password during the installation procedure using the Agilent MCCD Configuration Screens.

---

## API Function Summary

<b>cfAbort</b>	aborts a forming sequence
<b>cfCal</b>	begins a full calibration (mainframe and card)
<b>cfCalStandard</b>	begins a standard calibration (mainframe)
<b>cfCalTransfer</b>	begins a transfer calibration (card)
<b>cfClose</b>	closes a server connection
<b>cfDeleteGroup</b>	deletes a group from the Agilent MCCD
<b>cfGetCellStatus</b>	returns the status of an individual cell
<b>cfGetCellStatusString</b>	returns detailed information for a failed cell
<b>cfGetCurrent</b>	returns the current setting programmed by cfSetCurrent
<b>cfGetGroups</b>	Returns information about all defined groups
<b>cfGetDigitalConfig</b>	returns the setting of an individual digital I/O port
<b>cfGetDigitalPort</b>	reads a data word from the digital I/O port
<b>cfGetInstIdentify</b>	returns a description of the instrument
<b>cfGetInstStatus</b>	returns the instrument status
<b>cfGetMeasLogInterval</b>	returns the criteria that determines when data is logged
<b>cfGetOutputConfig</b>	returns the configuration of an output
<b>cfGetOutputProbeTest</b>	returns the output probe resistance limit
<b>cfGetOutputState</b>	returns the output state of the Agilent MCCD
<b>cfGetRunState</b>	returns the present instrument run state
<b>cfGetSense</b>	returns the setting of the remote or local sense
<b>cfGetSenseProbeTest</b>	returns the settings of the sense probe test
<b>cfGetSeqStep</b>	returns the parameters for a sequence step number
<b>cfGetSeqTest</b>	returns the parameters of one of the sequence tests
<b>cfGetSeqTestAnd</b>	returns the parameters of multiple tests combined with the AND function
<b>cfGetSeqTime</b>	returns the elapsed time since the sequence was triggered
<b>cfGetSerialConfig</b>	returns the communication parameters of a serial port
<b>cfGetSerialStatus</b>	returns the status of a serial port
<b>cfGetStepNumber</b>	returns a cell's present sequence step and the time since the step started
<b>cfGetShutdownDelay</b>	returns the delay value set by cfSetShutdownDelay
<b>cfGetShutdownMode</b>	returns the shut down mode setting
<b>cfGetTrigSource</b>	returns the selected trigger source
<b>cfGetUserIdentify</b>	returns the Name, Location, and Description information
<b>cfGetVoltage</b>	returns the voltage setting programmed by cfSetVoltage
<b>cfInitiate</b>	initiates a forming sequence
<b>cfMeasACResistance</b>	measures the ac resistance of a cell or all cells
<b>cfMeasCapacityAS</b>	measures accumulated ampere-hour capacity of a cell in its present step
<b>cfMeasCapacityWS</b>	measures accumulated watt-hour capacity of a cell in its present step
<b>cfMeasCurrent</b>	measures the current of a cell or all cells

<b>cfMeasDCResistance</b>	measures the dc resistance of a cell or all cells
<b>cfMeasOutputProbeResistance</b>	measures the output probe resistance of a cell or all cells
<b>cfMeasProbeContinuity</b>	checks the sense and output probe connections of a cell or all cells
<b>cfMeasSenseProbeResistance</b>	measures the resistance looking into the sense probes of a cell or all cells
<b>cfMeasVoltage</b>	measures the voltage of a cell or all cells
<b>cfOpen</b>	opens a connection to the Agilent MCCD
<b>cfOpenGroup</b>	associates a server handle with a defined group
<b>cfProtect</b>	forces the Agilent MCCD into a protected state
<b>cfProtectClear</b>	clears the protected state of the Agilent MCCD
<b>cfReadMeasLog</b>	returns measurements acquired during a forming sequence
<b>cfReadTestLog</b>	returns error messages from the test log
<b>cfReadSerial</b>	reads data from one of the serial ports
<b>cfReset</b>	sets programmable functions to their power-on state
<b>cfResetSeq</b>	aborts and clears a previously defined sequence
<b>cfRestart</b>	recalls a previously saved restart state
<b>cfSaveOutputConfig</b>	saves the output configuration in non-volatile memory
<b>cfSelftest</b>	begins an instrument selftest
<b>cfSetAutoConnect</b>	turns the automatic reconnect feature of the mccd.dll file on or off
<b>cfSetCurrent</b>	sets the output current
<b>cfSetDigitalConfig</b>	sets the operation of an individual digital I/O port
<b>cdSetDigitalPort</b>	writes a data word to the digital I/O port
<b>cfSetErrorFunction</b>	defines an error function
<b>cfSetGroup</b>	defines a group of cells
<b>cfSetMeasLogInterval</b>	defines the criteria for generating a measurement log entry
<b>cfSetOutputConfig</b>	configures the output cells as active or inactive
<b>cfSetOutputProbeTest</b>	sets the resistance limit of the output probe
<b>cfSetOutputState</b>	sets the instrument's output state off, charge, or discharge
<b>cfSetSense</b>	sets the voltage sense to remote or local
<b>cfSetSenseProbeTest</b>	sets the automatic testing of the sense probe resistance
<b>cfSetSeqStep</b>	defines an output sequence step
<b>cfSetSeqTest</b>	defines the tests performed during a sequence step
<b>cfSetSeqTestAnd</b>	defines multiple tests combined with the logical AND function
<b>cfSetSerialConfig</b>	sets the communication parameters of a serial port
<b>cfSetServerTimeout</b>	sets the connection inactivity timeout period
<b>cfSetShutdownDelay</b>	sets the shutdown delay period
<b>cfSetShutdownMode</b>	sets the shutdown mode to auto or manual
<b>cfSetTimeout</b>	sets the time the client waits for a response from the server
<b>cfSetTrigSource</b>	sets the trigger source to LAN or external
<b>cfSetVoltage</b>	sets the output voltage
<b>cfShutdown</b>	causes the Agilent MCCD to go to a safe state prior to shutting down
<b>cfStateDelete</b>	deletes a previously created instrument state
<b>cfStateList</b>	returns a list of instrument state names
<b>cfStateRecall</b>	loads a previously created instrument state
<b>cfStateSave</b>	saves the present instrument settings in non-volatile memory
<b>cfTrigger</b>	sends a trigger over the LAN
<b>cfWriteSerial</b>	writes data words to the serial port

---

## API Function Definitions

### cfAbort

**Syntax**

```
int cfAbort(CF_HANDLE server);
```

**Description**

Aborts a forming sequence, which sets the run state to CF\_IDLE. In the idle state the output conditions of each cell are defined by the functions cfSetVoltage, cfSetCurrent, and cfSetOutputState. The server argument can be either a handle to a group obtained by cfOpenGroup, or a handle to all cells in the instrument if no groups are defined.

### cfCal

---

**CAUTION:** Make sure that no cells are connected when executing cfCal.

---

**Syntax**

```
int cfCal(CF_HANDLE server);
```

**Description**

Begins a full calibration sequence. This function calibrates the Agilent MCCD's internal references and then transfers the calibration of the references to each channel. Thus, cfCal performs the same work as the cfCalStandard and cfCalTransfer functions.

Calibration requires that one of the supported voltmeters be connected to Serial Port A. There cannot be any loads or cells connected to the channel outputs, and the voltmeter input must be connected to the calibration output.

Since full calibration can take up to 15 minutes, calibration functions do not wait for calibration to complete. They return immediately after starting calibration. To monitor the progress and results of calibration, use cfGetInstStatus. While calibration is in progress, the CF\_CALIBRATING\_STAT bit is true. If any errors occur during calibration, the CF\_CAL\_ERROR\_STAT bit is true. Details of the errors can be obtained using cfReadTestLog.

### cfCalStandard

**Syntax**

```
int cfCalStandard(CF_HANDLE server);
```

**Description**

Begins calibration of the instrument's internal references. This requires that one of the supported voltmeters be connected to Serial Port A.

Calibration functions do not wait for calibration to complete. They return immediately after starting calibration. To monitor the progress and results of calibration, use cfGetInstStatus. While calibration is in progress, the CF\_CALIBRATING\_STAT bit is true. If any errors occur during calibration, the CF\_CAL\_ERROR\_STAT bit is true. Details of the errors can be obtained using cfReadTestLog.

## cfCalTransfer

---

**CAUTION:** Make sure that no cells are connected when executing cfCalTransfer.

---

### *Syntax*

```
int cfCalTransfer(CF_HANDLE server);
```

### *Description*

Begins a transfer calibration sequence. This function uses the instrument's internal references to calibrate the measurement and output circuits of each channel. There should not be any loads or cells connected to the outputs when this command is given.

Since transfer calibration can take up to 15 minutes, calibration functions do not wait for calibration to complete. They return immediately after starting calibration. To monitor the progress and results of calibration, use cfGetInstStatus. While calibration is in progress, the CF\_CALIBRATING\_STAT bit is true. If any errors occur during calibration, the CF\_CAL\_ERROR\_STAT bit is true. Details of the errors can be obtained using cfReadTestLog.

## cfClose

### *Syntax*

```
int cfClose(CF_HANDLE server);
```

### *Description*

Closes a server connection. An Agilent MCCD server can only accommodate a limited number of open client connections. Closing a connection makes it available to other clients. Closing a connection does not affect the output functions of the server, and all other instrument functions continue to operate undisturbed by cfOpen and cfClose commands.

## cfDeleteGroup

### *Syntax*

```
int cfDeleteGroup(CF_HANDLE server);
```

### *Description*

Deletes a group from the Agilent MCCD. Server is a handle that was previously obtained by a call to cfOpenGroup().

## cfGetCellStatus

### *Syntax*

```
int cfGetCellStatus(CF_HANDLE server, int cell, CF_CELL_STATUS *status);
```

### *Description*

Returns a value in the variable pointed to by status which indicates the current status of a cell in the forming process. The possible return values are:

<b>CF_UNTESTED</b>	The cell has not started a sequence since ac power was last turned on.
<b>CF_PASSED</b>	The cell completed the last forming sequence and passed all tests.
<b>CF_SEQUENCE_FAILED</b>	The cell failed a test during the last forming sequence.
<b>CF_OUT_PROBE_FAILED</b>	The cell failed an output probe resistance test during forming.
<b>CF_SENSE_PROBE_FAILED</b>	The cell failed a sense probe resistance test during forming.
<b>CF_INACTIVE</b>	The cell has been set inactive by cfSetOutputConfig.
<b>CF_SEQUENCING</b>	The cell is in the process of forming.
<b>CF_ABORTED</b>	The last forming sequence was aborted.

The cell argument can be an individual cell number from 1 to 256, or the constant CF\_ALL\_CELLS to read the status condition of all cells. If CF\_ALL\_CELLS is given, the status argument should point to an array of 256 enums that will receive the return values.

## cfGetCellStatusString

### *Syntax*

```
int cfGetCellStatusString(CF_HANDLE server, int cell, char *status);
```

### *Description*

Returns an ASCII string with details of any cell whose status is CF\_SEQUENCE\_FAILED. The cell argument must be an individual cell number from 1 to 256. The constant CF\_MAX\_CELL\_STATUS\_LEN defines the maximum length of the returned status string.

## cfGetCurrent

### *Syntax*

```
int cfGetCurrent(CF_HANDLE server, float *current);
```

### *Description*

Returns the idle state current setting set by cfSetCurrent. The idle state current is the value that the cell current limit will be set to when the forming sequence is in the idle state and the output state is enabled. The server argument can be either a handle to a group obtained by cfOpenGroup, or a handle to all cells in the instrument if no groups are defined.



## cfGetDigitalConfig

### Syntax

```
int cfGetDigitalConfig(CF_HANDLE server, int bitnum, CF_EXT_SIGNAL
 *signal, CF_POLARITY *polarity, CF_REFERENCE *reference);
```

### Description

This function returns the function and logic sense mapping any of the 16 pins of the digital I/O port. See the function cfSetDigitalConfig for a detailed description of digital I/O port configuration. The following signals are defined:

<b>CF_EXT_FAULT_IN</b>	External Fault Input
<b>CF_EXT_FAULT_OUT</b>	External Fault Output
<b>CF_EXT_INTERLOCK</b>	External Interlock
<b>CF_EXT_TRIGGER</b>	External Trigger
<b>CF_DIG_IN</b>	General purpose input
<b>CF_DIG_OUT</b>	General purpose output
<b>CF_DIG_IN_OUT</b>	General purpose input/output
<b>CF_POWER_FAIL_IN</b>	Power fail input
<b>CF_POWER_FAIL_OUT</b>	Power fail output
<b>CF_DIG_OUT_AND_NOT_FAULT_IN</b>	Digital output and not fault input

### See Also

cfSetDigitalPort, cfGetDigitalConfig

## cfGetDigitalPort

### Syntax

```
int cfGetDigitalPort(CF_HANDLE server, int *data);
```

### Description

Reads a data word from the digital I/O port. See the function cfSetDigitalConfig for a detailed description of the digital I/O port.

### See Also

cfSetDigitalPort, cfGetDigitalConfig

## cfGetGroups

### Syntax

```
int cfGetGroups(CF_HANDLE server, char
 names[CF_MAX_GROUPS][CF_MAX_GROUP_NAME_LEN], int start[CF_MAX_GROUPS],
 int size[CF_MAX_GROUPS]);
```

### Description

Returns information about all defined groups. The arguments names, start, and size are arrays of size CF\_MAX\_GROUPS which hold the return information of defined group names, their start cell numbers and sizes. If there are less than CF\_MAX\_GROUPS defined, the entry in the size array after the last valid group entry contains the value of 0.

## 6 - Language Dictionary

### *Example*

```
void query_groups(CF_SERVER server)
{
    char names[CF_MAX_GROUPS][CF_MAX_GROUP_NAME_LEN];
    int starts[CF_MAX_GROUPS];
    int sizes[CF_MAX_GROUPS];

    cfGetGroups(server, names, starts, sizes);
}
```

## **cfGetInstIdentify**

### *Syntax*

```
int cfGetInstIdentify(CF_HANDLE server, char *idstring);
```

### *Description*

This command returns a description of the instrument. The string begins with the model number, then the product name, followed by the firmware version number, followed by instrument option descriptions or abbreviations. The idstring is a maximum of CF\_MAX\_ID\_LEN characters in length and is returned as a null-terminated C string.

## **cfGetInstStatus**

### *Syntax*

```
int cfGetInstStatus(CF_HANDLE server, int *status);
```

### *Description*

Returns the instrument status. Individual bits within the status word are defined to indicate various status conditions. The following constants can be used to test different status conditions:

<b>CF_EXT_FAULT_IN_STAT</b>	An input configured to the CF_EXT_FAULT_IN function was asserted since the last time cfProtectClear was called.
<b>CF_EXT_INTERLOCK_STAT</b>	An input which was configured to the CF_EXT_INTERLOCK function is true
<b>CF_SERIAL1_SWITCH_STAT</b>	True when serial port 1 is set as the configuration terminal port by a hardware switch
<b>CF_LOW_RAIL_STAT</b>	The rail voltage got too low since the last time cfProtectClear was called.
<b>CF_HIGH_RAIL_STAT</b>	The rail voltage got too high since the last time cfProtectClear was called.
<b>CF_OVERTEMPERATURE_STAT</b>	The internal temperature got too high since the last time cfProtectClear was called.
<b>CF_CALIBRATING_STAT</b>	The instrument is calibrating
<b>CF_POWER_ON_STAT</b>	The instrument has not finished its power-on initialization
<b>CF_POWER_FAIL_STAT</b>	True whenever the CF_POWER_FAIL_IN signal is true.
<b>CF_RAIL_NOT_READY_STAT</b>	There is no dc voltage on the power bus
<b>CF_RESTART_STAT</b>	True whenever there is a saved shutdown state that can be restarted with cfRestart().
<b>CF_SELFTEST_STAT</b>	True when a selftest is in progress
<b>CF_SELFTEST_ERROR_STAT</b>	True when a selftest is in progress
<b>CF_SHUTDOWN_STAT</b>	True when either an automatic power fail shutdown occurred or cfShutdown() was called since the last time cfProtectClear() was called.
<b>CF_CAL_ERROR_STAT</b>	True when a selftest is in progress

**cfGetMeasLogInterval****Syntax**

```
int cfGetMeasLogInterval(CF_HANDLE server, int step_number, float
*volt_interval, float *curr_interval, float *time_interval);
```

**Description**

Returns voltage, current, and time change criteria that are used to determine when data is logged. The server argument can be either a handle to a group obtained by cfOpenGroup, or a handle to all cells in the instrument if no groups are defined. The step number argument can be an individual step, or the constant CF\_ALL\_STEPS to get the change criteria for all steps. If CF\_ALL\_STEPS is given, the volt\_interval, curr\_interval, and time\_interval arguments should point to arrays of floats of size CF\_MAX\_STEPS that will receive the return values.

**cfGetOutputConfig****Syntax**

```
int cfGetOutputConfig(CF_HANDLE server, int cell, CF_OUTPUT_CONFIG
*config);
```

**Description**

Returns the configuration of an output. An output configuration can be CF\_SET\_ACTIVE or CF\_SET\_INACTIVE. The cell argument can be an individual cell number from 1 to 256, or the constant CF\_ALL\_CELLS to get the output configuration for all cells. If CF\_ALL\_CELLS is given, the config argument should point to an array of 256 CF\_OUTPUT\_CONFIGs that will receive the return values.

A cell which is set to CF\_SET\_INACTIVE ignores most output and forming commands. Measurements for these cells always return the special value CF\_NOT\_A\_NUMBER.

**cfGetOutputProbeTest****Syntax**

```
int cfGetOutputProbeTest(CF_HANDLE server, float *resistance);
```

**Description**

Returns the resistance limit that is used when the output probes are tested during a forming sequence. If the probe resistance is higher than the resistance limit, the cell is marked as a failure. The server argument can be either a handle to a group obtained by cfOpenGroup, or a handle to all cells in the instrument if no groups are defined.

## **cfGetOutputState**

### *Syntax*

```
int cfGetOutputState(CF_HANDLE server, CF_OUTPUT_STATE *state);
```

### *Description*

Returns the output state of the Agilent MCCD when the run state is CF\_IDLE. The server argument can be either a handle to a group obtained by cfOpenGroup, or a handle to all cells in the instrument if no groups are defined. The possible return values are:

<b>CF_OUTPUT_OFF</b>	The output state of the Agilent MCCD is off.
<b>CF_OUTPUT_CHARGE</b>	The output of the Agilent MCCD is in the charging state.
<b>CF_OUTPUT_DISCHARGE</b>	The output of the Agilent MCCD is in the discharging state.

In the OFF state, the channel outputs are open-circuited and supply no current. In the charge and discharge states, channel outputs are controlled by cfSetVoltage and cfSetCurrent.

### *See Also*

cfSetOutputState, cfSetVoltage, cfSetCurrent

## **cfGetRunState**

### *Syntax*

```
int cfGetRunState(CF_HANDLE server, CF_RUN_STATE *state);
```

### *Description*

Returns the current instrument run state (CF\_IDLE, CF\_ERASING, CF\_INITIATED, CF\_FORMING, CF\_PROTECTED, CF\_NOT\_READY, CF\_INTERLOCKED, or CF\_HW\_FAILED). The server argument can be either a handle to a group obtained by cfOpenGroup, or a handle to all cells in the instrument if no groups are defined.

## **cfGetSense**

### *Syntax*

```
int cfGetSense(CF_HANDLE server, CF_SENSE *sense);
```

### *Description*

Returns the remote or local sense settings. The value returned is either CF\_SENSE\_REMOTE or CF\_SENSE\_LOCAL. Remote and local sense selection is controlled by cfSetSense.

### *See Also*

cfSetSense

## cfGetSenseProbeTest

### Syntax

```
int cfGetSenseProbeTest(CF_HANDLE server, CF_BOOLEAN *on_off);
```

### Description

Returns the setting of the sense probe test. The setting is either ON or OFF. The server argument can be either a handle to a group obtained by cfOpenGroup, or a handle to all cells in the instrument if no groups are defined. When this test is enabled, the instrument periodically measures the resistance of the sense probes and checks for a value that is low enough to allow accurate voltage measurements. If the probe resistance is too high and the testing is enabled, the forming sequence will be terminated for that cell.

### See Also

cfSetSenseProbeTest

## cfGetSeqStep

### Syntax

```
int cfGetSeqStep(CF_HANDLE server, int step_number, CF_SEQ_OUT
*out_type, float *voltage, float *current, float *time, float
*reserved);
```

### Description

Returns parameters for the given sequence step\_number. The server argument can be either a handle to a group obtained by cfOpenGroup, or a handle to all cells in the instrument if no groups are defined. If the step\_number is a step that has not been defined, the value returned in \*out\_type is CF\_STEP\_UNDEFINED.

## cfGetSeqTest

### Syntax

```
int cfGetSeqTest(CF_HANDLE server, CF_READP *read_pos, int *step_number,
CF_SEQ_TEST *meas_test_type, float *limit, CF_TIME_TEST *time_test_type,
float *time, CF_SEQ_ACTION *action);
```

### Description

Returns the parameters of one of the sequence tests. The server argument can be either a handle to a group obtained by cfOpenGroup, or a handle to all cells in the instrument if no groups are defined.

Sequence tests for the same step are stored within the instrument in ascending order on the time parameter. This is the order in which they are returned by successive calls to cfGetSeqTest. The value pointed to by the read\_pos argument controls which test is read. Read\_pos points to the special value CF\_READ\_FIRST to read the first test in the step. After the last test is read, subsequent calls to cfGetSeqTest will return the special value CF\_READ\_EOF in the value pointed to by read\_pos.

## cfGetSeqTestAnd

### Syntax

```
int cfGetSeqTestAnd(CF_HANDLE server, CF_READP *read_pos, int
*step_number, CF_SEQ_TEST *meas_test_type, float *limit, CF_TIME_TEST
*time_test_type, float *time, CF_SEQ_ACTION *action, int *count);
```

### Description

Returns the parameters of the sequence tests defined by the functions cfSetSeqTest or cfSetSeqTestAnd. The server argument can be either a handle to a group obtained by cfOpenGroup, or a handle to all cells in the instrument if no groups are defined. Operation is similar to cfSetSeqTest. The number of measurement tests and limits is returned in \*count. The arguments meas\_test\_type and limit must point to arrays of size CF\_MAX\_AND\_TESTS.

## cfGetSeqTime

### Syntax

```
int cfGetSeqTime(CF_HANDLE server, float *time);
```

### Description

Returns the time that has elapsed in seconds since the sequence was triggered. The server argument can be either a handle to a group obtained by cfOpenGroup, or a handle to all cells in the instrument if no groups are defined.

## cfGetSerialConfig

### Syntax

```
int cfGetConfig(CF_HANDLE server, int portnum, int *baudrate,
CF_SERIAL_PARITY *parity, int *wordsize, CF_SERIAL_FLOW *flow_ctrl);
```

### Description

Returns the communication parameters of one of the serial ports.

<b>port</b>	CF_PORTA or CF_PORTB
<b>baudrate</b>	1200, 2400, 4800, 9600, or 19200
<b>parity</b>	CF_PARITY_EVEN, CF_PARITY_ODD, or CF_PARITY_NONE
<b>wordsize</b>	7 or 8
<b>flow_ctrl</b>	CF_FLOW_RTS_CTS, CF_FLOW_XON_XOFF, or CF_FLOW_NONE

## cfGetSerialStatus

### Syntax

```
int cfGetSerialStatus(CF_HANDLE server, int portnum, int *status);
```

### Description

Returns the status of one of the serial ports. Definitions for these bits are

<b>CF_SERIAL_MAV</b>	message available
<b>CF_SERIAL_PE</b>	parity error
<b>CF_SERIAL_FE</b>	framing error
<b>CF_SERIAL_OE</b>	UART overrun error
<b>CF_SERIAL_INBUF_OE</b>	input buffer overrun error
<b>CF_SERIAL_OUTBUF_OE</b>	output buffer overrun error

Reading the serial status clears the error bits. The MAV bit is cleared when there are no characters in the port's FIFO to be read.

**cfGetShutdownDelay***Syntax*

```
int cfGetShutdownDelay(CF_HANDLE server, float *delay);
```

*Description*

Returns the delay value that is set by cfSetShutdownDelay().

**cfGetShutdownMode***Syntax*

```
int cfGetShutdownMode(CF_HANDLE server, int *mode);
```

*Description*

Returns the shutdown mode, CF\_AUTO or CF\_MANUAL.

**cfGetStepNumber***Syntax*

```
int cfGetStepNumber(CF_HANDLE server, int cell, int *step_number, float *time);
```

*Description*

Returns a cell's current forming sequence step number and the time that the cell has been in the current step in seconds. The cell argument can be an individual cell number from 1 to 256, or the constant CF\_ALL\_CELLS to request data for all cells. If CF\_ALL\_CELLS is given, the step\_number argument should point to an array of 256 integers and the time argument should point to an array of 256 floats that will receive the return values. The value returned in step\_number will be either a positive integer step number, or CF\_NOT\_FORMING.

**cfGetTrigSource***Syntax*

```
int cfGetTrigSource(CF_HANDLE server, CF_TRIG_SOURCE *source);
```

*Description*

Returns the selected trigger source. This can be CF\_LAN or CF\_EXTERNAL. The server argument can be either a handle to a group obtained by cfOpenGroup, or a handle to all cells in the instrument if no groups are defined.

**cfGetUserIdentify***Syntax*

```
int cfGetUserIdentify(CF_HANDLE server, char *idstring);
```

*Description*

Returns the Name, Location, and Description text fields that were set using the Agilent MCCD Configuration Screens. The fields are separated by newlines and terminated with an ASCII null character. The idstring is a maximum of CF\_MAX\_USER\_ID\_LEN characters in length.

## cfGetVoltage

### Syntax

```
int cfGetVoltage(CF_HANDLE server, float *voltage);
```

### Description

Returns the idle state voltage setting set by cfSetVoltage. The idle state voltage is the value that the cell voltage will be set to when the forming sequence is in the idle state and the output state is enabled. The server argument can be either a handle to a group obtained by cfOpenGroup, or a handle to all cells in the instrument if no groups are defined.

## cfInitiate

### Syntax

```
int cfInitiate(CF_HANDLE server);
```

### Description

Initiates a cell forming sequence. A cell forming sequence does not start until it has been initiated and then triggered. The server argument can be either a handle to a group obtained by cfOpenGroup, or a handle to all cells in the instrument if no groups are defined. cfInitiate returns an error if the trigger state is not in Idle or if the sequence is invalid.

### See Also

cfTrigger, cfSetTriggerSource, cfAbort

## cfMeasACResistance

### Syntax

```
int cfMeasACResistance(CF_HANDLE server, int cell, float *reading);
```

### Description

---

**NOTE:** Because this command may take several seconds to complete, you may need to temporarily adjust the cfSetTimeout function to account for the increased execution time.

---

Returns the measured ac resistance for a particular cell or for all cells. The cell argument can be an individual cell number from 1 to 256, or the constant CF\_ALL\_CELLS to request readings for all cells. If CF\_ALL\_CELLS is given, the reading argument should point to an array of 256 floats that will receive the return values.

If the ac resistance measurement cannot be made, either because the output for a cell is in the OFF state, the voltage sense is set to Local, or if there is insufficient current flowing to make the measurement, the special value CF\_NOT\_A\_NUMBER (9.91E37) is returned.

## cfMeasCapacityAS

### Syntax

```
int cfMeasCapacityAS(CF_HANDLE server, int cell, float *reading);
```

### Description

Returns the accumulated capacity in ampere-seconds of a cell in its present step. The capacity is reset to zero at the start of each step. If the cell is not in the forming state, the special value CF\_NOT\_A\_NUMBER is returned. The cell argument can be an individual cell number from 1 to 256, or the constant CF\_ALL\_CELLS to request readings for all cells. If CF\_ALL\_CELLS is given, the reading argument should point to an array of 256 floats that will receive the return values.



## cfMeasCapacityWS

### Syntax

```
int cfMeasCapacityWS(CF_HANDLE server, int cell, float *reading);
```

### Description

Returns the accumulated capacity in watt-seconds of a cell in its present step. The capacity is reset to zero at the start of each step. If the cell is not in the forming state, the special value CF\_NOT\_A\_NUMBER is returned. The cell argument can be an individual cell number from 1 to 256, or the constant CF\_ALL\_CELLS to request readings for all cells. If CF\_ALL\_CELLS is given, the reading argument should point to an array of 256 floats that will receive the return values.

## cfMeasCurrent

### Syntax

```
int cfMeasCurrent(CF_HANDLE server, int cell, float *reading);
```

### Description

Returns the measured current for a particular cell or for all cells. The cell argument can be an individual cell number from 1 to 256, or the constant CF\_ALL\_CELLS to request readings for all cells. If CF\_ALL\_CELLS is given, the reading argument should point to an array of 256 floats that will receive the return values.

## cfMeasDCResistance

### Syntax

```
int cfMeasDCResistance(CF_HANDLE server, int cell, float *reading);
```

### Description

---

**NOTE:** Because this command may take several seconds to complete, you may need to temporarily adjust the cfSetTimeout function to account for the increased execution time.

---

Returns the measured DC resistance for a particular cell or for all cells. The cell argument can be an individual cell number from 1 to 256, or the constant CF\_ALL\_CELLS to request readings for all cells. If CF\_ALL\_CELLS is given, the reading argument should point to an array of 256 floats that will receive the return values.

If the DC Resistance measurement cannot be made, either because the output for a cell is in the OFF state, the voltage sense is set to Local, or if there is insufficient current flowing to make the measurement, the special value CF\_NOT\_A\_NUMBER (9.91E37) is returned.

## cfMeasOutputProbeResistance

### Syntax

```
int cfMeasOutputProbeResistance(CF_HANDLE server, int cell, float *resistance);
```

### Description

---

**NOTE:** Because this command may take several seconds to complete, you may need to temporarily adjust the cfSetTimeout function to account for the increased execution time.

---

Measures and returns the output probe contact resistance for a particular cell or for all cells. Data is in ohms. The cell argument can be an individual cell number from 1 to 256, or the constant CF\_ALL\_CELLS to request readings for all cells. If CF\_ALL\_CELLS is given, the resistance argument should point to an array of size CF\_MAX\_CELLS that will receive the return values.

## 6 - Language Dictionary

To make an effective probe resistance measurement, there should be some significant current through the probe contacts to the cells. The `cfSetVoltage`, `cfSetCurrent`, and `cfSetOutputState` commands can be used to set up the proper conditions for this measurement. If the probe resistance measurement cannot be made, either because the output for a cell is in the OFF state, the voltage sense is set to Local, or if there is insufficient current flowing to make the measurement, the special value `CF_NOT_A_NUMBER` (9.91E37) is returned.

### **cfMeasProbeContinuity**

#### *Syntax*

```
int cfMeasProbeContinuity(CF_HANDLE server, int cell, CF_CONTINUITY
*result);
```

#### *Description*

---

**NOTE:** Because this command may take several seconds to complete, you may need to temporarily adjust the `cfSetTimeout` function to account for the increased execution time.

---

This command checks the sense and output probe connections for a particular cell or for all cells. The cell argument can be an individual cell number from 1 to 256, or the constant `CF_ALL_CELLS` to request readings for all cells. If `CF_ALL_CELLS` is given, the result argument should point to an array of size `CF_MAX_CELLS` that will receive the return values. The value returned in result will be one of the following constant definitions:

**CF\_PROBES\_OK**

**CF\_SENSE\_PROBE\_OPEN**

**CF\_OUTPUT\_PROBE\_OPEN**

**CF\_PROBES\_OPEN**

**CF\_CANNOT\_TEST** (either the unit is set to local sensing or a cell is inactive)

The Agilent MCCD must be configured for remote voltage sense and the probes must be connected to a battery cell to do probe continuity testing. No tests are performed if local voltage sense has been programmed.

### **cfMeasSenseProbeResistance**

#### *Syntax*

```
int cfMeasSenseProbeResistance(CF_HANDLE server, int cell, float
*resistance);
```

#### *Description*

---

**NOTE:** Because this command may take several seconds to complete, you may need to temporarily adjust the `cfSetTimeout` function to account for the increased execution time.

---

Measures and returns the resistance looking back into the sense probes for a particular cell or for all cells. Data is returned ohms. The cell argument can be an individual cell number from 1 to 256, or the constant `CF_ALL_CELLS` to request readings for all cells. If `CF_ALL_CELLS` is given, the resistance argument should point to an array of size `CF_MAX_CELLS` that will receive the return values.

To make an effective probe resistance measurement, there should be a cell connected at the output. The instrument cannot distinguish between resistance in the sense connections and output resistance of the cell.

**cfMeasVoltage****Syntax**

```
int cfMeasVoltage(CF_HANDLE server, int cell, float *reading);
```

**Description**

Returns the measured cell voltage in volts for a particular cell or for all cells. Voltage is measured at the selected sense terminals for each cell. The cell argument can be an individual cell number from 1 to 256, or the constant CF\_ALL\_CELLS to request readings for all cells. If CF\_ALL\_CELLS is given, the reading argument should point to an array of size CF\_MAX\_CELLS that will receive the return values.

**cfOpen****Syntax**

```
int cfOpen(char *server_name, CF_HANDLE *server, char *password);
```

**Description**

Before using any of the cell forming (cf) functions, you must establish a connection with the desired cell forming server. This function creates a connection and returns a handle to be used by all other cf functions. Access to cfOpen is protected by an alpha-numeric password, which is verified before the connection is permitted to be made. The password can be changed using a serial terminal connected to Serial Port B. The maximum length of the password is 32 characters. The server\_name argument can either be an IP address or the server name.

**Example**

```
#include <stdio.h>
#include <mccd.h>
main()
{
    CF_HANDLE server;
    if (cfOpen("15.14.248.100", &server, "mypassword"))
        printf("Cannot connect to MCCD server\n");
}
```

**cfOpenGroup****Syntax**

```
int cfOpenGroup(CF_HANDLE server, char *name, CF_HANDLE *group_handle);
```

**Description**

Associates a CF\_HANDLE with a defined group for subsequent control. The group handle returned can be used to direct API commands to the specified group.

When an API program is finished using a group handle, it should close the handle by calling cfClose and passing the group handle value. There are only a limited number of group handles available, and an API program can use them all up if it does not free group handles that are no longer needed.

When the server handle (a handle obtained by a call to cfOpen) is closed, all group handles associated with that server handle are automatically closed. In that case it is not necessary to close the group handles explicitly.

## 6 - Language Dictionary

### *Example*

```
#define MY_GROUP "1.5Ahour"
/*
 * Define group named "1.5Ahour" containing 64 cells
 * starting at cell 129.
 * Define a sequence step for the group, then free the group handle.
 */
void group_example(CF_HANDLE server)
{
    CF_HANDLE group_handle;

    cfSetGroup(server, MY_GROUP, 129, 64);
    cfOpenGroup(server, MY_GROUP, &group_handle);
    cfSetSeqStep(group_handle, 1, CF_CHARGE, 5.0, 1.0, 100.0, 0.0);
    cfClose(&group_handle);
}
```

### **cfProtect**

#### *Syntax*

```
int cfProtect(CF_HANDLE server);
```

#### *Description*

Forces the instrument into the CF\_PROTECTED state. The cell outputs are disabled, and all activities associated with cell forming are suspended.

### **cfProtectClear**

#### *Syntax*

```
int cfProtectClear(CF_HANDLE server);
```

#### *Description*

Whenever a protection condition occurs, the Agilent MCCD server goes into a CF\_PROTECTED state where outputs are disabled and sequences are paused. cfProtectClear will return the Agilent MCCD server to its previous state (state prior to protection event) if there are no longer any existing protect conditions. If any protect conditions are still true, cfProtectClear will leave the state of the Agilent MCCD server in CF\_PROTECTED.

cfProtectClear also clears all bits in the word returned by cfGetInstStatus that have false conditions. Any condition bits that are true (1) remain true in the event words.

### **cfReadMeasLog**

#### *Syntax*

```
int cfReadMeasLog(CF_HANDLE server, CF_READP *read_pos, int cell,
int step, int bufsize, char *buffer, int *retcount);
```

#### *Description*

This function returns entries from the measurement log. The server argument can be either a handle to a group obtained by cfOpenGroup, or a handle to all cells in the instrument if no groups are defined.

The measurement log contains measurements acquired during the forming sequence. For the sequence step types `CF_CHARGE`, `CF_DISCHARGE`, or `CF_REST`, a log entry is made at the beginning and end of a step. Additional log entries are made whenever the voltage, current, or time meet the criteria specified by the function `cfSetMeasLogInterval`. For all other sequence step types, only one entry is made containing a specific measurement.

The value pointed to by the `read_pos` argument controls which portion of the log is read. If this value is the special value `CF_READ_FIRST`, data is returned starting at the beginning of the log. Subsequent calls to `cfReadMeasLog` use the location pointed to by `read_pos` to keep track of the read position. If the value pointed to by `read_pos` is the special value `CF_READ_LAST`, the last entry for the specified cell is returned. If this special `read_pos` value is combined with the cell argument of `CF_ALL_CELLS` then the last 256 entries in the log are returned if `bufsize` is large enough to accept them. If `bufsize` is not large enough, the last entries that fit in `bufsize` are returned.

The cell and step arguments act as filters that allow limiting the returned log entries to a specific cell or specific step numbers. The cell argument can be an individual cell number from 1 to 256, or the constant `CF_ALL_CELLS` to read log entries for all cells. The step argument can be an individual step number, or the constant `CF_ALL_STEPS` to read log entries for all steps. Additional step arguments return tagged measurements. The following table summarizes the step arguments:

<b>&lt;step number&gt;</b>	returns entries for that step number
<b>CF_ALL_STEPS</b>	returns entries for all steps
<b>CF_STEP_TRANSITIONS</b>	returns summary entries of each step
<b>CF_TAGGED_ACR</b>	returns tagged ac resistance entries
<b>CF_TAGGED_DCR</b>	returns tagged dc resistance entries
<b>CF_TAGGED_OCV</b>	returns tagged open circuit voltage entries
<b>CF_TAGGED_CUM_AH</b>	returns tagged cumulative ampere-hour entries
<b>CF_TAGGED_CUM_WH</b>	returns tagged cumulative watt-hour entries

If the step argument is the special value `CF_STEP_TRANSITIONS`, the function returns a very abbreviated number of entries from each step. This can be used to obtain a quick summary of a sequence. For steps of type `CF_CHARGE`, `CF_DISCHARGE`, or `CF_REST`, it returns an entry at the beginning of the step and the last entry in the step. For all other sequence step types, it returns a single entry.

The number of characters read into the buffer is returned in `retcount`. `cfReadMeasLog` will not return a partial measure log entry, so the number of characters read will typically be slightly less than the buffer size. When the `retcount` value is 0, the end of the measure log has been reached. Reading the entire measurement log can be time consuming if the forming sequence is long and the logging intervals are set for frequent entries. There is an optimum buffer size that should be used if maximizing the reading speed is important. The macro `CF_MEAS_LOG_BUFSIZE` is provided in the header file `mccd.h` for this purpose, and can be used as shown in Example 1 in chapter 7.

Measurement log entries are sequences of ASCII formatted values separated by ASCII tab (`\t`) characters. Each log entry is terminated by a newline (`\n`) character. The format of a measurement log entry depends upon the step type of the corresponding sequence step. All log entries are the same format in the first 4 values, but the meaning of subsequent values depend on the step type.

## 6 - Language Dictionary

For sequence steps of type CF\_CHARGE, CF\_DISCHARGE, or CF\_REST, the format is:  
cell-number step-number time status entry-type volt-reading  
curr-reading amp-hours watt-hours <newline>.

For all other sequence step types, the format is:  
cell-number step-number time status entry-type value <newline>

<b>cell-number</b>	1 through 256												
<b>step-number</b>	1 through n, the number defined by cfSetSeqStep												
<b>time</b>	Time in seconds since the forming sequence was triggered												
<b>status</b>	A value that indicates the status of the cell												
	<table><thead><tr><th><u>Constant</u></th><th><u>Value</u></th><th><u>Description</u></th></tr></thead><tbody><tr><td>CF_CV</td><td>1</td><td>constant voltage mode</td></tr><tr><td>CF_CC_POS</td><td>2</td><td>constant current charge mode</td></tr><tr><td>CF_CC_NEG</td><td>4</td><td>constant current discharge mode</td></tr></tbody></table>	<u>Constant</u>	<u>Value</u>	<u>Description</u>	CF_CV	1	constant voltage mode	CF_CC_POS	2	constant current charge mode	CF_CC_NEG	4	constant current discharge mode
<u>Constant</u>	<u>Value</u>	<u>Description</u>											
CF_CV	1	constant voltage mode											
CF_CC_POS	2	constant current charge mode											
CF_CC_NEG	4	constant current discharge mode											
<b>entry-type</b>	One of the following character strings: Charge, Discharge, Rest, ACR, DCR, TaggedACR, TaggedDCR, Tagged OCV, TaggedCumAH, TaggedCumWH, ResetCumAH, ResetCumWH.												
<b>volt-reading</b>	Cell voltage measurement in volts												
<b>curr-reading</b>	Cell current measurement in amperes												
<b>amp-hours</b>	The cumulative ampere-hours measured from the beginning of this step-number.												
<b>watt-hours</b>	The cumulative watt-hours measured from the beginning of this step-number.												
<b>value</b>	The measurement or value related to the step type (either Tagged ACR, TaggedDCR, TaggedOCV, TaggedCumWH, TaggedCumAH).												

The measure log remains in the instrument's memory until a new forming sequence is started with the cfInitiate function.

## cfReadSerial

### *Syntax*

```
int cfReadSerial (CF_HANDLE server, CF_SERIAL_PORT port, int bufsize,  
char *buffer, int *retcount);
```

### *Description*

Reads data from one of the serial ports. The port argument can be CF\_PORTA or CF\_PORTB. A maximum of bufsize characters will be returned in buffer. The number of characters in the buffer is returned in retcount. If there are fewer than bufsize characters available to be read, the function returns only these characters and does not wait for the buffer to fill. The instrument stores characters from the serial ports in a FIFO buffer until they are read by the controller. The function cfSerialStatus can be used to test for serial error conditions.

### *See Also*

cfGetSerialStatus

## cfReadTestLog

### *Syntax*

```
int cfReadTestLog(CF_HANDLE server, CF_READP *read_pos, int bufsize,
char *buffer, int *retcount);
```

### *Description*

Returns up to bufsize characters from the test log. The test log contains entries which describe any errors that occur during calibration or selftest. The number of characters read into the buffer is returned in retcount. The value pointed to by the read\_pos argument controls which portion of the log is read. If this value is the special value CF\_READ\_FIRST, data is returned starting at the beginning of the log. Subsequent calls to cfReadSelftestLog use the location pointed to by read\_pos to keep track of the read position. When the retcount argument is 0, the end of the log has been reached.

The format of the test log is

```
error-number, error message <newline>
```

The test log remains readable in the instrument until either the line power is turned off or another cfSelftest, cfCal, cfCalStandard, or cfCalTransfer command is given.

## cfReset

### *Syntax*

```
int cfReset(CF_HANDLE server);
```

### *Description*

Sets most programmable functions to their power-on states. This command clears any previously defined sequence steps and sequence tests and aborts any sequence that may be in progress. All cell outputs are set to the off state.

cfReset does not affect settings of the following: cfGetSerialConfig, cfReadSerial, cfGetSerialStatus, or digital configuration. It does not clear any logs or data queues.

## cfResetSeq

### *Syntax*

```
int cfResetSeq(CF_HANDLE server);
```

### *Description*

Clears any previously defined sequence steps and sequence tests and aborts any sequence that may be in progress. The server argument can be either a handle to a group obtained by cfOpenGroup, or a handle to all cells in the instrument if no groups are defined.

## 6 - Language Dictionary

### cfRestart

*Syntax*

```
int cfRestart(CF_HANDLE server);
```

*Description*

This command causes the Agilent MCCD to recall a previously saved restart state. The Agilent MCCD must be in the CF\_IDLE state to perform a restart. The existence of a restart state can be queried by testing the CF\_RESTART bit of the status returned from cfGetInstStatus.

### cfSaveOutputConfig

*Syntax*

```
int cfSaveOutputConfig(CF_HANDLE server);
```

*Description*

This command causes the output configuration setting of each channel to be saved in non-volatile memory. These settings are set by cfSetOutputConfig.

### cfSelftest

---

**CAUTION:** Selftest causes voltage to be applied to the outputs. Make sure that no cells are connected when executing cfSelftest.

---

*Syntax*

```
int cfSelftest(CF_HANDLE server, int *reserved);
```

*Description*

This command starts an instrument selftest. This selftest is more thorough than the selftest that is performed automatically at power-on. The cell supply outputs should be disconnected from any cells or other loads before the cfSelftest function is called.

This function returns an integer value in the location pointed to by the reserved argument. The returned value should be ignored, but you must supply a pointer to an integer which will hold the return value.

Since a selftest can take many seconds to complete, the cfSelftest function does not wait for selftest to complete but returns immediately after starting selftest. During the selftest, the CF\_SELFTEST\_STAT bit is true in the status word returned by cfGetInstStatus. When selftest is finished, the CF\_SELFTEST\_STAT bit goes false. If any errors occur during selftest, the CF\_SELFTEST\_ERROR\_STAT bit is true. Details of the errors can be obtained using cfReadTestLog. The test log retains this error information until another selftest or calibration command is given.

*See Also*

cfReadTestLog, cf GetInstStatus



## cfSetAutoConnect

### Syntax

```
int cfSetAutoConnect(CF_HANDLE server, CF_BOOLEAN on_off);
```

### Description

This command turns the automatic reconnect feature of the mccd.dll file located on the client computer on or off. The Agilent MCCD mainframe server will close a connection if there is no activity for a period longer than the time set by cfSetServerTimeout. If the automatic reconnect feature is set to CF\_ON, the client mccd.dll will automatically try to reconnect to an Agilent MCCD mainframe server whose connection has been lost whenever an API function call is made. If the automatic reconnect feature is set to CF\_OFF, API functions will return an error if the server connection has been lost. In this case client programs should make sure that they communicate with the server at intervals smaller than the time set by cfSetServerTimeout, or the server will close the connection due to inactivity.

At the time the mccd.dll is first loaded, the auto connect feature is set to CF\_ON.

## cfSetCurrent

---

**CAUTION**     **Direct output control should not be used for charging cells. There is no protection against overcharging when using direct output control. Use this mode only for diagnostic and debugging purposes.**

---

### Syntax

```
int cfSetCurrent(CF_HANDLE server, float current);
```

### Description

Sets the output current in the IDLE state for diagnostic or debugging purposes. The server argument can be either a handle to a group obtained by cfOpenGroup, or a handle to all cells in the instrument if no groups are defined.

Agilent MCCD outputs can be directly controlled for diagnostic and debugging purposes without defining a sequence of steps and tests. Direct output control commands can only be used in the CF\_IDLE state. Voltage, current, and output state settings are set on all outputs simultaneously. Whenever the unit leaves the CF\_IDLE state, settings are reset to their power-on values.

### See Also

cfGetCurrent, cfSetVoltage, cfSetOutputState

**cfSetDigitalConfig****Syntax**

```
int cfSetDigitalConfig(CF_HANDLE server, int bitnum, CF_EXT_SIGNAL
signal, CF_POLARITY polarity, CF_REFERENCE reference);
```

**Description**

---

**NOTE:** The Agilent MCCD Configuration screens (see chapter 3) control the availability of cfSetDigitalConfig. If this menu item is set to lock out programmable access, cfSetDigitalConfig will return the error CF\_ACCESS\_DENIED

---

Sets the operation of any of the 16 pins of the digital I/O port. Digital I/O bits can be configured as independent chassis-referenced bits that can be used as inputs or outputs, or as isolated output pairs. When configured as isolated output pairs, each even numbered bit and the odd numbered bit that immediately follows it form a pair. For example, Bit 0 and bit 1 form a pair, bit 2 and bit 3 form a pair, etc., up to a maximum of 8 pairs.

The bitnum argument specifies the bit to be programmed and is a number between 0 and 15. 0 represents the least significant bit in the digital word that is set and read by cfSetDigitalPort and cfGetDigitalPort. The reference argument sets the configuration of a bit to either CF\_GROUNDED or CF\_ISOLATED. Values set by cfSetDigitalConfig are stored in non-volatile memory and are not affected by the power off or by cfReset.

**CF\_GROUNDED Operation**

In CF\_GROUNDED operation, the bit designated by the bitnum argument is configured as an independent, single-ended chassis-referenced bit that can be used as an input, output, or both input and output. Each bit must be configured separately in CF\_GROUNDED operation.

The polarity of a bit is set using the polarity argument. If the polarity is CF\_HIGH\_TRUE and the bit is configured as an output, then a 1 sent to the bit set by cfSetDigitalPort will be output as a high level at the connector. Likewise, if the bit is configured as an input, a high level at the connector will be returned as a 1 by cfGetDigitalPort. If the polarity is set to CF\_LOW\_TRUE, then the opposite polarity will be used for both output and input. The following table summarizes the choices for the signal argument in CF\_GROUNDED operation:

<b>CF_EXT_FAULT_IN</b>	External Fault input
<b>CF_EXT_FAULT_OUT</b>	External Fault output (has the same logical value as External Fault input)
<b>CF_EXT_INTERLOCK</b>	External Interlock input
<b>CF_EXT_TRIGGER</b>	External Trigger input
<b>CF_DIG_IN</b>	General purpose input
<b>CF_DIG_OUT</b>	General purpose output
<b>CF_DIG_INOUT</b>	General purpose input/output
<b>CF_POWER_FAIL_IN</b>	External Power Fail input
<b>CF_POWER_FAIL_OUT</b>	External Power Fail output. Goes true when a power-fail shutdown state is saved. Goes false at power-on, cfInitiate(), or cfRestart().
<b>CF_DIG_OUT_AND_NOT_FAULT_IN</b>	Combines a CF_DIG_OUT function with enabling logic from CF_EXT_FAULT_IN. When an External Fault Input is true, the OUTPUT_AND_NOT_FAULT_IN pin is held false.

When an output signal is programmed, the pin is driven by an open collector transistor. Writing a word to the port using `cfSetDigitalPort` will turn the transistor on or off based on the word and the *polarity* of the bit. Reading the port using `cfGetDigitalPort` returns the last value written to the bit.

When an input signal is programmed, the state of the input can be read using `cfGetDigitalPort`. Writing to the port has no affect on the bit.

When `CF_DIG_INOUT` is programmed, the bit can be used as both an input and an output. Writing a word that causes the output to go high turns the output transistor off and allows an external device to drive the port high or low. Writing a word that causes the output to go low turns the transistor on and drives the port bit low. Reading the port returns the actual state of the port, not the programmed value.

---

**NOTE:** If an even bit that was previously configured as `CF_ISOLATED` is set to `CF_GROUNDED`, the attributes of its adjacent paired bit (the odd bit) default to `CF_GROUNDED`, `CF_DIG_INOUT`, and `CF_LOW_TRUE`, unless otherwise programmed.

---

### *CF\_ISOLATED Operation*

When the reference argument is set to `CF_ISOLATED`, each even numbered bit and the odd numbered bit that immediately follows it form a pair. The pins on the output connector that correspond to each bit-pair are the plus and minus outputs of an optical isolator. The bit argument can be either the even or odd numbered bit of a pair when `cfSetDigitalConfig` is called. However, *only the even numbered bit of the pair is used to set the logic level of the output* with `cfSetDigitalPort`. `cfSetDigitalPort` ignores the odd numbered bits of any pair that is configured as `CF_ISOLATED`.

Any bit-pair whose reference is set to `CF_ISOLATED` can be used as a general purpose output by setting the signal argument to `CF_DIG_OUT`. The pair can also be used as an isolated fault output by setting the signal argument to `CF_EXT_FAULT_OUT`. The following table summarizes the signal choices for `CF_ISOLATED` operation:

<b>CF_EXT_FAULT_OUT</b>	External Fault output (has the same logical value as External Fault input)
<b>CF_DIG_OUT</b>	General purpose output
<b>CF_POWER_FAIL_OUT</b>	External Power Fail output.
<b>CF_DIG_OUT_AND_NOT_FAULT_IN</b>	Combines a <code>CF_DIG_OUT</code> function with enabling logic from <code>CF_EXT_FAULT_IN</code> .

The polarity of an `CF_ISOLATED` pair is set using the polarity argument. If the polarity is `CF_HIGH_TRUE`, then a 1 sent to the pair's even numbered bit by `cfSetDigitalPort` will be output as a high level at the connector. If the polarity is `CF_LOW_TRUE`, then a 1 sent to the pair's even numbered bit will be output as a low level at the connector.

Any pair that is set to `CF_ISOLATED` cannot be used as a digital input. The data returned by `cfGetDigitalPort` for a `CF_ISOLATED` pair consists of the programmed value in the even numbered bit and a 0 in the odd numbered bit.

### *See Also*

`cfSetDigitalPort`, `cfGetDigitalConfig`

**cfSetDigitalPort****Syntax**

```
int cfSetDigitalPort(CF_HANDLE server, int data);
```

**Description**

Write data to the digital I/O port. Data must be sent as the equivalent of a 16-bit binary word. For example, sending a value of 0 sets all bits low. Sending a value of 65,535 sets all bits high. Use the following values to set individual digital I/O bits:

bit #	value	bit #	value	bit #	value	bit #	value
0	1	4	16	8	256	12	4096
1	2	5	32	9	512	13	8192
2	4	6	64	10	1024	14	16,384
3	8	7	128	11	2048	15	32,768

Combine the above values to program multiple bits. For example, to set bits 3, 7, 10, and 11, send 3208 (8 + 128 + 1024 + 2048).

**See Also**

cfGetDigitalPort, cfGetDigitalConfig

**cfSetErrorFunction****Syntax**

```
int cfSetErrorFunction(void(*ErrorFn)(CF_HANDLE server, char *name, int
errorcode));
```

**Description**

Defines an error function that will be called by other instrument functions when they detect a non-zero return value. The argument ErrorFn is a pointer to a function returning void with 3 arguments. The application program can use this mechanism to be notified whenever a error value is returned from any of the Agilent MCCD library functions.

A null pointer can be passed as the ErrorFn argument function, in which case the error callback mechanism is turned off.

If a library function that does not have a server handle argument returns an error; the error function will be called with the server parameter value of CF\_NULL\_SERVER.

**Example**

```
void report_mccd_error(CF_HANDLE server, char *name, int error)
{
    printf("MCCD server returned error %d from API function %s\n",
        error, name);
}
main()
{
    /* Initialization code not shown here. */
    cfSetErrorFunction(report_mccd_error);
}
```

## cfSetGroup

### Syntax

```
int cfSetGroup(CF_HANDLE server, char *name, int start, int size);
```

### Description

Defines a group of cells by specifying a starting cell number and the total number of cells in the group. Name is a null terminated character string that serves to identify the group. Once the group has been created, a handle can be obtained using cfOpenGroup for subsequent control with API functions. Groups are volatile and disappear when the ac power is turned off. The number of characters in name must be less than CF\_MAX\_GROUP\_NAME\_LEN.

If the group name is longer than CF\_MAX\_GROUP\_NAME\_LEN - 1 characters, or if the name is a null string, an error is returned. The size argument must be greater than 0 or an error is returned.

## cfSetMeasLogInterval

### Syntax

```
int cfSetMeasLogInterval(CF_HANDLE server, int step_number, float volt_interval, float curr_interval, float time_interval);
```

### Description

Sets the voltage, current, and time change criteria for causing a new measure log entry to be written. The server argument can be either a handle to a group obtained by cfOpenGroup, or a handle to all cells in the instrument if no groups are defined. The step\_number argument can either be an individual step number or the constant CF\_ALL\_STEPS to set the criteria for all steps to the same values. Whenever a forming sequence is running (instrument state is CF\_FORMING) a measurement log entry will be made if any of the following are true:

- ◆ The measured cell voltage has changed by volt\_interval volts since the last entry.
- ◆ The measured cell current has changed by curr\_interval amperes since the last entry.
- ◆ Time\_interval seconds have elapsed since the last entry.

Setting any of these values to the special value of CF\_INFINITY will effectively turn off logging based on that particular parameter.

## cfSetOutputConfig

### Syntax

```
int cfSetOutputConfig(CF_HANDLE server, int first_cell, int last_cell, CF_OUTPUT_CONFIG config);
```

### Description

Set the configuration of an output to either CF\_SET\_ACTIVE or CF\_SET\_INACTIVE. All cells included in the range from first\_cell to last\_cell are set to the requested configuration. A cell that is set to CF\_SET\_INACTIVE ignores all output and forming commands. Measurements for these cells always return the special value CF\_NOT\_A\_NUMBER.

---

**NOTE:** This command only affects outputs that are in the Idle state. An error is generated and the command is ignored if any cells within the specified range are not in the Idle state.

---

## cfSetOutputProbeTest

---

**NOTE:** The Agilent MCCD must be configured for remote voltage sensing to perform output probe testing. No output probe tests are performed if local voltage sensing is configured.

---

### *Syntax*

```
int cfSetOutputProbeTest(CF_HANDLE server, float resistance);
```

### *Description*

Sets the resistance limit which is used when the output probes are tested during a forming sequence. The server argument can be either a handle to a group obtained by cfOpenGroup, or a handle to all cells in the instrument if no groups are defined. The resistance of the output probes is measured periodically during forming as long as the voltage difference between the power and sense probes is greater than 50mV. If the probe resistance is higher than the value set, the cell is marked as a failure. Automatic checking of output probe resistance is disabled by sending the resistance value of CF\_INFINITY.

## cfSetOutputState

---

**CAUTION** Direct output control should not be used for charging cells. There is no protection against overcharging when using direct output control. Use this mode only for diagnostic and debugging purposes.

---

### *Syntax*

```
int cfSetOutputState(CF_HANDLE server, CF_OUTPUT_STATE state);
```

### *Description*

Set the output state for diagnostic or debugging purposes. The server argument can be either a handle to a group obtained by cfOpenGroup, or a handle to all cells in the instrument if no groups are defined.

A state value of CF\_OUTPUT\_OFF sets the output state of the cell to OFF.

CF\_OUTPUT\_CHARGE sets the output so that it can supply charge.

CF\_OUTPUT\_DISCHARGE sets the output so that it can discharge (sink current) In the off state, the channel outputs are open-circuited and supply no current. In both the charge and discharge states, the channel outputs are controlled by cfSetVoltage and cfSetCurrent.

Agilent MCCD outputs can be directly controlled for diagnostic and debugging purposes without defining a sequence of steps and tests. Direct output control commands can only be used in the CF\_IDLE state. Voltage, current, and output state settings are set on all outputs simultaneously. Whenever the unit leaves the CF\_IDLE state, settings are reset to their power-on values.

### *See Also*

cfGetOutputState, cfSetVoltage, cfSetCurrent

## cfSetSense

### *Syntax*

```
int cfSetSense(CF_HANDLE server, CF_SENSE sense);
```

### *Description*

Sets voltage sense to remote or local sense. The sense argument is either CF\_SENSE\_REMOTE or CF\_SENSE\_LOCAL. The sense setting is stored in non-volatile memory and is retained when the ac power is off.

### *See Also*

cfGetSense

## cfSetSenseProbeTest

---

**NOTE:** The Agilent MCCD must be configured for remote voltage sensing to perform output probe testing. No output probe tests are performed if local voltage sensing is configured.

---

### *Syntax*

```
int cfSetSenseProbeTest(CF_HANDLE server, CF_BOOLEAN on_off);
```

### *Description*

Enables or disables the automatic testing of the remote sense probe resistance. The server argument can be either a handle to a group obtained by cfOpenGroup, or a handle to all cells in the instrument if no groups are defined.

When this test is enabled, the instrument periodically measures the resistance of the sense probes during a sequence, and checks for a value that is low enough to allow accurate voltage measurements. If the probe resistance is too high and the testing is enabled, the forming sequence will be terminated for that cell.

The instrument cannot distinguish between resistance in the sense probes and output resistance in the cell. It will not attempt to check sense probe resistance if the output voltage and current are not adequate to make the resistance measurement.

## cfSetSeqStep

### *Syntax*

```
int cfSetSeqStep(CF_HANDLE server, int step_number, CF_SEQ_OUT out_type, float voltage, float current, float time, float reserved);
```

### *Description*

Defines output sequence steps in terms of output regulation type, voltage limit, current limit, time, and an argument reserved for use with future enhancements (program the unused parameter to zero). The server argument can be either a handle to a group obtained by cfOpenGroup, or a handle to all cells in the instrument if no groups are defined. The output regulation types are:

## 6 - Language Dictionary

<b>CF_CHARGE</b>	Constant voltage/constant current charge
<b>CF_DISCHARGE</b>	Constant voltage/constant current discharge
<b>CF_REST</b>	Rest (output in high impedance state)
<b>CF_ACR</b>	AC resistance measurement
<b>CF_DCR</b>	DC resistance measurement
<b>CF_TAG_ACR</b>	Makes an ac resistance measurement which is identified in the measure log as a TaggedACR entry type.
<b>CF_TAG_DCR</b>	Makes an dc resistance measurement which is identified in the measure log as a TaggedDCR entry type.
<b>CF_TAG_OCV</b>	Makes an open circuit voltage measurement which is identified in the measure log as a TaggedOCV entry type.
<b>CF_TAG_CUM_AH</b>	Writes the cumulative ampere hours to the measure log as a TaggedCumAH entry type.
<b>CF_TAG_CUM_WH</b>	Writes the cumulative watt hours to the measure log as a TaggedCumAH entry type.
<b>CF_RESET_CUM_AH</b>	Resets the cumulative ampere hours measurement to zero.
<b>CF_RESET_CUM_WH</b>	Resets the cumulative watt hours measurement to zero.

There are two classes of step types. Charge, discharge, and rest step types define periods of time with specific stimulus to the cells. For these step types, the maximum duration of the step is given by the time argument in seconds. Transitions to the next state before the time period has elapsed can be affected by actions defined by the function `cfSetSeqTest`.

Other step types are used to control measurements and generate entries into the measure log. For these step types, the time argument is ignored, and the duration of the step is only the time required to perform the action associated with the step. For example, ACR and DCR measurements can be made at specific steps in the sequence. These can be either tagged or untagged measurements. Tagged measurements can be retrieved from the measurement log using a query filter which returns only these entries. Untagged measurements can also be read from the log, but these measurements cannot be queried selectively and will be returned along with all other entries when the entire log is read.

The Agilent MCCD also measures cell capacities in both ampere hours and watt hours. These capacities are reset to zero at the beginning of each sequence step, and they are reported as part of the standard measurements in each measure log entry. The Agilent MCCD also has the ability to accumulate capacity over several sequence steps. Special step types are provided to reset these cumulative capacities and to send them to the measure log at specific steps in the sequence. These are tagged measurements, which are retrieved using a query filter.

There is little capability to edit sequence steps. If a `step_number` is sent that is already defined, the new `step_number` settings replace the previous settings. There is no way to insert a new step between two previously defined steps, or to delete a single step. `cfResetSeq` deletes all sequence steps and tests, and should be sent prior to defining a new set of sequence steps and tests. If a forming sequence is in progress when `cfSetSeqStep` is given, an error is returned.

### *See Also*

`cfReset`, `cfSetSeqTest`, `cfGetSeqStep`



## cfSetSeqTest

### Syntax

```
int cfSetSeqTest(CF_HANDLE server, int step_number, CF_SEQ_TEST
meas_test_type, float limit, CF_TIME_TEST time_test_type, float time,
CF_SEQ_ACTION action);
```

### Description

Define tests performed during sequence steps. These tests allow a cell to advance to the next step when a measured value is achieved, or to fail a cell and remove it from further stimulus if a failure limit is exceeded. The server argument can be either a handle to a group obtained by cfOpenGroup, or a handle to all cells in the instrument if no groups are defined.

*step\_number* references the corresponding number from cfSetSeqStep.

*meas\_test\_type* is one of:

<b>CF_VOLT_GE</b>	The cell voltage that is greater than or equal to the programmed <i>limit</i>
<b>CF_VOLT_LE</b>	The cell voltage that is less than or equal to the programmed <i>limit</i>
<b>CF_CURR_GE</b>	The cell current that is greater than or equal to the programmed <i>limit</i>
<b>CF_CURR_LE</b>	The cell current that is less than or equal to the programmed <i>limit</i>
<b>CF_ACR_GE</b>	The cell ac resistance that is greater than or equal to the programmed <i>limit</i>
<b>CF_ACR_LE</b>	The cell ac resistance that is less than or equal to the programmed <i>limit</i>
<b>CF_DCR_GE</b>	The cell dc resistance that is greater than or equal to the programmed <i>limit</i>
<b>CF_DCR_LE</b>	The cell dc resistance that is less than or equal to the programmed <i>limit</i>
<b>CF_POWER_GE</b>	The absolute value of cell power in Watts (cell voltage x cell current) that is greater than or equal to the programmed <i>limit</i> .
<b>CF_POWER_LE</b>	The absolute value of cell power in Watts (cell voltage x cell current) that is less than or equal to the programmed <i>limit</i> .
<b>CF_AMPH_GE</b>	The absolute value of cell capacity in Ampere-hours that is greater than or equal to the programmed <i>limit</i> .
<b>CF_AMPH_LE</b>	The absolute value of cell capacity in Ampere-hours that is less than or equal to the programmed <i>limit</i> .
<b>CF_WATTH_GE</b>	The absolute value of cell capacity in Watt-hours that is greater than or equal to the programmed <i>limit</i> .
<b>CF_WATTH_LE</b>	The absolute value of cell capacity in Watt-hours that is less than or equal to the programmed <i>limit</i> .
<b>CF_POS_DVDT_GE</b>	The change in voltage during the standard measurement interval that is positive and greater than or equal to the programmed <i>limit</i> .
<b>CF_POS_DVDT_LE</b>	The change in voltage during the standard measurement interval that is positive and less than or equal to the programmed <i>limit</i> .
<b>CF_NEG_DVDT_GE</b>	The change in voltage during the standard measurement interval that is negative, and the magnitude of the change is greater than or equal to the programmed <i>limit</i> .
<b>CF_NEG_DVDT_LE</b>	The change in voltage during the standard measurement interval that is negative, and the magnitude of the change is less than or equal to the programmed <i>limit</i> .
<b>CF_POS_DIDT_GE</b>	The change in the magnitude of current during the standard measurement interval that is positive and greater than or equal to the programmed <i>limit</i> .
<b>CF_POS_DIDT_LE</b>	The change in the magnitude of current during the standard measurement interval that is positive and less than or equal to the programmed <i>limit</i> .
<b>CF_NEG_DIDT_GE</b>	The change in the magnitude of current during the standard measurement interval that is negative, and the magnitude of the change is greater than or equal to the programmed <i>limit</i> .

## 6 - Language Dictionary

<b>CF_NEG_DIDT_LE</b>	The change in the magnitude of current during the standard measurement interval that is negative, and the magnitude of the change is less than or equal to the programmed <i>limit</i> .
<b>CF_DVMAX_GE</b>	The magnitude of the difference between the voltage and the maximum voltage observed during the step that is greater than or equal to the programmed <i>limit</i> .
<b>CF_DVMAX_LE</b>	The magnitude of the difference between the voltage and the maximum voltage observed during the step that is less than or equal to the programmed <i>limit</i> .
<b>CF_DVMIN_GE</b>	The magnitude of the difference between the voltage and the minimum voltage observed during the step that is greater than or equal to the programmed <i>limit</i> .
<b>CF_DVMIN_LE</b>	The magnitude of the difference between the voltage and the minimum voltage observed during the step that is less than or equal to the programmed <i>limit</i> .
<b>CF_DIMAX_GE</b>	The magnitude of the difference between the absolute value of current and the maximum absolute value of current observed during the step that is greater than or equal to the programmed <i>limit</i> .
<b>CF_DIMAX_LE</b>	The magnitude of the difference between the absolute value of current and the maximum absolute value of current observed during the step that is less than or equal to the programmed <i>limit</i> .
<b>CF_DIMIN_GE</b>	The magnitude of the difference between the absolute value of current and the minimum absolute value of current observed during the step that is greater than or equal to the programmed <i>limit</i> .
<b>CF_DIMIN_LE</b>	The magnitude of the difference between the absolute value of current and the minimum absolute value of current observed during the step that is less than or equal to the programmed <i>limit</i> .

*time\_test\_type* is one of:

<b>CF_TEST_BEFORE</b>	Action is taken if the measurement test is true before the <i>time</i> argument
<b>CF_TEST_AT</b>	Action is taken if the measurement test is true at the <i>time</i> argument
<b>CF_TEST_AFTER</b>	Action is taken if the measurement test is true after the <i>time</i> argument
<b>CF_TEST_BEFORE_STIMULUS</b>	Action is taken if the measurement test is true <i>before</i> the stimulus is applied for this step. The outputs are in a reset condition during this test. The <i>time</i> argument is ignored for this <i>time_test_type</i> .

*time* is in seconds relative to the beginning of the present step number

*action* is the action taken when the *meas\_test\_type* and *time\_test\_type* are both satisfied. The action choices are:

<b>CF_NEXT</b>	Advance as soon as possible to the next step, short circuiting all remaining tests in the present step.
<b>CF_FAIL</b>	Mark the cell as a failure and disconnect it. No further tests or steps are applied to the cell.

---

**NOTE:** CF\_ACR\_LE and CF\_ACR\_GE can only be used with CF\_ACR steps.  
CF\_DCR\_LE and CF\_DCR\_GE can only be used with CF\_DCR steps.  
Other *meas\_test\_types* cannot be used with CF\_ACR or CF\_DCR steps.

---

You cannot delete a single test. *cfResetSeq* deletes all sequence steps and tests, and should be sent prior to defining a new set of sequence steps and tests. If a forming sequence is in progress when *cfSetSeqTest* is given, an error is returned.

## cfSetSeqTestAnd

### Syntax

```
int cfSetSeqTestAnd(CF_HANDLE server, int step_number, CF_SEQ_TEST
*meas_test_type, float *limit, CF_TIME_TEST time_test_type, float time,
CF_SEQ_ACTION action, int count);
```

### Description

This command is similar to `cfSetSeqTest`, but it allows multiple tests that are combined with a logical AND during a sequence. The action is not taken unless all measurement tests are true. The server argument can be either a handle to a group obtained by `cfOpenGroup`, or a handle to all cells in the instrument if no groups are defined. The count argument defines how many tests are contained in the `meas_tests_type` and `limit` array arguments.

The maximum number of tests that can be passed in the `meas_tests_type[]` and `limit[]` arrays is defined by the macro `CF_MAX_AND_TESTS`.

### Example

```
/* This example defines a test that will advance to the next step when
 * the voltage is less than 3.1 V and the current is less than 0.5A
 */
CF_SEQ_TEST meas_test[CF_MAX_AND_TESTS];
float limit[CF_MAX_AND_TESTS];
meas_test[0] = CF_VOLT_LE;
limit[0] = 3.1;
meas_test[1] = CF_CURR_LE;
limit[1] = 0.5;
cfSetSeqTestAnd(server, 1, meas_test, limit CF_TEST_AFTER, 0.0,
CF_NEXT, 2);
```

## cfSetSerialConfig

### Syntax

```
int cfSetSerialConfig(CF_HANDLE server, CF_SERIAL_PORT port, int
baudrate, CF_SERIAL_PARITY parity, int wordsize, CF_SERIAL_FLOW
flow_ctrl);
```

### Description

Sets the communication parameters of one of the serial ports.

<b>port</b>	CF_PORTA or CF_PORTB
<b>baudrate</b>	1200, 2400, 4800, 9600, or 19200
<b>parity</b>	CF_PARITY_EVEN, CF_PARITY_ODD, or CF_PARITY_NONE
<b>wordsize</b>	7 or 8
<b>flow_ctrl</b>	CF_FLOW_RTS_CTS, CF_FLOW_XON_XOFF, or CF_FLOW_NONE

## cfSetServerTimeout

### Syntax

```
int cfSetServerTimeout(CF_HANDLE server, float timeout);
```

### Description

This command sets the connection inactivity time-out period. The Agilent MCCD server will close a connection if there is no activity on it for a period longer than this time-out value. At power-on and after `cfReset`, the time-out value is set to 60 seconds.

## **cfSetShutdownDelay**

*Syntax*

```
int cfSetShutdownDelay(CF_HANDLE server, float delay);
```

*Description*

Sets the delay between the assertion of a true signal at a CF\_POWER\_FAIL\_IN input and the start of an Agilent MCCD shutdown when the shutdown mode has been set to CF\_AUTO. At power-on this time-out is set to 60 seconds. If the shutdown mode has been set to CF\_MANUAL, the delay has no effect.

## **cfSetShutdownMode**

*Syntax*

```
int cfSetShutdownMode(CF_HANDLE server, int mode);
```

*Description*

Sets the shutdown mode to CF\_AUTO or CF\_MANUAL. When set to CF\_AUTO, a true signal on the CF\_POWER\_FAIL\_IN input will cause the Agilent MCCD to execute a shutdown after the shutdown delay has elapsed if a valid restart state does not already exist. When set to CF\_MANUAL, the Agilent MCCD does not execute an automatic shutdown in response to a true CF\_POWER\_FAIL\_IN input (however it still reports the input state in the CF\_POWER\_FAIL\_STAT bit of instrument status).

The Agilent MCCD will not automatically save a restart state if a previously saved state still exists. Restart states are deleted on cfInitiate and cfRestart. The existence of a restart state can be queried by testing the CF\_RESTART bit of the status returned from cfGetInstStatus.

The power-on setting for cfSetShutdownMode is CF\_MANUAL.

## **cfSetTimeout**

*Syntax*

```
int cfSetTimeout(float timeout);
```

*Description*

Sets the maximum time in seconds that the client will wait for a response from an Agilent MCCD server. The default timeout value if not explicitly set is 30 seconds.

## **cfSetTrigSource**

*Syntax*

```
int cfSetTrigSource(CF_HANDLE server, CF_TRIG_SOURCE source);
```

*Description*

Sets the sequence trigger source to CF\_LAN or CF\_EXTERNAL. When set to CF\_LAN, a forming sequence in can be triggered using cfTrigger. When set to CF\_EXTERNAL, a forming sequence is triggered by a true signal on the digital input which is mapped into External Trigger. The server argument can be either a handle to a group obtained by cfOpenGroup, or a handle to all cells in the instrument if no groups are defined.

## cfSetVoltage

---

**CAUTION** Direct output control should not be used for charging cells. There is no protection against overcharging when using direct output control. Use this mode only for diagnostic and debugging purposes.

---

### *Syntax*

```
int cfSetVoltage(CF_HANDLE server, float voltage);
```

### *Description*

Sets the output voltage for diagnostic or debugging purposes. The server argument can be either a handle to a group obtained by cfOpenGroup, or a handle to all cells in the instrument if no groups are defined.

Agilent MCCD outputs can be directly controlled for diagnostic and debugging purposes without defining a sequence of steps and tests. Direct output control commands can only be used in the CF\_IDLE state. Voltage, current, and output state settings are set on all outputs simultaneously. Whenever the unit leaves the CF\_IDLE state, settings are reset to their power-on values.

## cfShutdown

### *Syntax*

```
int cfShutdown(CF_HANDLE server);
```

### *Description*

This command causes the Agilent MCCD to:

- Go to the CF\_PROTECTED state (causes CF\_SHUTDOWN\_STAT to become true in the status returned by cfGetInstStatus).
- Save its current state in non-volatile memory for later use with cfRestart.
- Assert a CF\_POWER\_FAIL\_OUT digital out signal.

Information in the saved state includes all sequence steps and tests. If a sequence is running (CF\_FORMING state), it includes the current state of each cell in the forming sequence, including its current step number, time in step, capacity, and pass/fail status. The measurement log is also saved. If the Agilent MCCD is in CF\_IDLE, the pass/fail results of the previous sequence and its measure log are saved.

## cfStateDelete

### *Syntax*

```
int cfStateDelete(CF_HANDLE server, char *state);
```

### *Description*

Deletes a named instrument state previously created with cfStateSave.

## 6 - Language Dictionary

### **cfStateList**

#### *Syntax*

```
int cfStateList(CF_HANDLE server, char *buffer);
```

#### *Description*

Returns a comma-separated and null terminated list of instrument state names that are stored on the server. The buffer must be large enough to hold a list of the names of the maximum number of states that can be saved in a Cell Forming Server. The constant `CF_MAX_STATE_LIST_LEN` can be used to allocate space for the buffer.

#### *Example*

```
char list_buffer[CF_MAX_STATE_LIST_LEN];

/* Read and print the list of instrument state names. */
cfStateList(server, list_buffer);
printf("%s\n", list_buffer);
```

### **cfStateRecall**

#### *Syntax*

```
int cfStateRecall(CF_HANDLE server, char *state);
```

#### *Description*

Loads a named instrument state previously created with `cfStateSave`. The server argument can be either a handle to a group obtained by `cfOpenGroup`, or a handle to all cells in the instrument if no groups are defined. All programmable functions of the instrument are set to the values stored in the state. This command also aborts any forming sequence that is in progress, setting the forming state to `CF_IDLE`.

### **cfStateSave**

#### *Syntax*

```
int cfStateSave(CF_HANDLE server, char *state);
```

#### *Description*

Saves the current instrument settings in a non-volatile state with the name given by the state parameter. The server argument can be either a handle to a group obtained by `cfOpenGroup`, or a handle to all cells in the instrument if no groups are defined. If a state already exists with the given name, the old state is over-written. State names are limited to `CF_MAX_STATE_NAME_LEN` characters in length.

### **cfTrigger**

#### *Syntax*

```
int cfTrigger(CF_HANDLE server);
```

#### *Description*

Sends a trigger from the `CF_LAN` trigger source. The server argument can be either a handle to a group obtained by `cfOpenGroup`, or a handle to all cells in the instrument if no groups are defined.

## **cfWriteSerial**

### ***Syntax***

```
int cfWriteSerial(CF_HANDLE server, CF_SERIAL_PORT port, char  
*port_data, int count);
```

### ***Description***

Writes count data words to the serial port.

### ***See Also***

cfSerialStatus, cfReadSerial, cfSerialConfig





## C Program Examples

---

### Example 1

This following C program shows you how to implement the example discussed in the beginning of chapter 5 using the API cell forming (cf) functions. The cell forming functions are included with the driver software supplied with the Agilent E4373A documentation package.

```
#include <stdio.h>
#include <mccd.h>

#define SECONDS_PER_MINUTE 60.0f

void setup(CF_HANDLE server);

main()
{
    CF_HANDLE server;
    int err_ret;
    char buf[CF_MEAS_LOG_BUFSIZE];
    int retcount;
    FILE *fp;
    CF_READP read_pos;
    CF_RUN_STATE presentState;

    /* Open the server connection */
    if (cfOpen("15.14.248.100", &server, "mypassword")) {
        printf("Cannot connect to Agilent MCCD\n");
        exit(1);
    }

    /* Reset the server to power-on defaults */
    cfReset(server);

    /* Set the trigger source to LAN */
    cfSetTrigSource(server, CF_LAN);

    /* Program the charge/discharge sequence */
    setup(server);

    /* Initiate sequence and check for sequence consistency */
    if (err_ret = cfInitiate(server)) {
        printf("Initiate error, code %d\n", err_ret);
        exit(err_ret);
    }

    /* Wait for runstate CF_INITIATED. */
    do {
        Sleep(1000);
        cfGetRunState(server, &presentState);
    }
```

## 7 - C Program Examples

```
    } while(presentState != CF_INITIATED);

    /* Start the sequence */
    cfTrigger(server);

    /* Wait for the sequence to end */
    do {
        cfGetRunState(server, &presentState);
        /* sleep or do something else */
    } while(presentState == CF_FORMING);

    /* Read entire measurement log and write it to a disk file */
    fp = fopen("logfile", "w");
    for (read_pos = CF_READ_FIRST; ; ) {
        cfReadMeasLog(server, &read_pos, CF_ALL_CELLS, CF_ALL_STEPS,
            CF_MEAS_LOG_BUFSIZE, buf, &retcount);
        if (retcount)
            fputs(buf, fp);
        else
            break;
    }
    fclose(fp);

    /* Close the server connection */
    cfClose(server);

    return(0);
}

/* Program the charge/discharge sequence */
void setup(CF_HANDLE server)
{
    /* Step 1 and tests. */
    cfSetSeqStep(server, 1, CF_CHARGE, 4.2, 0.295,
        20 * SECONDS_PER_MINUTE, 0.0);
    cfSetSeqTest(server, 1, CF_VOLT_GE, 3.8, CF_TEST_BEFORE,
        5 * SECONDS_PER_MINUTE, CF_FAIL);
    cfSetSeqTest(server, 1, CF_CURR_LE, 0.02, CF_TEST_AFTER,
        5 * SECONDS_PER_MINUTE, CF_NEXT);

    /* Step 2 is a rest step. */
    cfSetSeqStep(server, 2, CF_REST, 0.0, 0.0);
        10 * SECONDS_PER_MINUTE, 0.0);

    /* Step 3 and tests. */
    cfSetSeqStep(server, 3, CF_DISCHARGE, 3, 0.295,
        15 * SECONDS_PER_MINUTE, 0.0);
    cfSetSeqTest(server, 3, CF_VOLT_LE, 3, CF_TEST_BEFORE,
        5 * SECONDS_PER_MINUTE, CF_FAIL);
    cfSetSeqTest(server, 3, CF_VOLT_LE, 3, CF_TEST_AFTER,
        5 * SECONDS_PER_MINUTE, CF_NEXT);
    cfSetSeqTest(server, 3, CF_VOLT_GE, 3, CF_TEST_AT,
        15 * SECONDS_PER_MINUTE, CF_FAIL);

    /* Step 4 is a rest step. */
    cfSetSeqStep(server, 4, CF_REST, 0.0, 0.0);
        5 * SECONDS_PER_MINUTE, 0.0);
}
```

## Example 2

This following C program shows you how to implement the example discussed at the end of chapter 1 using the API cell forming functions. Note that this example only includes a brief cell forming sequence and does not include error checking after each function call. It primarily describes how you can incorporate the various high-level features of the Agilent MCCD such as the digital I/O and the serial ports in a cell forming sequence.

Serial port A is programmed to operate in passthrough mode, so that information from a barcode reader that is connected to port A is directly sent to the PC.

To match the example at the end of chapter 1, the digital ports are programmed as follows:

Pins 0, 1, and 2 are programmed as low-true general purpose digital inputs. To use the digital inputs connect a switch from the digital port to ground. Pin 0 is connected to the fixture switch. Pin 1 is connected to the Start button. Pin 2 is connected to a smoke detector switch. With the switches open, an internal +5Vpullup resistor sets these inputs high or FALSE. With the switches closed, the digital inputs are connected to common or low TRUE.

Pins 8 and 9 are programmed as low true general purpose outputs. To use the digital outputs connect a light from the digital port to a +24V source such as the auxiliary output. Pin 8 is connected to the Ready light. Pin 9 is connected to the Test light. When programmed to 0 (FALSE), the digital port is an open circuit and the light is off. When programmed to 1 (TRUE), the digital port is connected to common and the light turns on.

```

/* sample1.c */

#include <windows.h>
#include <stdio.h>
#include <stdlib.h>
#include <string.h>
#include <io.h>
#include "mccd.h"

/* Default server address and password */
#define DEFAULT_SERVER "15.14.250.125"
#define DEFAULT_PASSWORD "mypassword"

/* Digital port bit definitions */
#define DIG_FIXTURE_READY 0x0001
#define DIG_START_BUTTON 0x0002
#define DIG_SMOKE_DETECT 0x0004
#define DIG_READY_LIGHT 0x0100
#define DIG_TEST_LIGHT 0x0200

#define CLIENT_TIMEOUT 60.0f
#define MAX_BARCODE 256
#define LOG_FILE "MCCDLOG.TXT"
#define MEAS_BUF_SIZE 1024

/* Local function prototypes */
void APIError(CF_HANDLE hServer, char *szName, int nError);
char *RunStateToString(CF_RUN_STATE state);

```

## 7 - C Program Examples

```
/*
*****
Main function
*****
void main(int argc, char *argv[])
{
    char *szServerAddr = DEFAULT_SERVER;
    char *szPassword = DEFAULT_PASSWORD;
    CF_HANDLE hServer;
    int nResult;
    int nDigitalPort;
    char szBarCodeMsg[MAX_BARCODE];
    int nBarCodeCount;
    int nRunState;
    CF_READP readPos;
    FILE *hFile;
    char szMeasBuffer[MEAS_BUF_SIZE];
    int nMeasBufCount;
    float fCellResistance[CF_MAX_CELLS];

    /* Open a connection to an MCCD. */
    nResult = cfOpen(szServerAddr, &hServer, szPassword);
    if (nResult != CF_OK)
    {
        printf("Could not connect to MCCD: %s\n", szServerAddr);
        APIError(hServer, "cfOpen", nResult);
    }
    printf("Connected to MCCD: %s\n", szServerAddr);

    /*
     * Setup the client API DLL.
     */

    /* Install a central error handler function. */
    cfSetErrorFunction(APIError);

    /* Set the client timeout period. */
    cfSetTimeout(CLIENT_TIMEOUT);

    /*
     * Setup the MCCD server.
     */

    /* Reset the server to power-on defaults. */
    cfReset(hServer);

    /* Set voltage sense to remote. */
    cfSetSense(hServer, CF_SENSE_REMOTE);

    /* Set trigger source to LAN. */
    cfSetTrigSource(hServer, CF_LAN);

    /* Set measurement log intervals for all sequence steps. */
    cfSetMeasLogInterval(hServer, CF_ALL_STEPS, 0.1f, 0.1f, CF_INFINITY);

    /* Set serial port A configuration to use with bar code reader. */
    cfSetSerialConfig(hServer, CF_PORTA, 9600,
                      CF_PARITY_NONE, 8, CF_FLOW_NONE);

    /* Enable probe tip checking. */
    cfSetSenseProbeTest(hServer, CF_ON);
}
*/
```

```

/* Configure resistance limit for output probe test. */
cfSetOutputProbeTest(hServer, 0.1f);

/* Mark outputs 65 - 256 as unused by this fixture. */
cfSetOutputConfig(hServer, 1, 14, CF_SET_ACTIVE);
cfSetOutputConfig(hServer, 15, 256, CF_SET_INACTIVE);

/*
 * Turn on the fixture ready light to tell the operator that the
 * system is ready for a new tray of cells.
 */
cfGetDigitalPort(hServer, &nDigitalPort);
nDigitalPort |= DIG_READY_LIGHT;
cfSetDigitalPort(hServer, nDigitalPort);

/*
 * Poll serial port A for data from the bar code reader.
 */
while (1)
{
    cfReadSerial(hServer, CF_PORTA, MAX_BARCODE,
                 szBarCodeMsg, &nBarCodeCount);
    /* Check the data for a token that indicates end of data.
     * When token is found, break out of loop. (not shown)
     */
    break;
    /* Sleep for 1 second to suspend this process, but allow
     * other processes to continue to run.
     */
    Sleep(1000);
}

/*
 * Process the barcode message to determine what forming sequence
 * should be downloaded to the fixture. (not shown in this example)
 */

/* Download the forming sequence. */
cfSetSeqStep(hServer, 1, CF_CHARGE, 4.0f, 1.0f, 300.0f, 0.0f);
cfSetSeqStep(hServer, 2, CF_REST, 0.0f, 0.0f, 60.0f, 0.0f);
cfSetSeqStep(hServer, 3, CF_DISCHARGE, 0.5f, 2.0f, 120.0f, 0.0f);
cfSetSeqTest(hServer, 1, CF_VOLT_LE, 0.5f, CF_TEST_AFTER, 120.0f,
CF_FAIL);
cfSetSeqTest(hServer, 1, CF_VOLT_GE, 4.0f, CF_TEST_AFTER, 0.0f, CF_NEXT);
cfSetSeqTest(hServer, 3, CF_VOLT_LE, 1.0f, CF_TEST_AFTER, 0.0f, CF_NEXT);

/* Poll the fixture; wait until it is closed. */
while (1)
{
    cfGetDigitalPort(hServer, &nDigitalPort);
    if (nDigitalPort & DIG_FIXTURE_READY)
        break;
    /* Sleep for 1 second. */
    Sleep(1000);
}
/*
 * Poll digital port for START button pressed.
 * Since lines are not latched, must press button > 1 second.
 */
while (1)

```

## 7 - C Program Examples

```
{
    cfGetDigitalPort(hServer, &nDigitalPort);
    if (nDigitalPort & DIG_START_BUTTON)
        break;
    /* Sleep for 1 second. */
    Sleep(1000);
}
/*
 * Turn off the READY light and turn on the TEST light
 * to indicate to the operator that cell forming has started.
 */
cfGetDigitalPort(hServer, &nDigitalPort);
nDigitalPort &= ~DIG_READY_LIGHT;
nDigitalPort |= DIG_TEST_LIGHT;
cfSetDigitalPort(hServer, nDigitalPort);

/* Initiate the sequence. */
cfInitiate(hServer);

/*
 * Wait for sequencer to transition to initiated state.
 * This may take up to 1 minute while data logs are erased.
 */
while (1)
{
    cfGetRunState(hServer, &nRunState);
    if (nRunState == CF_INITIATED)
        break;
    Sleep(1000);
}
/* Trigger the sequence. */
cfTrigger(hServer);
printf("Forming sequence started.\n");

/*
 * The sequence is now running.
 * Display the sequencer state until it finishes.
 */
while (1)
{
    Sleep(5000);
    cfGetRunState(hServer, &nRunState);
    printf("Runstate = %s\r", RunStateToString(nRunState));
    if (nRunState == CF_IDLE)
        break;
}
/* The sequence is finished. */
/* Read the entire measurement log to a file. */
if((hFile = fopen(LOG_FILE, "w")) != NULL)
{
    readPos = CF_READ_FIRST;
    while (1)
    {
        cfReadMeasLog(hServer, &readPos, CF_ALL_CELLS, CF_ALL_STEPS,
            MEAS_BUF_SIZE, szMeasBuffer, &nMeasBufCount);
        if (nMeasBufCount == 0)
            break;
        fwrite(szMeasBuffer, sizeof(char), nMeasBufCount, hFile);
    }
    fclose(hFile);
}
```

```

/* Measure the internal resistance of all cells. */
cfMeasACResistance(hServer, CF_ALL_CELLS, fCellResistance);

/*
 * Turn off the TEST light and turn on the READY light
 * to indicate that it the tray can be removed from the fixture.
 */
cfGetDigitalPort(hServer, &nDigitalPort);
nDigitalPort &= ~DIG_TEST_LIGHT;
nDigitalPort |= DIG_READY_LIGHT;
cfSetDigitalPort(hServer, nDigitalPort);
printf("Forming sequence complete.\n");

/* Close the server connection. */
cfClose(hServer);
exit(0);
}

/*****
API error handler.
*****/
void APIError(CF_HANDLE hServer, char *szName, int nError)
{
    printf("\nServer = %d Function = %s Error = %d\n",
           hServer, szName, nError);
    cfClose(hServer);
    exit(1);
}

/*****
Convert sequence run state to a description string.
*****/
char *RunStateToString(CF_RUN_STATE state)
{
    switch (state) {
        case CF_NOT_READY:
            return "CF_NOT_READY ";
        case CF_IDLE:
            return "CF_IDLE ";
        case CF_ERASING:
            return "CF_ERASING ";
        case CF_INITIATED:
            return "CF_INITIATED ";
        case CF_FORMING:
            return "CF_FORMING ";
        case CF_INTERLOCKED:
            return "CF_INTERLOCKED";
        case CF_PROTECTED:
            return "CF_PROTECTED ";
        case CF_HW_FAILED:
            return "CF_HW_FAILED ";
    }
    return("Unknown state");
}
}

```

## Example 3

You can control up to 16 Agilent MCCDs from one PC and still achieve good system responsiveness, depending on the application program structure.

This following C program example uses a multi-threaded program in which each thread can independently control one Agilent MCCD but can share data with a user interface thread. This provides the advantage of a central system view of all of the Agilent MCCDs, with the simplicity of each thread controlling only one Agilent MCCD. With this type of program, you must be careful to use synchronization objects to access any shared data. Overall, using a multi-threaded program is simpler than writing a single-threaded program to control multiple Agilent MCCDs.

```
#include <windows.h>
#include <stdio.h>
#include <time.h>
#include "mccd.h"

#define MEAS_BUF_SIZE CF_MEAS_LOG_BUFSIZE
#define LINE_SIZE 80
#define PASSWORD "mufasa"

// Structure for thread information
typedef struct {
    char *szAddr;
    char *szLogFile;
    HANDLE hStart;
} THREAD_INFO;

THREAD_INFO ThreadInfo[] = {
    {"15.14.250.130", "mccdlog0.txt", NULL},
    {"15.14.250.124", "mccdlog1.txt", NULL},
};

// Local function prototypes
void GetTimeStamp(char *szTimeStamp);
void ErrorHandler(CF_HANDLE server, char *function, int errorcode);
DWORD WINAPI ReadThread(LPVOID lpvThreadParm);

/*****
Main function
*****/
void main (int argc, char *argv[])
{
    DWORD dwThreadId;
    HANDLE hReadThread0, hReadThread1;

    // Create events to signal threads to start reading.
    ThreadInfo[0].hStart = CreateEvent(NULL, FALSE, FALSE, NULL);
    ThreadInfo[1].hStart = CreateEvent(NULL, FALSE, FALSE, NULL);

    // Create threads to read log from MCCDs.
    hReadThread0 = CreateThread(NULL, 0, ReadThread, (LPVOID)0, 0,
    &dwThreadId);
    hReadThread1 = CreateThread(NULL, 0, ReadThread, (LPVOID)1, 0,
    &dwThreadId);
}
```



```

// Signal threads to start reading logs.
SetEvent(ThreadInfo[0].hStart);
SetEvent(ThreadInfo[1].hStart);

// Wait for threads to terminate.
WaitForSingleObject(hReadThread0, INFINITE);
WaitForSingleObject(hReadThread1, INFINITE);
printf("Press any key to exit\n");
getchar();
}
/*****
Thread to read log from MCCD.
*****/
DWORD WINAPI ReadThread(LPVOID lpvThreadParm)
{
    int nThread = (int)lpvThreadParm;
    CF_READP readPos;
    FILE *hFile;
    char szMeasBuffer[MEAS_BUF_SIZE];
    char szTimeStamp[LINE_SIZE];
    int nMeasBufCount;
    CF_HANDLE hServer;

    // Wait for a signal to start reading the data logs.
    WaitForSingleObject(ThreadInfo[nThread].hStart, INFINITE);

    // Open a connection to MCCD.
    printf("Thread %d trying MCCD: %s\n", nThread,
ThreadInfo[nThread].szAddr);
    if (cfOpen(ThreadInfo[nThread].szAddr, &hServer, PASSWORD) != CF_OK) {
        printf("Thread %d could not connect to MCCD: %s\n",
            nThread, ThreadInfo[nThread].szAddr);
        return 1;
    }
    printf("Thread %d connected to MCCD: %s\n", nThread,
ThreadInfo[nThread].szAddr);

    // Read the measurement log to a file.
    if((hFile = fopen(ThreadInfo[nThread].szLogFile, "w")) != NULL) {
        GetTimeStamp(szTimeStamp);
        fwrite(szTimeStamp, sizeof(char), strlen(szTimeStamp), hFile);
        readPos = CF_READ_FIRST;
        while (1) {
            cfReadMeasLog(hServer, &readPos, CF_ALL_CELLS, CF_ALL_STEPS,
                MEAS_BUF_SIZE, szMeasBuffer, &nMeasBufCount);
            if (nMeasBufCount == 0)
                break;
            fwrite(szMeasBuffer, sizeof(char), nMeasBufCount, hFile);
        }
        GetTimeStamp(szTimeStamp);
        fwrite(szTimeStamp, sizeof(char), strlen(szTimeStamp), hFile);
        fclose(hFile);
    }
    return 0;
}

```

## 7 - C Program Examples

```
/*
Return a timestamp string.
*/
void GetTimeStamp(char *szTimeStamp)
{
    char buf[128];

    _strdate(szTimeStamp);
    strcat(szTimeStamp, " ");
    _strtime(buf);
    strcat(szTimeStamp, buf);
    strcat(szTimeStamp, "\r\n");
}

/*
Error handler function.
*/
void ErrorHandler(CF_HANDLE server, char *name, int error)
{
    printf("ErrorHandler: Server = %d Function = %s Error = %d\n",
           server, name, error);
}
```

## Specifications

### Hardware Specifications

Specifications in Table A-1 are warranted. Specifications apply over an ambient temperature range of 0° C to 40° C. When charging, specifications apply for charging voltages from 0.5 V to maximum, and charge currents from minimum to maximum. When discharging, specifications apply for discharging voltages from 1.5 V to maximum and discharging currents from minimum to maximum. Accuracy specifications apply over the entire range of ac line and power bus conditions (line regulation), and charging/discharging levels (load regulation). Specifications are subject to change without notice.

**Table A-1. Agilent E4370A/E4374A MCCD Specifications**

Parameter	Condition	Value
<b>Maximum Programmable Output Voltage</b>	charging	5 V
<b>Maximum Compliance Voltage</b> (cell voltage + fixture/wiring voltage drops)	charging	5.5 V
<b>Maximum Programmable Output Current</b>	charging or discharging, per channel	2 A
<b>Maximum Output Leakage Current</b>	disabled, per channel, with an external voltage of -5V to +5 V	± 25 µA
<b>Maximum Power</b>	charging, per channel discharging, per channel	11 W 9 W
<b>Maximum Input Voltage</b>	discharging	4.5 V
<b>Voltage Programming Accuracy</b>	measured at sense connector input with remote sensing	± 1 mV
<b>Voltage Readback Accuracy</b>	measured at sense connector input with remote sensing	± 1 mV
<b>Current Programming Accuracy</b>	% of reading + offset ≤ 1A > 1A	± (0.05% + 1 mA) ± (0.1% + 1 mA)
<b>Current Readback Accuracy</b>	% of reading + offset ≤ 1A > 1A	± (0.05% + 1 mA) ± (0.1% + 1 mA)
<b>ac Resistance Measurement Accuracy</b>	% of reading + offset	± (1% + 1 mΩ)
<b>dc Resistance Measurement Accuracy</b>	% of reading + offset	± (1% + 1 mΩ)

Tables A-2 through A-4 list the supplemental characteristics of the Agilent E4370A/E4374A/E4371A MCCD System. Requirements for the external power bus source are also listed. Characteristics are not warranted but are descriptions of typical performance determined either by design or by type testing.

A - Specifications

**Table A-2. Agilent E4370A/E4374A MCCD Characteristics**

Parameter	Condition	Value
<b>ac Resistance Measurement</b>	maximum measurable	1 $\Omega$
	maximum time/output to measure <sup>1</sup>	1 s
<b>dc Resistance Measurement</b>	maximum measurable	1 $\Omega$
	maximum time/output to measure <sup>1</sup>	1 s
<b>Ah Capacity Measurement Accuracy</b>	% of reading + offset	$\pm (0.01\% + 1 \text{ mAh/h})$
<b>Wh Capacity Measurement Accuracy</b>	% of reading + offset	$\pm (0.01\% + 5 \text{ mWh/h})$
<b>Maximum Deviation of Measured Output Current from Programmed Output Current</b>	constant current mode	$\pm 2 \text{ mA}$
<b>Maximum Deviation of Measured Output Voltage from Programmed Output Voltage</b>	constant current mode	$\pm 2 \text{ mV}$
<b>Voltage Output Noise<sup>2</sup></b>	rms	30 mV
	peak-to-peak	100 mV
<b>Current Output Noise<sup>2</sup></b>	rms	1 mA
	peak-to-peak	10 mA
<b>Maximum Current Overshoot</b>	maximum duration of less than 5 ms	5 %
<b>Maximum Voltage Overshoot</b>		25 mV
<b>Maximum Current Risetime</b>		0.1 s
<b>Minimum Programming Current</b>	charging and discharging mode	25 mA
<b>Measurement Interval</b>	for data logging	1 s
	for sequence tests	1 s
	for probe check/channel <sup>3</sup>	1 s
<b>Step Time Interval</b>	maximum	596 hours
	minimum	1 s
<b>Maximum Number of Readings in Data Buffer</b>		349,504
<b>Maximum Sequence Length</b>		596 hours
<b>Maximum Number of Steps in Sequence</b>		100
<b>Maximum Number of Defined Groups</b>	for mainframes with 256 channels	8
<b>ac Input Line Requirements</b>	input voltage range	95 Vac - 250 Vac
	input frequency range	47 Hz - 63 Hz
	maximum input power	300 W
	max. current @ 100/120 Vac	4 A
	max. current @ 220/240 Vac	2 A
<b>Maximum Sense Probe Resistance<sup>3</sup></b>		1 k $\Omega$
<b>Auxiliary bias output power</b>	max. @ 5 to 24V/0.42 to 2 A	10 W
<b>Auxiliary bias output voltage</b>	max. @ 0 to 0.42A	24 V
	min. @ 0 to 2 A	5 V
<b>Auxiliary bias output current</b>	max. @ 5 V output	2 A
	min. @ 24 V output	0.42 A
<b>Auxiliary bias output voltage accuracy</b>	% of setting at any voltage and current	7 %
<b>Auxiliary bias output noise</b>	peak to peak at any voltage and current	100 mV

**Notes:**

<sup>1</sup>To measure 256 cells takes up to 5 minutes.

<sup>2</sup>At the power connector, with a bandwidth of 20Hz to 20MHz.

<sup>3</sup>To measure output probe resistance accurately there must be 50 mV between the +/- power leads and the +/- sense leads. To measure sense probe resistance accurately there must be 100 mV of cell voltage.

**Table A-2. Agilent E4370A/E4374A MCCD Characteristics (continued)**

Parameter	Condition	Value
<b>Non-isolated Digital I/O Characteristics</b>	max. low-level output voltage	0.4 V @ 20 mA sink 1 V @ 300 mA sink
	min. high-level output voltage	3.5 V @ 0 mA source 2.6V @ -200 $\mu$ A source
	max. high-level output current	250 $\mu$ A @ Voh = 24 V
	min. high-level input voltage	2.1 V
	max. low-level input voltage	0.5 V
	max. high-level input current	0.8 mA @ Vih min.
<b>Isolated Digital I/O Characteristics</b>	max. low-level output voltage max. high-level output current	0.6 V 100 $\mu$ A
<b>Maximum Airflow</b>	cubic meters per minute cubic feet per minute	7.1 250
<b>Maximum Exhaust Air Temperature Rise</b>	from inlet air to exhaust air	8 deg C
<b>Dimensions</b>	Height	221.5 mm
	Width	425.5 mm
	Depth	540.5 mm
<b>Weight</b>	for 1 mainframe with 4 cards	22 kg

**Table A-3. Agilent E4371A Powerbus Load Characteristics**

Use this information when integrating the Agilent E4371A Powerbus Load into your system.

Parameter	Condition	Value
<b>Recommended Maximum Power Dissipation</b>		5,400 W
<b>Normal Input Voltage</b>		26.5 - 27 Vdc
<b>Recommended Maximum Input Current</b>		200 A
<b>Maximum Wiring Voltage Drop between Agilent MCCD and Agilent Powerbus Load</b>	at maximum current	1.5 V
<b>Maximum Exhaust Air Temperature Rise</b>	from inlet air to exhaust air	40 deg C
<b>Maximum Airflow</b>	cubic meters per minute	10
	cubic feet per minute	350
<b>Dimensions</b>	Height	221.5 mm
	Width	425.5 mm
	Depth	540.5 mm
<b>Weight</b>		22.7 kg

**Table A-4. Requirements for External Power Bus Source**

Parameter	Condition	Value
<b>Nominal Output Voltage</b>		24 Vdc
<b>Output Voltage Range</b>		22.8 - 25.2 Vdc
<b>Voltage Output Noise<sup>1</sup></b>	rms	30 mV
	peak-to-peak	100 mV
<b>Maximum Output Current</b>	for <b>one</b> Agilent MCCD mainframe with 256 channels charging	133 A @ 5V, 2A/channel
<b>Maximum Output Power</b>	for <b>one</b> Agilent MCCD mainframe with 256 channels charging	3,200 W @ 5V, 2A/channel

**Notes:**

<sup>1</sup>Measured at the output, with a bandwidth of 20Hz to 20MHz.



# Calibration

---

## Calibration Types

There are three types of calibration available for the Agilent E4370A/E4374A MCCD.

- ◆ Full calibration, which calibrates the Agilent E4370A MCCD mainframe and all installed Agilent E4374A Charger/Discharger cards.
- ◆ Transfer calibration, which calibrates only the Agilent E4374A Charger/Discharger cards that are installed in the mainframe.
- ◆ Mainframe reference calibration, which calibrates only the Agilent E4370A MCCD mainframe.

Full calibration actually consists of mainframe reference calibration, which uses an external voltmeter to calibrate the internal reference voltages in the Agilent MCCD mainframe, followed by a transfer calibration, which uses the calibrated internal reference in the mainframe to calibrate all of the channels on the Agilent E4374A Charger/Discharger Cards. The entire process takes about fifteen minutes for 256 channels.

---

**CAUTION:** Make sure that no cells are connected when performing a Full Calibration or a Transfer calibration.

---

### Calibration Interval:

Full calibration of each Agilent E4370A/E4374A MCCD should be performed at 12 month intervals.

Transfer calibration must be performed whenever you install a new or a repaired charger/discharger card in the mainframe.

### Full Calibration

Calibration is accomplished by connecting a DMM to the rear calibration terminals of the power mainframe. A 24 volt dc source must be connected to the power bus. The internal references are then calibrated using a built-in program. This program will directly control the system voltmeter connected to the Port B RS-232 interface, and supports Agilent 3458A command sets. The calibrated reference voltages are then used to calibrate all charger/discharger cards through internal multiplexing circuitry using the transfer calibration process. You can execute a full calibration whenever the Agilent MCCD is in CF\_IDLE state. See table B-1 for the equipment list.

## Transfer Calibration

---

**NOTE:** Transfer calibration does not require an external voltmeter. It can be performed independently of the full calibration or the mainframe reference calibration. However, transfer calibration requires a 24 volt dc source to be connected to the power bus.

---

During transfer calibration, each individual channel is sequentially connected to the internal reference and gain and offset corrections are calculated and stored in non-volatile memory. You can execute a transfer calibration only when the Agilent MCCD is in CF\_IDLE state. Press the rear panel transfer calibration switch. This is useful if you have replaced a card in the mainframe after it has been serviced. See table B-1 for the equipment list.

## Mainframe Reference Calibration

Mainframe reference calibration (also referred to as standard calibration) calibrates the internal references in the Agilent MCCD mainframe. It requires an external voltmeter to be connected to Serial Port A of the Agilent MCCD. Refer to Figure B-1 for equipment connections. Mainframe reference calibration can be performed without having any Agilent E4374A cards installed in the mainframe, neither does mainframe reference calibration require a 24 Vdc source to be connected to the power bus.

**Table B-1. Calibration Equipment Required**

Equipment	Full Calibration	Mainframe Reference Calibration	Transfer Calibration
Agilent 3458A DMM	X	X	
24 V power bus or 24 V dc supply	X	X <sup>1</sup>	X
National Instruments GP-IB to RS-232 Converter <sup>2</sup>	X	X	
GPIB and RS-232 cable	X	X	
Wires to connect Agilent 3458A DMM to Agilent MCCD (AWG 16 recommended)	X	X	
Wires to connect 24 V dc supply to Agilent MCCD (AWG 16 recommended)	X		X

<sup>1</sup> A 24V dc supply is not required if there are no cards installed in the mainframe.

<sup>2</sup> To order the GPIB-232CV-A GP-IB-to-RS-232 converter, you need to know the part number for the country in which you will be using the device. Contact your local National Instruments office or access the Web at [www.nationalinstruments.com](http://www.nationalinstruments.com) for the appropriate part number and ordering information.

## Calibration Connections

Figure B-1 illustrated the calibration connections. Set the switches on the National Instruments GP-IB/RS-232 Converter box as shown in the figure. Make sure the Agilent 3458A GPIB address is set to 22. If you cannot connect the Agilent MCCD to the 24 V power bus, you can substitute a dc source rated at 24 V, 1 A.

---

**NOTE:** Always turn on the voltmeter **before** you turn on the RS232 converter.

---



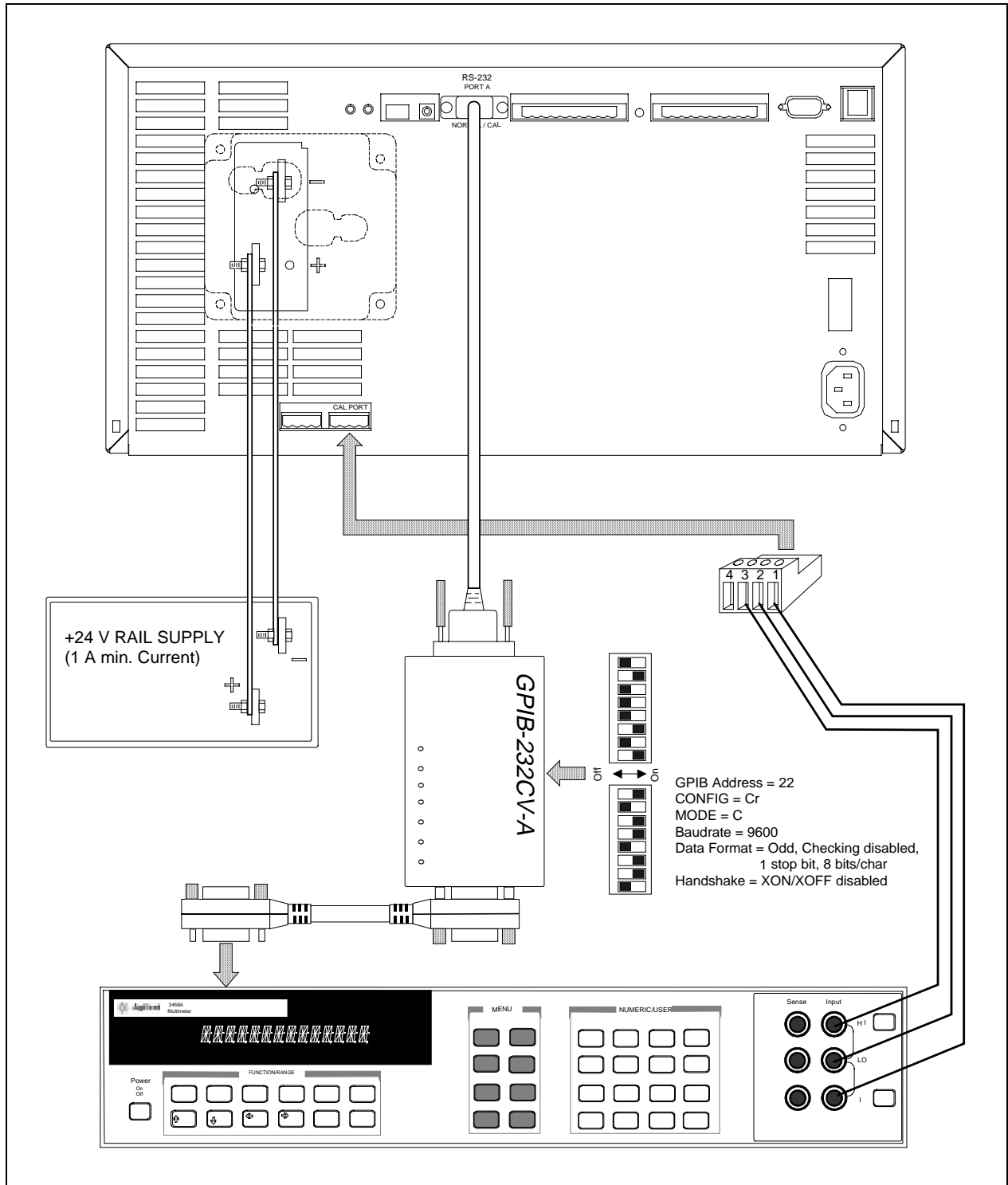

Figure B-1. Calibration Connections

---

## Accessing Calibration

Calibration control is accessible by one of three methods:

- ◆ the Agilent MCCD Configuration Screens,
- ◆ API calls over the LAN,
- ◆ the Web-based Agilent MCCD User Interface.

This section describes the first method in detail.

---

**Note:** Transfer calibration can also be run by pressing the Cal button on the rear panel.

---

### Agilent MCCD Configuration Screens

You can calibrate the Agilent MCCD using the Agilent MCCD Configuration Screens on your PC. Chapter 2 describes how to run this program.

To calibrate the Agilent MCCD using the Agilent MCCD Configuration Screens, flip the Port B switch (#4) on the back of the Agilent E4370A down (from Normal to Configure) and run the HyperTerminal program. When the Agilent MCCD Configuration Screens appear, select 4 to calibrate the Agilent E4370A MCCD mainframe and the Agilent E4374A Charger/Discharger.

Select 1 to perform a full calibration. Select 2 to perform a transfer calibration. Select 3 to perform a mainframe calibration, which calibrates only the mainframe reference voltage.

```
During full calibration and mainframe-reference calibration, a DMM
and Powerbus power supply must be connected to the MCCD. For the DMM,
connect to serial Port A with settings: 9600 baud, NO Parity, 8 bits.
Connect the DMM's inputs as follows: Input Hi to Cal Port 3, Input Lo
to Cal Port 2, and Current to Cal port 1.
```

```
During transfer calibration the Powerbus power supply must be
connected to the MCCD. Inactive outputs will not be calibrated.
Disconnected sense and load leads before calibrating.
```

- 1) Execute full calibration  
(takes approx 5 seconds per active channel.)
- 2) Execute transfer calibration  
(Takes approx 5 seconds per active channel.)
- 3) Execute Mainframe-reference calibration  
(takes approx 30 seconds.)
- 4) Set DMM model (HP3458 currently active)

```
Type a number and press Enter or ctrl-G to return to initial screen
```

## Rear panel transfer calibration switch

This push button switch is accessible through a recessed hole on the rear panel. When pressed, it initiates a transfer calibration sequence inside the Agilent MCCD. This is useful if you have replaced an Agilent E4374A Charger/Discharger card inside the mainframe. Note that the transfer calibration re-calibrates all of the cards inside the mainframe. Indicator lights next to the transfer calibration switch indicate the calibration status.

## API Calls over the LAN

The following API calls let you access the calibration functions:

<b>cfCal</b>	begins a full calibration (mainframe and card)
<b>cfCalStandard</b>	begins a standard calibration (mainframe)
<b>cfCalTransfer</b>	begins a transfer calibration (card)

Refer to chapter 6 for more information about these API function calls.

## Web-based Graphical User Interface

Refer to the on-line help provided with the Agilent MCCD User Interface for calibration information.

---

## Calibration Error Messages

The two LEDs on the rear panel indicate the status of calibration and report calibration errors. More extensive text-based error reporting is available through the Agilent MCCD User Interface and the API functions.

<b>CAL IN PROGRESS</b>	When flashing, it indicates that a calibration is in progress. Turns off when calibration is complete.
<b>CAL FAILED</b>	When lit, indicates that calibration has failed. Use this indicator in combination with the text based error reporting to isolate a failure as either on a card or on the mainframe.

To read the text based calibration error messages, use the `cfReadSelftestLog()` API function. If you are using the Agilent MCCD User Interface, you can read the error messages by accessing the System page, selecting Calibration and Selftest, and then clicking on Calibration Log. Write down the calibration error message and contact your Agilent Service Engineer.



## Dimension Drawings

Figure C-1 shows a simplified outline diagram of the Agilent E4370A M CCD mainframe. Figure C-2 shows a simplified outline diagram of the Agilent E4371A Powerbus Load.

The dimension drawings included in the back of this documentation binder provide additional information.

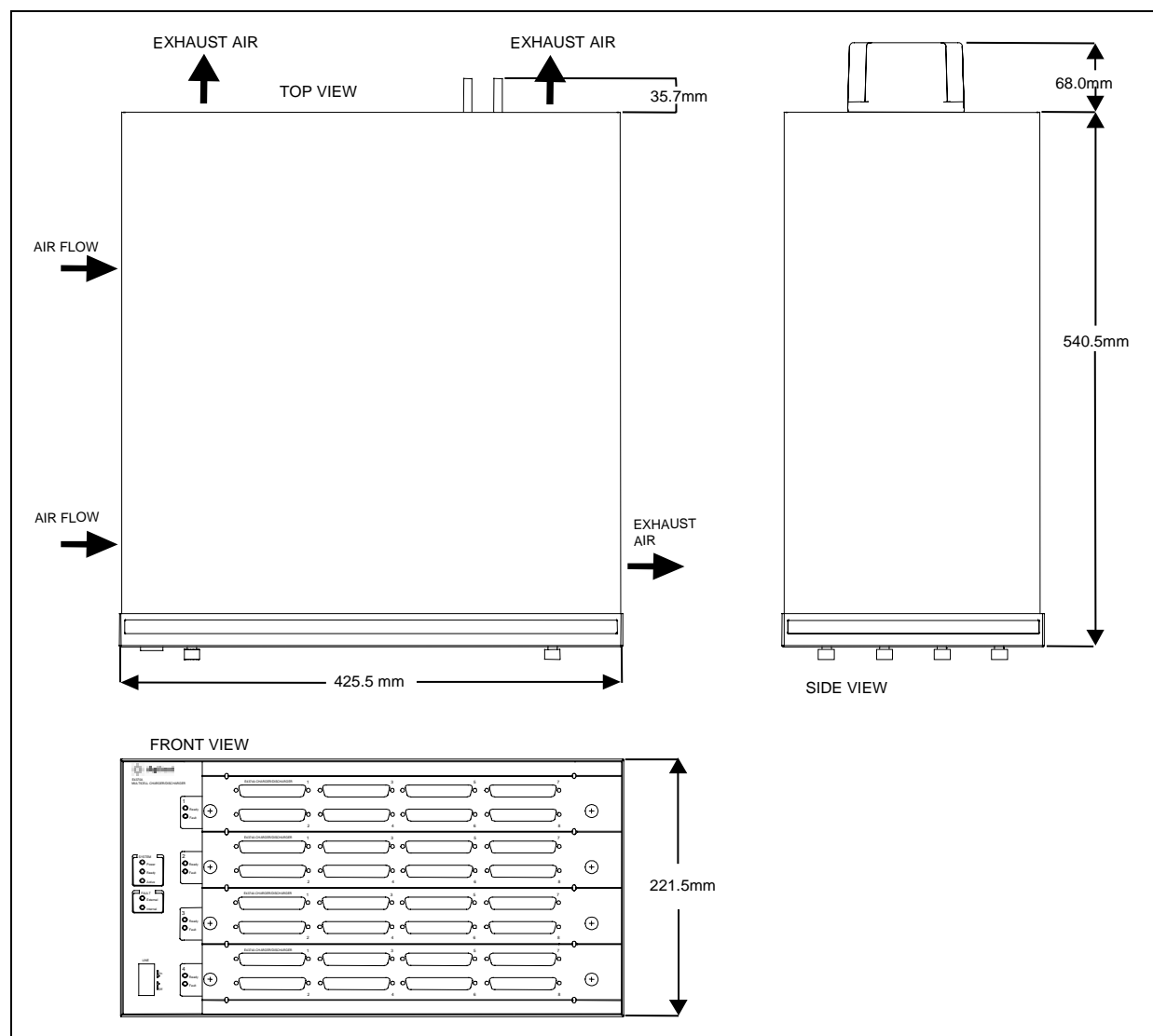
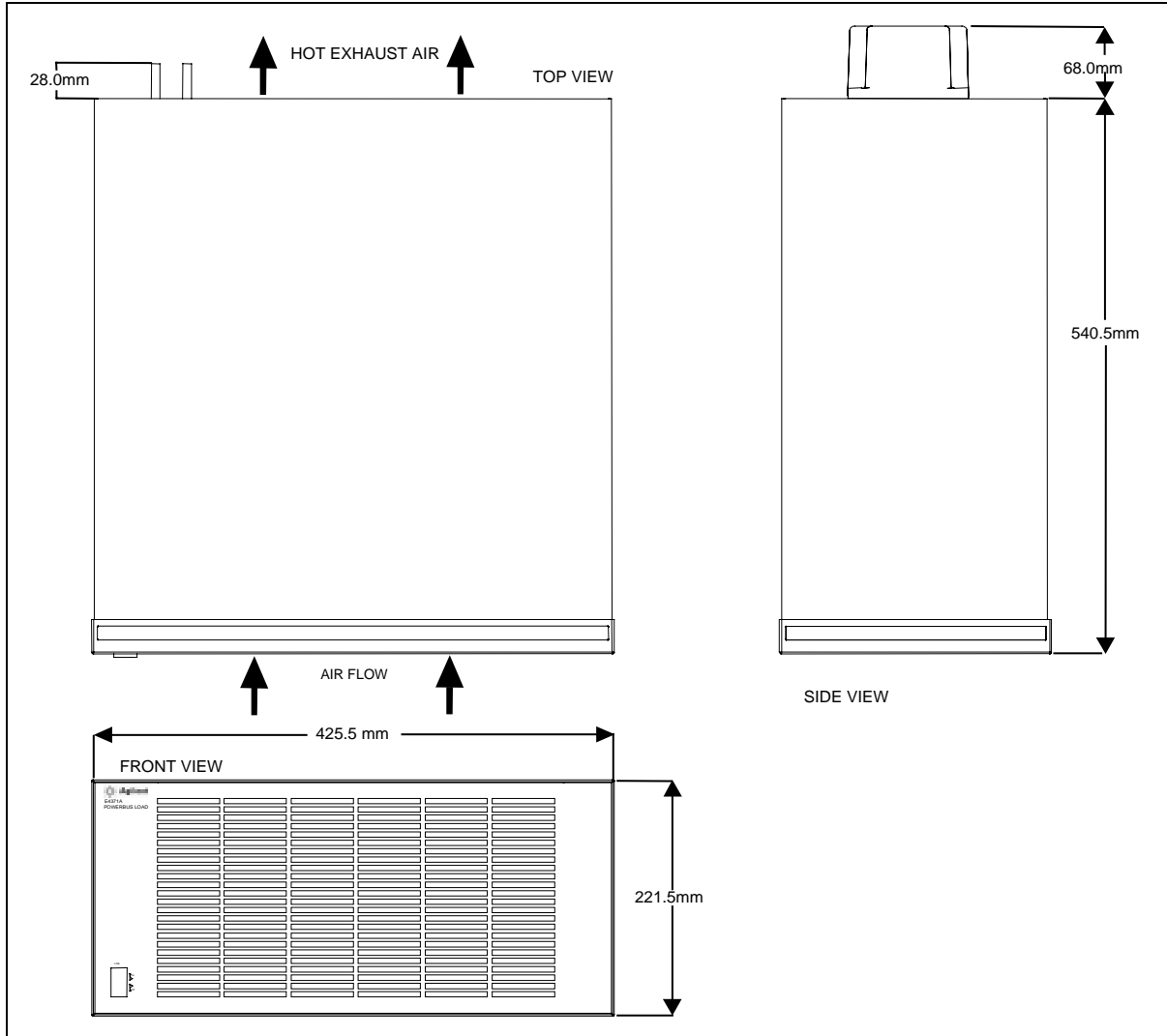

Figure C-1. Agilent M CCD Simplified Outline Diagram

## C - Dimension Drawings



**Figure C-2. Agilent Powerbus Load Simplified Outline Diagram**

# D

## Sense and Power Connector Pinouts

The figures and tables in this appendix document the sense and power pinout assignments on the front of the Agilent E4370A MCCD mainframe (refer to Figure 1-2). These figures are based on a fully-loaded, 256-channel mainframe configured as follows:

Card Number	Connector Number							
	1	2	3	4	5	6	7	8
1	1 - 8	9 - 16	17 - 24	25 - 32	33 - 40	41 - 48	49 - 56	57 - 64
2	65 - 72	73 - 80	81 - 88	89 - 96	97 - 104	105 - 112	113 - 120	121 - 128
3	129 - 136	137 - 144	145 - 152	153 - 160	161 - 168	169 - 176	177 - 184	185 - 192
4	193 - 200	201 - 208	209 - 216	217 - 224	225 - 232	233 - 240	241 - 248	249 - 256

## D - Sense and Power Connector Pinouts

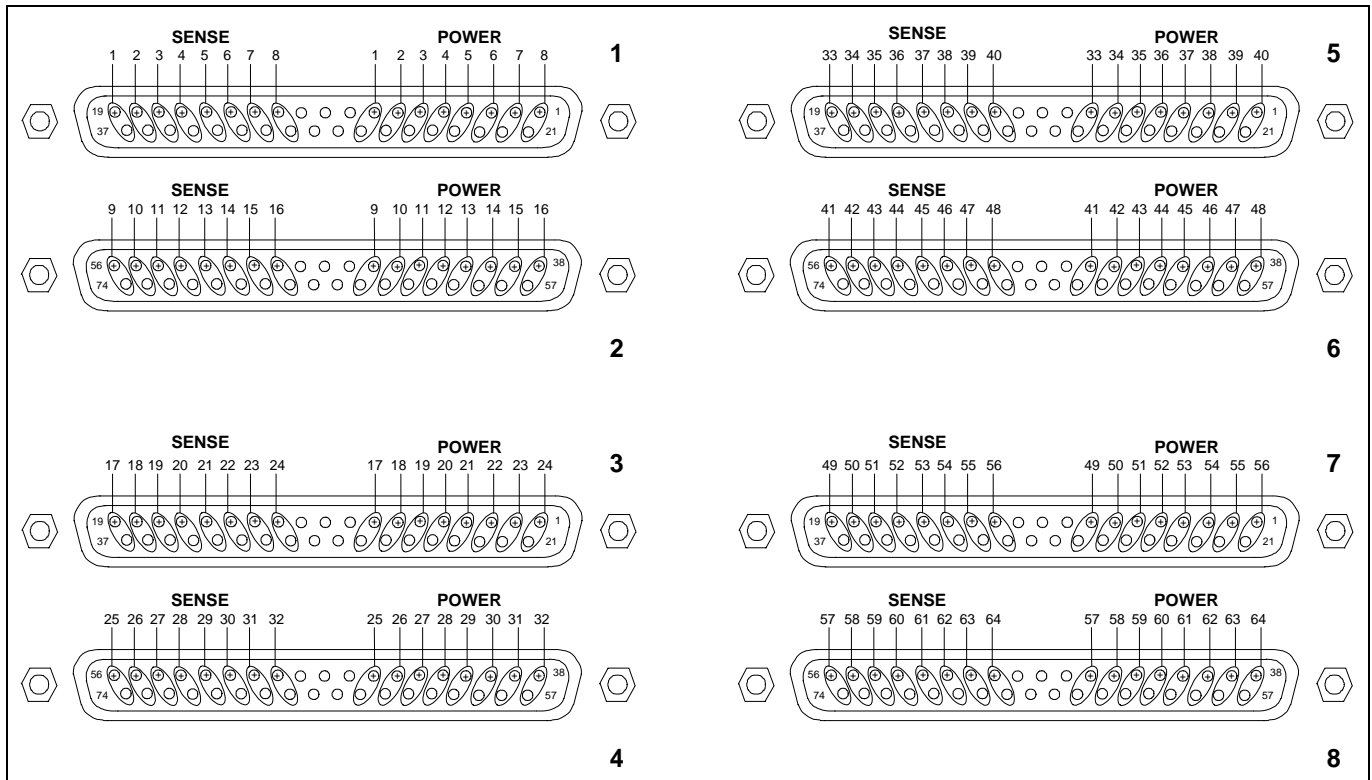

**Note:** Unlabeled pins are the minus connections of each pair.

**Figure D-1. Card 1 Sense and Power Connector Cell Assignments**

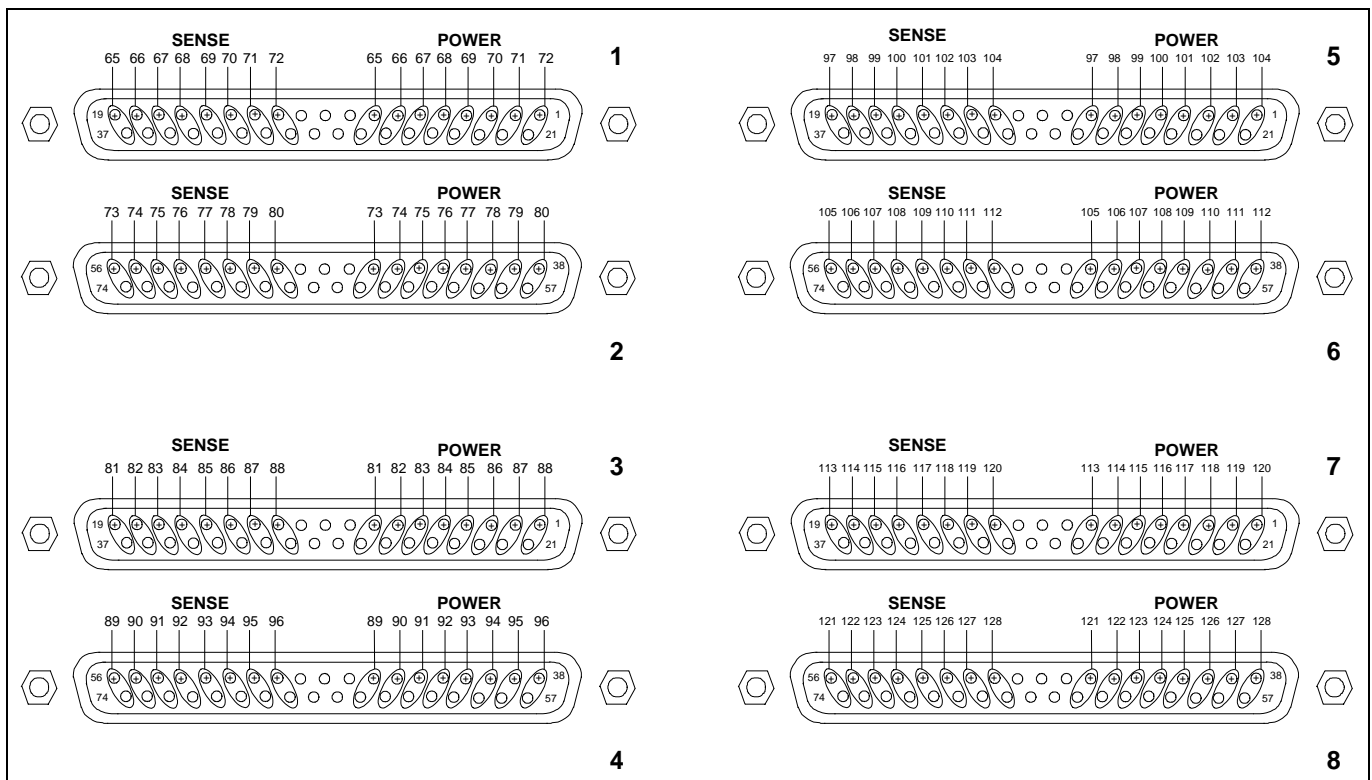

**Note:** Unlabeled pins are the minus connections of each pair.

**Figure D-2. Card 2 Sense and Power Connector Cell Assignments**



## Sense and Power Connector Pinouts - D

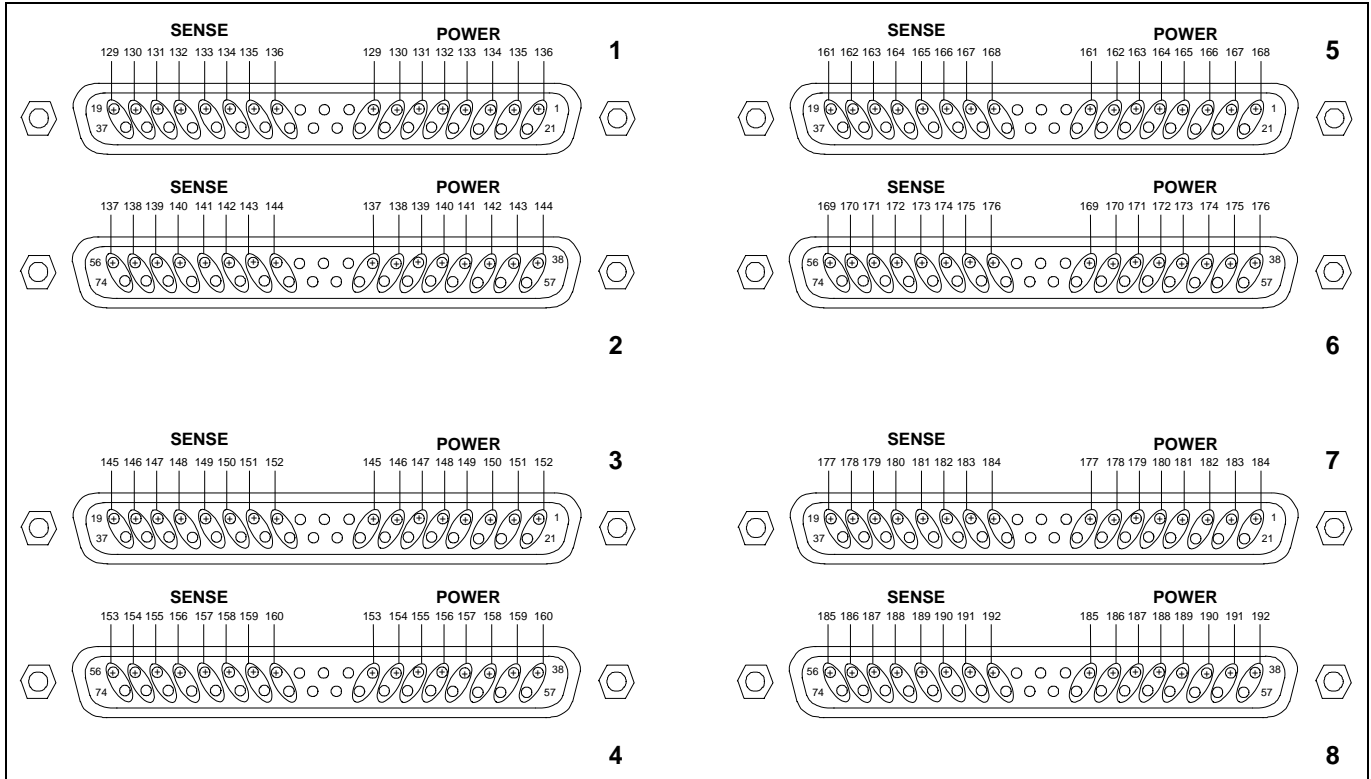

**Note:** Unlabeled pins are the minus connections of each pair.

**Figure D-3. Card 3 Sense and Power Connector Cell Assignments**

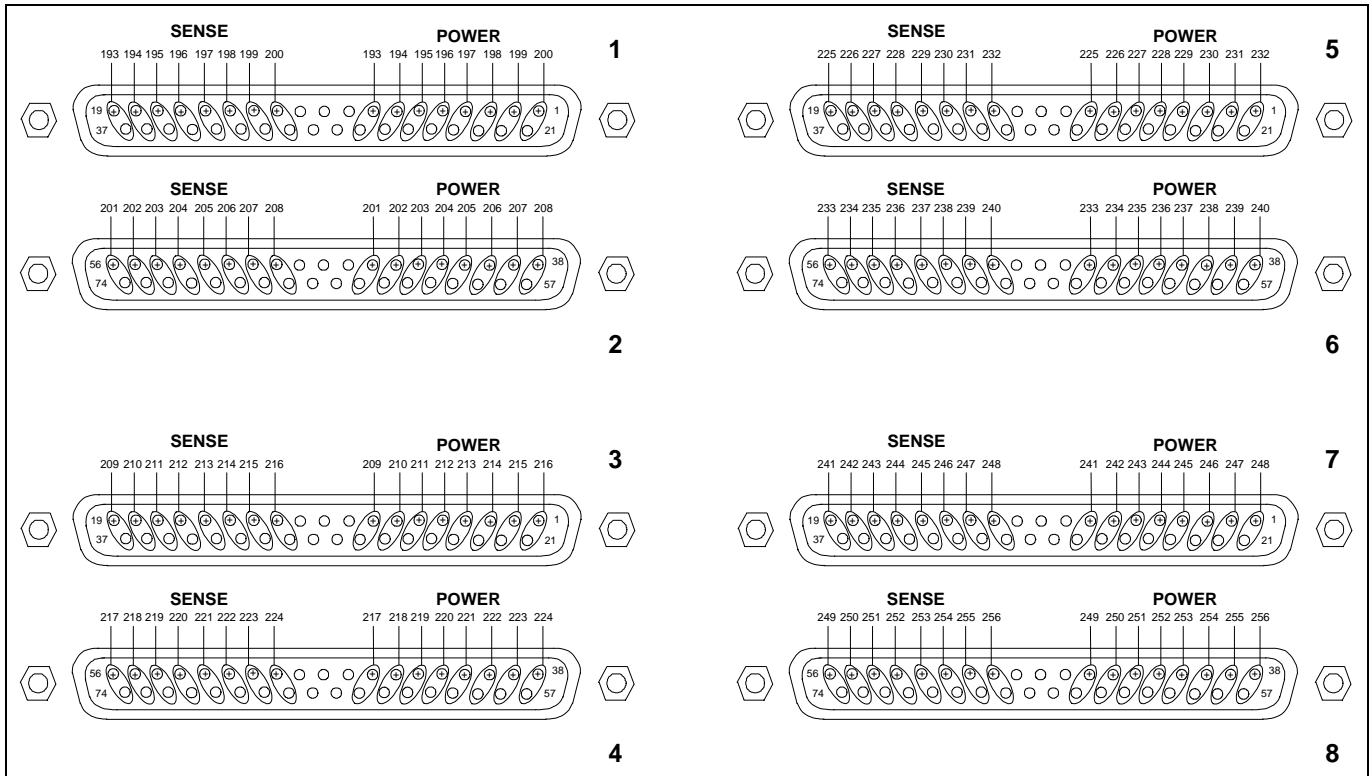

**Note:** Unlabeled pins are the minus connections of each pair.

**Figure D-4. Card 4 Sense and Power Connector Cell Assignments**

D - Sense and Power Connector Pinouts

**Table D-1. Card 1 Sense and Power Pinout Assignments**

Sense Pins	Cell Number	Power Pins	Sense Pins	Cell Number	Power Pins
<b>Connector 1</b>			<b>Connector 5</b>		
+19, -37	cell 1	+8, -27	+19, -37	cell 33	+8, -27
+18, -36	cell 2	+7, -26	+18, -36	cell 34	+7, -26
+17, -35	cell 3	+6, -25	+17, -35	cell 35	+6, -25
+16, -34	cell 4	+5, -24	+16, -34	cell 36	+5, -24
+15, -33	cell 5	+4, -23	+15, -33	cell 37	+4, -23
+14, -32	cell 6	+3, -22	+14, -32	cell 38	+3, -22
+13, -31	cell 7	+2, -21	+13, -31	cell 39	+2, -21
+12, -30	cell 8	+1, -20	+12, -30	cell 40	+1, -20
<b>Connector 2</b>			<b>Connector 6</b>		
+56, -74	cell 9	+45, -64	+56, -74	cell 41	+45, -64
+55, -73	cell 10	+44, -63	+55, -73	cell 42	+44, -63
+54, -72	cell 11	+43, -62	+54, -72	cell 43	+43, -62
+53, -71	cell 12	+42, -61	+53, -71	cell 44	+42, -61
+52, -70	cell 13	+41, -60	+52, -70	cell 45	+41, -60
+51, -69	cell 14	+40, -59	+51, -69	cell 46	+40, -59
+50, -68	cell 15	+39, -58	+50, -68	cell 47	+39, -58
+49, -67	cell 16	+38, -57	+49, -67	cell 48	+38, -57
<b>Connector 3</b>			<b>Connector 7</b>		
+19, -37	cell 17	+8, -27	+19, -37	cell 49	+8, -27
+18, -36	cell 18	+7, -26	+18, -36	cell 50	+7, -26
+17, -35	cell 19	+6, -25	+17, -35	cell 51	+6, -25
+16, -34	cell 20	+5, -24	+16, -34	cell 52	+5, -24
+15, -33	cell 21	+4, -23	+15, -33	cell 53	+4, -23
+14, -32	cell 22	+3, -22	+14, -32	cell 54	+3, -22
+13, -31	cell 23	+2, -21	+13, -31	cell 55	+2, -21
+12, -30	cell 24	+1, -20	+12, -30	cell 56	+1, -20
<b>Connector 4</b>			<b>Connector 8</b>		
+56, -74	cell 25	+45, -64	+56, -74	cell 57	+45, -64
+55, -73	cell 26	+44, -63	+55, -73	cell 58	+44, -63
+54, -72	cell 27	+43, -62	+54, -72	cell 59	+43, -62
+53, -71	cell 28	+42, -61	+53, -71	cell 60	+42, -61
+52, -70	cell 29	+41, -60	+52, -70	cell 61	+41, -60
+51, -69	cell 30	+40, -59	+51, -69	cell 62	+40, -59
+50, -68	cell 31	+39, -58	+50, -68	cell 63	+39, -58
+49, -67	cell 32	+38, -57	+49, -67	cell 64	+38, -57

**Note:** Connector pins 9 - 11, 28, 29, 46 - 48, 65, and 66 are not used.

**Table D-2. Card 2 Sense and Power Pinout Assignments**

Sense Pins	Cell Number	Power Pins	Sense Pins	Cell Number	Power Pins
<b>Connector 1</b>			<b>Connector 5</b>		
+19, -37	cell 65	+8, -27	+19, -37	cell 97	+8, -27
+18, -36	cell 66	+7, -26	+18, -36	cell 98	+7, -26
+17, -35	cell 67	+6, -25	+17, -35	cell 99	+6, -25
+16, -34	cell 68	+5, -24	+16, -34	cell 100	+5, -24
+15, -33	cell 69	+4, -23	+15, -33	cell 101	+4, -23
+14, -32	cell 70	+3, -22	+14, -32	cell 102	+3, -22
+13, -31	cell 71	+2, -21	+13, -31	cell 103	+2, -21
+12, -30	cell 72	+1, -20	+12, -30	cell 104	+1, -20
<b>Connector 2</b>			<b>Connector 6</b>		
+56, -74	cell 73	+45, -64	+56, -74	cell 105	+45, -64
+55, -73	cell 74	+44, -63	+55, -73	cell 106	+44, -63
+54, -72	cell 75	+43, -62	+54, -72	cell 107	+43, -62
+53, -71	cell 76	+42, -61	+53, -71	cell 108	+42, -61
+52, -70	cell 77	+41, -60	+52, -70	cell 109	+41, -60
+51, -69	cell 78	+40, -59	+51, -69	cell 110	+40, -59
+50, -68	cell 79	+39, -58	+50, -68	cell 111	+39, -58
+49, -67	cell 80	+38, -57	+49, -67	cell 112	+38, -57
<b>Connector 3</b>			<b>Connector 7</b>		
+19, -37	cell 81	+8, -27	+19, -37	cell 113	+8, -27
+18, -36	cell 82	+7, -26	+18, -36	cell 114	+7, -26
+17, -35	cell 83	+6, -25	+17, -35	cell 115	+6, -25
+16, -34	cell 84	+5, -24	+16, -34	cell 116	+5, -24
+15, -33	cell 85	+4, -23	+15, -33	cell 117	+4, -23
+14, -32	cell 86	+3, -22	+14, -32	cell 118	+3, -22
+13, -31	cell 87	+2, -21	+13, -31	cell 119	+2, -21
+12, -30	cell 88	+1, -20	+12, -30	cell 120	+1, -20
<b>Connector 4</b>			<b>Connector 8</b>		
+56, -74	cell 89	+45, -64	+56, -74	cell 121	+45, -64
+55, -73	cell 90	+44, -63	+55, -73	cell 122	+44, -63
+54, -72	cell 91	+43, -62	+54, -72	cell 123	+43, -62
+53, -71	cell 92	+42, -61	+53, -71	cell 124	+42, -61
+52, -70	cell 93	+41, -60	+52, -70	cell 125	+41, -60
+51, -69	cell 94	+40, -59	+51, -69	cell 126	+40, -59
+50, -68	cell 95	+39, -58	+50, -68	cell 127	+39, -58
+49, -67	cell 96	+38, -57	+49, -67	cell 128	+38, -57

**Note:** Connector pins 9 - 11, 28, 29, 46 - 48, 65, and 66 are not used.

D - Sense and Power Connector Pinouts

**Table D-3. Card 3 Sense and Power Pinout Assignments**

Sense Pins	Cell Number	Power Pins	Sense Pins	Cell Number	Power Pins
<b>Connector 1</b>			<b>Connector 5</b>		
+19, -37	cell 129	+8, -27	+19, -37	cell 161	+8, -27
+18, -36	cell 130	+7, -26	+18, -36	cell 162	+7, -26
+17, -35	cell 131	+6, -25	+17, -35	cell 163	+6, -25
+16, -34	cell 132	+5, -24	+16, -34	cell 164	+5, -24
+15, -33	cell 133	+4, -23	+15, -33	cell 165	+4, -23
+14, -32	cell 134	+3, -22	+14, -32	cell 166	+3, -22
+13, -31	cell 135	+2, -21	+13, -31	cell 167	+2, -21
+12, -30	cell 136	+1, -20	+12, -30	cell 168	+1, -20
<b>Connector 2</b>			<b>Connector 6</b>		
+56, -74	cell 137	+45, -64	+56, -74	cell 169	+45, -64
+55, -73	cell 138	+44, -63	+55, -73	cell 170	+44, -63
+54, -72	cell 139	+43, -62	+54, -72	cell 171	+43, -62
+53, -71	cell 140	+42, -61	+53, -71	cell 172	+42, -61
+52, -70	cell 141	+41, -60	+52, -70	cell 173	+41, -60
+51, -69	cell 142	+40, -59	+51, -69	cell 174	+40, -59
+50, -68	cell 143	+39, -58	+50, -68	cell 175	+39, -58
+49, -67	cell 144	+38, -57	+49, -67	cell 176	+38, -57
<b>Connector 3</b>			<b>Connector 7</b>		
+19, -37	cell 145	+8, -27	+19, -37	cell 177	+8, -27
+18, -36	cell 146	+7, -26	+18, -36	cell 178	+7, -26
+17, -35	cell 147	+6, -25	+17, -35	cell 179	+6, -25
+16, -34	cell 148	+5, -24	+16, -34	cell 180	+5, -24
+15, -33	cell 149	+4, -23	+15, -33	cell 181	+4, -23
+14, -32	cell 150	+3, -22	+14, -32	cell 182	+3, -22
+13, -31	cell 151	+2, -21	+13, -31	cell 183	+2, -21
+12, -30	cell 152	+1, -20	+12, -30	cell 184	+1, -20
<b>Connector 4</b>			<b>Connector 8</b>		
+56, -74	cell 153	+45, -64	+56, -74	cell 185	+45, -64
+55, -73	cell 154	+44, -63	+55, -73	cell 186	+44, -63
+54, -72	cell 155	+43, -62	+54, -72	cell 187	+43, -62
+53, -71	cell 156	+42, -61	+53, -71	cell 188	+42, -61
+52, -70	cell 157	+41, -60	+52, -70	cell 189	+41, -60
+51, -69	cell 158	+40, -59	+51, -69	cell 190	+40, -59
+50, -68	cell 159	+39, -58	+50, -68	cell 191	+39, -58
+49, -67	cell 160	+38, -57	+49, -67	cell 192	+38, -57

**Note:** Connector pins 9 - 11, 28, 29, 46 - 48, 65, and 66 are not used.

**Table D-4. Card 4 Sense and Power Pinout Assignments**

Sense Pins	Cell Number	Power Pins	Sense Pins	Cell Number	Power Pins
<b>Connector 1</b>			<b>Connector 5</b>		
+19, -37	cell 193	+8, -27	+19, -37	cell 225	+8, -27
+18, -36	cell 194	+7, -26	+18, -36	cell 226	+7, -26
+17, -35	cell 195	+6, -25	+17, -35	cell 227	+6, -25
+16, -34	cell 196	+5, -24	+16, -34	cell 228	+5, -24
+15, -33	cell 197	+4, -23	+15, -33	cell 229	+4, -23
+14, -32	cell 198	+3, -22	+14, -32	cell 230	+3, -22
+13, -31	cell 199	+2, -21	+13, -31	cell 231	+2, -21
+12, -30	cell 200	+1, -20	+12, -30	cell 232	+1, -20
<b>Connector 2</b>			<b>Connector 6</b>		
+56, -74	cell 201	+45, -64	+56, -74	cell 233	+45, -64
+55, -73	cell 202	+44, -63	+55, -73	cell 234	+44, -63
+54, -72	cell 203	+43, -62	+54, -72	cell 235	+43, -62
+53, -71	cell 204	+42, -61	+53, -71	cell 236	+42, -61
+52, -70	cell 205	+41, -60	+52, -70	cell 237	+41, -60
+51, -69	cell 206	+40, -59	+51, -69	cell 238	+40, -59
+50, -68	cell 207	+39, -58	+50, -68	cell 239	+39, -58
+49, -67	cell 208	+38, -57	+49, -67	cell 240	+38, -57
<b>Connector 3</b>			<b>Connector 7</b>		
+19, -37	cell 209	+8, -27	+19, -37	cell 241	+8, -27
+18, -36	cell 210	+7, -26	+18, -36	cell 242	+7, -26
+17, -35	cell 211	+6, -25	+17, -35	cell 243	+6, -25
+16, -34	cell 212	+5, -24	+16, -34	cell 244	+5, -24
+15, -33	cell 213	+4, -23	+15, -33	cell 245	+4, -23
+14, -32	cell 214	+3, -22	+14, -32	cell 246	+3, -22
+13, -31	cell 215	+2, -21	+13, -31	cell 247	+2, -21
+12, -30	cell 216	+1, -20	+12, -30	cell 248	+1, -20
<b>Connector 4</b>			<b>Connector 8</b>		
+56, -74	cell 217	+45, -64	+56, -74	cell 249	+45, -64
+55, -73	cell 218	+44, -63	+55, -73	cell 250	+44, -63
+54, -72	cell 219	+43, -62	+54, -72	cell 251	+43, -62
+53, -71	cell 220	+42, -61	+53, -71	cell 252	+42, -61
+52, -70	cell 221	+41, -60	+52, -70	cell 253	+41, -60
+51, -69	cell 222	+40, -59	+51, -69	cell 254	+40, -59
+50, -68	cell 223	+39, -58	+50, -68	cell 255	+39, -58
+49, -67	cell 224	+38, -57	+49, -67	cell 256	+38, -57

**Note:** Connector pins 9 - 11, 28, 29, 46 - 48, 65, and 66 are not used.



## In Case of Trouble

### Introduction

The Agilent E4370A MCCD has a built-in self test capability which is performed at power-on. Additionally a more complete self test can be done by executing the cfSelftest; function or running self test from the Agilent MCCD User Interface. This selftest capability provides an effective diagnostic tools to isolate problems for rapid repair. Refer to chapter 5 under Selftest for more information.

**CAUTION:** Make sure that no cells are connected when running a user-initiated self test to avoid potentially hazardous voltages from appearing across any cells during the testing process.

### Fault LEDs (see Figure 1-2)

If any of the **Fault** LEDs on the front of an Agilent E4370A/E4374A MCCD System are on, it indicates that there is a fault associated either with the mainframe or a charge/discharger card. Before replacing the card or mainframe, follow the procedures outlined in the following table.

**Table E-1. Fault Indicators**

<b>Agilent E4370A FAULT</b>	
<b>External</b>	<p>Indicates an external fault such as</p> <ul style="list-style-type: none"> <li>External digital fault signal,</li> <li>External power fail shutdown signal,</li> <li>High power bus voltage after power on,</li> <li>Low power bus voltage after power-on.</li> <li>Overtemperature.</li> </ul> <p>To clear the light, first remove the condition that caused the fault. Then either cycle power to the unit, send a Protect Clear API programming command, or press <b>Protect Clear</b> on the Agilent MCCD User Interface to clear the fault register.</p>
<b>Internal</b>	<p>Indicates an internal hardware fault such as</p> <ul style="list-style-type: none"> <li>Selftest failure.</li> <li>Calibration error.</li> <li>Hardware error.</li> </ul> <p>If the <b>Internal</b> LED is lit without any fault LEDs on the Agilent E4374A Charger/Discharger cards being lit, it indicates that the Agilent E4370A MCCD mainframe is defective. Return the unit for service.</p> <p>If a fault LED is lit on a charger/discharger card, turn the mainframe off and replace the defective card by loosening its thumbscrews and pulling the card out of its slot.</p> <p>If you replace a defective card and the Internal LED is still lit on the mainframe, the mainframe is probably defective. Return the unit for service.</p>

## E - In Case of Trouble

<b>Agilent E4374A Fault</b>	
<b>1, 2, 3, 4</b>	<p>Indicates an internal hardware fault such as</p> <ul style="list-style-type: none"><li>Selftest failure.</li><li>Calibration error.</li><li>Hardware error.</li></ul> <p>To read the text-based error message, use the <code>cfReadSelftestLog()</code> API function. If you are using the Agilent MCCD User Interface, you can read the error messages by accessing the System page, selecting Calibration and Selftest, and then clicking on Selftest Log. Write down the error message and contact your Agilent Service Engineer. If the card is defective, return the card for service. Agilent E4374A cards contain no user replaceable parts.</p>

---

## Selftest Error Messages

In addition to the front panel LEDs described in Table E-1, more extensive text-based error reporting is available through the Agilent MCCD User Interface and the API functions.

To read the text based selftest error messages, use the `cfReadSelftestLog()` API function. If you are using the Agilent MCCD User Interface, you can read the error messages by accessing the System page, selecting Calibration and Selftest, and then clicking on Selftest Log. Write down the selftest error message and contact your Agilent Service Engineer.



## —A—

- abort, 70
- airflow
  - mainframe, 25
  - powerbus load, 25
- amp-hour capacity measurement, 16
- API, 20
- API functions
  - guidelines, 67
  - summary, 68
- API library
  - installation, 36
- application programming interface, 20
- autoconnect, 89
- auxiliary output
  - connections, 35
  - ratings, 35

## —B—

- basic functions, 10
- block diagram, 9
- blocking functions, 67

## —C—

- C program
  - expanded example, 107
  - multi-threaded example, 112
  - sequence example, 105
- cables, 24
- calibration, 44, 70
  - calibration switch, 123
  - configuration screen, 122
  - connections, 120
  - equipment, 120
  - error messages, 123
  - full, 119
  - interval, 119
  - LEDs, 123
  - mainframe, 119
  - standard, 63, 70
  - transfer, 63, 71, 119
- cell forming example, 20, 49, 50
- cell forming overview, 49
- cell grouping, 54
- cell resistance, 16
- cell status, 59, 86
- cfAbort, 70
- cfCal, 70
- cfCal Standard, 70
- cfCalTransfer, 71
- cfClose, 71
- cfDeleteGroup, 71

- cfGetCellStatus, 72
- cfGetCellStatusString, 72
- cfGetCurrent, 72
- cfGetDigitalConfig, 73
- cfGetDigitalPort, 73
- cfGetGroups, 73
- cfGetInstIdentify, 74
- cfGetInstStatus, 74
- cfGetMeasLogInterval, 75
- cfGetOutputConfig, 75
- cfGetOutputProbeTest, 75
- cfGetOutputState, 76
- cfGetRunState, 76
- cfGetSense, 76
- cfGetSenseProbeTest, 77
- cfGetSeqStep, 77
- cfGetSeqTest, 77
- cfGetSeqTestMult, 78
- cfGetSeqTime, 78
- cfGetSerialConfig, 78
- cfGetSerialStatus, 78
- cfGetShutdownDelay, 79
- cfGetShutdownMode, 79
- cfGetStepNumber, 79
- cfGetTrig Source, 79
- cfGetUserIdentify, 79
- cfGetVoltage, 80
- cfInitiate, 80
- cfMeasACResistance, 80
- cfMeasCapacityAS, 80
- cfMeasCapacityWS, 81
- cfMeasCurrent, 81
- cfMeasDCResistance, 81
- cfMeasOutputProbeResistance, 81
- cfMeasProbeContinuity, 82
- cfMeasSenseProbeResistance, 82
- cfMeasVoltage, 83
- cfOpen, 83
- cfOpenGroup, 83
- cfProtect, 84
- cfProtectClear, 84
- cfReadMeasLog, 84
- cfReadSerial, 86
- cfReadTestLog, 87
- cfReset, 87
- cfResetSeq, 87
- cfRestart, 88
- cfSaveOutputConfig, 88
- cfSelftest, 88
- cfSetAutoconnect, 89
- cfSetCurrent, 89
- cfSetDigitalConfig, 90
- cfSetDigitalPort, 92
- cfSetErrorFunction, 92
- cfSetGroup, 93
- cfSetMeasLogInterval, 93
- cfSetOutputConfig, 93

## Index

- cfSetOutputProbeTest, 94
- cfSetOutputState, 94
- cfSetSense, 95
- cfSetSenseProbeTest, 95
- cfSetSeqStep, 95
- cfSetSeqTest, 97
- cfSetSeqTestMult, 99
- cfSetSerialConfig, 99
- cfSetServerTimeout, 99
- cfSetShutdownDelay, 100
- cfSetShutdownMode, 100
- cfSetTimeout, 100
- cfSetTrigSource, 100
- cfSetVoltage, 101
- cfShutdown, 101
- cfStateDelete, 101
- cfStateList, 102
- cfStateRecall, 102
- cfStateSave, 102
- cfTrigger, 102
- cfWriteSerial, 103
- channel
  - inactive, 26
- channel connections, 25
- characteristics, 115
  - external source, 117
  - powerbus load, 117
- charging mode
  - guidelines, 30
- close connection, 71
- com port connection, 38
- configuration screen, 38
  - calibration, 122
  - digital I/O, 41
  - identification, 40
  - miscellaneous, 41
  - network, 39
- configuring
  - output, 56
- connections, 25
  - remote sensing, 27
- connector, 24
  - manufacturers, 24
- connector, kits, 24
- connectors, 23
- current measurement, 15, 61

### —D—

- damage, 23
- data logging, 17
- delete
  - group, 71
- digital connections, 31
  - electrical characteristics, 32
  - wiring, 32
- digital I/O
  - configuration, 42
  - mixed, 44
  - polarity, 43
- digital operation

- grounded, 90
- isolated, 91
- polarity, 91

digital port, 64

dimensions

- mainframe, 25, 125
- powerbus load, 25, 126

direct output control, 62

discharging mode

- guidelines, 30

document scope, 4

documentation, 24

### —E—

- energy re-use, 15
- environmental conditions, 3
- erasing, 56
- error reporting, 67
- example program, 105, 107, 112
- ext fault, 57
- external fault input, 32
- external fault output, 32
- external interlock, 32
- external power source, 13
- external trigger, 32

### —F—

- fail, 49
- fault indicators, 135
- forming, 56
- front panel
  - mainframe, 10
  - power connector wiring, 27
  - sense connector wiring, 27
- function
  - cell grouping, 53
  - overview, 53

### —G—

- general purpose I/O, 31
- get
  - cell status, 72
  - cell status string, 72
  - current, 72
  - digital configuration, 73
  - digital port word, 73
  - group, 73
  - instrument identification, 74
  - instrument status, 74
  - measurement log interval, 75
  - output configuration, 75
  - output probe test limit, 75
  - output state, 76
  - run state, 76
  - sense probe test setting, 77
  - sense setting, 76
  - sequence step parameters, 77

- sequence step time, 78
- sequence test parameters, 77, 78
- serial port configuration, 78
- serial port status, 78
- step number, 79
- trigger source, 79
- user identification, 79
- voltage, 80

grouping functions, 54

## —H—

- high rail, 57
- HP MCCD configuration, 38
- HP MCCD measurement log, 47
- HP MCCD user interface, 45
  - using, 46
- HW failed, 57
- HyperTerminal configuration, 37

## —I—

- identification, 62
- idle, 56
- initiate, 80
- initiated, 56
- inspection, 23
- interlocked, 57

## —L—

- LAN connection, 37, 62
- load voltage drops, 26
- location
  - mainframe, 25
  - powerbus load, 25
- low rail, 57

## —M—

- measure
  - ac resistance, 80
  - ampere-second capacity, 80
  - current, 81
  - dc resistance, 81
  - output probe resistance, 81
  - probe continuity, 82
  - sense probe resistance, 82
  - voltage, 83
  - watt-second capacity, 81
- measurement log, 47, 60
  - data files, 48
- measurement log utility
  - installation, 36
- multiple mainframes, 14

## —N—

- next, 49
- non-volatile memory, 56

- not ready, 56, 57
- null modem cable, 34

## —O—

- open
  - group, 83
- open connection, 83
- output configuration, 56
- output sensing, 61
- output state, 62
- overtemperature, 57

## —P—

- password, 67
- password protection, 45
- pinouts
  - power connector, 127
  - sense connector, 127
- Port B switch setting, 38
- power bus
  - connections, 28
  - example, 29
  - wiring, 28
- power connector
  - pinouts, 127
  - wiring, 27
- power cord, 23
- power fail, 32, 58
  - input, 58
  - signal, 58
- Powerbus load, 12
- power-on, 58
  - selftest, 63
  - state, 87
- probe check
  - continuity, 65
  - power, 65
  - sense, 65, 67
- probe measurement, 61
- probe resistance, 17
- protected, 57
- protection
  - ac line failure, 19
  - clear, 84
  - enable, 84
  - external, 19
  - internal, 18
  - states, 57

## —R—

- read
  - measurement log, 60, 84
  - serial port data, 86
  - test log data, 87
- rear panel
  - mainframe, 12
- remote sensing, 27

## Index

repacking, 23  
reset, 58, 87  
reset sequence, 87  
resistance measurement, 61  
restart, 88  
RS-232  
    connections, 34  
    interface, 34  
run states, 55

### —S—

safety summary, 3  
safety symbols, 4  
save  
    output configuration, 88  
saving output configuration, 56  
selftest, 63, 88, 135  
    error messages, 136  
semi-automated example, 20  
sense connector  
    pinouts, 127  
    wiring, 27  
sequence control, 55  
serial port  
    configuration, 64  
    status, 64  
server  
    timeout, 99  
server connections, 67  
set  
    current, 62, 89  
    digital configuration, 90  
    digital port word, 92  
    error function, 92  
    group, 93  
    measurement log interval, 93  
    output configuration, 93  
    output probe resistance limit, 94  
    output sense probe, 95  
    output sequence step parameters, 95  
    output state, 62, 94  
    output voltage sensing, 95  
    sequence test parameters, 97, 99  
    serial port communication parameters, 99  
    timeout, 100  
    trigger source, 100  
    voltage, 62, 101  
set sequence step, 50, 54

set sequence test, 50, 54  
shutdown, 101  
    delay, 79, 100  
    mode, 79, 100  
software utility installation, 36  
specifications, 115  
state  
    delete, 101  
    list instrument states, 102  
    recall instrument states, 102  
    save instrument states, 102  
state storage, 58  
status, 59  
step, 49  
system capabilities, 9

### —T—

test, 49  
test log, 63  
test outcome, 50  
time stamp, 61  
timeout setting, 62  
trigger, 32  
trigger sequence, 102  
triggering critical measurements, 17

### —V—

Visual C++ configuration, 36  
voltage measurement, 15, 61

### —W—

warranty, 2  
watt-hour capacity, 16  
web accessible interface, 20  
web browser  
    access, 46  
    password, 45  
    settings, 45  
web interface, 45  
    using, 46  
wire resistance, 26, 27, 29  
    example, 27  
wire sizing, 30  
write serial port words, 103

## Agilent Sales and Support Office

For more information about Agilent Technologies test and measurement products, applications, services, and for a current sales office listing, visit our web site: <http://www.agilent.com/find/tmdir>

You can also contact one of the following centers and ask for a test and measurement sales representative.

### United States:

Agilent Technologies  
Test and Measurement Call Center  
P.O. Box 4026  
Englewood, CO 80155-4026  
(tel) 1 800 452 4844

### Latin America:

Agilent Technologies  
Latin American Region Headquarters  
5200 Blue Lagoon Drive, Suite #950  
Miami, Florida 33126  
U.S.A.  
(tel) (305) 267 4245  
(fax) (305) 267 4286

### Canada:

Agilent Technologies Canada Inc.  
5150 Spectrum Way  
Mississauga, Ontario  
L4W 5G1  
(tel) 1 877 894 4414

### Australia/New Zealand:

Agilent Technologies Australia Pty Ltd  
347 Burwood Highway  
Forest Hill, Victoria 3131  
(tel) 1-800 629 485 (Australia)  
(fax) (61 3) 9272 0749  
(tel) 0 800 738 378 (New Zealand)  
(fax) (64 4) 802 6881

### Europe:

Agilent Technologies  
Test & Measurement European Marketing Organisation  
P.O. Box 999  
1180 AZ Amstelveen  
The Netherlands  
(tel) (31 20) 547 9999

### Asia Pacific:

Agilent Technologies  
24/F, Cityplaza One, 1111 King's Road,  
Taikoo Shing, Hong Kong  
tel: (852)-3197-7777  
fax: (852)-2506-9284

### Japan:

Agilent Technologies Japan Ltd.  
Measurement Assistance Center  
9-1, Takakura-Cho, Hachioji-Shi,  
Tokyo 192-8510, Japan  
(tel) (81) 426 56 7832  
(fax) (81) 426 56 7840

Technical data is subject to change.