

# Measurement Guide and Programming Examples

## PSA and ESA Series Spectrum Analyzers

**This manual provides documentation for the following instruments:**

### **Agilent Technologies PSA Series**

**E4443A (3 Hz - 6.7 GHz)**  
**E4445A (3 Hz - 13.2 GHz)**  
**E4440A (3 Hz - 26.5 GHz)**  
**E4446A (3 Hz - 44 GHz)**  
**E4448A (3 Hz - 50 GHz)**

### **Agilent Technologies ESA-E Series**

**E4401B (9 kHz - 1.5 GHz)**  
**E4402B (9 kHz - 3.0 GHz)**  
**E4404B (9 kHz - 6.7 GHz)**  
**E4405B (9 kHz - 13.2 GHz)**  
**E4407B (9 kHz - 26.5 GHz)**

### **Agilent Technologies ESA-L Series**

**E4411B (9 kHz - 1.5 GHz)**  
**E4403B (9 kHz - 3.0 GHz)**  
**E4408B (9 kHz - 26.5 GHz)**



**Agilent Technologies**

**Manufacturing Part Number: E4401-90482**

**Supersedes: E4401-90466**

**Printed in USA**

**April 2004**

© Copyright 1999 - 2004 Agilent Technologies

---

## Notice

The information contained in this document is subject to change without notice.

Agilent Technologies makes no warranty of any kind with regard to this material, including but not limited to, the implied warranties of merchantability and fitness for a particular purpose. Agilent Technologies shall not be liable for errors contained herein or for incidental or consequential damages in connection with the furnishing, performance, or use of this material.

---

## Safety Information

The following safety symbols are used throughout this manual. Familiarize yourself with the symbols and their meaning before operating this instrument.

---

### WARNING

***Warning* denotes a hazard. It calls attention to a procedure which, if not correctly performed or adhered to, could result in injury or loss of life. Do not proceed beyond a warning note until the indicated conditions are fully understood and met.**

---

### CAUTION

*Caution* denotes a hazard. It calls attention to a procedure that, if not correctly performed or adhered to, could result in damage to or destruction of the instrument. Do not proceed beyond a caution sign until the indicated conditions are fully understood and met.

---

### NOTE

*Note* calls out special information for the user's attention. It provides operational information or additional instructions of which the user should be aware.

---



The instruction documentation symbol. The product is marked with this symbol when it is necessary for the user to refer to the instructions in the documentation.



This symbol is used to mark the on position of the power line switch.



This symbol is used to mark the standby position of the power line switch.



This symbol indicates that the input power required is AC.

---

---

**WARNING**      **This is a Safety Class 1 Product (provided with a protective earth ground incorporated in the power cord). The mains plug shall be inserted only in a socket outlet provided with a protected earth contact. Any interruption of the protective conductor inside or outside of the product is likely to make the product dangerous. Intentional interruption is prohibited.**

---

**WARNING**      **No operator serviceable parts inside. Refer servicing to qualified personnel. To prevent electrical shock do not remove covers.**

---

**WARNING**      **If this product is not used as specified, the protection provided by the equipment could be impaired. This product must be used in a normal condition (in which all means for protection are intact) only.**

---

**CAUTION**      Always use the three-prong AC power cord supplied with this product. Failure to ensure adequate grounding may cause product damage.

---

---

## **Where to Find the Latest Information**

Documentation is updated periodically. For the latest information about Agilent Technologies PSA and ESA spectrum analyzers, including firmware upgrades and application information, please visit the following Internet URL:

<http://www.agilent.com/find/psa>

<http://www.agilent.com/find/esa>

Microsoft® is a U.S. registered trademark of Microsoft Corporation.

Bluetooth™ is a trademark owned by its proprietor and used under license.



<b>1. Recommended Test Equipment</b>	
<b>2. Measuring Multiple Signals</b>	
Comparing Signals on the Same Screen Using Marker Delta	12
Comparing Signals on the Same Screen Using Marker Delta Pair	14
Comparing Signals not on the Same Screen Using Marker Delta	15
Resolving Signals of Equal Amplitude	17
Resolving Small Signals Hidden by Large Signals	20
Decreasing the Frequency Span Around the Signal	22
<b>3. Measuring a Low-Level Signal</b>	
Reducing Input Attenuation	26
Decreasing the Resolution Bandwidth	28
Using the Average Detector and Increased Sweep Time	29
Trace Averaging	30
<b>4. Improving Frequency Resolution and Accuracy</b>	
Using a Frequency Counter to Improve Frequency Resolution and Accuracy	32
<b>5. Tracking Drifting Signals</b>	
Measuring a Source's Frequency Drift	36
Tracking a Signal	38
<b>6. Making Distortion Measurements</b>	
Identifying Analyzer Generated Distortion	40
Third-Order Intermodulation Distortion	42
Measuring TOI Distortion with a One-Button Measurement	44
Measuring Harmonics and Harmonic Distortion with a One-Button Measurement	45
<b>7. Measuring Noise</b>	
Measuring Signal-to-Noise	48
Measuring Noise Using the Noise Marker	50
Measuring Noise-Like Signals Using Marker Pairs	52
Measuring Noise-Like Signals Using the Channel Power Measurement	54
<b>8. Making Time-Gated Measurements</b>	
Generating a Pulsed-RF FM Signal	58
Connecting the Instruments to Make Time-Gated Measurements	61
Gated LO Measurement (PSA)	62
Gated Video Measurement (ESA)	64
Gated FFT Measurement (PSA)	66

---

# Contents

## 9. Measuring Digital Communications Signals

Making Burst Power Measurements .....	68
Making Statistical Power Measurements (CCDF) .....	71
Making Adjacent Channel Power (ACP) Measurements .....	74
Making Multi-Carrier Power (MCP) Measurements .....	77

## 10. Using External Millimeter Mixers (Option AYZ)

Making Measurements With Agilent 11970 Series Harmonic Mixers .....	82
Setting Harmonic Mixer Bias Current .....	84
Entering Conversion-Loss Correction Data for Harmonic Mixers .....	85
Making Measurements with Agilent 11974 Series Preselected Harmonic Mixers .....	86
Frequency Tracking Calibration with Agilent 11974 Series Preselected Harmonic Mixers .....	88

## 11. Demodulating AM and FM Signals

Measuring the Modulation Rate of an AM Signal .....	92
Measuring the Modulation Index of an AM Signal .....	94
Demodulating an AM Signal Using the ESA Series .....	96
Demodulating an FM Signal Using the ESA-E Series (Requires Option BAA) .....	98

## 12. Using Segmented Sweep (ESA-E Series Spectrum Analyzers)

Measuring Harmonics Using Standard Sweep .....	102
Measuring Harmonics Using Segmented Sweep .....	104
Using Segmented Sweep With Limit Lines .....	106
Using Segmented Sweep to Monitor the Cellular Activity of a cdmaOne Band .....	108

## 13. Stimulus Response Measurements (ESA Options 1DN and 1DQ)

Making a Stimulus Response Transmission Measurement .....	112
Calculating the N dB Bandwidth Using Stimulus Response .....	114
Measuring Stop Band Attenuation Using Log Sweep (ESA-E Series) .....	116
Making a Reflection Calibration Measurement .....	118
Measuring Return Loss using the Reflection Calibration Routine .....	120

## 14. Demodulating and Viewing Television Signals (ESA-E Series Option B7B)

Demodulating and Viewing Television Signals .....	122
Measuring Depth of Modulation .....	126

## 15. Concepts

Resolving Closely Spaced Signals .....	130
Harmonic Distortion Calculations .....	132
Time Gating Concepts .....	133
Trigger Concepts .....	153

AM and FM Demodulation Concepts .....	157
Stimulus Response Measurement Concepts .....	158
<b>16.ESA/PSA Programming Examples</b>	
Examples Included in this Chapter: .....	164
Finding Additional Examples and More Information .....	165
Programming Examples Information and Requirements .....	166
Programming in C Using the VTL .....	167
Using C to Make a Power Suite ACPR Measurement on a cdmaOne Signal .....	176
Using C to Serial Poll the Analyzer to Determine when an Auto-alignment is Complete ..	179
Using C and Service Request (SRQ) to Determine When a Measurement is Complete ..	182
Using Visual Basic® 6 to Capture a Screen Image .....	188
Using Visual Basic® 6 to Transfer Binary Trace Data .....	192
Using Agilent VEE to Transfer Trace Data .....	197
<b>17.ESA Programming Examples</b>	
Examples Included in this Chapter: .....	200
Programming Examples System Requirements .....	201
Using C with Marker Peak Search and Peak Excursion Measurement Routines .....	202
Using C for Marker Delta Mode and Marker Minimum Search Functions .....	206
Using C to Perform Internal Self-Alignment .....	210
Using C to Read Trace Data in an ASCII Format (over GPIB) .....	214
Using C to Read Trace Data in a 32-Bit Real Format (over GPIB) .....	218
Using C to Read Trace Data in an ASCII Format (over RS-232) .....	223
Using C to Read Trace Data in a 32-bit Real Format (over RS-232) .....	228
Using C to Add Limit Lines .....	233
Using C to Measure Noise .....	239
Using C to Enter Amplitude Correction Data .....	243
Using C to Determine if an Error has Occurred .....	247
Using C to Measure Harmonic Distortion (over GPIB) .....	253
Using C to Measure Harmonic Distortion (over RS-232) .....	261
Using C to Make Faster Power Averaging Measurements .....	269
<b>18.PSA Programming Examples</b>	
Examples Included in this Chapter: .....	278
Programming Examples Information and Requirements .....	279
Using C with Marker Peak Search and Peak Excursion Measurement Routines .....	280
Using C for Saving and Recalling Instrument State Data .....	283
Using C to Save Binary Trace Data .....	287
Using C to Make a Power Calibration Measurement for a GSM Mobile Handset .....	291
Using C with the CALCulate:DATA:COMPRESS? RMS Command .....	297
Using C Over Socket LAN (UNIX) .....	303

---

## Contents

Using C Over Socket LAN (Windows NT) .....	323
Using Java Programming Over Socket LAN .....	326
Using the VXI Plug-N-Play Driver in LabVIEW® .....	335
Using LabVIEW® 6 to Make an EDGE GSM Measurement .....	336
Using Visual Basic® .NET with the IVI-Com Driver .....	338
Using Agilent VEE to Capture the Equivalent SCPI Learn String .....	342



---

# **1 Recommended Test Equipment**

**NOTE**

To find descriptions of specific analyzer functions, for the ESA, refer to the *Agilent Technologies ESA Series Spectrum Analyzers User's/Programmer's Reference Guide* and for the PSA, refer to the *Agilent Technologies PSA Series Spectrum Analyzers User's and Programmer's Reference Guide*.

Test Equipment	Specifications	Recommended Model
<b>Signal Sources</b>		
Signal Generator (2)	0.25 MHz to 4.0 GHz Ext Ref Input	E443XB series or E4438C
<b>Adapters</b>		
Type-N (m) to BNC (f) (3)		1250-0780
Termination, 50 $\Omega$ Type-N (m)		908A
<b>Cables</b>		
(3) BNC, 122-cm (48-in)		10503A
<b>Miscellaneous</b>		
Directional Bridge		86205A
Bandpass Filter	Center Frequency: 200 MHz Bandwidth: 10 MHz	
Lowpass Filter (2)	Cutoff Frequency: 300 MHz	0955-0455
RF Antenna		08920-61060

---

**2**

**Measuring Multiple Signals**

## Comparing Signals on the Same Screen Using Marker Delta

Using the analyzer, you can easily compare frequency and amplitude differences between signals, such as radio or television signal spectra. The analyzer delta marker function lets you compare two signals when both appear on the screen at one time.

In this procedure, the analyzer 10 MHz signal is used to measure frequency and amplitude differences between two signals on the same screen. Delta marker is used to demonstrate this comparison.

**Figure 2-1** An Example of Comparing Signals on the Same Screen

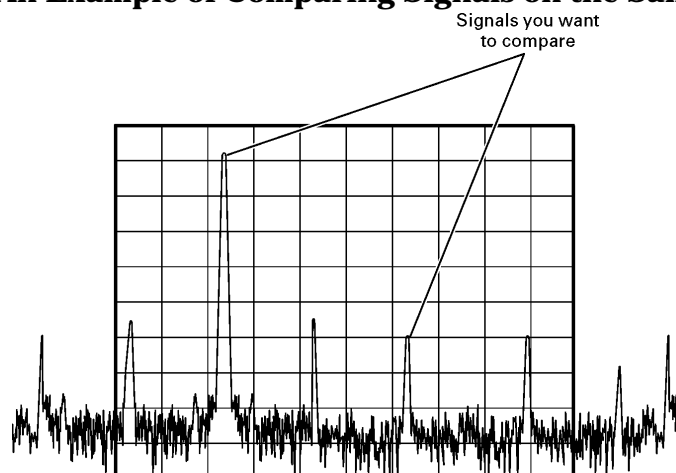

**Step 1.** Preset the analyzer:

Press **Preset, Factory Preset** (if present).

**Step 2.** (PSA)

a. Enable the rear panel 10 MHz output.

Press **System, Reference, 10 MHz Out** (On).

b. Connect the 10 MHz OUT (SWITCHED) from the rear panel to the front panel RF input.

(ESA)

Connect the rear panel 10 MHz REF OUT to the front panel RF input.

**Step 3.** Set the analyzer center frequency, span and reference level to view the 10 MHz signal and its harmonics up to 50 MHz:

Press **FREQUENCY Channel, Center Freq, 30, MHz**.

Press **SPAN X Scale, Span, 50, MHz**.

Press **AMPLITUDE Y Scale, Ref Level, 10, dBm**.

**Step 4.** Place a marker at the highest peak on the display (10 MHz):

Press **Peak Search**.

The **Next Pk Right** and **Next Pk Left** softkeys are available to move the marker from peak to peak. The marker should be on the 10 MHz reference signal:

**Step 5.** Anchor the first marker and activate a second marker:

Press **Marker, Delta**.

The label on the first marker now reads 1R, indicating that it is the reference point.

**Step 6.** Move the second marker to another signal peak using the front-panel knob or by using the **Peak Search** key:

Press **Peak Search, Next Peak** or

Press **Peak Search, Next Pk Right** or **Next Pk Left**.

The amplitude and frequency *difference* between the markers is displayed in the active function block. For ESA see the left side of [Figure 2-2](#) and the right side for PSA.

**Figure 2-2** Using the Delta Marker Function (ESA left, PSA right)

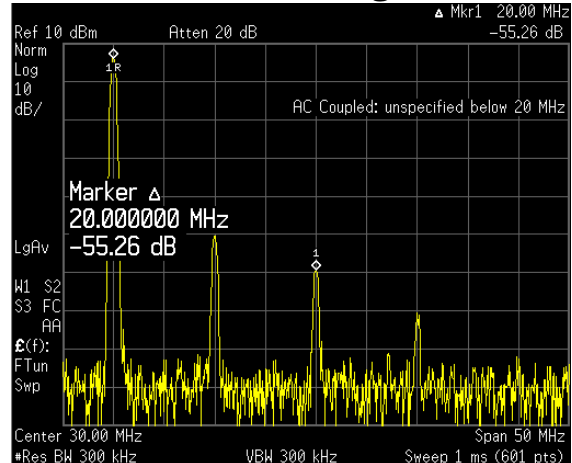
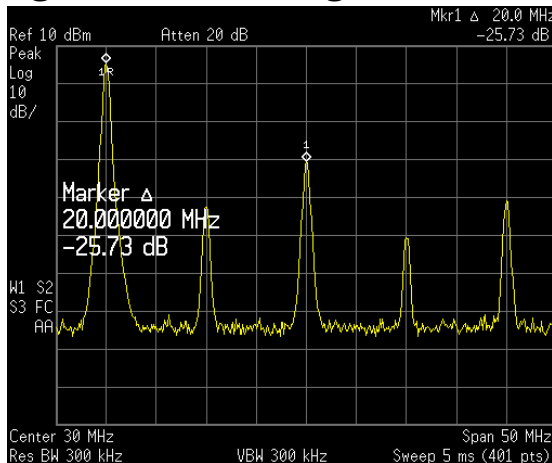

**NOTE**

The resolution of the marker readings can be increased by turning on the frequency count function.

Measuring Multiple Signals

## Comparing Signals on the Same Screen Using Marker Delta Pair

In this procedure, the analyzer 10 MHz signal is used to measure frequency and amplitude differences between two signals on the same screen using the delta pair marker function.

- Step 1.** Refer to the previous procedure “[Comparing Signals on the Same Screen Using Marker Delta](#)” on page 12 and follow steps 1, 2 and 3.
- Step 2.** Turn on Delta Pair reference marker to compare the 10 MHz signal and the 30 MHz signal:  
Press **Peak Search, Marker, Delta Pair (ref)**.  
Note that the **Delta Pair** marker does not anchor the first marker.
- Step 3.** Use the knob or **Peak Search** to move the second marker (labeled 1) to the 30 MHz peak:  
Press **Peak Search, Next Peak** or **Next Pk Right**.
- Step 4.** Use the front panel knob to move the ref marker to the 20 MHz peak:  
The active function displays the amplitude and frequency difference between the 20 MHz and 30 MHz peaks as shown in [Figure 2-3](#).

**Figure 2-3** Using the Delta Pair Marker Function (ESA left, PSA right)

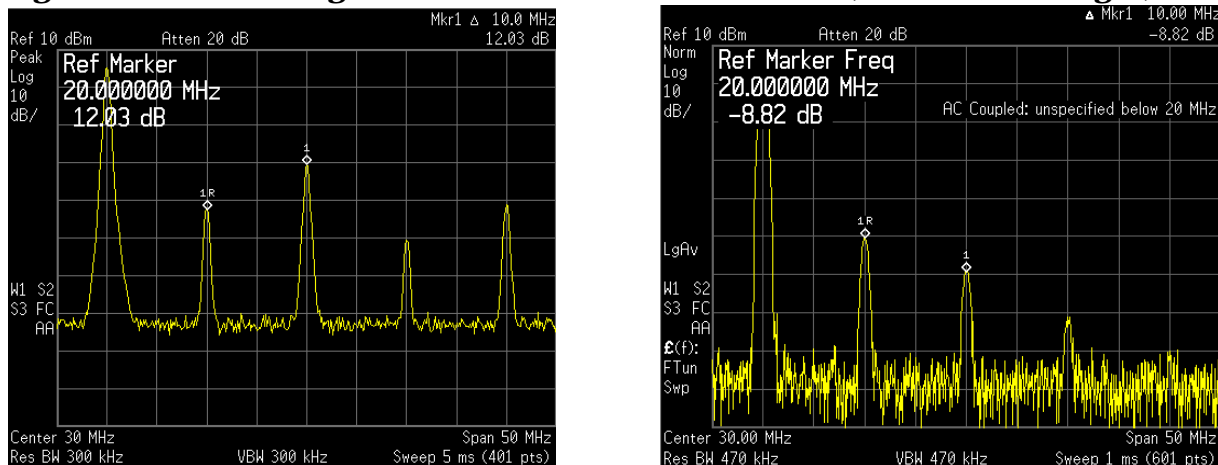

**NOTE**

In [Figure 2-3](#) notice that the active function readout has moved to the top left of the analyzer display. The active function position has three positions: top, center and bottom. To modify the active function position:

Press **Display, Active Fctn Position, Top (Center, or Bottom)**.

Center position is the factory default setting.

## Comparing Signals not on the Same Screen Using Marker Delta

Measure the frequency and amplitude difference between two signals that do not appear on the screen at one time. (This technique is useful for harmonic distortion tests when narrow span and narrow bandwidth are necessary to measure the low level harmonics.)

In this procedure, the analyzer 10 MHz signal is used to measure frequency and amplitude differences between one signal on screen and one signal off screen. Delta marker is used to demonstrate this comparison.

**Figure 2-4** Comparing One Signal on Screen with One Signal Off Screen

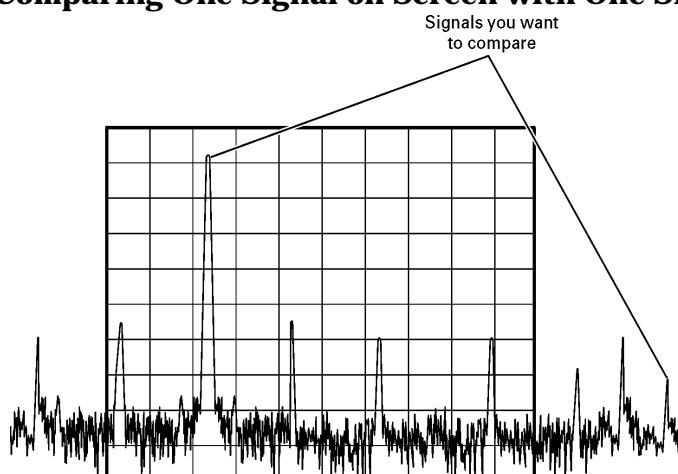

**Step 1.** Preset the analyzer:

Press **Preset**, **Factory Preset** (if present).

**Step 2.** (PSA)

a. Enable the rear panel 10 MHz output:

Press **System**, **Reference**, **10 MHz Out** (On).

b. Connect the 10 MHz OUT (SWITCHED) from the rear panel to the front panel RF input:

(ESA)

Connect the rear panel 10 MHz REF OUT to the front panel RF input.

**Step 3.** Set the center frequency, span and reference level to view only the 10 MHz signal:

Press **FREQUENCY Channel, Center Freq, 10, MHz.**

Press **SPAN X Scale, Span, 5, MHz.**

Press **AMPLITUDE Y Scale, Ref Level, 10, dBm.**

**Step 4.** Place a marker on the 10 MHz peak and then set the center frequency step size equal to the marker frequency (10 MHz):

Press **Peak Search.**

Press **Marker →, Mkr → CF Step.**

**Step 5.** Activate the marker delta function:

Press **Marker, Delta.**

**Step 6.** Increase the center frequency by 10 MHz:

Press **FREQUENCY Channel, Center Freq, ↑.**

The first marker moves to the left edge of the screen, at the amplitude of the first signal peak.

**Figure 2-5** shows the reference annotation for the delta marker (1R) at the left side of the display, indicating that the 10 MHz reference signal is at a lower frequency than the frequency range currently displayed.

The delta marker appears on the peak of the 20 MHz component. The delta marker annotation displays the amplitude and frequency difference between the 10 and 20 MHz signal peaks.

**Figure 2-5**

**Delta Marker with Reference Signal Off-Screen (ESA)**

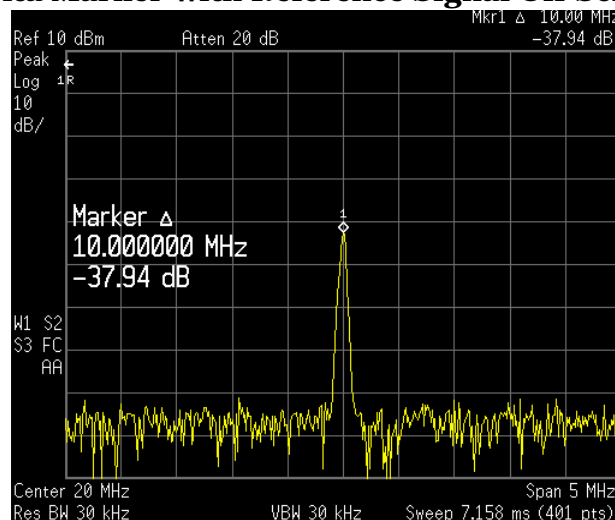

**Step 7.** Turn the markers off:

Press **Marker, Off.**



## Resolving Signals of Equal Amplitude

In this procedure a decrease in resolution bandwidth is used in combination with a decrease in video bandwidth to resolve two signals of equal amplitude with a frequency separation of 100 kHz. Notice that the final RBW selection to resolve the signals is the same width as the signal separation while the VBW is slightly narrower than the RBW.

**Step 1.** Connect two sources to the analyzer input as shown in [Figure 2-6](#).

**Figure 2-6** Setup for Obtaining Two Signals

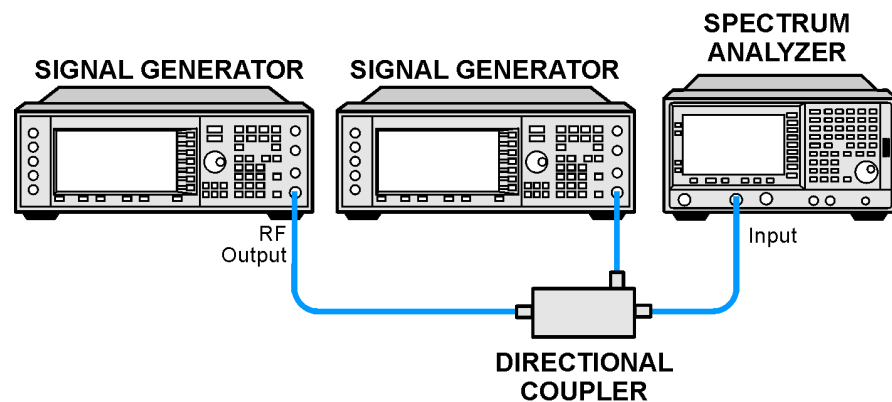

pl790b

**Step 2.** Set one source to 300 MHz. Set the frequency of the other source to 300.1 MHz. Set both source amplitudes to  $-20$  dBm. The amplitude of both signals should be approximately  $-20$  dBm at the output of the bridge.

**Step 3.** Setup the analyzer to view the signals:

- Press **Preset**, **Factory Preset** (if present).
- Press **FREQUENCY** Channel, **Center Freq**, **300**, **MHz**.
- Press **BW/Avg**, **Res BW**, **300**, **kHz**.
- Press **SPAN X Scale**, **Span**, **2**, **MHz**.

A single signal peak is visible. See [Figure 2-7](#) for an ESA example.

### NOTE

If the signal peak is not present on the display, span out to 20 MHz, turn signal tracking on, span back to 2 MHz and turn signal tracking off.:

- Press **SPAN**, **Span**, **20**, **MHz**.
- Press **Peak Search**, **FREQUENCY**, **Signal Track** (On).
- Press **SPAN**, **2**, **MHz**.
- Press **FREQUENCY**, **Signal Track** (Off)

Figure 2-7

Unresolved Signals of Equal Amplitude (ESA)

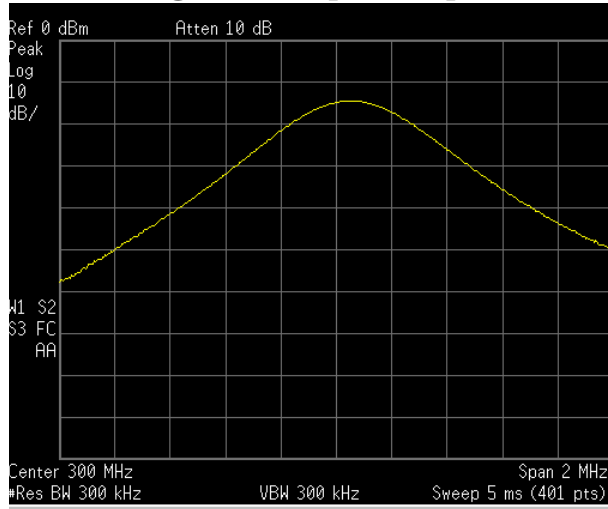

**Step 4.** Change the resolution bandwidth (RBW) to 100 kHz so that the RBW setting is less than or equal to the frequency separation of the two signals:

Press **BW/Avg, Res BW, 100, kHz.**

Notice that the peak of the signal has become flattened indicating that two signals may be present.

**Step 5.** Decrease the video bandwidth to 10 kHz:

Press **Video BW, 10, kHz.**

Two signals are now visible as shown with the ESA on the left side in [Figure 2-8](#) and the PSA on the right side. Use the front-panel knob or step keys to further reduce the resolution bandwidth and better resolve the signals.

Figure 2-8

Resolving Signals of Equal Amplitude (ESA left, PSA right)

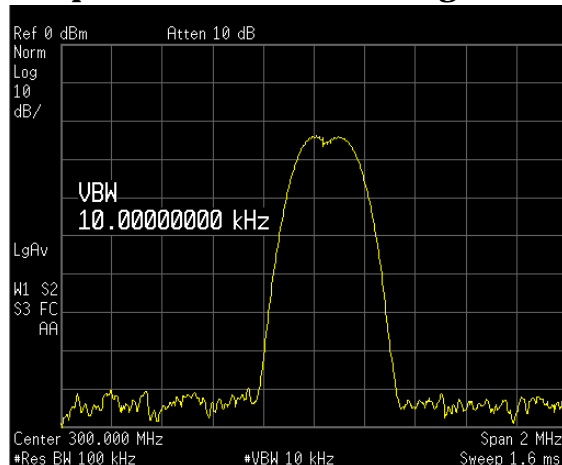
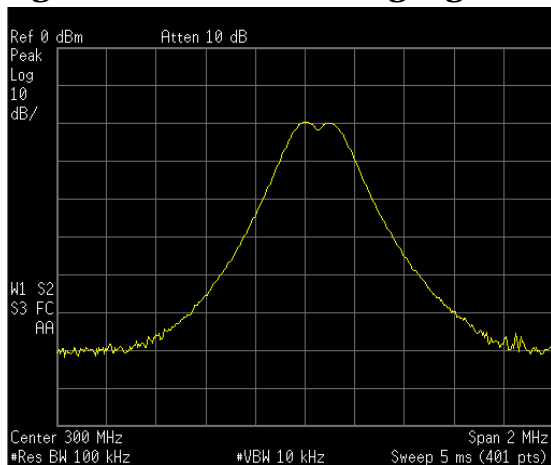

As the resolution bandwidth is decreased, resolution of the individual signals is improved and the sweep time is increased. For fastest measurement times, use the widest possible resolution bandwidth. Under factory preset conditions, the resolution bandwidth is “coupled” (or linked) to the span.

Since the resolution bandwidth has been changed from the coupled value, a # mark appears next to Res BW in the lower-left corner of the screen, indicating that the resolution bandwidth is uncoupled. (For more information on coupling, refer to the **Auto Couple** key description in the Agilent Technologies ESA Spectrum Analyzers User’s/Programmer’s Reference Guide and the PSA Spectrum Analyzers User’s/Programmer’s Reference Guide.)

---

**NOTE**

To resolve two signals of equal amplitude with a frequency separation of 200 kHz, the resolution bandwidth must be less than the signal separation so a resolution bandwidth of 100 kHz must be used. (For analyzers that use a 1-3-10 RBW step sequence, a 100 kHz RBW is the best choice for signal separation, but for high performance analyzers, like the PSA, a 180 kHz RBW can be selected by fine tuning the RBW filters at 10% increments.) Filter widths above 200 kHz exceed the 200 kHz signal separation and would not resolve the signals.

---

---

## Resolving Small Signals Hidden by Large Signals

This procedure uses narrow resolution bandwidths to resolve two input signals with a frequency separation of 155 kHz and an amplitude difference of 60 dB.

- Step 1.** Connect two sources to the analyzer input as shown in [Figure 2-6](#).
- Step 2.** Set one source to 300 MHz at  $-10$  dBm. Set the second source to 300.05 MHz, so that the signal is 50 kHz higher than the first signal. Set the amplitude of the signal to  $-70$  dBm (60 dB below the first signal).
- Step 3.** Set the analyzer as follows:
- Press **Preset, Factory Preset** (if present).
  - Press **FREQUENCY Channel, Center Freq, 300, MHz**.
  - Press **BW/Avg, 30, kHz**.
  - Press **SPAN X Scale, Span, 500, kHz**.

---

**NOTE** If the signal peak is not present on the display, span out to 20 MHz, turn signal tracking on, span back to 2 MHz and turn signal tracking off:

- Press **SPAN, Span, 20, MHz**.
- Press **Peak Search, FREQUENCY, Signal Track (On)**.
- Press **SPAN, 2, MHz**.
- Press **FREQUENCY, Signal Track (Off)**.

- 
- Step 4.** Set the 300 MHz signal to the reference level:
- Press **Peak Search, Mkr →, Mkr → Ref Lvl**.

---

**NOTE** The ESA 30 kHz filter shape factor of 15:1 (PSA is 4.1:1) has a bandwidth of 450 kHz at the 60 dB point (PSA has a BW of 123 kHz). The half-bandwidth (225 kHz for ESA and 61.5 kHz for PSA) is NOT narrower than the frequency separation of 50 kHz, so the input signals can not be resolved.

---

**Figure 2-9** Signal Resolution with a 30 kHz RBW (ESA left, PSA right)

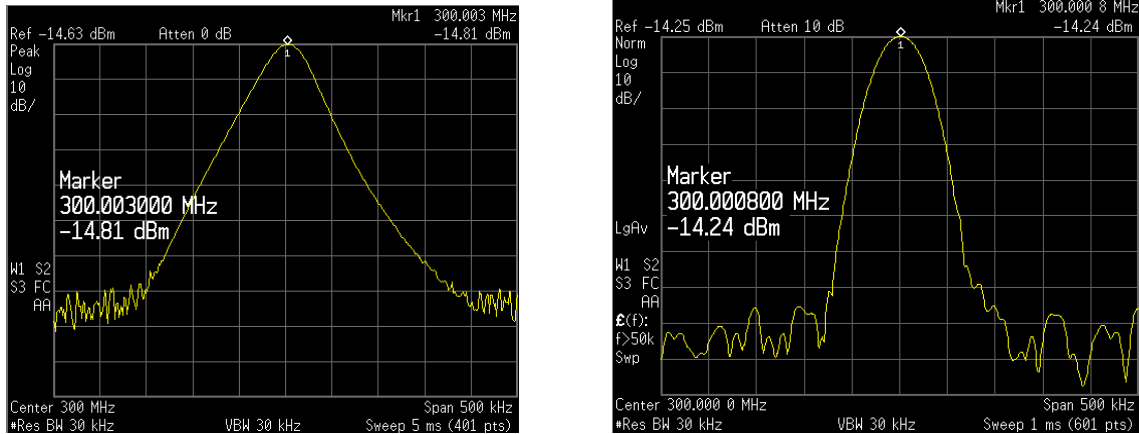

**Step 5.** Reduce the resolution bandwidth filter to view the smaller hidden signal. Place a delta marker on the smaller signal:

Press **BW/Avg, 1, kHz**.  
Press **Peak Search, Marker, 50, kHz**.

**NOTE**

The ESA 1 kHz filter shape factor of 15:1 (PSA is 4.1:1) has a bandwidth of 15 kHz at the 60 dB point (PSA has a BW of 4.1 kHz). The half-bandwidth (7.5 kHz for ESA and 2.05 kHz for PSA) is narrower than 50 kHz, so the input signals can be resolved.

**Figure 2-10** Signal Resolution with a 1 kHz RBW (ESA left, PSA right)

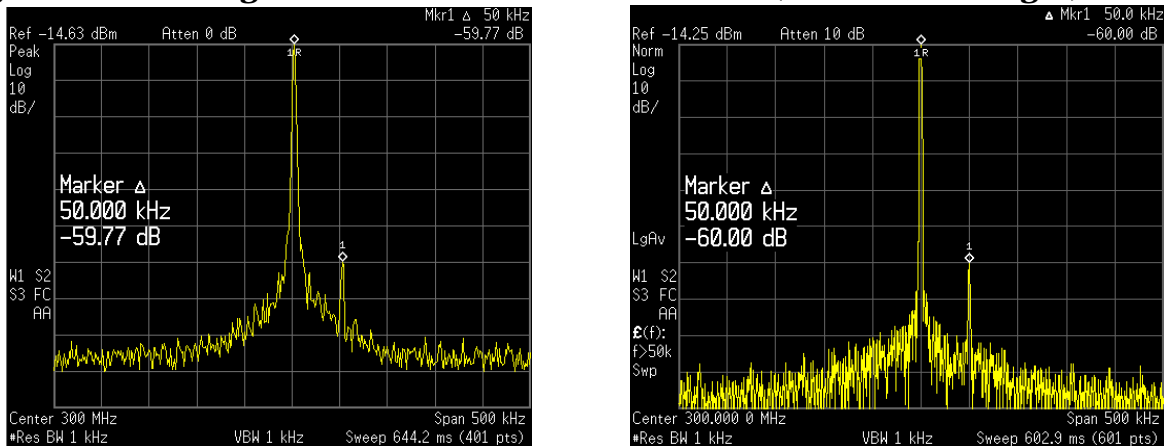

**NOTE**

To determine the resolution capability for intermediate amplitude differences, assume the filter skirts between the 3 dB and 60 dB points are parabolic, like an ideal Gaussian filter. The resolution capability is approximately:

$$12.04 \text{ dB} \cdot \left( \frac{\Delta f}{\text{RBW}} \right)^2$$

where  $\Delta f$  is the separation between the signals.

Measuring Multiple Signals

---

## Decreasing the Frequency Span Around the Signal

Using the analyzer signal track function, you can quickly decrease the span while keeping the signal at center frequency. This is a fast way to take a closer look at the area around the signal to identify signals that would otherwise not be resolved.

This procedure uses signal tracking and span zoom to view the analyzer 50 MHz reference signal in a 200 kHz span.

**Step 1.** Perform a factory preset:

Press **Preset, Factory Preset** (if present).

**Step 2.** Enable the internal 50 MHz amplitude reference signal of the analyzer as follows:

(PSA)

Press **Input/Output, Input Port, Amptd Ref**.

(ESA E4401B and E4411B)

Press **Input/Output, Amptd Ref (On)**.

(ESA E4402B, E4403B, E4404B, E4405B, E4407B and E4408B)

Connect a cable from the front panel AMPTD REF OUT to the analyzer RF input:

Press **Input/Output, Amptd Ref Out (On)**.

**Step 3.** Set the start frequency to 20 MHz and the stop frequency to 1 GHz:

Press **FREQUENCY Channel, Start Freq, 20, MHz**.

Press **FREQUENCY Channel, Stop Freq, 1, GHz**.

**Step 4.** Place a marker at the peak:

Press **Peak Search**.

**Step 5.** Turn on the signal tracking function to move the signal to the center of the screen (if it is not already positioned there):

Press **FREQUENCY Channel, Signal Track (On)**.

See the left-side of figure [Figure 2-11](#). (Note that the marker must be on the signal before turning signal track on.)

---

### NOTE

Because the signal track function automatically maintains the signal at the center of the screen, you can reduce the span quickly for a closer look. If the signal drifts off of the screen as you decrease the span, use a wider frequency span. (You can also use **Span Zoom**, in the **SPAN** menu, as a quick way to perform the **Peak Search, FREQUENCY, Signal Track, SPAN** key sequence.)

---

**Step 6.** Reduce span and resolution bandwidth to zoom in on the marked signal:

Press **SPAN X Scale, Span, 200, kHz.**

**NOTE**

If the span change is large enough, the span decreases in steps as automatic zoom is completed. See [Figure 2-11](#) on the right side. You can also use the front-panel knob or step keys to decrease the span and resolution bandwidth values.

**Step 7.** Turn off signal tracking:

Press **FREQUENCY Channel, Signal Track (Off).**

**Figure 2-11** Signal Tracking

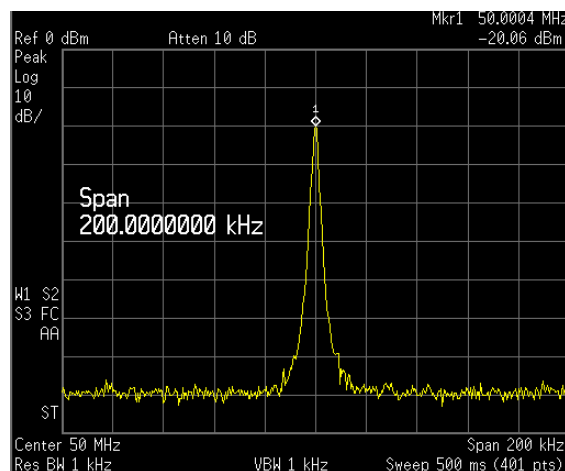
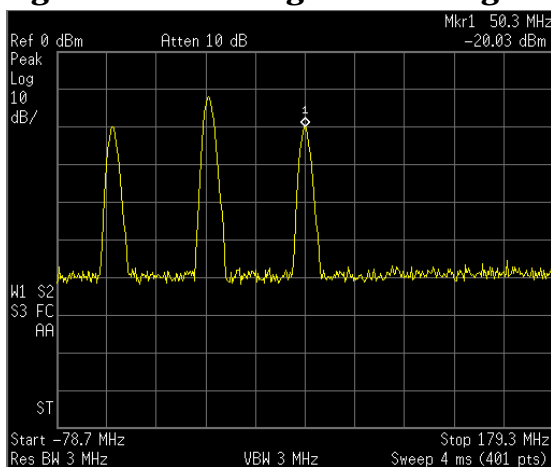

LEFT: Signal tracking on before span decrease  
RIGHT: After zooming in on the signal

Measuring Multiple Signals  
Decreasing the Frequency Span Around the Signal



---

---

**3****Measuring a Low-Level Signal**

## Reducing Input Attenuation

The ability to measure a low-level signal is limited by internally generated noise in the spectrum analyzer. The measurement setup can be changed in several ways to improve the analyzer sensitivity.

The input attenuator affects the level of a signal passing through the instrument. If a signal is very close to the noise floor, reducing input attenuation can bring the signal out of the noise.

**CAUTION** Ensure that the total power of all input signals at the analyzer RF input does not exceed +30 dBm (1 watt).

**Step 1.** Preset the analyzer:

Press **Preset, Factory Preset** (if present).

**Step 2.** Set the frequency of the signal source to 300 MHz. Set the source amplitude to -80 dBm. Connect the source RF OUTPUT to the analyzer RF INPUT.

**Step 3.** Set the center frequency, span and reference level:

Press **FREQUENCY Channel, Center Freq, 300, MHz**.  
Press **SPAN X Scale, Span, 5, MHz**.  
Press **AMPLITUDE Y Scale, Ref Level, 40, -dBm**.

**Step 4.** Move the desired peak (in this example, 300 MHz) to the center of the display:

Press **Peak Search, Marker →, Mkr → CF**.

**Step 5.** Reduce the span to 1 MHz (as shown in [Figure 3-1](#)) and if necessary re-center the peak:

Press **Span, 1, MHz**.

**Figure 3-1** Measuring a Low-Level Signal (ESA Display)

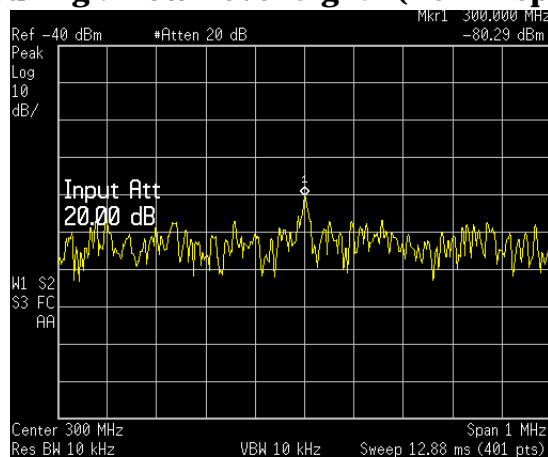

**Step 6.** Set the attenuation to 20 dB:

Press **AMPLITUDE Y Scale, Attenuation, 20, dB**.

Note that increasing the attenuation moves the noise floor closer to the signal level.

A “#” mark appears next to the **Atten** annotation at the top of the display, indicating that the attenuation is no longer coupled to other analyzer settings.

**Step 7.** To see the signal more clearly, set the attenuation to 0 dB:

Press **AMPLITUDE, Attenuation, 0, dB**.

See [Figure 3-2](#) shows 0 dB input attenuation.

**Figure 3-2** Measuring a Low-Level Signal Using 0 dB Attenuation (ESA)

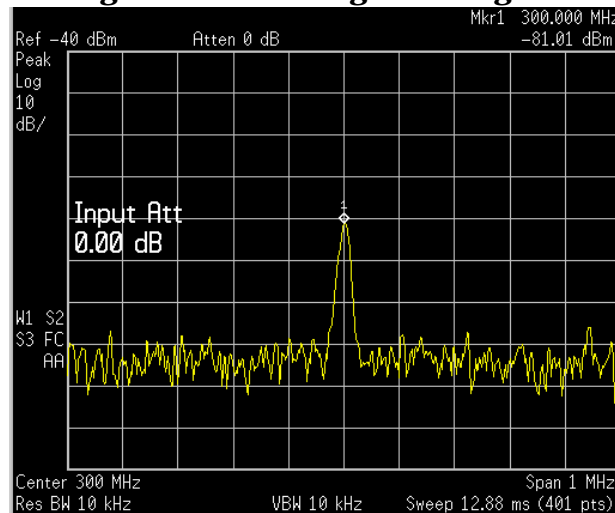

**CAUTION**

When you finish this example, increase the attenuation to protect the analyzer’s RF input:

Press **AMPLITUDE Y Scale, Attenuation (Auto)** or press **Auto Couple**.

**NOTE**

All figures in this chapter are screen captures from an ESA. Display and numerical results may be different for a PSA.

## Decreasing the Resolution Bandwidth

Resolution bandwidth settings affect the level of internal noise without affecting the level of continuous wave (CW) signals. Decreasing the RBW by a decade reduces the noise floor by 10 dB.

**Step 1.** Refer to the first procedure “Reducing Input Attenuation” on page 26 of this chapter and follow steps 1, 2 and 3.

**Step 2.** Decrease the resolution bandwidth:

Press **BW/Avg**, ↓.

The low-level signal appears more clearly because the noise level is reduced (see Figure 3-3).

Figure 3-3

Decreasing Resolution Bandwidth

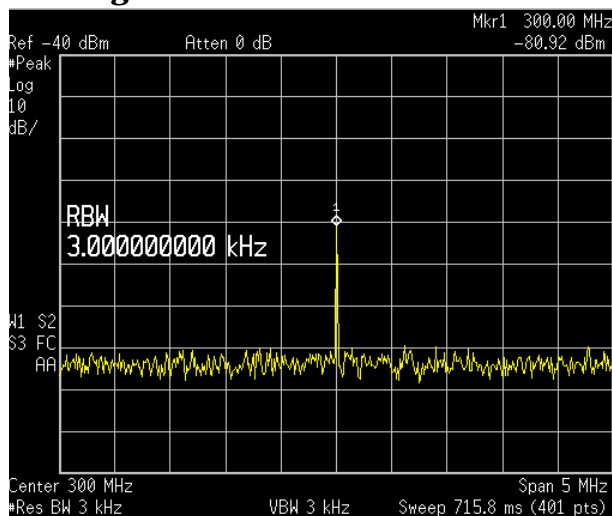

A “#” mark appears next to the Res BW annotation in the lower left corner of the screen, indicating that the resolution bandwidth is uncoupled.

**RBW Selections** You can use the step keys to change the RBW in a 1–3–10 sequence.

For ESA, RBWs below 1 kHz are digital and have a selectivity ratio of 5:1 while RBWs at 1 kHz and higher have a 15:1 selectivity ratio. The ESA’s maximum RBW is 5 MHz and the minimum is 1 Hz (optional).

All PSA RBWs are digital and have a selectivity ratio of 4.1:1. For PSA, choosing the next lower RBW for better sensitivity increases the sweep time by about 10:1 for swept measurements, and about 3:1 for FFT measurements (within the limits of RBW). Using the knob or keypad, you can select RBWs from 1 Hz to 3 MHz in approximately 10% increments, plus 4, 5, 6 and 8 MHz. This enables you to make the trade off between sweep time and sensitivity with finer resolution.

## Using the Average Detector and Increased Sweep Time

When the analyzer's noise masks low-level signals, changing to the average detector and increasing the sweep time smooths the noise and improves the signal's visibility. Slower sweeps are required to average more noise variations.

**Step 1.** Refer to the first procedure “Reducing Input Attenuation” on page 26 of this chapter and follow steps 1, 2 and 3.

**Step 2.** Select the average detector:

Press **Det/Demod, Detector, Average**.

A “#” mark appears next to the Avg annotation, indicating that the detector has been chosen manually (see Figure 3-4).

**Step 3.** Increase the sweep time to 100 ms:

Press **Sweep, Sweep Time, ↑**.

Note how the noise smooths out, as there is more time to average the values for each of the displayed data points.

**Step 4.** With the sweep time at 100 ms, change the average type to log averaging:

(ESA) Press **BW/Avg, Avg Type, Video Avg**.

(PSA) Press **BW/Avg, Avg/VBW Type, Log-Pwr**.

**Figure 3-4**

**Varying the Sweep Time with the Average Detector**

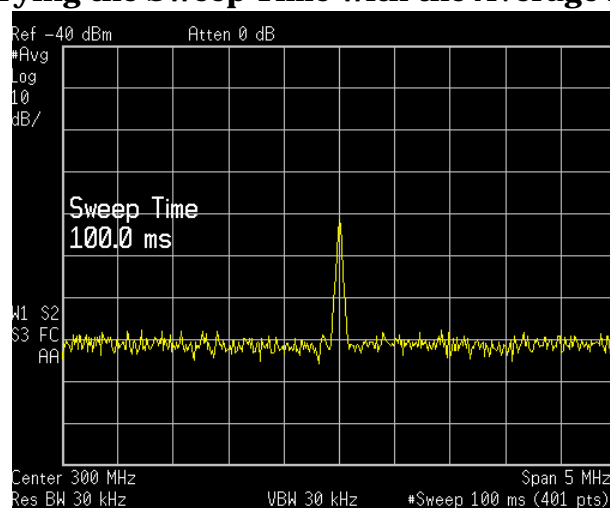

---

## Trace Averaging

Averaging is a digital process in which each trace point is averaged with the previous average for the same trace point. Selecting averaging, when the analyzer is autocoupled, changes the detection mode (from peak in ESA and normal in PSA) to sample, smoothing the displayed noise level. ESA sample mode displays the instantaneous value of the signal at the end of the time or frequency interval represented by each display point (for PSA it is the center of the time or frequency interval), rather than the value of the peak during the interval. Sample mode may not measure a signal's amplitude as accurately as normal mode, because it may not find the true peak.

---

**NOTE** This is a trace processing function and is not the same as using the average detector (as described on [page 29](#)).

---

**Step 1.** Refer to the first procedure “[Reducing Input Attenuation](#)” on [page 26](#) of this chapter and follow steps 1, 2 and 3.

**Step 2.** Turn video averaging on:

Press **BW/Avg, Average** (On).

As the averaging routine smooths the trace, low level signals become more visible. *Average 100* appears in the active function block.

**Step 3.** With average as the active function, set the number of averages to 25:

Press **25, Enter**.

Annotation on the left side of the graticule shows the type of averaging (the annotation for ESA is  $V_{Avg}$  and is  $LgAv$  for PSA), and the number of traces averaged.

Changing most active functions restarts the averaging, as does toggling the **Average** key. Once the set number of sweeps completes, the analyzer continues to provide a running average based on this set number.

---

**NOTE** If you want the measurement to stop after the set number of sweeps, use single sweep: Press **Sweep, Sweep** (to select **Single**), or press **Single** and then toggle the **Average** key.

---

---

# 4 Improving Frequency Resolution and Accuracy

---

## Using a Frequency Counter to Improve Frequency Resolution and Accuracy

This procedure uses the spectrum analyzer internal frequency counter to increase the resolution and accuracy of the frequency readout.

**Step 1.** Preset the analyzer:

Press **Preset, Factory Preset** (if present).

**Step 2.** Enable the internal 50 MHz amplitude reference signal as follows:

(PSA)

Press **Input/Output, Input Port, Amptd Ref**.

(ESA E4401B and E4411B)

Press **Input/Output, Amptd Ref (On)**.

(ESA E4402B, E4403B, E4404B, E4405B, E4407B and E4408B)

Connect a cable from the front panel AMPTD REF OUT to the analyzer RF input:

Press **Input/Output, Amptd Ref Out (On)**.

**Step 3.** Set the center frequency to 50 MHz and the span to 80 MHz:

Press **FREQUENCY Channel, Center Freq, 50, MHz**.

Press **SPAN X Scale, Span, 80, MHz**.

**Step 4.** Turn the frequency counter on:

(ESA) Press **Freq Count**.

(PSA) Press **Marker Fctn, Marker Count, Marker Count (On)**.

---

**NOTE**

The frequency and amplitude of the marker and the word *Marker* appears in the active function area (this is not the counted result). The counted result appears in the upper-right corner of the display to the right-side of *Cntrl*.

**Step 5.** Move the marker, with the front-panel knob, half-way down the skirt of the signal response.

Notice that the readout in the active frequency function changes while the counted frequency result (upper-right corner of display) does not. See [Figure 4-1](#). To get an accurate count, you do not need to place the marker at the exact peak of the signal response.

---

**NOTE**

Marker count properly functions only on CW signals or discrete spectral components. The marker must be > 25 dB above the displayed noise level.



**Figure 4-1** Using Marker Counter (ESA Display)

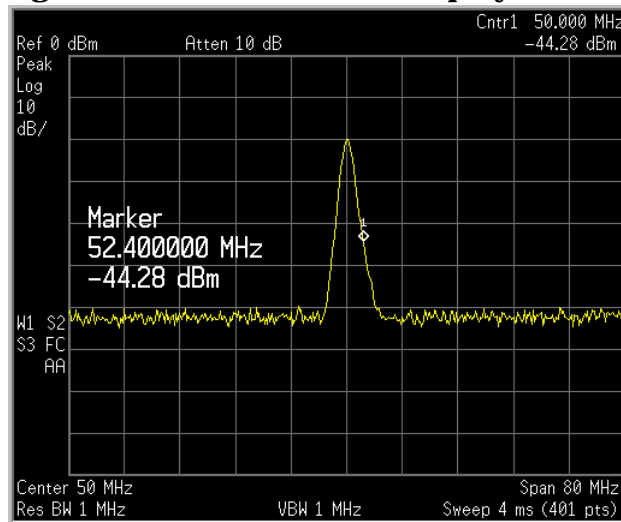

**Step 6.** Change counter resolution:

ESA frequency-counter resolution can be set from 1 Hz to 100 kHz by pressing **Freq Count, Resolution**.

PSA frequency-counter resolution is fixed at 0.001 Hz for 2 ms and longer gate times. Longer gate times allow for greater averaging of signals whose frequency is "noisy", at the expense of throughput.

**NOTE**

For PSA, if the **Gate Time** (under the **Marker Count** menu) is an integer multiple of the length of a power-line cycle (20 ms for 50 Hz power, 16.67 ms for 60 Hz power), the counter rejects incidental modulation at the power line rate. The shortest **Gate Time** that rejects both 50 and 60 Hz modulation is 100 ms (100 ms is the default **Gate Time** setting when set to **Auto**).

**Step 7.** The marker counter remains on until turned off. Turn off the marker counter:

(ESA) Press **Freq Count, Marker Count (Off)**. Or Press **Marker, Off**.  
(PSA) Press **Marker Fctn, Marker Count, Marker Count (Off)**. Or Press **Marker, Off**.

**NOTE**

When using the built-in frequency counter function with the ESA, if the ratio of the resolution bandwidth to the span is too small (less than or equal to 0.002), the **Marker Count: Widen Res BW** message appears on the display. It indicates that the resolution bandwidth is too narrow.

Improving Frequency Resolution and Accuracy

**Using a Frequency Counter to Improve Frequency Resolution and Accuracy**

---

# 5 Tracking Drifting Signals

---

## Measuring a Source's Frequency Drift

The analyzer can measure the short- and long-term stability of a source. The maximum amplitude level and the frequency drift of an input signal trace can be displayed and held by using the maximum-hold function. You can also use the maximum hold function if you want to determine how much of the frequency spectrum a signal occupies.

This procedure uses signal tracking to keep the drifting signal in the center of the display. The drifting is captured by the analyzer using maximum hold.

- Step 1.** Connect the signal generator to the analyzer input.
- Step 2.** Set the signal generator frequency to 300 MHz with an amplitude of -20 dBm.
- Step 3.** Set the analyzer center frequency, span and reference level.
- Press **Preset, Factory Preset** (if present).  
Press **FREQUENCY Channel, Center Freq, 300, MHz**.  
Press **SPAN X Scale, Span, 10, MHz**.  
Press **AMPLITUDE Y Scale, Ref Level, 10, -dBm**.

- Step 4.** Place a marker on the peak of the signal and turn signal tracking on:
- Press **Peak Search**.  
Press **FREQUENCY Channel, Signal Track (On)**.
- Reduce the span to 500 kHz:
- Press **SPAN, Span Zoom, 500, kHz**.
- Notice that the signal is held in the center of the display.

- Step 5.** Turn off the signal track function:
- Press **FREQUENCY Channel, Signal Track (Off)**.

- Step 6.** Measure the excursion of the signal with maximum hold:
- (ESA) Press **View/Trace, Max Hold**.  
(PSA) Press **Trace/View, Max Hold**.

As the signal varies, maximum hold maintains the maximum responses of the input signal.

---

### NOTE

Annotation on the left side of the screen indicates the trace mode. For example, M1 S2 S3 indicates trace 1 is in maximum-hold mode, trace 2 and trace 3 are in store-blank mode.

---

**Step 7.** Activate trace 2 (trace 2 should be underlined) and change the mode to continuous sweeping:

(ESA) Press **View/Trace, Trace (2)**.

(PSA) Press **Trace/View, Trace (2)**.

Press **Clear Write**.

Trace 1 remains in maximum hold mode to show any drift in the signal.

**Step 8.** Slowly change the frequency of the signal generator  $\pm 50$  kHz in 1 kHz increments. Your analyzer display should look similar to [Figure 5-1](#).

**Figure 5-1**

**Viewing a Drifting Signal With Max Hold and Clear Write**

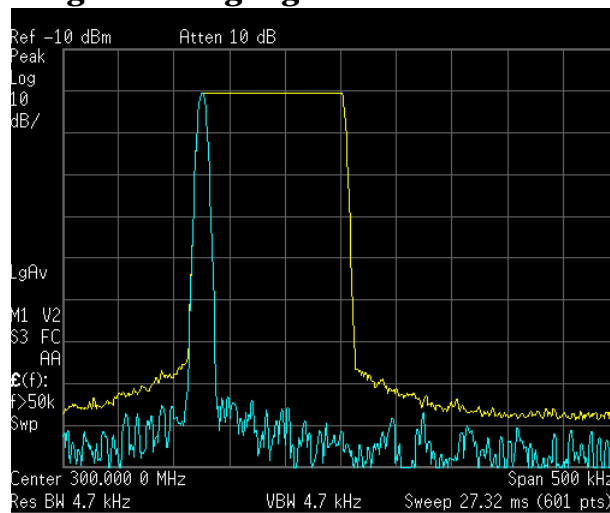

## Tracking a Signal

The signal track function is useful for tracking drifting signals that drift relatively slowly by keeping the signal centered on the display as the signal drifts. This procedure tracks a drifting signal.

Note that the primary function of the signal track function is to track unstable signals, not to track a signal as the center frequency of the analyzer is changed. If you choose to use the signal track function when changing center frequency, check to ensure that the signal found by the tracking function is the correct signal.

**Step 1.** Set the source frequency to 300 MHz with an amplitude of -20 dBm.

**Step 2.** Set the analyzer center frequency at a 1 MHz offset:

Press **Preset, Factory Preset** (if present).  
Press **FREQUENCY Channel, Center Freq, 301, MHz**.  
Press **SPAN X Scale, Span, 10, MHz**.

**Step 3.** Turn the signal tracking function on:

Press **FREQUENCY Channel, Signal Track (On)**.

Notice that signal tracking places a marker on the highest amplitude peak and then brings the selected peak to the center of the display. After each sweep the center frequency of the analyzer is adjusted to keep the selected peak in the center.

**Step 4.** Turn the delta marker on to read signal drift:

Press **Marker, Delta**.

**Step 5.** Tune the frequency of the signal generator in 100 kHz increments.

Notice that the center frequency of the analyzer also changes in 100 kHz increments, centering the signal with each increment.

**Figure 5-2** Tracking a Drifting Signal (ESA left, PSA right)

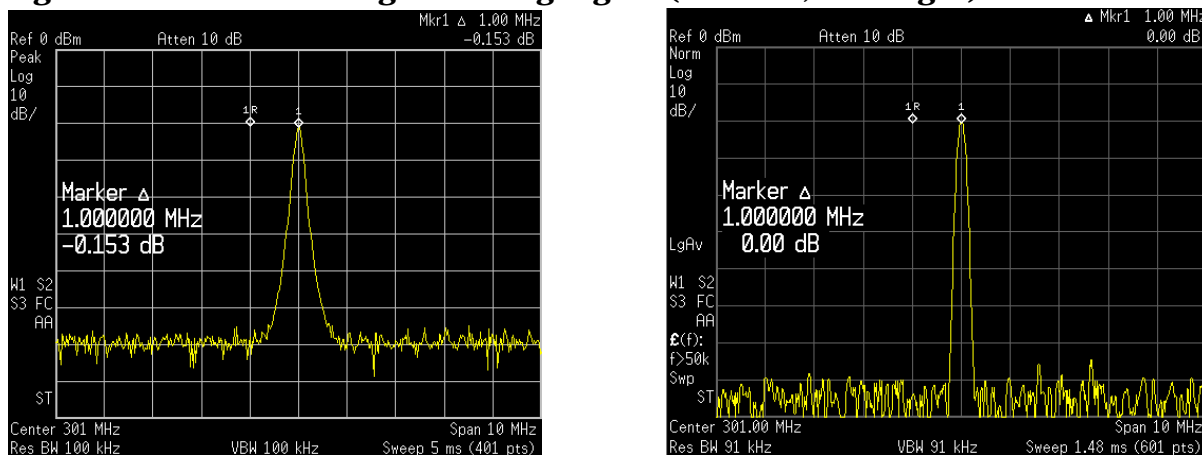

---

# **6 Making Distortion Measurements**

## Identifying Analyzer Generated Distortion

High level input signals may cause analyzer distortion products that could mask the real distortion measured on the input signal. Using trace 2 and the RF attenuator, you can determine which signals, if any, are internally generated distortion products.

Using a signal from a signal generator, determine whether the harmonic distortion products are generated by the analyzer.

- Step 1.** Connect the signal generator to the analyzer input.
- Step 2.** Set the source frequency to 200 MHz with an amplitude of 0 dBm.
- Step 3.** Set the analyzer center frequency and span:

Press **Preset**, **Factory Preset** (if present).  
Press **FREQUENCY Channel**, **Center Freq**, **400**, **MHz**.  
Press **SPAN X Scale**, **Span**, **500**, **MHz**.

The signal produces harmonic distortion products (spaced 200 MHz from the original 200 MHz signal) in the analyzer input mixer as shown in [Figure 6-1](#).

**Figure 6-1** Harmonic Distortion (ESA left, PSA right)

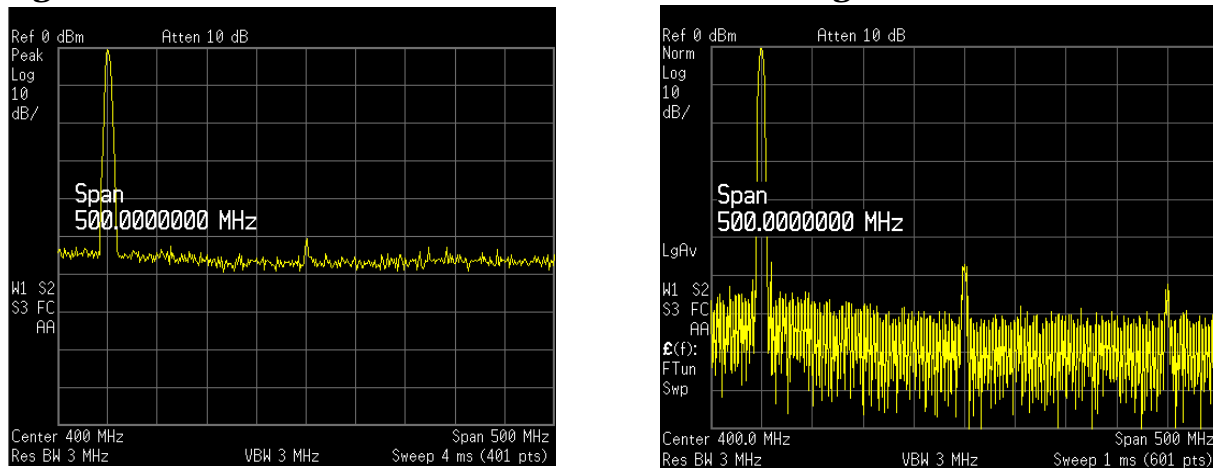

- Step 4.** Change the center frequency to the value of the first harmonic:

Press **Peak Search**, **Next Peak**, **Marker**→, **Mkr**→**CF**.

- Step 5.** Change the span to 50 MHz and re-center the signal:

Press **SPAN X Scale**, **Span**, **50**, **MHz**.  
Press **Peak Search**, **Marker**→, **Mkr**→**CF**.

- Step 6.** Set the attenuation to 0 dB:

Press **AMPLITUDE Y Scale**, **Attenuation**, **0**, **dB**.



**Step 7.** To determine whether the harmonic distortion products are generated by the analyzer, first save the trace data in trace 2 as follows:

(ESA) Press **View/Trace, Trace (2), Clear Write**.

(PSA) Press **Trace/View, Trace (2), Clear Write**.

**Step 8.** Allow trace 2 to update (minimum two sweeps), then store the data from trace 2 and place a delta marker on the harmonic of trace 2:

Press **View**.

Press **Peak Search, Marker, Delta**.

The analyzer display shows the stored data in trace 2 and the measured data in trace 1. The  $\Delta Mkr1$  amplitude reading is the difference in amplitude between the reference and active markers.

**Step 9.** Increase the RF attenuation to 10 dB:

Press **AMPLITUDE Y Scale, Attenuation, 10, dB**.

Notice the  $\Delta Mkr1$  amplitude reading. This is the difference in the distortion product amplitude readings between 0 dB and 10 dB input attenuation settings. If the  $\Delta Mkr1$  amplitude absolute value is approximately  $\geq 1$  dB for an input attenuator change, the distortion is being generated, at least in part, by the analyzer. In this case more input attenuation is necessary. See [Figure 6-2](#).

**Figure 6-2**

### RF Attenuation of 10 dB

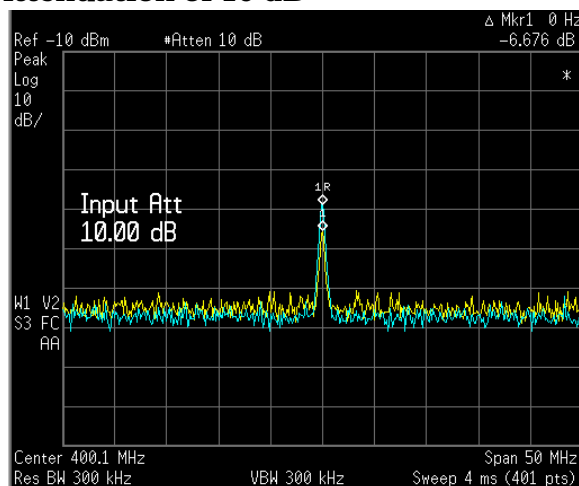

The  $\Delta Mkr1$  amplitude reading comes from two sources:

- 1) Increased input attenuation causes poorer signal-to-noise ratio. This can cause the  $\Delta Mkr1$  to be positive.
- 2) The reduced contribution of the analyzer circuits to the harmonic measurement can cause the  $\Delta Mkr1$  to be negative.

Large  $\Delta Mkr1$  measurements indicate significant measurement errors. Set the input attenuator to minimize the absolute value of  $\Delta Mkr1$ .

## Third-Order Intermodulation Distortion

Two-tone, third-order intermodulation distortion is a common test in communication systems. When two signals are present in a non-linear system, they can interact and create third-order intermodulation distortion products that are located close to the original signals. These distortion products are generated by system components such as amplifiers and mixers.

For the quick setup TOI measurement example, refer to “[Measuring TOI Distortion with a One-Button Measurement](#)” on page 44.

This procedure tests a device for third-order intermodulation using markers. Two sources are used, one set to 300 MHz and the other to 301 MHz.

- Step 1.** Connect the equipment as shown in [Figure 6-3](#). This combination of signal generators, low pass filters, and directional coupler (used as a combiner) results in a two-tone source with very low intermodulation distortion. Although the distortion from this setup may be better than the specified performance of the analyzer, it is useful for determining the TOI performance of the source/analyzer combination. After the performance of the source/analyzer combination has been verified, the device-under-test (DUT) (for example, an amplifier) would be inserted between the directional coupler output and the analyzer input.

**Figure 6-3**

**Third-Order Intermodulation Equipment Setup**

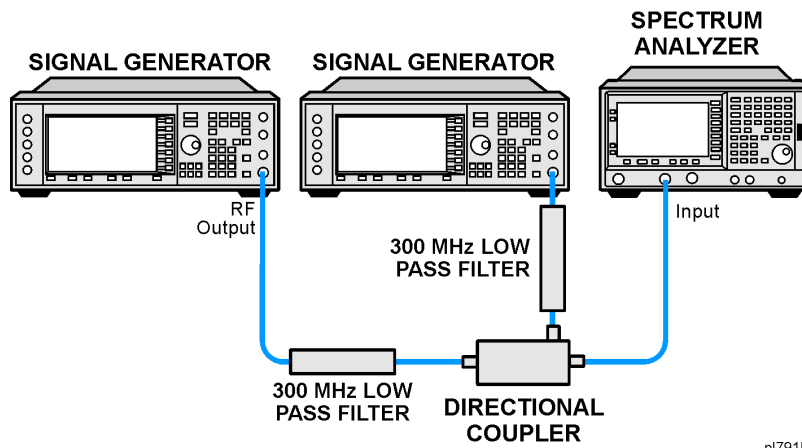

**NOTE**

The coupler should have a high degree of isolation between the two input ports so the sources do not intermodulate.

- Step 2.** Set one source (signal generator) to 300 MHz and the other source to 301 MHz, for a frequency separation of 1 MHz. Set the sources equal in amplitude as measured by the analyzer (in this example, they are set to  $-5$  dBm).

**Step 3.** Set the analyzer center frequency and span:

Press **Preset, Factory Preset** (if present).  
Press **FREQUENCY Channel, Center Freq, 300.5, MHz**.  
Press **SPAN X Scale, Span, 5, MHz**.

**Step 4.** Reduce the RBW until the distortion products are visible:

Press **BW/Avg, Res BW, ↓**.

**Step 5.** Set the mixer level to improve dynamic range:

(ESA) Press **AMPLITUDE Y Scale, More, Max Mixer Lvl, -30, dBm**.  
(PSA) Press **AMPLITUDE Y Scale, More, More, Max Mixer Lvl, -30, dBm**.

The analyzer automatically sets the attenuation so that a signal at the reference level has a maximum value of -30 dBm at the input mixer.

**Step 6.** Move the signal to the reference level:

Press **Peak Search, Mkr →, Mkr → Ref Lvl**.

**Step 7.** Reduce the RBW until the distortion products are visible:

Press **BW/Avg, Res BW, ↓**.

**Step 8.** Activate the second marker and place it on the peak of the distortion product (beside the test signal) using the **Next Peak** key.

Press **Marker, Delta, Peak Search, Next Peak**.

**Step 9.** Measure the other distortion product:

Press **Marker, Normal, Peak Search, Next Peak**.

**Step 10.** Measure the difference between this test signal and the second distortion product (see [Figure 6-4](#)):

Press **Delta, Peak Search, Next Peak**.

**Figure 6-4**

**Measuring the Distortion Product**

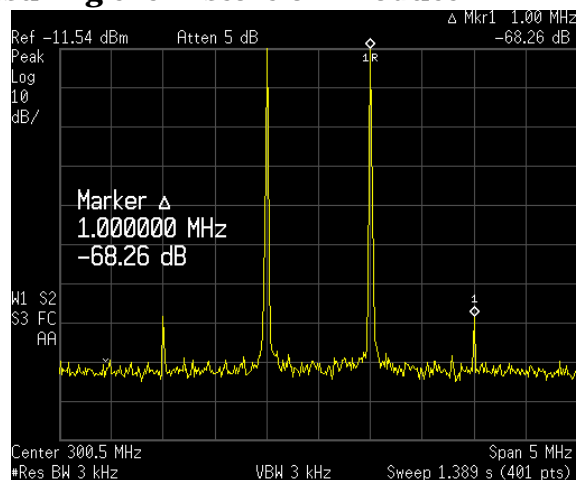

## Measuring TOI Distortion with a One-Button Measurement

One-button power measurements are a part of the Power Suite measurement utility and are standard on all ESA and PSA models. Power Suite uses preset analyzer states to measure some of the more common RF power tests. You can modify the preset states in the Power Suite measurements, giving you the flexibility to modify analyzer settings. Power Suite also has preset states for cellular, Bluetooth and WiFi radio formats for fast, accurate and repeatable measurements.

This procedure uses the intermodulation one-button test from the Power Suite Measure menu to automate the TOI measurement. It is measuring the TOI performance as in the previous procedure “Third-Order Intermodulation Distortion” on page 42.

**Step 1.** Refer to the second procedure “Third-Order Intermodulation Distortion” on page 42 of this chapter and follow steps 1 and 2.

**Step 2.** Set the analyzer center frequency to 300.5 MHz:

Press **Preset**, **Factory Preset** (if present).  
 Press **FREQUENCY Channel, Center Freq, 300.5, MHz**.

**Step 3.** Measure the intermodulation products using the Power Suite measurement tools:

Press **Measure, More, Intermod (TOI)**.

**Figure 6-5**

**Measuring the Distortion Products with Power Suite**

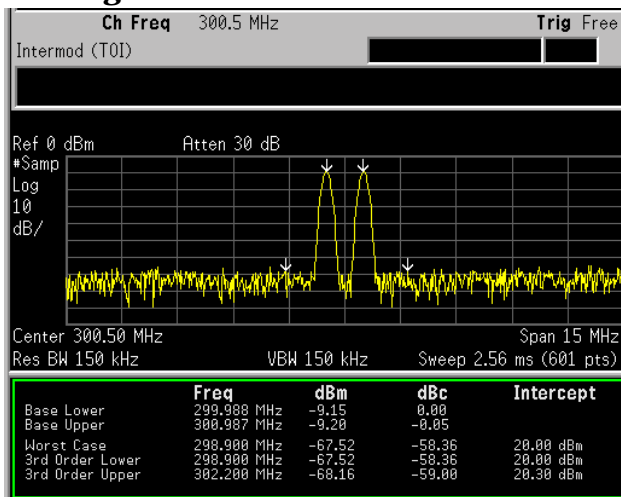

---

## Measuring Harmonics and Harmonic Distortion with a One-Button Measurement

This procedure measures the harmonics of the 10 MHz reference output signal. The harmonics and total harmonic distortion are measured using the one-button automated harmonic measurement.

**Step 1.** Preset the analyzer:

Press **Preset, Factory Preset** (if present).

**Step 2.** Connect the ESA 10 MHz reference output from the rear of the analyzer to the INPUT. For PSA turn the internal 10 MHz reference signal on:

(PSA) Press **System, Reference, 10MHz Out (On)**.

**Step 3.** Set the analyzer reference level, center frequency and RBW:

Press **AMPLITUDE Y Scale, Ref Level, 10, dBm**.

Press **FREQUENCY Channel, Center Freq, 10, MHz**.

Press **BW/Avg, Res BW, 300, kHz**.

**Step 4.** Run the Power Suite harmonic distortion measurement:

Press **Measure, More, Harmonic Distortion**.

**Step 5.** Set the number of harmonic distortion measurement averages to 3:

Press **Meas Setup, Avg Number (On), 3, Enter**

**Step 6.** Set the average mode to exponential to continuously update the result after each subsequent sweep:

Press **Meas Setup, Avg Mode (Exp)**.

Repeat average mode clears the averaged result after the specified number of averages is complete.

**Step 7.** Optimize the analyzer's dynamic range settings:

Press **Meas Setup, Optimize Ref Level**.

**Step 8.** Display the total harmonic distortion:

(ESA) Press **View/Trace, Harmonics & THD**.

(ESA) Press **Trace/View, Harmonics & THD**.

Making Distortion Measurements  
**Measuring Harmonics and Harmonic Distortion with a One-Button Measurement**

**Figure 6-6** **Measuring the Harmonic Distortion**

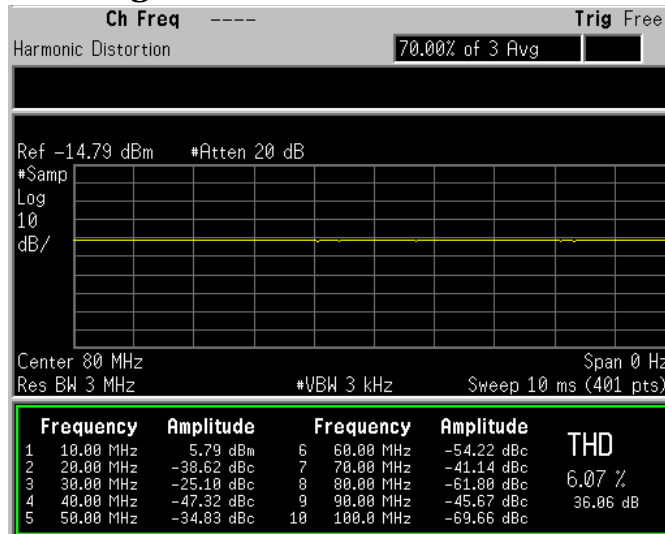

The amplitudes of the harmonics are listed relative to the fundamental frequency.

**NOTE** An asterisk (\*) appearing next to the total harmonic distortion value indicates that the ideal resolution bandwidths for one or more harmonics could not be set. These harmonics for which the resolution bandwidths could not be set are flagged with an asterisk beside their amplitude value. The measurement is still accurate as long as the signal has little or no modulation.

- Step 9.** Exit out of the harmonic distortion measurement:  
 Press **MEASURE**, Meas Off.

---

**7**

## **Measuring Noise**

## Measuring Signal-to-Noise

Signal-to-noise is a ratio used in many communication systems as an indication of noise in a system. Typically the more signals added to a system adds to the noise level, reducing the signal-to-noise ratio making it more difficult for modulated signals to be demodulated. This measurement is also referred to as carrier-to-noise in some communication systems.

The signal-to-noise measurement procedure below may be adapted to measure any signal in a system if the signal (carrier) is a discrete tone. If the signal in your system is modulated, it is necessary to modify the procedure to correctly measure the modulated signal level.

In this example the 50 MHz amplitude reference signal is used as the fundamental signal. The amplitude reference signal is assumed to be the signal of interest and the internal noise of the analyzer is measured as the system noise. To do this, you need to set the input attenuator such that both the signal and the noise are well within the calibrated region of the display.

**Step 1.** Preset the analyzer:

Press **Preset, Factory Preset** (if present).

**Step 2.** Enable the internal 50 MHz amplitude reference signal as follows:

(PSA)

Press **Input/Output, Input Port, Amptd Ref.**

(ESA E4401B and E4411B)

Press **Input/Output, Amptd Ref (On)**.

(ESA E4402B, E4403B, E4404B, E4405B, E4407B and E4408B)

Connect a cable from the front panel AMPTD REF OUT to the analyzer RF input:

Press **Input/Output, Amptd Ref Out (On)**.

**Step 3.** Set the center frequency, span, reference level and attenuation:

Press **FREQUENCY Channel, Center Freq, 50, MHz.**

Press **SPAN X Scale, Span, 1, MHz.**

Press **AMPLITUDE Y Scale, Ref Level, -10, dBm.**

Press **AMPLITUDE Y Scale, Attenuation, 40, dB.**

**Step 4.** Place a marker on the peak of the signal and then place a delta marker in the noise at a 200 kHz offset:

Press **Peak Search.**

Press **Marker, Delta, 200, kHz.**

**Step 5.** Turn on the marker noise function to view the signal-to-noise



measurement results:

(ESA) Press Marker, More, Function, Marker Noise.  
(PSA) Press Marker Fctn, Marker Noise.

**Figure 7-1** Measuring the Signal-to-Noise

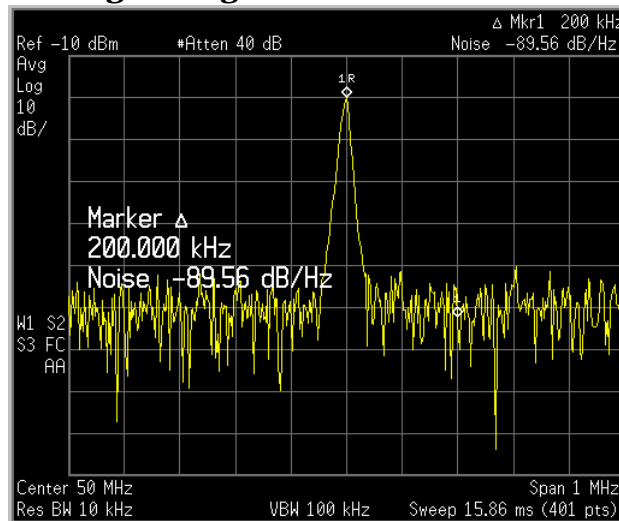

Read the signal-to-noise in dB/Hz, that is with the noise value determined for a 1 Hz noise bandwidth. If you wish the noise value for a different bandwidth, decrease the ratio by  $10 \times \log(BW)$ . For example, if the analyzer reading is  $-70$  dB/Hz but you have a channel bandwidth of 30 kHz:

$$S/N = -70 \text{ dB/Hz} + 10 \times \log(30 \text{ kHz}) = -25.23 \text{ dB}/(30 \text{ kHz})$$

**NOTE**

The display detection mode is now average. If the delta marker is closer than one quarter of a division away from the edge of the response to the discrete signal, the amplitude reference signal in this case, there is a potential for error in the noise measurement. See [“Measuring Noise Using the Noise Marker”](#) on page 50.

---

## Measuring Noise Using the Noise Marker

This procedure uses the marker function, **Marker Noise**, to measure noise in a 1 Hz bandwidth. In this example the noise marker measurement is made near the 50 MHz reference signal to illustrate the use of **Marker Noise**.

**Step 1.** Enable the internal 50 MHz reference signal of the analyzer:

(PSA)

Press **Input/Output, Input Port, Amptd Ref**.

(ESA E4401B and E4411B)

Press **Input/Output, Amptd Ref (On)**.

(ESA E4402B, E4403B, E4404B, E4405B, E4407B and E4408B)

Connect a cable from the front panel AMPTD REF OUT to the INPUT:

Press **Input/Output, Amptd Ref Out (On)**.

**Step 2.** Preset the analyzer and modify the analyzer settings:

Press **Preset, Factory Preset** (if present).

Press **FREQUENCY Channel, Center Freq, 49.98, MHz**.

Press **SPAN X Scale, Span, 100, kHz**.

Press **AMPLITUDE Y Scale, Ref Level, -10, dBm**.

Press **AMPLITUDE Y Scale, Attenuation, 40, dB**.

**Step 3.** Activate the noise marker:

(ESA) Press **Marker, More, Function, Marker Noise**.

(PSA) Press **Marker Fctn, Marker Noise**.

Note that display detection automatically changes to “Avg”; average detection calculates the noise marker from an average value of the displayed noise. Notice that the noise marker floats between the maximum and the minimum displayed noise points. The marker readout is in dBm (1 Hz) or dBm per unit bandwidth.

For noise power in a different bandwidth, add  $10 \times \log(\text{BW})$ . For example, for noise power in a 1 kHz bandwidth, dBm (1 kHz), add  $10 \times \log(1000)$  or 30 dB to the noise marker value.

---

### NOTE

ESA average detection is available for firmware revisions A.08.00 and later. Earlier firmware revisions earlier use sample detection for marker noise calculations.

---

**Step 4.** Reduce the variations of the sweep-to-sweep marker value by increasing the sweep time:

Press **Sweep, Sweep Time, 3, s**.

Increasing the sweep time when the average detector is enabled allows the trace to average over a longer time interval, thus reducing the variations in the results (increases measurement repeatability).

**Step 5.** Move the marker to 50 MHz (left display [Figure 7-2](#)):

Press **Marker**.  
Rotate the front-panel knob until the noise marker reads 50 MHz.

The noise marker value is based on the mean of 5% of the total number of sweep points centered at the marker. The points that are averaged span one-half of a division. Notice that the marker does not go to the peak of the signal because there are not enough points at the peak of the signal. The noise marker is also averaging points below the peak due to the narrow RBW.

**Step 6.** Widen the resolution bandwidth to allow the marker to make a more accurate peak power measurement using the noise marker:

Press **BW/Avg, Res BW, 10, kHz**.  
Press **Marker**.

**Figure 7-2 Noise Marker (Left - ESA 1 kHz RBW, Right - PSA 10 kHz RBW)**

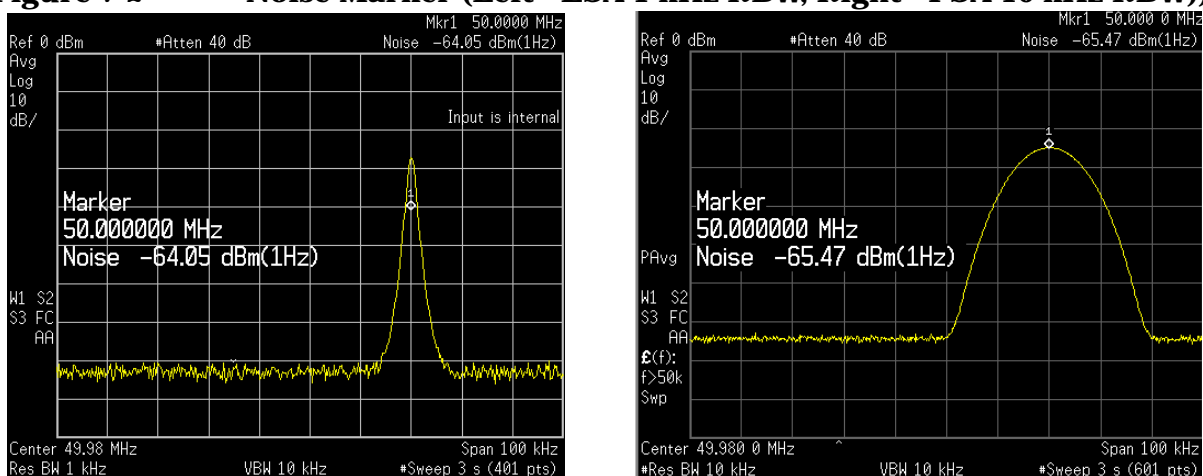

**Step 7.** Set the analyzer to zero span at the marker frequency:

Press **Mkr →, Mkr → CF**.  
Press **SPAN X Scale, Zero Span**.  
Press **Marker**.

Note that the marker amplitude value is now correct since all points averaged are at the same frequency and not influenced by the shape of the bandwidth filter.

Remember that the noise marker calculates a value based on an average of the points around the frequency of interest. Generally when making power measurements using the noise marker on discrete signals, first tune to the frequency of interest and then make your measurement in zero span (time-domain).

## Measuring Noise-Like Signals Using Marker Pairs

Marker pairs let you measure power over a frequency span. The markers allow you to easily and conveniently select any arbitrary portion of the displayed signal. However, while the analyzer, when autocoupled, makes sure the analysis is power-responding (rms voltage-responding), you must set all of the other parameters.

**Step 1.** Preset the analyzer:

Press **Preset, Factory Preset** (if present).

**Step 2.** Set the center frequency, span, reference level and attenuation:

Press **FREQUENCY Channel, Center Freq, 50, MHz**.

Press **SPAN X Scale, Span, 100, kHz**.

Press **AMPLITUDE Y Scale, Ref Level, -20, dBm**.

Press **AMPLITUDE Y Scale, Attenuation, 40, dB**.

**Step 3.** Turn on the marker span pair to setup the band power measurement in step 5:

Press **Marker, Span Pair, Span Pair (Span), 40, kHz**.

**Step 4.** Set the resolution and video bandwidths:

Press **BW/Avg, Res BW, 1, kHz**.

Press **BW/Avg, Video BW, 10, kHz**.

Common practice is to set the resolution bandwidth from 1% to 3% of the measurement (marker) span, 40 kHz in this example. For ESA, the video bandwidth should be at least ten times wider than the resolution bandwidth.

**Step 5.** Measure the total noise power between the markers:

(ESA) **Marker, More, Function, Band Power**.

(PSA) **Marker Fctn, Band/Intvl**.

**Step 6.** Add a discrete tone to see the effects on the reading. Enable the internal 50 MHz amplitude reference signal of the analyzer as follows:

(PSA)

Press **Input/Output, Input Port, Amptd Ref**.

(ESA E4401B and E4411B)

Press **Input/Output, Amptd Ref (On)**.

(ESA E4402B, E4403B, E4404B, E4405B, E4407B and E4408B)

Connect a cable from the front panel AMPTD REF OUT to the analyzer RF input:

Press **Input/Output, Amptd Ref Out (On)**.

**Figure 7-3 Band Power Marker Power Measurement (ESA left, PSA right)**

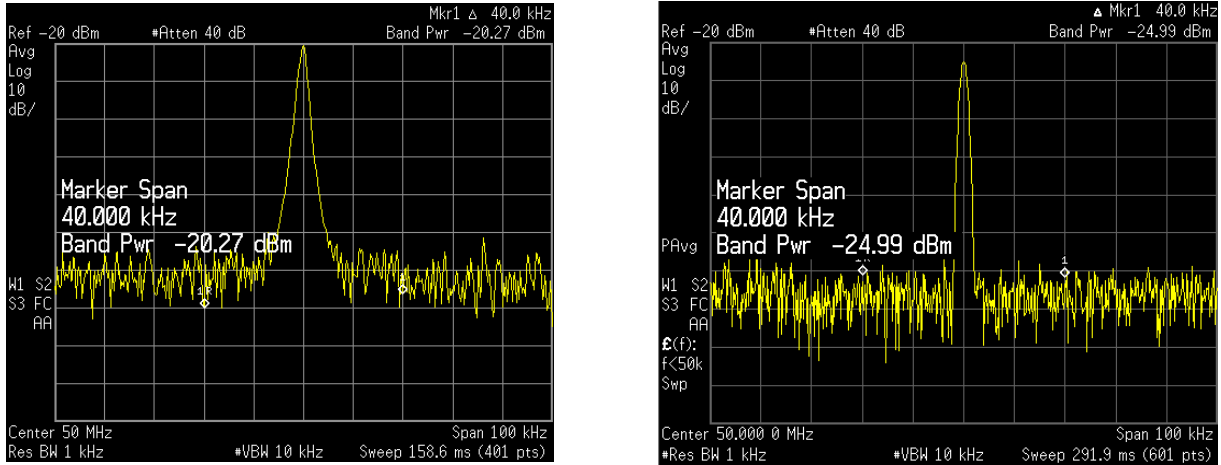

**Step 7.** Set the marker span pair to **Center** to move the markers (set at 40 kHz span) around without changing the span. Use the front-panel knob to move the band power markers and note the change in the power reading:

Press **Marker, Span Pair (Center)**, then rotate front-panel knob.

**NOTE**

You can also use **Delta Pair** to set the measurement start and stop points independently.

## Measuring Noise-Like Signals Using the Channel Power Measurement

You may want to measure the total power of a noise-like signal that occupies some bandwidth. Typically, channel power measurements are used to measure the total (channel) power in a selected bandwidth for a modulated (noise-like) signal. Alternatively, to manually calculate the channel power for a modulated signal, use the noise marker value and add  $10 \times \log(\text{channel BW})$ . However, if you are not certain of the characteristics of the signal, or if there are discrete spectral components in the band of interest, you can use the channel power measurement. This example uses the noise of the analyzer, adds a discrete tone, and assumes a channel bandwidth of 50 kHz. If desired, a specific signal may be substituted.

**Step 1.** Preset the analyzer:

Press **Preset, Factory Preset** (if present).

**Step 2.** Set the center frequency:

Press **FREQUENCY Channel, Center Freq, 50, MHz**.

**Step 3.** Start the channel power measurement:

Press **MEASURE, Channel Power**.

**Step 4.** Configure the display to show the combined spectrum view with channel power limits (span highlighted in blue):

(ESA) Press **View/Trace, Combined**.

(PSA) Press **Trace/View, Combined**.

**Step 5.** Turn averaging on:

Press **Meas Setup, Avg Number (On)**.

**Step 6.** Add a discrete tone to see the effects on the reading. Enable the internal 50 MHz amplitude reference signal of the analyzer as follows:

(PSA)

Press **Input/Output, Input Port, Amptd Ref**.

(ESA E4401B and E4411B)

Press **Input/Output, Amptd Ref (On)**.

(ESA E4402B, E4403B, E4404B, E4405B, E4407B and E4408B)

Connect a cable from the front panel AMPTD REF OUT to the analyzer RF input:

Press **Input/Output, Amptd Ref Out (On)**.

## Measuring Noise-Like Signals Using the Channel Power Measurement

**Step 7.** Optimize the analyzer reference level setting:

Press **Meas Setup, Optimize Ref Level.**

Your display should be similar to [Figure 7-4](#).

**Figure 7-4** Measuring Channel Power (ESA left, PSA right)

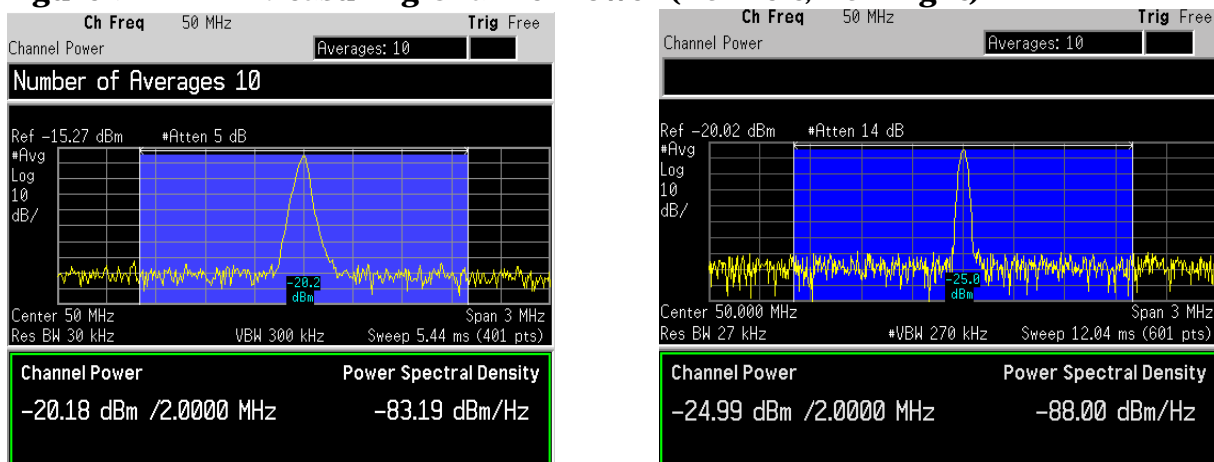

The power reading is essentially that of the tone; that is, the total noise power is far enough below that of the tone that the noise power contributes very little to the total.

The algorithm that computes the total power works equally well for signals of any statistical variant, whether tone-like, noise-like, or combination.

Measuring Noise  
**Measuring Noise-Like Signals Using the Channel Power Measurement**



---

**8**      **Making Time-Gated Measurements**

## Generating a Pulsed-RF FM Signal

Traditional frequency-domain spectrum analysis provides only limited information for certain signals. Examples of these difficult-to-analyze signal include the following:

- Pulsed-RF
- Time multiplexed
- Interleaved or intermittent
- Time domain multiple access (TDMA) radio formats
- Modulated burst

The time gating measurement examples use a simple frequency-modulated, pulsed-RF signal. The goal is to eliminate the pulse spectrum and then view the spectrum of the FM carrier as if it were continually on, rather than pulsed. This reveals low-level modulation components that are hidden by the pulse spectrum.

Refer back to these first three steps to setup the pulse signal, the pulsed-RF FM signal and the oscilloscope settings when performing the gated LO procedure ([page 62](#)), the gated video procedure ([page 64](#)) and gated FFT procedure ([page 66](#)).

For an instrument block diagram and instrument connections see “[Connecting the Instruments to Make Time-Gated Measurements](#)” on [page 61](#).

**Step 1.** Setup the pulse signal with a period of 5 ms and a width of 4 ms:

There are many ways to create a pulse signal. This example demonstrates how to create a pulse signal using a pulse generator or by using the internal function generator in the ESG. See [Table 8-1](#) for setup information of a pulse generator and [Table 8-2](#) for setup information of the internal generator of the ESG. Select either the pulse generator or a second ESG to create the pulse signal. You need two ESGs if you want to use the ESG internal function generator to create a pulse signal.

**Table 8-1**      **81100 Family Pulse Generator Settings**

Period	5 ms (or pulse frequency equal to 200 Hz)
Pulse width	4 ms
High output level	2.5 V
Waveform	pulse
Low output level	-2.5 V
Delay	0 or minimum

**Table 8-2 ESG #2 Internal Function Generator (LF OUT) Settings**

LF Out Source	FuncGen
LF Out Waveform	Pulse
LF Out Period	5 ms
LF Out Width (pulse width)	4 ms
LF Out Amplitude	2.5 Vp
LF Out	On
RF On/Off	Off
Mod On/Off	On

**Step 2.** Set up ESG #1 to transmit a pulsed-RF signal with frequency modulation. Set the FM deviation to 1 kHz and the FM rate to 50 kHz:

ESG #1 generates the pulsed FM signal by frequency modulating the carrier signal and then pulse modulating the FM signal. The pulse signal created in step 1 is connected to the EXT 2 INPUT (on the front of ESG #1). The ESG RF OUTPUT is the pulsed-RF FM signal to be analyzed by the spectrum analyzer.

**Table 8-3 ESG #1 Instrument Connections**

Frequency	40 MHz
Amplitude	0 dBm
Pulse	On
Pulse Source	Ext2 DC
FM	On
FM Path	1
FM Dev	1 kHz
FM Source	Internal
FM Rate	50 kHz
RF On/Off	On
Mod On/Off	On

Making Time-Gated Measurements  
 Generating a Pulsed-RF FM Signal

**Step 3.** Set up the oscilloscope to view the trigger, gate and RF signals (see [Figure 8-1](#) for an example of the oscilloscope display):

**Table 8-4** Agilent Infiniium Oscilloscope with 3 or more input channels: Instrument Connections

Timebase	1 ms/div
Channel 1	ON, 2 V/div, OFFSET = 2 V, DC coupled, 1 M $\Omega$ input, connect to the pulse signal (ESG LF OUTPUT or pulse generator OUTPUT). Adjust channel 1 settings as necessary.
Channel 2	ON, 500 mV/div, OFFSET = 2 V, DC coupled, 1 M $\Omega$ input, connect to the ESA GATE/HI SWP OUT connector or PSA TRIGGER 2 OUT connector on the spectrum analyzer. Adjust channel 2 settings as needed when gate is active.
Channel 3	ON, 500 mV/div, OFFSET = 0 V, DC coupled, 50 $\Omega$ input, connect to the ESG RF OUTPUT pulsed-RF signal. Adjust channel 3 settings as necessary.
Channel 4	OFF
Trigger	Edge, channel 1, level = 1.5 V, or as needed

**Figure 8-1** Viewing the Gate Timing with an Oscilloscope

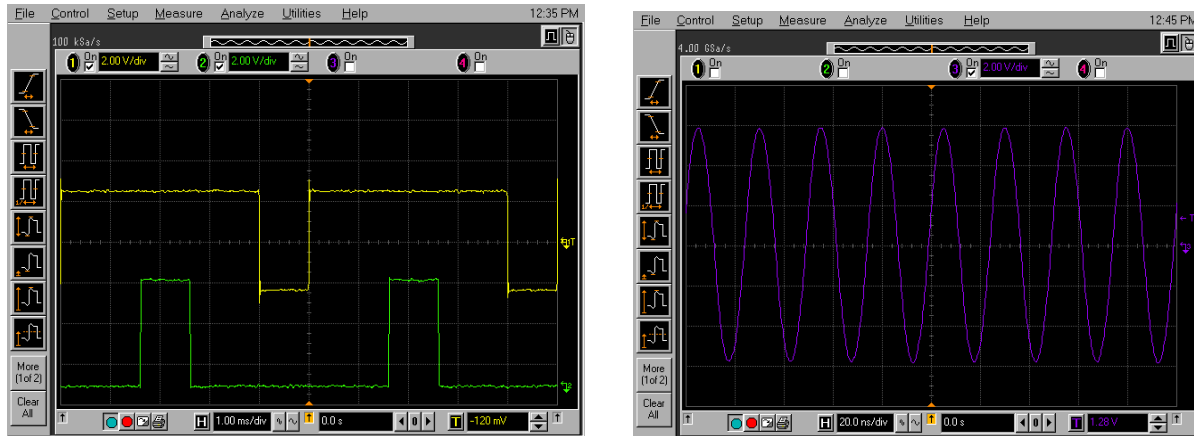

[Figure 8-1](#) oscilloscope channels:

1. Channel 1 (left display, top trace) - the trigger signal.
2. Channel 2 (left display, bottom trace) - the gate signal (gate signal is not be active until the gate is on in the spectrum analyzer).
3. Channel 3 (right display) - the RF output of the signal generator.

## Connecting the Instruments to Make Time-Gated Measurements

Figure 8-2 shows a block diagram of the test setup. ESG #1 produces a pulsed FM signal by using an external pulse signal. The external pulse signal is connected to the front of the ESG #1 to the EXT 2 INPUT to control the pulsing. The pulse signal is also used as the trigger signal. The oscilloscope is useful for illustrating timing interactions between the trigger signal and the gate. PSA Gate View could be used in place of the oscilloscope.

Using this measurement setup allows you to view all signal spectra on the spectrum analyzer and all timing signals on the oscilloscope. This setup is helpful when you perform gated measurements on unknown signals.

Figure 8-2 Instrument Connection Diagram

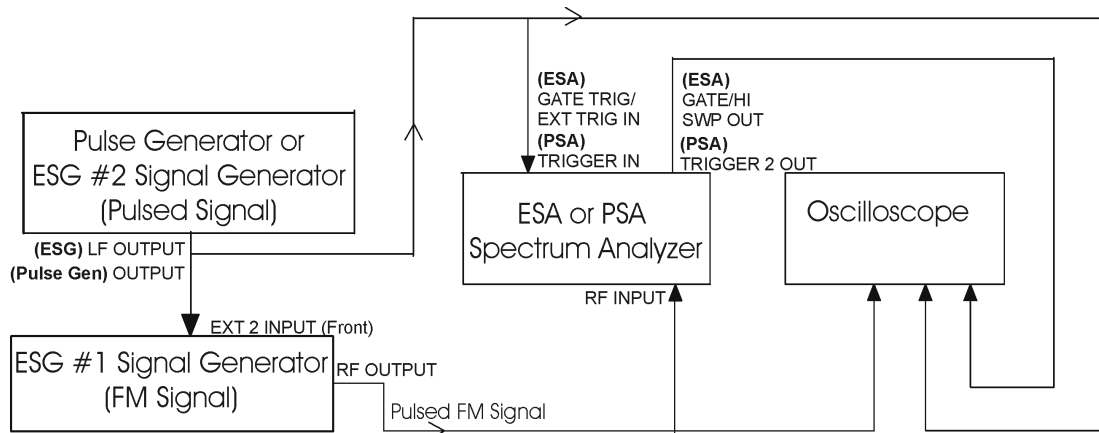

## Gated LO Measurement (PSA)

This procedure utilizes gated LO to gate the FM signal. For concept and theory information about gated LO see “[How Time Gating Works](#)” on page 135.

**Step 1.** Set the PSA center frequency, span and reference level:

Press **FREQUENCY Channel, Center Freq, 40, MHz.**  
Press **SPAN X Scale, Span, 500, kHz.**  
Press **AMPLITUDE Y Scale, Ref Level, -15, dBm.**

In [Figure 8-4](#) (left), the moving signals are a result of the pulsed signal. Using delta markers with a time readout, notice that the period of the spikes is at 5 ms (the same period as the pulse signal). Using time gating, these signals are blocked out, leaving the original FM signal.

**Step 2.** Set the gate source to the rear external trigger input:

Press **Sweep, Gate Setup, Gate Source, Ext Rear.**

**Step 3.** Set the gate delay to 2 ms and the gate length to 1 ms. Check that the gate trigger is set to positive:

Press **Sweep, Gate Setup, Delay, 2, ms.**  
Press **Sweep, Gate Setup, Length, 1, ms.**  
Press **Sweep, Gate Setup, Polarity (Pos).**

**Step 4.** Use the PSA gate view display to confirm the gate “on” time is during the RF burst interval (alternatively you could also use the oscilloscope to view the gate settings):

Press **Sweep, Gate Setup, Gate View (On).**

**Figure 8-3** Viewing the PSA Gate Settings with Gated LO

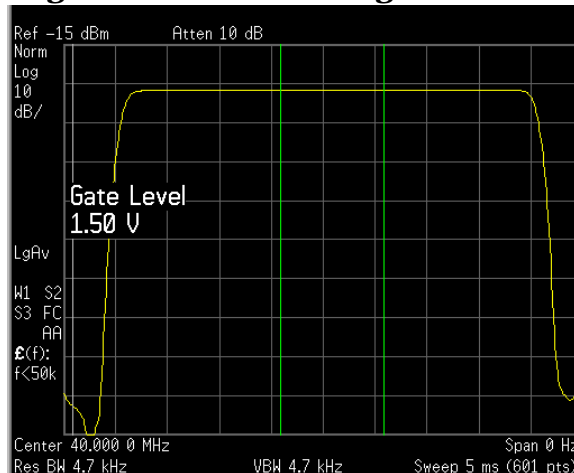

In [Figure 8-3](#) the gray vertical line (the far left line outside of the RF envelope) represents the location equivalent to a zero gate delay.

In [Figure 8-3](#) the vertical green parallel bars represent the gate settings. The first (left) bar is set at the delay time while the second (right) bar is set at the gate length, measured from the first bar. The trace of the signal in this time-domain view is the RF envelope. The gate signal is triggered off of the positive edge of the trigger signal.

When positioning the gate, a good starting point is to have it extend from 20% to 80% of the way through the pulse (for the PSA with linear-phase RBW filters).

While gate view mode is on, move the gate delay, length and polarity around. Notice the changes in the vertical gate bars while making your changes. Set the gate delay, length and polarity back to the step 3 settings.

**NOTE**

The PSA time gate triggering mode uses positive and negative edge triggering. Level triggering is not available.

**Step 5.** Turn the gate view off and enable the gate settings (see the right-side display in [Figure 8-4](#)):

Press **Sweep, Gate Setup, Gate View (Off)**.

Press **Sweep, Gate (On)**.

**Figure 8-4 Pulsed-RF FM Signal (Left), Gated FM Signal (Right)**

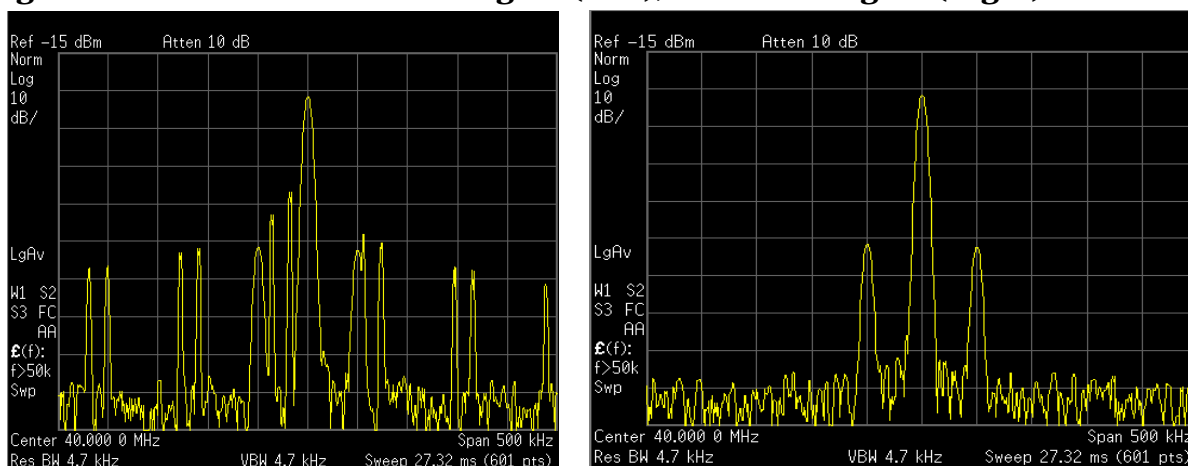

**Step 6.** Turn off the pulse modulation on ESG #1 by pressing **Pulse, Pulse** so that Off is selected.

Notice that the gated spectrum is much cleaner than the ungated spectrum (as seen in [Figure 8-4](#)). The spectrum you see with the gate on is the same as a frequency modulated signal without being pulsed. The displayed spectrum does not change and in both cases, you can see the two low-level modulation sidebands caused by the narrow-band FM.

## Gated Video Measurement (ESA)

This procedure utilizes gated video to gate the FM signal. For concept and theory information about gated video see [“How Time Gating Works”](#) on page 135.

**Step 1.** Set the ESA center frequency, span and reference level:

Press **FREQUENCY Channel, Center Freq, 40, MHz.**  
Press **SPAN X Scale, Span, 500, kHz.**  
Press **AMPLITUDE Y Scale, Ref Level, 0, dBm.**

**Step 2.** Set analyzer sweep time to 2005 ms:

Press **Sweep, Sweep Time, 2005, ms.**

For gated video, the calculated sweep time should be set to at least  $\# \text{ sweep points} \times \text{PRI}$  (pulse repetition interval) to ensure that the gate is on at least once during each of the 401 sweep points. In this example, the PRI is 5 ms, so you should set the sweep time to 401 times 5 ms, or 2005 ms. If the sweep time is set too fast, some trace points may show values of zero power or other incorrect low readings. If the trace seems incomplete or erratic, try a longer sweep time.

### NOTE

#### Good practices for determining the minimum sweep time for gated video:

In the event that the signal is not noisy, the sweep time can be set to less than  $\# \text{ sweep points} \times \text{PRI}$  (pulse repetition interval) (as calculated above). Instead of using PRI in the previous sweep time calculation, we can use the “gate off time” where sweep time equals  $\# \text{ sweep points} \times \text{gate off time}$ . In our example we could use a sweep time of 401 points times 4 ms or 1.604 s. Increase the width of video bandwidth to improve the probability of capturing the pulse using “gate off time”. If trace points are still showing values of zero power, increase the sweep time by small increments until there are no more dropouts.

**Figure 8-5**

#### Viewing the Pulsed-RF FM Signal (without gating)

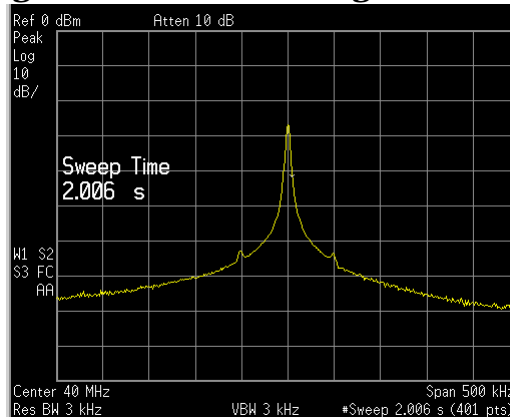



**Step 3.** Set the gate delay to 2 ms and the gate length to 1 ms. Check that the gate control is set to edge with a positive trigger:

- Press **Sweep, Gate, Gate Control (Edge)**.
- Press **Edge Gate, Slope (Pos)**.
- Press **Gate Delay, 2, ms**.
- Press **Gate Length, 1, ms**.

**Step 4.** Turn the gate on:

- Press **Sweep, Gate, Gate (On)**.

**Figure 8-6** Viewing the FM Signal of a Pulsed RF Signal using Gated Video

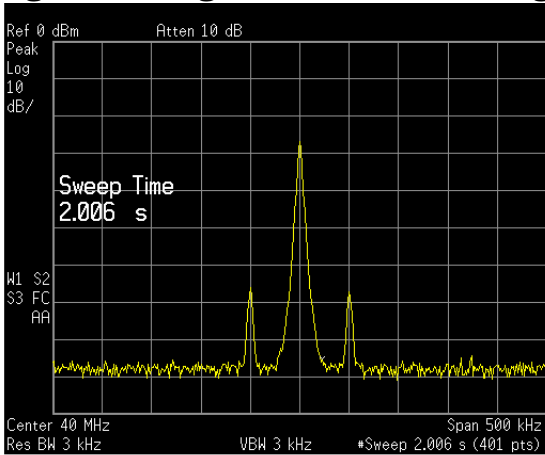

**Step 5.** Notice that the gated spectrum is much cleaner than the ungated spectrum (as seen in [Figure 8-5](#)). The spectrum you see is the same as a frequency modulated signal without being pulsed. To prove this, turn off the pulse modulation on ESG #1 by pressing **Pulse, Pulse** so that Off is selected. The displayed spectrum does not change.

**Step 6.** Check the oscilloscope display and ensure that the gate is positioned under the pulse. The gate should be set so that it is on somewhere between 25% to 80% of the pulse. [Figure 8-7](#) shows the oscilloscope display when the gate is positioned correctly (the bottom trace).

**Figure 8-7** The Oscilloscope Display

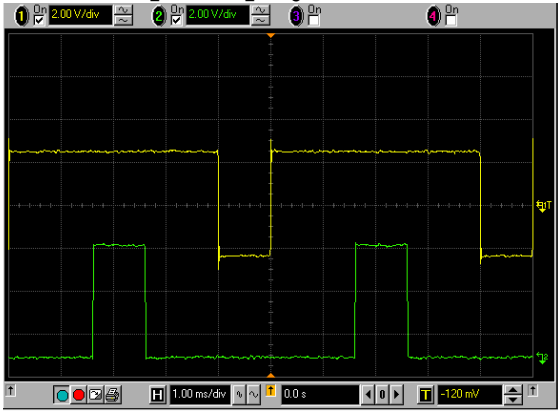

## Gated FFT Measurement (PSA)

This procedure utilizes gated FFT to gate the FM signal. For concept and theory information about gated FFT see “[How Time Gating Works](#)” on page 135.

**Step 1.** Set the PSA center frequency, span and reference level:

Press **FREQUENCY Channel, Center Freq, 40, MHz.**  
Press **SPAN X Scale, Span, 500, kHz.**  
Press **AMPLITUDE Y Scale, Ref Level, -15, dBm.**

**Step 2.** Set the trigger to the external rear trigger input:

Press **Trig, Ext Rear.**

**Step 3.** Select the minimum resolution bandwidth required:

Press **BW/Avg, Res BW (Auto).**

The duration of the analysis required is determined by the RBW. Divide 1.83 (always constant) by 4 ms to calculate the minimum RBW. The pulse width in our case is 4 ms so we need a minimum RBW of 458 Hz. In this case because the RBW is so narrow let the analyzer choose the RBW for the current analyzer settings (span). Check that the RBW is greater than 458 Hz.

With the above PSA settings, the RBW should be 4.7 kHz. Note that the measurement speed is faster than the gated LO example. Typically gated FFT is faster than gated LO for spans less than 10 MHz.

Vary the RBW settings and note the signal changes shape as the RBW transitions from 1 kHz to 300 Hz.

**Figure 8-8** Viewing the Gated FFT Measurement Results from the PSA

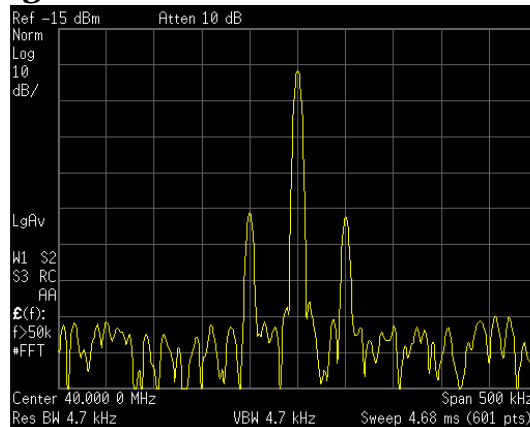

### NOTE

If the trigger event needs to be delayed use the **Trig Delay** function under the **Trig** menu. It is recommended to apply some small amount of trigger delay to allow time for the pulse modulator to settle.

---

**9**

**Measuring Digital  
Communications Signals**

---

## Making Burst Power Measurements

PSA and ESA spectrum analyzers make power measurements on digital communication signals fast and repeatable by providing a comprehensive suite of power-based one-button automated measurements with pre-set standards-based format setups. The automated measurements also include pass/fail functionality that allow the user to quickly check if the signal passed the measurement.

---

**NOTE** ESA spectrum analyzer sweep times: In zero-span, ESA can sweep as fast as 10  $\mu$ s with 2 points displayed. For 101 points, the minimum sweep time is 1 ms. Option AYX or B7D is recommended when faster sweep times are required.

---

The following example demonstrates how to make a burst power measurement on a Bluetooth™ signal broadcasting at 2.402 GHz.

- Step 1.** Using an ESG, setup a Bluetooth™ signal transmitting DH1 packets continuously at 2.402 GHz and  $-10$  dBm and connect the RF OUTPUT to the spectrum analyzer RF INPUT.
- Step 2.** Preset the analyzer, set the analyzer center frequency to 2.402 GHz:  
Press **Preset, Factory Preset** (if present).  
Press **FREQUENCY Channel, Center Freq, 2.402, GHz**.
- Step 3.** Set the analyzer radio mode to Bluetooth™ and check to make sure packet type DH1 is selected:  
Press **Mode Setup, Radio Std, More, Bluetooth**.  
Press **Mode Setup, Radio Std Setup, Packet Type (DH1)**.
- Step 4.** Select the burst power one-button measurement from the measure menu and optimize the reference level:  
Press **MEASURE, More, Burst Power**.  
Press **Meas Setup, Optimize Ref Level**.
- Step 5.** View the results of the burst power measurement using the full screen (See [Figure 9-1](#)):  
Press **Display, Full Screen**.

**Figure 9-1 Full Screen Display of Burst Power Measurement Results**

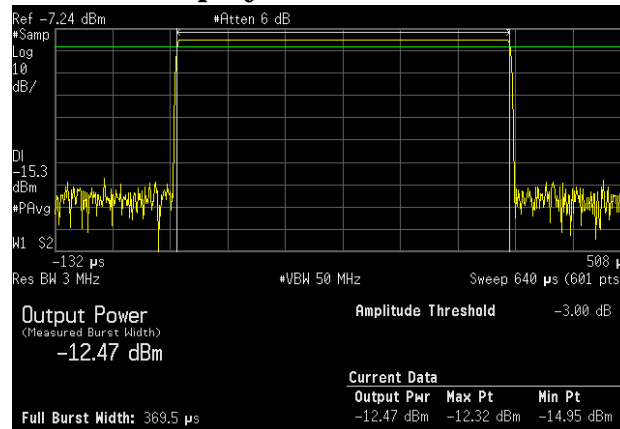

**NOTE** Press the Return key to exit the full screen display without changing any parameter values.

**Step 6.** Select one of the following three trigger methods to capture the bursted signal (RF burst is recommended, if available):

Press **Trig, RF Burst**.

For more information on trigger selections see [“Trigger Concepts” on page 153](#).

**NOTE** Although the trigger level allows the analyzer to detect the presence of a burst, the time samples contributing to the burst power measurement are determined by the threshold level, as described next.

**Step 7.** Set the relative threshold level above which the burst power measurement is calculated:

Press **Meas Setup, Threshold Lvl (Rel), -10, dB**.

The burst power measurement includes all points above the threshold and no points below. The threshold level is indicated on the display by the green horizontal line (for video triggering it is the upper line). In this example, the threshold level has been set to be 10 dB below the relative level of the burst. The mean power of the burst is measured from all data above the threshold level.

**Step 8.** Set the burst width to measure the central 200 μs of the burst:

Press **Meas Setup, Meas Method, Measured Burst Width, Burst Width (Man), 200, μs**.

The burst width is indicated on the screen by two vertical white lines. Manually setting the burst width allows you to make it a long time interval (to include the rising and falling edges of the burst) or to make it a short time interval, measuring a small central section of the burst.

Measuring Digital Communications Signals  
**Making Burst Power Measurements**

**NOTE** If you set the burst width manually to be wider than the screen's display, the vertical white lines move off the edges of the screen. This could give misleading results as only the data on the screen can be measured.

**NOTE** The Bluetooth™ standard states that power measurements should be taken over at least 20% to 80% of the duration of the burst.

**Step 9.** Increase the sweep time to display more than one burst at a time:

Press **Sweep**, **Sweep Time**, **6200, μs** (or **6.2, ms**).

The screen display shows several bursts in a single sweep as in [Figure 9-2](#). The burst power measurement measures the mean power of the first burst, indicated by the vertical white lines.

**Figure 9-2** Setting Burst Width (Left) Displaying Multiple Bursts (Right)

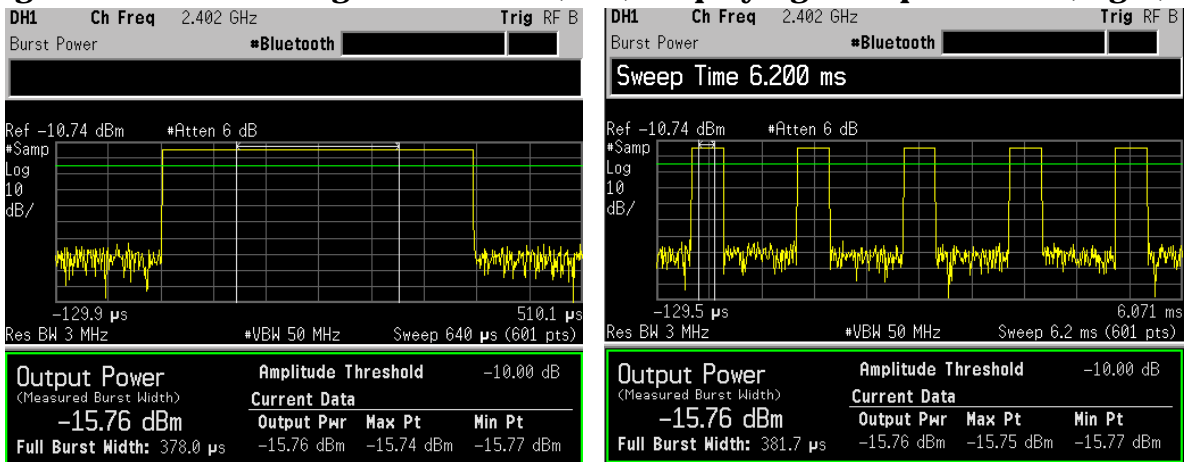

**NOTE** Although the burst power measurement still runs correctly when several bursts are displayed simultaneously, the timing accuracy of the measurement is degraded. For the best results (including the best trade-off between measurement variations and averaging time), it is recommended that the measurement be performed on a single burst.

---

## Making Statistical Power Measurements (CCDF)

---

**NOTE**

CCDF can be measured with ESA-E series analyzers with option AYX or B7D and with all PSA series analyzers.

Complementary cumulative distribution function (CCDF) curves characterize a signal by providing information about how much time the signal spends at or above a given power level. The CCDF measurement shows the percentage of time a signal spends at a particular power level. Percentage is on the vertical axis and power (in dB) is on the horizontal axis.

All CDMA signals, and W-CDMA signals in particular, are characterized by high power peaks that occur infrequently. It is important that these peaks are preserved otherwise separate data channels can not be received properly. Too many peak signals can also cause spectral regrowth. If a CDMA system works well most of the time and only fails occasionally, this can often be caused by compression of the higher peak signals.

The following example shows how to make a CCDF measurement on a W-CDMA signal broadcasting at 1.96 GHz.

- Step 1.** Using an ESG, setup a W-CDMA signal transmitting at 1.96 GHz and -10 dBm. Connect the RF OUTPUT to the spectrum analyzer RF INPUT.
- Step 2.** Preset the analyzer and set the center frequency to 1.96 GHz:  
Press **Preset, Factory Preset** (if present).  
Press **FREQUENCY Channel, Center Freq, 1.96, GHz**.
- Step 3.** Set the analyzer radio mode to 3GPP W-CDMA as a base station device:  
Press **Mode Setup, Radio Std, 3GPP W-CDMA**.  
Press **Mode Setup, Radio Std Setup, Device (BTS)**.
- Step 4.** Select the CCDF one-button measurement from the measure menu and then optimize the reference level and attenuation settings suitable for the CCDF measurement:  
Press **MEASURE, Power Stat CCDF**.  
Press **Meas Setup, Optimize Ref Level**.

**Figure 9-3 Power Stat CCDF Measurement on a W-CDMA Signal**

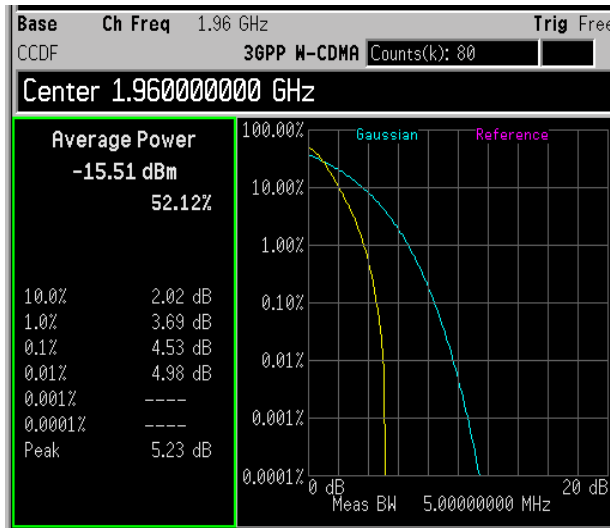

**Step 5.** Store your current measurement trace for future reference:

Press **Display, Store Ref Trace**.

When the power stat CCDF measurement is first made, the graphical display should show a signal typical of pure noise. This is labelled Gaussian, and is shown in aqua. Your CCDF measurement is displayed as a yellow plot. You have stored this measurement's plot to make for easy comparison with subsequent measurements.

**Step 6.** Display the stored trace:

Press **Display, Ref Trace (On)**.

The stored trace from your last measurement is displayed as a magenta plot (as shown in [Figure 9-4](#)), and allows direct comparison with your current measurement.

**Figure 9-4 Storing and Displaying a Power Stat CCDF Measurement**

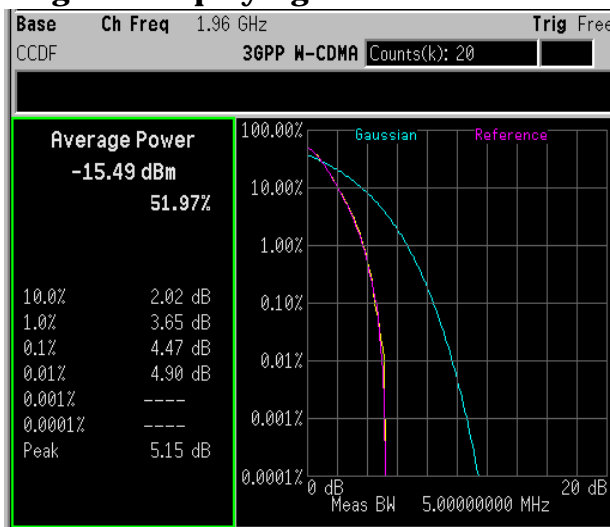



- Step 7.** Change the measurement bandwidth to 1 MHz:  
Press **Meas Setup, Meas BW, 1, MHz.**

**Figure 9-5** Reducing the measurement bandwidth to 1 MHz

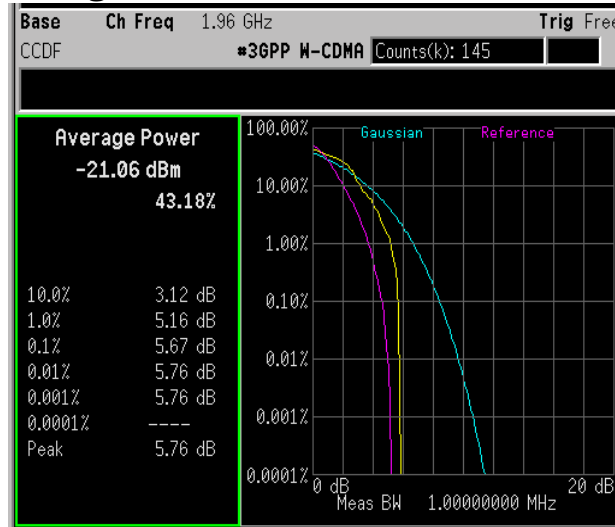

**NOTE** If you choose a measurement bandwidth setting that the analyzer cannot display, it automatically sets itself to the closest available bandwidth setting.

- Step 8.** Change the number of measured points from 100,000 (100k) to 1,000 (1k):

Press **Meas Setup, Counts, 1, kpoints.**

Reducing the number of points decreases the measurement time, however the number of points is a factor in determining measurement uncertainty and repeatability. Notice how the displayed plot loses a lot of its smoothness. You are gaining speed but reducing repeatability and increasing measurement uncertainty.

**NOTE** The number of points collected per sweep is dependent on the sampling rate and the measurement interval. The number of samples that have been processed are indicated at the top of the screen. The graphical plot is continuously updated so you can see it getting smoother as measurement uncertainty is reduced and repeatability improves.

- Step 9.** Change the scaling of the X-axis to 1 dB per division to optimize your particular measurement:

Press **SPAN X Scale, Scale/Div, 1, dB.**

---

## Making Adjacent Channel Power (ACP) Measurements

The adjacent channel power (ACP) measurement is also referred to as the adjacent channel power ratio (ACPR) and adjacent channel leakage ratio (ACLR). We use the term ACP to refer to this measurement.

ACP measures the total power (rms voltage) in the specified channel and up to six pairs of offset frequencies. The measurement result reports the ratios of the offset powers to the main channel power.

The following example shows how to make an ACP measurement on a W-CDMA base station signal broadcasting at 1.96 GHz.

- Step 1.** Using an ESG, setup a W-CDMA signal transmitting at 1.96 GHz and -10 dBm. Connect the RF OUTPUT to the spectrum analyzer RF INPUT.
- Step 2.** Preset the analyzer, set the analyzer center frequency to 1.96 GHz.  
Press **Preset, Factory Preset** (if present).  
Press **FREQUENCY Channel, Center Freq, 1.96, GHz**.
- Step 3.** Set the analyzer radio mode to 3GPP W-CDMA as a base station device:  
Press **Mode Setup, Radio Std, 3GPP W-CDMA**.  
Press **Mode Setup, Radio Std Setup, Device (BTS)**.
- Step 4.** Select the adjacent channel power one-button measurement from the measure menu and then optimize the reference level and attenuation settings suitable for the ACP measurement (see [Figure 9-6](#)):  
Press **MEASURE, ACP**.  
Press **Meas Setup, Optimize Ref Level**.

---

### NOTE

**Optimize Ref Level** protects against input signal overloads, but does not necessarily set the input attenuation and reference level for optimum measurement dynamic range.

To improve the measurement repeatability, increase the sweep time to smooth out the trace (average detector must be selected). Measurement repeatability can be traded off with sweep time.

To increase dynamic range, **Noise Correction** can be used to factor out the added power of the noise floor effects. Noise correction is very useful when measuring signals near the noise floor of the analyzer.

**Figure 9-6** ACP Measurement on a Base Station W-CDMA Signal

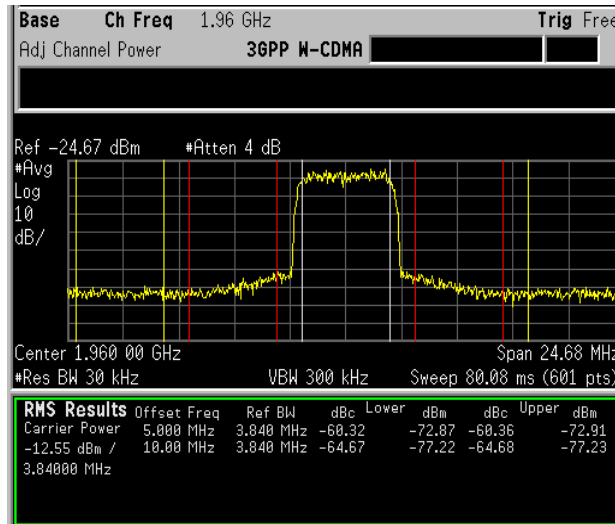

The frequency offsets, channel integration bandwidths, and span settings can all be modified from the default settings selected by the radio standard.

Two vertical white lines indicate the bandwidth limits of the central channel being measured.

Offsets A and B are designated by the adjacent pairs of red and yellow lines, in this case: 5 MHz and 10 MHz from the center frequency respectively.

**Step 5.** Select the combined spectrum and bar graph view of the results:

(ESA) Press **View/Trace, Combined**.

(PSA) Press **Trace/View, Combined**.

**Step 6.** View the results using the full screen:

Press **Display, Full Screen**.

**NOTE**

Press the **Return** key to exit the full screen display without changing any parameter values.

**Step 7.** Define a new third pair of offset frequencies:

Press **Meas Setup, Offset/Limits, Offset (C), Offset Freq (On), 15, MHz**.

This third pair of offset frequencies is offset by 15.0 MHz from the center frequency (the outside offset pair) as shown in [Figure 9-7](#). Three further pairs of offset frequencies (D, E and F) are also available.

Figure 9-7

Measuring a Third Adjacent Channel

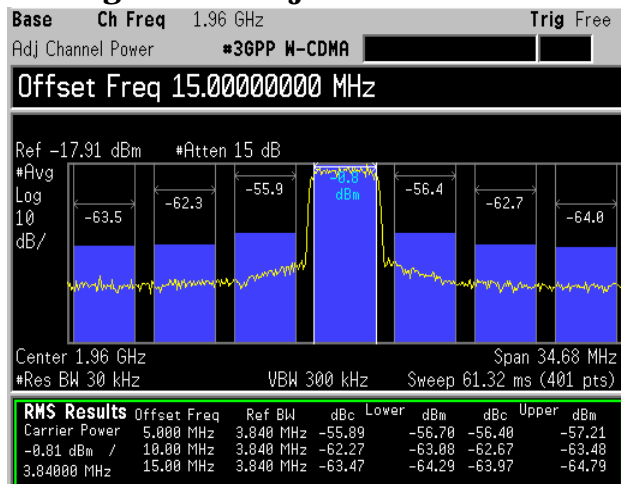

Step 8. Set pass/fail limits for each offset:

Press Meas Setup, Offset/Limits, Offset (A), Neg Offset Limit, -55, dB, Pos Offset Limit, -55, dB, Offset (B), Neg Offset Limit, -65, dB, Pos Offset Limit, -65, dB, Offset (C), Neg Offset Limit, -65, dB, Pos Offset Limit, -65, dB.

Step 9. Turn the limit test on:

Press Meas Setup, More, Limit Test (On).

In Figure 9-8 notice that offset A has passed, however offsets B and C have failed. Power levels that fall below our specified -65 dB for offsets B and C, fail. Failures are identified by the red letter “F” next to the levels (dBc and dBm) listed in the lower portion of the window called, “RMS Results”. The offset bar graph is also shaded red to identify a failure.

Figure 9-8

Setting Offset Limits

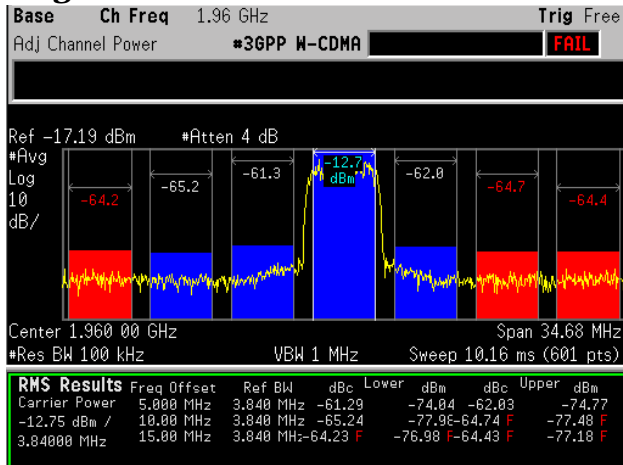

NOTE

You may increase the repeatability by increasing the sweep time.

---

## Making Multi-Carrier Power (MCP) Measurements

The multi-carrier power measurement measures the total power of up to 12 carriers and their adjacent channels for up to three pairs of offset frequencies. The offset frequency properties can be modified, including the offset frequency, the integration bandwidth and upper/lower limits. The carrier parameters can also be modified including carrier width, carrier integration bandwidth and whether the carrier is on or off. MCP can be setup with no radio standard selected or with radio standard settings for IS-95 and W-CDMA. Results for carriers without power present are displayed relative to the reference carrier. Results for adjacent channels are displayed in absolute power (dBm).

The following example shows how to make an MCP measurement on a W-CDMA base station broadcasting with 8 carriers on and with two carriers off. The transmitting carriers are spaced at 5 MHz intervals at the following frequencies: 977.5 MHz, 982.5 MHz, 987.5 MHz, 992.5 MHz, 1.0075 GHz, 1.0125 GHz, 1.0175 GHz and 1.0225 GHz.

---

### NOTE

**Recommended equipment:** The Agilent ESG signal generators can be used to transmit W-CDMA multi-carrier signals of up to 4 carriers. The multi-carrier signal parameters can be modified including channel setup, frequency offset and carrier power. An alternative way to setup multiple carriers is to use multiple ESGs, each transmitting one W-CDMA signal.

---

- Step 1.** Connect a W-CDMA signal with multiple carriers broadcasting at the frequencies stated above.
- Step 2.** Set the center frequency of the analyzer to the midpoint of all the carriers:  
  
Press **Preset, Factory Preset** (if present).  
Press **FREQUENCY Channel, Center Freq, 1, GHz**.
- Step 3.** Set the analyzer radio mode to 3GPP W-CDMA as a base station device:  
  
Press **Mode Setup, Radio Std, 3GPP W-CDMA**.  
Press **Mode Setup, Radio Std Setup, Device (BTS)**.
- Step 4.** Select the multi-carrier power one-button measurement from the measure menu and then optimize the reference level and attenuation settings suitable for the MCP measurement:  
  
Press **MEASURE, Multi Carrier Power**.  
Press **Meas Setup, Optimize Ref Level**.
- Step 5.** Set the carrier number to 10 (in our multi-carrier setup we have 8 carriers without 2 middle carriers):

## Measuring Digital Communications Signals Making Multi-Carrier Power (MCP) Measurements

Press **Meas Setup, Carrier Setup, Carriers, 10, Enter**.

**Step 6.** Configure carrier 5 to have no power present:

Press **Meas Setup, Carrier Setup, Configure Carriers, Carrier, 5, Enter, Carrier Pwr Present (No)**.

**Step 7.** Repeat step 6, configuring carrier 6 to have no power present.

**Step 8.** Display the results in full screen view (see [Figure 9-9](#)):

Press **Display, Full Screen**.

**Figure 9-9**

**MCP Measurement on a Base Station W-CDMA Signal**

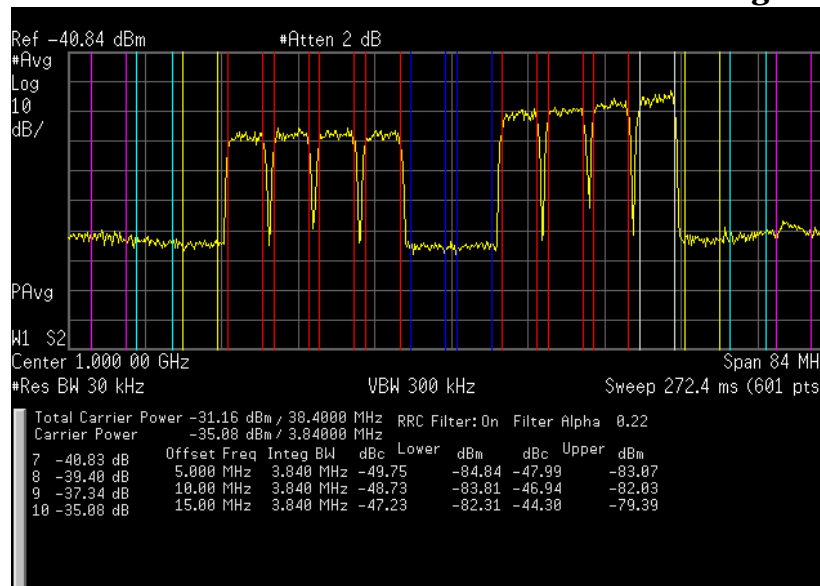

In this example, the intermodulation falls outside the transmit channels which are marked by the colored vertical lines. The white set indicates the reference carrier. The red sets contain the carriers with power present and the blue lines mark the carriers without power present. Limits for the upper and lower offsets can also be set as shown in the example: “[Making Adjacent Channel Power \(ACP\) Measurements](#)” on page 74.

**NOTE**

Press the **Return** key to exit the full screen display without changing any parameter values.

**Step 9.** View the results table of carriers 7-10:

Press **Meas Setup, Carrier Result, 7, Enter**.

**Step 10.** View the results in a combined spectrum and bar graph (see [Figure 9-10](#)):

(ESA) Press **View/Trace, Combined**.

(PSA) Press **Trace/View, Combined**.

**Figure 9-10 Combined Spectrum and Bar Graph View**

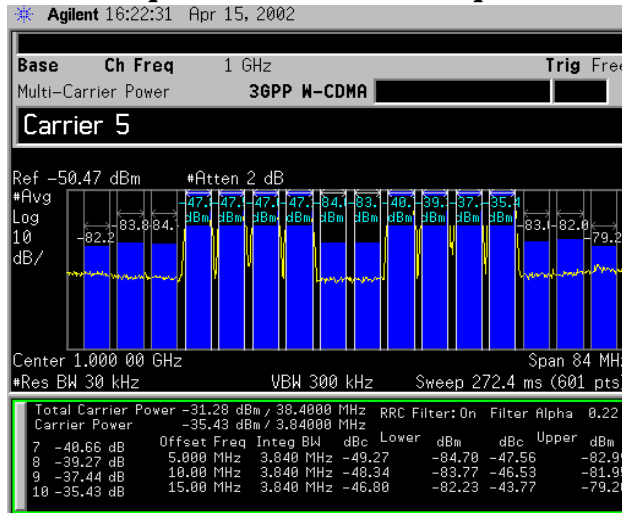

**Step 11.** Save the results file to a disk.

Press **File, Save, Type, More, Measurement Results, Save Now.**

The results are stored in a comma separated values format to be viewed by any personal computer spreadsheet application. All data shown on the display is included in this file.

Measuring Digital Communications Signals  
**Making Multi-Carrier Power (MCP) Measurements**



---

**10**

**Using External Millimeter  
Mixers (Option AYZ)**

## Making Measurements With Agilent 11970 Series Harmonic Mixers

External harmonic mixers can be used to extend the frequency range of the E4407B, E4440A, E4446A and E4448A spectrum analyzers. Agilent Technologies manufactures external mixers that do not require biasing and cover frequency ranges from 18 GHz to 110 GHz. For frequency ranges from 110 GHz up to 325 GHz, other mixers are available from other manufacturers (these mixers may require biasing). The Agilent Technologies E4407B, E4440A, E4446A, and E4448A spectrum analyzers support harmonic mixers and preselected harmonic mixers.

When using harmonic mixers, multiple mixing products are shown on the analyzer display. The output of a harmonic mixer contains the sum and difference frequencies of the input signal with the LO and all of its harmonics. To display the correct signal, signal identification can be used to remove all undesired mixing products. Once the correct signal is identified, signal identification must be turned off to measure the amplitude accurately.

**Step 1.** Connect the signal source and harmonic mixer to the analyzer as shown in [Figure 10-1](#).

**Figure 10-1** Instrument Connections with a 11970 Series Harmonic Mixer Spectrum Analyzer

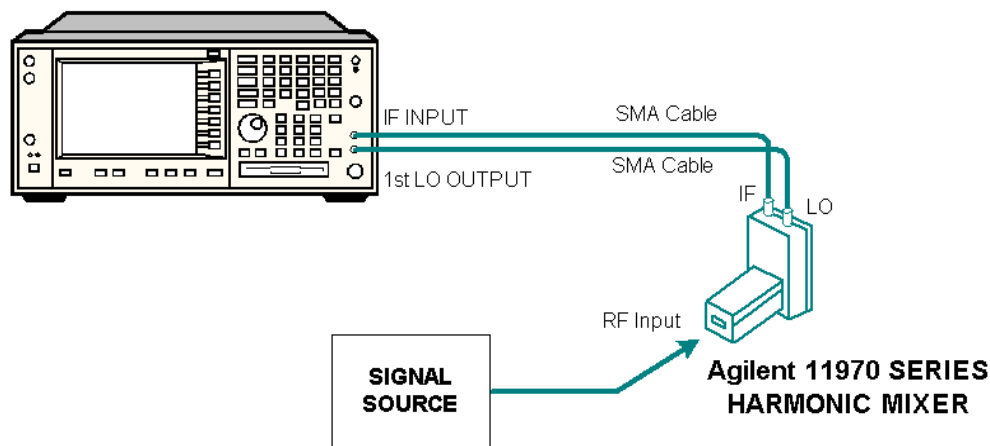

**CAUTION** The analyzer local oscillator output power is approximately +16 dBm. Be sure that your external harmonic mixer can accommodate the power level before connecting it to the analyzer.

**NOTE** Agilent 5061-5458 SMA type cables should be used to connect the mixer IF and LO ports to the analyzer. Do not over-tighten the cables. The maximum torque should not exceed 112 N-cm (10 in-lb.)

**Step 2.** Perform a factory preset:

Press **Preset, Factory Preset** (if present).

**Step 3.** Set up a high frequency signal on a microwave signal generator (no modulation required). Set the frequency to 35 GHz and the amplitude to 0 dBm.

**Step 4.** Select external mixing, and then select band A (from 26.5 to 40 GHz):

Press **Input/Output, Input Mixer, Input Mixer (Ext)**.

Press **Ext Mix Band, 26.5–40 GHz (A)**.

The IF output of a harmonic mixer contains a signal at the intermediate frequency of the analyzer whenever the harmonic frequency of the LO and the frequency of the RF differ by the intermediate frequency. As a result, within a single harmonic band, a single input signal can produce multiple responses on the analyzer display, only one of which is valid (see the left display in [Figure 10-2](#)). These responses come in pairs, where members of the valid response pair are separated by 642.8 MHz and either the right-most (for negative harmonics) or left-most (for positive harmonics) member of the pair is the correct response.

**Step 5.** Turn on the signal identification feature to show the real signal response at 35 GHz (by default, the type of signal identification is *Image Suppress*):

Press **Input/Output, Input Mixer, Signal ID (On)**.

**Step 6.** Place a marker on the real signal and turn off signal identification before making the final amplitude measurement:

Press **Peak Search**.

Press **Signal Ident (Off)**.

**Figure 10-2** Signal Identification (Left - Signal Id Off; Right - Signal Id On)

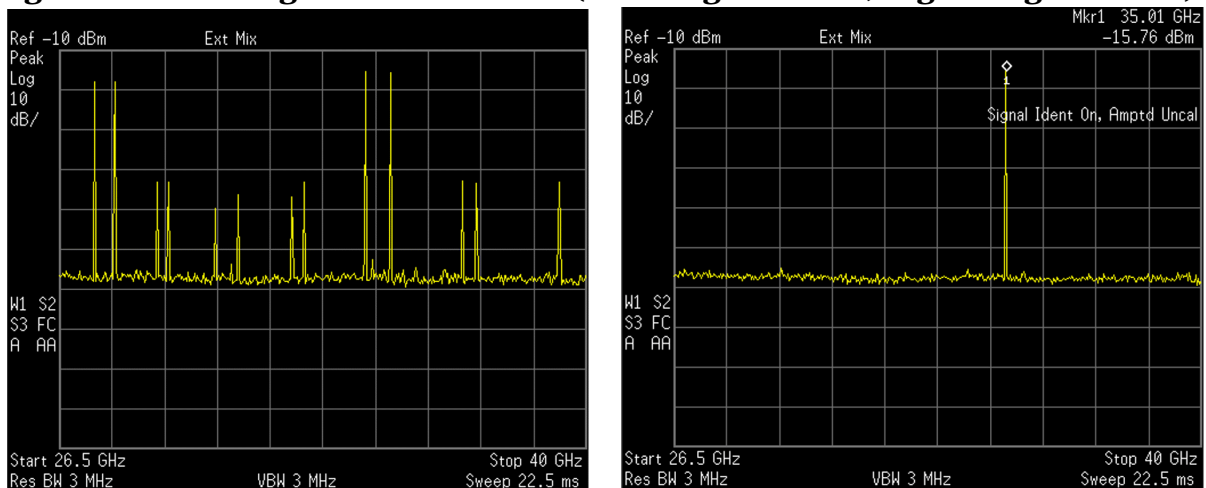

---

## Setting Harmonic Mixer Bias Current

The Agilent 11970 Series harmonic mixers do not require an external bias current. Harmonic mixers that require bias can also be used. The conversion loss calibration data for mixers requiring an external bias current are most accurate when the correct bias conditions are applied.

**Step 1.** Before continuing, complete the previous procedure “[Making Measurements With Agilent 11970 Series Harmonic Mixers](#)” on page 82 to set up the analyzer for external mixing in the band of interest.

**Step 2.** Activate the bias:

Press **Input/Output, Input Mixer, Mixer Config, Mixer Bias (On)**

A  $+I$  or  $-I$  appears in the display annotation indicating bias is on.

**Step 3.** Enter the desired bias current in mA.

The mixer bias is supplied from the **IF INPUT** port of the analyzer.

---

### CAUTION

The open-circuit bias voltage can be as great as  $\pm 3.5$  V through a source resistance of 500 ohms. Such voltage levels may appear when recalling an instrument state in which a bias setting has been stored.

---

### NOTE

The bias value that appears on the analyzer display is expressed in terms of short-circuit current (that is, the current that would flow if the **IF INPUT** were shorted to ground). The actual current flowing into the mixer is less.

---

---

## Entering Conversion-Loss Correction Data for Harmonic Mixers

You may want to correct your measurement for the conversion-loss of the external harmonic mixer that you are using. The amplitude correction feature can be used for this.

**Step 1.** Access the correction factor tables for editing:

Press **AMPLITUDE Y Scale, More, Corrections, Other**.

You must enter a set of amplitude correction values for the desired frequency range. Select a correction set for use with external mixing. The recommended correction set is **Other**.

**Step 2.** Edit the conversion loss data for the mixer in use. For Agilent 11970 Series harmonic mixers and Agilent 11974 Series preselected harmonic mixers, these values are listed on the mixer:

Press **Edit**.

The data consists of frequency/amplitude pairs. You can enter a single average value for correction over the entire frequency band. Or you can improve frequency response accuracy by entering multiple correction points across the band. Up to 200 points may be defined for each set.

**Step 3.** Once the desired correction points are entered, you must turn on the correction function to improve display calibration:

Press **Return, Correction (On)**.

Verify that the correction factors have been applied to the display data points by checking under the **Corrections** menu that **Apply Corrections** is set to **Yes**.

Once you have entered the correction set, save the correction set in internal memory or on floppy disk for future reference.

## Making Measurements with Agilent 11974 Series Preselected Harmonic Mixers

Preselected mixers apply a tracking filter to the input signal before sending it to the mixer. This makes the displayed results easier to understand because it eliminates the multiple mixing products that are displayed using harmonic mixers (see “[Making Measurements With Agilent 11970 Series Harmonic Mixers](#)” on page 82).

- Step 1.** Connect the signal source and preselected mixer to the analyzer as shown in [Figure 10-3](#).

**Figure 10-3 Instrument Connections with a Preselected Harmonic Mixer**  
Spectrum Analyzer

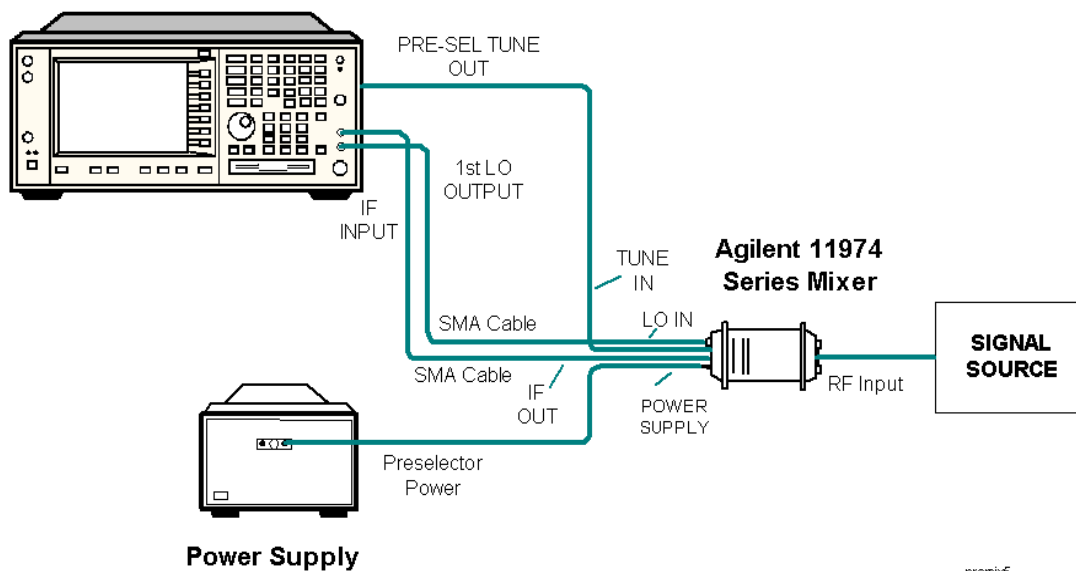

- Step 2.** Configure the analyzer for preselected external mixing:

Press **Input/Output**, **Input Mixer**, **Input Mixer (Ext)**, **Mixer Config**, **Mixer Type (Presel)**.

- Step 3.** If necessary, adjust the tracking of the preselected harmonic mixer using the procedure “[Frequency Tracking Calibration with Agilent 11974 Series Preselected Harmonic Mixers](#)” on page 88.

- Step 4.** Select the desired mixing band. In this example an Agilent 11974Q (33 to 50 GHz mixer) is used:

Press **Input/Output**, **Input Mixer**, **Ext Mix Band**, **33–50 GHz (Q)**.

- Step 5.** Set the microwave source to a frequency of 40 GHz and an amplitude of –15 dBm.

- Step 6.** Enter the conversion-loss data for the mixer, to calibrate the amplitude

## Making Measurements with Agilent 11974 Series Preselected Harmonic Mixers

of the display. The conversion-loss versus frequency data is on the calibration label on the bottom of the Agilent 11974, or on the supplied calibration sheet.

Use the procedure “[Entering Conversion-Loss Correction Data for Harmonic Mixers](#)” on page 85.

- Step 7.** To complete the amplitude calibration process, the preselector must be adjusted at each frequency of interest. Before making final amplitude measurements with the analyzer, perform the following:

Press **Peak Search**.

Press **SPAN X Scale, Span Zoom, 10, MHz**.

Press **AMPLITUDE Y Scale, Presel Center**.

The final amplitude measurement can now be read out with a marker. See [Figure 10-4](#).

**Figure 10-4**

### Amplitude Reading of the Preselected Response

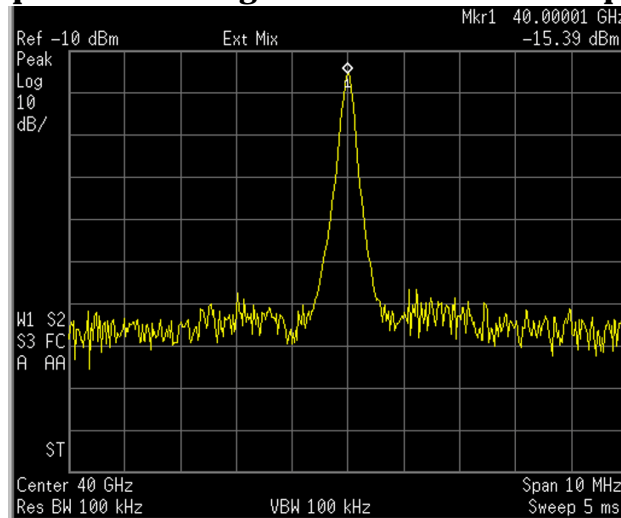

## Frequency Tracking Calibration with Agilent 11974 Series Preselected Harmonic Mixers

This procedure is used to align the frequency of the preselector filter of the Agilent 11974 to the tuned frequency of the analyzer. This procedure should be followed any time that the Agilent 11974 is connected to a different analyzer. The calibration should be periodically checked.

- Step 1.** Connect the signal source and preselected mixer to the analyzer as shown in [Figure 10-3](#).
- Step 2.** Set the Agilent 11974 rear-panel switches “Agilent 70907B” and “LEDS” to the ON position, and the other two switches to the OFF position, in order for the Agilent 11974 to properly scale to the tune signal of the analyzer.
- Step 3.** Configure the analyzer for a preselected external mixer:  
 Press **Preset, Factory Preset** (if present).  
 Press **Input/Output, Input Mixer, Input Mixer (Ext), Mixer Config, Mixer Type (Presel)**.
- Step 4.** Set the desired frequency band of operation for your mixer:  
 Press **Input/Output, Input Mixer, Ext Mix Band**, then select external mixing band (bands A, Q, U or V).
- Step 5.** Set the preselector adjustment to 0 MHz:  
 Press **AMPLITUDE Y Scale, Presel Adjust, 0, MHz**.
- Step 6.** Set the analyzer to zero span:  
 Press **SPAN X Scale, Zero Span**.
- Step 7.** Set the center frequency to the value in [Table 10-1](#) for your mixer:  
 Press **FREQUENCY Channel, Center Freq**, frequency value.
- On the rear panel of the Agilent 11974, adjust the corresponding potentiometer until one or both of the green LEDs are lit.

**Table 10-1** Start Frequency Preselector Adjustment

Mixer Agilent P/N	Analyzer Center Frequency	Potentiometer
11974A	26.5 GHz	“26.5 GHz Adjust”
11974Q	33.0 GHz	“33.0 GHz Adjust”
11974U	40.0 GHz	“40.0 GHz Adjust”



**Table 10-1** Start Frequency Preselector Adjustment (Continued)

Mixer Agilent P/N	Analyzer Center Frequency	Potentiometer
11974V	50.0 GHz	“50.0 GHz Adjust”

**Step 8.** Change the analyzer center frequency to the value indicated in [Table 10-2](#) and again adjust the corresponding potentiometer on the rear panel of the Agilent 11974 until one or both of the green LEDs are lit.

**Table 10-2** Stop Frequency Preselector Adjustment

Mixer Agilent P/N	Analyzer Center Frequency	Potentiometer
11974A	40.0 GHz	“40.0 GHz Adjust”
11974Q	50.0 GHz	“50.0 GHz Adjust”
11974U	60.0 GHz	“60.0 GHz Adjust”
11974V	75.0 GHz	“75.0 GHz Adjust”

**Step 9.** Repeat steps 6 and 7 until the green LEDs are lit at both frequencies.

Using External Millimeter Mixers (Option AYZ)  
**Frequency Tracking Calibration with Agilent 11974 Series Preselected  
Harmonic Mixers**

---

**11**

**Demodulating AM and FM  
Signals**

## Measuring the Modulation Rate of an AM Signal

This section demonstrates how to determine parameters of an AM signal, such as modulation rate and modulation index (depth) by using frequency and time domain measurements (see the concepts chapter [“AM and FM Demodulation Concepts”](#) on page 157 for more information). Using the ESA built-in AM demodulator, you can also tune-in and listen to an AM signal ([“Demodulating an AM Signal Using the ESA Series”](#) on page 96).

To obtain an AM signal, you can either connect a source transmitting an AM signal, or connect an antenna to the analyzer input and tune to a commercial AM broadcast station. For this demonstration an RF source is used to emulate an AM signal.

**Step 1.** Connect an Agilent ESG RF signal source to the analyzer INPUT. Set the ESG frequency to 300 MHz and the amplitude to -10 dBm. Set the AM depth to 80%, the AM rate to 1 kHz and turn AM on.

**Step 2.** Preset the analyzer and then set the center frequency, span, RBW and the sweep time:

Press **Preset, Factory Preset** (if present).  
Press **FREQUENCY Channel, Center Freq, 300, MHz**.  
Press **SPAN X Scale, Span, 500, kHz**.  
Press **BW/Avg, Res BW, 30, kHz**.  
Press **Sweep, Sweep Time, 20, ms**.

**Step 3.** Set the y-axis units to volts:

Press **AMPLITUDE Y Scale, More, Y-Axis Units, Volts**.

**Step 4.** Position the signal peak near the reference level:

Press **AMPLITUDE Y Scale, Ref Level**, (rotate front-panel knob).

**Step 5.** Change the y-scale type to linear:

Press **AMPLITUDE Y Scale, Scale Type (Lin)**.

**Step 6.** Set the analyzer in zero span to make time-domain measurements:

Press **SPAN X Scale, Zero Span**.  
Press **Sweep, Sweep Time, 5, ms**.

**Step 7.** Use the video trigger to stabilize the trace:

Press **Trig, Video**.

Since the modulation is a steady tone, you can use video trigger to trigger the analyzer sweep on the waveform and stabilize the trace, much like an oscilloscope. See [Figure 11-1](#).

---

**NOTE** If the trigger level is set too high or too low when video trigger mode is activated, the sweep stops. You need to adjust the trigger level up or down with the front-panel knob until the sweep begins again.

---

**Step 8.** Measure the AM rate using delta markers:

Press **Peak Search, Marker, Delta, Peak Search, Next Pk Right** or **Next Pk Left**.

Use markers and delta markers to measure the AM rate. Place the marker on a peak and then use a delta marker to measure the time difference between the peaks (this is the AM rate of the signal)

---

**NOTE** Make sure the delta markers above are placed on adjacent peaks. See [Figure 11-1](#). The frequency or the AM rate is 1 divided by the time between adjacent peaks:

$$\text{AM Rate} = 1/1.0 \text{ ms} = 1 \text{ kHz}$$

The spectrum analyzer can also make this rate calculation by changing the marker readout to inverse time.

Press **Marker, More, Readout, Inverse Time**.

---

In this example we calculated the time between time-domain peaks at the frequency of the peak of the AM signal. To make this measurement more accurately, set the center frequency to a point on the AM signal where the slope of the AM signal's skirt is steep and then set the analyzer in zero span. Set the analyzer sweep time to about 2 times the modulation rate and increase the number of sweep points.

Another way to calculate the modulation rate would be to view the signal in the frequency domain and measure the delta frequency between the peak of the carrier and the first sideband.

**Figure 11-1** Measuring Time Parameters

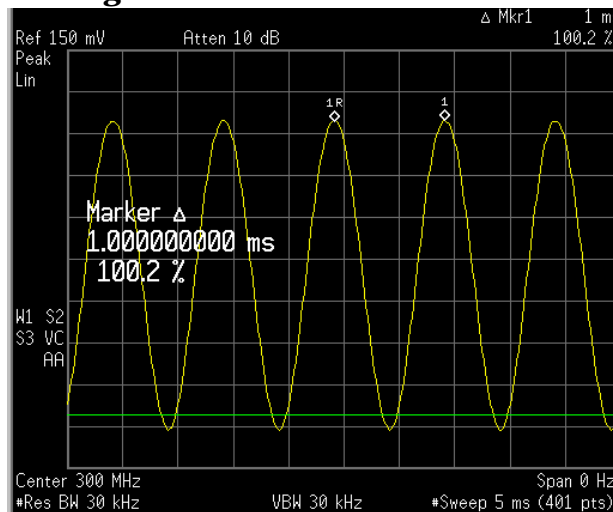

## Measuring the Modulation Index of an AM Signal

This procedure demonstrates how to use the spectrum analyzer as a fixed-tuned (time-domain) receiver to measure the modulation index as a percent AM value of an AM signal. Using the ESA built-in AM demodulator, you can also tune-in and listen to an AM signal (“Demodulating an AM Signal Using the ESA Series” on page 96).

- Step 1.** Follow steps 1 through 7 of the procedure “Measuring the Modulation Rate of an AM Signal” on page 92.
- Step 2.** Turn off all markers and place the analyzer in free run trigger mode:  
Press **Marker, Off.**  
Press **Trig, Free Run.**
- Step 3.** Increase the sweep time and decrease the VBW so that the waveform is displayed as a flat horizontal signal:  
Press **Sweep, Sweep Time, 5, s.**  
Press **BW/Avg, Video BW, 30, Hz.**
- Step 4.** Center the flat waveform at the mid-point of the y-axis and then widen the VBW and decrease the sweep time to display the waveform as a sine wave:  
Press **AMPLITUDE Y Scale, Ref Level.**  
Press **BW/Avg, Video BW, 100, kHz.**  
Press **Sweep, Sweep Time, 5, ms.**
- Step 5.** Measure the modulation index of the AM signal:  
To measure the modulation index as % AM, read the trace as follows (see [Figure 11-2](#) for display examples): 100% AM extends from the top graticule down to the bottom graticule. 80% AM (as in this example) is when the top of the signal is at 1 division below the top graticule and 1 division above the bottom graticule. To determine % AM of your signal count each y-axis division as 10%.

**Figure 11-2 AM Signal Measured in the Time Domain**

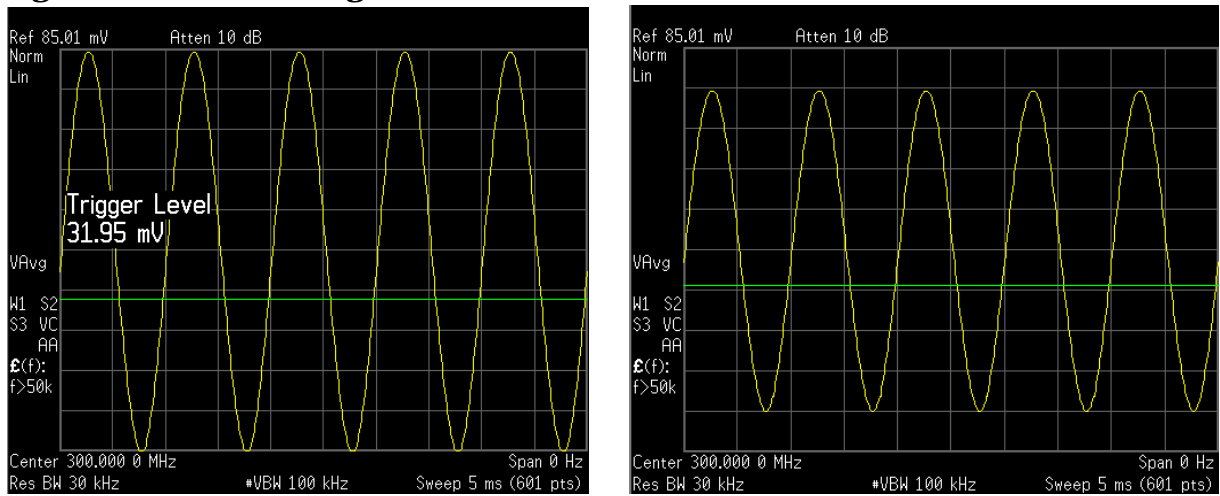

**LEFT: 100% AM Signal (Modulation Index = 1)**

**RIGHT: 80% AM Signal (Modulation Index = 0.8)**

## Demodulating an AM Signal Using the ESA Series

The demodulation functions listed in the menu under Det/Demod allow you to demodulate and hear signal information displayed on the analyzer. Simply place a marker on a signal of interest, set the analyzer in zero span, activate AM demodulation, turn the speaker on, and then listen.

**NOTE** AM demodulation is not available on the PSA Series spectrum analyzers.

**Step 1.** Perform a factory preset:

Press **Preset, Factory Preset** (if present).

**Step 2.** Connect an antenna to the analyzer input.

**Step 3.** Select a frequency range on the analyzer, such as the range for AM radio broadcasts. For example, the frequency range for AM broadcasts in the United States is 550 kHz to 1650 kHz:

Press **FREQUENCY, Start Freq, 550, kHz, Stop Freq, 1650, kHz.**

**Step 4.** Place a marker on the signal of interest (see [Figure 11-3](#)):

Press **Peak Search, Next Pk Right** or **Next Pk Left**.

**Figure 11-3** AM Broadcast Signals

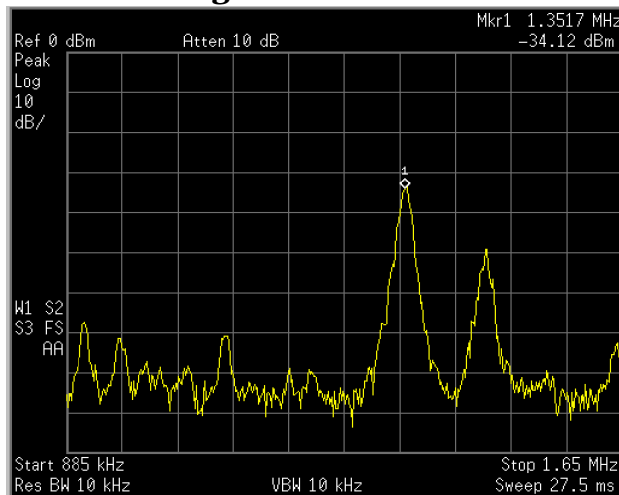

**Step 5.** Set the frequency of the signal of interest to center frequency:

Press **Peak Search, Next Pk Right** or **Next Pk Left** (as necessary), **Marker→**, and **Mkr→CF**.

**Step 6.** Reduce the span to 1 MHz by using the step down key (↓) and **Mkr→CF**



multiple times, keeping the signal of interest in the center of the display until the span is 1 MHz:

Press **SPAN X Scale, Span, (↓), Mkr→CF**.

**Step 7.** Set the analyzer into time-domain with zero span:

Press **SPAN X Scale, Zero Span**.

**Step 8.** Change the resolution bandwidth to 100 kHz:

Press **BW/Avg, Res BW, 100, kHz**.

**Step 9.** Set the top of the signal near the top of the display by changing the reference level with the front-panel knob:

Press **AMPLITUDE Y Scale**, rotate front-panel knob.

**Step 10.** Set the amplitude scale to linear and then re-adjust the reference level to keep the signal centered in the display:

Press **AMPLITUDE Y Scale, Scale Type (Lin)**.

Press **AMPLITUDE Y Scale, Ref Level**, rotate front-panel knob.

**Step 11.** Set the detector type to sample and turn on AM demodulation:

Press **Det/Demod, Detector, Sample**.

Press **Det/Demod, Demod, AM**.

**Step 12.** Listen to the demodulated AM signal (adjust the volume as necessary):

Press **Det/Demod, Demod, Speaker (On)**.

**Step 13.** Measure the modulation index (AM depth as a percentage):

Press **Sweep Time, 5, s**.

Press **BW/Avg, Video BW, 30, Hz**.

Press **AMPLITUDE Y Scale, Ref Level** (use the front-panel knob to adjust the trace to the middle of the screen).

Press **BW/Avg, Video BW, 100, kHz**.

Press **Sweep, Sweep Time, 5, ms**.

The middle horizontal graticule line represents 0% AM; the top and bottom horizontal lines represent 100% AM.

---

**NOTE**

The signal to the speaker is interrupted during retrace because the analyzer is performing automatic alignment routines. To eliminate the interruption and clicks between sweeps, turn the auto alignment function off by pressing **System, Alignments, Auto Align, Off**.

Refer to the specifications for information about operating the analyzer with the alignments turned off.

---

---

## Demodulating an FM Signal Using the ESA-E Series (Requires Option BAA)

This section demonstrates how to demodulate and listen to an FM signal using the ESA built-in FM demodulator with option BAA.

Using the ESA's built in FM demodulator you can tune to an FM signal and view the results of the detector output as displayed in the time domain. Alternatively, the demodulated signal is also available as an audio output (to the speaker or headphone jack) and as video output (on the rear panel of the ESA).

---

**NOTE** FM demodulation is not available on the PSA Series spectrum analyzers.

---

**Step 1.** Perform a factory preset:

Press **Preset, Factory Preset** (if present).

**Step 2.** Use an ESG RF source or an antenna for an FM signal to analyze. In this example an ESG is used transmitting at 300 MHz with FM deviation of 10 kHz and FM rate of 1 kHz.

---

**NOTE** If you are using a broadcast FM signal in the United States, for example, the FM channels are broadcasting between 87.7 MHz to 107.7 MHz.

---

**Step 3.** Before continuing with the demodulation of the FM signal, calibrate the demodulator:

Press **System, Alignments, Align Now, FM demod.**

**Step 4.** Set the center frequency to the center of the FM signal (in this case 300 MHz):

Press **FREQUENCY Channel, Center Freq, 300, MHz.**

**Step 5.** Set the analyzer to zero span for time-domain analysis:

Press **SPAN X Scale, Zero Span.**

Press **Sweep, Sweep Time, 4, ms.**

**Step 6.** Set the resolution bandwidth to capture the full bandwidth of the FM signal. To calculate the required bandwidth use

$$RBW = ((2 \times \text{Frequency Deviation}) + (2 \times \text{Modulation Rate}))$$

In our case the RBW should be:  $(2 \times 10 \text{ kHz}) + (2 \times 1 \text{ kHz}) = 22 \text{ kHz}$   
With ESA's 1-3-10 sequence RBW selections, choose the next highest RBW of 30 kHz:

Press **BW/Avg, Res BW, 30, kHz**.

**Step 7.** Turn on the FM demodulator:

Press **Det/Demod, Demod, FM**.

**Step 8.** Change the vertical scaling:

Press **AMPLITUDE Y Scale, Scale/Div, 5, kHz**.

**Figure 11-4** FM Demodulation (ESG FM Signal with 10 kHz Deviation)

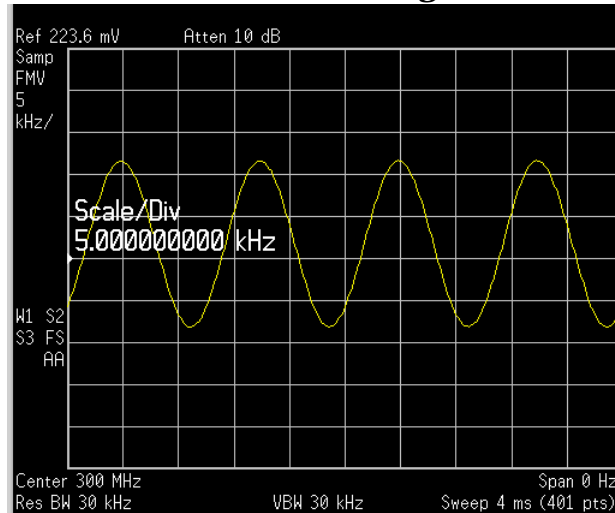

**Step 9.** Calculate the FM deviation using markers with max hold and min hold functionality (also note that each division has 5 kHz of FM deviation if you wanted to visually calculate the deviation):

Press **View/Trace, Max Hold**.

Wait until the trace appears to be a flat line before continuing to the next button sequence below:

Press **Marker, Delta, View/Trace, Min Hold**.

The value on the screen from the delta value of max hold and min hold is the peak-to-peak deviation value. We are interested in the average value which we can calculate by dividing the peak-to-peak value by 2. In our case it should be approximately  $20 \text{ kHz}/2$  or 10 kHz.

**Figure 11-5** Calculating Frequency Deviation

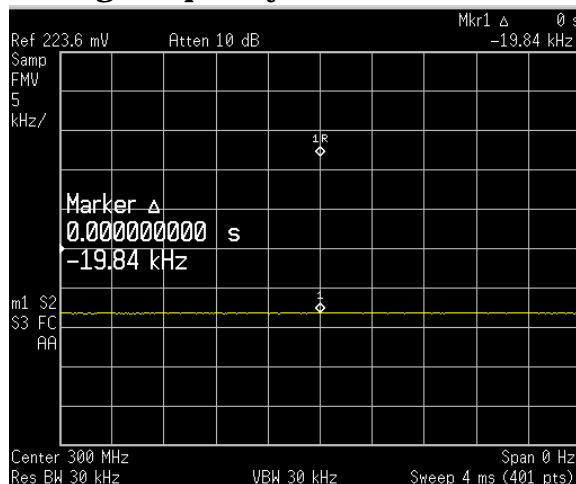

**Step 10.** Take a single sweep of the demodulated signal and then calculate the FM rate using delta markers on adjacent peaks. Change the marker readout value to inverse time for a frequency calculation of the FM rate:

- Press **Marker, Off**.
- Press **View/Trace, Clear Write**.
- Press **Single, Peak Search, Marker, Delta, Peak Search, Next Pk Right (or Next Pk Left)**.
- Press **Marker, More, Readout, Inverse Time**.

**Figure 11-6** Calculating Modulation Rate

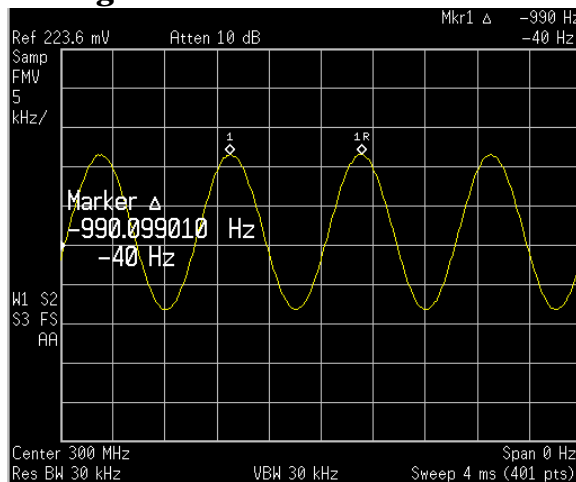

**Step 11.** Listen to the FM signal (first put the analyzer back into continuous sweeping mode):

- Press **Sweep, Sweep (Cont)**.
- Press **Det/Demod, Demod, Speaker (On)**.

Adjust the volume of the internal speaker with the volume knob on the front-panel. Alternatively you can also use the headphone jack (located below the 3.5 inch floppy disk drive).

---

**12**

## **Using Segmented Sweep (ESA-E Series Spectrum Analyzers)**

---

## Measuring Harmonics Using Standard Sweep

This procedure measures the fundamental 50 MHz signal plus the second and third harmonics. Compare the measurement times with this procedure, sweeping from 20 MHz to 170 MHz versus the next procedure “[Measuring Harmonics Using Segmented Sweep](#)” on page 104.

**Step 1.** Preset the instrument:

Press **Preset, Factory Preset** (if present).

**Step 2.** Use the analyzer internal 50 MHz amplitude reference signal:

For ESA model numbers E4401B and E4411B, use the internal 50 MHz amplitude reference signal.

Press **Input/Output, Amptd Ref (On)**.

For all other ESA model numbers connect a cable between the front-panel AMPTD REF OUT to the analyzer INPUT.

Press **Input/Output, Amptd Ref Out (On)**.

**Step 3.** Set the frequency span to view the fundamental signal, second harmonic and third harmonic:

Press **FREQUENCY Channel, Start Freq, 20, MHz, Stop Freq, 170, MHz**.

Press **AMPLITUDE Y Scale, Ref Level, -20, dBm**.

**Step 4.** Set the resolution bandwidth and video bandwidth:

Press **BW/Avg, Res BW, 1, kHz**.

Press **BW/Avg, Video BW, 1, kHz**.

**Step 5.** Place a marker at the 50 MHz signal (you may need to wait for a minute until the analyzer sweeps past 50 MHz):

Press **Peak Search**.

Refer to [Figure 12-1](#) to see the result of this first measurement in this example. Notice the minimum sweep time is set at 193.3 seconds in order to provide accurate data. If you attempt to enter a faster sweep time, the Meas Uncal message is shown in the upper right corner of the display.

Figure 12-1

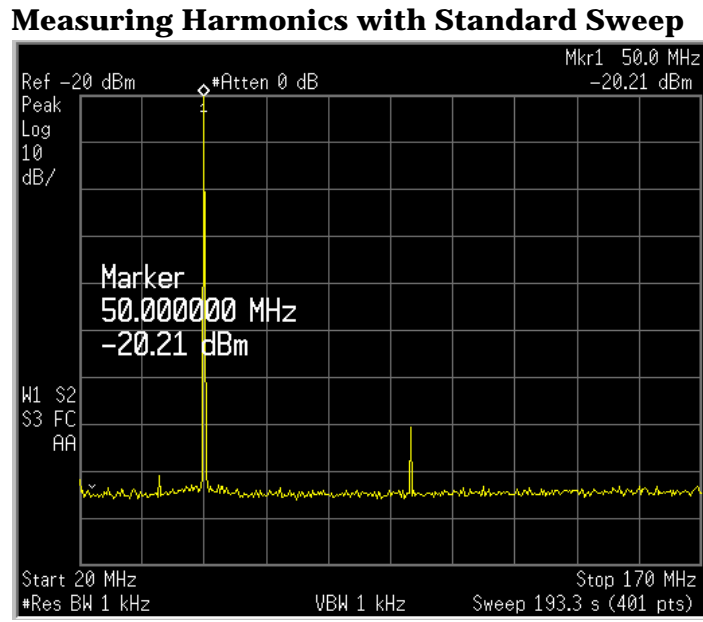

---

## Measuring Harmonics Using Segmented Sweep

Segmented sweep allows you to define many bands of interest and display them as a single trace. Although the following examples only involve a maximum of 3 segments, you can set up the trace to display 32 segments simultaneously.

This procedure uses segmented sweep to measure the 50 MHz fundamental signal, the second harmonic and the third harmonic. Compare the measurement time differences between the previous procedure, “[Measuring Harmonics Using Standard Sweep](#)” on page 102 and this procedure using segmented sweep. Segmented sweep is faster than sweeping the full span to capture the fundamental signal to the third harmonic.

**Step 1.** Preset the instrument:

Press **Preset, Factory Preset** (if present).

**Step 2.** Turn on the internal 50 MHz amplitude reference signal as in [step 2](#) from the “[Measuring Harmonics Using Standard Sweep](#)” on page 102, section above.

**Step 3.** Set the reference level and attenuation:

Press **AMPLITUDE Y Scale, Ref Level, -20, dBm**.  
Press **AMPLITUDE Y Scale, Attenuation, 5, dB**.

**Step 4.** Open the segmented sweep editor:

Press **Sweep, Segmented, Modify, Edit**.

Three segments are going to be set up, as in [Figure 12-2](#) below, to view the fundamental signal, second harmonic and third harmonic.

**Step 5.** Set the first segment parameters:

Press **Segment, 1, Enter**.  
Press **Center Freq, 50, MHz**.  
Press **Span, 100, kHz**.  
Press **Video BW, 30, Hz**.

**Step 6.** Set the second segment parameters:

Press **Segment, 2, Enter**.  
Press **Center Freq, 100, MHz**.  
Press **Span, 100, kHz**.  
Press **Video BW, 30, Hz**.

**Step 7.** Set the third segment parameters:

Press **Segment, 3, Enter**.



## Using Segmented Sweep (ESA-E Series Spectrum Analyzers) Measuring Harmonics Using Segmented Sweep

Press **Center Freq**, 150, MHz.  
Press **Span**, 100, kHz.  
Press **Video BW**, 30, Hz.

Notice that the total sweep time for the 3 segments is only 8.13 seconds (plus a minimal time for transitions between segments). This is considerably shorter than the **193.3 seconds** required to view the same signals without segmented sweep.

**Figure 12-2**

### Reducing Sweep Time with Segmented Sweep

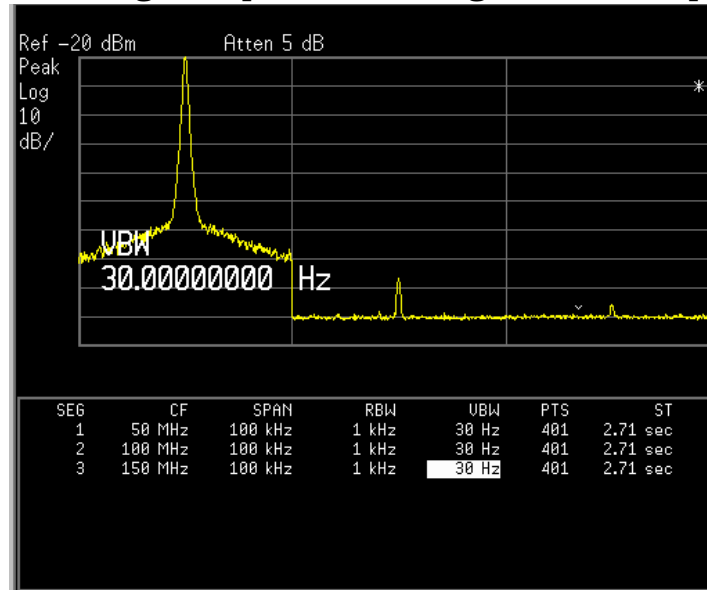

---

## Using Segmented Sweep With Limit Lines

Segmented sweep can also use other standard spectrum analyzer functionality, such as limit lines. In this procedure three segments are used. In the first segment, the limit lines are used to verify that the signal phase noise is acceptable. The second and third segments are used to verify the harmonic signals are below a specified amplitude.

**Step 1.** Connect the 10 MHz REF OUT from the rear panel to the front-panel INPUT. Preset the instrument:

Press **Preset, Factory Preset** (if present).

**Step 2.** Place the peak of the fundamental signal at the top of the graticule:

Press **AMPLITUDE Y Scale, Ref Level, 8, dBm**.

**Step 3.** Open the segmented sweep editor:

Press **Sweep, Segmented, Modify, Edit**.

**Step 4.** Display the fundamental signal in the first segment:

Press **Segment, 1, Enter**.  
Press **Center Freq, 10, MHz**.  
Press **Span, 500, kHz**.  
Press **Res BW, 3, kHz**.  
Press **Video BW, 30, Hz**.  
Press **Points, 1000, Enter**.

**Step 5.** Display the second harmonic in the second segment:

Press **Segment, 2, Enter**.  
Press **Center Freq, 20, MHz**.  
Press **Span, 100, kHz**.

**Step 6.** Display the third harmonic in the third segment:

Press **Segment, 3, Enter**.  
Press **Center Freq, 30, MHz**.  
Press **Span, 100, kHz**.

**Step 7.** Open the limit line editor:

Press **Display, Limits, Limit 1, Type (Upper), Edit**.

**Step 8.** Enter the limit line data from [Table 12-1](#) below. To enter the table data:

Press **Point, 1, Enter, Frequency, 9.75, MHz, Amplitude, -80, dBm, Connected (Yes)**.

**Step 9.** Begin the next limit line point:

Press **Tab =>|**.

**Step 10.** Enter points 2 through 11 from [Table 12-1](#):

**Table 12-1**

**Limit Line Data**

Point	Frequency	Amplitude	Connected
1	9.75 MHz	- 80 dBm	Yes
2	9.8 MHz	- 75 dBm	Yes
3	9.9 MHz	- 70 dBm	Yes
4	9.95 MHz	6 dBm	Yes
5	10.05 MHz	6 dBm	Yes
6	10.1 MHz	- 70 dBm	Yes
7	10.2 MHz	- 75 dBm	Yes
8	10.25 MHz	- 80 dBm	Yes
9	19.95 MHz	- 30 dBm	Yes
10	29.95 MHz	- 15 dBm	Yes
11	30.05 MHz	- 15 dBm	Yes

**Step 11.** Turn the limits on:

Press **Return**, **Limit (On)**.

**Step 12.** Turn the limit test on to determine if the fundamental signal and harmonics pass:

Press **Test (On)**.

**Figure 12-3**

**Segmented Sweep with Limit Line Test**

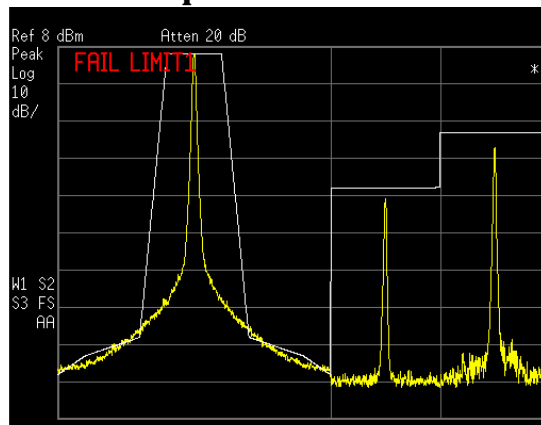

This procedure can verify compliance with phase noise and harmonics specifications. You can save this instrument state and limit lines in a “setup” type file for future applications (**File, Save, Type, Setup, Save Now**). Replace the 10 MHz reference signal of the analyzer with the device under test (DUT) to create a similar measurement.

## Using Segmented Sweep to Monitor the Cellular Activity of a cdmaOne Band

In this example set up two segments to monitor the forward and reverse links of a U.S. IS-95A cellular band. The third segment is used to zoom in on an area of interest. You can use any communications band of interest in your area to duplicate this example.

**Step 1.** Perform a factory preset:

Press **Preset, Factory Preset** (if present).

**Step 2.** Turn on the internal preamp (if installed):

Press **AMPLITUDE Y Scale, More, Int Preamp (On)**.

**Step 3.** Open the segmented sweep editor:

Press **Sweep, Segmented, Modify, Edit**.

**Step 4.** Monitor the activity in the cdmaOne band with the first segment:

Press **Center Freq, 836.5, MHz**.

Press **Span, 25, MHz**.

Press **Res BW, 10, kHz**.

**Step 5.** Set the reference level to place the signal in the middle of the display:

Press **AMPLITUDE Y Scale, Ref Level, 40, -dBm**.

**Step 6.** Monitor the activity of the base station with the second segment:

Press **Sweep, Segmented, Modify, Edit, Segment, 2, Enter**.

Press **Center Freq, 881.5, MHz**.

Press **Span, 25, MHz**.

Press **Res BW, 10, kHz**.

**Figure 12-4** Monitoring the Reverse and Forward Links

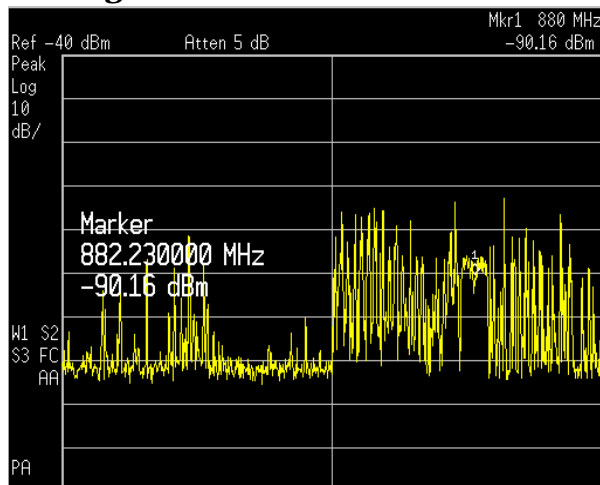

## Using Segmented Sweep to Monitor the Cellular Activity of a cdmaOne Band

**Step 7.** Locate the frequency of the cdmaOne signal with a marker:

Press **Marker**, then rotate front-panel knob.

Notice that in this example, there are two cdmaOne carriers located at 882.23 MHz, as shown in [Figure 12-4](#).

**Step 8.** Set the center frequency of segment 3 to 882.23 MHz:

Press **Sweep, Segmented, Modify, Edit, Segment, 3, Enter**.  
Press **Center Freq, 882.23, MHz**.

**Step 9.** Set the span to greater than twice the cdmaOne bandwidth (2 times 1.2288 MHz) since there are two cdma carriers side-by-side:

Press **Span, 2.7, MHz**.  
Press **Res BW, 10, kHz**.

**Step 10.** Set trace 1 to maximum hold and set trace 2 to minimum hold:

Press **Trace/View, Trace 1, Max Hold**.  
Press **Trace/View, Trace 2, Min Hold**.

**Figure 12-5** Monitoring Cellular Bands in Segmented Sweep

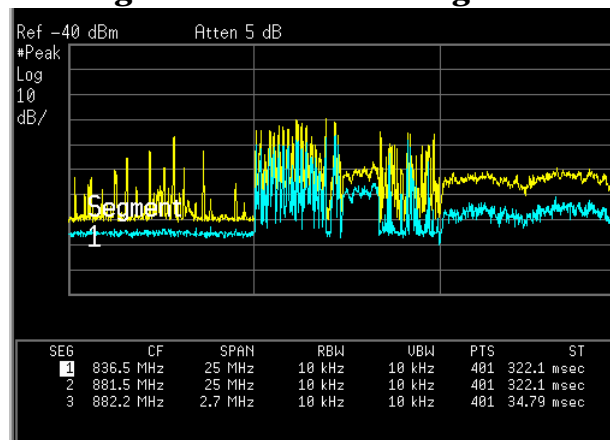

[Figure 12-5](#) displays the results of this setup over an extended period of time. As expected, the minimum hold trace of segment 1 shows no continuously present carriers. This is indicative of cellular activity. If a persistent signal exists, it may represent the presence of an interfering carrier. In this example, segment 3 shows continuous transmission of the carrier without interference.

Using Segmented Sweep (ESA-E Series Spectrum Analyzers)

**Using Segmented Sweep to Monitor the Cellular Activity of a cdmaOne Band**

---

**13**

**Stimulus Response  
Measurements (ESA Options 1DN  
and 1DQ)**

## Making a Stimulus Response Transmission Measurement

The procedure below describes how to use a built-in tracking generator to measure the rejection of a band pass filter, a type of transmission measurement. Refer to the concepts chapter “[Stimulus Response Measurement Concepts](#)” on page 158 for more information a making stimulus response measurements including adjusting the tracking generator output power and measuring the N dB bandwidth.

- Step 1.** To measure the rejection of a band pass filter, connect the equipment as shown in [Figure 13-1](#). A 200 MHz bandpass filter as the DUT.

**Figure 13-1** Transmission Measurement Test Setup

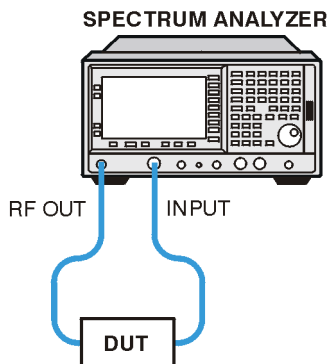

- Step 2.** Perform a factory preset:  
Press **Preset, Factory Preset** (if present).
- Step 3.** View the rejection of the bandpass filter. Set a wide RBW:  
Press **FREQUENCY Channel, Center Freq, 200, MHz**.  
Press **SPAN X Scale, Span, 100, MHz**.  
Press **BW/Avg, Res BW, 3, MHz**.
- Step 4.** Turn on the tracking generator:  
Press **Source, Amplitude (On), -10, dBm**.

---

**CAUTION** Excessive signal input may damage the DUT. Do not exceed the maximum power that the device under test can tolerate.

---

**NOTE** To reduce ripples caused by source return loss, use 10 dB (E4401B or E4411B) or 8 dB (all other models) or greater tracking generator output attenuation. Tracking generator output attenuation is normally a function of the source power selected. However, the output attenuation may be controlled in the **Source** menu.

---



**Step 5.** Put the sweep time into stimulus response auto coupled mode:

Press **Sweep, Swp Coupling (SR)**.

**Step 6.** Increase measurement sensitivity and smooth the noise:

Press **BW/Avg, Res BW, 30, kHz**.

Press **BW/Avg, Video BW, 300, Hz**.

A decrease in displayed amplitude is caused by tracking error.

**Step 7.** Use peak tracking to correct the frequency offset:

Press **Source, Tracking Peak**.

Tracking error occurs when the output frequency of the tracking generator is not exactly matched to the input frequency of the analyzer. The amplitude should return to the value that was displayed prior to the decrease in resolution bandwidth.

**Step 8.** Connect the cable from the tracking generator output to the analyzer input. Store the frequency response in trace 3 and normalize:

Press **View/Trace, More, Normalize, Store Ref (1→3), Normalize (On)**.

See [“Normalization Concepts” on page 159](#) for information on normalization.

**Step 9.** Reconnect the DUT to the analyzer and change the normalized reference position:

Press **View/Trace, More, Normalize, Norm Ref Posn**.

**Step 10.** Measure the rejection of the bandpass filter:

Press **Marker, 200, MHz, Delta, 45, MHz**.

The marker readout displays the rejection of the filter at 45 MHz above the center of the bandpass. See [Figure 13-2](#).

**Figure 13-2**

**Measure the Rejection Range**

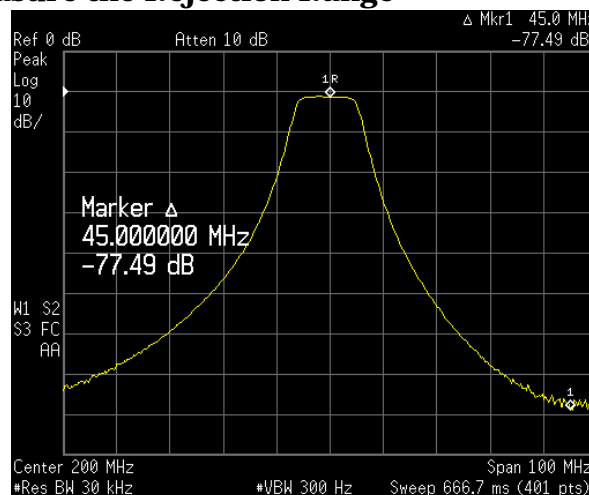

## Calculating the N dB Bandwidth Using Stimulus Response

This procedure uses the tracking generator for transmission stimulus response measurements to calculate the 3 dB bandwidth of a 200 MHz bandpass filter. See the concepts section “[Measuring Device Bandwidth](#)” on page 160 for more information on this measurement.

- Step 1.** To measure the rejection of a bandpass filter, connect the equipment as shown in [Figure 13-3](#). This example uses a 200 MHz bandpass filter.

**Figure 13-3** Transmission Measurement Test Setup

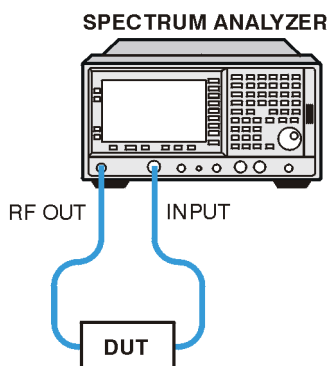

b173b

- Step 2.** Perform a factory preset:  
Press **Preset, Factory Preset** (if present).
- Step 3.** Set the center frequency, span and the resolution bandwidth:  
Press **FREQUENCY Channel, Center Freq, 200, MHz**.  
Press **SPAN X Scale, Span, 100, MHz**.  
Press **BW/Avg, Res BW, 10, kHz**.
- Step 4.** Turn on the tracking generator and set the output power to  $-10$  dBm:  
Press **Source, Amplitude (On),  $-10$ , dBm**.

---

**CAUTION** Excessive signal input may damage the DUT. Do not exceed the maximum power that the device under test can tolerate.

---

---

**NOTE** To reduce ripples caused by source return loss, use 10 dB (E4401B or E4411B) or 8 dB (all other models) or greater tracking generator output attenuation. Tracking generator output attenuation is normally a function of the source power selected.

---

**Step 5.** Put the sweep time of the analyzer into stimulus response auto coupled mode:

Press **Sweep, Swp Coupling (SR)**.

Auto coupled sweep times are usually much faster for stimulus response measurements than they are for spectrum analyzer (SA) measurements. If necessary, adjust the reference level to place the signal on screen.

**Step 6.** Activate the N dB bandwidth function (See [Figure 13-4](#)):

Press **Peak Search, More, N dB Points (On)**.

**Figure 13-4** AM Signal Measured in the Time Domain

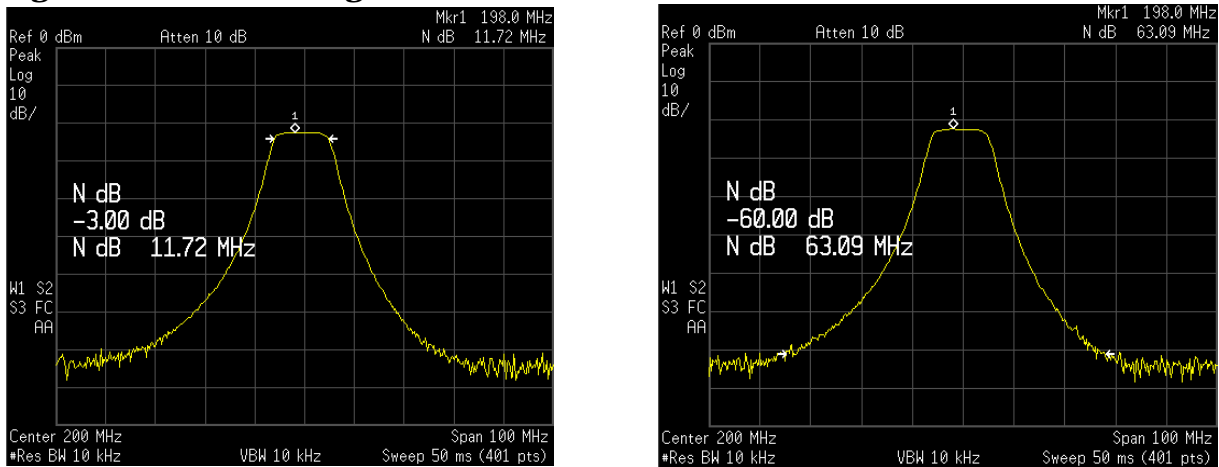

LEFT: N dB Bandwidth Measurement at -3 dB

RIGHT: N dB Bandwidth Measurement at -60 dB

**NOTE**

The knob or the data entry keys can be used to change the N dB value from -3 dB to -60 dB to measure the 60 dB bandwidth of the filter.

**Step 7.** Turn off the N dB Points measurement:

Press **N dB Points (Off)**.

## Measuring Stop Band Attenuation Using Log Sweep (ESA-E Series)

When measuring filter characteristics, it is useful to look at the stimulus response over a wide frequency range. Setting the analyzer x-axis (frequency) to display logarithmically provides this function.

The following example uses the tracking generator to measure the stop band attenuation of a 10 MHz low pass filter.

- Step 1.** To measure the response of a low pass filter, connect the equipment as shown in [Figure 13-5](#). This example uses a 10 MHz low pass filter.

**Figure 13-5** Transmission Measurement Test Setup

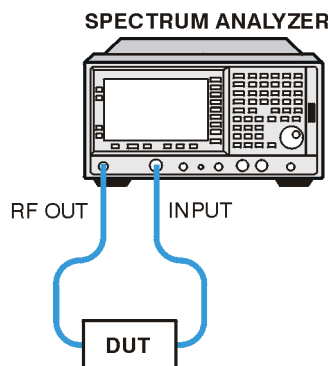

- Step 2.** Perform a factory preset:  
Press **Preset, Factory Preset** (if present).
- Step 3.** Set the start and stop frequencies:  
Press **FREQUENCY Channel, Start Freq, 100, kHz**.  
Press **FREQUENCY Channel, Stop Freq, 1, GHz**.  
Press **FREQUENCY Channel, Scale Type (Log)**.
- Step 4.** Set the resolution bandwidth to 10 kHz:  
Press **BW/Avg, Res BW, 10, kHz**.
- Step 5.** For E4407B analyzers with option UKB, set the input coupling to DC:  
Press **Input, Coupling (DC)**.
- Step 6.** Turn on the tracking generator and if necessary, set the output power to -10 dBm:  
Press **Source, Amplitude (On), -10, dBm**.

**CAUTION**

Excessive signal input may damage the DUT. Do not exceed the maximum power that the device under test can tolerate.

- Step 7.** Put the sweep time into stimulus response auto coupled mode:  
Press **Sweep, Swp Coupling (SR)**.  
Adjust the reference level if necessary to place the signal on screen.
- Step 8.** Connect the cable (but not the DUT) from the tracking generator output to the analyzer input. Store the frequency response into trace 3 and normalize:  
Press **View/Trace, More, Normalize, Store Ref (1→3), Normalize (On)**.
- Step 9.** Reconnect the DUT to the analyzer. Note that the units of the reference level have changed to dB, indicating that this is now a relative measurement.
- Step 10.** To change the normalized reference position:  
Press **View/Trace, More, Normalize, Norm Ref Posn, 9, Enter**.
- Step 11.** Place the reference marker at the specified cutoff frequency:  
Press **Marker, Delta Pair (Ref), 10, MHz**.
- Step 12.** Place the second marker at 20 MHz:  
Press **Delta Pair (Delta), 20, MHz**.  
  
In this example, the attenuation over this frequency range is 63.32 dB/octave (one octave above the cutoff frequency).
- Step 13.** Use the front-panel knob to place the marker at the highest peak in the stop band to determine the minimum stop band attenuation. In this example, the peak occurs at 708.76 MHz. The attenuation is 54.92 dB.

**Figure 13-6 Minimum Stop Band Attenuation**

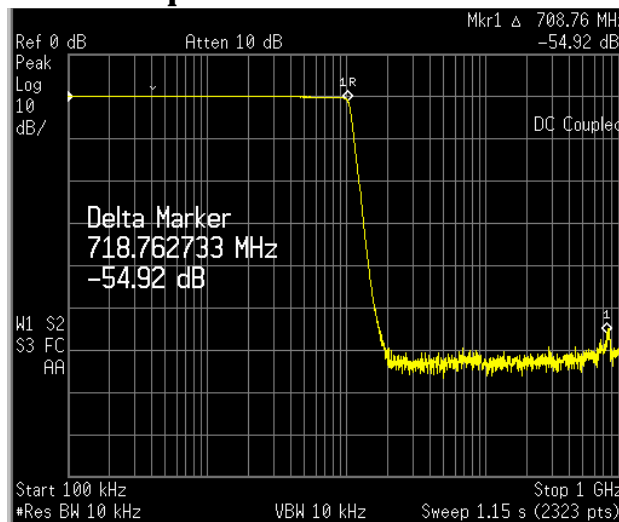

## Making a Reflection Calibration Measurement

The following procedure makes a reflection measurement using a coupler or directional bridge to measure the return loss of a filter. This example uses a 200 MHz bandpass filter as the DUT.

The calibration standard for reflection measurements is usually a short circuit connected at the reference plane (the point at which the device under test (DUT) is connected.) See Figure 13-7. A short circuit has a reflection coefficient of 1 (0 dB return loss). It reflects all incident power and provides a convenient 0 dB reference.

- Step 1.** Connect the DUT to the directional bridge or coupler as shown in Figure 13-7. Terminate the unconnected port of the DUT.

Figure 13-7

### Reflection Measurement Short Calibration Test Setup

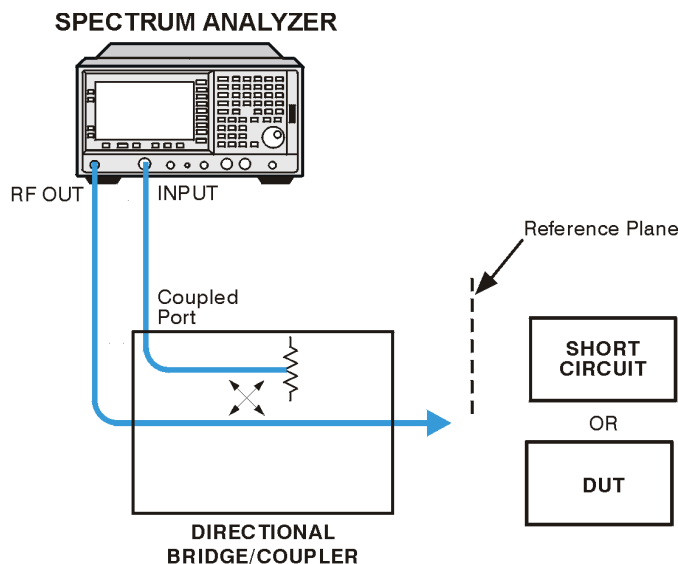

#### NOTE

If possible, use a coupler or bridge with the correct test port connector for both calibrating and measuring. Any adapter between the test port and DUT degrades coupler/bridge directivity and system source match. Ideally, you should use the same adapter for the calibration and the measurement. Be sure to terminate the second port of a two port device.

- Step 2.** Connect the tracking generator output of the analyzer to the directional bridge or coupler.
- Step 3.** Connect the analyzer input to the *coupled* port of the directional bridge or coupler.
- Step 4.** Perform a factory preset:  
Press **Preset, Factory Preset** (if present).

**Step 5.** Turn on the tracking generator and set the output power to  $-10$  dBm:  
Press **Source, Amplitude (On),  $-10$ , dBm.**

---

**CAUTION** Excessive signal input may damage the DUT. Do not exceed the maximum power that the device under test can tolerate.

---

**Step 6.** Set the center frequency, span and resolution bandwidth:  
Press **FREQUENCY Channel, Center Freq, 200, MHz.**  
Press **SPAN X Scale, Span, 100, MHz.**  
Press **BW/Avg, Res BW, 3, MHz.**

**Step 7.** Replace the DUT with a short circuit.

**Step 8.** Normalize the trace:

**View/Trace, More, Normalize, Store Ref (1 $\rightarrow$ 3), Normalize (On).**

This activates the trace 1 minus trace 3 function and display the results in trace 1 (see [Figure 13-8](#)). The normalized trace or flat line represents 0 dB return loss. Normalization occurs each sweep. Replace the short circuit with the DUT.

---

**NOTE** Since the reference trace is stored in trace 3, changing trace 3 to **Clear Write** invalidates the normalization.

---

**Figure 13-8** Short Circuit Normalized

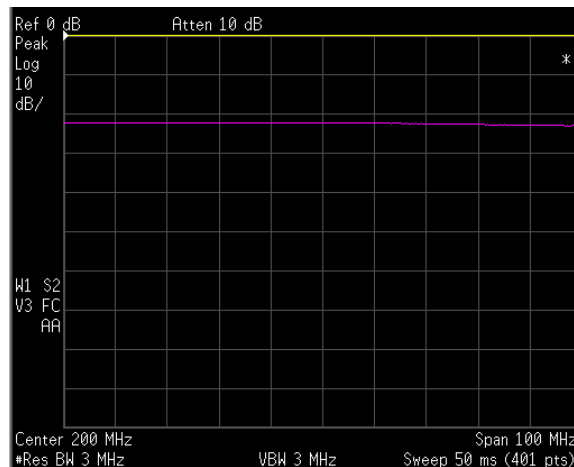

## Measuring Return Loss using the Reflection Calibration Routine

This procedure uses the reflection calibration routine in the preceding procedure “[Making a Reflection Calibration Measurement](#)” on page 118 to calculate the return loss of the 200 MHz bandpass filter. See the concepts section “[Converting Return Loss to VSWR](#)” on page 160 to find the VSWR for the measured return loss.

- Step 1.** After calibrating the system with the above procedure, reconnect the filter in place of the short circuit without changing any analyzer settings.
- Step 2.** Use the marker to read return loss. Position the marker with the front-panel knob to read the return loss at that frequency:

Press **Marker**, rotate front-panel knob.

### NOTE

Or you can use the Min Search function to measure return loss by pressing **Peak Search**, **Min Search**, a marker is placed at the point where the return loss is maximized. See [Figure 13-9](#).

**Figure 13-9** Measuring the Return Loss of the Filter

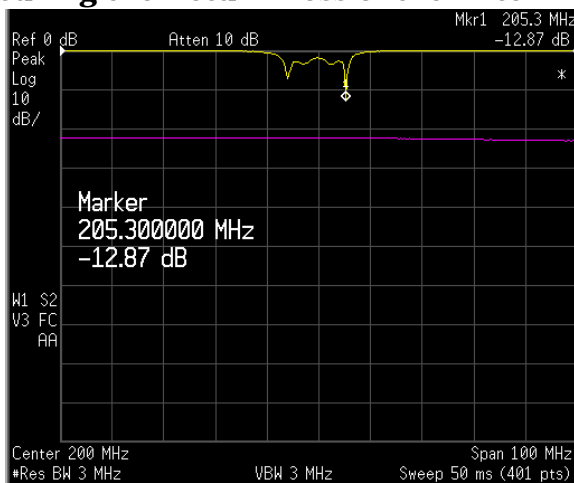



---

**14**

**Demodulating and Viewing  
Television Signals  
(ESA-E Series Option B7B)**

---

## Demodulating and Viewing Television Signals

ESA-E Series with option B7B (TV trigger and picture on screen) allows you to trigger the sweep of the analyzer on a specific television line of a demodulated TV waveform. Option B7B also allows you to view the television picture represented by the TV waveform on the color LCD display of the analyzer.

This procedure sets up the analyzer to trigger on the TV video waveform and to view the picture of the TV signal on the analyzer.

For more information on TV trigger setup see the concepts chapter “[TV Trigger Setup Menu Functions](#)” on page 154.

- Step 1.** Connect a source which contains suitable TV carrier signals (for example, terrestrial broadcast or CATV signals).
- Step 2.** Disable the background alignment process while viewing TV pictures:

Press **System, Alignments, Auto Align, Off**.

This is necessary to prevent the background alignment process from interrupting the signal paths of the analyzer during the sweep retrace period so as to maintain a constant, uninterrupted video waveform.

---

### NOTE

After viewing the TV waveform or picture, re-enable the background alignment process by pressing **System, Alignments, Auto Align, All**. If the background alignment has been disabled for more than 60 minutes or the ambient temperature has changed more than 3 degrees centigrade, press **System, Alignments, Align Now, All** to ensure measurement accuracy. See the Specifications and Characteristics Chapter for your analyzer model in the specifications guide, for information about alignment requirements.

- Step 3.** Set the center frequency of the analyzer to match the TV video carrier frequency and set the span to 20 MHz to capture the TV channel:
- Press **FREQUENCY Channel**, then enter the desired value and units. Press **SPAN X Scale, Span, 20, MHz**.
- Step 4.** Auto couple the analyzer settings:
- Press **Auto Couple, Auto All** (if present, newer software only).
- Step 5.** Adjust the reference level of the analyzer to the peak video carrier level:
- Press **AMPLITUDE Y Scale**, then use the knob or step keys.

---

### NOTE

If the signal is weak and accompanied by excessive noise, you may choose to enable the internal preamp, if installed, to improve the signal-to-noise ratio. Press **AMPLITUDE, More, Int Preamp (On)**.

When viewing the spectrum, for analog TV channels, there should be a strong, “noise-like” video carrier at the center frequency, a weaker, “noise-like” chrominance sub-carrier located 3.58 MHz (NTSC standard) or 4.3 to 4.4 MHz (PAL or SECAM standards) above the video carrier, and a tightly-grouped sound carrier located 4.5 to 6.5 MHz above the video carrier. If you are viewing broadcast or cable TV signals, the lower adjacent channel sound carrier may be very close to the video carrier at the center frequency.

**Step 6.** Change the RBW to 3 MHz:

Press **BW/Avg, Res BW, 3, MHz**.

If the test signal does not have adjacent channels present, change the resolution bandwidth to 5 MHz. If strong adjacent channel signals are present (primarily the sound carrier of the lower adjacent channel), set the RBW to 1 MHz.

**Step 7.** Set the amplitude scale type of the analyzer to linear:

Press **AMPLITUDE Y Scale, Scale Type (Lin)**.

**Step 8.** Set the detector mode of the analyzer to sample:

Press **Det/Demod, Detector, Sample**.

**Step 9.** Set the analyzer in time-domain span:

Press **SPAN X Scale, Zero Span**.

**Step 10.** Adjust the reference level so that the signal peaks are within half of a division of the top of the display.

Press **AMPLITUDE Y Scale**, then use the knob or arrow keys.

**Step 11.** Set up the TV trigger properties:

Press **Trig, TV Trig Setup**.

Press **Field, Entire Frame, Sync (Pos)** (or **Sync (Neg)** for SECAM signals. Press **Standard**, then select the appropriate standard for the video signal.

Press **TV Source, SA**.

**Step 12.** Enable the TV trigger:

Press **Trig, TV**.

The default line number for triggering can be changed to any value from 1 to 525 or from 1 to 625, depending on the selected video standard.

**Step 13.** Decrease the sweep time to view several TV lines (if you have option AYX or B7D):

Press **Sweep, Sweep Time, 500,  $\mu$ s**.

A time domain display of the demodulated TV waveform will now be visible. The signals used for Figure 14-1 were produced by a Phillips PM 5518-TX Color TV Pattern Generator.

**Figure 14-1 Demodulated RF Waveform**

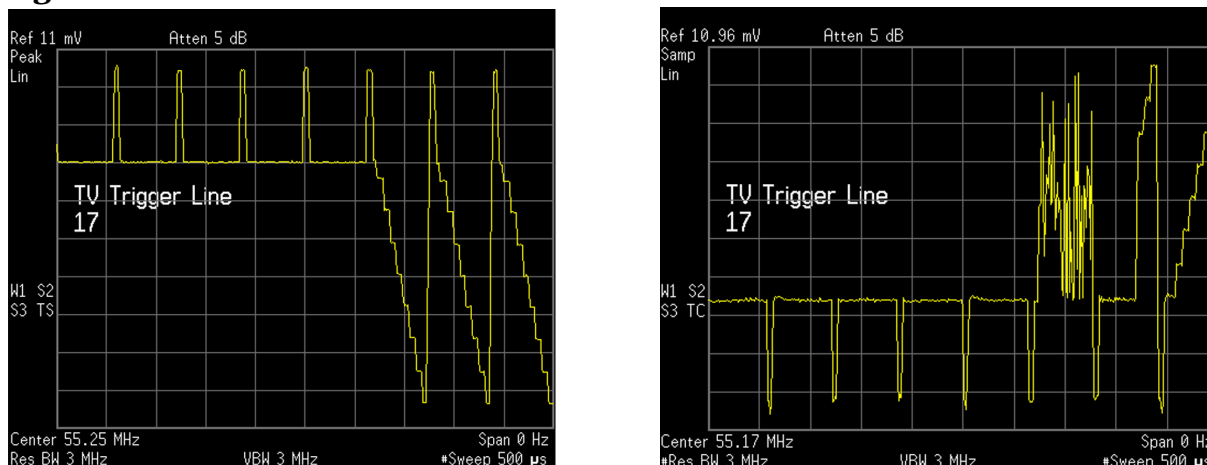

LEFT: NTSC; PAL is Similar  
RIGHT: SECAM

If **Trig**, **TV** is the active function, the line number used to trigger the analyzer sweep can be changed to examine the different parts of the video waveform. The line numbering scheme varies with TV standard, but TV test patterns will often be inserted in or near line 17.

**Step 14.** Set a long sweep time of 100 seconds to minimize disruption of the analog signal path during the instrument retrace to optimize picture quality:

Press **Sweep**, **Sweep Time**, **100**, **s**.

**Step 15.** To obtain the best color picture quality with NTSC and PAL signals, set the center frequency 1.75 MHz above the video carrier frequency:

Press **FREQUENCY Channel**, **CF Step**, **1.75**, **MHz**, **Center Freq**, **↑**.

Setting the center frequency above the video carrier frequency centers the analyzer's tuned frequency between the video carrier and the color subcarrier.

**Step 16.** Turn on the spectrum analyzer display into a TV monitor:

Press **Trig**, **TV Trig Setup**, **TV Monitor**.

**Figure 14-2** TV Picture Display

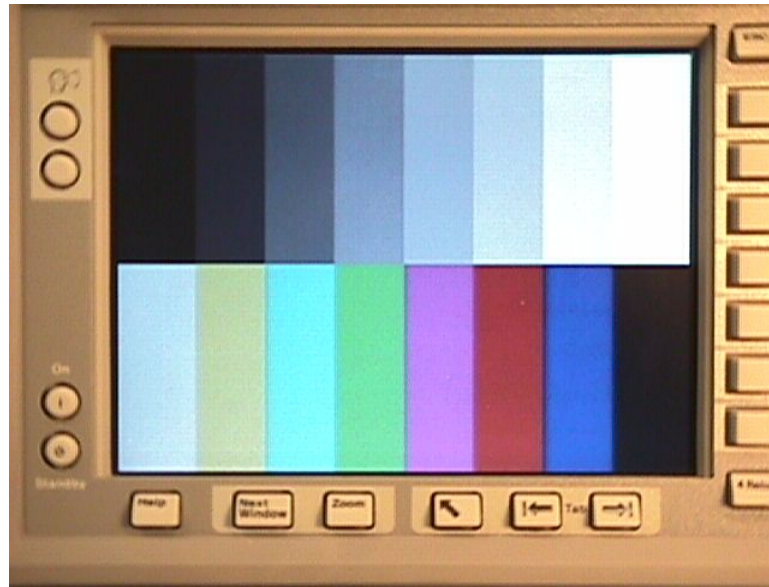

When the picture is active, you can adjust the value of the function that was active prior to enabling the picture. For example, if center frequency was the active function and the frequency step size was set to the TV channel frequency spacing, you can increment or decrement through the TV channels by pressing the step keys ( $\downarrow$   $\uparrow$ ) of the analyzer. If resolution bandwidth was the active function, you can increase or decrease the amount of filtering to deal with strong adjacent channel signals.

---

**NOTE**

When using the knob to vary the value of the active function, be aware that the instrument settings will not be updated until you stop turning the knob. Make small movements of the knob with frequent pauses.

---

## Measuring Depth of Modulation

The depth of modulation provides a measure of the percentage of amplitude modulation (AM) on the visual carrier. With Option B7B, the analyzer can be used to measure the horizontal synchronization pulse level and vertical interval test signal (VITS) white level on an individual TV line from which a calculation of percent AM can be made. Note that this measurement method will not be valid for some types of scrambled video signals.

This procedure measures depth of modulation on an individual TV line.

For more information on TV trigger setup see the concepts chapter “TV Trigger Setup Menu Functions” on page 154.

---

**NOTE** Before continuing, be sure you have performed the steps in “Demodulating and Viewing Television Signals” on page 122 at the beginning of the section to display a TV waveform with linear scaling.

---

- Step 1.** Trigger on a TV line that has a test signal containing the reference white level within the waveform (100 IRE) such as the FCC, NTC-7 or ITU Composite Test Signal (typically found at or near line 17 within field 1 or field 2):

Press **Trig, TV**, and enter a line number.

- Step 2.** Set the sweep time to 80  $\mu$ s (option AYX or B7D required) to view a complete TV line:

Press **Sweep, Sweep Time, 80,  $\mu$ s**.

- Step 3.** Set the resolution bandwidth and the video bandwidth to 1 MHz:

Press **BW/Avg, Res BW, 1, MHz**.

Press **BW/Avg, Video BW, 1, MHz**.

- Step 4.** Turn on video averaging to 10 averages:

Press **BW/Avg, Average (On), 10, Enter**.

This minimizes the waveform variations caused by the presence of additional RF signals near the picture carrier, as well as waveform noise or jitter.

- Step 5.** Enable a normal marker and using the front-panel knob move the marker within the sync tip (NTSC or PAL waveforms) or the white level (SECAM waveforms) at the top of the waveform:

Press **Marker, Normal**, then rotate the front-panel knob (or press **Peak Search**).

**Step 6.** Enable a delta marker and using the front-panel knob move the delta marker within the white level (NTSC or PAL waveforms) or the sync tip (SECAM waveforms) at the bottom of the waveform:

Press **Marker**, **Delta**, then rotate front-panel knob (or press **Peak Search**, **Min Search**).

**Figure 14-3** Measuring Marker Delta (%) for Depth of Modulation (NTSC)

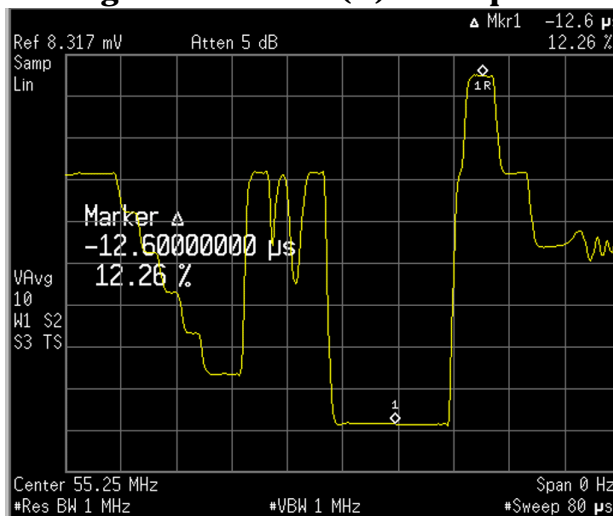

The depth of modulation (in percent) can now be determined by subtracting the marker readout (in percent) from 100. A typical value would be 87.5%.





---

**15** **Concepts**

---

## Resolving Closely Spaced Signals

### Resolving Signals of Equal Amplitude

Two equal-amplitude input signals that are close in frequency can appear as a single signal trace on the analyzer display. Responding to a single-frequency signal, a swept-tuned analyzer traces out the shape of the selected internal IF (intermediate frequency) filter (typically referred to as the resolution bandwidth or RBW filter). As you change the filter bandwidth, you change the width of the displayed response. If a wide filter is used and two equal-amplitude input signals are close enough in frequency, then the two signals will appear as one signal. If a narrow enough filter is used, the two input signals can be discriminated and appear as separate peaks. Thus, signal resolution is determined by the IF filters inside the analyzer.

The bandwidth of the IF filter tells us how close together equal amplitude signals can be and still be distinguished from each other. The resolution bandwidth function selects an IF filter setting for a measurement. Typically, resolution bandwidth is defined as the 3 dB bandwidth of the filter. However, resolution bandwidth may also be defined as the 6 dB or impulse bandwidth of the filter.

Generally, to resolve two signals of equal amplitude, the resolution bandwidth must be less than or equal to the frequency separation of the two signals. If the bandwidth is equal to the separation and the video bandwidth is less than the resolution bandwidth, a dip of approximately 3 dB is seen between the peaks of the two equal signals, and it is clear that more than one signal is present.

For ESA spectrum analyzers when the resolution bandwidth is  $\geq 1$  kHz and for PSA spectrum analyzers in swept mode, to keep the analyzer measurement calibrated, sweep time is automatically set to a value that is inversely proportional to the square of the resolution bandwidth ( $1/BW^2$ ). So, if the resolution bandwidth is reduced by a factor of 10, the sweep time is increased by a factor of 100 when sweep time and bandwidth settings are coupled. For the shortest measurement times, use the widest resolution bandwidth that still permits discrimination of all desired signals. Sweep time is also a function of which detector is in use, peak detector sweeps as fast or more quickly than sample or average detectors. The ESA allows you to select from 1 kHz to 3 MHz resolution bandwidths in a 1, 3, 10 sequence and select a 5 MHz resolution bandwidth. The PSA allows RBW selections up to 8 MHz in the same steps as ESA and it has the flexibility to fine tune RBWs in increments of 10% for a total of 160 RBW settings. The ESA and PSA have CISPR bandwidths (200 Hz, 9 kHz and 120 kHz at  $-6$  dB) for maximum measurement flexibility. The PSA also has MIL EMI bandwidths of 10 Hz, 100 Hz, 1 kHz, 10 kHz, 100 kHz and 1 MHz.

For best sweep times and keeping the analyzer calibrated set the sweep time (**Sweep, Sweep Time**) to **Auto**, and the auto sweep time (**Sweep, Auto Sweep Time**) to **Norm**. Use the widest resolution bandwidth that still permits resolution of all desired signals.

**NOTE**

**For ESA-E Series Spectrum Analyzers:**

Option 1DR adds narrower resolution bandwidths, from 10 Hz to 300 Hz, in a 1-3-10 sequence and 200 Hz CISPR bandwidth. These bandwidths are digitally implemented and have a much narrower shape factor than the wider, analog resolution bandwidths. Also, the auto coupled sweep times when using the digital resolution bandwidths are much faster than analog bandwidths of the same width. For analyzers with Option 1DR, firmware revision A.08.00 and greater, and Option 1D5 which adds a high-stability frequency precision reference to the analyzer, resolution bandwidths of 1 Hz and 3 Hz are also available.

**Resolving Small Signals Hidden by Large Signals**

When dealing with the resolution of signals that are close together and not equal in amplitude, you must consider the shape of the IF filter of the analyzer, as well as its 3 dB bandwidth. (See [“Resolving Signals of Equal Amplitude” on page 130](#) for more information.) The shape of a filter is defined by the selectivity, which is the ratio of the 60 dB bandwidth to the 3 dB bandwidth. If a small signal is too close to a larger signal, the smaller signal can be hidden by the skirt of the larger signal.

To view the smaller signal, select a resolution bandwidth such that  $k$  is less than  $a$  (see [Figure 15-1](#)). The separation between the two signals ( $a$ ) must be greater than half the filter width of the larger signal ( $k$ ), measured at the amplitude level of the smaller signal.

The digital filters in the ESA and PSA have filter widths about one-third as wide as typical analog RBW filters. This enables you to resolve close signals with a wider RBW (for a faster sweep time).

**Figure 15-1**

**RBW Requirements for Resolving Small Signals**

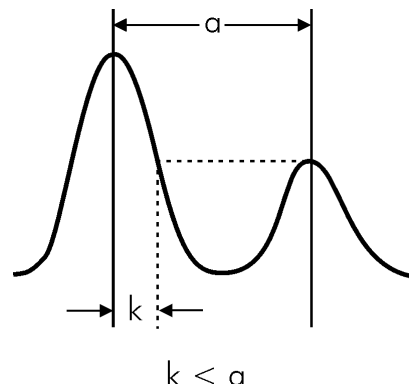

## Harmonic Distortion Calculations

The analyzer provides a one-button automated measurement for harmonic measurements (from the second to the tenth harmonic) and provides a calculation of the total harmonic distortion for continuous wave signals or complex digitally modulated carriers.

When the harmonic distortion measurement is activated, the analyzer searches for the fundamental and determines the frequencies of the harmonics. The analyzer then changes to zero span, and measures the amplitude of each harmonic. The analyzer calculates the total harmonic distortion by dividing the root-sum-squares of the harmonic voltages by the fundamental signal voltage and then provides the result as a percentage.

$$\%THD = 100 \times \frac{\left( \sqrt{\sum_{h=2}^{H_{\max}} E_h^2} \right)}{E_f}$$

Where:

%THD = Total Harmonic Distortion as a percentage

h = harmonic number

$H_{\max}$  = Maximum Harmonic Value listed

$E_h$  = voltage of harmonic h

$E_f$  = voltage of fundamental signal

### Example of a THD calculation:

If the number of harmonics selected is 5 ( $H_{\max} = 5$ ) and the measured values are as follows:

$$E_f = 5 \text{ dBm} = 3.162 \text{ mW} = 397.6 \text{ mV}$$

$$E_2 = -42 \text{ dBc} = -37 \text{ dBm} = 199.5 \text{ nW} = 3.159 \text{ mV}$$

$$E_3 = -26 \text{ dBc} = -21 \text{ dBm} = 7.943 \text{ } \mu\text{W} = 19.93 \text{ mV}$$

$$E_4 = -49 \text{ dBc} = -44 \text{ dBm} = 39.81 \text{ nW} = 1.411 \text{ mV}$$

$$E_5 = -36 \text{ dBc} = -31 \text{ dBm} = 794.3 \text{ nW} = 6.302 \text{ mV}$$

then,

$$THD = 100 \times \frac{\sqrt{3.159 \text{ mV}^2 + 19.93 \text{ mV}^2 + 1.411 \text{ mV}^2 + 6.301 \text{ mV}^2}}{397.6 \text{ mV}} = 5.33\%$$

## Time Gating Concepts

### Introduction: Using Time Gating on a Simplified Digital Radio Signal

This section shows you the concepts of using time gating on a simplified digital radio signal. “[Making Time-Gated Measurements](#)” on page 57 demonstrates time gating examples using the ESA and PSA.

[Figure 15-2](#) shows a signal with two radios, radio 1 and radio 2, that are time-sharing a single frequency channel. Radio 1 transmits for 1 ms then radio 2 transmits for 1 ms.

**Figure 15-2**

### Simplified Digital Mobile-Radio Signal in Time Domain

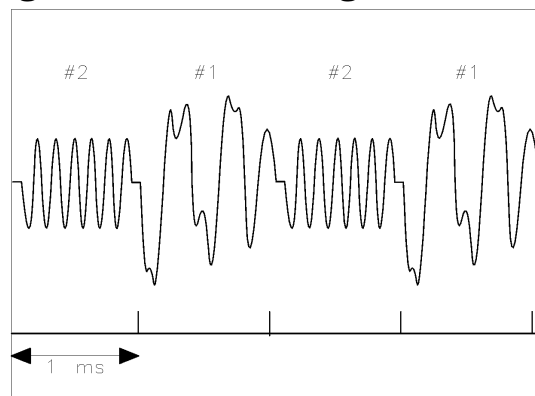

We want to measure the unique frequency spectrum of each transmitter.

A spectrum analyzer without time gating cannot do this. By the time the spectrum analyzer has completed its measurement sweep, which lasts about 50 ms, the radio transmissions switch back and forth 25 times. Because the radios are both transmitting at the same frequency, their frequency spectra overlap, as shown in [Figure 15-3](#). The spectrum analyzer shows the combined spectrum; you cannot tell which part of the spectrum results from which signal.

**Figure 15-3** Frequency Spectra of the Combined Radio Signals

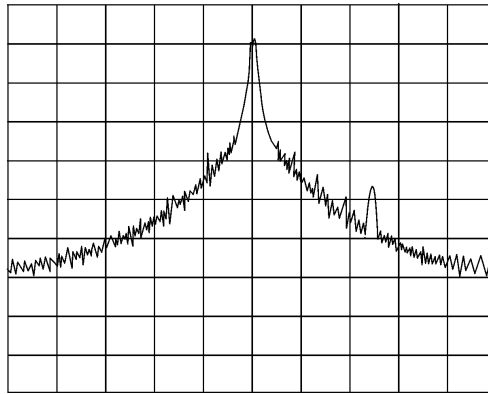

Time gating allows you to see the separate spectrum of radio 1 or radio 2 to determine the source of the spurious signal, as shown in Figure 15-4.

**Figure 15-4** Time-Gated Spectrum of Radio 1

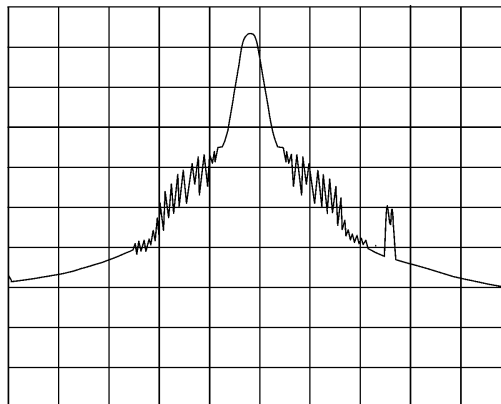

**Figure 15-5** Time-Gated Spectrum of Radio 2

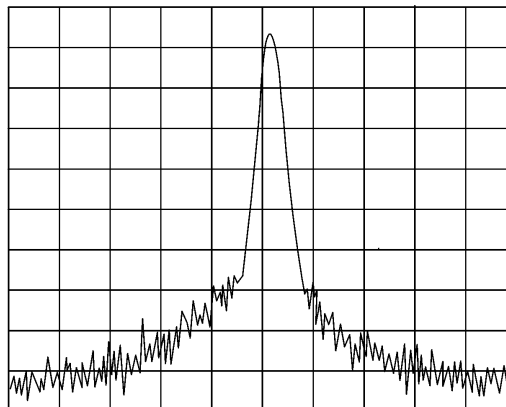

Time gating lets you define a time window (or time gate) of when a measurement is performed. This lets you specify the part of a signal that you want to measure, and exclude or mask other signals that might interfere.

## How Time Gating Works

Time gating is achieved by the spectrum analyzer selectively interrupting the path of the detected signal, with a gate, as shown in Figure 15-7 and Figure 15-8. The gate determines the times at which it captures measurement data (when the gate is turned “on,” under the Gate menu, the signal is being passed, otherwise when the gate is “off,” the signal is being blocked). Under the right conditions, the only signals that the analyzer measures are those present at the input to the analyzer when the gate is on. With the correct spectrum analyzer settings, all other signals are masked out.

There are typically two main types of gating conditions, *edge* and *level*:

- With edge gating, the gate timing is controlled by user parameters (gate delay and gate length) following the selected (rising or falling) edge of the trigger signal. The gate passes a signal on the edge of the trigger signal (after the gate delay time has been met) and blocks the signal at the end of the gate length.

With edge gating, the gate control signal is usually an external periodic TTL signal that rises and falls in synchronization with the rise and fall of the pulsed radio signal. The gate delay is the time the analyzer waits after the trigger event to enable the gate (see Figure 15-6).

- With level gating, the gate will pass a signal when the gate signal meets the specified level (high or low). The gate blocks the signal when the level conditions are no longer satisfied (level gating does not use gate length or gate delay parameters).

Figure 15-6

### Edge Trigger Timing Relationships

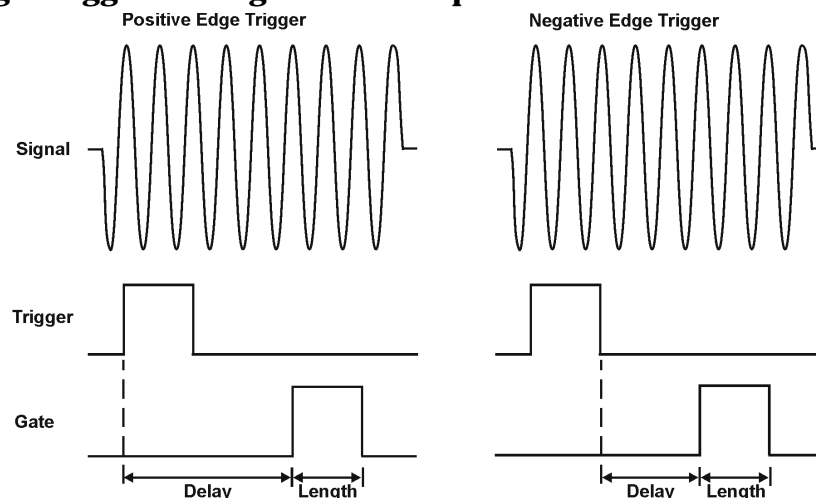

With Agilent PSA and ESA spectrum analyzers, there are three different implementations for time gating; gated LO, gated video and gated FFT. Gated LO and gated FFT are only available on the PSA spectrum analyzers while gated video is only available on the ESA.

### Gated LO Concepts (PSA Spectrum Analyzers)

Gated LO is a very sophisticated type of time gating that sweeps the LO only while the gate is “on” and the gate is passing a signal. See [Figure 15-7](#) for a simplified block diagram of gated LO operation. Notice that the gate control signal controls when the scan generator is sweeping and when the gate passes or blocks a signal. This allows the analyzer to sweep only during the periods when the gate passes a signal. Since gated LO only sweeps during periods when the gate is “on” and the gate is passing a signal, gated LO results in faster measurements than gated video.

**Figure 15-7** Gated LO PSA Spectrum Analyzer Block Diagram

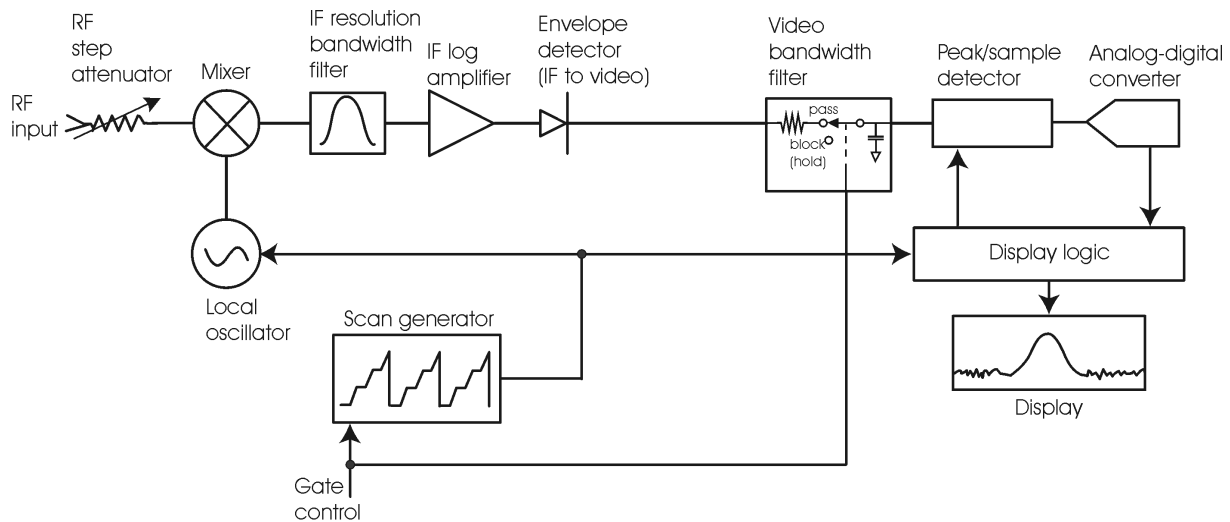

**NOTE**

Gated LO is available on all PSA models with firmware release A.04.12 or greater and the appropriate hardware. See service notes E4440A-09, E4443A-08, E4445A-08, E4446A-06 or E4448A-07 for more information on the hardware requirements.

### Gated Video Concepts (ESA Spectrum Analyzers)

Gated video may be thought of as a simple gate switch, which connects the signal to the input of the spectrum analyzer. When the gate is “on” (under the Gate menu) the gate is passing a signal. When the gate is “off,” the gate is blocking the signal. Whenever the gate is passing a signal, the analyzer sees the signal. In [Figure 15-8](#) notice that the gate is placed after the envelope detector and before the video bandwidth filter in the IF path (hence “gated video”).

The RF section of the spectrum analyzer responds to the signal. The selective gating occurs before the video processing. This means that there are some limitations on the gate settings because of signal response times in the RF signal path.



With video gating the analyzer is continually sweeping, independent of the position and length of the gate. The analyzer must be swept at a minimum sweep time (see the sweep time calculations later in this chapter) to capture the signal when the gate is passing a signal. Because of this, video gating is typically slower than gated LO and gated FFT.

**Figure 15-8 Gated Video ESA Spectrum Analyzer Block Diagram**

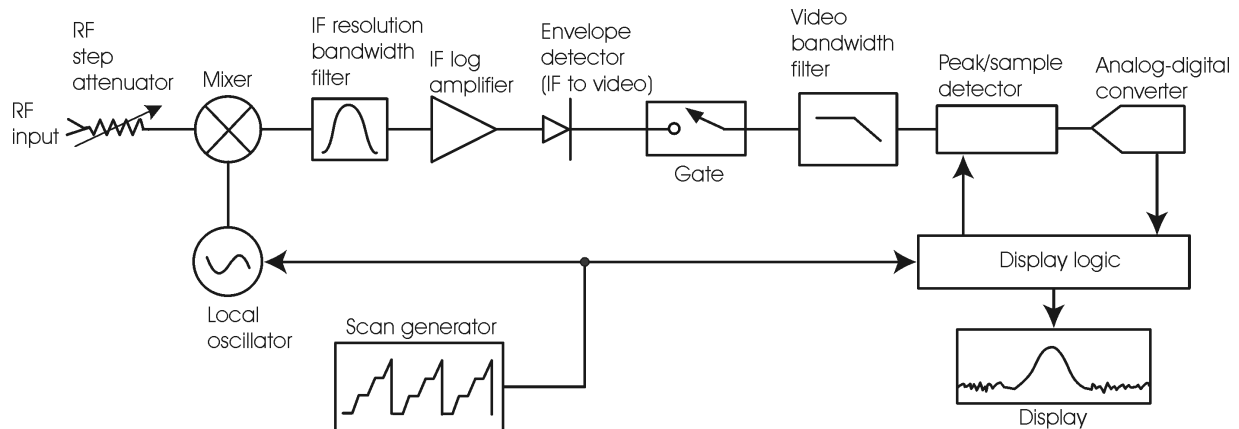

**NOTE**

Gated video is available only on the Agilent ESA-E Series spectrum analyzers (E4401B, E4402B, E4404B, E4405B and E4407B) with option 1D6.

**Gated FFT Concepts (PSA Spectrum Analyzer)**

Gated FFT (Fast-Fourier Transform) is an FFT measurement which begins when the trigger conditions are satisfied.

The process of making a spectrum measurement with FFTs is inherently a “gated” process, in that the spectrum is computed from a time record of short duration, much like a gate signal in swept-gated analysis.

Using the PSA in FFT mode, the duration of the time record to be gated is:

$$\text{FFT Time Record (to be gated)} = \frac{1.83}{\text{RBW}}$$

The duration of the time record is within a tolerance of approximately 3% for resolution bandwidths up through 1 MHz. Unlike swept gated analysis, the duration of the analysis in gated FFT is fixed by the RBW, not by the gate signal. Because FFT analysis is faster than swept analysis (up to 10 MHz), the gated FFT measurements can have better frequency resolution (a narrower RBW) than swept analysis for a given duration of the signal to be analyzed.

**Figure 15-9** Gated FFT Timing Diagram

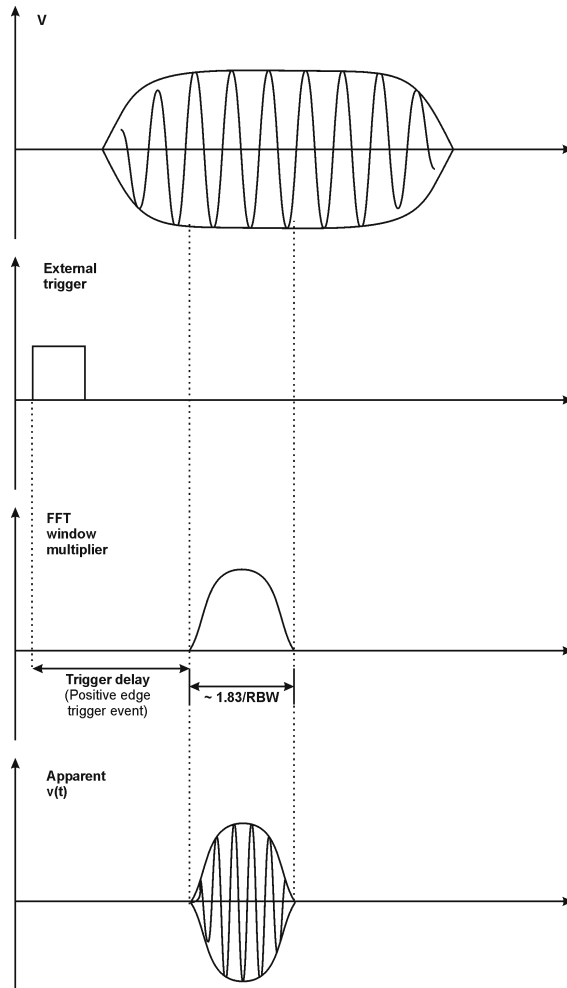

### Time Gating Basics (Gated LO and Gated Video)

The gate passes or blocks a signal with the following conditions:

- **Trigger condition** - Usually an external transistor-transistor logic (TTL) periodic signal for edge triggering and a high/low TTL signal for level triggering.
- **Gate delay** - The time after the trigger condition is met when the gate will pass a signal (for edge triggering).
- **Gate length** - The gate length setting determines the length of time a gate will pass a signal (for edge triggering).

To understand time gating better, consider a spectrum measurement performed on two pulsed-RF signals sharing the same frequency spectrum. You will need to consider the timing interaction of three signals with this example:

- The composite of the two pulsed-RF signals.

- The gate trigger signal (a periodic TTL level signal).
- The gate signal. This TTL signal is low when the gate is "off" (blocking) and high when the gate is "on" (passing).

The timing interactions between the three signals are best understood if you observe them in the time domain (see [Figure 15-10](#)).

The main goal is to measure the spectrum of signal 1 and determine if it has any low-level modulation or spurious signals.

Because the pulse trains of signal 1 and signal 2 have almost the same carrier frequency, their spectra overlap. Signal 2 will dominate in the frequency domain due to its greater amplitude. Without gating, you won't see the spectrum of signal 1; it is masked by signal 2.

To measure signal 1, the gate must be on only during the pulses from signal 1. The gate will be off at all other times, thus excluding all other signals. To position the gate, set the gate delay and gate length, as shown in [Figure 15-10](#), so that the gate is on only during some central part of the pulse. Carefully avoid positioning the gate over the rising or falling pulse edges. When gating is activated, the gate output signal will indicate actual gate position in time, as shown in the line labeled "Gate."

**Figure 15-10** Timing Relationship of Signals During Gating

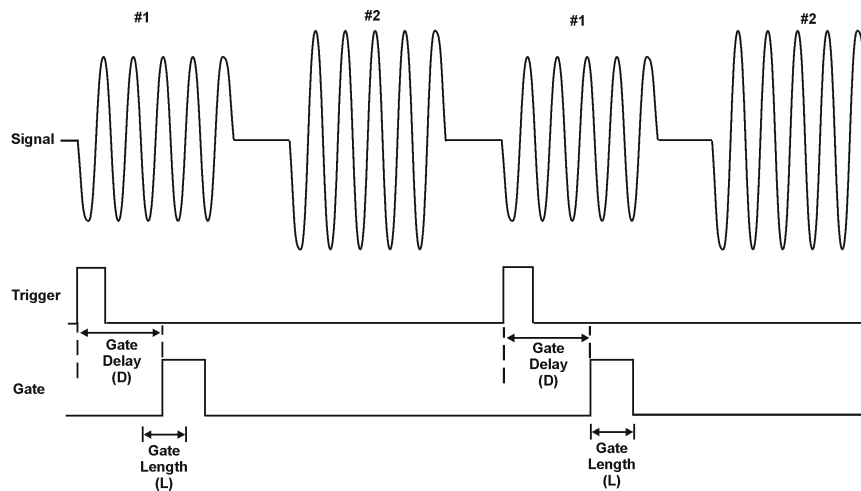

Once the spectrum analyzer is set up to perform the gate measurement, the spectrum of signal 1 is visible and the spectrum of signal 2 is excluded, as shown in [Figure 15-12](#). In addition, when viewing signal 1, you also will have eliminated the pulse spectrum generated from the pulse edges. Gating has allowed you to view spectral components that otherwise would be hidden.

**Figure 15-11** Signal within pulse #1 (time-domain view)

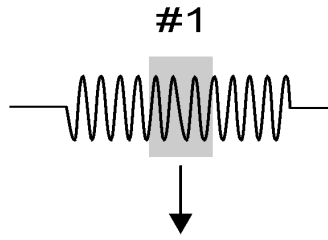

aj159e

**Figure 15-12** Using Time Gating to View Signal 1 (spectrum view)

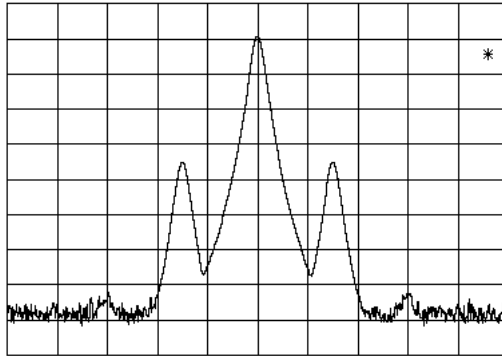

Moving the gate so that it is positioned over the middle of signal 2 produces a result as shown in [Figure 15-14](#). Here, you see only the spectrum within the pulses of signal 2; signal 1 is excluded.

**Figure 15-13** Signal within pulse #2 (time-domain view)

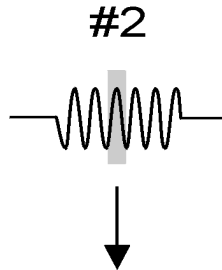

aj160e

**Figure 15-14** Using Time Gating to View Signal 2 (spectrum view)

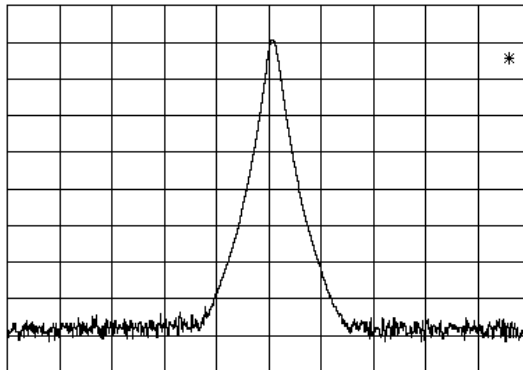

## Measuring a Complex/Unknown Signal

---

**NOTE**

---

The steps below help to determine the spectrum analyzer settings when using time gating. The steps apply to the time gating approaches using gated LO on the PSA and gated video on the ESA.

This example shows you how to use time gating to measure a very specific signal. Most signals requiring time gating are fairly complex and in some cases extra steps may be required to perform a measurement.

**Step 1.** Determine how your signal under test appears in the time domain and how it is synchronized to the trigger signal.

You need to do this to position the time gate by setting the delay relative to the trigger signal. To set the delay, you need to know the timing relationship between the trigger and the signal under test. Unless you already have a good idea of how the two signals look in the time domain, you can examine the signals with an oscilloscope to determine the following parameters:

- Trigger type (edge or level triggering)
- Pulse repetition interval (PRI), which is the length of time between trigger events (the trigger period).
- Pulse width, or  $\tau$
- Signal delay (SD), which is the length of time occurring between the trigger event and when the signal is present and stable. If your trigger occurs at the same time as the signal, signal delay will be zero.

**Figure 15-15** Time-domain Parameters

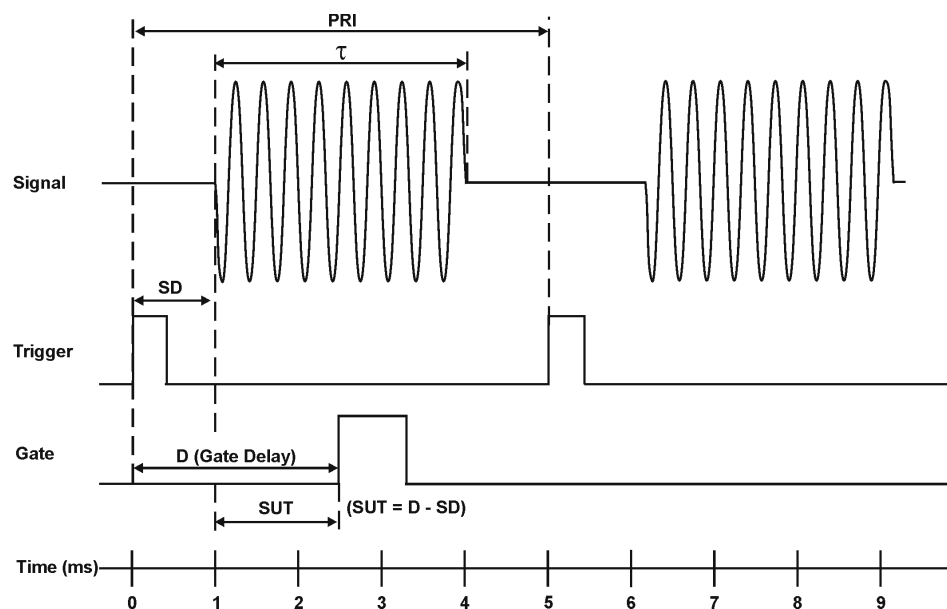

In [Figure 15-15](#), the parameters are:

- Pulse repetition interval (PRI) is 5 ms.
- Pulse width ( $\tau$ ) is 3 ms.
- Signal delay (SD) is 1 ms for positive edge trigger (0.8 ms for negative edge trigger).
- Gate delay (D) is 2.5 ms.
- Setup time (SUT) is 1.5 ms.

**Step 2.** Set the spectrum analyzer sweep time:

**PSA:** Sweep time does not affect the results of gated LO unless the sweep time is set too fast. In the event the sweep time is set too fast, Meas Uncal appears on the screen and the sweep time will need to be increased.

**ESA:** Sweep time does affect the results from gated video. The sweep time must be set accordingly for correct time gating results. The sweep time should be set to at least the number of *sweep points* - 1 multiplied by the *PRI* (pulse repetition interval).

**Step 3.** Locate the signal under test on the display of the spectrum analyzer. Set the center frequency and span to view the signal characteristics that you are interested in measuring. Although the analyzer is not yet configured for correct gated measurements, you will want to determine the approximate frequency and span in which to display the signal of interest. If the signal is erratic or intermittent, you may want to hold the maximum value of the signal with **Max Hold** (located under the

**View/Trace (ESA) or Trace/View (PSA) menu) to determine the frequency of peak energy.**

To optimize measurement speed, set the span narrow enough so that the display will still show the signal characteristics you want to measure. For example, if you wanted to look for spurious signals within a 200 kHz frequency range, you might set the frequency span to just over 200 kHz.

- Step 4.** Determine the setup time and signal delay to set up the gate signal. Turn on the gate and adjust the gate parameters including gate delay and gate length as shown below.

Generally, the gate should be positioned over a part of the signal that is stable, not over a pulse edge or other transition that might disturb the spectrum. Starting the gate at the center of the pulse gives a setup time of about half the pulse width. Setup time describes the length of time during which that signal is present and stable before the gate comes on. The setup time (SUT) must be adequately long enough for the RBW filters to settle following the burst-on transients. Signal delay (SD) is the length of time after the trigger, but before the signal of interest occurs and becomes stable. If the trigger occurs simultaneously with the signal of interest, SD is equal to zero, and SUT is equal to the gate delay. Otherwise, SUT is equal to the gate delay minus SD. See [Figure 15-16](#).

**Figure 15-16 Positioning the Gate**

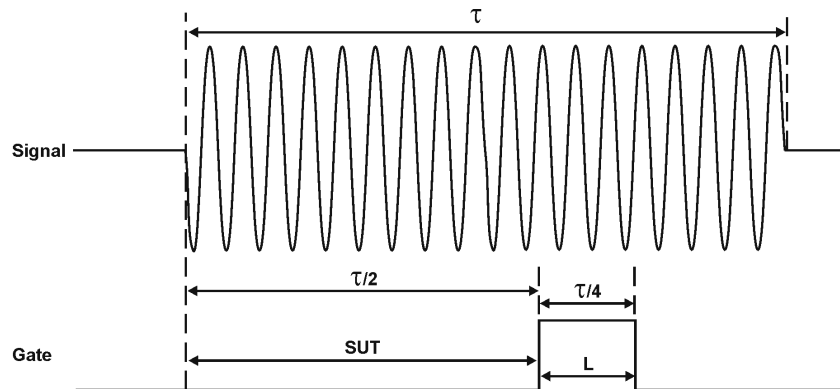

There is flexibility in positioning the gate, but some positions offer a wider choice of resolution bandwidths. A good rule of thumb is to position the gate from 20% to 80% of the burst for PSA, and 25% to 80% of the burst for ESA. Doing so provides a reasonable compromise between setup time and gate length.

**Figure 15-17** Best Position for Gate

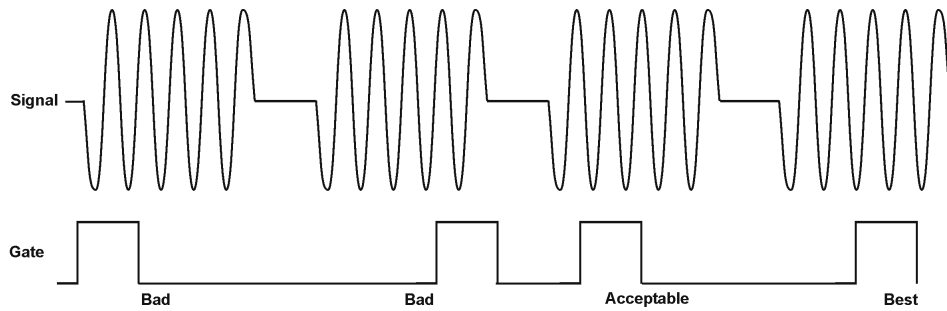

As a general rule, you will obtain the best measurement results if you position the gate relatively late within the signal of interest, but without extending the gate over the trailing pulse edge or signal transition. Doing so maximizes setup time and provides the resolution bandwidth filters of the spectrum analyzer the most time to settle before a gated measurement is made. "Relatively late," in this case, means allowing a setup time of approximately 2 divided by the resolution bandwidth (see step 5 for RBW calculations).

As an example, if you want to use a 1 kHz resolution bandwidth for measurements, you will need to allow a setup time of at least 2 ms.

Note that the signal need not be an RF pulse. It could be simply a particular period of modulation in a signal that is continuously operating at full power, or it could even be during the off time between pulses. Depending on your specific application, adjust the gate position to allow for progressively longer setup times (ensuring that the gate is not left on over another signal change such as a pulse edge or transient), and select the gate delay and length that offer the best signal-to-noise ratio on the display.

If you were measuring the spectrum occurring between pulses, you should use the same (or longer) setup time after the pulse goes away, but before the gate goes on. This lets the resolution bandwidth filters fully discharge the large pulse before the measurement is made on the low-level interpulse signal.

**Figure 15-18** Setup Time for Interpulse Measurement

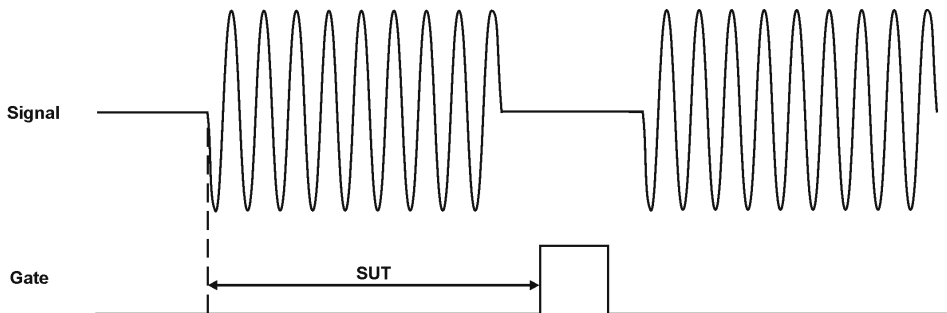



**Step 5.** The resolution bandwidth will need to be adjusted for gated LO and gated video. The video bandwidth will only need to be adjusted for gated video.

**Resolution Bandwidth:**

The resolution bandwidth you can choose is determined by the gate position, so you can trade off longer setup times for narrower resolution bandwidths. This trade-off is due to the time required for the resolution-bandwidth filters to fully charge before the gate comes on. Setup time, as mentioned, is the length of time that the signal is present and stable before the gate comes on.

**Figure 15-19 Resolution Bandwidth Filter Charge-Up Effects**

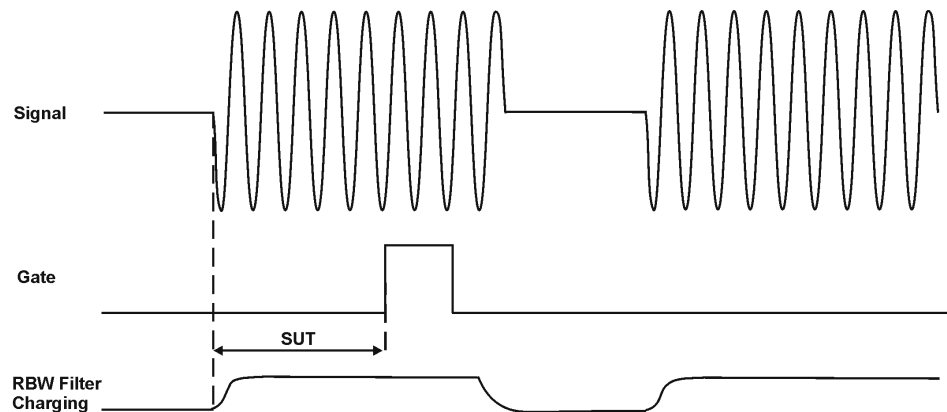

Because the resolution-bandwidth filters are band-limited devices, they require a finite amount of time to react to changing conditions. Specifically, the filters take time to charge fully after the analyzer is exposed to a pulsed signal.

Because setup time should be greater than filter charge times, be sure

$$\text{that: } (ESA)SUT > \frac{2}{RBW} \text{ and } (PSA)SUT > \frac{2.16}{RBW} + 3.3\mu s$$

$$(PSA)\text{Gate Length} > \frac{3}{RBW} + 1.5\mu s$$

where SUT is the same as the gate delay in this example. In this example with SUT equal to 1.5 ms, for ESA, RBW is greater than 2/1.5 ms; that is, RBW is greater than 1333 Hz. The resolution bandwidth should be set to the next larger value, 3 kHz.

**Video Bandwidth:**

Just as the resolution bandwidth filter needs a finite amount of time to charge and discharge, so does the video filter, which is a post-detection filter used mainly to smooth the measurement trace. Regardless of the length of the real RF pulse, the video filter sees a pulse no longer than the gate length, and the filter will spend part of that time charging up.

## Concepts

### Time Gating Concepts

Reducing the video-bandwidth filter too fast causes the signal to appear to drop in amplitude on the screen.

If you are in doubt about the proper video bandwidth to choose, set it to its maximum and reduce it gradually until the detected signal level drops slightly. Then reset it to the value it was at just before the signal dropped.

Leave both RBW and VBW in the manual mode, not Auto. This is important so that they will not change if the span is changed. The setting readout on the bottom line of the analyzer screen should show a "#" sign next to the function names (for example, #Res BW, #VBW, and #Sweep), indicating that they have been set manually.

#### *Setting the ESA VBW:*

To ensure that a true peak value is obtained before the gate goes off, the video filter must have a charge time of less than the gate length. For this purpose, you can approximate the charge time of the video filter as  $1/\text{VBW}$ , where VBW is the  $-3$  dB bandwidth of the video filter.

Therefore, you will want to be sure that:  $\text{gate length} > \frac{1}{(\text{ESA})\text{VBW}}$

For example using ESA, if you use a 1 kHz video bandwidth for noise smoothing, you need a gate length greater than 1 ms. Alternatively, if you use a gate as narrow as 1  $\mu\text{s}$ , you should use a video filter of 1 MHz.

#### *Setting the PSA VBW:*

For gated LO measurements the VBW filter acts as a track-and-hold between sweep times. With this behavior, the VBW does not need to resettle on each restart of the sweep.

### **Step 6.** Adjust span as necessary, and perform your measurement.

The analyzer is set up to perform accurate measurements. Freeze the trace data by activating single sweep, or by placing your active trace in view mode. Use the markers to measure the signal parameters you chose in step 1. If necessary, adjust span, but do not decrease resolution bandwidth, video bandwidth, or sweep time.

## "Quick Rules" for Making Time-Gated Measurements

This section summarizes the rules described in the previous sections.

**Table 15-1** **Determining Spectrum Analyzer Settings for Viewing a Pulsed RF Signal**

Spectrum Analyzer Function	Spectrum Analyzer Setting	Comments
Sweep Time (gated video only - ESA)	Set the sweep time to be equal to or greater than (number of sweep points - 1) × pulse repetition interval (PRI):	Because the gate must be on at least once per trace point, the sweep time should be set such that the sweep time for each trace point is greater than or equal to the pulse repetition interval.
Gate Delay	The gate delay is equal to the signal delay plus one-fourth the pulse width: Gate Delay = Signal Delay + $\tau/4$	The gate delay must be set so that the gating captures the pulse. If the gate delay is too short or too long, the gating can miss the pulse or include resolution bandwidth transient responses.
Gate Length	The gate length minimum is equal to one-fourth the pulse width (maximum about one-half): Gate Length = $\tau/4$ (PSA) Gate Length > 3/RBW + 1.5 $\mu$ s	If the gate length is too long, the signal display can include transients caused by the spectrum analyzer filters.  The recommendation for gate placement can be between 20% to 80% of the pulse for PSA and 25% to 80% of the pulse for ESA.
Resolution Bandwidth	Set the resolution bandwidth: (ESA) RBW > 2/(Gate Delay – Signal Delay) (PSA) RBW > 2.16/(Gate Delay – Signal Delay) + 3.3 $\mu$ s	The resolution bandwidth must be wide enough so that the charging time for the resolution bandwidth filters is less than the pulse width of the signal.
Video Bandwidth	Set the video bandwidth: (ESA) VBW > 1/gate length	The video bandwidth must be wide enough so that the rise times of the video bandwidth does not attenuate the signal (in gated video applications). There are no requirements for PSA VBW settings using gated LO.

**Figure 15-20 Gate Positioning Parameters**

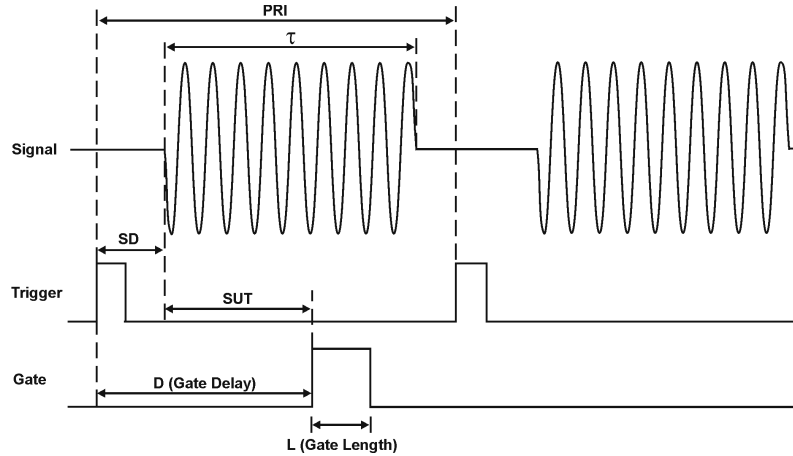

Most control settings are determined by two key parameters of the signal under test: the pulse repetition interval (PRI) and the pulse width ( $\tau$ ). If you know these parameters, you can begin by picking some standard settings. Table 15-2 and Table 15-3 summarize the parameters for a signal whose trigger event occurs at the same time as the beginning of the pulse (in other words, SD is 0). If your signal has a non-zero delay, just add it to the recommended gate delay.

**Table 15-2 Suggested Initial Settings for Known Pulse Width ( $\tau$ ) and Zero Signal Delay**

Pulse width ( $\tau$ )	Gate Delay ( $SD + \tau/2$ )	Resolution Bandwidth ( $2 > SUT$ )	Gate Length ( $\tau/4$ )	Video Bandwidth ( $1/\text{gate length}$ ) ESA gated video only
4 $\mu\text{s}$	3 $\mu\text{s}$	1 MHz	1 $\mu\text{s}$	1 MHz
10 $\mu\text{s}$	5 $\mu\text{s}$	1 MHz	3 $\mu\text{s}$	1 MHz
50 $\mu\text{s}$	25 $\mu\text{s}$	100 kHz	13 $\mu\text{s}$	100 kHz
63.5 $\mu\text{s}$	32 $\mu\text{s}$	100 kHz	16 $\mu\text{s}$	100 kHz
100 $\mu\text{s}$	50 $\mu\text{s}$	100 kHz	25 $\mu\text{s}$	100 kHz
500 $\mu\text{s}$	250 $\mu\text{s}$	10 kHz	125 $\mu\text{s}$	10 kHz
1 ms	500 $\mu\text{s}$	10 kHz	250 $\mu\text{s}$	10 kHz
5 ms	2.5 ms	1 kHz	1.25 ms	1 kHz
10 ms	5 ms	1 kHz	2.5 ms	1 kHz
16.6 ms	8.3 ms	1 kHz	4 ms	1 kHz
33 ms	16.5 ms	1 kHz	8 ms	1 kHz
50 ms	25 ms	1 kHz	13 ms	1 kHz
100 ms	50 ms	1 kHz	25 ms	1 kHz
$\geq 130$ ms	65 ms	1 kHz	33 ms	1 kHz

**NOTE** [Table 15-3](#) below applies only to ESA spectrum analyzers. PSA gated LO time gating is not affected by analyzer sweep times (unless the sweep time is set too fast, Meas Uncal appears on the screen and the sweep time will need to be increased).

**Table 15-3 Suggested Sweep Times for an ESA at 401 Sweep Points and a Known Pulse Repetition Interval or Pulse Repetition Frequency**

Pulse Repetition Interval (PRI)	Pulse Repetition Frequency (PRF)	Sweep Time (minimum)*
50 $\mu$ s	20 kHz	20.1 ms
100 $\mu$ s	10 kHz	40.1 ms
500 $\mu$ s	2 kHz	201 ms
1 ms	1 kHz	401 ms
5 ms	200 Hz	2.01 s
10 ms	100 Hz	4.01 s
16.7 ms	60 Hz	6.7 s
20 ms	50 Hz	8.02 s
33.3 ms	30 Hz	13.4 s
50 ms	20 Hz	20.1 s
100 ms	10 Hz	40.1 s
>170 ms	Use the MAX HOLD trace function and take several measurement sweeps.	
* The number of sweep points can be set to values between 101 and 8192. The minimum sweep time is equal to the (number of sweep points minus 1) times (pulse repetition interval).		

**Table 15-4 If You Have a Problem with the Time-Gated Measurement**

Symptom	Possible Causes	Suggested Solution
(ESA only) Erratic analyzer trace with random vertical lines or dropouts extending below the peak trace amplitude.	1) Sweep rate too fast to ensure at least one gate occurrence per trace point. 2) Detector may be set to something other than peak, sample or average.	Increase sweep time until dropouts disappear. See <a href="#">Table 15-3</a> for sweep time calculations.

**Table 15-4 If You Have a Problem with the Time-Gated Measurement**

Symptom	Possible Causes	Suggested Solution
Erratic analyzer trace with dropouts that are not removed by increasing analyzer sweep time; oscilloscope view of gate output signal jumps erratically in time domain.	Gate Delay may be greater than trigger repetition interval.	Reduce Gate Delay until it is less than trigger interval.  For PSA check <b>Gate View</b> to make sure the gate delay is timed properly.
Gate does not trigger.	1) Gate trigger voltage may be too low. 2) Gate may not be activated. 3) (PSA) <b>Gate Source</b> selection may be wrong.	Ensure gate trigger reaches TTL levels. Check to see if other connections to trigger signal may be reducing voltage. If using an oscilloscope, check that all inputs are high impedance, not 50 $\Omega$
Display spectrum does not change when the gate is turned on.	Insufficient setup time.	Increase setup time for the current resolution bandwidth, or increase resolution bandwidth.
Displayed spectrum too low in amplitude.	Resolution bandwidth or video bandwidth filters not charging fully.	Widen resolution bandwidth or video bandwidth, or both.

## Using the Edge Mode or Level Mode for Triggering

### NOTE

PSA spectrum analyzers use edge mode triggering. ESA spectrum analyzers can use edge or level triggering modes.

Depending on the trigger signal that you are working with, you can trigger the gate in one of two separate modes: edge or level. This gate-trigger function is separate from the normal external trigger capability of the spectrum analyzer, which initiates a sweep of a measurement trace based on an external TTL signal.

### Edge Mode

Edge mode lets you position the gate relative to either the rising or falling edge of a TTL trigger signal. The left diagram of [Figure 15-21](#) shows triggering on the positive edge of the trigger signal while the right diagram shows negative edge triggering.

Example of key presses to initiate positive edge triggering:  
(ESA) Press **Sweep, Gate, Edge Gate, Slope (Pos)**.  
(PSA) Press **Sweep, Gate Setup, Polarity (Pos)**.

**Figure 15-21**

### Using Positive or Negative Edge Triggering

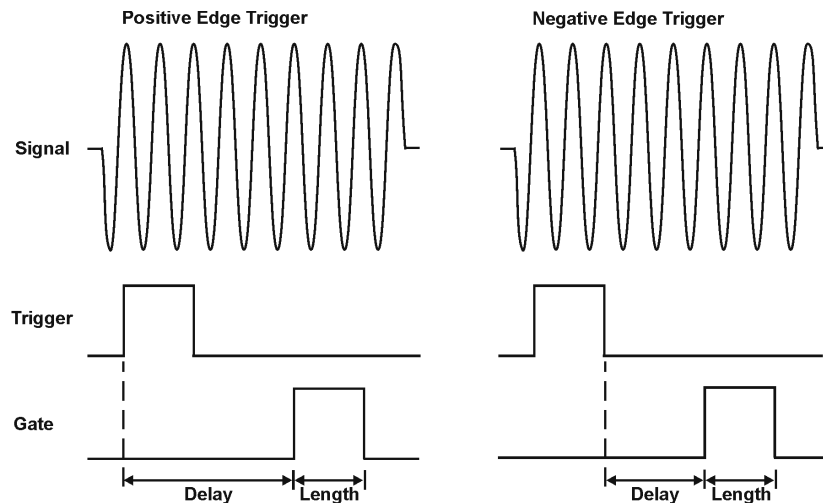

### Level Mode (ESA)

In level gate-control mode, an external trigger signal opens and closes the gate. Either the TTL high level or TTL low level opens the gate, depending on the setting of **Level Gate**. Gate delay and gate length control functions are not applicable when using level mode triggering. Level mode is useful when your trigger signal occurs at exactly the same time as does the portion of the signal you want to measure.

## Noise Measurements Using Time Gating

Time gating can be used to measure many types of signals. However, they must be repetitive and for ESA, have a TTL timing trigger signal available to synchronize the gate. Noise is not a repetitive signal, so if you need to use gating when measuring noise, you should understand the impact on the measurement results.

To measure the power accurately of a noisy signal, or noise-like signal with time gating, a sample or average detector should be used. Average and sample detection is available for both ESA and PSA spectrum analyzers when time gating is on.

If peak detection is used during a gated measurement the power reading will be higher than if average detection is used. The resulting value increases as the time interval increases, because the probability of finding the statistically rarer larger peaks increases. For very accurate noise measurements using the gated function, the impact of these considerations must be calculated based on the current spectrum analyzer settings.

The equation below can be used to calculate a correction value for the measured noise using peak detection. Subtract the correction from the measured value.

$$\text{Correction} = 10 \log_{10}[\ln(2\pi\tau BW_i + e)]$$

where:

- $BW_i$  is the impulse bandwidth  
ESA is approximately  $1.62 \times$  resolution bandwidth, for resolution bandwidths  $\geq 1$  kHz.  
PSA is approximately  $1.5 \times$  resolution bandwidth, for resolution bandwidths  $\leq 3$  MHz.
- $\tau$  is the time interval over which the peak detection occurs and is equal to the sweep time/(number of sweep points – 1).

Refer to Agilent Technologies Application Note 1303, page 18, for more details.



## Trigger Concepts

### Selecting a Trigger

**NOTE**

If you are using an ESA with firmware revision A.07.xx or lower, you can use video and external triggering as set up below in numbers 1 and 2. If you have firmware A.08.xx or later and Option B7E with board part number E4401-60224 or higher, RF burst triggering is also available (recommended for this example). PSA can use video, external and RF burst triggering.

To determine the ESA firmware revision number and hardware board part number:

Press **System, More, Show System.**

Press **System, More, Show Hdw.**

#### 1. Video Triggering

Video triggering controls the sweep time based on the detected and VBW filtered envelop signal to steady the bursted signal on the display and to synchronize the measurement with the burst of interest. Video triggering triggers the measurement at the point at which the rising signal crosses the video trigger horizontal green line on the display:

Press **Trig, Video, -30, dBm.**

#### 2. External Triggering

In the event that you have an external trigger available that can be used to synchronize with the burst of interest, connect the trigger signal to the rear of the ESA using the GATE TRIG/EXT TRIG IN (TTL) input connector. For the PSA use either the trigger input connector on the front (EXT TRIGGER IN) or the rear (TRIGGER IN) of the instrument. It might be necessary to adjust the trigger level (as indicated by the lower horizontal green line) by rotating the front panel knob or by entering the numeric value on the keypad.

(ESA) Press **Trig, External.**

(PSA) Press **Trig, Ext Front** or **Ext Rear.**

#### 3. RF Burst Triggering

RF burst triggering occurs in the IF circuitry chain, as opposed to after the video detection circuitry with video triggering. In the event video triggering is used, the detection filters are limited to the maximum width of the resolution bandwidth filters. Set the analyzer in RF burst trigger mode (RF burst is a default trigger for PSA):

Press **Trig, RF Burst.**

## TV Trigger

### TV Trigger Setup Menu Functions

- TV Source

When **TV Source** is set to **SA**, the analyzer demodulates the TV signal, by using the analyzer as a fixed tuned receiver. This allows stable, zero span sweeps of the baseband video waveform (band limited by the RBW and VBW filters).

When **TV Source** is set to **EXT VIDEO IN**, an external baseband video signal may be used to produce the TV line trigger. In this case, an external TV tuner can be used to obtain the baseband waveform of the given RF carrier for triggering the analyzer sweep. This will allow the analyzer to be used in swept mode for measurements of the RF spectrum to synchronize to the video modulation. The **EXT VIDEO IN** connector is located on the rear panel of the analyzer.

- TV Standard

Selection of a TV standard establishes the number of TV lines and the kind of color encoding method that is used. The number of TV lines establishes the defaults for the TV line counting circuits of the analyzer and the color encoding method is used to properly set up the TV picture display circuits. Option B7B supports both 525 line and 625 line systems and can provide a color TV picture output for NTSC and PAL color encoding methods. A black and white picture is provided for the SECAM method.

The ability to display a color picture is limited by the bandwidth settings of the analyzer (resolution bandwidth and video bandwidth). However, baseband video signals input to the **EXT VIDEO IN** connector on the rear panel of the analyzer are minimally filtered, allowing a full color display of NTSC or PAL TV signals.

**Table 15-5**

TV Standard	Number of Lines per Frame	Approximate Field Rate	Color Encoding Method	Color Subcarrier Frequency
NTSC-M	525	60 Hz	NTSC	3.58 MHz
NTSC-Japan (no pedestal)	525	60 Hz	NTSC	3.58 MHz
PAL-M	525	60 Hz	PAL	4.43 MHz
PAL-B,D,G,H,I	625	50 Hz	PAL	4.43 MHz
PAL-N	625	50 Hz	PAL	4.43 MHz
PAL-N Combination	625	50 Hz	PAL	3.58 MHz

**Table 15-5**

<b>TV Standard</b>	<b>Number of Lines per Frame</b>	<b>Approximate Field Rate</b>	<b>Color Encoding Method</b>	<b>Color Subcarrier Frequency</b>
SECAM	625	50 Hz	SECAM	4.406 MHz, 4.250 MHz

- **Field**

A television image or frame is composed of 525 (or 625 lines) delivered in two successive fields of 262.5 (or 312.5 lines) interlaced together on a CRT when displayed.

When **Field** is set to **Entire Frame**, the line count starts at line one in field one (often referred to as the “odd field”) and ends at 525 (or 625) in field two (often referred to as the “even field”).

When **Field** is set to **Field One** or **Field Two**, the line count begins at “1” with the first full line in the selected field and ends at count 263 (or 313) for Field One, and 262 (or 312) for Field Two.

- **Sync**

Analog broadcast or cable television signals are usually amplitude modulated on an RF carrier. For NTSC and PAL broadcasts, typically the RF carrier amplitude is maximized at the sync tips of the baseband video waveform and minimized at the “white” level. This results in a demodulated waveform on the analyzer where the sync pulses are on top, or positive (**Sync (Pos)**).

With SECAM broadcasts, typically the RF carrier amplitude is minimized at the sync tips of the video waveform and maximized at the “white” level. This results in a waveform on the analyzer where the sync pulses are at the bottom, or negative (**Sync (Neg)**).

A normal baseband video waveform for all TV standards will have the sync tips on the bottom. When **TV Source** is set to **Ext Video In**, **Sync** should be set to **Neg**.

- **TV Monitor**

When **TV Monitor** is pressed, the picture represented by the video waveform selected with **TV Source** is presented on the LCD display of the analyzer. The picture can only be viewed, not printed or saved. Pressing a key that normally brings up a menu restores the original graphical display with the selected menu enabled.

### **Trigger Settings and Fast Time Domain Sweeps**

Trigger delay can be used to move the sweep trigger point arbitrarily across a given TV line or lines to allow closer examination of waveform patterns (Press Trig, Trig Delay, and enter a delay time).

In fast sweeps ( $20\ \mu\text{s}$  to less than  $5\ \text{ms}$ ), there may be up to one trace point of variation in the start time of the waveform digitalization process with respect to the actual TV trigger pulse. This randomness leads to the appearance of visual jitter on the LCD display of the analyzer. In this situation, video averaging may be used ( $N = 5$ , for example) to improve the “visual stability” of the displayed waveform. This type of jitter does not occur when sweep times are set greater than or equal to  $5\ \text{ms}$  where digitalization begins less than  $100\ \text{ns}$  after the trigger pulse in that mode (much less than 1 trace point of jitter).

## AM and FM Demodulation Concepts

### Demodulating an AM Signal Using the Analyzer as a Fixed Tuned Receiver (Time-Domain)

The zero span mode can be used to recover amplitude modulation on a carrier signal.

The following functions establish a clear display of the waveform:

- Triggering stabilizes the waveform trace by triggering on the modulation envelope. If the modulation of the signal is stable, video trigger synchronizes the sweep with the demodulated waveform.
- Linear display mode should be used in amplitude modulation (AM) measurements to avoid distortion caused by the logarithmic amplifier when demodulating signals.
- Sweep time to view the rate of the AM signal.
- RBW and VBW are selected according to the signal bandwidth.

### Demodulating an FM Signal Using the Analyzer as a Fixed Tuned Receiver (Time-Domain)

To recover the frequency modulated signal, a spectrum analyzer can be used as a manually tuned receiver (zero span). However, in contrast to AM, the signal is not tuned into the passband center, but to one slope of the filter curve as [Figure 15-22](#).

**Figure 15-22** Determining FM Parameters using FM to AM Conversion

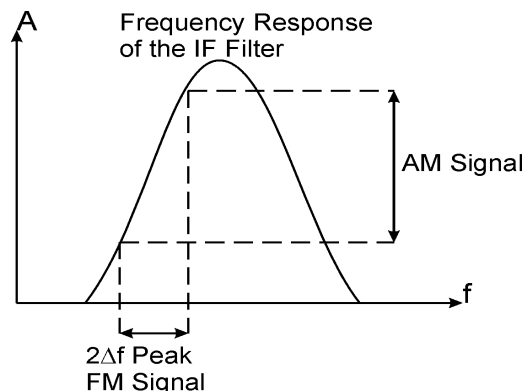

Here the frequency variations of the FM signal are converted into amplitude variations (FM to AM conversion). The reason we want to measure the AM component is that the envelope detector responds only to AM variations. There are no changes in amplitude if the frequency changes of the FM signal are limited to the flat part of the RBW (IF filter). The resultant AM signal is then detected with the envelope detector and displayed in the time domain.

---

## Stimulus Response Measurement Concepts

---

**NOTE** Stimulus response measurements require option 1DN or 1DQ with ESA spectrum analyzers.

---

### Stimulus Response Overview

Stimulus response measurements require a source to stimulate a device under test (DUT), a receiver to analyze the frequency response characteristics of the DUT, and, for return loss measurements, a directional coupler or bridge. Characterization of a DUT can be made in terms of its transmission or reflection parameters. Examples of transmission measurements include flatness and rejection. Return loss is an example of a reflection measurement.

A spectrum analyzer combined with a tracking generator forms a stimulus response measurement system. With the tracking generator as the swept source and the analyzer as the receiver, operation is the same as a single channel scalar network analyzer. The tracking generator output frequency must be made to precisely track the analyzer input frequency for good narrow band operation. A narrow band system has a wide dynamic measurement range. This wide dynamic range will be illustrated in the following example.

There are three basic steps in performing a stimulus response measurement, whether it is a transmission or a reflection measurement. The first step is to set up the analyzer, the second is to normalize, and the last step is to perform the measurement.

### Tracking Generator Unleveled Condition

When using the tracking generator, the message `TG unleveled` may appear. The `TG unleveled` message indicates that the tracking generator source power (Source, Amplitude) could not be maintained at the selected level during some portion of the sweep. If the unleveled condition exists at the beginning of the sweep, the message will be displayed immediately. If the unleveled condition occurs after the sweep begins, the message will be displayed after the sweep is completed. A momentary unleveled condition may not be detected when the sweep time is short. The message will be cleared after a sweep is completed with no unleveled conditions.

The unleveled condition may be caused by any of the following:

- Start frequency is too low or the stop frequency is too high. The unleveled condition is likely to occur if the true frequency range exceeds the tracking generator frequency specification (especially the low frequency specification).

- Source attenuation may be set incorrectly (select **Attenuation** (Auto) for optimum setting).
- The source power may be set too high or too low, use **Amplitude** (Off) then **Amplitude** (On) to reset it.
- The source power sweep may be set too high, resulting in an unlevelled condition at the end of the sweep. Use **Power Sweep** (Off) then **Power Sweep** (On) to decrease the amplitude.
- Reverse RF power from the device under test detected by the tracking generator ALC (automatic level control) system.

## Sweeping in Stimulus Response Auto Coupled Mode

Auto coupled sweep times are usually much faster for stimulus response measurements than they are for spectrum analyzer (SA) measurements.

In the stimulus response mode, the Q of the DUT can determine the fastest rate at which the analyzer can be swept. (Q is the quality factor, which is the center frequency of the DUT divided by the bandwidth of the DUT.) To determine whether the analyzer is sweeping too fast, slow the sweep and note whether there is a frequency or amplitude shift of the trace. Continue to slow the sweep until there is no longer a frequency or amplitude shift.

## Normalization Concepts

To make a transmission measurement accurately, the frequency response of the test system must be known. Normalization is used to eliminate this error from the measurement. To measure the frequency response of the test system, connect the cable (but not the DUT) from the tracking generator output to the analyzer input.

Press **View/Trace, More, Normalize, Store Ref (1→3), Normalize** (On).

The frequency response of the test system is automatically stored in trace 3 and a normalization is performed. This means that the active displayed trace is now the ratio of the input data to the data stored in trace 3. (The reference trace is Trace 3 with firmware revision A.04.00 and later)

When normalization is on, trace math is being performed on the active trace. The trace math performed is (trace 1 – trace 3 + the normalized reference position), with the result placed into trace 1. Remember that trace 1 contains the measurement trace, trace 3 contains the stored reference trace of the system frequency response, and normalized reference position is indicated by arrowheads at the edges of the graticule.

---

**NOTE**

---

Since the reference trace is stored in trace 3, changing trace 3 to **Clear Write** will invalidate the normalization.

Reconnect the DUT to the analyzer. Note that the units of the reference level have changed to dB, indicating that this is now a relative measurement. Change the normalized reference position:

Press **View/Trace, More, Normalize, Norm Ref Posn.**

Arrowheads at the left and right edges of the graticule mark the normalized reference position, or the position where 0 dB insertion loss (transmission measurements) or 0 dB return loss (reflection measurements) will normally reside. You can change the position of the normalized trace, within the range of the graticule by entering a position number.

### Measuring Device Bandwidth

It is often necessary to measure device bandwidth, such as when testing a bandpass filter. There is a key in the **Peak Search** menu that will perform this function. The device signal being measured must be displayed before activating the measurement. The span must include the full response.

Activate the measurement by toggling the **N dB Points** key to On. The analyzer places arrow markers at the -3 dB points on either side of the response and reads the bandwidth. For other bandwidth responses enter the number of dB down desired, from -1 dB to -80 dB.

No other signal can appear on the display within N dB of the highest signal. The measured signal cannot have more than one peak that is greater than or equal to N dB. A signal must have a peak greater than the currently defined peak excursion to be identified. The default value for the peak excursion is 6 dB.

Measurements are made continuously, updating at the end of each sweep. This allows you to make adjustments and see changes as they happen. The single sweep mode can also be used, providing time to study or record the data.

The N dB bandwidth measurement error is typically  $\pm 1\%$  of the span.

### Converting Return Loss to VSWR

Return loss can be expressed as a voltage standing wave ratio (VSWR) value using the following table or formula:

**Table 15-6 Power to VSWR Conversion**

Return Loss (dB)	VSWR	Return Loss (dB)	VSWR	Return Loss (dB)	VSWR	Return Loss (dB)	VSWR	Return Loss (dB)	VSWR
4.0	4.42	14.0	1.50	18.0	1.29	28.0	1.08	38.0	1.03
6.0	3.01	14.2	1.48	18.5	1.27	28.5	1.08	38.5	1.02



**Table 15-6 Power to VSWR Conversion**

Return Loss (dB)	VSWR	Return Loss (dB)	VSWR	Return Loss (dB)	VSWR	Return Loss (dB)	VSWR	Return Loss (dB)	VSWR
8.0	2.32	14.4	1.47	19.0	1.25	29.0	1.07	39.0	1.02
10.0	1.92	14.6	1.46	19.5	1.24	29.5	1.07	39.5	1.02
10.5	1.85	14.8	1.44	20.0	1.22	30.0	1.07	40.0	1.02
11.0	1.78	15.0	1.43	20.5	1.21	30.5	1.06	40.5	1.02
11.2	1.76	15.2	1.42	21.0	1.20	31.0	1.06	41.0	1.02
11.4	1.74	15.4	1.41	21.5	1.18	31.5	1.05	41.5	1.02
11.6	1.71	15.6	1.40	22.0	1.17	32.0	1.05	42.0	1.02
11.8	1.69	15.8	1.39	22.5	1.16	32.5	1.05	42.5	1.02
12.0	1.67	16.0	1.38	23.0	1.15	33.0	1.05	43.0	1.01
12.2	1.65	16.2	1.37	23.5	1.14	33.5	1.04	43.5	1.01
12.4	1.63	16.4	1.36	24.0	1.13	34.0	1.04	44.0	1.01
12.6	1.61	16.6	1.35	24.5	1.13	34.5	1.04	44.5	1.01
12.8	1.59	16.8	1.34	25.0	1.12	35.0	1.04	45.0	1.01
13.0	1.58	17.0	1.33	25.5	1.11	35.5	1.03	45.5	1.01
13.2	1.56	17.2	1.32	26.0	1.11	36.0	1.03	46.0	1.01
13.4	1.54	17.4	1.31	26.5	1.10	36.5	1.03	46.5	1.01
13.6	1.53	17.6	1.30	27.0	1.09	37.0	1.03	47.0	1.01
13.8	1.51	17.8	1.30	27.5	1.09	37.5	1.03	47.5	1.01

$$VSWR = \frac{1 + 10^{\frac{-RL}{20}}}{1 - 10^{\frac{-RL}{20}}}$$

Where: RL is the measured return loss value.

VSWR is sometimes stated as a ratio. For example: 1.2:1 “one point two to one” VSWR. The first number is the VSWR value taken from the table or calculated using the formula. The second number is always 1.

Concepts  
**Stimulus Response Measurement Concepts**

---

**16**

**ESA/PSA Programming  
Examples**

---

## Examples Included in this Chapter:

The following C and Visual Basic examples work with both the ESA Series and the PSA Series of spectrum analyzers. There is also a section on programming in C using the Agilent VTL (VISA transition library).

*Programming using the Agilent VTL:*

- [“Programming in C Using the VTL” on page 167](#)

*Programming Examples for ESA and PSA spectrum analyzers:*

- [“Using C to Make a Power Suite ACPR Measurement on a cdmaOne Signal” on page 176](#)
- [“Using C to Serial Poll the Analyzer to Determine when an Auto-alignment is Complete” on page 179](#)
- [“Using C and Service Request \(SRQ\) to Determine When a Measurement is Complete” on page 182](#)
- [“Using Visual Basic® 6 to Capture a Screen Image” on page 188](#)
- [“Using Visual Basic® 6 to Transfer Binary Trace Data” on page 192](#)
- [“Using Agilent VEE to Transfer Trace Data” on page 197](#)

Visual Basic is a registered trademark of Microsoft Corporation.

---

## Finding Additional Examples and More Information

These examples are available on the Agilent Technologies PSA Series documentation CD-ROM or the ESA Series documentation CD-ROM. They can also be found from the URLs:

<http://www.agilent.com/find/esa>

<http://www.agilent.com/find/psa>

*VXI plug&play drivers:* There are additional examples that use the VXI plug&play instrument drivers. These examples are included in the on-line documentation in the driver itself. The driver allows you to use several different programming languages including: VEE, LabVIEW, C, C++, and BASIC. The software drivers can also be found at the above URLs.

*Interchangeable Virtual Instruments COM (IVI-COM) drivers:* Develop system automation software easily and quickly. IVI-COM drivers take full advantage of application development environments such as Visual Studio using Visual Basic, C# or Visual C++ as well as Agilent's Test and Measurement Toolkit. You can now develop application programs that are portable across computer platforms and I/O interfaces. With IVI-COM drivers you do not need to have in depth test instrument knowledge to develop sophisticated measurement software. IVI-COM drivers provide a compatible interface to all. COM environments. The IVI-COM software drivers can be found at the URL

<http://www.agilent.com/find/ivi-com>

*IntuiLink software:* There are additional examples that use the IntuiLink software. IntuiLink allows you to capture screen and trace data for display and manipulation in the Windows COM environment. These examples are included on the Intuilink CD. The latest version of IntuiLink can also be found at the URL

<http://www.agilent.com/find/intuilink>

---

## Programming Examples Information and Requirements

- The programming examples were written for use on an IBM compatible PC.
- The programming examples use C, Visual Basic and VEE programming languages.
- The programming examples use GPIB and LAN interfaces.
- Many of the examples use the SCPI programming commands, though there are some that use the plug&play or IVI.com drivers.
- Most of the examples are written in C using the Agilent VISA transition library.

The VISA transition library must be installed and the GPIB card configured. The Agilent I/O libraries contain the latest VISA transition library and is available at: [www.agilent.com/iolib](http://www.agilent.com/iolib)

---

## Programming in C Using the VTL

The C programming examples that are provided are written using the C programming language and the Agilent VTL (VISA transition library). This section includes some basic information about programming in the C language. Note that some of this information may not be relevant to your particular application. (For example, if you are not using VXI instruments, the VXI references will not be relevant).

Refer to your C programming language documentation for more details. (This information is taken from the manual “VISA Transition Library”, part number E2090-90026.) The following topics are included:

- “Typical Example Program Contents” on page 168
- “Linking to VTL Libraries” on page 169
- “Compiling and Linking a VTL Program” on page 169
- “Example Program” on page 171
- “Including the VISA Declarations File” on page 171
- “Opening a Session” on page 172
- “Device Sessions” on page 172
- “Addressing a Session” on page 174
- “Closing a Session” on page 175

## Typical Example Program Contents

The following is a summary of the VTL function calls used in the example programs.

<code>visa.h</code>	This file is included at the beginning of the file to provide the function prototypes and constants defined by VTL.
<code>ViSession</code>	The <code>ViSession</code> is a VTL data type. Each object that will establish a communication channel must be defined as <code>ViSession</code> .
<code>viOpenDefaultRM</code>	You must first open a session with the default resource manager with the <code>viOpenDefaultRM</code> function. This function will initialize the default resource manager and return a pointer to that resource manager session.
<code>viOpen</code>	This function establishes a communication channel with the device specified. A session identifier that can be used with other VTL functions is returned. This call must be made for each device you will be using.
<code>viPrintf</code> <code>viScanf</code>	These are the VTL formatted I/O functions that are patterned after those used in the C programming language. The <code>viPrintf</code> call sends the IEEE 488.2 <code>*RST</code> command to the instrument and puts it in a known state. The <code>viPrintf</code> call is used again to query for the device identification ( <code>*IDN?</code> ). The <code>viScanf</code> call is then used to read the results.
<code>viClose</code>	This function must be used to close each session. When you close a device session, all data structures that had been allocated for the session will be de-allocated. When you close the default manager session, all sessions opened using the default manager session will be closed.



## Linking to VTL Libraries

Your application must link to one of the VTL import libraries:

32-bit Version:

`C:\VXIPNP\WIN95\LIB\MSC\VISA32.LIB` for Microsoft compilers

`C:\VXIPNP\WIN95\LIB\BC\VISA32.LIB` for Borland compilers

16-bit Version:

`C:\VXIPNP\WIN\LIB\MSC\VISA.LIB` for Microsoft compilers

`C:\VXIPNP\WIN\LIB\BC\VISA.LIB` for Borland compilers

See the following section, “[Compiling and Linking a VTL Program](#)” for information on how to use the VTL run-time libraries.

## Compiling and Linking a VTL Program

### 32-bit Applications

The following is a summary of important compiler-specific considerations for several C/C++ compiler products when developing WIN32 applications.

For Microsoft Visual C++ version 2.0 compilers:

- Select `Project | Update All Dependencies` from the menu.
- Select `Project | Settings` from the menu. Click on the `C/C++` button. Select `Code Generation` from the `Use Run-Time Libraries` list box. VTL requires these definitions for WIN32. Click on `OK` to close the dialog boxes.
- Select `Project | Settings` from the menu. Click on the `Link` button and add `visa32.lib` to the `Object / Library Modules` list box. Optionally, you may add the library directly to your project file. Click on `OK` to close the dialog boxes.
- You may wish to add the include file and library file search paths. They are set by doing the following:
  1. Select `Tools | Options` from the menu.
  2. Click on the `Directories` button to set the include file path.
  3. Select `Include Files` from the `Show Directories For` list box.
  4. Click on the `Add` button and type in the following:  
`C:\VXIPNP\WIN95\INCLUDE`
  5. Select `Library Files` from the `Show Directories For` list box.

## ESA/PSA Programming Examples Programming in C Using the VTL

6. Click on the Add button and type in the following:

```
C:\VXIPNP\WIN95\LIB\MSC
```

For Borland C++ version 4.0 compilers:

- You may wish to add the include file and library file search paths. They are set under the Options | Project menu selection. Double click on Directories from the Topics list box and add the following:

```
C:\VXIPNP\WIN95\INCLUDE
```

```
C:\VXIPNP\WIN95\LIB\BC
```

### 16-bit Applications

The following is a summary of important compiler-specific considerations for the Windows compiler.

For Microsoft Visual C++ version 1.5:

- To set the memory model, do the following:
  1. Select Options | Project.
  2. Click on the Compiler button, then select Memory Model from the Category list.
  3. Click on the Model list arrow to display the model options, and select Large.
  4. Click on OK to close the Compiler dialog box.
- You may wish to add the include file and library file search paths. They are set under the Options | Directories menu selection:

```
C:\VXIPNP\WIN\INCLUDE
```

```
C:\VXIPNP\WIN\LIB\MSC
```

Otherwise, the library and include files should be explicitly specified in the project file.

## Example Program

This example program queries a GPIB device for an identification string and prints the results. Note that you must change the address.

```
/*idn.c - program filename */

#include "visa.h"
#include <stdio.h>

void main ()
{
    /*Open session to GPIB device at address 18 */
    ViOpenDefaultRM (&defaultRM);
    ViOpen (defaultRM, GPIB0::18::INSTR", VI_NULL,
            VI_NULL, &vi);

    /*Initialize device */
    viPrintf (vi, "*RST\n");

    /*Send an *IDN? string to the device */
    printf (vi, "*IDN?\n");

    /*Read results */
    viScanf (vi, "%t", &buf);

    /*Print results */
    printf ("Instrument identification string: %s\n", buf);

    /* Close sessions */
    viClose (vi);
    viClose (defaultRM);
}
```

## Including the VISA Declarations File

For C and C++ programs, you must include the `visa.h` header file at the beginning of every file that contains VTL function calls:

```
#include "visa.h"
```

This header file contains the VISA function prototypes and the definitions for all VISA constants and error codes. The `visa.h` header file includes the `visatype.h` header file.

The `visatype.h` header file defines most of the VISA types. The VISA types are used throughout VTL to specify data types used in the functions. For example, the `viOpenDefaultRM` function requires a pointer to a parameter of type `ViSession`. If you find `ViSession` in the `visatype.h` header file, you will find that `ViSession` is eventually typed as an unsigned long.

## Opening a Session

A session is a channel of communication. Sessions must first be opened on the default resource manager, and then for each device you will be using. The following is a summary of sessions that can be opened:

- A **resource manager session** is used to initialize the VISA system. It is a parent session that knows about all the opened sessions. A resource manager session must be opened before any other session can be opened.
- A **device session** is used to communicate with a device on an interface. A device session must be opened for each device you will be using. When you use a device session you can communicate without worrying about the type of interface to which it is connected. This insulation makes applications more robust and portable across interfaces. Typically a device is an instrument, but could be a computer, a plotter, or a printer.

---

**NOTE**

All devices that you will be using need to be connected and in working condition prior to the first VTL function call (`viOpenDefaultRM`). The system is configured only on the *first* `viOpenDefaultRM` per process. Therefore, if `viOpenDefaultRM` is called without devices connected and then called again when devices are connected, the devices will not be recognized. You must close **ALL** resource manager sessions and re-open with all devices connected and in working condition.

---

## Device Sessions

There are two parts to opening a communications session with a specific device. First you must open a session to the default resource manager with the `viOpenDefaultRM` function. The first call to this function initializes the default resource manager and returns a session to that resource manager session. You only need to open the default manager session once. However, subsequent calls to `viOpenDefaultRM` returns a session to a unique session to the same default resource manager resource.

Next, you open a session with a specific device with the `viOpen` function. This function uses the session returned from `viOpenDefaultRM` and returns its own session to identify the device session. The following shows the function syntax:

```
viOpenDefaultRM (sesn);  
viOpen (sesn, rsrcName, accessMode, timeout, vi);
```

The session returned from `viOpenDefaultRM` must be used in the `sesn` parameter of the `viOpen` function. The `viOpen` function then uses that session and the device address specified in the `rsrcName` parameter to open a device session. The `vi` parameter in `viOpen` returns a session identifier that can be used with other VTL functions.

Your program may have several sessions open at the same time by creating multiple session identifiers by calling the `viOpen` function multiple times.

The following summarizes the parameters in the previous function calls:

<i>sesn</i>	This is a session returned from the <code>viOpenDefaultRM</code> function that identifies the resource manager session.
<i>rsrcName</i>	This is a unique symbolic name of the device (device address).
<i>accessMode</i>	This parameter is not used for VTL. Use <code>VI_NULL</code> .
<i>timeout</i>	This parameter is not used for VTL. Use <code>VI_NULL</code> .
<i>vi</i>	This is a pointer to the session identifier for this particular device session. This pointer will be used to identify this device session when using other VTL functions.

The following is an example of opening sessions with a GPIB multimeter and a GPIB-VXI scanner:

```
ViSession defaultRM, dmm, scanner;
.
.
viOpenDefaultRM(&defaultRM);
viOpen (defaultRM, "GPIB0::22::INSTR", VI_NULL,
        VI_NULL, &dmm);
viOpen (defaultRM, "GPIB-VXI0::24::INSTR", VI_NULL,
        VI_NULL, &scanner);
.
.
viClose (scanner);
viClose (dmm);
viClose(defaultRM);
```

The above function first opens a session with the default resource manager. The session returned from the resource manager and a device address is then used to open a session with the GPIB device at address 22. That session will now be identified as **dmm** when using other VTL functions. The session returned from the resource manager is then used again with another device address to open a session with the GPIB-VXI device at primary address 9 and VXI logical address 24. That session will now be identified as **scanner** when using other VTL functions. See the following section for information on addressing particular devices.

## Addressing a Session

As seen in the previous section, the *rsrcName* parameter in the `viOpen` function is used to identify a specific device. This parameter is made up of the VTL interface name and the device address. The interface name is determined when you run the VTL Configuration Utility. This name is usually the interface type followed by a number. The following table illustrates the format of the *rsrcName* for the different interface types:

Interface	Syntax
VXI	VXI [ <i>board</i> ]:: <i>VXI logical address</i> ::INSTR]
GPIB-VXI	GPIB-VXI [ <i>board</i> ]:: <i>VXI logical address</i> ::INSTR]
GPIB	GPIB [ <i>board</i> ]:: <i>primary address</i> :: <i>secondary address</i> ::INSTR]

The following describes the parameters used above:

*board* This optional parameter is used if you have more than one interface of the same type. The default value for *board* is 0.

*VXI logical address* This is the logical address of the VXI instrument.

*primary address* This is the primary address of the GPIB device.

*secondary address* This optional parameter is the secondary address of the GPIB device. If no secondary address is specified, none is assumed.

INSTR This is an optional parameter that indicates that you are communicating with a resource that is of type **INSTR**, meaning instrument.

---

**NOTE**

If you want to be compatible with future releases of VTL and VISA, you must include the INSTR parameter in the syntax.

---

The following are examples of valid symbolic names:

XI0::24::INSTR Device at VXI logical address 24 that is of VISA type INSTR.

VXI2::128 Device at VXI logical address 128, in the third VXI system (VXI2).

GPIB-VXI0::24 A VXI device at logical address 24. This VXI device is connected via a GPIB-VXI command module.

GPIB0::7::0 A GPIB device at primary address 7 and secondary address 0 on the GPIB interface.

The following is an example of opening a device session with the GPIB device at primary address 23.

```
ViSession defaultRM, vi;  
.br/>.br/>viOpenDefaultRM (&defaultRM);  
viOpen (defaultRM, "GPIB0::23::INSTR", VI_NULL,VI_NULL,&vi);  
.br/>.br/>viClose(vi);  
viClose (defaultRM);
```

### Closing a Session

The `viClose` function must be used to close each session. You can close the specific device session, which will free all data structures that had been allocated for the session. If you close the default resource manager session, all sessions opened using that resource manager will be closed.

Since system resources are also used when searching for resources (`viFindRsrc`) or waiting for events (`viWaitOnEvent`), the `viClose` function needs to be called to free up find lists and event contexts.

---

## Using C to Make a Power Suite ACPR Measurement on a cdmaOne Signal

This C programming example (ACPR.c) can be found on the Documentation CD.

### Example:

```

/*****
*   ACPR.c
*   Adjacent Channel Power Measurement using Power Suite
*   Agilent Technologies 2001
*
*   Instrument Requirements:
*       PSA with firmware version >= A.02.00 or
*       ESA with firmware version >= A.08.00
*
*   Note: You can select which ACPR radio standard you would like by
*         changing the standard for the RADIO:STANDARD command.
*         This example sets the radio standard to IS95.
*
*   Note: For PSA, ensure that you are SA mode before running this program.
*
*****/

#include <stdio.h>
#include <stdlib.h>
#include <string.h>
#include "visa.h"

void main ()
{
    /*program variable*/
    ViSession defaultRM, viPSA;
    ViStatus viStatus    = 0;
    ViChar _VI_FAR cResult[2000] = {0};
    int iNum =0;

```



```
int iSwpPnts = 401;
double freq,value;
static ViChar *cToken ;
long lCount=0L;
char sTraceInfo [1024]= {0};
FILE *fDataFile;
unsigned long lBytesRetrieved;
char *psaSetup = // PSA setup initialization
    "RST;CLS;" // Reset the device and clear status
    ":INIT:CONT 0;"// Set analyzer to single sweep mode
    ":RADIO:STANDARD IS95";// Set the Radio Standard to IS95

/*open session to GPIB device at address 18 */
viStatus=viOpenDefaultRM (&defaultRM);
viStatus=viOpen (defaultRM, "GPIB0::18::INSTR", VI_NULL,VI_NULL, &viPSA);

/*check opening session sucess*/
if(viStatus)
{
    printf("Could not open a session to GPIB device at address 18!\n");
    exit(0);
}
/*Increase timeout to 20 sec*/
viSetAttribute(viPSA,VI_ATTR_TMO_VALUE,20000);

/*Send setup commands to instrument */
viPrintf(viPSA,"%s\n",psaSetup);

/*Get the center freq from user*/
printf("What is the center carrier frequency in MHz?\n");
scanf( "%lf",&freq);

/*Set the center freq*/
viPrintf(viPSA,"freq:center %lf MHZ\n",freq);

/*Perform an ACPR measurement*/
```

## ESA/PSA Programming Examples

### Using C to Make a Power Suite ACPR Measurement on a cdmaOne Signal

```

viQueryf(viPSA,"%s\n", "%#t", "READ:ACP?;*wai" , &iNum , cResult);

/*Remove the "," from the ASCII data for analyzing data*/
cToken = strtok(cResult,",");

/*Save data to an ASCII to a file, by removing the "," token*/
fDataFile=fopen("C:\\ACPR.txt","w");
fprintf(fDataFile,"ACPR.exe Output\nAgilent Technologies 2001\n\n");
fprintf(fDataFile,"Please read Programmer's Reference for an\n");
fprintf(fDataFile,"explanation of returned results.\n\n");
while (cToken != NULL)
    {
        lCount++;
        value = atof(cToken);
        fprintf(fDataFile,"\tReturn value[%d] = %lf\n",lCount,value);
        cToken =strtok(NULL,",");
    }
    fprintf(fDataFile,"\nTotal number of return points of ACPR measurement :[%d]
\n\n",lCount);
fclose(fDataFile);

/*print message to the standard output*/
printf("The The ACPR Measurement Result was saved to C:\\ACPR.txt file\n\n");

/* Close session */
viClose (viPSA);
viClose (defaultRM);
}

```

---

## Using C to Serial Poll the Analyzer to Determine when an Auto-alignment is Complete

This C programming example (SerAlign.c) can be found on the Documentation CD.

### Example:

```
/******  
* SerAlign.c  
* Serial Poll Alignment Routine  
* Agilent Technologies 2001  
*  
* Instrument Requirements:  
*   PSA Series Spectrum Analyzer or  
*   ESA Series Spectrum Analyers or  
*   VSA Series Transmitter Tester  
*  
* This program demonstrates how to  
* 1) Perform an instrument alignment.  
* 2) Poll the instrument to determine when the operation is complete.  
* 3) Query to determine if the alignment was successfully completed.  
*  
*****/  
  
#include <stdio.h>  
#include <stdlib.h>  
#include <windows.h>  
#include "visa.h"  
  
void main ()  
{  
    /*program variables*/  
    ViSession defaultRM, viPSA;  
    ViStatus viStatus = 0;  
    ViUInt16 esr,stat;
```

## ESA/PSA Programming Examples

### Using C to Serial Poll the Analyzer to Determine when an Auto-alignment is Complete

```

long lResult = 0;
long lOpc = 0;
char cEnter = 0;

/*open session to GPIB device at address 18 */
viStatus=viOpenDefaultRM (&defaultRM);
viStatus=viOpen (defaultRM, "GPIB0::18::INSTR", VI_NULL,VI_NULL,&viPSA);

/*check opening session sucess*/
if(viStatus)
{
    printf("Could not open a session to GPIB device at address 18!\n");
    exit(0);
}

/*increase timeout to 60 sec*/
viSetAttribute(viPSA,VI_ATTR_TMO_VALUE,60000);

/*Clear the analyzer*/
viClear(viPSA);

/*Clear all event registers*/
viPrintf(viPSA, "*CLS\n");

/* Set the Status Event Enable Register */
viPrintf(viPSA, "*ESE 1\n");

/*Initiate self-alignment*/
viPrintf(viPSA, "CAL:ALL\n");

/* Send the Operation complete command so that the
stand event register will be set to 1 once
the pending alignment command is complete */
viPrintf(viPSA, "*OPC\n");

/* print message to standard output */

```

```
printf("Performing self-alignment.\n");

/* Serial pole the instrument for operation complete */
while(1)
{
    viQueryf(viPSA,"*ESR?\n", "%ld",&esr);
    printf(".");
    if (esr & 1) break;//look for operation complete bit
    Sleep (1000);// wait 1000ms before polling again
}

/* Query the Status Questionable Condition Register */
viQueryf(viPSA,":STAT:QUES:CAL:COND?\n", "%ld",&stat);

/*Determine if alignment was successful*/
if (stat)
    printf("\nAlignment not successful\n\n");
else
    printf("\nAlignment successful\n\n");

/*reset timeout to 5 sec*/
viSetAttribute(viPSA,VI_ATTR_TMO_VALUE,5000);

/*print message to the standard output*/
printf("Press Return to exit program \n\n");
scanf("%c",&cEnter);

/* Close session */
viClose (viPSA);
viClose (defaultRM);
}
```

---

## Using C and Service Request (SRQ) to Determine When a Measurement is Complete

This C programming example (SRQ.c) can be found on the Documentation CD.

```
/*
*****
*   SRQ.C
*   Determine when a measurement is done by waiting for SRQ
*   and reading Status Register
*
*   Instrument Requirements:
*       PSA/ESA/EMC Series Spectrum Analyzers.
*
*   This C programming demonstrates how:
*   A. Set the service request mask to assert SRQ when
*       either a measurement is uncalibrated or an error
*       message has occurred.
*   B. Initiate a sweep and wait for the SRQ interrupt
*   C. Poll all instruments and report the nature of the
*       interrupt on the spectrum analyzer
*
*   You have a royalty-free right to use, modify, reproduce and distribute
*   the Sample Application Files (and/or any modified version) in any way
*   you find useful, provided that you agree that Agilent Technologies has
*   no warranty, obligations or liability for any Sample Application Files.
*
*   Agilent Technologies provides programming examples for illustration only,
*   This sample program assumes that you are familiar with the programming
*   language being demonstrated and the tools used to create and debug
*   procedures. Agilent Technologies support engineers can help explain the
*   functionality of Agilent Technologies software components and associated
*   commands, but they will not modify these samples to provide added
*   functionality or construct procedures to meet your specific needs.
*
*   Copyright © 1999- 2004 Agilent Technologies Inc. All rights reserved.
*/
```

```
*****/
#include <stdio.h>
#include <windows.h>
#include "visa.h"

ViSession defaultRM, viSA;
ViStatus errStatus;
ViAddr iAddress;
int iSrqOccurred=0;
char cBuf[3]={0};

/*Wait until SRQ is generated and for the handler to be called. Print
something while waiting. When interrupt occurs it will be handled by
interrupt handler*/
void WaitForSRQ()
{
    long lCount = 0L;
    iSrqOccurred = 0;

    for (lCount = 0; (lCount < 10) && (iSrqOccurred == 0); lCount++)
    {
        long lCount2 = 0;
        printf(".");
        while ((lCount2++ < 100) && (iSrqOccurred == 0))
        {
            Sleep(10);
        }
    }
}

/*Interrupt handler, trigger event handler */
ViStatus _VI_FUNCH mySrqHdlr(ViSession viSA, ViEventType eventType, ViEvent
ctx, ViAddr userHdlr)
{
    ViUInt16 iStatusByte;
```

## ESA/PSA Programming Examples

### Using C and Service Request (SRQ) to Determine When a Measurement is Complete

```

/* Make sure it is an SRQ event, ignore if stray event*/
if (eventType!=VI_EVENT_SERVICE_REQ)
{
    printf ("\n Stray event type0x%lx\n",eventType);

    /*Return successfully*/
    return VI_SUCCESS;
}

/* When an interrupt occurs,determine which device generated the interrupt
(if an instrument other than the PSA/ESA generates the interrupt, simply report
"Instrument at GPIB Address xxx Has Generated an Interrupt").*/
printf ("\n\n SRQ event occurred!\n");

/*Get the GPIB address of the insrument, which has interrupted*/
viQueryf(viSA,"SYST:COMM:GPIB:SELF:ADDR?\n","%t", cBuf);
printf ("\n Instrument at GPIB address %s has generated an interrupt!\n",cBuf);

/*Get the status byte*/
/* If the PSA/ESA generated the interrupt, determine the nature of the
interrupt;
    did the measurement complete or an error message occur?*/
viQueryf(viSA, "*ESR?\n", "%d", &iStatusByte);
if ( (0x01 & iStatusByte))
    printf("\n SRQ message:\t Measurement complete\n");
else if ( (0x02 | 0x10 | 0x20 & iStatusByte ))
    printf ("\n SRQ message:\t Error Message Occurred\n");

/*Return successfully*/
iSrqOccurred =1;
viReadSTB(viSA,&iStatusByte);
return VI_SUCCESS;
}

/* Main Program*/
void main()
{

```



```
/*Program Variables*/
ViStatus viStatus = 0;
long lOpc=0;

/* Open a GPIB session at address 18*/
viStatus=viOpenDefaultRM(&defaultRM);
viStatus=viOpen(defaultRM,"GPIB0::18",VI_NULL,VI_NULL,&viSA);
if(viStatus)
{
    printf("Could not open a session to GPIB device at address 18!\n");
    exit(0);
}

/* Set I/O timeout to twenty seconds */
viSetAttribute(viSA,VI_ATTR_TMO_VALUE,20000);

/*Clear the instrument*/
viClear(viSA);

/*Reset the instrument*/
viPrintf(viSA,"*RST\n");

/*Clear the status byte of the instrument*/
viPrintf(viSA,"*CLS\n");

/*Put the analyzer in a single sweep*/
viPrintf(viSA,"INIT:CONT 0 \n");

/* Change the instrument mode to Spectrum Analysis */
viPrintf(viSA,":INST:NSEL 1\n");

/*Set the analyzer resolution bandwidth to 300 Khz*/
viPrintf(viSA,"SENS:BAND:RES 300 KHz\n");

/*Set the analyzer to 10MHz span*/
viPrintf(viSA,"SENS:FREQ:SPAN 10MHz\n");
```

## ESA/PSA Programming Examples

### Using C and Service Request (SRQ) to Determine When a Measurement is Complete

```

/*Initiate a sweep*/
viPrintf(viSA, "INIT:IMM\n");

/*Make sure the previous command has been completed*/
viQueryf(viSA, "*OPC?\n", "%d", &lOpc);
if (!lOpc)
{
    printf("\nProgram Abort! error ocurred: last command was not
completed!\n");
    exit(0);
}
/* Set the service request mask to assert SRQ when either a measurement
is completed or an error message has occurred.*/
viPrintf(viSA, "*SRE 96\n");
viPrintf(viSA, "*ESE 35\n");

/* Configure the computer to respond to an interrupt*/
/*install the handler and enable it */
viInstallHandler(viSA, VI_EVENT_SERVICE_REQ, mySrqHdlr, iAddress);
viEnableEvent(viSA, VI_EVENT_SERVICE_REQ, VI_HNDLR, VI_NULL);

/* Print Comment to user */
printf("Sending illegal command 'IDN' and then waiting for SRQ\n");

/*Send an undefined command to the device*/
viPrintf(viSA, "IDN\n");

/*Wait for SRQ */
WaitForSRQ();

/*Set video averaging to 50 sweeps and turn averaging On*/
viPrintf(viSA, ":SENS:AVER:TYPE LPOW;:SENS:AVER:COUN 50;:SENS:AVER:STAT ON\n");

/* Print Comment to user */
printf("\nInitiating measurement and waiting for SRQ when measurement

```

```
done.\n");

/*Initiate the sweeps and set the *OPC bit after the sweeps are completed*/
viPrintf(viSA,":INIT:IMM;*OPC\n");

/*Wait for SRQ */
WaitForSRQ();

/*Disable and uninstall the interrupt handler*/
viDisableEvent (viSA, VI_EVENT_SERVICE_REQ,VI_HNDLR);
viUninstallHandler(viSA, VI_EVENT_SERVICE_REQ, mySrqHdlr,iAddress);

/*Clear the instrument status register*/
viPrintf(viSA,"*SRE 0 \n");

/*Clear the status byte of the instrument*/
viPrintf(viSA,"*CLS\n");

/*Close the session*/
viClose(viSA);
viClose(defaultRM);
}
```

---

## Using Visual Basic® 6 to Capture a Screen Image

This is a Visual Basic example that stores the current screen image on your PC. The program works with the ESA or PSA Series spectrum analyzers. The bas file (screen.bas) and a compiled executable (screen.exe) can be found on the Documentation CD.

This example:

1. Stores the current screen image on the instrument's flash as C:PICTURE.GIF.
2. Transfers the image over GPIB or LAN and stores it on your PC in the current directory as picture.gif.
3. The file C:PICTURE.GIF is then deleted from the instrument's flash.

---

**NOTE** This example uses GPIB address 18 for the spectrum analyzer.

```

'' *****
'' Copyright (c) 1999- 2003 Agilent Technologies Inc. All rights reserved.
''
'' You have a royalty-free right to use, modify, reproduce and distribute
'' the Sample Application Files (and/or any modified version) in any way
'' you find useful, provided that you agree that Agilent Technologies has
'' no warranty, obligations or liability for any Sample Application Files.
''
'' Agilent Technologies provides programming examples for illustration only,
'' This sample program assumes that you are familiar with the programming
'' language being demonstrated and the tools used to create and debug
'' procedures. Agilent Technologies support engineers can help explain the
'' functionality of Agilent Technologies software components and associated
'' commands, but they will not modify these samples to provide added
'' functionality or construct procedures to meet your specific needs.
'' *****

'' To develop VISA applications in Microsoft Visual Basic, you first need
'' to add the Visual Basic (VB) declaration file in your VB project as a
'' Module. This file contains the VISA function definitions and constant

```

```

'' declarations needed to make VISA calls from Visual Basic.
'' To add this module to your project in VB 6, from the menu, select
'' Project->Add Module, select the 'Existing' tab, and browse to the
'' directory containing the VB Declaration file, select visa32.bas, and
'' press 'Open'.
''
'' The name and location of the VB declaration file depends on which
'' operating system you are using. Assuming the 'standard' VISA directory
'' of C:\Program Files\VISA or the 'standard' VXIpnP directory of
'' C:\VXIpnP, the visa32.bas file can be located in one of the following:
''
'' \winnt\agvisa\include\visa32.bas - Windows NT/2000/XP
'' \winnt\include\visa32.bas      - Windows NT/2000/XP
'' \win95\include\visa32.bas     - Windows 95/98/Me
''
''
'' screen.bas
'' The following example program is written for the PSA and ESA Series
'' Spectrum Analyzers. It stores the current screen image on the
'' instrument's flash as C:PICTURE.GIF. It then transfers the image over
'' GPIB or LAN and stores the image on your PC in the current directory
'' as picture.gif. The file C:PICTURE.GIF is then deleted on the
'' instrument's flash.
''
''
Option Explicit

Private Sub Main()
    ' Declare Variables used in the program
    Dim status As Long      'VISA function status return code
    Dim defrm As Long      'Session to Default Resource Manager
    Dim vi As Long         'Session to instrument
    Dim x As Integer       'Loop Variable
    Dim ArrayPtr(1) As Long 'Array of Pointers
    Dim ResultsArray(50000) As Byte 'results array, Big enough to hold a GIF
    Dim length As Long     'Number of bytes returned from instrument
    Dim fnum As Integer    'File Number to used to open file to store data
    Dim isOpen As Boolean  'Boolean flag used to keep track of open file

```

## ESA/PSA Programming Examples Using Visual Basic® 6 to Capture a Screen Image

```
Dim headerlength As Long 'length of header

'Set the default number of bytes that will be contained in the
'ResultsArray to 50,000 (50kB)
length = 50000

'Set the array of pointers to the addresses of the variables
ArrayPtr(0) = VarPtr(length)
ArrayPtr(1) = VarPtr(ResultsArray(0))

>Delete picture.gif file if it exists
On Error Resume Next
Kill "picture.gif"

On Error GoTo Error_Handler

' Open the default resource manager session
status = viOpenDefaultRM(defrm)

' Open the session. Note: For PSA, to use LAN, change the string to
' "TCPIP0::xxx.xxx.xxx.xxx::inst0::INSTR" where xxxxx is the IP address
status = viOpen(defrm, "GPIB0::18::INSTR", 0, 0, vi)
If (status < 0) Then GoTo VisaErrorHandler

' Set the I/O timeout to fifteen seconds
status = viSetAttribute(vi, VI_ATTR_TMO_VALUE, 15000)
If (status < 0) Then GoTo VisaErrorHandler

'Store the current screen image on flash as C:PICTURE.GIF
status = viVPrintf(vi, ":MMEM:STOR:SCR 'C:PICTURE.GIF'" + Chr$(10), 0)
If (status < 0) Then GoTo VisaErrorHandler

'Grab the screen image file from the instrument
status = viQueryf(vi, ":MMEM:DATA? 'C:PICTURE.GIF'" + Chr$(10), _
    "%#y", ArrayPtr(0))
```

```
'Delete the temporary file on the flash named C:PICTURE.GIF
status = viVPrintf(vi, ":MMEM:DEL 'C:PICTURE.GIF'" + Chr$(10), 0)
If (status < 0) Then GoTo VisaErrorHandler

'Close the vi session and the resource manager session
Call viClose(vi)
Call viClose(defrm)

'Store the results in a text file
fnum = FreeFile() 'Get the next free file number
Open "picture.gif" For Binary As #fnum
isOpen = True
headerlength = 2 + (Chr$(ResultsArray(1)))
For x = headerlength To length - 2
Put #fnum, , ResultsArray(x)
Next x

' Intentionally flow into Error Handler to close file
Error_Handler:
' Raise the error (if any), but first close the file
If isOpen Then Close #fnum
If Err Then Err.Raise Err.Number, , Err.Description
Exit Sub

VisaErrorHandler:
Dim strVisaErr As String * 200
Call viStatusDesc(defrm, status, strVisaErr)
MsgBox "*** Error : " & strVisaErr, vbExclamation, "VISA Error Message"
Exit Sub
End Sub
```

---

## Using Visual Basic® 6 to Transfer Binary Trace Data

This is a Visual Basic example that gets binary trace data from the instrument. Binary data transfers are faster than the default ASCII transfer mode, because less data is sent over the bus. This example works with the ESA or PSA Series spectrum analyzers. The bas file (bintrace.bas) and a compiled executable (bintrace.exe) can be found on the Documentation CD.

This example:

1. Queries the IDN (identification) string from the instrument.
2. While in Spectrum Analysis mode, it reads the trace data in binary format (Real,32 or Real,64 or Int,32).
3. Stores the data is then to a file "bintrace.txt".

---

**NOTE** This example uses GPIB address 18 for the spectrum analyzer.

```

'' *****
'' Copyright (c) 1999- 2003 Agilent Technologies Inc. All rights reserved.
''
'' You have a royalty-free right to use, modify, reproduce and distribute
'' the Sample Application Files (and/or any modified version) in any way
'' you find useful, provided that you agree that Agilent Technologies has
'' no warranty, obligations or liability for any Sample Application Files.
''
'' Agilent Technologies provides programming examples for illustration only,
'' This sample program assumes that you are familiar with the programming
'' language being demonstrated and the tools used to create and debug
'' procedures. Agilent Technologies support engineers can help explain the
'' functionality of Agilent Technologies software components and associated
'' commands, but they will not modify these samples to provide added
'' functionality or construct procedures to meet your specific needs.
'' *****

'' To develop VISA applications in Microsoft Visual Basic, you first need
'' to add the Visual Basic (VB) declaration file in your VB project as a
'' Module. This file contains the VISA function definitions and constant

```



```

'' declarations needed to make VISA calls from Visual Basic.
'' To add this module to your project in VB 6, from the menu, select
'' Project->Add Module, select the 'Existing' tab, and browse to the
'' directory containing the VB Declaration file, select visa32.bas, and
'' press 'Open'.
''
'' The name and location of the VB declaration file depends on which
'' operating system you are using. Assuming the 'standard' VISA directory
'' of C:\Program Files\VISA or the 'standard' VXIpnP directory of
'' C:\VXIpnP, the visa32.bas file can be located in one of the following:
''
'' \winnt\agvisa\include\visa32.bas - Windows NT/2000/XP
'' \winnt\include\visa32.bas      - Windows NT/2000/XP
'' \win95\include\visa32.bas     - Windows 95/98/Me

.....
' bintrace.bas
' The following example program is written for the PSA and ESA Series
' Spectrum Analyzers. It queries the IDN string from the instrument
' and then reads the trace data in Spectrum Analysis mode in binary
' format (Real,32 or Real,64 or Int,32). The data is then stored to a
' file "bintrace.txt".
' Binary transfers are faster than the default ASCII transfer mode,
' because less data is sent over the bus.
.....

Option Explicit

Private Sub Main()
    ' Declare Variables used in the program
    Dim status As Long      'VISA function status return code
    Dim defrm As Long      'Session to Default Resource Manager
    Dim vi As Long         'Session to instrument
    Dim strRes As String * 100 'Fixed length string to hold *IDN? Results
    Dim x As Integer       'Loop Variable
    Dim output As String   'output string variable
    Dim ArrayPtr(1) As Long 'Array of Pointers

```

## ESA/PSA Programming Examples Using Visual Basic® 6 to Transfer Binary Trace Data

```

Dim ResultsArray(8192) As Single 'trace element array of Real,32 values
'For Real,64 data use Double. For Int,32 data use Long
Dim length As Long           'Number of trace elements return from instrument
Dim fnum As Integer         'File Number to used to open file to store data
Dim isOpen As Boolean       'Boolean flag used to keep track of open file

'Set the default number of trace elements to the ResultsArray size
'Note: PSA and ESA currently support up to 8192 trace points
length = 8192

'Set the array of pointers to the addresses of the variables
ArrayPtr(0) = VarPtr(length)
ArrayPtr(1) = VarPtr(ResultsArray(0))

On Error GoTo Error_Handler

' Open the default resource manager session
status = viOpenDefaultRM(defrm)

' Open the session. Note: For PSA, to use LAN, change the string to
' "TCPIP0::xxx.xxx.xxx.xxx::inst0::INTSR" where xxxxx is the IP address
status = viOpen(defrm, "GPIB0::18::INSTR", 0, 0, vi)
If (status < 0) Then GoTo VisaErrorHandler

' Set the I/O timeout to five seconds
status = viSetAttribute(vi, VI_ATTR_TMO_VALUE, 5000)
If (status < 0) Then GoTo VisaErrorHandler

'Ask for the devices's *IDN string.
status = viVPrintf(vi, "*IDN?" + Chr$(10), 0)
If (status < 0) Then GoTo VisaErrorHandler

'Read back the IDN string from the instrument
status = viVScanf(vi, "%t", strRes)
If (status < 0) Then GoTo VisaErrorHandler

```

```
'Print the IDN string results in a message box
MsgBox (strRes)

'Change the instrument mode to Spectrum Analysis
status = viVPrintf(vi, ":INST:NSEL 1" + Chr$(10), 0)
If (status < 0) Then GoTo VisaErrorHandler

' Set instrument trace data format to 32-bit Real
' Note: For higher precision use 64-bit data, ":FORM REAL,64"
' For faster data transfer for ESA, use ":FORM INT,32"
status = viVPrintf(vi, ":FORM REAL,32" + Chr$(10), 0)
If (status < 0) Then GoTo VisaErrorHandler

'Set Analyzer to single sweep mode
status = viVPrintf(vi, ":INIT:CONT 0" + Chr$(10), 0)
If (status < 0) Then GoTo VisaErrorHandler

'Trigger a sweep and wait for sweep to complete
status = viVPrintf(vi, ":INIT:IMM;*WAI" + Chr$(10), 0)
If (status < 0) Then GoTo VisaErrorHandler

'Query the trace data from the instrument
'Note: Change the "%#zb" to "%#Zb" for Real,64 data
'      For Int,32 leave the modifier as "%#zb"
status = viVQueryf(vi, ":TRAC:DATA? TRACE1" + Chr$(10), _
    "%#zb", ArrayPtr(0))

'Close the vi session and the resource manager session
Call viClose(vi)
Call viClose(defrm)

'Print number of elements returned
MsgBox ("Number of trace elements returned = " & length)

'Create a string from the ResultsArray to output to a file
For x = 0 To length - 1
```

## ESA/PSA Programming Examples

### Using Visual Basic® 6 to Transfer Binary Trace Data

```
    output = output & ResultsArray(x) & vbCrLf
Next x

'Print Results to the Screen
MsgBox (output)

'Store the results in a text file
fnum = FreeFile() 'Get the next free file number
Open "bintrace.txt" For Output As #fnum
isOpen = True
Print #fnum, output

' Intentionally flow into Error Handler to close file
Error_Handler:
    ' Raise the error (if any), but first close the file
    If isOpen Then Close #fnum
    If Err Then Err.Raise Err.Number, , Err.Description
    Exit Sub

VisaErrorHandler:
    Dim strVisaErr As String * 200
    Call viStatusDesc(defrm, status, strVisaErr)
    MsgBox "*** Error : " & strVisaErr, vbExclamation, "VISA Error Message"
    Exit Sub
End Sub
```

## Using Agilent VEE to Transfer Trace Data

This VEE programming example transfers trace data from a PSA or ESA series spectrum analyzer. The program supports data transfer types to integer 32, real 32, real 64 and ASCII data.

### VEE Window Capture of “tracetransfer.vee”:

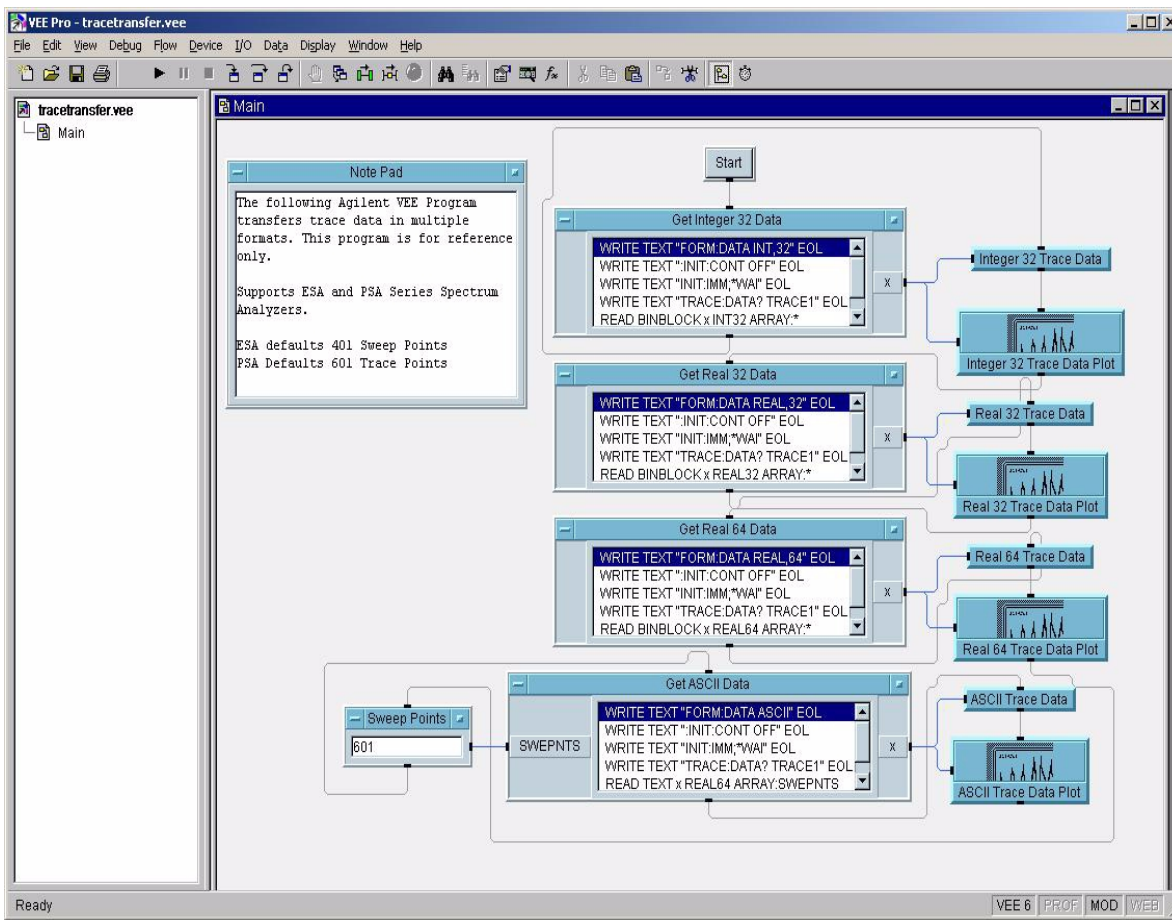

ESA/PSA Programming Examples  
Using Agilent VEE to Transfer Trace Data

---

**17**      **ESA Programming Examples**

## **Examples Included in this Chapter:**

This chapter includes C programming examples of how to program the ESA series using SCPI commands. Twelve examples are written for ESA analyzers with GPIB interface (Option A4H). Three examples are written for ESA analyzers with an RS-232 interface (Option 1AX). These examples do not apply to analyzers that have Option 290 (8590 Series Programming Code Compatibility).

“Using C with Marker Peak Search and Peak Excursion Measurement Routines” on page 202

“Using C for Marker Delta Mode and Marker Minimum Search Functions” on page 206

“Using C to Perform Internal Self-Alignment” on page 210

“Using C to Read Trace Data in an ASCII Format (over GPIB)” on page 214

“Using C to Read Trace Data in a 32-Bit Real Format (over GPIB)” on page 218

“Using C to Read Trace Data in an ASCII Format (over RS-232)” on page 223

“Using C to Read Trace Data in a 32-bit Real Format (over RS-232)” on page 228

“Using C to Add Limit Lines” on page 233

“Using C to Measure Noise” on page 239

“Using C to Enter Amplitude Correction Data” on page 243

“Using C to Determine if an Error has Occurred” on page 247

“Using C to Measure Harmonic Distortion (over GPIB)” on page 253

“Using C to Measure Harmonic Distortion (over RS-232)” on page 261

“Using C to Make Faster Power Averaging Measurements” on page 269



## Programming Examples System Requirements

The ESA Series examples were written for use on an IBM compatible PC configured as follows:

- Pentium processor
- Windows 95/98/2000/XP or Windows NT 4.0 operating system
- C programming language
- National Instruments GPIB interface card (for analyzers with Option A4H)
- National Instruments VISA Transition Libraries (VTL)
- COM1 serial port configured as follows (for analyzers with Option 1AX)
  - 9600 baud
  - 8 data bits
  - 1 stop bit
  - no parity bits
  - hardware flow control

A HP/Agilent 82341C card may be substituted for the National Instruments GPIB, and the HP VISA libraries may be substituted for the National Instruments VISA Transition Libraries. If substitutions are made, the subdirectories for the include and library files will be different than those listed in the following paragraphs. Refer to the documentation for your interface card and the VISA libraries for details.

## Using C with Marker Peak Search and Peak Excursion Measurement Routines

This C programming example (mkpkrsch.c) can be found on the Documentation CD.

```

/*****/
/* Using Marker Peak Search and Peak Excursion          */
/*                                                    */
/* This example is for the E44xxB ESA Spectrum Analyzers */
/* and E740xA EMC Analyzers.                          */
/*                                                    */
/* This C programming example does the following.      */
/* The SCPI instrument commands used are given as     */
/* reference.                                          */
/*                                                    */
/* - Opens a GPIB session at address 18                */
/* - Clears the Analyzer                               */
/*   *CLS                                              */
/* - Resets the Analyzer                               */
/*   *RST                                              */
/* - Sets the analyzer center frequency, span and units */
/*   SENS:FREQ:CENT freq                               */
/*   SENS:FREQ:SPAN freq                               */
/*   UNIT:POW DBM                                     */
/* - Set the input port to the 50 MHz amplitude reference */
/*   CAL:SOUR:STAT ON                                  */
/* - Set the analyzer to single sweep mode             */
/*   INIT:CONT 0                                       */
/* - Prompt the user for peak excursion and set them   */
/*   CALC:MARK:PEAK:EXC dB                             */
/* - Set the peak threshold to -90 dBm                 */
/*   TRAC:MATH:PEAK:THR:STAT ON                       */
/*   TRAC:MATH:PEAK:THR -90                           */
/* - Trigger a sweep and wait for sweep to complete   */
/*   INIT:IMM;*WAI                                     */
/* - Set the marker to the maximum peak                */
/*   CALC:MARK:MAX                                      */
/* - Query and read the marker frequency and amplitude */
/*   CALC:MARK:X?                                      */
/*   CALC:MARK:Y?                                      */
/* - Close the session                                 */
/*****/

```

```

#include <stdio.h>
#include <stdlib.h>
#include <math.h>
#include <conio.h>
#include <ctype.h>
#include <string.h>
#include "visa.h"

#define hpESA_IDN_E4401B  "Hewlett-Packard, E4401B"
#define hpESA_IDN_E4411B  "Hewlett-Packard, E4411B"
#define hpEMC_IDN_E7401A  "Hewlett-Packard, E7401A"

ViSession defaultRM, viESA;
ViStatus  errStatus;
ViChar    cIdBuff[256]= {0};
char      cEnter = 0;
int       iResult = 0;

/*Set the input port to 50MHz amplitude reference*/
void Route50MHzSignal()
{
    viQueryf(viESA, "*IDN?\n", "%t", &cIdBuff);
    iResult = (strncmp( cIdBuff, hpESA_IDN_E4401B, strlen(hpESA_IDN_E4401B)) &&
strncmp( cIdBuff, hpESA_IDN_E4411B, strlen(hpESA_IDN_E4411B)) && strncmp( cIdBuff,
hpEMC_IDN_E7401A, strlen(hpEMC_IDN_E7401A)));
    if( iResult == 0 )
    {
        /*Set the input port to the 50MHz amplitude reference for the models*/
        /*E4401B, E4411B and E7401A*/
        viPrintf(viESA,"CAL:SOUR:STAT ON \n");
    }
    else
    {
        /* For the analyzers having frequency limits >= 3GHz, prompt the user*/
        /* to connect the amplitude reference output to the input*/
        printf ("Connect AMPTD REF OUT to the INPUT \n");
        printf (".....Press Return to continue \n");
        scanf( "%c",&cEnter);

        /*Externally route the 50MHz Signal*/
        viPrintf(viESA,"CAL:SOUR:STAT ON \n");
    }
}

void main()

```



```
/*Set the peak threshold */
viPrintf(viESA,"CALC:MARK:PEAK:THR -90 \n");

/*Trigger a sweep and wait for completion*/
viPrintf(viESA,"INIT:IMM;*WAI\n");

/*Set the marker to the maximum peak*/
viPrintf(viESA,"CALC:MARK:MAX \n");

/*Query and read the marker frequency*/
viQueryf(viESA,"CALC:MARK:X? \n","%lf",&dMarkerFreq);
printf("\n\t RESULT: Marker Frequency is: %lf MHZ \n\n",dMarkerFreq/10e5);

/*Query and read the marker amplitude*/
viQueryf(viESA,"CALC:MARK:Y?\n","%lf",&dMarkerAmpl);
printf("\t RESULT: Marker Amplitude is: %lf dBm \n\n",dMarkerAmpl);

/*Close the session*/
viClose(viESA);
viClose(defaultRM);
}
```

## Using C for Marker Delta Mode and Marker Minimum Search Functions

This C programming example (mkrdelta.c) can be found on the Documentation CD.

```
/* ***** */
/* Using Marker Delta Mode and Marker Minimum Search */
/* */
/* This example is for the E44xxB ESA Spectrum Analyzers */
/* and E740xA EMC Analyzers. */
/* */
/* This C programming example does the following. */
/* The SCPI instrument commands used are given as */
/* reference. */
/* */
/* - Opens a GPIB session at address 18 */
/* - Clears the Analyzer */
/* - Resets the Analyzer */
/* *RST */
/* - Set the input port to the 50 MHz amplitude reference */
/* CAL:SOUR:STAT ON */
/* - Set the analyzer to single sweep mode */
/* INIT:CONT 0 */
/* - Prompts the user for the start and stop frequencies */
/* - Sets the start and stop frequencies */
/* SENS:FREQ:START freq */
/* SENS:FREQ:STOP freq */
/* - Trigger a sweep and wait for sweep completion */
/* INIT:IMM;*WAI */
/* - Set the marker to the maximum peak */
/* CALC:MARK:MAX */
/* - Set the analyzer to activate the delta marker */
/* CALC:MARK:MODE DELT */
/* - Trigger a sweep and wait for sweep completion */
/* INIT:IMM;*WAI */
/* - Set the marker to the minimum amplitude mode */
/* CALC:MARK:MIN */
/* - Query and read the marker amplitude */
/* CALC:MARK:Y? */
/* - Close the session */
/* ***** */

#include <stdio.h>
```

```

#include <stdlib.h>
#include <math.h>
#include <conio.h>
#include <ctype.h>
#include <string.h>
#include "visa.h"

#define hpESA_IDN_E4401B  "Hewlett-Packard, E4401B"
#define hpESA_IDN_E4411B  "Hewlett-Packard, E4411B"
#define hpEMC_IDN_E7401A  "Hewlett-Packard, E7401A"

ViSession defaultRM, viESA;
ViStatus  errStatus;
ViChar    cIdBuff[256] ={0};
char      cEnter = 0;
int       iResult =0;

/*Set the input port to the 50MHz amplitude reference*/
void Route50MHzSignal()
{
    viQueryf(viESA, "*IDN?\n", "%t", &cIdBuff);
    iResult = (strncmp( cIdBuff, hpESA_IDN_E4401B, strlen(hpESA_IDN_E4401B)) &&
strncmp( cIdBuff, hpESA_IDN_E4411B, strlen(hpESA_IDN_E4411B)) && strncmp( cIdBuff,
hpEMC_IDN_E7401A, strlen(hpEMC_IDN_E7401A)));
    if( iResult == 0 )
    {
        /*Set the input port to the 50MHz amplitude reference for the models*/
        /* E4401B, E4411B and E7401A*/
        viPrintf(viESA,"CAL:SOUR:STAT ON \n");
    }
    else
    {
        /* For the analyzers having frequency limits >= 3GHz, prompt the user*/
        /* to connect the amplitude reference output to the input*/
        printf ("Connect AMPTD REF OUT to the INPUT \n");
        printf (".....Press Return to continue \n");
        scanf( "%c",&cEnter);

        /*Externally route the 50MHz Signal*/
        viPrintf(viESA,"CAL:SOUR:STAT ON \n");
    }
}

void main()
{
    /*Program Variable*/

```

## ESA Programming Examples

### Using C for Marker Delta Mode and Marker Minimum Search Functions

```
ViStatus viStatus = 0;
double dStartFreq = 0.0;
double dStopFreq = 0.0;
double dMarkerAmplitude = 0.0;
long lOpc = 0L;

/* Open an GPIB session at address 18*/
viStatus=viOpenDefaultRM(&defaultRM);
viStatus=viOpen(defaultRM,"GPIB0::18",VI_NULL,VI_NULL,&viESA);
if(viStatus)
{
    printf("Could not open a session to GPIB device at address 18!\n");
    exit(0);
}
/*Clear the instrument*/
viClear(viESA);

/*Reset the instrument*/
viPrintf(viESA,"*RST\n");

/*Display the program heading */
printf("\n\t\t Marker Delta Program \n\n" );

/*Check for the instrument model number and route the 50MHz signal accordingly*/
Route50MHzSignal();

/*Set the analyzer to single sweep mode*/
viPrintf(viESA,"INIT:CONT 0\n");

/*Prompt the user for the start frequency*/
printf("\t Enter the Start frequency in MHz ");

/*The user enters the start frequency*/
scanf("%lf",&dStartFreq);

/*Prompt the user for the stop frequency*/
printf("\t Enter the Stop frequency in MHz ");

/*The user enters the stop frequency*/
scanf("%lf",&dStopFreq);

/*Set the analyzer to the values given by the user*/
viPrintf(viESA,"SENS:FREQ:STAR %lf MHZ \n;SENS:FREQ:STOP %lf
MHZ\n",dStartFreq,dStopFreq);

/*Trigger a sweep, wait for completion*/
```



```
viPrintf(viESA, "INIT:IMM;*WAI\n");

/*Set the marker to the maximum peak*/
viPrintf(viESA, "CALC:MARK:MAX\n");

/*Set the analyzer to activate delta marker mode*/
    viPrintf(viESA, "CALC:MARK:MODE DELT\n");

/*Trigger a sweep, wait for completion*/
viPrintf(viESA, "INIT:IMM;*WAI\n");

/*Set the marker to minimum amplitude*/
viPrintf(viESA, "CALC:MARK:MIN\n");

/*Query and read the marker amplitude*/
viQueryf(viESA, "CALC:MARK:Y?\n", "%lf", &dMarkerAmplitude);

/*print the marker amplitude*/
printf("\n\n\tRESULT: Marker Amplitude Delta = %lf dB\n\n", dMarkerAmplitude);

/*Close the session*/
viClose(viESA);
viClose(defaultRM);
}
```

## Using C to Perform Internal Self-Alignment

This C programming example (intalign.c) can be found on the Documentation CD.

```

/*****
/* Performing Internal Self-alignment */
/*
/* This example is for the E44xxB ESA Spectrum Analyzers */
/* and E740xA EMC Analyzers. */
/*
/* This example shows two ways of executing an internal */
/* self-alignment. The first demonstrates using the *OPC? */
/* query to determine when the alignment has completed. The */
/* second demonstrates using the query form of the CAL:ALL */
/* command to not only determine when the alignment has */
/* been completed, but the pass/fail status of the align- */
/* ment process. */
/*
/* This C programming example does the following. */
/* The SCPI instrument commands used are given as */
/* reference. */
/*
/* - Opens a GPIB session at address 18 */
/* - Clears the Analyzer */
/* *CLS */
/* - Resets the Analyzer */
/* *RST */
/* - VISA function sets the time out to infinite */
/* - Initiate self-alignment */
/* CAL:ALL */
/* - Query for operation complete */
/* *OPC? */
/* - Query for results of self-alignment */
/* CAL:ALL? */
/* - Report the results of the self-alignment */
/* - Close the session */
*****/

#include <stdio.h>
#include <stdlib.h>
#include <math.h>
#include <ctype.h>
#include <string.h>
#include "visa.h"

```

```

#define hpESA_IDN_E4401B  "Hewlett-Packard, E4401B"
#define hpESA_IDN_E4411B  "Hewlett-Packard, E4411B"
#define hpEMC_IDN_E7401A  "Hewlett-Packard, E7401A"

ViSession defaultRM, viESA;
ViStatus  errStatus;
ViChar    cIdBuff[256]= {0};
char      cEnter = 0;
int       iResult = 0;

/*Set the input port to 50MHz amplitude reference*/
void Route50MHzSignal()
{

    viQueryf(viESA, "*IDN?\n", "%t", &cIdBuff);
    iResult = (strncmp( cIdBuff, hpESA_IDN_E4401B, strlen(hpESA_IDN_E4401B)) &&
    strncmp( cIdBuff, hpESA_IDN_E4411B, strlen(hpESA_IDN_E4411B)) && strncmp( cIdBuff,
    hpEMC_IDN_E7401A, strlen(hpEMC_IDN_E7401A)));
    if( iResult == 0 )
    {
        /*Set the input port to the 50MHz amplitude reference for the models*/
        /*E4401B, E4411B, and E7401A*/
        viPrintf(viESA,"CAL:SOUR:STAT ON \n");
    }
    else
    {
        /* For the analyzers having frequency limits >= 3GHz, prompt the user*/
        /* to connect the amplitude reference output to the input*/
        printf ("Connect AMPTD REF OUT to the INPUT \n");
        printf (".....Press Return to continue \n");
        scanf( "%c",&cEnter);

        /*Externally route the 50MHz Signal*/
        viPrintf(viESA,"CAL:SOUR:STAT ON \n");
    }
}

void main()
{
    /*Program Variables*/
    ViStatus viStatus = 0;
    long lOpc =0L;
    long lResult =0L;

    /* Open a GPIB session at address 18*/

```

## ESA Programming Examples Using C to Perform Internal Self-Alignment

```
viStatus=viOpenDefaultRM(&defaultRM);
viStatus=viOpen(defaultRM,"GPIB0::18",VI_NULL,VI_NULL,&viESA);
if(viStatus)
{
    printf("Could not open a session to GPIB device at address 18!\n");
    exit(0);
}
/*Clear the instrument*/
viClear(viESA);

/*Reset the instrument*/
viPrintf(viESA,"*RST\n");

/*Display the program heading */
printf("\n\t\t Internal Self-Alignment Program \n\n" );

/*Check for the instrument model number and route the 50MHz-signal accordingly*/
Route50MHzSignal();

/*VISA function sets the time out to infinite for this specified session*/
viSetAttribute(viESA, VI_ATTR_TMO_VALUE, VI_TMO_INFINITE);
printf("\t Performing first self alignment ..... " );

/*Initiate a self-alignment */
viPrintf(viESA,"CAL:ALL\n");

/*Query for operation complete*/
viQueryf(viESA, "*OPC?\n", "%d", &lOpc);
printf ("\n\n\t First Self Alignment is Done \n\n");
if (!lOpc)
{
    printf("Program Abort! error ocurred: last command was not completed!\n");
    exit(0);
}
printf ("\n\n\t Press Return to continue with next alignment \n\n");
scanf( "%c",&cEnter);
printf("\t Performing next self alignment ..... " );

/* Query for self-alignment results*/
viQueryf(viESA,"CAL:ALL?\n", "%d",&lResult);
if (lResult)
    printf ("\n\n\t Self-alignment Failed \n");
else
    printf ("\n\n\t Self-alignment Passed \n");

/* Query for operation complete*/
```

```
viQueryf(viESA, "*OPC?\n", "%d", &lOpc);  
if (!lOpc)  
{  
    printf("Program Abort! error occurred: last command was not completed!\n");  
    exit(0);  
}  
/*Close the session*/  
viClose(viESA);  
viClose(defaultRM);  
}
```

## Using C to Read Trace Data in an ASCII Format (over GPIB)

This C programming example (ascgpi.c) can be found on the Documentation CD.

```
/* Reading Trace Data using ASCII Format (GPIB) */
/*
/* This example is for the E44xxB ESA Spectrum Analyzers */
/* and E740xA EMC Analyzers. */
/*
/* The required SCPI instrument commands are given as */
/* reference. */
/*
/* - Opens a GPIB session at address 18 */
/* - Clears the Analyzer */
/* - Resets the Analyzer */
/* *RST */
/* - Set the input port to the 50 MHz amplitude reference */
/* E4411B or E4401B */
/* CAL:SOUR:STAT ON */
/* E4402, E4403B, E4404BE, 4405B, E4407B or E4408B */
/* Prompt to connect AMPTD REF OUT to INPUT */
/* CAL:SOUR STAT ON */
/* - Query for the number of sweep points (only applies to */
/* firmware revisions A.04.00 and later); default is 401 */
/* SENS:SWE:POIN? */
/* - Sets the analyzer center frequency to 50 MHz */
/* SENS:FREQ:CENT 50 MHZ */
/* - Sets the analyzer span to 50 MHz */
/* SENS:FREQ:SPAN 50 MHZ */
/* - Set the analyzer to single sweep mode */
/* INIT:CONT 0 */
/* - Trigger a sweep and wait for sweep to complete */
/* INIT:IMM;*WAI */
/* - Specify units in dBm */
/* UNIT:POW DBM */
/* - Set the analyzer trace data to ASCII */
/* FORM:DATA: ASC */
/* - Trigger a sweep and wait for sweep to complete */
/* INIT:IMM;*WAI */
/* - Query the trace data */
/* TRAC:DATA? TRACE1 */
```

```

/* - Remove the "," from the ACSII data          */
/* - Save the trace data to an ASCII file       */
/* - Close the session                          */
/*****/

#include <stdio.h>
#include <stdlib.h>
#include <math.h>
#include <conio.h>
#include <ctype.h>
#include <string.h>
#include "visa.h"

#define hpESA_IDN_E4401B  "Hewlett-Packard, E4401B"
#define hpESA_IDN_E4411B  "Hewlett-Packard, E4411B"
#define hpEMC_IDN_E7401A  "Hewlett-Packard, E7401A"

ViSession defaultRM, viESA;
ViStatus  errStatus;
ViChar    cIdBuff[256] = {0};
char      cEnter = 0;
int       iResult = 0;

/*Set the input port to 50MHz amplitude reference*/
void Route50MHzSignal()
{
    viQueryf(viESA, "*IDN?\n", "%t", &cIdBuff);
    iResult = (strncmp( cIdBuff, hpESA_IDN_E4401B, strlen(hpESA_IDN_E4401B)) &&
    strncmp( cIdBuff, hpESA_IDN_E4411B, strlen(hpESA_IDN_E4411B)) && strncmp( cIdBuff,
    hpEMC_IDN_E7401A, strlen(hpEMC_IDN_E7401A)));
    if( iResult == 0 )
    {
        /*Set the input port to the 50MHz amplitude reference for the models*/
        /*E4401B, E4411B and E7401A*/
        viPrintf(viESA, "CAL:SOUR:STAT ON \n");
    }
    else
    {
        /* For the analyzers having frequency limits >= 3GHz, prompt the user*/
        /* to connect the amplitude reference output to the input*/
        printf ("Connect AMPTD REF OUT to the INPUT \n");
        printf (".....Press Return to continue \n");
        scanf( "%c", &cEnter);

        /*Externally route the 50MHz Signal*/
        viPrintf(viESA, "CAL:SOUR:STAT ON \n");
    }
}

```

## ESA Programming Examples Using C to Read Trace Data in an ASCII Format (over GPIB)

```
}
}

void main()
{
    /*Program Variable*/
    ViStatus viStatus = 0;
    /*Dimension cResult to 13 bytes per sweep point, 8192 sweep points maximum*/
    ViChar _VI_FAR cResult[106496] = {0};
    FILE *fTraceFile;
    static ViChar *cToken ;
    int iNum =0;
    int iSwpPnts = 401;
    long lCount=0L;
    long lOpc=0;

    /*iNum set to 13 times number of sweep points, 8192 sweep points maximum*/
    iNum =106496;
    lCount =0;

    /* Open a GPIB session at address 18*/
    viStatus=viOpenDefaultRM(&defaultRM);
    viStatus=viOpen(defaultRM,"GPIB0::18",VI_NULL,VI_NULL,&viESA);
    if(viStatus)
    {
        printf("Could not open a session to GPIB device at address 18!\n");
        exit(0);
    }
    /* Clear the instrument */
    viClear(viESA);

    /*Reset the instrument. This will set number of sweep points to default of 401*/
    viPrintf(viESA,"*RST\n");

    /*Display the program heading */
    printf("\n\t\t Read in Trace Data using ASCII Format (GPIB) Program \n\n" );

    /* Check for the instrument model number and route the 50MHz signal accordingly*/
    Route50MHzSignal();

    /*Query number of sweep points per trace (firmware revision A.04.00 and later)*/
    /*For firmware revisions prior to A.04.00, the number of sweep points is 401*/
    iSwpPnts = 401;
    viQueryf(viESA,"SENSE:SWEEP:POINTS?\n", "%d",&iSwpPnts);

    /*Set the analyzer center frequency to 50MHz*/
}
```



```

viPrintf(viESA,"SENS:FREQ:CENT 50 MHz\n");

/*Set the analyzer to 50MHz Span*/
viPrintf(viESA,"SENS:FREQ:SPAN 50 MHz\n");

/*Set the analyzer to single sweep mode */
viPrintf(viESA,"INIT:CONT 0 \n");

/*Trigger a sweep and wait for sweep to complete */
viPrintf(viESA,"INIT:IMM;*WAI\n");

/* Specify units in dBm*/
viPrintf(viESA,"UNIT:POW DBM \n");

/*Set analyzer trace data format to ASCII Format*/
viPrintf(viESA,"FORM:DATA ASC \n");

/*Trigger a sweep and wait for sweep to complete */
viPrintf(viESA,"INIT:IMM;*WAI\n");

/*Query the Trace Data using ASCII Format */
viQueryf(viESA,"%s\n", "%#t","TRAC:DATA? TRACE1" , &iNum , cResult);

/*Remove the "," from the ASCII trace data for analyzing data*/
    cToken = strtok(cResult,",");

/*Save trace data to an ASCII to a file, by removing the "," token*/
fTraceFile=fopen("C:\\temp\\ReadAscGpib.txt","w");
fprintf(fTraceFile,"ReadAscGpib.exe Output\nAgilent Technologies 2000\n\n");
fprintf(fTraceFile,"\tAmplitude of point[%d] = %s dBm\n",lCount+1,cToken);
    while (cToken != NULL)
    {
        lCount++;
        cToken =strtok(NULL,",");
        if (lCount != iSwpPnts)
            fprintf(fTraceFile,"\tAmplitude of point[%d] = %s
dBm\n",lCount+1,cToken);
    }
    fprintf(fTraceFile,"\n\nThe Total trace data points of the spectrum are:[%d]
\n\n",lCount);
    fclose(fTraceFile);

/*Close the session*/
viClose(viESA);
viClose(defaultRM);
}

```

## Using C to Read Trace Data in a 32-Bit Real Format (over GPIB)

This C programming example (32btgpi.c) can be found on the Documentation CD.

```

/*****/
/* Reading Trace Data using 32-bit Real Format (GPIB) */
/* */
/* This example is for the E44xxB ESA Spectrum Analyzers */
/* and E740xA EMC Analyzers. */
/* */
/* This C programming example does the following. */
/* The SCPI instrument commands used are given as */
/* reference. */
/* */
/* - Opens a GPIB session at address 18 */
/* - Clears the Analyzer */
/* - Resets the Analyzer */
/* *RST */
/* - Set the input port to the 50 MHz amplitude reference */
/* CAL:SOUR:STAT ON */
/* - Query for the number of sweep points (for firmware */
/* revisions A.04.00 and later). Default is 401. */
/* SENS:SWE:POIN? */
/* - Calculate the number of bytes in the header */
/* - Set the analyzer to single sweep mode */
/* INIT:CONT 0 */
/* - Sets the analyzer center frequency and span to 50 MHz */
/* SENS:FREQ:CENT 50 MHZ */
/* SENS:FREQ:SPAN 50 MHZ */
/* - Specify 10 dB per division for the amplitude scale in */
/* and dBm Units */
/* DISP:WIND:TRAC:Y:SCAL:PDIV 10 dB */
/* UNIT:POW DBM */
/* - Set the analyzer trace data to 32-bit Real */
/* FORM:DATA: REAL,32 */
/* - Set the binary order to swap */
/* FORM:BORD SWAP */
/* - Trigger a sweep and wait for sweep to complete */
/* INIT:IMM;*WAI */
/* - Calculate the number of bytes in the trace record */
/* - Query the trace data */
/* TRAC:DATA? TRACE1 */

```

```

/* - Remove the "," from the ACSII data          */
/* - Save the trace data to an ASCII file        */
/* - Close the session                          */
/*****/

#include <stdio.h>
#include <stdlib.h>
#include <math.h>
#include <conio.h>
#include <ctype.h>
#include <string.h>
#include "visa.h"

#define hpESA_IDN_E4401B "Hewlett-Packard, E4401B"
#define hpESA_IDN_E4411B "Hewlett-Packard, E4411B"
#define hpEMC_IDN_E7401A "Hewlett-Packard, E7401A"

ViSession defaultRM, viESA;
ViChar    cIdBuff[256];
char      cEnter =0;
int       iResult =0;

void Route50MHzSignal()
{
viQueryf(viESA, "*IDN?\n", "%t", &cIdBuff);
iResult = (strncmp( cIdBuff, hpESA_IDN_E4401B, strlen(hpESA_IDN_E4401B)) &&
strncmp( cIdBuff, hpESA_IDN_E4411B, strlen(hpESA_IDN_E4411B)) && strncmp( cIdBuff,
hpEMC_IDN_E7401A, strlen(hpEMC_IDN_E7401A)));
if( iResult == 0 )
{
/*Set the input port to the 50MHz internal reference source for the models*/
/*E4401B, E4411B and E7401A*/
viPrintf(viESA,"CAL:SOUR:STAT ON \n");
}
else
{
/* For the analyzers having frequency limits >= 3GHz, prompt the user to*/
/* connect the amplitude reference output to the input*/
printf ("Connect AMPD REF OUT to the INPUT \n");
printf (".....Press Return to continue \n");
scanf( "%c",&cEnter);

/*Externally route the 50MHz Signal*/
viPrintf(viESA,"CAL:SOUR:STAT ON \n");
}
}
}

```

## ESA Programming Examples Using C to Read Trace Data in a 32-Bit Real Format (over GPIB)

```
void main()
{
/*Program Variables*/
ViStatus viStatus= 0;
    ViChar _VI_FAR cResult[5000] = {0};
ViReal32 dTraceArray[401] = {0};
char cBufferInfo[6]= {0};
long lNumberBytes =0L;
long lOpc =0L;
unsigned long lRetCount = 0L;
int iSize = 0;
/*BytesPerPoint is 4 for Real32 or Int32 formats, 8 for Real64, and 2 for Uint16*/
int iBytesPerPnt = 4;
int iSwpPnts = 401;
int iDataBytes=1604;
int iHeaderBytes=6;
FILE *fTraceFile;

/* Open a GPIB session at address 18*/
viStatus=viOpenDefaultRM(&defaultRM);
viStatus=viOpen(defaultRM, "GPIB0::18",VI_NULL,VI_NULL,&viESA);
if(viStatus)
{
    printf("Could not open a session to GPIB device at address 18!\n");
    exit(0);
}
/*Clear the instrument */
viClear(viESA);

/*Reset the instrument. This will set number of sweep points to default of 401*/
viPrintf(viESA, "*RST\n");

/*Display the program heading */
printf("\n\t\t Read in Trace Data using 32-bit Real Format (using GPIB) \n\n" );

/* Set the input port to the 50MHz amplitude reference*/
Route50MHzSignal();

/*Query number of sweep points per trace (firmware revision A.04.00 and later)*/
/*For firmware revisions prior to A.04.00, the number of sweep points is 401*/
iSwpPnts=401;
viQueryf(viESA, "SENSE:SWEEP:POINTS?\n", "%d",&iSwpPnts);

/*Calculate number of bytes in the header. The header consists of the "#" sign*/
/*followed by a digit representing the number of digits to follow. The digits */
```

```
/*which follow represent the number of sweep points multiplied by the number */
/*of bytes per point. */
iHeaderBytes = 3;          /*iDataBytes >3, plus increment for "#" and "n"*/
iDataBytes = (iSwpPnts*iBytesPerPnt);
lNumberBytes = iDataBytes;
while ((iDataBytes = (iDataBytes / 10 )) > 0 )
{
    iHeaderBytes++;
}

/*Set analyzer to single sweep mode */
viPrintf(viESA,"INIT:CONT 0 \n");

/*Set the analyzer to 50MHz-center frequency */
viPrintf(viESA,"SENS:FREQ:CENT 50 MHZ\n");

/*Set the analyzer to 50MHz Span */
viPrintf(viESA,"SENS:FREQ:SPAN 50 MHZ\n");

/* Specify dB per division of each vertical division and Units */
viPrintf(viESA,"DISP:WIND:TRAC:Y:SCAL:PDIV 10dB\n");
viPrintf(viESA,"UNIT:POW DBM\n");

/*Set analyzer trace data format to 32-bit Real */
viPrintf(viESA,"FORM:DATA REAL,32 \n");

/*Set the binary byte order to SWAP */
viPrintf(viESA, "FORM:BORD SWAP\n");

/*Trigger a sweep and wait for sweep to complete*/
viPrintf(viESA,"INIT:IMM;*WAI\n");

/*Calculate size of trace record. This will be sum of HeaderBytes, NumberBytes*/
/*(the actual data bytes) and the "/n" terminator*/
iSize = lNumberBytes +iHeaderBytes+1;

/*Get trace header data and trace data */
viPrintf(viESA,"TRAC:DATA? TRACE1\n");
viRead (viESA,(ViBuf)cResult,iSize,&lRetCount);

/*Extract the trace data*/
memcpy(dTraceArray,cResult+iHeaderBytes,(size_t)lNumberBytes);

/*Save trace data to an ASCII file*/
fTraceFile=fopen("C:\\temp\\ReadTrace32Gpib.txt","w");
fprintf(fTraceFile,"ReadTrace32Gpib.exe Output\nAgilent Technologies 2000\n\n");
```

## ESA Programming Examples

### Using C to Read Trace Data in a 32-Bit Real Format (over GPIB)

```
fprintf(fTraceFile,"The %d trace data points of the
spectrum:\n\n", (lNumberBytes/4));
for ( long i=0;i<lNumberBytes/4;i++)
    fprintf(fTraceFile, "\tAmplitude of point[%d] = %.2lf
dBm\n", i+1, dTraceArray[i]);
fclose(fTraceFile);

/*Close the session*/
viClose(viESA);
viClose(defaultRM);
}
```

---

## Using C to Read Trace Data in an ASCII Format (over RS-232)

This C programming example (ascrs232.c) can be found on the Documentation CD.

```
/* **** */
/* Reading Trace Data using ASCII Format (RS-232) */
/* */
/* This example is for the E44xxB ESA Spectrum Analyzers */
/* and E740xA EMC Analyzers. */
/* */
/* This C programming example does the following. */
/* The SCPI instrument commands used are given as */
/* reference. */
/* */
/* - Opens an RS-232 session at COM1/COM2 */
/* - Clears the Analyzer */
/* - Resets the Analyzer */
/* *RST */
/* - Set the input port to the 50 MHz amplitude reference */
/* CAL:SOUR:STAT ON */
/* - Query for the number of sweep points (for firmware */
/* revisions A.04.00 and later). Default is 401. */
/* SENS:SWE:POIN? */
/* - Set the analyzer to single sweep mode */
/* INIT:CONT 0 */
/* - Sets the analyzer center frequency and span to 50 MHz */
/* SENS:FREQ:CENT 50 MHZ */
/* SENS:FREQ:SPAN 50 MHZ */
/* - Trigger a sweep */
/* INIT:IMM */
/* - Check for operation complete */
/* *OPC? */
/* - Specify dBm Unit */
/* UNIT:POW DBM */
/* - Set the analyzer trace data ASCII */
/* FORM:DATA: ASC */
/* - Trigger a sweep */
/* INIT:IMM */
/* - Check for operation complete */
/* *OPC? */
/* - Query the trace data */
/* TRAC:DATA? TRACE1 */
```





```
}
}

void main()
{
/*Program Variable*/
ViStatus viStatus = 0;
/*Dimension cResult to 13 bytes per sweep point, 8192 sweep points maximum*/
ViChar _VI_FAR cResult[106496] = {0};
FILE *fTraceFile;
    static ViChar *cToken;
int  iNum  =0;
int  iSwpPnts = 401;
long lCount=0L;
long lOpc=0L;

/*iNum set to 13 times number of sweep points, 8192 sweep points maximum*/
iNum =106496;
    lCount =0;

/* Open a serial session at COM1 */
viStatus=viOpenDefaultRM(&defaultRM);
if (viStatus =viOpen(defaultRM,"ASRL1::INSTR",VI_NULL,VI_NULL,&viESA) !=
VI_SUCCESS)
{
    printf("Could not open a session to ASRL device at COM1!\n");
    exit(0);
}
/* Clear the instrument */
viClear(viESA);

/*Reset the instrument. This will set number of sweep points to default of 401*/
viPrintf(viESA,"*RST\n");

/*Display the program heading */
printf("\n\t\tRead in Trace Data using ASCII Format (RS232) Program \n\n" );

/* Check for the instrument model number and route the 50MHz signal accordingly*/
Route50MHzSignal();

/*Query number of sweep points per trace (firmware revision A.04.00 and later)*/
/*For firmware revisions prior to A.04.00, the number of sweep points is 401 */
iSwpPnts = 401;
viQueryf(viESA, "SENSE:SWEEP:POINTS?\n", "%d", &iSwpPnts);

/*Set the analyzer center frequency to 50MHz */
```

## ESA Programming Examples Using C to Read Trace Data in an ASCII Format (over RS-232)

```
viPrintf(viESA,"SENS:FREQ:CENT 50 MHz\n");

/*Set the analyzer to 50MHz Span*/
viPrintf(viESA,"SENS:FREQ:SPAN 50 MHz\n");

/*set the analyzer to single sweep mode*/
viPrintf(viESA,"INIT:CONT 0 \n");

/*Trigger a spectrum measurement*/
viPrintf(viESA,"INIT:IMM \n");

/*Read the operation complete query*/
viQueryf(viESA, "*OPC?\n", "%d", &lOpc);
if (!lOpc)
{
    printf("Program Abort! error ocurred: last command was not completed!\n");
    exit(0);
}
/*Specify units in dBm*/
viPrintf(viESA,"UNIT:POW DBM \n");

/*Set analyzer trace data format to ASCII Format*/
viPrintf(viESA,"FORM:DATA ASC \n");

/*Trigger a spectrum measurement*/
viPrintf(viESA,"INIT:IMM \n");

/*Read the operation complete query */
viQueryf(viESA, "*OPC?\n", "%d", &lOpc);
if (!lOpc)
{
    printf("Program Abort! error ocurred: last command was not completed!\n");
    exit(0);
}
/*Query the Trace Data using ASCII Format */
viQueryf(viESA,"%s\n", "%#t","TRAC:DATA? TRACE1" , &iNum , cResult);

/*Remove the "," from the ASCII trace data for analyzing data*/
cToken = strtok(cResult,",");

/*Save trace data to an ASCII to a file, by removing the "," token*/
fTraceFile=fopen("C:\\temp\\ReadAscRS232.txt","w");
fprintf(fTraceFile,"ReadAscRS232.exe Output\nHewlett-Packard 1999\n\n");
fprintf(fTraceFile,"\tAmplitude of point[%d] = %s dBm\n",lCount+1,cToken);
while (cToken != NULL)
{
```

```
lCount++;
cToken =strtok(NULL, ",");
    if (lCount != iSwpPnts)
        fprintf(fTraceFile, "\tAmplitude of point[%d] = %s
dBm\n", lCount+1, cToken);
    }
fprintf(fTraceFile, "\n\nThe Total trace data points of the spectrum are:[%d]
\n\n", lCount);
fclose(fTraceFile);

/*Close the session*/
viClose(viESA);
viClose(defaultRM);
}
```

## Using C to Read Trace Data in a 32-bit Real Format (over RS-232)

This C programming example (32brs232.c) can be found on the Documentation CD.

```

/*****
/* Reading Trace Data using 32-bit Real Format (RS-232) */
/*
/* This example is for the E44xxB ESA Spectrum Analyzers */
/* and E740xA EMC Analyzers. */
/*
/* This C programming example does the following. */
/* The SCPI instrument commands used are given as */
/* reference. */
/*
/* - Opens an RS-232 session at COM1/COM2 */
/* - Clears the Analyzer */
/* - Resets the Analyzer */
/* *RST */
/* - Set the input port to the 50 MHz amplitude reference */
/* CAL:SOUR:STAT ON */
/* - Query for the number of sweep points (for firmware */
/* revision A.04.00 and later). Default is 401. */
/* SENS:SWE:POIN? */
/* - Calculate the number of bytes in the header */
/* - Set the analyzer to single sweep mode */
/* INIT:CONT 0 */
/* - Sets the analyzer center frequency and span to 50 MHz */
/* SENS:FREQ:CENT 50 MHZ */
/* SENS:FREQ:SPAN 50 MHZ */
/* - Specify 10 dB per division for the amplitude scale in */
/* and dBm Units */
/* DISP:WIND:TRAC:Y:SCAL:PDIV 10 dB */
/* UNIT:POW DBM */
/* - Set the analyzer trace data to 32-bit Real */
/* FORM:DATA: REAL,32 */
/* - Set the binary order to swap */
/* FORM:BORD SWAP */
/* - Trigger a sweep */
/* INIT:IMM */
/* - Check for operation complete */
/* *OPC? */
/* - Calculate the number of bytes in the trace record */
*/

```

```

/* - Set VISA timeout to 60 seconds, to allow for slower      */
/*   transfer times caused by higher number of sweep points */
/*   at low baud rates.                                     */
/* - Set VISA to terminate read after buffer is empty       */
/* - Query the trace data                                   */
/*   TRAC:DATA? TRACE1                                     */
/* - Reset VISA timeout to 3 seconds                       */
/* - Remove the "," from the ACSII data                    */
/* - Save the trace data to an ASCII file                 */
/* - Close the session                                    */
/*****

#include <stdio.h>
#include <stdlib.h>
#include <math.h>
#include <conio.h>
#include <ctype.h>
#include <string.h>
#include "visa.h"

#define hpESA_IDN_E4401B  "Hewlett-Packard, E4401B"
#define hpESA_IDN_E4411B  "Hewlett-Packard, E4411B"
#define hpEMC_IDN_E7401A  "Hewlett-Packard, E7401A"

ViSession defaultRM, viESA;
ViStatus  errStatus;
ViChar    cIdBuff[256]= {0};
char      cEnter = 0;
int       iResult = 0;

/*Set the input port to 50MHz amplitude reference*/
void Route50MHzSignal()
{
viQueryf(viESA, "*IDN?\n", "%t", &cIdBuff);
iResult = (strncmp( cIdBuff, hpESA_IDN_E4401B, strlen(hpESA_IDN_E4401B)) &&
strncmp( cIdBuff, hpESA_IDN_E4411B, strlen(hpESA_IDN_E4411B)) && strncmp( cIdBuff,
hpEMC_IDN_E7401A, strlen(hpEMC_IDN_E7401A)));
if( iResult == 0 )
{
/*Set the input port to the 50MHz amplitude reference for the models*/
/*E4411B and E4401B*/
viPrintf(viESA, "CAL:SOUR:STAT ON \n");
}
else
{

```

## ESA Programming Examples

### Using C to Read Trace Data in a 32-bit Real Format (over RS-232)

```
/* For the analyzers having frequency limits >= 3GHz, prompt the user to*/
/* connect the amplitude reference output to the input*/
printf ("Connect AMPTD REF OUT to the INPUT \n");
printf (".....Press Return to continue \n");
scanf( "%c",&cEnter);

/*Externally route the 50MHz Signal*/
viPrintf(viESA,"CAL:SOUR:STAT ON \n");
}
}

void main()
{
/*Program Variables*/
ViStatus viStatus= 0;
    ViChar _VI_FAR cResult[1024000] = {0};
ViReal32 dTraceArray[1024] = {0};
char cBufferInfo[7]= {0};
long lNumberBytes =0L;
long lOpc =0L;
unsigned long lRetCount = 0L;
int iSize = 0;
/*BytesPerPnt is 4 for Real32 or Int32 formats, 8 for Real64, and 2 for Uint16*/
int iBytesPerPnt = 4;
int iSwpPnts = 401; /*Number of points per sweep*/
int iDataBytes = 1604; /*Number of data points, assuming 4 bytes per point*/
int iHeaderBytes = 6; /*Number of bytes in the header, assuming 1604 data bytes*/
FILE *fTraceFile;

/* Open a serial session at COM1 */
viStatus=viOpenDefaultRM(&defaultRM);
if (viStatus =viOpen(defaultRM,"ASRL1::INSTR",VI_NULL,VI_NULL,&viESA) !=
VI_SUCCESS)
{
    printf("Could not open a session to ASRL device at COM1!!\n");
    exit(0);
}
/*Clear the instrument */
viClear(viESA);

/*Reset the instrument. This will set number of sweep points to default of 401*/
viPrintf(viESA,"*RST\n");

/*Display the program heading */
printf("\n\t\t\t Read in Trace Data using ASCII Format (using RS-232) Program \n\n"
);
```

```
/* Set the input port to the internal 50MHz reference source */
Route50MHzSignal();

/*Query number of sweep points per trace (firmware revision A.04.00 or later)*/
/*For firmware revisions prior to A.04.00, the number of sweep points is 401 */
iSwpPnts = 401;
viQueryf(viESA, "SENSE:SWEEP:POINTS?\n", "%d", &iSwpPnts);

/*Calculate number of bytes in the header. The header consists of the "#" sign*/
/*followed by a digit representing the number of digits to follow. The digits */
/*which follow represent the number of sweep points multiplied by the number */
/*of bytes per point. */
iHeaderBytes = 3;          /*iDataBytes >0, plus increment for "#" and "n" */
iDataBytes = (iSwpPnts*iBytesPerPnt);
    lNumberBytes = iDataBytes;
while ((iDataBytes = (iDataBytes / 10 )) > 0 )
{
    iHeaderBytes++;
}

/*Set analyzer to single sweep mode */
viPrintf(viESA, "INIT:CONT 0 \n");

/* Set the analyzer to 50MHz-center frequency */
viPrintf(viESA, "SENS:FREQ:CENT 50 MHZ\n");

/*Set the analyzer to 50MHz Span */
viPrintf(viESA, "SENS:FREQ:SPAN 50 MHZ\n");

/* Specify dB per division of each vertical division & Units */
viPrintf(viESA, "DISP:WIND:TRAC:Y:SCAL:PDIV 10dB\n");
viPrintf(viESA, "UNIT:POW DBM\n");

/*Set analyzer trace data format to 32-bit Real */
viPrintf(viESA, "FORM:DATA REAL,32\n");

/*Set the binary byte order to SWAP */
viPrintf(viESA, "FORM:BORD SWAP\n");

/*Trigger a sweep */
viPrintf(viESA, "INIT:IMM\n");

/*Read the operation complete query */
viQueryf(viESA, "*OPC?\n", "%d", &lOpc);
if (!lOpc)
```

## ESA Programming Examples

### Using C to Read Trace Data in a 32-bit Real Format (over RS-232)

```
{
    printf("Program Abort! error occurred: last command was not completed!\n");
    exit(0);
}
/*Calculate size of trace record. This will be the sum of HeaderBytes, Number*/
/*Bytes (the actual data bytes) and the "\n" terminator*/
iSize = lNumberBytes + iHeaderBytes + 1;

/*Increase timeout to 60 sec*/
viSetAttribute(viESA,VI_ATTR_TMO_VALUE,60000);

/*Set RS-232 interface to terminate when the buffer is empty*/
viSetAttribute(viESA,VI_ATTR_ASRL_END_IN,VI_ATTR_ASRL_END_NONE);

/*Get trace header data and trace data*/
viPrintf(viESA,"TRAC:DATA? TRACE1\n");
viRead (viESA,(ViBuf)cResult,iSize,&lRetCount);

/*Reset timeout to 3 sec*/
viSetAttribute(viESA,VI_ATTR_TMO_VALUE,3000);

/*Extract the trace data*/
memcpy(dTraceArray,cResult+iHeaderBytes,(size_t)lNumberBytes);

/*Save trace data to an ASCII file*/
fTraceFile=fopen("C:\\temp\\ReadTrace32Rs232.txt","w");
fprintf(fTraceFile,"ReadTrace32Rs232.exe Output\nHewlett-Packard 1999\n\n");
fprintf(fTraceFile,"The %d trace data points of the
spectrum:\n\n", (lNumberBytes/4));
for ( long i=0;i<lNumberBytes/iBytesPerPnt;i++)
    fprintf(fTraceFile,"\tAmplitude of point[%d] = %.2lf
dBm\n",i+1,dTraceArray[i]);
fclose(fTraceFile);

/*Close the session*/
viClose(viESA);
viClose(defaultRM);
}
```



## Using C to Add Limit Lines

This C programming example (limlines.c) can be found on the Documentation CD.

```

/*****/
/* Using Limit Lines */
/*
/* This example is for the E44xxB ESA Spectrum Analyzers */
/* and E740xA EMC Analyzers. */
/*
/* This C programming example does the following. */
/* The SCPI instrument commands used are given as */
/* reference. */
/*
/*
/* - Open a GPIB session at address 18. */
/* - Clear the analyzer. */
/* *CLR */
/* - Reset the analyzer. */
/* *RST */
/* - Set Y-Axis Units to dBm */
/* UNIT:POW DBM */
/* - Define the upper limit line to have frequency/ */
/* amplitude pairs. */
/* CALC:LLINE1:CONT:DOM FREQ */
/* CALC:LLINE1:TYPE UPP */
/* CALC:LLINE1:DISP ON */
/* CALC:LLINE1:DATA freq1,amp1,1,freq2,amp2,1... */
/* - Define the lower limit line to have frequency/amplitude */
/* pairs. */
/* CALC:LLINE2:CONT:DOM FREQ */
/* CALC:LLINE2:TYPE LOW */
/* CALC:LLINE2:DISP ON */
/* CALC:LLINE2:DATA freq1,amp1,1,freq2,amp2,1... */
/* - Turn the limit line test function on. */
/* CALC:LLINE2:STAT ON */
/* - Set the analyzer to a center frequency of 50 MHz, span */
/* to 20 MHz, and resolution bandwidth to 1 MHz. */
/* SENS:FREQ:SPAN 20 MHZ */
/* SENS:FREQ:CENT 50 MHZ */
/* SENS:BWID:RES 1 MHZ */
/* - Turn the limit line test function on. */
/* - Set the analyzer reference level to 0 dBm. */
/* DISP:WIND:TRAC:Y:SCAL:RLEV 0 */

```

## ESA Programming Examples Using C to Add Limit Lines

```
/* - Set the input port to the 50 MHz amplitude reference. */
/*      CAL:SOUR:STAT ON                                     */
/* - Check to see if limit line passes or fails.  It should */
/*      pass.                                               */
/*      CALC:LLINE:FAIL?                                    */
/* - Pause for 5 seconds.                                   */
/* - Deactivate the 50 MHz alignment signal.               */
/*      CAL:SOUR:STAT OFF                                    */
/* - The limit line test should fail.                     */
/* - Close the session.                                    */
/*****/

#include <stdio.h>
#include <stdlib.h>
#include <math.h>
#include <conio.h>
#include <ctype.h>
#include <string.h>
#include <windows.h>
#include "visa.h"
#define YIELD Sleep(5000)

#define hpESA_IDN_E4401B "Hewlett-Packard, E4401B"
#define hpESA_IDN_E4411B "Hewlett-Packard, E4411B"
#define hpEMC_IDN_E7401A "Hewlett-Packard, E7401A"

ViSession defaultRM, viESA;
ViStatus  errStatus;
ViChar    cIdBuff[256]= {0};
char      cEnter = 0;
int       iResult = 0;
long      lLimitTest =0L;

/*Set the input port to 50MHz amplitude reference*/
void Route50MHzSignal()
{
    viQueryf(viESA, "*IDN?\n", "%t", &cIdBuff);
    iResult = (strncmp( cIdBuff, hpESA_IDN_E4401B, strlen(hpESA_IDN_E4401B)) &&
    strncmp( cIdBuff, hpESA_IDN_E4411B, strlen(hpESA_IDN_E4411B)) && strncmp( cIdBuff,
    hpEMC_IDN_E7401A, strlen(hpEMC_IDN_E7401A)));
    if( iResult == 0 )
    {
        /*Set the input port to the 50MHz amplitude reference for the models*/
        /*E4401B, E4411B, and E7401A*/
        viPrintf(viESA,"CAL:SOUR:STAT ON \n");
    }
}
```

```

else
{
    /* For the analyzers having frequency limits >= 3GHz, prompt the user*/
    /* to connect the amplitude reference output to the input*/
    printf ("Connect AMPTD REF OUT to the INPUT \n");
    printf (".....Press Return to continue \n");
    scanf( "%c",&cEnter);

    /*Externally route the 50MHz Signal*/
    viPrintf(viESA,"CAL:SOUR:STAT ON \n");
}
}

void printResult()
{
    viQueryf(viESA, "CALC:CLIM:FAIL?\n", "%ld", &lLimitTest);
    if (lLimitTest!=0)
    {
        printf ("\n\t..Limit Line Failed.....\n");
        viQueryf(viESA, "CALC:LLINE1:FAIL?\n", "%ld", &lLimitTest);
        if (lLimitTest==0)
            printf ("\n\t.....Limit Line1 Passed \n");
        else printf ("\n\t.....Limit Line1 Failed \n");

        viQueryf(viESA, "CALC:LLINE2:FAIL?\n", "%ld", &lLimitTest);
        if (lLimitTest==0)
            printf ("\n\t.....Limit Line2 Passed \n");

        else printf ("\n\t.....Limit Line2 Failed \n");
    }
    else
    printf ("\n\t..Limit Test Pass\n");
}

void main()
{
    /*Program Variable*/
    ViStatus viStatus = 0;
    long lOpc =0L;

    /* Open a GPIB session at address 18*/
    viStatus=viOpenDefaultRM(&defaultRM);
    viStatus=viOpen(defaultRM,"GPIB0::18",VI_NULL,VI_NULL,&viESA);
    if(viStatus)
    {
        printf("Could not open a session to GPIB device at address 18!\n");
    }
}

```

## ESA Programming Examples Using C to Add Limit Lines

```
        exit(0);
    }
    /*Clear the instrument*/
    viClear(viESA);

    /*Reset the instrument*/
    viPrintf(viESA, "*RST\n");

    /* Check for the instrument model number and route the 50MHz signal accordingly*/
    /*Route50MHzSignal();

    /*Display the program heading */
    printf("\n\t\t Limit Lines Program \n\n" );

    /*Set the Y-Axis Units to dBm */
    viPrintf(viESA, "UNIT:POW DBM\n");

    /*Set to Frequency Domain Mode*/
    viPrintf(viESA, "CALC:LLINE1:CONT:DOM FREQ\n");

    /*Delete any current limit line and define the upper limit line
    to have the following frequency/amplitude pairs*/
    viPrintf(viESA, "CALC:LLINE1:TYPE UPP\n");

    /* Turn on display*/
    viPrintf(viESA, "CALC:LLINE1:DISP ON\n");

    /*Send the upper limit line data*/
    viPrintf(viESA, "CALC:LLINE1:DATA 40E06,-50,1, 45E06,-20,1, 50E06,-15,1,
55E06,-20,1, 60E06,-50,1\n");

    /* Turn on display*/
    viPrintf(viESA, "CALC:LLINE1:DISP ON\n");

    /*Delete any current limit line and define the lower limit line
    to have the following frequency/amplitude pairs*/
    viPrintf(viESA, "CALC:LLINE2:TYPE LOW\n");

    /*Send the lower limit line data*/
    viPrintf(viESA, "CALC:LLINE2:DATA
40E06,-100,1,49.99E06,-100,1,50E06,-30,1,50.01E06,-100,1,60E06,-100,1\n");

    /* Turn on display*/
    viPrintf(viESA, "CALC:LLINE2:DISP ON\n");

    /*Turn the limit line test function on.*/
```

```

viPrintf(viESA,"CALC:LLINE2:STAT ON\n");

/*Set the analyzer to a center frequency of 50 MHz, span to 20 MHz,
and resolution bandwidth to 1 MHz.*/
viPrintf(viESA,"SENS:FREQ:CENT 50e6\n");
viPrintf(viESA,"SENS:FREQ:SPAN 20e6\n");
viPrintf(viESA,"SENS:BWID:RES 1e6\n");

/*Set the analyzer reference level to 0 dBm*/
viPrintf(viESA,"DISP:WIND:TRAC:Y:SCAL:RLEV 0 \n");

/* Check for the instrument model number and route the 50MHz-signal accordingly*/
Route50MHzSignal();

/*Trigger a spectrum measurement*/
viPrintf(viESA,"INIT:IMM \n");
/*Check for operation complete */

viQueryf(viESA, "*OPC?\n", "%d", &lOpc);
if (!lOpc)
{
    printf("Program Abort! error occurred: last command was not completed!\n");
    exit(0);
}
/*Check to see if limit line passes or fails. It should pass.*/
printf ("\n\t Limit Line status after activating the 50MHz signal \n");

/*Print the limits line result*/
printResult();

/*Pause for 5 seconds*/
YIELD;

/*Deactivate the 50 MHz alignment signal.*/
viPrintf(viESA,"CAL:SOUR:STAT OFF\n");

/*Trigger a spectrum measurement*/
viPrintf(viESA,"INIT:IMM \n");

/*Check for operation complete */
viQueryf(viESA, "*OPC?\n", "%d", &lOpc);
if (!lOpc)
{
    printf("Program Abort! error occurred: last command was not completed!\n");
    exit(0);
}

```

## ESA Programming Examples Using C to Add Limit Lines

```
/* The limit line test should fail.*/  
printf ("\n\t Limit Line status after de-activating the 50MHz signal \n");  
  
/*Print the limits line result*/  
printResult();  
  
/*Close the session*/  
viClose(viESA);  
viClose(defaultRM);  
}
```

## Using C to Measure Noise

This C programming example (noise.c) can be found on the Documentation CD.

```

/*****/
/* Measuring Noise */
/* */
/* This example is for the E44xxB ESA Spectrum Analyzers */
/* and E740xA EMC Analyzers. */
/* */
/* This C programming example does the following. */
/* The SCPI instrument commands used are given as */
/* reference. */
/* */
/* - Opens a GPIB session at address 18 */
/* - Clears the Analyzer */
/* - Resets the Analyzer */
/* *RST */
/* - Sets the center frequency and span */
/* SENS:FREQ:CENT 50 MHZ */
/* SENS:FREQ:SPAN 10 MHZ */
/* - Set the input port to the 50 MHz amplitude reference */
/* CAL:SOUR:STAT ON */
/* - Set the analyzer to single sweep mode */
/* INIT:CONT 0 */
/* - Trigger a sweep and wait for sweep completion */
/* INIT:IMM;*WAI */
/* - Set the marker to the maximum peak */
/* CALC:MARK:MAX */
/* - Set the analyzer to active delta marker */
/* CALC:MARK:MODE DELT */
/* - Set the delta marker to 2 MHz */
/* CALC:MARK:X 2E+6 */
/* - Activate the noise marker function */
/* CALC:MARK:FUNC NOIS */
/* - Trigger a sweep and wait for sweep completion */
/* INIT:IMM;*WAI */
/* - Query the marker delta amplitude from the analyzer */
/* CALC:MARK:Y? */
/* - Report the marker delta amplitude as the carrier to */
/* noise ratio in dBc/Hz */
/* - Close the session */
/*****/

```

## ESA Programming Examples Using C to Measure Noise

```
#include <stdio.h>
#include <stdlib.h>
#include <math.h>
#include <conio.h>
#include <ctype.h>
#include <string.h>
#include "visa.h"

#define hpESA_IDN_E4401B "Hewlett-Packard, E4401B"
#define hpESA_IDN_E4411B "Hewlett-Packard, E4411B"
#define hpEMC_IDN_E7401A "Hewlett-Packard, E7401A"

ViSession defaultRM, viESA;
ViStatus  errStatus;
ViChar    cIdBuff[256]= {0};
char      cEnter = 0;
int       iResult = 0;
long      lOpc =0L;

/*Set the input port to 50MHz amplitude reference*/
void Route50MHzSignal()
{
    viQueryf(viESA, "*IDN?\n", "%t", &cIdBuff);
    iResult = (strncmp( cIdBuff, hpESA_IDN_E4401B, strlen(hpESA_IDN_E4401B)) &&
    strncmp( cIdBuff, hpESA_IDN_E4411B, strlen(hpESA_IDN_E4411B)) && strncmp( cIdBuff,
    hpEMC_IDN_E7401A, strlen(hpEMC_IDN_E7401A)));
    if( iResult == 0 )
    {
        /*Set the input port to the 50MHz amplitude reference for the models*/
        /*E4401B, E4411B amd E7401A*/
        viPrintf(viESA,"CAL:SOUR:STAT ON \n");
    }
    else
    {
        /* For the analyzers having frequency limits >= 3GHz, prompt the user*/
        /* to connect the amplitude reference output to the input*/
        printf ("Connect AMPTD REF OUT to the INPUT \n");
        printf (". . . . .Press Return to continue \n");
        scanf( "%c",&cEnter);

        /*Externally route the 50MHz Signal*/
        viPrintf(viESA,"CAL:SOUR:STAT ON \n");
    }
}
}
```



```

void main()
{
  /*Program Variables*/
  ViStatus viStatus = 0;
  double dMarkAmp =0.0;
  long lOpc=0L;

  /*Open a GPIB session at address 18*/
  viStatus=viOpenDefaultRM(&defaultRM);
  viStatus=viOpen(defaultRM,"GPIB0::18",VI_NULL,VI_NULL,&viESA);
  if(viStatus)
  {
    printf("Could not open a session to GPIB device at address 18!\n");
    exit(0);
  }
  /*Clear the Instrument*/
  viClear(viESA);

  /*Reset the Instrument*/
  viPrintf(viESA,"*RST\n");

  /*Display the program heading */
  printf("\n\t\t Noise Program \n\n" );

  /* Check for the instrument model number and route the 50MHz signal accordingly*/
  Route50MHzSignal();

  /*Set the analyzer center frequency to 50MHz*/
  viPrintf(viESA,"SENS:FREQ:CENT 50e6\n");

  /*Set the analyzer span to 10MHz*/
  viPrintf(viESA,"SENS:FREQ:SPAN 10e6\n");

  /*Set the analyzer in a single sweep mode*/
  viPrintf(viESA,"INIT:CONT 0 \n");

  /*Trigger a sweep and wait for sweep completion*/
  viPrintf(viESA,"INIT:IMM;*WAI \n");

  /*Set the marker to the maximum peak*/
  viPrintf(viESA,"CALC:MARK:MAX \n");

  /*Check for operation complete*/
  viQueryf(viESA, "*OPC?\n", "%d", &lOpc);
  if (!lOpc)
  {

```

## ESA Programming Examples Using C to Measure Noise

```
printf("Program Abort! error occurred: last command was not completed!\n");
exit(0);
}

/*Set the analyzer in a single sweep mode*/
viPrintf(viESA,"INIT:CONT 0 \n");

/*Trigger a spectrum measurement*/
viPrintf(viESA,"INIT:IMM \n");

/*Set the analyzer in active delta marker mode*/
viPrintf(viESA,"CALC:MARK:MODE DELT \n");

/*Set the marker delta frequency to 2 MHz. This places the
active marker two divisions to the right of the input signal.*/
viPrintf(viESA,"CALC:MARK:X 2E+6 \n");

/*Activate the noise marker function.*/
viPrintf(viESA,"CALC:MARK:FUNC NOIS \n");

/*Trigger a sweep and wait for sweep completion*/
viPrintf(viESA,"INIT:IMM;*WAI \n");

/*Query and read the marker delta amplitude from the analyzer*/
viQueryf(viESA,"CALC:MARK:Y? \n","%lf",&dMarkAmp);

/*Report the marker delta amplitude as the carrier-to-noise ratio in dBc/Hz*/
printf("\t Marker Amplitude = %lf dBc/Hz\n",dMarkAmp);

/*Close the session*/
viClose(viESA);
viClose(defaultRM);
}
```

## Using C to Enter Amplitude Correction Data

This C programming example (amplcorr.c) can be found on the Documentation CD.

```

/*****/
/* Entering Amplitude Correction Data */
/* */
/* This example is for the E44xxB ESA Spectrum Analyzers */
/* and E740xA EMC Analyzers. */
/* */
/* This C programming example does the following. */
/* The SCPI instrument commands used are given as */
/* reference. */
/* */
/* - Opens a GPIB session at address 18 */
/* - Clears the Analyzer */
/* - Resets the Analyzer */
/* *RST */
/* - Sets the stop frequency to 1.5 GHz */
/* SENS:FREQ:STOP 1.5 GHZ */
/* - Set the input port to the 50 MHz amplitude reference */
/* CAL:SOUR:STAT ON */
/* - Enter amplitude correction frequency/amplitude pairs: */
/* 0 Hz/ 0 dB, 100 MHz/5 dB, 1 GHz/-5 dB, 1.5 GHz/ 10 dB */
/* SENS:CORR:CSET1:DATA 0,0,100E6,5.0,1.0E9,-5.0,... */
/* - Activate amplitude correction */
/* SENS:CORR:CSET1:DATA */
/* SENS:CORR:CSET1:ALL:STAT ON */
/* - Query the analyzer for the amplitude corection factors */
/* SENS:CORR:CSET1:DATA? */
/* - Store them in an array */
/* - Display the array */
/* - Close the session */
/*****/

#include <stdio.h>
#include <stdlib.h>
#include <math.h>
#include <conio.h>
#include <ctype.h>
#include <string.h>
#include "visa.h"

```

## ESA Programming Examples Using C to Enter Amplitude Correction Data

```
#define hpESA_IDN_E4401B "Hewlett-Packard, E4401B"
#define hpESA_IDN_E4411B "Hewlett-Packard, E4411B"
#define hpEMC_IDN_E7401A "Hewlett-Packard, E7401A"

ViSession defaultRM, viESA;
ViStatus  errStatus;
ViChar    cIdBuff[256]= {0};
char      cEnter = 0;
int       iResult = 0;

/*Set the input port to 50MHz amplitude reference*/
void Route50MHzSignal()
{

viQueryf(viESA, "*IDN?\n", "%t", &cIdBuff);
iResult = (strncmp( cIdBuff, hpESA_IDN_E4401B, strlen(hpESA_IDN_E4401B)) &&
strncmp( cIdBuff, hpESA_IDN_E4411B, strlen(hpESA_IDN_E4411B)) && strncmp( cIdBuff,
hpEMC_IDN_E7401A, strlen(hpEMC_IDN_E7401A)));
if( iResult == 0 )
{
    /*Set the input port to the 50MHz amplitude reference for the models*/
    /*E4401B, E4411B, and E7401A*/
    viPrintf(viESA,"CAL:SOUR:STAT ON \n");
}
else
{
    /* For the analyzers having frequency limits >= 3GHz, prompt the user*/
    /* to connect the amplitude reference output to the input*/
    printf ("Connect AMPTD REF OUT to the INPUT \n");
    printf (".....Press Return to continue \n");
    scanf( "%c",&cEnter);

    /*Externally route the 50MHz Signal*/
    viPrintf(viESA,"CAL:SOUR:STAT ON \n");
}
}

void main()
{
/*Program Variables*/
    ViChar _VI_FAR cResult[1024] ={0};
    ViReal64 _VI_FAR aRealArray[2][100] ={0};
    ViStatus viStatus = 0;
    int iNum =0;
    int iNoOfPoints =0;
    long lCount = 0;
```

```

long lFreq=0L;
long lAmpltd=1;
    static ViChar *cToken;

/*No of amplitude corrections points */
iNoOfPoints = 4;

/* Open a GPIB session at address 18*/
viStatus=viOpenDefaultRM(&defaultRM);
viStatus=viOpen(defaultRM,"GPIB0::18",VI_NULL,VI_NULL,&viESA);
if(viStatus)
{
    printf("Could not open a session to GPIB device at address 18!\n");
    exit(0);
}
/*Clear the instrument*/
viClear(viESA);

/*Reset the instrument*/
viPrintf(viESA,"*RST\n");

/*Display the program heading */
printf("\n\t\t Amplitude Correction Program \n\n" );

/*Set the stop frequency to 1.5 GHz */
viPrintf(viESA,"SENS:FREQ:STOP 1.5 GHz\n");

/* Check for the instrument model number and route the 50MHz signal accordingly*/
Route50MHzSignal();

/* Purge any currently-loaded amplitude correction factors*/
viPrintf(viESA,"SENS:CORR:CSET1:DEL \n");

/* Enter amp cor frequency/amplitude pairs:
    0 Hz, 0 dB, 100 MHz, 5 dB, 1 GHz, -5 dB, 1.5GHz,10*/
viPrintf(viESA,"SENS:CORR:CSET1:DATA ");
viPrintf(viESA,"0, 0.0,");
viPrintf(viESA,"100.E6, 5.0,");
viPrintf(viESA,"1.E9, -5.0,");
viPrintf(viESA,"1.5E9, 10 \n");

/* Activate amplitude correction. Notice that the noise floor slopes
up from 0 Hz to 100 MHz, then downward by 10 dB to 1 GHz, then upwards
again by 15 dB to 1.5 GHz.*/
viPrintf(viESA,"SENS:CORR:CSET1:STATE ON \n");
viPrintf(viESA,"SENS:CORR:CSET:ALL:STAT ON \n");

```

## ESA Programming Examples Using C to Enter Amplitude Correction Data

```
/*Query the analyzer for its amplitude correction factors */
viQueryf(viESA,"SENS:CORR:CSET1:DATA?" , "%s" , &cResult);

/*Remove the "," from the amplitude correction for analyzing data*/
cToken = strtok(cResult,",");

/*Store the array (frequency) value into a two-dimensional real array*/
aRealArray[lFreq=0][lCount=0] = atof( cToken);

/*Remove the "," from the amplitude correction for analyzing data*/
cToken =strtok(NULL,",");

/*Store the array(amplitude) value into a two-dimensional real array*/
aRealArray[lAmpltd=1][lCount] = atof(cToken);
while (cToken != NULL)
{
    lCount++;
    if (lCount == iNoOfPoints)
    {
        lCount --;
        break;
    }
    /*Remove the "," from the amplitude correction for analyzing data*/
    cToken =strtok(NULL,",");

    /*Store the array (frequency) value into a two-dimensional real array*/
    aRealArray[lFreq][lCount] = atof(cToken);
    cToken =strtok(NULL,",");

    /*Store the array (amplitude) value into a two-dimensional real array*/
    aRealArray[lAmpltd][lCount] = atof(cToken);
}
/*Display the contents of the array.*/
for (long i=0;i<=lCount;i++)
{
    printf("\tFrequency of point[%d] = %f MHz\n",i,aRealArray[lFreq][i]/1e6);
    printf("\tAmplitude of point[%d] = %f dB\n",i,aRealArray[lAmpltd][i]);
}
/*Close the session*/
viClose(viESA);
viClose(defaultRM);
}
```

---

## Using C to Determine if an Error has Occurred

This C programming example (error.c) can be found on the Documentation CD.

```
/******  
/* Determine if an error has occurred */  
/* */  
/* This example is for the E44xxB ESA Spectrum Analyzers */  
/* and E740xA EMC Analyzers. */  
/* */  
/* This C programming example does the following. */  
/* The SCPI instrument commands used are given as */  
/* reference. */  
/* */  
/* - Opens a GPIB session at address 18 */  
/* - Clears the Analyzer */  
/* *CLS */  
/* - Resets the Analyzer */  
/* *RST */  
/* - Sets the service request mask to assert SRQ when */  
/* either a measurement is uncalibrated or an error */  
/* message has occurred. */  
/* STAT:QUES:ENAB 512 */  
/* STAT:QUES:INT:ENAB 8 */  
/* *ESE 35 */  
/* *SRE 104 */  
/* - Set the center frequency to 500MHz and span to 100MHz */  
/* SENS:FREQ:CENT 500 MHZ */  
/* SENS:FREQ:SPAN 100 MHZ */  
/* - Set the analyzer to an uncalibrated state */  
/* - When an interrupt occurs, poll all instruments */  
/* - Report the nature of the interrupt on the ESA analyzer */  
/* - Pause 5 seconds to observe the analyzer */  
/* - Sets the service request mask to assert SRQ when */  
/* either a measurement is uncalibrated or an error */  
/* message has occurred. */  
/* *ESE 35 */  
/* *SRE 96 */  
/* - Send an illegal command to the ESA */  
/* IDN (illegal command) */  
/* - When an interrupt occurs, poll all instruments */  
/* - Report the nature of the interrupt on the ESA analyzer */  
/* - Clear the analyzer status registers */  
/* *SRE 0 */
```

## ESA Programming Examples Using C to Determine if an Error has Occurred

```
/*      *ESE 0                                          */
/*      STAT:QUES:ENAB 0                              */
/*      STAT:QUES:INT:ENAB 0                          */
/*      *CLS                                           */
/* - Continue monitoring for an interrupt              */
/* - Close the session                                 */
/*****/

#include <stdio.h>
#include <stdlib.h>
#include <math.h>
#include <conio.h>
#include <ctype.h>
#include <string.h>
#include <windows.h>
#include "visa.h"

#define hpESA_IDN_E4401B "Hewlett-Packard, E4401B"
#define hpESA_IDN_E4411B "Hewlett-Packard, E4411B"
#define hpEMC_IDN_E7401A "Hewlett-Packard, E7401A"
#define YIELD Sleep(10)

ViSession defaultRM, viESA;
ViStatus  errStatus;
ViChar    cIdBuff[256] = {0};
char      cEnter =0;
int       iResult =0;
int       iSrqOccurred = 0;
char      cBuf[3]={0};

/*Wait until SRQ is generated and for the handler to be called. Print
something while waiting. When interrupt occurs it will be handled by
interrupt handler*/
void WaitForSRQ()
{
long    lCount = 0L;
iSrqOccurred    =0;

printf ("\t\nWaiting for an SRQ to be generated ...");
for (lCount =0;(lCount<10) && (iSrqOccurred ==0); lCount++)
{
    long lCount2 =0;
    printf(".");
    while ((lCount2++ < 100) && (iSrqOccurred ==0))
    {
```



```

        YIELD;
    }
}
printf("\n");

}

/*Set the input port to 50MHz amplitude reference*/
void Route50MHzSignal()
{
viQueryf(viESA, "*IDN?\n", "%t", &cIdBuff);
iResult = (strncmp( cIdBuff, hpESA_IDN_E4401B, strlen(hpESA_IDN_E4401B)) &&
          strncmp( cIdBuff, hpESA_IDN_E4411B, strlen(hpESA_IDN_E4411B)) && strncmp( cIdBuff,
          hpEMC_IDN_E7401A, strlen(hpEMC_IDN_E7401A)));
if( iResult == 0 )
{
    /*Set the input port to the 50MHz amplitude reference for the models*/
    /*E4401B, E4411B and E7401A*/
    viPrintf(viESA,"CAL:SOUR:STAT ON \n");
}
else
{
    /* For the analyzers having frequency limits >= 3GHz, prompt the user*/
    /* to connect the amplitude reference output to the input*/
    printf ("Connect AMPTD REF OUT to the INPUT \n");
    printf (".....Press Return to continue \n");
    scanf( "%c",&cEnter);

    /*Externally route the 50MHz Signal*/
    viPrintf(viESA,"CAL:SOUR:STAT ON \n");
}
}

/*Interrupt handler,trigger event handler */
ViStatus _VI_FUNCH sSrQHdlr(ViSession viESA, ViEventType eventType, ViEvent
ctx,ViAddr userHdlr)
{
ViUInt16 iStatusByte=0;
long lCond = 0L;

/* Make sure it is an SRQ event, ignore if stray event*/
if (eventType!=VI_EVENT_SERVICE_REQ)
{
    printf ("\n Stray event type0x%lx\n",eventType);
    /*Return successfully*/
}
}

```

## ESA Programming Examples Using C to Determine if an Error has Occurred

```
        return VI_SUCCESS;
    }
    /* When an interrupt occurs, determine which device generated the interrupt
       (if an instrument other than the ESA generates the interrupt, simply report
       "Instrument at GPIB Address xxx Has Generated an Interrupt").*/
    printf ("\n SRQ Event Occurred!\n");
    printf ("\n ... Original Device Session = %ld\n",viESA);

    /*Get the GPIB address of the instrument, which has interrupted*/
    viQueryf(viESA,"SYST:COMM:GPIB:SELF:ADDR?\n","%t", cBuf);
    printf ("\n Instrument at GPIB Address %s Has Generated an Interrupt!\n",cBuf);

    /*Get the status byte*/
    /* If the ESA generated the interrupt, determine the nature of the interrupt
       either a measurement is uncalibrated or an error message has occurred?*/
    viQueryf(viESA, "STAT:QUES:INT:EVENT?\n", "%d", &iStatusByte);
    if ( (0x08 & iStatusByte)
        printf("\n SRQ message:\t Measurement uncalibrated\n");

    /* If the ESA generated the interrupt, determine the nature of the interrupt;
       did is the measurement complete or an error message occur?*/
    viQueryf(viESA, "*ESR?\n", "%d", &iStatusByte);
    if ( (iStatusByte !=0) && (0x01 & iStatusByte)
        printf("\n SRQ message:\t Measurement complete\n");
    else if ( (iStatusByte !=0) && (0x02 | 0x10 | 0x20 & iStatusByte ))
        printf ("\n SRQ message:\t Error Message Occurred\n");

    /*Return successfully*/
    iSrqOccurred =1;
    viReadSTB(viESA, &iStatusByte);
    return VI_SUCCESS;
}

void main()
{
    /*Program Variables*/
    ViStatus viStatus = 0;
    long     lOpc= 0L;
    int      iIntNum= 0;
    long     lCount= 0L;

    /* Open a GPIB session at address 18*/
    viStatus=viOpenDefaultRM(&defaultRM);
    viStatus=viOpen(defaultRM,"GPIB0::18",VI_NULL,VI_NULL,&viESA);
    if(viStatus)
    {
```

```

        printf("Could not open a session to GPIB device at address 18!\n");
        exit(0);
    }
    /*Clear the instrument*/
    viClear(viESA);

    /*Reset the instrument*/
    viPrintf(viESA,"*RST\n");

    /*Clear the status byte of the instrument*/
    viPrintf(viESA,"*CLS\n");

    /*Display the program heading */
    printf("\n\t\t Status register - Determine if an Error has Occurred\n\n" );

    /* Check for the instrument model number and route the 50MHz-signal accordingly*/
    Route50MHzSignal();

    /*Put the analyzer in single sweep*/
    viPrintf(viESA,"INIT:CONT 0 \n");

    /*Set the service request mask to assert SRQ when either a measurement
    is uncalibrated (i.e. "Meas Uncal" displayed on screen) or an error
    message has occurred.*/
    viPrintf(viESA,"STAT:QUES:ENAB 512\n");
    viPrintf(viESA,"STAT:QUES:INT:ENAB 8\n");
    viPrintf(viESA,"*ESE 35\n");
    viPrintf(viESA,"*SRE 104\n");

    /*Configure the computer to respond to an interrupt,install the handler
    and enable it */
    viInstallHandler(viESA, VI_EVENT_SERVICE_REQ, sSrqHdlr,ViAddr(10));
    viEnableEvent(viESA, VI_EVENT_SERVICE_REQ,VI_HNDLR,VI_NULL);
    iSrqOccurred =0;

    /*Set the analyzer to a 500 MHz center frequency*/
    viPrintf(viESA,"SENS:FREQ:CENT 500 MHZ \n");

    /*Set the analyzer to a 100 MHz span*/
    viPrintf(viESA,"SENS:FREQ:SPAN 100 MHZ\n");

    /*Set the analyzer to a auto resolution BW*/
    viPrintf(viESA,"SENS:BAND:RES:AUTO 1\n");

    /*Set the analyzer to a Auto Sweep Time*/
    viPrintf(viESA,"SENS:SWE:TIME:AUTO 1\n");

```

## ESA Programming Examples Using C to Determine if an Error has Occurred

```
/*Allow analyzer to sweep several times.*/
viPrintf(viESA,"INIT:CONT 1 \n");

/*Manually couple sweeptime to 5ms. reduce resolution BW to 30 KHz.
"Meas Uncal" should be displayed on the screen, and an interrupt should
be generated.*/
viPrintf(viESA,"SENS:SWE:TIME 5 ms \n");
viPrintf(viESA,"SENS:BAND:RES 30 KHZ \n");

/*Wait for SRQ*/
WaitForSRQ();

/*Pause for 5 seconds to observe "Meas Uncal" message on ESA display*/
Sleep(5000);

/* Set the service request mask to assert SRQ when either a measurement
is completed or an error message has occurred.*/
viPrintf(viESA,"*SRE 96\n");
viPrintf(viESA,"*ESE 35\n");

/*Send an undefined command to the device*/
viPrintf(viESA,"IDN\n");

/*Wait for SRQ*/
WaitForSRQ();

/*Disable and uninstall the interrupt handler*/
viDisableEvent (viESA, VI_EVENT_SERVICE_REQ,VI_HNDLR);
viUninstallHandler(viESA, VI_EVENT_SERVICE_REQ, sSrqHdlr,ViAddr(10));

/*Clear the instrument status register*/
viPrintf(viESA,"*SRE 0 \n");
viPrintf(viESA,"*ESE 0 \n");
viPrintf(viESA,"STAT:QUES:ENAB 0\n");
viPrintf(viESA,"STAT:QUES:INT:ENAB 0\n");

/*Clear the status byte of the instrument*/
viPrintf(viESA,"*CLS\n");

/*Close the session*/
viClose(viESA);
viClose(defaultRM);
}
```

---

## Using C to Measure Harmonic Distortion (over GPIB)

This C programming example (harmgpi.c) can be found on the Documentation CD.

```
/* **** */
/* Measuring Harmonic Distortion (GPIB) */
/*
/* This example is for the E44xxB ESA Spectrum Analyzers */
/* and E740xA EMC Analyzers. */
/*
/* This C programming example does the following. */
/* The SCPI instrument commands used are given as */
/* reference. */
/*
/* - Opens a GPIB session at address 18 */
/* - Clears the Analyzer */
/* *CLS */
/* - Resets the Analyzer */
/* *RST */
/* - Set the input port to the 50 MHz reference */
/* CAL:SOUR:STAT ON */
/* - Set the analyzer center frequency to the fundamental */
/* SENS:FREQ:CENT freq */
/* - Set the analyzer to 10 MHz span */
/* SENS:FREQ:SPAN 10 MHZ */
/* - Set the analyzer to single sweep mode */
/* INIT:CONT 0 */
/* - Take a sweep and wait for sweep completion */
/* INIT:IMM;*WAI */
/* - Perform the peak search */
/* CALC:MARK:MAX */
/* - Set the marker to reference level */
/* CALC:MARK:SET:RLEV */
/* - Take a sweep and wait for sweep completion */
/* INIT:IMM;*WAI */
/* - Perform the peak search */
/* CALC:MARK:MAX */
/* - Change VISA timeout to 60 seconds */
/* - Activate signal track */
/* CALC:MARK:TRCK:STAT ON */
/* - Perform narrow span and wait */
/* SENS:FREQ:SPAN 10e4 */
/* - Check for operation complete */
```

## ESA Programming Examples Using C to Measure Harmonic Distortion (over GPIB)

```
/*      *OPC?                                     */
/* - De-activate signal track                     */
/*      CALC:MARK:TRCK:STAT OFF                  */
/* - Reset VISA timeout to 3 seconds              */
/* - Set units to dBm                            */
/*      UNIT:POW DBM                             */
/* - Take a sweep and wait for sweep completion  */
/*      INIT:IMM;                                */
/*      *OPC?                                     */
/* - Perform the peak search                      */
/*      CALC:MARK:MAX                             */
/* - Read the marker amplitude, this is the fundamental Level*/
/*      CALC:MARK:Y?                             */
/* - Change the amplitude units to volts         */
/*      UNIT:POW V                               */
/* - Take a sweep                                */
/*      INIT:IMM                                  */
/* - Check for operation complete                 */
/*      *OPC?                                     */
/* - Read the marker amplitude in volts, this is the */
/*      fundamental amplitude in volts.           */
/*      CALC:MARK:Y?                             */
/* - Read the marker frequency                   */
/*      CALC:MARK:X?                             */
/* - Measure each harmonic amplitude as follows:  */
/*      Set the span to 20 MHz                    */
/*      SENS:FREQ:SPAN 20 MHZ                    */
/*      Set the center frequency to the desired harmonic */
/*      SENS:FREQ:CENT <freq>                    */
/*      Take a sweep and wait for operation complete */
/*      INIT:IMM                                  */
/*      *OPC?                                     */
/*      Perform peak search                       */
/*      CALC:MARK:MAX                             */
/*      Set VISA timeout to 60 seconds            */
/*      Activate signal track                     */
/*      CALC:MARK:TRCK:STAT ON                    */
/*      Zoom down to a 100 kHz span               */
/*      SENS:FREQ:SPAN 10E4                       */
/*      Take a sweep and wait for operation complete */
/*      INIT:IMM                                  */
/*      *OPC?                                     */
/*      Signal track off                          */
/*      CALC:MARK:TRCK:STAT OFF                  */
/*      Reset VISA timeout to 3 seconds           */
/*      Perform Peak Search                       */
```

```

/*      CALC:MARK:MAX      */
/*      Set marker amplitude in volts      */
/*      UNIT:POW V      */
/*      Query, read the marker amplitude in volts      */
/*      CALC:MARK:Y?      */
/*      Change the amplitude units to dBm and read the      */
/*      marker amplitude.      */
/*      UNIT:POW DBM      */
/* - Calculate the relative amplitude of each harmonic      */
/* relative to the fundamental      */
/* - Calculate the total harmonic distortion      */
/* - Display the fundamental amplitude in dBm, fundamental      */
/* frequency in MHz, relative amplitude of each harmonic      */
/* in dBc and total harmonic distortion in percent      */
/* - Close the session      */
/*****/

#include <stdio.h>
#include <stdlib.h>
#include <math.h>
#include <conio.h>
#include <ctype.h>
#include <string.h>
#include "visa.h"

#define hpESA_IDN_E4401B "Hewlett-Packard, E4401B"
#define hpESA_IDN_E4411B "Hewlett-Packard, E4411B"
#define hpEMC_IDN_E7401A "Hewlett-Packard, E7401A"

ViSession defaultRM, viESA;
ViStatus  errStatus;
ViChar    cIdBuff[256]= {0};
char      cEnter = 0;
int       iResult = 0;
long      lOpc =0L;

/*Set the input port to 50MHz amplitude reference*/
void Route50MHzSignal()
{

viQueryf(viESA, "*IDN?\n", "%t", &cIdBuff);
iResult = (strcmp( cIdBuff, hpESA_IDN_E4401B, strlen(hpESA_IDN_E4401B)) &&
strcmp( cIdBuff, hpESA_IDN_E4411B, strlen(hpESA_IDN_E4411B)) && strcmp( cIdBuff,
hpEMC_IDN_E7401A, strlen(hpEMC_IDN_E7401A)));
if( iResult == 0 )
{

```

## ESA Programming Examples Using C to Measure Harmonic Distortion (over GPIB)

```
/*Set the input port to the 50MHz amplitude reference for the models*/
/*E4401B, E4411B, and E7401A*/
viPrintf(viESA,"CAL:SOUR:STAT ON \n");
}
else
{
    /* For the analyzers having frequency limits >= 3GHz, prompt the user*/
    /* to connect the amplitude reference output to the input*/
    printf ("Connect AMPTD REF OUT to the INPUT \n");
    printf (". . . . .Press Return to continue \n");
    scanf( "%c",&cEnter);
    /*Externally route the 50MHz Signal*/
    viPrintf(viESA,"CAL:SOUR:STAT ON \n");
}
}

void TakeSweep()
{
    /*Take a sweep and wait for the sweep completion*/
    viPrintf(viESA,"INIT:IMM\n");
    viQueryf(viESA, "*OPC?\n", "%d", &lOpc);
    if (!lOpc)
    {
        printf("Program Abort! Error occurred: last command was not completed! \n");
        exit(0);
    }
}

void main()
{
    /*Program Variables*/
    ViStatus viStatus = 0;
    double dFundamental = 0.0;
    double dHarmFreq =0.0;
    float fHarmV[10] ={0.0};
    float fHarmDbm[10]={0.0};
    float fRelAmptd[10]={0.0};
    float fFundaAmptdDbm=0.0;
    double dFundaAmptdV=0.0;
    double dMarkerFreq = 0.0;
    double dPrctDistort =0.0;
    double dSumSquare =0.0;
    long lMaxHarmonic =0L;
    long lNum=0L;

    /*Setting default values*/
```



```
lMaxHarmonic =5;
dFundamental =50.0;

/* Open a GPIB session at address 18*/
viStatus=viOpenDefaultRM(&defaultRM);
viStatus=viOpen(defaultRM,"GPIB0::18",VI_NULL,VI_NULL,&viESA);
if(viStatus)
{
    printf("Could not open a session to GPIB device at address 18!\n");
    exit(0);
}
/*Clear the instrument*/
viClear(viESA);

/*Reset the instrument*/
viPrintf(viESA,"*RST\n");

/*Display the program heading */
printf("\n\t\t Harmonic Distortion Program \n\n" );

/* Check for the instrument model number and route the 50MHz-signal accordingly*/
Route50MHzSignal();

/*Prompt user for fundamental frequency*/
printf("\t Enter the input signal fundamental frequency in MHz ");

/*The user enters fundamental frequency*/
scanf("%lf",&dFundamental);

/*Set the analyzer center frequency to the fundamental frequency. */
viPrintf(viESA,"SENS:FREQ:CENT %lf MHZ \n;",dFundamental);

/*Set the analyzer to 10MHz Span */
viPrintf(viESA,"SENS:FREQ:SPAN 10 MHZ\n");

/*Put the analyzer in a single sweep */
viPrintf(viESA,"INIT:CONT 0 \n");

/*Trigger a sweep, wait for sweep completion*/
viPrintf(viESA,"INIT:IMM;*WAI\n");

/*Perform a peak search */
viPrintf(viESA,"CALC:MARK:MAX \n");

/* Place the signal at the reference level using the
   marker-to-reference level command and take sweep */
```

## ESA Programming Examples Using C to Measure Harmonic Distortion (over GPIB)

```
viPrintf(viESA,"CALC:MARK:SET:RLEV \n");

/*Trigger a sweep, wait for sweep completion*/
viPrintf(viESA,"INIT:IMM;*WAI\n");

/*Perform a peak search */
viPrintf(viESA,"CALC:MARK:MAX \n");

/*increase timeout to 60 sec*/
viSetAttribute(viESA,VI_ATTR_TMO_VALUE,60000);

/*Perform activate signal track */
viPrintf(viESA,"CALC:MARK:TRCK:STAT ON \n");

/*Take a sweep and wait for the sweep completion*/
TakeSweep();

/*Perform narrow span and wait */
viPrintf(viESA,"SENS:FREQ:SPAN 10e4 \n");

/*Take a sweep and wait for the sweep completion*/
TakeSweep();

/*De activate the signal track */
viPrintf(viESA,"CALC:MARK:TRCK:STAT OFF \n");

/*Reset timeout to 3 sec*/
viSetAttribute(viESA,VI_ATTR_TMO_VALUE,3000);

/*Set units to DBM*/
viPrintf(viESA,"UNIT:POW DBM \n");

/*Perform a peak search */
viPrintf(viESA,"CALC:MARK:MAX \n");

/*Read the marker amplitude, this is the fundamental amplitude
in dBm */
viQueryf(viESA,"CALC:MARK:Y?\n","%lf", &fFundaAmptdDbm);

/*Change the amplitude units to Volts */
viPrintf(viESA,"UNIT:POW V \n");

/*Read the marker amplitude in volts, This is the fundamental amplitude
in Volts (necessary for the THD calculation).*/
viQueryf(viESA,"CALC:MARK:Y?\n","%lf",&dFundaAmptdV);
```

```

/*Read the marker frequency. */
viQueryf(viESA, "CALC:MARK:X? \n", "%lf", &dMarkerFreq);
dFundamental = dMarkerFreq;

/*Measure each harmonic amplitude as follows: */
for ( lNum=2;lNum<=lMaxHarmonic;lNum++)
{
    /*Measuring the Harmonic No#[%d] message */
    printf("\n\t Measuring the Harmonic No [%d] \n", lNum );

    /*Set the span to 20 MHz*/
    viPrintf(viESA, "SENS:FREQ:SPAN 20 MHZ \n");

    /*Set the center frequency to the nominal harmonic frequency*/
    dHarmFreq = lNum*dFundamental;
    viPrintf(viESA, "SENS:FREQ:CENT %lf HZ \n;", dHarmFreq);

    /*Take a sweep and wait for the sweep completion*/
    TakeSweep();

    /*Perform a peak search and wait for completion */
    viPrintf(viESA, "CALC:MARK:MAX\n");

    /*increase timeout to 60 sec*/
    viSetAttribute(viESA, VI_ATTR_TMO_VALUE, 60000);

    /*Activate signal track */
    viPrintf(viESA, "CALC:MARK:TRCK:STAT ON\n");

    /*Zoom down to a 100 kHz span */
    viPrintf(viESA, "SENS:FREQ:SPAN 10e4\n");

    /*Take a sweep and wait for the sweep completion*/
    TakeSweep();

    /* Signal track off */
    viPrintf(viESA, "CALC:MARK:TRCK:STAT OFF\n");

    /*Reset timeout to 3 sec*/
    viSetAttribute(viESA, VI_ATTR_TMO_VALUE, 3000);

    /*Set Marker Amplitude in Volts*/
    viPrintf(viESA, "UNIT:POW V\n");

    /*Perform a peak search and wait for completion*/
    viPrintf(viESA, "CALC:MARK:MAX\n");
}

```

## ESA Programming Examples Using C to Measure Harmonic Distortion (over GPIB)

```
/*Query and read the Marker Amplitude in Volts*/
/*Store the result in the array.*/
viQueryf(viESA,"CALC:MARK:Y?\n","%lf",&fHarmV[lNum]);

/*Change the amplitude units to DBM */
viPrintf(viESA,"UNIT:POW DBM\n");

/* Read the marker amplitude */
viQueryf(viESA,"CALC:MARK:Y?\n","%lf",&fHarmDbm[lNum]);
}

/*Sum the square of each element in the fHarmV array. Then
calculate the relative amplitude of each harmonic relative
to the fundamental */
for (lNum=2;lNum<=lMaxHarmonic;lNum++)
{
    dSumSquare= dSumSquare + (pow (double(fHarmV[lNum]),2.0));
    /* Relative Amplitude */
    fRelAmptd[lNum] = fHarmDbm[lNum] - fFundaAmptdDbm ;
}
/*Calculate the total harmonic distortion by dividing the square root of
the sum of the squares (dSumSquare) by the fundamental amplitude in Volts
(dFundaAmptdV).Multiply this value by 100 to obtain a result in percent*/
dPrctDistort = ((sqrt(double (dSumSquare))) /dFundaAmptdV) *100 ;

/*Fundamental amplitude in dBm */
printf("\n\t Fundamental Amplitude:%lf dB \n\n",fFundaAmptdDbm);

/*Fundamental Frequency in MHz*/
printf("\t Fundamental Frequency is:%lf MHz \n\n",dFundamental/10e5);

/*Relative amplitude of each harmonic in dBc*/
for (lNum=2;lNum<=lMaxHarmonic;lNum++)
    printf("\t Relative amplitude of Harmonic[%d]:%lf dBc
\n\n",lNum,fRelAmptd[lNum]);

/*Total harmonic distortion in percent*/
printf("\t Total Harmonic Distortion:%lf percent \n\n",dPrctDistort);

/*Close the session*/
viClose(viESA);
viClose(defaultRM);
}
```

---

## Using C to Measure Harmonic Distortion (over RS-232)

This C programming example (harmrs23.c) can be found on the Documentation CD.

```
/* **** */
/* Measuring Harmonic Distortion (RS-232) */
/* */
/* This example is for the E44xxB ESA Spectrum Analyzers */
/* and E740xA EMC Analyzers. */
/* */
/* This C programming example does the following. */
/* The SCPI instrument commands used are given as */
/* reference. */
/* */
/* - Opens an RS-232 session to the COM1 serial port */
/* - Clears the Analyzer */
/* *CLS */
/* - Resets the Analyzer */
/* *RST */
/* - Set the input port to the 50 MHz reference */
/* CAL:SOUR:STAT ON */
/* - Set the analyzer center frequency to the fundamental */
/* SENS:FREQ:CENT freq */
/* - Set the analyzer to 10 MHz span */
/* SENS:FREQ:SPAN 10 MHZ */
/* - Set the analyzer to single sweep mode */
/* INIT:CONT 0 */
/* - Trigger a sweep and wait for sweep completion */
/* INIT:IMM;*WAI */
/* - Perform the peak search */
/* CALC:MARK:MAX */
/* - Set the marker to reference level */
/* CALC:MARK:SET:RLEV */
/* - Trigger a sweep and wait for sweep completion */
/* INIT:IMM;*WAI */
/* - Perform the peak search */
/* CALC:MARK:MAX */
/* - Change VISA timeout to 60 seconds */
/* - Activate signal track */
/* CALC:MARK:TRCK:STAT ON */
/* - Perform narrow span and wait */
/* SENS:FREQ:SPAN 10e4 */
/* - Check for operation complete */
```

## ESA Programming Examples Using C to Measure Harmonic Distortion (over RS-232)

```
/*      *OPC?                                     */
/* - De-activate signal track                       */
/*      CALC:MARK:TRCK:STAT OFF                    */
/* - Reset VISA timeout to 3 seconds                */
/* - Set units to dBm                              */
/*      UNIT:POW DBM                               */
/* - Take a sweep and wait for sweep completion    */
/*      INIT:IMM;                                  */
/*      *OPC?                                     */
/* - Perform the peak search                       */
/*      CALC:MARK:MAX                              */
/* - Read the marker amplitude, this is the fundamental Level*/
/*      CALC:MARK:Y?                              */
/* - Change the amplitude units to volts           */
/*      UNIT:POW V                                 */
/* - Take a sweep                                  */
/*      INIT:IMM                                  */
/* - Check for operation complete                  */
/*      *OPC?                                     */
/* - Read the marker amplitude in volts, this is the */
/*      fundamental amplitude in volts.            */
/*      CALC:MARK:Y?                              */
/* - Read the marker frequency                     */
/*      CALC:MARK:X?                              */
/* - Measure each harmonic amplitude as follows:   */
/*      Set the span to 20 MHz                      */
/*      SENS:FREQ:SPAN 20 MHZ                      */
/*      Set the center frequency to the desired harmonic */
/*      SENS:FREQ:CENT <freq>                     */
/*      Take a sweep and wait for operation complete */
/*      INIT:IMM                                  */
/*      *OPC?                                     */
/*      Perform peak search                        */
/*      CALC:MARK:MAX                              */
/*      Set VISA timeout to 60 seconds             */
/*      Activate signal track                      */
/*      CALC:MARK:TRCK:STAT ON                     */
/*      Zoom down to a 100 kHz span               */
/*      SENS:FREQ:SPAN 10E4                        */
/*      Take a sweep and wait for operation complete */
/*      INIT:IMM                                  */
/*      *OPC?                                     */
/*      Signal track off                          */
/*      CALC:MARK:TRCK:STAT OFF                    */
/*      Reset VISA timeout to 3 seconds            */
/*      Perform Peak Search                        */
```

```

/*      CALC:MARK:MAX      */
/*      Set marker amplitude in volts      */
/*      UNIT:POW V      */
/*      Query, read the marker amplitude in volts      */
/*      CALC:MARK:Y?      */
/*      Change the amplitude units to dBm and read the      */
/*      marker amplitude.      */
/*      UNIT:POW DBM      */
/* - Calculate the relative amplitude of each harmonic      */
/* relative to the fundamental      */
/* - Calculate the total harmonic distortion      */
/* - Display the fundamental amplitude in dBm, fundamental      */
/* frequency in MHz, relative amplitude of each harmonic      */
/* in dBc and total harmonic distortion in percent      */
/* - Close the session      */
/*****/

#include <stdio.h>
#include <stdlib.h>
#include <math.h>
#include <conio.h>
#include <ctype.h>
#include <string.h>
#include <visa.h>

#define hpESA_IDN_E4401B "Hewlett-Packard, E4401B"
#define hpESA_IDN_E4411B "Hewlett-Packard, E4411B"
#define hpEMC_IDN_E7401A "Hewlett-Packard, E7401A"

ViSession defaultRM, viESA;
ViStatus  errStatus;
ViChar    cIdBuff[256]= {0};
char      cEnter = 0;
int       iResult = 0;
long      lOpc =0L ;

/*Set the input port to 50MHz amplitude reference*/
void Route50MHzSignal()
{

viQueryf(viESA, "*IDN?\n", "%t", &cIdBuff);
iResult = (strcmp( cIdBuff, hpESA_IDN_E4401B, strlen(hpESA_IDN_E4401B)) &&
strcmp( cIdBuff, hpESA_IDN_E4411B, strlen(hpESA_IDN_E4411B)) && strcmp( cIdBuff,
hpEMC_IDN_E7401A, strlen(hpEMC_IDN_E7401A)));
if( iResult == 0 )
{

```

## ESA Programming Examples Using C to Measure Harmonic Distortion (over RS-232)

```
/*Set the input port to the 50MHz amplitude reference for the models*/
/*E4411B, E4401B*/
viPrintf(viESA,"CAL:SOUR:STAT ON\n");
}
else
{
    /* For the analyzers having frequency limits >= 3GHz, prompt the user*/
    /* to connect the amplitude reference output to the input*/
    printf ("Connect AMPTD REF OUT to the INPUT \n");
    printf (".....Press Return to continue \n");
    scanf( "%c",&cEnter);

    /*Externally route the 50MHz Signal*/
    viPrintf(viESA,"CAL:SOUR:STAT ON\n");
}
}

void TakeSweep()
{
    /*Take a sweep and wait for the sweep completion*/
    viPrintf(viESA,"INIT:IMM\n");
    viQueryf(viESA, "*OPC?\n", "%d", &lOpc);
    if (!lOpc)
    {
        printf("Program Abort! Error occurred: last command was not completed! \n");
        exit(0);
    }
}

void main()
{
    /*Program Variables*/
    ViStatus viStatus = 0;
    double dFundamental = 0.0;
    double dHarmFreq = 0.0;
    float fHarmV[10] ={0.0};
    float fHarmDbm[10]={0.0};
    float fRelAmptd[10]={0.0};
    float fFundaAmptdDbm=0.0;
    double dFundaAmptdV=0.0;
    double dMarkerFreq = 0.0;
    double dPrctDistort =0.0;
    double dSumSquare =0.0;
    long lMaxHarmonic =0L;
    long lNum=0L;
```



```
/*Setting default values*/
lMaxHarmonic =5;
dFundamental =50.0;

/* Open a serial session at COM1 */
viStatus=viOpenDefaultRM(&defaultRM);
if (viStatus =viOpen(defaultRM,"ASRL1::INSTR",VI_NULL,VI_NULL,&viESA) !=
VI_SUCCESS)
{
    printf("Could not open a session to ASRL device at COM1!\n");
    exit(0);
}
/*Clear the instrument*/
viClear(viESA);

/*Reset the instrument*/
viPrintf(viESA,"*RST\n");

/*Display the program heading */
printf("\n\t\t Harmonic Distortion Program \n\n" );

/* Check for the instrument model number and route the 50MHz-signal accordingly*/
Route50MHzSignal();

/*Prompt user for fundamental frequency*/
printf("\t Enter the input signal fundamental frequency in MHz ");

/*The user enters fundamental frequency*/
scanf("%lf",&dFundamental);

/*Set the analyzer center frequency to the fundamental frequency. */
viPrintf(viESA,"SENS:FREQ:CENT %lf MHZ\n",dFundamental);

/*Set the analyzer to 10MHz Span */
viPrintf(viESA,"SENS:FREQ:SPAN 10 MHZ\n");

/*Put the analyzer in a single sweep mode */
viPrintf(viESA,"INIT:CONT 0\n");

/*Trigger a sweep, wait for sweep completion*/
viPrintf(viESA,"INIT:IMM;*WAI\n");

/*Perform a peak search */
viPrintf(viESA,"CALC:MARK:MAX\n");
```

## ESA Programming Examples Using C to Measure Harmonic Distortion (over RS-232)

```
/* Place the signal at the reference level using the
   marker-to-reference level command and take sweep */
viPrintf(viESA,"CALC:MARK:SET:RLEV\n");

/*Trigger a sweep, wait for sweep completion*/
viPrintf(viESA,"INIT:IMM;*WAI\n");

/*Perform a peak search */
viPrintf(viESA,"CALC:MARK:MAX\n");

/*Increase timeout to 60 sec*/
viSetAttribute(viESA,VI_ATTR_TMO_VALUE,60000);

/*Perform activate signal track */
viPrintf(viESA,"CALC:MARK:TRCK:STAT ON\n");

/*Take a sweep and wait for the sweep completion*/
TakeSweep();

/*Perform narrow span and wait */
viPrintf(viESA,"SENS:FREQ:SPAN 10e4\n");

/*Take a sweep and wait for the sweep completion*/
TakeSweep();

/*De activate the signal track */
viPrintf(viESA,"CALC:MARK:TRCK:STAT OFF\n");

/*Reset timeout to 3 sec*/
viSetAttribute(viESA,VI_ATTR_TMO_VALUE,3000);

/*Set units to dBm*/
viPrintf(viESA,"UNIT:POW DBM\n");

/*Perform a peak search */
viPrintf(viESA,"CALC:MARK:MAX\n");

/*Read the marker amplitude, this is the fundamental amplitude
   in dBm */
viQueryf(viESA,"CALC:MARK:Y?\n","%1f", &fFundaAmptdBm);

/*Change the amplitude units to Volts */
viPrintf(viESA,"UNIT:POW V\n");

/*Read the marker amplitude in volts, This is the fundamental amplitude
   in Volts (necessary for the THD calculation).*/
```

```
viQueryf(viESA, "CALC:MARK:Y?\n", "%lf", &dFundaAmptdV);

/*Read the marker frequency. */
viQueryf(viESA, "CALC:MARK:X? \n", "%lf", &dMarkerFreq);
dFundamental = dMarkerFreq;

/*Measure each harmonic amplitude as follows: */
for ( lNum=2;lNum<=lMaxHarmonic;lNum++)
{
    /*Measuring the Harmonic No#[%d] message */
    printf("\n\t Measuring the Harmonic No [%d] \n", lNum );

    /*Set the span to 20 MHz*/
    viPrintf(viESA, "SENS:FREQ:SPAN 20 MHZ\n");

    /*Set the center frequency to the nominal harmonic frquency*/
    dHarmFreq = lNum * dFundamental;
    viPrintf(viESA, "SENS:FREQ:CENT %lf HZ\n", dHarmFreq);

    /*Take a sweep and wait for the sweep completion*/
    TakeSweep();

    /*Perform a peak search and wait for completion */
    viPrintf(viESA, "CALC:MARK:MAX\n");

    /*Increase timeout to 60 sec*/
    viSetAttribute(viESA, VI_ATTR_TMO_VALUE, 60000);

    /*Activate signal track */
    viPrintf(viESA, "CALC:MARK:TRCK:STAT ON\n");

    /*Zoom down to a 100 KHz span */
    viPrintf(viESA, "SENS:FREQ:SPAN 10e4\n");

    /*Take a sweep and wait for the sweep completion*/
    TakeSweep();

    /* Signal track off */
    viPrintf(viESA, "CALC:MARK:TRCK:STAT OFF\n");

    /*Reset timeout to 3 sec*/
    viSetAttribute(viESA, VI_ATTR_TMO_VALUE, 3000);

    /*Set marker amplitude in Volts*/
    viPrintf(viESA, "UNIT:POW V\n");
}
```

## ESA Programming Examples Using C to Measure Harmonic Distortion (over RS-232)

```
/*Perform a peak search and wait for completion*/
viPrintf(viESA,"CALC:MARK:MAX\n");

/*Query and read the marker amplitude in Volts*/
/*Store the result in the fHarmV array.*/
viQueryf(viESA,"CALC:MARK:Y?\n", "%lf", &fHarmV[lNum]);

/*Change the amplitude units to dBm */
viPrintf(viESA,"UNIT:POW DBM\n");

/* Read the marker amplitude */
viQueryf(viESA,"CALC:MARK:Y?\n", "%lf", &fHarmDbm[lNum]);
}

/*Sum the square of each element in the fHarmV array and calculate
the relative amplitude of each harmonic relative to the fundamental*/
for (lNum=2;lNum<=lMaxHarmonic;lNum++)
{
    dSumSquare= dSumSquare + (pow (double(fHarmV[lNum]) ,2.0));

    /* Relative Amplitude */
    fRelAmptd[lNum] = fHarmDbm[lNum] - fFundaAmptdDbm ;
}

/*Calculate the total harmonic distortion by dividing the square root of
the sum of the squares (dSumSquare) by the fundamental amplitude in Volts
(dFundaAmptdV).Multiply this value by 100 to obtain a result in percent*/
dPrctDistort = ((sqrt(double (dSumSquare))) /dFundaAmptdV) *100 ;

/*Fundamental amplitude in dBm */
printf("\nFundamental Amplitude: %lf dB \n",fFundaAmptdDbm);

/*Fundamental frequency in MHz*/
printf("Fundamental Frequency is: %lf MHz \n",dFundamental/10e5);

/*Relative amplitude of each harmonic in dBc*/
for (lNum=2;lNum<=lMaxHarmonic;lNum++)
    printf("Relative amplitude of Harmonic[%d]: %lf dBc
\n",lNum,fRelAmptd[lNum]);

/*Total harmonic distortion in percent*/
printf("Total Harmonic Distortion: %lf percent\n",dPrctDistort);

/*Close the session*/
viClose(viESA);
viClose(defaultRM);
}
```

## Using C to Make Faster Power Averaging Measurements

This C programming example (average.c) can be found on the Documentation CD.

```

/*****/
/* Average.c  Agilent Technologies 1999 */
/* */
/* This C programming example does the following: */
/* Performs Power Averaging of Multiple ESA Measurements */
/* and Writes the Result back to a Trace for display */
/* */
/* The required SCPI instrument commands are given as */
/* reference. */
/* */
/* - Opens a GPIB device at address 18 */
/* - Clears and Resets the Analyzer to a known state */
/*     SYST:PRES:TYPE FACT */
/*     *RST */
/* - Identify the Instrument model */
/*     *IDN? */
/* - Sets the analyzer center frequency and span */
/*     SENS:FREQ:CENT freq */
/*     SENS:FREQ:SPAN freq */
/* - Sets the analyzer resolution bandwidth */
/*     SENS:BAND rbw */
/* - Selects sampled as the detector mode */
/*     SENS:DET SAMP */
/* - Disable optional Input/Output functions */
/*     :SYST:PORT:IFVS:ENAB OFF */
/* - Turn off auto-alignment */
/*     CAL:AUTO OFF */
/* - Select the desired number of sweep points */
/*     SWE:POINTS points */
/* - Select the appropriate display reference level and */
/*     amplitude reference routing */
/*     E4402B/03B/04B/05B/07B/08B or E7402A/03A/04A/05A */
/*     DISP:WIND:TRAC:Y:RLEV -20 DBM */
/*     CAL:SOUR:STAT ON */
/*     E4401B, E4411B, or E7401A */
/*     DISP:WIND:TRAC:Y:RLEV -25 DBM */
/*     CAL:SOUR:STAT ON; */
/* - Select single sweep mode */
/*     INIT:CONT OFF */
/* - Disable local display */

```

## ESA Programming Examples Using C to Make Faster Power Averaging Measurements

```

/*      DISP:ENAB OFF          */
/* - Select internal machine binary data format (milli-dBm) */
/*      FORM:DAT INT,32      */
/* - Select appropriate byte order (Intel) */
/*      FORM:BORD SWAP      */
/* - Repeat the following the requested number of times: */
/* - Trigger a measurement and wait for completion */
/*      INIT:*OPC?          */
/* - Read the resulting measurement trace */
/*      TRAC:DATA? TRACE1   */
/* - Compute running averaged power at all trace points */
/* - Display measurement statistics */
/* - Write averaged data to second trace display */
/*      TRAC:DATA TRACE2 <definite length block of data> */
/* - Enable viewing of second trace */
/*      TRACE2:MODE VIEW    */
/* - Enable local display for viewing */
/*      DISP:ENAB ON        */
/* - Select continuous sweep mode */
/*      INIT:CONT ON        */
/* - Close session and Return instrument to local control */
/*****

```

```

#include <stdio.h>
#include <stdlib.h>
#include <string.h>
#include <math.h>
#include <sys\timeb.h>
#include <visa.h>

```

```

#define hpESA_IDN_E4401B "Hewlett-Packard, E4401B"
#define hpESA_IDN_E4411B "Hewlett-Packard, E4411B"
#define hpEMC_IDN_E7401A "Hewlett-Packard, E7401A"

```

```

#define NUM_TRACES 100      /* number of traces to average */
*/
#define NUM_POINTS 401     /* requested number of points/trace */
*/
#define CENTER 50          /* center frequency in MHz, an integer */
*/
#define SPAN 20            /* span frequency in MHz, an integer */
*/
#define RBW 300           /* resolution BW in kHz, an integer */
*/

#define DISPLAY 0          /* ESA display enable, disable for speed */
*/

```

```

#define DATA_LENGTH      4  /* number of data bytes in one trace point
*/
#define MAX_POINTS 8192    /* maximum number of points/trace in ESA
*/

int iNumTraces = NUM_TRACES, /* number of traces to average
*/
    iRbw = RBW,              /* resolution bandwidth
*/
    iNumPoints = NUM_POINTS, /* actual number of trace points per sweep
*/
    iSpan = SPAN,           /* Analyzer Frequency Span in MHz
*/
    iCenter = CENTER;      /* Analyzer Center frequency in MHz
*/

int iResult =0;

unsigned long lRetCount;    /* the number of bytes transferred in one trace record
*/

double dDelta, dTimePer, dPower;

struct timeb start_time, stop_time, elapsed_time;

char cCommand[100];
char cBuffer[100];
char cEnter;
double dPwrAvgArray[MAX_POINTS];

ViUInt32 iHeaderLength,    /* header is "#nyyy..." n is number of chars in yyy,
*/
    iArrayLength,         /* yyy is the total data length in bytes
*/
    iTermLength = 1,     /* iArrayLength is number of bytes of data
*/
    iBlockSize,         /* the response message includes a LF character
*/
    iTotRetCount;       /* number of bytes expected in one trace definite block
*/
    /* total number of bytes actually transferred
*/

ViSession defaultRM, viESA;

/* reserve space for the header, data and terminator */
ViChar cInBuffer[sizeof("#nyyy1") + (MAX_POINTS * DATA_LENGTH) ];
ViChar cOutBuffer[sizeof("TRAC:DATA TRACE2,#nyyy1") + (MAX_POINTS * DATA_LENGTH
) ];

/***** Calculate length byte in block header

```

## ESA Programming Examples Using C to Make Faster Power Averaging Measurements

```
*****/  
int HeaderLength(int iArrayLength)      {  
    int iHeaderLength;  
  
    iHeaderLength = 3; /* iArrayLength >0 plus increment for "#" and "n"  
*/  
    while ( (iArrayLength = (iArrayLength / 10)) > 0 )      {  
        iHeaderLength++;  
    }  
  
    return(iHeaderLength);  
}  
  
/*****          prepare ESA for measurement  
*****/  
void setup() {  
  
    viPrintf(viESA, ":SENS:FREQ:CENT %i MHz\n", iCenter);  
    viPrintf(viESA, ":SENS:FREQ:SPAN %i MHz\n", iSpan);  
    viPrintf(viESA, ":SENS:BAND %i KHZ\n", iRbw);  
  
    /* use the sampling detector for power-average calculations      */  
    viPrintf(viESA, ":DET SAMP\n");  
  
    /* Turn off analog output of option board to maximize measurement rate */  
    viPrintf(viESA, ":SYST:PORT:IFVS:ENAB OFF\n");  
  
    /* Turn auto align off to maximize measurement rate      */  
    viPrintf(viESA, ":CAL:AUTO OFF\n");  
  
    /* set requested number of points      */  
    viPrintf(viESA, ":SWE:POINTS %i\n", NUM_POINTS);  
  
    printf("This program will measure and calculate\n");  
    printf ("the power average of %i %i-point  
traces.\n", iNumTraces, iNumPoints);  
  
    /* Turn on 50 MHz amplitude reference signal      */  
    viPrintf(viESA, ":CAL:SOUR:STAT ON\n");  
  
    /* Identify the instrument and get the model number      */  
    viQueryf(viESA, "*IDN?\n", "%t", &cBuffer);  
  
    iResult = (strncmp( cBuffer, hpESA_IDN_E4401B, strlen(hpESA_IDN_E4401B)) &&  
strncmp( cBuffer, hpESA_IDN_E4411B, strlen(hpESA_IDN_E4411B)) && strncmp( cBuffer,  
hpEMC_IDN_E7401A, strlen(hpEMC_IDN_E7401A)));  
    if( iResult == 0 )
```



```

{
/*Set the input port to the 50MHz amplitude reference for the models*/
/*E4401B, E4411B and E7401A*/
viPrintf(viESA,":DISP:WIND:TRAC:Y:RLEV -25 DBM\n");
viPrintf(viESA,"CAL:SOUR:STAT ON \n");
}
else
{
/* For the analyzers having frequency limits >= 3GHz, prompt the user*/
/* to connect the amplitude reference output to the input*/
printf ("Connect AMPTD REF OUT to the INPUT \n");
printf (".....Press Return to continue \n");
scanf( "%c",&cEnter);

/*Externally route the 50MHz Signal*/
viPrintf(viESA, ":DISP:WIND:TRAC:Y:RLEV -20 DBM\n");
viPrintf(viESA,"CAL:SOUR:STAT ON \n");
}

/* Single sweep mode */
viPrintf(viESA, ":INIT:CONT OFF\n");

/* Turn off the local display to maximize measurement rate */
if(!DISPLAY) {
    viPrintf(viESA, ":DISP:ENAB OFF\n");
}

/* transfer data in definite length,32 bit integer blocks. Select */
/* machine units (milli-dBm) to maximize measurement rate */
viPrintf(viESA, ":FORM:DATA INT,32\n" );

/* select the byte order; low-byte first for Intel platforms */
/* To further increase measurement rate,:FORM:BORD NORM could */
/* be used instead. The byte ordering would then need to be */
/* done within this program. */
viPrintf(viESA, ":FORM:BORD SWAP\n");

/* pre-calculate amount of data to be transferred per measurement */
iTermLength = 1;
iArrayLength = iNumPoints * DATA_LENGTH;
iHeaderLength = HeaderLength(iArrayLength);
iBlockSize = iHeaderLength + iArrayLength + iTermLength;
}

```

## ESA Programming Examples

### Using C to Make Faster Power Averaging Measurements

```
/******          Write binary trace data to ESA          *****/
void write_binary_trace(char *cScpiCommand, int *ipTraceData)  {

    /* trace data must point to an integer array of size NUM_POINTS          */
    memcpy(&cOutBuffer[strlen(cScpiCommand)], ipTraceData, iArrayLength);
    memcpy(&cOutBuffer, cScpiCommand, strlen(cScpiCommand));

    /* Add a <newline> to the end of the data, This isn't necessary          */
    /* if the GPIB card has been configured to assert EOI when the last      */
    /* character is sent, but it ensures a valid iTermLength is provided.    */
    cOutBuffer[iArrayLength + strlen(cScpiCommand)] = 0x0A;
    iBlockSize = (strlen(cScpiCommand) + iArrayLength + 1);
    viWrite(viESA, (ViBuf) cOutBuffer, iBlockSize, &lRetCount );
}

/******  Measure and calculate power-average of multiple measurements
*****/
void average()  {
    int i=0, iLoop=0;
    int iArray[NUM_POINTS];

    long lOpc =0L;
    double dLogTen = log(10.0);

    setup();

    iTotalRetCount = lRetCount = 0;

    /* start the timer          */
    ftime( &start_time );

    /* Now run through the event loop iNumTraces times          */
    for(i=0; i<iNumTraces; i++)  {

/* trigger a new measurement and wait for complete          */
        viPrintf(viESA, ":INIT:IMM;*WAI\n");

        /* Read the trace data into a buffer          */
        viPrintf(viESA, ":TRAC:DATA? TRACE1\n");
        viRead(viESA, (ViBuf) cInBuffer, (ViUInt32) iBlockSize, &lRetCount );
        iTotalRetCount += lRetCount;

        /* copy trace data to an array,          */
        /* byte order swapping  could be done here rather than in ESA          */
        memcpy(iArray, &cInBuffer[iHeaderLength], iArrayLength);
    }
}
```

```

/* calculate a running dPower-average */
for(iLoop = 0; iLoop < NUM_POINTS; iLoop++) {
    /* running average of dPower, in milliwatts */
    dPower = exp( dLogTen * (iArray[iLoop]/10000.0));
    if(i > 0) {
        dPwrAvgArray[iLoop] += ((dPower - dPwrAvgArray[iLoop])/(i+1));
    }
    else {
        dPwrAvgArray[iLoop] = dPower;
    }
}
} /* end of event loop */

/* stop the timer */
ftime( &stop_time );

/* Calculate elapsed time */
if (start_time.millitm > stop_time.millitm) {
    stop_time.millitm += 1000;
    stop_time.time--;
}
elapsed_time.millitm = stop_time.millitm - start_time.millitm;
elapsed_time.time = stop_time.time - start_time.time;

/* This is measurement time in milliseconds */
dDelta = (1000.0 * elapsed_time.time) + (elapsed_time.millitm);

/* show measurement statistics */
dTimePer=dDelta/((float)iNumTraces);
printf("\tPower average of %i %i-point traces performed in %3.1f
seconds\n", iNumTraces, iNumPoints, dDelta/1000);
printf("\t%6.1f milliseconds per averaged measurement\n", dTimePer);
printf("\t%6.1f averaged measurements per second\n", 1000.0/dTimePer);
printf("\t%i bytes transferred per trace, %i bytes total\n\n", lRetCount,
iTotalRetCount);
return;
}

/***** Main *****/
void main(void) {
    int iLoop;
    int iAvgArray[NUM_POINTS];
    ViStatus viStatus;

    /* Open a GPIB session at address 18 */
    viStatus = viOpenDefaultRM(&defaultRM);

```

## ESA Programming Examples

### Using C to Make Faster Power Averaging Measurements

```
viStatus = viOpen(defaultRM, "GPIB0::18", VI_NULL, VI_NULL, &viESA);
if(viStatus)
{
    printf("Could not open a session to GPIB device at address 18!\n");
    exit(0);
}

/*Clear the Instrument */
viClear(viESA);

/* go to known instrument state with cleared status byte */
viPrintf(viESA, ":SYST:PRES:TYPE FACT;*RST\n");

/* measure, transfer and calculate power average of multiple traces */
average();

/* convert average power array back to integer array */
for (iLoop = 0; iLoop < iNumPoints; iLoop++) {
    dPower = 10.0 * log10( dPwrAvgArray[iLoop]);
    iAvgArray[iLoop] = (int) (1000.0 * dPower);
}

/* build 'TRAC:DATA TRACE2,#nyyy' header and write the result to Trace 2 */
sprintf(cCommand, ":TRAC:DATA TRACE2,#%i%i", HeaderLength(iArrayLength)-2,
iArrayLength);
write_binary_trace(cCommand, iAvgArray);

/* enable the trace, local display and return to continuous sweep */
viPrintf(viESA, ":TRACE2:MODE VIEW::DISP:ENAB ON::INIT:CONT ON\n");

/* Close session */
viClose(viESA);
viClose(defaultRM);

} /***** End of Main *****/
```

---

**18**      **PSA Programming Examples**

## Examples Included in this Chapter:

- “Using C with Marker Peak Search and Peak Excursion Measurement Routines” on page 280
- “Using C for Saving and Recalling Instrument State Data” on page 283
- “Using C to Save Binary Trace Data” on page 287
- “Using C to Make a Power Calibration Measurement for a GSM Mobile Handset” on page 291
- “Using C with the CALCulate:DATA:COMPRESS? RMS Command” on page 297
- “Using C Over Socket LAN (UNIX)” on page 303
- “Using C Over Socket LAN (Windows NT)” on page 323
- “Using Java Programming Over Socket LAN” on page 326
- “Using the VXI Plug-N-Play Driver in LabVIEW®” on page 335
- “Using LabVIEW® 6 to Make an EDGE GSM Measurement” on page 336
- “Using Visual Basic® .NET with the IVI-Com Driver” on page 338
- “Using Agilent VEE to Capture the Equivalent SCPI Learn String” on page 342

LabVIEW is a registered trademark of National Instruments Corporation.

Visual Basic is a registered trademark of Microsoft Corporation.

## Programming Examples Information and Requirements

- The programming examples were written for use on an IBM compatible PC.
- The programming examples use C, Visual Basic and LabVIEW programming languages.
- There are examples using GPIB and LAN interfaces.
- Many of the examples use the SCPI programming commands, though there are some that use the plug&play or IVI.com drivers.
- Most of the examples are written in C using the Agilent VISA transition library.

The VISA transition library must be installed and the GPIB card configured. The Agilent I/O libraries contain the latest VISA transition library and is available at: [www.agilent.com/iolib](http://www.agilent.com/iolib)

---

## Using C with Marker Peak Search and Peak Excursion Measurement Routines

This C programming example (peaksrch.c) can be found on the Documentation CD.

```
/* **** */
/* peaksrch.c */
/* Agilent Technologies 2001 */
/* */
/* Using Marker Peak Search and Peak Excursion */
/* */
/* This example is for the E444xA PSA Spectrum Analyzers */
/* */
/* This C programming example does the following. */
/* */
/* - Open a GPIB session at address 18 */
/* - Select Spectrum Analysis Mode */
/* - Reset & Clear the Analyzer */
/* - Set the analyzer center frequency and span */
/* - Set the input port to the 50 MHz amplitude reference */
/* - Set the analyzer to single sweep mode */
/* - Prompt the user for peak excursion level in dBm */
/* - Set the peak threshold to user defined level */
/* - Trigger a sweep and wait for sweep to complete */
/* - Set the marker to the maximum peak */
/* - Query and read the marker frequency and amplitude */
/* - Close the session */
/* **** */

#include <windows.h>
#include <stdio.h>
#include "visa.h"

ViSession defaultRM, viPSA;
ViStatus errStatus;
```



```
void main()
{
    /*Program Variables*/
    ViStatus viStatus = 0;
    char cEnter = 0;
    int iResult = 0;
    double dMarkerFreq = 0;
    double dMarkerAmpl = 0;
    float fPeakExcursion =0;
    long lOpc = 0L;

    char *psaSetup = // PSA setup initialization
        ":INST SA;" // Change to Spectrum Analysis mode
        "*RST;*CLS;" // Reset the device and clear status
        ":SENS:FREQ:CENT 50 MHz;"// Set center freq to 50 MHz
        ":SENS:FREQ:SPAN 50 MHz;"// Set freq span to 50 MHz
        ":SENS:FEED AREF;"// Set input port to internal 50 MHz ref
        ":INIT:CONT 0;"// Set analyzer to single sweep mode
        ":CALC:MARK:PEAK:THR -90;"// Set the peak threshold to -90 dBm

    /*Open a GPIB session at address 18.*/
    viStatus=viOpenDefaultRM(&defaultRM);
    viStatus=viOpen(defaultRM, "GPIB0::18", VI_NULL, VI_NULL, &viPSA);
    if(viStatus)
    {
        printf("Could not open a session to GPIB device at address 18!\n");
        exit(0);
    }

    /*Display the program heading */
    printf("\n\t\t Marker Program \n\n" );

    /* Send setup commands to instrument */
    viPrintf(viPSA, "%s\n", psaSetup);
}
```

## PSA Programming Examples

### Using C with Marker Peak Search and Peak Excursion Measurement Routines

```
/*User enters the peak excursion value */
printf("\t Enter PEAK EXCURSION level in dBm:  ");
scanf( "%f",&fPeakExcursion);

/*Set the peak excursion*/
viPrintf(viPSA,"CALC:MARK:PEAK:EXC %lfDB \n",fPeakExcursion);

/*Trigger a sweep and wait for completion*/
viPrintf(viPSA,"INIT:IMM;*WAI\n");

/*Set the marker to the maximum peak*/
viPrintf(viPSA,"CALC:MARK:MAX \n");

/*Query and read the marker frequency*/
viQueryf(viPSA,"CALC:MARK:X? \n","%lf",&dMarkerFreq);
printf("\n\t RESULT: Marker Frequency is: %lf MHz \n\n",dMarkerFreq/10e5);

/*Query and read the marker amplitude*/
viQueryf(viPSA,"CALC:MARK:Y?\n","%lf",&dMarkerAmpl);
printf("\t RESULT: Marker Amplitude is: %lf dBm \n\n",dMarkerAmpl);

/*Close the session*/
viClose(viPSA);
viClose(defaultRM);
}
```

---

## Using C for Saving and Recalling Instrument State Data

This C programming example (State.c) can be found on the Documentation CD.

```
/******  
* State.c  
* Agilent Technologies 2001  
*  
* PSA Series Transmitter Tester using VISA for I/O  
* This program shows how to save and recall a state of the instrument  
*  
*****/  
  
#include <stdio.h>  
#include <stdlib.h>  
#include <conio.h>  
#include "visa.h"  
  
void main ()  
{  
    /*program variables*/  
    ViSession defaultRM, viVSA;  
    ViStatus viStatus= 0;  
  
    /*open session to GPIB device at address 18 */  
    viStatus=viOpenDefaultRM (&defaultRM);  
    viStatus=viOpen (defaultRM, "GPIB0::18::INSTR", VI_NULL,VI_NULL, &viVSA);  
  
    /*check opening session sucess*/  
    if(viStatus)  
    {  
        printf("Could not open a session to GPIB device at address 18!\n");  
        exit(0);  
    }  
}
```

## PSA Programming Examples Using C for Saving and Recalling Instrument State Data

```
/*set the instrument to SA mode*/
viPrintf(viVSA, "INST SA\n");

/*reset the instrument */
viPrintf(viVSA, "*RST\n");

/*set the input port to the internal 50Mhz reference source*/
viPrintf(viVSA, "SENS:FEED AREF\n");

/*tune the analyzer to 50MHZ*/
viPrintf(viVSA, "SENS:FREQ:CENT 50E6\n");

/*change the span*/
viPrintf(viVSA, "SENS:FREQ:SPAN 10 MHZ\n");

/*turn the display line on*/
viPrintf(viVSA, "DISP:WIND:TRACE:Y:DLINE:STATE ON\n");

/*change the resolution bandwidth*/
viPrintf(viVSA, "SENS:SPEC:BAND:RES 100E3\n");

/*change the Y Axis Scale/Div*/
viPrintf(viVSA, "DISP:WIND:TRAC:Y:SCAL:PDIV 5\n");

/*Change the display refernece level*/
viPrintf(viVSA, "DISP:WIND:TRAC:Y:SCAL:RLEV -15\n");

/*trigger the instrument*/
viPrintf(viVSA, "INIT:IMM;*WAI\n");

/*save this state in register 10.
!!!Carefull this will overwrite register 10*/

viPrintf(viVSA, "*SAV 10\n");
/*display message*/
```



PSA Programming Examples  
Using C for Saving and Recalling Instrument State Data

```
viPrintf(viVSA, "*RST;*wai\n");

/*Set the instrument to continuous sweep */
viPrintf(viVSA, "INIT:CONT 1\n");

/* close session */
viClose (viVSA);
viClose (defaultRM);
}
```

## Using C to Save Binary Trace Data

This C programming example (Trace.c) can be found on the Documentation CD.

This example uses Option B7J.

```

/*****
*   Trace.c
*   Agilent Technologies 2001
*
*   Instrument Requirements:
*       E444xA with option B7J and firmware version >= A.02.00 or
*       E4406A with firmware version >= A.05.00
*
*   This Program shows how to get and save binary trace data in Basic mode
*   The results are saved to C:\trace.txt
*****/

#include <stdio.h>
#include <stdlib.h>
#include <windows.h>
#include "visa.h"

void main ()
{
    /*program variable*/
    ViSession defaultRM, viPSA;
    ViStatus viStatus= 0;
    char sBuffer[80]= {0};
    char dummyvar;
    FILE *fTraceFile;
    long lNumberPoints= 0;
    long lNumberBytes= 0;
    long lLength= 0;
    long i = 0;
    long lOpc = 0L;
    unsigned long lBytesRetrieved;

```

## PSA Programming Examples Using C to Save Binary Trace Data

```
ViReal64 adTraceArray[10240];

char *psaSetup =/* setup commands for VSA/PSA */
    ":INST BASIC;"/ * Set the instrument mode to Basic */
    "*RST;*CLS;"/ * Reset the device and clear status */
    ":INIT:CONT 0;"/ * Set analyzer to single measurement mode */
    ":FEED AREF;"/ * set the input port to the internal
        50MHz reference source */
    ":DISP:FORM:ZOOM1;"/ * zoom the spectrum display */
    ":FREQ:CENT 50E6;"/ * tune the analyzer to 50MHz */
    ":FORM REAL,64;"/ * Set the output format to a binary format */
    ":FORM:BORD SWAP;"/ * set the binary byte order to SWAP (for PC) */
    ":INIT:IMM;"/ * trigger a spectrum measurement */

/*open session to GPIB device at address 18 */
viStatus=viOpenDefaultRM (&defaultRM);
viStatus=viOpen (defaultRM, "GPIB0::18::INSTR", VI_NULL,VI_NULL, &viPSA);

/*check opening session success*/
if(viStatus)
{
    printf("Could not open a session to GPIB device at address 18!\n");
    exit(0);
}

/* Set I/O timeout to ten seconds */
viSetAttribute(viPSA,VI_ATTR_TMO_VALUE,10000);

/* Send setup commands to instrument */
viPrintf(viPSA,"%s\n",vsaSetup);

/* Query the instrument for Operation complete */
viQueryf(viPSA,"*OPC?\n", "%d", &lOpc);

/* fetch the spectrum trace data*/
viPrintf(viPSA,"FETC:SPEC7?\n");
```



```

/*print message to the standard output*/
printf("Getting the spectrum trace in binary format...\nPlease wait...\n\n");

/* get number of bytes in length of postceeding trace data
   and put this in sBuffer*/
viRead (viPSA,(ViBuf)sBuffer,2,&lBytesRetrieved);

/* Put the trace data into sBuffer */
viRead (viPSA,(ViBuf)sBuffer,sBuffer[1] - '0',&lBytesRetrieved);

/* append a null to sBuffer */
sBuffer[lBytesRetrieved] = 0;

/* convert sBuffer from ASCII to integer */
lNumberBytes = atoi(sBuffer);

/* calculate the number of points given the number of byte in the trace
   REAL 64 binary format means each number is represented by 8 bytes*/
lNumberPoints = lNumberBytes/sizeof(ViReal64);

/*get and save trace in data array */
viRead (viPSA,(ViBuf)adTraceArray,lNumberBytes,&lBytesRetrieved);

/* read the terminator character and discard */
viRead (viPSA,(ViBuf)sBuffer,1, &lLength);

/*print message to the standard output*/
printf("Querying instrument to see if any errors in Queue.\n");

/* loop until all errors read */
do
{
    viPrintf (viPSA,"SYST:ERR?\n");/* check for errors */
    viRead (viPSA,(ViBuf)sBuffer,80,&lLength);/* read back last error message
*/

```

## PSA Programming Examples Using C to Save Binary Trace Data

```
sBuffer[lLength] = 0; /* append a null to byte count */
printf("%s\n",sBuffer); /* print error buffer to display */
} while (sBuffer[1] != '0');

/* set the analyzer to continuous mode for manual use */
viPrintf(viPSA, "INIT:CONT 1\n");

/*save trace data to an ASCII file*/
fTraceFile=fopen("C:\\Trace.txt","w");
fprintf(fTraceFile,"Trace.exe Output\nAgilent Technologies 2001\n\n");
fprintf(fTraceFile,"List of %d points of the averaged spectrum
trace:\n\n",lNumberPoints);
for (i=0;i<lNumberPoints;i++)
    fprintf(fTraceFile,"\tAmplitude of point[%d] = %.2lf
dBm\n",i+1,adTraceArray[i]);
fclose(fTraceFile);

/*print message to the standard output*/
printf("The %d trace points were saved to C:\\Trace.txt
file\n\n",lNumberPoints);

/* Send message to standard output */
printf("\nPress Enter to set analyzer's input port back to RF.\n");
scanf("%c",&dummyvar);

/* set the input port to RF */
viPrintf(viPSA, "feed rf\n");

/* Close session */
viClose (viPSA);
viClose (defaultRM);
}
```



## PSA Programming Examples

### Using C to Make a Power Calibration Measurement for a GSM Mobile Handset

```
* Instrument Requirements:
*   E444xA with option B7J and firmware version >= A.05.00 or
*   E4406A with firmware version >= A.07.00 or
*
* Signal Source Setup:
*   Set up GSM/EDGE frame for either 1, 2, 4, or eight slots per frame.
*   When configuring two slots per frame, turn on slots 1 and 5
*   When configuring four slots per frame, turn on slots 1,3,5, and 7.
*   Set frame repeat to Single.
*   Set the signal amplitude to -5 dBm.
*   Set the signal source frequency to 935.2 MHz
*
* CALC:DATA2:COMP? DME parameters:
*   soffset = 25us (This avoids averaging data points when the burst
*                   is transitioning on.)
*   length = 526us (Period over which the power of the burst is averaged)
*   roffset = 4.6153846 ms / slots per frame (Repetition interval of burst)
*****/
#include <stdio.h>
#include <stdlib.h>
#include <windows.h>
#include <math.h>
#include "c:\program files\visa\winnt\include\visa.h"

void main ()
{
    /*program variable*/
    ViSession defaultRM, viVSA;
    ViStatus viStatus= 0;
    ViUInt16 stb;
    FILE *fDataFile;
    long lthrowaway,lbursts;
    long lNumberPoints= 0;
    long lNumberBytes= 0;
    long lLength      = 0;
```

```

long i                = 0;
long lOpc = 0L;
double sweeptime     = 0;
double burstinterval= 0;
unsigned long lBytesRetrieved;
ViReal64 addataArray[100];
char sBuffer[80]= {0};

char *basicSetup = // measurement setup commands for VSA/PSA
  " :INST:SEL BASIC;"// Put the instrument in Basic Mode
  "*RST;" // Preset the instrument
  "*CLS;    //"Clear the status byte
  " :STAT:OPER:ENAB 32;" //Enable Status Operation
  " :DISP:ENAB 0;"// Turn the Display off (improves Speed)
  " :FORM REAL,64;"// Set the ouput format to binary
  " :FORM:BORD SWAP;"// set the binary byte order to SWAP (for PC)
  " :CONF:WAV;"// Changes measurement to Waveform
  " :INIT:CONT 0;"// Puts instrument in single measurement mode
  " :CAL:AUTO OFF;"//Turn auto align off
  " :FREQ:CENTER 935.2MHZ;"//Set Center Freq to 935.2MHZ
  " :WAV:ACQ:PACK MED;"//Set DataPacking to Medium
  " :WAV:BAND:TYPE FLAT;"//Select Flattop RBW Filter
  " :WAV:DEC:FACT 4;"//Set Decimation Factor to 4
  " :WAV:DEC:STAT ON;"//Turn Decimation On
  " :DISP:WAV:WIND1:TRAC:Y:RLEV 5;" //Set referance level to 5 dBm
  " :WAV:BWID:RES 300kHz;"//Set Res bandwidth filter to 300kHz
  " :POW:RF:ATT 5;"//Set 5dB of internal attenuation
  " :WAV:ADC:RANG P0;"//Set ADC Range to P0, This is
  //necessary to prevent autoranging
  " :WAV:TRIG:SOUR IF;"//Set Trigger source to IF burst
  " :TRIG:SEQ:IF:LEV -20;"//Set IF Trig level to -20dB

/*open session to GPIB device at address 18 */
viStatus=viOpenDefaultRM (&defaultRM);
viStatus=viOpen (defaultRM, "GPIB0::18", VI_NULL,VI_NULL,&viVSA);

```

## PSA Programming Examples

### Using C to Make a Power Calibration Measurement for a GSM Mobile Handset

```
/*check opening session suces*/
if(viStatus)
{
    printf("Could not open a session to GPIB device at address 18!\n");
    exit(0);
}

/* Set I/O timeout to ten seconds */
viSetAttribute(viVSA,VI_ATTR_TMO_VALUE,10000);

viClear(viVSA);//send device clear to instrument

/*print message to the standard output*/
printf("Enter number of bursts per frame (1,2,4 or 8): ");
scanf( "%ld",&lbursts);

/* Send setup commands to instrument */
viPrintf(viVSA,"%s\n",basicSetup);

/* Calculate sweep time and set it*/
burstinterval = 4.6153846 / 1000.00 / lbursts;
sweeptime= burstinterval * 75.0;

viPrintf(viVSA,":WAV:SWE:TIME %fs\n",sweeptime);

/* Clear status event register */
viQueryf(viVSA,"STAT:OPER:EVENT?\n","%ld",&lthrowaway);

/* Initiate the waveform measurement and get the instrument ready
to calculate the mean RMS I/Q voltage in each burst
(We will convert these discreate values into Mean dBm Power values) */

viPrintf(viVSA,"INIT:IMM\n");

/* Serial poll the instrument to determine when it is waiting for
trigger and the GSM phone can be told to send its 75 bursts. */
```

```
while(1)
{
    viReadSTB(viVSA,&stb); //read status byte
    if (stb & 128) break; //look for "waiting for trigger" bit
    printf("Waiting on Analyzer...\n");
    Sleep (50); // wait 50 ms between each serial poll
}
/*print message to the standard output*/
printf("Analyzer is Ready!\n\nWaiting for phone to trigger...\n\n");

/*Query for Operation Complete */
viQueryf(viVSA,"*OPC?\n", "%d", &lOpc);

/*Use the CALC:DATA0:COMP command to return the average power in each burst*/
viPrintf(viVSA,":CALC:DATA2:COMP? DME,25E-6,526E-6,%f\n",burstinterval);

/* get number of bytes in length of postceeding data and put this in sBuffer*/
viRead (viVSA,(ViBuf)sBuffer,2,&lBytesRetrieved);
printf("Getting the burst data in binary format...\n\n");

/* Put the returned data into sBuffer */
viRead (viVSA,(ViBuf)sBuffer,sBuffer[1] - '0',&lBytesRetrieved);

/* append a null to sBuffer */
sBuffer[lBytesRetrieved] = 0;

/* convert sBuffer from ASCII to integer */
lNumberBytes = atoi(sBuffer);

/*calculate the number of returned values given the number of bytes.
    REAL 64 binary data means each number is represented by 8 bytes */
lNumberPoints = lNumberBytes/sizeof(ViReal64);

/*get and save returned data into an array */
viRead (viVSA,(ViBuf)adDataArray,lNumberBytes,&lBytesRetrieved);
```

PSA Programming Examples  
Using C to Make a Power Calibration Measurement for a GSM Mobile  
Handset

```
/* read the terminator character and discard */
viRead (viVSA,(ViBuf)sBuffer,1, &lthrowaway);

/*print message to the standard output*/
printf("Querying instrument to see if any errors in Queue.\n");

/* loop until all errors read */
do
{
    viPrintf (viVSA,"SYST:ERR?\n");          /* check for errors */
    viRead (viVSA,(ViBuf)sBuffer,80,&lLength);/* read back last error message */
    sBuffer[lLength] = 0;                    /* append a null to byte count */
    printf("%s\n",sBuffer);                  /* print error buffer to display */
} while (sBuffer[1] != '0');

/* Turn the Display of the instrument back on */
viPrintf(viVSA,"DISP:ENAB 1\n");

/*save result data to an ASCII file*/
fDataFile=fopen("powercal.txt","w");
fprintf(fDataFile,"powercal.exe Output\nAgilent Technologies 2003\n\n");
fprintf(fDataFile,"Power of %d GSM/EDGE bursts:\n",lNumberPoints);
fprintf(fDataFile,"(%d burst(s) per frame):\n\n",lbursts);
for (i=0;i<lNumberPoints;i++)
{
    fprintf(fDataFile,"\tPower of burst[%d] = %.2lf dBm\n",i+1,adDataArray[i]);
}
fclose(fDataFile);

/*print message to the standard output*/
printf("The %d burst powers were saved to powercal.txt
file.\n\n",lNumberPoints);

viClose (viVSA);
viClose (defaultRM);
}
```



## Using C with the CALCulate:DATA:COMPRESS? RMS Command

This C programming example (calcomp.c) can be found on the Documentation CD.

This program uses the CALCulate:DATA:COMPRESS? RMS command to average the voltage trace data to calculate power of consecutive GSM bursts. Older instrument firmware does *not* support the newer DME parameter described in the previous example. You will have to use the technique in this example to calculate the dB mean. This example uses the Waveform measurement in the Basic mode. Basic mode is optional -B7J- in the PSA Series spectrum analyzers and is standard in the E4406A Vector Signal Analyzer.

The CALC:DATA2:COMP? RMS command is used to return the power of 1 to 150 consecutive GSM/EDGE bursts. The RMS parameter returns the average of the voltage trace values. These measured values are then converted to dBm values.

This program also demonstrates how to serial poll the instrument to determine when the Message Available status bit is set.

```

/*****
calcomp.c
*   Agilent Technologies 2001
*
*   This program demonstrates the process of using the Waveform
*   measurement and the CALC:DATA0:COMP? RMS command to return the power
*   of 1 to 450 consecutive GSM/EDGE bursts (one burst per frame).
*   The data results are placed in an ASCII file, C:\calccomp.txt
*
*   Instrument Requirements:
*       E444xA with option B7J and firmware version >= A.02.00 or
*       E4406A with firmware version >= A.05.00 or
*
*   Signal Source Setup:
*       Turn on 1 slot per GSM/EDGE frame.
*       Set frame repeat to Continuous.
*       Set the signal amplitude to -5 dBm.
*       Set the signal source frequency to 935.2 MHz
*
*****/

```

PSA Programming Examples  
Using C with the CALCulate:DATA:COMPRESS? RMS Command

```

*      CALC:DATA0:COMP? RMS parameters:
*
*      soffset = 25us (This avoids averaging data points when the burst
*
*              is transitioning on.)
*
*      length = 526us (Period over which the power of the burst is averaged)
*
*      roffset = 4.165 ms (Repetition interval of burst. For this example
*
*              it is equal to one GSM frame: 4.165 ms.)
*****/
#include <stdio.h>
#include <stdlib.h>
#include <windows.h>
#include <math.h>
#include "visa.h"

void main ()
{
    /*program variable*/
    ViSession defaultRM, viPSA;
    ViStatus viStatus= 0;
    ViUInt16 stb;
    FILE *fDataFile;
    long lthrowaway,lbursts;
    long lNumberPoints= 0;
    long lNumberBytes= 0;
    long lLength      = 0;
    long i             = 0;
    long lOpc         = 0L;
    double sweeptime  = 0;
    unsigned long lBytesRetrieved;
    ViReal64 adDataArray[500];
    ViReal64 adPowerArray[500];
    char sBuffer[80]= {0};

    char *basicSetup = // measurement setup commands for VSA/PSA
        ":INST:SEL BASIC;"// Put the instrument in Basic Mode
        "*RST;"// Preset the instrument
        "*CLS;" //Clear the status byte

```

```
":DISP:ENAB 0;"// Turn the Display off (improves Speed)
":FORM REAL,64;"// Set the output format to binary
":FORM:BORD SWAP;"// set the binary byte order to SWAP (for PC)
":CONF:WAV;"// Changes measurement to Waveform
":INIT:CONT 0;"// Puts instrument in single measurement mode
":CAL:AUTO OFF;"//Turn auto align off
":FREQ:CENTER 935.2MHz;"//Set Center Freq to 935.2MHz
":WAV:ACQ:PACK MED;"//Set DataPacking to Medium
":WAV:BAND:TYPE FLAT;"//Select Flattop RBW Filter
":WAV:DEC:FACT 4;"//Set Decimation Factor to 4
":WAV:DEC:STAT ON;"//Turn Decimation On
":DISP:WAV:WIND1:TRAC:Y:RLEV 5;" //Set reference level to 5 dBm
":WAV:BWID:RES 300kHz;"//Set Res bandwidth filter to 300kHz
":POW:RF:ATT 5;"//Set 5dB of internal attenuation
":WAV:TRIG:SOUR IF;"//Set Trigger source to IF burst
":TRIG:SEQ:IF:LEV -20;"//Set IF Trig level to -20dB

/*open session to GPIB device at address 18 */
viStatus=viOpenDefaultRM (&defaultRM);
viStatus=viOpen (defaultRM, "GPIB0::18", VI_NULL,VI_NULL,&viPSA);

/*check opening session success*/
if(viStatus)
{
    printf("Could not open a session to GPIB device at address 18!\n");
    exit(0);
}

/* Set I/O timeout to ten seconds */
viSetAttribute(viPSA,VI_ATTR_TMO_VALUE,10000);

viClear(viPSA);//send device clear to instrument

/*print message to the standard output*/
printf("Enter number of bursts (1 to 450) to calculate mean power for: ");
scanf( "%ld",&lbursts);
```

## PSA Programming Examples

### Using C with the CALCulate:DATA:COMPRESS? RMS Command

```
/* Send setup commands to instrument */
viPrintf(viPSA,"%s\n",basicSetup);

/* Calculate sweep time and set it*/
sweeptime=4.6153846*lbursts;
viPrintf(viPSA,":WAV:SWE:TIME %fms\n",sweeptime);

/* Clear status event register */
viQueryf(viPSA,"STAT:OPER:EVENT?\n","%ld",&lthrowaway);

/* Initiate the waveform measurement */
viPrintf(viPSA,"INIT:IMM\n");

/* Query the instrument for Operation complete */
viQueryf(viPSA,"*OPC?\n", "%d", &lOpc);

/* Have the instrument calculate the mean RMS I/Q voltage in each burst
   (We will convert these discrete values into Mean dBm Power values) */
viPrintf (viPSA, ":CALC:DATA0:COMP? rms,25E-6,526E-6,4.61538461538E-3\n");

/* Serial poll the instrument to determine when Message Available
   Status Bit is set. The instrument's output buffer will then
   contain the measurement results*/
i=0;
while(1)
{
    i++;
    viReadSTB(viPSA,&stb); //read status byte
    if (stb & 16) break; //look for message available bit
    Sleep (20); // wait 100ms before polling again
}

/*print message to the standard output*/
printf("\nMessage Available status bit set after %ld serial poles.\n\n",i);
printf("Getting the burst data in binary format...\nPlease wait...\n\n");
```

```
/* get number of bytes in length of postceding data
   and put this in sBuffer*/
viRead (viPSA,(ViBuf)sBuffer,2,&lBytesRetrieved);

/* Put the returned data into sBuffer */
viRead (viPSA,(ViBuf)sBuffer,sBuffer[1] - '0',&lBytesRetrieved);

/* append a null to sBuffer */
sBuffer[lBytesRetrieved] = 0;

/* convert sBuffer from ASCII to integer */
lNumberBytes = atoi(sBuffer);

/*calculate the number of returned values given the number of bytes.
   REAL 64 binary data means each number is represented by 8 bytes */
lNumberPoints = lNumberBytes/sizeof(ViReal64);

/*get and save returned data into an array */
viRead (viPSA,(ViBuf)adDataArray,lNumberBytes,&lBytesRetrieved);

/* read the terminator character and discard */
viRead (viPSA,(ViBuf)sBuffer,1, &lthrowaway);

/*print message to the standard output*/
printf("Querying instrument to see if any errors in Queue.\n");

/* loop until all errors read */
do
{
    viPrintf (viPSA,"SYST:ERR?\n");          /* check for errors */
    viRead (viPSA,(ViBuf)sBuffer,80,&lLength);/* read back last error message */
    sBuffer[lLength] = 0;                   /* append a null to byte count */
    printf("%s\n",sBuffer);                 /* print error buffer to display */
} while (sBuffer[1] != '0');
```

## PSA Programming Examples

### Using C with the CALCulate:DATA:COMPRESS? RMS Command

```
/* Turn the Display of the instrument back on */
viPrintf(viPSA,"DISP:ENAB 1\n");

/*save result data to an ASCII file*/
fDataFile=fopen("C:\\calccomp.txt","w");
fprintf(fDataFile,"Calccomp.exe Output\nAgilent Technologies 2001\n\n");
fprintf(fDataFile,"Power of %d GSM/EDGE bursts:\n\n",lNumberPoints);
for (i=0;i<lNumberPoints;i++)
{
    /* Convert RMS voltage for each burst to Mean Power in dBm */
    adPowerArray[i]=10*log10(10*adDataArray[i]*adDataArray[i]);
    fprintf(fDataFile,"\tPower of burst[%d] = %.2lf
dBm\n",i+1,adPowerArray[i]);
}
fclose(fDataFile);
/*print message to the standard output*/
printf("The %d burst powers were saved to C:\\calccomp.txt
file.\n\n",lNumberPoints);

viClose (viPSA);
viClose (defaultRM);
}
```

## Using C Over Socket LAN (UNIX)

This C programming example (socketio.c) compiles in the HP-UX UNIX environment. It is portable to other UNIX environments with only minor changes.

In UNIX, LAN communication via sockets is very similar to reading or writing a file. The only difference is the `openSocket()` routine, which uses a few network library routines to create the TCP/IP network connection. Once this connection is created, the standard `fread()` and `fwrite()` routines are used for network communication.

In Windows, the routines `send()` and `recv()` must be used, since `fread()` and `fwrite()` may not work on sockets.

The program reads the analyzer's host name from the command line, followed by the SCPI command. It then opens a socket to the analyzer, using port 5025, and sends the command. If the command appears to be a query, the program queries the analyzer for a response, and prints the response.

This example program can also be used as a utility to talk to your analyzer from the command prompt on your UNIX workstation or Windows 95 PC, or from within a script.

This program is also available on your documentation CD ROM.

```

/*****
* $Header: socketio.c,v 1.5 96/10/04 20:29:32 roger Exp $
* $Revision: 1.5 $
* $Date: 96/10/04 20:29:32 $
*
* $Contributor:      LSID, MID $
*
* $Description:      Functions to talk to an Agilent E4440A spectrum
*                    analyzer via TCP/IP.  Uses command-line arguments.
*
*                    A TCP/IP connection to port 5025 is established and
*                    the resultant file descriptor is used to "talk" to the
*                    instrument using regular socket I/O mechanisms. $
*
*
*
* E4440A Examples:

```

## PSA Programming Examples Using C Over Socket LAN (UNIX)

```
*
* Query the center frequency:
*   lanio 15.4.43.5 'sens:freq:cent?'
*
* Query X and Y values of marker 1 and marker 2 (assumes they are on):
*   lanio myinst 'calc:spec:mark1:x?;y?; :calc:spec:mark2:x?;y?'
*
* Check for errors (gets one error):
*   lanio myinst 'syst:err?'
*
* Send a list of commands from a file, and number them:
*   cat scpi_cmds | lanio -n myinst
*
*****
*
* This program compiles and runs under
*   - HP-UX 10.20 (UNIX), using HP cc or gcc:
*       + cc -Aa      -O -o lanio  lanio.c
*       + gcc -Wall  -O -o lanio  lanio.c
*
*   - Windows 95, using Microsoft Visual C++ 4.0 Standard Edition
*   - Windows NT 3.51, using Microsoft Visual C++ 4.0
*       + Be sure to add  WSOCK32.LIB  to your list of libraries!
*       + Compile both lanio.c and getopt.c
*       + Consider re-naming the files to lanio.cpp and getopt.cpp
*
* Considerations:
*   - On UNIX systems, file I/O can be used on network sockets.
*     This makes programming very convenient, since routines like
*     getc(), fgets(), fscanf() and fprintf() can be used.  These
*     routines typically use the lower level read() and write() calls.
*
*   - In the Windows environment, file operations such as read(), write(),
*     and close() cannot be assumed to work correctly when applied to
*     sockets.  Instead, the functions send() and recv() MUST be used.
*/
```



```

/* Support both Win32 and HP-UX UNIX environment */
#ifdef _WIN32      /* Visual C++ 4.0 will define this */
# define WINSOCK
#endif

#ifndef WINSOCK
# ifndef _HPUX_SOURCE
# define _HPUX_SOURCE
# endif
#endif

#include <stdio.h>      /* for fprintf and NULL */
#include <string.h>     /* for memcpy and memset */
#include <stdlib.h>     /* for malloc(), atol() */
#include <errno.h>     /* for strerror */

#ifdef WINSOCK

#include <windows.h>

# ifndef _WINSOCKAPI_
# include <winsock.h>  // BSD-style socket functions
# endif

#else /* UNIX with BSD sockets */

# include <sys/socket.h> /* for connect and socket*/
# include <netinet/in.h> /* for sockaddr_in */
# include <netdb.h>      /* for gethostbyname */

# define SOCKET_ERROR (-1)
# define INVALID_SOCKET (-1)

typedef int SOCKET;

```

## PSA Programming Examples Using C Over Socket LAN (UNIX)

```
#endif /* WINSOCK */

#ifdef WINSOCK
    /* Declared in getopt.c. See example programs disk. */
    extern char *optarg;
    extern int  optind;
    extern int  getopt(int argc, char * const argv[], const char* optstring);
#else
# include <unistd.h>          /* for getopt(3C) */
#endif

#define COMMAND_ERROR  (1)
#define NO_CMD_ERROR  (0)

#define SCPI_PORT  5025
#define INPUT_BUF_SIZE (64*1024)

/*****
 * Display usage
 *****/
static void usage(char *basename)
{
    fprintf(stderr, "Usage: %s [-nqu] <hostname> [<command>]\n", basename);
    fprintf(stderr, "      %s [-nqu] <hostname> < stdin\n", basename);
    fprintf(stderr, " -n, number output lines\n");
    fprintf(stderr, " -q, quiet; do NOT echo lines\n");
    fprintf(stderr, " -e, show messages in error queue when done\n");
}

#ifdef WINSOCK
int init_winsock(void)
{
    WORD wVersionRequested;

```

```

WSADATA wsaData;
int err;
wVersionRequested = MAKEWORD(1, 1);
wVersionRequested = MAKEWORD(2, 0);

err = WSASStartup(wVersionRequested, &wsaData);

if (err != 0) {
    /* Tell the user that we couldn't find a useable */
    /* winsock.dll.      */
    fprintf(stderr, "Cannot initialize Winsock 1.1.\n");
    return -1;
}
return 0;
}

int close_winsock(void)
{
    WSACleanup();
    return 0;
}
#endif /* WINSOCK */

/*****
*
* > $Function: openSocket$
*
* $Description: open a TCP/IP socket connection to the instrument $
*
* $Parameters: $
*   (const char *) hostname . . . . Network name of instrument.
*                               This can be in dotted decimal notation.
*   (int) portNumber . . . . . The TCP/IP port to talk to.
*                               Use 5025 for the SCPI port.
*****/

```

## PSA Programming Examples Using C Over Socket LAN (UNIX)

```
*
* $Return:      (int) . . . . . A file descriptor similar to open(1).$
*
* $Errors:      returns -1 if anything goes wrong $
*
*****/
SOCKET openSocket(const char *hostname, int portNumber)
{
    struct hostent *hostPtr;
    struct sockaddr_in peeraddr_in;
    SOCKET s;

    memset(&peeraddr_in, 0, sizeof(struct sockaddr_in));

    /*****/
    /* map the desired host name to internal form. */
    /*****/
    hostPtr = gethostbyname(hostname);
    if (hostPtr == NULL)
    {
        fprintf(stderr, "unable to resolve hostname '%s'\n", hostname);
        return INVALID_SOCKET;
    }

    /*****/
    /* create a socket */
    /*****/
    s = socket(AF_INET, SOCK_STREAM, 0);
    if (s == INVALID_SOCKET)
    {
        fprintf(stderr, "unable to create socket to '%s': %s\n",
                hostname, strerror(errno));
        return INVALID_SOCKET;
    }
}
```

```

memcpy(&peeraddr_in.sin_addr.s_addr, hostPtr->h_addr, hostPtr->h_length);
peeraddr_in.sin_family = AF_INET;
peeraddr_in.sin_port = htons((unsigned short)portNumber);

if (connect(s, (const struct sockaddr*)&peeraddr_in,
           sizeof(struct sockaddr_in)) == SOCKET_ERROR)
{
    fprintf(stderr, "unable to create socket to '%s': %s\n",
           hostname, strerror(errno));
    return INVALID_SOCKET;
}

return s;
}

```

```

/*****
 *
 * $Function: commandInstrument$
 *
 * $Description: send a SCPI command to the instrument.$
 *
 * $Parameters: $
 *   (FILE *) . . . . . file pointer associated with TCP/IP socket.
 *   (const char *command) . . SCPI command string.
 * $Return: (char *) . . . . . a pointer to the result string.
 *
 * $Errors: returns 0 if send fails $
 *
 *****/
int commandInstrument(SOCKET sock,
                    const char *command)
{
    int count;

```

## PSA Programming Examples Using C Over Socket LAN (UNIX)

```
/* fprintf(stderr, "Sending \"%s\".\n", command); */
if (strchr(command, '\n') == NULL) {
    fprintf(stderr, "Warning: missing newline on command %s.\n", command);
}

count = send(sock, command, strlen(command), 0);
if (count == SOCKET_ERROR) {
    return COMMAND_ERROR;
}

return NO_CMD_ERROR;
}

/*****
 * recv_line(): similar to fgets(), but uses recv()
 *****/
char * recv_line(SOCKET sock, char * result, int maxLength)
{
#ifdef WINSOCK
    int cur_length = 0;
    int count;
    char * ptr = result;
    int err = 1;

    while (cur_length < maxLength) {
        /* Get a byte into ptr */
        count = recv(sock, ptr, 1, 0);

        /* If no chars to read, stop. */
        if (count < 1) {
            break;
        }
        cur_length += count;

        /* If we hit a newline, stop. */

```

```

        if (*ptr == '\n') {
            ptr++;
            err = 0;
            break;
        }
        ptr++;
    }

    *ptr = '\0';

    if (err) {
        return NULL;
    } else {
        return result;
    }
#else
    /*****
     * Simpler UNIX version, using file I/O.  recv() version works too.
     * This demonstrates how to use file I/O on sockets, in UNIX.
     *****/
    FILE * instFile;
    instFile = fdopen(sock, "r+");
    if (instFile == NULL)
    {
        fprintf(stderr, "Unable to create FILE * structure : %s\n",
                strerror(errno));
        exit(2);
    }
    return fgets(result, maxLength, instFile);
#endif
}

/*****

```

## PSA Programming Examples Using C Over Socket LAN (UNIX)

```
*
> $Function: queryInstrument$
*
* $Description: send a SCPI command to the instrument, return a response.$
*
* $Parameters: $
*   (FILE *) . . . . . file pointer associated with TCP/IP socket.
*   (const char *command) . . SCPI command string.
*   (char *result) . . . . . where to put the result.
*   (size_t) maxLength . . . . maximum size of result array in bytes.
*
* $Return: (long) . . . . . The number of bytes in result buffer.
*
* $Errors: returns 0 if anything goes wrong. $
*
*****/
long queryInstrument(SOCKET sock,
                    const char *command, char *result, size_t maxLength)
{
    long ch;
    char tmp_buf[8];
    long resultBytes = 0;
    int command_err;
    int count;

    /*****
     * Send command to analyzer
     *****/
    command_err = commandInstrument(sock, command);
    if (command_err) return COMMAND_ERROR;

    /*****
     * Read response from analyzer
     *****/
    count = recv(sock, tmp_buf, 1, 0); /* read 1 char */
}
```



```
ch = tmp_buf[0];

if ((count < 1) || (ch == EOF) || (ch == '\n'))
{
    *result = '\0'; /* null terminate result for ascii */
    return 0;
}

/* use a do-while so we can break out */
do
{
    if (ch == '#')
    {
        /* binary data encountered - figure out what it is */
        long numDigits;
        long numBytes = 0;
        /* char length[10]; */

        count = recv(sock, tmp_buf, 1, 0); /* read 1 char */
        ch = tmp_buf[0];
        if ((count < 1) || (ch == EOF)) break; /* End of file */

        if (ch < '0' || ch > '9') break; /* unexpected char */
        numDigits = ch - '0';

        if (numDigits)
        {
            /* read numDigits bytes into result string. */
            count = recv(sock, result, (int)numDigits, 0);
            result[count] = 0; /* null terminate */
            numBytes = atol(result);
        }

        if (numBytes)
        {
            resultBytes = 0;
```

## PSA Programming Examples Using C Over Socket LAN (UNIX)

```
/* Loop until we get all the bytes we requested. */
/* Each call seems to return up to 1457 bytes, on HP-UX 9.05 */
do {
    int rcount;
    rcount = recv(sock, result, (int)numBytes, 0);
    resultBytes += rcount;
    result      += rcount; /* Advance pointer */
} while ( resultBytes < numBytes );

/*****
 * For LAN dumps, there is always an extra trailing newline
 * Since there is no EOI line. For ASCII dumps this is
 * great but for binary dumps, it is not needed.
 *****/
if (resultBytes == numBytes)
{
    char junk;
    count = recv(sock, &junk, 1, 0);
}
else
{
    /* indefinite block ... dump til we read only a line feed */
    do
    {
        if (recv_line(sock, result, maxLength) == NULL) break;
        if (strlen(result)==1 && *result == '\n') break;
        resultBytes += strlen(result);
        result += strlen(result);
    } while (1);
}
else
{
    /* ASCII response (not a binary block) */
    *result = (char)ch;
```

```

    if (recv_line(sock, result+1, maxLength-1) == NULL) return 0;

    /* REMOVE trailing newline, if present. And terminate string. */
    resultBytes = strlen(result);
    if (result[resultBytes-1] == '\n') resultBytes -= 1;
    result[resultBytes] = '\0';
}
} while (0);

return resultBytes;
}

/*****
 *
 * > $Function: showErrors$
 *
 * $Description: Query the SCPI error queue, until empty. Print results. $
 *
 * $Return: (void)
 *
 *****/
void showErrors(SOCKET sock)
{
    const char * command = "SYST:ERR?\n";
    char result_str[256];

    do {
        queryInstrument(sock, command, result_str, sizeof(result_str)-1);

        /*****
         * Typical result_str:
         *   -221,"Settings conflict; Frequency span reduced."
         *   +0,"No error"
         *****/

```

## PSA Programming Examples Using C Over Socket LAN (UNIX)

```
* Don't bother decoding.
*****/
if (strncmp(result_str, "+0,", 3) == 0) {
    /* Matched +0,"No error" */
    break;
}
puts(result_str);
} while (1);
}

/*****
*
* > $Function: isQuery$
*
* $Description: Test current SCPI command to see if it a query. $
*
* $Return: (unsigned char) . . . non-zero if command is a query. 0 if not.
*
*****/
unsigned char isQuery( char* cmd )
{
    unsigned char q = 0 ;
    char *query ;

    /*****/
    /* if the command has a '?' in it, use queryInstrument. */
    /* otherwise, simply send the command. */
    /* Actually, we must a little more specific so that */
    /* marker value queries are treated as commands. */
    /* Example: SENS:FREQ:CENT (CALC1:MARK1:X?) */
    /*****/
    if ( (query = strchr(cmd, '?')) != NULL)
    {
        /* Make sure we don't have a marker value query, or
```

```

* any command with a '?' followed by a ')' character.
* This kind of command is not a query from our point of view.
* The analyzer does the query internally, and uses the result.
*/
query++ ;      /* bump past '?' */
while (*query)
{
    if (*query == ' ') /* attempt to ignore white spc */
        query++ ;
    else break ;
}

if ( *query != ')' )
{
    q = 1 ;
}
}
return q ;
}

/*****
*
> $Function: main$
*
* $Description: Read command line arguments, and talk to analyzer.
                Send query results to stdout. $
*
* $Return:  (int) . . . non-zero if an error occurs
*
*****/
int main(int argc, char *argv[])
{

    SOCKET instSock;

```

## PSA Programming Examples Using C Over Socket LAN (UNIX)

```
char *charBuf = (char *) malloc(INPUT_BUF_SIZE);
char *basename;
int chr;
char command[1024];
char *destination;
unsigned char quiet = 0;
unsigned char show_errs = 0;
int number = 0;

basename = strrchr(argv[0], '/');
if (basename != NULL)
    basename++;
else
    basename = argv[0];

while ( ( chr = getopt(argc,argv,"qune")) != EOF )
    switch (chr)
    {
        case 'q': quiet = 1; break;
        case 'n': number = 1; break ;
        case 'e': show_errs = 1; break ;
        case 'u':
        case '?': usage(basename); exit(1) ;
    }

/* now look for hostname and optional <command> */
if (optind < argc)
{
    destination = argv[optind++] ;
    strcpy(command, "");
    if (optind < argc)
    {
        while (optind < argc) {
            /* <hostname> <command> provided; only one command string */
            strcat(command, argv[optind++]);
            if (optind < argc) {
```

```

        strcat(command, " ");
    } else {
        strcat(command, "\n");
    }
}
else
{
    /* Only <hostname> provided; input on <stdin> */
    strcpy(command, "");

    if (optind > argc)
    {
        usage(basename);
        exit(1);
    }
}
else
{
    /* no hostname! */
    usage(basename);
    exit(1);
}

/*****
/* open a socket connection to the instrument */
*****/
#ifdef WINSOCK
    if (init_winsock() != 0) {
        exit(1);
    }
#endif /* WINSOCK */

    instSock = openSocket(destination, SCPI_PORT);
    if (instSock == INVALID_SOCKET) {

```

## PSA Programming Examples Using C Over Socket LAN (UNIX)

```
    fprintf(stderr, "Unable to open socket.\n");
    return 1;
}
/* fprintf(stderr, "Socket opened.\n"); */

if (strlen(command) > 0)
{
    /******
    /* if the command has a '?' in it, use queryInstrument. */
    /* otherwise, simply send the command. */
    /******
    if ( isQuery(command) )
    {
        long bufBytes;
        bufBytes = queryInstrument(instSock, command,
                                charBuf, INPUT_BUF_SIZE);

        if (!quiet)
        {
            fwrite(charBuf, bufBytes, 1, stdout);
            fwrite("\n", 1, 1, stdout) ;
            fflush(stdout);
        }
    }
    else
    {
        commandInstrument(instSock, command);
    }
}
else
{
    /* read a line from <stdin> */
    while ( gets(charBuf) != NULL )
    {
        if ( !strlen(charBuf) )
            continue ;
    }
}
```



```

if ( *charBuf == '#' || *charBuf == '!' )
    continue ;

strcat(charBuf, "\n");

if (!quiet)
{
    if (number)
    {
        char num[10];
        sprintf(num,"%d: ",number);
        fwrite(num, strlen(num), 1, stdout);
    }
    fwrite(charBuf, strlen(charBuf), 1, stdout) ;
    fflush(stdout);
}

if ( isQuery(charBuf) )
{
    long bufBytes;

    /* Put the query response into the same buffer as the
     * command string appended after the null terminator.
     */
    bufBytes = queryInstrument(instSock, charBuf,
                               charBuf + strlen(charBuf) + 1,
                               INPUT_BUF_SIZE -strlen(charBuf) );

    if (!quiet)
    {
        fwrite(" ", 2, 1, stdout) ;
        fwrite(charBuf + strlen(charBuf)+1, bufBytes, 1, stdout);
        fwrite("\n", 1, 1, stdout) ;
        fflush(stdout);
    }
}
else

```

## PSA Programming Examples Using C Over Socket LAN (UNIX)

```
        {
            commandInstrument(instSock, charBuf);
        }
        if (number) number++;
    }
}

if (show_errs) {
    showErrors(instSock);
}

#ifdef WINSOCK
    closesocket(instSock);
    close_winsock();
#else
    close(instSock);
#endif /* WINSOCK */

    return 0;
}

/* End of lanio.c */
```

---

## Using C Over Socket LAN (Windows NT)

This C programming example (getopt.c) compiles in the Windows NT environment. In Windows, the routines `send()` and `recv()` must be used, since `fread()` and `fwrite()` may not work on sockets.

The program reads the analyzer's host name from the command line, followed by the SCPI command. It then opens a socket to the analyzer, using port 5025, and sends the command. If the command appears to be a query, the program queries the analyzer for a response, and prints the response.

This example program can also be used as a utility to talk to your analyzer from the command prompt on your Windows NT PC, or from within a script.

```
/******
```

```
getopt(3C) getopt(3C)
```

### NAME

```
getopt - get option letter from argument vector
```

### SYNOPSIS

```
int getopt(int argc, char * const argv[], const char *optstring);
```

```
extern char *optarg;
```

```
extern int optind, opterr, optopt;
```

### DESCRIPTION

```
getopt returns the next option letter in argv (starting from argv[1]) that matches a letter in optstring. optstring is a string of recognized option letters; if a letter is followed by a colon, the option is expected to have an argument that may or may not be separated from it by white space. optarg is set to point to the start of the option argument on return from getopt.
```

```
getopt places in optind the argv index of the next argument to be processed. The external variable optind is initialized to 1 before
```

## PSA Programming Examples Using C Over Socket LAN (Windows NT)

the first call to the function getopt.

When all options have been processed (i.e., up to the first non-option argument), getopt returns EOF. The special option -- can be used to delimit the end of the options; EOF is returned, and -- is skipped.

```
*****/

#include <stdio.h>      /* For NULL, EOF */
#include <string.h>    /* For strchr() */

char *optarg;         /* Global argument pointer. */
int optind = 0;      /* Global argv index. */

static char *scan = NULL; /* Private scan pointer. */

int getopt( int argc, char * const argv[], const char* optstring)
{
    char c;
    char *posn;

    optarg = NULL;

    if (scan == NULL || *scan == '\0') {
        if (optind == 0)
            optind++;

        if (optind >= argc || argv[optind][0] != '-' || argv[optind][1] == '\0')
            return(EOF);
        if (strcmp(argv[optind], "--")==0) {
            optind++;
            return(EOF);
        }
    }

    scan = argv[optind]+1;
}
```

```
    optind++;
}

c = *scan++;
posn = strchr(optstring, c);      /* DDP */

if (posn == NULL || c == ':') {
    fprintf(stderr, "%s: unknown option -%c\n", argv[0], c);
    return('?');
}

posn++;
if (*posn == ':') {
    if (*scan != '\\0') {
        optarg = scan;
        scan = NULL;
    } else {
        optarg = argv[optind];
        optind++;
    }
}

return(c);
}
```

## Using Java Programming Over Socket LAN

This Java programming example (ScpiDemo.java) demonstrates simple socket programming with Java and can be found on the Documentation CD. It is written in Java programming language, and will compile with Java compilers versions 1.0 and above.

```
import java.awt.*;
import java.io.*;
import java.net.*;
import java.applet.*;

// This is a SCPI Demo to demonstrate how one can communicate with the
// E4440A PSA with a JAVA capable browser. This is the
// Main class for the SCPI Demo. This applet will need Socks.class to
// support the I/O commands and a ScpiDemo.html for a browser to load
// the applet.
// To use this applet, either compile this applet with a Java compiler
// or use the existing compiled classes. copy ScpiDemo.class,
// Socks.class and ScpiDemo.html to a floppy. Insert the floppy into
// your instrument. Load up a browser on your computer and do the
// following:
// 1. Load this URL in your browser:
// ftp://<Your instrument's IP address or name>/int/ScpiDemo.html
// 2. There should be two text windows show up in the browser:
// The top one is the SCPI response text area for any response
// coming back from the instrument. The bottom one is for you
// to enter a SCPI command. Type in a SCPI command and hit enter.
// If the command expects a response, it will show up in the top
// window.

public class ScpiDemo extends java.applet.Applet implements Runnable {
    Thread responseThread;
    Socks sck;
    URL appletBase;
    TextField scpiCommand = new TextField();
    TextArea scpiResponse = new TextArea(10, 60);
    Panel southPanel = new Panel();
```

```
Panel      p;

// Initialize the applets
public void init() {

    SetupSockets();
    SetupPanels();

    // Set up font type for both panels
    Font font = new Font("TimesRoman", Font.BOLD,14);
    scpiResponse.setFont(font);
    scpiCommand.setFont(font);
    scpiResponse.appendText("SCPI Demo Program:  Response messages\n");
    scpiResponse.appendText("-----\n");
}

// This routine is called whenever the applet is activated
public void start() {
    // Open the sockets if not already opened
    sck.OpenSockets();
    // Start a response thread
    StartResponseThread(true);
}

// This routine is called whenever the applet is out of scope
// i.e. minize browser
public void stop() {
    // Close all local sockets
    sck.CloseSockets();
    // Kill the response thread
    StartResponseThread(false);
}

// Action for sending out scpi commands
// This routine is called whenever a command is received from the
// SCPI command panel.
```

## PSA Programming Examples Using Java Programming Over Socket LAN

```
public boolean action(Event evt, Object what) {
    // If this is the correct target
    if (evt.target == scpiCommand) {
        // Get the scpi command
        String str = scpiCommand.getText();
        // Send it out to the Scpi socket
        sck.ScpiWriteLine(str);
        String tempStr = str.toLowerCase();
        // If command str is "syst:err?", don't need to send another one.
        if ( (tempStr.indexOf("syst") == -1) ||
            (tempStr.indexOf("err") == -1) ) {
            // Query for any error
            sck.ScpiWriteLine("syst:err?");
        }
        return true;
    }
    return false;
}

// Start/Stop a Response thread to display the response strings
private void StartResponseThread(boolean start) {
    if (start) {
        // Start a response thread
        responseThread = new Thread(this);
        responseThread.start();
    }
    else {
        // Kill the response thread
        responseThread = null;
    }
}

// Response thread running
public void run() {
    String str = ""; // Initialize str to null
```



```
// Clear the error queue before starting the thread
// in case if there's any error messages from the previous actions
while ( str.indexOf("No error") == -1 ) {
    sck.ScpiWriteLine("syst:err?");
    str = sck.ScpiReadLine();
}

// Start receiving response or error messages
while(true) {
    str = sck.ScpiReadLine();
    if ( str != null ) {
        // If response messages is "No error", do no display it,
        // replace it with "OK" instead.
        if ( str.equals("+0,\"No error\"") ) {
            str = "OK";
        }
        // Display any response messages in the Response panel
        scpResponse.appendText(str+"\n");
    }
}

// Set up and open the SCPI sockets
private void SetupSockets() {
    // Get server url
    appletBase = (URL)getCodeBase();
    // Open the sockets
    sck = new Socks(appletBase);
}

// Set up the SCPI command and response panels
private void SetupPanels() {
    // Set up SCPI command panel
    southPanel.setLayout(new GridLayout(1, 1));
    p = new Panel();
    p.setLayout(new BorderLayout());
}
```

## PSA Programming Examples Using Java Programming Over Socket LAN

```
p.add("West", new Label("SCPI command:"));
p.add("Center", scpiCommand);
southPanel.add(p);

// Set up the Response panel
setLayout(new BorderLayout(2,2));
add("Center", scpiResponse);
add("South", southPanel);
}
}

// Socks class is responsible for open/close/read/write operations
// from the predefined socket ports. For this example program,
// the only port used is 5025 for the SCPI port.
class Socks extends java.applet.Applet {
    // Socket Info
    // To add a new socket, add a constant here, change MAX_NUM_OF_SOCKETS
    // then, edit the constructor for the new socket.
    public final int SCPI=0;
    private final int MAX_NUM_OF_SOCKETS=1;

    // Port number
    // 5025 is the dedicated port number for E4440A Scpi Port
    private final int SCPI_PORT = 5025;

    // Socket info
    private URL appletBase;
    private Socket[] sock = new Socket[MAX_NUM_OF_SOCKETS];
    private DataInputStream[] sockIn = new DataInputStream[MAX_NUM_OF_SOCKETS];
    private PrintStream[] sockOut = new PrintStream[MAX_NUM_OF_SOCKETS];
    private int[] port = new int[MAX_NUM_OF_SOCKETS];
    private boolean[] sockOpen = new boolean[MAX_NUM_OF_SOCKETS];

    // Constructor
```

```

Socks(URL appletB)
{
    appletBase = appletB;

    // Set up for port array.
    port[SCPI] = SCPI_PORT;

    // Initialize the sock array
    for ( int i = 0; i < MAX_NUM_OF_SOCKETS; i++ ) {
        sock[i] = null;
        sockIn[i] = null;
        sockOut[i] = null;
        sockOpen[i] = false;
    }
}

//***** Sockects open/close routines
// Open the socket(s) if not already opened
public void OpenSockets()
{
    try {
        // Open each socket if possible
        for ( int i = 0; i < MAX_NUM_OF_SOCKETS; i++ ) {
            if ( !sockOpen[i] ) {
                sock[i] = new Socket(appletBase.getHost(),port[i]);
                sockIn[i] = new DataInputStream(sock[i].getInputStream());
                sockOut[i] = new PrintStream(sock[i].getOutputStream());
                if ( (sock[i] != null) && (sockIn[i] != null) &&
                    (sockOut[i] != null) ) {
                    sockOpen[i] = true;
                }
            }
        }
    }
    catch (IOException e) {
        System.out.println("Sock, Open Error "+e.getMessage());
    }
}

```

```
    }  
}  
  
// Close the socket(s) if opened  
public void CloseSocket(int s)  
{  
    try {  
        if ( sockOpen[s] == true ) {  
            // write blank line to exit servers elegantly  
            sockOut[s].println();  
            sockOut[s].flush();  
            sockIn[s].close();  
            sockOut[s].close();  
            sock[s].close();  
            sockOpen[s] = false;  
        }  
    }  
    catch (IOException e) {  
        System.out.println("Sock, Close Error "+e.getMessage());  
    }  
}  
  
// Close all sockets  
public void CloseSockets()  
{  
    for ( int i=0; i < MAX_NUM_OF_SOCKETS; i++ ) {  
        CloseSocket(i);  
    }  
}  
  
// Return the status of the socket, open or close.  
public boolean SockOpen(int s)  
{  
    return sockOpen[s];  
}
```

```
//***** Socket I/O routines.

//*** I/O routines for SCPI socket

// Write an ASCII string with carriage return to SCPI socket
public void ScpiWriteLine(String command)
{
    if ( SockOpen(SCPI) ) {
        sockOut[SCPI].println(command);
        sockOut[SCPI].flush();
    }
}

// Read an ASCII string, terminated with carriage return from SCPI socket
public String ScpiReadLine()
{
    try {
        if ( SockOpen(SCPI) ) {
            return sockIn[SCPI].readLine();
        }
    }
    catch (IOException e) {
        System.out.println("Scpi Read Line Error "+e.getMessage());
    }
    return null;
}

// Read a byte from SCPI socket
public byte ScpiReadByte()
{
    try {
        if ( SockOpen(SCPI) ) {
            return sockIn[SCPI].readByte();
        }
    }
}
```

PSA Programming Examples  
Using Java Programming Over Socket LAN

```
catch (IOException e) {  
    System.out.println("Scpi Read Byte Error "+e.getMessage());  
}  
return 0;  
}  
  
}
```

## Using the VXI Plug-N-Play Driver in LabVIEW®

This example shows how to use the VXI plug and play driver over LAN in LabVIEW 6. The vi file (lan\_pnp.vi) can be found on the Documentation CD.

You must have Version K of the Agilent IO libraries installed on your PC, either alone or installed side-by-side with the National Instruments IO libraries. Also, you must first import the VXI plug and play driver into LabVIEW before running this example. The instrument drivers are available at:

<http://www.agilent.com/find/iolib> (Click on instrument drivers.)

This example:

1. Opens a VXI 11.3 Lan connection to the instrument
2. Sets the Center Frequency to 1 GHz
3. Queries the instrument's center frequency
4. Closes the Lan connection to the instrument

**NOTE**

Substitute your instruments I.P. address for the one used in the example.

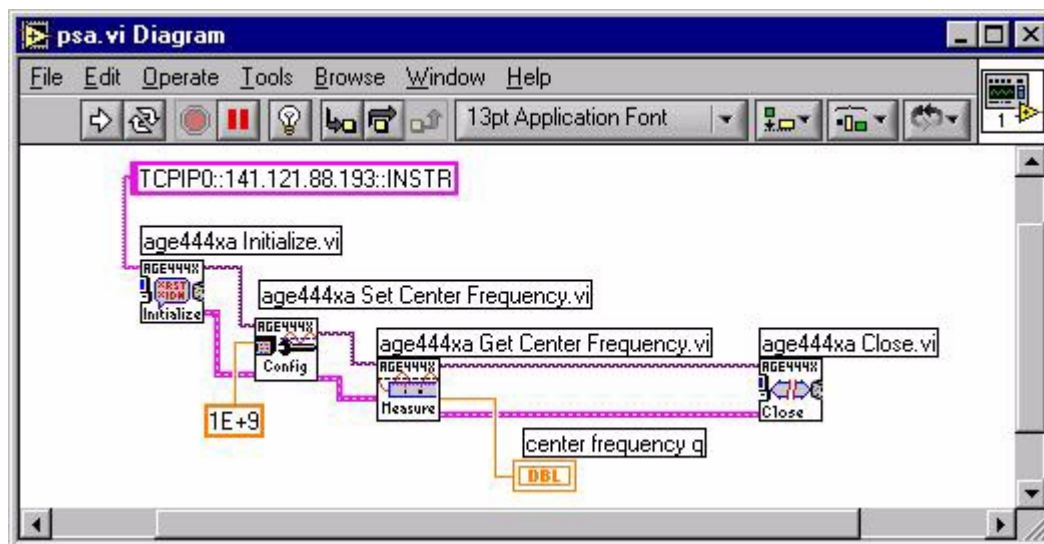

## Using LabVIEW® 6 to Make an EDGE GSM Measurement

This is a LabVIEW 6 example that uses SCPI commands instead of the instrument driver. It demonstrates reading ASCII trace points of entire EDGE waveform data in the Power Vs. Time measurement over LAN. This program uses the optional GSM/EDGE personality in the PSA Series Spectrum Analyzers and in the E4406A Vector Signal Analyzer. The vi file (epvt.vi) can be found on the Documentation CD.

This example:

1. Opens a VXI 11.3 Lan connection to the instrument
2. Changes the data format to ASCII.
3. Initiates a power vs. time measurement and reads the results.
4. The comma separated ASCII results string is converted to an array of values.

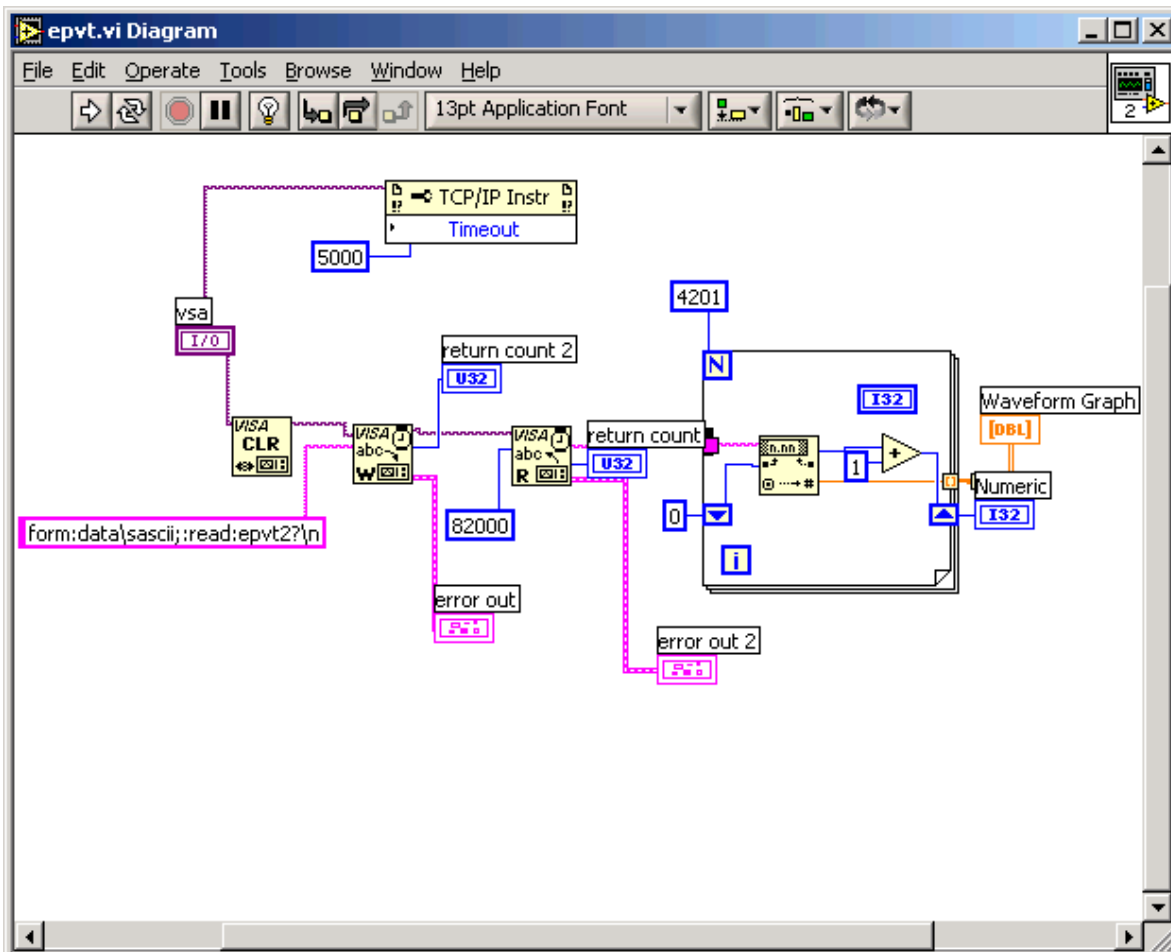



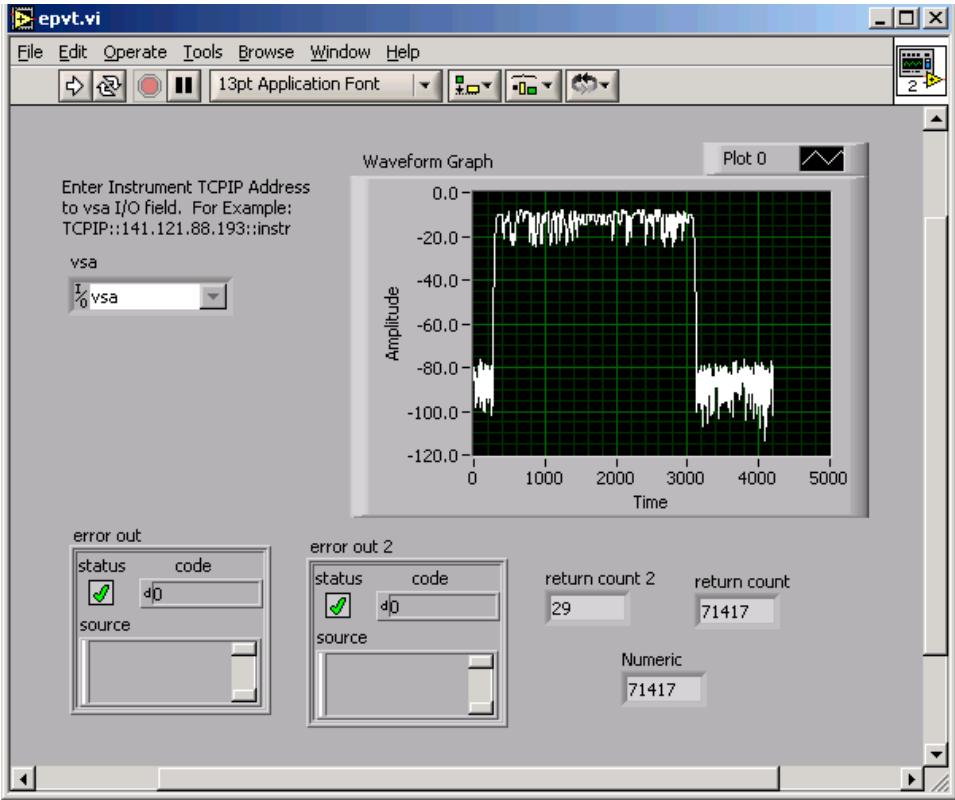

---

## Using Visual Basic® .NET with the IVI-Com Driver

This example uses Visual Basic .NET with the IVI-Com driver. It makes a time domain (Waveform) measurement using the Basic mode. Basic mode is standard in the E4406A Vector Signal Analyzer and is optional (B7J) in the PSA Series Spectrum Analyzers. The vb file (vbivicomsa\_basicwaveform.vb) and the compiled executable file (vbivicomsa.exe) can be found on the Documentation CD.

```
*****  
' VBIVIComSA_BasicWaveform.vb, August 5, 2003  
' This example demonstrates the use of the IVI-COM driver in VB.NET  
' through an interop assembly. The Raw I/Q trace data from the Waveform  
' measurement in Basic Mode is queried and printed to the screen.  
'  
' Requirements:  
' 1) E4406A or PSA Series Spectrum Analyzer with Option B7J  
' 2) Latest AgilentSa IVI-COM driver  
' You may download it here: http://www.agilent.com/find/inst\_drivers  
' This example was tested with version 2.1.0.0 of the driver  
' 3) Create a new project and add the References to this module  
' and to the the IVI-COM driver dlls:  
' For .NET, right click on Reference, choose Add Reference  
' and then click on Browse and directly link the DLLs in the directory:  
' C:\Program Files\IVI\Bin\Primary Interop Assemblies  
' Agilent.AgilentSa.Interop.dll  
' Agilent.AgilentSaAppBasic.Interop.dll  
' Agilent.Itl.Interop  
' IviDriverLib.dll  
' IviSpecAnLib.dll  
'  
' THIS CODE AND INFORMATION ARE PROVIDED "AS IS" WITHOUT WARRANTY OF ANY  
' KIND, EITHER EXPRESSED OR IMPLIED, INCLUDING BUT NOT LIMITED TO THE  
' IMPLIED WARRANTIES OF MERCHANTABILITY AND/OR FITNESS FOR A  
' PARTICULAR PURPOSE.  
'
```

```
' Copyright (c) 2003. Agilent Technologies, Inc.
'*****
Option Strict On

Imports Agilent.TMFramework
Imports Agilent.AgilentSa.Interop
Imports Ivi.Driver.Interop
Imports System.Runtime.InteropServices

Module ConsoleApp

    Sub Main()

        ' Prompt the user for the address of the instrument
        Dim address As String
        Console.WriteLine("Enter address of the instrument " & vbCrLf & _
            "(ex: GPIB0::18::INSTR or TCPIP0::192.168.100.2::inst0::INSTR):")
        address = Console.ReadLine()

        Try
            ' Create an instance of the driver, connection to the instrument
            ' is not established here, it is done by calling Initialize
            Dim instr As New AgilentSaClass()

            ' Establish the connection to the instrument
            ' Last parameter (DriverSetup) is optional, VB could omit it (but not C#)
            ' Important: Close must be called to release resources used by the driver
            instr.Initialize(address, False, False, "")

        Try
            ' INHERENT CAPABILITIES
            ' Note that it is not necessary to program against the IIviDriver
            ' interface, the same can be achieved by using the class directly
            ' Using the IIviDriver interface gives us interchangeable code
            Dim inherent As IIviDriver = instr
```

## PSA Programming Examples Using Visual Basic® .NET with the IVI-Com Driver

```
Dim manufacturer As String
Dim model As String
Dim firmware As String

manufacturer = inherent.Identity.InstrumentManufacturer
model = inherent.Identity.InstrumentModel
firmware = inherent.Identity.InstrumentFirmwareRevision
' Output instrument information to the console
Console.WriteLine("Manufacturer: " + manufacturer)
Console.WriteLine("Model: " + model)
Console.WriteLine("Firmware: " + firmware)

' Reset the instrument
inherent.Utility.Reset()

' INSTRUMENT SPECIFIC
' Using the IAgilentSa interface is not necessary or beneficial
' at the moment, but in the future if other instruments implement
' the IAgilentSa interface, the code that is written to work with
' that interface can be reused without changes, as opposed to code
' that is written against the class object directly
Dim sa As IAgilentSa = instr

' Obtain trace data from the instrument
Dim traceData As Array
sa.Application.Select("Basic")
'sa.Application.Basic.Waveform.Configure()
sa.Application.Basic.Spectrum.Traces.Initiate()
traceData = sa.Application.Basic.Waveform.Traces.Item("RawIQ").Read(10000)

' Output the trace data to the console
Console.WriteLine("Press ENTER to display trace data.")
Console.ReadLine()
Dim traceValue As Double
For Each traceValue In traceData
    Console.WriteLine(traceValue)
```

```
Next

Catch ex As Exception
    Console.WriteLine(ex.Message)

Finally
    ' Close the connection
    instr.Close()

End Try

Catch ex As COMException
    Console.WriteLine(ex.Message)

Catch ex As Exception
    Console.WriteLine(ex.Message)

End Try

' Wait for user input
Console.WriteLine("Press ENTER to end program.")
Console.ReadLine()

End Sub

End Module
```

## Using Agilent VEE to Capture the Equivalent SCPI Learn String

This example shows how to use VEE to emulate the \*LRN SCPI command. The VEE file (lrnstring.vee) can be found on the Documentation CD.

This VEE programming example transfers the saved state register (17 in this example) to the program. The program then copies this register back into the instrument and recalls the state. This, in many cases, is equivalent to the \*LRN SCPI command.

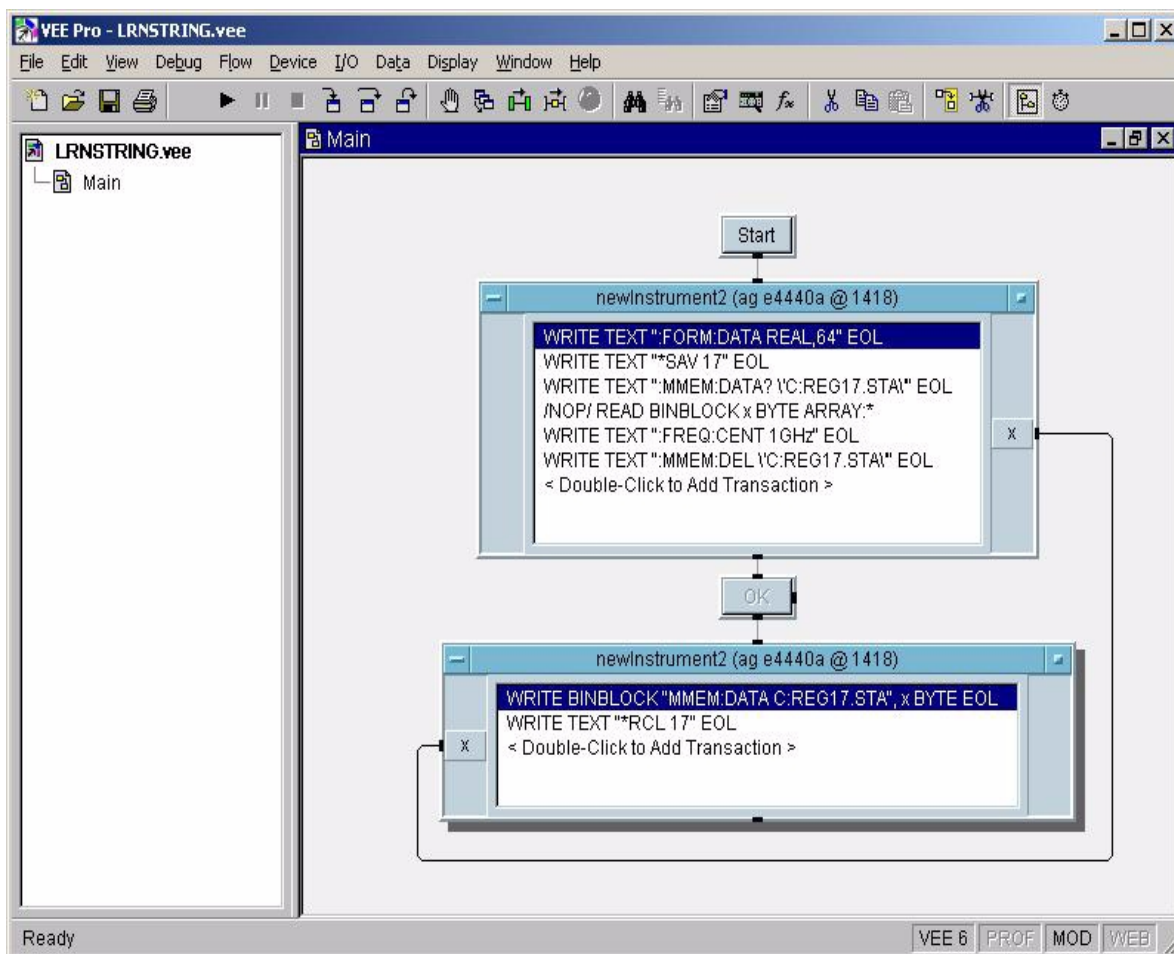

## A

ACPR  
C programming example 176  
active function position, moving 14  
adding limit lines programming example using C 233  
adjacent channel power measurement 74  
Agilent VEE program example 197, 342  
alignments programming example 179  
AM demodulation time-domain demodulation, manually calculating 157  
AM signal demodulation 92  
analyzer distortion products 40  
attenuation input, reducing 26  
setting automatically 27  
setting manually 27  
averaging description 30  
types 30  
averaging faster programming example using C 269

## B

Bluetooth power measurement 68  
burst power measurement 68

## C

C language  
addressing sessions 174  
closing sessions 175  
compiling and linking 169  
creating 167  
example 171  
opening session 172  
sessions 172  
using VISA library 167  
using VISA transition library 169, 171  
C programming, socket LAN, UNIX 303  
C programming, socket LAN, WIN NT 323  
calculate average power of GSM bursts programming example 297  
calibration programming example 179  
CCDF statistical power measurement 71  
channel power measurement

noise-like signals 54  
comparing signals two signals 12, 14  
two signals not on the same screen 15  
compressing measurement data, programming example 297  
Concepts  
AM demodulation 157  
FM demodulation 157  
concepts  
gated FFT (PSA) 137  
gated LO (PSA) 136  
gated video (ESA) 136  
harmonic distortion, calculation 132  
IF filter, defined 130  
resolving signals of equal amplitude 130  
resolving small signals hidden by large signals 131  
stimulus response 158  
time gating 133  
TV trigger 154  
counter resolution, readout 32

## D

delta marker 12, 14  
Demod key 96  
demodulating  
AM 92  
AM overview 92  
FM 98  
FM overview 98  
TV signals 121  
depth of modulation measurement 126  
detectors, average 29  
device bandwidth measurement 114, 160  
display active function position, moving 14  
distortion measurements harmonic 45  
identifying TOI distortion 42  
identifying distortion products 40  
overview 40  
distortion products 40  
drifting signals 38

## E

entering amplitude correction data programming example using C 243  
equipment 10

error status programming example using C 247  
examples  
AM demodulation  
ESA built-in AM demodulation 96  
manual demodulation 92  
average detector, using 29  
averaging, trace 30  
distortion harmonics 45  
identify distortion products 40  
TOI 42  
external mixing frequency tracking calibration 86  
preselected mixers, using 86  
unpreselected mixers, using 82  
FM demodulation  
ESA built-in FM demodulation 98  
frequency drift 36  
input attenuation, reducing 26  
marker counter 32  
measuring low-level signals 29  
noise  
band power marker 52  
channel power, using 54  
noise marker 50  
overview 48  
signal to noise 48  
power suite  
ACP 74  
burst power 68  
CCDF 71  
multi-carrier power 77  
resolution bandwidth, reducing 28  
segmented sweep monitor CDMA band 108  
using with limit lines 106  
view harmonics 104  
signals  
low-level, overview 26  
off-screen, comparing 15  
on-screen, comparing 12, 14  
resolving, equal amplitude 17  
resolving, small signals hidden by large signals 20  
stimulus response  
device bandwidth 114, 160  
filter response 116  
reflection calibration 118  
transmission 112  
time gating

- ESA-E time gate [64](#)
- PSA gated FFT [66](#)
- PSA gated sweep [62](#)
- trace averaging [30](#)
- tracking a signal [38](#)
- TV signals
  - demodulate and view [122](#)
  - depth of modulation [126](#)
- external mixing
  - entering conversion loss data [85](#)
  - preselected mixers, using [86](#)
  - setting mixer bias [84](#)
  - unpreselected mixers, using [82](#)
- F**
- finding hidden signals [131](#)
- FM demodulation
  - time-domain demodulation, manually calculating [157](#)
- FM signal demodulation [98](#)
- frequency readout resolution increased [32](#)
- G**
- gate delay
  - setting the gate delay, time gating [144](#)
- gate length
  - setting the gate length, time gating [144](#)
- gated FFT (PSA), concepts [137](#)
- gated LO (PSA), concepts [136](#)
- gated video (ESA), concepts [136](#)
- GSM mobile power calibration PSA programming example using C [291](#)
- GSM/EDGE program example, using LabVIEW [336](#)
- H**
- harmonic distortion
  - measuring harmonics [132](#)
  - measuring low-level signals [15](#)
- hold, maximum [36](#)
- I**
- identifying distortion products [40](#)
- initial setting for time gating [148](#)
- input attenuation, reducing [26](#)
- intermodulation distortion, third order [42](#), [132](#)
- internal self alignment
  - programming example using C [210](#)
- IVI-Com driver program example using Visual Basic .NET [338](#)
- J**
- Java programming, socket LAN [326](#)
- L**
- LabVIEW program example [335](#), [336](#)
- limit lines
  - entering data [107](#)
- low-level signals
  - harmonics, measuring [15](#)
  - input attenuation, reducing [26](#)
  - resolution bandwidth, reducing [28](#)
  - sweep time, reducing [29](#)
  - trace averaging [30](#)
- M**
- marker counter example
  - marker frequency resolution [32](#)
- marker delta mode programming example using C [206](#)
- marker peak search programming example using C [202](#), [280](#)
- markers
  - band power [52](#)
  - delta [12](#), [14](#)
  - noise marker [49](#), [50](#)
  - span pair [52](#)
- Max Hold key [36](#)
- maximum hold [36](#)
- MCP [77](#)
- measure harmonic distortion over GPIB programming example using C [253](#)
- measure harmonic distortion over RS-232 programming example using C [261](#)
- measure noise programming example using C [239](#)
- measurements
  - device bandwidth [114](#), [160](#)
  - distortion [40](#)
    - harmonics [45](#)
    - TOI [42](#)
  - frequency drift [36](#), [38](#)
  - noise
    - band power marker [52](#)
    - channel power [54](#)
    - noise marker [50](#)
    - overview [48](#)
    - signal to noise [48](#)
  - stimulus response [112](#)
    - filter response [116](#)
  - time gating [57](#)
    - ESA-E time gate [64](#)
- PSA gated FFT [66](#)
- PSA gated sweep [62](#)
- TV
  - depth of modulation [126](#)
  - fast time-domain sweeps [156](#)
- measuring return loss [120](#)
- measurements
  - distortion
    - identifying [40](#)
  - moving signals [38](#)
  - multi-carrier power measurement [77](#)
- N**
- N dB Points key [114](#), [160](#)
- noise measurements
  - band power marker, using [52](#)
  - channel power, using [54](#)
  - noise marker, using [50](#)
  - overview [48](#)
  - signal to noise [48](#)
  - sweep time, reducing [29](#)
- normalizing reference position [113](#), [159](#)
- Normalize On Off key [113](#), [159](#)
- O**
- openSocket [303](#), [323](#), [326](#)
- overview
  - stimulus response [112](#)
- overviews
  - distortion [40](#)
    - low-level signal [26](#)
  - noise [48](#)
  - resolving signals [130](#)
  - time gating [133](#)
- P**
- Plug-N-Play driver program example [335](#)
- positioning the gate, time gating [143](#)
- power suite
  - channel power [54](#)
  - measurements
    - ACP or adjacent channel power [74](#)
    - burst power [68](#)
    - CCDF [71](#)
    - MCP or multi-carrier power [77](#)
- power suite measurements [67](#)
- program example
  - Agilent VEE [197](#), [342](#)
  - C [176](#), [179](#), [182](#), [303](#), [323](#)



- C, using ESA 202, 206, 210, 214, 218, 223, 228, 233, 239, 243, 247, 253, 261, 269
- C, using PSA 280, 283, 287, 291, 297
- IVI-Com driver 338
- Java 326
- LabVIEW 335, 336
- socket LAN, UNIX using C 303
- socket LAN, using Java 326
- socket LAN, WIN NT using C 323
- Visual Basic 188, 192
- Visual Basic .NET 338
- VXI Plug-N-Play driver 335
- programming
  - example using C language 171
  - using C language 167
- programming example
  - ACPR measurement 176
  - adding limit lines, using C 233
  - alignments 179
  - calculate average power of GSM bursts 297
  - determine if an error occurred, using C 247
  - EDGE/GSM using LabVIEW 336
  - entering amplitude correction data, using C 243
  - GSM mobile power calibration with a PSA, using C 291
  - internal self-alignment, using C 210
  - IVI-Com driver, using Visual Basic .NET 338
  - list of ESA examples 200
  - making faster power averaging measurements, using C 269
  - marker delta mode, using C 206
  - marker peak search, using C 202, 280
  - measure harmonic distortion over GPIB, using C 253
  - measure harmonic distortion over RS-232, using C 261
  - measure noise, using C 239
  - read ESA 32-bit trace data over GPIB, using C 218
  - read ESA 32-bit trace data over RS-232, using C 228
  - read ESA ASCII trace data over GPIB, using C 214
  - read ESA ASCII trace data over RS-232, using C 223
  - saving and recalling PSA states, using C 283
  - saving PSA binary trace data, using C 287
  - SCPI learn string, using VEE 342
  - screen image capture 188
  - SRQ, using 182
  - system requirements, ESA examples 201
  - system requirements, PSA examples 279
  - transfer binary trace data 192
  - transfer trace data, using VEE 197
  - using C over socket LAN via UNIX 303
  - using C over socket LAN via WIN NT 323
  - using Java over socket LAN 326
  - VXI Plug-N-Play driver, using LabVIEW 335
- R**
- RBW selections 28
- read ESA 32-bit trace data over GPIB programming example using C 218
- read ESA 32-bit trace data over RS-232 programming example using C 228
- read ESA ASCII trace data over GPIB programming example using C 214
- read ESA ASCII trace data over RS-232 programming example using C 223
- reflection calibration and measurement 118
- resolving, equal amplitude 130
- resolution bandwidth
  - adjusting 28
  - resolving signals 131
- resolving signals
  - small signals hidden by large signals 131
- resolving two signals
  - equal amplitude 17, 130
- return loss
  - converting to VSWR 160
- return loss measurement 120
- rules for time gating 147
- S**
- saving and recalling PSA states
  - programming example using C 283
  - saving PSA binary trace data programming example using C 287
- SCPI learn string using VEE program example 342
- screen image capture programming example 188
- segmented sweep
  - CDMA example 108
  - measuring harmonics 104
  - using with limit lines 106
- signal parameters for a time-gated measurement 141
- signal tracking
  - example 38
  - marker tracking 22
  - using to resolve signals 22
- signals
  - low-level, overview 26
  - off-screen, comparing 15
  - on-screen, comparing 12, 14
  - resolving, overview 130
  - separating, overview 130
- socket LAN
  - Java program example 326
  - socket LAN, UNIX C program example 303
  - socket LAN, WIN NT C program example 323
- Span Zoom key 36
- SRQ
  - programming example 182
- stimulus response
  - measure response of a LP filter 116
- stimulus response measurements 112
- stimulus response, concepts 158
- sweep coupling
  - stimulus response measurements 113, 115, 117, 159
- sweep time and sensitivity trade off 28
- sweep time for a time-gated measurement 64, 142
- sweep time, changing 29
- T**
- test equipment 10
- third order intermodulation distortion example 42, 45
- time gating
  - description 133
  - ESA-E time gate, using 64
  - example 57
  - gated FFT (PSA), concepts 137

- gated LO (PSA), concepts [136](#)
  - gated video (ESA), concepts [136](#)
  - how time gating works [135](#)
  - initial settings [148](#)
  - keys [143](#)
  - positioning the gate [63](#), [143](#)
  - PSA gated FFT, using [66](#)
  - PSA gated sweep, using [62](#)
  - rules [147](#)
  - setting sweep time [148](#)
  - setting the gate length [144](#)
  - setting the resolution
    - bandwidth [144](#), [145](#)
  - setting the span [143](#), [146](#)
  - setting the video bandwidth [144](#), [146](#)
  - signal parameters [141](#)
  - steps for measuring unknown signals [141](#)
  - sweep time [64](#), [142](#)
  - triggering
    - edge mode [151](#)
    - level mode [151](#)
    - negative edge [151](#)
    - positive edge [151](#)
  - troubleshooting [149](#)
  - time gating measurement [57](#)
  - tracking generator
    - normalization [113](#), [160](#)
    - reflection calibration measurement [118](#)
    - source power control [112](#)
    - stimulus response [158](#)
    - stimulus response measurement [112](#)
    - sweep coupling [113](#), [115](#), [117](#), [159](#)
    - unleveled condition [158](#)
  - tracking unstable signals [38](#)
  - transfer binary trace data
    - programming example [192](#)
  - transfer trace data using VEE
    - program example [197](#)
  - troubleshooting
    - time-gated measurements [149](#)
  - TV picture viewing [121](#)
  - TV standard setup [154](#)
  - TV trigger setup [154](#)
- U**
- unstable signals [38](#)
- V**
- VISA library [169](#), [171](#)
  - Visual Basic .NET program
    - example [338](#)
  - Visual Basic program example
- screen image capture [188](#)
  - transfer binary trace data [192](#)
  - VSWR and return loss [160](#)
  - VTL, compiling and linking C language [169](#)
  - VXI Plug-N-Play driver program
    - example [335](#)
- W**
- W-CDMA ACP measurement [74](#)
  - W-CDMA CCDF power measurement [71](#)
  - W-CDMA multi-carrier power measurement [77](#)