

---

# Agilent N2757A GPIB Interface Module

Publication number N2757-92002  
Printed October 2002



© Copyright Agilent Technologies 2000-2002  
All Rights Reserved

---

## Installation Guide

---

# Introduction

The Agilent N2757A GPIB Interface Module provides remote communication with fast data transfers and full programmability for the following Agilent 54620/40-series Oscilloscopes:

- 54621A, 54622A, and 54624A Oscilloscopes
- 54621D and 54622D Mixed-Signal Oscilloscopes
- 54641A and 54642A Oscilloscopes
- 54641D and 54642D Mixed-Signal Oscilloscopes

The GPIB port can be used for remote programming and to link your pc to the oscilloscope when using the IntuiLink for 54600-series Oscilloscopes connectivity software. For programming specifics, refer to the 54620/40-series Oscilloscope Programmer's Guide shipped with your oscilloscope. For connectivity, refer to the IntuiLink for 54600-series oscilloscopes software for complete instructions.

The following are recommended GPIB cards you can purchase for your pc.

| <b>Part number</b> | <b>Description</b>   |
|--------------------|--|
| 82341C             | High-Performance GPIB Interface for Windows 3.1/95/98/NT               |
| 82341D             | High-Performance <i>plug&amp;play</i> GPIB Interface for Windows 95/98 |
| 82350A             | PCI High-Performance GPIB Interface Card for Windows 95/98/NT          |

---

## To install the interface module

- 1 Turn the oscilloscope power off.
- 2 Insert the tabs on top of the module into the holes on the back of the oscilloscope as shown below.
- 3 Push the module down until the connector-aligning tab on the back of the module snaps into the alignment slot on the back of the oscilloscope.
- 4 Secure the module to the oscilloscope using the screw on the module.

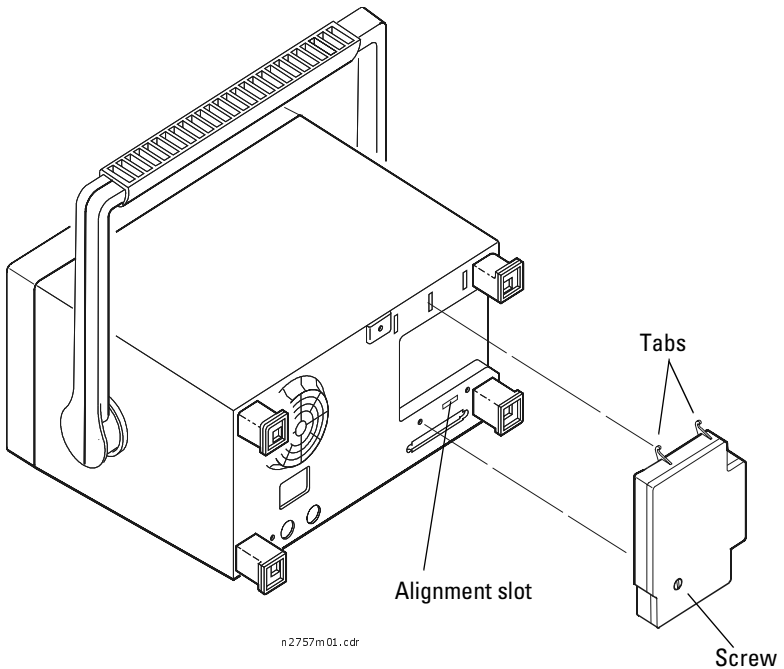

**To connect the GPIB cable**

---

**To connect the GPIB cable**

Connect your GPIB cable to the GPIB module and to your pc/controller. The following list shows recommended GPIB interface cables.

| <b>Part Number</b> | <b>Cable length</b> |
|--------------------|---------------------|
| 10833A             | 1 meter             |
| 10833B             | 2 meters            |
| 10833D             | 0.5 meter           |

If you need additional clearance between the GPIB socket on the pc GPIB interface card and the pc chassis you can purchase the 10834A GPIB adapter.

**RFI shielding**

The 10833 cables feature an improved shielding design to help reduce RFI levels in systems. To further reduce RFI levels, the interface module is shipped with a clip-on ferrite bead that you can attach to your GPIB cable. Lay the ferrite bead under the GPIB cable as shown below, then snap the two halves of the ferrite bead together. The ferrite bead should be attached as close to the interface module connection as possible.

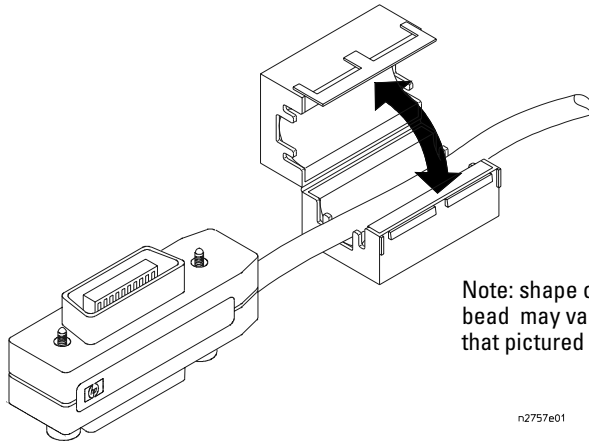

Note: shape of ferrite bead may vary from that pictured

n2757e01

---

## To verify the module is properly connected

- 1 Turn the oscilloscope power on.
- 2 Press the oscilloscope **Utility** key, then press the **Service** softkey.

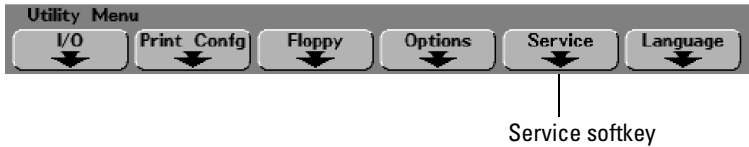

- 3 Press the **About Oscilloscope** softkey.

The **Option Module:** line should look similar to that displayed below.

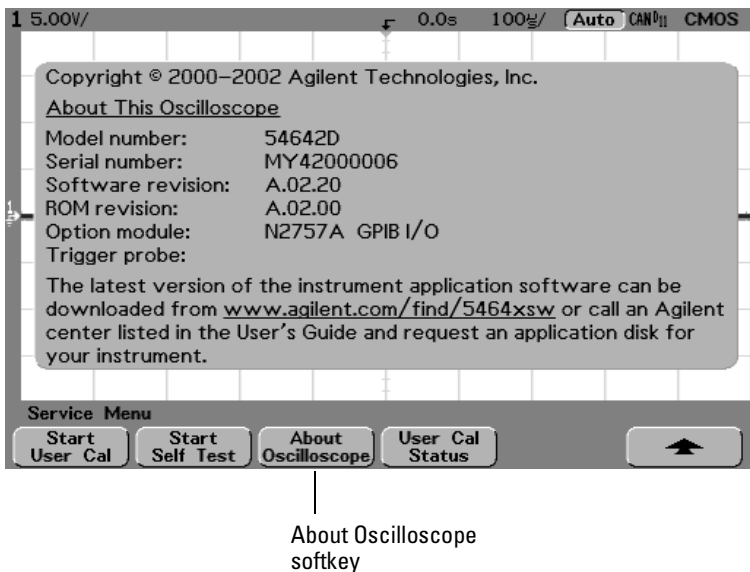

To set the GPIB address

---

## To set the GPIB address

- 1 Turn the oscilloscope power on.
- 2 Press the oscilloscope **Utility** key, then press the **I/O** softkey.



I/O softkey

- 3 Press the **Controller** softkey and select **GPIB**.
- 4 Turn the Entry knob to set the GPIB address. The selected address is displayed in the **Address** softkey.



Controller softkey

used for RS-232 only

Address softkey

# DECLARATION OF CONFORMITY

According to ISO/IEC Guide 22 and CEN//CENELEC EN 45014

**Manufacturer's Name:** Agilent Technologies, Inc. / Digital Design PGU

**Manufacturer's Address:** 1900 Garden of the Gods Road  
Colorado Springs, CO 80907, U.S.A.

## Declares, that the product

**Product Name:** Digitizing Oscilloscope Module

**Model Number(s):** N2757A

**Product Option(s):** This declaration covers all options of the above products(s)

## Conforms to the following product standards:

| EMC           | Standard   | Limit                                 |
|---------------|--|---------------------------------------|
|               | IEC 61326-1:1997+A1:1998 / EN 61326-1:1997+A1:1998         |                                       |
|               | CISPR 11:1990 / EN 55011:1991                              | Group 1, Class A <sup>[1]</sup>       |
|               | IEC 61000-4-2:1995+A1:1998 / EN 61000-4-2:1995             | 4 kV CD, 8 kV AD                      |
|               | IEC 61000-4-3:1995 / EN 61000-4-3:1995                     | 3 V/m, 80-1000 MHz                    |
|               | IEC 61000-4-4:1995 / EN 61000-4-4:1995                     | 0.5 kV signal lines, 1 kV power Lines |
|               | IEC 61000-4-6:1996 / EN 61000-4-6:1996                     | 3 V, 0.15-80 MHz                      |
|               | Canada: ICES-001:1998                                      |                                       |
|               | Australia/New Zealand: AS/NZS 2064.1                       |                                       |
| <b>Safety</b> | IEC 61010-1:1990+A1:1992+A2:1995 / EN 61010-1:1993+A2:1995 |                                       |
|               | Canada: CSA C22.2 No. 1010:1:1992                          |                                       |

## Conformity / Supplementary Information:

The product herewith complies with the requirements of the Low Voltage Directive 73/23/EEC and the EMC Directive 89/336/EEC (including 93/68/EEC) and carries the CE-marking accordingly (European Union)

<sup>[1]</sup> The product was tested in a typical configuration with Agilent Technologies test systems.

Date: 06/28/2000

  
Name

Ken Wyatt, Product Regulations Manager

For further information, please contact your local Agilent Technologies sales office, agent, or distributor.

### **Regulatory Information for Canada**

#### **ICES/NMB-001**

This ISM device complies with Canadian ICES-001.  
Cet appareil ISM est conforme à la norme NMB-001 du Canada.

### **Regulatory Information for Australia/New Zealand**

This ISM device complies with Australian/New Zealand AS/NZS 2064.1

 **N10149**



---

# Safety Notices

This apparatus has been designed and tested in accordance with IEC Publication 1010, Safety Requirements for Measuring Apparatus, and has been supplied in a safe condition. This is a Safety Class I instrument (provided with terminal for protective earthing). Before applying power, verify that the correct safety precautions are taken (see the following warnings). In addition, note the external markings on the instrument that are described under "Safety Symbols."

## Warnings

- Before turning on the instrument, you must connect the protective earth terminal of the instrument to the protective conductor of the (mains) power cord. The mains plug shall only be inserted in a socket outlet provided with a protective earth contact. You must not negate the protective action by using an extension cord (power cable) without a protective conductor (grounding). Grounding one conductor of a two-conductor outlet is not sufficient protection.
- Only fuses with the required rated current, voltage, and specified type (normal blow, time delay, etc.) should be used. Do not use repaired fuses or short-circuited fuseholders. To do so could cause a shock or fire hazard.
- If you energize this instrument by an auto transformer (for voltage reduction or mains isolation), the common terminal must be connected to the earth terminal of the power source.
- Whenever it is likely that the ground protection is impaired, you must make the instrument inoperative and secure it against any unintended operation.

- Service instructions are for trained service personnel. To avoid dangerous electric shock, do not perform any service unless qualified to do so. Do not attempt internal service or adjustment unless another person, capable of rendering first aid and resuscitation, is present.
- Do not install substitute parts or perform any unauthorized modification to the instrument.
- Capacitors inside the instrument may retain a charge even if the instrument is disconnected from its source of supply.
- Do not operate the instrument in the presence of flammable gasses or fumes. Operation of any electrical instrument in such an environment constitutes a definite safety hazard.
- Do not use the instrument in a manner not specified by the manufacturer.

## To clean the instrument

If the instrument requires cleaning: (1) Remove power from the instrument. (2) Clean the external surfaces of the instrument with a soft cloth dampened with a mixture of mild detergent and water. (3) Make sure that the instrument is completely dry before reconnecting it to a power source.

## Safety Symbols



Instruction manual symbol: the product is marked with this symbol when it is necessary for you to refer to the instruction manual in order to protect against damage to the product.



Hazardous voltage symbol.



Earth terminal symbol: Used to indicate a circuit common connected to grounded chassis.

---

# Notices

© Agilent Technologies, Inc. 2000-2002

No part of this manual may be reproduced in any form or by any means (including electronic storage and retrieval or translation into a foreign language) without prior agreement and written consent from Agilent Technologies, Inc. as governed by United States and international copyright laws.

## Manual Part Number

N2757-92000, October 2002

## Print History

N2757-92002, October 2002

N2757-92001, June 2000

N2757-92000, April 2000

Agilent Technologies, Inc.  
1601 California Street  
Palo Alto, CA 94304 USA

## Restricted Rights Legend

If software is for use in the performance of a U.S. Government prime contract or subcontract, Software is delivered and licensed as "Commercial computer software" as defined in DFAR 252.227-7014 (June 1995), or as a "commercial item" as defined in FAR 2.101(a) or as "Restricted computer software" as defined in FAR 52.227-19 (June 1987) or any equivalent agency regulation or contract clause. Use, duplication or disclosure of Software is subject to Agilent Technologies' standard commercial license terms, and non-DOD Departments and Agencies of the U.S. Government will receive no greater than Restricted Rights as defined in FAR 52.227-19(c)(1-2) (June 1987). U.S. Government users will receive no greater than Limited Rights as defined in FAR 52.227-14 (June 1987) or DFAR 252.227-7015 (b)(2) (November 1995), as applicable in any technical data.

## Document Warranty

The material contained in this document is provided "as is," and is subject to being changed, without notice, in future editions. Further, to the maximum extent permitted by applicable law, Agilent disclaims all warranties, either express or implied, with regard to this manual and any information contained herein, including but not limited to the implied warranties of merchantability and fitness for a particular purpose. Agilent shall not be liable for errors or for incidental or consequential damages in connection with the furnishing, use, or performance of this document or of any information contained herein. Should Agilent and the user have a separate written agreement with warranty terms covering the material in this document that conflict with these terms, the warranty terms in the separate agreement shall control.

## Technology Licenses

The hardware and/or software described in this document are furnished under a license and may be used or copied only in accordance with the terms of such license.

---

## WARNING

A WARNING notice denotes a hazard. It calls attention to an operating procedure, practice, or the like that, if not correctly performed or adhered to, could result in personal injury or death. Do not proceed beyond a WARNING notice until the indicated conditions are fully understood and met.

---

## CAUTION

A CAUTION notice denotes a hazard. It calls attention to an operating procedure, practice, or the like that, if not correctly performed or adhered to, could result in damage to the product or loss of important data. Do not proceed beyond a CAUTION notice until the indicated conditions are fully understood and met.



Agilent Technologies

---

# Agilent N2757A GPIB インタフェース・モジュール

マニュアル番号 N2757-92002  
2002年10月

© Copyright Agilent Technologies 2000-2002  
All Rights Reserved

---

## インストール・ガイド

---

## はじめに

Agilent N2757A GPIB インタフェース・モジュールは、以下の Agilent 54600 シリーズ・オシロスコープに対して、高速データ転送によるリモート通信およびフル・プログラマビリティを提供します。

54621A/22A/24A/41A/42A オシロスコープ

54621D/22D/41D/42D ミックスド・シグナル・オシロスコープ

GPIB ポートは、リモート・プログラミングに使用したり、IntuiLink for 54600 コネクティビティ・ソフトウェアを使って PC をオシロスコープとリンクする際に使用できます。プログラミングの詳細については、オシロスコープに付属の『54620/40 シリーズ・オシロスコープ プログラマーズ・ガイド』を参照してください。接続の方法については、IntuiLink for 54600 ソフトウェアを参照してください。

以下に、購入可能な PC 用推奨 GPIB カードを示します。

| 部品番号   | 説明  |
|--------|---|
| 82341C | 高性能 GPIB インタフェース、Windows 3.1/95/98/NT 用               |
| 82341D | 高性能 <i>plug&amp;play</i> GPIB インタフェース、Windows 95/98 用 |
| 82350A | PCI 高性能 GPIB インタフェース・カード、Windows 95/98/NT 用           |

## インターフェース・モジュールのインストール

- 1 オシロスコープの電源を切ります。
- 2 モジュール上部にあるタブを、以下の図に示すように、オシロスコープ背面の穴に入れます。
- 3 モジュールを押し下げて、モジュール背面にあるコネクタ位置合わせタブをオシロスコープ背面にある位置合わせスロットにはめ込みます。
- 4 モジュール上のねじで、モジュールをオシロスコープに固定します。

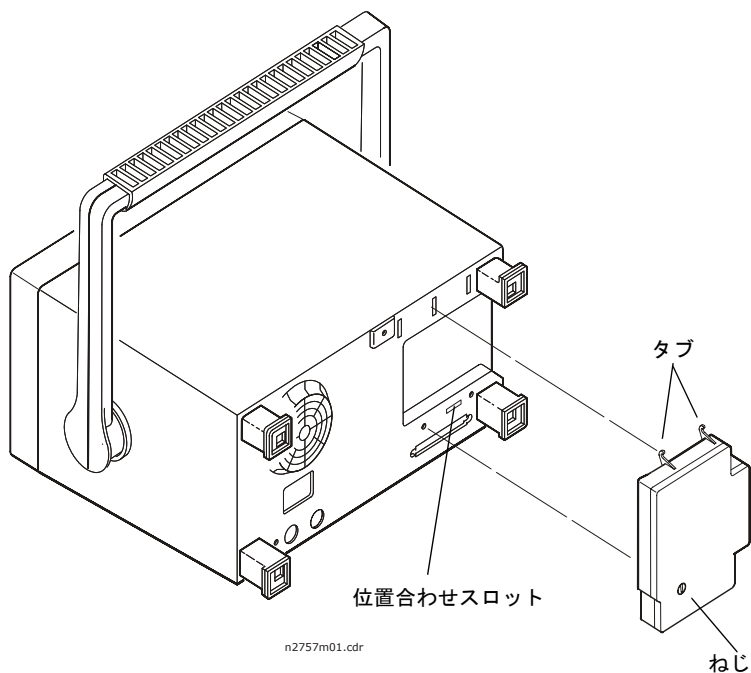

## GPIB ケーブルの接続

GPIB ケーブルを GPIB モジュールと PC/ コントローラに接続します。以下に、推奨 GPIB インタフェース・ケーブルを示します。

| 部品番号   | ケーブル長    |
|--------|----------|
| 10833A | 1 メートル   |
| 10833B | 2 メートル   |
| 10833D | 0.5 メートル |

PC の GPIB インタフェース・カード上の GPIB ソケットと PC シャーシ間の間隔をさらに広げたい場合は、10834A GPIB アダプタを購入してください。

### RFI シールド

10833 ケーブルはシールド設計が施されているため、システムの RFI レベルが下がります。さらに RFI レベルを下げるために、インタフェース・モジュールには GPIB ケーブルに取り付け可能なクリップオン・フェライト・ビーズが付属しています。以下の図に示すように、フェライト・ビーズを GPIB ケーブルの下に置いて、フェライト・ビーズの上側と下側をカチッと閉めます。フェライト・ビーズは、できるだけインタフェース・モジュール端子の近くに取り付けます。

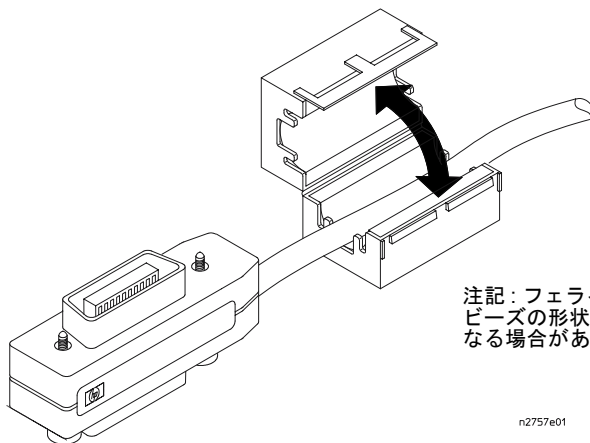

## モジュールの接続の確認

- 1 オシロスコープの電源を入れます。
- 2 オシロスコープの **Utility** キーを押した後、**Service** ソフトキーを押します。



Service ソフトキー

- 3 **About Oscilloscope** ソフトキーを押します。  
Option Module: 行に以下のように表示されるはずです。



About Oscilloscope  
ソフトキー

## GPIB アドレスの設定

- 1 オシロスコープの電源を入れます。
- 2 オシロスコープの **Utility** キーを押した後、**I/O** ソフトキーを押します。



IO ソフトキー

- 3 **Controller** ソフトキーを押して、**GPIB** を選択します。
- 4 Entry ノブを回して GPIB アドレスを設定します。選択したアドレスが **Address** ソフトキーに表示されます。



Controller  
ソフトキー

RS-232 にのみ  
使用

Address ソフトキー



## 納入後の保証について

- ハードウェア製品に対しては部品及び製造上の不具合について保証します。又、当社製品仕様に適合していることを保証します。  
ソフトウェアに対しては、媒体の不具合(ソフトウェアを当社指定のデバイス上適切にインストールし使用しているにもかかわらず、プログラミング・インストールを実行しない原因がソフトウェアを記録している媒体に因る場合)について保証します。又、当社が財産権を有するソフトウェア(特注品を除く)が当社製品仕様に適合していることを保証します。  
保証期間中にこれらの不具合、当社製品仕様への不適合がある旨連絡を受けた場合は、当社の判断で修理又は交換を行います。
- 保証による修理は、当社営業日の午前8時45分から午後5時30分の時間帯でお受けします。なお、保証期間中でも当社所定の出張修理地域外での出張修理は、技術者派遣費が有償となります。
- 当社の保証は、製品の動作が中断されないことや、エラーが皆無であることを保証するものではありません。保証期間中、当社が不具合を認めた製品を相当期間内に修理又は交換できない場合お客様は当該製品を返却して購入金額の返金を請求できます。
- 保証期間は、製品毎に定められています。保証は、当社が据付調整を行う製品については、据付調整完了日より開始します。但し、お客様の都合で据付調整を納入後31日以降に行う場合は31日目より保証が開始します。  
又、当社が据付調整を行わない製品については、納入日より保証が開始します。
- 当社の保証は、以下に起因する不具合に対しては適用されません。
  - (1) 不適當又は不完全な保守、校正によるとき
  - (2) 当社以外のソフトウェア、インターフェース、サプライ品によるとき
  - (3) 当社が認めていない改造によるとき
  - (4) 当社製品仕様に定めていない方法での使用、作動によるとき
  - (5) お客様による輸送中の過失、事故、滅失、損傷等によるとき
  - (6) お客様の据付場所の不備や不適正な保全によるとき
  - (7) 当社が認めていない保守又は修理によるとき
  - (8) 火災、風水害、地震、落雷等の天災によるとき
- 当社はここに定める以外の保証は行いません。又、製品の特定用途での市場商品価値や適合性に関する保証は致しかねます。
- 製品の保守修理用部品供給期間は、製品の廃止後最低5年です。

© Copyright Agilent Technologies 2000-2002 All Rights Reserved.

Reproduction, adaptation, or translation without prior written permission is prohibited, except as allowed under the copyright laws.

**Restricted Rights Legend.**

Use, duplication or disclosure by the U.S. Government is subject to restrictions as set forth in subparagraph (c) (1) (ii) of the Rights in Technical Data and Computer Software clause at DFARS 252.227-7013 for DOD agencies, and subparagraphs (c) (1) and (c) (2) of the Commercial Computer Software Restricted Rights clause at FAR 52.227-19 for other agencies. Agilent Technologies 3000 Hanover Street Palo Alto, California 94304 U.S.A.

**Document Warranty**

The information contained in this document is subject to change without notice.

**Agilent Technologies makes no warranty of any kind with regard to this material, including, but not limited to, the implied warranties of merchantability or fitness for a particular purpose.**

Agilent Technologies shall not be liable for errors contained herein or for damages in connection with the furnishing, performance, or use of this material.

**Product Warranty**

This Agilent Technologies product has a warranty against defects in material and workmanship for a period of 90 days from date of shipment. During the warranty period, Agilent Technologies will, at its option, either repair or replace products that prove to be defective.

For warranty service or repair, this product must be returned to a service facility designated by Agilent Technologies. For products returned to Agilent Technologies for warranty service, the Buyer shall prepay shipping charges to Agilent Technologies and Agilent Technologies shall pay shipping charges to return the product to the Buyer. However, the Buyer shall pay all shipping charges, duties, and taxes for products returned to Agilent Technologies from another country.

Agilent Technologies warrants that its software and firmware designated by Agilent Technologies for use with an instrument will execute its programming instructions when properly installed on that instrument. Agilent Technologies does not warrant that the operation of the instrument software, or firmware will be uninterrupted or error free.

**Limitation of Warranty**

The foregoing warranty shall not apply to defects resulting from improper or inadequate maintenance by the Buyer, Buyer-supplied software or interfacing, unauthorized modification or misuse, operation outside of the environmental specifications for the product, or improper site preparation or maintenance.

**No other warranty is expressed or implied. Agilent Technologies specifically disclaims the implied warranties of merchantability or fitness for a particular purpose.**

**Exclusive Remedies**

The remedies provided herein are the buyer's sole and exclusive remedies. Agilent Technologies shall not be liable for any direct, indirect, special, incidental, or consequential damages, whether based on contract, tort, or any other legal theory.

**Assistance**

Product maintenance agreements and other customer assistance agreements are available for Agilent Technologies products. For any assistance, contact your nearest Agilent Technologies Sales Office.

**Certification**

Agilent Technologies certifies that this product met its published specifications at the time of shipment from the factory. Agilent Technologies further certifies that its calibration measurements are traceable to the United States National Institute of Standards and Technology, to the extent allowed by the Institute's calibration facility, and to the calibration facilities of other International Standards Organization members.

## 安全性

本器は、IEC Publication 1010, Safety Requirements for Measuring Apparatus に準拠して設計および試験が行われ、安全基準を満たしています。本器は安全クラス 1 の測定器です (感電防止用アース端子が装備されています)。電源を入れる前に、安全上の注意が正しく守られているか確認してください (次の警告を参照してください)。さらに、「安全マーク」で説明する測定器上のマークにも注意してください。

## 安全マーク



取扱説明書マーク: 製品の損傷を防ぐために、ユーザがマニュアルを参照する必要がある場合、製品にこのマークが付けられています。



危険電圧を示します。



アース端子: 回路がシャーシ・アース端子に接続されていることを示します。

## 警告

警告記号は、危険であることを示しています。この記号のある箇所に記した手順や行為などは、正しく実行しなかったり、守らなかったりすると人身事故の危険があります。指示されている条件を完全に理解し、この条件に対応できるまで、警告記号を無視して先に進まないでください。

## 注意

注意記号は、危険であることを示しています。この記号のある箇所に記した手順や行為などを、正しく実行しなかったり守らなかった場合には、本製品の一部分またはすべてに損傷を与えたり、破壊したりするおそれがあります。指示されている条件を完全に理解し、この条件に対応できるまで、注意記号を無視して先に進まないでください。

## About this edition

This is the Agilent N2747A GPIB Interface Module Installation Guide.

マニュアル番号  
N2757-92002,  
2002年10月  
Printed in USA.

出版履歴  
N2757-92001, 2000年6月  
N2757-92000, 2000年4月

New editions are complete revisions of the manual. Many product updates do not require manual changes; and, conversely, manual corrections may be done without accompanying product changes. Therefore, do not expect a one-to-one correspondence between product updates and manual updates.

