

Noise Figure Analyzers NFA Series

Quick Reference Guide



Agilent Technologies

Manufacturing Part Number: N8972-90082

May 2001

© Copyright 2001 Agilent Technologies

Safety Notices

This product and related documentation must be reviewed for familiarization with safety markings and instructions before use.

This instrument has been designed and tested in accordance with IEC Publication 61010-1+A1+A2:1991 Safety Requirements for Electrical Equipment for Measurement, Control and Laboratory Use and has been supplied in a safe condition. The instruction documentation contains information and warnings which must be followed by the user to ensure safe operation and to maintain the instrument in a safe condition.

The information contained in this document is subject to change without notice.

Agilent Technologies makes no warranty of any kind with regard to this material, including but not limited to, the implied warranties of merchantability and fitness for a particular purpose. Agilent Technologies shall not be liable for errors contained herein or for incidental or consequential damages in connection with the furnishing, performance, or use of this material.

The following safety symbols are used throughout this manual. Familiarize yourself with the symbols and their meaning before operating this instrument.

WARNING

***Warning* denotes a hazard. It calls attention to a procedure which, if not correctly performed or adhered to, could result in injury or loss of life. Do not proceed beyond a warning note until the indicated conditions are fully understood and met.**

CAUTION

Caution denotes a hazard. It calls attention to a procedure that, if not correctly performed or adhered to, could result in damage to or destruction of the instrument. Do not proceed beyond a caution sign until the indicated conditions are fully understood and met.

NOTE

Note calls out special information for the user's attention. It provides operational information or additional instructions of which the user should be aware.

WARNING

This is a Safety Class 1 Product (provided with a protective earthing ground incorporated in the power cord). The mains plug shall only be inserted in a socket outlet provided with a protected earth contact. Any interruption of the protective conductor inside or outside of the product is likely to make the product dangerous. Intentional interruption is prohibited.

WARNING

If this product is not used as specified, the protection provided by the equipment could be impaired. This product must be used in a normal condition (in which all means for protection are intact) only.

WARNING

No operator serviceable parts inside. Refer servicing to qualified personnel. To prevent electrical shock do not remove covers.

WARNING

For continued protection against fire hazard, replace line fuses only with the same type and ratings (115V range; type F 5A 125V; 239V range F 5A 250V). The use of other fuses or materials is prohibited.

CAUTION

To prevent electrical shock, disconnect the instrument from the mains (line) before cleaning. Use a dry cloth or one slightly dampened with water to clean the external case parts. Do not attempt to clean internally.

Environmental requirements: This product is designed for indoor use only and to meet the following environmental conditions:

- Operating temperature: 0° C to +55° C
- Operating humidity: <95% relative
- Altitude: up to 4500 m

Warranty

This Agilent Technologies instrument product is warranted against defects in material and workmanship for a period of three years from date of shipment. During the warranty period, Agilent Technologies Company will, at its option, either repair or replace products which prove to be defective.

For warranty service or repair, this product must be returned to a service facility designated by Agilent Technologies. Buyer shall prepay shipping charges to Agilent Technologies and Agilent Technologies shall pay shipping charges to return the product to Buyer. However, Buyer shall pay all shipping charges, duties, and taxes for products returned to Agilent Technologies from another country.

Agilent Technologies warrants that its software and firmware designated by Agilent Technologies for use with an instrument will execute its programming instructions when properly installed on that instrument. Agilent Technologies does not warrant that the operation of the instrument, or software, or firmware will be uninterrupted or error-free.

LIMITATION OF WARRANTY

The foregoing warranty shall not apply to defects resulting from improper or inadequate maintenance by Buyer, Buyer-supplied software or interfacing, unauthorized modification or misuse, operation outside of the environmental specifications for the product, or improper site preparation or maintenance.

NO OTHER WARRANTY IS EXPRESSED OR IMPLIED. AGILENT TECHNOLOGIES SPECIFICALLY DISCLAIMS THE IMPLIED WARRANTIES OF MERCHANTABILITY AND FITNESS FOR A PARTICULAR PURPOSE.

EXCLUSIVE REMEDIES

THE REMEDIES PROVIDED HEREIN ARE BUYER'S SOLE AND EXCLUSIVE REMEDIES. AGILENT TECHNOLOGIES SHALL NOT BE LIABLE FOR ANY DIRECT, INDIRECT, SPECIAL, INCIDENTAL, OR CONSEQUENTIAL DAMAGES, WHETHER BASED ON CONTRACT, TORT, OR ANY OTHER LEGAL THEORY.

Where to Find the Latest Information

Documentation is updated periodically. For the latest information about Agilent NFA Noise Figure Analyzers, including firmware upgrades and application information, please visit the following Internet URL:

<http://www.agilent.com/find/nf/>

Manufacturer's Declaration

This statement is provided to comply with the requirements of the German Sound Emission Directive, from 18 January 1991.

This product has a sound pressure emission (at the operator position) < 70 dB(A).

- Sound Pressure $L_p < 70$ dB(A).
- At Operator Position.
- Normal Operation.
- According to ISO 7779:1988/EN 27779:1991 (Type Test).

Hersteller- bescheinigung

Diese Information steht im Zusammenhang mit den Anforderungen der Maschinenlärminformationsverordnung vom 18 Januar 1991.

- Schalldruckpegel $L_p < 70$ dB(A).
- Am Arbeitsplatz.
- Normaler Betrieb.
- Nach ISO 7779:1988/EN 27779:1991 (Typprüfung).

Contents

1. Getting Started

What You will Find in this Chapter	2
The Noise Figure Analyzer Features	3
3.0 GHz Mechanical Switch	3
Microwave Front Panel Connector	3
Overview of the Front Panel	4
Overview of the Rear Panel	8
Overview of the Front Panel Keys	10
How the Front Panel Keys are Organized	10
Navigating Through the Menu System	10
Display Annotation	12
Performing Common File Operations	16
Formatting a Diskette	16
Saving a File	18
Loading a File	19
Renaming a File	19
Copying a File	20
Deleting a File	21
Working with Tables	22

2. Making Basic Measurements

What You will Find in this Chapter	24
Entering Excess Noise Ratio (ENR) Data	25
Selecting a Common ENR Table	25
Entering ENR Table Data for Normal Noise Sources	26
Saving an ENR Table	29
Entering a Spot ENR Value	30
Entering a Spot Thot Value	31

Contents

Using a Smart Noise Source	32
Setting the Tcold value	34
Setting the Measurement Frequencies	37
Selecting Sweep Frequency Mode	37
Selecting List Frequency Mode	38
Selecting Fixed Frequency Mode	40
Setting the Bandwidth and Averaging	41
Selecting a Bandwidth Value	41
Setting Averaging	41
Calibrating the Analyzer	42
To perform a calibration	42
Selecting the RF Input Attenuation Range	44
Displaying the Measurement Results	46
Selecting the Display Format	46
Selecting Result Types to Display	48
Graphical Features	49
Setting the Scaling	52
Working with Markers	55
Indicating an Invalid Result	62
3. Advanced Features	
What You will Find in this Chapter	64
Setting up Limit Lines	65
Creating a Limit Line	66
Using Loss Compensation	67
Configuring Fixed Loss Compensation	67
Configuring Table Loss Compensation	68
Setting Temperature of Loss	70

Contents

Making Manual Measurements	71
Manual Measurements Procedure	71
4. Making Extended Frequency Measurements	
What You will Find in this Chapter	74
Overview of Configuring Extended Frequency Measurements	75
Measurement Modes	77
Basic Measurement — No Frequency Conversion	78
Frequency Down-converting DUT	80
Frequency Up-converting DUT	83
System Downconverter	86
Connecting the System	89
Setting Up the Noise Figure Analyzer	89
5. Performing System Operations	
What You will Find in this Chapter	94
Setting the GPIB Addresses	95
To Set the GPIB Addresses	95
Configuring the Serial Port	96
Configuring the Internal Alignment	97
Turning Alignment Off and On	97
Changing Alignment Mode	97
Alignment of the YIG Tuned Filter (YTF)	98
Displaying Error, System and Hardware Information	99
Displaying the Error History	99
Displaying System Information	99
Displaying Hardware Information	99
Presetting the Noise Figure Analyzer	100

Contents

Defining the Power-On/Preset Conditions	101
Setting the Power On Conditions.....	101
Setting the Preset Conditions	101
Restoring System Defaults	102
Setting the Time and Date.....	103
To turn the time and date on and off.....	103
To set the time and date.....	103
Configuring a Printer with the NFA.....	104
To Configure a Printer with the NFA	104
Testing Correct Printer Operation.....	104

1 **Getting Started**

This chapter introduces you to basic features of the Noise Figure Analyzer, including front panel and rear panel descriptions, and an overview of the display annotation.

What You will Find in this Chapter

This chapter covers the following:

- The Noise Figure Analyzer Features
- Overview of the Front Panel
- Overview of the Rear Panel
- Display Annotation
- Overview of the Front Panel Keys
- Performing Common File Operations
- Working with Tables

The Noise Figure Analyzer Features

3.0 GHz Mechanical Switch

The N8974A and N8975A NFA models have a mechanical switch fitted to allow them to switch between the 10 MHz to 3.0 GHz frequency range and the 3.0 GHz to 6.7 GHz and the 3.0 GHz to 26.5 GHz frequency ranges respectively. If the frequency range you are working in crosses the 3.0 GHz point, the mechanical switch operates. The mechanical switch has a limited number of cycles over which it is reliable.

To maximize the switches reliable life, switching over the 3.0 GHz switch should be limited where possible.

Microwave Front Panel Connector

The N8974A and N8975A NFA models are fitted with a precision 3.5mm male input connector. The models are supplied with a Precision 3.5mm Coaxial Adaptor (83059B) and a 3.5mm Spanner (8710-1933). When making connection you need to ensure you apply the correct torque and you use the adaptor where needed. Correct torque value guidance is in the *Agilent NFA Series Performance Verification and Calibration Guide*.

Overview of the Front Panel

Figure 1-1 Front Panel Overview

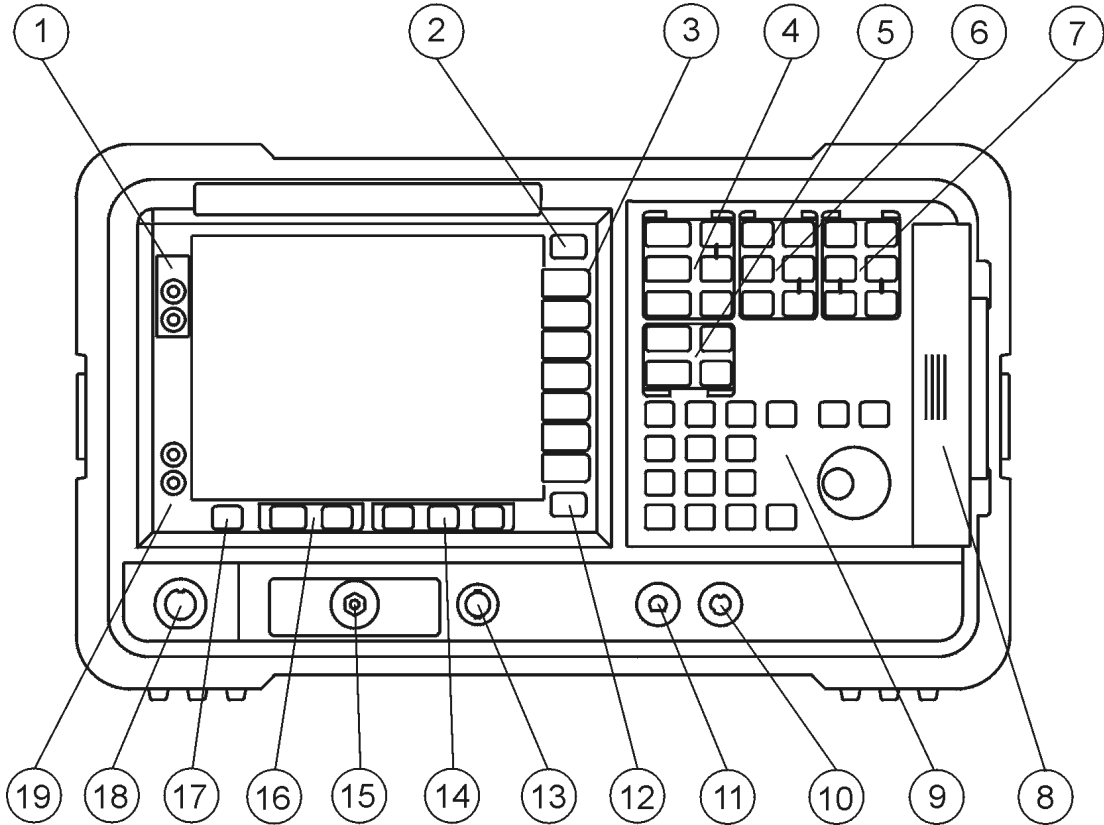

Table 1-1 Front Panel Item Descriptions

Item	Description
1	Viewing Angle keys allow you to adjust the display.
2	The Esc (escape) key cancels any entry in progress.
3	Menu keys are the unlabeled keys next to the screen. The menu key labels are shown on the display next to these unlabeled keys.

Table 1-1 Front Panel Item Descriptions

Item	Description
4	<p>The MEASURE functions allow you to configure the NFA parameters needed for making measurements.</p> <p>The Frequency/Points and Averaging/Bandwidth keys activate the primary set up function menu keys.</p> <p>The Calibrate key removes any second stage noise contribution from the measurement. The ENR key accesses the ENR menu.</p> <p>The Meas Mode and Mode Setup keys are used to configure the NFA to measure mixers and devices at frequencies greater than the basic frequency of the NFA using a Local Oscillator.</p>
5	<p>The DISPLAY functions allow you to configure the display results.</p>
6	<p>The CONTROL functions allow you to setup the NFA's advanced features.</p>
7	<p>SYSTEM functions affect the state of the NFA. Various setup and alignment routines are accessed with the System key.</p> <p>The green Preset key resets the NFA to a known state.</p> <p>The File key menu allows you to save and load the various NFA file types and access the File Manager. The Save Trace key executes the Save function defined under File.</p> <p>The Print Setup menu keys allow you to configure hardcopy output. The Print key sends hardcopy data to the printer.</p>
8	<p>The Media Door on the right side of the front panel accesses the 3.5 inch disk drive.</p>

Table 1-1 Front Panel Item Descriptions



Item	Description
9	<p>The Data Entry Keys, which include the Up/Down arrow keys, RPG (rotatable knob), and numeric keys, allow you to enter or change the numeric value of an active function.</p> <p>The Numeric Keys allows entry of exact values for many of the NFA functions. To terminate a numeric, where no unit labels have been presented, press the Enter key.</p> <p>The RPG allows continuous change of functions such as marker position.</p> <p>The Up/Down arrow keys allow discrete increases or decreases of the active function value.</p>
10	Not currently supported.
11	PROBE POWER provides power for other accessories.
12	The ← Prev key accesses the previously selected menu.
13	NOISE SOURCE DRIVE OUTPUT +28V PULSED this connector provides a 28 Vdc level to switch the noise source on. The noise source is off when no voltage is applied.
14	Tab Keys are used to move between, table input fields, fields on forms, and to move within the fields of the dialog box accessed by the File menu keys.
15	INPUT 50Ω This is the input connector for the NFA. N8972/3A models have a Type-N connector. N8974/5A models have a precision 3.5 mm connector.
16	<p>The  <i>Next Window</i> key selects which graph or result parameter is active.</p> <p>Pressing  <i>Zoom</i> key while in graph mode allows you to switch between the dual-graph and single-graph display.</p>
17	Press the Help key and then any front panel or menu key to get a short description of the key function and the associated remote command.

Table 1-1 **Front Panel Item Descriptions**

Item	Description
18	The Smart Noise Source (SNS) connector provides the interface to upload the ENR data, monitor the ambient temperature, and switch the SNS off and on.
19	The I (On) key turns the NFA on, while the O (Standby) key switches the NFA to standby.

Overview of the Rear Panel

Figure 1-2 Rear Panel Overview

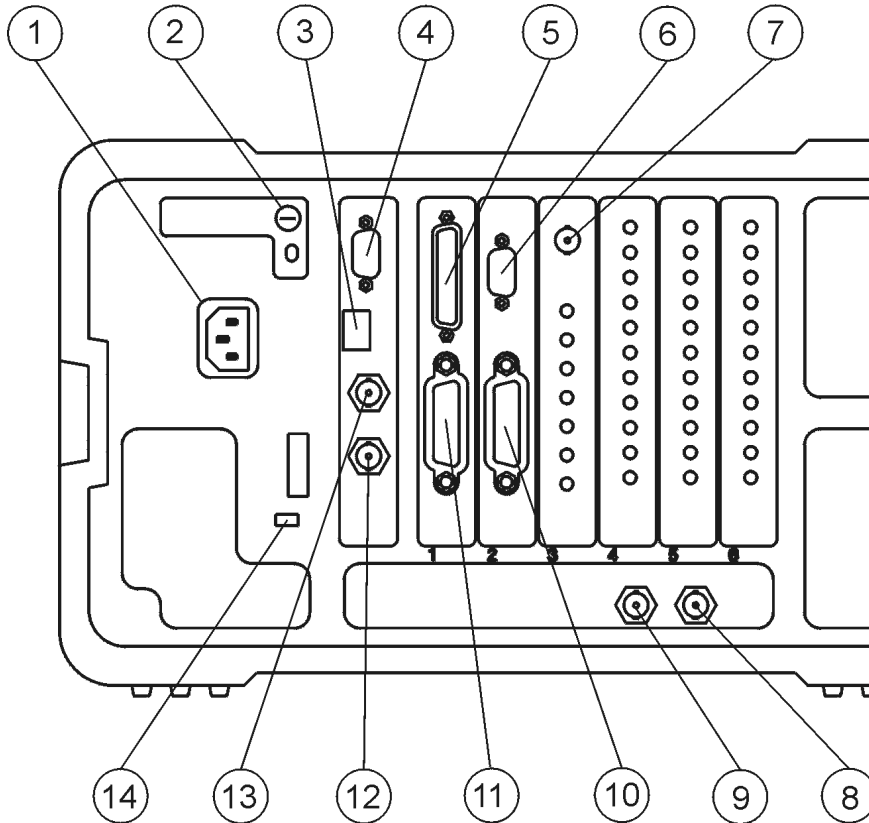

Table 1-2 Rear Panel Item Descriptions

Item	Description
1	Power input is the input for the AC line-power source.
2	Line Fuse. The fuse is removed by twisting counterclockwise 1/4 turn. Replace only with a fuse of the same rating. See the label on the rear panel and information in the <i>Setup Guide</i> .

Table 1-2 Rear Panel Item Descriptions

Item	Description
3	Service Connector. The service connector is for service use only.
4	VGA OUTPUT drives an external VGA compatible monitor with a signal that has 31.5 kHz horizontal, 60 Hz vertical synchronizing rate, non-interlaced.
5	PARALLEL interface port is for printing only.
6	RS-232 interface supports remote instrument operation.
7	Presel Tune Connector it is not currently supported.
8	10 MHz REF IN accepts an external frequency source to provide the 10 MHz, -15 to +10 dBm frequency reference used by the NFA.
9	10 MHz REF OUT provides a 10 MHz, 0 dBm minimum, timebase reference signal.
10	LO GPIB port is for the control of an external LO by the NFA.
11	MAIN GPIB interface port supports remote instrument operation.
12	AUX OUT (TTL) it is not currently supported.
13	AUX IN (TTL) it is not currently supported.
14	Power On Selection selects an instrument power preference.

Overview of the Front Panel Keys

How the Front Panel Keys are Organized

The front panel keys are divided into four main groups:

- **MEASURE** keys, which are used to configure the measurement parameters
- **CONTROL** keys, which are used to configure advanced measurement parameters
- **SYSTEM** keys, which perform system-level operations
- **DISPLAY** keys, which adjust the display characteristics of the measurement

Navigating Through the Menu System

Menu keys

Pressing any of the grey front panel keys in the **MEASURE**, **DISPLAY**, **RESULT** or **SYSTEM** key groupings accesses menus of functions that are displayed along the right-hand side of the display. These keys are called **menu keys**. See Figure 1-3.

Figure 1-3

Menu Keys

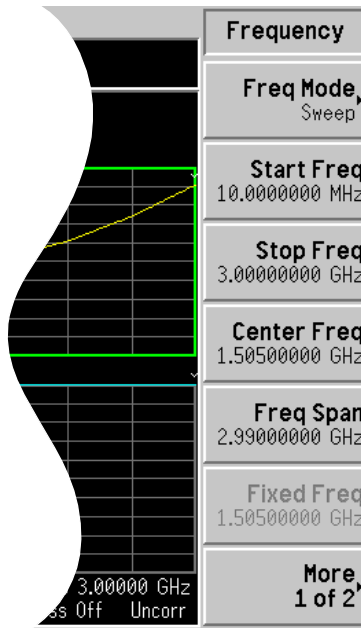

Action keys

Pressing any of the white keys (Calibrate, Full Screen, Restart, Save Trace and Print) invokes an action and these keys are called **action keys**.

To activate a menu key function

To activate a menu key function, press the key immediately to the right of the screen menu key. The menu keys that are displayed depend on which front panel key is pressed and which menu level or page is selected.

Selecting a function within a menu key

Some menu keys have functions contained within them, for example, On and Off. To turn the function on, press the menu key so that On is underlined. To turn the function off, press the menu key so that Off is underlined.

For a summary of all front panel keys and their related menu keys, see the User's Guide or the analyzer online help.

Display Annotation

The display annotation, shown in Figure 1-4, is referenced by numbers. Table 1-3 has a description and, where appropriate, a function key indicating which key activates the function related to the annotation.

Figure 1-4 Display Annotation

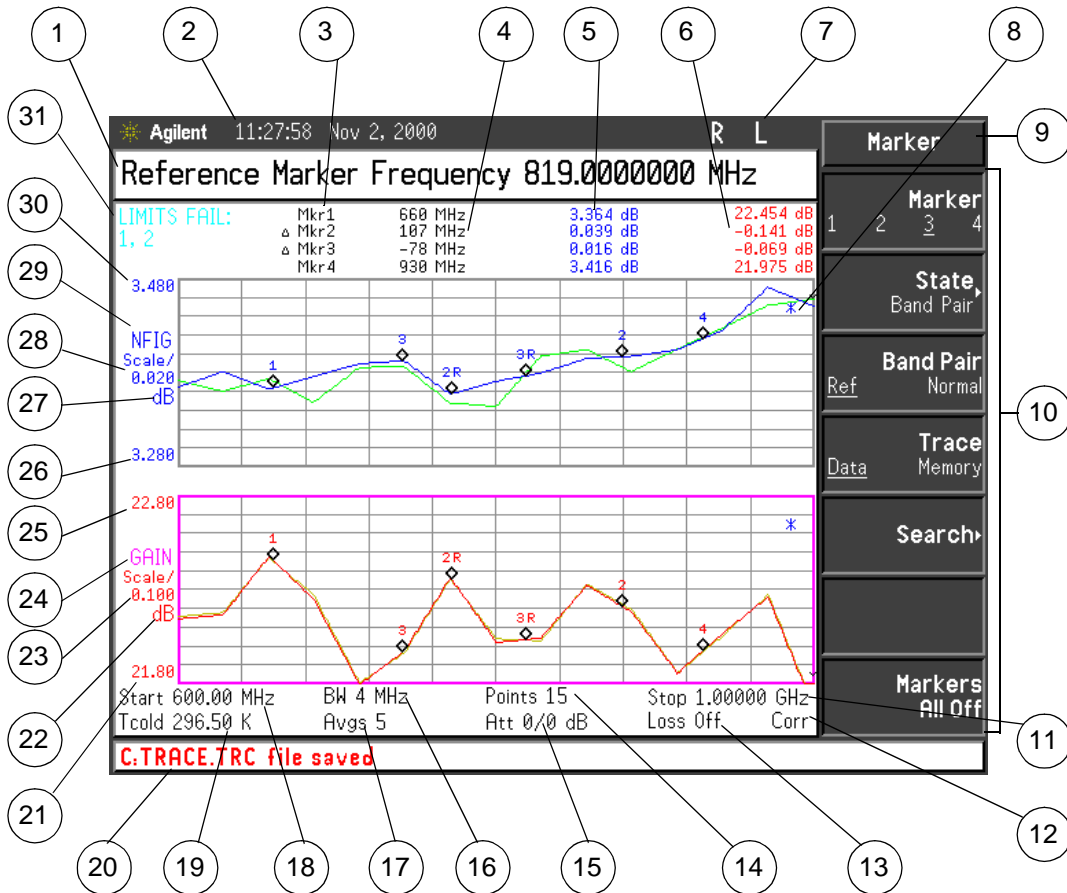

Each item is given a description and where applicable a function key associated with it.

Table 1-3 Display annotation item descriptions

Item	Description
1	The active function area displays the label and value of the currently active key.
2	The time and date display, controlled by the Time/Date menu key, under the System key menus.
3	The marker numbers are displayed in this column, each row displays the markers results. It is controlled by the Marker and the State menu keys.
4	The markers frequency is displayed in this column. It is controlled by the Marker and the State menu keys.
5	The upper trace measurement result is displayed in this column. It is controlled by either the Result, Marker, State menu keys.
6	The lower trace measurement result is displayed in this column. It is controlled by either the Result, Marker, State menu keys.
7	The GPIB annunciators RLTS.
8	The data invalid indicator appears when a measurement starts. It disappears after a complete sweep.
9	The key menu title, this is dependent on which key is selected.
10	The key menu.
11	The frequency span or stop frequency, controlled by the Freq Span or Stop Freq key.
12	Displays the measurement correction state, uncorrected or corrected. Controlled by the calibration state and the Corr key.
13	Displays the Loss Compensation status, On or Off. Controlled by the Loss Comp key.
14	The number of points, controlled by the Points menu key.

Table 1-3 Display annotation item descriptions

Item	Description
15	Displays the value of attenuation being applied. The left item is the RF attenuator and the right item is the microwave attenuator. On the N8972/3A only the RF attenuator status is displayed.
16	The bandwidth, controlled by the Bandwidth menu key. This is fixed at 4 MHz on the N8972A model.
17	The number of averages, controlled by the Averages menu key.
18	The center frequency or start frequency, controlled by the Center Freq or Start Freq menu keys.
19	The T_{cold} temperature value, controlled by the Tcold menu key.
20	The display status line, displays instrument status and error messages.
21	The lower trace lower limit, controlled by the Lower Limit menu key.
22	The lower trace unit of measurement on the Y-axis, controlled by the Result key or Scale menu key.
23	The lower trace scale, controlled by the Scale/Div menu key.
24	The lower trace result type, controlled by the Result key.
25	The lower trace upper limit, controlled by the Upper Limit menu key.
26	The upper trace lower limit, controlled by the Lower Limit menu key.
27	The upper trace unit of measurement on the Y-axis, controlled by the Result key or Scale menu key.
28	The upper trace scale, controlled by the Scale/Div menu key.
29	The upper trace result type, controlled by the Result key.
30	The upper trace upper limit, controlled by the Upper Limit menu key.

Table 1-3 Display annotation item descriptions

Item	Description
31	The limit line failure indicator.
Shown in Figure 1-5	The measurement mode status, controlled by the Meas Mode key. This information is displayed by default. The status disappears when the marker results are switched on.

Figure 1-5 Measurement Mode Status



Basic Setup Measurement Mode

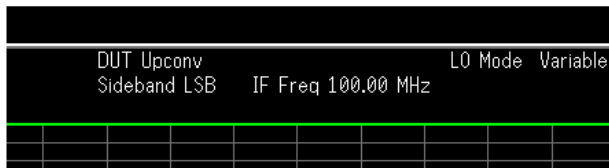

Using a Converter Measurement Mode

Performing Common File Operations

This section covers:

- Formatting a diskette
- Saving a file
- Loading a file
- Renaming a file
- Copying a file
- Deleting a file

Formatting a Diskette

The format is MS-DOS. It is not necessary to format your diskette with the NFA; pre-formatted disks can be used with the NFA.

- Step 1.** Place the diskette you wish to format into the diskette drive (A:) of the NFA.
- Step 2.** Access the file manager menu by pressing **File** key, **File Manager**. See Figure 1-6.

Figure 1-6 File Manager Menu

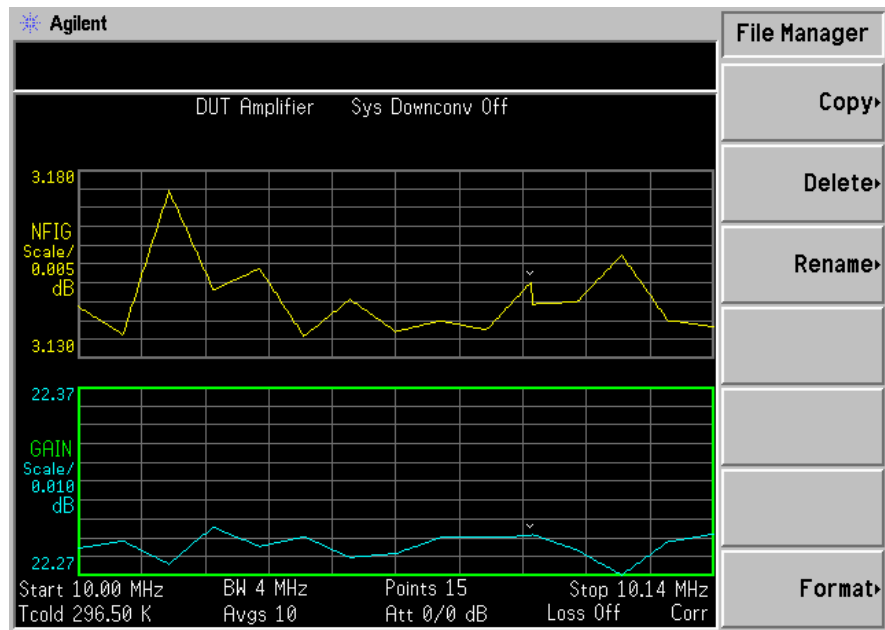

Step 3. Start the format process by pressing **Format**, then **Enter**.

Step 4. Press **Enter**, a second time to format the disk.

The format process takes approximately three minutes.

You are now ready to save files to the disk.

Saving a File

You can save files (ENR tables, states, traces, limits, frequency lists, loss tables, or screens) to a floppy disk (A:), or the internal drive (C:) of the NFA.

Step 1. To access the Save menu press **File, Save**.

Step 2. Select the type of file you want to save.

For example, if you have limit line table data present and want to save it, press **Limits**.

Step 3. Select the limit line table file you wish to save (1, 2, 3 or 4).

For example, to save file 2, press **2**.

Step 4. Enter a filename using the Alpha Editor menu keys.

Step 5. Select the drive you wish to save to by pressing **Tab** →, to move to directory and file list, press **Select**.

NOTE

If the correct drive is not listed in the **Path:** field, highlight **..** at the top of the directory list. This enables you to move up a directory. Press **Select**. To highlight the desired drive, [-A-] or [-C-]) use the arrow keys or the RPG, press **Select** when highlighted.

Step 6. Press **Enter**, to save the file to the drive.

Loading a File

You can load files (ENR tables, states, limits, frequency lists, or loss tables) from a floppy disk (A:\), or the internal drive (C:\).

NOTE

Not all the file types you save can be loaded back into the NFA. For example, screen files and trace files. The trace file is in a CSV (comma separated value) format, designed for use with a PC.

- Step 1.** To access the Load menu press **File, Load**.
- Step 2.** Select the type of file you want to load (ENR tables, states, limits, frequency lists, or loss tables).
- Step 3.** Select the drive where your file is located by pressing **Tab** →. Use the **RPG** to highlight [-C-] or [-A-], then press **Select**.
- Step 4.** Select the file you want to load into the NFA by changing the highlighted file with the up or down arrow keys to highlight the file name.
- Step 5.** Press **Enter** to load the specified file.

Renaming a File

You can rename a file in the [-C-] or [-A-] drive as follows:

- Step 1.** Press **File, File Manager, Rename** to access the Rename menu items.
- Step 2.** Select the type of file you want to rename (ENR tables, states, traces, limits, frequency lists, loss tables, or screens).

For example, if you are renaming a ENR table file, press **ENR**.
- Step 3.** Select the drive where your file is located, by pressing the **Tab** → key, press **Select**. To change drive, use the arrow keys to highlight [-C-] or [-A-], then press **Select**.
- Step 4.** Select the file you want to rename by moving the cursor with the **RPG** or arrow keys to highlight the file name.
- Step 5.** Press **Tab** → to enter the Alpha Editor menu. File names are limited to eight (8) characters.

Getting Started
Performing Common File Operations

Step 6. Press **Enter** and your file is now renamed and visible within the directory displayed on your NFA.

Copying a File

This allows you to copy a file to a different location on both the [-C-] and [-A-] drive.

Step 1. To access the Copy menu press **File, File Manager, Copy**.

Step 2. Put a formatted floppy in the A: drive.

Step 3. Select the type of file you want to copy (ENR tables, states, traces, limits, frequency lists, loss tables or screens).

For example, if you are copying a State file, press **State**.

Step 4. Select the drive where your file is located, by pressing **Tab** → to highlight the `From:Path:` field. Select the drive, using the RPG or arrow keys to highlight [-C-] or [-A-], then press **Select**.

Step 5. Select the file you wish to copy by highlighting the filename using the front-panel knob or arrow keys.

Step 6. Press **Tab** → to move to the `To:Path:` field and select the drive where you want to copy the file using the RPG or arrow keys then press **Select**.

NOTE

If the correct drive is not listed in the `Path:` field, highlight `..` at the top of the directory list. This enables you to move up a directory. Press **Select**, to highlight the desired drive, ([-A-] or [-C-]) then press **Select** again.

Step 7. Copy the file by pressing **Enter**.

Deleting a File

This allows you to delete a file from the [-C-] or [-A-] drive.

- Step 1.** To access the Delete menu press **File, File Manager, Delete**.
- Step 2.** Select the type of file you want to delete (ENR tables, states, traces, limits, frequency lists, loss tables, or screens).
- Step 3.** Select the drive where the file you wish to delete is located, by pressing **Tab** → then using the RPG or arrow keys to highlight [-C-] or [-A-], then press **Select**.

NOTE

If the correct drive is not listed in the `Path:` field, highlight `..` at the top of the directory list. This enables you to move up a directory. Press **Select**, to highlight the desired drive, ([-A-] or [-C-]) then press **Select** again.

- Step 4.** Select the file you want to delete by moving the cursor with the RPG or arrow keys to highlight the file name.
- Step 5.** Press **Enter** and your file is now deleted and is no longer visible in the directory displayed on your NFA.

Working with Tables

The Frequency List, ENR Table, Limit Line Editor, and Loss Compensation Tables use table forms. The following is an overview of how to use the features in these tables.

Table 1-4 **Using Tables**

To...	Use the...
Move the highlight bar within the table	Tab keys
Bring the highlight bar to the top of the table	Home key
Clear the table of all entries	Clear Table menu key
Delete a single row entry	Delete Row menu key
Add a new entry	Add menu key
Move the highlight bar up one row	Row Up menu key
Move the highlight bar down one row	Row Down menu key
Move the table up a page block	Page Up menu key
Move the table down a page block	Page Down menu key
Enter a value	Numerical key pad
Terminate a value	The unit values presented by the menu keys ^a
Connect Limit Line points	The arrow keys or the RPG

- a. A limit line value is a unitless value and it depends on the result's scale unit used.

2

Making Basic Measurements

This chapter describes how to make basic noise figure measurements using your NFA and also covers the most common measurement related tasks.

What You will Find in this Chapter

This chapter covers.

- Entering Excess Noise Ratio (ENR) Data
- Setting the Measurement Frequencies
- Setting the Bandwidth and Averaging
- Calibrating the Analyzer
- Displaying the Measurement Results

Entering Excess Noise Ratio (ENR) Data

You can enter ENR data for the noise source you are using as a table of values or as a single spot value. The table of values are used for measurements at several frequencies. The single spot value is used for single frequency measurements or it is applied across the whole frequency measurement range.

There are two types of noise source. The first type, for example, Agilent 346B, a normal noise source. These need their ENR data to be entered manually either using the ENR data stored previously on a diskette or by using the keypad. The other type, for example, Agilent N4000A, a Smart Noise Source (SNS), can upload the data automatically or when requested.

Selecting a Common ENR Table

To use the same ENR table for calibration and measurement, press the **Common Table** menu key to select **Common Table(On)**; see Figure 2-1.

This is the default setting. In this mode the **Cal Table** is not accessible.

Figure 2-1

Menu Keys showing Common ENR Table On

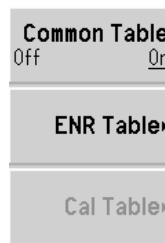

Making Basic Measurements

Entering Excess Noise Ratio (ENR) Data

To use different ENR tables for calibration and measurement, press the **Common Table** menu key to select **Common Table(Off)**; see Figure 2-2.

In this mode, the **Cal Table** menu key is accessible. This is the ENR table of the noise source used to calibrate the NFA. The **Meas Table** is used to make measurements. In **Common Table(Off)** mode the **ENR Table** is the **Meas Table** in the **Common Table(On)** mode.

Figure 2-2 Menu Keys showing Common ENR Table Off



NOTE

If you are using an SNS when **Common Table(Off)** is set, you need to set **Auto Load ENR(Off)** and use the **Fill Table From SNS** menu key. See “Loading the SNS ENR data to the Measurement or Calibration Table.” on page 33.

Entering ENR Table Data for Normal Noise Sources

You can enter ENR data in the form of an ENR table in four ways:

- manually by inputting the required frequencies and corresponding ENR values
- loading the ENR data from a diskette, on which the data has been previously stored
- loading the ENR data from the internal memory, where the data has been previously stored
- loading the ENR data over GPIB, see the *Programmer's Reference* for more details

To enter ENR table data manually

Step 1. Press the **ENR** key, and the **ENR Table** menu key.

Figure 2-3

An Empty ENR Table

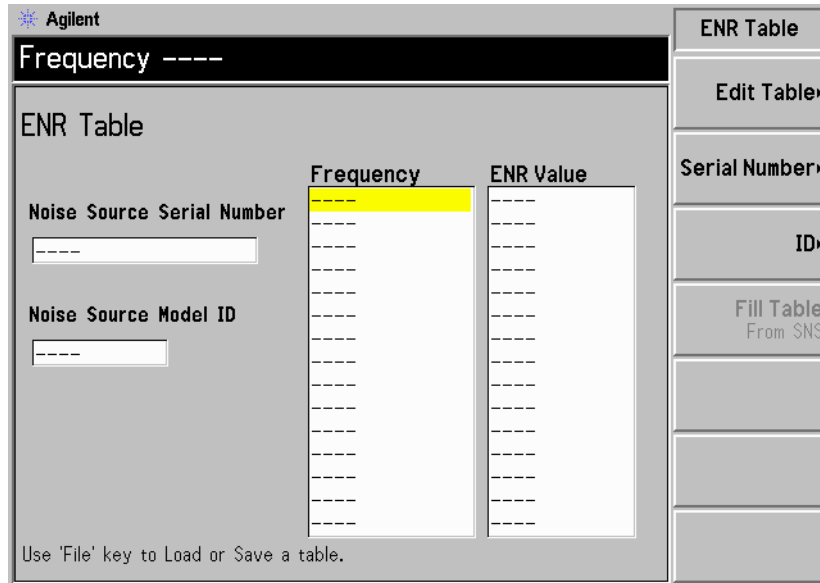

Step 2. Optional Step

Press the **Serial Number** menu key and enter the noise source serial number using the numeric keys and the Alpha Editor.

Step 3. Optional Step

Press the **ID** menu key and enter the noise source model number using the numeric keys and the Alpha Editor.

Step 4. Press the **Edit Table** menu key to enter the noise source ENR values.

Step 5. Enter the frequency value in the table using the numeric keys. Terminate it using the unit menu keys.

Step 6. Press the **Tab** → key to move the highlight to the ENR Value column and enter the corresponding ENR value of the ENR list.

When terminating the ENR value you can use either **dB**, **K**, **C**, or **F** menu keys. The **K**, **C**, or **F** entry is converted to appear in the table as **dB**.

Making Basic Measurements
Entering Excess Noise Ratio (ENR) Data

Step 7. Press the **Tab** → key to move the highlight to the Frequency column and enter the next frequency value on the ENR list.

Step 8. Repeat steps 5 to 7 until all the frequency and ENR values you need are entered.

Step 9. After completing the ENR table entries, press the **Prev** key or **ENR** key to return to the ENR menu.

Step 10. Optional Step

Once you have completed entering the ENR data, save the ENR table using the **File** key.

NOTE

ENR table data survives a power cycle and preset (except **Restore Sys Defaults**). You only need to save the ENR data to save you from entering the data again.

Figure 2-4 A Typical ENR Table after data entry

The screenshot shows the Agilent ENR Table interface. At the top, it displays "ENR Value 15.400 dB". Below this is the "ENR Table" section, which includes a table with two columns: "Frequency" and "ENR Value". The table contains 13 rows of data. The "Noise Source Serial Number" is 3318A14197 and the "Noise Source Model ID" is 346B. The "ENR Value" column shows values ranging from 15.330 dB to 15.440 dB. The value 15.400 dB is highlighted in yellow. To the right of the table is a vertical menu with buttons: "Edit Table", "Row Up", "Row Down", "Page Up", "Page Down", "Add", "Delete Row", and "Clear Table". At the bottom of the interface, it says "Use 'File' key to Load or Save a table."

Frequency	ENR Value
10.0000000 MHz	15.330 dB
100.000000 MHz	15.560 dB
1.00000000 GHz	15.360 dB
2.00000000 GHz	15.120 dB
3.00000000 GHz	14.970 dB
4.00000000 GHz	14.910 dB
5.00000000 GHz	14.850 dB
6.00000000 GHz	14.900 dB
7.00000000 GHz	14.860 dB
8.00000000 GHz	14.890 dB
9.00000000 GHz	15.010 dB
10.000000 GHz	15.110 dB
11.0000000 GHz	15.260 dB
12.0000000 GHz	15.400 dB
13.0000000 GHz	15.440 dB

To load ENR data from memory

- Step 1.** If the ENR file is on diskette, insert the diskette into the floppy drive of the NFA.
- Step 2.** Press the **File** key.
- Step 3.** Press the **Load** menu key to access the file system.
- Step 4.** Press the **ENR** menu key.
- Step 5.** Press either the **Meas Table** or **Cal Table** menu key.

A list of available files on the [-A-] or [-C-] drive is displayed. Use the arrow keys to access the appropriate file.

- Step 6.** Press the **Enter** key.

Saving an ENR Table

You can save an ENR table to the NFA's internal memory or to floppy disk as follows:

- Step 1.** Press the **File** key.
- Step 2.** Press the **Save** menu key.
- Step 3.** Press the **ENR** menu key.
- Step 4.** Press either the **Meas Table** or **Cal Table** menu key. Also, if you are using an SNS, an **SNS** menu key is available to select.

The **Alpha Editor** now appears, allowing you to create a name for the file.

- Step 5.** Input the name of the ENR table.
- Step 6.** Select using the arrow keys whether you want to save the files to the [-A-] or [-C-] drive.
- Step 7.** Press **Enter** to save the file.

Entering a Spot ENR Value

To enter a Spot ENR value:

- Step 1.** Press the **ENR** key, then the **Spot** menu key.
- Step 2.** Press the **Spot ENR** menu key.
- Step 3.** Enter an ENR value using the numeric keys and terminate it using the unit termination menu keys. The default value is 15.20 dB.

NOTE

If you are using a noise source with a calibrated ENR list and the frequency you want to measure is not a listed ENR value, then you need to interpolate the ENR list to an appropriate value.

To Enable Spot ENR Mode

- Step 1.** Press the **ENR** key, and select the **ENR Mode(Spot)** menu key.
- Step 2.** Press the **Spot** menu key, and select the **Spot Mode(ENR)** menu key.

Entering a Spot T_{hot} Value

To enter a Spot T_{hot} value:

- Step 1.** Press the **ENR** key, then the **Spot** menu key.
- Step 2.** Press the **Spot Thot** menu key.
- Step 3.** Enter a T_{hot} value using the numeric keys and terminate it using the unit termination menu keys. The default value is 9892.80 K.

To Enable Spot Thot Mode

- Step 1.** Press the **ENR** key, and select the **ENR Mode(Spot)** menu key.
- Step 2.** Press the **Spot** menu key, and select the **Spot Mode(Thot)** menu key.

Using a Smart Noise Source

NOTE

If there is an SNS connected to the NFA's Smart Noise Source port, the NFA, by default, selects the SNS as its noise source. If an SNS is not connected the NFA uses the normal noise source.

Selecting the Source Preference

If noise sources are connected to both ports you need to select a preference either **Preference(Normal)** or **Preference(SNS)**. The default setting is **Preference(SNS)**.

To select a noise source preference:

- Step 1.** Press the **ENR** key.
- Step 2.** Press the **SNS Setup** menu key.
- Step 3.** Press the **Preference** menu key changing it from the default **Preference(SNS)** to **Preference(Normal)**.

Loading the SNS ENR data to the Common Table.

You can enable the NFA to automatically upload the ENR data to the Common Table. To enable automatic loading on power up or the connection of the SNS to the NFA's Smart Noise Source port, set **Auto Load ENR(On)**. This enables the ENR data to load into the Common Table automatically. If you do not want to automatically upload the ENR data into the Common Table, press **Auto Load ENR(Off)**.

If you have selected **Auto Load ENR(Off)**, you can use the **Fill Table From SNS** menu key to upload the ENR data from the SNS. The **Fill Table From SNS** menu key is found under the **ENR Table** menu key. It is only active when an SNS is connected. This allows you to choose when to upload the ENR data to the ENR Table.

CAUTION

Do not disconnect the noise source from the NFA port while the data is being transferred.

Loading the SNS ENR data to the Measurement or Calibration Table.

NOTE

When an SNS is connected and **Auto Load ENR(On)** enabled, the **Common Table(On)** is set automatically. Hence, the SNS ENR data is loaded into the common ENR table.

You can use the **Fill Table From SNS** menu key to upload the ENR data from the SNS. This allows you to choose between **Meas Table** or **Cal Table**, as the destination for the ENR data.

- Step 1.** Press the **ENR** key.
- Step 2.** Press the **SNS Setup** menu key.
- Step 3.** Press the **Auto Load ENR** menu key setting it to **Auto Load ENR(Off)**.
- Step 4.** Press the **Common Table** menu key setting it to **Common Table(Off)**.
- Step 5.** Press the **Meas Table** or **Cal Table** menu key.
- Step 6.** Press the **Fill Table From SNS** menu key and wait until all the data is uploaded.

CAUTION

Do not disconnect the noise source from the NFA port while the data is being transferred.

Setting the T_{cold} value

When making measurements in different ambient temperature conditions you can change the T_{cold} value.

The default temperature value is set at 296.50K. The T_{cold} menu key is set to **Tcold(Default)** to confirm this default temperature.

There are three methods of changing the T_{cold} value. These are dependant on the type of noise source you are using.

- The first method is applicable when using either type of noise source and allows you to enter a T_{cold} value manually. This method is explained in “Changing the User Tcold value manually” on page 34.
- The second method is applicable when using the SNS noise source and it uploads the value automatically and updates the value after every sweep. This method is explained in “Setting the SNS Tcold value to Update Automatically” on page 35.
- The third method is applicable when using the SNS where you can set the value to be updated as you need. This method is explained in “Setting the SNS User Tcold value” on page 36.

Changing the User T_{cold} value manually

To change the User T_{cold} value:

Step 1. Press the **ENR** key.

Step 2. Press the **Tcold** menu key.

NOTE

When using an SNS, the **SNS Tcold** menu key must set to **SNS Tcold(Off)** for this feature to work.

Step 3. Press the **User Tcold** menu key setting it from the default **User Tcold(Off)** to **User Tcold(On)**.

The **Tcold** menu key, under the ENR menu keys, is now set to **Tcold(User)** to confirm you are using this temperature mode.

Step 4. Press the **User Value** menu key.

Enter a T_{cold} value using the numeric keys and terminate it using the unit termination menu keys.

The unit termination menu keys are in **K** (Kelvin), **C** (Celsius) or **F** (Fahrenheit).

Setting the SNS T_{cold} value to Update Automatically

This feature is only available when an SNS is connected to the NFA.

To set the SNS T_{cold} value:

Step 1. Press the **ENR** key.

Step 2. Press the **Tcold** menu key.

Step 3. Press the **SNS Tcold** menu key, if required, setting it to **SNS Tcold(On)**.

The **Tcold** menu key, under the ENR menu keys, is now set to **Tcold(Auto)** to confirm you are using this temperature mode.

Making Basic Measurements
Entering Excess Noise Ratio (ENR) Data

Setting the SNS User T_{cold} value

This feature only works when an SNS is connected to the NFA.

To change the User T_{cold} value:

Step 1. Press the **ENR** key.

Step 2. Press the **Tcold** menu key.

NOTE

When using an SNS, **SNS Tcold** must set to **SNS Tcold(Off)** for this feature to work.

Step 3. Press the **User Tcold** menu key changing it from the default **User Tcold(Off)** to **User Tcold(On)**.

Step 4. Press the **User Tcold From SNS** menu key.

The NFA uploads the **Tcold** value from the SNS and displays the value in the **User Value** menu key.

The **Tcold** menu key, under the ENR menu keys, is now set to **Tcold(User)** to confirm you are using this temperature mode.

Setting the Measurement Frequencies

Three frequency modes are available:

- **Sweep** — the measurement frequencies are obtained from the start and stop (or equivalent center and span) frequencies and the number of measurement points.
- **List** — the measurement frequencies are obtained from the frequency list entries.
- **Fixed** — where the measurement frequency is taken at a single fixed frequency.

Selecting Sweep Frequency Mode

CAUTION

The N8974A and N8975A NFA models have a mechanical switch fitted to allow them to switch between the RF frequency range and the microwave frequency range. If the frequency range you are working in crosses the 3.0 GHz point, the mechanical switch operates. The mechanical switch has a limited number of cycles over which it is reliable.

Switching over the 3.0 GHz switch should be limited where possible.

NOTE

You can press **Full Span** at anytime to return the frequency range to the specific NFA model's full range setting. If you do this after a calibration and the calibration has been made over a narrower frequency range, the calibration is invalid.

- Step 1.** Press the **Frequency/Points** key.
- Step 2.** Press the **Freq Mode** menu key to select frequency mode to **Freq Mode(Sweep)**.
- Step 3.** Set the frequency range by either entering the **Start Freq** and **Stop Freq** frequencies, or the **Center Freq** and the **Freq Span**.

Making Basic Measurements
Setting the Measurement Frequencies

Step 4. Press the **More 1 of 2, Points** menu keys.

Step 5. Enter the number of measurement points using the numeric keys. Press the **Enter** key to terminate.

Selecting List Frequency Mode

To set the NFA to use the data in the frequency list table:

Step 1. Press the **Frequency/Points, Freq Mode** menu keys.

Step 2. Press the **Fixed** menu key to set the frequency mode to **Freq Mode(List)**.

You can create a frequency list in the following ways:

- Manually, by specifying each individual point.
- From the swept points, by specifying the measurement frequency range and setting the NFA to generate equally spaced points within that range, using the **Fill** menu key.
- Loading a list from the internal memory or diskette, where the data has been previously stored.
- Loading a list over GPIB; see the ***Programmer's Reference*** if you want to use this method.

To Create a Frequency List Manually

Step 1. Press the **Frequency/Points** key and press the **More 1 of 2** menu key.

Step 2. Press the **Freq List** menu key.

Figure 2-5 An Empty Frequency List

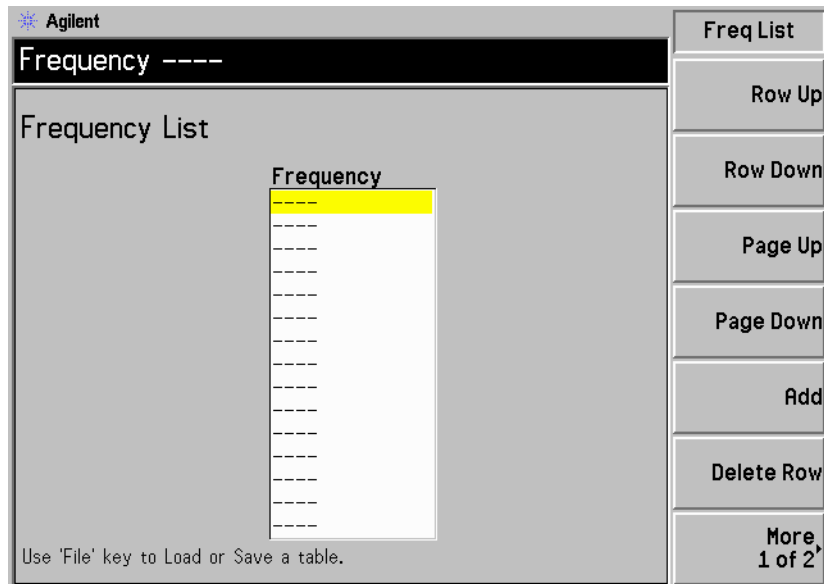

- Step 3.** Press the **More 1 of 2, Clear Table** menu keys.
- Step 4.** Enter the frequency value you want using the numeric keys. Terminate it using the unit menu keys which are presented to you.
- Step 5.** Press the **Tab →** key or **Row Down** menu key.
Enter the next frequency value by using the numeric key pad and the unit termination keys.
- Step 6.** Repeat step 5 until your list is complete.
- Step 7.** Save the Frequency List to the NFA internal memory or to a diskette if required using the **File** key. See “Saving a File” on page 18 for an explanation of this.

NOTE

If you do not save the frequency list, you may lose the data. This depends on your Power On/Preset condition.

Making Basic Measurements
Setting the Measurement Frequencies

Creating a Frequency List from Swept Points

You can create a frequency list from the swept mode frequency and points data.

To set the NFA to use the swept mode data:

- Step 1.** Press the **Frequency/Points, More 1 of 2** menu keys.
- Step 2.** Press the **Freq List, More 1 of 2** menu keys.
- Step 3.** Pressing the **Fill** menu key.

This clears the current frequency list and fills the list with the frequencies generated by the sweep frequency mode.

Selecting Fixed Frequency Mode

The fixed frequency mode is used when you want to make a measurement at a single frequency.

To set a fixed frequency:

- Step 1.** Press the **Frequency/Points, Freq Mode** menu keys.
- Step 2.** Press the **Fixed** menu key to set the frequency mode to **Freq Mode(Fixed)**.
The **Fixed Freq** menu key is now available.
- Step 3.** Press the **Fixed Freq** menu key and enter the frequency value using the numeric keys and the unit termination menu keys.

Setting the Bandwidth and Averaging

Selecting a Bandwidth Value

Step 1. Press the **Averaging/Bandwidth** key.

The current bandwidth is shown on the **Bandwidth** menu key.

Step 2. Press the **Bandwidth** menu key and select the bandwidth you want from the list of available options.

NOTE

On the N8972A model, the bandwidth menu key is unavailable. The bandwidth is fixed at 4MHz.

Setting Averaging

Increased averaging reduces jitter and provides more accurate measurement results. However, the measurement speed is sacrificed.

Enabling averaging

Averaging can be enabled by setting the **Averaging(On)**. To disable averaging set **Averaging(Off)**

Setting the Number of Averages

Step 1. Press the **Averaging/Bandwidth** key, and then the **Averages** menu key.

Step 2. Enter the numeric value you want using the numeric key pad. Terminate it with the **Enter** key.

Selecting the Averaging Mode

Averaging Mode can be set to **Average Mode(Point)** or **Average Mode(Sweep)**.

Calibrating the Analyzer

To compensate for the noise contribution of the NFA, the associated cabling, and so forth in the measurement path, a calibration is necessary.

To perform calibration you need to enter the ENR values and set up the frequency range, number of measurement points, the bandwidth, the averaging, and measurement mode to be used during the measurement. For more details on calibration, such as when to perform calibration and when calibration is invalidated and so forth, see the *User's Guide*.

To perform a calibration

Step 1. Verify that the correct ENR table is loaded in the NFA, or input the ENR values of the noise source into the NFA.

See “Entering Excess Noise Ratio (ENR) Data” on page 25 for more details.

Step 2. Configure the measurement parameters (frequency range, number of points, bandwidth, averages, and measurement mode) you want to use for the measurement.

Step 3. Connect the noise source output directly to the NFA input.

NOTE

If you are following this procedure using an N8974A or an N8975A models care needs to be taken when connecting the precision 3.5 mm connector by applying the correct torque. For an explanation of the connectors and guidance on the correct torque values, see the *Performance Verification and Calibration Guide*.

Figure 2-6 NFA Calibration with Normal Noise Source

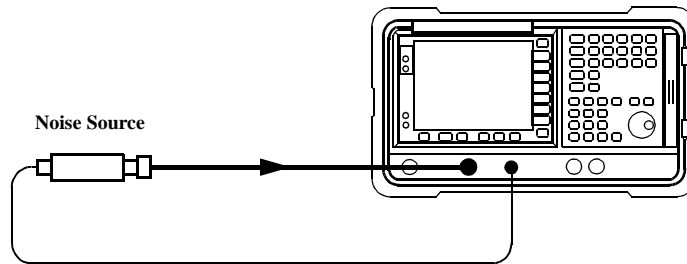

NOTE

You may need to use connector adaptors to connect the noise source output to the NFA input during calibration. The connectors you use need to be included in the measurement. If you remove the connectors from the measurement you need to apply Loss Compensation to compensate for any loss caused by the connectors removal. See “Using Loss Compensation” on page 67 for an explanation of this.

Step 4. If required select an input attenuator range by pressing the **Corr** key and the **Input Cal** menu key to set the minimum and maximum input attenuation.

See “Selecting the RF Input Attenuation Range” on page 44 for more details on input attenuation.

Step 5. Press the **Calibrate** key twice to initiate the calibration.

Selecting the RF Input Attenuation Range

When measuring a high-gain device you may need to increase the input attenuation. If you do not know the gain of the DUT, you can perform calibration using the default range, note what error codes are presented and then calibrate again using increased attenuation value. The attenuation value is indicated on the display. If the NFA continues to display error codes, there is a need to add external attenuator pads and correct for this attenuation using the Loss Compensation feature. For an explanation of how to use the feature, see “Using Loss Compensation” on page 67.

If an error message occurs while calibrating, you need to recalibrate. For a complete list of error codes see the *User’s Guide*.

To select the RF input attenuation:

- Step 1.** Press the **Corr** (Corrected) key.
- Step 2.** Press the **Input Cal** menu key and select the attenuation range you want
- Step 3.** Set the attenuator range using the **Min RF Atten** and **Max RF Atten** menu keys, and select the attenuation values you want from the list.

Selecting Microwave Input Attenuation Range

The N8974A and N8975A models have a microwave frequency range. When working in the microwave frequency range of 3.0 GHz to 26.5 GHz, the NFA has a default input attenuation for calibration of 0dB. Unlike the RF attenuators, the microwave attenuators cannot autorange. Therefore there is a risk of overdriving the instrument. In most cases 0dB attenuation is adequate. A guide to the input powers that each range can handle can be seen in Table 2-1.

Table 2-1

Power Detection and Ranging

Attenuation	Maximum Input Power	Approximate DUT Characteristics
0dB	-30dBm	Combined NF and Gain of DUT <25dB over full bandwidth
15dB	-20dBm	Combined NF and Gain of DUT <35dB over full bandwidth

Table 2-1 Power Detection and Ranging

Attenuation	Maximum Input Power	Approximate DUT Characteristics
30dB	-10dBm	Combined NF and Gain of DUT <45dB over full bandwidth

To select the microwave input attenuation:

- Step 1.** Press the **Corr** (Corrected) key.
- Step 2.** Press the **Input Cal** menu key and select the attenuation range you want
- Step 3.** Set the attenuator range using the **Min μ W Atten** and **Max μ W Atten** menu keys, and select the attenuation values you want from the list.

Setting the Microwave Input Attenuation after a Calibration

The microwave attenuators cannot autorange. Hence, when making a microwave measurement you must manually set the microwave input attenuation to avoid overdriving the NFA. To set the microwave input attenuation:

- Step 1.** Press the **Sweep** key.
- Step 2.** Press the **Manual Meas, More 1 of 2** menu key.
- Step 3.** Press the **Fixed μ W Att** menu key and select the attenuation range you want.
- Step 4.** Press the **More 2 of 2** menu key.
- Step 5.** Press the **RF/ μ W Atten** menu key to enable **RF/ μ W Atten(Fixed)**.

NOTE

If you want to set the RF input attenuation, “Setting the Microwave Input Attenuation after a Calibration” procedure can be applied to RF input attenuation. The procedure is similar except you need to substitute **Fixed RF Att** in **Step 3**.

Displaying the Measurement Results

The following display format features are available:

- Graph, Table or Meter mode display
- Single or dual-graph display allowing any two available result types to be displayed simultaneously
- Zoom to display only one result graph on the display
- Combine option to display two result types on the same graph
- Markers for searching the trace
- Display an active trace, a memory trace, or both
- Save the current active trace data to memory
- Switch the graticule on or off
- Switch display annotation on or off

NOTE

If the NFA's display has been previously disabled in Remote mode, you need to press the **System (LOCAL)** key to activate the display.

Selecting the Display Format

You can display the measurement results in either:

- Graph format
- Table format
- Meter format

To set the display format:

- Step 1.** Press the **Format** key.
- Step 2.** Press the **Format** menu key and select the **Graph**, **Table** or **Meter** menu key to select the display mode you want.

Navigating Around the Display

Active Graph

The active graph is highlighted by a green border. Noise Figure is the active graph by default.

Figure 2-7

Dual-graph display

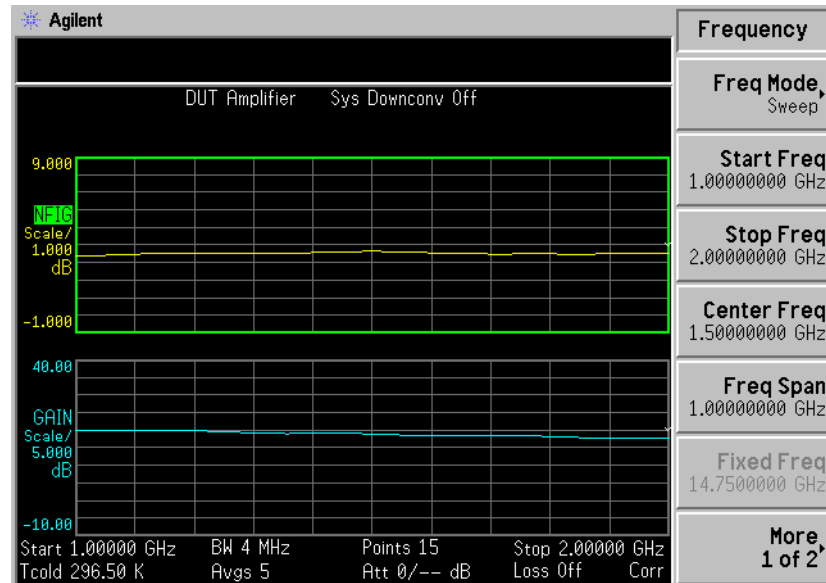

Changing the Active Graph

To change the active graph, press the  key below the display. This key allows you to set the upper or lower graph as the active graph.

NOTE

When in table or meter format the  key changes the active parameter.

Viewing the Full Screen

You can fill the entire display and remove the menu keys, the active function area annotation, and the display status line annotation from the display. Press the **Full Screen** key to view the full screen. Pressing the **Full Screen** key again returns it to the previous display.

Making Basic Measurements
Displaying the Measurement Results

NOTE



The **Full Screen** key also functions in table or meter format.

Selecting Result Types to Display

NOTE

You cannot display the same result type in both graphs. If you attempt this, an error message Each result type selected must differ from all others is displayed in the status line.

To specify which measurement results are displayed

- Step 1.** Select which measurement result is active using the  key.
- Step 2.** Press the **Result** key and select the result type that you want to display.
- Step 3.** Press the  key to make the other measurement result active.
- Step 4.** Press the **Result** key and select the result type you want to display.

NOTE

When you press the **Scale** key, the active measurement result's scale menu keys are shown.

Graphical Features

Viewing a single graph



While in graph format mode, you can press the  key located below the display and the active graph fills the display as a single graph, as shown in Figure 2-8. Pressing the key again returns the display to dual-graph.

Figure 2-8 **Displaying a single graph**

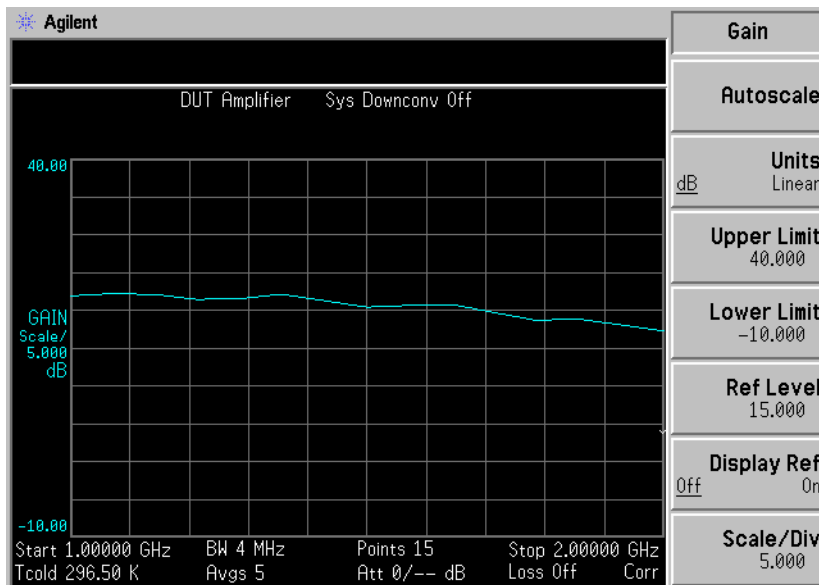

NOTE

When in single graph mode, pressing the  key displays the other single graph.

Making Basic Measurements

Displaying the Measurement Results

Combining two graphs on the same graph

The default setting is **Combined(Off)** and the graphs are not combined.

NOTE

When combining two graphs the Y-scale result limits are not re-scaled and both graphs have their own Y-scale result limits.

To combine the two graphs:

- Step 1.** Press the **Format** key and ensure **Format(Graph)** is selected.
- Step 2.** Press the **Combined(On)** menu key to combine the two currently displayed graphs on the same graph.

Figure 2-9 Typical display with two traces combined on the same graph

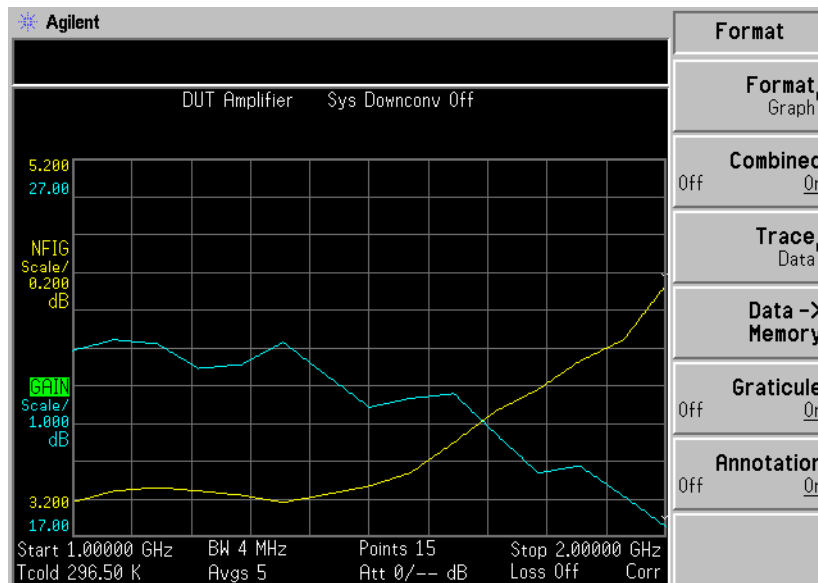

Displaying the Current Data Trace and the Recalled Memory Trace

When a trace finishes its first complete sweep, the **Data -> Memory** menu key becomes active.

To save a trace to memory, press the **Data -> Memory** menu key. After pressing the **Data -> Memory** menu key, the **Trace** menu key becomes active.

To view the saved trace, press the **Trace** menu key, followed by the **Memory** menu key. The memory trace is presented in the display.

To view both the saved trace and the current active trace, press the **Trace** menu key, followed by the **Data & Memory** menu key.

To view the current data trace only, press the **Trace** menu key, followed by the **Data** menu key. This is the default setting.

NOTE

Pressing **Autoscale** does not re-scale a memory trace.

Making Basic Measurements
Displaying the Measurement Results

Turning the Graticule On and Off

To turn the graticule on or off:

- Step 1.** Press the **Format** key.
- Step 2.** Press the Graticule menu key to select the Graticule(Off) or Graticule(On) as required.

Turning the Display Annotation On or Off

To turn the annotation on or off:

- Step 1.** Press the **Format** key.
- Step 2.** Press the Annotation menu key to select Annotation(Off) or Annotation(On) as required.

NOTE

When Annotation(Off) is selected and limit lines are set to Test(On) the limit line failure indicator is disabled.

Setting the Scaling

You can set the result's scale parameters in the active graph. To set the scale, press the **Scale** key.

NOTE

To change the active graph, press the **Result** key and select another measurement parameter's menu key. Press the **Scale** key to set the scale of the measurement parameter.

Figure 2-10 Typical Noise Figure Displayed on a Graph

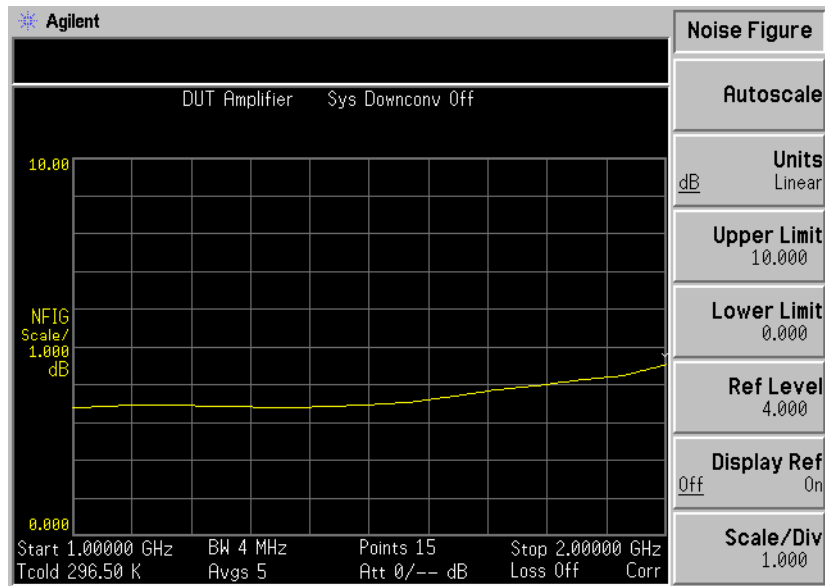

You can set the scale for the measurement parameter or press the **Autoscale** menu key. Pressing **Autoscale** selects the optimum values for **Upper Limit**, **Lower Limit**, and **Scale/Div**.

NOTE

If limit lines are set to **Display(On)**, and **Autoscale** is pressed or the scale is changed, the limit lines may no longer appear in the display.

NOTE

If a memory trace is set to display, and **Autoscale** is pressed or the scale is changed, the memory trace may no longer appear in the display.

Making Basic Measurements
Displaying the Measurement Results

Setting the Reference Level

NOTE

The reference level minimum and maximum limits are restricted to the values of the upper and lower scale settings.

NOTE

The reference level is only visible when the **Display Ref(On)** is enabled.

Step 1. Press the **Display Ref** menu key if you want the reference level displayed in the active graph. The default setting is **Display Ref(Off)**. Set the **Display Ref(On)** to switch the reference level on.

Step 2. Press the **Ref Level** menu key. Change the reference level value using the **RPG** or the numeric keys. Values that are entered using the numeric keys are terminated using the **Enter** key.

Working with Markers

NOTE

The marker functions only apply when you are working in graph format.

The NFA has four markers, **Marker(1)**, **Marker(2)**, **Marker(3)**, and **Marker(4)**. The markers are coupled to both the lower graph trace and upper graph trace.

Selecting Markers

To select a marker:

- Step 1.** Press the **Marker** key.
- Step 2.** Press the Marker menu key to select the marker of interest.
- Step 3.** Press the **State** menu key and press the **Normal** menu key to highlight it.

Figure 2-11 A Normal State Marker

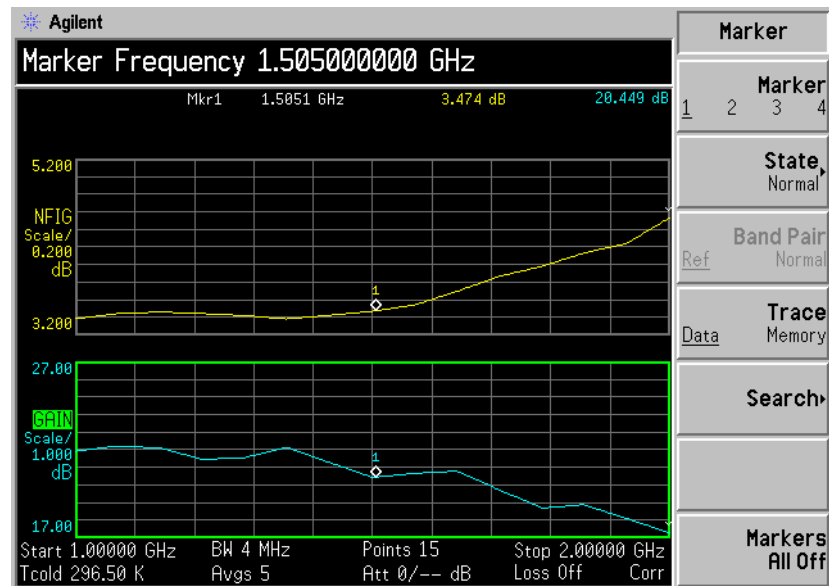

Turn the RPG to place the markers at the point on the trace you want to measure or use the numeric keys to enter the frequency of interest..

Making Basic Measurements

Displaying the Measurement Results

To turn an active marker off

To turn an active marker off, press the **State** menu key and press the **Off** menu key. This also removes the marker annotation above the graph and the marker frequency from active function area.

To change the active marker

The default active marker setting is **Marker(1)**. To change the active marker, press the **Marker** menu key. This moves the active marker from **Marker(1)** to **Marker(2)**. Press it again and it moves the active marker from **Marker(2)** to **Marker(3)**. This process is repeated until it returns to the **Marker(1)**.

Figure 2-12 Four Normal State Markers

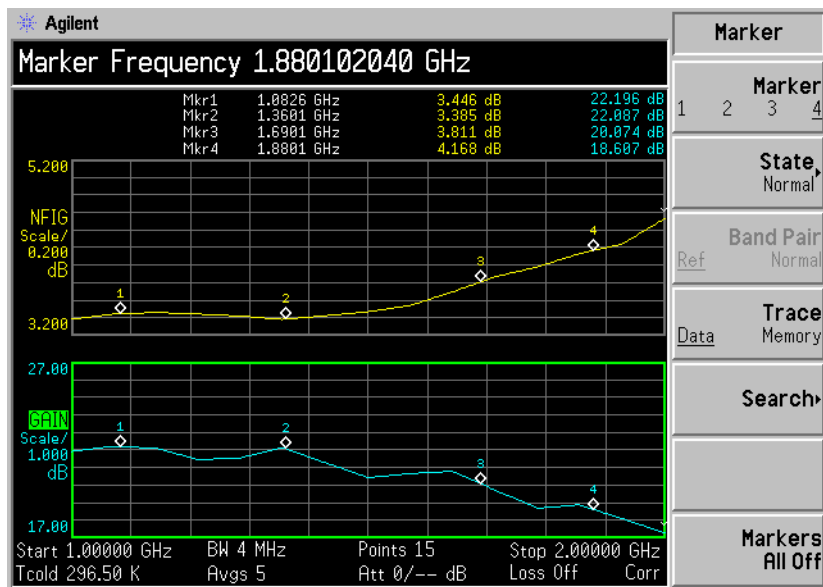

To Switch all the Markers Off

To switch all the markers off press **Markers All Off**. This turns off all the markers and associated annotation.

Changing the Marker States

To use Delta Markers

The **State(Delta)** menu key places a reference marker at the current position of the active marker. The delta markers enable you to measure the difference between the reference marker and the delta marker position on the trace.

To activate a Delta marker:

- Step 1.** Press the **Marker** key.
- Step 2.** Press the **Marker** menu key to select the marker of interest.
- Step 3.** Press the **State** menu key and press the **Delta** menu key to highlight it. Use the RPG to move the Delta marker from the reference. The annotation displays the difference.

To use Band Pair Markers

The **State(Band Pair)** menu key places two markers allowing you to choose to move either the normal marker or the reference marker. This feature is similar to the **State(Delta)** except you can choose to move either marker. The position of the reference marker remains fixed until **Band Pair(Normal)** menu key is pressed and the active marker becomes the fixed marker. This can be altered by pressing the **Band Pair(Ref)** menu key to enable the reference marker as the active marker.

To activate the Band Pair markers:

- Step 1.** Press the **Marker** key.
- Step 2.** Press the **Marker** menu key to select the marker of interest.
- Step 3.** Press the **State** menu key and press the **State(Band Pair)** menu key to highlight it.
- Step 4.** Use the RPG to move the active marker from the reference. The annotation displays the difference between the reference and the normal markers position.
- Step 5.** Pressing the **Band Pair** menu key sets the **Band Pair(Normal)** as the fixed marker allowing you to move the reference marker. Pressing the **Band Pair** menu key again sets the **Band Pair(Ref)** as the fixed marker allowing you to move the normal marker.

Making Basic Measurements
Displaying the Measurement Results

Figure 2-13 Band Pair with Normal Marker Enabled

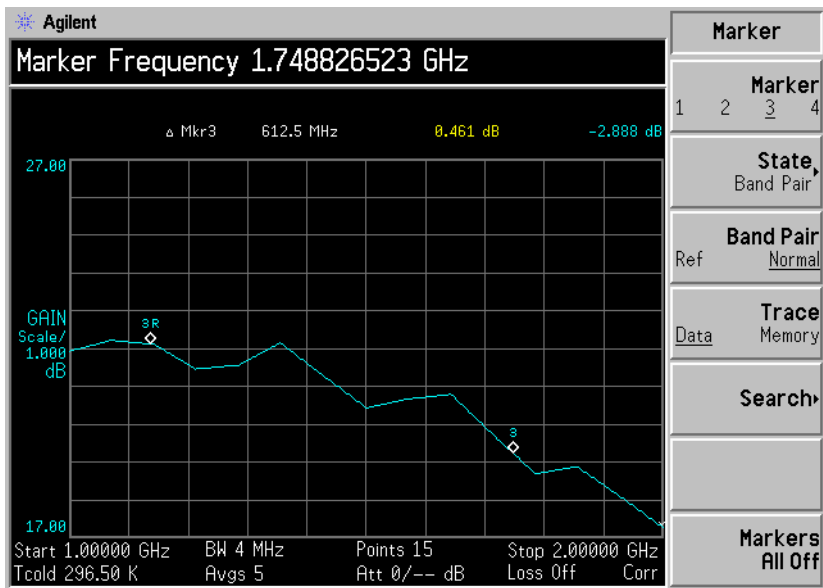

Marking Memory Traces

To place a marker on the recalled memory trace:

- Step 1.** Enable the **Trace(Memory)** menu key.
- Step 2.** Set the marker you want to use to **Normal**, **Delta**, or **Band Pair**.

The marker is placed on the memory trace. If **Trace(Data&Memory)** on the format menu is enabled, switching between **Trace(Data)** and **Trace(Memory)** switches the marker between the traces.

NOTE

If a marker is set to **Trace(Memory)** and the Memory trace is not displayed, the marker and its annotation are not displayed.

Making Basic Measurements
Displaying the Measurement Results

Searching with Markers

NOTE

If you are searching continuously the markers have additional annotation which identifies which marker is the minimum and the maximum. The annotation is “∨” a minimum, “^” a maximum. If you change the active graph the annotation remains on the original graph.

Searching for Min or Max point

You need to have activated a Normal or Delta marker state to perform a minimum or maximum search.

Figure 2-14

Typical Trace showing Maximum Point Found

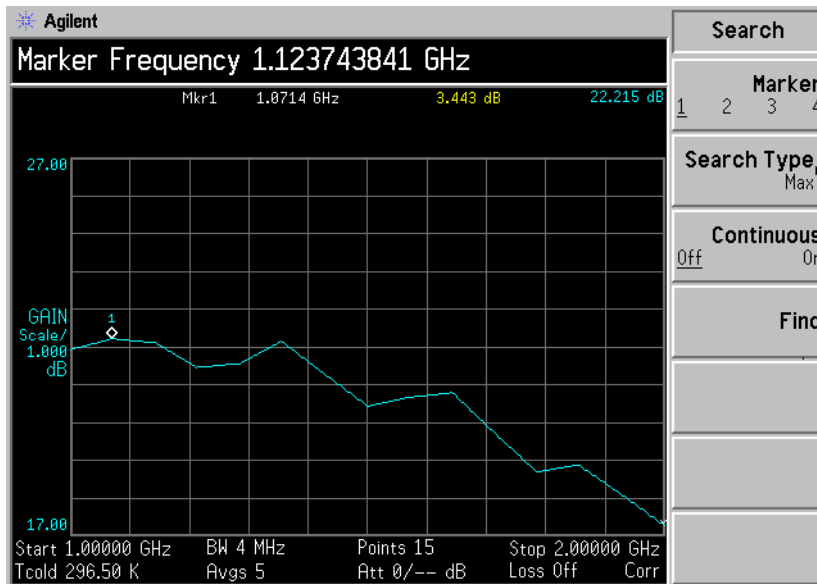

To search for the maximum point:

- Step 1.** Press the **Search** menu key.
- Step 2.** Press the **Search Type** menu key to select the **Search Type(Max)**.

Step 3. Press the **Find** menu key.

If you want to continuously find the maximum point on the trace, select **Continuous(On)**.

Searching for Peak to Peak points You need to have activated a marker state to Band Pair to perform a Peak to Peak search.

Figure 2-15 Peak to Peak Found

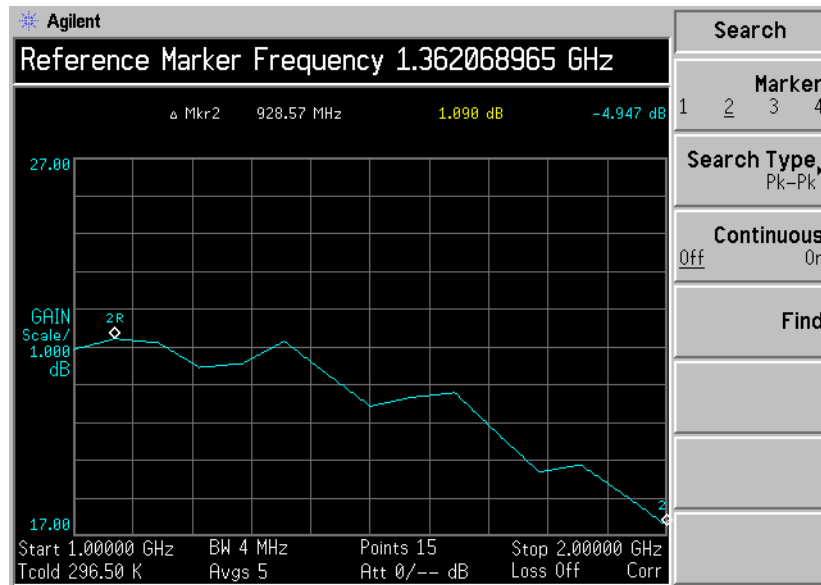

Step 1. Press the **Search** menu key.

Step 2. Press the **Search Type** menu key to select **Pk-Pk**.

Step 3. Press the **Find** menu key.

If you want to continuously find the maximum and minimum points on the trace, select **Continuous(On)**.

Indicating an Invalid Result

Several invalid result conditions may exist simultaneously. These conditions are ranked in order of severity and only the most severe condition present is displayed.

The ranking order is:

Table 2-2

Ranking Order of Invalid Result Conditions

Ranking Order	Invalid Result Condition	Marker Indicator
1	Hot power \leq cold power	“==”
2	Corrected calculation not possible	“XX”
3	Measurement result calculation invalid	“--”

The ranked order 2 only occurs if a corrected measurement is requested and either:

- The input range used at this measurement point is not calibrated.
- The input range is calibrated, but the calibration data is invalid at this point.

See the *User's Guide* for further information about the over and under range indicators.

3 **Advanced Features**

This chapter describes how to use the Limit Lines and Loss Compensation features on your Noise Figure Analyzer. It also covers how to make manual measurements.

What You will Find in this Chapter

This chapter covers:

- Setting up Limit Lines and using them for pass/fail testing of the measurements.
- Using Loss Compensation and using this to correct for system losses in cabling, switches, or connectors and so forth. Also, the use of S2P file formats to create Loss Compensation Tables.
- Making Manual Measurements.

Setting up Limit Lines

The NFA features four independent Limit Lines. The **Limit Line(1↑)** and **Limit Line(2↑)** are applied to the upper graph, and **Limit Line(3↓)** and **Limit Line(4↓)** are associated with the lower graph.

To change the Limit Line

The default limit line setting is **Limit(1↑)**. To change the active indicator, press the **Limit Line** menu key. This moves the active indicator from **Limit Line(1↑)** to **Limit Line(2↑)**, press it again and it moves the active indicator from **Limit Line(2↑)** to **Limit Line(3↓)**. This process is repeated until it returns to the **Limit Line(1↑)**.

Setting the Type of Limit Line

To set the limit line type, choose **Type(Upper)** if you want it to be above the trace or **Type(Lower)** if you want it to be below the trace. Each of the four limit line needs to be set up separately.

Enabling Testing against a Limit Line

To set the testing of the trace against the limit line, choose **Test(On)** if you want the result reported or **Test(Off)** if you do not want the result reported. Each of the four limit lines need to be set up separately.

NOTE

After a failure the **LIMITS FAIL:** indicator remains displayed until you either switch **Test(Off)**, change the limit line type, or press **Restart**.

Figure 3-1

Limit Fail Indicator

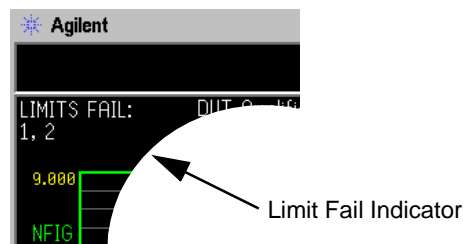

To Display a Limit Line

To display the limit line on the graph, choose **Display(On)**. To not display the limit line on the graph, choose **Display(Off)**. Each of the four limit line needs to be set up separately.

Advanced Features
Setting up Limit Lines

To Switch all the Limit Lines Off

To switch all the Limit Lines off, press **Limit Lines All Off**. This simultaneously switches off all Limit Lines, regardless of what graph or trace they are associated with and setting both **Test(Off)** and **Display(Off)**.

NOTE

When a limit line is switched off the limit line data is not affected.

Creating a Limit Line

Step 1. Press the **Limit Lines** key and select the limit line you want to create.

Step 2. Press the Editor menu key.

Step 3. Enter the first Frequency value. Press the **Tab** key.

Step 4. Enter the first **Limit** or Y-axis unit value. Press the **Tab** key.

For a limit line value to be useful, it should be derived from the scale values you are using to display the trace.

Step 5. Press the arrow key to change Connected to either **Yes** or **No**.

Step 6. Repeat this process until the limit line is defined.

The limit line is now defined. Press the **Prev** key or **Limit Line** key to return to the limit line menu. When saving a limit line table you need to specify which limit line number. See “Saving a File” on page 18.

NOTE

You can load a previously saved Limit Line table. However, you need to specify which limit line number you want loaded. See “Loading a File” on page 19.

Using Loss Compensation

You can configure the NFA to compensate for losses due to cabling, connectors and temperature effects that occur in the measurement setup. These can be between the Noise Source and the DUT, **Before DUT**, and/or between the DUT and the NFA input, **After DUT**.

You can also use S2P data file formats output from a Network Analyzer to create Loss Compensation tables. The NFA converts the S2P file format to a Loss Compensation table. If you are using S2P file formats see the *User's Guide* for an explanation.

Configuring Fixed Loss Compensation

- Step 1.** Press the **Loss Comp** key
- Step 2.** Press the **Setup** menu key to access the Loss Compensation Setup form, see Figure 3-2

Figure 3-2

Loss Compensation Setup Form

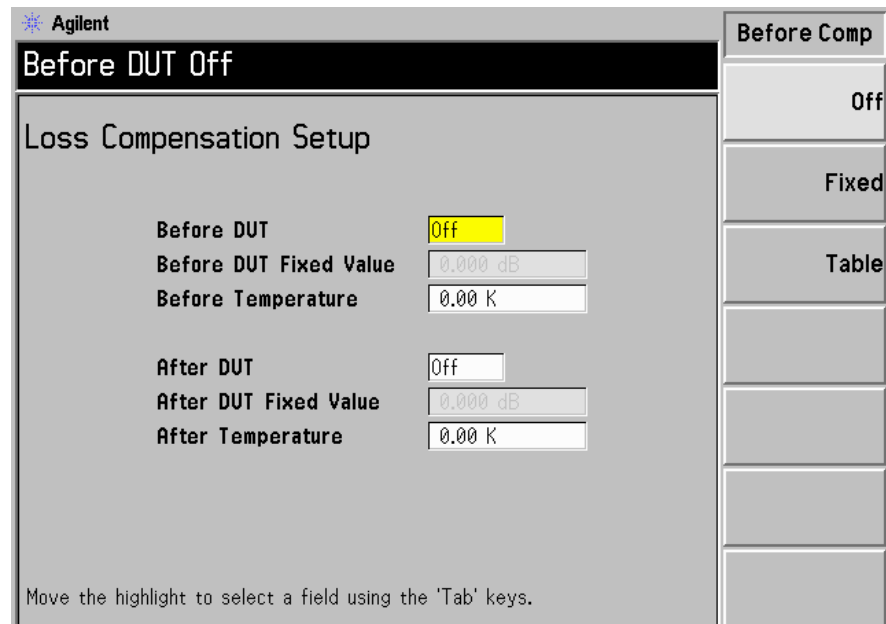

Agilent

Before DUT Off

Loss Compensation Setup

Before DUT

Before DUT Fixed Value

Before Temperature

After DUT

After DUT Fixed Value

After Temperature

Before Comp

Off

Fixed

Table

Move the highlight to select a field using the 'Tab' keys.

Using Loss Compensation

- Step 3.** When configuring loss compensation before the DUT, use the **Tab** key to navigate to the **Before DUT** field and set before DUT to fixed by selecting the **Fixed** menu key to highlight it.
- Step 4.** To set the loss compensation value before the DUT, use the **Tab** key to navigate to the **Before DUT Fixed Value** field and input the required value for the loss occurring before the DUT.
- Step 5.** When configuring loss compensation after the DUT, use the **Tab** key to navigate to the **After DUT** field and set after DUT to fixed by selecting the **Fixed** menu key to highlight it.
- Step 6.** To set the loss compensation value after the DUT, use the **Tab** key to navigate to the **After DUT Fixed Value** field and input the required value for the loss occurring after the DUT.

Configuring Table Loss Compensation

- Step 1.** Press the **Loss Comp** key
- Step 2.** Press the **Setup** menu key to access the **Loss Compensation Setup** form.
- Step 3.** When configuring table loss compensation before the DUT, use the **Tab** key to navigate to the **Before DUT** field and select the **Table** menu key to highlight it.
- Step 4.** When configuring table loss compensation after the DUT, use the **Tab** key to navigate to the **After DUT** field and select the **Table** menu key to highlight it.

NOTE

You can load a previously saved Loss Compensation table. However, you need to specify whether the Loss Compensation table is an **After Table** or a **Before Table**. See “Loading a File” on page 19.

Creating a Loss Compensation Table

To create a loss compensation table .

- Step 1.** Press the Loss Comp key, and the Before Table menu key.
- Step 2.** Enter the Loss Frequency value in the table using the numeric keys. Terminate it using the unit menu keys.
- Step 3.** Press the Tab key to move the highlight to the Loss Value column and enter the corresponding Loss Value.

When terminating the Loss Value you can use either **dB** or **linear** menu keys. However, the result appears in the table in dB.
- Step 4.** Press the Tab key to move the highlight to the Loss Frequency column and enter the next Loss Frequency Value.
- Step 5.** Repeat steps 2 to 4 until all the Loss Frequency and Loss Values you need are entered.
- Step 6.** After completing the Loss Compensation table entries, press the Prev key or Loss Comp key to return to the Loss Compensation menu.
- Step 7.** Once you have completed entering the Loss Compensation data, save the Loss Compensation table using the File key.

NOTE

If you do not save the Loss Compensation table, you may lose the data. This depends on your Power On/Preset condition.

Setting Temperature of Loss

Step 1. Press the **Loss Comp** key

Step 2. Press the **Setup** menu key to access the Loss Compensation Setup form, see .

Figure 3-3 Loss Compensation Setup Form with Temperature Selected

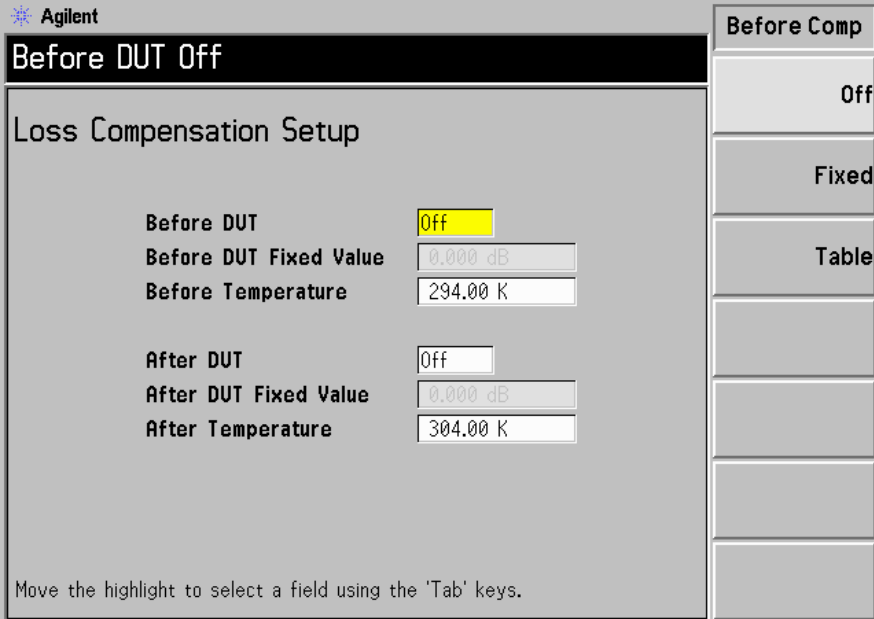

Agilent

Before DUT Off

Loss Compensation Setup

Before DUT Off

Before DUT Fixed Value 0.000 dB

Before Temperature 294.00 K

After DUT Off

After DUT Fixed Value 0.000 dB

After Temperature 304.00 K

Before Comp

Off

Fixed

Table

Move the highlight to select a field using the 'Tab' keys.

Step 3. To set the temperature value before the DUT, use the **Tab** key to navigate to the **Before Temperature** field and input the required temperature of loss value occurring before the DUT.

Step 4. To set the temperature value after the DUT, use the **Tab** key to navigate to the **After Temperature** field and input the required temperature of loss value occurring after the DUT.

Making Manual Measurements

The Noise Source is turned on or off by the appropriate **Noise Source(On)** and **Noise Source(Off)**, for example, **Noise Source(On)** provides Phot.

The following paragraphs give a step-by-step procedure for making the measurement. Several steps are required for measurements at each frequency point.

NOTE

When calibrating a series of frequency points and an error is made on one of the points, you need to start calibrating the series of frequency points again. Press the **Calibrate** key to reset the calibration.

NOTE

When measuring a series of frequency points and an error is made on one of the points, you need to start measuring the series of frequency points again. Press the **Restart** key to reset the measurement.

Manual Measurements Procedure

NOTE

Between each stage of this procedure, ensure you wait until the data invalid indicator has disappeared before you proceed.

The steps of a typical measurement are as follows:

Step 1. Find and hold RF/ μ W attenuators.

1. Connect the hot source, T_h , to the DUT input, and the DUT output to the NFA.
2. Press **Noise Source(On)** to measure noise power with the source at T_h .
3. Press **RF/ μ W Att(Hold)** to hold RF attenuators for the entire measurement.

Making Manual Measurements

Step 2. Calibrate.

1. Remove the DUT and connect the noise source to the NFA
2. Press **Calibration (On)** to calibrate with noise source at Phot.
3. Press **IF Att(Hold)** to hold the IF attenuators fixed at the new value or use the previously defined **IF Att(Fixed)** value.
4. Press **Accept** to store the Phot calibration reading.
5. Press **Noise Source(Off)** to select the Pcold calibration reading.
6. Press **Accept** to store the Pcold calibration reading.

Step 3. Measure.

1. Press **Calibration (Off)**.
2. Connect Noise Source to the DUT and the DUT to the NFA.
3. Press **Noise Source(On)** to select the Phot reading.
4. Press **IF Att(Auto)** to allow the IF attenuators to autorange.
5. Press **IF Att(Hold)** to hold the IF attenuators fixed at the new value or use the previously defined **IF Att(Fixed)** value.
6. Press **Accept** to store Phot measurement result.
7. Press **Noise Source(Off)** and press **Accept** to store Pcold measurement.

NOTE

If you have set up to measure a number of points over a frequency range. You need to change the point number by pressing the **Point** menu key and entering the point number and repeat the procedure from the next measurement point. Repeat this until all the points have been measured.

The points need not be measured sequentially.

4 Making Extended Frequency Measurements

This chapter describes how to make measurements outside the baseband frequency range of your Noise Figure Analyzer.

What You will Find in this Chapter

This chapter covers:

- Overview of Configuring Extended Frequency Measurements
- An overview of the Measurement Modes
- Connecting the System

Overview of Configuring Extended Frequency Measurements

Configuring extended frequency measurements involves four steps.

- Step 1.** Press the **System** key and configure the measurement system parameters as required using the **GPIB** and **External LO** menu items.

Table 4-1 **System Parameters**

Parameter	Description
NFA Address	This sets the NFA's GPIB address. Valid addresses are from 0 to 30. The default address is 8.
External LO Address	This sets the GPIB address of the External LO attached to the LO GPIB port. Valid addresses are from 0 to 30. The default address is 19.
LO GPIB Address	This sets the address through which other devices, attached to the LO GPIB, communicate with the NFA. Valid addresses are from 0 to 30. The default address is 8.
Command Set	This sets the External LO command language. The default setting is Command Set(SCPI) to operate a SCPI compliant LO. Command Set(Custom) is used when the External LO is not SCPI compliant and operated using the custom command strings.
LO Commands	This accesses the External LO Commands Form. The form is used to enter the commands used to control a non-SCPI-compliant External LO.

Table 4-1

System Parameters

Parameter	Description
Settling Time	This sets the settling time of the External LO. This is used as a settling period after the External LO frequency is changed.
Min and Max Frequency	This sets the minimum and maximum frequencies of the External LO.
Multiplier	This sets the multiplier value of the External LO frequency.

Step 2. Press the **Meas Mode** key to configure the measurement mode of the Noise Figure Analyzer.

For more details on the available measurement modes, see “Measurement Modes” on page 77.

Step 3. Press the **Mode Setup** key to configure the measurement mode parameters for the specific measurement mode you have selected.

Step 4. Configure the measurement (measurement frequency range, number of measurement points and averages and so forth) using the **Frequency/Points** and **Averaging/Bandwidth** keys.

For more details on configuring measurements, including calibration, see Chapter 2 , “Making Basic Measurements,” on page 23.

Measurement Modes

Available modes

The Noise Figure Analyzer offers the following measurement modes through the **Meas Mode** key on the front panel:

- The DUT is an amplifier-type device with no frequency conversion. This is the basic measurement mode where the measurement frequency is within the NFA's frequency range.
- The DUT is an amplifier-type device with frequency downconversion occurring in the measurement test setup (system downconversion). The LO can be either fixed or variable in this case.
- The DUT is a frequency downconverter (that is, frequency downconversion occurs in the DUT itself and not in the measurement test setup). The LO can be fixed or variable.
- The DUT is a frequency upconverter (that is, frequency up conversion occurs in the DUT itself and not in the measurement test setup). The LO can be fixed or variable.

NOTE

The **Amplifier** measurement mode is for any DUT that does not perform frequency conversion and includes amplifiers, filters, attenuators and so forth.

Noise figure measurements involving mixers are necessary when:

- The frequency conversion is part of the DUT. For example, the DUT is a mixer or a receiver.
- The frequency conversion is part of the measurement test set-up. The DUT is to be measured at a higher frequency than the NFA's frequency range covers, hence an external mixer and local oscillator are added to the measurement test set-up to convert this frequency to a frequency within the NFA's range.

The NFA can make a single frequency conversion, either in the DUT, or as an added **System Downconverter**, which configures the NFA as a frequency range extender. The NFA can also control an LO source remotely using the SCPI commands or the custom commands. Under this control the LO can be swept.

Basic Measurement — No Frequency Conversion

The basic measurement setup is shown in Figure 4-1, allowing you to compare more complex setups with it.

Figure 4-1 Basic Noise Figure Measurement — No Frequency Conversion

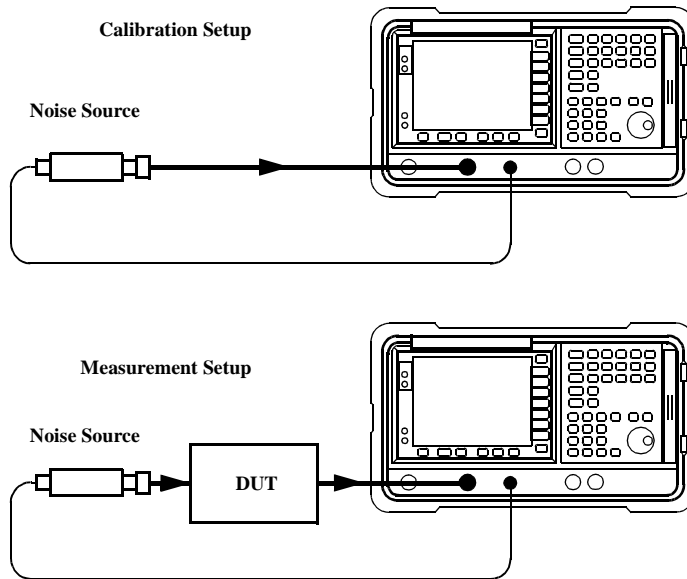

When an uncorrected measurement is performed, the result is the measured Noise Figure of all of the components after the noise source. When the calibration setup is connected and the calibration performed, the NFA measures its own noise figure and the connection set up. When a corrected measurement is performed, the contribution of the calibration setup is removed from the uncorrected result, giving a corrected measurement of the DUT only.

For these measurements the NFA mode is set to

DUT	Amplifier
System Downconverter	Off

NOTE

The RF input section on all NFA models has a built-in 3.0 GHz Low Pass Filter. This filter needs to be accounted for when planning your filter requirements during calibration and measurement.

NOTE

On the N8974A and the N8975A models the microwave input section has no filtering. This needs to be accounted for when planning your filter requirements for calibration and measurement. This is also important when making measurements which cross over the 3.0 GHz switch.

Frequency Down-converting DUT

In this mode, the DUT contains a frequency down-converting device, for example, a mixer or receiver.

There are two modes to choose from:

1. A variable frequency LO and fixed IF.

Making this measurement, the NFA remains locked at one frequency and the LO sweeps.

2. A fixed frequency LO and variable IF.

Making this measurement, the LO remains locked at one frequency and the NFA sweeps.

NOTE

Filtering is needed to remove the unwanted sideband when making single-sideband measurements in both modes. Ideally these filters should be included in the calibration path and measurement path. However, if it is not in the path, you can enter loss compensation to account for any additional error.

Fixed IF Variable LO (8970B Mode 1.3)

This is an overview of the key presses needed to set up the mode.

In the Measurement Mode Form set the following:

DUT	Downconv
System Downconverter	No Access
LO Mode	Variable

In the Mode Setup Form set the following:

IF Frequency	Enter a value
Sideband	LSB, USB or DSB
LO Control	On
External LO Power Level	Enter value and terminate using either dBm or W

NOTE

The External LO Power Level is displayed on the NFA as dBm.

In the **Frequency** menu, frequencies are specified as RF (input to DUT) frequencies.

Making Extended Frequency Measurements
Measurement Modes

Variable IF Fixed LO (8970B Mode 1.4)

These are an overview of the key presses needed to set up the mode.

In the Measurement Mode Form set the following:

DUT	Downconv
System Downconverter	No Access
LO Mode	Fixed

In the Mode Setup Form set the following:

LO Frequency	Enter a value
Sideband	LSB, USB or DSB
LO Control	Off or On
External LO Power Level	Enter value and terminate using either dBm or W

NOTE

The External LO Power Level is displayed on the NFA as dBm.

In the **Frequency** menu, frequencies are specified as IF (output from DUT) frequencies.

Frequency Up-converting DUT

In this mode, the DUT contains a frequency up-converting device, for example, a transmitter.

There are two modes to choose from:

1. A variable frequency LO and fixed IF.

Making this measurement, the NFA remains locked at one frequency and the LO sweeps.

2. A fixed frequency LO and variable IF.

Making this measurement, the LO remains locked at one frequency and the NFA sweeps.

Making Extended Frequency Measurements
Measurement Modes

Fixed IF Variable LO (8970B Mode 1.3 with SUM Sideband)

These are an overview of the key presses needed to setup using this mode. In this mode, the DSB measurement is not allowed.

In the Measurement Mode Form set the following:

DUT	Upconv
System Downconverter	No Access
LO Mode	Variable

In the Mode Setup Form set the following:

IF Frequency	Enter a value
Sideband	LSB or USB
LO Control	On
External LO Power Level	Enter value and terminate using either dBm or W

NOTE

The External LO Power Level is displayed on the NFA as dBm.

In the **Frequency** menu, frequencies are specified as RF (input to DUT) frequencies.

Variable IF Fixed LO (8970B Mode 1.4 with SUM Sideband)

These are an overview of the key presses needed to set up using this mode. In this mode, the DSB measurement is not allowed.

In the Measurement Mode Form set the following:

DUT	Upconverter
System Downconverter	No Access
LO Mode	Fixed

In the Mode Setup Form set the following:

LO Frequency	Enter a value
Sideband	LSB or USB
LO Control	Off or On
External LO Power Level	Enter value and terminate using either dBm or W

NOTE

The External LO Power Level is displayed on the NFA as dBm.

In the **Frequency** menu, frequencies are specified as IF (output from DUT) frequencies.

System Downconverter

The DUT is a non-frequency converting device, for example an amplifier or filter, and its frequency is higher than the NFA's measurement range. Frequency down-conversion is required within the measurement system, using a mixer, external to the DUT, to convert the signal of interest to the frequency range of the NFA.

There are two modes to choose from:

1. A variable frequency LO and fixed IF.

Making this measurement, the NFA remains locked at one frequency and the LO sweeps.

2. A fixed frequency LO and variable IF.

Making this measurement, the LO remains locked at one frequency and the NFA sweeps.

NOTE

Filtering is needed to remove the unwanted sideband when making single-sideband measurements in both modes. Ideally any filtering is included in the calibration path and measurement path. However, if it is not in the path, you can enter loss compensation to account for any additional error.

Fixed IF Variable LO (8970B Mode 1.1)

These are an overview of the key presses needed to set up using this mode.

In the Measurement Mode Form set the following:

DUT	Amplifier
System Downconverter	On
LO Mode	Variable

In the Mode Setup Form set the following:

IF Frequency	Enter a value
Sideband	LSB, USB or DSB
LO Control	On
External LO Power Level	Enter value and terminate using either dBm or W

NOTE

The External LO Power Level is displayed on the NFA as dBm.

In the **Frequency** menu, frequencies are specified as RF (input to DUT) frequencies.

Making Extended Frequency Measurements Measurement Modes

Variable IF Fixed LO (8970B Mode 1.2)

These are an overview of the key presses needed to set up using this mode.

In the Measurement Mode Form set the following:

DUT	Amplifier
System Downconverter	On
LO Mode	Fixed

In the Mode Setup Form set the following:

LO Frequency	Enter a value
Sideband	LSB or USB
LO Control	Off or On
External LO Power Level	Enter value and terminate using either dBm or W

NOTE

The External LO Power Level is displayed on the NFA as dBm.

In the **Frequency** menu, frequencies are specified as RF (input to DUT) frequencies.

Connecting the System

Figure 4-2 and Figure 4-3 show the connection diagram options you can use to calibrate the NFA and after calibration, to measure a DUT, whether it is a down-converter mixer, up-converter mixer, amplifier, or filter. It does not show where to place a filter to remove any unwanted sideband or input noise.

Setting Up the Noise Figure Analyzer

To connect the NFA to make measurements.

- Step 1.** Connect a GPIB cable between the NFA's LO GPIB rear panel connector and the Local Oscillator's GPIB connector.
- Step 2.** Turn on both instruments and press the **Preset** key to return the NFA to a known state.

The NFA can control the Local Oscillator, over its General Purpose Interface Bus (LO GPIB) without the need for an external controller. The NFA does not send LO controlling commands over its main GPIB. LO control is only done over its LO GPIB.

- Step 3.** Enter the ENR values in to the NFA. See "Entering Excess Noise Ratio (ENR) Data" on page 25 for the procedures to do this.
- Step 4.** Follow the procedure to calibrate the system, and measure the DUT, in the mode to suit your needs.

Figure 4-2 System Downconverter Mode

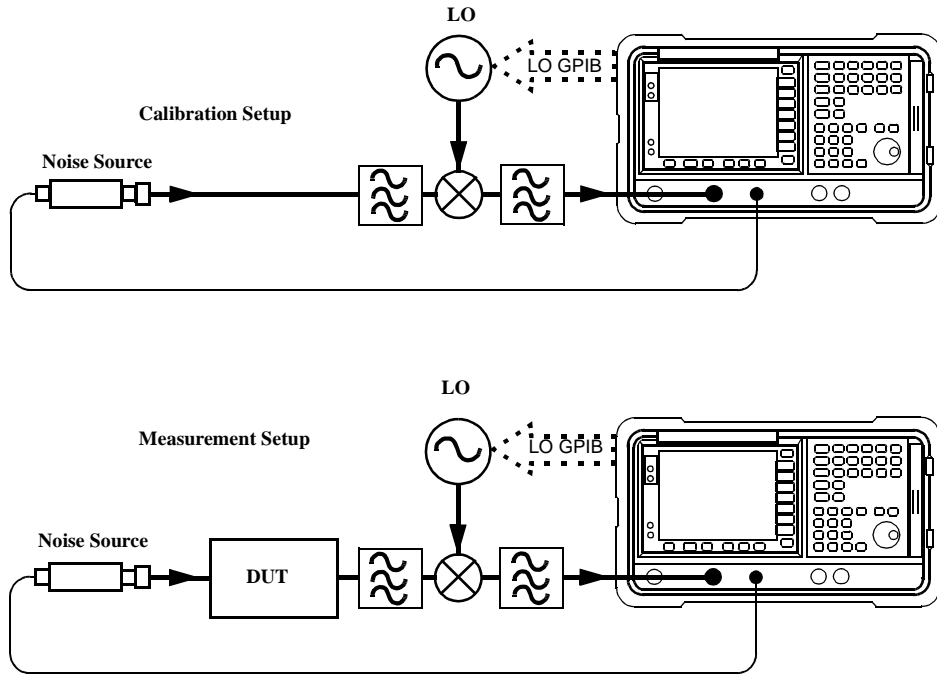
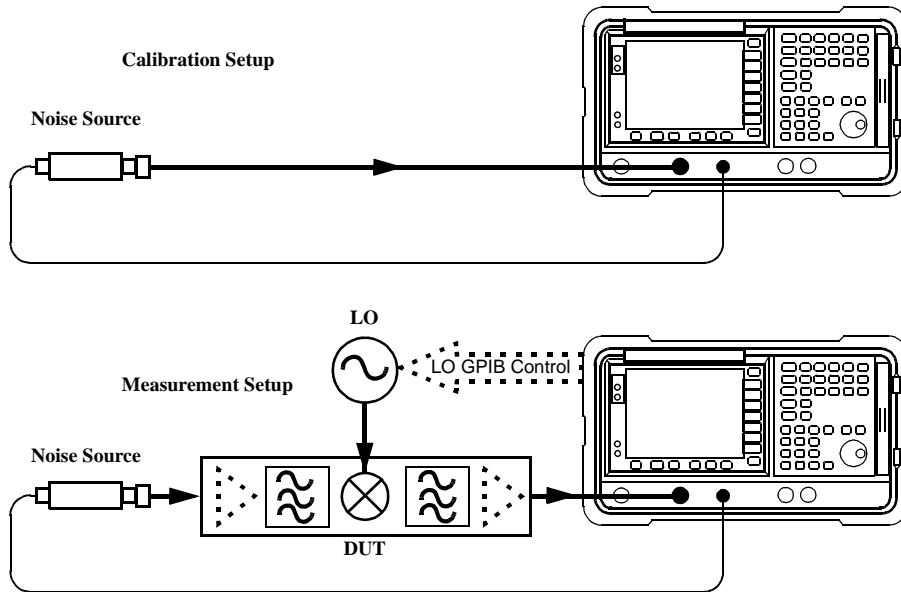

Figure 4-3 Frequency Converting DUT Measurement Modes



Making Extended Frequency Measurements
Connecting the System

5

Performing System Operations

This chapter describes how to perform the system-level tasks, such as configuring the Noise Figure Analyzer's GPIB address, defining the preset conditions and so forth.

What You will Find in this Chapter

This chapter covers:

- Setting the GPIB Addresses
- Configuring the Serial Port
- Configuring the Internal Alignment
- Displaying Error, System and Hardware Information
- Presetting the Noise Figure Analyzer
- Defining the Power-On/Preset Conditions
- Restoring System Defaults
- Setting the Time and Date
- Configuring a Printer with the NFA

Setting the GPIB Addresses

To Set the GPIB Addresses

Step 1. Press the **System** key

Step 2. Press the **GPIB** menu key.

Figure 5-1

System GPIB Form

The screenshot shows a software interface titled "System GPIB Form". At the top, a black bar contains the text "Noise Figure Analyzer Address 8". Below this, the main form area contains three input fields: "Noise Figure Analyzer Address" with the value "8" (highlighted in yellow), "External LO Address" with the value "19", and "LO GPIB Address" with the value "8". To the right of the main form is a vertical stack of seven buttons, the top one labeled "NFA Address" with a small "8" below it. At the bottom of the form, a note reads: "Move the highlight to select a field using the 'Tab' keys."

Step 3. Using the **Tab** key to navigate through the form configure the GPIB parameters as required.

For a description of the GPIB parameters, see the analyzer online help or the *User's Guide*.

NOTE

Ensure the **Remote Port** menu key is set **Remote Port(GPIB)**.

Configuring the Serial Port

Step 1. Press the **System** key

Step 2. Press the **Serial** menu key.

The System Serial Form now appears. See Figure 5-2

Figure 5-2

System Serial Form

The screenshot shows a terminal window titled "System Serial Form". At the top left, it displays "Baud 9600". The main area contains five configuration items, each with a corresponding input field:

- Data Terminal Ready: OFF
- Request To Send: OFF
- Baud: 9600 (highlighted in yellow)
- Receive Pacing: XON/XOFF
- Transmit Pacing: XON/XOFF

On the right side of the window, there is a vertical list of baud rate options: 1200, 2400, 4800, 9600, 19200, and 38400. At the bottom of the window, a message reads: "Move the highlight to select a field using the 'Tab' keys."

Step 3. Use the **Tab** keys to navigate through the form and the menu keys to configure the serial parameters as required.

For a description of the serial parameters, see the analyzer online help or the *User's Guide*.

NOTE

Ensure the **Remote Port** menu key is set **Remote Port(Serial)**. The NFA needs a power cycle to take effect if you changed it from **Remote Port(GPIB)**.

Configuring the Internal Alignment

Data from the internal alignment routine is necessary for accurate NFA operation. When enabled, the internal alignment routine runs continuously to ensure that the NFA is using current alignment data which improves the NFA's accuracy.

Turning Alignment Off and On

- Step 1.** Press the **System** key.
- Step 2.** Press the **Alignment** menu key to access the Alignment menu.
- Step 3.** Press the **Alignment** menu key selecting **Alignment(On)** or **Alignment(Off)** as required.

The default setting is **Alignment(On)**.

Changing Alignment Mode

- Step 1.** Press the **System** key.
- Step 2.** Press the **Alignment** menu key to access the Alignment menu.
- Step 3.** Press the **Alignmnt Mode** menu key selecting **Alignmnt Mode(Point)** or **Alignmnt Mode(Sweep)** as required.

The default mode setting is **Alignmnt(Sweep)**.

Alignment of the YIG Tuned Filter (YTF)

NOTE

The YTF alignment feature only applies to the N8974A and the N8975A models.

Step 1. Press the **System** key.

Step 2. Press the **Alignment** menu key to access the Alignment menu.

Step 3. Press the **Align YTF** menu key to set the YTF alignment.

You are prompted to press this key again. This feature ensures you do not accidentally erase the current YTF alignment data.

Step 4. Wait until the Alignment routine has completed.

Step 5. Press the **Save YTF Alignment** menu key to store the Alignment data.

Displaying Error, System and Hardware Information

Displaying the Error History

- Step 1.** Press the **System** key and the **More 1 of 3** menu key.
- Step 2.** Press **Show Errors** menu key to view the error queue.
- To clear the error screen, press **Clear Error Queue**.

Displaying System Information

- Step 1.** Press the **System** key and the **More 1 of 3** menu key.
- Step 2.** Press **Show System** menu key to view system information.

Displaying Hardware Information

- Step 1.** Press the **System** key and the **More 1 of 3** menu key.
- Step 2.** Press **Show Hdwr** menu key to view hardware information.

Presetting the Noise Figure Analyzer

To preset the analyzer using its factory defaults:

- Step 1.** Turn the NFA on by pressing the **On** key and wait for the power on process to complete.
- Step 2.** Press **System** key, **More 1 of 3**, **Power On/Preset**, **Preset (Factory)** menu keys.
- Step 3.** Press the green **Preset** key.

NOTE

Turning on the analyzer performs an instrument preset. Turning on the analyzer also fetches alignment data; clears both the input and output buffers; and sets the status byte to 0. The last state of the analyzer before it was turned off is recalled when **Power On(Last)** is selected (under the **System** key).

Defining the Power-On/Preset Conditions

The power up and preset conditions can be different if required. You can set the NFA to return it to a user-defined state after a power on or preset.

Setting the Power On Conditions

- Step 1.** Press the **System** key and the **More 1 of 3** menu key.
- Step 2.** Press the **Power On/Preset** menu key.
- Step 3.** Set **Power On** to **Power On(Last)** or **Power On(Preset)** as required.

'Last' means that the instrument, upon power on returns to the state it was in when it was powered off.

'Preset' means the instrument returns to its defined preset state.

Setting the Preset Conditions

You can set the NFA to return to its factory default state or a user defined state upon preset. The configured user defined state is provided by pressing the **Save User Preset** menu key to save the current NFA state

To set the preset conditions to factory default

- Step 1.** Press the **System** key and the **More 1 of 3** menu key.
- Step 2.** Press the **Power On/Preset** menu key.
- Step 3.** Enable the **Preset(Factory)** menu key.

To set the preset conditions to user defined

- Step 1.** Configure the NFA to the desired state.
- Step 2.** Press the **System** key and the **More 1 of 3** menu key.
- Step 3.** Press the **Power On/Preset** menu key.
- Step 4.** Enable the **Preset(User)** menu key.
- Step 5.** Press the **Save User Preset** menu key to save the current NFA state.

Restoring System Defaults

- Step 1.** Press the **System** key
- Step 2.** Press the **More 1 of 3** menu key.
- Step 3.** Press the **Restore Sys Defaults** menu key.

Setting the Time and Date

To turn the time and date on and off

- Step 1.** Press the **System** key.
- Step 2.** Press the **More 1 of 3** menu key.
- Step 3.** Press the **Time/Date** menu key.
- Step 4.** Press the **Time/Date** menu key to select **Time/Date(On)** or **Time/Date(Off)** as required.

To set the time and date

- Step 1.** Press the **System** key.
- Step 2.** Press the **More 1 of 3** menu key.
- Step 3.** Press the **Time/Date** menu key.
- Step 4.** Set the **Date Mode** to either US format **MDY** (Month/Day/Year) or European format **DMY** (Day/Month/Year).
- Step 5.** Enter the time in hhmmss (hours, minutes, seconds) format.
- Step 6.** Enter the date in yyyyymmdd (year, month, day) format.

Configuring a Printer with the NFA

Printer connection To connect your printer to the NFA, connect the printer to the parallel I/O interface connector of the NFA using an IEEE 1284 compliant parallel printer cable.

If appropriate, configure your printer (see your printer documentation for more details on configuring your printer).

To Configure a Printer with the NFA

- Step 1.** Power on the NFA and the printer.
- Step 2.** Press the **Print Setup** key and then press the **Printer Type** menu key. Refer to the analyzer online help or User's Guide for a description of the options.
- Step 3.** Press **Printer Type** to access the **Printer Type** menu keys and press **Auto** to make the NFA attempt to identify the connected printer.

The printer should now be automatically recognized by the NFA. If the printer is not automatically recognized, then see the *User's Guide* for more details on printer setup.

Testing Correct Printer Operation

When printer setup is complete test correct printer operation by pressing **Print Setup**, **Print (Screen)** and then pressing the **Print** key to print a test page.