

Verification Manual

OmniBER 718



Agilent Technologies

© Copyright Agilent Technologies. 2000

All rights reserved. Reproduction, adaption, or translation without prior written permission is prohibited, except as allowed under the copyright laws.

Part No. 37718-90252

Printed in U.K. May 2002

Documentation Warranty

The information contained in this document is subject to change without notice.

Agilent Technologies makes no warranty of any kind with regard to this material, including, but not limited to, the implied warranties or merchantability and fitness for a particular purpose.

Agilent Technologies shall not be liable for errors contained herein or for incidental or consequential damages in connection with the furnishing, performance, or use of this material.

WARNING

Warning Symbols Used on the Product



The product is marked with this symbol when the user should refer to the instruction manual in order to protect the apparatus against damage.

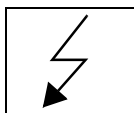

The product is marked with this symbol to indicate that hazardous voltages are present



The product is marked with this symbol to indicate that a laser is fitted. The user should refer to the laser safety information in this manual.

OmniBER 718

List of Contents

General Information

Warranty	1-1
Responsibilities of the Customer	1-2
Certification	1-3
Assistance	1-3
Notice.....	1-3
Restricted Rights Legend.....	1-3
Instruments Covered By Manual.....	1-4
Storage and Shipment.....	1-4
Repackaging for Shipment	1-4
Weight and Dimensions	1-5
Safety Precautions for the Operator	1-6
Lifting/Carrying the OmniBER 718	1-6
Safety Symbols	1-7
Operators Maintenance.....	1-8
Cleaning.....	1-8
Power Supply Fuse Replacement	1-9
Removing/Inserting Modules	1-9
Statement of Compliance	1-10
Australian EMC Regulations	1-10
Noise Declaration (German).....	1-10
Electromagnetic Compatibility.....	1-11
Electrostatic Discharge:	1-11
Declaration of Conformity	1-12

Installation

Initial Inspection	2-1
Operating Environment	2-2
Preparation for Use.....	2-3
Power Requirements	2-3

List of Contents

Fuses	2-3
Fuse Replacement	2-3
Connecting to the Power Supply	2-4
Connecting to the Network.....	2-6
All Connectors	2-6
Electrical Interface Connectors.....	2-6
Optical Interface Connectors	2-10
Connecting Accessories.....	2-12
10 Base-T Lan Connection Radiated Emissions	2-12
General Purpose Interface Bus	2-13
Additional Precautions for Service Engineers.....	2-15
Safety Precautions	2-15
ESD Precautions	2-15
Front Panel Soft Recovery (Cold Start).....	2-17

Performance Tests

Introduction	3-1
Equipment Required	3-1
Performance Test Record	3-1
Calibration Cycle	3-1
Instrument Model and Option Configuration	3-1
Recall Default Settings	3-4
Self Test	3-5
Description.....	3-5
PDH/DSn Internal Transmitter Clock Accuracy & Offset.....	3-10
Specifications.....	3-10
Description.....	3-10
Equipment Required	3-10
Procedure	3-11
E1 (2.048Mb/s) Frequency Accuracy.....	3-11
E2 (8.448Mb/s) Frequency Accuracy.....	3-12

List of Contents

E3 (34.368Mb/s) Frequency Accuracy	3-12
E4 (139.264 Mb/s) Frequency Accuracy	3-13
DS1 (1.544 Mb/s) Frequency Accuracy	3-13
DS3 (44.736 Mb/s) Frequency Accuracy	3-14
PDH/DSn Transmitter Output	3-15
Specification	3-15
Description.....	3-15
Equipment Required	3-16
Procedure	3-16
139.264 Mb/s - All 1's Pulse	3-16
Procedure - 34.368 Mb/s.....	3-20
Procedure - 8.448 Mb/s.....	3-22
Procedure - 2.048 Mb/s.....	3-24
Procedure - DSX-3	3-26
Procedure - DSX-1	3-29
PDH/DSn Receiver Equalization	3-33
Specifications	3-33
Description.....	3-33
Equipment Required	3-33
Procedure	3-34
PDH/DSn Receiver Monitor Levels	3-40
Specifications.....	3-40
Description.....	3-40
External Mux/Demux	3-45
Specifications.....	3-45
Description.....	3-45
Equipment Required	3-45
Procedure	3-46
PDH/DSn Frequency Measurement and Looped Clock	3-55
Specifications.....	3-55
Description.....	3-55
Equipment Required	3-55

List of Contents

Procedure	3-55
SDH/SONET Transmitter Clock Accuracy	3-59
Specification	3-59
Description.....	3-59
Equipment Required	3-59
Procedure	3-59
External Clock/Data Reference Inputs & Clock Reference Output	3-60
Specifications	3-60
Description.....	3-60
Equipment Required	3-60
Procedure	3-61
SDH/SONET Frequency Offsets	3-65
Specifications.....	3-65
Description.....	3-65
Equipment Required	3-65
Procedure	3-65
STM-0/STS-1 Transmitter Output Waveshape	3-67
Specifications.....	3-67
Description.....	3-67
Equipment Required	3-67
Procedure	3-67
STM-1/STS-3 Transmitter Output Waveshape	3-71
Specifications.....	3-71
Description.....	3-71
Equipment Required	3-71
Procedure	3-71
SDH/SONET Receiver Equalization	3-76
Specifications	3-76
Description.....	3-76
Equipment Required	3-76
Procedure	3-76
Procedure	3-78

List of Contents

SDH/SONET Receiver Monitor Levels	3-79
Specifications.....	3-79
Description.....	3-79
Equipment Required	3-79
Procedure	3-79
Multirate Optical Interfaces	3-83
Specification (1310 nm Transmitter up to 622 Mb/s)	3-83
Specification (1310 nm Transmitter up to 2488.32 Mb/s)	3-83
Specification (1550 nm Transmitter up to 622 Mb/s)	3-83
Specification (1550 nm Transmitter up to 2488.32 Mb/s)	3-83
Specification (Receiver) up to 2488.32 Mb/s	3-84
Specification (Receiver) up to 622.08 Mb/s	3-84
Description.....	3-84
Equipment Required	3-85
Procedure	3-85
PDH Transmit/Receive Jitter Amplitude Accuracy	3-89
Specifications.....	3-89
Description.....	3-89
Equipment Required	3-89
Procedure	3-90
DS1 Set-up for Tx/Rx Jitter Amplitude Accuracy	3-90
TX/RX Jitter Accuracy Test Setup, Ranges (10-20/1.6 UIp-p).....	3-94
External Jitter Generation and Demod Output	3-100
SDH Transmit/Receive Jitter Amplitude Accuracy	3-103
Specifications.....	3-103
Description.....	3-103
Equipment Required	3-104
Procedure	3-105
External Jitter Generation and Demod Output	3-121
Performance Test Record	3-125
Jitter Performance Test Record (option 200)	3-135

Terms

ETSI/ANSI Conversion and Equivalent Terms.....	4-1
--	-----

Self Test Overview

Self Tests	5-1
Overall Function Self Tests	5-1
All Tests (test time - up to 1 hour depending on options)	5-2
Specific Measurement Hardware/Function Tests	5-2
PDH Test (test time- approximately 20 minutes)	5-3
BER Test (test time- approximately 20 minutes)	5-4
JITTER Test (test time- approximately 20 minutes)	5-6
ATM Test (test time- approximately 15 minutes)	5-8
POS Test (test time- approximately 15 minutes).....	5-8

Option Structure/Module Configuration

Introduction.....	6-1
-------------------	-----

1

General Information

Warranty

Agilent Technologies PRODUCT	DURATION OF WARRANTY
OmniBER 718	1 year

- 1** Agilent warrants Agilent hardware, accessories and supplies against defects in materials and workmanship for the period specified above. If Agilent receives notice of such defects during the warranty period, Agilent will, at its option, either repair or replace products which prove to be defective. Replacement products may be either new or like-new.
- 2** Agilent warrants that Agilent software will not fail to execute its programming instructions, for the period specified above, due to defects in material and workmanship when properly installed and used. If Agilent receives notice of such defects during the warranty period, Agilent will replace software media which does not execute its programming instructions due to such defects.
- 3** Agilent does not warrant that the operation of Agilent products will be uninterrupted or error free. If Agilent is unable, within a reasonable time, to repair or replace any product to a condition as warranted, customer will be entitled to a refund of the purchase price upon prompt return of the product.
- 4** Agilent products may contain remanufactured parts equivalent to new in performance or may have been subject to incidental use.
- 5** The warranty period begins on the date of delivery or on the date of installation if installed by Agilent. If customer schedules or delays Agilent installation more than 30 days after delivery, warranty begins on the 31st day from delivery.
- 6** Warranty does not apply to defects resulting from (a) improper or inadequate maintenance or calibration, (b) software, interfacing, parts or supplies not supplied by Agilent, (c) unauthorized modification or misuse, (d) operation outside of the published environmental specifications for the product, or (e) improper site preparation or maintenance.

General Information

Warranty

- 7** TO THE EXTENT ALLOWED BY LOCAL LAW, THE ABOVE WARRANTIES ARE EXCLUSIVE AND NO OTHER WARRANTY OR CONDITION, WHETHER WRITTEN OR ORAL, IS EXPRESSED OR IMPLIED AND AGILENT SPECIFICALLY DISCLAIMS ANY IMPLIED WARRANTIES OR CONDITIONS OF MERCHANTABILITY, SATISFACTORY QUALITY, AND FITNESS FOR A PARTICULAR PURPOSE.
- 8** Agilent will be liable for damage to tangible property per incident up to the greater of \$300,000 or the actual amount paid for the product that is the subject of the claim, and for damages for bodily injury or death, to the extent that all such damages are determined by a court of competent jurisdiction to have been directly caused by a defective Agilent product.
- 9** TO THE EXTENT ALLOWED BY LOCAL LAW, THE REMEDIES IN THIS WARRANTY STATEMENT ARE CUSTOMER'S SOLE AND EXCLUSIVE REMEDIES. EXCEPT AS INDICATED ABOVE, IN NO EVENT WILL AGILENT OR ITS SUPPLIERS BE LIABLE FOR LOSS OF DATA OR FOR DIRECT, SPECIAL, INCIDENTAL, CONSEQUENTIAL (INCLUDING LOST PROFIT OR DATA), OR OTHER DAMAGE, WHETHER BASED IN CONTRACT, TORT, OR OTHERWISE.

FOR CONSUMER TRANSACTIONS IN AUSTRALIA AND NEW ZEALAND: THE WARRANTY TERMS CONTAINED IN THIS STATEMENT, EXCEPT TO THE EXTENT LAWFULLY PERMITTED, DO NOT EXCLUDE, RESTRICT OR MODIFY AND ARE IN ADDITION TO THE MANDATORY STATUTORY RIGHTS APPLICABLE TO THE SALE OF THIS PRODUCT TO YOU.

Responsibilities of the Customer

The customer shall provide:

- 1** Access to the products during the specified periods of coverage to perform maintenance.
- 2** Adequate working space around the products for servicing by Agilent personnel.
- 3** Access to and use of all information and facilities determined necessary by Agilent to service and/or maintain the products. (Insofar as these items may contain proprietary or classified information, the customer shall assume full responsibility for safeguarding and protection from wrongful use.
- 4** Routine operator maintenance and cleaning as specified in the Agilent Operating and Service Manuals.
- 5** Consumables such as paper, disks, magnetic tapes, ribbons, inks, pens, gases,

General Information

Warranty

solvents, columns, syringes, lamps, septa, needles, filters, frits, fuses, seals, detector flow cell windows, etc.

Certification

Agilent Technologies certifies that this product met its published specifications at the time of shipment from the factory. Agilent Technologies further certifies that its calibration measurements are traceable to the United States National Bureau of Standards, to the extent allowed by the Bureau's calibration facility and to the calibration facilities of other International Standards Organization members!

Assistance

Product maintenance agreements and other customer assistance agreements are available for Agilent products.

Notice

The information contained in this document is subject to change without notice.

Agilent shall not be liable for errors contained herein or for incidental or consequential damages in connection with the furnishing, performance or use of this material.

This document contains proprietary information which is protected by copyright. All rights are reserved. No part of this document may be photocopied or reproduced without the prior written consent of the manufacturer, Agilent Technologies.

Restricted Rights Legend

Use, duplication, or disclosure by the government is subject to restrictions as set forth in subdivision (b)(3)(ii) of the Rights in Technical Data and Computer Software clause at 52.227-7013. Agilent Technologies Company; 3000 Hanover Street; Palo Alto, California 94304.

Instruments Covered By Manual

Attached to the rear panel of the instrument is a serial number plate. The serial number plate has a two letter reference denoting country of origin (GB = Great Britain) and an eight digit serial number. The serial number is unique to each instrument and should be quoted in all correspondence with Agilent, especially when ordering replacement parts. Refer to Chapter 6 for instrument options covered.



Serial Number Plate

Storage and Shipment

The instrument may be stored or shipped in environments within the following limits:

Temperature	-20° C to +70° C -15° C to +50° C with lid printer
Altitude	Up to 4,600 meters (15,000 feet)

The instrument should also be protected from temperature extremes which could cause condensation within the instrument.

Repackaging for Shipment

Tagging for Service. If the instrument is being returned to Agilent Technologies for service, please complete a repair tag and attach it to the instrument.

General Information

Weight and Dimensions

Original Packaging. Containers and materials identical to those used in factory packaging are available from Agilent offices. If the instrument is being returned to Agilent for servicing, attach a tag indicating the type of service required, return address, model number, and full serial number. Mark the container FRAGILE to ensure careful handling. In any correspondence, refer to the instrument by model number and full serial number.

Other Packaging. The following general instructions should be followed when repackaging with commercially available materials:

- Wrap instrument in heavy paper or plastic. If the instrument is being shipped to Agilent, attach a tag indicating the type of service required, return address, model number and full serial number.
- Use a strong shipping container. A double wall carton made of 350 pound test material is adequate.
- Use a layer of shock absorbing material 70 to 100 mm (3 to 4 inch) thick, around all sides of the instrument to provide firm cushioning and prevent movement inside the container. Protect the Front Panel controls and Rear Panel connectors with cardboard.
- Seal shipping container securely.
- Mark shipping container FRAGILE to ensure careful handling.
- In any correspondence, refer to instrument by model number and full serial number.

Weight and Dimensions

Weight: 18 kg (40 lb) fully loaded

Dimensions: 190mm (7.5in) high, 340mm (14in) wide, 420mm (17in) deep (including cover).

Safety Precautions for the Operator

The following general safety precautions must be observed during all phases of operation, service, and repair of this instrument. Failure to comply with these precautions or with specific warnings elsewhere in this manual violates safety standards of design, manufacture, and intended use of the instrument. Agilent Technologies assumes no liability for the customer's failure to comply with these requirements.

In particular, the operator should note the following safety information:

- “Safety Symbols” on page 1-7
- “Connecting to the Power Supply” on page 2-4
- “Operating Environment” on page 2-2
- “Fuse Replacement” on page 2-3
- “Operators Maintenance” on page 1-8
- “Lifting/Carrying the OmniBER 718” on page 1-6

DO NOT operate damaged equipment: Whenever it is possible that the safety protection features built into this product have been impaired, either through physical damage, excessive moisture, or any other reason, **REMOVE POWER** and do not use the product until safe operation can be verified by service-trained personnel. If necessary, return the product to an Agilent Sales and Service Office for service and repair to ensure the safety features are maintained.

Lifting/Carrying the OmniBER 718

Before attempting to lift or carry the instrument consider the following basic lifting techniques to help avoid personal injury.

Using both arms to lift instrument.

- Reach for the instrument - bend your knees and waist, and keep your back straight.
- GRASP the instrument firmly.
- LIFT with your legs.
- KEEP your shoulders level.

General Information

Safety Precautions for the Operator

Safety Symbols

The following symbols on the instrument and in the manual indicate precautions which must be taken to maintain safe operation of the instrument



The Instruction Documentation Symbol. The product is marked with this symbol when it is necessary for the user to refer to the instructions in the supplied documentation.



Indicates the field wiring terminal that must be connected to earth ground before operating the equipment - protects against electrical shock in case of fault.

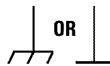

Frame or chassis ground terminal - typically connects to the equipment's metal frame.



Alternating current (AC)



Direct current (DC)



Indicates hazardous voltages

WARNING

Warning denotes a hazard. It calls attention to a procedure, which if not correctly performed or adhered to could result in injury or loss of life. Do not proceed beyond a warning note until the indicated conditions are fully understood and met.

CAUTION



Caution denotes a hazard. It calls attention to a procedure, which if not correctly performed or adhered to could result in damage to or destruction of the instrument. Do not proceed beyond a caution note until the indicated conditions are fully understood and met.



Indicates that a laser is fitted. The user must refer to the manual for specific Warning or Caution information to avoid personal injury or damage to the product.

Operators Maintenance

WARNING

NO OPERATOR SERVICEABLE PARTS INSIDE. REFER SERVICING TO QUALIFIED PERSONNEL. TO PREVENT ELECTRICAL SHOCK DO NOT REMOVE COVERS.

Maintenance appropriate for the operator is:

- Cabinet cleaning
- Optical Connector Cleaning
- Power supply fuse replacement
- Ensure ventilating fan cover is clean.

Cleaning

Instrument Cleaning

Clean the cabinet using a dry cloth only.

Optical Connector Cleaning

It is recommended that the optical connectors be cleaned at regular intervals using the following materials:

Description	HP Part Number
Blow Brush	9300-1131
Isopropyl Alcohol	8500-5344
Lens Cleaning Paper	9300-0761
Adhesive Tape Kit	15475-68701

CAUTION

Do not insert any tool or object into the IN or OUT ports of the instrument as damage to or contamination of the optical fibre may result.

General Information

Operators Maintenance

- 1** Recall Default settings (STORED SETTINGS 0) and remove the power from the OmniBER 718.
- 2** Remove the adapters from the IN and OUT ports. Use an 11 mm spanner to slacken the nut securing the adapter. On re-assembly tighten the nut using a torque spanner to 1.5 Nm.
- 3** Using the blow brush with the brush removed blow through the ferrule of the standard flexible connector and the adapter.

CAUTION

If the optical fibre of the fixed connector requires further cleaning this entails disassembly of the module which should only be carried out by suitably trained service personnel.

- 4** Apply some isopropyl alcohol to a piece of the cleaning paper and clean the barrel of the adapter. Using a new piece of cleaning paper, clean the face of the adapter. Repeat this operation, using a new piece of cleaning paper each time.
- 5** Lightly press the adhesive side of the tape provided against the front of the adapter, then remove it quickly - repeat twice. This removes any particles of cleaning paper which may be present.
- 6** Replace the adapters on the flexible connector.

Power Supply Fuse Replacement

See “Fuse Replacement” on page 2-3.

Removing/Inserting Modules

Modules should only be removed or inserted by trained personnel.

Statement of Compliance

This instrument has been designed and tested in accordance with IEC Publication 1010-1 + A1:1992 Safety requirements for Electrical Equipment for Measurement, Control and Laboratory Use, and has been supplied in a safe condition. The instruction documentation contains information and warnings which must be followed by the user to ensure safe operation and to maintain the instrument in a safe condition.



The CE mark shows that the product complies with all relevant European legal Directives.

ISM 1-A

This is a symbol of an Industrial Scientific and Medical Group 1 Class A product.



The CSA mark is a registered trademark of the Canadian Standards Association.

Australian EMC Regulations



The C-Tick mark is a registered trademark of the Spectrum Management Agency of Australia. This signifies compliance with the Australian EMC Framework Regulations under the terms of the Radiocommunications Act of 1992.

Noise Declaration (German)

LpA<70dB

am Arbeitsplatz (operator position)

normaler Betrieb (normal position)

nach DIN 45635 pt.19 (per ISO 7779)

Electromagnetic Compatibility

"This product conforms with the protection requirements of European Council Directive 89/336/EEC for Electromagnetic Compatibility (EMC).

The conformity assessment requirements have been met using the technical Construction file route to compliance, using EMC test specifications EN 55011:1991 (Group 1, Class A) and EN 50082-1:1992.

In order to preserve the EMC performance of the product, any cable which becomes worn or damaged must be replaced with the same type and specification.

See the Declaration of Conformity on 1-12.

See also "10 Base-T Lan Connection Radiated Emissions" on page 2-12.

Electrostatic Discharge:

"When any electrostatic air discharge is applied to the 37718A/37719A according to IEC 61000-4-3:1995, degradation of performance may be observed in the form of occasional bit errors being counted."

General Information
Declaration of Conformity

Declaration of Conformity according to ISO/IEC Guide 22 and EN45014		
Manufacturer's Name:	Agilent Technologies Ltd.	
Manufacturer's Address:	Telecomms Networks Test Division South Queensferry West Lothian, EH30 9TG Scotland, United Kingdom	
Declares that the product		
Product Name:	OmniBER 718 Communications Performance Analyzer	
Model Number:	Agilent 37718A	
Product Options:	This declaration covers all options of the above product as detailed in TCF A-5951-9852-01	
Conforms with the protection requirements of European Council Directive 89/336/EEC on the approximation of the laws of the member states relating to electromagnetic compatibility, against EMC test specifications EN 55011:1991 (Group 1, Class A) and EN 50082-1:1992.		
As Detailed in:	Electromagnetic Compatibility (EMC) Technical Construction File (TCF) No. A-5951-9852-01	
Assessed by:	DTI Appointed Competent Body EMC Test Centre, GEC-Marconi Avionics Ltd., Maxwell Building, Donibristle Industrial Park, Hillend, Dunfermline KY11 9LB Scotland, United Kingdom	
Technical Report Number:6893/2200/CBR, dated 21 August 1997		
Supplementary Information:		
The product conforms to the following safety standards:		
EN 61010-1(1993) IEC 61010-1(1990) +A1(1992) +A2(1995) CSA-C22.2 No. 1010.1-93 CFR Ch.1 1040.10 EN 60825-1(1994) / IEC 825-1(1993)		
The product herewith complies with the requirements of the Low Voltage Directive 73/23/EEC, and carries the CE marking accordingly.		
<i>South Queensferry, Scotland</i>	<i>28 May 1999</i>	
<i>Location</i>	<i>Date</i>	<i>W.R. Pearson / Quality Manager</i>

Europe Contact:
Your Local Agilent Sales and Service Office or Agilent Technologies GmbH, Department 2Q / Standards Europe
Herrenberger Strasse 130, D7030 Boblingen (Fax: +49-7031-143143)

General Information
Declaration of Conformity

Declaration of Conformity according to ISO/IEC Guide 22 and EN45014		
Manufacturer's Name:	Agilent Technologies Ltd.	
Manufacturer's Address:	Telecomms Networks Test Division South Queensferry West Lothian, EH30 9TG Scotland, United Kingdom	
Declares that the product		
Product Name:	OmniBER 718 Communications Performance Analyzer	
Model Number:	Agilent 37718B	
Product Options:	This declaration covers all options of the above product as detailed in TCF A-5951-9852-01	
Conforms with the protection requirements of European Council Directive 89/336/EEC on the approximation of the laws of the member states relating to electromagnetic compatibility, against EMC test specifications EN 55011:1991 (Group 1, Class A) and EN 50082-1:1992 .		
As Detailed in:	Electromagnetic Compatibility (EMC) Technical Construction File (TCF) No. A-5951-9852-01	
Assessed by:	DTI Appointed Competent Body EMC Test Centre, GEC-Marconi Avionics Ltd., Maxwell Building, Donibristle Industrial Park, Hillend, Dunfermline KY11 9LB Scotland, United Kingdom	
Technical Report Number:6893/2200/CBR, dated 21 August 1997		
Supplementary Information:	The product conforms to the following safety standards: EN 61010-1(1993) IEC 61010-1(1990) +A1(1992) +A2(1995) CSA-C22.2 No. 1010.1-93 CFR Ch.1 1040.10 EN 60825-1(1994) / IEC 825-1(1993)	
The product herewith complies with the requirements of the Low Voltage Directive 73/23/EEC, and carries the CE marking accordingly.		
<i>South Queensferry, Scotland</i>	<i>30 July 1999</i>	
<i>Location</i>	<i>Date</i>	<i>W.R. Pearson / Quality Manager</i>

Europe Contact:
Your Local Agilent Sales and Service Office or Agilent Technologies GmbH, Department 2Q / Standards Europe
Herrenberger Strasse 130, D7030 Boblingen (Fax: +49-7031-143143)

Europe Contact:

General Information
Declaration of Conformity

Declaration of Conformity according to ISO/IEC Guide 22 and EN45014		
Manufacturer's Name:	Agilent Technologies Ltd.	
Manufacturer's Address:	Telecomms Networks Test Division South Queensferry West Lothian, EH30 9TG Scotland, United Kingdom	
Declares that the product		
Product Name:	OmniBER 718 Communications Performance Analyzer	
Model Number:	Agilent 37718C	
Product Options:	This declaration covers all options of the above product as detailed in TCF A-5951-9852-01	
Conforms with the protection requirements of European Council Directive 89/336/EEC on the approximation of the laws of the member states relating to electromagnetic compatibility, against EMC test specifications EN 55011:1991 (Group 1, Class A) and EN 50082-1:1992 .		
As Detailed in:	Electromagnetic Compatibility (EMC) Technical Construction File (TCF) No. A-5951-9852-01	
Assessed by:	DTI Appointed Competent Body EMC Test Centre, GEC-Marconi Avionics Ltd., Maxwell Building, Donibristle Industrial Park, Hillend, Dunfermline KY11 9LB Scotland, United Kingdom	
Technical Report Number:6893/2200/CBR, dated 21 August 1997		
Supplementary Information:	The product conforms to the following safety standards: EN 61010-1(1993) IEC 61010-1(1990) +A1(1992) +A2(1995) CSA-C22.2 No. 1010.1-93 CFR Ch.1 1040.10 EN 60825-1(1994) / IEC 825-1(1993)	
The product herewith complies with the requirements of the Low Voltage Directive 73/23/EEC, and carries the CE marking accordingly.		
<i>South Queensferry, Scotland</i>	<i>30 July 1999</i>	
Location	Date	W.R. Pearson / Quality Manager

Your Local Agilent Sales and Service Office or Agilent Technologies GmbH, Department 2Q / Standards Europe
Herrenberger Strasse 130, D7030 Boblingen (Fax: +49-7031-143143)

2

Installation

Initial Inspection

WARNING

TO AVOID HAZARDOUS ELECTRICAL SHOCK, DO NOT PERFORM ELECTRICAL TESTS WHEN THERE ARE SIGNS OF SHIPPING DAMAGE TO ANY PORTION OF THE OUTER ENCLOSURE (COVERS, PANELS, METERS).

Inspect the shipping container for damage. If the shipping container or cushioning material is damaged, it should be kept until the contents of the shipment have been checked for completeness and the instrument has been checked both mechanically and electrically. Procedures for checking electrical operation are given in Chapter 3. If the contents of the shipment are incomplete, if there is mechanical damage or defect, notify the nearest Agilent Office. If the instrument does not pass the electrical performance tests given in Chapter 3, notify the nearest Agilent office. If the shipping container is also damaged, or the cushioning material shows signs of stress, notify the carrier as well as the nearest Agilent office. Keep the shipping materials for the carrier's inspection. The Agilent office will arrange for repair or replacement without waiting for claim settlement.

Operating Environment

This instrument is designed for Indoor use only.

DO NOT operate the product in an explosive atmosphere or in the presence of flammable gasses or fumes.

This instrument may be operated in environments within the following limits:

Temperature: 0°C to +45°C
+5°C to +40°C for Jitter operation
+5°C to +35°C with lid printer

Altitude up to 3050 m (10,000 ft)

Humidity up to 95% relative humidity to 40°C, but it should be protected from temperature extremes which may cause condensation.

To ensure adequate cooling do not obstruct air vents in the instrument cabinet. Do not for example operate the instrument if it is standing on its rear feet, as air vents may be obstructed by floor covering.

CAUTION

This instrument is designed for use in Installation Category II and Pollution Degree 2 per IEC 61010.0-1 and 60664 respectively.

CAUTION

VENTILATION REQUIREMENTS: When installing the instrument in a cabinet, the convection into and out of the instrument must not be restricted. If the total power dissipated in the cabinet is greater than 800 watts, then forced convection must be used.

Preparation for Use

WARNING

FOR CONTINUED PROTECTION AGAINST FIRE HAZARD REPLACE FUSE ONLY WITH SAME TYPE AND RATINGS (see “Fuses” on page 2-3).

WARNING

If this instrument is not used as specified, the protection provided by the equipment could be impaired. This instrument must be used in a normal condition only (in which all means for protection are intact).

Power Requirements



The OmniBER 718 Communications Performance Analyzer requires a power source of 100 V to 240 V ac at a frequency between 47 Hz and 63 Hz (nominal).

Total power consumption is 450 VA (maximum).

The fuse rating for the power source is given in the following table.

Fuses

Line Voltage	Fuse Rating	Agilent Part Number
100 V to 240 V	5 A Timed, 250 V	2110-1120

Fuse Replacement

Only the ac line fuse located at the rear of the instrument may be replaced by the operator.

WARNING

ALL OTHER FUSE REPLACEMENT SHOULD ONLY BE CARRIED OUT BY SUITABLY TRAINED SERVICE PERSONNEL AWARE OF THE HAZARDS INVOLVED.

WARNING

BEFORE REMOVING THE FUSE, THE AC LINE POWER CORD SHOULD BE DISCONNECTED FROM THE POWER SOURCE AND THE OTHER END DISCONNECTED FROM THE INSTRUMENT.

Installation
Preparation for Use

WARNING

ONLY USE A FUSE OF THE CORRECT RATING AS LISTED IN “Fuses” on page 2-3. DO NOT use repaired fuses or short-circuited fuseholders: For continued protection against fire, replace the line fuse(s) only with fuse(s) of the same voltage and current rating and type.

The fuse is removed by inserting a suitable flat bladed tool into the slot in the fuse cap and turning counter-clockwise. The cap and the fuse can then be removed and the fuse changed for another of the correct rating. The fuse rating and Agilent part number are listed in “Fuses” on page 2-3.

Connecting to the Power Supply

WARNING

This is a Safety Class I instrument (provided with a protective earthing ground, incorporated in the powercord). The mains plug shall only be inserted in a socket outlet provided with a protective earth contact. Any interruption of the protective conductor inside or outside of the instrument is likely to make the instrument dangerous. Intentional interruption is prohibited.

WARNING

Appliance coupler (mains input powercord) is the power disconnect device. Do not position the instrument such that access to the coupler is impaired.

CAUTION

Before switching on this instrument, make sure that the line supply voltage is in the specified ranges. Range selection is automatic.

Installation
Preparation for Use

Power Cord

WARNING

TO AVOID THE POSSIBILITY OF INJURY OR DEATH, THE FOLLOWING PRECAUTIONS MUST BE FOLLOWED BEFORE THE INSTRUMENT IS SWITCHED ON:-

WARNING

(a) Note that the protection provided by grounding the instrument cabinet may be lost if any power cable other than the three-pronged type is used to couple the ac line voltage to the instrument. Under these circumstances, the external protective earth terminal will be connected to ground.

WARNING

(b) If this instrument is to be energized via an auto-transformer to reduce or increase the line voltage, make sure that the common terminal is connected to the neutral pole of the power source.

WARNING

(c) The power cable plug shall only be inserted into a socket outlet provided with a protective ground contact. The protective action must not be negated by the use of an extension cord without a protective conductor (grounding).

The power cord supplied with each instrument varies with the country of destination. The following figure illustrates the standard power plug and cord configurations that are commonly used. The part number shown beneath each plug is the part number of the appropriate power cord and plug. If the appropriate power cord is not included with the instrument notify the nearest Agilent office and a replacement will be provided.

Power Cord Configurations and Part Numbers

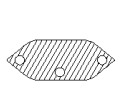
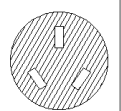
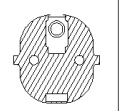
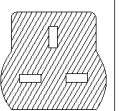
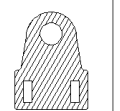
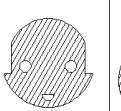
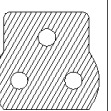
						
8120-2104	8120-1369	8120-1689	8120-1351	8120-1378 US 8120-4753 JAP	8120-2956	8120-4211

Connecting to the Network

The network connectors are located on the modules at the side of the instrument. The connections available depend on the options fitted to your instrument.

Before Connecting, note the Warning and Caution information given.

All Connectors

CAUTION

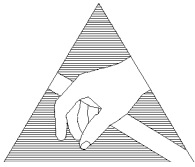

When connecting or disconnecting, ensure that you are grounded or, make contact with the metal surface of the Mainframe with your free hand to bring you, the module, and the mainframe to the same static potential.

Modules remain susceptible to ESD damage while the module is installed in the Mainframe

Additional ESD information is required when servicing see “Additional Precautions for Service Engineers” on page 2-15.

Electrical Interface Connectors

RECEIVER **2,8,34,DS3 IN**

PDH/DSn receiver input interface. Allows the connection of 75 Ω unbalanced data signals (all rates)

TRANSMIT **2,8,34,DS3 OUT**

PDH/DSn transmitter output interface. Provides 75 Ω unbalanced data output (all rates)

140Mb/s 75 Ω IN

Clock/E4 input interface. Allows the connection of 75 Ω unbalanced 139.264 Mb/s data signals.

140Mb/s 75 Ω OUT

Clock/E4 output interface. Allows the connection of 75 Ω unbalanced 139.264 Mb/s data signals. A “keep alive” signal is output when the transmit signal is SDH/SONET.

DS1 100 Ω , **2Mb/s 120 Ω IN**

PDH / DSn receiver input interface. Allows the connection of 100 Ω balanced DS1 and 120 Ω balanced 2 Mb/s data signals.

Installation

Connecting to the Network

DS1 100 Ω, 2Mb/s 120 Ω OUT	PDH / DS _n transmitter output interface. Provides 100 Ω balanced DS1 and 120 Ω balanced 2 Mb/s data signals. A “keep alive” signal is output when the transmit signal is SDH/SONET.
52/155 Mb/s DATA IN	SDH/SONET receiver input interface. Allows the connection of 75 Ω unbalanced STM 0/1, STS 1/3 electrical signals.
52/155 Mb/s DATA OUT	SDH/SONET transmitter output interface. Provides a 75 Ω unbalanced STM 0/1, STS 1/3 electrical output.
Jitter Mod 75 Ω IN	External jitter modulated signals can be applied to this port
Demod 75 Ω OUT	A demodulated jitter output port is supplied.
64k REF IN 10M REF IN 2M REF IN DS1 REF IN	These ports allow connection of timing reference signals. Note unused external clock ports must not have a signal present.
REF OUT	Provides a 2 MHz reference Clock Output.
MUX 2Mb/s 75 Ω	Allows the insertion of an external 2 Mb/s tributary into the transmitted payload.
MUX DS1 100 Ω	Allows an externally supplied DS1 signal to be inserted in any or all timeslot(s) of a DS3 signal. In conjunction with the SDH/SONET module a DS1 signal can be inserted into a VT1.5 or TU-11.
MUX 2 Mb/s 75 Ω	Allows an externally supplied 2.048 Mb/s signal to be inserted in any or all timeslot(s) of a 34 Mb/s signal. In conjunction with the SDH module a 2.048 Mb/s signal can be inserted into a TU-12.

Installation

Connecting to the Network

DEMUX DS1 **100 Ω**

Allows a DS1 signal to be dropped from any timeslot of a DS3 signal. In conjunction with the SDH/SONET module this port allows the demultiplexing of a DS1 signal carried in a VT1.5

DEMUX **2 Mb/s 75 Ω**

Allows a 2.048 Mb/s signal to be dropped from any timeslot of an 8.448 Mb/s, 34.368 Mb/s or 139.264 Mb/s signal.

CLOCK TRIGGER

Reference SDH/SONET clock trigger output 51 MHz; nominal +/- 400 mV into 50 ohms.

DCC

Allows the Drop and Insert of Regenerator Section (192 kb/s) and Multiplexer Section (576 kb/s) Data Communication Channels (DCC).

The following connections are available:

Pin Number	Connection
1	Shield Ground
2	Data input for Tx(-)
3	Tx Clock
4	Data Output from Rx(-)
5	NC
6	Rx Clock(-)
7	NC
8	Signal Ground
9	Data Input for Tx(+)
10	Tx Clock(+)
11	Data output from Rx(+)
12	NC
13	Rx Clock(+)
14	NC
15	NC

Installation
Connecting to the Network

***PROTECTED
MONITOR POINT
INPUT***

52/155/622 Mb/s (NRZ); Line Code NRZ; Level nominal 1 V Pk-Pk into 50 ohms;
SMA connector.

Optical Interface Connectors

For your protection, review all laser information given in this manual before installing or using the instrument.

WARNING

To prevent personal injury, avoid use that may be hazardous to others, and maintain the module in a safe condition. Ensure the information given below is reviewed before operating the module.

Laser Product Classification

All optical modules are classified as Class I (non-hazardous) laser product in the USA which complies with the United States Food and Drug Administration (FDA) Standard 21 CFR Ch.1 1040.10, and are classified as Class 1 (non-hazardous) laser products in Europe which complies with EN 60825-1 (1994).

To avoid hazardous exposure to laser radiation, it is recommended that the following practices are observed during system operation:

- **ALWAYS DEACTIVATE THE LASER BEFORE CONNECTING OR DISCONNECTING OPTICAL CABLES.**

- When connecting or disconnecting optical cables between the module and device-under-test, observe the connection sequences given below.

Connecting: Connect the optical cable to the input of the device-under-test **before** connecting to the module's *Optical Out* connector.

Disconnecting: Disconnect the optical cable from the module's *Optical Out* connector **before** disconnecting from the device-under-test. Always fit the fibre optic connector dust caps over the laser aperture.

- NEVER examine or stare into the open end of a broken, severed, or disconnected optical cable when it is connected to the module's *Optical Out* connector.
- Arrange for service-trained personnel, who are aware of the hazards involved, to repair optical cables.

Installation

Connecting to the Network

CAUTION

1. Use of controls or adjustments or performance of procedures other than those specified herein may result in hazardous radiation exposure.
 2. Always fit the fibre optic connector dust caps on each connector when not in use. Before connection is made, *always* clean the connector ferrule tip with acetone or alcohol and a cotton swab. Dry the connector with compressed air. Failure to maintain cleanliness of connectors is liable to cause excessive insertion loss.
-

Laser Warning Symbols

The front panel of the optical module has the following label:

CLASS 1 LASER PRODUCT

NOTE

CLASS 1 LASER PRODUCT translates as follows:

Finnish - LUOKAN 1 LASERLAITE

Finnish/Swedish - KLAS 1 LASER APPARAT

This label indicates that the radiant energy present in this instrument is non-hazardous.

OPTICAL IN

Allows connection of an optical signal, wavelength 1200 to 1600 nm, at a maximum power level of -8 dBm (Agilent 37718A) or -3 dBm (Agilent 37718B/C). **NEVER EXCEED +3 dBm.**

Accepts STM-0, STM-1, STM-4 and STM-16. Also accepts SONET signals OC-1, OC-3, OC-12, and OC-48 depending on the model and options fitted.

OPTICAL OUT

Provides an STM-0, STM-1, STM-4 or STM-16 optical signal (OC-1, OC-3, OC-12 or OC-48 SONET signals) at wavelength 1280 to 1335nm, and/or 1480 to 1580 nm, at a nominal power level of +1 dBm depending on model and options.

Cleaning Optical Connectors

See “Optical Connector Cleaning” on page 1-8

Connecting Accessories

LID Provides the output for the option 602 printer which is fitted in the cover (LID) of the instrument.

VGA Provides the output for a display monitor.

HANDSET Allows connection of a telephone handset for communication across the network.

Printer
GP-IB, RS232,
PARALLEL ONLY External printer connection details are given in the Users Guide.
The port selected for external printer use is not available for remote control.

Remote Control
GP-IB, RS232,
10 BASE -T Remote control connection is given in the Remote Control Manual.
The port selected for remote control use is not available for an external printer.

10 Base-T Lan Connection Radiated Emissions

To ensure compliance with EN 55011 (1991) a category 5, FTP patch lead, RJ45 cable should be used to connect the LAN port on the processor module marked "10 Base-T".

Installation
Connecting Accessories

General Purpose Interface Bus

The OmniBER 718 Communications Performance Analyzer (Option 601) is connected to the GPIB by means of an appropriate GPIB cable. The GPIB interconnecting cables available are listed in the following table.

GPIB Interconnecting Cables

Length	Accessory Number
1 meter	HP 10833A
2 meters	HP 10833B
4 meters	HP 10833C
0.5 meter	HP 10833D

To achieve interface design performance standards, restrictions are placed on the GPIB system cable lengths. These restrictions allow the bus interface electronics to maintain correct line voltage levels and timing relationships.

When connecting an GPIB system the following rules should be observed:

The total GPIB cable length used must be less than or equal to 20 meters (65.6 feet).

The total GPIB cable length used must be less than or equal to 2 meters (6 feet) × the total number of devices connected to the bus.

A standard GPIB connector is provided on the instrument. The connections are shown in the following figure. The mating connector part number is HP 1251-0293 or Amphenol 57-30240.

Installation
Connecting Accessories

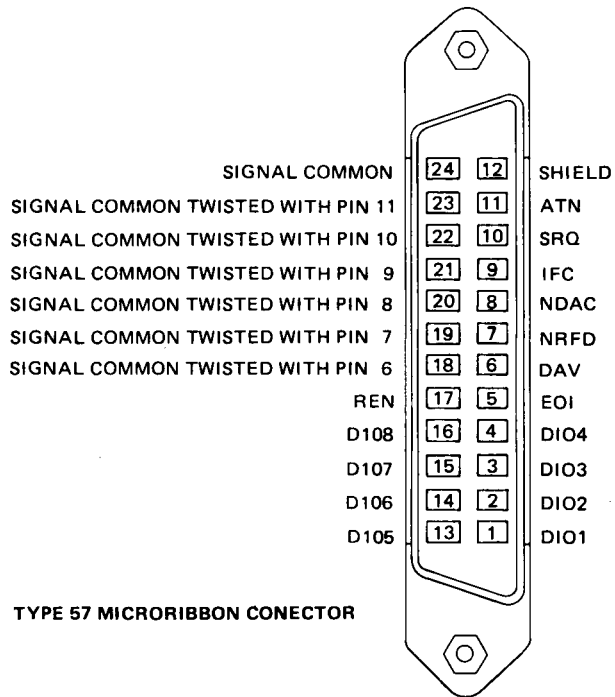

GPIB Address Selection

The OmniBER 718 (Option 601) GPIB address is accessed on the OTHER display under the REMOTE CONTROL function.

The address can be set to any value between 0 and 30 inclusive.

Additional Precautions for Service Engineers

Safety Precautions

DO NOT substitute parts or modify equipment: Because of the danger of introducing additional hazards, do not install substitute parts or perform any unauthorized modification to the product. Return the product to an Agilent Sales and Service Office for service and repair to ensure the safety features are maintained.

DO NOT service or adjust alone: Under certain conditions, dangerous voltages may exist even with the equipment switched off. To avoid dangerous electrical shock, service personnel must not attempt internal service or adjustment unless another person, capable of rendering first aid and resuscitation, is present.

Review “Safety Precautions for the Operator” on page 1-6.

ESD Precautions

CAUTION

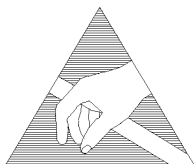

When making connections to the modules, review “Connecting to the Network” on page 2-6.

The module contains components sensitive to electrostatic discharge. To prevent component damage, carefully follow the handling precautions presented below.

The smallest static voltage most people can feel is about 3500 volts. It takes less than one tenth of that (about 300 volts) to destroy or severely damage static sensitive circuits. Often, static damage does not immediately cause a malfunction but significantly reduces the component’s life. Adhering to the following precautions will reduce the risk of static discharge damage.

- Keep the module in its conductive storage box when not installed in the Main-frame. Save the box for future storage of the module.
- Before handling the module, select a work area where potential static sources are minimized. Avoid working in carpeted areas and non-conductive chairs. Keep body movement to a minimum. Agilent recommends that you use a controlled static workstation.
- Handle the module by its front-panel. Avoid touching any components or edge connectors. When you install the module, keep one hand in contact with the pro-

Installation

Additional Precautions for Service Engineers

tective bag as you pick up the module with your other hand. Then, before installing the module, ensure that you are grounded or make contact with the metal surface of the Mainframe with your free hand to bring you, the module, and the mainframe to the same static potential. **This also applies whenever you connect/disconnect cables on the front-panel.**

Front Panel Soft Recovery (Cold Start)

Use the following procedure if you need to perform a front panel soft recovery (i.e. cold start) of the instrument.

Soft Recovery Procedure

- 1** Switch off the instrument.
- 2** On the instrument front panel - press and hold softkeys 0 and 4 simultaneously (the softkeys immediately below the display; key 0 is on the extreme left).
- 3** Power up the OmniBER 718 while holding the softkeys pressed.
- 4** When the LOS LED has flashed OFF and then ON again, the keys can be released.
- 5** The LOS LED will flash OFF/ON again several times (7), followed by an audible 'beep' and the display indicating 'Initializing Instrument'.
- 6** Once the initiations is complete the display will indicate:
'Firmware Revision Update'
'Default settings assumed'
Hit any key to attempt restart'
- 7** Hit any key, then wait approximately 10 seconds. The instrument should return to its default settings and normal operation.

Installation
Additional Precautions for Service Engineers

3

Performance Tests

Introduction

The procedures given in this Section, test the OmniBER's performance using the Specifications provided, as performance standards. Tests are intended to be performed in the recommended order for a full instrument calibration check. Tests can be run individually, however it will be assumed that any preceding test would meet specifications.

Equipment Required

Equipment required for the Performance Tests is given in this Chapter. Any equipment which meets or exceeds the critical specification of the equipment listed, may be substituted. Recommended models are those typically used in Agilent Service Centers. Alternative models are also listed.

Performance Test Record

The results of the Performance Tests may be recorded on the Test Records at the end of this Chapter. The Performance Test Record lists all the tested specifications and the acceptable limits. The results recorded at incoming inspection may be used for comparison during periodic maintenance, troubleshooting or after repair or adjustment.

Calibration Cycle

This instrument requires periodic verification of performance. Depending on use and environmental conditions, the instrument should be checked approximately once every 2 years, using these Performance Tests.

Instrument Model and Option Configuration

Please refer to Chapter 6 and the instrument Specifications for information on option configuration.

Performance Tests

Introduction

Figure 3-1 Recommended Test Equipment

Instrument	Critical Specification	Recommended Model
Oscilloscope	400 MHz Bandwidth, 1 M Ω Input Termination Telecom mask measurement capability.	HP 54520A opt 001 or HP 54810A opt 001
Frequency Synthesizer	75 Ω Output, Sinewave to 80 MHz, Amplitude to 3 V pk-pk at 10 kHz, 1 Hz resolution	HP 3335A opt 001 or HP 3325B & HP 8657A with 50/75 Ω matching pad
Signal Generator	Sinewave 700 kHz to 170 MHz, Amplitude 500 mV	HP 8657A
Frequency Counter	Range 0 to 200 MHz, 2 channels with accuracy <0.1ppm. (Ratio Mode)	HP 5325A opt 010 or HP 53181A opt 001
Spectrum Analyzer**	Frequency >2.5 Gb/s. Resolution bandwidth 10 Hz.	HP 8560E
Optical Coupler**	1310 and 1510 nm. 10/90% output.	HP 15477C
Optical Power Meter and Sensor Module	Range -8 dBm to -15 dBm, Wavelength 1270-1560 nm	HP 8153A and HP 81536A
Lightwave Converter	Wavelength 1300 to 1560 nm, Conversion Gain >300 volts/watt, Frequency Response < 3 dB down at 1 GHz.	HP 11982A opt 012
Optical Attenuator	Wavelength 1200 - 1600 nm, Range 0 - 30 dB	HP 8157A or HP 8156A opt 100
FC/PC Optical Interface Connector	Unique	HP 81000FI (Qty 4)
Optical Cables	Unique	HP 11871A (Qty 2)
PDH Structured Test Set	Unique	OmniBER 718, OmniBER 719 or HP 37717C opt 110
64 kb/s Clock Generator	64 kb/s ternary clock.	HP 37732A
75 Ω Attenuator Kit	0 to 200 MHz 3, 6, 10, 20 dB fixed attenuator pads	HP 86213A
Cable Simulator #E1	75 Ω coaxial cable 6 dB loss at 1 MHz	8120-0049 (120 m)*
Cable Simulator #E2	75 Ω coaxial cable 6 dB loss at 4 MHz	8120-0049 (80 m)*
Cable Simulator #E3	75 Ω coaxial cable 12 dB loss at 17 MHz	8120-0049 (120 m)*
Cable Simulator #E4	75 Ω coaxial cable 12 dB loss at 70 MHz	8120-0049 (80 m)*
Cable Simulator #E1-M	75 Ω coaxial cable 3 dB loss at 1 MHz	8120-0049 (60 m)*

Performance Tests

Introduction

Figure 3-1 Recommended Test Equipment, continued

Instrument	Critical Specification	Recommended Model
Cable Simulator #E2-M	75Ω coaxial cable 3 dB loss at 4 MHz	8120-0049 (40 m)*
Cable Simulator #E3-M	75Ω coaxial cable 6 dB loss at 17 MHz	8120-0049 (60 m)*
Cable Simulator #E4-M	75Ω coaxial cable 6 dB loss at 70 MHz	8120-0049 (40 m)*
Cable Simulator #DS1	75Ω coaxial cable. Equivalent to 655 feet ABAM cable.	8120-0049 (80m)*
Cable Simulator #DS3	75Ω coaxial cable. Equivalent to 450 feet of 728A cable	8120-0049 (55m)*
Cable Simulator STM-0/STS-1	75Ω coaxial cable 6 dB loss at 26 MHz	8120-0049 (50 m)*
Cable Simulator STM-1/STS-3	75Ω coaxial cable 12 dB loss at 78 MHz	8120-0049 (75 m)*
75Ω Termination	0 to 200 MHz	HP 15522-80010
T Connector	BNC to Dual BNC	HP 1250-0781
Adaptor	SMA to BNC	1250-1787 (Qty 2)
Adaptor	Type N to BNC	HP 1250-1534 (Qty 2)
Adaptor	Type N to N	HP 1250-1528 (Qty 2)
Balanced/Unbalanced Converter	110Ω balanced: 75Ω Unbalanced (nominal)	HP 15508B (Qty 2)
Blocking Capacitor	0.18uF 200V	HP 10240B

* Note: Cable lengths quoted are typical for the half bit rate loss. Ideally, cables should be trimmed to correct length/loss by measuring with a Network Analyzer.

** Note: Spectrum Analyzer/Optical Coupler are only required for the OmniBER Jitter options.

Self Test Loopback Cables and Accessories

HP E4545A 3m fibre optic cable FC/CP connectors. (supplied accessory)

HP E4546A FC/CP 15 dB attenuator. (supplied accessory)

HP 15525A 75 ohm BNC, 3 off.

HP 15512A Siemens 3 pin

HP 15670A Bantam 110 ohm, 2 off.

DCC 15 pin loopback plug - see figure in DCC Test.





Formatted floppy disk.

Performance Tests

Introduction

Recall Default Settings

The Performance Tests require the OmniBER to be set to a pre-defined (default) state at the beginning of each test.

- 1 Using **OTHER**, display softkeys,    and  set up the **OTHER** **STORED SETTINGS** display as shown opposite

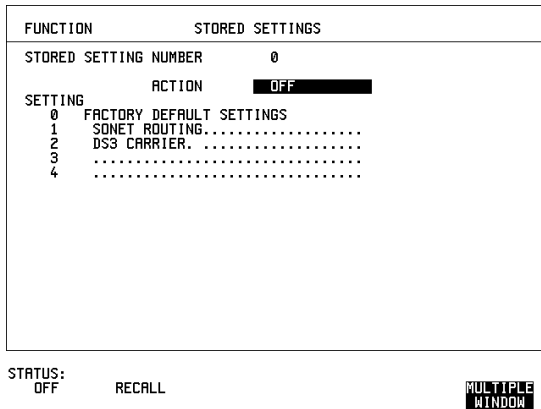

- 2 Press **RECALL** to recall the instrument default settings. The instrument display will blank for a few seconds while the settings are recalled and the status display will indicate stored settings number 0 recalled.

Self Test

Self Test

Description

Before carrying out the performance tests run Self Test to ascertain the integrity of the OmniBER. These tests take at least 1 hour to complete depending on the options fitted. Alternatively you can run Confidence Tests which only takes 2 to 3 minutes to complete. This is not a full verification but performs BER measurements with internal and external loopbacks fitted.

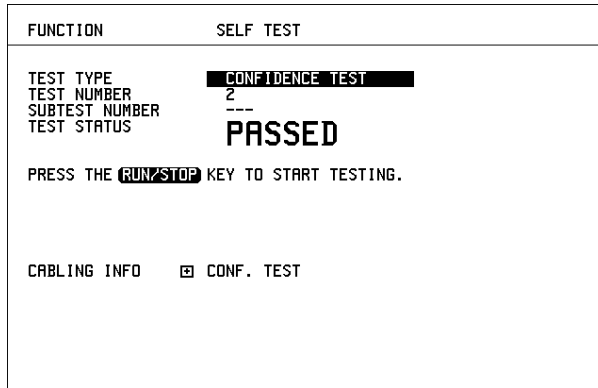

STATUS: ALL TESTS CPU TESTS CONF. TESTS PDH TESTS MORE MULTIPLE WINDOW

Run Confidence TESTS

- 1 Choose TEST TYPE **CONF. TESTS** on the **(OTHER) SELF TEST** display.

CAUTION

Safety precaution, care and connection cleanliness are essential to avoid optical signal degradation or damage. see Operators Maintenance in chapter 1 and see Optical Interface Connectors in chapter 2 if in doubt.
The use of air-gap attenuators is not recommended.
Failure to attenuate the optical signal could result in damage to the optical receiver.

Performance Tests

Self Test

NOTE

If the Optical Interface is a Dual Wavelength Option the **1550 nm** IN and OUT ports are not connected at this stage and can be tested later.

If any or all of these connections are not made the OmniBER will FAIL Self Test.

- 2** Make the loopback connections listed below:
 - Connect the 15 dB optical attenuator provided at the Optical OUT and then connect the attenuator output to Optical IN using the optical cable supplied with your instrument.
 - Connect Multirate Analyser IN to OUT.
 - Connect Transmit module 75 Ω OUT to Receive module 75 Ω IN.
 - Connect Transmit module 100/120 Ω OUT to Receive module 100/120 Ω IN.
- 3** Press **RUN/STOP** to activate the Self Test. TEST STATUS RUNNING will be displayed.
 - The information pertaining to TEST TYPE, TEST NUMBER and SUBTEST NUMBER will change as the Self Test progresses.
 - If the OmniBER is functioning correctly, after a time of 2 to 3 minutes, TEST STATUS PASSED is displayed.
 - If TEST STATUS [FAIL nnn] is displayed, check the displayed error information and check loopback connections are correct. Repeat the test and if the problem persists contact your local Agilent representative. See Chapter 5 for information.

NOTE

Each individual self test requires unique loopback connections. To obtain a list of the connections required move the highlighted cursor to CABLING INFO and press **SET**. The Loopbacks list will appear on the display. Also refer to Chapter 5 for Self Test connection information.

Performance Tests

Self Test

FUNCTION	SELF TEST
TEST TYPE	PDH TESTS
TEST NUMBER	3
SUBTEST NUMBER	---
TEST STATUS	RFANY

PDH SELFTEST - CABLING INFORMATION

PAYLOAD MODULE CONNECTIONS :

- CONNECT PDH OUT TO PDH IN (UNBALANCED DS3, 210/s, 3410/s)
- CONNECT PDH OUT TO PDH IN (BALANCED 210/s)
- CONNECT MUX TO DEMUX (BALANCED DS1)
- CONNECT MUX TO DEMUX (UNBALANCED 210/s)

STATUS:

**MULTIPLE
WINDOW**

Run ALL TESTS

- 1 Choose TEST TYPE **ALL TESTS** on the **OTHER SELF TEST** display.
- 2 Insert a formatted disk into the instrument disk drive.
- 3 Make the loopback connections listed below:
Connect the 15 dB optical attenuator provided, to Optical OUT and connect the attenuator output to Optical IN.
Connect Multirate Analyser IN to OUT.
Connect Transmit module 75 Ω OUT to Receive module 75 Ω IN.
Connect Transmit module 100/120 Ω OUT to Receive module 100/120 Ω IN.
Connect Transmit module 75 Ω MUX to Receive module 75 Ω DEMUX.
Connect Transmit module 100/120 Ω MUX to Receive module 100/120 Ω DEMUX.
- 4 Press **RUN/STOP** to activate the Self Test. TEST STATUS RUNNING will be displayed.
The information pertaining to TEST TYPE, TEST NUMBER and SUBTEST NUMBER will change as the Self Test progresses.
If the OmniBER is functioning correctly, after a time of at least 1 hour, TEST STATUS PASSED is displayed.
If TEST STATUS [FAIL nnn] is displayed, check the displayed error information and check loopback connections are correct. Repeat the test and if the problem persists contact your local Agilent representative. See Chapter 5 for information.

Performance Tests

Self Test

FUNCTION	SELF TEST
TEST TYPE	ALL TESTS
TEST NUMBER	0
SUBTEST NUMBER	---
TEST STATUS	READY
PRESS THE RUN/STOP KEY TO START TESTING.	
CABLING INFO	<input checked="" type="checkbox"/> ALL

STATUS:
ALL TESTS CPU TESTS CONF. TESTS PDH TESTS MORE **MULTIPLE WINDOW**

1550 nm Dual Wavelength Tests:

If a Dual Wavelength Optical Interface is fitted, repeat the CONFIDENCE test with 1550 nm selected.

- 1 Select 1550 nm OPTICS wavelength
- 2 Connect 1550 nm OUT to IN via 15 dB Optical Attenuator. Ensure the attenuator is inserted in the OUT port.
- 3 Run the test.

Performance Tests

Self Test

DCC Port Tests:

- 1 Select BER TESTS
- 2 Make the following connections at the Multirate Analyzer DCC port.

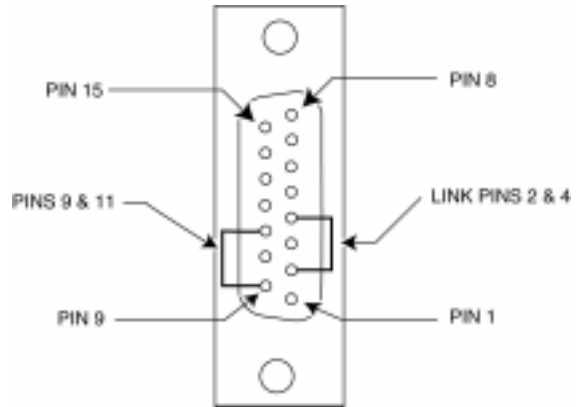

- 3 Run the BER TESTS.

PDH/DSn Internal Transmitter Clock Accuracy & Offset

Specifications

Rate	Frequency
E4	139.264 MHz \pm 4.5 ppm
E3	34.368 MHz \pm 4.5 ppm
E2	8.448 MHz \pm 4.5 ppm
E1	2.048 MHz \pm 4.5 ppm
DS1	1.544 MHz \pm 4.5 ppm
DS3	44.736 MHz \pm 4.5 ppm

Description

This test verifies that the PDH transmit data rates are within limits. These limits assume the instrument is within the calibration cycle. The Frequency Offset capability (deviation from Standard Bit Rate) is also checked.

For E1 to E4 a Frequency Counter connected to the PDH/DSn Signal Out port measures the data rate on an “all ones” pattern. This gives an indirect measure of the internal transmitter clock frequency as the data is clocked by the internal clock oscillator. Because the Frequency Counter triggers from the positive pulses only, the frequency count will, for Ternary signals E1, E2 & E3, be half the selected data rate. For DS-1 and DS-3 the Frequency Counter is connected to the CLOCK OUT port.

Equipment Required

Frequency Counter	: HP 5335A Option 010
75Ω Termination	: HP 15522-80010
T Connector	: HP 1250-0781

PDH/DSn Internal Transmitter Clock Accuracy & Offset

Procedure

- 1 Recall the OmniBER's default settings as shown on Page 3-4.
- 2 Connect the 75Ω OUT port of the PDH/DSn module to the Frequency Counter. Terminate the Frequency Counter input in 75Ω (use the T connector).
- 3 Set the **TRANSMIT** display as shown opposite



NOTE

When changing the PDH Rate or Offset value the VCXO takes time to settle. As a consequence the frequency counter reading will not stabilize until “VCXO OUTPUT BIT RATE SETTLING” clears from the STATUS line of the display.

E1 (2.048Mb/s) Frequency Accuracy

- 4 Adjust the Frequency Counter ATTEN and Trigger Level to obtain a stable reading and ensure that the frequency counter reading is between 1023995 Hz and 1024005 Hz.
- 5 Select FREQUENCY OFFSET [+50PPM].
- 6 Adjust the Frequency Counter ATTEN and Trigger Level to obtain a stable reading and ensure that the frequency counter reading is between 1024046.5 Hz and 1024055.5 Hz.

Performance Tests

PDH/DSn Internal Transmitter Clock Accuracy & Offset

- 7 Select FREQUENCY OFFSET [-50PPM].
- 8 Adjust the Frequency Counter ATTEN and Trigger Level to obtain a stable reading and ensure that the frequency counter reading is between 1023944 Hz and 1023953 Hz.

E2 (8.448Mb/s) Frequency Accuracy

- 9 Select SIGNAL [8Mb/s]; PATTERN [ALL 1's] on the **TRANSMIT** display.
- 10 Adjust the Frequency Counter ATTEN and Trigger Level to obtain a stable reading and ensure that the frequency counter reading is between 4223981 Hz and 4224019 Hz.
- 11 Select FREQUENCY OFFSET [+30PPM].
- 12 Adjust the Frequency Counter ATTEN and Trigger Level to obtain a stable reading and ensure that the frequency counter reading is between 4224107.5 Hz and 4224145.7 Hz.
- 13 Select FREQUENCY OFFSET [-30PPM].
- 14 Adjust the Frequency Counter ATTEN and Trigger Level to obtain a stable reading and ensure that the frequency counter reading is between 4223854 Hz and 4223892 Hz.

E3 (34.368Mb/s) Frequency Accuracy

- 15 Select SIGNAL [34Mb/s] PATTERN [ALL 1's] on the **TRANSMIT** display.
- 16 Adjust the Frequency Counter ATTEN and Trigger Level to obtain a stable reading and ensure that the frequency counter reading is between 17183922.7 Hz and 17184077.4 Hz.
- 17 Select FREQUENCY OFFSET [+20PPM]
- 18 Adjust the Frequency Counter ATTEN and Trigger Level to obtain a stable reading and ensure that the frequency counter reading is between 17184266 and 17184421 Hz.
- 19 Select FREQUENCY OFFSET [-20PPM]
- 20 Adjust the Frequency Counter ATTEN and Trigger Level to obtain a stable reading and ensure that the frequency counter reading is between 17183579 Hz and 17183734 Hz.

Performance Tests

PDH/DSn Internal Transmitter Clock Accuracy & Offset

- 21 Select FREQUENCY OFFSET [USER OFFSET] [+100PPM]
- 22 Adjust the Frequency Counter ATTEN and Trigger Level to obtain a stable reading and ensure that the frequency counter reading is between 17185641 Hz and 17185796 Hz.
- 23 Select FREQUENCY OFFSET [USER OFFSET] [-100PPM]
- 24 Adjust the Frequency Counter ATTEN and Trigger Level to obtain a stable reading and ensure that the frequency counter reading is between 17182205 Hz and 17182359 Hz.

NOTE

Please note if Options 012 is fitted the E4 rate is generated from the 75Ω OUT port of the E4 Clock Card which is situated next to the PDH/DSn module.

E4 (139.264 Mb/s) Frequency Accuracy

- 25 Select SIGNAL [140 Mb/s] PATTERN [ALL 1's] on the **TRANSMIT** display.
- 26 Adjust the Frequency Counter ATTEN and Trigger Level to obtain a stable reading and ensure that the frequency counter reading is between 69631686.5 Hz and 69632318.5 Hz.
- 27 Select FREQUENCY OFFSET [+15PPM].
- 28 Adjust the Frequency Counter ATTEN and Trigger Level to obtain a stable reading and ensure that the frequency counter reading is between 69632731 Hz and 69633358 Hz.
- 29 Select FREQUENCY OFFSET [-15PPM].
- 30 Adjust the Frequency Counter ATTEN and Trigger Level to obtain a stable reading and ensure that the frequency counter reading is between 69630642 Hz and 69631269 Hz.

DS1 (1.544 Mb/s) Frequency Accuracy

- 31 Connect the CLOCK OUT port of the PDH/DSn module to the Frequency Counter.
- 32 Select SIGNAL [DS1 1.5 Mb/s] on the **TRANSMIT** display.
- 33 Adjust the Frequency Counter ATTEN and Trigger Level to obtain a stable reading and ensure that the frequency counter reading is between 1543993 Hz and 1544007 Hz.
- 34 Select FREQUENCY OFFSET [+32PPM]

Performance Tests

PDH/DSn Internal Transmitter Clock Accuracy & Offset

- 35 Adjust the Frequency Counter ATTEN and Trigger Level to obtain a stable reading and ensure that the frequency counter reading is between 1544042 Hz and 1544056 Hz.
- 36 Select FREQUENCY OFFSET [-32PPM]
- 37 Adjust the Frequency Counter ATTEN and Trigger Level to obtain a stable reading and ensure that the frequency counter reading is between 1543944 Hz and 1543958 Hz.

DS3 (44.736 Mb/s) Frequency Accuracy

- 38 Connect the CLOCK OUT port of the PDH/DSn module to the Frequency Counter.
- 39 Select SIGNAL [DS3] on the **TRANSMIT** display.
- 40 Adjust the Frequency Counter ATTEN and Trigger Level to obtain a stable reading and ensure that the frequency counter reading is between 44735799 Hz and 44736201 Hz.
- 41 Select FREQUENCY OFFSET [+20PPM]
- 42 Adjust the Frequency Counter ATTEN and Trigger Level to obtain a stable reading and ensure that the frequency counter reading is between 44736693 Hz and 44737096 Hz.
- 43 Select FREQUENCY OFFSET [-20PPM]
- 44 Adjust the Frequency Counter ATTEN and Trigger Level to obtain a stable reading and ensure that the frequency counter reading is between 44734904 Hz and 44735307 Hz.
- 45 Disconnect all the test equipment.

PDH/DSn Transmitter Output

Specification

Rate	Level	Waveshape
DSX-1	2.4 V - 3.6 V	Fits mask T1.102-1993
DS1-LO	As DSX-1 with 655' ABAM Cable	
DS3-HI	0.36 V - 0.85 V	
DSX-3	560 mV pk (nominal)	Fits mask T1.102-1993
DS3-900	330 mV pk (nominal)	
E1 Balanced	3.00 V (nominal)	As per ITU rec G703
E1 Unbalanced	2.37 V (nominal)	As per ITU rec G703
E2 Unbalanced	2.37 V (nominal)	As per ITU rec G703
E3 Unbalanced	1.0 V (nominal)	As per ITU rec G703
E4 Unbalanced	1.0 V \pm 0.1 V	As per ITU rec G703

Description

This test ensures the transmitter output level and pulse shape meet the required specifications at all PDH/DSn rates. The Transmitter output is connected to an Oscilloscope and the waveshape compared with the predefined masks stored in the Oscilloscope memory. The signal levels are also measured using the Oscilloscope.

Performance Tests
PDH/DSn Transmitter Output

Equipment Required

Oscilloscope	: HP 54520A Option 001
110Ω/75Ω Balanced to Unbalanced Converter	: HP 15508B
75Ω Termination	: HP 15522-80010

Procedure

NOTE

This performance test is written using the HP 54520A Oscilloscope with Option 001 - Telecom Masks Application. If any other Oscilloscope is used the keystrokes given in this procedure will not apply. The Positive pulse masks are contained in the ROOT directory of the Telecom Mask Application Disk and the Negative pulse masks are in the INV_MASK directory.

Installing the Telecom Masks Option

- 1 Insert the Disk containing the Telecom Mask into the Oscilloscope Disk Drive.
- 2 Press SHIFT (Blue Key) DISK
- 3 Press **DIRECTORY** softkey then **ROOT DIRECTORY** softkey

139.264 Mb/s - All 1's Pulse

- 1 Recall the OmniBER's default settings as shown on page 3-4.
- 2 Set the **TRANSMIT** display as shown on following page.

Performance Tests

PDH/DSn Transmitter Output



- 3 Connect the 139Mb/s 75Ω OUT port to the Oscilloscope CHAN 1, terminate in 75Ω.
- 4 Select CHAN 1 on the Oscilloscope and set to 1 MΩ input impedance.

Load the Telecom Mask

- 5 On the Oscilloscope, use the following key sequence to select and load the required Telecom Mask:
 - a/ SHIFT (Blue Key) APPLICATION.
 - b/ **TELECOM MASK/MASK** softkey.
 - c/ Use ENTRY/MEASURE control to select 139BIN1 in the highlighted MSK FILES window.
 - d/ **LOAD SETUP 8 M1M2** softkey.

Compare Pulse with Mask

- 6 On the Oscilloscope, use the following key sequence to compare the pulse with the mask:
 - a/ RECALL 8
 - b/ DEFINE MEAS
 - c/ **COMPARE** softkey
 - d/ **TEST ON** softkey
 - e/ **M1M2** softkey
 - f/ **AFTER FAIL CONTINUE** softkey
 - g/ RUN
- 7 The Oscilloscope will automatically display and compare an isolated positive pulse with the mask limits. A PASS message should appear on the Oscilloscope.

Performance Tests

PDH/DSn Transmitter Output

NOTE

It may be necessary to visibly fit the waveform to the mask by adjusting the Oscilloscope vertical position and horizontal delay to obtain a PASS on the Mask.

- 8 Measure the peak pulse amplitude at the mid pulse-width using the Oscilloscope and verify that this is between 900 mV-1.1V Pk-Pk.

All 0's Pulse

- 9 Select PATTERN [ALL 0's] on the **TRANSMIT** display.

Load the Telecom Mask

- 10 On the Oscilloscope, use the following key sequence to select and load the required Telecom Mask:
 - a/ SHIFT (Blue Key) APPLICATION.
 - b/ **TELECOM MASK/MASK** softkey.
 - c/ Use ENTRY/MEASURE control to select 139BIN0 in the highlighted MSK FILES window.
 - d/ **LOAD SETUP 8 M1M2** softkey.

Compare Pulse with Mask

- 11 On the Oscilloscope, use the following key sequence to compare the pulse with the mask:
 - a/ RECALL 8
 - b/ DEFINE MEAS
 - c/ **COMPARE** softkey
 - d/ **TEST ON** softkey
 - e/ **M1M2** softkey
 - f/ **AFTER FAIL CONTINUE** softkey
 - g/ RUN
- 12 The Oscilloscope will automatically display and compare an isolated positive pulse with the mask limits. A PASS message should appear on the Oscilloscope.

NOTE

It may be necessary to visibly fit the waveform to the mask by adjusting the Oscilloscope vertical position and horizontal delay to obtain a PASS on the Mask.

- 13 Measure the peak pulse amplitude at the mid pulse-width using the Oscilloscope and verify that this is between 900 mV-1.1V Pk-Pk.
- 14 Select PATTERN to [ALL 0's] on the **TRANSMIT** display.

Performance Tests

PDH/DSn Transmitter Output

- 15** On the Oscilloscope, use the following key sequence to access the inverted mask.
 - a/ SHIFT (Blue Key) DISK
 - b/ **DIRECTORY** softkey
 - c/ Use ENTRY/MEASURE control to highlight INV_MASK
 - d/ **CHANGE DIRECTORY** softkey
- 16** Repeat steps 5 to 13 to check pulses against Inverted masks.

Performance Tests
PDH/DSn Transmitter Output

Procedure - 34.368 Mb/s

Positive Pulse

- 1 Recall the OmniBER's default settings as shown on page 3-4.
- 2 Set the **TRANSMIT** display as shown opposite.



- 3 Connect the PDH/DSn 75Ω OUT port to the Oscilloscope CHAN 1, terminate in 75Ω.
- 4 Select CHAN 1 on the Oscilloscope and set to 1 MΩ input impedance.

Load the Telecom Mask

- 5 On the Oscilloscope, use the following key sequence to select and load the required Telecom Mask:
 - a/ SHIFT (Blue Key) APPLICATION.
 - b/ **TELECOM MASK/MASK** softkey.
 - c/ Use ENTRY/MEASURE control to select 34MG703 in the highlighted MSK FILES window.
 - d/ **LOAD SETUP 8 M1M2** softkey.

Compare Pulse with Mask

- 6 On the Oscilloscope, use the following key sequence to compare the pulse with the mask:
 - a/ RECALL 8
 - b/ DEFINE MEAS
 - c/ **COMPARE** softkey

Performance Tests

PDH/DSn Transmitter Output

- d/ **TEST ON** softkey
- e/ **M1M2** softkey
- f/ **AFTER FAIL CONTINUE** softkey
- g/ RUN

- 7 The Oscilloscope will automatically display and compare an isolated positive pulse with the mask limits. A PASS message should appear on the Oscilloscope.

NOTE

It may be necessary to visibly fit the waveform to the mask by adjusting the Oscilloscope vertical position and horizontal delay to obtain a PASS on the Mask.

- 8 Measure the peak pulse amplitude at the mid pulse-width using the Oscilloscope and verify that this is approximately 1.0 Volt.

Negative Pulse

- 9 On the Oscilloscope, use the following key sequence to access the inverted mask.
- a/ SHIFT (Blue Key) DISK
 - b/ **DIRECTORY** softkey
 - c/ Use ENTRY/MEASURE control to highlight INV_MASK
 - d/ **CHANGE DIRECTORY** softkey

Load the Telecom Mask

- 10 On the Oscilloscope, use the following key sequence to select and load the required Telecom Mask:
- a/ SHIFT (Blue Key) APPLICATION.
 - b/ **TELECOM MASK/MASK** softkey.
 - c/ Use ENTRY/MEASURE control to select 34MG703 in the highlighted MSK FILES window.
 - d/ **LOAD SETUP 8 M1M2** softkey.

Compare Pulse with Mask

- 11 On the Oscilloscope, use the following key sequence to compare the pulse with the mask:
- a/ RECALL 8
 - b/ DEFINE MEAS
 - c/ **COMPARE** softkey
 - d/ **TEST ON** softkey
 - e/ **M1M2** softkey
 - f/ **AFTER FAIL CONTINUE** softkey
 - g/ RUN

Performance Tests

PDH/DSn Transmitter Output

- 12 The Oscilloscope will automatically display and compare an isolated positive pulse with the mask limits. A PASS message should appear on the Oscilloscope

NOTE

It may be necessary to visibly fit the waveform to the mask by adjusting the Oscilloscope vertical position and horizontal delay to obtain a PASS on the Mask.

- 13 Measure the peak pulse amplitude at the mid pulse-width using the Oscilloscope and verify that this is approximately 1.0 Volt.

Procedure - 8.448 Mb/s

Positive Pulse

- 1 Recall the OmniBER's default settings as shown on page 3-4.
- 2 Set the **TRANSMIT** display as shown below.



- 3 Connect the PDH/DSn 75Ω OUT port to the Oscilloscope CHAN 1, terminate in 75Ω.
- 4 Select CHAN 1 on the Oscilloscope and set to 1 MΩ input impedance.

Load the Telecom Mask

- 5 On the Oscilloscope, use the following key sequence to select and load the required Telecom Mask:
 - a/ SHIFT (Blue Key) APPLICATION.
 - b/ **TELECOM MASK/MASK** softkey.

Performance Tests

PDH/DSn Transmitter Output

- c/ Use ENTRY/MEASURE control to select 8MG703 in the highlighted MSK FILES window.
- d/ **LOAD SETUP 8 M1M2** softkey.

Compare Pulse with Mask

- 6 On the Oscilloscope, use the following key sequence to compare the pulse with the mask:
 - a/ RECALL 8
 - b/ DEFINE MEAS
 - c/ **COMPARE** softkey
 - d/ **TEST ON** softkey
 - e/ **M1M2** softkey
 - f/ **AFTER FAIL CONTINUE** softkey
 - g/ RUN
- 7 The Oscilloscope will automatically display and compare an isolated positive pulse with the mask limits. A PASS message should appear on the Oscilloscope.

NOTE

It may be necessary to visibly fit the waveform to the mask by adjusting the Oscilloscope vertical position and horizontal delay to obtain a PASS on the Mask.

- 8 Measure the peak pulse amplitude at the mid pulse-width using the Oscilloscope and verify that this is approximately 2.37 Volts.

Negative Pulse

- 9 On the Oscilloscope, use the following key sequence to access the inverted mask.
 - a/ SHIFT (Blue Key) DISK
 - b/ **DIRECTORY** softkey
 - c/ Use ENTRY/MEASURE control to highlight INV_MASK
 - d/ **CHANGE DIRECTORY** softkey

Load the Telecom Mask

- 10 On the Oscilloscope, use the following key sequence to select and load the required Telecom Mask:
 - a/ SHIFT (Blue Key) APPLICATION.
 - b/ **TELECOM MASK/MASK** softkey.
 - c/ Use ENTRY/MEASURE control to select 8MG703 in the highlighted MSK FILES window.
 - d/ **LOAD SETUP 8 M1M2** softkey.

Performance Tests

PDH/DSn Transmitter Output

Compare Pulse with Mask

- 11 On the Oscilloscope, use the following key sequence to compare the pulse with the mask:
 - a/ RECALL 8
 - b/ DEFINE MEAS
 - c/ **COMPARE** softkey
 - d/ **TEST ON** softkey
 - e/ **M1M2** softkey
 - f/ **AFTER FAIL CONTINUE** softkey
 - g/ RUN

The Oscilloscope will automatically display and compare an isolated positive pulse with the mask limits. A PASS message should appear on the Oscilloscope

NOTE

It may be necessary to visibly fit the waveform to the mask by adjusting the Oscilloscope vertical position and horizontal delay to obtain a PASS on the Mask.

- 12 Measure the peak pulse amplitude at the mid pulse-width using the Oscilloscope and verify that this is approximately 2.37 Volts.

Procedure - 2.048 Mb/s

Positive Pulse

- 1 Recall the OmniBER's default settings as shown on page 3-4.
- 2 Set the **TRANSMIT** display as shown below.



Performance Tests

PDH/DSn Transmitter Output

- 3 Connect the PDH/DSn 75Ω OUT port to the Oscilloscope CHAN 1, terminate in 75Ω.
- 4 Select CHAN 1 on the Oscilloscope and set to 1 MΩ input impedance.

Load the Telecom Mask

- 5 On the Oscilloscope, use the following key sequence to select and load the required Telecom Mask:
 - a/ SHIFT (Blue Key) APPLICATION.
 - b/ **TELECOM MASK/MASK** softkey.
 - c/ Use ENTRY/MEASURE control to select DS_1E in the highlighted MSK FILES window.
 - d/ **LOAD SETUP 8 M1M2** softkey.

Compare Pulse with Mask

- 6 On the Oscilloscope, use the following key sequence to compare the pulse with the mask:
 - a/ RECALL 8
 - b/ DEFINE MEAS
 - c/ **COMPARE** softkey
 - d/ **TEST ON** softkey
 - e/ **M1M2** softkey
 - f/ **AFTER FAIL CONTINUE** softkey
 - g/ RUN
- 7 The Oscilloscope will automatically display and compare an isolated positive pulse with the mask limits. A PASS message should appear on the Oscilloscope.

NOTE

It may be necessary to visibly fit the waveform to the mask by adjusting the Oscilloscope vertical position and horizontal delay to obtain a PASS on the Mask.

- 8 Measure the peak pulse amplitude at the mid pulse-width using the Oscilloscope and verify that this is approximately 2.37 Volts.

Negative Pulse

- 9 On the Oscilloscope, use the following key sequence to access the inverted mask.
 - a/ SHIFT (Blue Key) DISK
 - b/ **DIRECTORY** softkey
 - c/ Use ENTRY/MEASURE control to highlight INV_MASK

Performance Tests
PDH/DSn Transmitter Output

d/ **CHANGE DIRECTORY** softkey

Load the Telecom Mask

- 10** On the Oscilloscope, use the following key sequence to select and load the required Telecom Mask:
- a/ SHIFT (Blue Key) APPLICATION.
 - b/ **TELECOM MASK/MASK** softkey.
 - c/ Use ENTRY/MEASURE control to select DS_1E in the highlighted MSK FILES window.
 - d/ **LOAD SETUP 8 M1M2** softkey.

Compare Pulse with Mask

- 11** On the Oscilloscope, use the following key sequence to compare the pulse with the mask:
- a/ RECALL 8
 - b/ DEFINE MEAS
 - c/ **COMPARE** softkey
 - d/ **TEST ON** softkey
 - e/ **M1M2** softkey
 - f/ **AFTER FAIL CONTINUE** softkey
 - g/ RUN
- 12** The Oscilloscope will automatically display and compare an isolated positive pulse with the mask limits. A PASS message should appear on the Oscilloscope.

NOTE

It may be necessary to visibly fit the waveform to the mask by adjusting the Oscilloscope vertical position and horizontal delay to obtain a PASS on the Mask.

- 13** Measure the peak pulse amplitude at the mid pulse-width using the Oscilloscope and verify that this is approximately 2.37 Volts.

Procedure - DSX-3

Positive Pulse

- 1** Recall the OmniBER's default settings as shown on page 3-4.
- 2** Set the **TRANSMIT** display as shown on following page.

Performance Tests

PDH/DSn Transmitter Output



- 3 Connect the PDH/DSn 75Ω OUT port to the Oscilloscope CHAN 1, terminate in 75Ω.
- 4 Select CHAN 1 on the Oscilloscope and set to 1 MΩ input impedance.

Load the Telecom Mask

- 5 On the Oscilloscope, use the following key sequence to select and load the required Telecom Mask:
 - a/ SHIFT (Blue Key) APPLICATION.
 - b/ **TELECOM MASK/MASK** softkey.
 - c/ Use ENTRY/MEASURE control to select DS3_92 in the highlighted MSK FILES window.
 - d/ **LOAD SETUP 8 M1M2** softkey.

Compare Pulse with Mask

- 6 On the Oscilloscope, use the following key sequence to compare the pulse with the mask:
 - a/ RECALL 8
 - b/ DEFINE MEAS
 - c/ **COMPARE** softkey
 - d/ **TEST ON** softkey
 - e/ **M1M2** softkey
 - f/ **AFTER FAIL CONTINUE** softkey
 - g/ RUN

Performance Tests

PDH/DSn Transmitter Output

- 7 The Oscilloscope will automatically display and compare an isolated positive pulse with the mask limits. A PASS message should appear on the Oscilloscope.

NOTE

It may be necessary to select **MASK** softkey and **MASK AUTO** / **MASK ALIGN** or visibly fit the waveform to the mask by adjusting the Oscilloscope vertical gain/ position and horizontal delay to obtain a PASS on the Mask.

- 8 Measure the peak pulse amplitude at the mid pulse-width using the Oscilloscope and verify that this is between 360 mV and 850 mV.

Negative Pulse

- 9 On the Oscilloscope, use the following key sequence to access the inverted mask.
 - a/ SHIFT (Blue Key) DISK
 - b/ **DIRECTORY** softkey
 - c/ Use ENTRY/MEASURE control to highlight INV_MASK
 - d/ **CHANGE DIRECTORY** softkey

Load the Telecom Mask

- 10 On the Oscilloscope, use the following key sequence to select and load the required Telecom Mask:
 - a/ SHIFT (Blue Key) APPLICATION.
 - b/ **TELECOM MASK/MASK** softkey.
 - c/ Use ENTRY/MEASURE control to select DS3_92 in the highlighted MSK FILES window.
 - d/ **LOAD SETUP 8 M1M2** softkey.

Compare Pulse with Mask

- 11 On the Oscilloscope, use the following key sequence to compare the pulse with the mask:
 - a/ RECALL 8
 - b/ DEFINE MEAS
 - c/ **COMPARE** softkey
 - d/ **TEST ON** softkey
 - e/ **M1M2** softkey
 - f/ **AFTER FAIL CONTINUE** softkey
 - g/ RUN
- 12 The Oscilloscope will automatically display and compare an isolated positive pulse with the mask limits. A PASS message should appear on the Oscilloscope.

Performance Tests

PDH/DSn Transmitter Output

NOTE

It may be necessary to select **MASK** and **MASK AUTO / MASK ALIGN** to visibly fit the waveform to the mask by adjusting the Oscilloscope vertical gain/position and horizontal delay to obtain a PASS on the Mask.

- 13 Measure the peak pulse amplitude at the mid pulse-width using the Oscilloscope and verify that this is between 360 mV and 850 mV.
- 14 Set the **TRANSMIT** signal to HIGH and check that the peak pulse amplitude is approximately 0.9V.
- 15 Set the **TRANSMIT** signal to LOW and check that the peak pulse amplitude is approximately 0.3V.

Procedure - DSX-1

Positive Pulse

- 1 Recall the OmniBER's default settings as shown on page 3-4.
- 2 Connect the DSn 100 Ω OUT port to the Oscilloscope via the HP 15508B Balanced to unbalanced Converter and terminate in 75 Ω at the Oscilloscope input.
- 3 Select the Transmitter Output page.
- 4 Set the **TRANSMIT** display as shown below.



- 5 Select CHAN 1 on the Oscilloscope and set to 1 M Ω input impedance.

PDH/DSn Transmitter Output

Load the Telecom Mask

- 6 On the Oscilloscope, use the following key sequence to select and load the required Telecom Mask:
 - a/ SHIFT (Blue Key) APPLICATION.
 - b/ **TELECOM MASK/MASK** softkey.
 - c/ Use ENTRY/MEASURE control to select DS1_NEW in the highlighted MSK FILES window.
 - d/ **LOAD SETUP 8 M1M2** softkey.

Compare Pulse with Mask

- 7 On the Oscilloscope, use the following key sequence to compare the pulse with the mask:
 - a/ RECALL 8, (Ensure CH1 Impedance is reset to 1 M Ω . Select TRIGGER, SETUP and set **PATTERN TRIGGER** softkey to **Trig'd**).
 - b/ DEFINE MEAS
 - c/ **COMPARE** softkey
 - d/ **TEST ON** softkey
 - e/ **M1M2** softkey
 - f/ **AFTER FAIL CONTINUE** softkey
 - g/ RUN

NOTE

Using the balanced to unbalanced converter reduces the pulse amplitude by a factor of 1.266. This will cause the comparison with the mask to fail. To overcome this select CHAN 1 ON and reduce the Volts/Division setting (highlighted on the softkey display). Reduced Volts/Division = highlighted value/1.266. The new value can be entered using the keypad

- 8 The Oscilloscope will compare the positive pulse with the mask limits. A PASS message should appear on the Oscilloscope.

NOTE

It may be necessary to visibly fit the waveform to the mask by adjusting the Oscilloscope vertical position and horizontal delay to obtain a PASS on the Mask.

- 9 Measure the peak pulse amplitude at the mid pulse-width using the Oscilloscope and verify that this is between 1.896V and 2.844V.

Negative Pulse

- 10 On the Oscilloscope, use the following key sequence to access the inverted mask.
 - a/ SHIFT (Blue Key) DISK

Performance Tests

PDH/DSn Transmitter Output

- b/ **DIRECTORY** softkey
- c/ Use ENTRY/MEASURE control to highlight INV_MASK
- d/ **CHANGE DIRECTORY** softkey

Load the Telecom Mask

- 11** On the Oscilloscope, use the following key sequence to select and load the required Telecom Mask:
- a/ SHIFT (Blue Key) APPLICATION.
 - b/ **TELECOM MASK/MASK** softkey.
 - c/ Use ENTRY/MEASURE control to select DS1_NEW in the highlighted MSK FILES window.
 - d/ **LOAD SETUP 8 M1M2** softkey.

Compare Pulse with Mask

- 12** On the Oscilloscope, use the following key sequence to compare the pulse with the mask:
- a/ RECALL 8, (Ensure CH1 Impedance is reset to 1 M Ω . Select TRIGGER, SETUP and set **PATTERN TRIGGER** softkey to **Trig'd**).
 - b/ DEFINE MEAS

- c/ **COMPARE** softkey
- d/ **TEST ON** softkey
- e/ **M1M2** softkey
- f/ **AFTER FAIL CONTINUE** softkey
- g/ RUN

NOTE

Using the balanced to unbalanced converter reduces the pulse amplitude by a factor of 1.266. This will cause the comparison with the mask to fail. To overcome this select CHAN 1 ON and reduce the Volts/Division setting (highlighted on the softkey display). Reduced Volts/Division = highlighted value/1.266. The new value can be entered using the keypad

- 13** The Oscilloscope will compare the negative pulse with the mask limits. A PASS message should appear on the Oscilloscope.

NOTE

It may be necessary to visibly fit the waveform to the mask by adjusting the Oscilloscope vertical position and horizontal delay to obtain a PASS on the Mask.

- 14** Measure the peak pulse amplitude at the mid pulse-width using the Oscilloscope
-

Performance Tests

PDH/DSn Transmitter Output

and verify that this is between 1.896V and 2.844V.

- 15 Set the **TRANSMIT** signal to LOW and check that the peak pulse amplitude reduces by approximately 20% and pulse shape has slower rise/fall edges.
- 16 Disconnect all the test equipment.

PDH/DSn Receiver Equalization

Specifications

Data Rate/Connector Interface	Maximum cable loss or length
E1- 2.048 Mb/s Bal	6 dB loss @ 1/2 data rate for \sqrt{f} cable.
E1- 2.048 Mb/s Un-Bal	6 dB loss @ 1/2 data rate for \sqrt{f} cable.
E2 - 8.448 Mb/s	6 dB loss @ 1/2 data rate for \sqrt{f} cable.
E3 - 34.368 Mb/s	12 dB loss @ 1/2 data rate for \sqrt{f} cable.
E4 - 139.264 Mb/s	12 dB loss @ 1/2 data rate for \sqrt{f} cable.
DS1- 1.544 Mb/s	655 feet length of ABAM cable, with DSX -1
DS3 - 44.736 Mb/s	900 feet length of \sqrt{f} cable, with DS3-HI.

Description

The Receiver Equalization is checked by looping the transmitter output to receiver input through a special Cable. This simulates the specified cable loss at the rate under test. A BER measurement is run and a check made for no errors in the results page.

Equipment Required

Cable Simulator E4	: 80 metres of 8120-0049
Cable Simulator E3	: 120 metres of 8120-0049
Cable Simulator E2	: 80 metres of 8120-0049
Cable Simulator E1	: 120 metres of 8120-0049
Cable Simulator DS3	: 55 metres of 8120-0049
Cable Simulator DS1	: 80 metres of 8120-0049
110Ω/75Ω Balanced to Unbalanced Converter	: HP 15508B (Qty 2)

Performance Tests

PDH/DSn Receiver Equalization

Procedure

- 1 Recall the OmniBER's default settings as shown on page 3-4.
- 2 Select **SETTINGS CONTROL** TRANSMITTER and RECEIVER [COUPLED] on the **OTHER** display.

139.264 Mb/s

- 3 Set the **TRANSMIT** display as shown below.



- 4 Connect Cable Simulator E4 between the 139 Mb/s 75Ω OUT and 75Ω IN ports.
- 5 Press **RESULTS** **TROUBLE** **SCAN** then **RUN/STOP** to start the measurement.
- 6 Ensure that NO TROUBLE is displayed on the **RESULTS** display after 30 seconds.
- 7 Press **RUN/STOP** to stop the measurement.

Performance Tests
PDH/DSn Receiver Equalization

34.368 Mb/s

- 8 Set the **TRANSMIT** display as shown below



- 9 Connect Cable Simulator E3 between PDH/DSn 75Ω OUT and 75Ω IN ports.
- 10 Press **RESULTS** **TROUBLE** **SCAN** then **RUN/STOP** to start the measurement.
- 11 Ensure that NO TROUBLE is displayed on the **RESULTS** display after 30 seconds.
- 12 Press **RUN/STOP** to stop the measurement.

Performance Tests

PDH/DSn Receiver Equalization

DS3 (44.736 Mb/s)

13 Set the **TRANSMIT** display as shown below.



14 Connect Cable Simulator DS3 between the DSn 75Ω OUT and 75Ω IN ports.

15 Press **RESULTS** **TROUBLE** **SCAN** then **RUN/STOP** to start the measurement.

16 Ensure that NO TROUBLE is displayed on the **RESULTS** display after 30 seconds.

17 Press **RUN/STOP** to stop the measurement.

NOTE

If Cable Simulator DS3 is not available, it is permissible to select DS3-900' on the **TRANSMIT** display and connect the OmniBER's 75Ω OUT port direct to the 75Ω IN port. This setup assumes the DS3-900' output signal is within specification.

Performance Tests
PDH/DSn Receiver Equalization

8.448 Mb/s

18 Set the **TRANSMIT** display as shown below.



19 Connect Cable Simulator E2 between the PDH/DSn 75Ω OUT and 75Ω IN ports.

20 Press **RESULTS** **TROUBLE** **SCAN** then **RUN/STOP** to start the measurement.

21 Ensure that NO TROUBLE is displayed on the **RESULTS** display after 30 seconds.

22 Press **RUN/STOP** to stop the measurement.

Performance Tests

PDH/DSn Receiver Equalization

2.048 Mb/s

23 Set the **TRANSMIT** display as shown below.



24 Connect Cable Simulator E1 between the PDH/DSn 75Ω OUT and 75Ω IN ports.

25 Press **RESULTS** **TROUBLE** **SCAN** then **RUN/STOP** to start the measurement.

26 Ensure that NO TROUBLE is displayed on the **RESULTS** display after 30 seconds.

27 Press **RUN/STOP** to stop the measurement.

Performance Tests

PDH/DSn Receiver Equalization

DS1 (1.544 Mb/s)

28 Set the **TRANSMIT** display as shown below.



29 Connect Cable Simulator DS1 between the 110Ω OUT and 110Ω IN ports via two Balanced to Unbalanced Converters (HP 15508B).

30 Press **RESULTS** **TROUBLE** **SCAN** then **RUN/STOP** to start the measurement.

31 Ensure that NO TROUBLE is displayed on the **RESULTS** display after 30 seconds.

32 Press **RUN/STOP** to stop the measurement.

NOTE

If Cable Simulator DS1 is not available, it is permissible to select DS1-LO on the **TRANSMIT** display and connect the 110Ω OUT port direct to the 110Ω IN port. This setup assumes the DS1-LO output signal is within specification.

PDH/DSn Receiver Monitor Levels

Specifications

Data Rate/Connector Interface	Nominal Loss (dB) c.f. Terminate level	Maximum equivalent cable loss
E1 - 2.048 Mb/s Bal	20, 26, 30	6 dB loss @ 1/2 data rate for \sqrt{f} cable. 3dB loss @ 1/2 data rate for \sqrt{f} cable.
E1 - 2.048 Mb/s Un-Bal	20, 26,30	6 dB loss @ 1/2 data rate for \sqrt{f} cable.
E2 - 8.448 Mb/s	20, 26,	6 dB loss @ 1/2 data rate for \sqrt{f} cable.
E3 - 34.368 Mb/s	20, 26	12 dB loss @ 1/2 data rate for \sqrt{f} cable.
E4 - 139.264 Mb/s	20, 26	12 dB loss @ 1/2 data rate for \sqrt{f} cable.
DS1 - 1.544 Mb/s	20, 26, 30	DSX-1 plus 655 feet of ABAM cable DSX-1
DS3 - 44.736 Mb/s	20, 26	900 feet length of \sqrt{f} cable, with DS3-HI.

Description

The signal from the PDH Transmitter is applied to the PDH Receiver after attenuating by an amount equal to the selected Receiver Flat Loss plus the specified Cable Loss. The Flat Loss is obtained from a 75 Ω attenuator kit. The Cable Loss is supplied by inserting the correct Cable Simulators for each bit rate in the attenuation path.

Equipment Required

Cable Simulator E4-M : 40 metres of 8120-0049
Cable Simulator E3-M : 60 metres of 8120-0049
Cable Simulator E2-M : 40 metres of 8120-0049

Performance Tests

PDH/DSn Receiver Monitor Levels

Cable Simulator E1-M	: 60 metres of 8120-0049
Cable Simulator DS3	: 55 metres of 8120-0049
Cable Simulator DS1	: 80 metres of 8120-0049
75Ω Attenuator Kit	: HP 86213A
Type N/BNC adaptors	: HP 1250-1534 & -1528 (2 off each)

Procedure

- 1 Recall the OmniBER's default settings as shown on page 3-4.
- 2 Connect the equipment as shown in Figure 3-1.

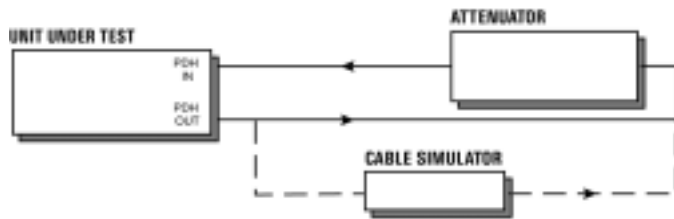

Figure 3-1

Receiver Monitor Input Test Setup

2.048 Mb/s (E1)

- 1 Press **TRANSMIT** and set up the **MAIN SETTINGS** display as shown on following page.

Performance Tests
PDH/DSn Receiver Monitor Levels



- 2 Press **RECEIVE** and set up the **MAIN SETTINGS** display as shown below.

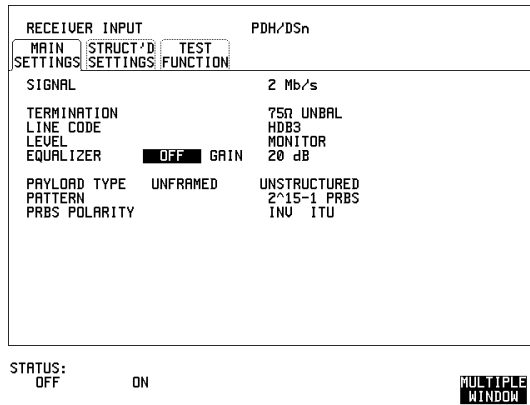

- 3 Press **RESULTS TROUBLE SCAN**
- 4 Press **RUN/STOP** to start the measurement.
- 5 Ensure that NO TROUBLE is displayed on the **RESULTS** display after 30 seconds.
- 6 Press **RUN/STOP** to stop the measurement.
- 7 Press **RECEIVE** and select EQUALIZATION [ON] GAIN [20 dB].
- 8 Connect Cable Simulator E1-M between the PDH OUT Port and the 20dB attenuator.

Performance Tests

PDH/DSn Receiver Monitor Levels

- 9 Press **[RESULTS]** **TROUBLE SCAN** then **[RUN/STOP]** to start the measurement.
- 10 Ensure that NO TROUBLE is displayed on the **[RESULTS]** display after 30 seconds. Press **[RUN/STOP]** to stop the measurement.
- 11 Connect the 6 dB Fixed Attenuator in the signal path to give a total path attenuation of 26 dB.
- 12 Press **[RECEIVE]** and select GAIN to [26 dB].
- 13 Press **[RESULTS]**; **TROUBLE SCAN** then **[RUN/STOP]** to start the measurement.
- 14 Ensure that NO TROUBLE is displayed on the **[RESULTS]** display after 30 seconds. Press **[RUN/STOP]** to stop the measurement.
- 15 Remove Cable Simulator E1-M from the signal path.
- 16 Press **[RECEIVE]** and select EQUALIZATION [OFF].
- 17 Press **[RESULTS]**; **TROUBLE SCAN** then **[RUN/STOP]** to start the measurement.
- 18 Ensure that NO TROUBLE is displayed on the **[RESULTS]** display after 30 seconds. Press **[RUN/STOP]** to stop the measurement.
- 19 Remove the 6 dB fixed attenuator and connect the 10 dB Fixed Attenuator in the signal path to give a total path attenuation of 30 dB.
- 20 Press **[RECEIVE]** and set GAIN to [30 dB].
- 21 Press **[RESULTS]** **TROUBLE SCAN** then **[RUN/STOP]** to start the measurement.
- 22 Ensure that NO TROUBLE is displayed on the **[RESULTS]** display after 30 seconds. Press **[RUN/STOP]** to stop the measurement.
- 23 Press **[RECEIVE]** and select EQUALIZATION [ON].
- 24 Connect Cable Simulator E1-M between the PDH OUT Port and the attenuator.
- 25 Press **[RESULTS]** **TROUBLE SCAN** . Press **[RUN/STOP]** to start the measurement.
- 26 Ensure that NO TROUBLE is displayed on the **[RESULTS]** display after 30 seconds. Press **[RUN/STOP]** to stop the measurement.

Performance Tests

PDH/DSn Receiver Monitor Levels

8.448 Mb/s (E2)

- 27** Repeat steps 1 to 26 (20 dB, 26 dB and 30 dB tests) with the OmniBER's **TRANSMIT** and **RECEIVE** displays set to SIGNAL [8 Mb/s] and Cable Simulator E2-M fitted in place of Cable Simulator E1-M.

34.368 Mb/s (E3)

- 28** Repeat steps 1 to 18 (20 dB and 26 dB tests) with the OmniBER's **TRANSMIT** and **RECEIVE** displays set to SIGNAL [34 Mb/s] and Cable Simulator E3-M fitted in place of Cable Simulator E1-M.

139.264 Mb/s (E4)

- 29** Repeat steps 1 to 18 (20 dB and 26 dB tests) with the OmniBER's **TRANSMIT** and **RECEIVE** displays set to SIGNAL [140 Mb/s] and Cable Simulator E4-M fitted in place of Cable Simulator E1-M.

1.544 Mb/s (DS-1)

- 30** Repeat steps 1 to 26 (20 dB, 26 dB and 30 dB tests) with the OmniBER's **TRANSMIT** and **RECEIVE** displays set to SIGNAL [DSX-1]. Connect Cable Simulator DS1 between two Balanced to Unbalanced converters and fit in place of Cable Simulator E1-M.

44.736 Mb/s (DS-3)

- 31** Repeat steps 1 to 18 (20 dB and 26 dB tests) with the OmniBER's **TRANSMIT** and **RECEIVE** displays set to SIGNAL [DSX-3] and Cable Simulator DS3 fitted in place of Cable Simulator E1-M.
- 32** Disconnect all the test equipment.

External Mux/Demux

Specifications

Rate	Interface	Source
2.048 Mb/s (E1)	Nominally meets ITU-T Rec. G.703 for unbalanced coaxial pair.	Accepts a 2 Mb/s Unbalanced signal conforming to ITU-T Rec. G.703.
1.544 Mb/s (DS-1)	Nominally meets T1.102-1993 for Balanced pair.	Accepts a DS-1 balanced signal conforming to T1.102-1993.

Description

This test verifies operation of the PDH/DSn mux and demux hardware and confirms the output characteristics of the external demux port on the PDH/DSn Receiver. The *PDH/DSn Test Set* is set up to transmit an unframed 2 Mb/s/DS-1 pattern. This is applied to the OmniBER's INSERT Port. The 2 Mb/s/DS-1 signal is multiplexed into a 34 Mb/s/DS-3 data stream. The OmniBER's transmitter and receiver are looped. The unframed 2 Mb/s/DS-1 signal is demultiplexed from the 34 Mb/s/DS-3 data stream and sent to the *PDH/DSn Test Set* via the OmniBER's DROP port. A BER test is performed to verify the integrity of the 2 Mb/s/DS-1 signal. The output from the DROP Port is then applied to an Oscilloscope, and the waveform characteristics are checked to ensure they meet specifications.

Equipment Required

Oscilloscope : HP 54520A Option 001
PDH Test Set : OmniBER
75 Ω Termination : HP 15522-80010
T Connector : HP 1250-0781

NOTE

The *Test Set* used in this procedure is the OmniBER. Any other PDH Test Set, capable of generating and measuring at 2 Mb/s/DS-1 unframed, can be used.

Performance Tests
External Mux/Demux

Procedure

2 Mb/s Mux/Demux

- 1 Recall the OmniBER's default settings as shown on page 3-4.
- 2 Connect the equipment as shown in Figure 3-2.

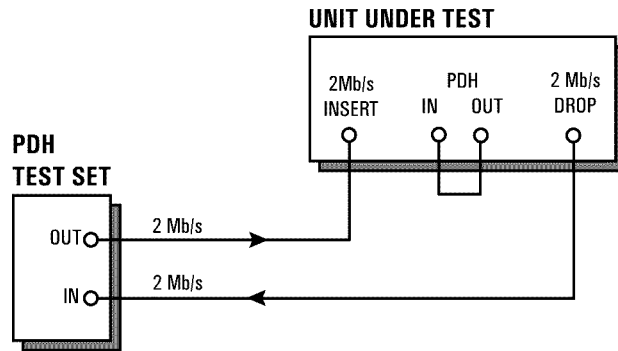
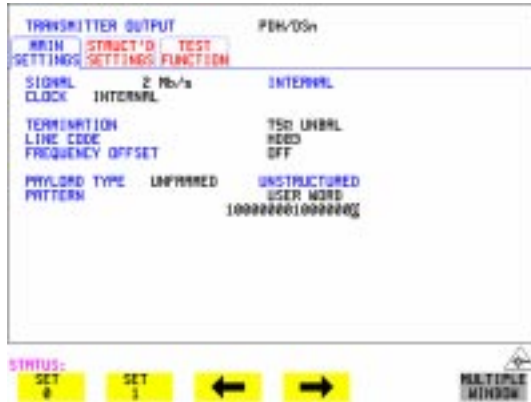

Figure 3-2 External Mux/Demux Test Setup

Performance Tests
External Mux/Demux

- 3 Press **TRANSMIT** on the *Test Set* and set up the display as shown below.



- 4 Press **RECEIVE** on the *Test Set* and set up the display as shown below.

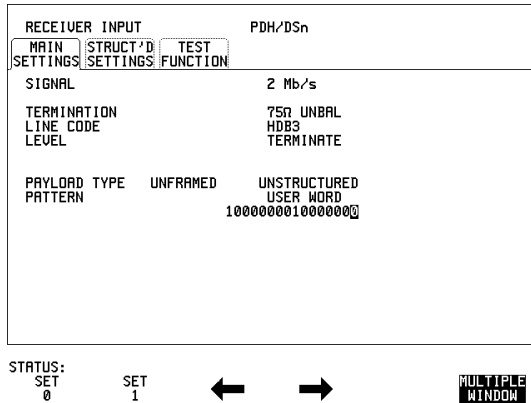

Performance Tests
External Mux/Demux

- 5 Press **TRANSMIT** on the OmniBER and set up the **MAIN SETTINGS** display as shown below.



- 6 Press **TRANSMIT** on the OmniBER and set up the **STRUCTURED SETTINGS** display as shown below.

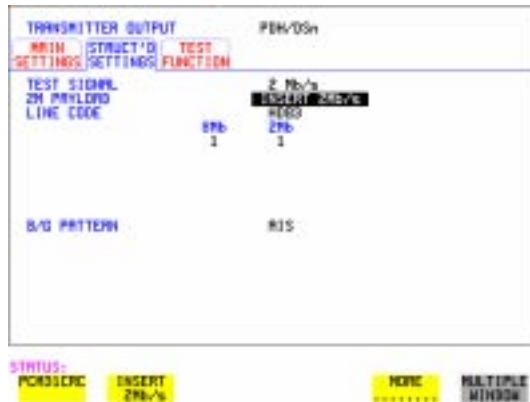

Performance Tests

External Mux/Demux

- 7 Press **RECEIVE** on the OmniBER and set up the **MAIN SETTINGS** display as shown below.

RECEIVER INPUT		PDH/DSn
MAIN SETTINGS	STRUCT'D SETTINGS	TEST FUNCTION
SIGNAL		34 Mb/s
TERMINATION		75Ω UNBAL
LINE CODE		HDB3
LEVEL		TERMINATE
PAYLOAD TYPE	FRAMED	STRUCTURED
TO SET TEST SIGNAL, FIRST SELECT THE 'STRUCT'D SETTINGS' FOLDER ABOVE		

STATUS:

MULTIPLE WINDOW

- 8 Press **RECEIVE** on the OmniBER and set up the **STRUCTURED SETTINGS** display as shown below.

RECEIVER INPUT		PDH/DSn
MAIN SETTINGS	STRUCT'D SETTINGS	TEST FUNCTION
TEST SIGNAL		2 Mb/s
2M PAYLOAD		DROP 2Mb/s
LINE CODE		HDB3
	8Mb	2Mb
	1	1

STATUS:

UNFRAMED PCM30 PCM31 PCM30CRC MORE **MULTIPLE WINDOW**

- 9 Press **RUN/STOP** on the Test Set. Press **RESULTS TROUBLE SCAN** on the Test Set and ensure that NO TROUBLE is displayed.
- 10 Press SINGLE error add key on the Test Set and ensure the Bit Error count increments by one each time the key is pressed.

Performance Tests
External Mux/Demux

2.048 Mb/s Positive Pulse

- 11 Disconnect the UUT 75Ω DROP port from the Test Set and connect to the Oscilloscope. Terminate in 75Ω at the Oscilloscope input.
- 12 Select CHAN 1 on the Oscilloscope and set to 1 MΩ input impedance.

Load the Telecom Mask

- 13 On the Oscilloscope, use the following key sequence to select and load the required Telecom Mask:
 - a/ SHIFT (Blue Key) APPLICATION.
 - b/ **TELECOM MASK/MASK** softkey.
 - c/ Use ENTRY/MEASURE control to select DS_1E in the highlighted MSK FILES window.
 - d/ **LOAD SETUP 8 M1M2** softkey.

Compare Pulse with Mask

- 14 On the Oscilloscope, use the following key sequence to compare the pulse with the mask:
 - a/ RECALL 8
 - b/ DEFINE MEAS
 - c/ **COMPARE** softkey
 - d/ **TEST ON** softkey
 - e/ **M1M2** softkey
 - f/ **AFTER FAIL CONTINUE** softkey
 - g/ RUN
- 15 The Oscilloscope will automatically display and compare an isolated positive pulse with the mask limits. A PASS message should appear on the Oscilloscope.

NOTE

It may be necessary to visibly fit the waveform to the mask by adjusting the Oscilloscope vertical position and horizontal delay to obtain a PASS on the Mask.

- 16 Measure the peak pulse amplitude at the mid pulse-width using the Oscilloscope and verify that this is approximately 2.37 Volts.

2.048 Mb/s Negative Pulse

- 17 On the Oscilloscope, use the following key sequence to access the inverted mask.
 - a/ SHIFT (Blue Key) DISK
 - b/ **DIRECTORY** softkey
 - c/ Use ENTRY/MEASURE control to highlight INV_MASK
 - d/ **CHANGE DIRECTORY** softkey

Performance Tests

External Mux/Demux

Load the Telecom Mask

- 18** On the Oscilloscope, use the following key sequence to select and load the required Telecom Mask:
- a/ SHIFT (Blue Key) APPLICATION.
 - b/ **TELECOM MASK/MASK** softkey.
 - c/ Use ENTRY/MEASURE control to select DS_1E in the highlighted MSK FILES window.
 - d/ **LOAD SETUP 8 M1M2** softkey.

Compare Pulse with Mask

- 19** On the Oscilloscope, use the following key sequence to compare the pulse with the mask:
- a/ RECALL 8
 - b/ DEFINE MEAS
 - c/ **COMPARE** softkey
 - d/ **TEST ON** softkey
 - e/ **M1M2** softkey
 - f/ **AFTER FAIL CONTINUE** softkey
 - g/ RUN
- 20** The Oscilloscope will automatically display and compare an isolated positive pulse with the mask limits. A PASS message should appear on the Oscilloscope.

NOTE

It may be necessary to visibly fit the waveform to the mask by adjusting the Oscilloscope vertical position and horizontal delay to obtain a PASS on the Mask.

- 21** Measure the peak pulse amplitude at the mid pulse-width using the Oscilloscope and verify that this is approximately 2.37 Volts.

DS-1 Mux and Demux

- 1** Connect the UUT balanced DS-1 Insert and Drop ports to the DS-1 Balanced Ports of the Test Set and repeat steps 3 through 10 substituting DS-1 for 2 Mb/s and DS-3 for 34 Mb/s.

DS-1 Positive Pulse

- 2** Disconnect the UUT 100 Ω DROP port from the Test Set and connect to the Oscilloscope via the HP 15508B Balanced to unbalanced Converter. Terminate in 75 Ω at the Oscilloscope input.
- 3** Select CHAN 1 on the Oscilloscope and set to 1 M Ω input impedance.

Performance Tests

External Mux/Demux

Load the Telecom Mask

- 4 On the Oscilloscope, use the following key sequence to select and load the required Telecom Mask:
 - a/ SHIFT (Blue Key) APPLICATION.
 - b/ **TELECOM MASK/MASK** softkey.
 - c/ Use ENTRY/MEASURE control to select DS1_NEW in the highlighted MSK FILES window.
 - d/ **LOAD SETUP 8 M1M2** softkey.

Compare Pulse with Mask

- 5 On the Oscilloscope, use the following key sequence to compare the pulse with the mask:
 - a/ RECALL 8, (Ensure CH1 Impedance is reset to 1 M Ω . Select TRIGGER, SETUP and set **PATTERN TRIGGER** softkey to **Trig'd**).
 - b/ DEFINE MEAS
 - c/ **COMPARE** softkey
 - d/ **TEST ON** softkey
 - e/ **M1M2** softkey
 - f/ **AFTER FAIL CONTINUE** softkey
 - g/ RUN

NOTE

Using the balanced to unbalanced converter reduces the pulse amplitude by a factor of 1.266. This will cause the comparison with the mask to fail. To overcome this select CHAN 1 ON and reduce the Volts/Division setting (highlighted on the softkey display). Reduced Volts/Division = highlighted value/1.266. The new value can be entered using the keypad

- 6 The Oscilloscope will compare the positive pulse with the mask limits. A PASS message should appear on the Oscilloscope.

NOTE

It may be necessary to visibly fit the waveform to the mask by adjusting the Oscilloscope vertical position and horizontal delay to obtain a PASS on the Mask.

- 7 Measure the peak pulse amplitude at the mid pulse-width using the Oscilloscope and verify that this is between 1.896V and 2.844V.

DS-1 Negative Pulse

- 8 On the Oscilloscope, use the following key sequence to access the inverted mask.
 - a/ SHIFT (Blue Key) DISK

Performance Tests

External Mux/Demux

- b/ **DIRECTORY** softkey
- c/ Use ENTRY/MEASURE control to highlight INV_MASK
- d/ **CHANGE DIRECTORY** softkey

Load the Telecom Mask

- 9 On the Oscilloscope, use the following key sequence to select and load the required Telecom Mask:
- a/ SHIFT (Blue Key) APPLICATION.
 - b/ **TELECOM MASK/MASK** softkey.
 - c/ Use ENTRY/MEASURE control to select DS1_NEW in the highlighted MSK FILES window.
 - d/ **LOAD SETUP 8 M1M2** softkey.

Compare Pulse with Mask

- 10 On the Oscilloscope, use the following key sequence to compare the pulse with the mask:
- a/ RECALL 8, (Ensure CH1 Impedance is reset to 1 M Ω . Select TRIGGER, SETUP and set **PATTERN TRIGGER** softkey to **Trig'd**).
 - b/ DEFINE MEAS
 - c/ **COMPARE** softkey
 - d/ **TEST ON** softkey
 - e/ **M1M2** softkey
 - f/ **AFTER FAIL CONTINUE** softkey
 - g/ RUN

NOTE

Using the balanced to unbalanced converter reduces the pulse amplitude by a factor of 1.266. This will cause the comparison with the mask to fail. To overcome this select CHAN 1 ON and reduce the Volts/Division setting (highlighted on the softkey display). Reduced Volts/Division = highlighted value/1.266. The new value can be entered using the keypad

- 11 The Oscilloscope will compare the negative pulse with the mask limits. A PASS message should appear on the Oscilloscope.

NOTE

It may be necessary to visibly fit the waveform to the mask by adjusting the Oscilloscope vertical position and horizontal delay to obtain a PASS on the Mask.

- 12 Measure the peak pulse amplitude at the mid pulse-width using the Oscilloscope and verify that this is between 1.896V and 2.844V.

Performance Tests
External Mux/Demux

13 Disconnect all test equipment.

PDH/DSn Frequency Measurement and Looped Clock

Specifications

Accuracy	±4.5 ppm
Measured Offset	±100 ppm

Description

This test verifies that the OmniBER's Receiver Frequency Measurement is within specified limits. These limits assume the instrument is within the calibration cycle.

A Synthesizer is used to generate a sinewave at half the data rate. This is applied to the OmniBER's Receiver Signal In port. As this signal corresponds to an *All Ones Ternary Signal*, the OmniBER's receiver should sync up with no errors if set to PATTERN [ALL ONES]. The Frequency Measurement accuracy of the OmniBER can be determined by comparison with the frequency displayed on the Synthesizer. Frequency Offset Measurement is also verified during this test as the OmniBER will display deviation from the expected Signal In frequency in ppm. The PDH transmitter recovered clock function is also verified at 2 Mb/s using the frequency counter in RATIO mode.

Equipment Required

Synthesizer : HP 3335A Option 001 (75Ω)

Frequency Counter : HP 5335A Option 010

Procedure

- 1 Recall the OmniBER's default settings as shown on page 3-4.
- 2 Connect up the equipment as shown in Figure 3-3.

Performance Tests
PDH/DSn Frequency Measurement and Looped Clock

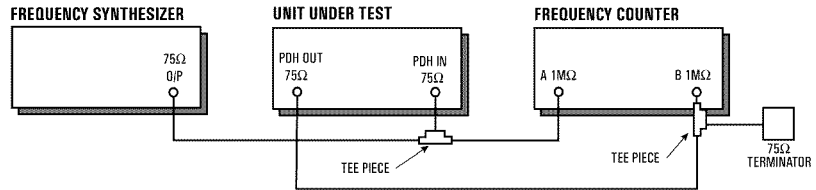
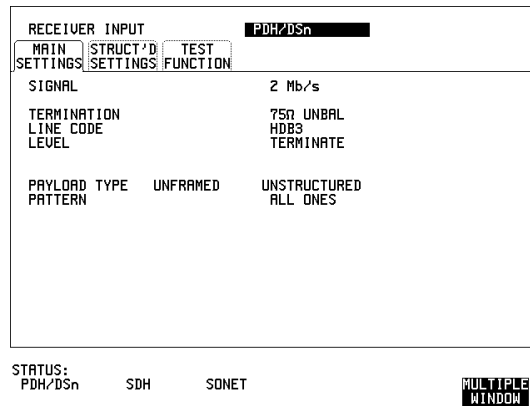

Figure 3-3 Receiver Frequency Measurement Test Setup

- 3 Set the Synthesizer to:
 FREQUENCY - 1024.000 kHz sinewave
 AMPLITUDE - +10 dBm.
- 4 Set the frequency counter to RATIO A/B.
- 5 Press **RECEIVE** and set up the display as shown below.



Performance Tests
PDH/DSn Frequency Measurement and Looped Clock

6 Press **TRANSMIT** and set up the display as shown below.

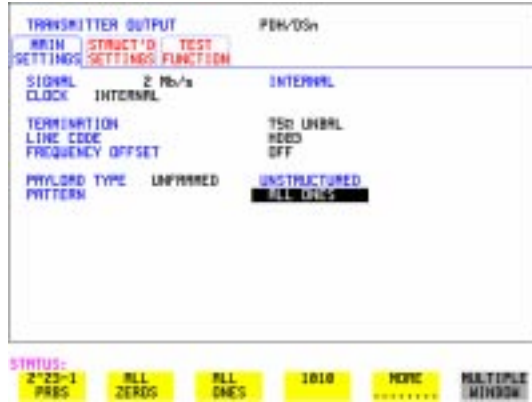

7 Press **RESULTS** and set up the display as shown below.

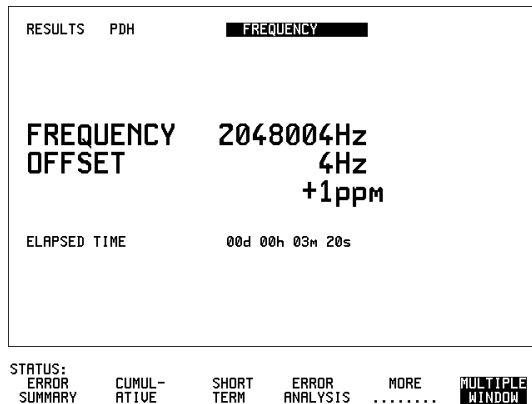

- 8 Verify that the FREQUENCY displayed is between 2047991 Hz and 2048009 Hz.
- 9 Verify that the Offset displayed is between +4.5 ppm and -4.5 ppm.
- 10 Set the synthesizer frequency to 1024.102 kHz and verify that the frequency displayed on the **RESULTS** display is between 2048.194 kHz and 2048.214 kHz.

Performance Tests

PDH/DSn Frequency Measurement and Looped Clock

- 11 Verify that the Offset displayed is between 95.5 ppm and 104.5 ppm. The frequency counter should read 1.00.
- 12 Set the synthesizer frequency to 1023.898 kHz and verify that the frequency displayed on the **RESULTS** display is between 2047.786 kHz and 2047.806 kHz.
- 13 Verify that the Offset displayed is between -95.5 ppm and -104.5 ppm. The frequency counter should read 1.00.
- 14 Set the synthesizer level to +10 dBm;set the synthesizer frequency and the OmniBER to the settings given in Table 3-2 and verify the displayed Offset at each point.

Table 3-2 PDH/DSn Offsets

Receive Frequency	Synthesizer Frequency	Displayed Offset
8 Mb/s (E2)	4224,000 Hz	-4.5 to +4.5 ppm
8 Mb/s (E2)	4223,578 Hz	-95.5 to -104.5 ppm
8 Mb/s (E2)	4224,422 Hz	+95.5 to +104.5 ppm
34 Mb/s (E3)	17,184,000 Hz	-4.5 to +4.5 ppm
34 Mb/s (E3)	17,182,282 Hz	-95.5 to -104.5 ppm
34 Mb/s (E3)	17,185,718 Hz	+95.5 to +104.5 ppm
140 Mb/s (E4)	69,632,000 Hz	-4.5 to +4.5 ppm
140 Mb/s (E4)	69,625,036 Hz	-95.5 to -104.5 ppm
140 Mb/s (E4)	69,638,963 Hz	+95.5 to +104.5 ppm
1.544 Mb/s (DS-1)	772,000 Hz	-4.5 to +4.5 ppm
1.544 Mb/s (DS-1)	771,923 Hz	-95.5 to -104.5 ppm
1.544 Mb/s (DS-1)	772,077 Hz	+95.5 to +104.5 ppm
44.736 Mb/s (DS-3)	22,368,000 Hz	-4.5 to +4.5 ppm
44.736 Mb/s (DS-3)	22,365,763 Hz	-95.5 to -104.5 ppm
44.736 Mb/s (DS-3)	22,370,237 Hz	+95.5 to +104.5 ppm

SDH/SONET Transmitter Clock Accuracy

Specification

Bit Rate	Accuracy
51.84 Mb/s	±4.5 ppm

Description

The test uses a Frequency Counter connected to the Multirate Analyzer module Clock Trigger output port. This output is derived from the Clock module internal 10 MHz clock oscillator providing a 51.84 MHz that is directly related to all SDH/SONET output rates.

Equipment Required

Frequency Counter : HP 5335A Option 010

Procedure

- 1** Recall the OmniBER's default settings as shown on page 3-4.
- 2** Set the Transmitter Output to SDH/SONET.
- 3** Connect the OmniBER's Multirate Analyzer module CLOCK TRIGGER port to the Frequency Counter Input A, set the input termination to 50 Ω .
- 4** Adjust the Frequency Counter Trigger Level to obtain a stable reading and ensure that the Frequency Counter reads between 51.839670 MHz and 51.840230 MHz.
- 5** Disconnect all the test equipment.

External Clock/Data Reference Inputs & Clock Reference Output

Specifications

Clock Rate	Description
2.048 Mb/s MTS	Accepts timing reference as per ITU-T G.811
10 MHz Reference	Accepts 10 MHz timing reference
1.544 Mb/s BITS	Accepts DS-1 timing reference as per TA-TSY-000378
64 kb/s	Accepts 64 kb/s timing reference as per ITU-T G.703 Section 1.2.2
STM-1/STS-3 Receive	Recovers clock from received STM/STS input signal.

NOTE

The rates available are dependent on the OmniBER model and options fitted.

Description

This test verifies that signal integrity is maintained when an EXTERNAL clock is used as a reference.

Equipment Required

Synthesizer : HP 3335A option 001 (75Ω)

PDH/DSn Test Set : OmniBER 718

110Ω/75Ω Balanced to Unbalanced Converter : HP 15508B

Frequency Counter : HP 5335A Opt 010

64kb/s Test Set : HP 37732A

Performance Tests

External Clock/Data Reference Inputs & Clock Reference Output

Procedure

MTS Clock - Clock Format

- 1 Connect the 52/155 Mb/s DATA OUT port to the 52/155 Mb/s DATA IN port.
- 2 Recall the OmniBER's default settings as shown on page 3-4 and set the **OTHER SETTINGS CONTROL** display as shown below.

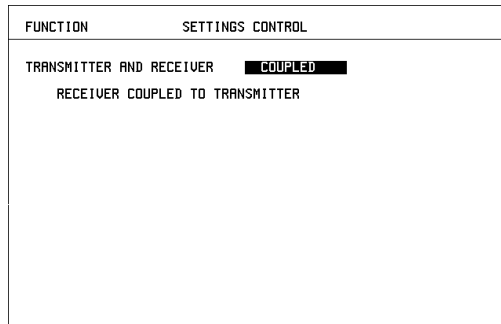

STATUS:
INDEP-
ENDENT

COUPLED

**MULTIPLE
WINDOW**

- 3 Press **TRANSMIT** and set up the display as shown below.

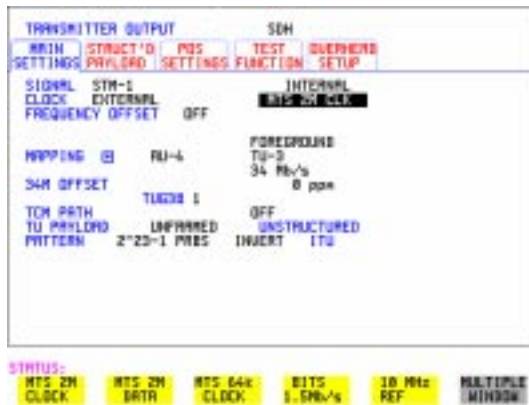

- 4 Set the HP 3335A to 2.048 MHz at +10 dBm.

Performance Tests

External Clock/Data Reference Inputs & Clock Reference Output

- 5 Connect the HP 3335A to the OmniBER's 75Ω 2M REF IN port on the Clock module.
- 6 Press **RESULTS**; **TROUBLE SCAN**.
- 7 Press **RUN/STOP**, check that the display reads NO TROUBLE and all the Alarm leds are off.
- 8 Press **RUN/STOP** to halt the measurement.

Clock REF OUT

- 9 Connect the Clock REF Out port to the Frequency Counter and check that a 2.048 MHz signal is present.

MTS Clock - Data

- 10 Disconnect the HP 3335A Synthesizer from the OmniBER's 75Ω 2M REF IN port.
- 11 Set the PDH/DSn Test Set to transmit a 2 Mb/s unframed signal.
- 12 Connect the PDH/DSn Test Set, 75Ω Output to the OmniBER's 75Ω 2M REF IN Port and recall the default settings as shown on page 3-4.
- 13 Set the **TRANSMIT** display as shown below.

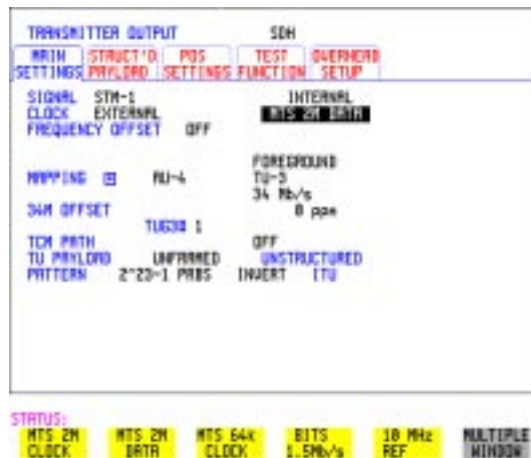

- 14 Select CLOCK EXTERNAL [2 Mb/s DATA] on the SDH **TRANSMIT** Display.
- 15 Press **RESULTS** **TROUBLE SCAN** then **RUN/STOP**.

Performance Tests

External Clock/Data Reference Inputs & Clock Reference Output

- 16 Check that the **RESULTS** Display reads NO TROUBLE and all the Alarm LEDs are off. Press **RUN/STOP** to halt the measurement.
- 17 Disconnect the PDH/DSn Test Set, 75Ω 2 Mb/s PDH Output from the 75Ω 2M REF IN Port.
- 18 Connect the PDH/DSn Test Set, 120Ω 2 Mb/s PDH Output to the 120Ω 2M REF IN Port.
- 19 Change the PDH O/P termination to 120Ω on the PDH/DSn Test Set and the OmniBER.
- 20 Press **RESULTS TROUBLE SCAN** then **RUN/STOP** on .
- 21 Check that the **RESULTS** Display reads NO TROUBLE and all the Alarm LEDs are off. Press **RUN/STOP** to halt the measurement.

STM-1/STS-3 Receive Data

- 22 Disconnect the PDH/DSn Test Set Data Output from the OmniBER's 120Ω 2M REF IN port.
- 23 Disconnect the 52/155 Mb/s DATA OUT port from the 52/155 Mb/s DATA IN port
- 24 Select CLOCK [STM-1/STS-3 RECEIVE] ON the OmniBER's **TRANSMIT** display.
- 25 The SDH Clock Loss Alarm led should be lit on the OmniBER.
- 26 Set the Synthesizer frequency to 77.760 MHz and amplitude to +10 dBm.
- 27 Connect the Synthesizer to the 75Ω 52/155 Mb/s DATA IN port.
- 28 Ensure that the SDH/SONET Clock Loss Alarm Led is not lit.

NOTE

As the signal is unframed the LOF/OOF etc. alarms will be on.

10 MHz Reference

- 29 Select CLOCK [EXTERNAL] [10 MHz REF] on the OmniBER's **TRANSMIT** display.
- 30 The SDH/SONET Clock Loss Alarm led should be lit on the OmniBER.
- 31 Set the Synthesizer frequency to 10.000 MHz and amplitude to +10 dBm.
- 32 Connect the Synthesizer to the OmniBER's 75Ω 2M REF IN Port.
- 33 Ensure that the SDH/SONET Clock Loss Alarm Led is not lit.

Performance Tests

External Clock/Data Reference Inputs & Clock Reference Output

BITS Clock

- 34 Select CLOCK [BITS] ON the OmniBER's **TRANSMIT** display.
- 35 The SDH/SONET Clock Loss Alarm led should be lit on the OmniBER.
- 36 Set the Synthesizer frequency to 772 kHz and amplitude to +10 dBm.
- 37 Connect the Synthesizer, via the Balanced to Unbalanced converter, to the OmniBER's 100 Ω BITS Clock Port.
- 38 Ensure that the SDH/SONET Clock Loss Alarm Led is not lit.

64 kb/s Clock

- 39 Select CLOCK [64 kb/s] on the OmniBER's **TRANSMIT** display.
- 40 The SDH/SONET Clock Loss Alarm led should be lit on the OmniBER.
- 41 Set the 64kb/s Test Set to provide a 64kb/s Clock Signal.

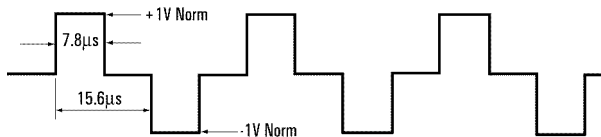

Suitable 64kb/s AMI signal (into 100/120 ohms balanced)
if 64kb/s Test set is not available.
Signal must be derived from a stable synthesized source.

- 42 Connect the Clock Signal to the OmniBER's balanced 64K Clock input.
- 43 Ensure that the SDH/SONET Clock Loss Alarm Led is not lit.
- 44 Disconnect all the test equipment.

SDH/SONET Frequency Offsets

Specifications

Range	±999 ppm
Resolution	0.1 ppm
Accuracy	0.02 ppm

Description

The test uses a Frequency Counter connected to the Multirate Analyzer module Clock Trigger output port. This output is derived from the Clock module and is directly related to the SDH/SONET output rate. An external 10 MHz reference from a Signal Generator is used to clock the OmniBER and also provides a timebase reference for the Frequency counter. The counter measures the Clock Trigger frequency to check the offset accuracy and range.

Equipment Required

Signal Generator	: HP 8657A
Frequency Counter	: HP 5335A Opt 010
T Connector	: HP 1250-0781

Procedure

- 1 Recall the OmniBER's default settings as shown on page 3-4. Set the Transmitter Output to SDH/SONET.
- 2 Select CLOCK [10 MHz REF] on the OmniBER's **TRANSMIT** display.
- 3 Connect the HP8657A to the OmniBER's Unbalanced 75Ω 2M REF IN port on the Clock Module.
- 4 Set the Signal Generator frequency to 10.000 MHz and amplitude to +10 dBm.
- 5 Check the Clock Loss Alarm Led is not lit.
- 6 Connect the Signal Generator, Timebase OUT port (rear panel), to the counter Timebase IN port (rear panel).

Performance Tests

SDH/SONET Frequency Offsets

- 7 Check the Counter EXT TIME BASE flag is illuminated on the front panel.
- 8 Connect the OmniBER's Multirate Analyzer module CLOCK TRIGGER port to the Frequency Counter, set input termination to 50Ω .
- 9 Adjust the Frequency Counter Trigger Level to obtain a stable reading.
- 10 The reading should be between 51.839999 - 51.840001 MHz. If not check setup and ensure the Counter is locked to the Signal Generator.
- 11 Set the OmniBER's frequency offset to the settings given in Table 3-3 and verify the frequency at each step is within the Min/Max limits.

Table 3-3 SDH/SONET Offset

Offset (ppm)	Min Expected Frequency	Max Expected Frequency
-999ppm	51788210.8 Hz	51788212.9 Hz
-100ppm	51834814.9 Hz	51834817.1 Hz
-66.6ppm	51836546.4 Hz	51836548.5 Hz
+33.3ppm	51841725.2 Hz	51841727.3 Hz
+100ppm	51845182.9 Hz	51845185.1 Hz
+999ppm	51891787.1 Hz	51891789.2 Hz

- 12 Disconnect all the test equipment.

STM-0/STS-1 Transmitter Output Waveshape

Specifications

Level	Pulse Amplitude & Shape
Cross-Connect (450 feet)	530 mV peak (nominal). Compliant with GR-253, Issue 1, Figure 4-10 and draft recommendation ITU-R F.750, Appendix1
HIGH	1 V peak (nominal)
LOW	300 mV peak (nominal)

Description

An Oscilloscope is connected to the OmniBER's Transmitter STM-0/STS-1 output and used to check the STM-0/STS-1 waveshape against the relevant mask.

Equipment Required

Oscilloscope : HP 54520A Option 001
75 Ω Termination : HP 15522-80010
T Connector : HP 1250-0781

Procedure

Positive Pulse

- 1 Recall the OmniBER 718 default settings as shown on page 3-4 and set up the **TRANSMIT** display as shown on the following page.

Performance Tests

STM-0/STS-1 Transmitter Output Waveshape



- 2 Connect the 52/155 Mb/s 75Ω DATA OUT port to the Oscilloscope CHAN 1, terminate in 75Ω.
- 3 Select CHAN 1 on the Oscilloscope and set to 1 MΩ input impedance.

Load the Telecom Mask

- 4 On the Oscilloscope, use the following key sequence to select and load the required Telecom Mask:
 - a/ SHIFT (Blue Key) APPLICATION.
 - b/ **TELECOM MASK/MASK** softkey.
 - c/ Use ENTRY/MEASURE control to select STS1_93 in the highlighted MSK FILES window.
 - d/ **LOAD SETUP 8 M1M2** softkey.

Compare Pulse with Mask

- 5 On the Oscilloscope, use the following key sequence to compare the pulse with the mask:
 - a/ RECALL 8
 - b/ DEFINE MEAS
 - c/ **COMPARE** softkey
 - d/ **TEST ON** softkey
 - e/ **M1M2** softkey
 - f/ **AFTER FAIL CONTINUE** softkey
 - g/ RUN
- 6 The Oscilloscope will automatically display and compare an isolated positive pulse with the mask limits. A PASS message should appear on the Oscilloscope.

STM-0/STS-1 Transmitter Output Waveshape

NOTE

It may be necessary to select **MASK** softkey and **MASK AUTO** / **MASK ALIGN** or to visibly fit the waveform to the mask by adjusting the Oscilloscope vertical gain/ position and horizontal delay to obtain a PASS on the Mask.

- 7 Measure the peak pulse amplitude at the mid pulse-width using the Oscilloscope and verify that this is nominally 530 mV.

Negative Pulse

- 8 On the Oscilloscope, use the following key sequence to access the inverted mask.
 - a/ SHIFT (Blue Key) DISK
 - b/ **DIRECTORY** softkey
 - c/ Use ENTRY/MEASURE control to highlight INV_MASK
 - d/ **CHANGE DIRECTORY** softkey

Load the Telecom Mask

- 9 On the Oscilloscope, use the following key sequence to select and load the required Telecom Mask:
 - a/ SHIFT (Blue Key) APPLICATION.
 - b/ **TELECOM MASK/MASK** softkey.
 - c/ Use ENTRY/MEASURE control to select STS1_93 in the highlighted MSK FILES window.
 - d/ **LOAD SETUP 8 M1M2** softkey.

Compare Pulse with Mask

- 10 On the Oscilloscope, use the following key sequence to compare the pulse with the mask:
 - a/ RECALL 8
 - b/ DEFINE MEAS
 - c/ **COMPARE** softkey
 - d/ **TEST ON** softkey
 - e/ **M1M2** softkey
 - f/ **AFTER FAIL CONTINUE** softkey
 - g/ RUN
- 11 The Oscilloscope will automatically display and compare an isolated positive pulse with the mask limits. A PASS message should appear on the Oscilloscope.

Performance Tests

STM-0/STS-1 Transmitter Output Waveshape

NOTE

It may be necessary to select **MASK** and **MASK AUTO** / **MASK ALIGN** to visibly fit the waveform to the mask by adjusting the Oscilloscope vertical gain/position and horizontal delay to obtain a PASS on the Mask.

- 12** Measure the peak pulse amplitude at the mid pulse-width using the Oscilloscope and verify that this is nominally 530 mV.
- 13** Change the signal to STM-0/STS-1 HIGH and check that the +ve and -ve pulses are nominally 1 V.
- 14** Change the signal to STM-0/STS-1 LOW and check that the +ve and -ve pulses (max) peaks are nominally 300 mV.

STM-1/STS-3 Transmitter Output Waveshape

Specifications

Pulse Shape	Meets ITU Recommendation G.703
Amplitude	$\pm 0.5V \pm 10\%$

Description

An Oscilloscope is connected to the OmniBER's Transmitter STM-1/STS-3 output and used to view the waveforms with All Ones and All Zeros patterns selected in turn. The displayed waveshape is checked against the relevant mask. The STM/STS Framing is disabled during this test.

Equipment Required

Oscilloscope	HP 54520A - option 001
75Ω Termination	HP 15522-80010
T Connector	HP 1250-0781

Procedure

NOTE

This performance test is written using the HP 54520A Oscilloscope with Option 001 - Telecom Masks Application. If any other Oscilloscope is used the keystrokes given in this procedure will not apply.

Installing the Telecom Masks Option

- 1 Insert the Disk containing the Telecom Mask into the Oscilloscope Disk Drive.
- 2 Press **SHIFT** (Blue Key) **DISK**
- 3 Press **DIRECTORY** then **ROOT DIRECTORY**.

Performance Tests

STM-1/STS-3 Transmitter Output Waveshape

All Ones Pulse

- 1 Connect up the equipment as shown in Figure 3-4 and recall the OmniBER default settings as shown on page 3-4.

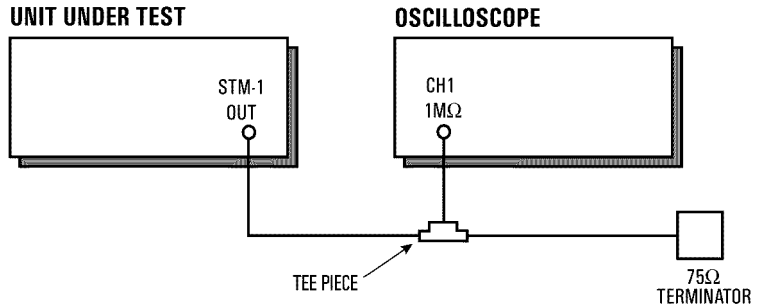

Figure 3-4 STM-1/STS-3 Transmitter Output Waveshape Test Setup

- 2 Press **TRANSMIT** and set up the display as shown below.



Performance Tests

STM-1/STS-3 Transmitter Output Waveshape

- 3 Press **OTHER** **CALIBRATION** and enter the calibration password - 1243. Set up the display as shown opposite.

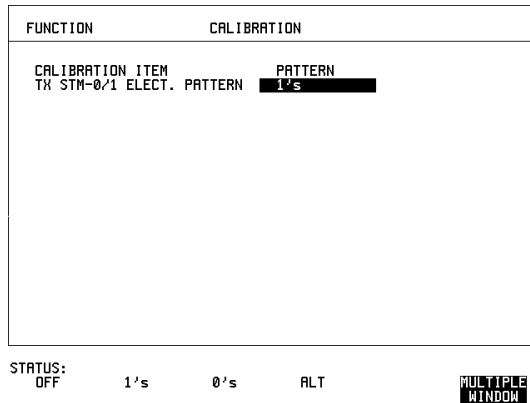

- 4 Connect the 52/155 Mb/s 75Ω DATA OUT port to the Oscilloscope, terminate in 75Ω.
- 5 Select CHAN on the Oscilloscope and set to 1 MΩ input impedance.

Load the Telecom Mask

- 6 On the Oscilloscope, use the following key sequence to select and load the required Telecom Mask:
 - a/ SHIFT (Blue Key) APPLICATION.
 - b/ **TELECOM MASK/MASK** softkey.
 - c/ Use ENTRY/MEASURE control to select 155BIN1 in the highlighted MSK FILES window.
 - d/ **LOAD SETUP 8 M1M2** softkey.

Compare Pulse with Mask

- 7 On the Oscilloscope, use the following key sequence to compare the pulse with the mask:
 - a/ RECALL 8, (Ensure CH1 Impedance is reset to 1 MΩ)
 - c/ **COMPARE** softkey
 - d/ **TEST ON** softkey
 - e/ **M1M2** softkey
 - f/ **AFTER FAIL CONTINUE** softkey
 - g/ RUN

Performance Tests

STM-1/STS-3 Transmitter Output Waveshape

- 8 The Oscilloscope will automatically display and compare an isolated positive pulse with the mask limits. A PASS message should appear on the Oscilloscope.

NOTE

It may be necessary to visibly fit the waveform to the mask by adjusting the Oscilloscope vertical position and horizontal delay to obtain a PASS on the Mask.

- 9 Measure the peak pulse amplitude at the mid pulse-width using the Oscilloscope and verify that this is between 450 mV and 550 mV. (i.e. 900 mV-1.1V Pk-Pk)

All 0's Pulse

- 10 Select PATTERN [ALL 0's] on the **OTHER** **CALIBRATION** display.

Load the Telecom Mask

- 11 On the Oscilloscope, use the following key sequence to select and load the required Telecom Mask:
- a/ SHIFT (Blue Key) APPLICATION.
 - b/ **TELECOM MASK/MASK** softkey.
 - c/ Use ENTRY/MEASURE control to select 155BIN0 in the highlighted MSK FILES window.
 - d/ **LOAD SETUP 8 M1M2** softkey.

Compare Pulse with Mask

- 12 On the Oscilloscope, use the following key sequence to compare the pulse with the mask:
- a/ RECALL 8, (Ensure CH1 Impedance is reset to 1 M Ω)
 - b/ DEFINE MEAS
 - c/ **COMPARE** softkey
 - d/ **TEST ON** softkey
 - e/ **M1M2** softkey
 - f/ **AFTER FAIL CONTINUE** softkey
 - g/ RUN
- 13 The Oscilloscope will automatically display and compare an isolated positive pulse with the mask limits. A PASS message should appear on the Oscilloscope.

Performance Tests

STM-1/STS-3 Transmitter Output Waveshape

NOTE

It may be necessary to visibly fit the waveform to the mask by adjusting the Oscilloscope vertical position and horizontal delay to obtain a PASS on the Mask.

- 14** Measure the peak pulse amplitude at the mid pulse-width using the Oscilloscope and verify that this is between 450 mV and 550 mV. (i.e. 900 mV-1.1V Pk-Pk)
- 15** On the Oscilloscope, use the following key sequence to access the inverted mask.
 - a/ SHIFT (Blue Key) DISK
 - b/ **DIRECTORY** softkey
 - c/ Use ENTRY/MEASURE control to highlight INV_MASK
 - d/ **CHANGE DIRECTORY** softkey
- 16** Repeat steps 6 to 14 to check pulses against Inverted masks.
- 17** Set CALIBRATION PATTERN to OFF and disconnect all the test equipment.

SDH/SONET Receiver Equalization

Specifications

Rate	Equalization
STM-0/STS-1 - 51.84 Mb/s	12 dB for root f cable at 1/2 bit rate
STM-1/STS-3 - 155.52 Mb/s	12 dB for root f cable at 1/2 bit rate

Description

The Receiver Equalization is checked by looping the transmitter output to receiver input through a special Cable Simulator. This device is designed to simulate the specified cable loss at the rate under test. A BER measurement is run and a check made for no errors in the results page.

Equipment Required

Cable Simulator STM-0/STS-1 50 metres of 8120-0049

Cable Simulator STM-1/STS-3 75 metres of 8120-0049

Procedure

STM-0/STS-1

- 1 Recall the OmniBER's default settings as shown on page 3-4 and set the **OTHER** **SETTINGS** **CONTROL** display as shown on the following page.

Performance Tests

SDH/SONET Receiver Equalization

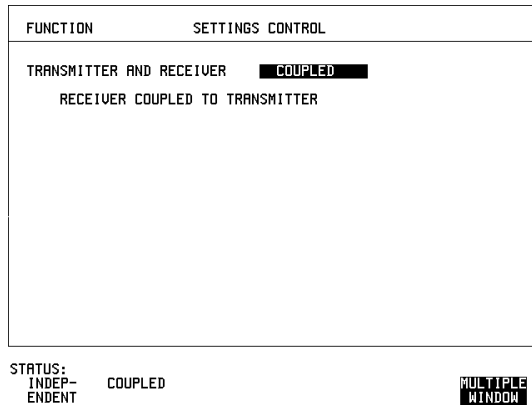

- Set the **TRANSMIT** display as shown below.

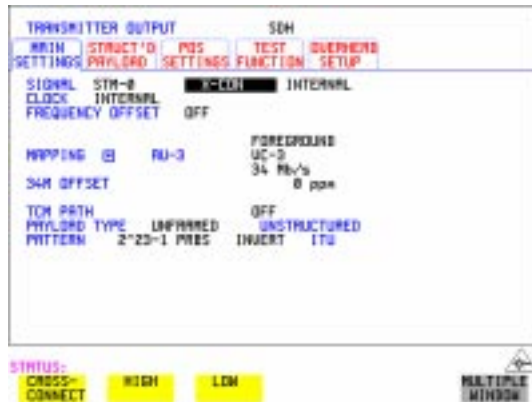

- Connect Cable Simulator STS-1 between the 52/155 Mb/s 75Ω DATA OUT and 52/155 Mb/s 75Ω DATA IN ports.
- Press **RESULTS** **TROUBLE** **SCAN** then **RUN/STOP** to start the measurement.
- Ensure that NO TROUBLE is displayed on the **RESULTS** display after 30 seconds.
- Press **RUN/STOP** to stop the measurement.

Performance Tests

SDH/SONET Receiver Equalization

Procedure

STM-1/STS-3

Set the **TRANSMIT** display as shown below.

7



- 8 Connect Cable Simulator STS-3 between the 52/155 Mb/s 75Ω DATA OUT and 52/155 Mb/s 75Ω DATA IN ports.
- 9 Press **RESULTS** **TROUBLE** **SCAN** then **RUN/STOP** to start the measurement.
- 10 Ensure that NO TROUBLE is displayed on the **RESULTS** display after 30 seconds.
- 11 Press **RUN/STOP** to stop the measurement.
- 12 Disconnect all the equipment.

SDH/SONET Receiver Monitor Levels

Specifications

Bit Rate	Nominal Loss	Equalization at 1/2 Bit Rate
STM-0/STS-1 - 51.84 Mb/s	20, 26 dB	12 dB
STM-1/STS-3 - 155.52 Mb/s	20, 26 dB	12 dB

Description

The signal from the OmniBER's SDH/SONET Transmitter is applied to the SDH/SONET Receiver after attenuating by an amount equal to the selected Receiver Flat Loss plus the specified Cable Loss. The Flat Loss is obtained from a 75 Ω attenuator kit. The Cable Loss is supplied by inserting the correct Cable Simulators for each bit rate in the attenuation path.

Equipment Required

Cable Simulator STM-0/STS-1 50 metres of 8120-0049

Cable Simulator STM-1/STS-3 75 metres of 8120-0049

75 Ω Attenuator Kit HP 86213A

Procedure

- 1 Recall the OmniBER's default settings as shown on page 3-4.
- 2 Connect the equipment as shown in Figure 3-5.

Performance Tests
SDH/SONET Receiver Monitor Levels

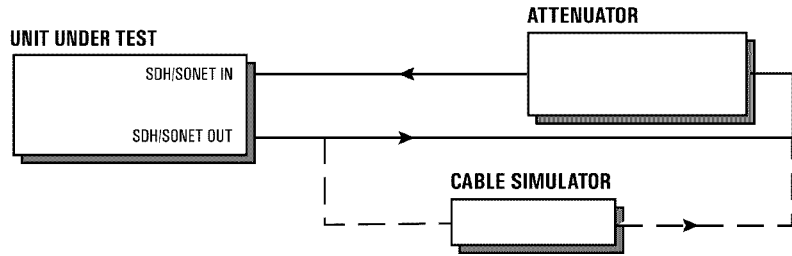
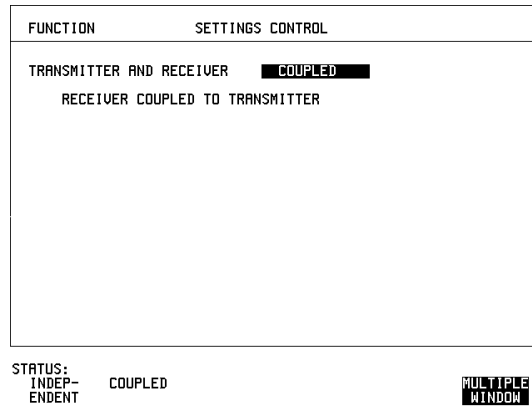

Figure 3-5 Receiver Monitor Input Test Setup

STM-0/STS-1

- 1 Set the **OTHER** **SETTINGS** **CONTROL** display as shown below.



Performance Tests

SDH/SONET Receiver Monitor Levels

- 2 Press **RECEIVE** and set up the **MAIN SETTINGS** display below.

RECEIVER INPUT		SDH	
MAIN SETTINGS	STRUCT'D PAYLOAD	TEST FUNCTION	OVERHEAD MONITOR
SIGNAL LEVEL		STM-0 MONITOR	
GAIN		20 dB	
MAPPING	<input checked="" type="checkbox"/> AU-3	UC-3	34 Mb/s
PAYLOAD TYPE	UNFRAMED	UNSTRUCTURED	
PATTERN	2^23-1 PRBS	INVERT	ITU

STATUS:
20 dB 26 dB **MULTIPLE WINDOW**

- 3 Press **RESULTS TROUBLE SCAN**
- 4 Press **RUN/STOP** to start the measurement.
- 5 After 30 seconds ensure that NO TROUBLE is displayed on the **RESULTS** display
- 6 Press **RUN/STOP** to stop the measurement.
- 7 Connect Cable Simulator STS-1 between the 52/155 Mb/s DATA OUT Port and the attenuator.
- 8 Press **RESULTS TROUBLE SCAN** then **RUN/STOP** to start the measurement.
- 9 Ensure that NO TROUBLE is displayed on the **RESULTS** display after 30 seconds.
- 10 Press **RUN/STOP** to stop the measurement.
- 11 Connect the 6 dB Fixed Attenuator in the signal path to give a total path attenuation of 26 dB.
- 12 Press **RECEIVE** and select MONITOR LEVEL [26 dB].
- 13 Press **RESULTS TROUBLE SCAN** then **RUN/STOP** to start the measurement.
- 14 Ensure that NO TROUBLE is displayed on the **RESULTS** display after 30 seconds.

Performance Tests

SDH/SONET Receiver Monitor Levels

- 15 Press **RUN/STOP** to stop the measurement.
- 16 Remove Cable Simulator STS-1 from the signal path.
- 17 Press **RESULTS**; **TROUBLE SCAN** then **RUN/STOP** to start the measurement.
- 18 Ensure that NO TROUBLE is displayed on the **RESULTS** display after 30 seconds.
- 19 Press **RUN/STOP** to stop the measurement.

STM-1/STS-3

- 20 Repeat steps 1 to 19 (20 dB and 26 dB tests) with the **RECEIVE** display set to SIGNAL [STM-1/STS-3] and Cable Simulator STS-3 fitted in place of Cable Simulator STS-1.
- 21 Disconnect all the equipment.

Multirate Optical Interfaces

Specification (1310 nm Transmitter up to 622 Mb/s)

Wavelength	1280 nm to 1335 nm (Typical 1310 nm)
Power Output	-3.0 dBm to +2.0 dBm (Typical 0.0 dBm)
Line Coding	NRZ
Safety Class	Class 1, FDA 21 CFR Ch.1 1040.10 and EN 60825
Data Rates	51.84, 155.52, or 622.08 Mb/s (Nominal)

Specification (1310 nm Transmitter up to 2488.32 Mb/s)

Wavelength	1280 nm to 1330 nm (Typical 1310 nm)
Power Output	+1 dBm \pm 2 dBm
Line Coding	NRZ
Safety Class	Class 1, FDA 21 CFR Ch.1 1040.10 and EN 60825
Data Rates	51.84, 155.52, 622.08 or 2488.32 Mb/s (Nominal)

Specification (1550 nm Transmitter up to 622 Mb/s)

Wavelength	1480 nm to 1580 nm (Typical 1550 nm)
Power Output	-3.0 dBm to +2.0 dBm (Typical 0.0 dBm)
Line Coding	NRZ
Safety Class	Class 1, FDA 21 CFR Ch.1 1040.10 and EN 60825
Data Rates	51.84, 155.52, or 622.08 Mb/s (Nominal)

Specification (1550 nm Transmitter up to 2488.32 Mb/s)

Wavelength	1530 nm to 1570 nm (Typical 1550 nm)
Power Output	+1 dBm \pm 2 dBm
Line Coding	NRZ
Safety Class	Class 1, FDA 21 CFR Ch.1 1040.10 and EN 60825
Data Rates	51.84, 155.52, 622.08 or 2488.32 Mb/s (Nominal)

Performance Tests
Multirate Optical Interfaces

Specification (Receiver) up to 2488.32 Mb/s

Wavelength	1200 nm to 1600 nm
Maximum Input Power	-8 dBm (for BER of $1.0E^{-10}$)
Line Coding	NRZ
Sensitivity	-28 dBm (STM-0/1/4, OC-1/3/12) -28 dBm Minimum (STM-16, OC-48) (wavelength=1310/1550 nm, Modulation = 100%, Data= $2^{23}-1$, BER= $1.0E^{-10}$)
PMP Electrical Input	150mV pk-pk (Nominal) 51.84, 155.52 and 622.08 Mb/s only
PMP Impedance	Nominal 50Ω

Specification (Receiver) up to 622.08 Mb/s

Wavelength	1200 nm to 1600 nm
Maximum Input Power	-3 dBm (for BER of $1.0E^{-10}$)
Line Coding	NRZ
Sensitivity	-28 dBm (STM-0/1, OC-1/3) -28 dBm Minimum (STM-4, OC-12) (wavelength=1310/1550 nm, Modulation=100%, Data= $2^{23}-1$, BER= $1.0E^{-10}$)
PMP Electrical Input	150 mV pk-pk (Nominal), 51.84, 155.52 and 622.08 Mb/s only
PMP Impedance	Nominal 50Ω

NOTE

The rates available are dependent on the OmniBER model and options fitted.

Description

The optical power output is measured on a power meter.

The receiver sensitivity is verified by attenuating the transmitter output and checking for no errors in back-to-back mode.

The Protected Monitor Point (PMP) functionality is verified by looping the OmniBER's Optical Output to the PMP input via an Optical Attenuator and Lightwave Converter, then checking for error-free operation.

Performance Tests
Multirate Optical Interfaces

Equipment Required

Power Meter	: HP 8153A
Power Meter Sensor Module	: HP 81536A
Oscilloscope	: HP 54520A
Lightwave Converter	: HP 11982A
Optical Attenuator	: HP 8157A
FC/PC Connector Interface	: HP 81000FI (Qty. 4)
Optical Cables (qty 2)	: HP 11871A
Adaptor (SMA to BNC)	: HP 1250-1787

WARNING

Safety precautions must be observed when handling the OmniBER's Optical Modules as these generate laser signals which can cause serious injury. The guidelines below must be followed:

Check the connector configuration of the 2.5 Gb/s Fiber Optic Interfaces. If non FC/PC connectors are fitted then remove them, then fit the FC/PC connector interface.

Check for any damage to the OmniBER's Fiber Optic Interface spring loaded aperture covers and connectors. Do not power up the instrument if in any doubt about the integrity of these connectors.

Make all connections to the OmniBER's Fiber Optic Interfaces before powering up the instrument.

Procedure

- 1 Switch on the OmniBER and recall the default settings as shown on page 3-4.

1310nm - Optical Power Output

- 2 Connect the OmniBER's Optical Out Port to the HP8153A.
Ensure all optical connectors are carefully cleaned before connections are made.
Ensure that all connections are tight and that the cable has no twists.
- 3 Set up the HP 8153A as follows:
 - a. Press **PARAM** key to display wavelength [λ]
 - b. Using **←**, **→**, **↑** and **↓** keys, set the wavelength to 1310nm.
 - c. Press **PARAM** key to display Time [t]
 - d. Using **←**, **→**, **↑** and **↓** keys, set the time to 200mS.

Performance Tests

Multirate Optical Interfaces

- e. Press **PARAM** key to display REF.
 - f. Using **←**, **→**, **↑** and **↓** keys, set the REF to 0.000 dBm.
 - g. Press **PARAM** key to display CAL.
 - h. Using **←**, **→**, **↑** and **↓** keys, set the CAL to 0.000 dBm.
 - i. Press the **ZERO** key on the Power Meter to calibrate - the Power Meter is now ready.
- 4 Press **MODE** to select the Power Level measurement on the HP 8153A.
 - 5 Press **TRANSMIT** | **SDH** or **SONET** | and select SIGNAL [STM-0 OPT] or [OC-1].
 - 6 Check the HP 8153A Power Meter reading is between +1 dBm \pm 2 dBm for a 37718A. Or is between -3 dBm and +2dBm (Typically +0 dBm) for a 37718B/C.
 - 7 Press **TRANSMIT** | **SDH** or **SONET** | and select SIGNAL [STM-1 OPT] or [OC-3].
 - 8 Check the HP 8153A Power Meter reading is between +1 dBm \pm 2 dBm for a 37718A. Or is between -3 dBm and +2dBm (Typically +0 dBm) for a 37718B/C.
 - 9 **37718A/B only.** Press **TRANSMIT** | **SDH** or **SONET** | and select SIGNAL [STM-4 OPT] or [OC-12].
 - 10 **37718A/B only.** Check the HP 8153A Power Meter reading is +1 dBm \pm 2 dBm for a 37718A. Or is between -3 dBm and +2dBm (Typically +0 dBm) for a 37718B/C.
 - 11 **37718A only.** Press **TRANSMIT** | **SDH** or **SONET** | and select SIGNAL [STM-16 OPT] or [OC-48].
 - 12 **37718A only.** Check the HP 8153A Power Meter reading is +1 dBm \pm 2 dBm for a 37718A.

Optical Receiver Sensitivity

- 13 Recall the OmniBER's default settings as shown on page 3-4.
- 14 Set the Optical Attenuator to ATTEN 15 dB, WAVELENGTH 1310 nm; CAL=0; ENB ON. Connect the Optical Attenuator between the Power Meter and the OmniBER's Optical Out port (ensure that all connections are tight and that the cable has no twists).
- 15 Press **TRANSMIT** | **SDH** or **SONET** | and select SIGNAL [STM-0 OPT] or [OC-1].
- 16 Adjust the Optical Attenuator to obtain a reading of -28 dBm on the Power Meter.
- 17 Recall the OmniBER's default settings as shown on page 3-4.

Performance Tests

Multirate Optical Interfaces

- 18 Disconnect the Optical Attenuator Output from the HP 8153A and connect to the OmniBER's Optical IN Port. Ensure all optical connectors are carefully cleaned before connections are made. Ensure that all connections are tight and that the cable has no twists.
- 19 Press **OTHER** then **SETTINGS CONTROL** and select TRANSMITTER AND RECEIVER [COUPLED].
- 20 Press **TRANSMIT** | **SDH** or **SONET** and select SIGNAL [STM-0 OPT] or [OC-1].
- 21 Press **RESULTS** **TROUBLE SCAN** then **RUN/STOP** to start a measurement.
- 22 After 5 minutes check that NO TROUBLE is displayed on the **RESULTS** display.
- 23 Repeat steps 16 through 22, substituting SIGNAL [STM-1 OPT] or [OC-3] in steps 18 & 23.
- 24 **37718A/B only.** Repeat steps 16 through 22, substituting SIGNAL [STM-4 OPT] or [OC-12] in steps 18 & 23. If 37718B/C then adjust the Optical Attenuator to obtain a reading of -28 dBm on the Power Meter
- 25 **37718A only.** Repeat steps 16 through 22, substituting SIGNAL [STM-16 OPT] or [OC-48] in steps 18 & 23.

PMP Electrical Input

- 26 Recall the OmniBER's default settings as shown on page 3-4.
- 27 Disconnect the optical cable from the OmniBER's Optical IN port and connect to the HP 11982A Lightwave Converter input.
- 28 Connect the output from the Lightwave Converter to the Oscilloscope using the SMA/BNC adaptor and 50 Ω BNC cable.
- 29 Press **TRANSMIT** | **SDH** or **SONET** and select SIGNAL [STM-0 OPT] or [OC-1].
- 30 Press **AUTOSCALE** on the Oscilloscope and adjust the Timebase and Range to obtain an STM-0/OC-1 waveform.
- 31 Measure the amplitude of the waveform using the Oscilloscope and adjust the Optical Attenuator until the amplitude is 150mV pk-pk.
- 32 Disconnect the output of the Lightwave Converter from the Oscilloscope and connect instead to the OmniBER's Optical Module Monitor input.

Performance Tests

Multirate Optical Interfaces

33 Press **RECEIVE** and set up the display as shown below.

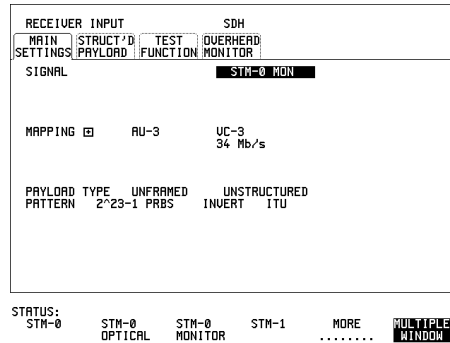

34 Press **RESULTS TROUBLE SCAN** then **RUN/STOP** to start the measurement.

35 After 5 minutes, check that NO TROUBLE is displayed on the **RESULTS** display. Press **RUN/STOP** to stop the measurement.

36 Recall the OmniBER's default settings as shown on page 3-4.

37 Repeat steps 28 to 36 but with [STM-1 OPT] or [OC-3] selected on the OmniBER's **TRANSMIT** and **RECEIVE** displays.

38 Recall the OmniBER's default settings as shown on page 3-4.

39 Repeat steps 28 to 36 but with [STM-4 OPT] or [OC-12] selected on the OmniBER's **TRANSMIT** and **RECEIVE** displays.

Procedure 1550 nm - Optical Power Output

40 Repeat steps 1 through 12 substituting 1550nm for 1310nm.

Optical Receiver Sensitivity

41 Repeat Steps 13 through 25 substituting 1550nm for 1310nm.

PDH Transmit/Receive Jitter Amplitude Accuracy

Specifications

Please refer to the PDH Tx/Rx Jitter Specifications given in the Specifications document provided.

Description

The OmniBER's Transmitter Unbalanced PDH Output is looped to the PDH Input and the signal is also monitored on the Spectrum Analyzer. The OmniBER's Jitter modulation frequency is set to a Jitter Amplitude/Frequency check point for the selected Bit Rate and the Spectrum Analyzer set to observe the displayed spectrum centered at this bit rate. The OmniBER's jitter Modulation amplitude is adjusted to the level at which a Bessel Null is expected, then fine-tuned to null the carrier. The jitter Amplitude (UI pk-pk) displayed on the OmniBER's Transmitter and Receiver are checked to ensure they meet specified limits. The test is repeated for various Jitter Amplitude/Frequency points for each Bit Rate.

Equipment Required

Spectrum Analyzer	: HP 8560E
Oscilloscope	: HP 54520A
75Ω/50Ω Matching Pad	: HP 11825B
75Ω Power Splitter	: SUHNER 4901.02A
Synthesizer	: HP 3335B Opt 001
75Ω Termination	: HP 15522-80010
Blocking Capacitor	: HP 10240B
75Ω/110Ω Unbal/Bal	: HP 15508B Qty 2

PDH Transmit/Receive Jitter Amplitude Accuracy

Procedure

- 1 Connect up the equipment as shown in Figure 3-6.

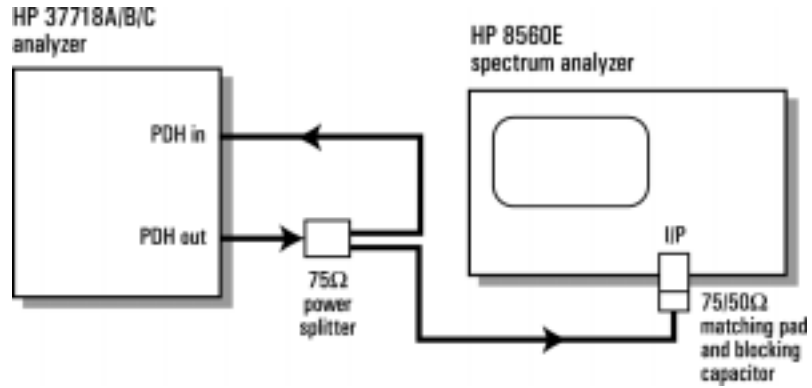
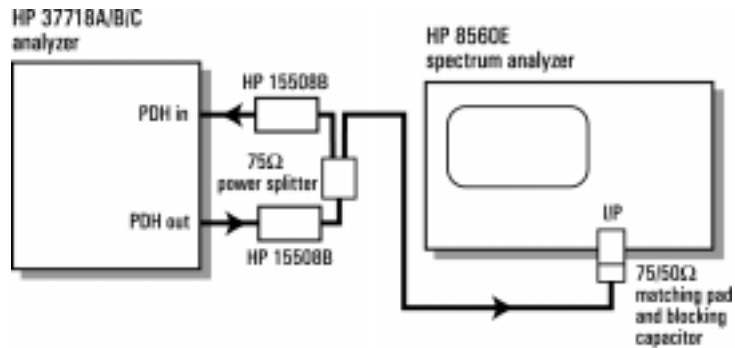

Figure 3-6 PDH Tx/Rx Jitter Test Setup



DS1 Set-up for Tx/Rx Jitter Amplitude Accuracy

- 2 Recall the OmniBER's default settings as shown on page 3-4.

Performance Tests

PDH Transmit/Receive Jitter Amplitude Accuracy

- 3 Set up the OmniBER's **OTHER** display as shown below.

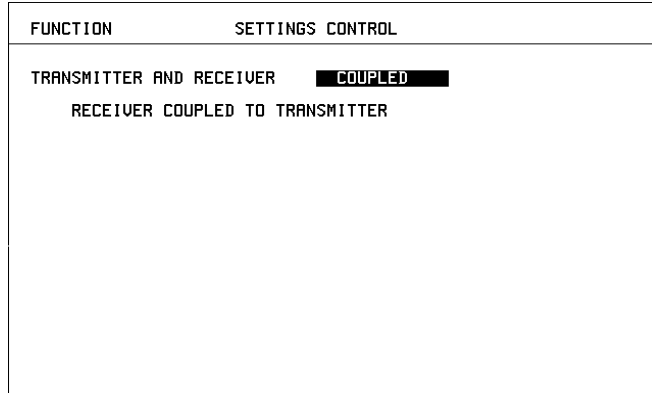

STATUS:
INDEP-
ENDENT COUPLED

MULTIPLE
WINDOW

Transmit/Receive Jitter Amplitude Accuracy, Ranges (10-20/1.6UIp-p)

- 4 Set up the OmniBER's **TRANSMIT** display as shown below.

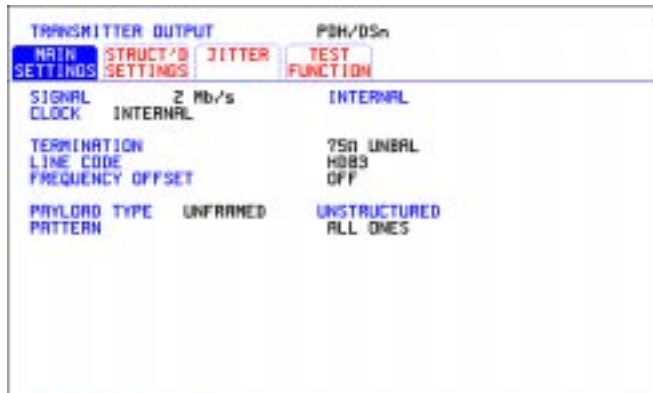

STATUS: **RES. AC. ON**

MULTIPLE
WINDOW

Performance Tests

PDH Transmit/Receive Jitter Amplitude Accuracy

- 5 Select TRANSMITTER OUTPUT SETTINGS [JITTER] and set up the display as shown below.

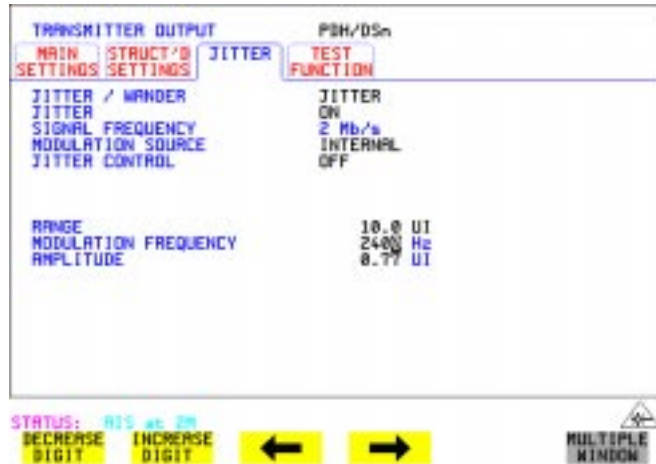

- 6 Select RECEIVER INPUT SETTINGS [JITTER] and set up as shown below.

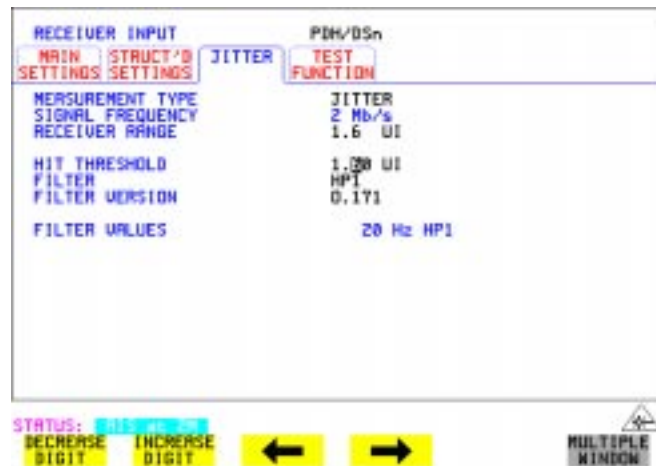

Performance Tests

PDH Transmit/Receive Jitter Amplitude Accuracy

- 7 Select **[RESULTS]** and set for PDH Jitter, Short Term. Set to Multiple Window to allow observation of TX/RX Jitter and Results pages.

TRANSMITTER OUTPUT		PDH/DSh	
MAIN	STRUCT'D	JITTER	TEST
SETTINGS	SETTINGS	FUNCTION	
JITTER / WANDER	JITTER		
JITTER	ON		
SIGNAL FREQUENCY	2 Mhz		
MODULATION SOURCE	INTERNAL		
JITTER CONTROL	OFF		
RANGE	10.0 UI		
MODULATION FREQUENCY	2400 Hz		
AMPLITUDE	0.77 UI		

RECEIVER INPUT		PDH/DSh	
MAIN	STRUCT'D	JITTER	TEST
SETTINGS	SETTINGS	FUNCTION	
MEASUREMENT TYPE	JITTER		
SIGNAL FREQUENCY	2 Mhz		
RECEIVER RANGE	1.6 UI		
HIT THRESHOLD	1.60 UI		
FILTER	HP1		
FILTER VERSION	0.171		
FILTER VALUES	20 Hz HP1		

RESULTS	JITTER	SHORT TERM
+VE PEAK	0.376UI	
-VE PEAK	0.376UI	
PEAK-PEAK	0.752UI	
RMS	0.266UI	
FILTERS	20 Hz HP1	
ELAPSED TIME	00d 00h 00m 42s	

FUNCTION	FLOPPY DISK
DISK OPERATION	SAVE
FILE TYPE	SCREEN DUMP
NAME	3 .BMP
BMP DIR : A:\	
BMP FILE: 3.BMP	
A:\	
LABEL: no label	FREE: 838656 Bytes

STATUS:	SHORT	AUTO	TRANSFER	
CUMUL	TERM	TOLER	FUNCTION	
ACTIVE				SINGLE
				WINDOW

- 8 Check the Receiver AIS Led is on.
- 9 Set the Spectrum Analyzer as follows:
 - Centre Frequency - 2048 kHz (set to bit rate being checked)
 - Frequency Span - 25 kHz (approx 10 times the jitter modulation frequency)
 - Reference Level - 0 dBm.
 - Sweep Time - Auto.
 - Video Bandwidth - Auto.
 - Resolution Bandwidth - Auto.

Performance Tests
PDH Transmit/Receive Jitter Amplitude Accuracy

TX/RX Jitter Accuracy Test Setup, Ranges (10-20/1.6 UIp-p)

- Adjust the OmniBER's jitter amplitude until the first **Bessel Null** is observed on the Spectrum Analyzer i.e first dip in the carrier level (see Figure 3-7).

Figure 7 Bessel Null Example

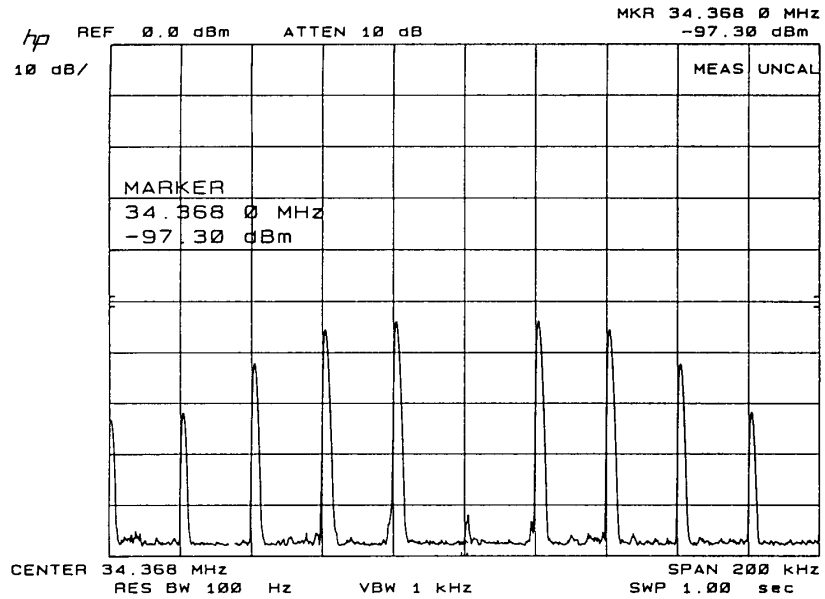

NOTE

Set the Spectrum Analyzer centre frequency to the bit rate being tested.

- Press RUN to start the measurement.
- Ensure the Jitter amplitude displayed on the OmniBER's Transmit and Receive displays are between the minimum and maximum limits given in Table 3-4.

Performance Tests
PDH Transmit/Receive Jitter Amplitude Accuracy

Table 3-4 Tx/Rx Jitter Amplitude Accuracy, Ranges (10-20/1.6 Ulp-p)

Bit Rate/ Center Frequency	Modulation Frequency	Nulled Jitter Amplitude (UI)	Minimum Jitter (UI)	Maximum Jitter (UI)	Minimum Jitter (UI)	Maximum Jitter (UI)
			TX	TX	RX	RX
2048kHz	2400Hz	0.77	0.69	0.83	0.711	0.829
8448kHz	10700Hz	0.77	0.69	0.83	0.706	0.834
34368kHz	4000Hz	0.77	0.69	0.83	0.706	0.834
139264kHz	4000Hz	0.77	0.68	0.84	0.706	0.834
1544kHz	500Hz	0.77	0.69	0.83	0.712	0.828
44736kHz	4000Hz	0.77	0.69	0.83	0.706	0.834

- 13 Press STOP to stop measurement.
- 14 Check the Jitter accuracy for each value in Table 3-4. In each case, set the OmniBER's Rate and Spectrum Analyzer Center Frequency to the value given in column 1 of the table (**Set the OmniBER's PATTERN to ALL ONES and JITTER AMPLITUDE to minimum after each change of Bit Rate**). Set the OmniBER's Jitter Modulation Frequency and Amplitude to the values given in columns 2 and 3 of the table. Fine-tune the amplitude to obtain the lowest carrier level on the Spectrum Analyzer display and check that the jitter amplitude displayed on the OmniBER's TX settings & RX results are between the limits given in columns 4 to 7 of Table 3-4.

Performance Tests

PDH Transmit/Receive Jitter Amplitude Accuracy

Transmit/Receive Jitter Amplitude Accuracy, Ranges (10-20/16 UIp-p)

15 Set up the OmniBER's **TRANSMIT** display as shown below.

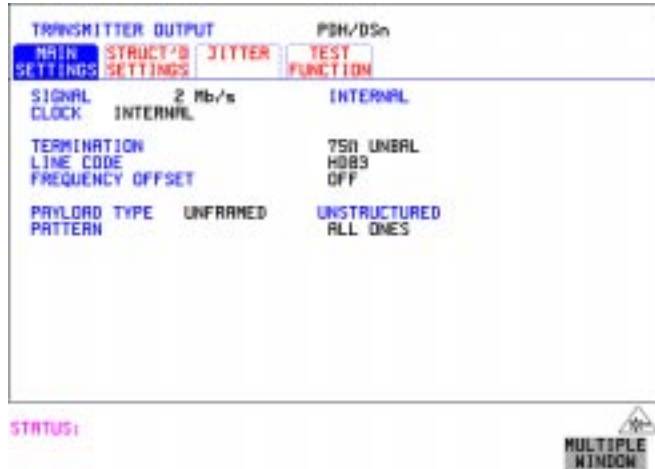

16 Select **TRANSMIT JITTER** and set up the display as shown below.

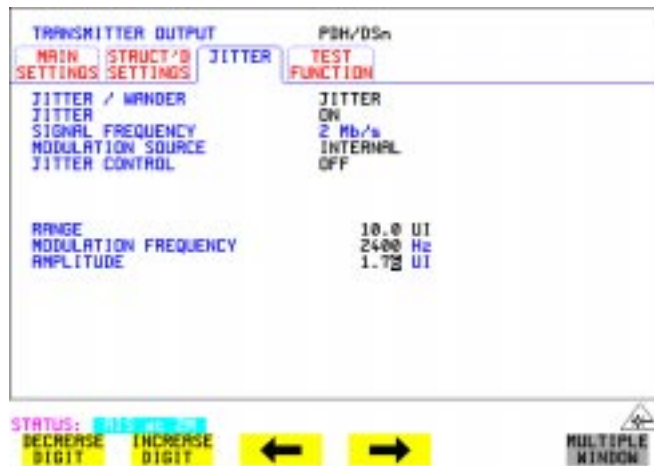

Performance Tests

PDH Transmit/Receive Jitter Amplitude Accuracy

- 17 Select RECEIVER INPUT SETTINGS [JITTER] and set up the display as shown below.

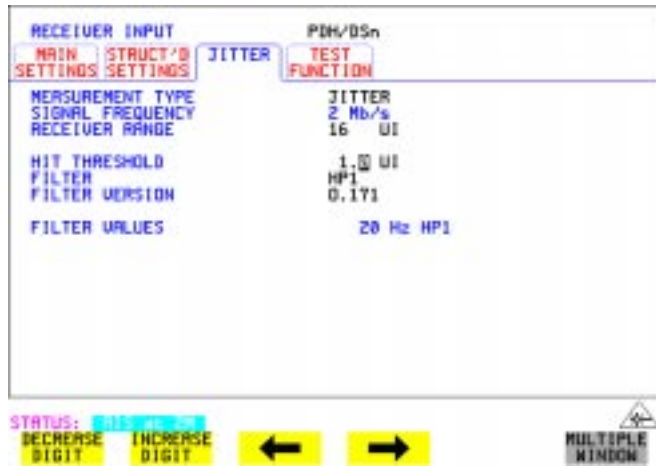

- 18 Select **[RESULTS]** and set for PDH Jitter, Short Term. (Timing Control, 1 Second, Manual). Set to Multiple Window to allow observation of TX/RX Jitter and Results pages.

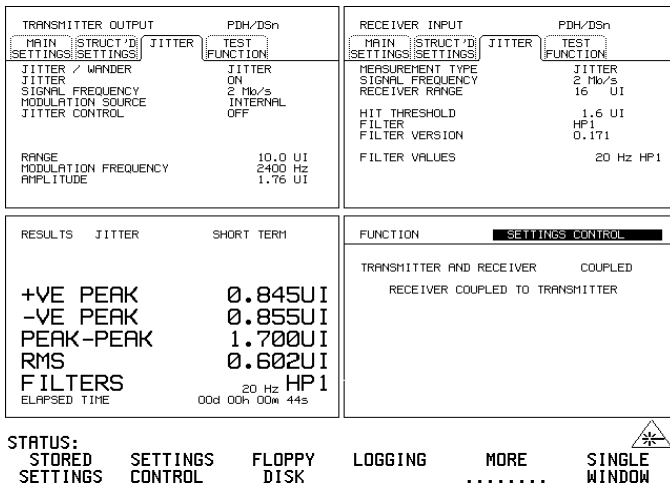

Performance Tests

PDH Transmit/Receive Jitter Amplitude Accuracy

- 19 Check the Receiver AIS Led is on. NOTE :- The hits led will also be on if the hits threshold on the jitter receiver is exceeded.
- 20 Set the Spectrum Analyzer as follows:
 - Centre Frequency - 2048 kHz
 - Frequency Span - 25 kHz
 - Reference Level - 0 dBm
 - Sweep Time - 1.0 s
 - Video Bandwidth - 1 kHz
 - Resolution Bandwidth - 100Hz
- 21 Adjust the OmniBER's jitter amplitude until the second **Bessel Null** is observed on the Spectrum Analyzer i.e second dip in the carrier level.
- 22 Ensure the Jitter amplitude displayed on the OmniBER's **TX** display is between the minimum and maximum limits given in Table 3-5.

NOTE

To optimize **Bessel Null** to check the Receiver Accuracy it is necessary to use an external modulation source to give better amplitude resolution. The OmniBER is set to accept External modulation source and the synthesizer is set to the same jitter frequency as used for Internal modulation and the level is fine adjusted to optimize the null point being checked.

- 23 Set the TX MODULATION SOURCE to EXTERNAL. Set the synthesizer to the jitter frequency being tested and set the level to achieve the null being tested. Check the Received Jitter Accuracy is within the limits in Table 3-5.
- 24 Return the TX MODULATION SOURCE to INTERNAL.
- 25 Check the Jitter accuracy for each value in Table 3-5. In each case, set the OmniBER's Rate and Spectrum Analyzer Center Frequency to the value given in column 1 of the table (**Set the OmniBER's PATTERN to ALL ONES and the JITTER AMPLITUDE to minimum after each change of Bit Rate**). Set the OmniBER's Jitter Modulation Frequency and Amplitude to the values given in columns 2 and 3 of the table. Fine-tune the amplitude to obtain the lowest carrier level on the Spectrum Analyzer display and check that the **TX** jitter amplitude displayed on the OmniBER is between the limits given in columns 4 and 5 of Table 3-5.

Performance Tests
PDH Transmit/Receive Jitter Amplitude Accuracy

Table 3-5 Range 10-20/16 Tx/Rx Jitter Amplitude Accuracy

Bit Rate/ Center Frequency	Modulation Frequency	Nulled Jitter Amplitude (UI)	Minimum Jitter (UI) TX	Maximum Jitter (UI) TX	Minimum Jitter (UI) RX	Maximum Jitter (UI) RX
2048kHz	2400Hz	1.76	1.67	1.85	1.587	1.933
2048kHz	2400Hz	4.76	4.52	5.00	4.377	5.143
2048kHz	2400Hz	8.76	8.32	9.20	8.097	9.423
8448kHz	10700Hz	1.76	1.67	1.85	1.587	1.933
8448kHz	10700Hz	5.76	5.47	6.05	5.307	6.213
8448kHz	10700Hz	8.76	8.32	9.20	8.097	9.423
34368kHz	4000Hz	2.76	2.62	2.90	2.517	3.003
34368kHz	4000Hz	6.76	6.42	7.10	6.237	7.283
34368kHz	4000Hz	8.76	8.32	9.20	8.097	9.423
139264kHz	4000Hz	3.76	3.57	3.95	3.447	4.073
139264kHz	4000Hz	7.76	7.37	8.15	7.167	8.353
139264kHz	4000Hz	8.76	8.32	9.20	8.097	9.423
1544kHz	500Hz	1.76	1.67	1.85	1.587	1.933
1544kHz	500Hz	4.76	4.52	5.00	4.377	5.143
1544kHz	500Hz	8.76	8.32	9.20	8.097	9.423
44736kHz	4000Hz	2.76	2.62	2.90	2.517	3.003
44736kHz	4000Hz	6.76	6.42	7.10	6.237	7.283
44736kHz	4000Hz	8.76	8.32	9.20	8.097	9.423

PDH Transmit/Receive Jitter Amplitude Accuracy

External Jitter Generation and Demod Output

- 1 Add the Synthesizer and Oscilloscope to the existing set-up as shown below.

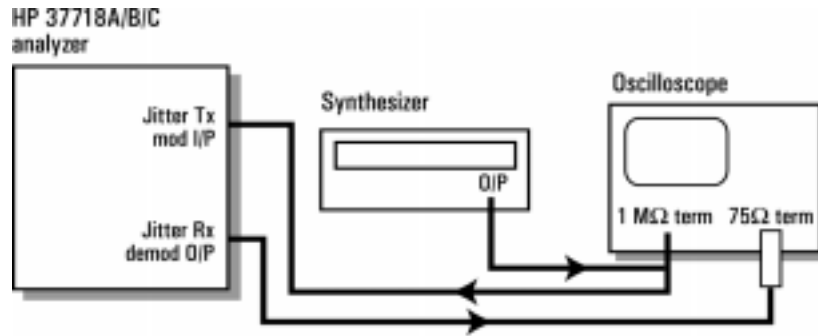
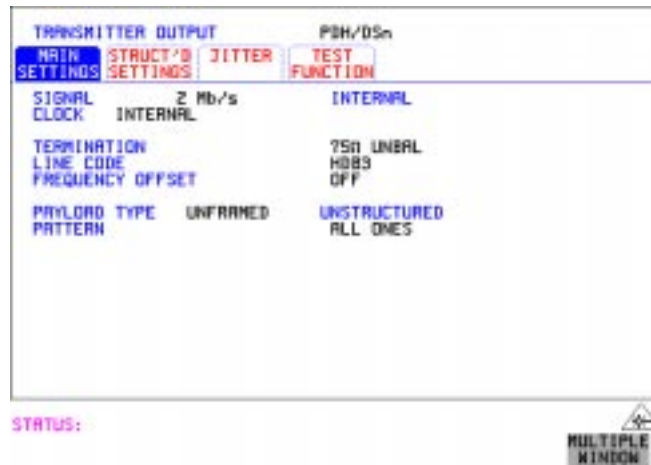

Figure 3-8 PDH External Jitter Generation and Demod Output Test Setup

- 2 Set up the OmniBER's **TRANSMIT** display as shown below.



Performance Tests

PDH Transmit/Receive Jitter Amplitude Accuracy

- 3 Select TRANSMITTER OUTPUT SETTINGS [JITTER] and set up the display as shown below.

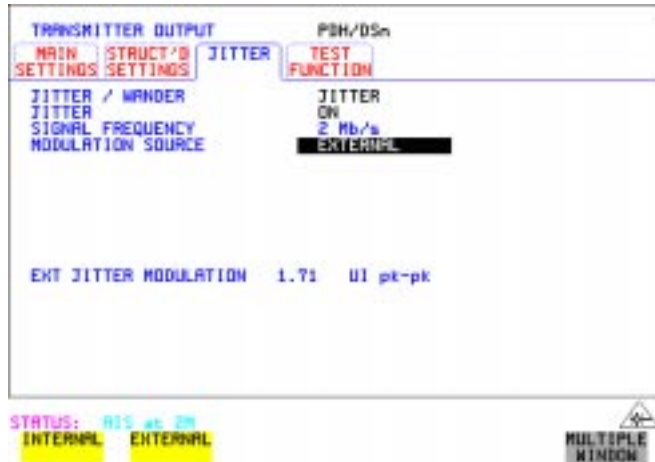

- 4 Select RECEIVER INPUT SETTINGS [JITTER] and set up as shown below:

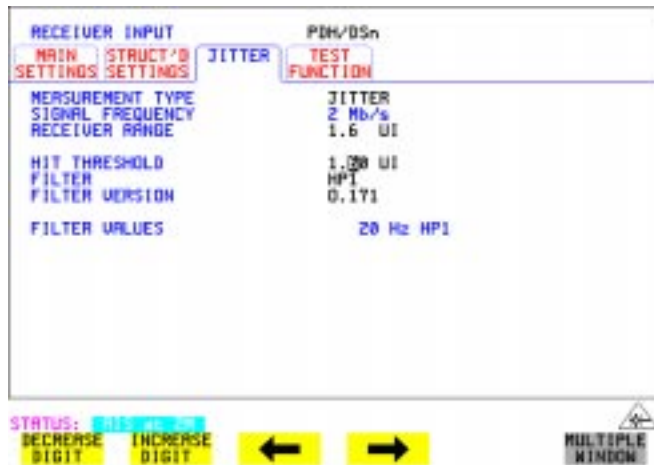

Performance Tests

PDH Transmit/Receive Jitter Amplitude Accuracy

- 5 Set the Spectrum Analyzer as follows:
 - Centre Frequency - 2048 kHz (set to bit rate being checked)
 - Frequency Span - 25 kHz (approx 10 times the jitter modulation frequency)
 - Reference Level - 0 dBm
 - Sweep Time - Auto
 - Video Bandwidth - Auto
 - Resolution Bandwidth - Auto
- 6 Set the Synthesizer to Frequency 10 kHz and minimum Output level.
- 7 Increase the Synthesizer output level until the first **Bessel Null** is observed on the Spectrum Analyzer.
- 8 Check that the Synthesizer amplitude waveform on the Oscilloscope is between 1.76V pk_pk and 2.84V pk_pk.
- 9 Check that the OmniBER's Demod Output amplitude waveform on the Oscilloscope is between 707 and 833mV pk_pk.

SDH Transmit/Receive Jitter Amplitude Accuracy

Specifications

Please refer to the SDH Tx/Rx Jitter Specifications given in the Specifications document provided.

Description

The OmniBER's Transmitter SDH Output is looped to the SDH Input and the signal is also monitored on the Spectrum Analyzer. The OmniBER's Jitter modulation frequency is set to a Jitter Amplitude/Frequency check point for the selected SDH Rate and the Spectrum Analyzer set to observe the displayed spectrum centered at half this bit rate. The OmniBER's jitter Modulation amplitude is adjusted to known modulation levels using **Carrier to Sideband Ratio**, **Bessel Null** and **Peak Deviation** methods for reference. The jitter Amplitude (UI pk-pk) displayed on the OmniBER's Transmitter and Receiver is checked to ensure it is within specified limits. The test is repeated for various Jitter Amplitude/Frequency points to check the TX and RX ranges.

The Optical SDH rates are tested in a similar way. In this case the OmniBER's Optical Transmit signal is split using an optical coupler. Part is looped back via an Optical Attenuator to the OmniBER's Receiver. The split signal is passed through an O/E Converter to provide an electrical version of the signal for Spectrum Analysis.

Because the SDH Data signal is scrambled this is switched off to observe the spectral components at half bit rate. A special Calibration test signal is selected which sets the output pattern to alternating 1/0.

Performance Tests
SDH Transmit/Receive Jitter Amplitude Accuracy

WARNING

Safety precautions must be observed when handling the OmniBER's Optical Modules as these generate laser signals which can cause injury. The guidelines below must be followed:

Check the connector configuration of the Fiber Optic Interfaces. If these are fitted with a connector interface other than FC/PC then remove the existing connector interface and fit the FC/PC connector interface.

Check for any damage to the OmniBER's Fiber Optic Interface spring loaded aperture covers and connectors. Do not power up the instrument if in any doubt about the integrity of these connectors.

Equipment Required

Spectrum Analyzer	: HP 8560E
Optical Coupler	: HP 15744C
O/E Converter	: HP 11982A
Optical Attenuator	: HP 8156A*
Synthesizer	: HP 3335B Opt 001
Oscilloscope	: HP 54520A
75Ω/50Ω Matching Pad	: HP 11825B
75Ω Power Splitter	: SUHNER 4901.02A
75Ω Termination	: HP 15522-80010
Blocking Capacitor	: HP 10240B

* Note the 15dB optical attenuator accessory E4546A (supplied with your instrument) is NOT suitable for this purpose.

- 1 Recall the OmniBER's default settings as shown on page 3-4.

Performance Tests

SDH Transmit/Receive Jitter Amplitude Accuracy

- 2 Set up the OmniBER's **OTHER** display as shown below.

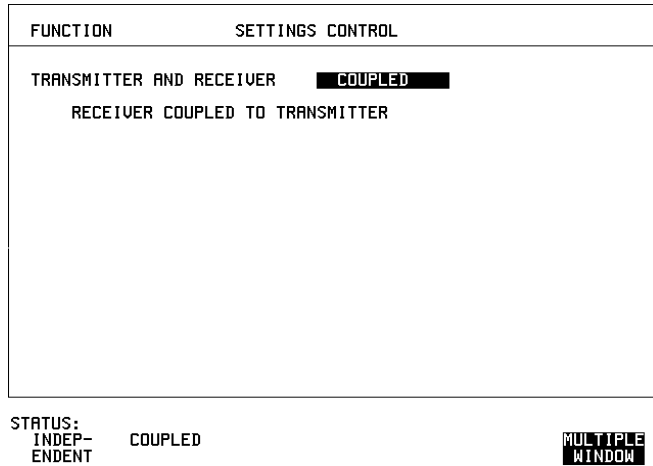

Procedure

STM-0e Electrical Transmit/Receive SDH Jitter Amplitude Accuracy

- 3 Connect up the equipment as shown in Figure 3-9.

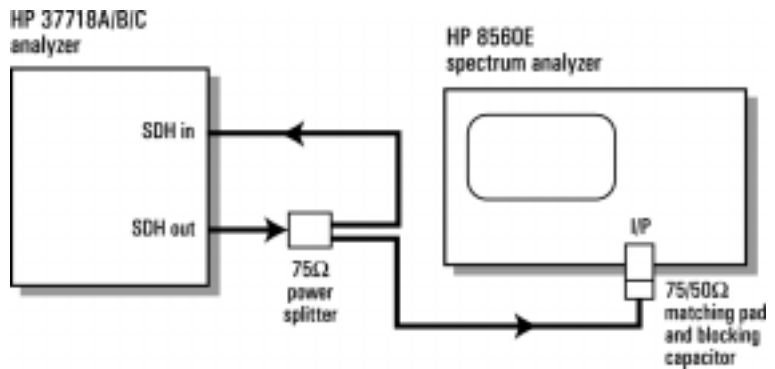
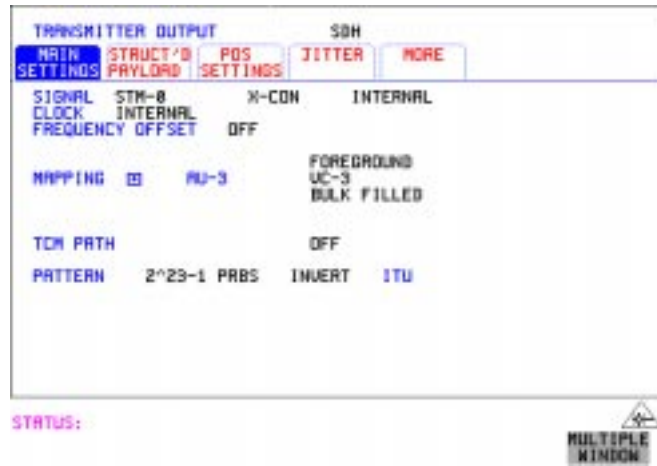

Figure 3-9 STM-0e Electrical Transmit/Receive Test Setup

Performance Tests

SDH Transmit/Receive Jitter Amplitude Accuracy

- 4 Select **TRANSMIT** and set up the OmniBER's display as shown below. Set up for STM-0 E CMI with bulk loading.



- 5 Select **TRANSMIT JITTER** and ensure Jitter is set to OFF.

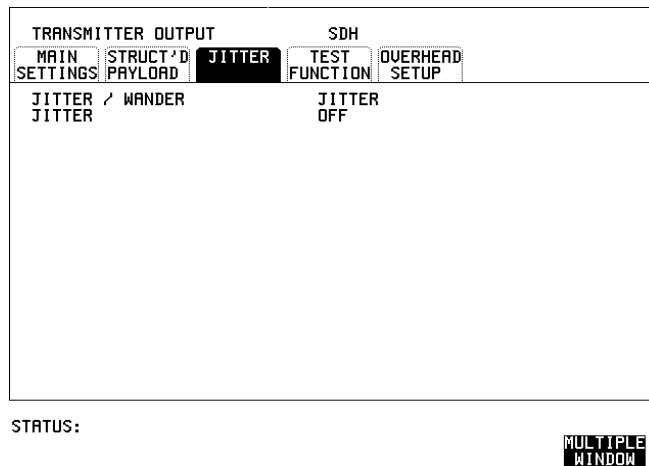

Performance Tests

SDH Transmit/Receive Jitter Amplitude Accuracy

- Select RECEIVER INPUT SETTINGS [JITTER] and set up as shown below.

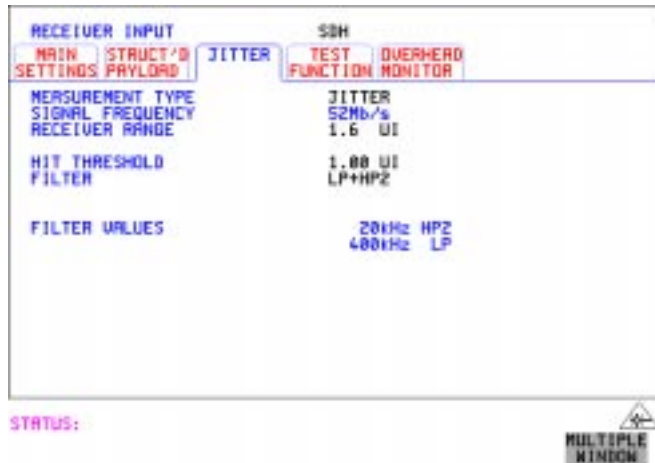

- Select **RESULTS** and set for SDH Jitter, Short Term. (Ensure the Timing Control is set for I Sec Manual)
 Set to Multiple Window to allow observation of TX/RX Jitter and Results pages.

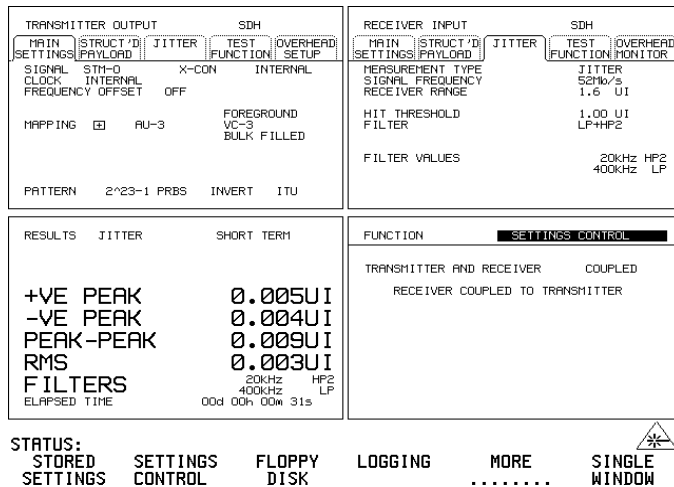

Performance Tests

SDH Transmit/Receive Jitter Amplitude Accuracy

- 8 Press RUN.
Check that there are no SDH result errors and that the Received Jitter results are:
< 0.050 UI p-p
- 9 Press STOP to halt measurement. Change Receiver Filter to LP+HP1. Press RUN and check that the Received Jitter results are:
< 0.050 UI p-p

Press STOP to halt measurement.

- 10 Select **OTHER** display and CALIBRATION and set up PATTERN to ALT as shown below.

FUNCTION	CALIBRATION
CALIBRATION ITEM	PATTERN
TX STM-0/1 ELECT. PATTERN	ALT

STATUS:
STORED SETTINGS SETTINGS CONTROL FLOPPY DISK LOGGING MORE **MULTIPLE WINDOW**

Note to access CALIBRATION pages you must enter code 1243 to gain access.

Note: Do not select or run any other **Calibration Items**.

NOTE

The receiver will show SDH errors, (LOF/OOF, PATTERN LOSS, AU-LOP), when pattern is set to ALT as there is no Framing etc. This calibration test pattern allows spectral monitoring of the jittered signal

Performance Tests

SDH Transmit/Receive Jitter Amplitude Accuracy

- 11 Select **TRANSMIT** **JITTER** and set up the display as shown below.

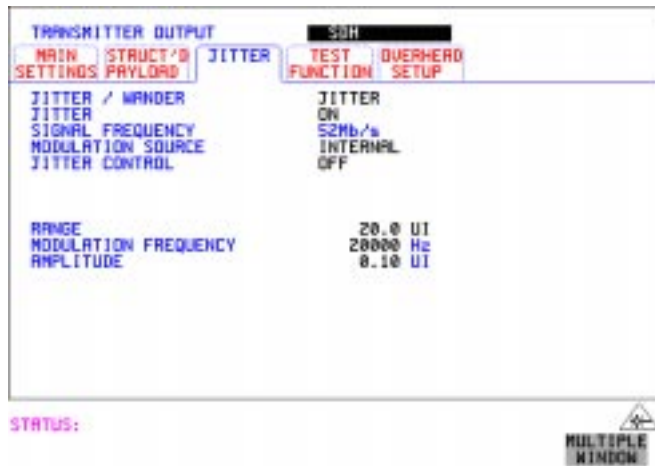

- 12 Set the Spectrum Analyzer as follows:

Centre Frequency - 25.92 MHz (half bit rate being tested)

e.g. 77.76 MHz for STM-1, 311.04 MHz for STM-4, 1.24416 GHz for STM-16.

Frequency Span - 100 kHz (set to approx 5 times the Jitter frequency in step 11)

Reference Level - approx -15dBm depends splitter/optical coupler & O/E converter used.

Sweep Time - Auto.

Video Bandwidth - Auto.

Resolution Bandwidth - Auto.

- 13 Increase the Jitter Amplitude from minimum until the **Carrier to Sideband Ratio** is nearest to -15.97dB. This should be at approx 0.20 UI p-p. Use the Spectrum Analyzer dB/Div and delta marker measurement to aid measurement. Note for STM-1e use - 22.07db = 0.10 UI p-p and for optical SDH rates use - 15.97db = 0.20 UI p-p.

Performance Tests
SDH Transmit/Receive Jitter Amplitude Accuracy

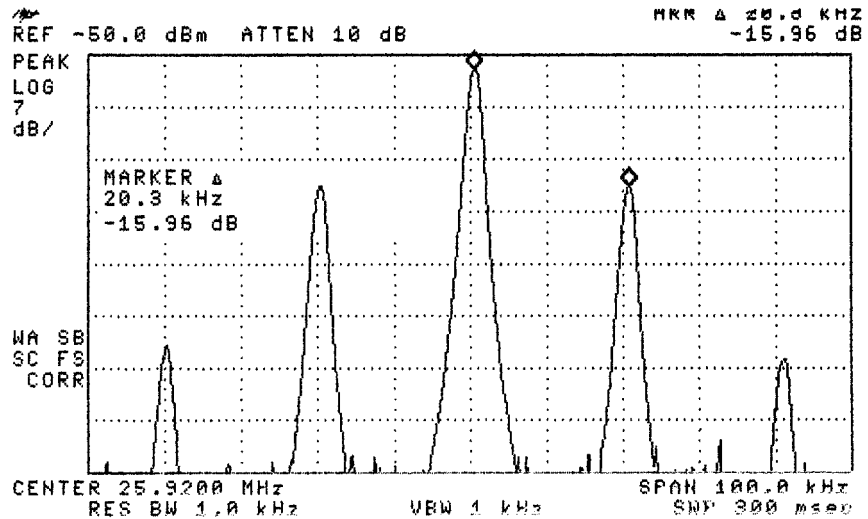

Figure 3-10 Carrier to Sideband Ratio Example

NOTE

Compensate the measurement if necessary to balance any difference between the upper and lower sideband amplitudes.

NOTE

To optimize amplitude for checking the Receiver Accuracy it may be necessary to use an external modulation source to give better amplitude resolution. Set the OmniBER to accept an External modulation source and set the synthesizer to the same jitter frequency as used for Internal modulation. Adjust the level from minimum until the Carrier/Sideband amplitude is within 0.10 dB of the required difference.

14 Set the Calibration Pattern to OFF. Check that there are no SDH errors.

15 Select **RESULTS**. Press RUN to start measurement.

Check the TX Jitter UI p-p setting is between 0.16 and 0.24 UI p-p

Check the RX Jitter results are between 0.125 and 0.275 UI p-p.

SDH Transmit/Receive Jitter Amplitude Accuracy

NOTE

If using Multiple Display window ensure RESULTS display is selected before running measurement.

- 16** Press STOP to halt measurement. Change Receiver Filter to LP+HP2.
- 17** Set the Calibration Pattern to ALT
- 18** Change the Jitter Frequency to 200 kHz and adjust the Spectrum Analyzer span to approx 5 times the Jitter frequency. Adjust the OmniBER's Transmit Jitter amplitude if necessary for a **Carrier to Sideband Ratio** is nearest to -15.97dB. This should be at approx 0.20 UI p-p. Use the Spectrum Analyzer dB/Div and delta marker measurement to aid measurement. Note for STM-1e use - 22.07db = 0.10 UI p-p and for optical SDH rates use - 15.97db = 0.20 UI p-p.
- 19** Set the Calibration Pattern to OFF. Check that there are no SDH errors.
- 20** Select **RESULTS** . Press RUN to start measurement.
Check the TX Jitter UI p-p setting is between 0.16 and 0.24 UI p-p
Check the RX Jitter results are between 0.125 and 0.275 UI p-p.
Press STOP to halt measurement.
- 21** Set the Calibration Pattern to ALT
- 22** Change the Jitter Frequency to 2.0 kHz and adjust the Spectrum Analyzer span to approx 3 times the Jitter frequency.
- 23** Adjust the OmniBER's jitter amplitude (approximately 0.91 UI) and adjust until the Carrier and first sidebands observed on the Spectrum Analyzer are the same amplitude within 0.10 dB (see Figure 3-11).

Performance Tests
SDH Transmit/Receive Jitter Amplitude Accuracy

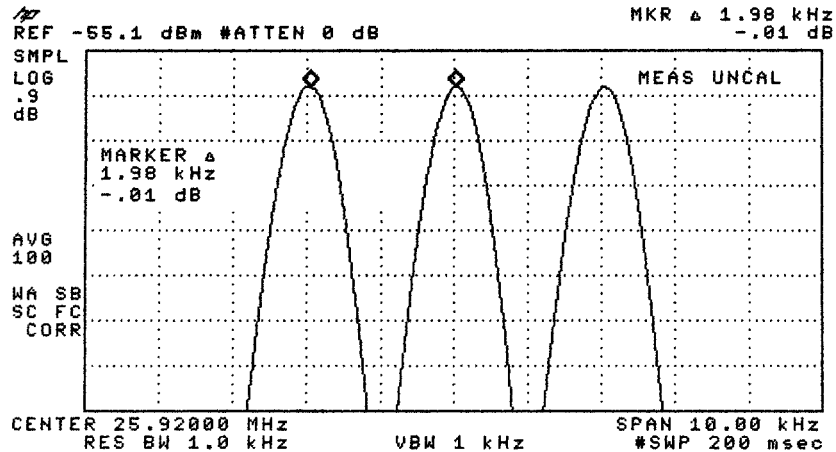

Figure 3-11 Carrier/Sideband Equal Example

NOTE

Note: Use Spectrum Analyzer dB/Div to improve Marker Resolution as necessary.

- 24 Set the Calibration Pattern to OFF. Check that there are no SDH errors.
- 25 Set Receiver Filter to LP+HP1. Select RESULTS. Press RUN to start measurement.
Check the TX Jitter UI p-p setting is between 0.82 and 1.00 UI p-p
Check the RX Jitter results are between 0.796 and 1.024 UI p-p.
Press STOP to halt measurement.
- 26 Set the Calibration Pattern to ALT.
- 27 Change the Receiver Range to 16UI.
- 28 Change the Jitter Frequency to 1 kHz and adjust the Spectrum Analyzer span to approx 5 times the Jitter frequency.
- 29 Adjust the OmniBER's jitter amplitude (approximately 3.52 UI) until the 2nd **Bessel Null** is observed on the Spectrum Analyzer i.e 2nd dip in the carrier level (see Figure 3-12).

Performance Tests
SDH Transmit/Receive Jitter Amplitude Accuracy

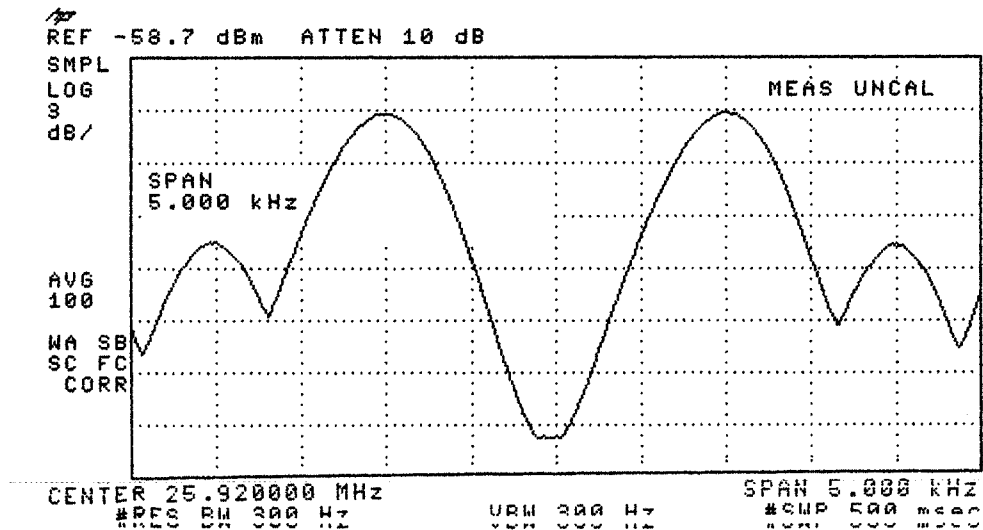

Figure 12 Second Bessel Null Example

- 30 Set the Calibration Pattern to OFF. Check that there are no SDH errors.
 NOTE :- The hits led will be on if the hits threshold on the jitter receiver is exceeded.
- 31 Ensure the Receiver Filter to LP+HP1. Select **RESULTS** . Press RUN to start the measurement.
 Check the TX Jitter UI p-p setting is between 3.30 and 3.74 UI p-p
 Check the RX Jitter results are between 3.174 and 3.866 UI p-p.
 Press STOP to halt measurement.
- 32 Set the Calibration Pattern to ALT
- 33 Change the Jitter Frequency to 800 Hz and adjust the Spectrum Analyzer span to approx 5 times the Jitter frequency.
- 34 Adjust the OmniBER's jitter amplitude (approximately 7.52 UI) until the 4th **Bessel Null** is observed on the Spectrum Analyzer i.e 4th dip in the carrier level (see Figure 3-10). For STM-1 use 7.52 4th null, STM-4 use 11.52 UI, 6th null. For STM-16 use 9.52 UI, 5th null.

Performance Tests

SDH Transmit/Receive Jitter Amplitude Accuracy

- 35 Set the Calibration Pattern to OFF. Check that there are no SDH errors.
- 36 Set the Receiver Filter to LP+HP1. Select **RESULTS** . Press RUN to start the measurement.
Check the TX Jitter UI p-p setting is between 7.10 and 7.94 UI p-p.
Check the RX Jitter results are between 6.756 and 8.164 UI p-p.
- 37 Press STOP to halt measurement.
- 38 Set the Calibration Pattern to ALT
- 39 Change the Transmit Jitter Range to LF 20 UI and Receiver Measurement Type to EXTENDED.
- 40 Change the Jitter Frequency to 50Hz and Jitter Amplitude to 20UI p-p.

NOTE

Set the Spectrum Analyzer Span to approx 7 kHz and adjust Bandwidth & Sweep Time controls as necessary. Measure the peak to peak deviation of the carrier using markers. Adjust the Jitter Amplitude until the deviation at the amplitude peaks is 2.90 ± 0.07 kHz.

NOTE

It may be necessary to use an external modulation source to give better amplitude resolution to optimise the measurement . The OmniBER is set to accept External modulation source and the synthesizer is set to the same jitter frequency as used for Internal modulation and the level is fine adjusted to the desired frequency span.

Performance Tests
SDH Transmit/Receive Jitter Amplitude Accuracy

Figure 3-13 Peak Deviation Example

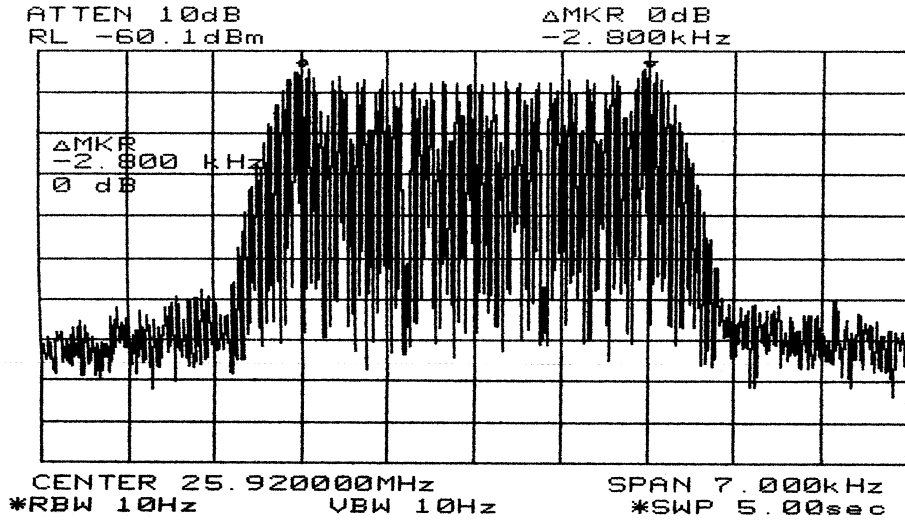

	Centre Freq	Span	BW	Sweep	Δ Freq kHz
For STM-1	77.76 MHz	7 kHz	10 Hz	8 seconds	4.95 +/-0.5
For STM-4	311.04 MHz	24 kHz	10 Hz	12 seconds	20.3 ±0.25
For STM-16	1.24416 GHz	90 kHz	10 Hz	33 seconds	82.3 ±0.5

41 Set the Calibration Pattern to OFF. Check that there are no SDH errors

42 Select **[RESULTS]**. Press RUN to start measurement.
 Check the Transmit Display is between 18.80 and 21.20 UI p-p
 Check the RX Jitter results are between 18.550 and 21.450 UI p-p.
 Press STOP to halt measurement.

43 Set Jitter to OFF.

SDH Transmit/Receive Jitter Amplitude Accuracy

STM-1 electrical

44 Repeat steps 6 to 43 using the information in the Table below for STM-1 electrical

STEP	TX Range	RX Range	RX Filter	Tx UI p-p	Tx Freq	TX Result MIN p-p	TX Result MAX p-p	RX Result MIN p-p	RX Result MAX p-p
6-8	OFF	1.6UI	LP+HP2	OFF	OFF	OFF	OFF	N/A	0.050
9	OFF	1.6UI	LP+HP1	OFF	OFF	OFF	OFF	N/A	0.050
13-15	20	1.6UI	LP+HP1	0.1	65 kHz	0.06	0.14	0.043	0.157
16-20			LP+HP2		650 kHz	0.06	0.14	0.043	0.157
22-25			LP+HP1	0.91	6.5K	0.82	1.00	0.796	1.024
27-31		16UI		3.52	4K	3.30	3.74	3.174	3.866
33-37				7.52	2.5 kHz	7.10	7.94	6.756	8.164
39-43	50	64	FIXED	33	50Hz	30.82	35.18	28.35	37.65

Optical Transmit/Receive SDH Jitter Accuracy

45 Connect the equipment as shown below.

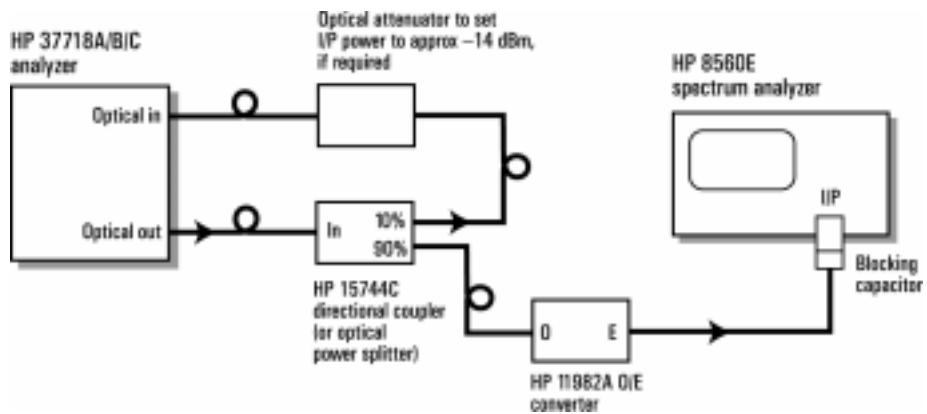
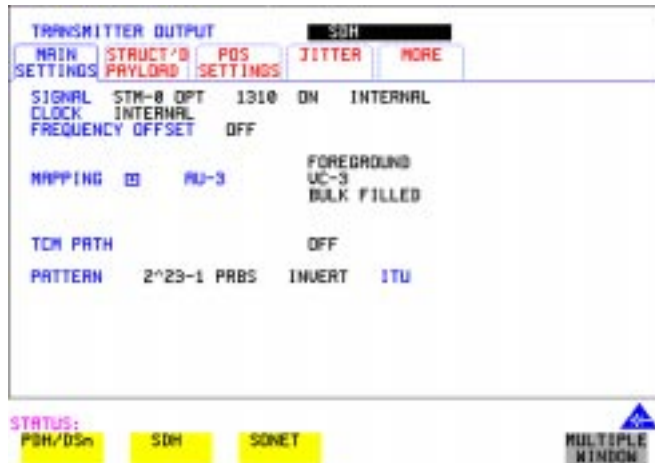

Figure 3-14 Optical Transmit/Receive SDH Jitter Test Setup

Performance Tests

SDH Transmit/Receive Jitter Amplitude Accuracy

46 Set up the OmniBER's **TRANSMIT** display as shown below.



NOTE

Use the available wavelength 1310/1550nm. Where both are fitted select 1310nm.

47 Select **TRANSMIT** **JITTER** and ensure Jitter is set to OFF and Calibration Pattern is set to OFF.

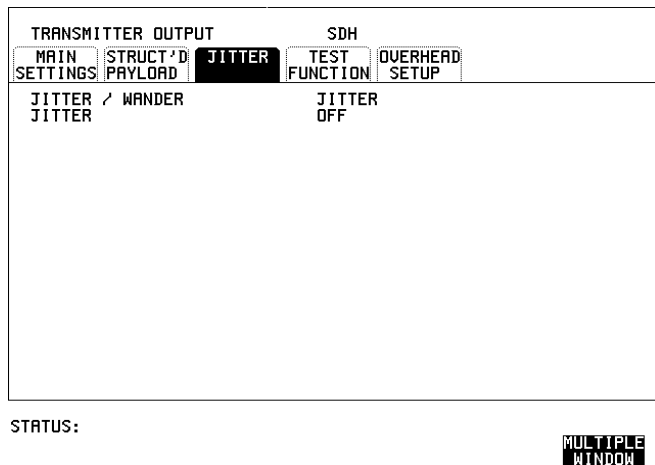

Performance Tests

SDH Transmit/Receive Jitter Amplitude Accuracy

- 48** Check the Optical Power measurement Results and adjust the Optical Attenuation as necessary for Received optical power within the BER & JITTER range. Record the Optical power reading.

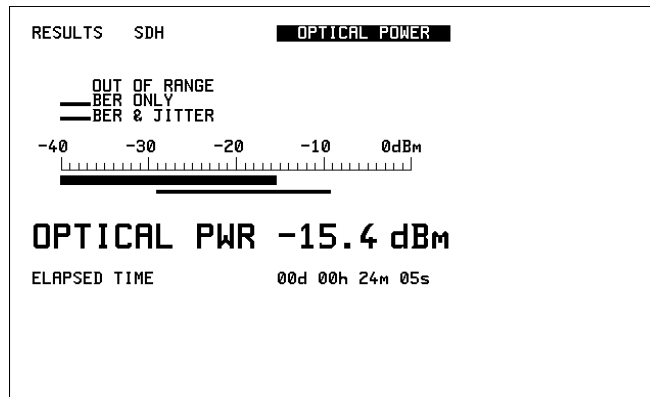

STATUS:
OPTICAL
POWER

MORE **MULTIPLE WINDOW**
.....

STM-0 Optical

- 49** Repeat steps 6 to 43 using the information in the Table below for STM-0 Optical Rate.

STEP	TX Range	RX Range	RX Filter	Tx UI p-p	Tx Freq	TX Result MIN p-p	TX Result MAX p-p	RX Result MIN p-p	RX Result MAX p-p
6-8	OFF	1.6UI	LP+HP2	OFF	OFF	OFF	OFF	N/A	0.050
9	OFF	1.6UI	LP+HP1	OFF	OFF	OFF	OFF	N/A	0.050
13-15	20	1.6UI	LP+HP1	0.2	20 kHz	0.16	0.24	0.125	0.275
16-20			LP+HP2		200 kHz	0.16	0.24	0.125	0.275
22-25			LP+HP1	0.91	2.0 kHz	0.82	1.00	0.796	1.024
27-31		16UI		3.52	1.0 kHz	3.30	3.74	3.174	3.866
33-37				7.52	800 Hz	7.10	7.94	6.756	8.164
39-43	LF 20	64	FIXED	20	50Hz	18.80	21.20	18.55	21.45

Performance Tests

SDH Transmit/Receive Jitter Amplitude Accuracy

STM-1 Optical

50 Repeat steps 6 to 43 using the information in the Table below for STM-1 Optical Rate.

STEP	Tx Range	RX Range	RX Filter	Tx UI p-p	Tx Freq	TX Result MIN p-p	TX Result MAX p-p	RX Result MIN p-p	RX Result MAX p-p
6-8	OFF	1.6UI	LP+HP2	OFF	OFF	OFF	OFF	N/A	0.050
9	OFF	1.6UI	LP+HP1	OFF	OFF	OFF	OFF	N/A	0.050
13-15	20	1.6UI	LP+HP1	0.2	65 kHz	0.16	0.24	0.125	0.275
16-20			LP+HP2		650 kHz	0.16	0.24	0.125	0.275
22-25			LP+HP1	0.91	6.5K	0.82	1.00	0.796	1.024
27-31		16UI		3.52	4K	3.30	3.74	3.174	3.866
33-37				7.52	2.5 kHz	7.10	7.94	6.756	8.164
39-43	50	64	FIXED	33	50Hz	30.82	35.18	28.35	37.65

STM-4 Optical

51 Change Transmit/Receive Rate to STM-4 Optical with AU4-4C Mapped Bulk Filled 2²³ PRBS Payload. Check and adjust the optical power as necessary. Ensure Jitter is OFF and Calibration Pattern is OFF, then repeat steps 6 to 43 using the information in the Table below for STM-4.

STEP	Tx Range	RX Range	RX Filter	Tx UI p-p	Tx Freq	TX Result MIN p-p	TX Result MAX p-p	RX Result MIN p-p	RX Result MAX p-p
6-8	OFF	1.6UI	LP+HP2	OFF	OFF	OFF	OFF	N/A	0.070
9	OFF	1.6UI	LP+HP1	OFF	OFF	OFF	OFF	N/A	0.070
13-15	20	1.6UI	LP+HP1	0.2	250K	0.15	0.25	0.116	0.284
16-20			LP+HP2		2.5M	0.15	0.25	0.111	0.291
22-25			LP+HP1	0.91	25K	0.82	1.00	0.776	1.044
27-31		16UI		3.52	10K	3.30	3.74	3.174	3.866
33-37				11.52	5K	10.90	12.14	10.401	12.426
39-43	200	256	FIXED	132	50Hz	124.37	139.63	113.40	150.60

Performance Tests

SDH Transmit/Receive Jitter Amplitude Accuracy

STM-16 Optical

52 .Change Transmit/Receive Rate to STM-16 Optical with AU4-16C Mapped Bulk Filled 2²³ PRBS Payload. Check and adjust the optical power as necessary. Ensure Jitter is OFF and Calibration Pattern is OFF, then repeat steps 6 to 43 using the information in the Table below for STM-16.

STEP	Tx Range	RX Range	RX Filter	Tx UI p-p	Tx Freq	TX Result MIN p-p	TX Result MAX p-p	RX Result MIN p-p	RX Result MAX p-p						
6-8	OFF	1.6UI	LP+HP2	OFF	OFF	OFF	OFF	N/A	0.070						
9	OFF	1.6UI	LP+HP1	OFF	OFF	OFF	OFF	N/A	0.070						
13-15	20	1.6UI	LP+HP1	0.2	1M	0.14	0.26	0.114	0.286						
16-20			LP+HP2		10 M					0.13	0.27	0.100	0.300		
22-25			LP+HP1		0.91					100K	0.81	1.01	0.795	1.026	
27-31			64UI							3.52	50K	3.29	3.75	3.124	3.916
33-37											9.52	25K	8.99	10.05	8.53
39-43	800	1024	FIXED	528	50Hz	499.60	556.40	451.60	604.40						

53 In the case of dual wavelength option units set to the alternative wavelength (1550nm) and repeat steps 6-9 for each rate.

SDH Transmit/Receive Jitter Amplitude Accuracy

External Jitter Generation and Demod Output

- 1 Add the Synthesizer and Oscilloscope to the set-up as shown below.

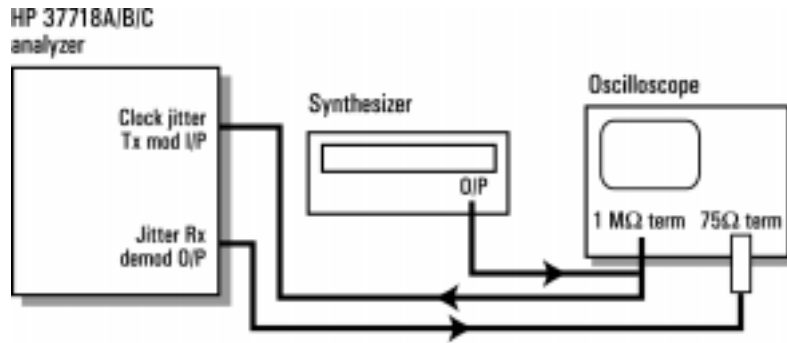
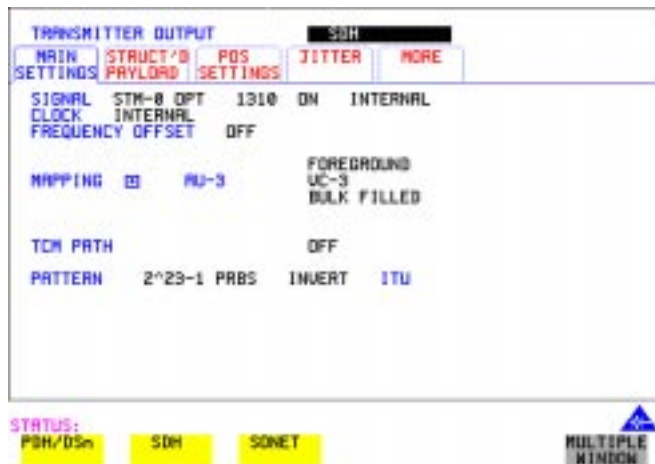

Figure 15 SDH External Jitter Generation and Demod Output Test Setup

- 2 Set up the OmniBER's **TRANSMIT** display as shown below.



Performance Tests

SDH Transmit/Receive Jitter Amplitude Accuracy

- 3 Select TRANSMITTER OUTPUT SETTINGS **JITTER** and set up the display as shown below.

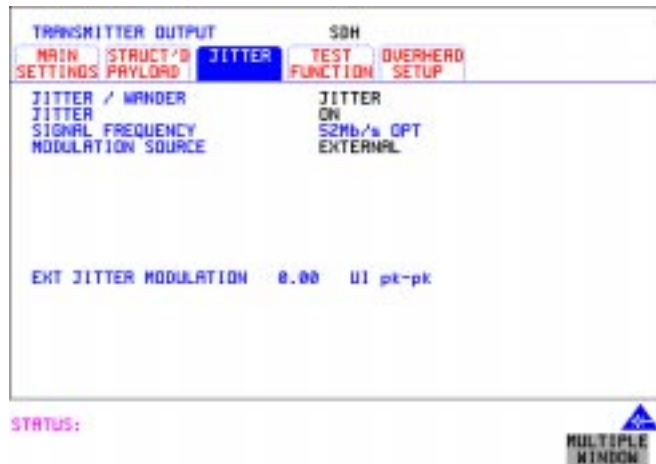

- 4 Select RECEIVER INPUT SETTINGS **JITTER** and set up the display as shown below.

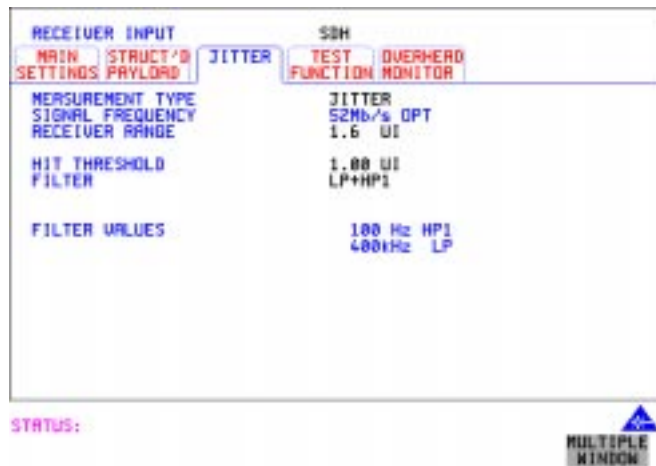

Performance Tests

SDH Transmit/Receive Jitter Amplitude Accuracy

- 5** Set the Calibration Pattern to ALT.
- 6** Set the Spectrum Analyzer as follows:
 - Centre Frequency - 25.92 MHz (half bit rate being tested)
 - Frequency Span - 30 kHz (approx 3 times the Jitter frequency)
 - Reference Level - approx -15dBm
 - Sweep Time - Auto
 - Video Bandwidth - Auto
 - Resolution Bandwidth - Auto
- 7** Set the Synthesizer to Frequency 10 kHz and minimum Output level.
- 8** Increase the Synthesizer output level until the Carrier and first sidebands are equal as observed on the Spectrum Analyzer (see Figure 3-11).
- 9** Check that the Synthesizer amplitude waveform on the Oscilloscope is between 364 and 546 mV pk_pk.
- 10** Check that the OmniBER's Demod Output amplitude waveform on the Oscilloscope is between 756 mV and 1.075 V pk_pk.
- 11** Set the Calibration Pattern to OFF and set Jitter to OFF.

Performance Tests

SDH Transmit/Receive Jitter Amplitude Accuracy

Performance Tests
Performance Test Record

Performance Test Record

OmniBER 718	
Multirate Communications Performance Analyzer	
Location:	Serial No.:
Tested by:	Options:
Temperature:	Certified by:
Humidity:	Date:

Note the test steps applicable are dependent on the instrument options and bit rates available.
 Enter N/A if a test does not apply for your instrument

Performance Test Record

Page No.	Test Description		Result		
			Min	Actual	Max
3-5	Self Test				
3-6	Step 3	Confidence Tests		Pass/Fail	
3-7	Step 4	All Tests		Pass/Fail	
3-8	Step 3	1550 nm Tests		Pass/Fail	
3-9	Step 3	DCC Tests		Pass/Fail	
3-10	PDH/DSn Internal Transmitter Clock Accuracy & Offset				
3-11	Step 4:	2 Mb/s	1.023995 MHz		1.024005 MHz
	Step 6:	2 Mb/s +50 ppm	1.0240465 MHz		1.0240555 MHz
	Step 8:	2 Mb/s -50 ppm	1.023944 MHz		1.023953 MHz
3-12	Step 10:	8 Mb/s	4.223981 MHz		4.224019 MHz
	Step 12:	8 Mb/s +30 ppm	4.2241075 MHz		4.2242915 MHz
	Step 14:	8 Mb/s -30 ppm	4.223854 MHz		4.223892 MHz
3-12	Step 16:	34 Mb/s	17.18389227 MHz		17.1840774 MHz

Performance Tests
Performance Test Record

Performance Test Record , continued

Page No.	Test Description		Result		
			Min	Actual	Max
	Step 18:	34 Mb/s +20ppm	17.184266 MHz		17.184421 MHz
	Step 20:	34 Mb/s -20ppm	17.183579 MHz		17.183734 MHz
	Step 22:	34 Mb/s +100ppm	17.185641 MHz		17.185796 MHz
	Step 24:	34 Mb/s -100ppm	17.182205 MHz		17.182359 MHz
3-13	Step 26:	140 Mb/s	69.6316865 MHz		69.6323185 MHz
	Step 28:	140 Mb/s +15ppm	69.632731 MHz		69.633358 MHz
	Step 30:	140 Mb/s -15ppm	69.630642 MHz		69.631269 MHz
	Step 33:	1.544 Mb/s	1.543993 MHz		1.544007 MHz
	Step 35:	1.544 Mb/s +32ppm	1.544042 MHz		1.544056 MHz
	Step 37:	1.544 Mb/s -32ppm	1.543944 MHz		1.543958 MHz
3-14	Step 40:	44.736 Mb/s	44.735799 MHz		44.736201 MHz
	Step 42:	44.736 Mb/s +20ppm	44.736693 MHz		44.737096 MHz
	Step 44:	44.736 Mb/s -20ppm	44.734904 MHz		44.735307 MHz
3-15	PDH/DSn Transmitter Output				
3-16		139.264Mb/s (E4)			
	Step 7:	All 1's Pulse		Pass/Fail	
	Step 8:	Pulse amplitude		Pass/Fail	
3-18	Step 12:	All 0's Pulse		Pass/Fail	
	Step 13:	Pulse amplitude		Pass/Fail	
3-20		34.368Mb/s (E3)			
	Step 7:	+ve Pulse		Pass/Fail	
	Step 8:	+ve Pulse amplitude		Pass/Fail	
	Step 12:	-ve Pulse		Pass/Fail	
	Step 13:	-ve Pulse amplitude		Pass/Fail	
3-22		8.448Mb/s (E2)			

Performance Tests
Performance Test Record

Performance Test Record , continued

Page No.	Test Description		Result		
			Min	Actual	Max
	Step 7	+ve Pulse		Pass/Fail	
	Step 8:	+ve Pulse amplitude		Pass/Fail	
	Step 12:	-ve Pulse		Pass/Fail	
	Step 13:	-ve Pulse amplitude		Pass/Fail	
3-24		2.048Mb/s (E1)			
	Step 7:	+ve Pulse		Pass/Fail	
	Step 8:	+ve Pulse amplitude		Pass/Fail	
	Step 12:	-ve Pulse		Pass/Fail	
	Step 13:	-ve Pulse amplitude		Pass/Fail	
3-26		44.736Mb/s (DSX3)			
	Step 7:	+ve Pulse		Pass/Fail	
	Step 8:	+ve Pulse amplitude		Pass/Fail	
	Step 12:	-ve Pulse		Pass/Fail	
	Step 13:	-ve Pulse amplitude		Pass/Fail	
	Step 14:	High amplitude		Pass/Fail	
	Step 15:	Low amplitude		Pass/Fail	
3-29		1.544Mb/s (DSX1)			
	Step 8:	+ve Pulse		Pass/Fail	
	Step 9:	+ve Pulse amplitude		Pass/Fail	
	Step 13:	-ve Pulse		Pass/Fail	
	Step 14:	-ve Pulse amplitude		Pass/Fail	
	Step 15:	Low amplitude		Pass/Fail	
3-33	PDH/DSn Receiver Equalization				
3-34	Step 6:	139.264 Mb/s (E4)		Pass/Fail	

Performance Tests
Performance Test Record

Performance Test Record , continued

Page No.	Test Description		Result		
			Min	Actual	Max
3-35	Step 11:	34.368 Mb/s (E3)		Pass/Fail	
3-36	Step 16:	44.736 Mb/s (DS3)		Pass/Fail	
3-37	Step 21:	8.448 Mb/s (E2)		Pass/Fail	
3-38	Step 26:	2.048 Mb/s (E1)		Pass/Fail	
3-39	Step 31:	1.544 Mb/s (DS1)		Pass/Fail	
3-40	PDH/DSn Receiver Monitor Levels				
3-41		2.048Mb/s (E1)			
	Step 5:	20 dB		Pass/Fail	
	Step 10:	20 dB & Equalization		Pass/Fail	
	Step 14:	26 dB & Equalization		Pass/Fail	
	Step 18:	26 dB		Pass/Fail	
	Step 22:	30 dB		Pass/Fail	
	Step 26:	30 dB & Equalization		Pass/Fail	
3-44		8.448Mb/s (E2)			
	Step 27:	20 dB		Pass/Fail	
	Step 27:	20 dB & Equalization		Pass/Fail	
	Step 27:	26 dB & Equalization		Pass/Fail	
	Step 27:	26 dB		Pass/Fail	
	Step 27:	30 db		Pass/Fail	
	Step 27:	30 dB & Equalization		Pass/Fail	
3-44		34.368Mb/s (E3)			
	Step 28:	20 dB		Pass/Fail	
	Step 28:	20 dB & Equalization		Pass/Fail	
	Step 28:	26 dB & Equalization		Pass/Fail	
	Step 28:	26 dB		Pass/Fail	
3-44		139.264Mb/s (E4)			

Performance Tests
Performance Test Record

Performance Test Record , continued

Page No.	Test Description		Result		
			Min	Actual	Max
	Step 29:	20 dB		Pass/Fail	
	Step 29:	20 dB & Equalization		Pass/Fail	
	Step 29:	26 dB & Equalization		Pass/Fail	
	Step 29:	26 dB		Pass/Fail	
3-44		1.544Mb/s (DS1)			
	Step 30:	20 dB		Pass/Fail	
	Step 30:	20 dB & Equalization		Pass/Fail	
	Step 30:	26 dB & Equalization		Pass/Fail	
	Step 30:	26 dB		Pass/Fail	
	Step 30:	30 db		Pass/Fail	
	Step 30:	30 dB & Equalization		Pass/Fail	
3-44		44.736Mb/s (DS3)			
	Step 31:	20 dB		Pass/Fail	
	Step 31:	20 dB & Equalization		Pass/Fail	
	Step 31:	26 dB & Equalization		Pass/Fail	
	Step 31:	26 dB		Pass/Fail	
3-45	External Mux/Demux				
	Step 9:	2 Mb/s Bit & Code EC		Pass/Fail	
	Step 10:	2 Mb/s Bit Error Add		Pass/Fail	
	Step 15:	+ve Mask 2 Mb/s		Pass/Fail	
	Step 16:	+ve Amp 2 Mb/s		Pass/Fail	
	Step 20:	-ve Mask 2 Mb/s		Pass/Fail	
	Step 21:	-ve Amp 2 Mb/s		Pass/Fail	
3-51	DS-1 Mux and Demux				
	Step 1:	DS-1 Bit & Code EC		Pass/Fail	
	Step 1:	DS-1 Bit Error Add		Pass/Fail	
3-52	Step 6:	+ve Pulse Mask DS-1		Pass/Fail	

Performance Tests
Performance Test Record

Performance Test Record , continued

Page No.	Test Description		Result		
			Min	Actual	Max
3-52	Step 7:	+ve Pulse Amp DS-1		Pass/Fail	
	Step 11	-ve Pulse Mask DS-1		Pass/Fail	
3-53	Step 12:	-ve Pulse Amp DS-1		Pass/Fail	
3-55	PDH Frequ. Measurement and Looped Clock				
	Step 8:	2Mb/s frequency	2.047991 MHz		2.048009 MHz
	Step 9:	Offset (0 ppm)	-4.5 ppm		+4.5 ppm
	Step 10:	Frequency+100 ppm	2.048194 MHz		2.048214 MHz
3-58	Step 11:	Offset +100 ppm	+95.5 ppm		+104.5 ppm
	Step 12:	Frequency-100 ppm	2.047786 MHz		2.047806 MHz
	Step 13:	Offset -100 ppm	-95.5 ppm		-104.5 ppm
	Step 13:	Frequency Counter		Pass/Fail	
	Step 14:	8Mb/s 0 ppm	-4.5 ppm		+4.5 ppm
	Step 14:	8Mb/s -100 ppm	-95.5 ppm		-104.5 ppm
	Step 14:	8Mb/s +100 ppm	+95.5 ppm		+104.5 ppm
	Step 14:	34 Mb/s 0 ppm	-4.5 ppm		+4.5 ppm
	Step 14:	34 Mb/s -100 ppm	-95.5 ppm		-104.5 ppm
	Step 14:	34 Mb/s +100 ppm	+95.5 ppm		+104.5 ppm
	Step 14:	140 Mb/s 0 ppm	-4.5 ppm		+4.5 ppm
	Step 14:	140 Mb/s -100 ppm	-95.5 ppm		-104.5 ppm
	Step 14:	140 Mb/s +100 ppm	+95.5 ppm		+104.5 ppm
3-58	Step 14:	1.544 Mb/s 0 ppm	-4.5 ppm		+4.5 ppm
	Step 14:	1.544 Mb/s -100 ppm	-95.5 ppm		-104.5 ppm
	Step 14:	1.544 Mb/s +100 ppm	+95.5 ppm		+104.5 ppm
	Step 14:	44.736 Mb/s 0 ppm	-4.5 ppm		+4.5 ppm
	Step 14:	44.736Mb/s -100 ppm	-95.5 ppm		-104.5 ppm
	Step 14:	44.736Mb/s+100 ppm	+95.5 ppm		+104.5 ppm

Performance Tests
Performance Test Record

Performance Test Record , continued

Page No.	Test Description		Result		
			Min	Actual	Max
3-59	SDH/SONET Transmitter Clock Accuracy				
	Step 4:	Frequency	51.839670 MHz		51.840230 MHz
3-60	External Clock/Data Reference Inputs & Clock Reference Output				
3-62	Step 7:	2Mb/s Clock		Pass/Fail	
	Step 9:	Ref Clock Out		Pass/Fail	
3-63	Step 16:	2 Mb/s Data		Pass/Fail	
	Step 21:	2 Mb/s Data Balanced		Pass/Fail	
	Step 25:	Rx Data Clock Loss		Pass/Fail	
	Step 28:	Rx Data Clock Gain		Pass/Fail	
	Step 30:	10 MHz Clock Loss		Pass/Fail	
3-63	Step 33:	10 MHz Clock Gain		Pass/Fail	
	Step 35:	BITS Clock - LED on		Pass/Fail	
	Step 38:	BITS Clock - LED off		Pass/Fail	
	Step 41:	64 kb/s Clock Loss		Pass/Fail	
	Step 42:	64 kb/s Clock Gain		Pass/Fail	
3-65	SDH/SONET Freq. Offsets				
	Step 5:	Clock Loss		Pass/Fail	
3-66	Step 10:	0 ppm		51.84MHz	
3-66	Step 11:	-999 ppm	51.7882108 MHz		51.7882129 MHz
	Step 11:	-100 ppm	51.8348149 MHz		51.8348171MHz
	Step 11:	-66 ppm	51.8365464 MHz		51.8365485 MHz
	Step 11:	+33 ppm	51.8417252 MHz		51.8417273 MHz
	Step 11:	+100 ppm	51.8451829 MHz		51.8451851MHz
	Step 11:	+999 ppm	51.8917871 MHz		51.8917892 MHz

Performance Tests
Performance Test Record

Performance Test Record , continued

Page No.	Test Description		Result		
			Min	Actual	Max
3-67	STM-0/STS-1 Transmitter Output Waveshape				
3-68	Step 6:	+ve Pulse		Pass/Fail	
3-69	Step 7:	+ve Pulse Amp		Pass/Fail	
	Step 11:	-ve Pulse		Pass/Fail	
3-70	Step 12:	-ve Pulse Amp		Pass/Fail	
	Step 13:	High amplitude		Pass/Fail	
	Step 14:	Low Amplitude		Pass/Fail	
3-71	STM-1/STS-3 Transmitter Output Waveshape				
3-74	Step 8:	All 1's Pulse		Pass/Fail	
	Step 9:	Pulse Amp	450 mV pk		550 mV pk
	Step 13	All 0's Pulse		Pass/Fail	
3-75	Step 14:	Pulse Amp	450 mV pk		550 mV pk
3-76	SDH/SONET Receiver Equalization				
3-77	Step 5:	STM-0/STS-1		Pass/Fail	
3-78	Step 10:	STM-1/STS-3		Pass/Fail	
3-79	SDH/SONET Receiver Monitor Levels				
3-80		STM-0/STS-1			
3-81	Step 5:	20dB		Pass/Fail	
	Step 9:	20dB + Equalization		Pass/Fail	
	Step 14:	26dB + Equalization		Pass/Fail	
3-82	Step 18:	26dB		Pass/Fail	
3-82		STM-1/STS-3			
	Step 20:	20dB		Pass/Fail	
	Step 20:	20dB + Equalization		Pass/Fail	

Performance Tests
Performance Test Record

Performance Test Record , continued

Page No.	Test Description		Result		
			Min	Actual	Max
	Step 20:	26dB + Equalization		Pass/Fail	
	Step 20:	26dB		Pass/Fail	
3-83	Multirate Optical Interface				
		Power 1310 nm			
3-86	Step 6:	STM-0/OC-1	-1 dBm (37718A) -3 dBm (37718B/C)		+3 dBm (37718A) +2 dBm (37718B/C)
	Step 8:	STM-1/OC-3	-1 dBm (37718A) -3 dBm (37718B/C)		+3 dBm (37718A) +2 dBm (37718B/C)
	Step 10:	STM-4/OC-12	-1 dBm (37718A) -3 dBm (37718B/C)		+3 dBm (37718A) +2 dBm (37718B/C)
	Step 12:	STM-16/OC-48	-1 dBm (37718A)		+3 dBm (37718A)
		Sensitivity 1310 nm			
3-87	Step 22:	STM-0/OC-1		Pass/Fail	
	Step 23:	STM-1/OC-3		Pass/Fail	
	Step 24:	STM-4/OC-12		Pass/Fail	
	Step 25:	STM-16/OC-48		Pass/Fail	
		PMP input			
3-88	Step 35:	STM-0/OC-1		Pass/Fail	
	Step 37:	STM-1/OC-3		Pass/Fail	
	Step 39:	STM-4/OC-12		Pass/Fail	
		Power 1550nm			
3-88	Step 40:	STM-0/OC-1	-1 dBm (37718A) -3 dBm (37718B/C)		+3 dBm (37718A) +2 dBm (37718B/C)
	Step 40:	STM-1/OC-3	-1 dBm (37718A) -3 dBm (37718B/C)		+3 dBm (37718A) +2 dBm (37718B/C)
	Step 40:	STM-4/OC-12	-1 dBm (37718A) -3 dBm (37718B/C)		+3 dBm (37718A) +2 dBm (37718B/C)
	Step 40:	STM-16/OC-48	-1 dBm (37718A)		+3 dBm (37718A)
		Sensitivity 1550nm			

Performance Tests
Performance Test Record

Performance Test Record , continued

Page No.	Test Description		Result		
			Min	Actual	Max
	Step 41:	STM-0/OC-1		Pass/Fail	
	Step 41:	STM-1/OC-3		Pass/Fail	
	Step 41:	STM-4/OC-12		Pass/Fail	
	Step 41:	STM-16/OC-48		Pass/Fail	

Performance Tests
Jitter Performance Test Record (option 200)

Jitter Performance Test Record (option 200)

Agilent Model 37718A/B/C up to 2.5 Gb/s Multirate Communications Performance Analyzer (Jitter options only)	
Location:	Serial No.:
Tested by:	Options:
Temperature:	Certified by:
Humidity:	Date:

Performance Test Record

Page No.	Test Description		Result		
			Min	Actual	Max
3-89	PDH Tx/Rx Jitter Amplitude Accuracy				
	Step 8	AIS LED On		Pass/Fail	
	Step 12	2048 kHz - Tx	0.69 UI		0.83 UI
	Step 12	2048 kHz - Rx	0.711 UI		0.829 UI
	Step 12	8448 kHz - Tx	0.69 UI		0.83 UI
	Step 12	8448 kHz - Rx	0.706 UI		0.834 UI
	Step 12	34368 kHz - Tx	0.69 UI		0.83 UI
	Step 12	34368 kHz - Rx	0.706 UI		0.834 UI
	Step 12	139264 kHz - Tx	0.68 UI		0.84 UI
	Step 12	139264 kHz - Rx	0.706 UI		0.834 UI
	Step 12	1544 kHz -Tx	0.69 UI		0.83 UI
	Step 12	1544 kHz - Rx	0.712 UI		0.828 UI
	Step 12	44736 kHz - Tx	0.69 UI		0.83 UI
	Step 12	44736 kHz - Rx	0.706 UI		0.834 UI

Performance Tests

Jitter Performance Test Record (option 200)**Performance Test Record , continued**

Page No.	Test Description		Result		
			Min	Actual	Max
	Step 19	AIS LED On		Pass/Fail	
	Step 22	2048 kHz Null 1.76 UI	Tx 1.67 UI		Tx 1.85 UI
		2048 kHz Null 1.76 U	Rx 1.587 UI		Rx 1.933 UI
		2048 kHz Null 4.76 UI	Tx 4.52 UI		Tx 5.00 UI
	Step 22	2048 kHz Null 4.76 UI	Rx 4.377 UI		Rx 5.143 UI
		2048 kHz Null 8.76 UI	Tx 8.32 UI		Tx 9.20 UI
		2048 kHz Null 8.76 UI	Rx 8.097 UI		Rx 9.423 UI
		8448 kHz Null 1.76 UI	Tx 1.67 UI		Tx 1.85 UI
		8448 kHz Null 1.76 UI	Rx 1.587 UI		Rx 1.933 UI
		8448 kHz Null 5.76 UI	Tx 5.47 Ui		Tx 6.05 UI
		8448 kHz Null 5.76 UI	Rx 5.307 UI		Rx 6.213 UI
		8448 kHz Null 8.76 UI	Tx 8.32 UI		Tx 9.20 UI
		8448 kHz Null 8.76 UI	Rx 8.097 UI		Rx 9.423 UI
		34368 kHz Null 2.76 UI	Tx 2.62 Ui		Tx 2.90 UI
		34368 kHz Null 2.76 UI	Rx 2.517 UI		Rx3.003 UI
		34368 kHz Null 6.76 UI	Tx 6.42 UI		Tx 7.10 UI
		34368 kHz Null 6.76 UI	Rx 6.237 UI		Rx 7.283 UII
		34368 kHz Null 8.76 UI	Tx 8.32 Ui		Tx 9.20 UI
		34368 kHz Null 8.76 UI	Rx 8.097 UI		Rx 9.423 UI
		139264 kHz Null 3.76	Tx 3.57 UI		Tx 3.95 UI
		139264 kHz Null 3.76	Rx 3.447 UI		Rx 4.073 UI
		139264 kHz Null 7.76	Tx 7.37 UI		Tx 8.15 UI
		139264 kHz Null 7.76	Rx 7.167 UI		Rx 8.353 UI
		139264 kHz Null 8.76	Tx 8.32 UI		Tx 9.20 UI
	Step 22	139264 kHz Null 8.76	Rx 8.097 UI		Rx 9.423 UI
	Step 22	1544 kHz Null 1.76 UI	Tx 1.67 UI		Tx 1.85 UI

Performance Tests

Jitter Performance Test Record (option 200)

Performance Test Record , continued

Page No.	Test Description		Result		
			Min	Actual	Max
	Step 22	1544 kHz Null 1.76 U	Rx 1.587 UI		Rx 1.933 UI
	Step 22	1544 kHz Null 4.76 UI	Tx 4.52 UI		Tx 5.00 UI
		1544 kHz Null 4.76 UI	Rx 4.377 UI		Rx 5.143 UI
		1544 kHz Null 8.76 UI	Tx 8.32 UI		Tx 9.20 UI
		1544 kHz Null 8.76 UI	Rx 8.097 UI		Rx 9.423 UI
		44736 kHz Null 2.76 UI	Tx 2.62 Ui		Tx 2.90 UI
		44736 kHz Null 2.76 UI	Rx 2.517 UI		Rx3.003 UI
		44736 kHz Null 6.76 UI	Tx 6.42 UI		Tx 7.10 UI
		44736 kHz Null 6.76 UI	Rx 6.237 UI		Rx 7.283 UII
		44736 kHz Null 8.76 UI	Tx 8.32 UI		Tx 9.20 UI
	Step 22	44736 kHz Null 8.76 UI	Rx 8.097 UI		Rx 9.423 UI
	PDH Demod Output Amp.				
3-100	Step 9	Demod Output Amp.	707 mV p-p		833 mV p-p
3-103	SDH Tx/Rx Jitter Amplitude Accuracy				
3-105	STM 0 Electrical				
	Step 8	No SDH result errors		Pass/Fail	
	Step 8	Jitter result			<0.050 UI p-p
	Step 9:	Jitter result			<0.050 UI p-p
	Step 14:	No SDH errors		Pass/Fail	
	Step 15:	Tx Jitter results	0.16 UI p-p		0.24 UI p-p
		Rx Jitter results	0.125 UI p-p		0.275 UI p-p
	Step 19	No SDH errors		Pass/Fail	
	Step 20	Tx results	0.16 UI p-p		0.24 UI p-p
		Rx Jitter results	0.125 UI p-p		0.275 UI p-p

Performance Tests
Jitter Performance Test Record (option 200)

Performance Test Record , continued

Page No.	Test Description		Result		
			Min	Actual	Max
	Step 24	No SDH errors		Pass/Fail	
	Step 25	Tx Jiter results	0.82UI p-p		1.00 UI p-p
		Rx Jitter results	0.796 UI p-p		1.024 UI p-p
	Step 30	No SDH errors		Pass/Fail	
	Step 31	Tx Jitter results	3.30 UI p-p		3.74 UI p-p
		Rx Jitter Results	3.204 UI p-p		3.836 UI p-p
	Step 35	No SDH errors		Pass/Fail	
	Step 36	Tx Jitter results	7.10 UI p-p		7.94 UI p-p
		Rx Jitter results	6.756 UI p-p		8.164 UI p-p
	Step 41	No SDH errors		Pass/Fail	
	Step 42	Tx Jitter result	18.80 UI p-p		21.20 UI p-p
		Rx Jitter result	18.550 UI p-p		21.450 UI p-p
3-116	STM1 Electrical				
	Step 8	No SDH result errors		Pass/Fail	
	Step 8	Jitter result			<0.050 UI p-p
	Step 9:	Jitter result			<0.050 UI p-p
	Step 14:	No SDH errors		Pass/Fail	
	Step 15:	Tx Jitter results	0.06 UI p-p		0.14 UI p-p
		Rx Jitter results	0.042 UI p-p		0.158 UI p-p
	Step 19	No SDH errors		Pass/Fail	
	Step 20	Tx results	0.06 UI p-p		0.14 UI p-p
		Rx Jitter results	0.042 UI p-p		0.158 UI p-p
	Step 24	No SDH errors		Pass/Fail	
	Step 25	Tx Jiter results	0.82UI p-p		1.00 UI p-p
		Rx Jitter results	0.796 UI p-p		1.024 UI p-p

Performance Tests

Jitter Performance Test Record (option 200)**Performance Test Record , continued**

Page No.	Test Description		Min	Result Actual	Max
	Step 30	No SDH errors		Pass/Fail	
	Step 31	Tx Jitter results	3.30 UI p-p		3.74 UI p-p
		Rx Jitter Results	3.204 UI p-p		3.836 UI p-p
	Step 35	No SDH errors		Pass/Fail	
	Step 36	Tx Jitter results	7.10 UI p-p		7.94 UI p-p
		Rx Jitter results	6.756 UI p-p		8.164 UI p-p
	Step 41	No SDH errors		Pass/Fail	
	Step 42	Tx Jitter result	30.82 UI p-p		35.18 UI p-p
		Rx Jitter result	28.350 UI p-p		37.650 UI p-p
3-118	STM 0 Optical				
	Step 8	No SDH result errors		Pass/Fail	
	Step 8	Jitter result			<0.050 UI p-p
	Step 9:	Jitter result			<0.050 UI p-p
	Step 14:	No SDH errors		Pass/Fail	
	Step 15:	Tx Jitter results	0.16 UI p-p		0.24 UI p-p
		Rx Jitter results	0.125 UI p-p		0.275 UI p-p
	Step 19	No SDH errors		Pass/Fail	
	Step 20	Tx results	0.16 UI p-p		0.24 UI p-p
		Rx Jitter results	0.125 UI p-p		0.275 UI p-p
	Step 24	No SDH errors		Pass/Fail	
	Step 25	Tx Jiter results	0.82UI p-p		1.00 UI p-p
		Rx Jitter results	0.796 UI p-p		1.024 UI p-p
	Step 30	No SDH errors		Pass/Fail	
	Step 31	Tx Jitter results	3.30 UI p-p		3.74 UI p-p

Performance Tests
Jitter Performance Test Record (option 200)

Performance Test Record , continued

Page No.	Test Description		Min	Result Actual	Max
		Rx Jitter Results	3.204 UI p-p		3.836 UI p-p
	Step 35	No SDH errors		Pass/Fail	
	Step 36	Tx Jitter results	7.10 UI p-p		7.94 UI p-p
		Rx Jitter results	6.756 UI p-p		8.164 UI p-p
	Step 41	No SDH errors		Pass/Fail	
	Step 42	Tx Jitter result	18.80 UI p-p		21.20 UI p-p
		Rx Jitter result	18.550 UI p-p		21.450 UI p-p
3-119	STM1 Optical				
	Step 47	Optical Power dBm	N/A		N/A/
	Step 48	step 8 No SDH errors		Pass/Fail	
		step 8 Rx result	N/A		0.050 UI p-p
		step 9 Rx result	N/A		0.050 UI p-p
	Step 48	step 13-15 Tx result	0.16 UI p-p		0.24 UI p-p
		step 13-15 Rx result	0.125 UI p-p		0.275 UI p-p
		step 14 No SDH errors		Pass/Fail	
		step 18-20 Tx result	0.16 UI p-p		0.24 UI p-p
		step 18-20 Rx result	0.125 UI p-p		0.275 UI p-p
		step 19 No SDH errors		Pass/Fail	
		step 22-25 Tx result	0.82UI p-p		1.00 UI p-p
		step 22-25 Rx result	0.796 UI p-p		1.024 UI p-p
		step 24 No SDH errors		Pass/Fail	
		step 27-31 Tx result	3.30 UI p-p		3.74 UI p-p
		step 27-31 Rx result	3.174 UI p-p		3.866 UI p-p

Performance Tests

Jitter Performance Test Record (option 200)**Performance Test Record , continued**

Page No.	Test Description		Min	Result Actual	Max
		step 30 No SDH errors		Pass/Fail	
		step 33-37 Tx result	7.10 UI p-p		7.94 UI p-p
		step 33-37 Rx result	6.756 UI p-p		8.164 UI p-p
		step 35 No SDH errors		Pass/Fail	
		step 39-43 Tx result	30.82 UI p-p		35.18 UI p-p
		step 39-43 Rx result	28.350 UI p-p		37.650 UI p-p
		step 41 No SDH errors		Pass/Fail	
3-119	STM 4 Optical				
	Step 49	Optical Power dBm	N/A		N/A
		step 8 No SDH errors		Pass/Fail	
		step 8 Rx result	N/A		0.070 UI p-p
		step 9 Rx result	N/A		0.070 UI p-p
		step 13-15 Tx result	0.15 UI p-p		0.25 UI p-p
		step 13-15 Rx result	0.118 UI p-p		0.284 UI p-p
		step 14 No SDH errors		Pass/Fail	
		step 18-20 Tx result	0.15 UI p-p		0.25 UI p-p
		step 18-20 Rx result	0.111 UI p-p		0.291 UI p-p
		step 19 No SDH errors		Pass/Fail	
		step 22-25 Tx result	0.82 UI p-p		1.00 UI p-p
		step 22-25 Rx result	0.776 UI p-p		1.044 UI p-p
		step 24 No SDH errors		Pass/Fail	
		step 27-31 Tx result	3.30 UI p-p		3.74 UI p-p
		step 27-31 Rx result	3.174 UI p-p		3.866 UI p-p
		step 30 No SDH errors		Pass/Fail	

Performance Tests
Jitter Performance Test Record (option 200)

Performance Test Record , continued

Page No.	Test Description		Min	Result Actual	Max
		step 33-37 Tx result	10.90 Ui p-p		12.14 UI p-p
		step 33-37 Rx result	10.401 UI p-p		12.426 UI p-p
		step 35 No SDH errors		Pass/Fail	
		step 39-43 Tx result	124.37 UI p-p		139.63 UI p-p
	Step 49	step 39-43 Rx result	113.40 UI p-p		150.60 UI p-p
		step 41 No SDH errors		Pass/Fail	
3-120	STM 16 Optical				
	Step 50	Optical Power dBm	N/A		N/A
		step 8 No SDH errors		Pass/Fail	
		step 8 Rx result	N/A		0.070 UI p-p
		step 9 Rx result	N/A		0.070 UI p-p
		step 13-15 Tx result	0.14 UI p-p		0.26 UI p-p
		step 13-15 Rx result	0.114 UI p-p		0.286 UI p-p
		step 14 No SDH errors		Pass/Fail	
		step 18-20 Tx result	0.13 UI p-p		0.27 UI p-p
		step 18-20 Rx result	0.100 UI p-p		0.300 UI p-p
		step 19 No SDH errors		Pass/Fail	
		step 22-25 Tx result	0.81 UI p-p		1.01 UI p-p
		step 22-25 Rx result	0.795 UI p-p		1.026 UI p-p
		step 24 No SDH errors		Pass/Fail	
		step 27-31 Tx result	3.29 UI p-p		3.75 UI p-p
		step 27-31 Rx result	3.124 UI p-p		3.916 UI p-p
		step 30 No SDH errors		Pass/Fail	
		step 33-37 Tx result	8.99 Ui p-p		10.05 UI p-p

Performance Tests

Jitter Performance Test Record (option 200)**Performance Test Record , continued**

Page No.	Test Description		Min	Result Actual	Max
		step 33-37 Rx result	8.53 UI p-p		10.34 UI p-p
		step 35 No SDH errors		Pass/Fail	
		step 39-43 Tx result	499.60 UI p-p		556.40 UI p-p
		step 39-43 Rx result	451.60 UI p-p		604.40 UI p-p
		step 41 No SDH errors		Pass/Fail	
3-119	Step 53	STM-1 Optical			
		step 8 Rx result	N/A		0.050 UI p-p
		step 8 No SDH errors		Pass/Fail	
		step 9 Rx result	N/A		0.050 UI p-p
3-119	Step 53	STM-4 Optical			
		step 8 Rx result	N/A		0.070 UI p-p
		step 8 No SDH errors		Pass/Fail	
		step 9 Rx result	N/A		0.070 UI p-p
3-120	Step53	STM-16 Optical			
		step 8 Rx result	N/A		0.070 UI p-p
		step 9 Rx result	N/A		0.070 UI p-p
		step 8 No SDH errors		Pass/Fail	
3-121	SDH Ext. Jitter Generation/ Demod Output				
	Step 9	Input Tx mod.	364mV p-p		546 mV p-p
	Step 10	Demod O/P Amp	756 mV p-p		1.075 V p-p

Performance Tests
Jitter Performance Test Record (option 200)

4

Terms

This section contains a table of the current (and earlier) ETSI terms and the ANSI equivalents.

ETSI/ANSI Conversion and Equivalent Terms**Introduction**

The terminology used on the instrument display can be ETSI (SDH) or ANSI (SONET) terminology. Refer to the table given in this chapter for an explanation of equivalent SDH/SONET terms.

ETSI: European Telecommunications Standards Institute.

ANSI: American National Standards Institute.

ETSI Term	ANSI Term
AU-3	STS-1 SPE + H1, H2, H3
AU-4	STS-3c SPE + H1, H2, H3
BIP (Bit Interleaved parity)	CV (Code Violation)
High Order Path (HP / HO)	STS Path
I-n Intra Office, (n=STM-n level)	Intermediate Reach (IR)
L-n.1 or L-n.2 long haul	LR long reach
Low Order Path (LP / LO)	VT Path
LP-REI	REI-V
M.S.P	A.P.S
Multiplexer Section (MS)	Line
Multiplexer Section Protection	Automatic Protection Switching
MS-AIS	Line AIS / AIS-L
MS-BIP	Line CV / CV-L

Terms

ETSI Term	ANSI Term
MS-DCC	Line DCC / DCC-L
MS-REI	Line FEBE / REI-L
MS-RDI	Line FERF / RDI-L
Multiplexer Section Overhead	Line Overhead
Network Node Interface	Line Interface
OOF	SEF (severely errored frame defect)
Path AIS / AU-AIS	AIS-P
Path REI / HP REI	REI-P
Path FERF / HP RDI	RDI-P
Path IEC / AU-IEC	IEC-P
Path Overhead	Path Overhead
Regenerator	Repeater
Regenerator Section (RS)	Section
Regenerator Section Overhead	Section Overhead
Remote Alarm Indicator	RAI
RS-DCC	Section DCC (DCC-S)
Section Overhead (SOH)	Transport Overhead (TOH)
S-n.1 or S-n.2 short haul	Short Reach (SR)
SOH	TOH
STM-m	OC-n / STS-n (where $m = n \div 3$ for $m \geq 1$)
STM-0	STS-1
STM-1	OC3c / STS-3c
STM-4	OC-12 / STS-12
STM-16	OC-48 / STS-48
Tributary Unit (TU)	Virtual Tributary (VT)

Terms

ETSI Term	ANSI Term
TU	VT
TU-11	VT 1.5
TU-12	VT 2
TU-2	VT 6
TU-3	NONE
TU BIP	VT BIP (CV-V)
TU RDI / LP-RDI	RDI-V
TUG	VT Group
TUG2	VT Group (12 columns)
TUG3	VT Group (86 columns)
TU multiframe	VT superframe
TU PATH AIS	VT AIS (AIS-V)
VC	SPE
VC4	STS3C SPE
Virtual Container (VC)	Synchronous Payload Envelope (SPE)

NOTE: VC is an ETSI abbreviation for Virtual Container and an ETSI/ANSI abbreviation for (ATM) Virtual Channel. The context of VC must therefore be taken into account when converting between standards.

5

Self Test Overview

Self Tests

This section gives an overview of the Self Tests and their function.

There are several Self Test selections. Some providing overall functional tests and others provide specific measurement hardware/functions tests.

Overall Function Self Tests

Confidence Test (test time - < 5 minutes depending on options)

Provides a quick verification of the main instrument functions using external back-to-back loopback of the instrument Transmit/Receive sections. See the Table below for a list of the subtests, and Figure 5-1 for the external loopback cabling required for this test. Use this test to provide a quick operational verification.

<u>Subtest</u>	<u>Test Function</u>
1	PDH 140 Mb/s Structured 64 kb/s
2	PDH 2 Mb/s 120 ohm balanced
3	PDH 34 Mb/s Structured 64 kb/s
4	PDH DS1, D4 Structured 64 kb/s
5	SDH, STM-0e Test
6	SDH, STM-0o Test
7	SDH, STM-1e Test
8	SDH, STM-1o Test
9	SDH, STM-4o Test
10	SDH, STM-16o Test
11	OPT 200 Jitter Test, PDH 34 Mb/s
12	OPT 200 Jitter Test, SDH 622 Mb/s

Self Tests

All Tests (test time - up to 1 hour depending on options)

Provides an extensive back-to-back verification test of the instrument operation. The test uses much of the specific function tests, performing the appropriate subtest depending on options fitted. Test are run as follows.

CPU test

CONFIDENCE test

PDH test

BER test (Note does not perform DCC port test)

JITTER test

ATM test

POS test

See Tables for each of these tests for a list of the subtests and Figure 5-1 for the loopback cabling required for this test. Note a Formatted floppy disk is required as the CPU test is run as part of All Tests selection.

Use this test to provide a comprehensive operational verification.

Specific Measurement Hardware/Function Tests

CPU Tests (test time - approximately 2 minutes)

Provides a quick test of the Main and Front Panel processors. No external cabling is required, but formatted floppy disk must be installed.

<u>Subtest</u>	<u>Test Function</u>
1	Flash ROM CRC checks
2	Ram Test
3-7	Not used
8	In-Lid Printer present check, (if option 602 fitted)
9	Not used
10	Floppy disk write/read
11	Not used
12-16	Front Panel processor checks

Self Tests

PDH Test (test time- approximately 20 minutes)

Provides comprehensive test of the PDH Transmit/Receive sections. Note this test is run as part of ALL TESTS. The Subtests used are dependent on PDH option.

<u>Subtest</u>	<u>Test Function</u>
1-7	Line Code Tests (140/34/8/2 MHz Unable 75 ohm)
8-9	Line Code Tests (2 MHz Balanced 120 ohm)
10-21	Frequency Offset (140/34/8/2 MHz)
22-36	Error Add/Detect (34/2 MHz)
37-44	Framing (140/2 MHz)
45-53	Structured Payloads (140/34/8 MHz)
54-63	Patterns (140/34/8 MHz)
64	Drop/Insert (2 MHz)
65-72	Round Trip Delay (64 kb/s)
73-82	Not used
83-86	Line Code Tests (DS3/DS1 Unable 75 ohm)
87-88	Line Code Tests (DS1 Balanced 110 ohm)
89-94	Frequency Offset (DS3/DS1)
95-112	Error Add/Detect (DS3/DS1)
113-120	Framing (DS3/DS1)
121-130	Structured Payloads (DS3/DS1)
134-140	Patterns (DS3/DS1)
141	Drop/Insert (DS1)
142-145	Round Trip Delay
146-148	DS1 Unbalanced Tx/Rx tests
149-150	DS3 Unbalanced Tx/Rx tests

Self Tests

BER Test (test time- approximately 20 minutes)

These tests perform extensive test of the SDH/SONET Electrical and Optical Transmit/Receive sections. Note this test is run as part of ALL TESTS with the exception of Subtest 83, DCC port test.

<u>Subtest</u>	<u>Test Function</u>
1	STM-16 MUX/DEMUX Internal Loopback
2-4	STM-0e Pulse Shape
5-8	Basic STM-0o Tx/Rx Test
7-8	Basic STM-1e Tx/Rx Test
9-10	Basic STM-1o Tx/Rx Test
11-12	Basic STM-4o Tx/Rx Test
13-14	Basic STM-16o Tx/Rx Test
15-17	STM-4o Frequency Measurement
18	STM-16o Frequency Measurement
19-20	Clock Reference Source
21-22	Optical Power Measurement
23	Overhead Byte Defaults [part 1]
24	Overhead Byte Defaults [part 2]
25	STM16o J0 Path Trace Message
26	J1 Path Trace Message
27	J2 Path Trace Message
28-35	SDH Error Add[RATE]/Detection
36-44	SDH Single Error Add/Detection
45	STM-16o Entire Frame Error Add/Detect
46	A1A2 Frame Error Add
47-49	PDH Payload Error Add[RATE]/Detection
50-52	PDH Payload Single Error Add/Detection
53-67	Alarm Generation/Detection
68-69	OOB Alarm Generation/Detection

Self Test Overview

Self Tests

70	TU-3/TU12 Mixed Payload Test
71	TU-12/TU-3 Mixed Payload Test
72	TU-3/TU-11 Mixed Payload Tests
73	TU-11/TU-3 Mixed Payload Tests
74-75	AU New Pointer Test
76-77	AU Frequency Offset Pointer Moves
78-79	TU Frequency Pointer Moves
80-81	STM-160 140 Mb/s Payload VC Offset Test
82	TU-3 Background Pattern Test
83	DCC Port Test
84-87	Stress Test
88-99	Service Disruption Test
100-122	TCM Error Add/Detection
123-134	TCM Alarm Generation/Detection
135-137	TCM APId Message

Self Tests

JITTER Test (test time- approximately 20 minutes)

These tests apply to the OmniBER with Option 200 fitted. Provides extensive tests of the PDH/SDH/SONET Tx/Rx Jitter sections. Note this test is run as part of ALL TESTS.

<u>Subtest</u>	<u>Test Function</u>
1-2	Jitter Receiver Internal Loopback tests
3-47	Jitter Filter tests
50	Jitter PLL test
51-53	2Mb/s Tx/Rx Jitter Tests
54-56	8Mb/s Tx/Rx Jitter Tests
57-59	34Mb/s Tx/Rx Jitter Tests
60-62	140Mb/s Tx/Rx Jitter Tests
63-64	STM1e Tx/Rx Jitter Tests
65-66	STM1o Tx/Rx Jitter Tests
67-68	STM-4 Tx/Rx Jitter Tests
69-70	STM-16 Tx/Rx Jitter Tests
71-73	DS1 Tx/Rx Jitter tests
74-76	DS3 Tx/Rx Jitter tests
77-78	STM-0E Tx/Rx Jitter tests
79-80	STM-0O Tx/Rx Jitter tests
81-102	Not used
103-108	2Mb/s Tx/Rx Jitter Tests
109-114	8Mb/s Tx/Rx Jitter Tests
115-120	34Mb/s Tx/Rx Jitter Tests
121-126	140Mb/s Tx/Rx Jitter Tests
127-132	DS1 Tx/Rx Jitter tests
133-138	DS3 Tx/Rx Jitter tests
139-144	STM-0E Tx/Rx Jitter tests
145-150	STM-0O Tx/Rx Jitter tests

Self Test Overview

Self Tests

151-156	STM1e Tx/Rx Jitter Tests
157-162	STM1o Tx/Rx Jitter Tests
163-168	STM-4 Tx/Rx Jitter Tests
169-174	STM-16 Tx/Rx Jitter Tests
175-177	Wander Tests
178	Transfer Test 155 Electrical
179	Transfer Test 2M
180	Transfer Test 2.5G

Long Gating test (test time- approximately 6 Hours)

This test performs an extended gating check of each SDH/SONET Optical rate to confirm error free operation. Test time at each rate is sufficient to ensure that the error ratio is less than 1 in 10^{12} . The test does NOT form part of ALL TESTS.

<u>Subtest</u>	<u>Test Function</u>
1	Tx/Rx STM-0o with Bulk 2^{23} Payload
2	Tx/Rx STM-1o with Bulk 2^{23} Payload
3	Tx/Rx STM-4o with Bulk 2^{23} Payload
4	Tx/Rx STM-16o with Bulk 2^{23} Payload

Self Test Overview

Self Tests

ATM Test (test time- approximately 15 minutes)

These tests apply to the OmniBER with Options 350 and 300 are fitted. Note this test is run as part of ALL TESTS.

<u>Subtest</u>	<u>Test Function</u>
1-14	Basic Path Integrity
15-32	Header Generation & Filtering
33-41	Tx 2.4Gb/s Regeneration
42-47	Tx/Rx Pointer Processing
48-51	Alarm Add and Detection
52-64	Error Add and Detection
65-77	Test Cell Generation & Synchronisation
78	34M G832 Trail Trace
79-81	Jitter Tolerance

POS Test (test time- approximately 15 minutes)

These tests apply to the OmniBER with Options 350 and 310 are fitted. Note this test is run as part of ALL TESTS.

<u>Subtest</u>	<u>Test Function</u>
1-14	Basic Path Integrity
15-23	Random Packet/Gap Data/Clock Path Integrity
24-33	Alarm Add and Detection
34-43	Error Add and Detection
44-53	Packet Rate
54-55	Jitter Tolerance

Self Test Overview

Self Tests

Loopbacks Required by Each Self Test

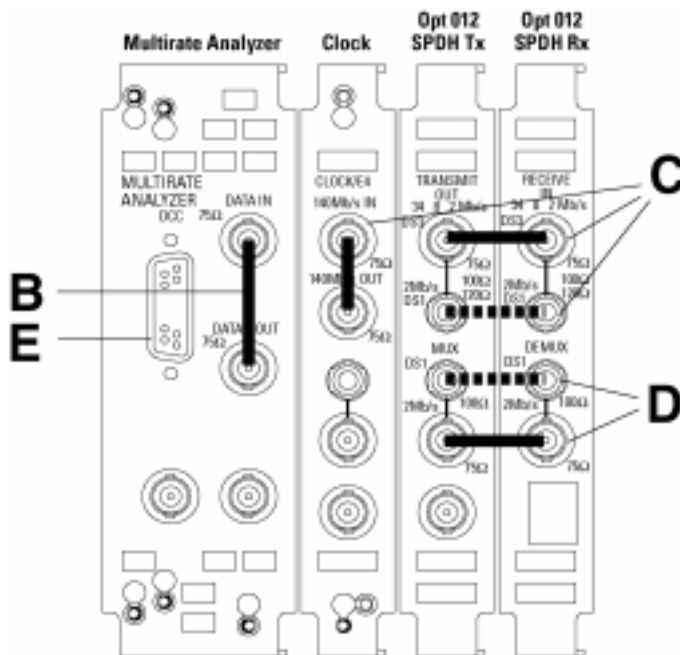

OmniBER 718B/C communications performance analyzer
155M electrical tester

Minimum loopbacks required by each test

TEST	A	B	C	D	E	F
Conf		X	X			
All		X	X	X		X
CPU						X
PDH			X	X		
BER		X			X	
Jitter		X	X			
Long gating						

- HP 15652A BNC 75Ω loopback
- HP 15670A Bantam 118Ω loopback
- HP 4545A 3m fiber optic cable FC/PC

Note 1:
A formatted floppy disk must be fitted into the disk drive before running All or CPU self tests.

Note 2:
A 15 dB optical attenuator (HP 4546A) must be fitted at the optical output port.

Note 3:
If running BER self tests, a loopback must be connected to the DCC port (see P3-5).

F

Self Test Overview

Self Tests

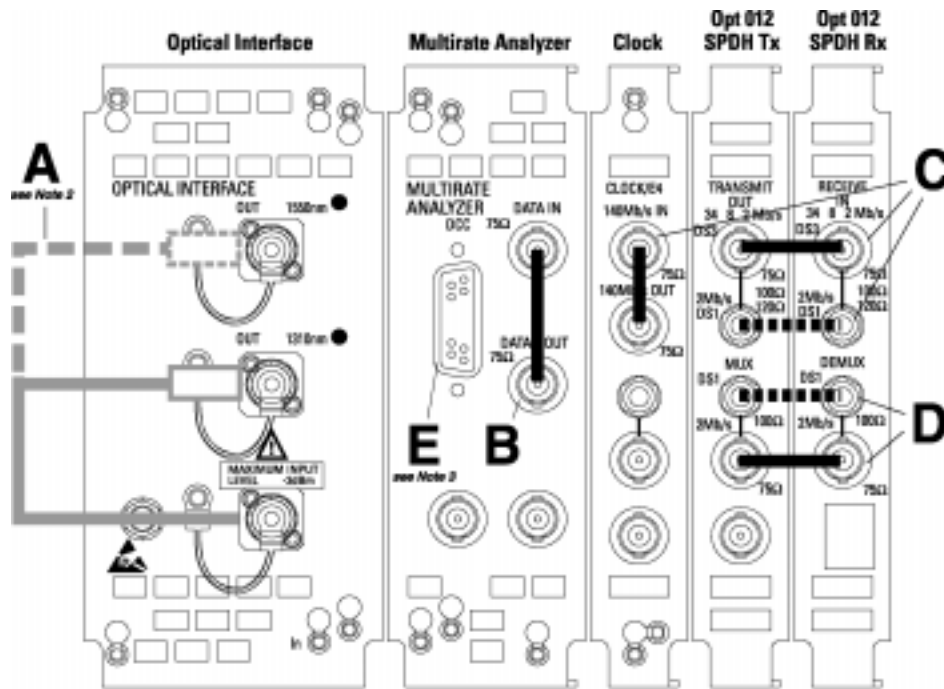

**OmniBER 718B/C communications performance analyzer
622M/155M dual wavelength tester**

Minimum loopbacks required by each test

TEST	A	B	C	D	E	F
Conf	X	X	X			
All	X	X	X	X		X
CPU						X
PDH			X	X		
BER	X	X			X	
Jitter	X	X	X			
Long gating	X					

— HP 15652A BNC 75Ω loopback

■ HP 15670A Bantam 110Ω loopback

— HP 4545A 3m fiber optic cable FC/PC

Note 1:

A formatted floppy disk must be fitted into the disk drive before running 'All' or 'CPU' self tests.

Note 2:

A 15 dB optical attenuator (HP 4548A) must be fitted at the optical output port.

Note 3:

If running BER self tests, a loopback must be connected to the OSC port (see PS-9).

Self Test Overview

Self Tests

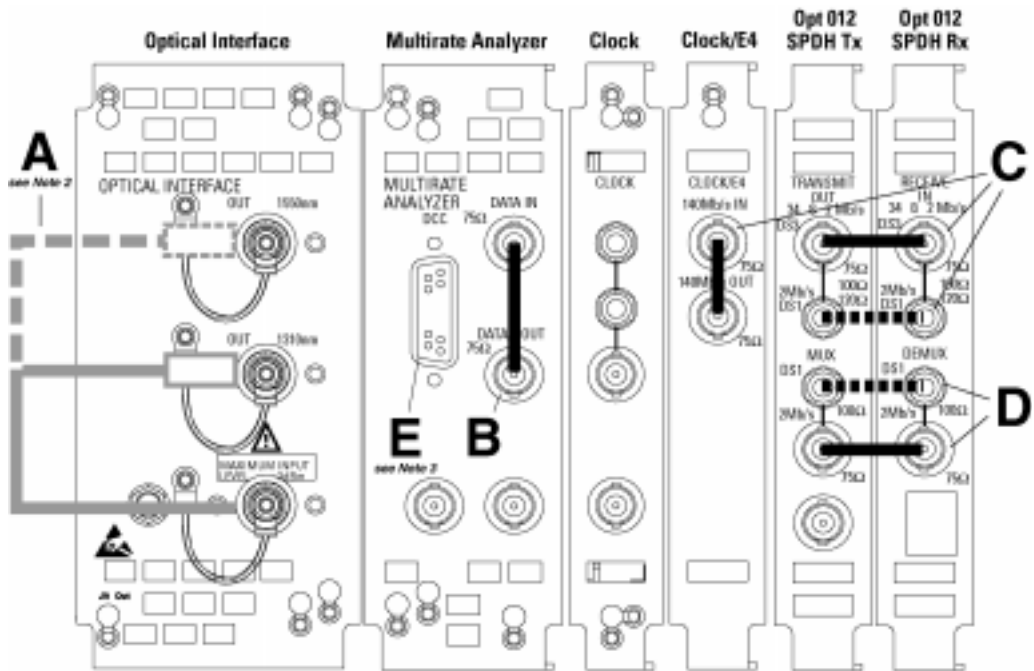

OmniBER 718A communications performance analyzer
2.5 Gb/s dual wavelength tester

Minimum loopbacks required by each test

TEST	A	B	C	D	E	F
Conf	X	X	X			
All	X	X	X	X		X
CPU						X
PDH			X	X		
BER	X	X			X	
Jitter	X	X	X			
Long gating	X					

- HP 15552A BNC 75Ω loopback
- HP 15670A Bantam 110Ω loopback
- HP 4545A 3m fiber optic cable FC/PC

Note 1:
 A formatted floppy disk must be fitted into the disk drive before running 'All' or 'CPU' self tests.

Note 2:
 A 15 dB optical attenuator (HP 4546A) must be fitted at the optical output port.

Note 3:
 If running BER self tests, a loopback must be connected to the DCC port (see P3-9).

F

Self Test Overview

Self Tests

Self Test Errors

The Tests will halt if a Self Test Error is detected. A message indicating the test point being run and error detected is displayed. Check all loopback connections and re-run the test. If the problem persists and contact your local Agilent Service Office or representative. Tests should only performed in a stable ambient environment where the instrument will not be disturbed during test.

The Self Test Error code numbering uses the following numeric format.

First Number indicates the Test being run.

CPU	1xxx
CONFIDENCE	2xxx
PDH	3xxx (for Subtests < 100), 18xxx (for Subtests 100+)
BER	4xxx
JITTER	5xxx (for Subtests<100, 20xxx (for Subtests 100+)
LONG GATING	6xxx
ATM	7xxx
POS	8xxx

Note ALL TESTS uses the number from the tests it calls.

The next digits indicate the Subtest, e.g. 415x, is Subtest 15 of Test 4 (BER).

(where subtests are >99 the numbering restarts)

The last digit indicates the error type. In general these are -

- 1 = Loss of Signal
- 2 = specific for subtest
- 3 = test result too low
- 4 = test result too high
- 5 = loss of frame sync
- 6 = loss of pointer sync
- 7 = loss of pattern sync

The error codes are accompanied by appropriate error messages.

6

Option Structure/Module Configuration

Introduction

Agilent's OmniBER provides SDH/SONET test capability, a choice of 1310 nm and 1550 nm Optics, BER, ATM and Jitter testing over the range from PDH rates up to 2.488 Gb/s.

OmniBER Mainframe

OmniBER 718A provides SDH/SONET test capability at 2.5 Gb/s and below.

OmniBER 718B provides SDH/SONET test capability at 622 Mb/s and below.

OmniBER 718C provides SDH/SONET test capability at 155 Mb/s and below.

PDH/Dsn Option

Option 012 provides E1, E2, E3, E4, DS1, and DS3 rates.

SDH/SONET Options

Option 001 provides SDH only.

Option 002 provides SDH/SONET.

OPTICS Options

Option 104 provides 1310 nm Optics.

Option 105 provides 1550 nm Optics.

Option 106 provides 1310/1550 nm Dual Optics.

JITTER Option

Option 200 provides jitter generation and measurement

ATM Options

Option 300 provides ATM up to 2.5 Gb/s.

POS Option

Option 310 provides POS payloads.

Option Structure/Module Configuration

OmniBER 718A/B/C Multirate BER configurations - Options 104/105/106

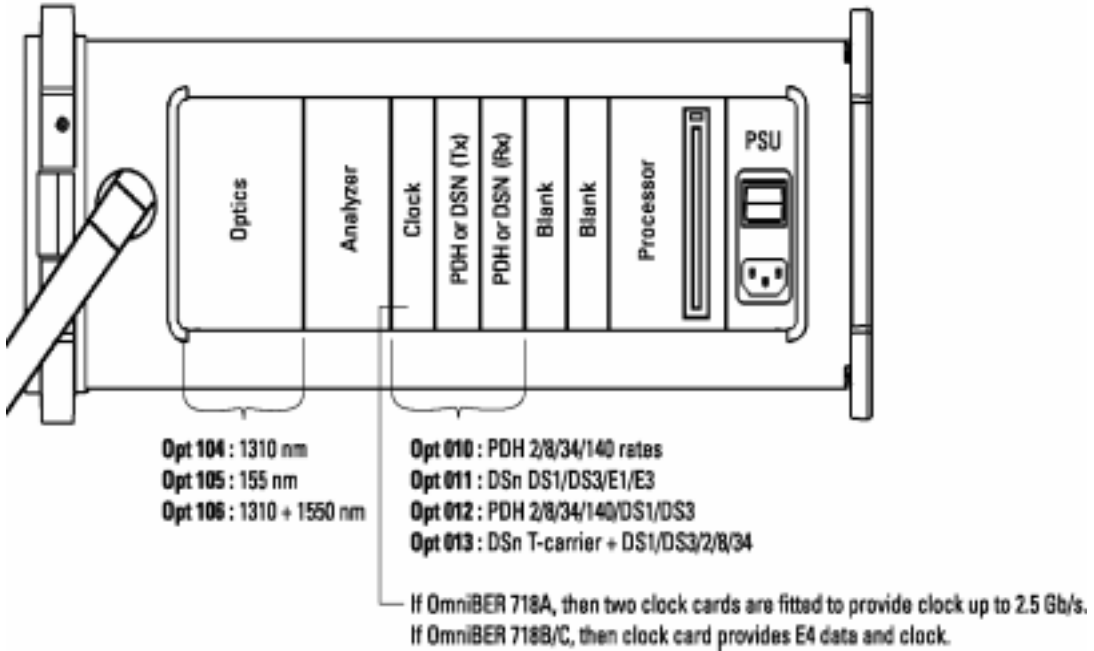

Option Structure/Module Configuration

OmniBER 718A/B/C Multirate BER+ JITTER configurations

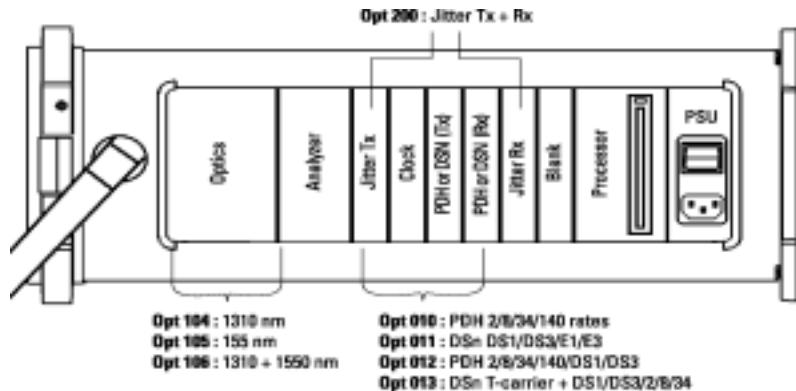

If OmniBER 718A, then two clock cards are fitted to provide clock up to 2.5 Gb/s.
If OmniBER 718B/C, then clock card provides E4 data and clock.

Option Structure/Module Configuration

Numerics

- 1.5M REF IN 2-7
- 2M REF IN 2-7
- 52/155 Mb/s DATA IN 2-7
- 52/155 Mb/s DATA OUT 2-7
- 64k REF IN 2-7

A

Accessories

 Connection 2-12

Alternative External MTS Clock 3-65

ANSI 4-1

Assistance 1-3

Australian EMC Regulations

 Compliance with 1-10

C

Calibration Cycle 3-1

Certification 1-3

Cleaning 1-8

 Instrument 1-8

 Optical Connectors 1-8

CLOCK TRIGGER 2-8

Compliance, Statement of 1-10

Connecting

 Accessories 2-12

 ESD Precautions Necessary 2-6

 To the Network 2-6

 To the Power Supply 2-4

Connectors

 Electrical Interface 2-6

 Optical Interface 2-10

D

DCC Port Tests 3-9

Default Settings 3-4

DEMUX 2 Mb/s 75 ohm Connector 2-8

DEMUX DS1 100 ohm Connector 2-8

DH/SONET Receiver Equalization 3-76

Dimensions and Weight 1-5

DS1 (1.544 Mb/s) Frequency Accuracy 3-13

DS1 100 ohm, 2Mb/s 120 ohm IN Connector 2-6

DS1 100 ohm, 2Mb/s 120 ohm OUT 2-7

DS3 (44.736 Mb/s) Frequency Accuracy 3-14

E

E1 (2.048Mb/s) Frequency Accuracy 3-11

E3 (34.368Mb/s) Frequency Accuracy 3-12

E4 (139.264 Mb/s) Frequency Accuracy 3-13

Electrical Interface Connectors 2-6

Electromagnetic Compatibility 1-11

Environment

 Operating 2-2

 Storage and Shipment 1-4

ESD Precautions

 For the Service Engineer 2-6, 2-15

ETSI 4-1

ETSI/ANSI Conversion and Equivalent Terms 4-1

External 2Mb/s Mux/Demux 3-45

External Clock/Data Reference Inputs & Clock Reference Output 3-60

External Jitter Generation and Demod Output 3-100

External MTS Clock 3-60

External Mux/Demux 3-45

F

Fuse Replacement 2-3

Fuses 2-3

G

General Purpose Interface Bus 2-13

GP-IB

 Address Selection 2-14

GPIB 2-13

GP-IB Address 2-14

Index

GP-IB Connection 2-13

H

HANDSET Connector 2-12

I

Inspection, Initial 2-1

Instrument Cleaning 1-8

Instruments Covered By Manual 1-4

Internal SDH Transmitter Clock 3-59

J

Jitt. Amp. PDH Tx/Rx 3-89

Jitt. Amp. SDH Tx/Rx 3-103

L

Laser apertures

 Location 2-11

LID Connector 2-12

Lifting/Carrying the Instrument 1-6

Location of Laser Apertures 2-11

Loopbacks Required by Each Self Test 5-9

M

Maintenance by the Operator 1-8

Multirate Optical Interfaces 3-83

MUX 2 Mb/s 75 ohm Connector 2-7

MUX Connector 2-7

MUX DS1 100 ohm Connector 2-7

N

Noise Declaration (German) 1-10

O

Operators Maintenance 1-8

Optical Connector Cleaning 1-8

OPTICAL IN Connector 2-11

Optical Interface Connectors 2-10

OPTICAL OUT Connector 2-11

Option Structure 6-1

P

PDH Frequency Measurement and Looped Clock
3-55, 3-58

PDH Receiver Equalization 3-33, 3-76

PDH Transmit/Receive Jitter Amplitude Accuracy
3-89

PDH Tx/Rx Jit. Amp. 3-89

PDH/DSn Frequency Measurement and Looped
Clock 3-55

PDH/DSn Internal Transmitter Clock Accuracy &
Offset 3-10

PDH/DSn Receiver Equalization 3-33

PDH/DSn Receiver Monitor Levels 3-40

PDH/DSn Transmitter Output 3-15

Performance Test Record 3-125, 3-135

Power Cord 2-5

Power Requirements 2-3

Power Supply Connection 2-4

Precautions

 ESD when connecting 2-6

Precautions for the Service Engineer 2-15

Preparation for Use 2-3

Printer GP-IB, RS232, PARALLEL ONLY Con-
nector 2-12

R

Recall Default Settings 3-4

RECEIVER 2,8,34,140 IN 2-6

Recommended Test Equipment 3-2, 3-5

REF OUT 2-7

Remote Control GP-IB, RS232, 10 BASE -T Con-
nector 2-12

Repackaging 1-4

Responsibilities of the Customer 1-2

Restricted Rights Legend 1-3

S

Safety Information 1-6

Safety Precautions

 For the Operator 1-6

 For the Service Engineer 2-15

Safety Symbols 1-7

Index

SDH Frequency Offsets 3-65, 3-66
SDH Transmit/Receive Jitter Amplitude Accuracy 3-103
SDH Tx/Rx Jitt. Amp. 3-103
SDH/SONET Frequency Offsets 3-65
SDH/SONET Receiver Monitor Levels 3-79
SDH/SONET Transmitter Clock Accuracy 3-59
Self Test 3-5
Self Test Errors 5-12
Self Test Loopback Cables and Accessories 3-3
Self Test Overview 5-1
Self Tests 5-1
Serial Number Plate 1-4
Shipping Container Inspection 2-1
SPDH Receiver Monitor Levels 3-40, 3-79
Statement of Compliance 1-10
STM-0/STS-1 Transmitter Output Waveshape 3-67
STM-1 Transmitter Output Waveshape 3-67, 3-71
STM-1/STM-4 Optical Interface 3-83
STM-1/STS-3 Transmitter Output Waveshape 3-71
Storage and Shipment 1-4
Symbols, Safety 1-7
T
TRANSMIT 2,8,34,140 OUT 2-6
V
VGA Connector 2-12
W
warning symbols 2-11
Warranty 1-1
Weight and Dimensions 1-5

Index

About This Edition

This is the first edition of the 37718-90252 manual. It documents the product as of May 2002.

© Copyright Agilent Technologies. 2000

All rights reserved. Reproduction, adaption, or translation without prior written permission is prohibited, except as allowed under the copyright laws.

Sales and Service Offices

An up-to-date list of Agilent Offices is available through the Agilent Website at URL:
<http://www.agilent.com>

In This Book

This book contains installation information and techniques for checking instrument specifications.

Printed in U.K. 05/02
37718-90252



Agilent Technologies