

Keysight Technologies InfiniiVision Series Oscilloscopes with 89600 VSA Software

Broadband vector
signal analysis
using Keysight InfiniiVision
Series oscilloscopes

Application Note

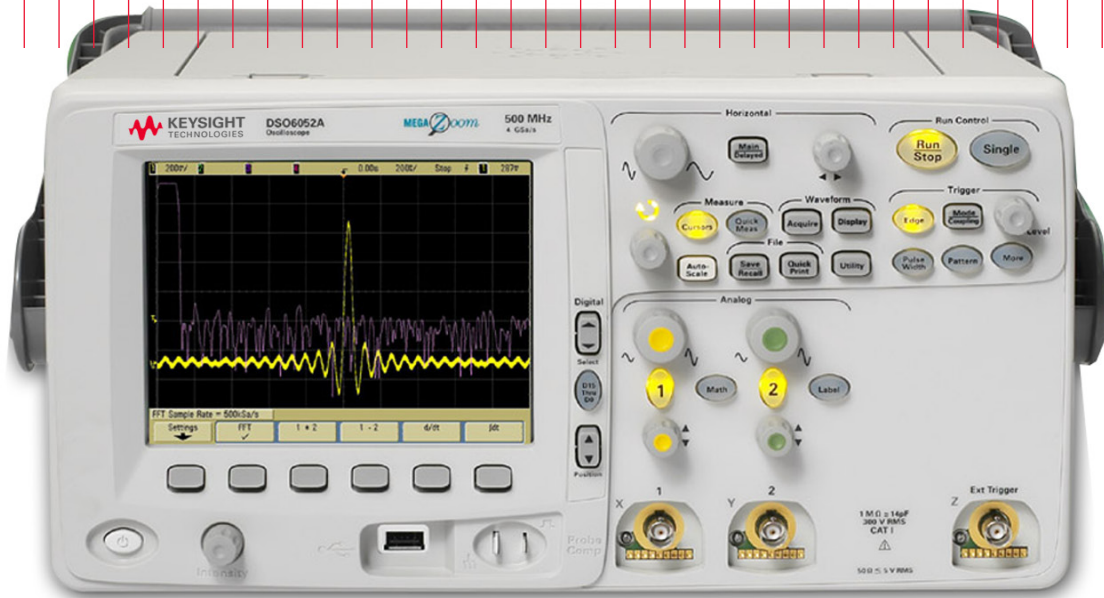

Overview

This application note describes the characteristics, setup, and operation of the Keysight Technologies Inc. InfiniiVision 4000 X-Series, 3000 X-Series, 6000, and 7000 Series oscilloscopes when combined with the 89600 VSA software to provide broadband vector signal analysis. By taking advantage of the layered architecture and extensive digital signal processing (DSP) routines of the 89600 VSA software, the oscilloscope becomes a new “front end” data acquisition subsystem for the 89600 VSA software. This hardware-software combination provides up to 1.5 GHz of analysis bandwidth depending on the oscilloscope used. See Table 1 for the supported oscilloscope models and the corresponding analysis bandwidths. Appendix A contains suggestions for wideband downconverters.

The 8-bit, high sample rate analog-to-digital converter (ADC) in the InfiniiVision Series oscilloscopes produces the large analysis bandwidths shown in Table 1. These bandwidths are capable of providing a spurious-free dynamic range greater than or equal to 40 dB. This is sufficient for 1.5 to 2% error vector magnitude measurements in most cases. For spectrum measurements with higher dynamic range, a traditional spectrum analyzer should be used.

Table 1. InfiniiVision Series oscilloscopes supported by 89600 VSA software

Model	Analysis bandwidth	Max. sample rate	Main time memory option
610x/710x ¹	0 to 1.0 GHz	4 GSa/s	1M (2M, 8M options)
605x/705x	0 to 500 MHz	2 GSa/s	1M (2M, 8M options)
603x ²	0 to 300 MHz	1 GSa/s	1M (2M, 8M options)
703x ²	0 to 350 MHz	1 GSa/s	8 Mpts standard
701x	0 to 100 MHz	400 MSa/s	8 Mpts standard
601x	0 to 100 MHz	500 MSa/s	1M (2M option)
601x	0 to 100 MHz	400 MSa/s	8 Mpts (option)
305x	0 to 500 MHz	4 GSa/s ³	2M (4M option)
303x	0 to 350 MHz	4 GSa/s ³	2M (4M option)
3024	0 to 200 MHz	4 GSa/s ³	2M (4M option)
301x	0 to 100 MHz	4 GSa/s ³	2M (4M option)
310x	0 to 1.0 GHz	5 GSa/s	2M (4M option)
41544	0 to 1.5 GHz	5 GSa/s	4M
4104	0 to 1.0 GHz	5 GSa/s ⁵	4M
405x	0 to 500 MHz	5 GSa/s ⁵	4M
403x	0 to 350 MHz	5 GSa/s ⁵	4M
402x	0 to 200 MHz	5 GSa/s ⁵	4M

Try before you buy!

Download the 89600 software and use it free for 14 days to make measurements with your analysis hardware, or use our recorded demo signals by selecting **File> Recall> Recall Demo> QPSK>** on the software toolbar. Request your free trial license today:

www.keysight.com/find/89600_trial.

89600 VSA software

1. 781.25 MHz bandwidth and 2 Gsa/s when using adjacent channels (full channel mode).
2. 2 Gsa/s with 8 M option using non-adjacent channels (half-channel mode).
3. 2 GSa/s when using adjacent channels (full channel mode).
4. 1.0 GHz bandwidth and 2.5 GSa/s when using adjacent channels (full channel mode).
5. 2.5 GSa/s when using adjacent channels (full channel mode).

The 89600 VSA vector signal analysis software is the heart of the broadband VSA and oscilloscope combination, providing flexible tools for analyzing and demodulating even the most advanced digital modulations, including those not defined by an established standard.

The 89600 VSA makes measurements on signals in the time and frequency domains using either the baseband or IF Zoom mode. In baseband mode, the analysis frequency range is from 0 Hz to the stop frequency. In IF Zoom mode, the analysis frequency range is defined by center frequency and span. There is also an I+jQ mode for analyzing two baseband quadrature channels. Results for any mode can be displayed as magnitude or phase, in I/Q and several other formats. For supported 4-channel InfiniiVision oscilloscope models, the 89600 software provides up to four channels of vector signal analysis, or dual I+jQ capability.

89600 VSA software continued

With optional digital demodulation analysis, Option AYA, modulation quality measurements in the form of error vector magnitude (EVM) can be made on digital wireless communications signals with bandwidths of hundreds of MHz. In addition, powerful diagnosis capabilities allow you to determine the exact impairments that cause a digitally modulated signal to fail quality standards.

The InfiniiVision Series supports baseband signal analysis up to the maximum bandwidth supported for MIMO applications.

- For IEEE 802.11n WLAN applications, Option B7Z provides 2-, 3-, 4- or 8-channels for up to 8x8 MIMO analysis. The InfiniiVision oscilloscopes have a maximum of 4 channels each, so with Option B7Z they can support up to 4x4 MIMO analysis.
- Mobile WiMAX™ 2x2 MIMO analysis is available in Option B7Y IEEE 802.16e OFDMA modulation analysis.
- For LTE applications, options BHD for LTE FDD and BHE for LTE TDD provide 2-, 4-, or 8-channels for up to 8x8 MIMO analysis. The InfiniiVision oscilloscopes have a maximum of 4 channels each, so with options BHD and BHE they can support up to 4x4 MIMO analysis.

The features of the digital demodulator include variable-block-size signal acquisition, pulse burst edge search, synch word search and a user-controllable adaptive equalizer.

User-selectable filter types include cosine (raised and square-root raised), Gaussian, lowpass, and user-defined. You can vary the filter alpha/BT shape factor. Supported modulation formats for both burst and continuous carriers include FSK, BPSK, QPSK, OQPSK, DQPSK, $\pi/4$ DQPSK, 8PSK, $\pi/8$ D8PSK, QAM (16 to 1024), APSK (16 and 32) and MSK and much more. For more information, see www.keysight.com/find/89600VSA.

In addition, the 89600 software provides a signal record feature for later playback and analysis.

Required software revisions

The following table lists the software revisions for an oscilloscope to work with the 89600 software. Firmware version numbers greater than these will also work.

Table 2. Software revision numbers

Model number	LAN, USB	GPIB	89600
6000 Series	A.02.02	–	13.0
6000 Series	–	A.03.00	13.0
7000 Series	A.05.00	Not applicable	13.0
3000 X-Series	02.00	02.00	15.0
4000 X-Series	03.00	Not applicable	16.0

The 89600 VSA software is designed to run remotely in a PC connected to the oscilloscope.

Install 89600 VSA Software

Remote PC connection

Insert the Keysight 89600 Series software installation media (DVD) and follow the instructions in the Installation Manager Window. Click **Install 89600 VSA**. Continue through the Installation Manager to complete the installation. Exit the Installation Manager window.

Hardware Configuration

I/O between computer and oscilloscope

Connect the oscilloscope and the computer as shown in Figure 1a, 1b, or 1c. There are three options for the connection, USB, GPIB, and LAN. Refer to Appendix B for more information on the cabling interface cards.

Note that you may need to select your interface (USB, GPIB or LAN) in the oscilloscope in order to activate it.

For improved measurement speed, use of USB is recommended.

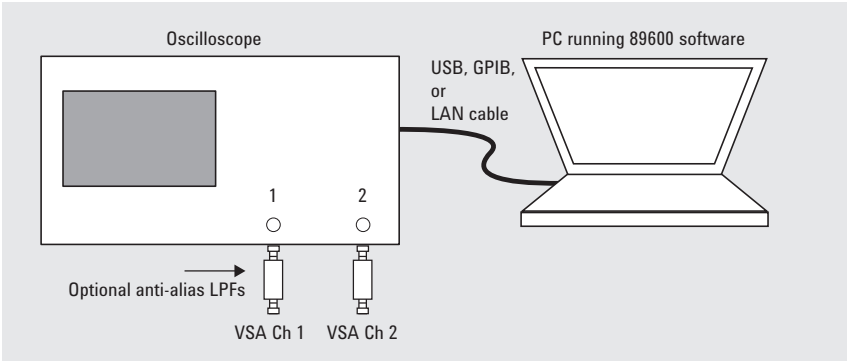

Figure 1a. Equipment connections for 2-channel oscilloscopes

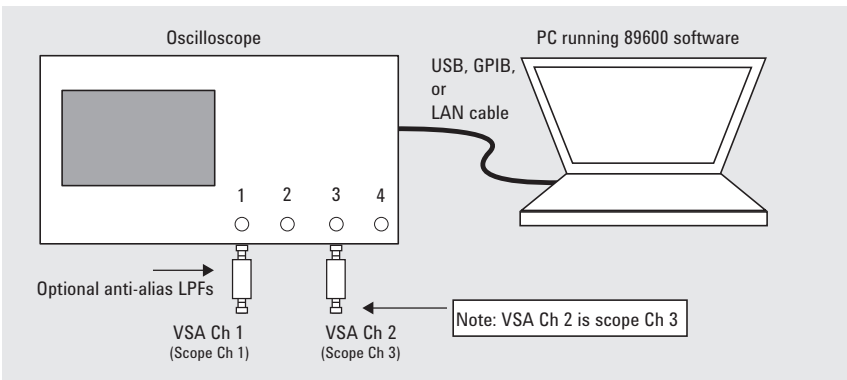

Figure 1b. Equipment connections for 4-channel oscilloscopes when using 2 VSA channels¹

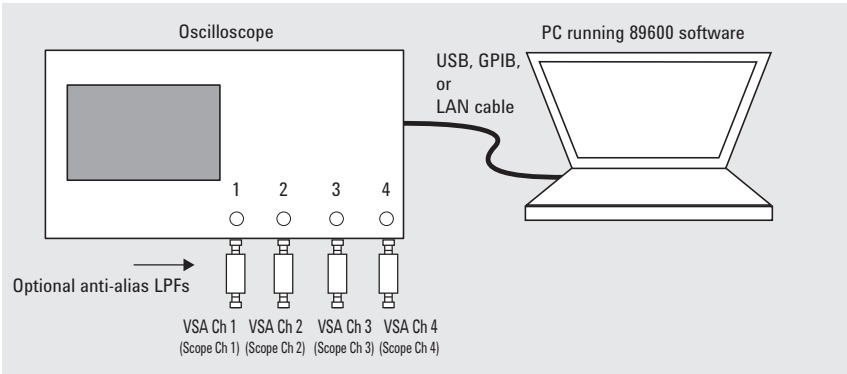

Figure 1c. Equipment connections for 4-channel oscilloscope used to provide 3- or 4-channel VSA measurements using the 89600 VSA software.¹

Anti-alias filters and alias exposure-free mode

The broadband VSA software and scope combination can be configured to be essentially alias-free by using the Full Rate sampling mode and installing an external lowpass filter on the oscilloscope input.

The characteristics needed for the low pass filter are given in Table 3. Both the cutoff frequency, as well as the frequency at which the signal must be down by at least 40 dB, are given.¹

Table 3. External lowpass filters

Oscilloscope model	Cutoff	Stop band frequency (loss > 40 dB)
310x (using adjacent channels)	1 GHz	1.5 GHz
4154 (using adjacent channels)	1 GHz	1.5 GHz
610x/710x (using non-adjacent channels)	1 GHz	3 GHz
610x/710x (using adjacent channels)	781.25 MHz	1.22 GHz
605x/705x	500 MHz	1.5 GHz
603x	300 MHz	700 MHz
703x	350 MHz	650 MHz
601x/701x	100 MHz	300 MHz

Operation

Operation of the broadband 89600 VSA software and InfiniiVision oscilloscope combination is substantially the same as that of the standalone 89600 VSA software. See the following sections for some differences or special configurations.

NOTE: Calibrate the oscilloscope periodically by following its calibration instructions.

Full Rate mode

When the Sample mode is set to Full Rate using the **Input > Extensions... > SampleMode > FullRate** menu path, the oscilloscope sample rate is fixed at the maximum for each oscilloscope model according to Table 4.

Table 4. Sample rates of InfiniiVision Series oscilloscopes in Full Rate mode

Oscilloscope model	Full sample rate
301x	1 GSa/s
3024	1 GSa/s
303x	2 GSa/s
305x	4 GSa/s (2 GSa/s when adjacent scope channels used)
601x	400 MSa/s (8 M option)
601x	500 MSa/s (1M, 2M option)
603x	1 GSa/s (1M, 2M option)
603x/703x	2 GSa/s (8 M standard)
605x/705x	2 GSa/s
610x/710x	4 GSa/s (2 GSa/s when adjacent scope channels used)
701x	400 MSa/s (8 M standard)
310x	5 GSa/s (2.5 GSa/s when adjacent scope channels used)
402x	1.0 GSa/s (625 MSa/s when adjacent scope channels used)
403x	2.5 GSa/s
405x	2.5 GSa/s
4104	5 GSa/s (2.5 GSa/s when adjacent scope channels used)
4154	5 GSa/s (2.5 GSa/s when adjacent scope channels used)

Sampling modes: full rate and user rate

1. Low pass filters are available from many vendors, including Mini-Circuits, Inc., 1-800-654-7949, www.minicircuits.com.

With the addition of the anti-alias lowpass filter described above, this mode is free of alias exposure zones. This means that no signal anywhere in the range of the broadband combination of the 89600 VSA software and the InfiniiVision scope's center frequency will alias upon the desired signal and corrupt the measurement.

There is a trade-off when using this mode. The measurement time or Main Time is limited by the memory in the oscilloscope. Optional memory is available for some oscilloscopes to increase the maximum Main Time. If a longer Main Time (or Result Length for digital demodulation) is needed for more resolution in the frequency domain, go to the **Input** menu, click on **Extensions...>SampleMode** and select **User Rate** from the drop-down menu, and set the **UserSampleRate** parameter. Make sure that you thoroughly review the user rate section below before using this mode. The Main Time limit for any sample rate is shown in the operating region curves that appear later in this Application Note.

NOTE: Any limitation to Main Time (or Result Length) will be indicated by the inability of the software to increase the Main Time or decrease RBW when number of Frequency Points is increased.

User Rate mode

The user rate setting allows you to directly control the oscilloscope's sample rate. In this mode you select the oscilloscope sample rate to be used. The actual sample rate selected will be the highest rate that is less than or equal to the **UserSampleRate** setting. By controlling the oscilloscope's sample rate you can directly influence the update rate of the 89600 VSA. This is because sample rate directly affects the number of points the oscilloscope must transfer to the PC. Certain measurements can be made significantly faster by limiting the oscilloscope sample rate due to reduced data transfer requirements.

Sampling modes:
full rate and user rate
continued

There are two types of signal aliasing to be concerned with when using the 89600 VSA software with the InfiniiVision Series oscilloscope. The first is aliasing of unwanted out-of-band signals into the measurement span. This will not be a problem with the majority of clean, single-signal devices. However, devices with multiple or spurious signals could have this type of aliasing. It is the user's responsibility to check for these signals. See Table 5 for more suggestions. A second type of aliasing happens when the sample rate causes the in-band signal to fold over on itself. This in-band (or self-) aliasing is avoided in Full Rate mode. However, in User Rate in-band aliasing may be a problem. To avoid in-band aliasing you must select a suitable sample rate based on your measurement center frequency and span.

To avoid in-band aliasing the oscilloscope sample rate (F_s) must be selected so that the analysis span falls within confined regions. Staying within these regions prevents the analysis span from being positioned too close to $F_s/2$. When F_s is selected so that the span is confined to be within a single gray box (see diagrams below), in-band aliasing is avoided. See the following table for the equations that describe these in-band alias-free regions.

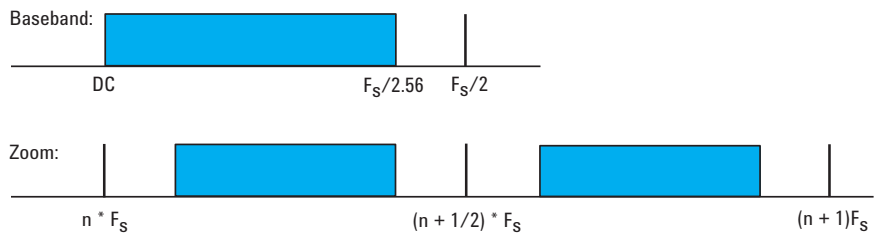

Figure 2. Avoiding in-band aliasing by selecting F_s within a confined span

The primary use of User Rate mode is to increase the update rate for measurements that have been carefully engineered to avoid unwanted alias signals.

NOTE: The 89600 software does not attempt to avoid alias exposure regions when in User Rate mode.

This table summarizes the difference in approach to alias protection between the various sample modes:

Table 5. Varying approaches for alias protection

Full Rate	Both in-band and out-of-band aliasing are prevented through use of an appropriate low-pass filter.
User Rate	<p>You are responsible to avoid in-band aliasing through appropriate selection of sample rate based on center frequency and span. To ensure no in-band aliasing is present the oscilloscope sample rate (F_s) must be selected to meet this criteria:</p> <p>Baseband: $F_{STOP} \leq F_s/2.56$</p> <p>Zoom: $(n * F_s)/2 \leq F_{CENTER} - (1.28 * F_{SPAN})/2$ AND $((n+1) * F_s)/2 \geq F_{CENTER} + (1.28 * F_{SPAN})/2$ where $n = 1, 2, 3, 4, \dots$</p> <p>Out-of-band aliasing is minimized through the use of an appropriate low-pass filter, and is eliminated through the use of an appropriate band-pass filter. It is the user's responsibility to provide either.</p>

Triggering with the 89600 VSA software

The trigger parameter hold-off has two modes in the 89600 VSA software useful for broadband vector signal analysis: below level and conventional. The below level mode definition is optimized for high duty cycle communications bursts and is different from the traditional definition of hold-off for low duty cycle pulses.

See the 89600's interactive Help tool for a description of below level and conventional hold-off modes. See the oscilloscope's Help tool for a description of the traditional low duty cycle hold-off.

Special trigger modes: custom trigger commands

The InfiniiVision Series oscilloscopes have extensive trigger conditioning and pattern capability. To take advantage of any mode not covered in the broadband VSA software, a custom trigger mode is available. Click **Input > Extensions... > CustomTrigType** and click the **check box**. You can then enter the SCPI commands for specific triggering modes using the custom trigger command entry box. Enter the sequence of SCPI trigger commands in the **CustomTrigCommand** dialog box. Use a semicolon to separate the commands. The commands will be transmitted to the oscilloscope upon clicking the last **OK** box when closing the **Input** windows and whenever standard trigger commands are sent.

Changing the preset conditions

The preset conditions can be changed for the oscilloscope by entering SCPI commands in the **Input > Extensions...** menu path and entering commands in the **UserSCIPreset** area. Separate commands with a semicolon. Verify that any commands do not conflict with the normal operation of the software.

Feature availability

- No Magnitude Trigger (however, Channel Trigger is available).
- Possible limitation of movement on the operating region curve to avoid alias corruption of the measured signal. This depends on the settings of Center Frequency, Span, Sample Mode, and number of Frequency Points. There is also potential interference due to the alias products of out-of-band signals. (See Table 5.)
- No built-in wideband calibrator. The frequency response corrections are determined from factory data.

Time and Frequency Span Operating Region

The relationship of main time length, span, and sample rate

The operating region curves for the broadband 89600 and oscilloscope combination are different from those of standalone 89600 VSAs because the Main Time Length may be limited for some sample rate, center frequency, and span combinations. The differences are due to three hardware characteristics of the wideband ADCs in the InfiniiVision Series oscilloscopes:

- A much higher sampling rate
- The lack of a hardware decimator, which means the decimation must be performed by the software from same-length records taken at much higher sampling rates
- Limited memory capacity

The record length, or Main Time Length of a measurement is shown in the lower right corner of a spectrum or time display window. This is the length of time the oscilloscope sampled the input waveform for the measurement. These samples are transferred to the DSP and measurement algorithms running on the software.

Maximum Main Time Length is normally adjusted by setting number of Frequency Points in the **MeasSetup > ResBW** menu. ResBW Coupling is set to Auto, and ResBW Mode is set to Arbitrary or 1-3-10. The Time tab can then be used to set Main Time Length up to this maximum limit. This setup keeps Main Time Length maximized and within the DSP requirements.

Although Main Time Length can be adjusted directly by the **MeasSetup > Time** menu, it cannot be greater than the limit imposed by the number of Frequency Points line on the operating region chart. See the online Help tool for a complete discussion.

Note: The maximum Main Time Length can be found as follows:

The relationship between the parameters is shown below:

$$\text{Max Main Time Length} = \frac{\text{Number of frequency points}}{\text{Span}}$$

$$\text{where Span} = \frac{\text{Sample rate}}{1.28} \text{ (for IF Zoom mode)}$$

$$\text{Max Main Time Length} = \frac{1.28 \times \text{Number frequency points}}{\text{Sample rate}}$$

where *Sample rate* = current sample rate computed by the software for alias-free measurements

Maximum Main Time Length may be further limited by oscilloscope memory depth.

Operating region curves for InfiniiVision Series oscilloscopes

Several interrelated characteristics of both the InfiniiVision Series oscilloscopes and the 89600 VSA software combine to form a region within which the software is constrained to operate. The 89600 VSA software characteristics that affect this operating region include maximum number of time points, the minimum number of time points (not user settable), a maximum acquisition record size (not user settable) and a maximum decimation factor (not user settable). The InfiniiVision Series characteristics that affect the operating region are sample rate and memory depth. This section describes the effects each of these parameters have on the VSA operating region.

The operating region is described in terms of span and time record length. For a given window type it could just as easily be described in terms of span and RBW. Figure 3 shows the effects of the number of time points the 89600 VSA software is allowed to collect. Because sample spacing is inversely proportional to span, the record length decreases as span increases. Although a family of lines is shown, only two define the operating region at any one time. The lowest line gives the smallest time record length allowed for any given span. The position of this line is determined by minimum number of time points (16) the 89600 requires in a time record. The line that defines the upper time record length boundary is positioned by the maximum number of time points the 89600 allows in a time record. The maximum number of time points is determined by the Frequency Points setting (**MeasSetup > ResBW > Frequency Points**). The 89600 VSA is constrained to operate in the region between these two lines. Note that the operating lines of Figure 3 are the same for all InfiniiVision Series models.

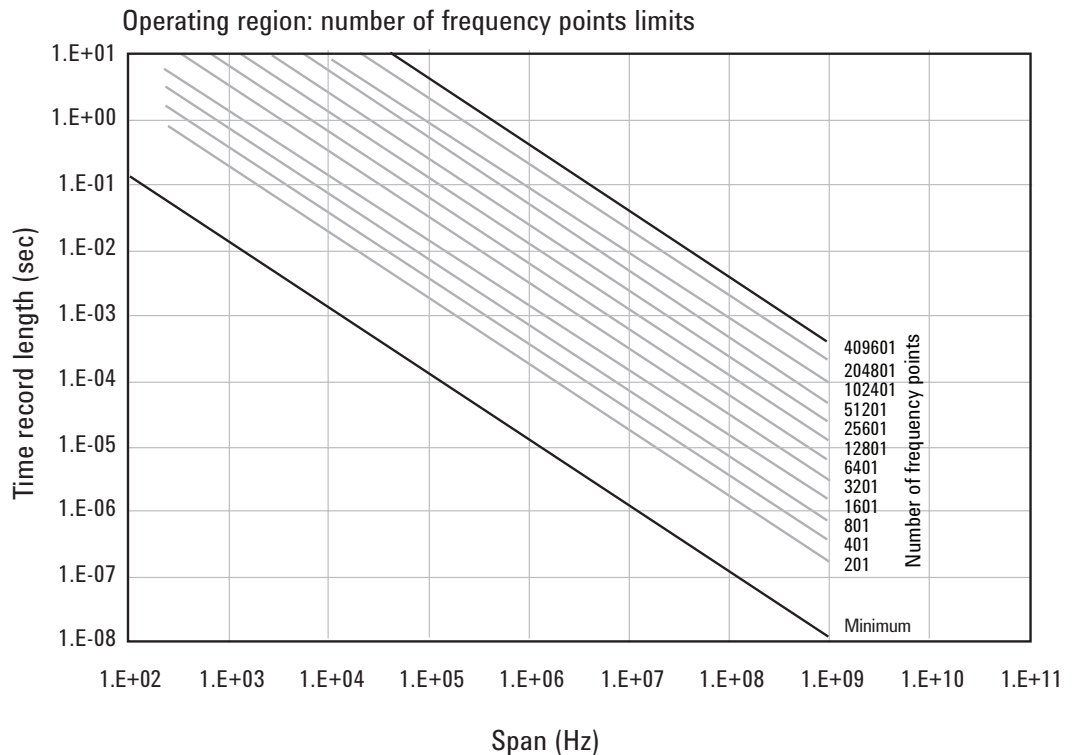

Figure 3. The user-settable parameter, frequency points, begins to determine the boundaries of the time record length and frequency span operating region.

Operating region curves for InfiniiVision Series oscilloscopes *continued*

In addition to the time record length limits, there are limits to the allowable range of spans. These are represented as vertical lines on the operating region in Figure 4. The upper span limit is set by the scope's sample rate. For the highest sample rate supported by the scope this boundary may be further limited by the analog performance of the scope's front-end. To zoom in on a signal of interest by reducing the span, traditional VSA instrumentation reduces the effective sample rate through the use of decimating filters while keeping the ADC at full rate. This technique allows for maximum alias protection. Unlike traditional VSA instruments, the InfiniiVision Series scopes have no decimating filters. To compensate for this shortcoming, decimating filters have been built into the 89600 VSA software. The maximum amount of decimation allowed by the 89600 VSA software sets the minimum span for any given scope sample rate.

The operating region depicted in Figure 4 is determined by constraints imposed by both time record length and span. The InfiniiVision Series scopes support many sample rates. For each sample rate, the operating region shifts slightly on the operating region graph. As the sample rate decreases, the operating region shifts slightly up and to the left. So, for any given scope, there will be a family of overlapping operating regions, one for each supported sample rate.

In general, these regions would be the same for every scope that supports a given sample rate. The only difference is when the maximum span at the maximum sample rate is limited by analog performance of the scope's front-end rather than just by the sample rate.

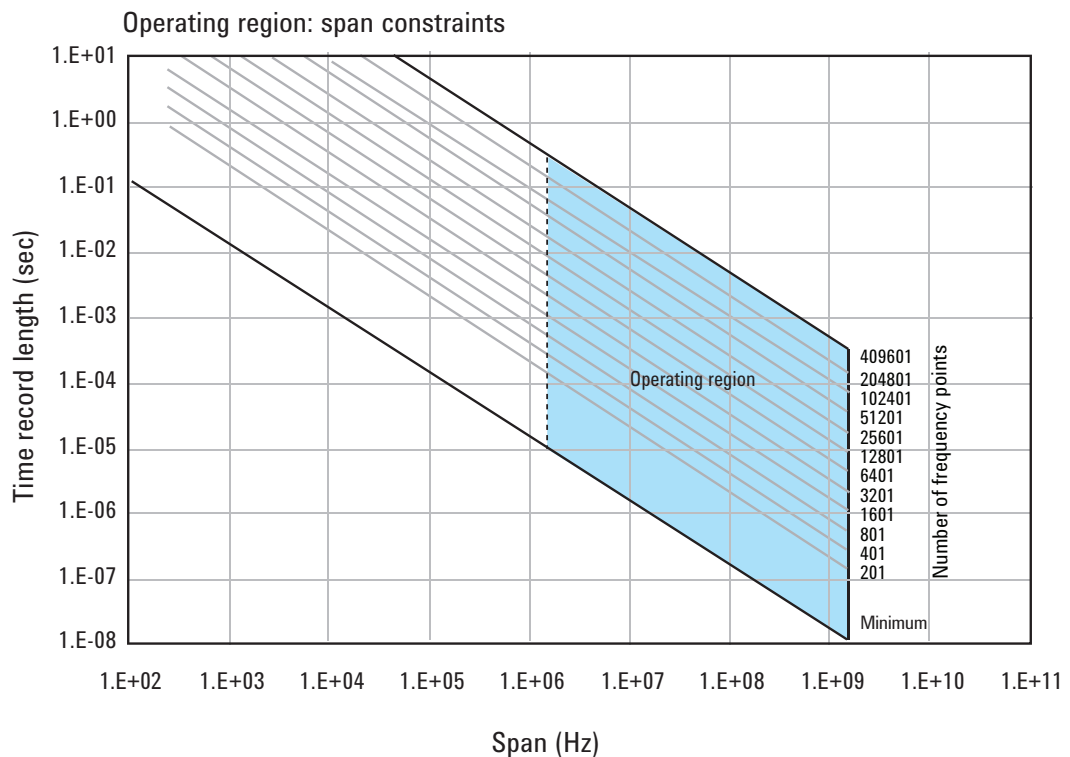

Figure 4. The allowable range of spans, which may differ by model, further bound the operating region of the oscilloscope.

Operating region curves for
 InfiniiVision Series oscillo-
 scopes *continued*

In addition to time record and sample rate limits, the operating region can be further limited by memory constraints. Both the scope and the 89600 VSA software impose different, but similar, constraints due to maximum memory usage. Figure 5 shows how memory limits can actually affect both maximum time length and minimum span (mostly the horizontal curve that drops at the left). For a given scope sample rate the scope memory imposes an upper bound on the time record length. This is shown as the upper portion of the operating region that is effectively cut off by the horizontal memory line. This limit is fairly constant until the span narrows significantly. The sharp drop at the left end of the memory curve is due to the effects of decimation and extra points acquired for 89600 VSA software filter settling. As the amount of decimation increases, the portion of the available sample memory that is required for settling becomes a much higher percentage of the available overall sample memory. When this happens, the portion of the sample memory that is available for displayed time record length is quickly reduced.

The memory curve moves up, exposing more of the available operating region, as the scope's optional memory is increased. However, the 89600 VSA software imposes its own record size limit. Increasing the scope's memory beyond the 89600 VSA software limit has no further impact on the available operating region.

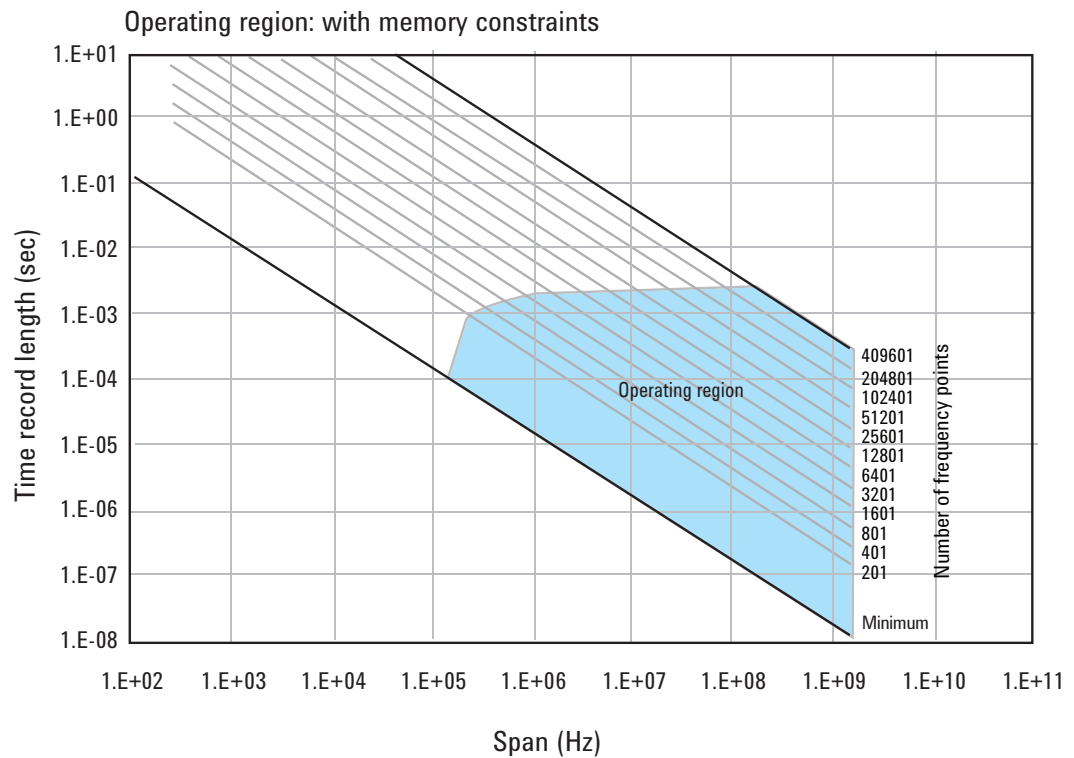

Figure 5. The oscilloscope's available memory also constrains the operating region.

Operating region curves for
 InfiniiVision Series oscillo-
 scopes *continued*

Taken together, these constraints form an operating region that the 89600 VSA software must remain within (Figure 6). To complete our understanding there are a couple of additional points regarding sampling mode and alias exposure that must be presented.

The graphs presented in this section describe discrete operating regions that are a function of sample rate. In Full Rate or User Rate sample modes a single operating region curve fully describes the constraints imposed on the measurement.

In Full Rate sample mode with the use of appropriate low pass filtering (Table 3) signal aliasing is completely avoided. In this case the Operating Region is renamed Alias Exposure Free Zone to indicate this special condition.

Although the operating regions for all scope models are similar, each model may have important differences in their operating region curves due to differences in maximum sample rate, front-end analog performance, and memory option. Appendix D provides the operating curves for all supported InfiniiVision Series scopes and most memory options.

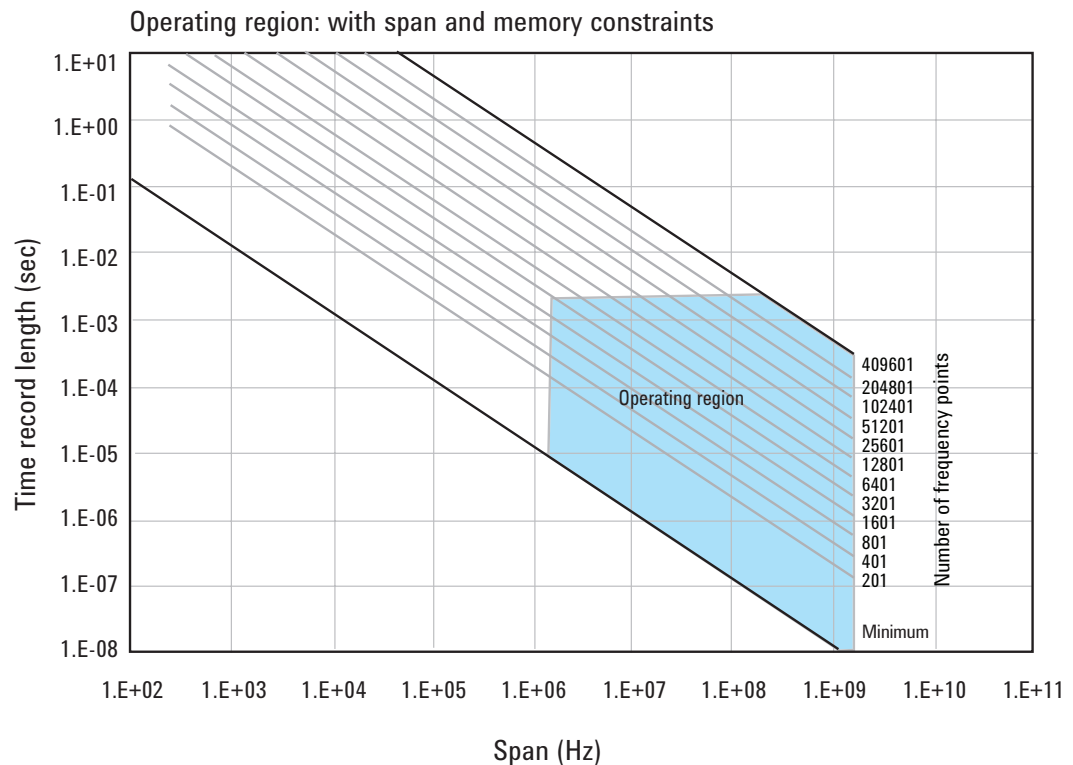

Figure 6. The true operating region is fully described when constrained by all the previous parameters: number of frequency points, span, and oscilloscope memory. See Appendix D for operating region charts for the various supported oscilloscopes.

Recording limits for Infini- iVision Series oscilloscopes

The 89600 VSA software allows the acquisition of long records to be captured. Analysis is done as a post-processing operation. This feature is called Recording. Recordings can be much longer than time records in live measurements.

When making an 89600 VSA recording, the scope sample rate and memory depth determines the maximum recording length. When in User Rate the maximum recording lengths will increase as the sample rate decreases. The following table indicates the maximum recording length at full rate for each supported scope.

Table 6. Maximum recording lengths at maximum span for each oscilloscope model with memory as shown. Recording lengths are best case for non-adjacent channels on 4 channel models; or 1 channel on 2 channel models.

Model	Max span	Recording length for possible memory configuration			
		1 M	2 M	4M	8 M
610x/710x	1 GHz	100 μ s	200 μ s	N/A	1 ms
605x/705x	500 MHz	200 μ s	400 μ s	N/A	2 ms
603x	300 MHz	400 μ s	800 μ s	N/A	2 ms
601x	100 MHz	800 μ s	1.6 ms	N/A	10 ms
701x	100 MHz	N/A	N/A	N/A	10 ms
703x	350 MHz	400 μ s	800 μ s	N/A	2 ms
305x	500 MHz		199 μ s	498 μ s	
303x	350 MHz		398 μ s	997 μ s	
3024	200 MHz		797 μ s	1.99 ms	
301x	100 MHz		797 μ s	1.99 ms	
310x	1.0 GHz		199 μ s	199 μ s	
4154	1.5 GHz			199 μ s	
4104	1.0 GHz			199 μ s	
405x	500 MHz			498 μ s	
403x	350 MHz			498 μ s	
402x	200 MHz			1.99 ms	

Table 7. Maximum recording lengths when using adjacent channels (e.g., using both channels of a 2-channel scope, or 3- or 4- channels of 4-channel models)

Model	Max span	Recording length for possible memory configuration			
		1 M	2 M	4M	8 M
610x/710x	781.25 MHz	99.5 μ s	200 μ s	N/A	1 ms
605x/705x	500 MHz	99.5 μ s	199 μ s	N/A	996 μ s
603x	300 MHz	199 μ s	398 μ s	N/A	996 μ s
601x	100 MHz	398 μ s	796 μ s	N/A	4.98 ms
701x	100 MHz	N/A	N/A	N/A	4.88 ms
703x	350 MHz	199 μ s	398 μ s	N/A	996 μ s
305x	500 MHz		198 μ s	497 μ s	
303x	350 MHz		198 μ s	497 μ s	
3024	200 MHz		397 μ s	994 μ s	
301x	100 MHz		397 μ s	994 μ s	
310x	1.0 GHz		199 μ s	199 μ s	
4154	1.0 GHz			199 μ s	
4104	1.0 GHz			199 μ s	
405x	500 MHz			199 μ s	
403x	350 MHz			199 μ s	
402x	200 MHz			995 μ s	

Out-of-Band Alias Exposure Zones

The user rate sampling mode increases the maximum Main Time length at the expense of possible aliasing of out-of-band signals into the frequency span of the measurement. The spectrum ranges subject to the alias conversion are called alias exposure zones. To determine if any out-of-band signals exist in the exposure zones, run the Alias Exposure Zone Checker macro.

Setting up the alias exposure zone checker

Follow this procedure for setting up the Alias Exposure Zone Checker:

1. Start the 89600 VSA application.
2. Click on **Utilities > Macros...** Use the **Import...** button to navigate to the Examples\Macros subdirectory in the directory where you installed the 89600 VSA software application (for example, C:\Program Files\Keysight\89600 Software <version>\89600 VSA Software\Examples\Macros). Select **RecallSetupAfterAliasCheck** and **AliasChecker** folders, and click **OK**.

Using the alias exposure zone checker

To display the alias checker programs, click on **Window > Macros** to automatically display the Macro window.

The Alias Exposure Zone Checker macro calculates the frequencies of the alias exposure zones for any combination of center frequency, span, and oscilloscope sample rate. It then measures the power in each zone and compares it to the power of the desired signal in the span of the measurement setup at the time the checker was started. An unwanted signal in an exposure zone is a source of interference if it is larger than the desired signal's amplitude minus 40 dB. This -40 dBc threshold is approximately the same level as the quantization errors in the oscilloscope's 8-bit digitizer, and represents the limit of the oscilloscope's dynamic range. The -40 dBc level is sufficient for 1 to 2 percent EVM measurements.

Using the alias exposure zone checker *continued*

Launch the checker macro by using the tool path **Utilities > Macros...** Click on **Alias Checker** then the **Build & Run** button, or run the macro by clicking on the macro name in the macro window.

Alias zone checking is performed on only one channel at a time. A dialog window will appear asking you to select the desired oscilloscope logical channel to check. Type it in and click **OK**.

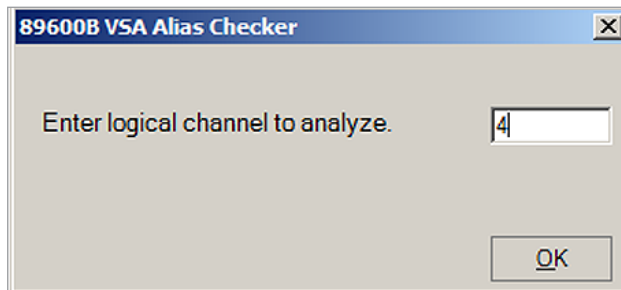

When the macro continues, a full-span spectrum trace (Figure 7) will appear in Trace A (yellow). It shows the desired signal plus any unwanted signals. Superimposed is a red Trace B showing boxes for each exposure zone frequency range. Any unwanted signal falling inside the zone box is a source of alias interference. If the height of any box is higher than the yellow reference line, the power in that zone is greater than the -40 dBc threshold of interference.

Click **Yes** in the checker dialog box to return to the original measurement setup. Click **No** for further examination of the out-of-band signals. You can return to the original measurement setup by clicking on **Utilities > Macros...** and then the **Recall Setup After Alias Check** macro and the **Build & Run** button. You may also run the **RecallSetupAfterAliasCheck** macro by clicking on the macro name in the macro window.

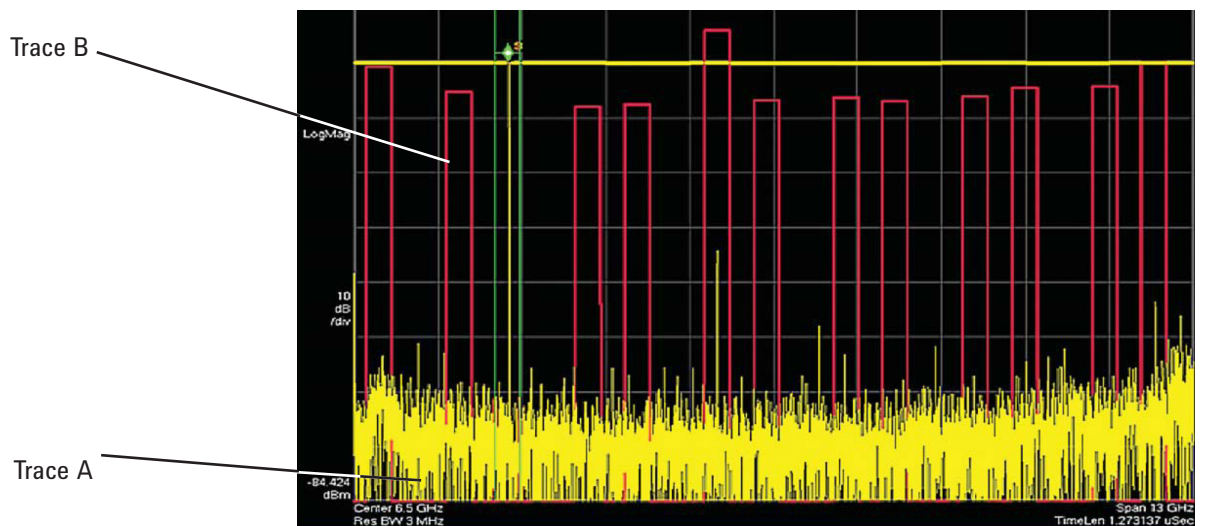

Figure 7. Alias Exposure Zone Checker results. The desired signal is at 2.38 GHz. The unwanted signal in the fifth alias zone at 5.62 GHz is over 5 dB above the threshold line, shown in yellow here.

Using the alias exposure zone checker *continued*

When no alias zones exist because the current sampling mode is alias free, no red zone boxes will appear. In addition, the message **No Alias Zones Detected! Restore Initial Settings?** will appear (see Figure 8).

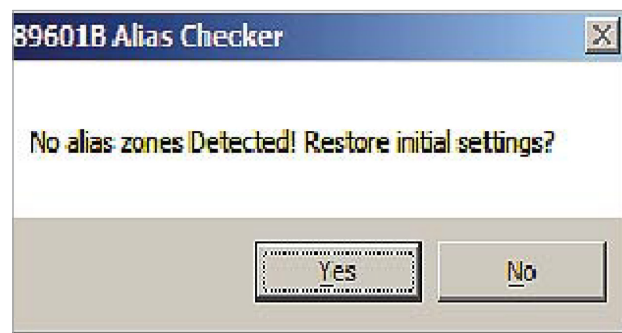
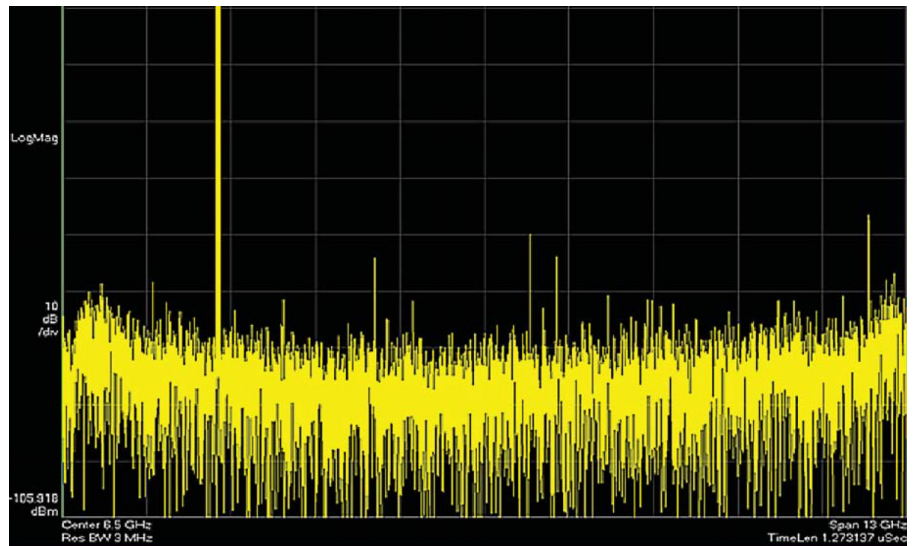

Figure 8. Alias checker results when no zones are detected. No red alias zone boxes appear.

Using the alias exposure zone checker *continued*

When the original center frequency/span is inadvertently tuned to an alias response of a signal whose frequency is not the center frequency, the checker will attempt to suggest the signal's frequency. The checker results at the desired center frequency location (area formed by green bands with marker lines) will show no signal, and a large signal will appear in one of the zones, as shown in Figure 9. Further, all zone boxes will be well above the yellow threshold line.

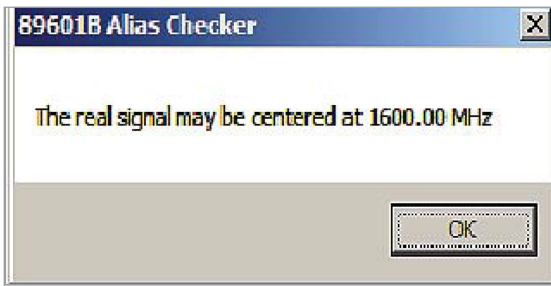
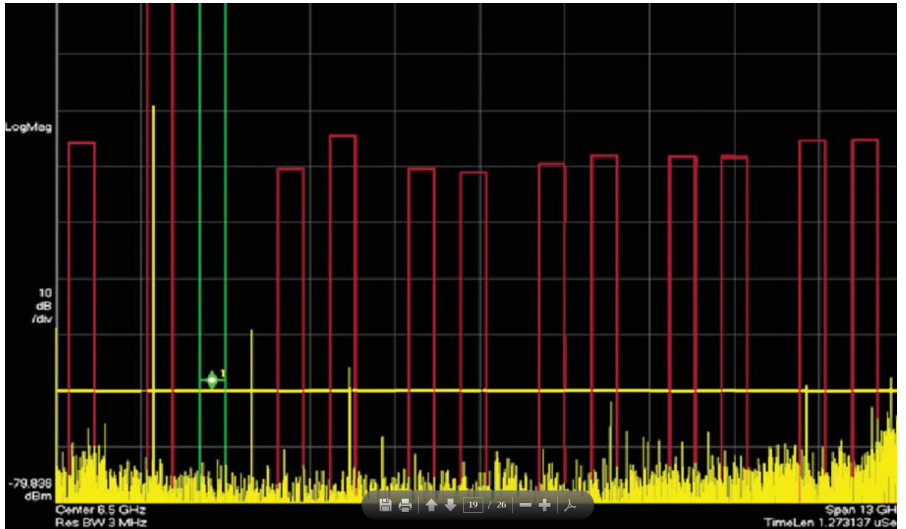

Figure 9. Alias checker results when the center frequency is originally tuned to an alias product. The checker shows no signal at the desired frequency (see green bands with marker) and large zone boxes at the zones containing the desired signal.

Appendix A

Downconverting RF and microwave signals into the range of the InfiniiVision Series oscilloscopes

External components with wide bandwidths can be used to downconvert signals into the range of the broadband VSA software and InfiniiVision scope combination.

The 89600 VSA software can account for the mixing equation of the external downconverter. While the downconverter cannot be controlled by the software, the downconverter's input center frequency, IF bandwidth, external bandwidth, and IF mirroring can be taken into account by using the **Input > User Calibration...** menu tab and making appropriate selections for your hardware set-up. See the Help text for further details on using the external frequency tool.

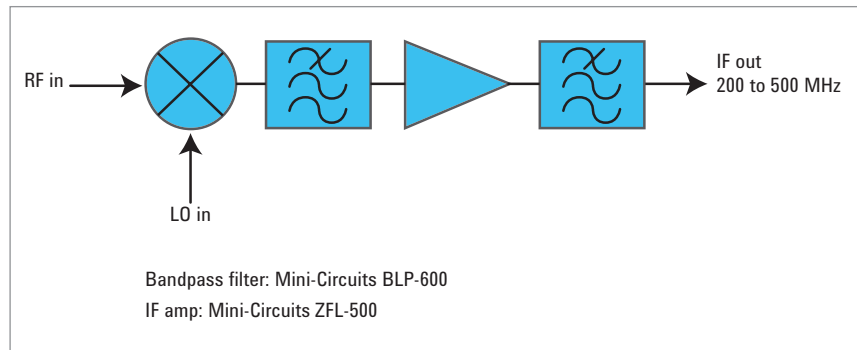

Figure 10. Block diagram of suggested downconverter. See Table 4 for further details.

Table 8. External wideband downconverter details

RF range	Mixer	LO	IF amp	Remarks
0 to 1 GHz (see Table 1)		None	None	Use oscilloscope Ch 1 or Ch 3 (VSA Ch 2)
0.2 to 6 GHz	Marki ¹ M2- 0006MA	16 to 19 dBm $F_{LO} = F_{RF} - F_{IF}$	Mini-Circuits ² ZFL-500 $F_{IF} = 200 - 500$ MHz	Mxr: CL = 8 dB, TOI = 18 dBm Amp: gain = 20 dB, NF = 5.5 dB, TOI = +18 dBm
5 to 40 GHz	Marki ¹ M9-0540IN	3 to 17 dBm $F_{LO} = F_{RF} - F_{IF}$	As above	Mxr: CL = 8 dB, TOI = 16 dBm
26.5 to 40 GHz	Keysight 11970A	15 dBm $F_{LO} = (F_{RF} - F_{IF})/8$ $F = 0$ to 1 GHz	As above	8th harmonic waveguide mixer. Mxr: CL = 22 dB, TOI = 15 dBm
33 to 50 GHz	Keysight 11970Q	15 dBm $F_{LO} = (F_{RF} - F_{IF})/10$ $F_{IF} = 0$ to 1 GHz	As above	10th harmonic waveguide mixer. Mxr: CL = 24 dB, TOI = 15 dBm

1. Marki Microwave,
Telephone: 408-778-4200, FAX: 408-778-4300,
www.markimicrowave.com.

2. Mini-Circuits, Inc., 1-800-654-7949,
44-1252-83600,
<http://www.minicircuits.com>.

Appendix B
Cables and I/O cards
for connecting a PC to an
InfiniiVision Series
oscilloscope

Table 9. PC interfaces and connection cables

Description	Part number	Notes
LAN cross-over cable	8121-0545	Available from Keysight.
PCMCIA GPIB card	778034-02	For laptop PC's. Comes with two-meter GPIB cable. Available from National Instruments.
PCI GPIB interface card	82350	For desktop PC's. Requires GPIB cable (10833A). Available from Keysight.
USB/GPIB interface	82357	Requires USB port, available from Keysight.
LAN/GPIB gateway	E5810	Requires LAN port, available from Keysight.
LAN/GPIB gateway	10833A	Available from Keysight.

Appendix C
PC requirements to run
89600 software

The 89600 VSA requires a PC connected via USB, GPIB, or LAN I/O to the InfiniiVision Series oscilloscope. Either a laptop or desktop PC may be used. For best immunity from electrostatic discharge (ESD), use a desktop PC. For a list of current PC requirements, see www.keysight.com/find/89600-pc.

Appendix D
Operating region curves

Half-channel mode operating region curves

The following curves refer to half-channel and full-channel modes, which describe the manner in which the optional memory is shared. Table 10 provides the definition of these modes.

Table 10. Half-channel and full-channel operation modes

Scope channels	VSA channels used	Mode
2	1	Half-ch
2	2	Full-ch
4	1	Half-ch
4	2	Half-ch
4	3	Full-ch
4	4	Full-ch

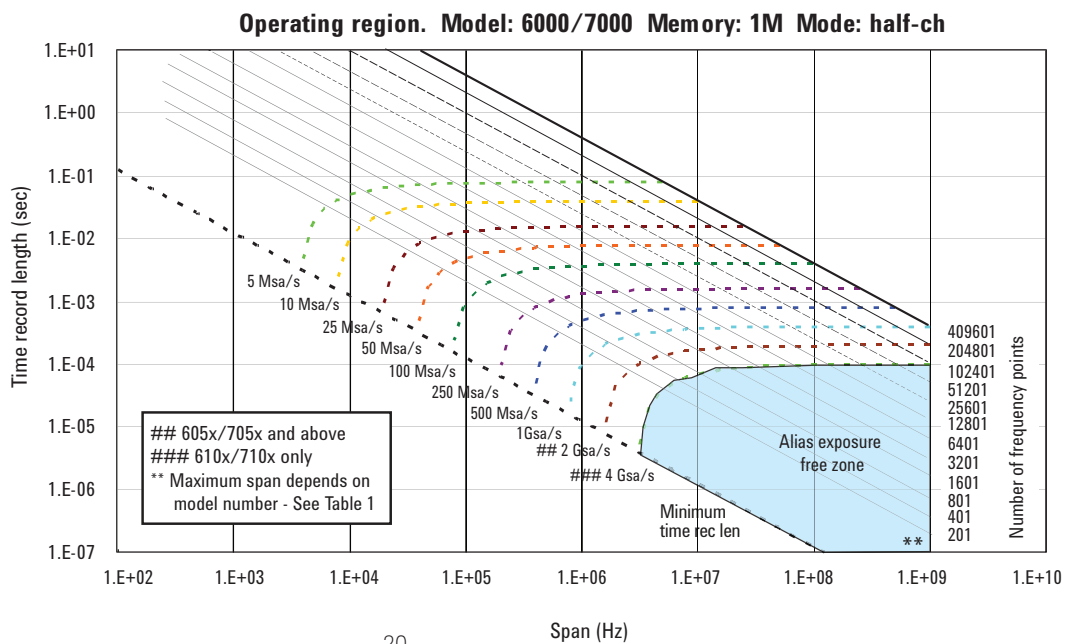

Appendix D

Operating region curves

Half-channel mode operating region curves, continued

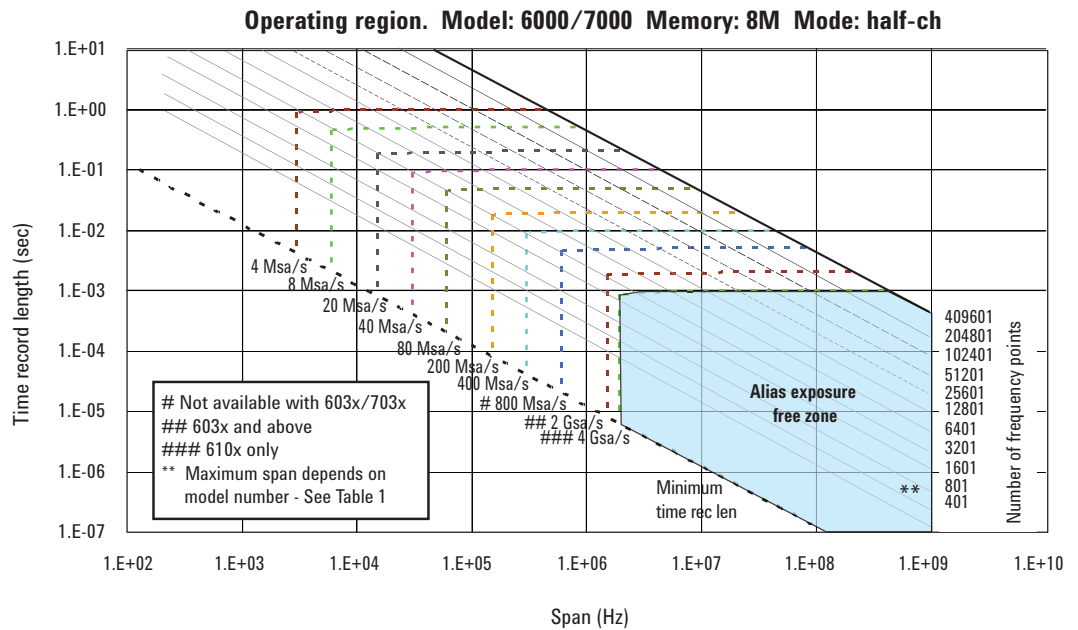
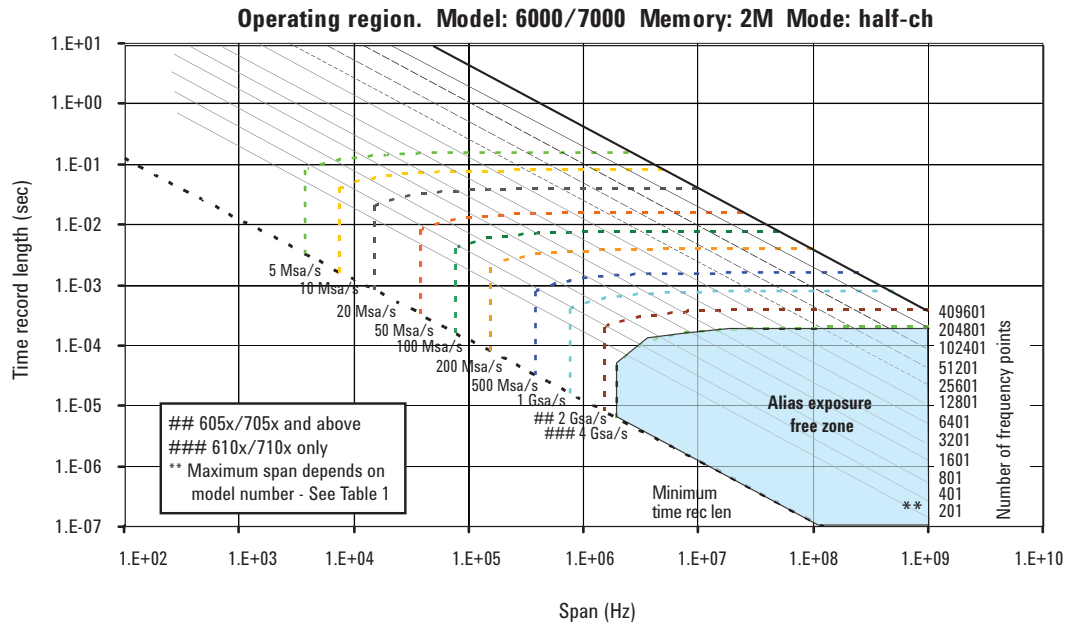

Appendix D

Operating region curves

Full-channel mode operating region curves

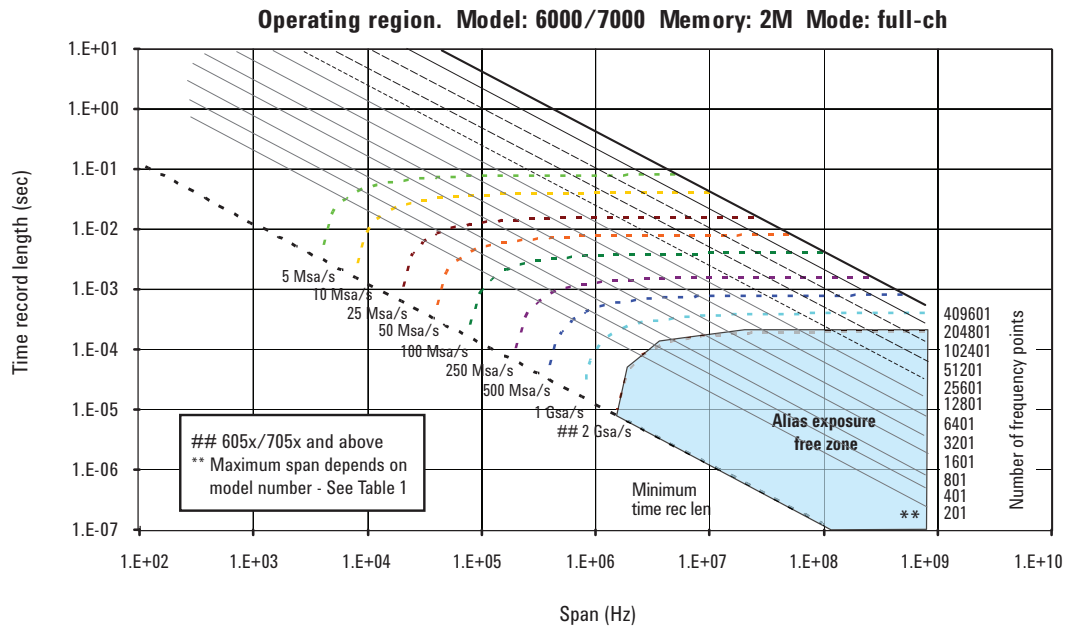
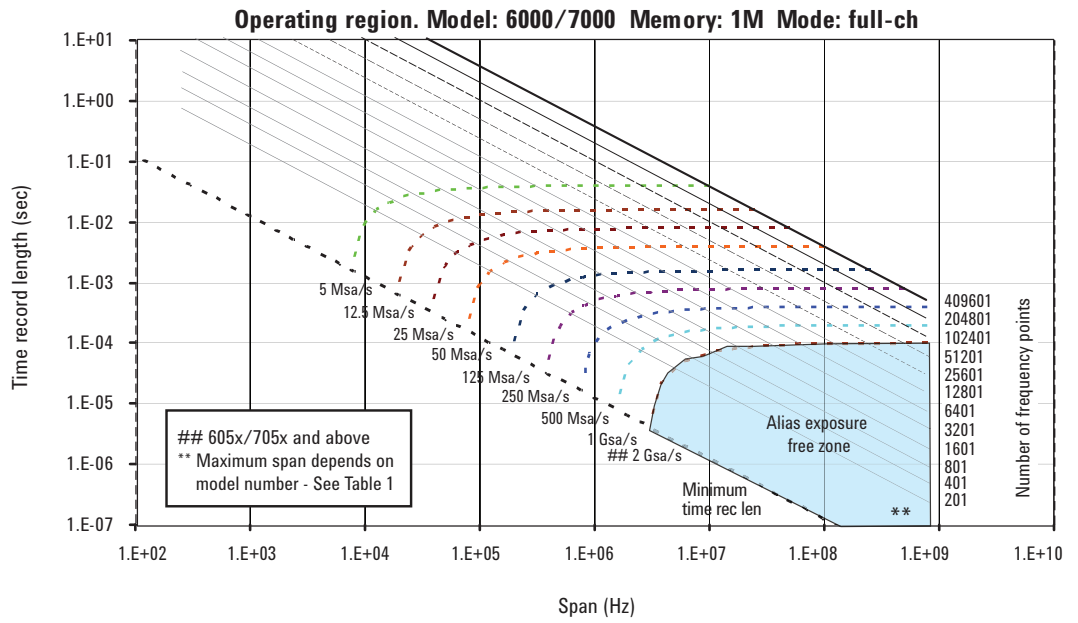

Appendix D

Operating region curves

Full-channel mode operating region curves, continued

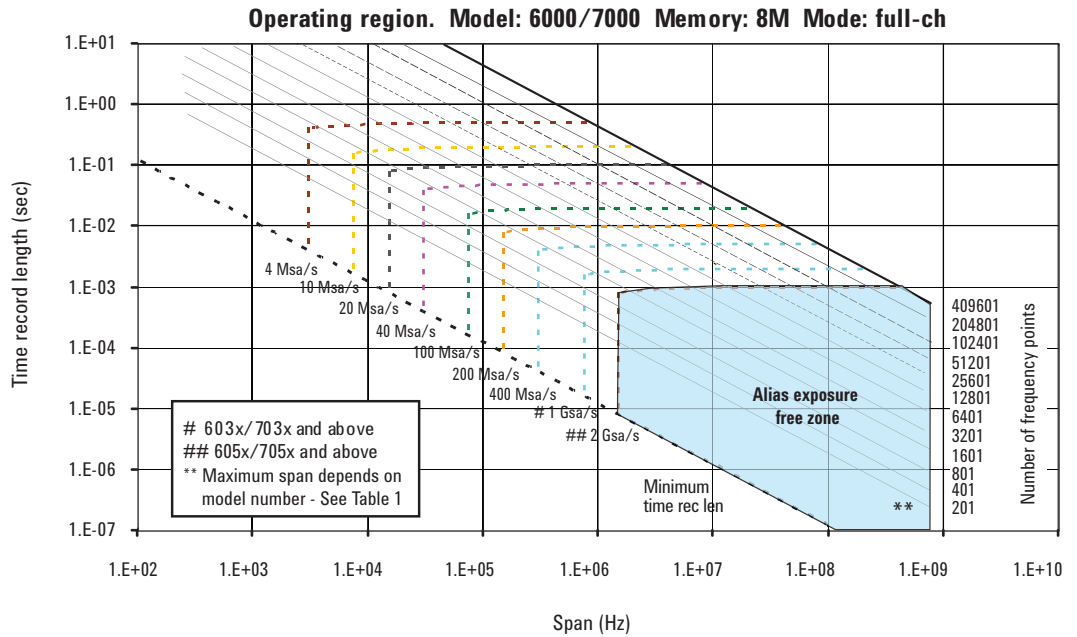

Additional Resources

Web

www.keysight.com/find/89600VSA
www.keysight.com/find/infiniivision

Literature

89600 VSA Software, Brochure, 5990-6553EN
89600 VSA Software, Configuration Guide, 5990-6386EN
89601B/BN-200 Basic VSA and -300 Hardware Connectivity, Technical Overview, 5990-6405EN
Infiniium Oscilloscopes with 89600 VSA Software, Application Note, 5990-6819EN
Successful VSA Analysis Using an Oscilloscope, Application Note, 5990-3276EN
Keysight 6000 Series Oscilloscopes with the 89600 VSA Software, Technical Overview, 5989-6936EN

myKeysight

myKeysight

www.keysight.com/find/mykeysight

A personalized view into the information most relevant to you.

Three-Year Warranty

www.keysight.com/find/ThreeYearWarranty

Keysight's commitment to superior product quality and lower total cost of ownership. The only test and measurement company with three-year warranty standard on all instruments, worldwide.



Keysight Assurance Plans

www.keysight.com/find/AssurancePlans

Up to five years of protection and no budgetary surprises to ensure your instruments are operating to specification so you can rely on accurate measurements.



www.keysight.com/quality

Keysight Technologies, Inc.

DEKRA Certified ISO 9001:2008

Quality Management System



Keysight Channel Partners

www.keysight.com/find/channelpartners

Get the best of both worlds: Keysight's measurement expertise and product breadth, combined with channel partner convenience.

WiMAX, Mobile WiMAX, WiMAX Forum, the eWiMAX Forum logo, WiMAX Forum Certified, and the WiMAX Forum Certified logo are US trademarks of the WiMAX Forum.

www.keysight.com/find/89600VSA

For more information on Keysight Technologies' products, applications or services, please contact your local Keysight office. The complete list is available at: www.keysight.com/find/contactus

Americas

Canada	(877) 894 4414
Brazil	55 11 3351 7010
Mexico	001 800 254 2440
United States	(800) 829 4444

Asia Pacific

Australia	1 800 629 485
China	800 810 0189
Hong Kong	800 938 693
India	1 800 112 929
Japan	0120 (421) 345
Korea	080 769 0800
Malaysia	1 800 888 848
Singapore	1 800 375 8100
Taiwan	0800 047 866
Other AP Countries	(65) 6375 8100

Europe & Middle East

Austria	0800 001122
Belgium	0800 58580
Finland	0800 523252
France	0805 980333
Germany	0800 6270999
Ireland	1800 832700
Israel	1 809 343051
Italy	800 599100
Luxembourg	+32 800 58580
Netherlands	0800 0233200
Russia	8800 5009286
Spain	0800 000154
Sweden	0200 882255
Switzerland	0800 805353
	Opt. 1 (DE)
	Opt. 2 (FR)
	Opt. 3 (IT)
United Kingdom	0800 0260637

For other unlisted countries:
www.keysight.com/find/contactus
 (BP-07-01-14)