

LIGHTWAVE CATALOG

Optical-Electrical/Polarization/Complex Modulation Analysis

2014

VOLUME II



Anticipate — Accelerate — Achieve



Agilent Technologies

Get greater reliability—standard

Since more than 30 years, Agilent offers high-performance solutions to support you in building the high-speed communication network. Your experience and feedback helped us to continuously improve the product performance and quality, while significantly reducing the cost, especially when it comes to manufacturing optical components.



Your needs and my confidence into our quality let me now offer our products with a 3-year warranty that's standard on all instruments, worldwide. This combination of reliability and coverage brings you three key benefits: increased confidence in instrument uptime, reduced cost of ownership and greater convenience. It's just one more way our solutions help you achieve your business goals. When you choose Agilent, you get greater reliability—standard.

Juergen Beck

Vice President and General Manager
Digital Photonic Test Division

Volume 2: Optical-Electrical / Polarization / Complex Modulation

Table of Content	2
N4392A Portable Optical Modulation Analyzer	3
NEW Infiniium Z-Series Oscilloscopes	4
Applications: Optical Modulation Analysis Tools	5
Applications: Coherent Transmitter and Modulator Test	7
Applications: Coherent Transmitter Test in Manufacturing	8
Applications: Advanced research on OFDM	9
Applications: Research on Modulation Formats	10
Impairments in Complex Modulation Transmission	11
Applications: Lightwave Component Analysis	13
N7781B Polarization Analyzer	14
N7782B PER Analyzer and N7783B Thermal Cycling Unit	15
N7784B, N7785B, N7786B Polarization Controllers	17
N7788B Optical Component Analyzer	19
86038B Photonic Dispersion and Loss Analyzer	21
N4373D Lightwave Component Analyzer	23
N4374B Lightwave Component Analyzer	24
N4375D Lightwave Component Analyzer	25
N4376D Lightwave Component Analyzer	26
N4391A Optical Modulation Analyzer	27
N4392A Portable Optical Modulation Analyzer	28
NEW N4392A Integrated Intradyme Coherent Receiver Test	30
N4392A Integrated Coherent Receiver (ICR) Test	31
Infiniium 90000 Q-Series Oscilloscopes	33
90000 Series Oscilloscopes with the 81495A Highspeed Optical/Electrical Converter	34
81490A Reference Transmitter	35
M8190A 12 GSa/s Arbitrary Waveform Generator (AWG)	36
B2901A/02A/11A/12A Precision Source/Measure Unit (SMU)	38
B2961A/B2962A 6.5 Digit Low Noise Power Source	39



New
Smart
Setup

The new Agilent N4392A optical modulation analyzer (OMA) lets you see the true nature of complex modulated signals.

Powered by the Agilent 89600 vector signal analysis software, you get deeper analysis and greater flexibility.

At a fraction of the cost, size and weight of a typical OMA, you can put the N4392A on your bench.

N4392A optical modulation analyzer:

Compact, portable and affordable

Ready for 40/100G

32 Gbaud symbol rate

63 GSa/s sample rate

Explore the N4392A OMA, and order your 2014 Lightwave Catalog
www.agilent.com/find/OMACompact

© Agilent Technologies, Inc. 2014

u.s. 1-800-829-4444 canada 1-877-894-4414

Anticipate — Accelerate — Achieve



Agilent Technologies

Infiniium Z-Series Oscilloscopes



Achieve New Extremes

**63 GHz of real-time bandwidth on 2 channels
33 GHz of real-time bandwidth on 4 channels**

Applications

Optical Modulation Analysis Tools

www.agilent.com/find/oma

Optical I-Q diagram

The I-Q diagram (also called a polar or vector diagram) displays demodulated data, traced as the in-phase signal (I) on the x-axis versus the quadrature-phase signal (Q) on the y-axis.

This tool gives deeper insight into the transition behavior of the signal, showing overshoot and an indication of whether the signal is bandwidth limited when a transition is not close to a straight line.

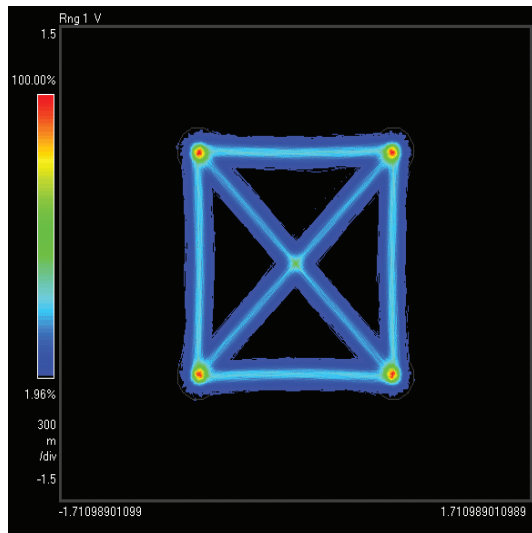

Optical constellation diagram

In a constellation diagram information is shown in a two-dimensional polar diagram, displaying amplitude and phase of the signal. The constellation diagram shows the I-Q positions that correspond to the symbol clock times. These points are commonly referred to as detection decision-points, and are called symbols. Constellation diagrams help identify such things as amplitude imbalance, quadrature error, or phase noise.

The constellation diagram gives fast insight into the quality of the transmitted signal as it is possible to see distortions or offsets in the constellation points. In addition, the offset and the distortion are quantified as parameters for easy comparison to other measurements.

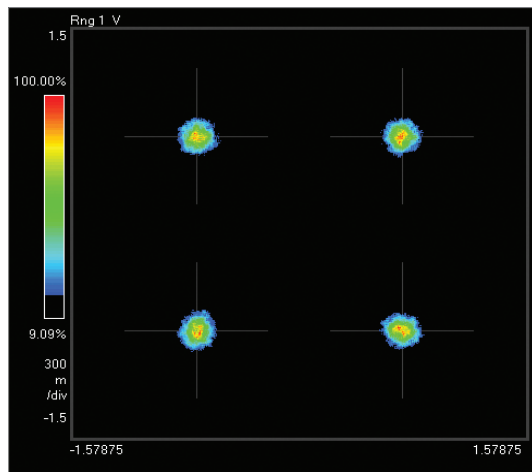

Symbol table/error summary

This result is one of the most powerful tools in the digital demodulation tools. Here, demodulated bits can be seen along with error statistics for all of the demodulated symbols. Modulation accuracy can be quickly assessed by reviewing the rms EVM value. Other valuable parameters are also reported as seen in the image below.

- Frequency error
- I-Q offset
- Quadrature error
- Gain imbalance

D: Ch1 QPSK Syms/Errs						
EVM	=	406.72	m%rms	867.11	m%pk at sym	83
MagErr	=	278.60	m%rms	717.38	m%pk at sym	47
Phase Err	=	161.24	mdeg	-419.13	mdegpk at sym	89
Freq Err	=	78.400	kHz	SNR(MER)	=	48.261 dB
IQ Offset	=	-69.771	dB	Rho	=	0.99998
Quad Err	=	23.806	mdeg	Gain Imb	=	0.008 dB

0	10000111	10000111	10000111	10000111	10000111	10000
64	10000111	10000111	10000111	10000111	10000111	10000
128	10000111	10000111	10000111	10000111	10000111	10000
192	10000111	10000111	10000111	10000111	10000111	10000
256	10000111	10000111	10000111	10000111	10000111	10000

Eye-diagram of I or Q signal

An eye-diagram is simply the display of the I (real) or Q (imaginary) signal versus time, as triggered by the symbol clock. The display can be configured so that the eye-diagram of the real (I) and imaginary (Q) part of the signal are visible at the same time.

Eye-diagrams are well-known analysis tools in the optical ON/OFF keying modulation analysis. Here, this analysis capability is extended to include the imaginary part.

This tool allows comparison of I and Q eye openings, illustrating possible imbalances very quickly.

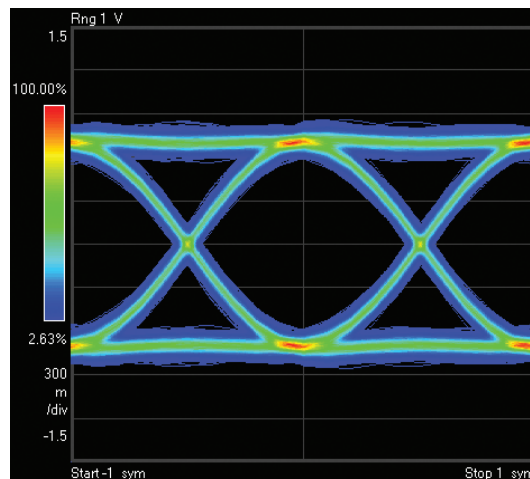

Applications

Optical Modulation Analysis Tools

www.agilent.com/find/oma

Error vector magnitude

The error vector time trace shows computed error vector between measured I-Q points and the reference I-Q points. The data can be displayed as error vector magnitude, error vector phase, the I component only or the Q component only.

This tool gives a quick visual indication of how the signal matches the ideal signal.

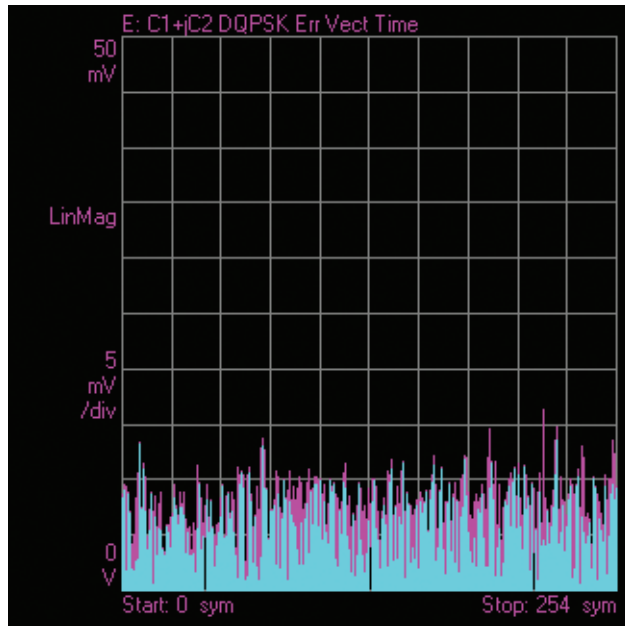

Error vector limit test

The error vector concept is a very powerful way to qualify the overall performance of an complex modulated signal. Testing against a limit with pass/fail indication covers all typical error sources that could occur during transmitter manufacturing, alignment or along a link.

While deploying a new link operating with complex modulated signals, the pass fail test is an easy-to-use and powerful tool to test the physical layer signal quality against a defined limit. Having a physical layer signal in the desired quality is a prerequisite for well performing higher layer protocols.

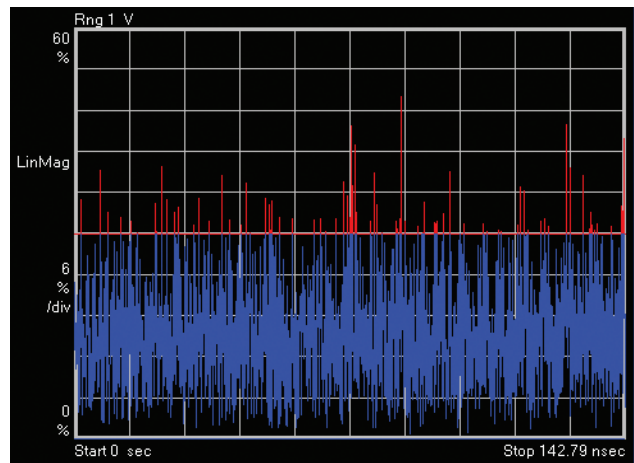

$$EVM [n] = \sqrt{I \text{ err} [n]^2 + Q \text{ err} [n]^2}$$

Where [n] = measurement at the symbol time

I err = I reference – I measurement

Q err = Q reference – Q measurement

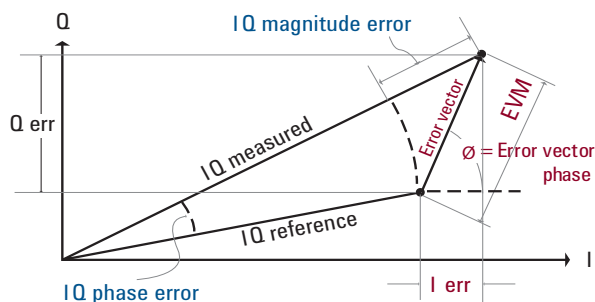

Bit/Symbol/Error analysis

Beside the wide variety of physical parameters that can be analyzed, the optical modulation analyzer also offers the bit and symbol error analysis. Being able to detect the transmitted symbols and bits, enables comparison of the measured data against the real transmitted data.

With PRBS of any polynomial up to 2³¹ and the option for user defined patterns, the optical modulation analyzer is able to actually count the symbol errors and measure the bit error ratio during a burst.

Having these analysis tools, it is now very easy to identify the error causing element, — transmitter, link or receiver — if a classic electrical point to point BER test fails.

In addition this feature offers the option to perform a stress test on a receiver, by exactly knowing the quality of the receiver input signal and being able to compare to the overall BER of the system.

Applications

Coherent Transmitter and Modulator Test

www.agilent.com/find/n4392a

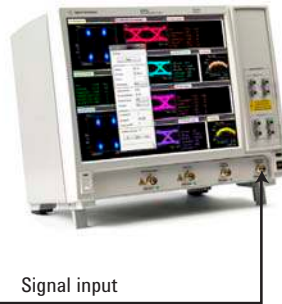
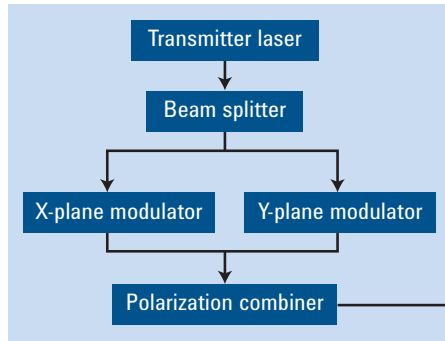

Transmitter signal integrity characterization

- Transmitter signal performance verification
- Verify optimal alignment biasing circuits and skews
- Transmitter vendor qualification
- Final pass fail test in manufacturing
- Evaluation of transmitter components for best signal fidelity

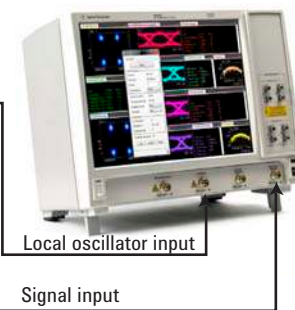
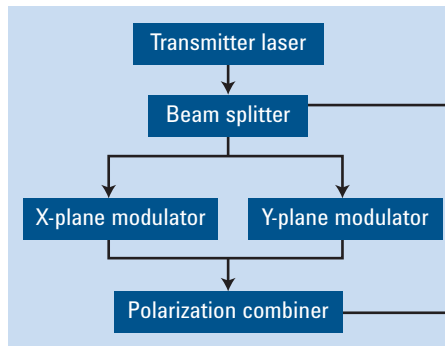

Homodyne component characterization

- Component evaluation independent of carrier laser phase noise
- Modulator in system qualification
- Modulator in-application verification
- Advanced debugging to detect hidden transmitter issues

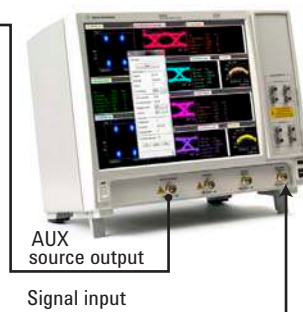
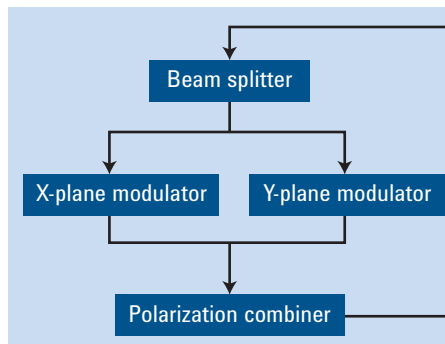

Component evaluation

- Cost effective modulator evaluation
- Cost effective modulator driver evaluation
- Final specification test in application of IQ modulator
- Homodyne testsetup to evaluate influence of phase noise

Applications

Coherent Transmitter Test in Manufacturing

www.agilent.com/find/n4392a

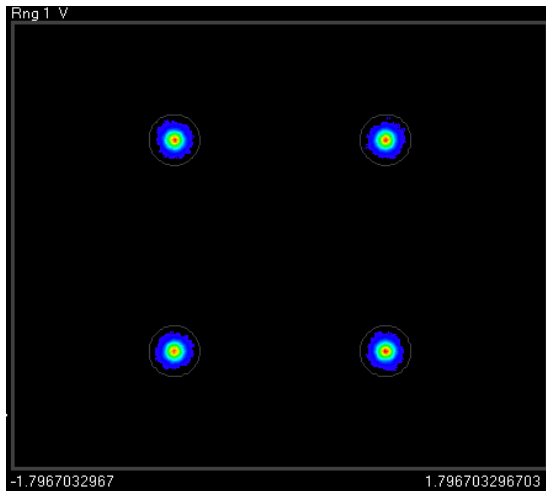

Optical constellation diagram

In a constellation diagram, signal information is shown only at the middle of a symbol time. This represents exactly the time stamp a real receiver will take to decide on the transmitted data. These points are commonly referred to as detection decision-points, and are interpreted as the digital symbols. Constellation diagrams help identify effects like amplitude imbalance, quadrature error, or phase noise just to mention some of them.

For calculating the BER based on statistical data a Gaussian noise distortion is required in the same way as for Q factor based BER calculation. The color coded display option gives a fast indication if this requirement for BER calculation based on noise statistics is fulfilled.

For complex modulated signals the statistic BER is calculated based on the EVM calculation of the software.

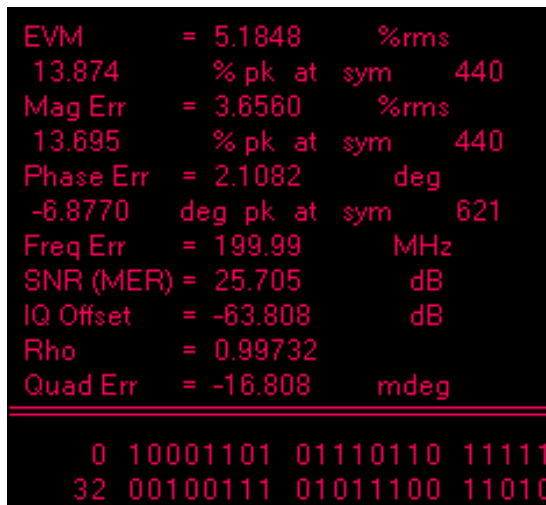

Symbol table/error summary

This result table is one of the most powerful tools of the vector analysis software. With just a few scalar parameters you can get full insight in your transmitter quality and in addition get an indication on the most likely error source in coherent optical transmitter.

The following list describes these parameters briefly:

- EVM to check overall transmitter signal distortions including noise
- I-Q offset for checking transmitter alignment
- Quadrature error to verify 90 degree bias point alignment in transmitter modulator
- Gain imbalance between I and Q signal path in transmitter (not displayed here)
- Signal to noise ratio based on EVM measurements

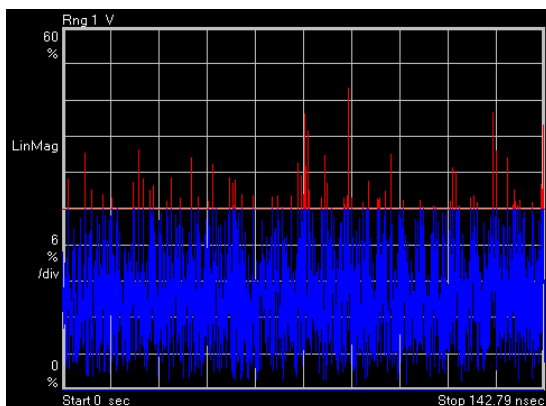

EVM limit test

Error vector magnitude (EVM) is described as a scalar by calculating the rms value of the error vector of all measured symbols within one burst of data recording. A good transmitter shows a white noise like error vector distribution along all symbols. The limit test functionality can detect any violation of a customer definable value and display this in different colors on the screen as shown in figure left. In addition a fail indication is provided by the software. For manufacturing purposes this can be controlled and queried via the easy to use SCPI software interface.

Applications

Research on Modulation Formats

www.agilent.com/find/n4392a

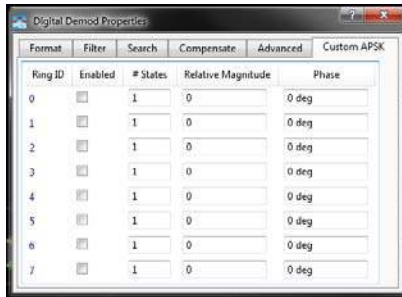

Customer configurable APSK demodulator

This new generic decoder allows the user to configure a custom decoding scheme in accordance with the applied IQ signal.

Up to 8 amplitude levels can be combined freely with up to 256 phase levels. This provides nearly unlimited freedom in research to define and evaluate the transmission behavior of a proprietary modulation format.

The setup is easy and straightforward. Some examples are shown below.

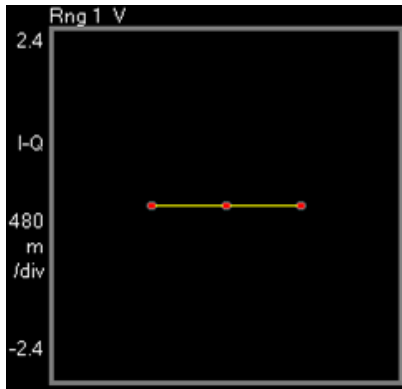

Optical duobinary decoder

In 40 G transmission systems, an optical duobinary format is often used. In order to test the physical layer signal at the transmitter output or along a link, the analysis software now supports this commonly used optical format.

A predefined setting that has a preconfigured optical duo binary decoder is part of the instrument and the analysis software.

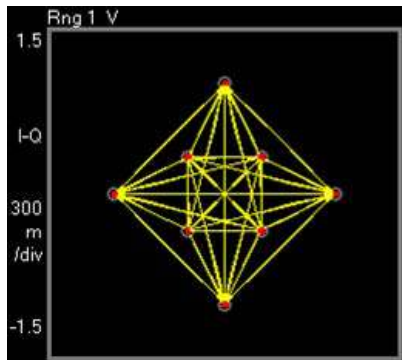

Optical 8 QAM decoder

This example of a coding scheme can code 3 bits per symbol with a maximum distance between the constellation points, providing a good signal to noise ratio.

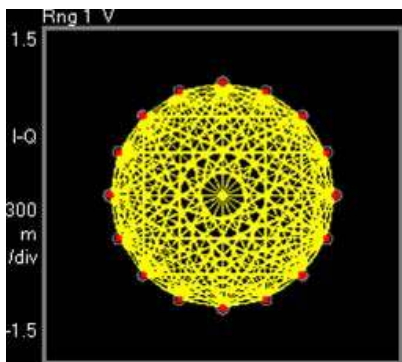

Optical 16 PSK decoder

This is another example of a more complex pure phase modulated optical signal that is sometimes used in research.

With the custom-defined APSK decoder, the same analysis tools are available as in the predefined decoders.

Impairments in Complex Modulation Transmission

www.agilent.com/find/oma

To describe the quality of a complex modulated signal, there are a variety of parameters in place.

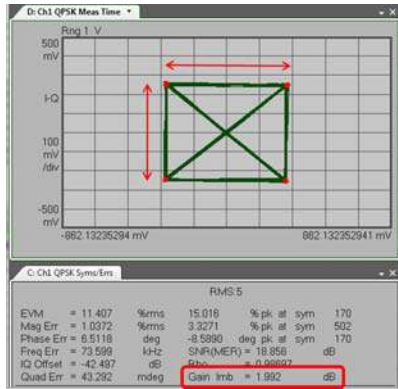

Gain imbalance

Gain imbalance compares the gain of the I signal with the gain of the Q signal and is expressed in dB. The effects of IQ gain imbalance are best viewed in constellation diagrams where the width of the constellation diagram doesn't match its height.

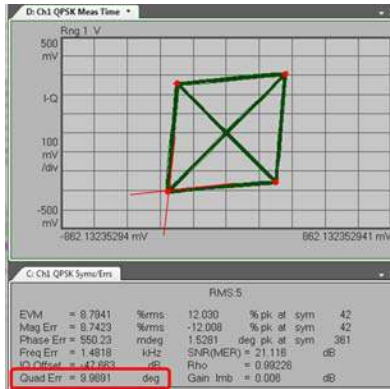

Quadrature error

Quadrature error indicates the orthogonal error between the I and Q Quadrature-Phase. Ideally, I and Q should be orthogonal (90 degrees apart). A quadrature error of -3 degrees means I and Q are 87 degrees apart.

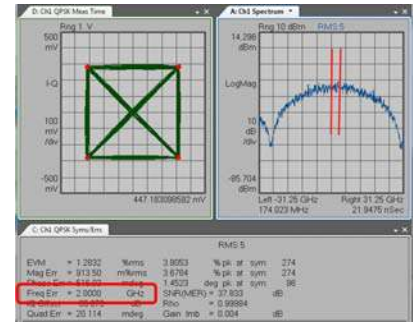

Frequency error

Frequency error shows the carrier's frequency error relative to the local oscillator. This error data is displayed in Hertz and reflects the amount of frequency shift that the instrument must perform to achieve carrier lock.

Note: The frequency error does not influence the error vector magnitude measurement.

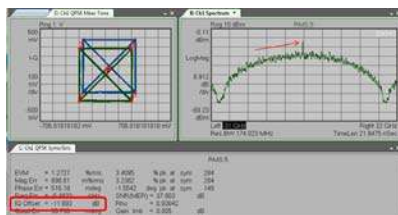

IQ offset

IQ offset (also called I/Q origin offset) indicates the magnitude of the carrier feed through signal. When there is no carrier feed through, IQ offset is zero (-infinity dB).

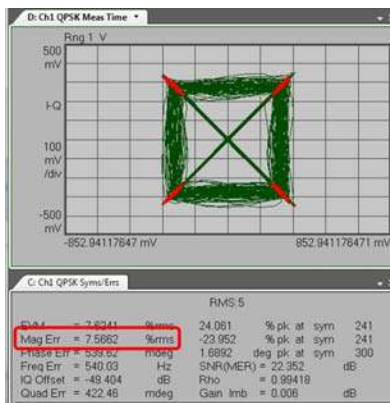

Magnitude error

Magnitude error is the difference in amplitude between the measured signal and the I/Q reference signal.

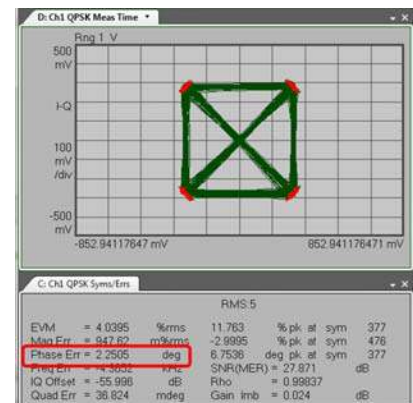

Phase error

Phase error is the phase difference between the I/Q reference signal and the I/Q measured signal, as measured at the symbol time.

Impairments in Complex Modulation Transmission

www.agilent.com/find/oma

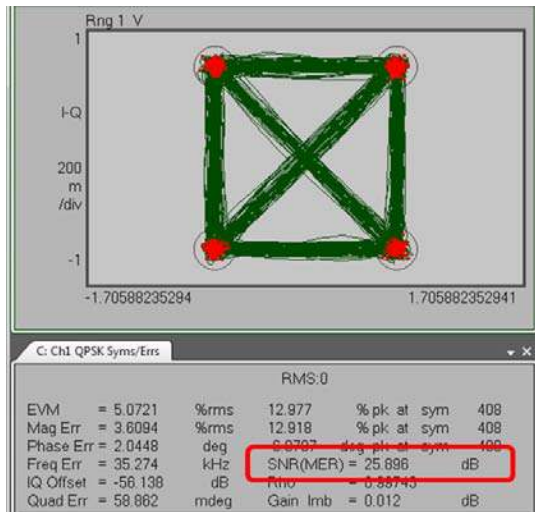

SNR (MER) – signal to noise ratio (modulation error ratio)

SNR (MER) - Signal to Noise Ratio (Modulation Error Ratio) is the signal-to-noise ratio, where signal is the average symbol power of the transmitted waveform. The noise power includes any term that causes the symbol to deviate from its ideal state.

Note: SNR and OSNR are only equal in Gaussian noise limited systems, when proper normalization is used (OSNR is typically measured with 100 pm RBW).

$$SNR = 10 \log \frac{\sum_{n=1}^N (IQ \text{ reference vector at symbols})^2}{\sum_{n=1}^N (\text{error vector at symbols})^2}$$

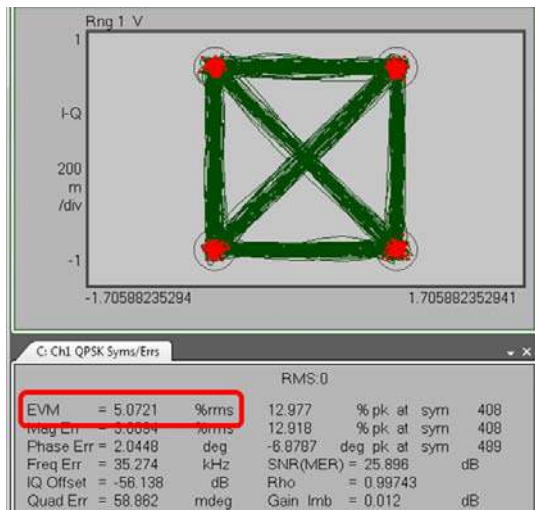

Error vector and error vector magnitude as a global measure

EVM %rms is a normalized measure of all error vectors in the measured data burst. EVM is an excellent indicator summarizing most impairments of a complex modulated signal. Thus a good EVM %rms ensures low impairments including noise are present. Vice versa a bad EVM %rms does not indicate to a distinct impairment parameter. In this case the OMA and the other described parameters help to debug the root cause for worse EVM %rms.

Be aware EVM %rms is not a traceable and standardized parameter therefore it should be used only as relative measure.

In digital photonic transmission systems, the performance is ultimately determined by Bit Error Ratio Test (BERT). As this parameter describes the performance of the whole system, it is necessary to design and qualify subcomponents like modulators and PIN detectors, which are analog by nature, with different parameters that reflect their individual performance.

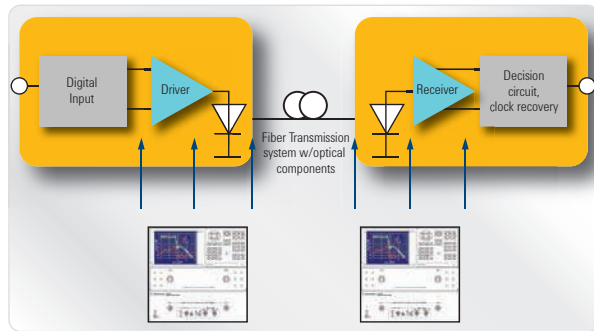

These components significantly influence the overall performance dependant of modulation frequency system with the following parameters:

- 3 dB bandwidth of the electro- optical transmission
- Relative frequency response, quantifying how the signal is transformed between optical and electrical connection
- Absolute frequency response, relating the conversion efficiency of signals from the input to the output
- Electrical reflection at the RF port
- Group delay of the opto-electronic component to qualify the distortion caused by frequency dependent delay

In many cases it is necessary to qualify the lab prototype of a receiver or transmitter for manufacturing. In this case the device under test needs to be characterized under various environmental and operating conditions. With the .NET based remote control this task can be automated to verify the optimal working conditions of the device. In the following manufacturing process each device can be characterized using this automated control of the LCA via LAN.

O/E characterization

The measurement of an electro-optical receiver device consists of the ratio of output electrical modulation current to input optical modulation power. Responsivity for OE devices described how a change in optical power produces a change in electrical current. Graphically this is shown in the figure below.

The LCA measures the input optical modulation power and output modulation current and displays the ratio of the two in Amps/Watt.

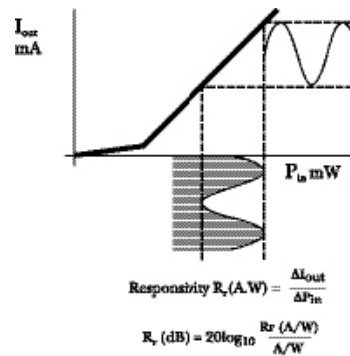

E/O characterization

The measurement process for EO devices is similar to OE devices. The measurement of an EO transmitter is a combination of input modulating current and output optical modulation power. Slope responsivity is used to describe how a change in input current produces a change in optical power. Graphically this is shown in the figure below.

An LCA measures input modulating current and output modulation power and displays the ratio of the two in Watts/Amp, either linearly or in decibels.

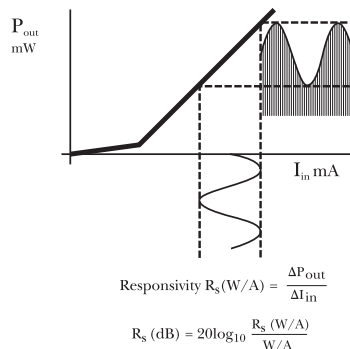

Agilent N7781B Polarization Analyzer

www.agilent.com/find/pol



The Agilent N7781B is a compact high-speed polarization analyzer which provides comprehensive capabilities for analyzing polarization properties of optical signals. This includes representation of the State of Polarization (SOP) on the Poincaré Sphere (Stokes Parameter). The on-board algorithms together with the on-board calibration data ensure highly accurate operation across a broad wavelength range.

Due to its real time measurement capability (1 MSamples/s) the instrument is well suited for analyzing disturbed and fluctuating signals as well as for control applications requiring real time feedback of polarization information.

Analogue data output ports are provided, for example for support of control loops in automated manufacturing test systems.

Powerful User Interface and remote programming capabilities are provided by the Polarization Navigator software package of the N7700A Photonic Application Suite.

Key features:

- Measurement of Stokes Parameter (SOP)
- Measurement of degree of polarization (DOP)
- High-speed operation (> 1 MSamples/s)
- Analog output port for DOP/SOP data

Monitoring/Measurement application of

- State of Polarization (SOP), Stokes Parameter
- Degree of Polarization (DOP)
- High-Speed Analysis of SOP/DOP of Recirculating Signal

Instrument setup: Polarization analyzer setup

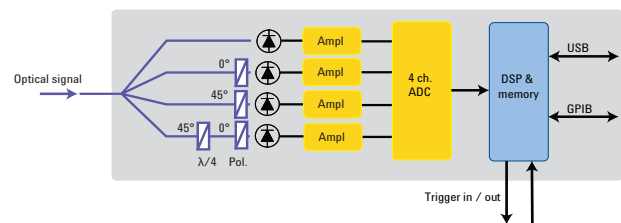

The instrument setup of the Agilent N7781B polarization analyzer is shown in the figure above. It consists of a unique polarimeter optics and a high-speed sampling subsystem. The measurement principle is based on splitting the light into four sub beams which are filtered through different polarizers. The resulting four power levels are evaluated using on-board calibration data to obtain an accurate SOP- and DOP-measurement.

N7781B Polarization Analyzer ^[1]

Wavelength

Specification wavelength range	1270 to 1375 nm (Opt 300, O-band) 1270 to 1375 nm, 1460 to 1620 nm (Opt 400, O/C/L-band) 1460 to 1620 nm (Opt 500, C/L-band)
--------------------------------	--

Operating wavelength range ^[2]	1260 to 1640 nm
---	-----------------

Polarization analysis

SOP uncertainty ^{[3],[4]} (typ.), DOP uncertainty ^[3]	1.5° / ± 2.0%
DOP uncertainty after user calibration ^{[3],[5]} (typ.)	± 0.5%
Maximum sampling rate	Up to 1 MHz

Optical power measurement

Relative power uncertainty ^[3]	C/L-band: ± 0.03 dB (± 0.02 dB typ.), O-band: ± 0.07 dB (± 0.04 dB typ.)
Input power range	-50 to +7 dBm
Maximum safe optical input power	+12 dBm

[1] Ambient temperature change max. ± 0.5°C since normalization. Specification valid on day of calibration.
 [2] SOP/DOP measurements are possible outside the specification wavelength range if a manual user calibration is performed.
 [3] Input power > -30 dBm
 [4] DOP > 95%
 [5] User calibration requires a source with DOP = 100%. User calibration is valid for a fixed wavelength.



Agilent's N7782B series of PER analyzers has been designed for high speed and highly accurate testing of the polarization extinction ratio (PER) in PM fibers. The polarimetric measurement principle guarantees reliable measurements of PER values of up to 50 dB. The real time measurement capability in combination with automation interfaces makes this unit ideally suited for integration in manufacturing systems, for example pig-tailing stations for laser diodes and planar waveguide components. Analog interfaces are provided for integration of the system in control loop applications.

Key benefits

- Accurate PER-measurement up to 50 dB
- Real-time display of PER
- Easy-to-use: Reliable results independent of operator skill set
- Swept-wavelength and heating/stretching method available
- Measurement of the PER versus wavelength
- Fast/slow axis detection
- Instruments available for 1260 up to 1640 nm
- Internal fixed wavelength sources at 850 nm/1310 nm/1550 nm available

Applications

- **Laser diode PMF pig-tailing** Alignment of the PM fiber during the pig tailing process is supported by real-time display of the PER and the optical power
- **PMF splicing** In order to support the alignment during the splicing process of PM fibers the Agilent N7782B provides real time display of the optical power and of the angular misalignment of the two fibers
- **PM component characterization** measurement of the PER on PM components like fiber polarizers, PMF couplers, PMF splitters, etc.
- **Characterization of PMF cross-coupling** polarization crosstalk in a PM fiber is measured and displayed as PER
- **PM splice characterization** The angular misalignment of a PM splice can be measured in a non-destructive way. Even multiple splices in a chain can be characterized independently.

Agilent N7782B and N7783B application examples

The wavelength scanning method

Using Agilent's tunable laser source 81600B series in combination with the Agilent N7782B PER analyzer allows measuring the PER as a function of wavelength.

The heating/stretching method

The heating/stretching method provides accurate measurements of the PER at a single wavelength. This method supports in particular well the measurement using narrow-band laser sources. An optional internal laser source allows stand-alone operation of the system.

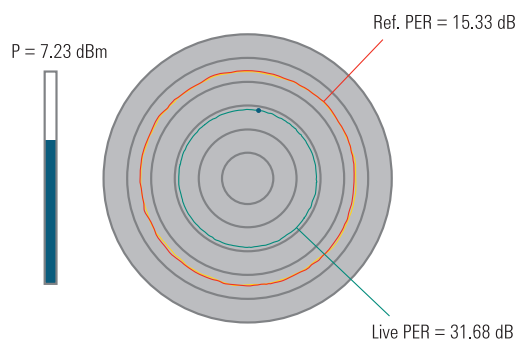

Agilent's thermal cycling unit N7783B is fully controlled by the Agilent N7782B PER analyzer and allows accurate and repeatable cycling of the temperature of the fiber under test. The PER measurement system consisting of the Agilent N7782B and the Agilent N7783B shows excellent accuracy and repeatability. Ease of use and automation interfaces, such as analog output ports for active alignment, make it particularly useful for production environments.

N7783B thermal cycling unit



For characterizing an optical connection between two polarization maintaining fibers (PMFs), such as an optical splice, two thermal cycling units (Agilent N7783B) can be used. This eliminates the influence of input polarization or subsequent fibers at the output and isolates the angular misalignment of the connection located between the two thermal cycling units.

Agilent N7782B PER Analyzer and N7783B Thermal Cycling Unit

www.agilent.com/find/pol

Specifications ^[1] N7782B PER Analyzer

Wavelength

Specification wavelength range	1270 to 1375 nm (Opt 300, O-band) 1270 to 1375 nm, 1460 to 1620 nm (Opt 400, O/C/L-band) 1460 to 1620 nm (Opt 500, C/L-band)
Operating wavelength range ^[2]	1260 to 1640 nm (Opt 300/400/500)

PER analysis

PER range ^[3,4]	0 to 50 dB
PER uncertainty, single-TCU method (typ.) ^[3,4]	PER = 0 to 30 dB 0.30 dB PER = 30 to 50 dB 0.60 dB

Splice angle analysis

Splice angle uncertainty, dual-TCU method (typ.) ^[3,4]	$\pm (0.1^\circ + 4\% \times \text{angle})$
---	---

Optical power

Input power range	-50 to +7 dBm (Opt 300/400/500)
-------------------	---------------------------------

Internal laser source

Wavelength	Opt. 401 (O-band): 1290 to 1360 nm, 1310 nm typ. Opt. 501, 401 (C-band): 1510 to 1580 nm, 1550 nm typ.
Output power ^[5] (typ.)	Opt. 401 (O-band): -12 dBm Opt. 501, 401 (C-band): -10 dBm

[1] Ambient temperature change max. $\pm 0.5^\circ\text{C}$ since normalization. Specification valid on day of calibration.

[2] PER measurements are possible outside the specification wavelength range if the user performs a manual calibration. Note that a fully polarized light source is needed for calibration.

[3] Input power > -30 dBm

[4] Narrow-band light source with DOP $> 95\%$ needed.

[5] At room temperature.

N7783B Thermal Cycling Unit Characteristics

Fiber jacket diameter	Up to 3 mm
Ambient temperature range	20 to 30 °C
Minimum peak-to-peak temperature tuning range	50 K
Power	100 to 240 VAC, < 36 W
Dimensions (H x W x D)	64 mm x 160 mm x 61 mm

Agilent N7784B, N7785B, N7786B Polarization Controllers

www.agilent.com/find/pol



N7784B



N7785B



N7786B

These 3 instruments are all based on high-speed solid state optics to rapidly switch the polarization of an incoming signal. They are used with polarized input signals from lasers and can adjust, scan or align the output state of polarization. The instruments are controlled from an external PC and convenient graphical user interface control is provided with the included Polarization Navigator software, distributed with the N7700A Photonic Application Suite. Automated control is provided by the GPIB and USB interfaces.

N7785B Synchronous scrambler

The N7785B Synchronous scrambler provides fast SOP switching in response to internal or external triggering. This supports optical network simulations that often require switching of the signal SOP in a random way within a few microseconds, such as in recirculating loop tests. The SOP is switched rapidly, and then held for a predefined time until it again

switches to a new SOP. The output SOP is controlled but not determined by the N7785B and will be changed if the input SOP changes. The output SOP can be adjusted to a desired external condition, such as maximizing the signal through a polarizer. Application routines in the Polarization Navigator software can be used for random scrambling and continuous scrambling (where the state of polarization moves smoothly about the Poincaré sphere, similar to a flipper-style scrambler) over a wide range of speeds as for fast SOP-change tolerance testing of coherent receivers.

N7784B Polarization controller

The N7784B Polarization controller provides alignment and fast stabilization of SOP into polarization maintaining fiber (PMF) or with respect to an external condition by adding an analog feedback and polarizer path to the basic N7785B configuration.

For alignment into PMF, the input signal is first routed through the fast switching controller with single-mode fiber (SMF) and is available at an intermediate front panel output. An external jumper fiber is used to route the signal into the polarizer path consisting of a polarizing beam splitter with one output monitored by a photodetector. The other output is coupled to the front panel output with PMF. The signal from the photodetector is used to actively align and stabilize the input signal into the PMF output that could then be connected to a modulator or other polarization dependent device. Similarly, the signal can be used directly from the intermediate output and a user-configured setup can provide the feedback for optimizing the desired SOP from the instrument.

N7786B Polarization synthesizer

The N7786B Polarization synthesizer includes internal SOP monitoring and feedback via a tap coupler to determinately set and hold any chosen states or sequences of polarization. This allows generation of sequences with chosen relative SOP orientation. This is often used for component analysis based on Mueller Matrix or Jones Matrix analysis. The uniquely fast switching supports the new single-sweep spectral PDL measurements with the N7700A software, which eliminates sensitivity to environmental stability and minimizes measurement time. Analysis of these results into transmission spectra of the primary device axes (like TE and TM) is also achieved in this way. The real-time monitoring and logging of output SOP permits accurate calculation including the wavelength dependence of the SOP.

The real-time monitoring and feedback also are used in this instrument to provide stabilized SOP, even with fluctuation and drift of the input SOP.

The output SOP can be defined in following ways:

- **Set-and-forget:** When the front panel button is pushed, the current SOP is stored and maintained, even if polarization changes occur at the instrument input
- **Defined Stokes:** The target output SOP can be defined by the user using the Stokes parameters

The Polarization Navigator also has a convenient button to quickly change from a manually adjusted SOP to the corresponding orthogonal state, as can be used to check extinction ratio.

Agilent N7784B, N7785B, N7786B Polarization Controllers

www.agilent.com/find/pol

Specifications ^[1] N7784B Polarization Controller

Wavelength	
Operating wavelength range	1260 to 1640 nm
Wavelength range in stabilizer mode ^[2]	1520 to 1580 nm
Polarization control and stabilization	
SOP switching time (open-loop)	< 10 μ s
PER at PMF output (typical)	> 23 dB
Stabilizer response time ^[3] (typ.)	2 ms
Optical power	
Insertion loss port I > port II ^[4]	< 3.5 dB (< 3.0 dB, typ.)
Insertion loss port III > port IV ^[5]	< 1.8 dB (< 1.4 dB, typ.)
PDL port I > port II (typ.)	< 0.2 dB (C/L-band), < 0.5 dB (O-band)
Maximum safe input power	Port I: 20 dBm, Port III: 3 dBm
Input power range in stabilizer mode	Port III: -30 to 0 dBm

[1] Ambient temperature change max. ± 0.5 °C since normalization. Specification valid on day of calibration;

[2] Outside the stabilizer wavelength range, the PER at PMF Output may be degraded;

[3] Input power at Port III > -30 dBm, response to an immediate step of 180° on the Poincaré sphere;

[4] For SOP scrambling/switching, only ports I/II are used;

[5] Valid for optimum input polarization at PBS input (Port III). Add insertion loss of port I/II and III/IV to obtain total insertion loss for SOP stabilizing mode.

Specifications ^[1] N7785B Synchronous Scrambler

Wavelength	
Operating wavelength range	1260 to 1640 nm
Polarization control	
SOP switching time	< 10 μ s
Optical power	
Insertion loss	< 3.5 dB (< 3.0 dB, typ.)
PDL (typ.)	< 0.2 dB (C/L-band), < 0.5 dB (O-band)
Maximum safe input power	20 dBm

[1] Ambient temperature change max. ± 0.5 °C since normalization. Specification valid on day of calibration

Specifications ^[1] N7786B Polarization Synthesizer

Wavelength	
Specification wavelength range	1270 to 1375 nm, 1460 to 1620 nm (Opt 400, O/C/L-band) 1460 to 1620 nm (Opt 500, C/L-band)
Operating wavelength range ^[2]	1260 to 1640 nm
Polarization control and stabilization	
SOP switching time (non deterministic)	< 10 μ s
SOP cycling time ^[6]	< 25 μ s
Remaining SOP error after deterministic SOP setting (typ.) ^[7]	< 3° at input SOP movement rate of 1.2 rad/s < 6.5° at input SOP movement rate of 40 rad/s
Polarization analysis	
SOP uncertainty ^{[3],[4]}	1.5°
DOP uncertainty ^[3]	$\pm 2.0\%$
DOP uncertainty after user ^{[3],[5]} calibration (typ.)	$\pm 0.5\%$
Optical power measurement	
Relative power uncertainty ^[3]	C/L-Band: ± 0.14 dB (± 0.12 dB typ.), O-band: ± 0.16 dB (± 0.14 dB typ.)
Input power range	-38 to +19 dBm
Optical power	
Insertion loss	< 4.0 dB (< 3.5 dB, typ.)
PDL (typ.)	< 0.2 dB (C/L-band), < 0.5 dB (O-band)
Maximum safe input power	20 dBm

[1] Ambient temperature change max. ± 0.5 °C since normalization. Specification valid on day of calibration.

[2] SOP/DOP measurements are possible outside the specification wavelength range if the user performs a manual calibration.

[3] Input power > -20 dBm.

[4] DOP > 95%.

[5] User calibration requires a source with a 100% DOP.

[6] The instrument adaptively finds the polarization controller settings to let the SOP cycle through user-defined polarization states (closed loop operation). After having found these settings, the SOP can cycle through the polarization states in open loop operation.

[7] This value is defined to be 5 times the standard deviation of the angular SOP error on the Poincaré sphere. Valid if controller is turned on. Power at instrument input > -10 dBm.

Agilent N7788B Optical Component Analyzer

www.agilent.com/find/pol



N7788B optical component analyzer

General information

Agilent Technologies pushes the limits of component measurements with the N7788B Component Analyzer. Its proprietary technology is comparable with the well-known Jones-Matrix-Eigenanalysis (JME) which is the standard method for measuring Polarization Mode Dispersion (PMD) or differential group delay (DGD) of optical devices. Compared to the JME, Agilent's new single scan technology offers a range of advantages:

A complete set of parameters:

- DGD/PMD / PDL / 2nd order PMD
- Power / Loss
- TE / TM-Loss
- Principal States of Polarization (PSPs)
- Jones and Mueller Matrices

For measuring these parameters, the N7788B is used together with an Agilent continuous-sweep tunable laser like the 81600B or 81960A, and control is provided with the Polarization Navigator package of the N7700A Photonic Application Suite. The N7788B also provide the full polarization analysis functionality of the N7781B.

Key benefits

Highest accuracy in a single sweep: No averaging over multiple sweeps required

High measurement speed:

- Complete measurement across C/L-band in less than 10 seconds (no need to wait for many averages)
- Robustness against fiber movement/vibration and drift:
- Fixing fibers with sticky tape on the table or even operation on isolated optical table is not required!
- No limitation on optical path length of component
- The internal referencing scheme guarantees reliable and accurate measurements.

Applications

- Fiber characterization: SMF, PMF, DCF
- Passive component testing: Filters, isolators, circulators
- Dynamic component/module testing: OADM/ROADM
- Active component testing: EDFAs, SOAs, VOAs
- Link test: In-Channel measurements across amplifiers

Designed for the manufacturing floor

High throughput:

A complete analysis across the C and the L band is performed in less than 10 seconds!

Remote control:

Control of the instrument and application software with the COM interface provides powerful and convenient automation.

Report generation:

Generating PDF reports is supported. The content including layout is configurable by the user.

Real-time power readout:

High throughput measurement of non-connectorized components is supported by providing a real time power readout which enables fiber coupling of the new device.

Instrument setup and application examples

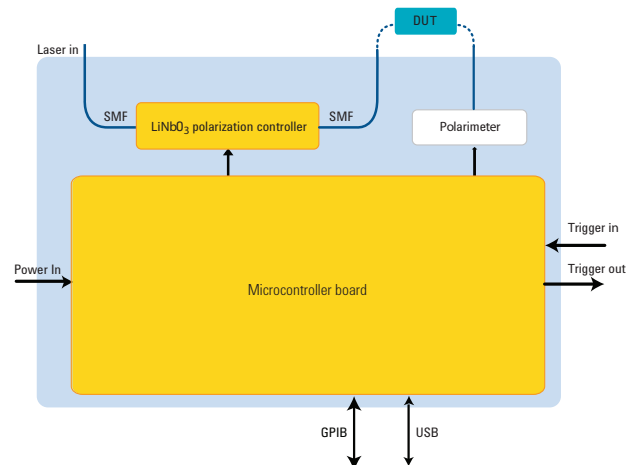

The instrument setup is shown in the figure above. A Lithium-Niobate polarization controller determines the input polarization to the DUT. While the tunable laser source is sweeping over the desired wavelength range, a polarimeter analyzes the output state of polarization while input polarization is being modified. The result will be a highly accurate device characterization with respect to DGD/PDL/Loss etc. Furthermore, the internal optical switch provides continuous self calibration for excellent repeatability.

Resolving TE/TM insertion loss

The TE/TM-function allows accurate determination of the minimum and maximum loss of the DUT at each wavelength. Due to birefringence, optical filters tend to show different transmission functions depending on the polarization state.

Long term measurements

The capability of performing quick PMD-measurements makes this measurement system well-suited for collecting long-term PMD data. The PC software allows to continuously collect the spectral PMD data and store it on the hard disc. The data can then be visualized as pseudo-color plot (see figure).

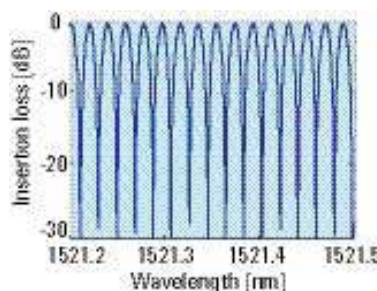
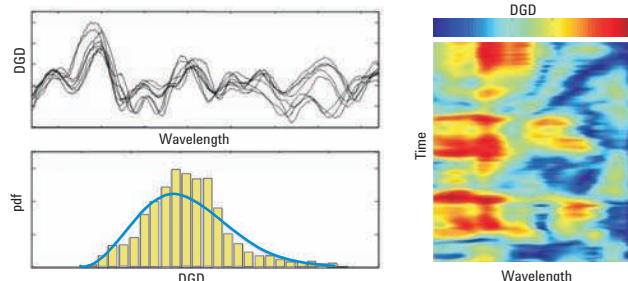

Excellent spectral resolution

Due to the excellent spectral resolution with the 81600B TLS, the Agilent N7788B is best suited for intra-channel DGD/PDL characterization. The All-Parameter-JME algorithm allows flexible adjustments of the wavelength resolution without the need to repeat the measurement. This simplifies finding the optimum trade-off between PDL/DGD accuracy and wavelength resolution.

Specifications ^[1] N7788B Optical Component Analyzer

Wavelength

Specification wavelength range	1270 to 1375 nm (Opt 300, O-band) 1270 to 1375 nm, 1460 to 1620 nm (Opt 400, O/C/L-band) 1460 to 1620 nm (Opt 500, C/L-band)
Operating wavelength range ^[2]	1260 to 1640 nm

Differential delay

DGD uncertainty ^[3]	Resolution 2.0 nm: $\pm (30 \text{ fs} + 3.0\% \times \text{DGD})$ Resolution 0.1 nm: $\pm (30 \text{ fs} + 3.0\% \times \text{DGD})$
DGD measurement range ^[3]	0 to 1000 ps
PMD uncertainty ^[4]	$\pm (30 \text{ fs} + 2.0\% \times \text{PMD})$
PMD repeatability (typ.)	$\pm 3 \text{ fs}$
PMD measurement range ^[4]	0 to 300 ps

Loss

PDL uncertainty ^[5]	C/L-band: $\pm (0.05 \text{ dB} + 4\% \times \text{PDL})$ O-band: $\pm (0.10 \text{ dB} + 4\% \times \text{PDL})$
PDL repeatability (typ.)	$\pm 0.005 \text{ dB}$
Insertion loss uncertainty (typ.) ^[3]	C/L-band: $\pm 0.03 \text{ dB}$ O-band: $\pm 0.07 \text{ dB}$
Insertion loss dynamic range (typ.) ^[3]	$> 41 \text{ dB}$ (for TLS power levels higher than -6 dBm , increase value accordingly)

Polarization analysis

See N7781B specifications

Optical power measurement

See N7781B specifications

[1] Ambient temperature change max. $\pm 0.5^\circ\text{C}$ since normalization. Valid for 81600B tunable laser source family. Tunable laser power set to -6 dBm . Sweep over specification wavelength range. Specification does not include instability in test device. Specified loss ranges include loss of test device and any additional switches or connections in the optical path. Specification valid on day of calibration.

[2] SOP/DOP measurements are only possible outside the specification wavelength range if the user performs a manual calibration.

[3] DUT properties: Insertion Loss $< 30 \text{ dB}$, PDL $< 1 \text{ dB}$, DGD $< 150 \text{ ps}$. Specification is typical for DGD $> 150 \text{ ps}$.

[4] DUT properties: Insertion Loss $< 41 \text{ dB}$, PDL $< 3 \text{ dB}$, PMD $< 50 \text{ ps}$. Applies for highly mode-coupled devices such as single mode fibers. Specification applies for PMD being the averaged DGD over a wavelength span of 100 nm. Specification is typical for PMD $> 50 \text{ ps}$.

[5] DUT properties: Insertion Loss $< 25 \text{ dB}$, PDL $< 6 \text{ dB}$. Note: DUT connectors are considered being part of the DUT. Thus, angled connectors will add to the device PDL.

Agilent 86038B Photonic Dispersion and Loss Analyzer

www.agilent.com/find/pol

- **Fastest measurement speed for manufacturing test**
- **Highest CD and PMD accuracy and resolution for manufacturing and R&D**
- **Specified operation over 1260 to 1640 nm (O-L band)**
- **2nd-order PMD, GD-ripple and other analysis functions**
- **Expandable for enhanced PDL accuracy and multiport use**
- **Industry-standard measurements with the modulation phase shift method for measurements to any length**



The Agilent 86038B continues Agilent's tradition in measuring chromatic dispersion with this instrument for full dispersion and insertion loss analysis in fast swept-wavelength measurements with polarization resolution. It simultaneously measures chromatic dispersion (CD) and group delay, polarization mode dispersion (PMD) and DGD, insertion loss (IL), and polarization dependent loss (PDL) and optical length and phase. An advanced implementation of the industry standard modulation phase shift method (MPS) provides fast CD and GD traces with high selectable wavelength resolution and low noise without repeated averaging. Use of the polarization resolved MPS method with a wide range of modulation frequency allows measurements to any device length and to highest resolution.

The 86038B uses the industry standard Modulation Phase Shift (MPS) method for both GD/CD and DGD measurements. The advanced implementation of the MPS method delivers both high GD and wavelength resolution. The basic method is standardized in IEC 60793-1-42. The method is documented for DGD and PMD in other standards such as IEC 61280-4-4. This is the one method that can determine a DGD value from measurements only at that wavelength, allowing high resolution with low noise.

The 86038B uses fast swept measurements that are ideal for manufacturing. On the manufacturing floor, success depends on high volume throughput, fast ramp-up and reduced cost of test. Trust in your results is vital. The MPS method used on the 86038B avoids sensitivity to thermal drifts and mechanical vibrations. And the Drift Correction feature assists in obtaining repeatable and stable measurements even in an unstable environment.

Key capabilities

Simultaneous GD, CD, DGD, PMD, IL, and PDL spectra with a single connection and a single setup reduce test time, instrument footprint and measurement uncertainty.

CD uncertainty: ± 0.07 ps/nm; $\pm 0.3\%$ CD

Zero dispersion wavelength uncertainty: ± 0.015 nm

Group delay repeatability: $< \pm 0.03$ ps ($< \pm 30$ fs)

PMD uncertainty: ± 0.07 ps

Differential group delay uncertainty: ± 100 fs

Enhanced PDL and insertion loss accuracy: PDL < 0.05 dB, Loss < 0.02 dB

High speed swept measurements: DGD measurements over 100 nm can be obtained in less than 30 seconds

GD/CD measurements automatically corrected for PMD: Allows very accurate CD measurements

6 polarization-state measurements: This selectable method adds additional accuracy to polarization measurements, especially over wide wavelength ranges

Up to 4-port component testing:

Agilent's 81595B Modular Optical Switch allows testing of up to 4 ports of a multichannel DUT

Wide dynamic range: > 40 dB

Flexible choice of wavelength range: From 1260 to 1640 nm

Supports multiple wavelength band operation by controlling up to 4 tunable lasers. Automatic laser switching is available on request.

Drift correction: Provides excellent stability and accuracy when the environmental conditions of the room or the test device are gradually changing

Selectable and high wavelength resolution: Resolution to < 0.2 pm for challenges like GD ripple characterization and up to 2.5 GHz MPS modulation frequency for lowest noise fiber characterization

Powerful remote control: Write your own applications for enhanced measurement control and analysis

Fast and accurate length measurement

In a few seconds, the fiber or device length can be determined, short or long. The measurement, according to the standard IEC 60793-1-22 and using the modulation frequency range of the 86038B supports determination of CD and PMD coefficients of fiber, the dependence of dispersion on length. The short length accuracy of 0.02 mm corresponds to absolute delay measurements with 100 fs accuracy.

Agilent 86038B Photonic Dispersion and Loss Analyzer

www.agilent.com/find/pol

Specifications 86038B Photonic Dispersion and Loss Analyzer (condensed: full details in 86038B Data Sheet)

(swept wavelength mode; ambient temperature change < ±0.5 °C since normalization; TLS power, 0 dBm; sweep over specified wavelength range)

Group delay and differential group delay measurement

(modulation frequency, 2 GHz; IF bandwidth, 70 Hz; wavelength increment, 1 nm; PDA correction)

Accessories	86038B - 505 86038B - 510 86038B - 520	81595B 1 x 4 modular optical switch for 4 port operation Verification fiber Spare hard drive			
For device insertion loss		4 dB	< 10 dB	< 20 dB typ.	< 30 dB typ.
Relative GD uncertainty		± 50 fs	± 100 fs	± 350 fs	± 4 ps
Relative GD repeatability		± 30 fs	± 50 fs	± 300 fs	± 3.5 ps
DGD uncertainty		± 100 fs ± 2.5% of DGD	± 150 fs ± 3% of DGD	± 500 fs ± 2% of DGD	± 5 ps ± 12% of DGD
DGD repeatability		± 50 fs ± 1% of DGD	± 100 fs ± 2% of DGD	± 350 fs ± 1.5% of DGD	± 3.5 ps ± 12% of DGD
PMD uncertainty (typ., av. over 100 nm range)		± 70 fs ± 2% of PMD	± 100 fs ± 2% of PMD	± 300 fs ± 2% of PMD	± 3 ps ± 4% of PMD
CD uncertainty (ps/nm) at 1 nm wavelength resolution		± (0.07 + 0.3 % of CD)	± (0.14 + 0.3 % of CD)	± (0.5 + 0.3 % of CD)	± (6 + 0.3% of CD)
Zero-dispersion wavelength uncertainty for a fiber with 1 ps/nm ² l-slope (derived from specification)		± 0.015 nm	± 0.022 nm	± 0.058 nm	± 0.6 nm
Modulation frequency		Settable: 5 MHz to 2.5 GHz			
Length uncertainty		± (0.02 mm + 0.00001 of length, (typ., specification valid for < 50 km)			
PDL uncertainty		Without Option 400: ± (0.15 dB + 3% of PDL) typ. With Option 400: ± (0.05 dB + 3% of PDL); loss 0 to 4 dB			
Gain/loss uncertainty		Without Option 400: ± (0.1 dB + 5% of PDL) typ. With Option 400: ± 0.02 dB, loss < 10 dB; ± 0.04 dB, loss < 30 dB			
Dynamic range		> 40 dB, typ.			
Wavelength range		Full range (nm)		Range of specifications (nm)	
- Option #120 or 320		1440 to 1640		1475 to 1625	
- Option #116 or 316		1495 to 1640		1510 to 1620	
- Option #115 or 315		1450 to 1590		1480 to 1580	
- Option #114 or 314		1370 to 1495		1420 to 1490	
- Option #113 or 313		1260 to 1375		1270 to 1350	
Absolute wavelength uncertainty (swept/stepped mode)		With Option 410: ± 4 pm typ. / ± 2 pm typ. Without Option 410: ± 6.1 pm typ. / ± 10 pm, ± 3.6 pm typ.			
Rel. wavelength uncertainty (swept/stepped mode)		± 4 pm typ. / ± 5 pm, ± 2 pm typ.			
Assembled dimensions (H x W x D) (single TLS configuration)		555 mm x 435 mm x 555 mm 54 kg (120 lb)			
Performance options	86038B - 400 86038B - 400	Enhanced PDL and loss accuracy Add 86122C multi-wavelength meter for ± 1.0 pm accuracy			

Agilent N4373D Lightwave Component Analyzer

www.agilent.com/find/lca

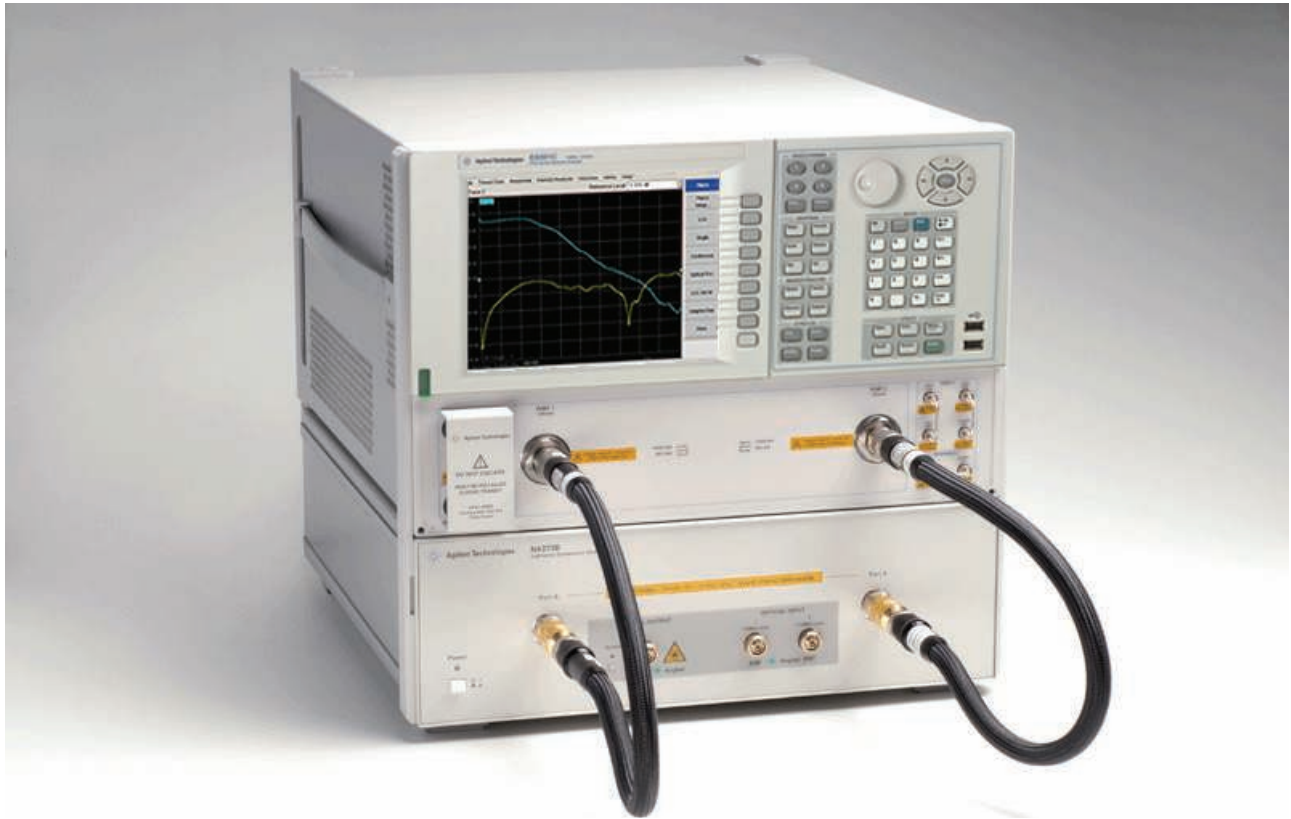

The new N4373D offers the latest 5227A series network analyzers with 2-port or 4-port configuration. This LCA is the ideal measurement solution for test of electro-optical components up to 67 GHz. It is the ideal test instrument for electro-optical components for 56 Gbaud coherent transmission, as well as Radio over Fiber (RoF) and aerospace and defense (A&D) electro-optical test applications.

The N4373D is traceable to international standards and provides guaranteed specifications for electro-optical responsively S-parameter measurements in a turn-key solution. In combination with N4694A electronic calibration kit you get fastest setup of your test, so you can focus on developing your components.

Fast and easy measurement setup increases productivity as time-consuming electrical calibration steps are automated and optical calibration by the operator is no longer necessary.

Additional benefits

- Built-in average power meter for fast transmitter power test
- SCPI remote control
- PMF optical output for reliable modulator test
- User selectable optical transmitter output power helps to adapt to target test conditions

Absolute frequency response accuracy at 26.5 GHz

- < 0.9 dBe at 50 GHz (typ.)
- < 1.3 dBe at 67 GHz (typ.)

Relative frequency response accuracy at 26.5 GHz

- < 0.5 dBe at 50 GHz (typ.)
- < 1.3 dBe at 67 GHz (typ.)

Noise floor 26.5 GHz

- < -59 dB (W/A) at 67 GHz for E/O measurements
- < -55 dB (A/W) at 67 GHz for O/E measurements

Benefits

- Design assurance with fast, accurate and complete measurements
- Quick time-to-market with fast test turnaround
- Protected investment with flexibility to add and change options and wavelength range
- Efficient use of measurement time with intuitive and powerful user interface and measurements at the touch-of-a-button
- Confident and easy analysis with built-in smoothing and fitting tools
- High uptime with worldwide service and support and modular repair capabilities
- Easy data transfer with LAN and USB connectivity
- Optimized use of time with programmable automation

Agilent N4374B Lightwave Component Analyzer

www.agilent.com/find/lca

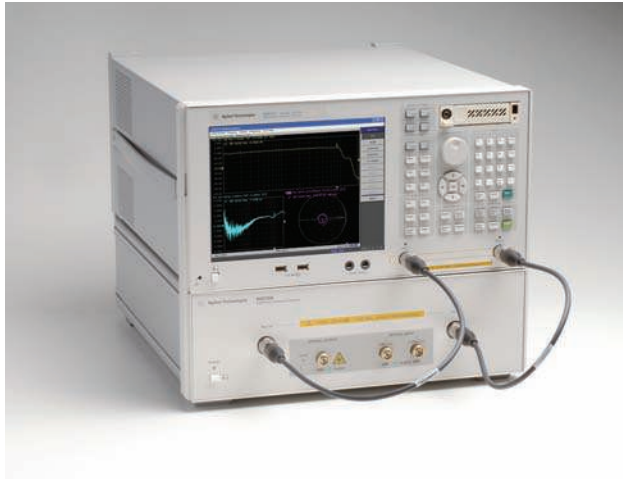

The new N4374B lightwave component analyzer (LCA) is the successor of the 8702 LCA with target application in CATV and Radio over Fiber (RoF). It is based on ENA-C series network analyzers. CATV is supported by offering a 75 Ω referenced measurement. To do this a minimum loss pad is included to adapt from 50 Ω to 75 Ω . With the adapter removal tool included in the ENA all test results show the correct 75 Ω referenced results.

With up to 4.5 GHz modulation frequency range electro-optical S-parameter tests for 3G and LTE RoF applications are well supported. Traceable specifications for relative and absolute responsivity make the tests results independent of the instrument personality that makes the test results comparable between supplier and vendor or between various locations.

It's the excellent accuracy and repeatability that improves yield from tests performed with the N4374B, by narrowing margins needed to pass the tested devices resulting in improved manufacturing yield. The turn-key solution offers fastest time to market. With the more than 3 times faster tests compared to the 8702 series this LCA helps to significantly reduce manufacturing cost.

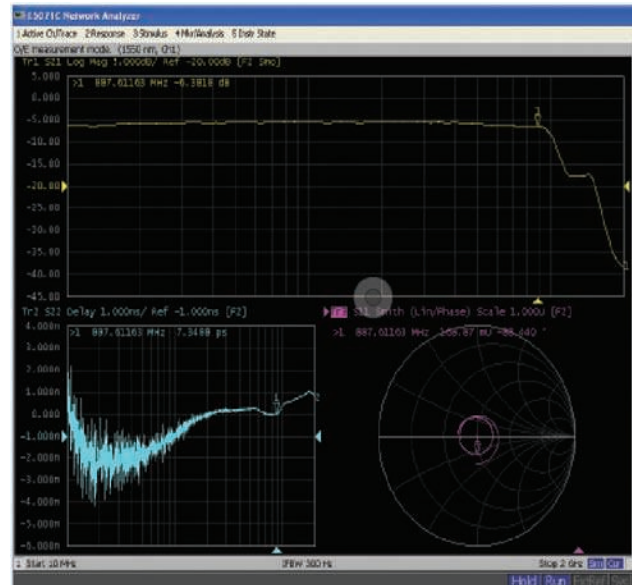

Key benefits

- High absolute and relative accuracy measurements improve the yield of development and production processes
- Support of 75 Ω devices
- Significantly increased productivity using fast and easy measurement setup with a unique new calibration process leads to lower cost of test
- Identical LCA software and remote control across the N437xB/C family simplifies integration
- Transmitter wavelength 1550 nm and/or 1310 nm
- Built-in optical power meter
- Settable transmitter output power
- External optical input option
- Integrated Bias-T option in ENA

System performance extract (typical data @1550 nm)		100 kHz to 0.7 GHz	0.7 GHz to 4.5 GHz
Relative frequency response uncertainty	E/O	± 0.7 dBe	± 0.5 dBe
	O/E	± 0.7 dBe	± 0.5 dBe
Absolute frequency response uncertainty	E/O	± 1.7 dBe	± 1.5 dBe
	O/E	± 1.7 dBe	± 1.5 dBe
Frequency response repeatability	E/O, O/E	± 0.02 dBe	± 0.02 dBe
Noise floor	E/O	-60 dB (W/A)	-80 dB (W/A)
	O/E	-50 dB (A/W)	-70 dB (A/W)
Phase uncertainty (typ.)	E/O	—	$\pm 2.0^\circ$
	O/E	—	$\pm 2.0^\circ$
Group delay uncertainty		Derived from phase uncertainty, see section "Group delay uncertainty". Example: $\pm 2.0^\circ \geq \pm 8$ ps (1 GHz aperture)	

Agilent N4375D Lightwave Component Analyzer

www.agilent.com/find/lca

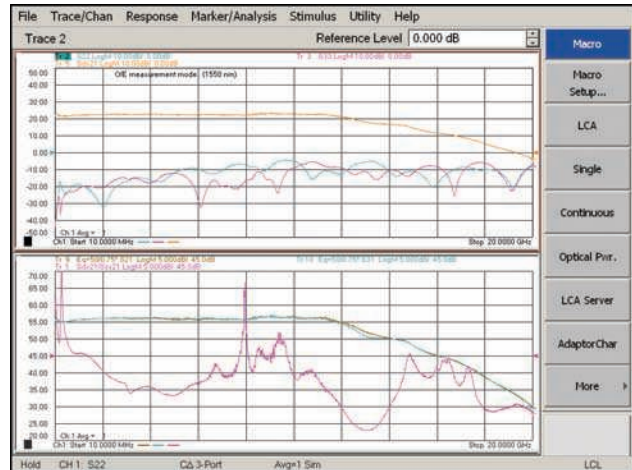

Agilent's N4375D lightwave component analyzer (LCA) is the successor of the industry standard 8703A/B LCA. Its target application is the test of electro-optical components for 10 GbE, Fibre Channel FCx8, FCx10 and FCx16.

With a completely new design of the optical test set and a new RF-switched architecture, together with the latest PNA family of network analyzers, the N4375D guarantees excellent electro-optical measurement performance. In addition a unique new calibration concept significantly reduces time from powering up the LCA until the first calibrated measurement can be made. This increases productivity in R&D and on the manufacturing floor.

The fully integrated "turnkey" solution reduces time to market, compared to the time-consuming development of a selfmade setup. By optimizing the electrical and optical design of the N4375D for lowest noise and ripple, the accuracy has been improved by more than a factor of 3 and is now independent of the electrical return loss of the device under test. It is the excellent accuracy that improves the yield from tests performed with the N4375D, by narrowing margins needed to pass the tested devices. NIST traceability ensures worldwide comparability of test results.

Key benefits

- High absolute and relative accuracy measurements improve the yield of development and production processes
- High confidence and fast time-to-market with a NIST traceable turnkey solution
- Significantly increased productivity using the fast and easy measurement setup with a unique new calibration process leads to lower cost of test
- More than 3 times faster than predecessor 8703A/B series speeds up every test procedure
- New switched architecture of optical test set for long term reliability and stability of test results
- Identical LCA software and remote control across the N437xx family simplifies integration
- Transmitter wavelength 1550 nm and/or 1310 nm
- Built-in optical power meter
- Settable transmitter output power
- External optical source input option

System performance extract (typical data @1550 nm)		0.05 GHz to 0.2 GHz	0.2 GHz to 0.7 GHz	0.7 GHz to 20 GHz
Relative frequency response uncertainty	E/O	± 0.7 dBc	± 0.5 dBc	± 0.5 dBc
	O/E	± 0.7 dBc	± 0.5 dBc	± 0.5 dBc
Absolute frequency response uncertainty	E/O	± 1.7 dBc	± 1.5 dBc	± 1.5 dBc
	O/E	± 1.7 dBc	± 1.5 dBc	± 1.5 dBc
Frequency response repeatability	E/O, O/E	± 0.02 dBc	± 0.02 dBc	± 0.05 dBc
Noise floor	E/O	-60 dB (W/A)	-86 dB (W/A)	-86 dB (W/A)
	O/E	-49 dB (A/W)	-72 dB (A/W)	-74 dB (A/W)
Phase uncertainty (typ.)	E/O	-	± 2.0°	± 2.0°
	O/E	-	± 2.0°	± 2.0°
Group delay uncertainty	Derived from phase uncertainty, see section "Group delay uncertainty". Example: ± 2.0° > ± 8 ps (1 GHz aperture)			

Agilent N4376D Lightwave Component Analyzer

www.agilent.com/find/lca

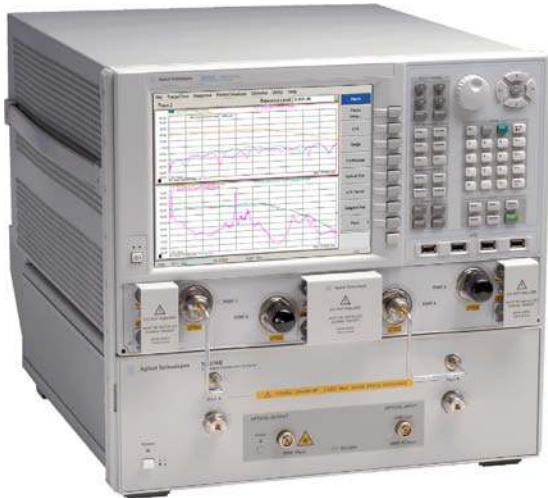

Agilent's N4376D multimode lightwave component analyzer (LCA) operates at 850 nm to characterize short wavelength 10 GbE, Fibre Channel FCx8, FCx10 and FCx16 electro-optical components, with up to 20 or 26.5 GHz modulation range. The N4376D also supports the test of transmitter and receivers for ultra fast optical computer or server backplanes and optical chip-to-chip connections in high speed computers and server applications. With a completely new design of the optical test set and a new RF-switched architecture, together with the latest PNA family of network analyzers, the N4376D guarantees excellent electro-optical measurement performance. In addition a unique new calibration concept significantly reduces time from powering up the LCA until the first calibrated measurement can be made. This increases productivity in R&D and on the manufacturing floor.

Multimode measurements are typically much more critical regarding repeatability and stability than single-mode measurements. A well defined and stable launch condition increases measurement repeatability. The N4376D has typical multimode launch conditions as defined by the IEEE 802.3ae standard, resulting in application realistic and repeatable test results.

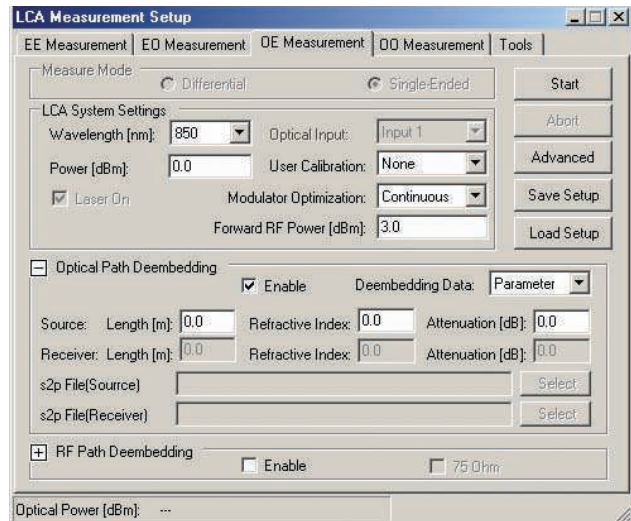

Key benefits

- Traceable multimode S21 test at 850 nm wavelength
- IEEE 802.3ae launch power distribution leads to test results comparable to the final application
- Fast and easy measurement setup and calibration for all standard tests
- High confidence and fast time-to-market with a traceable turn-key solution
- Significantly increased productivity using the fast and easy measurement setup with a unique new calibration process leads to lower cost of test
- Test right at target launch condition eliminates test uncertainty
- Identical LCA software and remote control across the N437xB/C family simplifies integration
- LC or SC straight connectors
- Built-in optical power meter for fast transmitter power verification
- Powerful remote control with state of the art programming interface based on Microsoft NET or COM
- Identical LCA software and remote control across the N437xx family simplifies integration

System performance extract (typical data @ 850 nm)		0.05 GHz to 0.2 GHz	0.2 GHz to 10 GHz	10 GHz to 26.5 GHz
Relative frequency response uncertainty	E/O	± 1.3 dBc	± 1.3 dBc	± 1.6 dBc
	O/E	± 1.3 dBc	± 1.3 dBc	± 1.6 dBc
Absolute frequency response uncertainty	E/O	± 2.0 dBc	± 2.0 dBc	± 2.0 dBc
	O/E	± 1.7 dBc	± 2.0 dBc	± 2.0 dBc
Frequency response repeatability	E/O, O/E	± 0.2 dBc	± 0.1 dBc	± 0.1 dBc
Noise floor	E/O	-50 dB (W/A)	-70 dB (W/A)	-70 dB (W/A)
	O/E	-40 dB (A/W)	-60 dB (A/W)	-60 dB (A/W)

Agilent N4391A Optical Modulation Analyzer

www.agilent.com/find/oma

- **Advanced research for 400 G and beyond**
- **Highest true analog bandwidth**
- **Highest analysis wavelength range**
- **Ideal for research on super-channels**

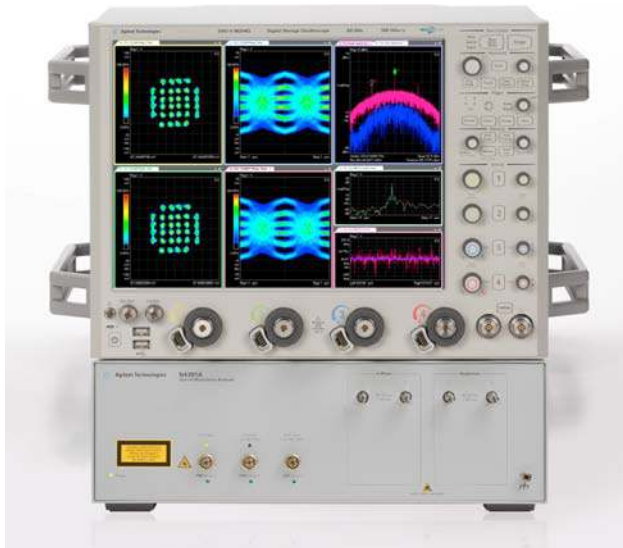

Unlike the high-speed optical networks of the past, where modulating an optical wave's amplitude on and off at high-rates was sufficient, today's optical links are following the wireless industry's lead to high order modulation formats. Complex modulation formats extend beyond on-off keying by encoding communication symbols with both amplitude and phase information. The N4391A optical modulation analyzer is optimized for analysis of these kinds of new optical modulation formats. It supports transmission rates of 40/100 G and beyond. The N4391A is the ideal instrument for advanced research on higher than 112 Gbit/s transmission speeds.

Characterization of the signal quality of a vector modulated signal right at the transmitter output or along the link is the core application of this kind of instrument. Most important analysis and measurement tools are:

- Optical constellation diagram
- Error vector magnitude (EVM)
- Phase error
- BER on physical layer
- CD, 1st order PMD compensation and measurement
- Quadrature error
- IQ imbalance
- I or Q eye-diagram
- High resolution spectrum
- Spectrogram of many analysis tools
- Laser line width

- Polarization of analyzed symbols
- Support of more than 30 modulation formats
- Adaptive equalization
- Variable phase tracking bandwidth

Key performance data with a 90000-Q series oscilloscope

- 33 GHz true analog bandwidth
- 62 Gbaud symbol rate
- 66 GHz spectrum analysis

Features and benefits

- Wide-bandwidth time-domain polarization-diverse coherent optical receiver, for state-of-the-art advanced modulation format analysis
- Performance verification within minutes for highest reliability of your test results
- Customer configurable OFDM decoder
- Customer configurable APSK decoder
- Real-time sampling for optimal phase tracking
- Highest flexibility, with numerous modulation formats, analysis tools and instrument configurations
- No clock input or hardware clock recovery necessary.
- Long pattern analysis available
- Flexible hardware and software concept for future adoption to new requirements and investment protection
- CD and first order PMD measurement and compensation for link tests with vector modulated signals

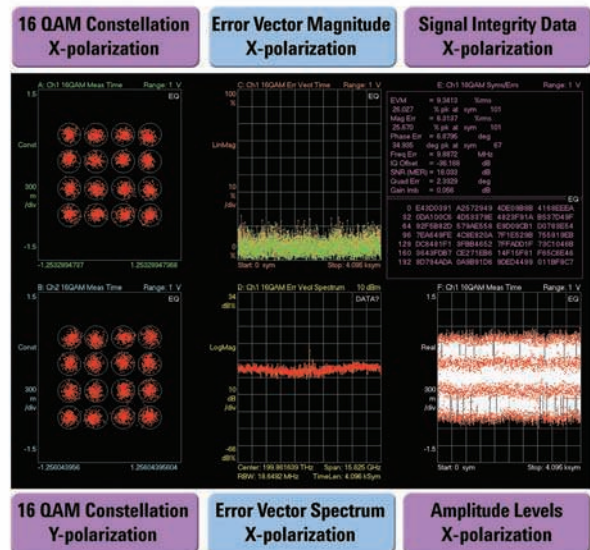

Agilent N4392A Portable Optical Modulation Analyzer

www.agilent.com/find/n4392a

- **40/100 G coherent transmission test**
- **Coherent transmitter characterization**
- **Integrated Intradyne Coherent Receiver Test**
- **Coherent transmission link test**
- **Error vector analysis capabilities**
- **Less than 13 kg (28.7 lbs.)**
- **Built-in calibration**
- **Built-in performance verification**
- **Built-in high-performance digitizer**

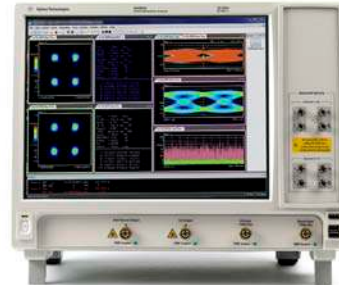

You will no longer have to share an optical modulation analyzer among colleagues or even departments because of its high initial investment price.

You will no longer have to move your device under test to another location because it's too hard to move the analyzer, just to perform a short measurement.

You will no longer have to ship your optical modulation analyzer to service once a year for performance verification and recalibration. Now the instrument does all this for you whenever you think it is necessary, increasing the time you can use your instrument.

The N4392A is the next generation of optical modulation analyzers in a compact housing of a mid-size oscilloscope. With 15" screen size, even more analysis parameters can be visualized at the same time, leading to faster debugging results.

Compact

Integration of a digitizer, optics and analysis PC leads to a compact turn-key instrument. It also avoids any external cabling, making the instrument robust and easy to set up wherever needed.

Despite the smaller size, the new N4392A offers a big laptop-size screen, giving you more insight in your signal for understanding and debugging your signals even faster.

Portable

The integration in a compact mid-size oscilloscope housing results in a lightweight instrument, which can be easily moved to any location in a lab or on the manufacturing floor. Operators who need to analyze and debug signals at the physical layer will enjoy this feature as well.

Affordable

The N4392A is designed for best price-performance balance, achieved by combining advanced integration technologies with built-in calibration and performance verification tools. This leads to longer intervals between recalibration, extending uptime in research and manufacturing and resulting in reduced cost of ownership without leaving any doubt about the performance of the instrument.



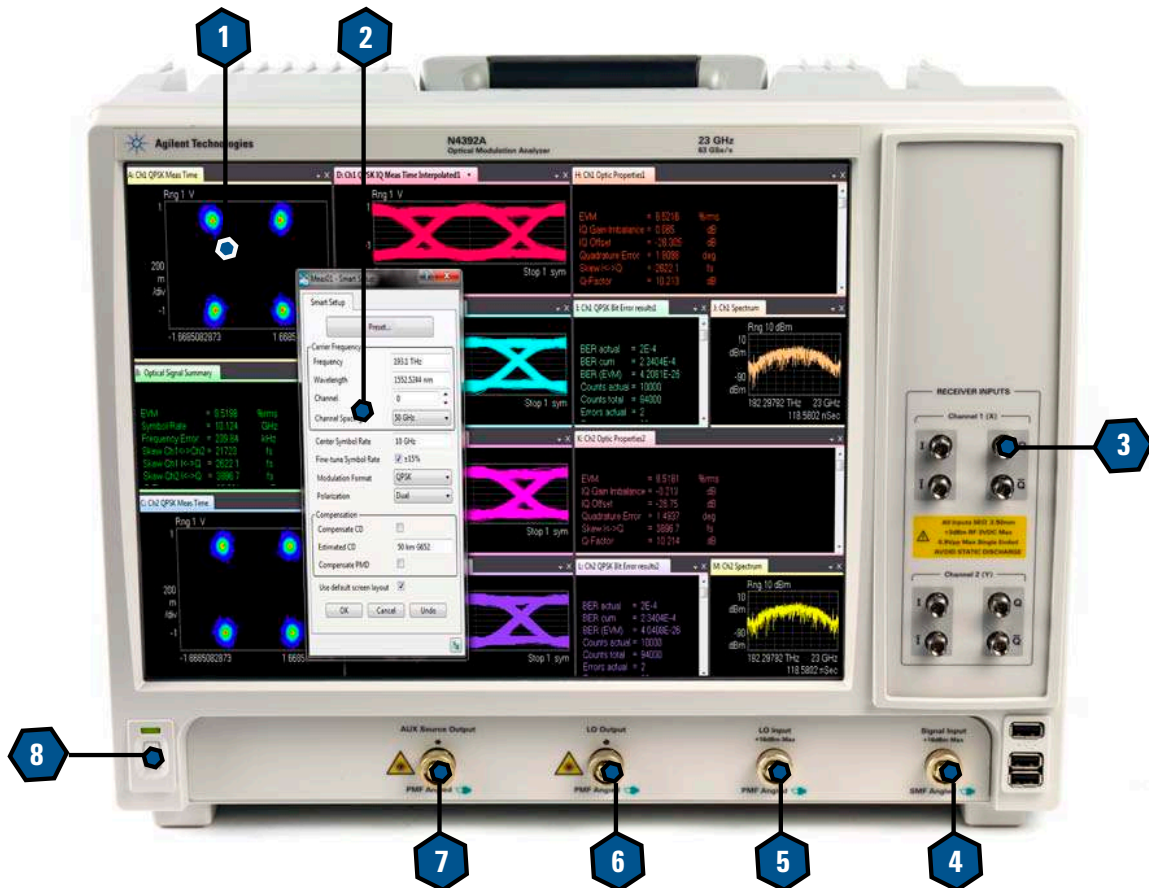

1. Vector signal analysis

Like the N4391A, the N4392A is based on the Agilent 89601B vector signal analysis software which is extended for optical requirements. One software platform ensures exchangeability of setting files and measurement results between R&D and manufacturing. This also makes results comparable and exchangeable.

2. Predefined setups

For easiest setup of standard 40 G and 100 G modulation formats.

3. RF inputs

Characterize and evaluate your own IQ demodulator with four differential RF digitizer inputs as required for OIF compliant integrated coherent receivers. (Option 310)

4. Signal input

Feed in your signal under test at this input, for modulation analysis that gives you the highest confidence in your test results.

5. LO input

In experiments where an extremely stable local oscillator with linewidth in the low kHz range is required, this input can be used as Local oscillator (LO) input for external lasers. (Option 320)

6. LO output

Get part of the local oscillator signal to the output for monitoring or setting up a homodyne experiment. (Option 320)

7. AUX source output

This output (Option 320) provides you with a CW laser signal which can be used to drive your transmitter or use it as an auxiliary output to calibrate an external integrated IQ demodulator. (Option 320)

8. Power ON/OFF

Agilent N4392A Integrated Intradyn Coherent Receiver Test

www.agilent.com/find/oma

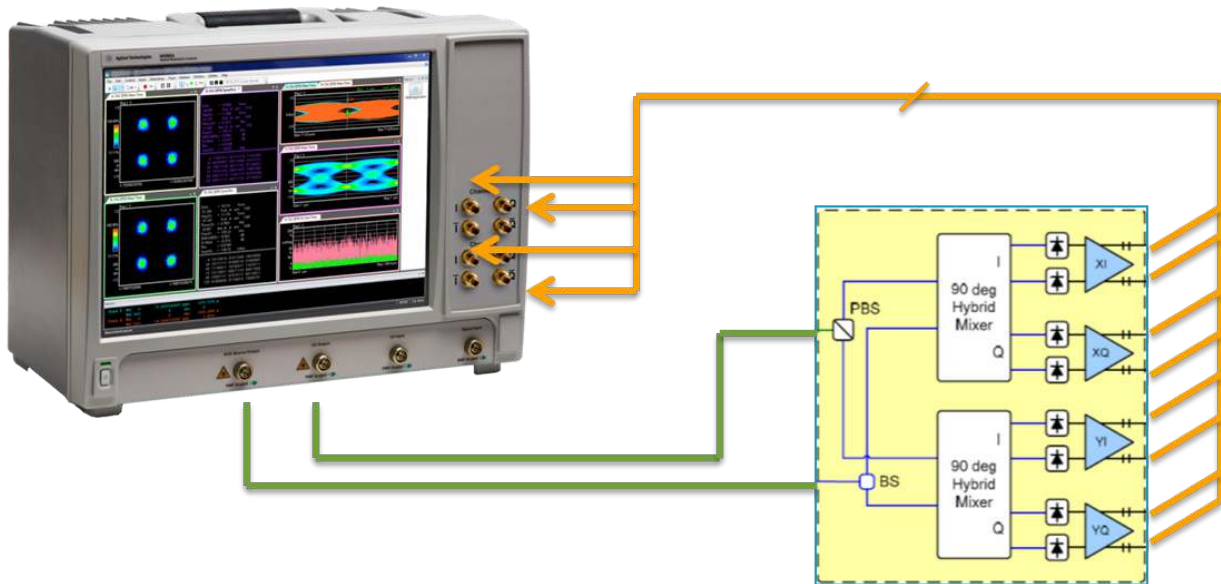

The test of an integrated intradyne coherent receiver (ICR) as defined by Optical Internetworking Forum requires many parameters to test for each device. These devices can be tested in the above illustrated setup quickly and easily. Again the EVM concept offers a powerful tool to verify the overall quality of an ICR within a second. This setup simulates a golden transmitter which has better performance than any production-series transmitter. Analyzing this

signal in the same way as a normal transmitter signal can reveal impairments that reflect the intrinsic performance of the ICR under test (see left screens in the screen shot below) and therefore indicates limitations to the performance that can be achieved.

In addition to the spectral display on the right screens, the image suppression gives you an indication of distortions in the system and shows how well balanced your photodiodes are.

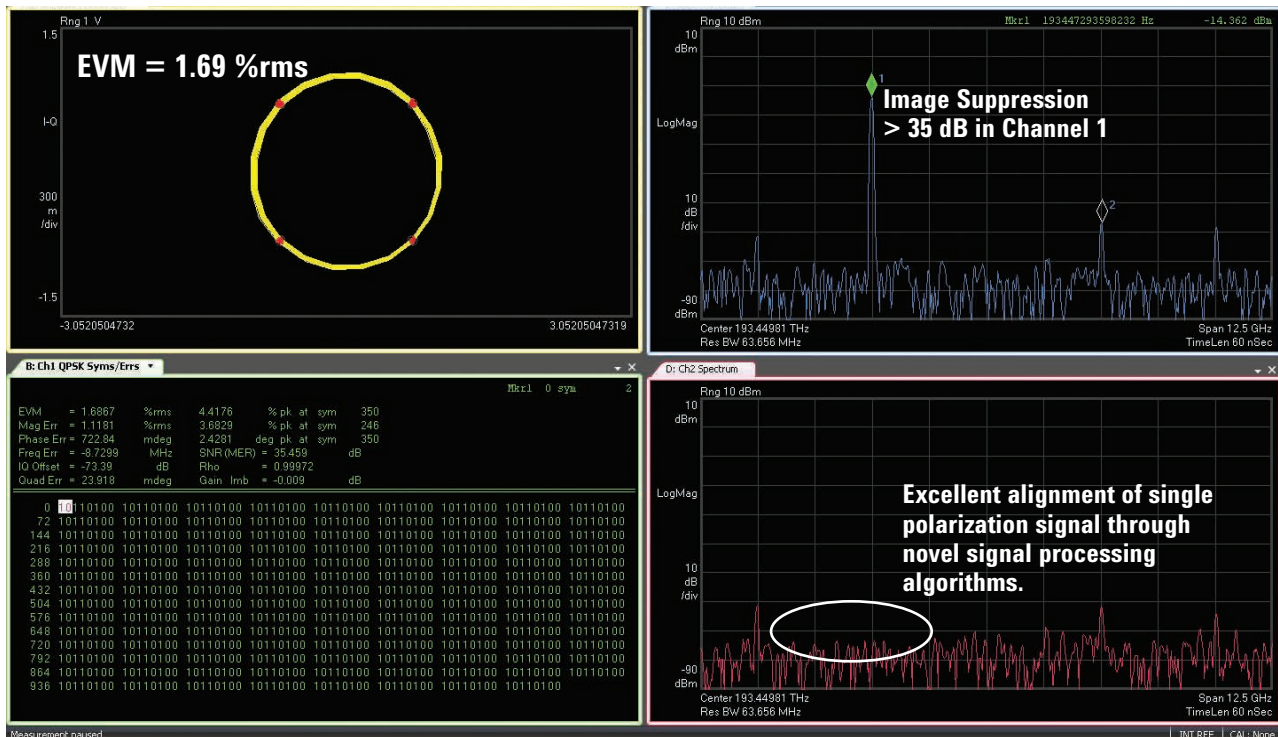

Agilent N4392A Integrated Coherent Receiver (ICR) Test

www.agilent.com/find/oma

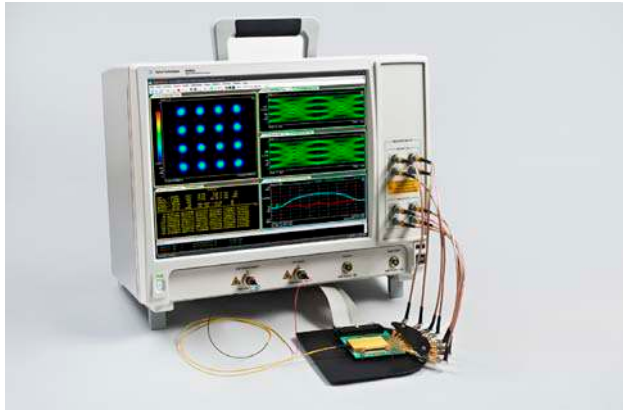

Test setup to verify performance of ICR

Intradynne integrated coherent receiver test

For detection of complex modulated optical signals OIF defined an electro-optical component typically described as integrated dual polarization intradyne coherent receiver (ICR). This component contains optical and electro-optical components in one package, as shown in the figure left as device under test.

The hybrid contains many components that need to be integrated and perform seamless as a black box coherent receiver.

The integrated component needs to be tested in research and in manufacturing.

The N4392A offers tools, like option 310 and 430, to test this kind of devices and extract parameters that characterize the behavior of the component.

With the N4392A it is possible to test the component in an environment that is identical to the final application providing highest confidence in the performance of the component:

- This test is performed with the N4392A by generating a beat signal within the detection band to the ICR optical inputs
- This test is an excellent setup to verify the intrinsic performance of the ICR as it reflects noise impairments and all kinds of distortions
- The IQ and constellation diagram gives an indication on the noise and the distortion of the signal of the ICR created from a nearly perfect beat signal. The same parameter that are used to quantify the signal quality (EVM, IQ offset, IQ imbalance, Quadrature error) can be used to qualify the intrinsic performance of the component
- Image suppression in a spectral display gives a good indication of presence of imbalances between channels and PIN diodes in the coherent receiver. A good image suppression and large common mode rejection ratio indicate a well balanced receiver

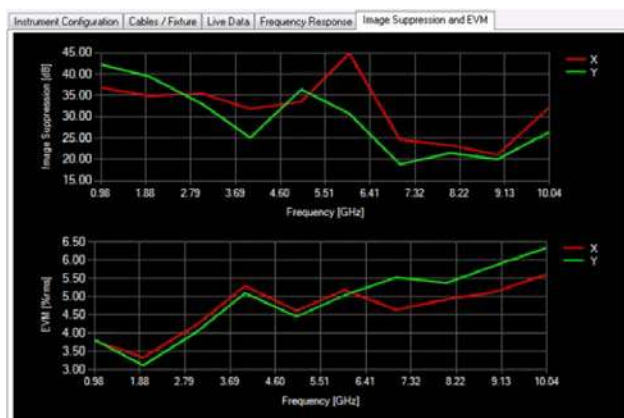
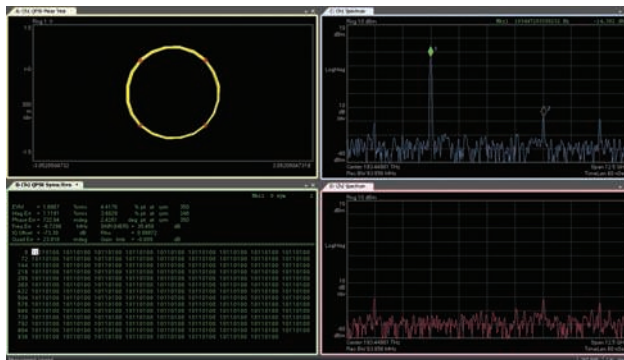
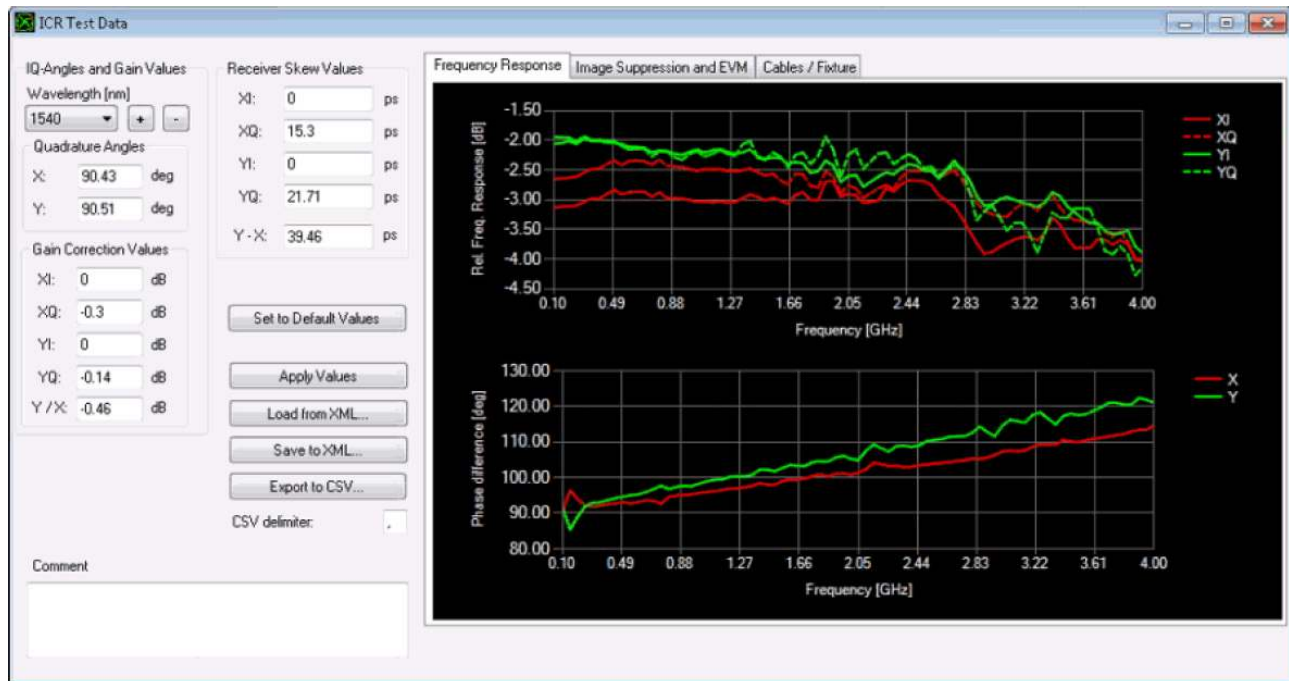

Image suppression is an excellent indication of the presence of potential distortions within the optical receiver. An image suppression in the order > 35 dB indicates high CMRR of well balanced PIN diodes and well de-skewed I-Q channels in the ICR under test.

EVM is an excellent indicator of the overall quality of a complex modulated signal. This concept is applied in that test by creating a beat signal in the ICR and analyzing it in the same way as a complex modulated signal. This emulates a kind of ideal stimulus of the ICR. With this test the EVM can be measured at a single frequency point along the receiver bandwidth of the device under test and within the digitizer bandwidth. This measurement provides additional insight to the device under test, ensuring distortion free measurements at each tested frequency point with good EVM.

Agilent N4392A Integrated Coherent Receiver (ICR) Test

www.agilent.com/find/oma



Integrated coherent receiver test provides most relevant test parameters as defined by OIF to characterize integrated coherent receiver components. The following test results are provided by the software:

- Relative frequency response $S_{21}(f)$ for each tributary
- Phase difference between X and Y polarization as function of frequency
- Image suppression over frequency
- Error vector magnitude (EVM % rms) over frequency (in addition to OIF) requirements
- Image suppression over frequency (in addition to OIF)

The following parameter are frequency independent impairments measured by the ICR test software:

- Quadrature angles between I and Q for each polarization plane X and Y
- Gain correction values for balanced gain for each polarization plane
- Skew values between each tributary with reference to one channel

Compact - Portable - Affordable



Agilent Infiniium 90000 Q-Series Oscilloscopes

www.agilent.com/find/90000Q-Series

- The industry's highest real-time bandwidth with 63 GHz
- The industry's highest 4-channel bandwidth with 33 GHz in a single frame
- The industry's lowest noise and jitter measurement floor
- The industry's deepest memory



The Infiniium 90000 Q-Series oscilloscope

At the extremes of electrical and optical measurements, the right oscilloscope will help you explore the “what” and understand the “why”.

That's the idea behind Q-Series oscilloscopes, our latest step forward in the application of Agilent's microwave expertise to real-time oscilloscopes. With industry-leading bandwidths, the Q-Series lets you see your fastest signals as they really are. Equip your lab with Q-Series scopes—and achieve your real edge.

Specifications

- 63 GHz analog bandwidth
- 2 channel sample rate: 160 GSa/s
- 4 channel sample rate: 80 GSa/s
- 2 Gpts of memory
- > 20 GHz edge trigger bandwidth
- 30 GHz probing system

Features and benefits

- Up to 33 GHz true analog bandwidth on four channels
- 40 GHz support to the N4391A in near future
- Up to 120 Gbaud symbol rate analysis
- Four times better EVM noise floor than typical QPSK transmitter
- Compact four channels in turn-key solution
- 4 x 80-Gs real-time sampling for optimal phase tracking
- Well-defined interface to include your own MATLAB algorithms
- Customer-configurable APSK and OFDM decoders

Using in next generation optical communications research

Q-Series oscilloscopes are also available in combination with the N4391A optical modulation analyzer as a fully specified turn-key instrument. This compact solution offers the highest bandwidth available on the market and is the most advanced test solution for advanced research on 400 G and terabit transmission.

Even for the lower 20 GHz bandwidth range, this compact and easy-to-use solution is a reference system for 100 G transmission required by R&D labs working at 100 G and beyond. By providing four channels of 33 GHz bandwidth, the Q-Series saves you the expense of a second instrument to analyze dual polarization.

If you prefer to operate with your own optical receivers but want to benefit from the enormous analysis capability, you can get the N4391A's analysis software as a standalone package.

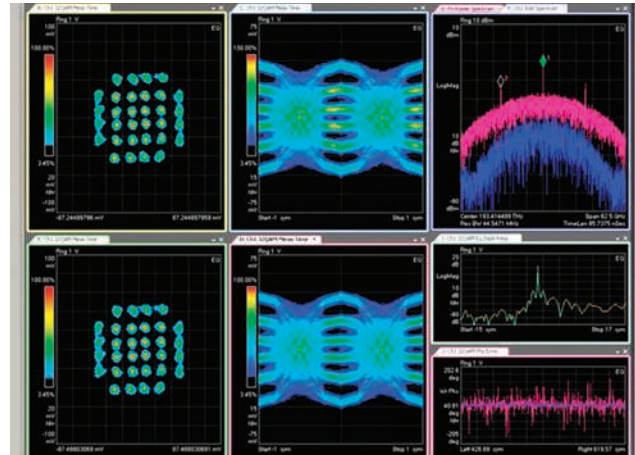

The N4391A offers a powerful toolset to debug the most challenging errors, with tools proven by thousands of RF engineers

Configuring systems with high channel counts

Two oscilloscope ADC channels are required to measure the I and Q vector components of a single coherent optical channel. Capacity of systems can be further increased by modulating orthogonal polarizations and/or multiple core fibers. For each additional effective carrier, another pair of oscilloscope channels is required. The Agilent 90000 Q-Series can be configured with four channels, each with 33 GHz of bandwidth.

For applications requiring wider bandwidths, over 60 GHz can be achieved in two channels. To increase the channel count or to create more than two channels with over 60 GHz of bandwidth, it is possible to gang together multiple oscilloscopes. Through tying together each oscilloscope on a common 10 MHz reference, the overall system can be synchronized with a channel-to-channel timing uncertainty less than 200 fs.

Agilent 90000 Series Oscilloscopes with the 81495A Highspeed Optical/Electrical Converter

www.agilent.com/find/90000a
www.agilent.com/find/ref



- Capture optical signals of interest using advanced triggering capabilities for maximum flexibility
- Take advantage of a record length of up to 1 billion samples to acquire a contiguous optical waveform for extended analysis
- Perform various functions on your optical waveforms in real time with the built-in math functions or tightly integrated MATLAB® environment

Troubleshoot optical systems and measurements with the flexibility of a real-time scope

The Agilent Infiniium 90000 Series real-time digital storage oscilloscopes (DSO) and digital signal analyzers (DSA) provide superior signal integrity and deep application analysis to give you better insight into your designs. Now you can use these high-performance scopes with the 81495A optical reference receiver to make advanced optical measurements. The 81495A is an optical electrical (O/E) converter optimized for transceiver loop-back test. Combine the 81495A with a 90000 Series scope and you can quickly and smoothly move through optical waveform measurement and advanced analysis using the Infiniium's intuitive interface and large touch screen.

Enjoy advanced capture and analysis capabilities

With the 90000 Series' industry-exclusive ultra-deep 2 Gpts of memory and combined software/hardware triggering, you can quickly capture complex and infrequent signals for the most effective debugging and analysis. Agilent's advanced InfiniScan software enables you to trigger on specific data patterns and provides virtually unlimited triggering combinations. In addition, the available record length of up to 1 billion samples allows capture and analysis of long data streams – up to 25 ms of data at 80 GSa/s with post-processing.

Performance overview

- 20, 40 or 80 GSa/s sampling rate
- 10 Mpts to 2 Gpts record length
- 22 MSa/s max data transfer rate
- Advanced triggering, industry's only 3-level sequence triggering

Perform a range of analyses

An Infiniium 90000 Series oscilloscope combined with the 81495A optical reference receiver offers an excellent real-time solution that enables advanced analysis of optical waveforms. Measurements and math functions include:

- Waveform, Eye-diagram, Jitter analysis, Statistics
- Histogram analysis of "1" and "0" levels for extinction ratio (ER) and optical modulation amplitude (OMA) measurements
- Mask testing, Waveform math
- In addition, this combination of instruments supports any scientific optical measurement setup that requires O/E conversion up to 9 GHz



81495A Reference Receiver

Simplify optical measurements

The intuitive user-interface and versatility of the 90000 Series oscilloscopes let you connect to the 81495A and set up your scope for optical measurements in just a few simple steps. The seamless integration of the module-scope system into the industry-standard Agilent LMS platform extends your optical test capabilities.

Get the most accurate measurements

The 90000 Series oscilloscopes feature the industry's lowest noise floor, which ensures you see the true performance of the device under test. Combining the scope with the low noise floor and low jitter of the 81495A optical reference receiver produces a powerful system that supports reliable O/E conversion for advanced optical waveform analysis.

Speed up optical measurements

The 90000 Series scopes' real-time signal acquisition allows fast single-shot capture of optical data streams. The integrated average optical power meter of the 81495A optical reference receiver provides quick signal-level verification and diagnosis.

Use the ideal optical front-end solution

The 81495A optical reference receiver is a module for the industry-standard Agilent lightwave measurement systems (LMS) mainframes. The module's linear transfer characteristics and advanced capabilities make it an excellent optical front end for real-time oscilloscopes:

- Reference receiver response with modulation bandwidth of 9 GHz
- Multimode fiber input, accepting both single- and multimode signals
- Optical wavelengths from 750 to 1650 nm
- Measurements with 20 to 80% rise-times down to about 35 ps



Agilent's 81490A Reference Transmitter is designed to offer excellent eye quality as a reference for testing 10 GbE -LR/-ER, 10 G Fibre Channel and short reach transceivers, such as 10 GBase-SR, 40 GBase-SR4, 100 GBase-SR10 and according to 10 GFC Fibre Channel specifications.

The Reference Transmitter is available for Multimode 850 nm and Single-mode 1310 nm/1550 nm applications. Offering both 1310 nm and 1550 nm in one module gives the fastest reconfiguration between these two transmission bands without reconnecting. The integration in the LMS mainframe offers an integration of the reference transmitter into the N4917A stressed eye software package. Of course a separate usage of the transmitter is also supported with SCPI language.

81490A-135

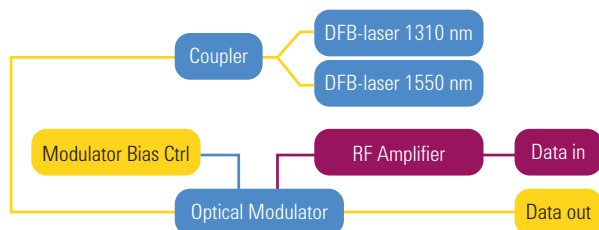

81490A-135 1310 nm/1550 nm reference transmitter

81490A-E03

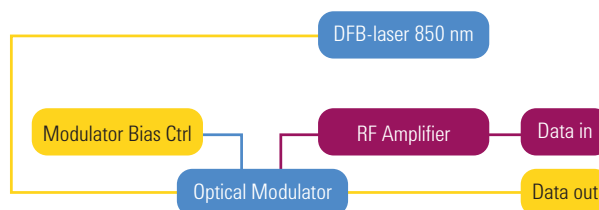

The separation of the signal source and the modulator is the only way to offer a zero-chirp modulation. This is essential for a clean and repeatable eye-diagram when modulating with an appropriate clean external source to fulfill the requirements of the IEEE standard. Another advantage of this design compared to directly modulated transmitters is the wide extinction ratio range that can only be achieved with this design.

Benefits

- Repeatable and reproducible measurements permit lower production test margins and improved specifications of the characterized devices
- Reliable measurements ensure comparability of the test results
- Support for full compliance to IEEE 802.3 stressed eye test in combination with the N4917A Optical Receiver Stress Test solution
- Wide extinction range offers highest test range coverage to ensure best quality of the tested devices under all target operating conditions
- Rapid test reconfiguration with dual-wavelength to switch between 1310 nm and 1550 nm by remote control or manually without exchanging a module
- Scalability with integration into industry-standard Agilent LMS platform extends your optical workbench capabilities

Application

- Reference transmitter for stressed eye compliance test according to IEEE 802.3 and 10 G Fiber Channel
- Creation of arbitrary optical modulation signals in combination with waveform generators
- General transmission system test with special pulse patterns in combination with a pattern generator

Specifications

Operational data rate: 622 Mb/s to 12.5 Gb/s

Electro-optical modulation bandwidth: 10 MHz to 33 GHz typ.

Electro-optical conversion ratio: > 5 mW/V

Maximum extinction ratio: > 10 dB

Vertical eye closure penalty: VECF < 0.7 dB (Option E03), VECF < 0.5 dB (Option 135)

Jitter (peak - peak): < 18 ps (Option E03), < 12 ps (Option 135)

Relative intensity noise (RIN): RIN < -136 dB/Hz

Transmitter wavelength: 850 ± 10 nm (Option E03), 1310 ± 10 nm, 1550 ± 10 nm (Option 135)

Average optical output power

P > 0.0 dBm (Option E03), P > 5.0 dBm (Option 135)

Agilent M8190A 12 GSa/s Arbitrary Waveform Generator (AWG)

www.agilent.com/find/m8190a



Three amplifiers for different applications

- Direct DAC—optimized for I/Q signal generation with best SFDR & HD
 - SFDR up to -80 dBc (typ.),
 $f_{out} = 100$ MHz, measured
DC to 1 GHz
 - Amplitude ~ 350 mVpp ...
700 mVpp, offset
 -20 to $+20$ mV
 - Differential output
- DC amplifier ¹—optimized for serial data /time domain applications
 - Amplitude 500 mV_{pp} to 1.0 V_{pp}; output voltage window:
 -1.0 to $+3.3$ V
 - $t_{rise/fall, 20\% \text{ to } 80\%} < 60$ ps
 - Differential output
- AC amplifier ¹—optimized to generate direct IF/RF signals
 - 50 MHz to 5 GHz bandwidth
 - Single ended, AC coupled output
 - Amplitude: 200 mV_{pp} to 2.0 V_{pp}

M8190A at a glance

- Precision AWG with two DAC settings
 - 14-bit vertical resolution up to 8 GSa/s sampling rate
 - 12-bit vertical resolution up to 12 GSa/s sampling rate
- Variable sample rate from 125 MSa/s to 8/12 GSa/s
- Spurious-free-dynamic range (SFDR) up to 80 dBc typical
- Harmonic distortion (HD) up to -72 dBc typ.
- Up to 2 GSa arbitrary waveform memory per channel with advanced sequencing
- Analog bandwidth 5 GHz per channel or IQ bandwidth 10 GHz per module
- 3-levels sequencing capabilities
- Digital up-conversion
- Turn-key bundled configuration including chassis and connectivity
- Form-factor: 2 U AXIe module, controlled via external PC or AXIe system controller
- Supported software Agilent Benchlink Waveform Editor, MATLAB, LABVIEW, Agilent Signal Studio (pulse builder and multitone ²), Agilent SystemVue, Agilent wideband waveform center

The M8190A Arbitrary Waveform Generator works with all leading software platforms



High Spectral Efficiency with the Agilent M8190A Arbitrary Waveform Generator

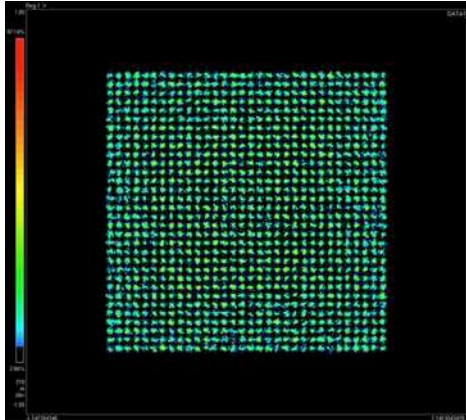

Optical 1024 QAM: 10 bits/Symbol in at 3 GSymbols/sec generated with the high precision M8190A AWG

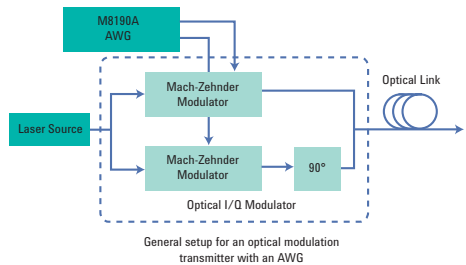

General setup for an optical modulation transmitter with an AWG

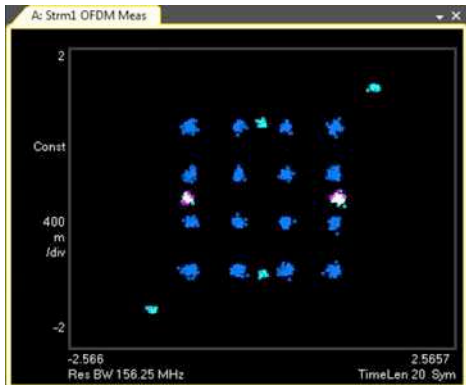

10 Gb/s OFDM Signal with 64 subcarriers generated with the high precision M8190A AWG

The never-ending demand for more data and for higher-speed data can be addressed either due to higher sampling rate/bandwidth or with higher modulation. High order modulations allow cramming more information into the same channel bandwidth but require a very precise and clean signal. With an optical 1024QAM modulation for example it is possible to generate 60 Gbit/s signal, the source is the M8190A a 14 bit arbitrary waveform generator. The signal quality results in up to 20 bit/s/Hz spectral efficiency in dual polarization coherent optical transmission.

Reaching higher spectral efficiency with higher order modulation schemes is one way to serve the broadband hunger by staying with the same infrastructure. Another method would be using a new technology of coding namely CO-OFDM. It stands for Coherent Optical – Orthogonal Frequency Division Multiplexing. This technology is already used for many years in the wireless communication domain and now enters the optical communication world. The main idea behind OFDM is using a numerous orthogonal subcarriers to encode and transmit the data. Each carrier is then complex modulated itself. Either a simple QPSK scheme can be used or higher-order QAM modulations.

Optical OFDM is particularly advantageous in PON networks. With it the bandwidth can be adjusted dynamically by client plus OFDM makes use of cost effective electronic devices instead of costly optical devices in the communication link.

Agilent B2901A/02A/11A/12A Precision Source/Measure Unit (SMU)

www.agilent.com/find/precisionSMU



The Agilent B2900A Series of Precision Source/Measure Units are compact and cost-effective bench-top Source/Measure Units (SMUs) with the capability to output and measure both voltage and current. An SMU combines the capabilities of a current source, a voltage source, current meter and a voltage meter along with the capability to switch easily between these various functions into a single instrument.

Best-in-class performance

The Agilent B2900A series of SMUs provide best-in-class performance at a lower price than ever before. They have broad voltage (210 V) and current (3 A DC and 10.5 A pulsed) sourcing capability, excellent precision (minimum 10 fA/100 nV sourcing and measuring resolution) and high measurement throughput. They also support an arbitrary waveform generation function. In addition, the Agilent B2900A series possess a superior graphical user interface with various viewing modes that dramatically improve test productivity, debug and characterization. The versatile integrated source and measurement capabilities of the Agilent B2900 series SMUs make them an ideal choice for testing semiconductors, active/passive components and a variety of other devices and materials.

Four models

The Agilent B2900A series consists of four models, the B2901A, B2902A, B2911A and B2912A, differentiated through their available features (number of digits displayed, measurement resolution, minimum timing interval, supported viewing modes, etc.) and by the number of SMU channels (one or two) they contain. This makes it easy to select the exact price/performance point to meet your testing needs.

Broad application range

The B2900 series has a broad application range that spans from R&D and education uses to industrial development, test and manufacturing. Moreover, they work equally well as either standalone or system components.

Key features & specifications

Measurement capabilities

- Supports one-channel (B2901A and B2911A) and two-channel (B2902A and B2912A) configurations
- Minimum source resolution: 10 fA/100 nV, minimum measurement resolution: 10 fA/100 nV (B2911A and B2912A)
- Minimum source resolution: 1 pA /1 μ V, minimum measurement resolution: 100 fA/100 nV (B2901A and B2902A)
- Maximum output: 210 V, 3 A DC/10.5 A pulse
- Arbitrary waveform generation and digitizing capabilities from 10 μ s (B2911A and B2912A) and 20 μ s (B2901A and B2902A) interval

General features

- Integrated 4-quadrant source and measurement capabilities
- The 4.3" color display supports both graphical and numerical view modes
- Free application software to facilitate PC-based instrument control
- High throughput and SCPI command supporting conventional SMU command set

Agilent B2961A/B2962A 6.5 Digit Low Noise Power Source

www.agilent.com/find/precisionSource



The B2961A/B2962A is a revolutionary power supply for precision low noise voltage/current sourcing that features 6.5 digit, 100 nV/10 fA resolution, 10 μ Vrms noise, bipolar 210 V/3 A (10.5 A pulse) range, innovative sourcing functions, and GUI (Graphical User Interface).

- The world's only 6.5 digit resolution power source with a bipolar sourcing range from 100 nV to 210 V and 10 fA to 3 A (DC)/10.5 A (pulsed)
- Optional ultra-low noise filters can reveal your device's true characteristics with low noise performance (10 μ Vrms from 10 Hz to 20 MHz, 1 nVrms/ $\sqrt{\text{Hz}}$ @10 kHz)
- Supports both pre-defined and user-defined arbitrary waveform generation (1 MHz to 10 kHz)
- Output voltage and current can be verified quickly using the built-in 4.5 digit voltage/current monitor
- Output voltage and current can be checked graphically on the 4.3" LCD front panel using the time-domain voltage/current waveform viewer
- Programmable output resistance feature enables the emulation of a wide variety of DC voltage and current characteristics, such as driver ICs, regulators, energy generating devices, etc.
- Free application software for easy PC-based instrument control
- LXI Core conformant, USB2.0, GPIB, LAN and digital I/O interface

The world's only 6.5 digit source with a bipolar range of 100 nV to 210 V and 10 fA to 10.5 A

The Agilent B2961A/B2962A Power Source has broad voltage (up to ± 210 V) and current (up to ± 3 A DC and ± 10.5 A pulsed) sourcing ranges and excellent 6.5 digit resolution (minimum 100 nV/10 fA program resolution). Unlike a typical power supply/source, it supports 4-quadrant operation that gives you the freedom to accurately and precisely supply any voltage or current contained within its ranges regardless of polarity.

Noise floor of 10 μ Vrms (1 nVrms / $\sqrt{\text{Hz}}$ @10 kHz) outperforms even linear power supplies

Low noise performance is required for the development of noise sensitive devices such as VCOs (voltage controlled oscillators), ADC/DAC, new material based components, etc. However, conventional power supplies and sources have not been able to achieve the noise level required for these applications. The Agilent B2961A/B2962A supports an optional external low noise filter that enables ultra-low noise performance down to 10 μ Vrms and 1 nVrms/ $\sqrt{\text{Hz}}$ (at 10 kHz), providing unparalleled low noise performance in a low-cost bench-top power source.

Innovative sourcing capabilities enable test and evaluation not possible with conventional power supplies and sources

The Agilent B2961A/B2962A supports a number of innovative sourcing capabilities for test and evaluation that are not available on conventional power supplies and sources. For example, the Agilent B2961A/B2962A has the ability to generate not only DC signals but also pulsed, swept and arbitrary waveforms (1 MHz to 10 kHz) in both voltage and current. Its arbitrary waveform generation capability supports common waveform types such as sine, ramp, square, etc. in addition to user-defined waveforms.

The Agilent B2961A/B2962A also supports an advanced programmable output resistance feature that allows you to specify either a particular output resistance or a specific voltage versus current source characteristic. This feature is ideal for emulating a wide variety of devices (such as batteries, photovoltaic cells, sensors, transducers, etc.) that are otherwise difficult to simulate.

Finally, the Agilent B2961A/B2962A has a 4.3 inch wide LCD and all of its capabilities are accessible from its front-panel graphical user interface (GUI). The graphical display not only simplifies user-operation, but it also facilitates viewing measurement results. With the built-in 4.5 digit voltage and current monitoring capability, you can check the output voltage or current graphically by the time domain voltage/current waveform viewer. This permits quick checking and debugging of measurement results without the need for additional equipment.



myAgilent

www.agilent.com/find/myagilent

A personalized view into the information most relevant to you.



www.axiestandard.org

AdvancedTCA® Extensions for Instrumentation and Test (AXIe) is an open standard that extends the AdvancedTCA for general purpose and semiconductor test. Agilent is a founding member of the AXIe consortium.



www.lxistandard.org

LAN eXTensions for Instruments puts the power of Ethernet and the Web inside your test systems. Agilent is a founding member of the LXI consortium.



Three-Year Warranty

www.agilent.com/find/ThreeYearWarranty

Beyond product specification, changing the ownership experience. Agilent is the only test and measurement company that offers three-year warranty on all instruments, worldwide.



Agilent Assurance Plans

www.agilent.com/find/AssurancePlans

Five years of protection and no budgetary surprises to ensure your instruments are operating to specifications and you can continually rely on accurate measurements.



www.agilent.com/quality

Agilent Electronic Measurement Group
DEKRA Certified ISO 9001:2008
Quality Management System

Agilent Channel Partners

www.agilent.com/find/channelpartners

Get the best of both worlds: Agilent's measurement expertise and product breadth, combined with channel partner convenience.

Related Literature:

Lightwave Catalog Volume 1:

General Photonic Test 5989-6753EN

Lightwave Catalog Volume 3:

Bit Error Ratio and Waveform Analysis

5991-1802EN

www.agilent.com

www.agilent.com/find/lightwave

For more information on Agilent Technologies' products, applications or services, please contact your local Agilent office. The complete list is available at:

www.agilent.com/find/contactus

Americas

Canada	(877) 894 4414
Brazil	(11) 4197 3600
Mexico	01800 5064 800
United States	(800) 829 4444

Asia Pacific

Australia	1 800 629 485
China	800 810 0189
Hong Kong	800 938 693
India	1 800 112 929
Japan	0120 (421) 345
Korea	080 769 0800
Malaysia	1 800 888 848
Singapore	1 800 375 8100
Taiwan	0800 047 866
Other AP Countries	(65) 375 8100

Europe & Middle East

Belgium	32 (0) 2 404 93 40
Denmark	45 45 80 12 15
Finland	358 (0) 10 855 2100
France	0825 010 700*
	*0.125 €/minute
Germany	49 (0) 7031 464 6333
Ireland	1890 924 204
Israel	972-3-9288-504/544
Italy	39 02 92 60 8484
Netherlands	31 (0) 20 547 2111
Spain	34 (91) 631 3300
Sweden	0200-88 22 55
United Kingdom	44 (0) 118 927 6201

For other unlisted countries:

www.agilent.com/find/contactus

Product specifications and descriptions in this document subject to change without notice.

© Agilent Technologies, Inc. 2014

Published in USA, March 24, 2014

5989-6754EN



Agilent Technologies