

NOTICE: This document contains references to Agilent Technologies. Agilent's former Test and Measurement business has become Keysight Technologies. For more information, go to www.keysight.com.



Agilent M9351A PXI Downconverter 50 MHz to 2.9 GHz



Startup Guide

Notices

© Agilent Technologies, Inc. 2010-2013

No part of this manual may be reproduced in any form or by any means (including electronic storage and retrieval or translation into a foreign language) without prior agreement and written consent from Agilent Technologies, Inc. as governed by United States and international copyright laws.

Manual Part Number

M9351-90001

Edition

January 2013. build 2013.01.17.1441

Printed in USA

Agilent Technologies, Inc.

Sales and Technical Support

To contact Agilent for sales and technical support, refer to the “support” links on the following Agilent web resources:

- www.agilent.com/find/M9351A (product-specific information and support, software and documentation updates)
- www.agilent.com/find/M9392A (product-specific information and support, software and documentation updates)
- www.agilent.com/find/assist (worldwide contact information for repair and service)

Information on preventing damage to your Agilent equipment can be found at www.agilent.com/find/tips.

Regulatory Compliance

This product has been designed and tested in accordance with accepted industry standards, and has been supplied in a safe condition. To review the Declaration of Conformity, go to <http://regulations.corporate.agilent.com/DoC/search.htm>.

Warranty

The material contained in this document is provided “as is,” and is subject to being changed, without notice, in future editions. Further, to the maximum extent permitted by applicable law, Agilent disclaims all warranties, either express or implied, with regard to this manual and any information contained herein, including but not limited to the implied warranties of merchantability and fitness for a particular purpose. Agilent shall not be liable for errors or for incidental or consequential damages in connection with the furnishing, use, or performance of this document or of any information contained herein. Should Agilent and the user have a separate written agreement with warranty terms covering the material in this document that conflict with these terms, the warranty terms in the separate agreement shall control.

Technology Licenses

The hardware and/or software described in this document are furnished under a license and may be used or copied only in accordance with the terms of such license.

Restricted Rights Legend

If software is for use in the performance of a U.S. Government prime contract or sub-contract, Software is delivered and licensed as “Commercial computer software” as defined in DFAR 252.227-7014 (June 1995), or as a “commercial item” as defined in FAR 2.101(a) or as “Restricted computer software” as defined in FAR 52.227-19 (June 1987) or any equivalent agency regulation or contract clause. Use, duplication or disclosure of Software is subject to Agilent Technologies’ standard commercial license terms, and non-DOD Departments and Agencies of the U.S. Government will receive no greater than Restricted Rights as defined in FAR 52.227-19(c)(1-2) (June 1987). U.S. Government users will receive no greater than Limited Rights as defined in FAR 52.227-14 (June 1987) or DFAR 252.227-7015 (b)(2) (November 1995), as applicable in any technical data.

Safety Notices

The following safety precautions should be observed before using this product and any associated instrumentation.

This product is intended for use by qualified personnel who recognize shock hazards and are familiar with the safety precautions required to avoid possible injury. Read and follow all installation, operation, and maintenance information carefully before using the product.

WARNING

If this product is not used as specified, the protection provided by the equipment could be impaired. This product must be used in a normal condition (in which all means for protection are intact) only.

The types of product users are:

- **Responsible body** is the individual or group responsible for the use and maintenance of equipment, for ensuring that the equipment is operated within its specifications and operating limits, and for ensuring operators are adequately trained.
- **Operators** use the product for its intended function. They must be trained in electrical safety procedures and proper use of the instrument. They must be protected from electric shock and contact with hazardous live circuits.
- **Maintenance personnel** perform routine procedures on the product to keep it operating properly (for example, setting the line voltage or replacing consumable materials). Maintenance procedures are described in the user documentation. The procedures explicitly state if the operator may perform them. Otherwise, they should be performed only by service personnel.
- **Service personnel** are trained to work on live circuits, perform safe installations, and repair products. Only properly trained service personnel may perform installation and service procedures.

Agilent products are designed for use with electrical signals that are rated Measurement Category I and Measurement Category II, as described in the International Electrotechnical Commission (IEC) Standard IEC 60664. Most measurement, control, and data I/O signals are Measurement Category I and must not be directly connected to mains voltage or to voltage sources with high transient over-voltages. Measurement Category II connections require protection for high transient over-voltages often associated with local AC mains connections. Assume all measurement, control, and data I/O connections are for connection to Category I sources unless otherwise marked or described in the user documentation.

Exercise extreme caution when a shock hazard is present. Lethal voltage may be present on cable connector jacks or test fixtures. The American National Standards Institute (ANSI) states that a shock hazard exists when voltage levels greater than 30V RMS, 42.4V peak, or 60VDC are present. A good safety practice is to expect that hazardous voltage is present in any unknown circuit before measuring.

Operators of this product must be protected from electric shock at all times. The responsible body must ensure that operators are prevented access and/or insulated from every connection point. In some cases, connections must be exposed to potential human contact. Product operators in these circumstances must be trained to protect themselves from the risk of electric shock. If the circuit is capable of operating at or above 1000V, no conductive part of the circuit may be exposed.

Do not connect switching cards directly to unlimited power circuits. They are intended to be used with impedance-limited sources. NEVER connect switching cards directly to AC mains. When connecting sources to switching cards, install protective devices to limit fault current and voltage to the card.

Before operating an instrument, ensure that the line cord is connected to a properly-grounded power receptacle. Inspect the connecting cables, test leads, and jumpers for

possible wear, cracks, or breaks before each use.

When installing equipment where access to the main power cord is restricted, such as rack mounting, a separate main input power disconnect device must be provided in close proximity to the equipment and within easy reach of the operator.

For maximum safety, do not touch the product, test cables, or any other instruments while power is applied to the circuit under test. ALWAYS remove power from the entire test system and discharge any capacitors before: connecting or disconnecting cables or jumpers, installing or removing switching cards, or making internal changes, such as installing or removing jumpers.

Do not touch any object that could provide a current path to the common side of the circuit under test or power line (earth) ground. Always make measurements with dry hands while standing on a dry, insulated surface capable of withstanding the voltage being measured.

The instrument and accessories must be used in accordance with its specifications and operating instructions, or the safety of the equipment may be impaired.

Do not exceed the maximum signal levels of the instruments and accessories, as defined in the specifications and operating information, and as shown on the instrument or test fixture panels, or switching card.

When fuses are used in a product, replace with the same type and rating for continued protection against fire hazard.

Chassis connections must only be used as shield connections for measuring circuits, NOT as safety earth ground connections.

If you are using a test fixture, keep the lid closed while power is applied to the device under test. Safe operation requires the use of a lid interlock.

CAUTION

A **CAUTION** notice denotes a hazard. It calls attention to an operating procedure, practice, or the like that, if not correctly performed or adhered to, could result in damage to the product or loss of important data. Do not proceed beyond a **CAUTION** notice until the indicated conditions are fully understood and met.

WARNING

A **WARNING** notice denotes a hazard. It calls attention to an operating procedure, practice, or the like that, if not correctly performed or adhered to, could result in personal injury or death. Do not proceed beyond a **WARNING** notice until the indicated conditions are fully understood and met.

Instrumentation and accessories shall not be connected to humans.

Before performing any maintenance, disconnect the line cord and all test cables.

To maintain protection from electric shock and fire, replacement components in mains circuits – including the power transformer, test leads, and input jacks – must be purchased from Agilent. Standard fuses with applicable national safety approvals may be used if the rating and type are the same. Other components that are not safety-related may be purchased from other suppliers as long as they are equivalent to the original component (note that selected parts should be purchased only through Agilent to maintain accuracy and functionality of the product). If you are unsure about the applicability of a replacement component, call an Agilent office for information.

WARNING

No operator serviceable parts inside. Refer servicing to qualified personnel. To prevent electrical shock do not remove covers. For continued protection against fire hazard, replace fuse with same type and rating.

PRODUCT MARKINGS:



The CE mark is a registered trademark of the European Community.



The C-Tick mark is a registered trademark of the Australian Spectrum Management Agency.

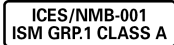

This symbol indicates product compliance with the Canadian Interference-Causing Equipment Standard (ICES-001). It also identifies the product is an Industrial Scientific and Medical Group 1 Class A product (CISPR 11, Clause 4).



This symbol indicates separate collection for electrical and electronic equipment, mandated under EU law as of August 13, 2005. All electric and electronic equipment are required to be separated from normal waste for disposal (Reference WEEE Directive, 2002/96/EC).



This symbol on an instrument means caution, risk of danger. You should refer to the operating instructions located in the user documentation in all cases where the symbol is marked on the instrument.



This symbol indicates the time period during which no hazardous or toxic substance elements are expected to leak or deteriorate during normal use. Forty years is the expected useful life of the product.



This symbol indicates the instrument is sensitive to electrostatic discharge (ESD). ESD can damage the highly sensitive components in your instrument. ESD damage is most likely to occur as the module is being installed or when cables are connected or disconnected. Protect the circuits from ESD damage by wearing a grounding strap that provides a high resistance path to ground. Alternatively, ground yourself to discharge any built-up static charge by touching the outer shell of any grounded instrument chassis before touching the port connectors.

CLEANING PRECAUTIONS:

WARNING

To prevent electrical shock, disconnect the Agilent Technologies instrument from mains before cleaning. Use a dry cloth or one slightly dampened with water to clean the external case parts. Do not attempt to clean internally. To clean the connectors, use alcohol in a well-ventilated area. Allow all residual alcohol moisture to evaporate, and the fumes to dissipate prior to energizing the instrument.

Table of Contents

Documentation Map	7
M9351A Introduction	8
Related Documentation	8
Follow the Startup Sequence	8
Step 1: Unpack and Inspect the Module	9
ESD	9
Inspect for Damage	9
Return a Module for Service	9
Step 2: Verify M9351A Shipment Contents	10
Step 3: Install the Software	10
System Requirements	10
Hardware Requirements	11
Power up the Controller	11
Software Installation Overview	11
Software Installation Procedure	12
Step 4: Install the Module	13
Recommended Practices for Temperature Control	13
Module Installation Procedure	13
Agilent M9351A PXI Downconverter Front Panel Features	15
Front Panel Connectors	15
Front Panel LEDs	15
Agilent M9351A PXI Downconverter System Connections	16
Agilent M9392A PXI Vector Signal Analyzer Cabling Diagram	16
Agilent M9351A Block Diagram	17
Step 5 Verify Operation of the M9351A Module	17
Conduct M9351A Self Test	18
Conduct M9351A Operational Check (optional)	18
Step 6: Installation is Complete	21
API Overview	21
IVI Drivers	21
LabVIEW Driver	21
M9351A Specifications	21

Documentation Map

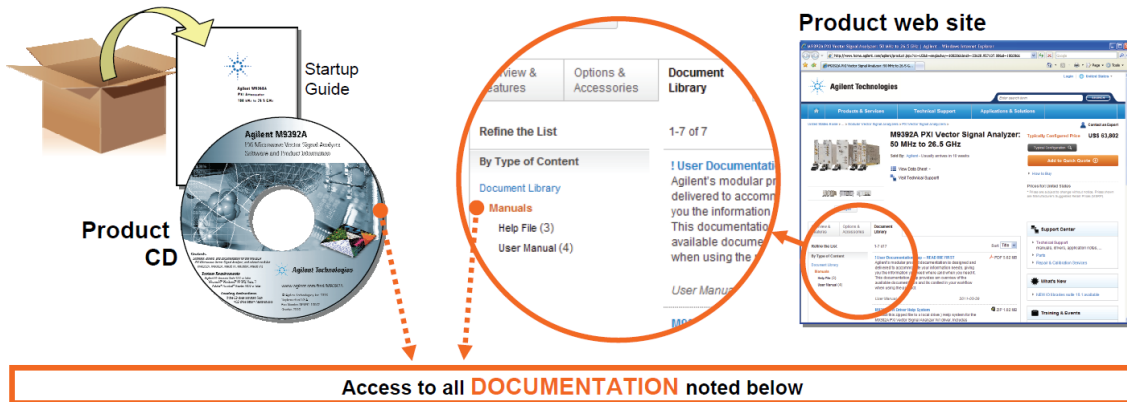

Startup Guide



- Unpack product
- Verify shipment
- Install software
- Install hardware
- Verify operation
- Troubleshooting

Data Sheet



- Product description
- Technical specifications

Soft Front Panel (SFP) user interface

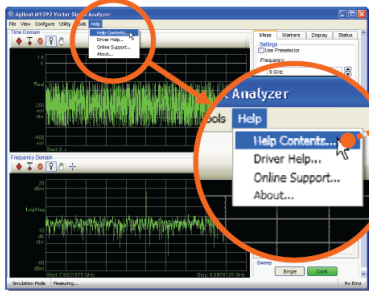

SFP help system

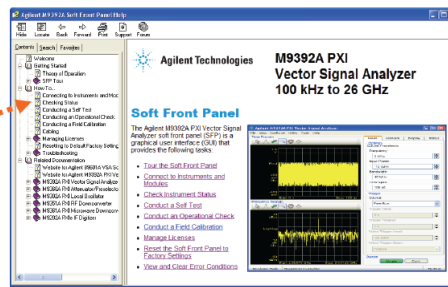

- Theory of operation
- Block diagram
- Configuration
- Self test
- Operational check
- Field calibration
- Troubleshooting

Visual Studio

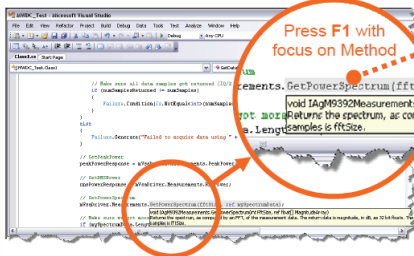

IVI Driver help system

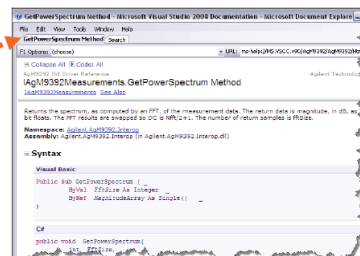

- IVI-COM and IVI-C driver programmer's reference
- Sample programs

LabVIEW

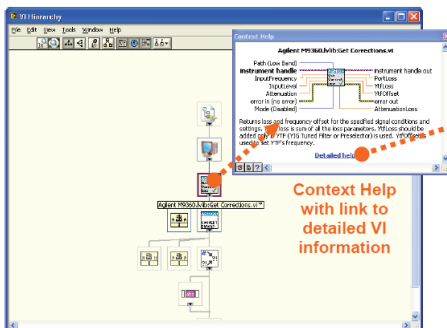

LabVIEW Driver help system

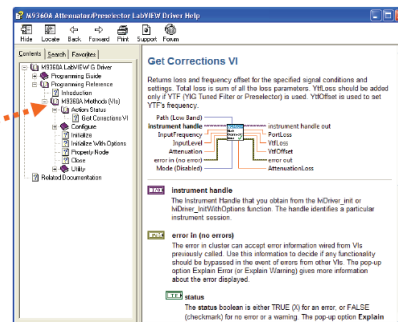

- LabVIEW driver programmer's reference
- Sample programs

M9351A Introduction

The scope of this Startup Guide is to detail the processes of receiving and installing the Agilent M9351A PXI Downconverter, installing the required software, and verifying basic module operation. If you have any questions after reviewing this information, please contact your local Agilent Technologies Inc. representative or contact us through our website at www.agilent.com/find/M9351A.

Related Documentation

This Startup Guide and the documentation listed below are on the CD and at www.agilent.com/find/M9351A (go to **Document Library** > **Manuals**).

- M9351A Soft Front Panel help system
- M9351A device driver API help systems (IVI-C/IVI-COM and LabVIEW G)
- M9351A specifications (Data Sheet)

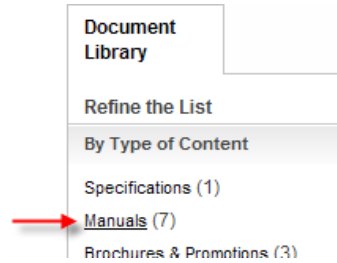

Follow the Startup Sequence

WARNING Closely follow the startup process flow in this document. Deviating from the sequence can cause unpredictable system behavior, damage your system, and may cause personal injury.

Step 1: Unpack and Inspect



Step 2: Verify Shipment



Step 3: Install Drivers and Software

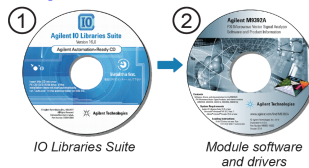

Step 4: Install Module

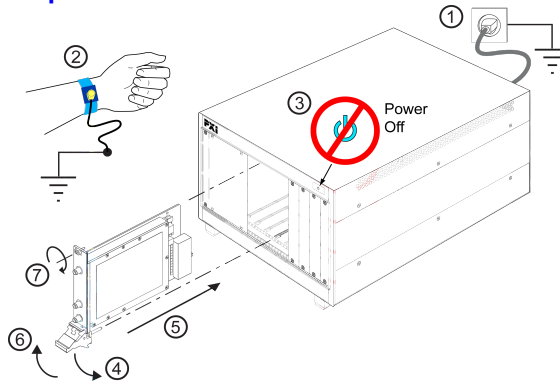

Step 5: Verify Operation with the Soft Front Panel (SFP)



Step 6: INSTALLATION PROCESS COMPLETE.
Proceed to program your product through the API.

Step 1: Unpack and Inspect the Module

CAUTION

The module is shipped in materials which prevent damage from static. The module should only be removed from the packaging in an anti-static area ensuring that correct anti-static precautions are taken. Store all modules in anti-static envelopes when not in use.

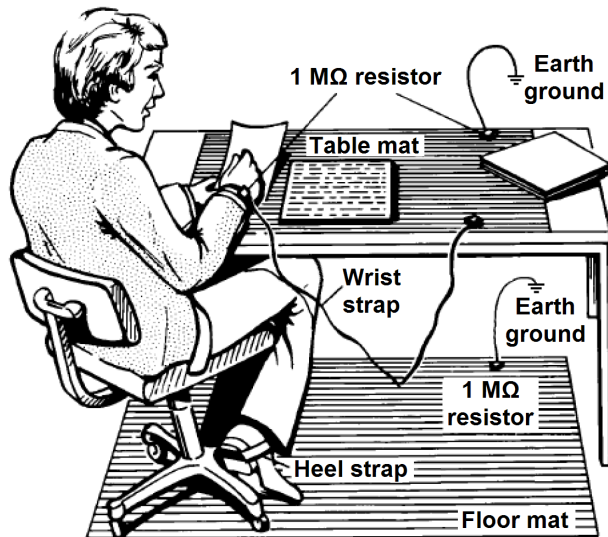
ESD

Electrostatic discharge (ESD) can damage or destroy electronic components. Use a static-safe work station to perform all work on electronic assemblies. The figure (left) shows a static-safe work station using two types of ESD protection: conductive table-mat and wrist-strap combination, and conductive floor-mat and heel-strap combination. Both types, when used together, provide a significant level of ESD protection. Of the two, only the table-mat and wrist-strap combination provides adequate ESD protection when used alone. To ensure user safety, the static-safe accessories must provide at least 1 MΩ of isolation from ground.

WARNING

DO NOT use these techniques for a static-safe work station when working on circuitry with a voltage potential greater than 500 volts.

Inspect for Damage

After unpacking a module, inspect it for any shipping damage. Report any damage to the shipping agent immediately, as such damage is not covered by the warranty (see warranty information at beginning of this document).

CAUTION

To avoid damage when handling a module, do not touch exposed connector pins.

NOTE

See www.agilent.com/find/tips for information on preventing damage to your Agilent equipment.

Return a Module for Service

Should it become necessary to return a module for repair or service, follow the steps below:

1. Review the warranty information shipped with your product.
2. Contact Agilent to obtain a Return Material Authorization (RMA) and return address. For assistance finding Agilent contact information, go to www.agilent.com/find/assist (worldwide contact information for repair and service) or refer to the “Support” information on the product web page at www.agilent.com/find/M9351A.
3. Write the following information on a tag and attach it to the malfunctioning equipment:
 - Name and address of owner. A P.O. box is not acceptable as a return address.
 - Module serial number(s). The serial number label is located on the side panel of the module. The serial number can also be read from the Soft Front Panel interface – after the hardware is installed.
 - Description of failure or service required.

Step 2: Verify M9351A Shipment Contents

4. Pack the module in its original ESD bag and packing carton. If the original carton is not available, use bubble wrap or packing peanuts and place the instrument in a sealed container and mark the container “FRAGILE”.
5. On the shipping label, write ATTENTION REPAIR DEPARTMENT and the RMA number.

NOTE

If any correspondence is required, refer to the product by serial number and model number.

Step 2: Verify M9351A Shipment Contents

The following items are included with your Agilent M9351A PXI Downconverter order:

- Agilent M9392A PXI Vector Signal Analyzer Software and Product Information CD. It contains software, drivers and all product printed documentation in PDF format. The part number for this CD is M9392-10002
- Agilent IO Libraries Suite CD. The part number for this CD is E2094-60003.
- Agilent M9351A PXI Downconverter Startup Guide in hard copy (M9351-90001)
- Calibration certificate
- Commercial calibration certificate with test data (M9351-UK6) if ordered.
- Cable, semi-rigid, A2 (M9351-20001)
- Cable, semi-rigid, A5 (M9351-20002)
- Cable, coaxial, SMB/SMB, 190 mm, B1 (8120-5016)
- Cable, coaxial SMB/SMB, 75 mm, B2 (8121-2072)

NOTE

All the files contained on the CDs are available for download at www.agilent.com/find/M9351A.

Step 3: Install the Software

System Requirements

Topic	Windows® 7 and Vista Requirements	Windows® XP Requirements
Operating system	Windows 7 (32 bit and 64 bit); Windows® Vista, SP1 and SP2 (32-bit and 64-bit)	Window® XP, Service Pack 3
Processor speed	1 GHz 32-bit (x86), 1 GHz 64-bit (x64), no support for Itanium64	600 MHz or higher required 800 MHz recommended
Available memory	1 GB minimum	256 MB minimum (1 GB or greater recommended)
Available disk space	1.5 GB available hard disk space, includes: <ul style="list-style-type: none">• 1 GB available for Microsoft .NET Framework 3.5 SP1 ²• 100 MB for Agilent IO Libraries Suite	
Video	Support for DirectX 9 graphics with 128 MB graphics memory recommended (Super VGA graphics is supported)	Super VGA (800x600) 256 colors or more
Browser	Microsoft® Internet Explorer 7.0 or greater	Microsoft® Internet Explorer 6.0 or greater

¹ This is the required disk space for installation. Typically, less disk space is required for operation than is required for installation.

² .NET Framework Runtime Components are installed by default with Windows 7 and Vista. Therefore, you may not need this amount of disk space.

Hardware Requirements

Topic	Requirements
Chassis	cPCI(J1), PXI-1, or PXIe hybrid chassis slot
Host controller	A PXI or PXI Express embedded controller or remote controller (external PC connected to the chassis by a PCI-to-PXI interface) is required.
Embedded controller	Agilent M9036A or an embedded controller that meets the following requirements: <ul style="list-style-type: none"> • PXIe system controller (PXI-1 embedded controllers are not compatible) • Utilize a 2x8, 4x4, or 1x4 PXIe system slot link configuration. • Run one of the operating systems listed in System Requirements (above).
Remote controller	(for Agilent M9018A chassis use only) Agilent M9021 Cable Interface x8 with one of the following PC interface options: <ul style="list-style-type: none"> • Agilent M9045B PCIe ExpressCard Adaptor x1, with cable (for a laptop PC) • Agilent M9048A PCIe Desktop Adaptor x8, with cable (for desktop PCs) Or an equivalent remote controller using a PC running one of the operating systems listed in System Requirements (above).

Power up the Controller

CAUTION

If you are using a remote controller and you have installed the interface cable, you must power up the chassis **BEFORE** you power up the PC. When you power down your chassis, Shut Down the PC **BEFORE** you power down the chassis.

If you are using an embedded controller, complete the following steps:

1. Install the embedded controller module into the compatible chassis. The Agilent M9036A PXIe Embedded Controller and Agilent M9018A PXIe Chassis are recommended. Please refer to the embedded controller and chassis documentation for further details.
2. Connect peripherals (mouse, keyboard, monitor).
3. Power up the chassis.

Software Installation Overview

This installation includes the following:

- Agilent IO Libraries Suite (IOLS), which includes the Agilent Connections Expert. This software is included with your shipment (CD part number E2094-60003), and is also available at www.agilent.com/find/iosuite. This software must be installed first.

NOTE

Version 16.3.16603.3 (or newer) of the Agilent IO Libraries Suite is required.

- Instrument software, which includes the SFP, device drivers (IVI-C, IVI-COM, and LabVIEW G) and documentation for the M9392A Vector Signal Analyzer. This software is included with your shipment (CD part number M9392-10002), and is also available at www.agilent.com/find/M9392A.

Step 3: Install the Software

Software Installation Procedure

1. Install the Agilent IO Libraries Suite from the Agilent IO Libraries Suite CD (E2094-60003) provided in your ship kit. Follow the installer prompts to install the IO libraries.
2. Install the M9351A product software:
 - a. Using the Agilent M9392A PXI Vector Signal Analyzer Software and Product Information CD (M9392-10002), launch the installer.
 - b. Follow the installer prompts. Choose a "Complete" installation to install all software and documentation, or a "Custom" installation to select from a listing of modules and other features.

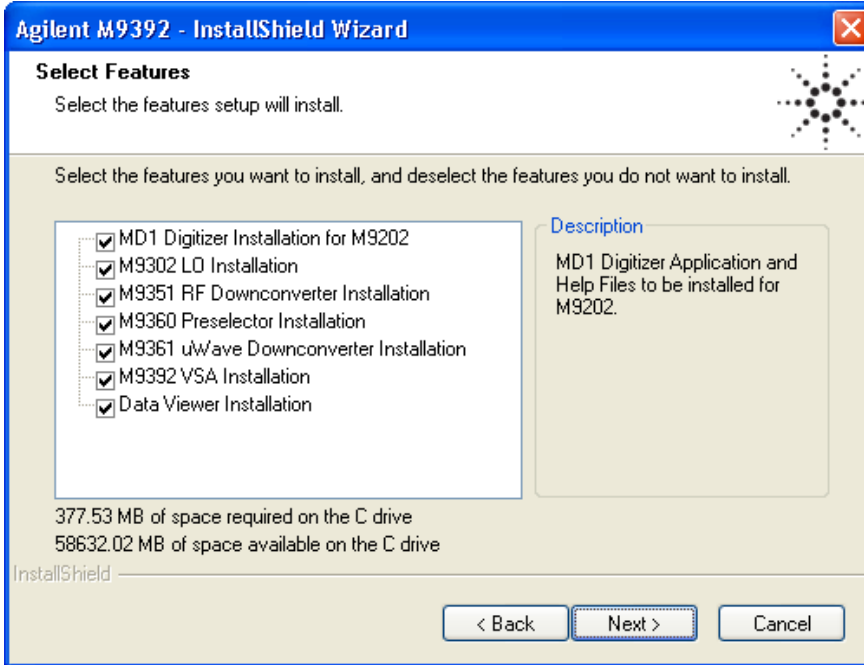

3. Power down the host PC.

CAUTION

If you are using a remote controller, Shut Down the PC **BEFORE** you power down the chassis. When you restore power, power up the chassis **BEFORE** you power up the PC.

Step 4: Install the Module

CAUTION

PXI hardware does not support "hot-swap" (changing modules while power is applied to the chassis) capabilities. Before installing or removing a module to/from the chassis, power off the chassis to prevent damage to the module.

NOTE

This module can be used in a chassis with cPCI(J1), PXI-1, or PXIe hybrid slots.

Recommended Practices for Temperature Control

- Use slot blockers and EMC filler panels in empty module slots to assure proper operating temperatures.
- At ambient temperatures above 45° C (113° F) set the chassis fan to High.
- The use of an Agilent M9018A Chassis and slot blockers optimizes module temperature performance.

Module Installation Procedure

3

The module can be installed in any standard PXI slot marked with a peripheral slot compatibility image (a circle containing the slot number).

7^H

The module can also be installed in any hybrid PXI slot marked with a peripheral slot compatibility image (the letter "H" and a solid circle containing the slot number).

1. Make sure that the line cord is plugged in to establish earth ground and that the chassis power switch is Off.
2. If the chassis has multiple fan speed settings, ensure that the fan switch is set to **AUTO**.
3. Position the chassis to provide ample space between the chassis fan intake and exhaust vents. Blockage by walls or obstructions affects the air flow needed for cooling. (Refer to the chassis documentation for more information about cooling).
4. Before inserting the module into the chassis, back the mounting screws out to ensure that there is no interference between the screws and the mounting rails.
5. Holding the module by the injector/ejector handle, slide it into an available PXI (or hybrid) slot, as shown in the figure below.

Step 4: Install the Module

- a. Install the module into the slot of the chassis by placing the module card edges into the front module guides (top and bottom).
- b. Slide the module to the rear of the chassis and ensure that the injector/ejector handle is pushed down in the unlatched (downward) position.
- c. Slide the module completely into the chassis. When you begin to feel resistance, pull up on the injector/ejector handle to fully inject the module into the chassis.

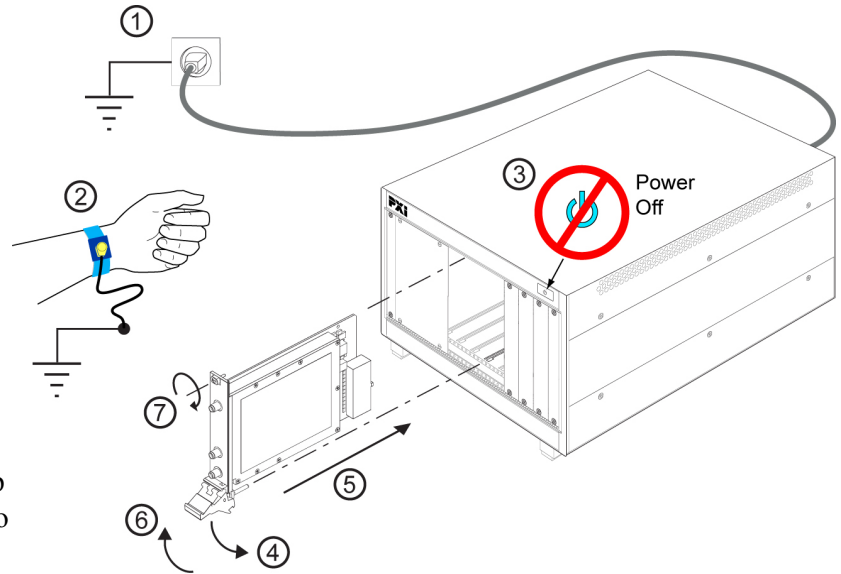

7. Secure the front panel to the chassis using the two module front-panel mounting screws. Performance may suffer if the screws are not tightened properly.
8. Verify that the PXI chassis fans are operable and free of dust and other contaminants that may restrict airflow.
9. Install filler panels and slot blockers after installing the module. Missing filler panels or slot blockers may disrupt air circulation in the chassis.
10. Use the Cabling Diagram plus the Cable and Module Table on the next page to attach the cables to the instrument. The torque specification for SMA connectors is 8 Lb-In (0.904 Nm).
11. If you are using a PCIe Cable Interface, such as the Agilent M9021, connect the Cable Interface in the chassis to the PC host per the instructions that came with the Cable Interface.
12. Power up the PXI chassis.
13. Reboot the PC host.

Agilent M9351A PXI Downconverter Front Panel Features

CAUTION

The maximum input to the RF input connector (RF IN) must not exceed +10 dBm.

CAUTION

When using an Agilent M9360A PXI Attenuator/Preselector with an M9351A, caution must be exercised. Although the M9360A can accept an input power level of +10 dBm without damage, the operating range of the M9351A is -30 dBm to -160 dBm. Attenuation is required so that the power out of the M9360A does not exceed the maximum power that can be applied to the M9351A RF IN connector.



Front Panel Connectors

Connector	Description
RF IN	This SMA female connector inputs an RF signal (50 MHz to 2.0 GHz) from the M9360A to be downconverted. The operating range is -30 dBm to -160 dBm. Damage occurs above +10 dBm.
LO IN	This SMA female connector receives the LO signal from the M9360A. This LO signal is used to downconvert the RF signal that is input to the RF IN connector and produces a 500 MHz IF OUT.
REF IN 100 MHz	This SMB male connector supplies a 100 MHz reference signal from the M9302A. This 100 MHz signal is phase-coherent with the 10 MHz reference being used.
VIDEO OUT	This SMB male connector is used to deliver the video output signal. This video output is a DC level which is representative of the total signal power contained within the IF passband of the instrument.
IF OUT	This SMB male connector is used to output an IF signal to the AUX IN connector of the M9361A. This IF signal can be 100 kHz to 500 MHz when an IF signal is supplied through the RF IN connector and bypass mode is selected, thereby bypassing the downconversion circuitry. When the downconversion circuitry is used, a 500 MHz signal is output.

Front Panel LEDs

LED	Description
STATUS	<p>This LED indicates the overall health of the M9351A and is a summary of the following LEDs, covering the power supplies and other hardware operations. The M9351A has extensive built-in-tests (BIT) and specific issues can be identified by observing the status indicators on the front panel. This LED has four possible states:</p> <ul style="list-style-type: none"> • Green = Power supplies and all module hardware are operational. • Amber = Power supplies are good, but there is a hardware failure. • Red = Power supply failure and a hardware failure or: <ul style="list-style-type: none"> ◦ Frequency is ≥ 2.75 GHz. ◦ M9351A LO IN is disconnected. ◦ M9360A LO IN is disconnected. ◦ 100 MHz REF IN is disconnected. • Off = Power supply failure, other module hardware appears functional. Since a power supply failure can mask other hardware problems, this is not an indication that only a power supply could be faulty.
ACCESS	Each time the module is written to, or read from, this amber LED blinks.

NOTE

The front panel LED behavior is valid only when the SFP is running or when the `Initialize` function/method has been called, using the application programming interface (API).

Step 4: Install the Module

Agilent M9351A PXI Downconverter System Connections

This section contains a cabling diagram for the M9392A PXI Vector Signal Analyzer, a cable and module association table, and a block diagram for the M9351A.

Agilent M9392A PXI Vector Signal Analyzer Cabling Diagram

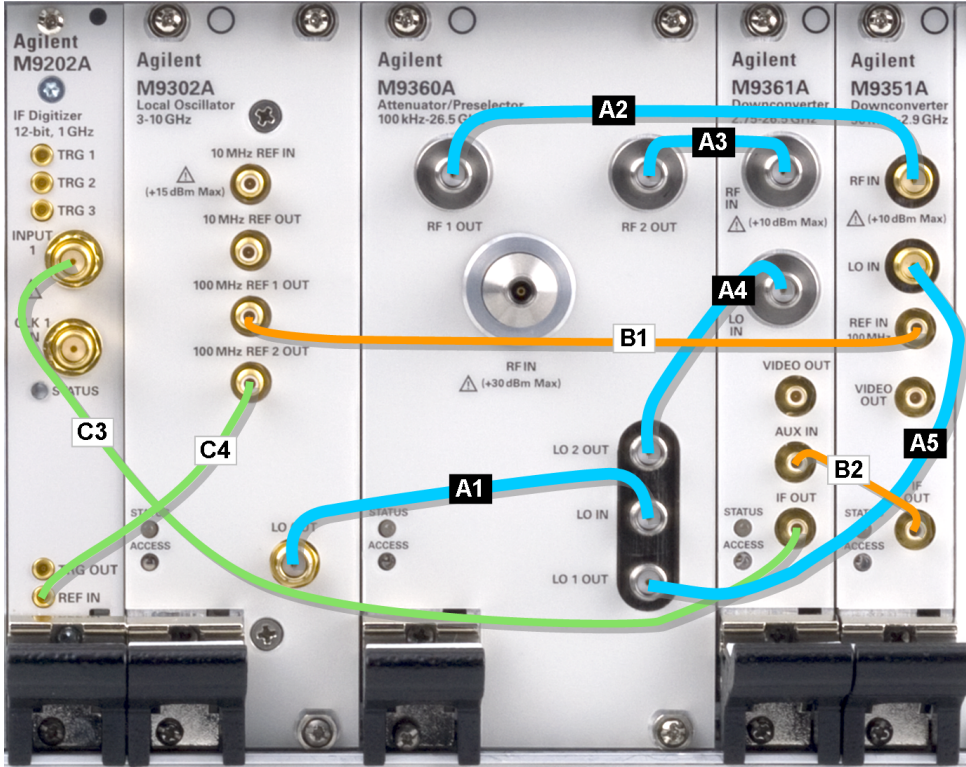

Cable and Module Table

Ships with Module	Ref Des	Agilent Part Number	Connection	Cable Description
M9360A	A1	M9360-20001	M9302A LO OUT – M9360A LO IN	Cable, semi-rigid, Master LO (SMA-SMA)
M9351A	A2	M9351-20001	M9360A RF 1 OUT – M9351A RF IN	Cable, semi-rigid (SMA-SMA)
M9361A	A3	M9361-20001	M9360A RF 2 OUT – M9361A RF IN	Cable, semi-rigid (SMA-SMA)
M9361A	A4	M9361-20002	M9360A LO 2 OUT – M9361A LO IN	Cable, semi-rigid (SMA-SMA)
M9351A	A5	M9351-20002	M9360A LO 1 OUT – M9351A LO IN	Cable, semi-rigid (SMA-SMA)
M9351A	B1	8120-5016	M9351A REF IN – M9302A REF 1 OUT	Cable, coaxial, SMB-SMB (160 mm)
M9351A	B2	8121-2072	M9351A IF OUT – M9361A AUX IN	Cable, coaxial, SMB-SMB (75 mm)
M9202A	C3	8120-5531	M9361A IF OUT – M9202A INPUT 1	Cable, SMB - SMA coaxial (190 mm)
M9202A	C4	8121-2042	M9302A REF 2 OUT – M9202A REF IN	Cable, A06/A32 80G (SMB-MMCX)
M9202A	*	8121-2041	n/a	Cable, A06/A32 190G (SMB-MMCX)
M9202A	*	8121-2041	n/a	Cable, A06/A32 190G (SMB-MMCX)

Torque specification for all SMA connectors is 8 Lb-In (0.904 Nm).

* These cables are not required to configure an Agilent M9392A PXI Vector Signal Analyzer. See the Agilent M9392A PXI Vector Signal Analyzer Cabling Diagram above. These cables are provided for using the Agilent M9202A PXI IF Digitizer in other applications.

No cables are shipped with the Agilent M9302A PXI Local Oscillator module.

Agilent M9351A Block Diagram

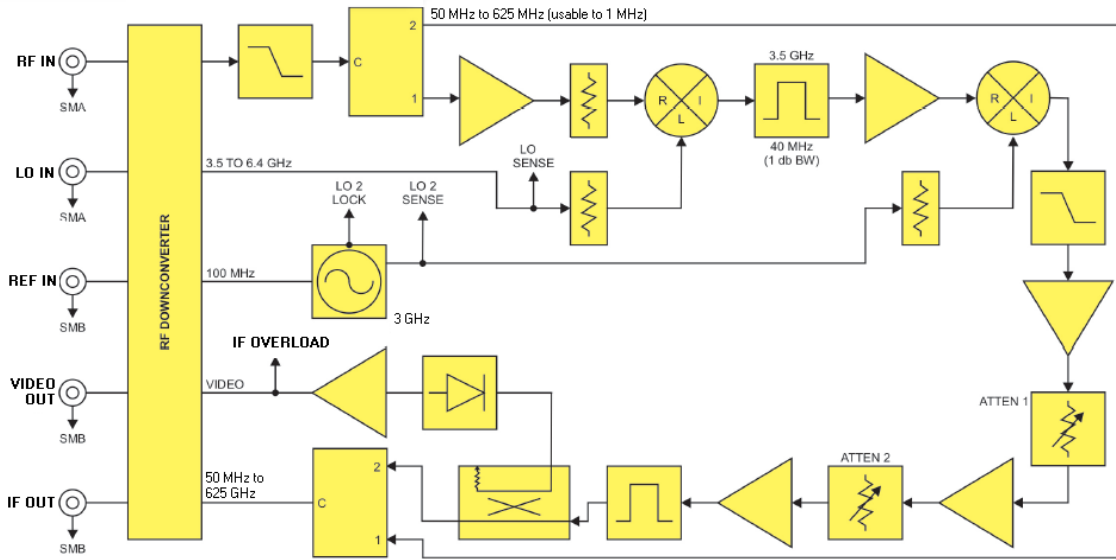

Step 5 Verify Operation of the M9351A Module

The intention of this step is to verify correct operation of the newly installed module. Run Agilent Connection Expert (from the desktop icon, or from **Start > Programs > Agilent IO Libraries Suite > Agilent Connection Expert**). It will display the modules that are installed. Review the configuration data and then launch the SFP. This will provide control of the module for self test and other operational verification procedures.

Agilent M9351A Instrument Properties

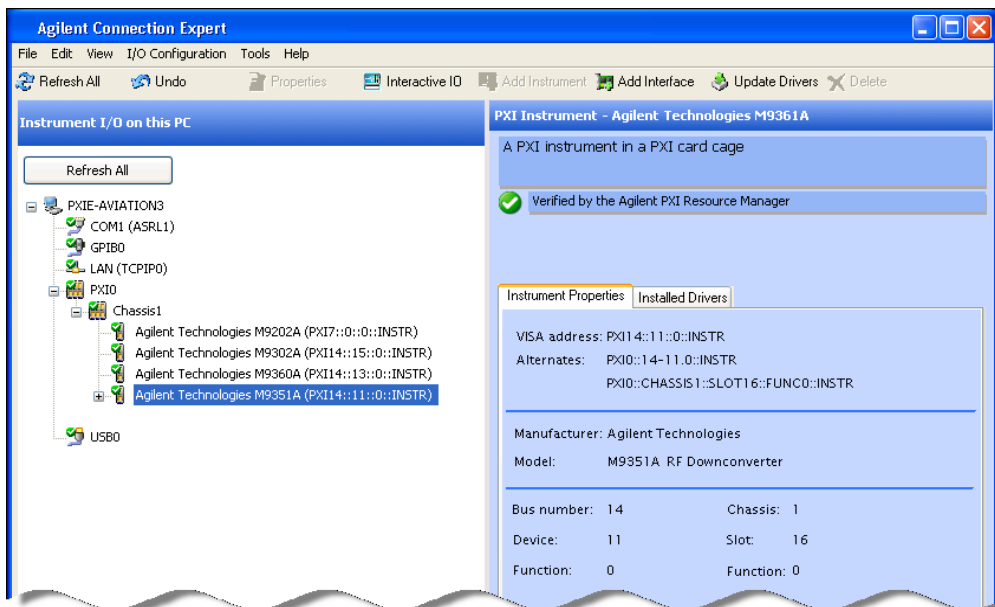

NOTE If the module does not appear in the Agilent Connection Expert, restart your PC or embedded controller and start Agilent Connection Expert again.

Step 5 Verify Operation of the M9351A Module

Agilent M9351A Installed Drivers

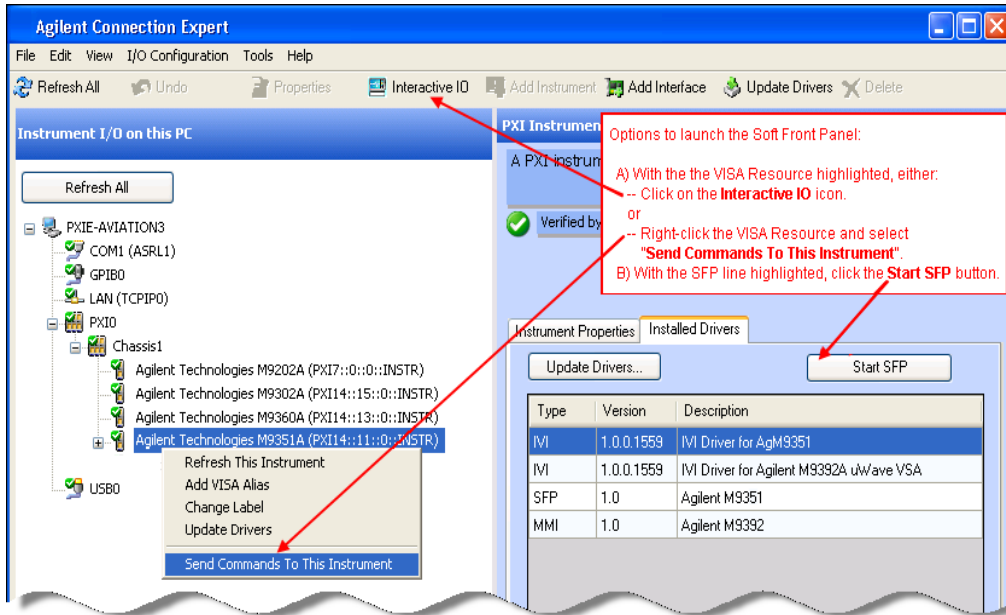

Conduct M9351A Self Test

The purpose of the self test is to verify power and perform an internal check of module sub-components.

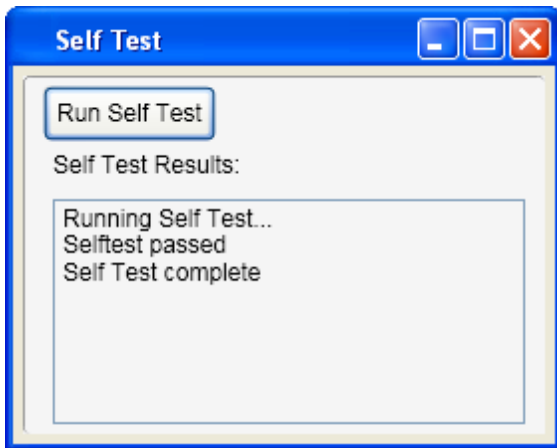

Conduct M9351A Operational Check (optional)

Requirements for Operational Check

The Agilent M9351A PXI Downconverter operational check measures the signal paths from the LO IN and RF IN connectors to the IF OUT connector. The following process verifies that all associated switches, connectors, cables and circuitry are operational.

Required Hardware

To verify that the module functions requires external equipment. This includes a precision microwave source and a power meter. You will not be using the module interconnect cables, so some high-quality flexible 3.5 mm cables will be required, plus adaptors to connect the PSG (precision signal generator) and power meter to 3.5 mm connectors. Please refer to the following table for recommended hardware.

Hardware	Description
Agilent E8257D-532 or E8267D-532	Precision Signal Generator 31.8 GHz
Agilent N1913A or N1914A	Single / Dual Channel Power Meter
Agilent N8485A, Option 100	10 MHz to 26.5 GHz Power Sensor
Agilent 11730A	Power Sensor Cable

M9351A Operational Check Procedure

NOTE

First run the Agilent M9302A PXI Local Oscillator operational check to ensure that it is operating correctly.

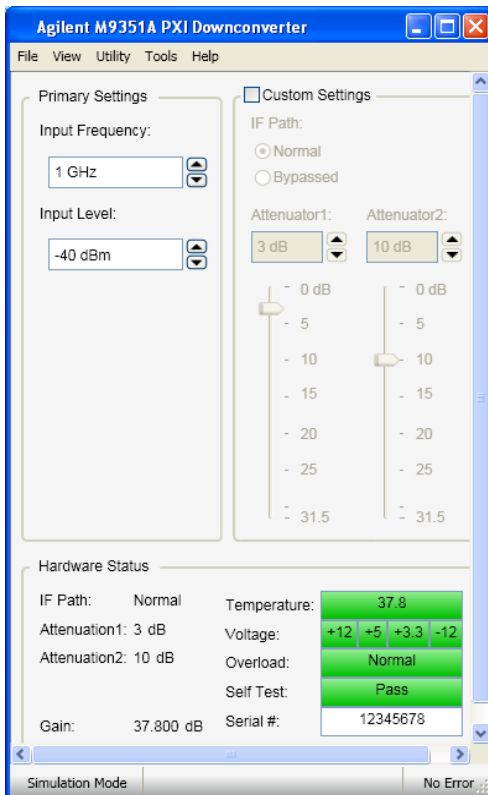

CAUTION

Make sure that the IF OUT connector of the M9351A is not routed to the AUX IN connector of the Agilent M9361A PXI Downconverter.

1. Run the M9351A soft front panel (SFP).
2. Conduct a Self Test (**Utility > Self Test... > Run Self Test**).
 - a. If self test passes, go to next step.
 - b. If the self test fails, check to see if the failure is due to a missing connection. If an M9302A LO and 100 MHz reference signals are not present, the STATUS LED will be red and self test will report "Internal LO sense not present" and/or "Internal LO not locked". If the problem is not a missing connection, the module needs repair. See "[Return a Module for Service](#)" on page 9.
3. If connected, remove the IF OUT cable going to the M9361A AUX IN.
4. Connect the M9302A LO OUT to the LO IN connector of the M9351A downconverter.
5. M9302A LO setup

Step 5 Verify Operation of the M9351A Module

- a. Connect the M9302A 100 MHz REF 1 OUT to the M9351A REF IN 100 MHz.
 - b. Connect the M9302A LO OUT to the M9351A LO IN.
 - c. Using the M9302A SFP set the LO frequency to 5.50 GHz.
6. PSG setup:
- a. Connect the PSG RF Out to the M9351A RF IN.
 - b. Set the frequency to 2 GHz (3.50 GHz below the M9302A LO frequency).
 - c. Set the amplitude to -40 dBm
7. Connect a power meter to the M9351A IF OUT. The power should be between 0 dBm and -5 dBm.
8. On the M9351A SFP:
- a. Under Primary Settings set the Input Frequency to 400 MHz.
 - b. Select Custom Settings and select Bypassed.
9. Set the PSG:
- a. Frequency to 400 MHz
 - b. Amplitude to -40 dBm
10. The power meter reading should be $-40 \text{ dBm} \pm 3 \text{ dB}$
11. If all measurements are correct the module is working properly, if not the module needs servicing .

If a Problem is Found

If a problem is found, do the following checks:

1. Verify that all relevant hardware is turned on.
2. Verify that the M9302A and M9351A paths are correctly set from the SFPs and that the signal generator is set to the proper power/frequency and that all cables are properly connected. All SMA connector are torqued to 8 Lb-In (0.904 Nm).
3. Check that the Status LED is green.
4. Verify that the ACCESS LED flashes each time that the module is written to.
5. See "[Return a Module for Service](#)" on page [9](#). for details on sending the module to Agilent Technologies Inc. for service.

Step 6: Installation is Complete

Proceed to program your product by means of the application programming interface (API) for the supplied drivers.

API Overview

IVI Drivers

Agilent's IVI drivers simplify the creation and maintenance of instrument control applications in a variety of development environments; they allow programmatic control of instrumentation while providing a greater degree of instrument interchangeability and code reuse. IVI drivers currently come in two basic types: IVI-COM and IVI-C. Although the functionality offered by both types of drivers is often very similar, the fundamental differences in interface technology results in a very different end-user experience. The IVI drivers support compiling application programs for 32- or 64-bit platforms.

Supported ADEs: Arguably the most important consideration in comparing IVI-COM and IVI-C drivers is the end user experience in various ADEs. Since IVI-COM drivers are based on Microsoft COM technology, it's not surprising that IVI-COM drivers offer the richest user experience in Microsoft ADEs. Users working in Visual C++, Visual C#, Visual Basic.NET, and Visual Basic 6 enjoy a host of features, such as object browsers, IntelliSense, and context-sensitive help.

When you install the product software, the IVI driver files are installed in the standard IVI Foundation directories (for example, C:\Program Files\IVI Foundation\IVI\Drivers\AgM9351). Example programs are provided to demonstrate most driver functionality (for example, C:\Program Files\IVI Foundation\IVI\Drivers\AgM9351\Examples). The reference material for the driver functions (a Microsoft HTML Help .chm file) is installed with the IVI driver and is available for Microsoft Visual Studio's IntelliSense context linking. In addition, you can directly access the chm file (AgM9351.chm) from this Start menu location: **Start > All Programs > Agilent IVI Drivers > AgM9351 > Documentation.**

LabVIEW Driver

In addition to the IVI drivers, Agilent provides a LabVIEW driver that includes all the functionality of the IVI-C driver. When you install the product software, the LabVIEW driver is installed to each LabVIEW instr.lib directory for each version of LabVIEW you have on your computer. Example programs are provided to demonstrate most driver functionality. The reference information for the driver (a Microsoft HTML Help .chm file) is also installed with the driver and the content is available from LabVIEW's Context Help window. In addition, you can directly access the chm file (AgM9351_LabVIEW_Help.chm) from this Start menu location: **Start > All Programs > Agilent > M9392 > AgM9351 LabVIEW Help.**

M9351A Specifications

The Data Sheet for the M9351A is included on the Agilent M9392A VSA Software and Product Information CD that came with your module. This document contains specification information. To find the latest update, go to <http://cp.literature.agilent.com/litweb/pdf/5990-6055EN.pdf>.



The Modular Tangram

The four-sided geometric symbol that appears in Agilent modular product literature is called a tangram. The goal of this seven-piece puzzle is to create shapes—from simple to complex. As with a tangram, the possibilities may seem infinite as you begin to create a new test system. With a set of clearly defined elements—hardware, software—Agilent can help you create the system you need, from simple to complex.

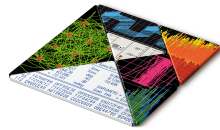

DISCOVER the Alternatives ...

... Agilent **MODULAR** Products



Agilent Advantage Services is committed to your success throughout your equipment's lifetime.
www.agilent.com/find/advantageservices



Agilent Email Updates keep you informed on the latest product, support and application information.
www.agilent.com/find/emailupdates



Agilent Channel Partners provide sales and solutions support. For details, see
www.agilent.com/find/channelpartners



ISO 9001:2008 certified. For details, see
www.agilent.com/quality

PXI www.pxisa.org

PICMG and the PICMG logo, CompactPCI and the CompactPCI logo, AdvancedTCA and the AdvancedTCA logo are US registered trademarks of the PCI Industrial Computers Manufacturers Group. "PCIe" and "PCI EXPRESS" are registered trademarks and/or service marks of PC-SIG. Microsoft, Windows, Visual Studio, Visual C++, Visual C#, and Visual Basic are either registered trademark or trademarks of Microsoft Corporation.

Product descriptions in this document are subject to change without notice.

© Agilent Technologies, Inc. 2010-2013

www.agilent.com

www.agilent.com/find/modular

www.agilent.com/find/M9351A

For more information on Agilent Technologies' products, applications or services, please contact your local Agilent office. (For additional listings, go to www.agilent.com/find/assist.)

Americas

Canada	(877) 894 4414
Brazil	(11) 4197 3500
Mexico	01800 5064 800
United States	(800) 829 4444

Asia Pacific

Australia	1 800 629 485
China	800 810 0189
Hong Kong	800 938 693
India	1 800 112 929
Japan	0120 (421) 345
Korea	080 769 0800
Malaysia	1 800 888 848
Singapore	1 800 375 8100
Taiwan	0800 047 866
Thailand	1 800 226 008

Europe & Middle East

Austria	43 (0) 1 360 277 1571
Belgium	32 (0) 2 404 93 40
Denmark	45 70 13 15 15
Finland	358 (0) 10 855 2100
France	0825 010 700 (0.125 €/minute)
Germany	49 (0) 7031 464 6333
Ireland	1890 924 204
Israel	972 3 9288 504 / 544
Italy	39 02 92 60 8484
Netherlands	31 (0) 20 547 2111
Spain	34 (91) 631 3300
Sweden	0200 88 22 55
Switzerland	0800 80 53 53
United Kingdom	44 (0) 118 9276201



Agilent Technologies