

Keysight Technologies M9362AD01 PXIe

Startup Guide

Notice: This document contains references to Agilent. Please note that Agilent's Test and Measurement business has become Keysight Technologies. For more information, go to www.keysight.com.

Notices

© Keysight Technologies 2014

No part of this manual may be reproduced in any form or by any means (including electronic storage and retrieval or translation into a foreign language) without prior agreement and written consent from Keysight Technologies, Inc. as governed by United States and international copyright laws.

Manual Part Number

M9499-90001

Print Date

September 2014

Supersedes: June 2014

Published in USA

Keysight Technologies Inc.
1400 Fountaingrove Parkway
Santa Rosa, CA 95403

Where to Find the Latest Information

Documentation is updated periodically. For the latest information about these products, including instrument software upgrades, application information, and product information, browse to the following URL, search for the name of your product:

<http://www.keysight.com/find>

Technology Licenses

The hardware and/or software described in this document are furnished under a license and may be used or copied only in accordance with the terms of such license.

Restricted Rights Legend

If software is for use in the performance of a U.S. Government prime contract or subcontract, Software is delivered and licensed as "Commercial computer software" as defined in DFAR 252.227-7014 (June 1995), or as a "commercial item" as defined in FAR 2.101(a) or as "Restricted computer software" as defined in FAR 52.227-19 (June 1987) or any equivalent agency regulation or contract clause. Use, duplication or disclosure of Software is subject to Keysight Technologies' standard commercial license terms, and non-DOD Departments and Agencies of the U.S. Government will receive no greater than Restricted Rights as defined in FAR 52.227-19(c)(1-2) (June 1987). U.S. Government users will receive no greater than Limited Rights as defined in FAR 52.227-14 (June 1987) or DFAR 252.227-7015 (b)(2) (November 1995), as applicable in any technical data.

Warranty

THE MATERIAL CONTAINED IN THIS DOCUMENT IS PROVIDED "AS IS," AND IS SUBJECT TO BEING CHANGED, WITHOUT NOTICE, IN FUTURE EDITIONS. FURTHER, TO THE MAXIMUM EXTENT PERMITTED BY APPLICABLE LAW, KEYSIGHT DISCLAIMS ALL WARRANTIES, EITHER EXPRESS OR IMPLIED WITH REGARD TO THIS MANUAL AND ANY INFORMATION CONTAINED HEREIN, INCLUDING BUT NOT LIMITED TO THE IMPLIED WARRANTIES OF MERCHANTABILITY AND FITNESS FOR A PARTICULAR PURPOSE. KEYSIGHT SHALL NOT BE LIABLE FOR ERRORS OR FOR INCIDENTAL OR CONSEQUENTIAL DAMAGES IN CONNECTION WITH THE FURNISHING, USE, OR PERFORMANCE OF THIS DOCUMENT OR ANY INFORMATION CONTAINED HEREIN. SHOULD KEYSIGHT AND THE USER HAVE A SEPARATE WRITTEN AGREEMENT WITH WARRANTY TERMS COVERING THE MATERIAL IN THIS DOCUMENT THAT CONFLICT WITH THESE TERMS, THE WARRANTY TERMS IN THE SEPARATE AGREEMENT WILL CONTROL.

Safety Notices

CAUTION

A **CAUTION** notice denotes a hazard. It calls attention to an operating procedure, practice, or the like that, if not correctly performed or adhered to, could result in damage to the product or loss of important data. Do not proceed beyond a **CAUTION** notice until the indicated conditions are fully understood and met.

WARNING

A **WARNING** notice denotes a hazard. It calls attention to an operating procedure, practice, or the like that, if not correctly performed or adhered to, could result in personal injury or death. Do not proceed beyond a **WARNING** notice until the indicated conditions are fully understood and met.

Table of Contents

M9362AD01

Documentation Map	2
Introduction	2
Related Documentation	2
Definitions for Specifications	3
Step 1: Unpack and Inspect the Module	4
Inspect for Damage	4
Step 2: Verify Shipment Contents	5
Dimensions and Weight	5
Available Options	5
Test Set Options	5
Cables	6
Step 3: Install the Software	7
Power up the Controller	8
Install the Software	8
Software Installation Procedure	8
Step 4: Install the Module	9
Front Panel Features Option F26	11
M9362AD01-F26 Connectors	12
RF Inputs (A, B, C or D)	12
IF Outputs (A, B, C or D)	12
LO Input	12
LO Output	12
Status LED	12
Front Panel Features Option F40	13
M9362AD01-F40 Connectors	14
RF Inputs (A, B, C or D)	14
IF Outputs (A, B, C or D)	14
LO Input	14
Status LED	14
Front Panel M9362AD01 Option F50	15
M9362AD01-F50 Connectors	16
RF Inputs (A, B, C or D)	16
IF Outputs (A, B, C or D)	16
LO Input	16
Status LED	16
General Characteristics	17
Typical Conversion Efficiency Plots	18
Operational Procedure	22
PNA Setup	22
Block Diagrams	27
Safety and Information	30
Introduction	30
Safety Earth Ground	30
Declaration of Conformity	30
Statement of Compliance	30
Connector Care and Cleaning Precautions	31
Regulatory Information	32
Instrument Markings	32
Keysight Support, Services, and Assistance	33
Service and Support Options	33
Return a Module for Service	33

Contents

M9362AD01

Documentation Map

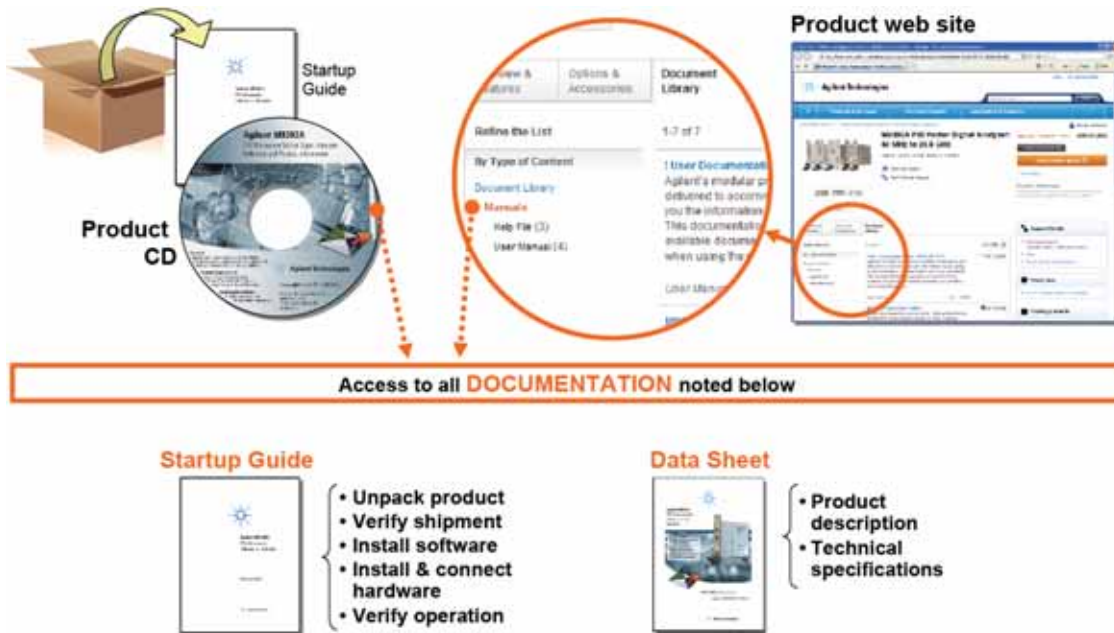

Introduction

The scope of this Startup Guide is to detail the processes of receiving and installing the Keysight M9362AD01 PXIe Microwave Quad Downconverter, installing the required software, and verifying basic module operation. If you have any questions after reviewing this information, contact your local Keysight Technologies representative.

Related Documentation

This Startup Guide and the documentation listed below can be found on the CD that shipped with the product; these documents are also available at <http://www.keysight.com/find/M9362AD01>.

- Keysight M9362AD01 PXIe Microwave Quad Downconverter Specifications (Data Sheet).

Definitions for Specifications

Specifications describe the warranted performance of calibrated instruments that have been stored for a minimum of 2 hours within the operating temperature range of 0 to 55°C, unless otherwise stated, and after a 45 minute warm-up period. Data represented in this document are specifications unless otherwise noted.

Characteristics describe product performance that is useful in the application of the product, but that is not covered by the product warranty. Characteristics are often referred to as *Typical* or *Nominal* values. Characteristics are represented in italics.

- *Nominal* describes representative performance that is useful in the application of the product when operated over a 20 to 30 °C temperature range. Nominal performance is not warranted.
- *Typical* describes characteristic performance, which 80% of instruments are expected to meet when operated over a 20 to 30 °C temperature range. Typical performance is not warranted.

Step 1: Unpack and Inspect the Module

CAUTION The module is shipped in materials which prevent damage from static. The module should only be removed from the packaging in an anti-static area ensuring that correct anti-static precautions are taken. Store all modules in anti-static envelopes when not in use.

Electrostatic discharge (ESD) can damage or destroy electronic components. The module is shipped in materials which prevent damage from static, and should only be removed from the packaging in an anti-static area ensuring that the correct anti-static precautions are taken.

Two types of ESD protection are listed below. Purchase acceptable ESD accessories from your local supplier.

- Conductive table-mat and wrist-strap combination
- Conductive floor-mat and heel-strap combination

Both types, when used together, provide a significant level of ESD protection. To ensure user safety, static-safe accessories must provide at least 1 M Ω of isolation from ground.

WARNING These techniques for a static-safe work station should not be used when working on circuitry with a voltage potential greater than 500 volts.

Inspect for Damage

After unpacking a module, carefully inspect it for any shipping damage. Report any damage to the shipping agent immediately, as such damage is not covered by the warranty. Refer to **“Keysight Support, Services, and Assistance” on page 33**. Keep the damaged shipping materials (if any) for inspection by the carrier and an Keysight Technologies representative.

CAUTION To avoid damage when handling a module, do not touch exposed connector pins.

NOTE See <http://www.keysight.com/find/tips> for information on preventing damage to your Keysight equipment.

Step 2: Verify Shipment Contents

Table 1 contains the items included with your M9362AD01 PXIe Microwave Quad Downconverter order:

Table 1 **Content List**

Keysight Part Number	Description	Qty
9320-6636	Functional Test Certificate	1
5185-1605	Envelope-Cal Certificate	1
M9499-10008	M9362AD01 Software and Product Information CD	1
M9499-90001	Startup Guide	1

NOTE All of the files contained on the CDs are available at <http://www.keysight.com/find/M9362AD01>.

Dimensions and Weight

Table 2 **Module Dimensions**

Model	Weight	Height	Width	Depth
M9362AD01	0.9 kg 2 lb (±0.5 lb)	12.8 cm (5 in)	6 cm (2.4 in)	17.5 cm (6.9 in)

Available Options

Test Set Options

The M9362AD01 has three available options, refer to the block diagrams:

- Option F26 - 10 MHz to 26.5 GHz Quad Downconverter ([Figure 24 on page 27](#))
- Option F40 - 10 MHz to 40 GHz Quad Downconverter ([Figure 25 on page 28](#))
- Option F50 - 10 MHz to 50 GHz Quad Downconverter ([Figure 26 on page 29](#))

Cables

M9362AD01-CA3	Qty	IF JUMPER CABLES for use with Keysight M9210A PXI-H 10-bit High-Speed Digitizing Scope
8120-2066	4	Cable Assembly, SMA (m) to BNC (m), 190 mm

Figure 1 IF Jumper Cable



M9362AD01-CA4	Qty	LO INTERCONNECT KIT for use with Keysight M9302A PXI Local Oscillator with Option F26
0955-0426	1	Microwave Attenuator, 14 dB
M9499-20032	1	Cable Assembly, SMA (m) to BNC (m), 190 mm

Figure 2 LO Jumper Cable



Step 3: Install the Software

Table 3 System Requirements

Topic	Requirements		
Operating System	Window XP, Service Pack 3	Windows Vista®, SP1 and SP2 (32-bit and 64-bit), Business, Ultimate, Enterprise, Home Basic, and Home Premium	Windows 7, (32-bit and 64-bit) Starter, Ultimate, Home Basic, Home Premium, Professional, Ultimate, Enterprise
Processor speed	600 MHz or higher required 800 MHz recommended	1 GHz 32-bit (x86), 1 GHz 64-bit (x64), no support for Itanium64	1 GHz 32-bit (x86), 1 GHz 64-bit (x64), no support for Itanium64
Available memory	256 MB minimum (1 GB or greater recommended)	1 GB minimum	1 GB minimum
Available disk space ¹	1.5 GB available hard disk space, includes: - 1 GB available for Microsoft.NET Framework 3.5 SP1 ² - 100 MB for Keysight IO Libraries Suite		
Video	Super VGA (800x600) 256 colors or more	Support for DirectX 9 graphics with 128 MB graphics memory recommended (Super VGA graphics is supported)	Support for DirectX 9 graphics with 128 MB graphics memory recommended (Super VGA graphics is supported)
Browser	Microsoft Internet Explorer 6.0 or greater	Microsoft Internet Explorer 7.0 or greater	Microsoft Internet Explorer 7.0 or greater

1. Because of the installation procedure, less disk space may be required for operation than is required for installation. The amount of space listed above is required for installation.
2. NET Framework Runtime Components are installed by default with Windows Vista. Therefore, you may not need this amount of disk space.

Table 4 Hardware Requirements

Topic	Requirements
Chassis	PXIe or PXIe hybrid chassis slot.
PXIe System/ host Controller	A PXI or PXI Express embedded controller or remote controller (external PC connected to the chassis via a PCI-to-PXI interface) is required.
Embedded Controller	Keysight M9036A or an embedded controller that meets the following requirements: - PXIe system controller (PXI-1 embedded controllers are not compatible) - Utilize a 2x8, 4x4, or 1x4 PXIe system slot link configuration. - Run one of the operating systems listed in System Requirements (above).
Remote Controller	(for Keysight M9018A chassis use only) Keysight M9021 Cable Interface x8 with one of the following PC interface options: - Keysight M9045 PCIe ExpressCard Adapter x1, with cable (for a laptop PC) - Keysight M9047 PCIe Desktop Adapter x8, with cable (for desktop PCs) Or an equivalent remote controller using a PC running one of the operating systems listed in System Requirements (above).
Chassis	PXIe system/ host controller A PXI or PXI Express embedded controller or remote controller (external PC connected to the chassis via a PCI-to-PXI interface) is required.

Power up the Controller

CAUTION If you are using a remote controller and you have installed the interface cable, you must power up the chassis **BEFORE** you power up the PC. When you power down your chassis, shut down the PC **BEFORE** you power down the chassis.

If you are using an embedded controller, complete the following steps:

1. Install the embedded controller into the chassis. The Keysight M9306A PXIe Embedded Controller and Keysight M9018A PXIe Chassis are recommended. Refer to the controller and chassis documentation for details.
2. Connect peripherals (mouse, keyboard and monitor).
3. Power up the chassis.

Install the Software

This installation includes the following software:

NOTE Version 16.1 (or newer) of the Keysight IO Libraries Suite is required.

- Keysight IO Libraries Suite (IOLS), which includes the Keysight Connections Expert, is included with your shipment (CD part number E2904-60003), and is also available at <http://www.keysight.com/find/iosuite>.
- Instrument software, which includes device drivers and user documentation, is included with your shipment (CD part number M9499-10008), and is also available at <http://www.keysight.com/find/M9362AD01>.

Software Installation Procedure

This installation includes the following software:

Use the following procedure to install the software:

1. From the Keysight IOLS CD (E2904-60003) browser launch the installer.
2. Follow the installer prompts to install the IO libraries.
3. From the M9362AD01 Software and Product Information CD (M9499-10008) launch the installer.
4. After installation is complete, power down the host PC, and then the chassis if using a remote controller.

CAUTION If you are using a remote controller, shut down the PC **BEFORE** you power down the chassis. When you restore power, power up the chassis **BEFORE** you power up the PC.

Step 4: Install the Module

CAUTION PXI hardware does not support "hot-swap" capabilities (changing modules while power is applied to the chassis). Before installing a module into the chassis, the chassis must be powered off to prevent damage to the module.

NOTE This Module can be used in a chassis with a PXIe and PXI-H hybrid slots.



The M9352A can also be installed in any hybrid PXI slot marked with a peripheral slot compatibility image (the letter "H" and a solid circle containing the slot number).



The M9352A can also be installed in any hybrid PXI slot marked with a peripheral slot compatibility image (the letter "H" and a solid circle containing the slot number).

1. Make sure that the line cord is plugged in to establish earth ground and that the chassis power switch is in the Off (Standby) position.
2. If the chassis has multiple fan speed settings, ensure that the fans are set to automatic.
3. Position the chassis so that there is ample space between the chassis fan intake and exhaust vents. Blockage by walls or obstructions affects the air flow needed for cooling. (Refer to the chassis documentation for more information about cooling).
4. Before installing a module, be sure to remove the plastic thread protectors from the mounting screws. Before inserting the module into the chassis, back the mounting screws out to ensure that there is no interference between the screws and the mounting rails.
5. Holding the module by the injector/ejector handle, slide it into an available PXI (or hybrid) slot, as shown in [Figure 3 on page 10](#).
 - a. Install the module into the PXI slot of the chassis by placing the module card edges into the front module guides (top and bottom).
 - b. Slide the module to the rear of the chassis and ensure that the injector/ejector handle is pushed down in the unlatched (downward) position.
 - c. Slide the module completely into the chassis. When you begin to feel resistance, push up on the injector/ejector handle to fully insert the module into the chassis.

Figure 3 Installing the M9352A

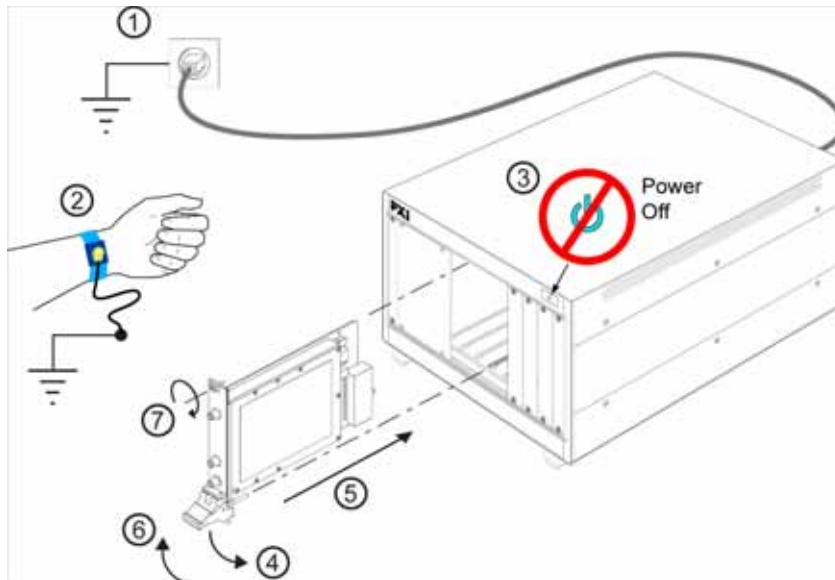

6. Secure the front panel to the chassis using the two module front-panel mounting screws. Performance may suffer if the screws are not tightened properly.
7. Verify that the PXI chassis fans are operable and free of dust and other contaminants that may restrict airflow.
8. Install all filler panels after installing the module. Missing filler panels may disrupt necessary air circulation in the chassis.
9. If you are using a PC host, such as the Keysight M9021, connect the Cable Interface in the chassis to the PC host per the instructions that came with the Cable Interface.
10. Power up the PXI chassis.
11. Reboot the PC host.

Front Panel Features Option F26

Figure 4 Front Panel M9362AD01



M9362AD01-F26 Connectors

CAUTION The maximum input to any of the RF Input connectors (A, B, C, or D) must not exceed +18 dBm with 0 VDC offset. The maximum input to the LO Input connector must not exceed +5 dBm with 0 VDC offset.

RF Inputs (A, B, C or D)

This APC 3.5 mm female connector inputs a signal (10 MHz to 26.5 GHz, at a maximum of +18 dBm with 0 VDC offset) that will be downconverted and directed to IF Output A, B, C or D.

IF Outputs (A, B, C or D)

This SMA female connector outputs an IF signal (0.01 to 1.5 GHz) that is derived from the RF Input A, B, C or D.

LO Input

This APC 3.5 mm female connector inputs a signal (10 MHz to 26.5 GHz, at a maximum of +5 dBm with 0 VDC offset) that is used as the LO to downconvert the RF Inputs A, B, C or D and to provide a buffered LO Output.

LO Output

This APC 3.5 mm female connector outputs a signal (10 MHz to 26.5 GHz) that can be used as the LO Input to an additional M9362AD01 PXIe Microwave Quad Downconverter.

Status LED

This LED has four possible states:

- **Green** = The power supplies are operational and in specification. It also indicates that all module hardware is operational.
- **Amber** = The power supplies are operational and in specification, but there is a hardware problem.
- **Red** = There is a power supply failure and a hardware failure.
- **Off** = A power supply failure, but the other module hardware appears to be functional. Since a power supply failure can mask other hardware problems, this is not an indication that only a power supply could be at fault.

Front Panel Features Option F40

Figure 5 Front Panel M9362AD01-F40

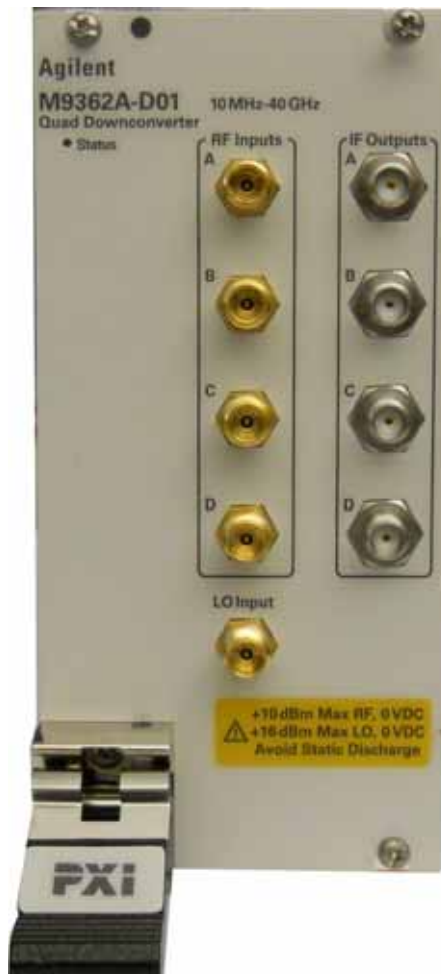

M9362AD01-F40 Connectors

CAUTION The maximum input to any of the RF Input connectors (A, B, C, or D) must not exceed +10 dBm with 0 VDC offset. The maximum input to the LO Input connector must not exceed +16 dBm with 0 VDC offset.

RF Inputs (A, B, C or D)

This 1.85 mm female connector inputs a signal (10 MHz to 40 GHz, at a maximum of +10 dBm with 0 VDC offset) that will be downconverted and directed to IF Output A, B, C or D.

IF Outputs (A, B, C or D)

This SMA female connector outputs an IF signal (0.01 to 3 GHz) that is derived from the RF Input A, B, C or D.

LO Input

This 1.85 mm female connector inputs a signal (10 MHz to 40 GHz, at a maximum of +16 dBm with 0 VDC offset) that is used as the LO to downconvert the RF Inputs A, B, C or D.

Status LED

This LED has four possible states:

- **Green** = The power supplies are operational and in specification. It also indicates that all module hardware is operational. Note that the Green LED will not be active unless the Soft Front Panel (SFP) is active.
- **Amber** = The power supplies are operational and in specification, but there is a hardware problem.
- **Red** = There is a power supply failure and a hardware failure.
- **Off** = A power supply failure, but the other module hardware appears to be functional. Since a power supply failure can mask other hardware problems, this is not an indication that only a power supply could be at fault.

Front Panel M9362AD01 Option F50

Figure 6 Front Panel M9362AD01-F50

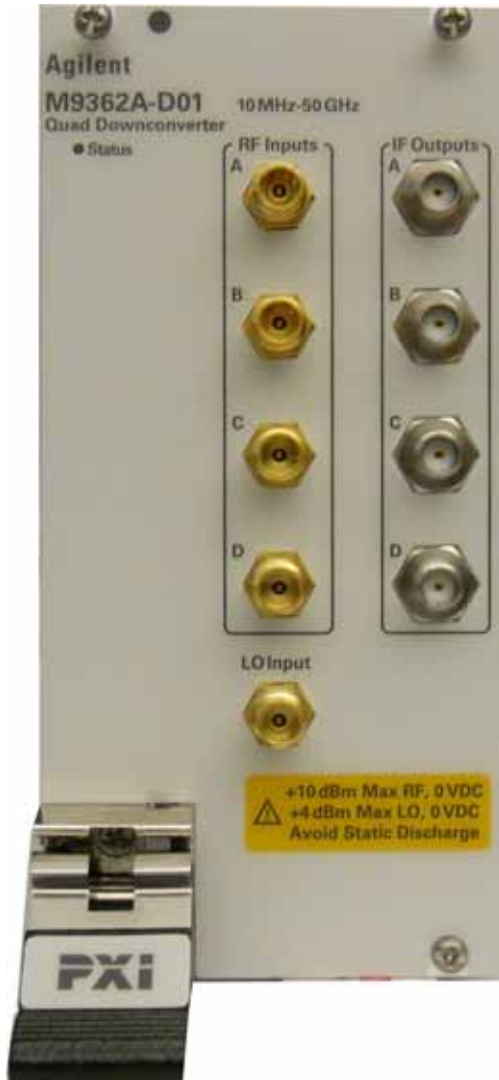

M9362AD01-F50 Connectors

CAUTION The maximum input to any of the RF Input connectors (A, B, C, or D) must not exceed +10 dBm with 0 VDC offset. The maximum input to the LO Input connector must not exceed +4 dBm with 0 VDC offset.

RF Inputs (A, B, C or D)

This 1.85 mm female connector inputs a signal (10 MHz to 50 GHz, at a maximum of +10 dBm with 0 VDC offset) that will be downconverted and directed to IF Output A,B,C or D.

IF Outputs (A, B, C or D)

This SMA female connector outputs an IF signal (0.01 to 3 GHz) that is derived from the RF Input A,B,C or D.

LO Input

This 1.85 mm female connector inputs a signal (10 MHz to 26.5 GHz, at a maximum of +4 dBm with 0 VDC offset) that is used as the LO to downconvert the RF Inputs A, B, C or D.

Status LED

This LED has four possible states:

- **Green** = The power supplies are operational and in specification. It also indicates that all module hardware is operational. Note that the Green LED will not be active unless the Soft Front Panel (SFP) is active.
- **Amber** = The power supplies are operational and in specification, but there is a hardware problem.
- **Red** = There is a power supply failure and a hardware failure.
- **Off** = A power supply failure, but the other module hardware appears to be functional. Since a power supply failure can mask other hardware problems, this is not an indication that only a power supply could be at fault.

General Characteristics

Table 5 M9362AD01 Typical Characteristics Performance¹

Input and Output Ports	Option F26		Option F40		Option F50	
	Freq Range	Connectors	Freq Range	Connectors	Freq Range	Connectors
Connector Ports						
RF Port	0.01 to 50 GHz	3.5 mm (f)	0.01 to 40 GHz	1.85 mm (f)	0.01 to 50 GHz	1.85 mm (f)
LO Port	0.01 to 26.5 GHz	3.5 mm (f)	0.01 to 40 GHz	1.85 mm (f)	0.01 to 26.5 GHz	1.85 mm (f)
IF Port	0.01 to 1.5 GHz	SMA (f)	0.01 to 1.5 GHz	SMA (f)	0.01 to 1.5 GHz	SMA (f)
Input and Output Power Levels						
Input Power Damage						
Frequency Range	0.01 to 26.5 GHz		0.01 to 40 GHz		0.01 to 26.5 GHz	26.5 to 50 GHz
RF Port	+18 dBm		+10 dBm		+10 dBm	
LO Port	+5 dBm		+16 dBm		+4 dBm	
Optimum Power Levels						
RF Power	-15 dBm		-15 dBm		-15 dBm	-20 dBm
LO Power	0 dBm		+10 dBm		0 dBm	
RF Compression						
Ports A-D @ 0.1 dB	-13 dBm		-12 dBm		-10 dBm	-15 dBm
Ports A-D @ 1.0 dB	-7 dBm		-5 dBm		-5 dBm	-10 dBm
Conversion Efficiency, IF Output at 10 MHz, RF Input Power set to 0.1 dB Compression Point						
Frequency Range	0.01 to 26.5 GHz		0.01 to 40 GHz		0.01 to 26.5 GHz	26.5 to 50 GHz
Conversion Efficiency	6 to -8 dB		1 to -9 dB		1 to -5 dB	-10 to -20 dB
Output Power	-4 to -18 dBm		-10 to -22 dBm		-10 to -15 dBm	-25 to -35 dBm
Additional Characteristics						
Frequency Range	0.01 to 26.5 GHz		0.01 to 26.5 GHz	0.01 to 40 GHz	0.01 to 26.5 GHz	26.5 to 50 GHz
Noise Figure	24 dB		-	-	-	-
Channel to channel Isolation	< -80 dB		< -65 dB	< -65 dB	< -65 dB	< -60 dB
LO to IF Leakage	< -15 dB		< -15 dB		< -15 dB	
RF Input Port Match						
Frequency Range	0.01 to 10 GHz	10 to 26.5 GHz	0.01 to 26.5 GHz	26.5 to 40 GHz	0.01 to 26.5 GHz	26.5 to 50 GHz
Ports A-D	-10 dB	-5 dB	-5 dB	-8 dB	-10 dB	-5 dB

1. Refer to "Definitions for Specifications" on page 3.

Typical Conversion Efficiency Plots

NOTE Set the IF frequency to 10 MHz for conversion efficiency.

Figure 7 F26 Conversion Efficiency

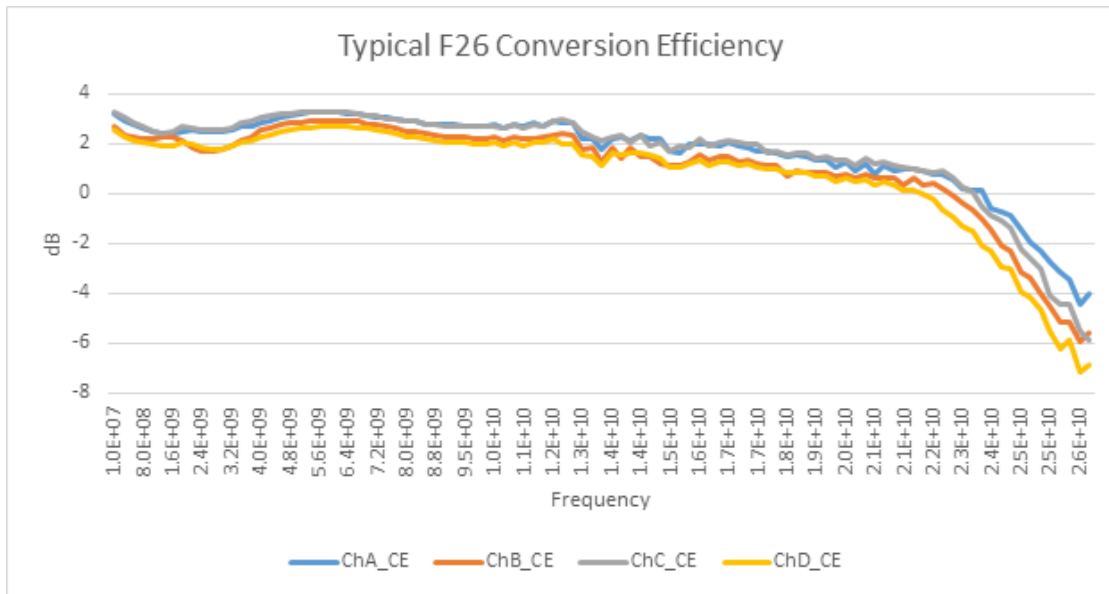

Figure 8 F40 Conversion Efficiency

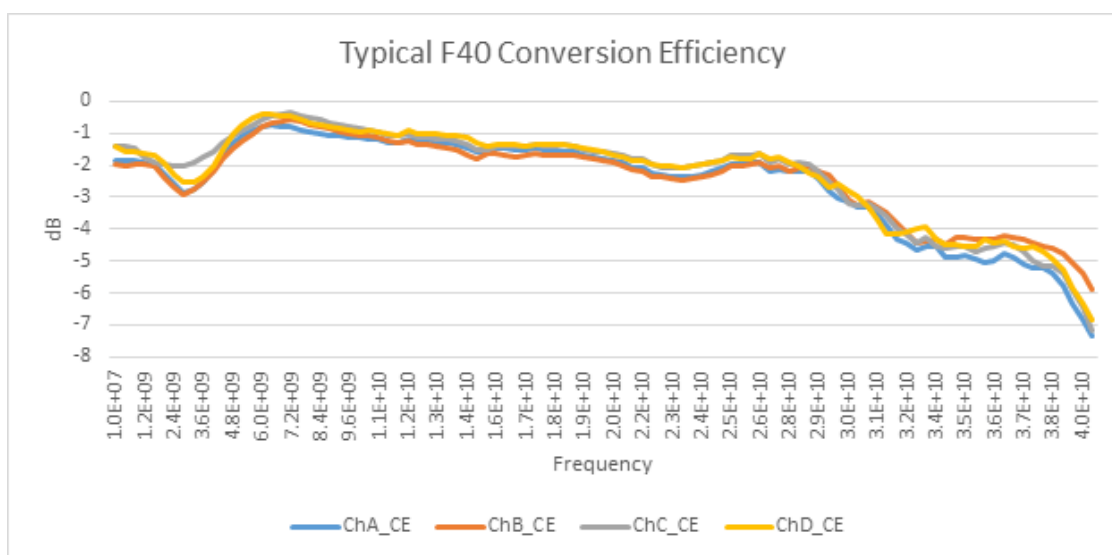

Figure 9 F50 Conversion Efficiency (Low Band)

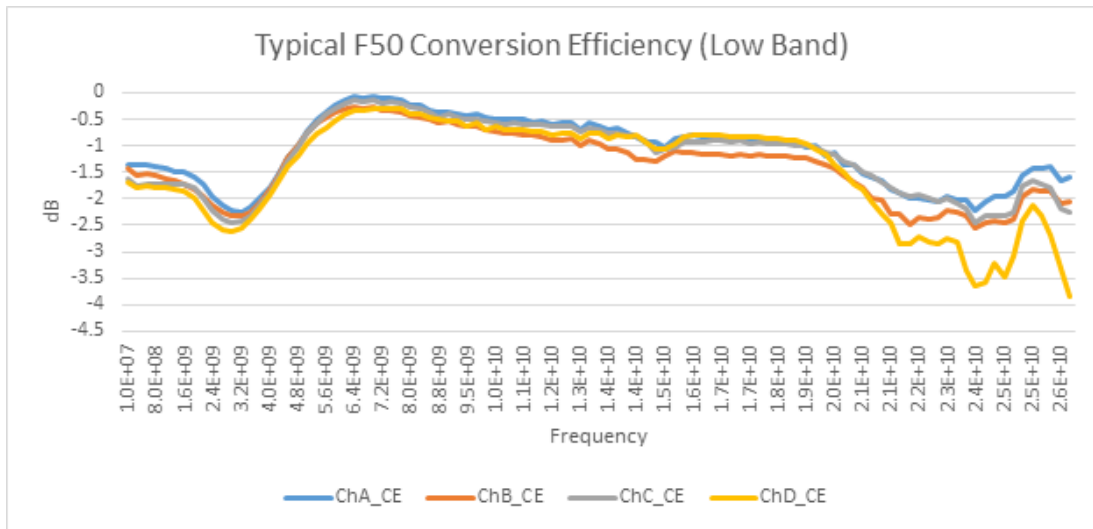

Figure 10 F50 Conversion Efficiency (High Band)

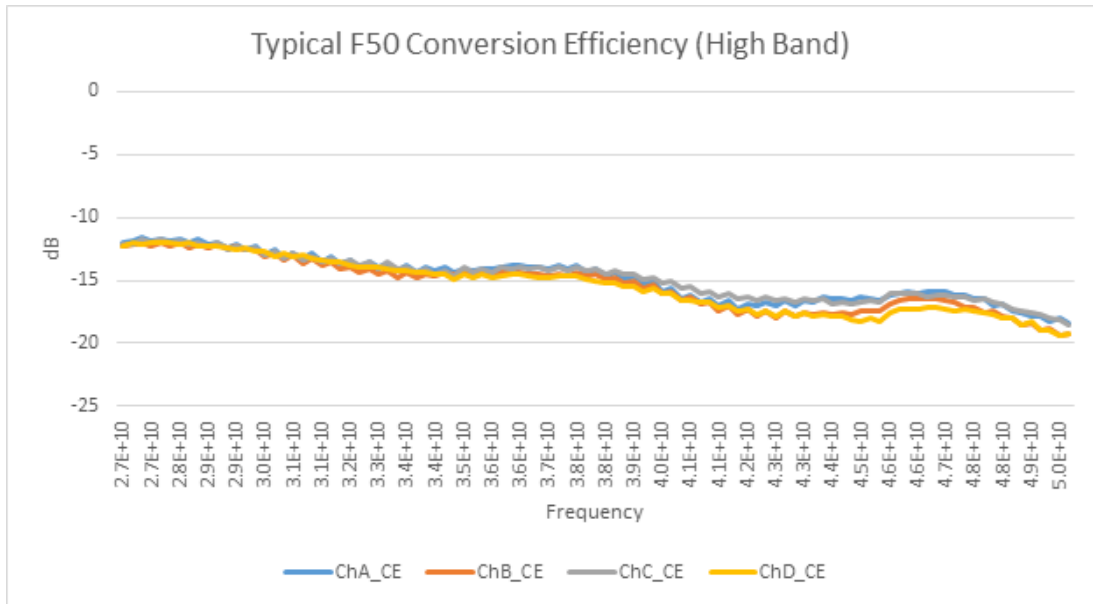

Figure 11 F26 IF Band width

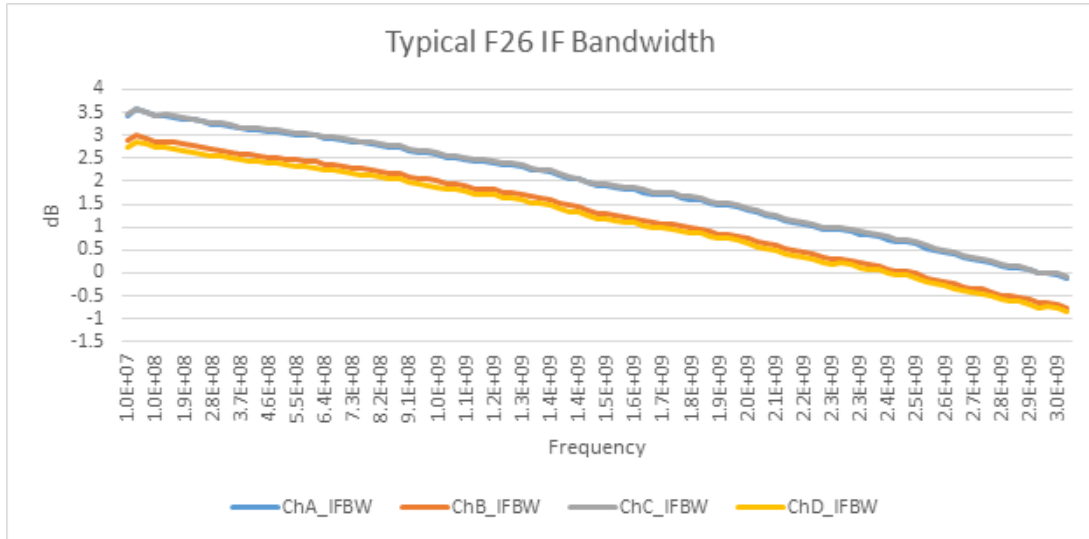

Figure 12 F40 and F50 IF Band width (Low Band)

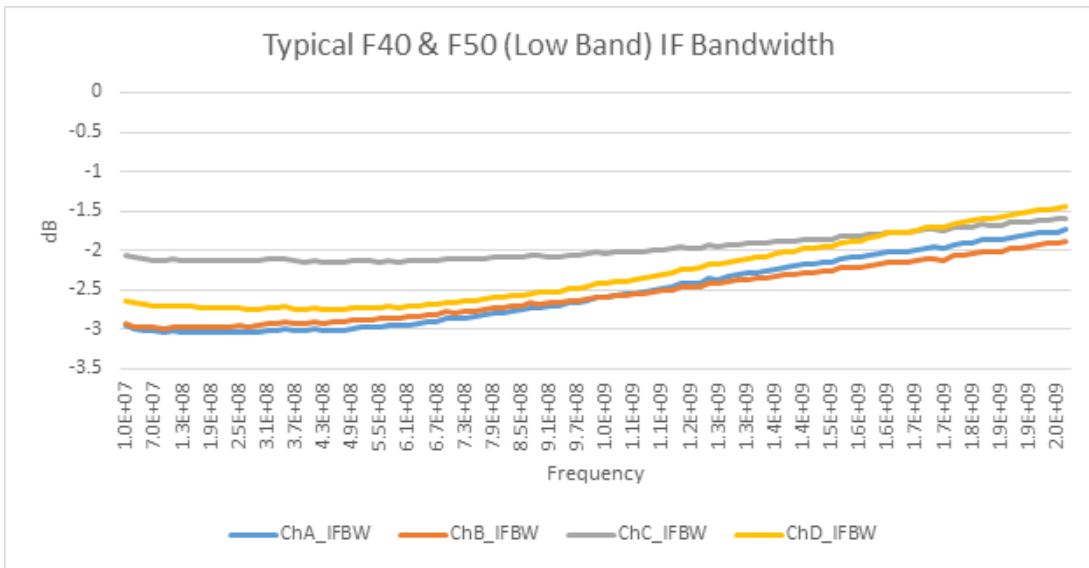

Figure 13 F50 IF Band width (High Band)

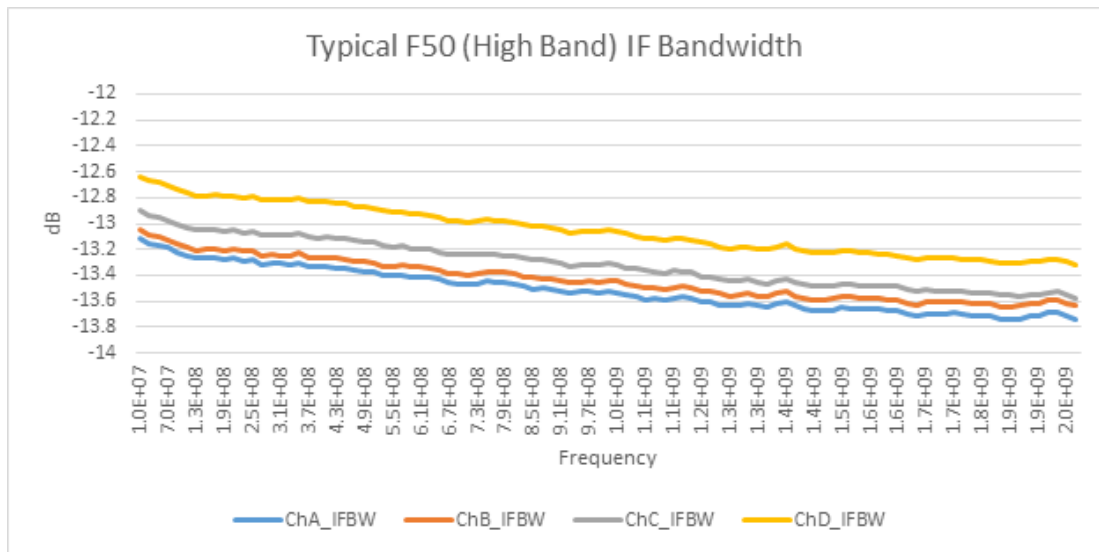
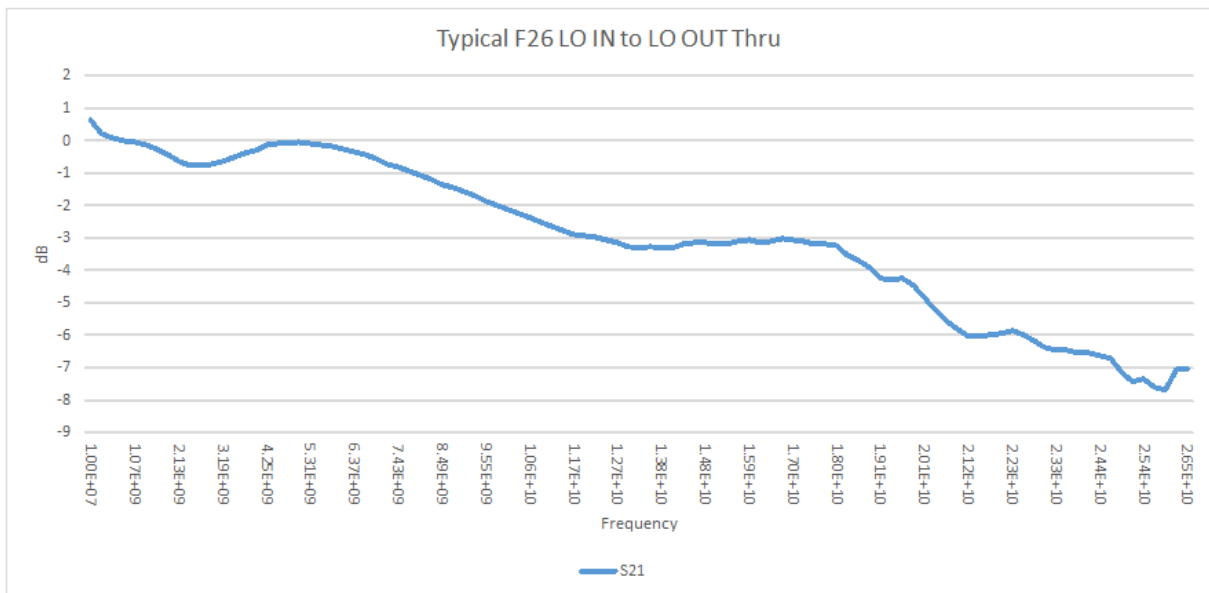

Figure 14 F26 LO IN to LO OUT Through



Operational Procedure

The following procedure was created using a PNA. The PNA uses its two internal sources, one for the RF and the second as the LO signals. The PMAR (Power Meter As Receiver) measurement method was chosen to characterize the IF Output performance. The M9362AD01 performance can be checked against the Output Power characteristics in **“General Characteristics”** on page 17. This procedure assumes the operator or user knows how to use the PNA.

The Operational Procedure can also be verified using two separate PSG sources, one for the RF and a second for the LO. Use a power meter to measure the IF Output. The M9362AD01 performance can be checked against the output power characteristics in the technical specifications in **Table 5** on page 17.

Performance can vary. This is a simple operator procedure that verifies that the unit is functional. This procedure should not be used for measuring the units typical characteristic as hard specifications.

NOTE Optimum RF and LO power levels can found in **Table 5** on page 17.

NOTE Option F40 will require an amplifier to ensure the LO power is set at 10 dBm. Use of an attenuator maybe required.

PNA Setup

Figure 15 PMAR Set on the PNA

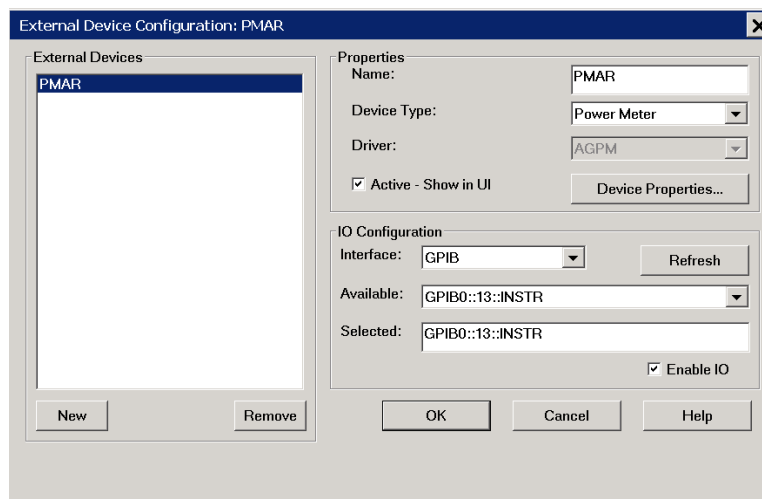

Figure 16 Select Measure

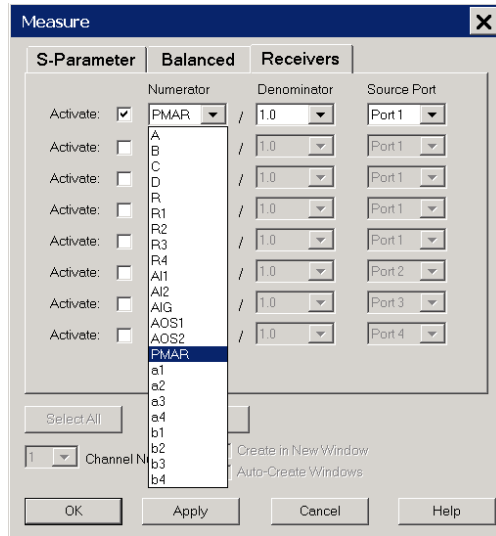

Figure 17 Source and Attenuator Settings

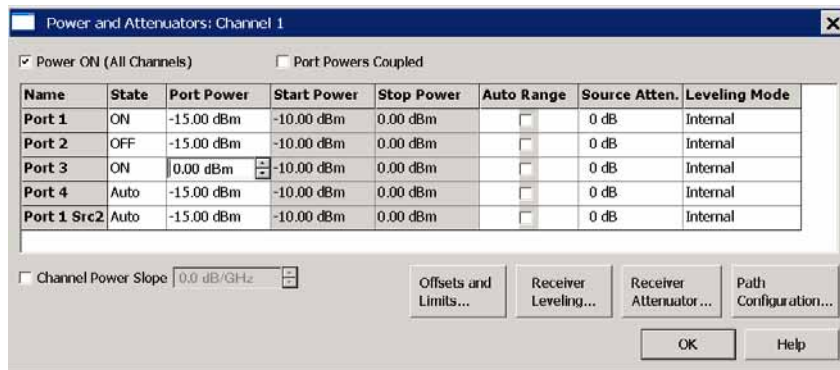

Figure 18 F26 and F50 (Low Band) Frequency Offset

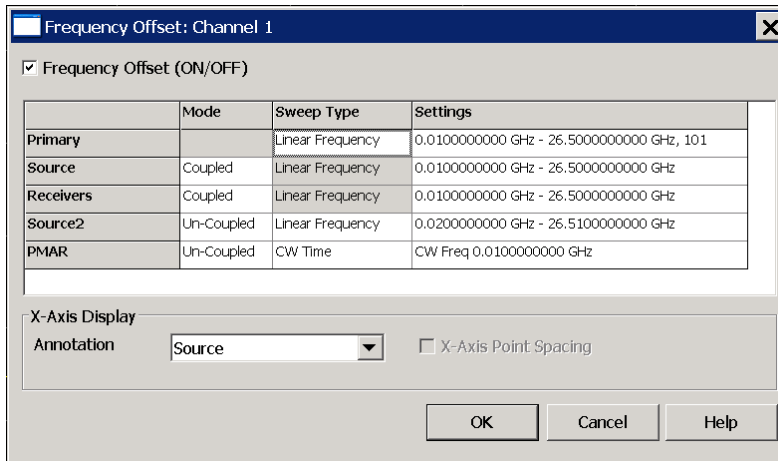

Figure 19 F40 Frequency Offset

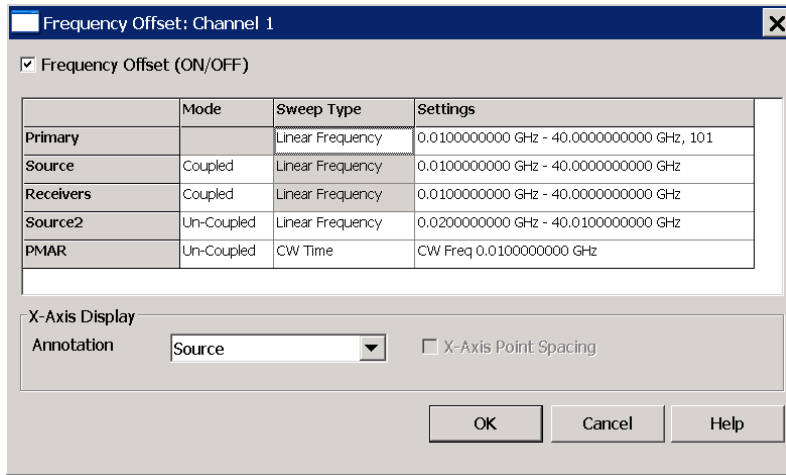

Figure 20 F50 (High Band) Frequency Offset

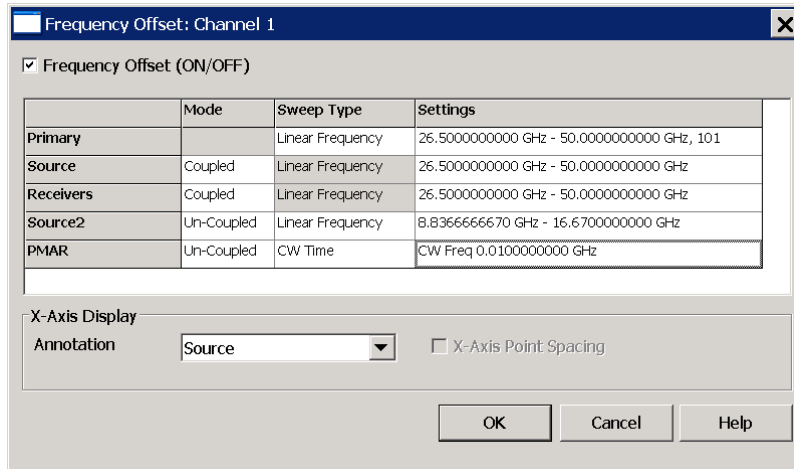

Figure 21 F26 and F50 (Low Band) OP Conversion Efficiency

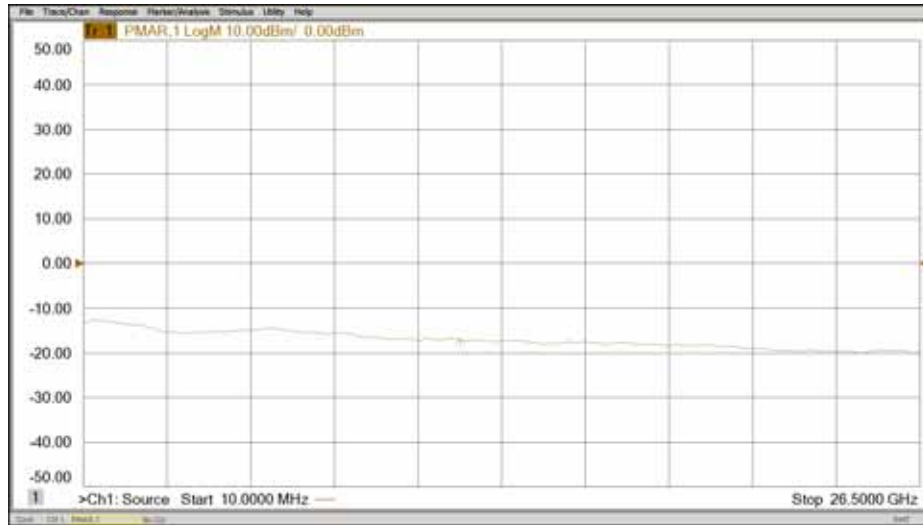

Figure 22 F40 OP Conversion Efficiency

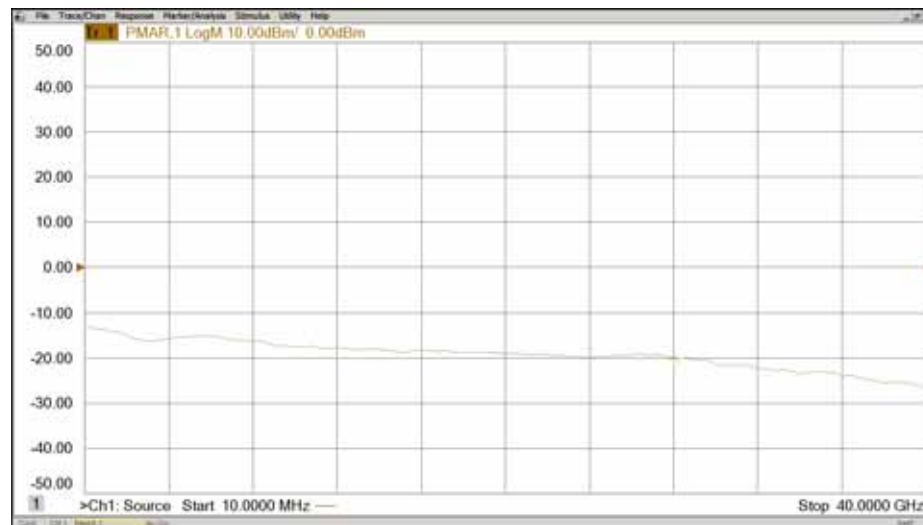
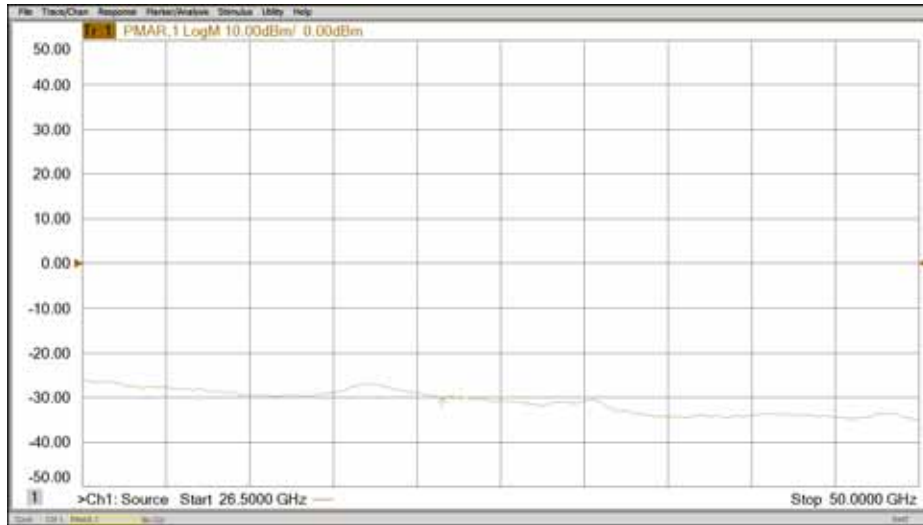

Figure 23 F50 (High Band) OP Conversion Efficiency



Block Diagrams

Figure 24 M9362AD01 Block Diagram (Option F26)

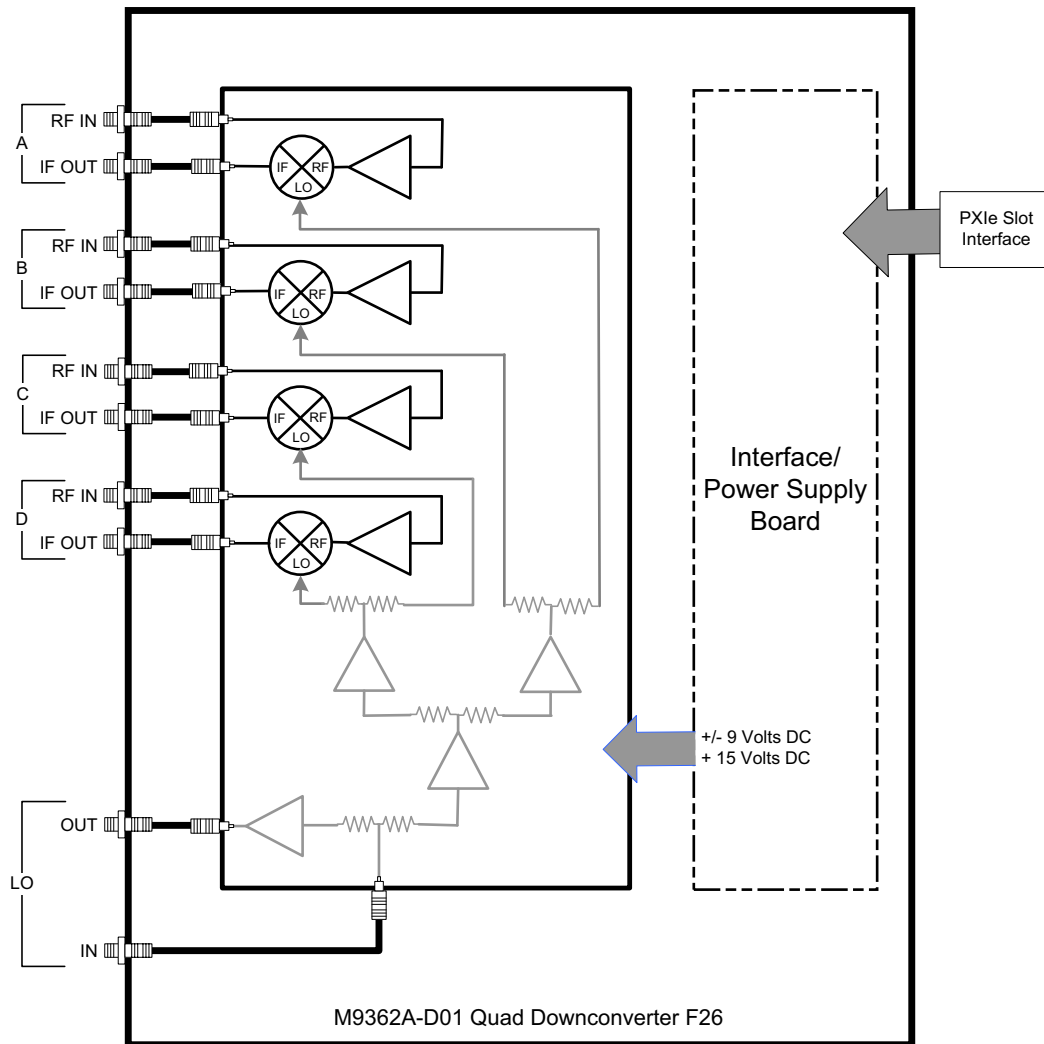

Figure 25 M9362AD01 Block Diagram (Option F40)

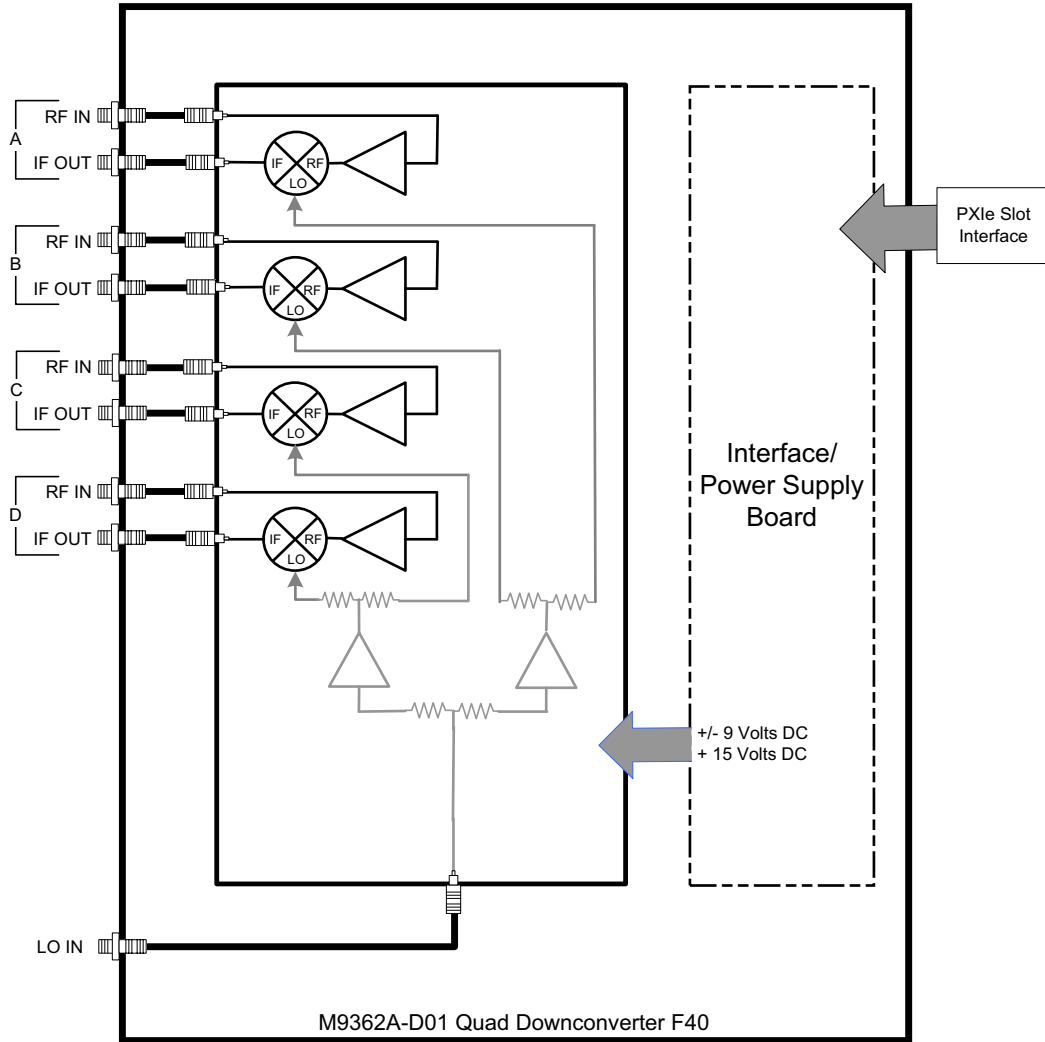
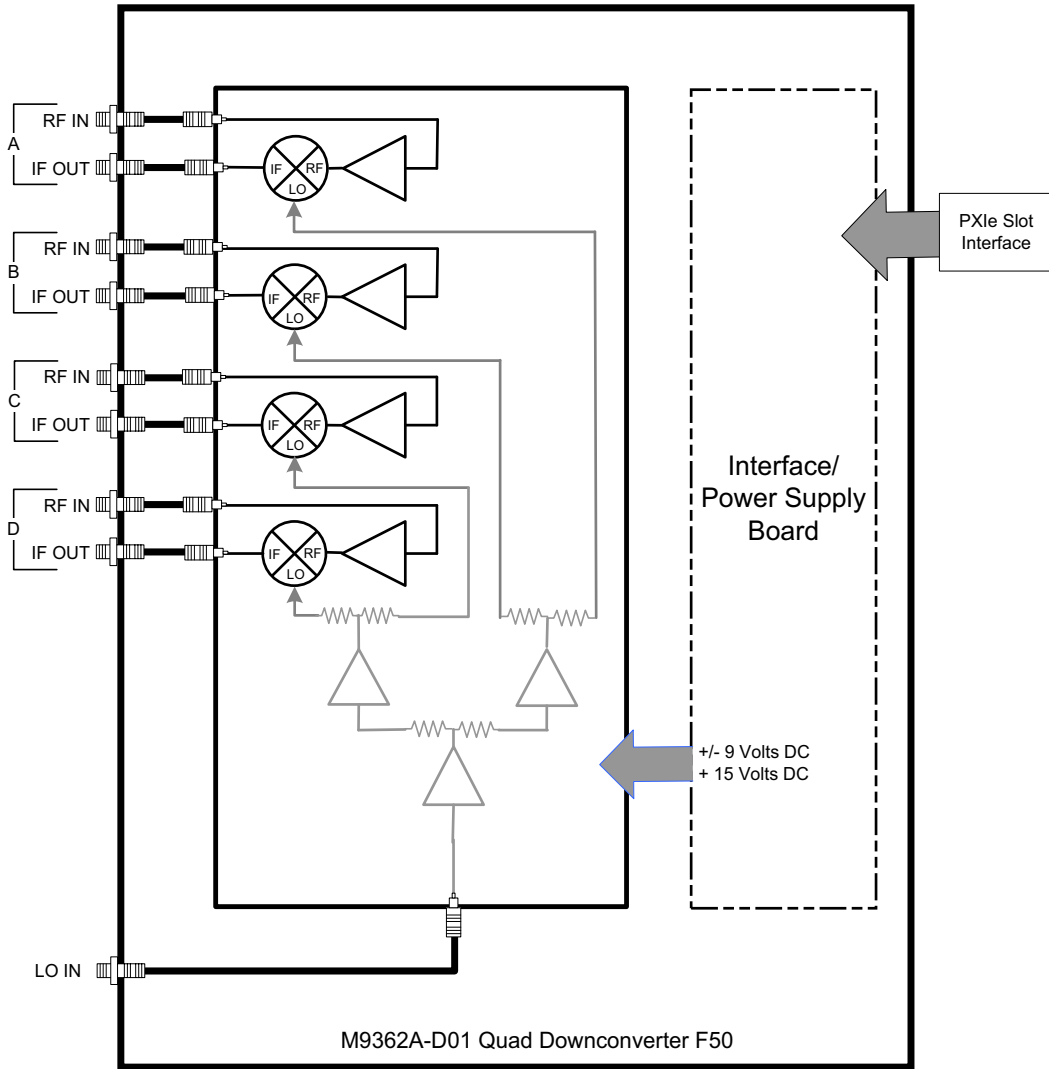

Figure 26 M9362AD01 Block Diagram (Option F50)



Safety and Information

Introduction

Review this product and related documentation to familiarize yourself with safety markings and instructions before you operate the instrument.

This product has been designed and tested in accordance with accepted industry standards, and has been supplied in a safe condition. The documentation contains information and warnings that must be followed by the user to ensure safe operation and to maintain the product in a safe condition.

Safety Earth Ground

WARNING This is a Safety Class I Product (provided with a protective earthing ground incorporated in the power cord). The mains plug shall be only be inserted in a socket outlet provided with a protective earth contact. Any interruption of the protective conductor inside or outside of the product is likely to make the product dangerous. Intentional interruption is prohibited.

CAUTION Always use the three prong AC power cord supplied with this product. Failure to ensure adequate earth grounding by not using this cord may cause product damage and the risk of electrical shock.

Declaration of Conformity

Declarations of Conformity for this product and for other Keysight products may be downloaded from the Keysight Regulatory Website. Click on "Declarations of Conformity" and enter your product number to find the latest Declaration of Conformity statement.

<http://regulations.about.keysight.com>

Statement of Compliance

This instrument has been designed and tested in accordance with CAN/CSA 22.2 No. 61010-1-04, UL Std No. 61010-1 (2nd Edition).

Connector Care and Cleaning Precautions

Remove the power cord to the instrument. To clean the connectors use alcohol in a well ventilated area. Allow all residual alcohol moisture to evaporate, and fumes to dissipate prior to energizing the instrument.

WARNING To prevent electrical shock, disconnect the M9362AD01 from mains electrical supply before cleaning. Use a dry cloth or one slightly dampened with water to clean the external case parts. Do not attempt to clean internally.

WARNING If flammable cleaning materials are used, the material shall not be stored, or left open in the area of the equipment. Adequate ventilation shall be assured to prevent the combustion of fumes, or vapors.

Regulatory Information

This section contains information that is required by various government regulatory agencies.

Instrument Markings



South Korean Certification (KC) mark; includes the marking's identifier code which follows the format: MSIP-REM-YYY-ZZZZZZZZZZZZ.



This symbol indicates separate collection for electrical and electronic equipment, mandated under EU law as of August 13, 2005. All electric and electronic equipment are required to be separated from normal waste for disposal (Reference WEEE Directive, 2002/96/EC).

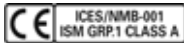

The CE mark is a registered trademark of the European Community. (If accompanied by a year, it is when the design was proven.)



The RCM mark is a registered trademark of the Australian Communications and Media Authority



Indicates the time period during which no hazardous or toxic substance elements are expected to leak or deteriorate during normal use. Forty years is the expected useful life of the product.



This symbol indicates that PXI is a U.S. registered trademark of the PXI System Alliance.



This symbol indicates the instrument is sensitive to electrostatic discharge (ESD). ESD can damage the highly sensitive components in your instrument. ESD damage is most likely to occur as the module is being installed or when cables are connected or disconnected. Protect the circuits from ESD damage by wearing a grounding strap that provides a high resistance path to ground. Alternatively, ground yourself to discharge any built-up static charge by touching the outer shell of any grounded instrument chassis before touching the port connectors.

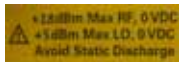

Maximum RF Input power. (Option F26)

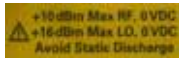

Maximum RF Input power. (Option F40)

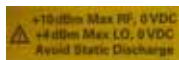

Maximum RF Input power. (Option F50)

Keysight Support, Services, and Assistance

Service and Support Options

There are many other repair and calibration options available from the Keysight Technologies support organization. These options cover a range of service agreements with varying response times. Contact Keysight for additional information on available service agreements for this product.

Return a Module for Service

Should it become necessary to return a module for repair or service, follow the steps below:

1. Review the warranty information shipped with your product.
2. Contact Keysight to obtain a Return Material Authorization (RMA) and return address. If you need assistance finding Keysight contact information go to <http://www.keysight.com/find/assist> (worldwide contact information for repair and service) or refer to the "Support" information on the product web page.
3. Write the following information on a tag and attach it to the malfunctioning equipment:
 - Name and address of owner. P.O. boxes are not acceptable as return addresses.
 - Product model number (for example, M9362AD01).
 - Product serial number (for example, MYXXXXXXXX). The serial number label is located on the side panel of the module.
 - Description of failure or service required
4. Carefully pack the module in its original ESD bag and packing carton. If the original carton is not available, use bubble wrap or packing peanuts and place the instrument in a sealed container and mark the container "FRAGILE".
5. On the shipping label, write ATTENTION REPAIR DEPARTMENT and the RMA number.

NOTE If any correspondence is required, refer to the product by serial number and model number.
