



**75000 SERIES B**

**Mainframes**  
**E1300B and E1301B**

---

**User's Manual**



**Agilent Technologies**

Copyright © Agilent Technologies, Inc., 1989, 1990, 1991, 2006



---

## Certification

*Agilent Technologies certifies that this product met its published specifications at the time of shipment from the factory. Agilent Technologies further certifies that its calibration measurements are traceable to the United States National Institute of Standards and Technology (formerly National Bureau of Standards), to the extent allowed by that organization's calibration facility, and to the calibration facilities of other International Standards Organization members.*

---

## Warranty

This Agilent Technologies product is warranted against defects in materials and workmanship for a period of three years from date of shipment. Duration and conditions of warranty for this product may be superseded when the product is integrated into (becomes a part of) other Agilent products. During the warranty period, Agilent Technologies will, at its option, either repair or replace products which prove to be defective.

For warranty service or repair, this product must be returned to a service facility designated by Agilent Technologies. Buyer shall pre-pay shipping charges to Agilent and Agilent shall pay shipping charges to return the product to Buyer. However, Buyer shall pay all shipping charges, duties, and taxes for products returned to Agilent from another country.

Agilent warrants that its software and firmware designated by Agilent for use with a product will execute its programming instructions when properly installed on that product. Agilent does not warrant that the operation of the product, or software, or firmware will be uninterrupted or error free.

## Limitation Of Warranty

The foregoing warranty shall not apply to defects resulting from improper or inadequate maintenance by Buyer, Buyer-supplied products or interfacing, unauthorized modification or misuse, operation outside of the environmental specifications for the product, or improper site preparation or maintenance.

The design and implementation of any circuit on this product is the sole responsibility of the Buyer. Agilent does not warrant the Buyer's circuitry or malfunctions of Agilent products that result from the Buyer's circuitry. In addition, Agilent does not warrant any damage that occurs as a result of the Buyer's circuit or any defects that result from Buyer-supplied products.

NO OTHER WARRANTY IS EXPRESSED OR IMPLIED. Agilent SPECIFICALLY DISCLAIMS THE IMPLIED WARRANTIES OF MERCHANTABILITY AND FITNESS FOR A PARTICULAR PURPOSE.

## Exclusive Remedies

THE REMEDIES PROVIDED HEREIN ARE BUYER'S SOLE AND EXCLUSIVE REMEDIES. Agilent SHALL NOT BE LIABLE FOR ANY DIRECT, INDIRECT, SPECIAL, INCIDENTAL, OR CONSEQUENTIAL DAMAGES, WHETHER BASED ON CONTRACT, TORT, OR ANY OTHER LEGAL THEORY.

---

## Notice

The information contained in this document is subject to change without notice. Agilent Technologies MAKES NO WARRANTY OF ANY KIND WITH REGARD TO THIS MATERIAL, INCLUDING, BUT NOT LIMITED TO, THE IMPLIED WARRANTIES OF MERCHANTABILITY AND FITNESS FOR A PARTICULAR PURPOSE. Agilent shall not be liable for errors contained herein or for incidental or consequential damages in connection with the furnishing, performance or use of this material. This document contains proprietary information which is protected by copyright. All rights are reserved. No part of this document may be photocopied, reproduced, or translated to another language without the prior written consent of Agilent Technologies, Inc. Agilent assumes no responsibility for the use or reliability of its software on equipment that is not furnished by Agilent.

---

## U.S. Government Restricted Rights

The Software and Documentation have been developed entirely at private expense. They are delivered and licensed as "commercial computer software" as defined in DFARS 252.227-7013 (Oct 1988), DFARS 252.211-7015 (May 1991) or DFARS 252.227-7014 (Jun 1995), as a "commercial item" as defined in FAR 2.101(a), or as "Restricted computer software" as defined in FAR 52.227-19 (Jun 1987)(or any equivalent agency regulation or contract clause), whichever is applicable. You have only those rights provided for such Software and Documentation by the applicable FAR or DFARS clause or the Agilent standard software agreement for the product involved.

---

Agilent E1300B and E1301B Mainframes Service Manual  
Edition 3 Rev 3

## Printing History

The Printing History shown below lists all Editions and Updates of this manual and the printing date(s). The first printing of the manual is Edition 1. The Edition number increments by 1 whenever the manual is revised. Updates, which are issued between Editions, contain replacement pages to correct the current Edition of the manual. Updates are numbered sequentially starting with Update 1. When a new Edition is created, it contains all the Update information for the previous Edition. Each new Edition or Update also includes a revised copy of this printing history page. Many product updates or revisions do not require manual changes and, conversely, manual corrections may be done without accompanying product changes. Therefore, do not expect a one-to-one correspondence between product updates and manual updates.

Edition 1 (Part Number E1300-90001). . . . . October 1989                      Edition 3 Rev 3 . . . . . September 2012  
Edition 2 (Part Number E1300-90002). . . . . September 1990  
Edition 3 (Part Number E1300-90005). . . . . November 1991  
Edition 3 Rev 2 (Part Number E1300-90005) . . . February 2006

## Trademark Information

Microsoft® and MS-DOS® are U.S. registered trademarks of Microsoft Corporation. IBM® and PC-DOS® are U.S. registered trademarks of International Business Machines Corporation. DEC®, VT100®, and VT220® are registered trademarks of Digital Equipment Corporation. WYSE® is a registered trademark of Wyse Technology. WY-30™ is a trademark of Wyse Technology. Macintosh® is a registered trademark of Apple Computer Inc.

---

## Safety Symbols



Instruction manual symbol affixed to product. Indicates that the user must refer to the manual for specific WARNING or CAUTION information to avoid personal injury or damage to the product.



Alternating current (AC).



Direct current (DC).



Indicates hazardous voltages.



Indicates the field wiring terminal that must be connected to earth ground before operating the equipment—protects against electrical shock in case of fault.

**WARNING**

Calls attention to a procedure, practice, or condition that could cause bodily injury or death.

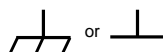

Frame or chassis ground terminal—typically connects to the equipment's metal frame.

**CAUTION**

Calls attention to a procedure, practice, or condition that could possibly cause damage to equipment or permanent loss of data.

---

## WARNINGS

**The following general safety precautions must be observed during all phases of operation, service, and repair of this product. Failure to comply with these precautions or with specific warnings elsewhere in this manual violates safety standards of design, manufacture, and intended use of the product. Agilent Technologies assumes no liability for the customer's failure to comply with these requirements.**

**Ground the equipment:** For Safety Class 1 equipment (equipment having a protective earth terminal), an uninterruptible safety earth ground must be provided from the mains power source to the product input wiring terminals or supplied power cable.

**DO NOT operate the product in an explosive atmosphere or in the presence of flammable gases or fumes.**

For continued protection against fire, replace the line fuse(s) only with fuse(s) of the same voltage and current rating and type. DO NOT use repaired fuses or short-circuited fuse holders.

**Keep away from live circuits:** Operating personnel must not remove equipment covers or shields. Procedures involving the removal of covers or shields are for use by service-trained personnel only. Under certain conditions, dangerous voltages may exist even with the equipment switched off. To avoid dangerous electrical shock, DO NOT perform procedures involving cover or shield removal unless you are qualified to do so.

**DO NOT operate damaged equipment:** Whenever it is possible that the safety protection features built into this product have been impaired, either through physical damage, excessive moisture, or any other reason, REMOVE POWER and do not use the product until safe operation can be verified by service-trained personnel. If necessary, return the product to an Agilent Technologies Sales and Service Office for service and repair to ensure that safety features are maintained.

**DO NOT service or adjust alone:** Do not attempt internal service or adjustment unless another person, capable of rendering first aid and resuscitation, is present.

**DO NOT substitute parts or modify equipment:** Because of the danger of introducing additional hazards, do not install substitute parts or perform any unauthorized modification to the product. Return the product to an Agilent Technologies Sales and Service Office for service and repair to ensure that safety features are maintained.

# Declaration of Conformity

Declarations of Conformity for this product and for other Agilent products may be downloaded from the Internet. There are two methods to obtain the Declaration of Conformity:

- Go to <http://regulations.corporate.agilent.com/DoC/search.htm> . You can then search by product number to find the latest Declaration of Conformity.
- Alternately, you can go to the product web page ([www.agilent.com/find/E1300B](http://www.agilent.com/find/E1300B)), click on the Document Library tab then scroll down until you find the Declaration of Conformity link.

# Agilent 75000 Series B Documentation

---

## Manual Descriptions

**Installation and Getting Started Guide.** Contains step-by-step instructions for all aspects of plug-in module and mainframe installation. This guide also contains introductory programming information and examples.

**Agilent E1300B/E1301B Mainframe User's Manual.** Contains programming information for the mainframe, front panel operation information (for the Agilent E 1301B mainframe), and general programming information for instruments installed in the mainframe.

**Plug-In Module User's Manuals.** Contains plug-in module programming and configuration information. These manuals contains examples for the most-used module functions, and a complete TMSL command reference for the plug-in module.

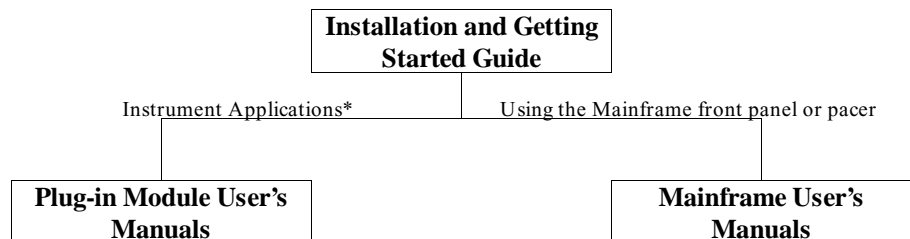

\* For Scanning Voltmeter Applications, refer to the Agilent E 1326A/E1411A 5 1/2 Digit Multimeter User's Manual.

## Suggested Sequence for Using the Manuals

---

## Related Documents

**Agilent Instrument BASIC User's Handbook.** Includes three books: *Agilent Instrument BASIC Programming Techniques*, *Agilent Instrument BASIC Interfacing Techniques*, and *Agilent Instrument BASIC Language Reference*.

**Using Agilent Instrument BASIC with the E1405.** Contains information on the version of Agilent Instrument Basic which can be installed in ROM in your E 1405B Command Module.

**Beginner's Guide to SCPI.** Explains the fundamentals of programming instruments with Standard Commands for Programmable Instruments (SCPI). We recommend this guide to anyone who is programming with TMSL for the first time.

**Tutorial Description of the General Purpose Interface Bus.** Describes the technical fundamentals of the General Purpose Interface Bus (GPIB). This book also includes general information on IEEE 488.2 Common Commands. We recommend this book to anyone who is programming with IEEE 488.2 for the first time.

**IEEE Standard 488.2-1987, IEEE Standard Codes, Formats, Protocols, and Common Commands.** Describes the underlying message formats and data types used in TMSL and defines Common Commands. You may find this document useful if you need to know the precise definition of certain message formats, data types, or Common Commands. Available from: The Institute of Electrical and Electronic Engineers, Inc.; 345 East 47th Street; New York, NY 10017; USA

**VXIbus System Specifications.** Agilent part number E 1400-90006.

**The VMEbus Specification.** Available from: VMEbus International Trade Association; 10229 N. Scottsdale Road, Suite E; Scottsdale, AZ 85253; U.S.A.

# About this Manual

---

## Manual Content

|  |  |
|--|--|
|  | This manual shows how to use the Agilent E1300/E1301 Mainframe and how to operate and program instruments within the mainframe using SCPI (Standard Commands for Programmable Instruments) commands and IEEE 488.2 Common Commands. For installation and configuration information refer to the "Agilent 75000 Series B Installation and Getting Started Guide". |
| <b>Chapter 1:<br/>Getting Started</b>                          | This chapter contains a mainframe description, discusses the instrument concept, and contains introductory programming examples.   |
| <b>Chapter 2: Using the<br/>Front Panel</b>                    | This chapter describes how to use the Agilent E1301 mainframe's front panel keyboard and display to operate instruments in the mainframe.  |
| <b>Chapter 3: Using the Display<br/>Terminal Interface</b>     | This chapter describes how to use a display terminal to operate instruments in the mainframe.  |
| <b>Chapter 4: Using the<br/>Mainframe</b>                      | This chapter shows how to use the mainframe's Pacer, how to change the primary GPIB address, and how to synchronize internal and external instruments using the mainframe's Trigger In and Event Out ports.  |
| <b>Chapter 5: Downloading<br/>Device Drivers</b>               | This chapter contains information on downloading device drivers into non-volatile memory using both GPIB and RS-232 connections.   |
| <b>Chapter 6: Controlling<br/>Instruments using GPIB</b>       | This chapter shows some general concepts for operating instruments in the mainframe using IEEE 488.2 Common Commands and the GPIB interface.   |
| <b>Chapter 7:<br/>Command Reference</b>                        | The command reference contains a detailed description of each System Instrument command. It includes information on the choice of settings and examples showing the context in which the command is used. It also contains command references for the supported IEEE 488.2 Common Commands and IEEE 488.1 GPIB Messages.   |
| <b>Appendix A: Specification</b>                               | This appendix contains a list of the Mainframe's operating specifications.   |
| <b>Appendix B:<br/>Error Messages</b>                          | This appendix lists SCPI error codes and messages for the System Instrument, and possible causes.  |
| <b>Appendix C: Connecting &amp;<br/>Configuring a Terminal</b> | This appendix shows how to set-up a terminal for use with the Display Terminal Interface described in Chapter 3.   |
| <b>Appendix D: Sending Binary<br/>Data Over RS-232</b>         | This Appendix contains information on transferring binary files over an RS-232 interface. It includes information on how these files are coded for transmission.   |



# Table of Contents

---

## 1. Getting Started

|   |     |
|---|-----|
| Using This Chapter . . . . .                | 1-1 |
| Mainframe Description . . . . .             | 1-1 |
| Optional Mainframe Memory . . . . .         | 1-1 |
| Instrument Definition . . . . .             | 1-3 |
| Instrument Logical Addresses . . . . .      | 1-4 |
| Instrument Secondary Addresses . . . . .    | 1-4 |
| Unassigned Modules . . . . .                | 1-4 |
| Introductory Programming Examples . . . . . | 1-4 |

## 2. Using the Front Panel

|  |      |
|--|------|
| Using this Chapter . . . . .               | 2-1  |
| Front Panel Features . . . . .             | 2-1  |
| Using Menus . . . . .                      | 2-2  |
| A 60-Second Menu Tutorial . . . . .        | 2-2  |
| Using the System Instrument Menu . . . . . | 2-3  |
| Using the Other Instrument Menus . . . . . | 2-5  |
| Monitor Mode . . . . .                     | 2-8  |
| Executing Commands . . . . .               | 2-9  |
| Editing . . . . .                          | 2-9  |
| Key Descriptions . . . . .                 | 2-10 |
| Menu Keys . . . . .                        | 2-10 |
| Display Control & Editing Keys . . . . .   | 2-10 |
| Instrument Control Keys . . . . .          | 2-11 |
| Other Keys . . . . .                       | 2-11 |
| In Case of Difficulty . . . . .            | 2-12 |
| Instrument Menus . . . . .                 | 2-13 |

## 3. Using the Display Terminal Interface

|  |      |
|--|------|
| Using this Chapter . . . . .               | 3-1  |
| Terminal Interface Features . . . . .      | 3-2  |
| Using Menus . . . . .                      | 3-3  |
| A 60-Second Menu Tutorial . . . . .        | 3-3  |
| Using the System Instrument Menu . . . . . | 3-5  |
| Using the Other Instrument Menus . . . . . | 3-8  |
| 3-11                                       |      |
| Monitor Mode . . . . .                     | 3-11 |
| Executing Commands . . . . .               | 3-13 |
| Editing . . . . .                          | 3-13 |
| General Key Descriptions . . . . .         | 3-14 |
| Menu and Menu Control Keys . . . . .       | 3-14 |
| Editing Keys . . . . .                     | 3-14 |
| Instrument Control Keys . . . . .          | 3-15 |
| Other Keys . . . . .                       | 3-15 |

|   |      |
|---|------|
| Using Supported Terminals . . . . .           | 3-16 |
| The Supported Terminals . . . . .             | 3-16 |
| Using the HP 700/22 . . . . .                 | 3-17 |
| Using the WYSEØ WY-30œ . . . . .              | 3-19 |
| Using Other Terminals . . . . .               | 3-19 |
| What “Not Supported” Means . . . . .          | 3-20 |
| Testing Terminals for Compatibility . . . . . | 3-20 |
| Using a Terminal Without Menus . . . . .      | 3-21 |
| In Case of Difficulty . . . . .               | 3-23 |
| Instrument Menus . . . . .                    | 3-25 |

#### **4. Using the Mainframe**

|   |     |
|---|-----|
| Using this Chapter . . . . .                              | 4-1 |
| Using the Pacer . . . . .                                 | 4-1 |
| Changing the Primary GPIB Address . . . . .               | 4-3 |
| Synchronizing Internal and External Instruments . . . . . | 4-3 |
| Mainframe Data Memory . . . . .                           | 4-6 |
| Using Mainframe Data Memory . . . . .                     | 4-6 |
| Non-Volatile User Memory . . . . .                        | 4-7 |
| Allocating a User Memory Segment . . . . .                | 4-7 |
| Locating the NRAM segment . . . . .                       | 4-7 |
| Using :DOWNload and :UPload? to Access Data . . . . .     | 4-9 |
| Data Formats for :DOWNload . . . . .                      | 4-9 |

#### **5. Downloading Device Drivers**

|   |      |
|---|------|
| About this Chapter . . . . .                              | 5-1  |
| What You Will Need . . . . .                              | 5-1  |
| Memory Configuration . . . . .                            | 5-3  |
| Download Program Configuration . . . . .                  | 5-4  |
| Editing the Configuration File . . . . .                  | 5-4  |
| Downloading Drivers in MS-DOS Systems . . . . .           | 5-6  |
| Downloading Drivers in GPIB Systems with IBASIC . . . . . | 5-7  |
| Downloading Drivers in GPIB Systems with BASIC . . . . .  | 5-8  |
| Downloading Multiple Drivers . . . . .                    | 5-9  |
| Checking Driver Status . . . . .                          | 5-9  |
| Manually Downloading a Driverdown manual . . . . .        | 5-10 |
| Preparing Memory for Manual Downloading . . . . .         | 5-10 |
| Manually Downloading Over GPIB . . . . .                  | 5-11 |
| Manually Downloading Over RS-232 . . . . .                | 5-11 |

#### **6. Controlling Instruments Using GPIB**

|  |     |
|--|-----|
| About this Chapter . . . . .               | 6-1 |
| Programming Hints . . . . .                | 6-1 |
| Status System Structure . . . . .          | 6-2 |
| The Status Byte Register . . . . .         | 6-3 |
| Reading the Status Byte Register . . . . . | 6-4 |
| Service Request Enable Register . . . . .  | 6-5 |

|  |      |
|--|------|
| The Service Request Bit . . . . .                                | 6-5  |
| Clearing the Service Request Enable Register . . . . .           | 6-5  |
| Standard Event Status Register . . . . .                         | 6-6  |
| Unmasking Standard Event Status Bits . . . . .                   | 6-6  |
| Reading the Standard Event Status Enable Register Mask . . . . . | 6-7  |
| Reading the Standard Event Status Register . . . . .             | 6-7  |
| Operation Status Group . . . . .                                 | 6-7  |
| Reading the Condition Register . . . . .                         | 6-8  |
| Unmasking the Operation Event Register Bits . . . . .            | 6-8  |
| Clearing the Operation Event Register Bits . . . . .             | 6-9  |
| Using the Operation Status Group Registers . . . . .             | 6-9  |
| Clearing Status . . . . .  | 6-10 |
| Interrupting an External Computer . . . . .                      | 6-10 |
| Synchronizing an External Computer and Instruments . . . . .     | 6-12 |

## 7. System Instrument Command Reference

|  |      |
|--|------|
| About This Chapter . . . . .                     | 7-1  |
| Command Types . . . . .                          | 7-1  |
| Common Command Format . . . . .                  | 7-1  |
| SCPI Command Format . . . . .                    | 7-1  |
| Linking Commands . . . . .                       | 7-3  |
| SCPI Command Reference . . . . .                 | 7-4  |
| ABORt . . . . .                                  | 7-4  |
| DIAGnostic . . . . .                             | 7-5  |
| INITiate . . . . .                               | 7-29 |
| [SOURce] . . . . .                               | 7-30 |
| STATus . . . . .                                 | 7-32 |
| SYSTem . . . . .                                 | 7-35 |
| TRIGger . . . . .                                | 7-51 |
| VXI 7-54   |      |
| Common Command Reference . . . . .               | 7-65 |
| *CLS . . . . .                                   | 7-66 |
| *DMC < name_string> , < command_block> . . . . . | 7-66 |
| *EMC < enable> . . . . .                         | 7-66 |
| *EMC? . . . . .                                  | 7-66 |
| *ESE < mask> . . . . .                           | 7-66 |
| *ESE? . . . . .                                  | 7-67 |
| *ESR? . . . . .                                  | 7-67 |
| *GMC? < name_string> . . . . .                   | 7-67 |
| *IDN? . . . . .                                  | 7-68 |
| *LMC? . . . . .                                  | 7-68 |
| *LRN? . . . . .                                  | 7-68 |
| *OPC . . . . .                                   | 7-69 |
| *OPC? . . . . .                                  | 7-69 |
| *PMC . . . . .                                   | 7-69 |
| *PSC < flag> . . . . .                           | 7-69 |
| *PSC? . . . . .                                  | 7-69 |
| *RCL < state number> . . . . .                   | 7-70 |
| *RMC < name_string> . . . . .                    | 7-70 |
| *RST . . . . .                                   | 7-70 |
| *SAV < state number> . . . . .                   | 7-70 |

|   |      |
|---|------|
| *SRE < mask> . . . . .                                      | 7-70 |
| *SRE? . . . . .   | 7-71 |
| *STB? . . . . .   | 7-71 |
| *TRG . . . . .  | 7-71 |
| *TST? . . . . .   | 7-71 |
| *WAI . . . . .  | 7-71 |
| GPIB Message Reference . . . . .                            | 7-72 |
| Go To Local (GTL) . . . . .                                 | 7-72 |
| Group Execute Trigger (GET) . . . . .                       | 7-72 |
| Interface Clear (IFC) . . . . .                             | 7-72 |
| Device Clear (DCL) or Selected Device Clear (SDC) . . . . . | 7-73 |
| Local Lockout (LLO) . . . . .                               | 7-73 |
| Remote . . . . .  | 7-74 |
| Serial Poll (SPOLL) . . . . .                               | 7-74 |
| Command Quick Reference . . . . .                           | 7-75 |

## A. Specifications

|   |      |
|---|------|
| Mainframe Specifications . . . . .                    | A-1  |
| Pacer (50% duty cycle): . . . . .                     | A-1  |
| Real-time Clock: . . . . .                            | A-1  |
| Trigger Input: . . . . .                              | A-1  |
| Non-volatile added memory storage lifetime: . . . . . | A-1  |
| Slots: . . . . .                                      | A-1  |
| EMC, RFI, Safety: . . . . .                           | A-1  |
| Size: . . . . .                                       | A-2  |
| Weight: . . . . .                                     | A-2  |
| Power: . . . . .                                      | A-2  |
| Cooling: . . . . .                                    | A-2  |
| Humidity: . . . . .                                   | A-2  |
| Operating temperature: . . . . .                      | A-2  |
| Storage temperature: . . . . .                        | A-2  |
| SCPI Conformance Information . . . . .                | A-3  |
| Switchbox Configuration . . . . .                     | A-3  |
| Multimeter Commands . . . . .                         | A-4  |
| Counter Commands . . . . .                            | A-6  |
| D/A Converter Commands . . . . .                      | A-8  |
| Digital I/O Commands . . . . .                        | A-9  |
| System Instrument Commands . . . . .                  | A-10 |

## B. Error Messages

|   |     |
|---|-----|
| Using This Appendix . . . . .                 | B-1 |
| Reading an Instrument's Error Queue . . . . . | B-1 |
| Error Types . . . . .                         | B-2 |
| Command Errors . . . . .                      | B-2 |
| Execution Errors . . . . .                    | B-2 |
| Device-Specific Errors . . . . .              | B-2 |
| Query Errors . . . . .                        | B-2 |
| Start-up Error Messages . . . . .             | B-5 |

**C. Connecting and Configuring a Display Terminal**

|  |     |
|--|-----|
| Using this Appendix . . . . .                      | C-1 |
| Overview . . . . .                                 | C-1 |
| Connecting a Terminal to the Mainframe . . . . .   | C-1 |
| Configuring a Terminal for the Mainframe . . . . . | C-3 |
| Starting with Default Mainframe Settings . . . . . | C-3 |
| Restoring the Default Configuration . . . . .      | C-3 |
| Configuring the Terminal . . . . .                 | C-3 |
| Trying it . . . . .                                | C-4 |
| Configuring the Mainframe with Menus . . . . .     | C-4 |

**D. Sending Binary Data Over RS-232**

|  |     |
|--|-----|
| About this Appendix . . . . .                            | D-1 |
| Formatting Binary Data for RS-232 Transmission . . . . . | D-1 |
| Sending Binary Data Over RS-232 . . . . .                | D-2 |
| Setting Up the Mainframe . . . . .                       | D-2 |



## Getting Started

---

### Using This Chapter

This chapter describes the Agilent E 1300B/E 1301B Mainframe, defines the instrument concept, and explains how plug-in modules are designated as instruments in the mainframe. This chapter also contains introductory programming examples showing how to read and set the mainframe's clock and calendar. This chapter contains the following sections:

- Mainframe Description . . . . . 1-1
- Instrument Definition . . . . . 1-3
- Introductory Programming Examples . . . . . 1-4

---

### Mainframe Description

The Agilent E 1301B mainframe contains a front panel keyboard and display; the Agilent E 1300B has no keyboard or display. Otherwise, there is no conceptual difference between the two mainframes. Both models provide a terminal based user interface (Display Terminal Interface) through the built-in, or optional plug-in serial interfaces. The front panel keyboard and display are discussed in Chapter 2 of this manual. The Display Terminal Interface is discussed in Chapter 3.

The mainframe handles such high level operations as language translation of IEEE-488.2 Common Commands and SCPI (Standard Commands for Programmable Instruments) commands; module-to-module synchronization; and memory management. When installed in the mainframe, SCPI-compatible register-based plug-in modules behave as independent instruments operating under control of SCPI commands and Common Commands. Plug-in modules that are not SCPI-compatible must be programmed at a register level (see the VXI:REG:WRITE and VXI:REG:READ? commands in Chapter 5 of this manual for more information). Figure 1-2 shows the E 1300B/E 1301B Mainframe's A- and B-size plug-in module slots, GPIB\* connector, RS-232 port, and input/output ports.

### Optional Mainframe Memory

The mainframe comes from the factory with 256 kBytes of non-volatile memory (RAM) for reading storage. You can install up to 2 MBytes of optional RAM. The E 1320A provides 500 kBytes while the E 1321A provides 1 MByte of memory. Optional RAM replaces the standard memory and is *not* in addition to it (e.g. the mainframe with an optional 1 Mbyte module has 1Mbyte available).

\* GPIB is the implementation of IEEE Std 488.1-1978.

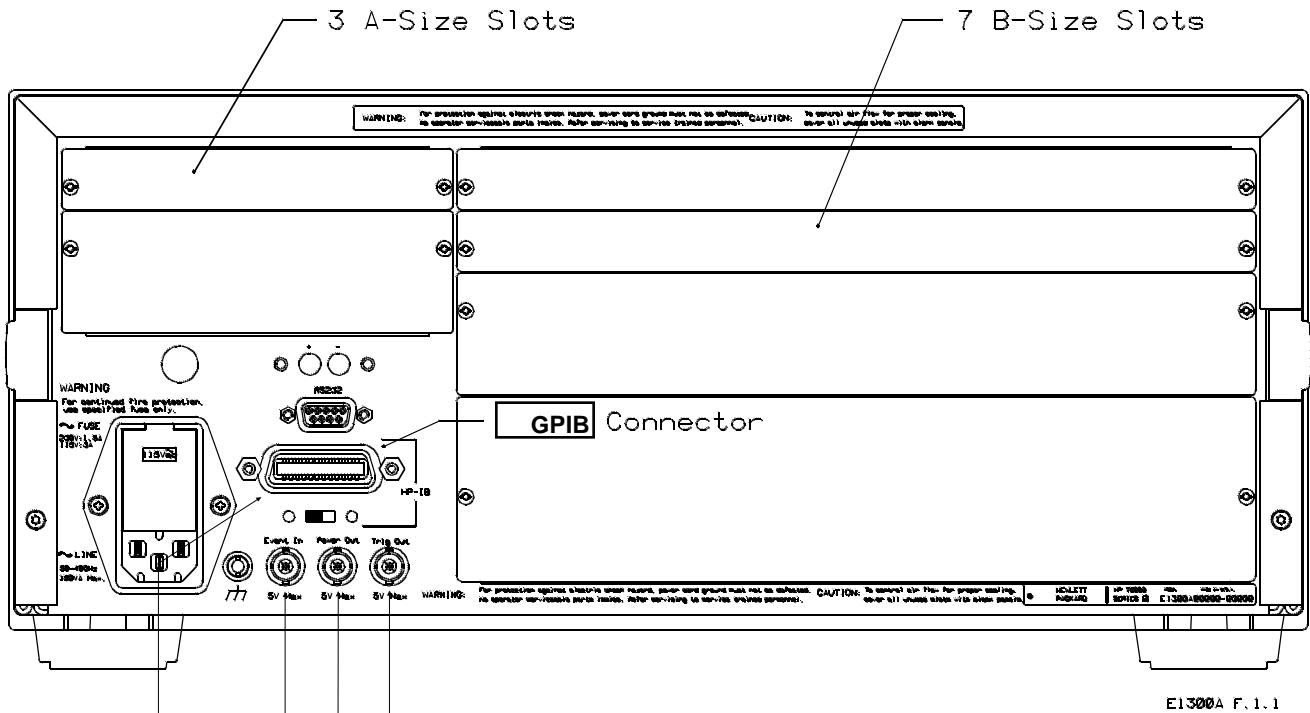

**Trig Out:** Allows an instrument to output a negative-going pulse to indicate the occurrence of some event such as closing a channel on a Switchbox Instrument. The signal levels are standard TTL (0V to 5V). This pulse can be used to synchronize external equipment to the instrument (see Chapter 5 for examples). You direct the pulse from the appropriate instrument to the Trig Out port using the OUTP:STAT ON command.

**Pacer Out:** Allows you to output a square wave signal to trigger or pace external equipment such as scanners or voltmeters. You can control the period of the square wave signal and the number of periods output. The signal levels are standard TTL (0V to 5V). Refer to Chapters 4 and 5 for more information on the Pacer.

**Event In:** Allows an instrument to be armed or triggered from an external negative-going signal. The signal levels are standard TTL (0V to 5V). Use an instrument's ARM:SOUR:EXT command or the TRIG:SOUR:EXT command to direct the Event In port to that instrument.

**RS-232:** Serial interface provides a user interface using a terminal or a computer running terminal emulator software. The user interface provides the functionality of the E 1301's keyboard and display. If present, the optional IBASIC interpreter can be configured to control the RS-232 port.

Figure 1-1. Mainframe Features



## Instrument Definition

SCPI-compatible plug-in modules installed in the mainframe are treated as independent instruments each having a unique secondary GPIB address. As shown in Figure 1-3, each instrument is assigned a dedicated error queue, input and output buffers, status registers and, if applicable, dedicated mainframe memory space for readings or data. An instrument may be composed of a single plug-in module (such as a counter) or multiple plug-in modules (for a Switchbox or Scanning Voltmeter Instrument). In addition, the mainframe contains a built-in instrument called the System Instrument which has a Pacer for timing external devices. The System Instrument also can control the built-in RS-232, as well as up to seven optional Agilent E 1324A plug-in serial interfaces.

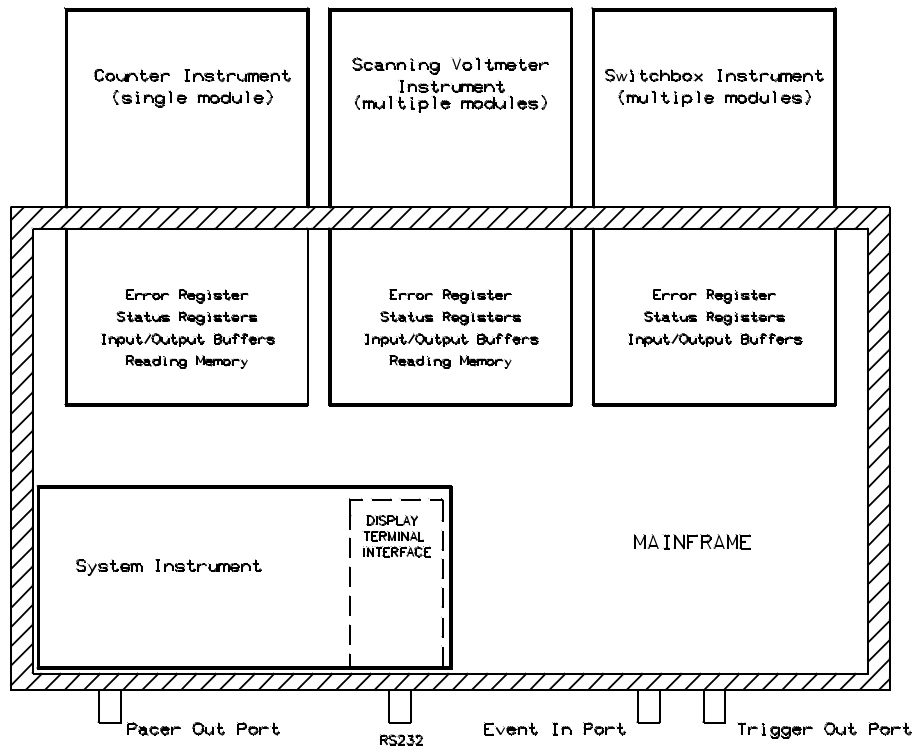

E1300A F. 1.2:

Figure 1-2. Instrument Concept

## Instrument Logical Addresses

Instruments are identified by a logical address which directly relates to its GPIB secondary address. Instruments come from the factory with a preset logical address. You can change the factory setting during installation (see the "Agilent 75000 Series B Installation and Getting Started Guide" for instructions).

A single-module instrument must have its logical address set to an integer multiple of 8 (0, 8, 16, 24, ... 240). In a multiple-module instrument, only one of the modules has a logical address that is an integer multiple of 8. The other modules in the multiple-module instrument must have consecutive logical addresses. For example, in a Scanning Voltmeter, if the voltmeter module has a logical address of 16, the other modules in that instrument must have logical addresses of 17, 18, 19 and so on. The same applies to the System Instrument whose logical address is fixed at 0. An E 1324A plug-in serial interface controlled by the System Instrument would be set to logical address 1. A second E 1324A would be set to logical address 2 and so on.

## Instrument Secondary Addresses

An instrument's GPIB secondary address is simply the logical address divided by 8 (for a multiple-module instrument, the lowest logical address divided by 8). For example, an instrument with a logical address of 16 has a secondary address of 02. The secondary address allows access to a particular instrument when programming via GPIB. (The System Instrument's secondary address is 00 and is the only address that cannot be changed).

## Unassigned Modules

An unassigned module in an E 1300B/E 1301B Mainframe is one that does not have a logical address that is a multiple of 8 (8, 16, 24...240) and is not part of a Scanning Voltmeter or Switchbox configuration. You can only program these modules at the register level using the VXI:WRITE and VXI:READ? commands (see Chapter 5 of this manual for more information on these commands).

---

## Introductory Programming Examples

This section shows how to send SCPI and Common Commands to the mainframe's System Instrument and how to read data back. The following assumes that you send the commands or read the data over GPIB. To send SCPI commands or to read data, specify the:

- Computer's GPIB interface address
- Mainframe's GPIB primary address
- Instrument's GPIB secondary address
- SCPI command string or Common Command

For instruments in the mainframe, the primary address is the same as the mainframe address (i.e., the factory setting is 09). The instrument's secondary address is simply the logical address divided by 8 (e.g., logical addresses of 8, 16, 24, or 32, result in secondary addresses of 01, 02, 03, or 04, respectively).

**Example: Reading the Time**

This program reads and prints the time from the System Instrument's internal clock. The computer used in the example is an Agilent Series 200/300 computer with Agilent BASIC as the program language. The computer interfaces to the mainframe using the General Purpose Interface Bus (GPIB). The GPIB interface select code is 7, the GPIB primary address is 09, and the GPIB secondary address is 00 (System Instrument). Resulting in a combined address of 70900.

|                              |   |
|------------------------------|---|
| 10 OUTPUT 70900;"* RST"      | <i>Reset System Instrument using Common Command</i> |
| 20 OUTPUT 70900;"SYST:TIME?" | <i>Send SCPI query command to return time</i>       |
| 30 ENTER 70900; H,M,S        | <i>Place hour in H, minutes in M, seconds in S</i>  |
| 40 PRINT H,M,S               | <i>Print time</i>                                   |
| 50 END                       |   |

**Typical response:** + 16, + 15, + 30 (4:15:30 PM)

**Example: Setting the Time**

Set the clock using the 24 hour *hour,minute,second* format. Execute the following line to set the time to 14,00,00 (i.e., 2:00:00 PM).

SYST:TIME 14,00,00

**Example: Reading the Date**

This program reads and prints the date stored in the mainframe's internal calendar.

|                              |   |
|------------------------------|---|
| 10 OUTPUT 70900;"SYST:DATE?" | <i>Send SCPI query command to return date</i> |
| 20 ENTER 70900; Y,M,D        | <i>Place year in Y, month in M, day in D</i>  |
| 30 PRINT Y,M,D               | <i>Print date</i>                             |
| 40 END                       |   |

**Typical response:** + 1989, + 9, + 16 (September 16, 1989)

**Example: Setting the Date**

Set the date using the *YYYY,MM,DD* format. Executing the following line sets the date to 1990,1,13 (January 13, 1990).

SYST:DATE 1990,1,13



## Using the Front Panel

### Using this Chapter

This chapter shows you how to use the Agilent E1301B Mainframe's front panel keyboard and display to operate instruments in the mainframe. It contains the following sections:

- Front Panel Features ..... 2-1
- Using Menus ..... 2-2
- Executing Commands ..... 2-9
- Key Descriptions ..... 2-10
- In Case of Difficulty ..... 2-12
- Instrument Menus ..... 2-13

### Front Panel Features

Figure 2-1 shows the front panel's QWERTY keyboard and the dedicated key groupings. The tutorials in this chapter show how to use most of the dedicated keys. See "Key Descriptions" near the end of this chapter for a complete description of each dedicated key.

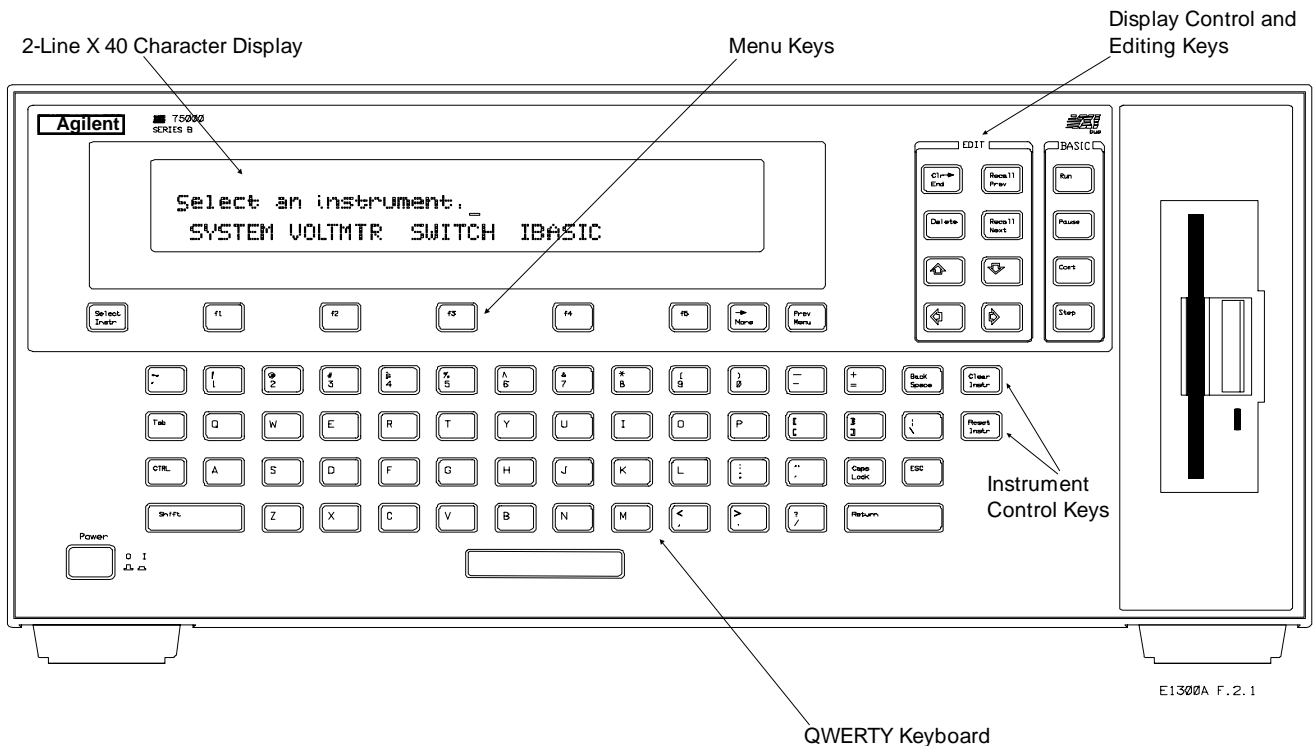
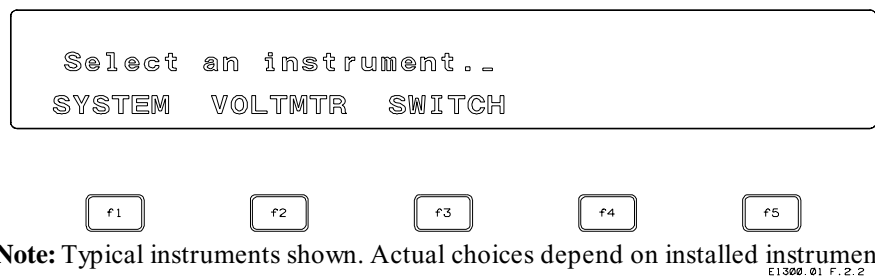

Figure 2-1. Front Panel Features

## Using Menus

You can access a System Instrument menu and a variety of other instrument menus (depending on installed instruments) from the front panel. These menus incorporate the most used functions but do not provide access to all of the instrument commands. If a particular function is not available from a menu, you can type the corresponding command string and execute it from the front panel. See “Executing Commands” later in this chapter for more information.

When you select an instrument, you are assigning the keyboard and display to that instrument. This means that any menu operations, commands executed or recalled, errors displayed, etc. pertain only to that instrument. Front panel operation of an instrument is independent from other instruments and independent from the remote operation of the instrument. To operate another instrument from the front panel, you must select that instrument.



**Note:** Typical instruments shown. Actual choices depend on installed instruments

**Figure 2-2. Select an Instrument Menu**

### A 60-Second Menu Tutorial

Following the power-on sequence or a system reset the display shows the *Select an instrument* menu (see Figure 2-2) which lets you select one of the instruments listed.

The menu keys are located directly below the display. To select a displayed menu choice, press the function key (**f1 - f5**) directly below the choice. This chapter shows key labels in bold text.

- When there are more than five menu choices, an arrow appears on the right side of the display. Press **More** to display the next group of choices. By repeatedly pressing **More** you can display all groups of choices. After you have displayed all groups of choices, pressing **More** again returns to the first group of choices.
- When the display is requesting information (input prompt) such as *Enter the device's logical address*, just type the information and press **Return**.

If you press the wrong menu key and do not want to enter the requested information, you can escape the input prompt and stay at the same menu level by pressing **ESC** or **Prev Menu**.

If you make an incorrect entry in response to an input prompt, the top line of the display will show an error message. When this happens, just select that menu choice again (**f1 - f5** keys), re-type the correct information, and press **Return**.

- Press **Prev Menu** to return to the previous menu within an instrument menu or escape from an input prompt. Press **Select Instr** to return to the *Select an Instrument* menu. Note that when you leave an instrument and return later, you return to the same menu location you were when you left. In addition, any other displayed information (instrument responses or commands being entered) will also be displayed when you return.
- In addition to the menu keys, **Clear Instr** and **Reset Instr** are helpful when operating an instrument. **Clear Instr** clears the instrument's front panel input and output buffers (remote buffers are not cleared) and returns to the top level of the instrument menu. Press **Clear Instr** whenever an instrument is busy, is not responding to front panel control, or to abort a command being entered from the front panel. **Reset Instr** clears all front panel and remote input and output buffers and resets the instrument.

### Using the System Instrument Menu

The System Instrument menu allows you to:

- Set or read the system GPIB address
- Reset (reboot) the mainframe
- Display the logical addresses of installed instruments
- Display information about installed instruments

#### How to Set or Read the System GPIB Address

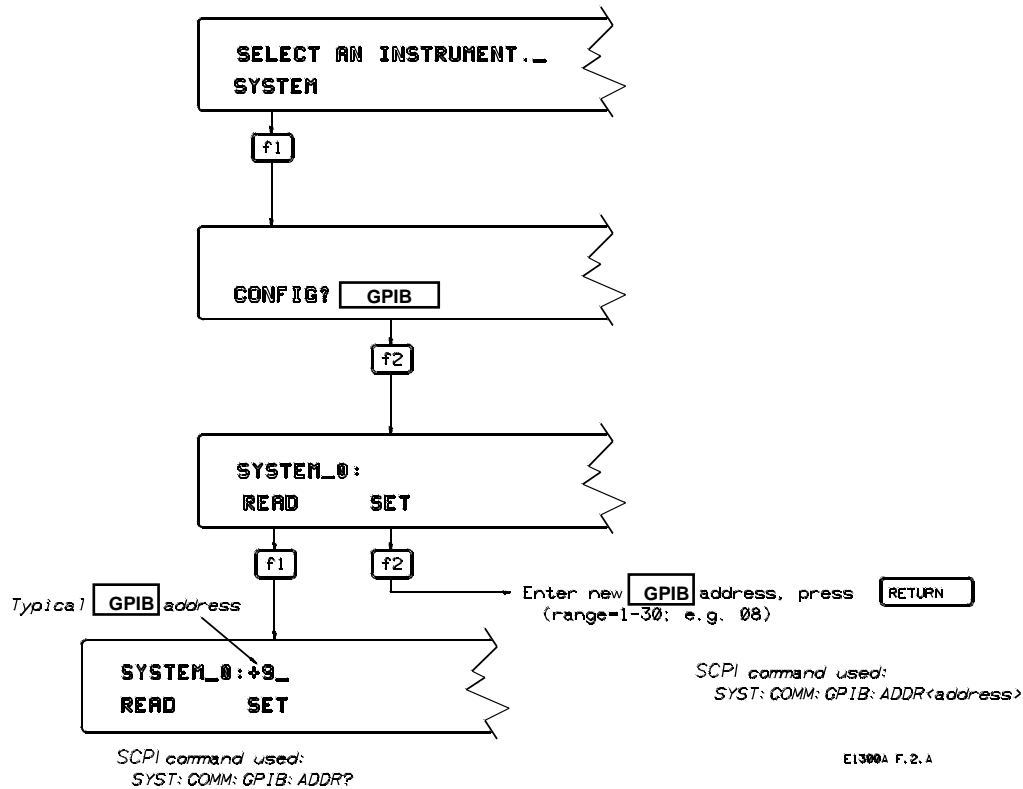

## How to Reset the System

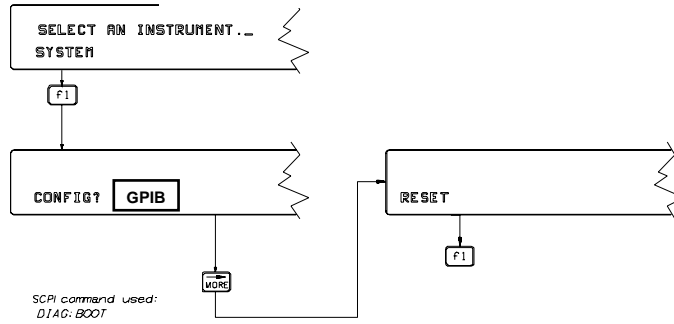

Note: The RESET menu selection is equivalent to the DIAG:BOOT command which has the same effect as cycling power to the mainframe. Pressing Reset Instr from the System Instrument menu is equivalent to executing the \*RST command which resets the System Instrument.

## How to Display Logical Addresses or Instrument Information

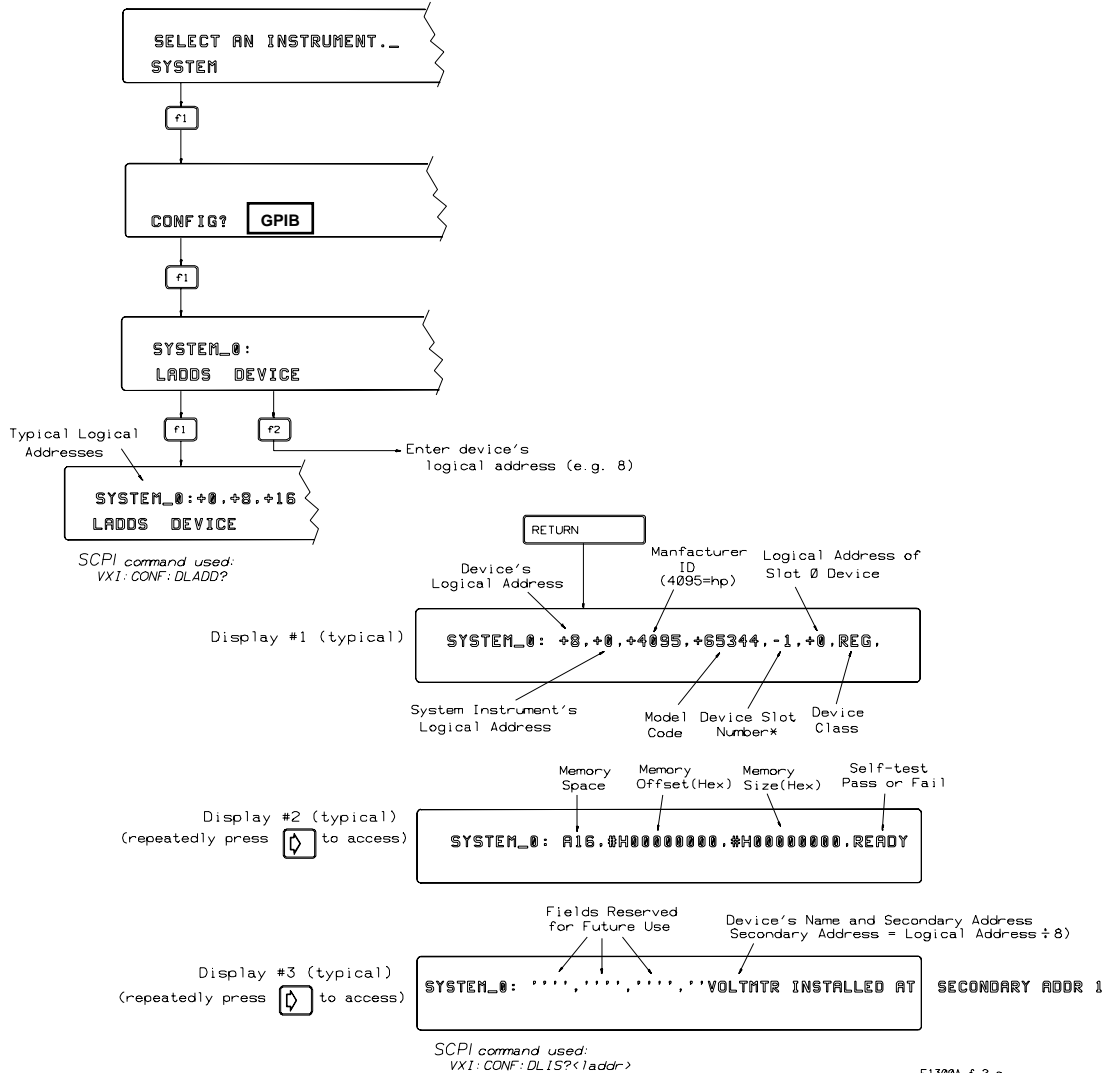



## Using the Other Instrument Menus

The instrument menus allow you to access the most-used instrument functions or to monitor an instrument (monitor mode) while it is being controlled from remote. We'll use the Switchbox menu to show you how to use the instrument menus. Menus are available for many but not all instruments. See "Instrument Menus", later in this chapter, for more information on a particular instrument's menu. The Switchbox menu allows you to:

- Open and Close Channels
- Scan Channels
- Display Module Type and Description
- Monitor a Switchbox
- Reset a selected switch module

### Selecting the Switchbox

To select the Switchbox, press the function key (**f1 - f5**) directly below the word SWITCH in the "*Select an instrument*" menu. (If the "*Select an instrument*" menu is not being displayed press **Select Instr.**)

---

### Note

After you press the function key below the word SWITCH, the top line of the display may show: "*Select SWITCH at logical address: \_*" while the bottom line of the display lists two or more logical addresses. This means more than one Switchbox is installed in the mainframe. To select one of the Switchboxes, press the function key directly below the corresponding logical address.

---

The charts on the following pages show how to use the Switchbox menu. Keep the following points in mind when using the menu:

- The card number identifies a module within the Switchbox. The module with the lowest logical address is always card number 01. The module with the next successive logical address is card number 02 and so on.
- The @ character is required preceding a channel list when executing a Switchbox command from the front panel or remote. When entering a channel list in response to a menu prompt however, do not precede it with the @ character. Doing so causes a syntax error.

## How to Open/Close Channels

Switchbox instrument at logical address 16  
(Secondary address = 02)

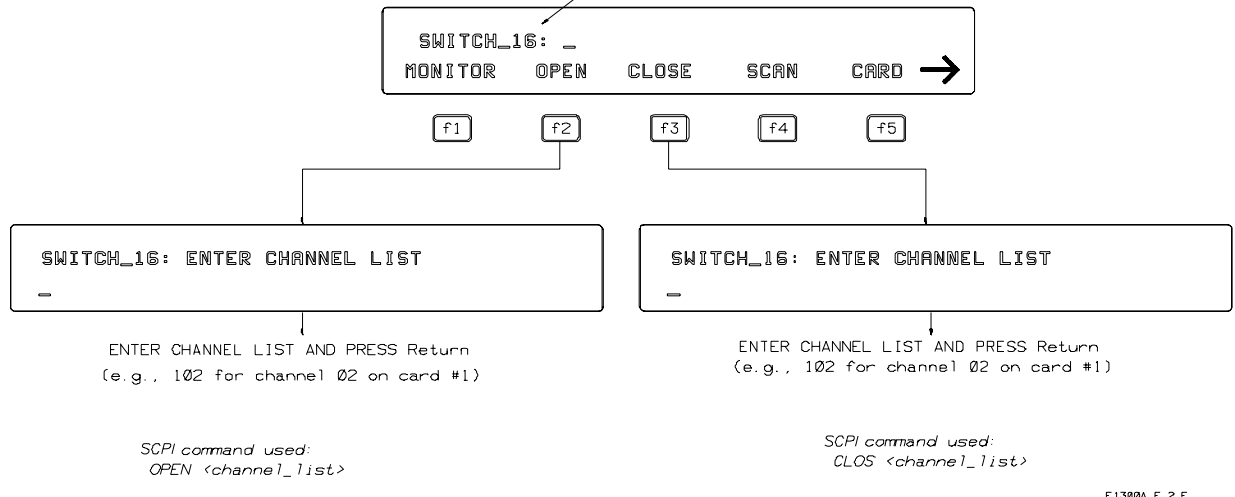

## How to Scan Channels

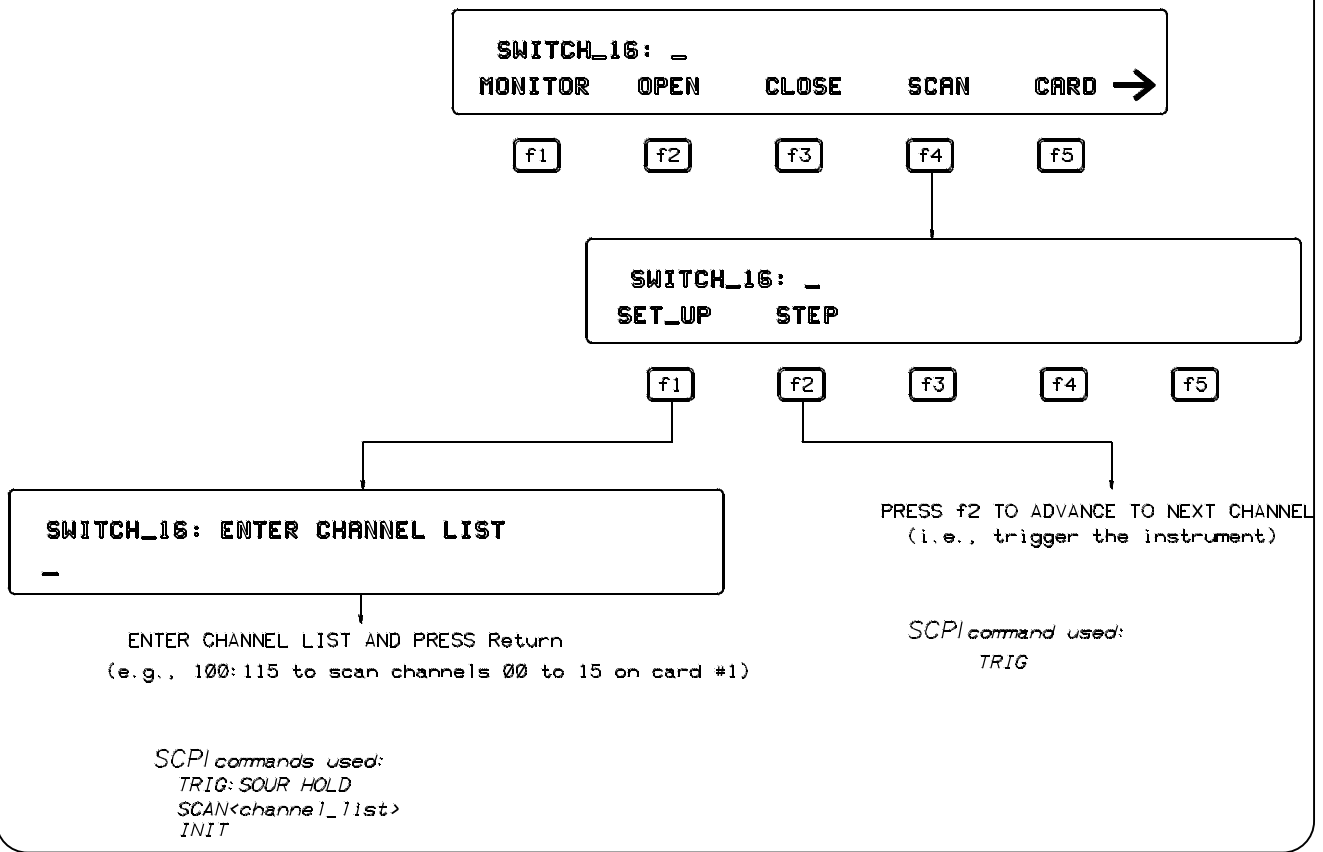

## How to Display Monitor Type, Description, or Reset Module

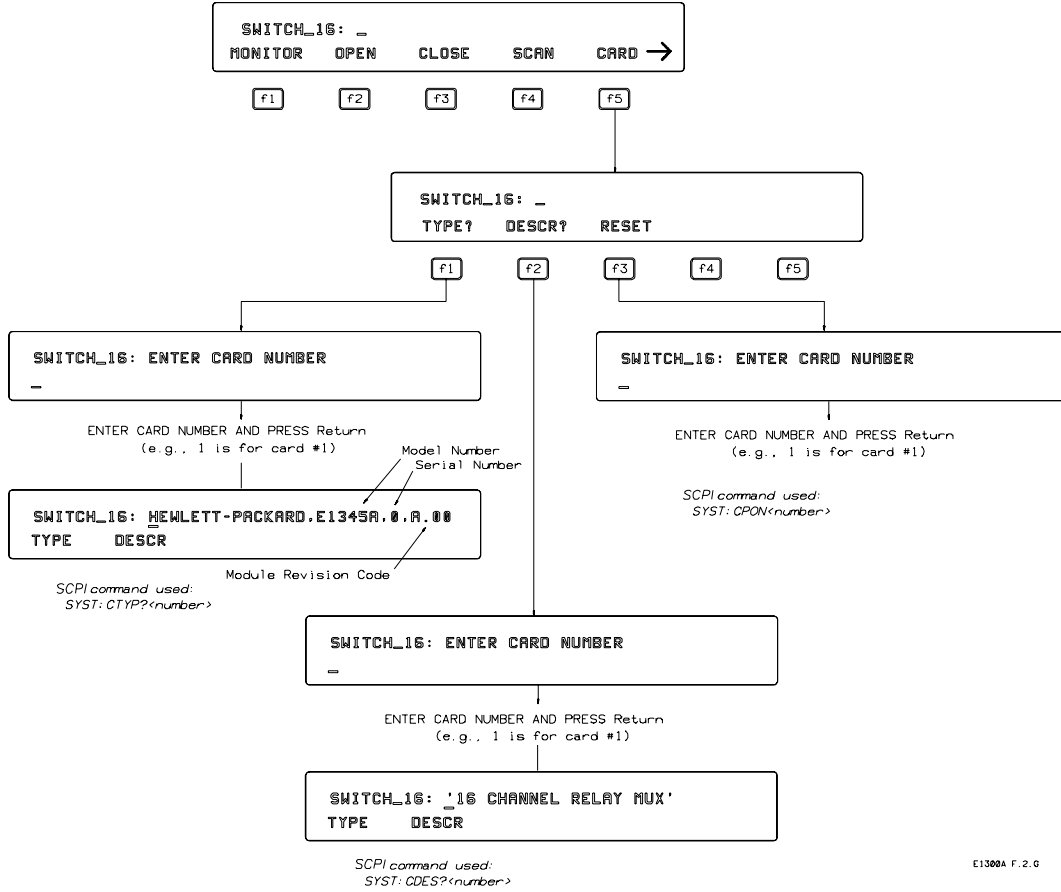

## How to Select Monitor Mode

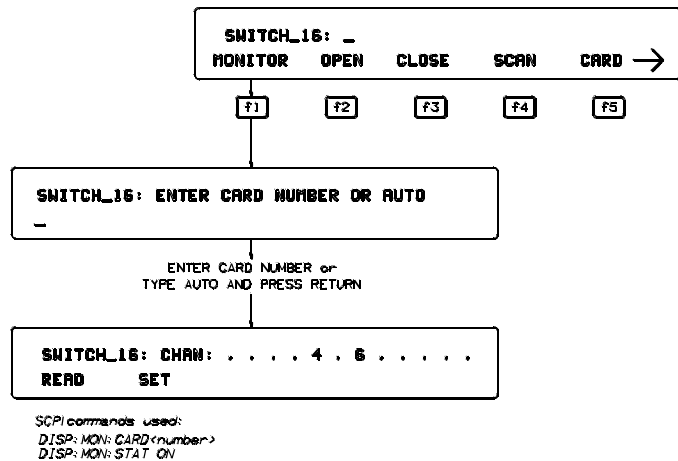

## Monitor Mode

Monitor mode displays the status of an instrument while it is being controlled from remote. Monitor mode is useful for debugging programs. You can place an instrument in monitor mode using front panel menus, or by executing the `DISP:MON:STAT ON` command from the front panel or by remote. (Executing the remote `DISP:MON:STAT ON` command is the only way to assign the display/keyboard to an instrument from remote.) Pressing most front panel keys will automatically exit monitor mode and return to the instrument menu. However, you can use the left and right arrow keys in monitor mode to view long displays.

## Note

Enabling monitor mode slows instrument operations. If the timing or speed of instrument operations is critical (such as making multimeter readings at a precise time interval), you should not use monitor mode.

Table 2-8 shows the status annunciators that may appear in the bottom line of the display in monitor mode. Some instruments also have device-specific annunciators (see the plug-in module manual for more information).

**Table 2-1. Monitor Mode Display Annunciators**

| Annunciator | Description  |
|-------------|--|
| mon         | The instrument is in monitor mode                          |
| bsy         | The instrument is executing a command                      |
| err         | An error has occurred (see “Reading Error Messages” below) |
| srq         | A service request has occurred                             |

## Reading Error Messages

Whenever the display is showing the *err* annunciator, an error has occurred for the instrument being monitored. You can read the error message, although doing so cancels monitor mode. To read an error message, press the following keys:



The error message will be displayed in the top line of the display. To see if another error was logged, repeat the above keystrokes or press:



After you have read all the error messages, executing the `SYST:ERR?` command causes the display to show: `+ 0 No error`. After reading the error message(s), press **f1** to return to monitor mode.

---

## Executing Commands

From the front panel, you can type and execute IEEE 488.2 Common Commands and SCPI Commands for the instrument presently selected by the *Select an instrument* menu. (However, you cannot execute a command when the display is requesting that you input information.) This is particularly useful for accessing functions not available in an instrument's menu. For example, the System Instrument contains a Pacer that can be programmed to output a square wave signal on the mainframe's Pacer Out port. From the System Instrument menu, you can program the Pacer to output 10 square wave cycles with a period of 1 second each by typing the following commands and pressing **Return** after each command (see Chapter 3 for more information on the Pacer).

```
SOUR:PULS:COUN 10
SOUR:PULS:PER 1
INIT:IMM
TRIG:SOUR IMM
```

As another example, after selecting the Switchbox, suppose you must set up and execute a scan list with automatic advance (automatic advance is not available from the menu). You can do this by typing the following command string and pressing **Return** (notice that by linking the commands together with a semicolon and colon you need press **Return** only once).

```
TRIG:SOUR IMM;:SCAN (@100:105);:INIT
```

## Editing

The display editing keys (shown on the following page) allow you to edit user-entered data or commands. When editing, the display is in insert mode. That is, typed characters will be inserted into the string at the present cursor position.

## Key Descriptions

This section explains the function of each of the front panel's dedicated keys. If a key is not functional in a particular situation, pressing that key does nothing except to cause a beep. Users of the optional IBASIC interpreter should refer to their IBASIC manual set for additional editing functions.

### Menu Keys



Selects the menu choice displayed directly above each key.



Returns to the *Select an instrument* menu.



Returns to the previous menu level within an instrument menu or escapes from an input prompt. When you reach the top of an instrument's menu, pressing **Prev Menu** does nothing except to cause a beep.



The display can show a maximum of five menu choices at a time. When there are more than five menu choices, an arrow appears on the right side of the display. Press **More** to display the next group of choices. By repeatedly pressing **More** you can display all groups of choices. After you have displayed all groups of choices, pressing **More** again returns to the first group of choices.



Recalls the last command entered from the front panel. After recalling a command, it can be edited or re-executed. You can recall from a stack of previously executed commands by repeatedly pressing **Recall Prev**. When you reach the bottom of the stack (the last line in the buffer), pressing **Recall Prev** does nothing except to cause a beep. Pressing **Shift** with **Recall Prev** recalls the last SCPI command generated by a menu operation. For example, reading the time using the menus (SYSTEM, TIME, READ) generates and executes the SCPI command SYST:TIME?. A recalled command can be executed by pressing the **Return** key. You can also edit a recalled command before you execute it.



Accesses commands in the opposite order to that of **Recall Prev**. Pressing **Recall Next** does nothing until you have pressed **Recall Prev** at least twice.



Performs the same function as **Prev Menu**.

### Display Control & Editing Keys



(Right arrow key.) Moves the cursor one character space to the right while leaving characters intact. Use the right arrow key to scroll displays that are longer than the display size. Pressing **Shift** followed by the right arrow key moves the cursor to the end of the line. Pressing **CTRL** followed by the right arrow key moves the cursor 4 character spaces to the right.



(Left arrow key.) Moves the cursor one character space to the left while leaving characters intact. Use the left and right arrow keys to scroll displays that are longer than the display size. Pressing **Shift** followed by the left arrow key moves

the cursor to the beginning of the line. Pressing **CTRL** followed by the left arrow key moves the cursor 4 character spaces to the left.



Erases the character at the present cursor position (for user-entered data only).



Erases the character to the left of the cursor (for user-entered data only).



(Clear-to-end key.) Erases all characters from the present cursor position to the end of the input line (for user-entered data only). Pressing **Shift** followed by the clear-to-end key erases the entire line and moves the cursor to the beginning of the line.

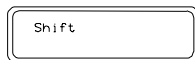

Selects the upper-case alphabetic characters or the character shown on the top half of a key. You can either hold down **Shift** while pressing another key or press and release **Shift** and then press another key.



Sets all alphabetic keys to uppercase (capitals); does not affect the other keys. To return to lowercase, press **Caps Lock** again.

## Instrument Control Keys



Resets only the selected instrument (equivalent of executing \*RST). **Reset Instr** also clears the instrument's front panel and remote input and output buffers. **Reset Instr** is the only front panel key that can affect an instrument being operated from remote.



Clears the front panel input and output buffers (remote buffers are not cleared) of the selected instrument and returns to the top level of the instrument menu. Press **Clear Instr** whenever an instrument is busy, is not responding to front panel control, or to abort a command being entered from the front panel.

## Other Keys



End of line. Enters your responses to menu prompts. Executes commands entered from the front panel keyboard.



Selects alternate key definitions. You can either hold down **CTRL** while pressing another key or press and release **CTRL** and then press another key. These CTRL key sequences provide short-cuts for some menu key sequences as well as additional functions not directly available from dedicated front panel keys. For a complete list of all CTRL key sequences see table 3-3 in the next chapter.

## In Case of Difficulty

| Problem:  | Problem Cause/Solution:   |
|---|---|
| Error -113 undefined header error occurs after entering data in response to a menu prompt.  | For some commands used by the menus, the data entered is appended to a command header. For example, if you enter "1" as the port number for a digital I/O module, the command used is DIG:HAND1:MODE NONE where HAND1 indicates the port number. If your entry was invalid or incorrect, error -113 occurs.   |
| Following the power-on sequence or system reset the display shows:<br><br>Configuration errors. Select SYSTEM<br>Press any key to continue_         | An unassigned device (incorrect logical address) was detected, or the contents of non-volatile memory may have been lost. If you cycle power or perform system reset, the display will show the logical address of the unassigned device. You can also check the logical addresses using the CONFIG? -- LADDS branch of the System Instrument menu. Refer to Chapter 1 of this manual for a discussion of logical addresses and unassigned devices. |
| The display shows: "instrument in local lockout". Menus seem to work but nothing happens when I reach the bottom level or try to execute a command. | The front panel has been locked-out (GPIB local lockout). You can re-enable menu operation by cancelling local lockout (from remote) or by cycling mainframe power.   |
| Display cannot be removed from monitor mode.  | Monitor mode was entered from remote (DISP:MON:STAT ON command) and the front panel has also been locked out (GPIB local lockout). Either cancel the local lockout or execute DISP:MON:STAT OFF (from remote).  |
| Display shows:<br><br>Can not connect to instrument<br>Press any key to continue_   | A hardware or software problem has occurred in the instrument preventing it from responding to front panel control.   |
| After selecting an instrument the display shows:<br><br>busy.   | The instrument is busy performing an operation. Press <b>Clear Instr</b> to abort the instrument operations and allow the front panel to access the instrument.   |
| Display shows:<br><br>Instrument in use by another display.<br>Press any key to continue_   | The instrument has already been selected from the Display Terminal Interface. An instrument can only be "attached" to one display at a time. At the terminal, return to the "Select instrument" menu. The instrument can now be selected from the Front Panel.  |



---

## Instrument Menus

This section contains charts showing the structure and content for all front panel instrument menus. Also shown in the charts are the SCPI or Common Commands used and descriptions of menu-controlled instrument operations.

This section contains the following charts:

- System Instrument Menu . . . . . 2-14
- Switchbox Menu . . . . . 2-16
- Scanning Voltmeter Menu . . . . . 2-18
- Agilent E 1326A 5 1/2 Digit Multimeter Menu . . . . . 2-20
- Agilent E 1328A 4-Channel D/A Converter Menu . . . . . 2-21
- Agilent E 1330A Quad 8-Bit Digital I/O Menu . . . . . 2-22
- Agilent E 1332A 4-Channel Counter/Totalizer Menu . . . . . 2-24
- Agilent E 1333A 3-Channel Universal Counter Menu . . . . . 2-26

**2-14 Using the Display Terminal Interface**

**System Instrument Menu**

Menu Levels and Content

| Level 1 | Level 2 | Level 3 | Level 4 | Level 5 | Level 6 | User Entry | Command(s) Used                 | Description  |
|---------|---------|---------|---------|---------|---------|------------|---------------------------------|--|
| SYSTEM  | CONFIG? | LADDRS  |         |         |         |            | VXI:CONF:DLIAD?                 | Displays logical addresses of mainframe instruments  |
|         |         | DEVICE  |         |         |         |            | VXI:CONF:DLIS? < log_addr >     | Displays information about the device at the specified logical address. (Refer to the Command Reference for details) |
|         | GPIB    | READ    |         |         |         |            | SYST:COMM:GPIB:ADDR?            | Displays GPIB address  |
|         |         | SET     |         |         |         |            | SYST:COMM:GPIB:ADDR < address > |  |
|         | RS232   | BAUD    |         |         |         |            | SYST:COMM:SER[n]:BAUD?          | Read current baud rate   |
|         |         | READ    |         |         |         |            | SYST:COMM:SER[n]:BAUD 300       | Sets the serial interface baud rate to 300   |
|         |         | SET     |         |         |         |            | SYST:COMM:SER[n]:BAUD 1200      | Sets the serial interface baud rate to 1200  |
|         |         |         |         |         |         |            | SYST:COMM:SER[n]:BAUD 2400      | Sets the serial interface baud rate to 2400  |
|         |         |         |         |         |         |            | SYST:COMM:SER[n]:BAUD 9600      | Sets the serial interface baud rate to 9600  |
|         |         |         |         |         |         |            | SYST:COMM:SER[n]:BAUD 19200     | Sets the serial interface baud rate to 19200   |
|         |         | PARITY  |         |         |         |            | SYST:COMM:SER[n]:PAR?           | Read current parity type   |
|         |         | READ    |         |         |         |            | SYST:COMM:SER[n]:PAR EVEN       | Sets the serial interface parity to even   |
|         |         | SET     |         |         |         |            | SYST:COMM:SER[n]:PAR ODD        | Sets the serial interface parity to odd  |
|         |         |         |         |         |         |            | SYST:COMM:SER[n]:PAR ONE        | Sets the serial interface parity to one  |
|         |         |         |         |         |         |            | SYST:COMM:SER[n]:PAR ZERO       | Sets the serial interface parity to zero   |
|         |         |         |         |         |         |            | SYST:COMM:SER[n]:PAR NONE       | Sets the serial interface parity to none   |
|         |         | BITS    |         |         |         |            | SYST:COMM:SER[n]:BITS?          | Read current data bit width  |
|         |         | READ    |         |         |         |            | SYST:COMM:SER[n]:BITS 7         | Sets the data width to 7 bits  |
|         |         | SET     |         |         |         |            | SYST:COMM:SER[n]:BITS 8         | Sets the data width to 8 bits  |
|         |         | PACE    |         |         |         |            | SYST:COMM:SER[n]:PACE?          | Read current pacing type   |
|         |         | READ    |         |         |         |            | SYST:COMM:SER[n]:PACE XON       | Enables XON/ XOFF software handshaking   |
|         |         | SET     |         |         |         |            | SYST:COMM:SER[n]:PACE NONE      | Disables XON/ XOFF software handshaking  |

(continued on following page)

# System Instrument Menu

Menu Levels and Content

| Level 1 | Level 2 | Level 3 | Level 4 | Level 5 | Level 6                        | User Entry           | Command(s) Used                      | Description   |
|---------|---------|---------|---------|---------|--------------------------------|----------------------|--------------------------------------|---|
|         |         |         |         |         | (continued from previous page) |                      |                                      |   |
|         |         | CONTROL | DTR     | READ    |                                | card number          | SYST:COMM:SER[n]:CONT:DTR?           | Read current setting for DTR line                                       |
|         |         |         |         | SET     | ON                             | card number          | SYST:COMM:SER[n]:CONT:DTR ON         | Set DTR line to static + V  |
|         |         |         |         |         | OFF                            | card number          | SYST:COMM:SER[n]:CONT:DTR OFF        | Set DTR line to static -V   |
|         |         |         |         |         | IBFULL                         | card number          | SYST:COMM:SER[n]:CONT:DTR IBF        | Set DTR for hardware handshaking  |
|         |         |         |         |         | STANDRD                        | card number          | SYST:COMM:SER[n]:CONT:DTR STAN       | DTR operates to RS-232 standard   |
|         |         |         | RTS     | READ    |                                | card number          | SYST:COMM:SER[n]:CONT:RTS?           | Read current setting for RTS line                                       |
|         |         |         |         | SET     | ON                             | card number          | SYST:COMM:SER[n]:CONT:RTS ON         | Set RTS line to static + V  |
|         |         |         |         |         | OFF                            | card number          | SYST:COMM:SER[n]:CONT:RTS OFF        | Set RTS line to static -V   |
|         |         |         |         |         | IBFULL                         | card number          | SYST:COMM:SER[n]:CONT:RTS IBF        | Set RTS for hardware handshaking  |
|         |         |         |         |         | STANDRD                        | card number          | SYST:COMM:SER[n]:CONT:RTS STAN       | RTS operates to RS-232 standard   |
|         |         |         | STORE   |         |                                | card number          | DIAG:COMM:SER[n]:STORE               | Store current serial communications settings into non-volatile storage. |
|         | DEBUG   |         | READ    |         |                                | laddr, reg_num       | VXI:READ? < laddr> , < reg>          | Read register in A16 address space.                                     |
|         |         |         | WRITE   |         |                                | laddr, reg_num, data | VXI:WRIT < laddr> , < reg> , < data> | Write data to register in A16 address space.                            |
|         | TIME    |         | READ    |         |                                | time                 | SYST:TIME?                           | Read the current system clock   |
|         |         |         | SET     |         |                                |                      | SYST:TIME < time>                    | Set the system clock  |
|         | DATE    |         | READ    |         |                                | date                 | SYST:DATE?                           | Read the current system calendar  |
|         |         |         | SET     |         |                                |                      | SYST:DATE < date>                    | Set the system calendar   |
|         | RESET   |         |         |         |                                |                      | DIAG:BOOT                            | Resets mainframe using the configuration stored in non-volatile memory  |

### Switchbox Menu

Menu Levels and Content

| Level 1 | Level 2 | Level 3 | User Entry            | Command(s) Used                             | Description  |
|---------|---------|---------|-----------------------|---|--|
| SWITCH  | MONITOR |         | card number ‡ or AUTO | DISP:MON:CARD < card_number> ;STAT ON       | Monitor instrument operations  |
|         | OPEN    |         | channel list †        | OPEN (@channel_list)                        | Open channel(s)  |
|         | CLOSE   |         | channel list †        | CLOS (@channel_list)                        | Close channel(s)   |
|         | SCAN    | SET_UP  | channel list †        | TRIG:SOUR HOLD::SCAN < channel_list> ::INIT | Set up channels to scan  |
|         |         | STEP    | channel list †        | TRIG  | Step to next channel in scan list                                    |
|         | CARD    | TYPE?   | card number ‡         | SYST:CTYP? < card_number>                   | Display module ID information  |
|         |         | DESCR?  | card number ‡         | SYST:CDES? < card_number>                   | Display module description   |
|         |         | RESET   | card number ‡         | SYST:CPON < card_number>                    | Return module to power-on state                                      |
|         |         | TEST    |                       | *TST?                                       | Runs self-test, displays results (+ 0= pass; any other number= fail) |

† Channel lists are of the form "ccnn" (single channel), "ccnn,ccnn" (two or more channels), "ccnn:ccnn" (range of channels); where "cc" is the card number and "nn" is the channel number. For example, to access channel 2 on card number 1 specify 102.

‡ The card number identifies a module within the Switchbox. The switch module with the lowest logical address is always card number 01. The switch module with the next successive logical address is card number 02 and so on.

*Notes*

### Scanning Voltmeter Menu

Menu Levels and Content

| Level 1 | Level 2 | Level 3 | Level 4 | User Entry                   | Command(s) Used                          | Description                                     |
|---------|---------|---------|---------|------------------------------|--|---|
| VOLTMTR | MONITOR |         |         | channel list † or 0 for auto | DISP:MON:CHAN < channel_list > ; STAT ON | Monitor instrument operations                   |
|         | VDC     |         |         | channel list †               | MEAS:VOLT:DC? < channel_list >           | Measure DC voltage on each channel              |
|         | VAC     |         |         | channel list †               | MEAS:VOLT:AC? < channel_list >           | Measure AC voltage on each channel              |
|         | OHM     |         |         | channel list †               | MEAS:RES? < channel_list >               | Measure 2-wire resistance on each channel       |
|         | TEMP    | TCOUPLE | B       | channel list †               | MEAS:TEMP? TC,B, < channel_list >        | Measure °C of B thermocouple on each channel    |
|         |         |         | E       | channel list †               | MEAS:TEMP? TC,E, < channel_list >        | Measure °C of E thermocouple on each channel    |
|         |         |         | J       | channel list †               | MEAS:TEMP? TC,J, < channel_list >        | Measure °C of J thermocouple on each channel    |
|         |         |         | K       | channel list †               | MEAS:TEMP? TC,K, < channel_list >        | Measure °C of K thermocouple on each channel    |
|         |         |         | N14     | channel list †               | MEAS:TEMP? TC,N14, < channel_list >      | Measure °C of N14 thermocouple on each channel  |
|         |         |         | N28     | channel list †               | MEAS:TEMP? TC,N28, < channel_list >      | Measure °C of N28 thermocouple on each channel  |
|         |         |         | R       | channel list †               | MEAS:TEMP? TC,R, < channel_list >        | Measure °C of R thermocouple on each channel    |
|         |         |         | S       | channel list †               | MEAS:TEMP? TC,S, < channel_list >        | Measure °C of S thermocouple on each channel    |
|         |         |         | T       | channel list †               | MEAS:TEMP? TC,T, < channel_list >        | Measure °C of T thermocouple on each channel    |
|         |         |         | THERMIS | channel list †               | MEAS:TEMP? THER,2252, < channel_list >   | Measure °C of 2252 Ω thermistor on each channel |
|         |         |         | 5K      | channel list †               | MEAS:TEMP? THER,5000, < channel_list >   | Measure °C of 5k Ω thermistor on each channel   |
|         |         |         | 10K     | channel list †               | MEAS:TEMP? THER,10000, < channel_list >  | Measure °C of 10k Ω thermistor on each channel  |
|         |         |         | RTD     | channel list †               | MEAS:TEMP? RTD,85, < channel_list >      | Measure °C of 385 RTD on each channel (4-wire)  |
|         |         |         | 385     | channel list †               | MEAS:TEMP? RTD,92, < channel_list >      | Measure °C of 392 RTD on each channel (4-wire)  |
|         |         |         | 392     | channel list †               | MEAS:TEMP? RTD,92, < channel_list >      | Measure °C of 392 RTD on each channel (4-wire)  |
|         | STRAIN  | QUARTER |         | channel list †               | MEAS:STR:QUAR? < channel_list >          | Measure strain with quarter bridge              |
|         |         | HALF    | BENDING | channel list †               | MEAS:STR:HBEN? < channel_list >          | Measure strain with bending half bridge         |
|         |         |         | POISSON | channel list †               | MEAS:STR:HPO? < channel_list >           | Measure strain with Poisson half bridge         |
|         |         | FULL    | BENDING | channel list †               | MEAS:STR:FBEN? < channel_list >          | Measure strain with bending full bridge         |
|         |         |         | BENPOIS | channel list †               | MEAS:STR:FBP? < channel_list >           | Measure strain with Bending Poisson full bridge |
|         |         |         | POISSON | channel list †               | MEAS:STR:FPO? < channel_list >           | Measure strain with Poisson full bridge         |

(continued on following page)

# Scanning Voltmeter Menu

Menu Levels and Content

| Level 1                        | Level 2 | Level 3 | Level 4 | User Entry     | Command(s) Used                 | Description  |
|--------------------------------|---------|---------|---------|----------------|---------------------------------|--|
| (continued from previous page) |         |         |         |                |                                 |  |
|                                |         | UNSTRN  |         | channel list † | MEAS:STR:UNST? < channel_list > | Measure bridge unstrained  |
|                                |         | DIAG    | COMPRES | channel list † | MEAS:STR:QCOM? < channel_list > | Compression shunt diagnostic   |
|                                |         |         | TENSION | channel list † | MEAS:STR:QTEN? < channel_list > | Tension shunt diagnostic   |
|                                |         | CARD    | TYPE?   | card number ‡  | SYST:CTYP? < card_number >      | Displays module ID information                                       |
|                                |         |         | DESQR?  | card number ‡  | SYST:CDES? < card_number >      | Displays module description  |
|                                |         |         | TEST    |                | *TST?                           | Runs self-test, displays results (+ 0= pass; any other number= fail) |

† Channel lists are of the form "ccnn" (single channel), "conn,conn" (two or more channels), "conn,conn" (range of channels); where "cc" is the card number and "nn" is the channel number. For example, to access channel 2 on card number 1 specify 102.

‡ The card number identifies a module within the Switchbox. The switch module with the lowest logical address is always card number 01. The switch module with the next successive logical address is card number 02 and so on.

### Agilent E1326B/E1411B 5 1/2 Digit Multimeter (Standalone) Menu

Menu Levels and Content

| Level 1 | Level 2 | Level 3 | Level 4 | User Entry | Command(s) Used      | Description  |
|---------|---------|---------|---------|------------|----------------------|--|
| VOLTMTR | MONITOR |         |         |            |                      | Display instrument operations                                    |
|         | VDC     |         |         |            | DISP:MON:STAT ON     | Measure DC volts   |
|         | VAC     |         |         |            | MEAS:VOLT:DC?        | Measure AC volts   |
|         | OHM     |         |         |            | MEAS:VOLT:AC?        | Measure 4-wire ohms  |
|         | TEMP    | THERMIS | 2252    |            | MEAS:TEMP? FTH,2252  | Measure °C of 2252Ω thermistor (4-wire measurement)              |
|         |         |         | 5K      |            | MEAS:TEMP? FTH,5000  | Measure °C of 5kΩ thermistor (4-wire measurement)                |
|         |         |         | 10K     |            | MEAS:TEMP? FTH,10000 | Measure °C of 10kΩ thermistor (4-wire measurement)               |
|         |         | RTD     | 385     |            | MEAS:TEMP FRTD,85?   | Measure °C of 100Ω RTD with alpha = 385 (4-wire measurement)     |
|         |         |         | 392     |            | MEAS:TEMP FRTD,92?   | Measure °C of 100Ω RTD with alpha = 392 (4-wire measurement)     |
|         | TEST    |         |         |            | *TST?                | Run self-test, display results (0= pass; any other number= fail) |

† Channel lists are of the form "ccnn" (single channel), "ccnn,ccnn" (two or more channels), "ccnn:ccnn" (range of channels); where "cc" is the card number and "nn" is the channel number. For example, to access channel 2 on card number 1 specify 102.

‡ The card number identifies a module within the Switchbox. The switch module with the lowest logical address is always card number 01. The switch module with the next successive logical address is card number 02 and so on.



# Agilent E1328A 4-Channel D/A Converter Menu

Menu Levels and Content

| Level 1 | Level 2 | Level 3 | Level 4 | User Entry | Command(s) Used            | Description  |                             |
|---------|---------|---------|---------|------------|----------------------------|--|-----------------------------|
| D/A     | MONITOR | CHAN1   |         |            | DISP:MON:CHAN 1;STAT ON    | Monitor instrument operations on channel 1                         |                             |
|         |         | CHAN2   |         |            | DISP:MON:CHAN 2;STAT ON    | Monitor instrument operations on channel 2                         |                             |
|         |         | CHAN3   |         |            | DISP:MON:CHAN 3;STAT ON    | Monitor instrument operations on channel 3                         |                             |
|         |         | CHAN4   |         |            | DISP:MON:CHAN 4;STAT ON    | Monitor instrument operations on channel 4                         |                             |
|         |         | AUTO    |         |            | DISP:MON:CHAN AUTO;STAT ON | Monitor instrument operations on active channel                    |                             |
|         | OUTPUT  | VOLTAGE | CHAN1   |            | voltage †                  | VOLT1 < voltage>   | Output voltage on channel 1 |
|         |         |         | CHAN2   |            | voltage †                  | VOLT2 < voltage>   | Output voltage on channel 2 |
|         |         |         | CHAN3   |            | voltage †                  | VOLT3 < voltage>   | Output voltage on channel 3 |
|         |         |         | CHAN4   |            | voltage †                  | VOLT4 < voltage>   | Output voltage on channel 4 |
|         |         | CURRENT | CHAN1   |            | current ‡                  | CURR1 < current>   | Output current on channel 1 |
|         |         |         | CHAN2   |            | current ‡                  | CURR2 < current>   | Output current on channel 2 |
|         |         |         | CHAN3   |            | current ‡                  | CURR3 < current>   | Output current on channel 3 |
|         |         |         | CHAN4   |            | current ‡                  | CURR4 < current>   | Output current on channel 4 |
|         | TEST    |         |         |            | *TST?                      | Run self-test, display results (+ 0= pass; any other number= fail) |                             |

†Enter voltage values in volts. Typical examples are: + 3.5, -2, + 500E-3.

‡Enter current values in amps. Typical examples are: .05, + 200E-3.

### Agilent E1330A Quad 8-Bit Digital Input/Output Menu

Menu Levels and Content

| Level 1 | Level 2 | Level 3 | Level 4 | User Entry             | Command(s) Used                              | Description                                      |                                       |
|---------|---------|---------|---------|------------------------|--|--|---------------------------------------|
| DIG_I/O | MONITOR | PORT0   |         |                        | DISP:MON:CHAN 0;STAT ON                      | Monitor instrument operations on port 0          |                                       |
|         |         | PORT1   |         |                        | DISP:MON:CHAN 1;STAT ON                      | Monitor instrument operations on port 1          |                                       |
|         |         | PORT2   |         |                        | DISP:MON:CHAN 2;STAT ON                      | Monitor instrument operations on port 2          |                                       |
|         |         | PORT3   |         |                        | DISP:MON:CHAN 3;STAT ON                      | Monitor instrument operations on port 3          |                                       |
|         |         | AUTO    |         |                        | DISP:MON:CHAN AUTO;STAT ON                   | Monitor instrument operations on any active port |                                       |
|         | READ    | R_BYTE  | PORT0   |                        |  | DIG:HAND0:MODE NONE::MEAS:DIG:DATA0?             | Reads port 0 after handshake          |
|         |         |         | PORT1   |                        |  | DIG:HAND1:MODE NONE::MEAS:DIG:DATA1?             | Reads port 1 after handshake          |
|         |         |         | PORT2   |                        |  | DIG:HAND2:MODE NONE::MEAS:DIG:DATA2?             | Reads port 2 after handshake          |
|         |         | R_BIT   | PORT3   |                        |  | DIG:HAND3:MODE NONE::MEAS:DIG:DATA3?             | Reads port 3 after handshake          |
|         |         |         | PORT0   |                        | bit (0-7)                                    | DIG:HAND0:MODE NONE::MEAS:DIG:DATA0:BITm?        | Reads bit m on port 0 after handshake |
|         |         |         | PORT1   |                        | bit (0-7)                                    | DIG:HAND1:MODE NONE::MEAS:DIG:DATA1:BITm?        | Reads bit m on port 1 after handshake |
|         | WRITE   | W_BYTE  | PORT2   |                        |  | DIG:HAND2:MODE NONE::MEAS:DIG:DATA2:BITm?        | Reads bit m on port 2 after handshake |
|         |         |         | PORT3   |                        |  | DIG:HAND3:MODE NONE::MEAS:DIG:DATA3:BITm?        | Reads bit m on port 3 after handshake |
|         |         |         | PORT0   |                        | data (0-255)                                 | DIG:HAND0:MODE NONE::DIG:DATA0 < data>           | Writes data to port 0                 |
|         |         |         | PORT1   |                        | data (0-255)                                 | DIG:HAND1:MODE NONE::DIG:DATA1 < data>           | Writes data to port 1                 |
| W_BIT   | W_BIT   | PORT2   |         | data (0-255)           | DIG:HAND2:MODE NONE::DIG:DATA2 < data>       | Writes data to port 2                            |                                       |
|         |         | PORT3   |         | data (0-255)           | DIG:HAND3:MODE NONE::DIG:DATA3 < data>       | Writes data to port 3                            |                                       |
|         |         | PORT0   |         | bit (0-7), value (0,1) | DIG:HAND0:MODE NONE::DIG:DATA0:BITm < value> | Writes data to bit m on port 0                   |                                       |
|         |         | PORT1   |         | bit (0-7), value (0,1) | DIG:HAND1:MODE NONE::DIG:DATA1:BITm < value> | Writes data to bit m on port 1                   |                                       |
|         |         | PORT2   |         | bit (0-7), value (0,1) | DIG:HAND2:MODE NONE::DIG:DATA2:BITm < value> | Writes data to bit m on port 2                   |                                       |
|         |         | PORT3   |         | bit (0-7), value (0,1) | DIG:HAND3:MODE NONE::DIG:DATA3:BITm < value> | Writes data to bit m on port 3                   |                                       |

*Notes*

### Agilent E1332A 4-Channel Counter/Totalizer Menu

Menu Levels and Content

| Level 1 | Level 2 | Level 3 | Level 4 | Level 5 | User Entry  | Command(s) Used            | Description                                     |
|---------|---------|---------|---------|---------|-------------|----------------------------|---|
| COUNTER | MONITOR | CHAN1   |         |         |             | DISP:MON:CHAN 1;STAT ON    | Monitor instrument operations on channel 1      |
|         |         | CHAN2   |         |         |             | DISP:MON:CHAN 2;STAT ON    | Monitor instrument operations on channel 2      |
|         |         | CHAN3   |         |         |             | DISP:MON:CHAN 3;STAT ON    | Monitor instrument operations on channel 3      |
|         |         | CHAN4   |         |         |             | DISP:MON:CHAN 4;STAT ON    | Monitor instrument operations on channel 4      |
|         |         | AUTO    |         |         |             | DISP:MON:CHAN AUTO;STAT ON | Monitor instrument operations on active channel |
|         | INPUT   | LEVEL   | CHAN1&2 |         | voltage †   | SENS1:EVEN:LEV < value>    | Set level trigger voltage for channels 1 & 2    |
|         |         |         | CHAN3&4 |         | voltage †   | SENS3:EVEN:LEV < value>    | Set level trigger voltage for channels 3 & 4    |
|         |         | SLOPE   | CHAN1   | POS     |             | SENS1:EVEN:SLOP POS        | Positive level trigger slope for channel 1      |
|         |         |         |         | NEG     |             | SENS1:EVEN:SLOP NEG        | Negative level trigger slope for channel 1      |
|         |         |         | CHAN2   | POS     |             | SENS2:EVEN:SLOP POS        | Positive level trigger slope for channel 2      |
|         |         |         |         | NEG     |             | SENS2:EVEN:SLOP NEG        | Negative level trigger slope for channel 2      |
|         |         |         | CHAN3   | POS     |             | SENS3:EVEN:SLOP POS        | Positive level trigger slope for channel 3      |
|         |         |         |         | NEG     |             | SENS3:EVEN:SLOP NEG        | Negative level trigger slope for channel 3      |
|         |         |         | CHAN4   | POS     |             | SENS4:EVEN:SLOP POS        | Positive level trigger slope for channel 4      |
|         |         |         |         | NEG     |             | SENS4:EVEN:SLOP NEG        | Negative level trigger slope for channel 4      |
|         |         | ISOLATE | ON      |         |             | INP:ISOL ON                | Input isolation on                              |
|         |         |         | OFF     |         |             | INP:ISOL OFF               | Input isolation off                             |
|         |         | FILTER  | ON      |         |             | INP:FILT ON                | Input filter on                                 |
|         |         |         | OFF     |         |             | INP:FILT OFF               | Input filter off                                |
|         |         |         | FREQ    |         | frequency ‡ | INP:FILT:FREQ < value>     | Set input filter frequency                      |
|         | FREQ    | CHAN1   |         |         |             | TRIG:SOUR IMM::MEAS1:FREQ? | Frequency measurement on channel 1              |
|         |         | CHAN3   |         |         |             | TRIG:SOUR IMM::MEAS3:FREQ? | Frequency measurement on channel 3              |
|         | PERIOD  | CHAN1   |         |         |             | TRIG:SOUR IMM::MEAS1:PER?  | Period measurement on channel 1                 |
|         |         | CHAN3   |         |         |             | TRIG:SOUR IMM::MEAS3:PER?  | Period measurement on channel 3                 |

(continued on following page)

# Agilent E1332A 4-Channel Counter/Totalizer Menu

Menu Levels and Content

| Level 1 | Level 2 | Level 3 | Level 4 | Level 5 | User Entry                     | Command(s) Used                 | Description  |
|---------|---------|---------|---------|---------|--------------------------------|---------------------------------|--|
|         |         |         |         |         | (continued from previous page) |                                 |  |
|         | TIMEINT | CHAN1   |         |         |                                | TRIG:SOUR IMM::MEAS1:TINT?      | Time interval measurement on channel 1                             |
|         |         | CHAN3   |         |         |                                | TRIG:SOUR IMM::MEAS3:TINT?      | Time interval measurement on channel 3                             |
|         | POS_PW  | CHAN2   |         |         |                                | TRIG:SOUR IMM::MEAS2:PWID?      | Positive pulse width measurement on channel 2                      |
|         |         | CHAN4   |         |         |                                | TRIG:SOUR IMM::MEAS4:PWID?      | Positive pulse width measurement on channel 4                      |
|         | NEG_PW  | CHAN2   |         |         |                                | TRIG:SOUR IMM::MEAS2:NWID?      | Negative pulse width measurement on channel 2                      |
|         |         | CHAN4   |         |         |                                | TRIG:SOUR IMM::MEAS4:NWID?      | Negative pulse width measurement on channel 4                      |
|         | UDCOUNT | CHAN1   | START   |         |                                | TRIG:SOUR IMM::CONF1:UDC::INIT1 | Up/ down count, subtract ch. 2 count from ch. 1 count              |
|         |         |         | READ    |         |                                | FETC1?                          | Get up/ down count from channels 1 & 2                             |
|         |         | CHAN3   | START   |         |                                | TRIG:SOUR IMM::CONF3:UDC::INIT3 | Up/ down count, subtract ch. 4 count from ch. 3 count              |
|         |         |         | READ    |         |                                | FETC3?                          | Get up/ down count from channels 3 & 4                             |
|         | TOTALIZ | CHAN1   | START   |         |                                | TRIG:SOUR IMM::CONF1:TOT::INIT1 | Totalize on channel 1  |
|         |         |         | READ    |         |                                | FETC1?                          | Get totalize count on channel 1                                    |
|         |         | CHAN2   | START   |         |                                | TRIG:SOUR IMM::CONF2:TOT::INIT2 | Totalize on channel 2  |
|         |         |         | READ    |         |                                | FETC2?                          | Get totalize count on channel 2                                    |
|         |         | CHAN3   | START   |         |                                | TRIG:SOUR IMM::CONF3:TOT::INIT3 | Totalize on channel 3  |
|         |         |         | READ    |         |                                | FETC3?                          | Get totalize count on channel 3                                    |
|         |         | CHAN4   | START   |         |                                | TRIG:SOUR IMM::CONF4:TOT::INIT4 | Totalize on channel 4  |
|         |         |         | READ    |         |                                | FETC4?                          | Get totalize count on channel 4                                    |
|         | TEST    |         |         |         |                                | * TST?                          | Run self-test, display results (+ 0= pass; any other number= fail) |

†Enter voltage values in volts. Typical examples are: + 3.5, -2, + 500E-3.

#Enter frequency value in hertz. Typical examples are: 60, 120, 1E3.

# Agilent E1333A 3-Channel Universal Counter Menu

Menu Levels and Content

| Level 1 | Level 2 | Level 3 | Level 4 | Level 5 | User Entry | Command(s) Used             | Description                                     |  |
|---------|---------|---------|---------|---------|------------|-----------------------------|---|--|
| COUNTER | MONITOR | CHAN1   |         |         |            | DISP:MON:CHAN 1;STAT ON     | Monitor instrument operations on channel 1      |  |
|         |         | CHAN2   |         |         |            | DISP:MON:CHAN 2;STAT ON     | Monitor instrument operations on channel 2      |  |
| INPUT   | LEVEL   | CHAN1   |         |         |            | DISP:MON:CHAN 3;STAT ON     | Monitor instrument operation on channel 3       |  |
|         |         |         | AUTO    |         |            | DISP:MON:CHAN AUTO;STAT ON  | Monitor instrument operations on active channel |  |
|         |         | SLOPE   | POS     |         |            | SENS1:EVEN:LEV< value>      | Set trigger level voltage for channel 1         |  |
|         |         |         | NEG     |         |            | SENS2:EVEN:LEV< value>      | Set trigger level voltage for channel 2         |  |
|         | COUPLE  | AC      | DC      |         |            | SENS1:EVEN:SLOP POS         | Positive trigger slope for channel 1            |  |
|         |         |         | NEG     |         |            | SENS1:EVEN:SLOP NEG         | Negative trigger slope for channel 1            |  |
|         | IMPED   | 50_OHM  | 1_MOHM  | 0dB     |            |                             | SENS2:EVEN:SLOP POS                             | Positive trigger slope for channel 2         |
|         |         |         |         | 20dB    |            |                             | SENS2:EVEN:SLOP NEG                             | Negative trigger slope for channel 2         |
|         | ATTEN   | ON      | OFF     |         |            | INP:COUP AC                 | AC-coupled input (channels 1 & 2 only)          |  |
|         |         |         |         |         |            | INP:COUP DC                 | DC-coupled input (channels 1&2)                 |  |
| FILTER  | CHAN1   | CHAN2   | CHAN3   |         |            | INP:IMP 50                  | 50Ω input resistance (channels 1 & 2 only)      |  |
|         |         |         |         |         |            |                             | INP:IMP 1e6                                     | 1MΩ input resistance (channels 1 & 2 only)   |
| FREQ    | CHAN1   | CHAN2   | CHAN3   |         |            | INP:ATT 0                   | No input attenuation (channels 1 & 2 only)      |  |
|         |         |         |         |         |            |                             | INP:ATT 20                                      | 20dB input attenuation (channels 1 & 2 only) |
| PERIOD  | CHAN1   | CHAN2   |         |         |            | INP:FILT ON                 | Input filter on (channels 1 & 2 only)           |  |
|         |         |         |         |         |            | INP:FILT OFF                | Input filter off (channels 1 & 2 only)          |  |
|         |         |         |         |         |            | TRIG: SOUR IMM;:MEAS1:FREQ? | Frequency measurement on channel 1              |  |
|         |         |         |         |         |            | TRIG: SOUR IMM;:MEAS2:FREQ? | Frequency measurement on channel 2              |  |
|         |         |         |         |         |            | TRIG: SOUR IMM;:MEAS3:FREQ? | Frequency measurement on channel 3              |  |
|         |         |         |         |         |            | TRIG: SOUR IMM;:MEAS1:PER?  | Period measurement on channel 1                 |  |
|         |         |         |         |         |            | TRIG: SOUR IMM;:MEAS2:PER?  | Period measurement on channel 2                 |  |

(continued on following page)

# Agilent E1333A 3-Channel Universal Counter Menu

Menu Levels and Content

| Level 1                        | Level 2 | Level 3  | Level 4 | Level 5 | User Entry | Command(s) Used | Description  |
|--------------------------------|---------|--|---------|---------|------------|-----------------|--|
| (continued from previous page) | TIMEINT | CHAN1<br>└─┬─<br>CHAN2                                       |         |         |            |                 | Time interval measurement on channel 1                             |
|                                | POS_PW  | CHAN1<br>└─┬─<br>CHAN2                                       |         |         |            |                 | Time interval measurement on channel 2                             |
|                                | NEG_PW  | CHAN1<br>└─┬─<br>CHAN2                                       |         |         |            |                 | Positive pulse width measurement on channel 1                      |
|                                | RATIO   | CHAN1<br>└─┬─<br>CHAN2                                       |         |         |            |                 | Positive pulse width measurement on channel 2                      |
|                                | TOTALIZ | CHAN1 ─┬─ START<br>└─┬─ READ<br>CHAN2 ─┬─ START<br>└─┬─ READ |         |         |            |                 | Negative pulse width measurement on channel 1                      |
|                                | TEST    |  |         |         |            |                 | Negative pulse width measurement on channel 2                      |
|                                |         |  |         |         |            |                 | Ratio of channel 1/ channel 2                                      |
|                                |         |  |         |         |            |                 | Ratio of channel 2/ channel 1                                      |
|                                |         |  |         |         |            |                 | Totalize on channel 1  |
|                                |         |  |         |         |            |                 | Display totalize count   |
|                                |         |  |         |         |            |                 | Totalize on channel 2  |
|                                |         |  |         |         |            |                 | Display totalize count   |
|                                |         |  |         |         |            |                 | Run self-test, display results (+ 0= pass; any other number= fail) |

(continued from previous page)

TRIG: SOUR IMM;:MEAS1:TINT?  
 TRIG: SOUR IMM;:MEAS2:TINT?  
 TRIG: SOUR IMM;:MEAS1:PWID?  
 TRIG: SOUR IMM;:MEAS2:PWID?  
 TRIG: SOUR IMM;:MEAS1:NWID?  
 TRIG: SOUR IMM;:MEAS2:NWID?  
 TRIG: SOUR IMM;:MEAS1:RAT?  
 TRIG: SOUR IMM;:MEAS2:RAT?  
 TRIG: SOUR IMM;:CONF1:TOT;:INIT1  
 FETC1?  
 TRIG: SOUR IMM;:CONF2:TOT;:INIT2  
 FETC2?  
 \* TST?

†Enter voltage values in volts. Typical examples are: + 3.5, -2, + 500E-3.

*Notes*



## Using the Display Terminal Interface

---

### Using this Chapter

This chapter shows you how to use the Agilent E 1300B and Agilent E 1301B Mainframes' Display Terminal Interface (terminal interface) to operate instruments in the mainframe. The terminal interface uses the built-in RS-232 and/or the optional Agilent E 1324A Datacomm Module to provide all of the features of the Agilent E 1301B's front panel, plus comfortable keyboard position and full screen display. It contains the following sections:

- Terminal Interface Features . . . . . 3-2
- Using Menus . . . . . 3-3
- Executing Commands . . . . . 3-13
- General Key Descriptions . . . . . 3-14
- Using Supported Terminals . . . . . 3-16
- Using Other Terminals . . . . . 3-19
- In Case of Difficulty . . . . . 3-23
- Instrument Menus . . . . . 3-25

---

### Note

This chapter discusses *using* the display terminal interface. It assumes that you have already connected your terminal and configured it to communicate with your mainframe. For information on connecting and configuring your terminal, refer to Appendix C in this manual.

---

## Terminal Interface Features

Figure 3-2 shows a typical terminal interface display with its function labels across the bottom of the screen. The first five function keys (**f1** through **f5**) select instrument menu choices. Function keys **f6** through **f8** provide menu control and access to utility functions. The tutorials in this chapter show how to use most of the menu control and utility function keys. See “General Key Descriptions” near the end of this chapter for a complete description of each of these key functions.

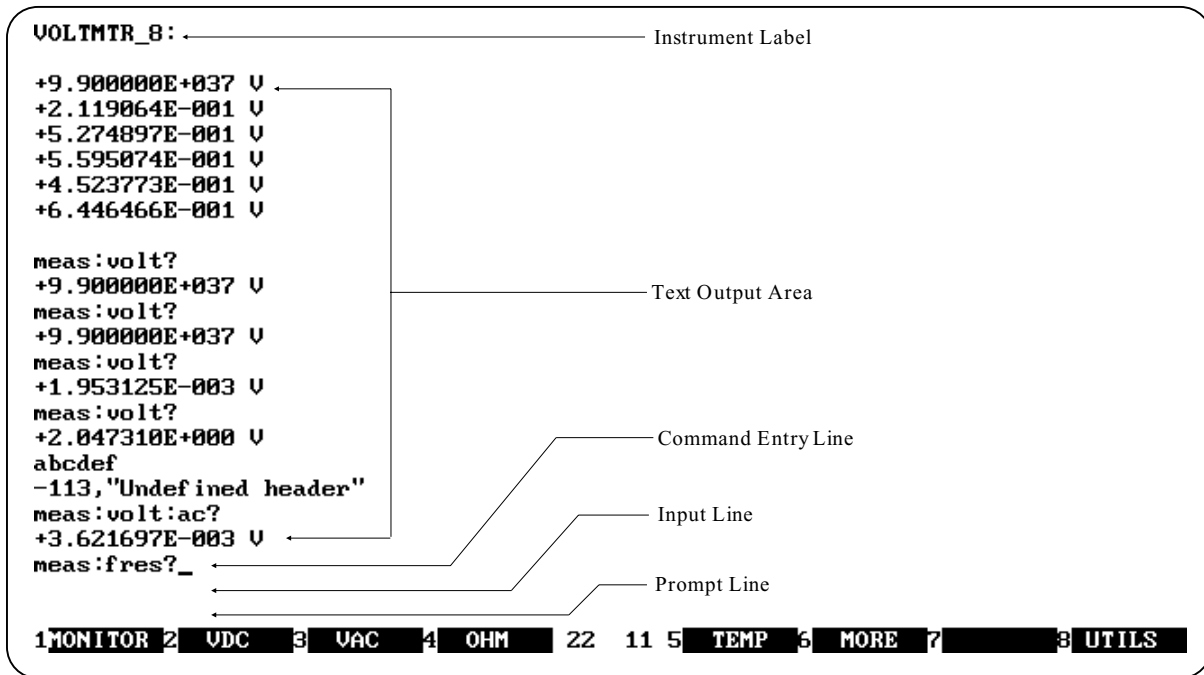

- Notes:**
1. Example screens are from HP AdvanceLink terminal emulator.
  2. Later screen examples are shown compressed (only 4 lines tall) and may show only part of the screen width.

**Figure 3-1. Typical Terminal Interface Display**

---

## Using Menus

A System Instrument menu and a variety of other instrument menus (depending on installed instruments) are available from the terminal interface. These menus incorporate the most used functions but do not provide access to the complete functionality of an instrument. If a particular function is not available from a menu, you can type the corresponding Common Command or SCPI command string and execute it from the terminal interface. See “Executing Commands” later in this chapter for more information.

When you select an instrument, you are assigning the terminal interface to that instrument. This means that any menu operations, commands executed or recalled, errors displayed, etc. pertain only to that instrument. Terminal interface operation of an instrument is independent from other instruments and independent from the remote operation of the instrument. To operate another instrument from the terminal interface, you must select that instrument.

Select an instrument.\_



```
1 SYSTEM 2 VOLTMR 3 SWITCH 4 IBASIC 21 22 5 6 7 8 UTILS
```

**Note:** Typical instruments shown. Actual choices depend on installed instrument

**Figure 3-2. "Select an instrument" Menu**

### A 60-Second Menu Tutorial

Following the power-on sequence or a system reset, the screen shows the *Select an instrument* menu (see Figure 3-2). This menu allows you to select one of the instruments listed.

The menu select and menu control function keys (usually labeled **f1** - **f8** on their key caps) are defined by eight function labels located across the bottom of the terminal screen. Once you learn how these keys operate, using the menus is easy (key labels are shown in bold text in this chapter):

To select a displayed menu choice, press the function key (**f1** - **f5**) which corresponds to the function key label.

- When there are more than five menu choices, function key **f6** becomes labeled **MORE**. Press **MORE** to display the next group of choices. By repeatedly pressing **MORE** you can display all groups of choices. After you have displayed all groups of choices, pressing **MORE** again returns to the first group of choices.
- Whenever the screen is requesting information (input prompt) such as *Enter the device's logical address*, just type the information and press **Return** (may be **Enter** on a terminal emulator).

If you pressed the wrong menu key and do not want to enter the requested information, you can escape the input prompt and stay at the same menu level by pressing **ESC** or **PRV\_MENU**.

If you make an incorrect entry in response to an input prompt, the bottom line of the Text Output Area will show an error message. When this happens, just select that menu choice again (**f1 - f5** keys), re-type the correct information, and press **Return**.

- Press **PRV\_MENU** or **ESC** to return to the previous menu within an instrument menu or escape from an input prompt. Press **SEL\_INST** to return to the *Select an Instrument* menu (see next item). Note that when you leave an instrument and return later, you return to the same menu location you were when you left. In addition, any information below the Text Output Area will also be re-displayed when you return.
- In addition to the instrument menu keys, **CLR\_INST**, **RST\_INST** and **SEL\_INST** are helpful when operating instruments. These and other utility keys are accessed by pressing the **UTILS** key. See “Executing Commands” for information on the **RCL\_....** keys in this menu.

**CLR\_INST** clears the instrument’s terminal interface input and output buffers (remote buffers are not cleared) and returns to the top level of the instrument menu. Press **CLR\_INST** whenever an instrument is busy, is not responding to terminal interface control, or to abort a command being entered from the terminal interface.

**RST\_INST** clears all terminal interface and remote input and output buffers and resets the instrument.

**SEL\_INST** returns you to the *Select an Instrument* menu. Note that

**SEL\_INST** is the key “under” the **UTILS** key. You can easily return to the *Select an Instrument* menu by pressing **f8** twice.

### How to Access the Utility Keys

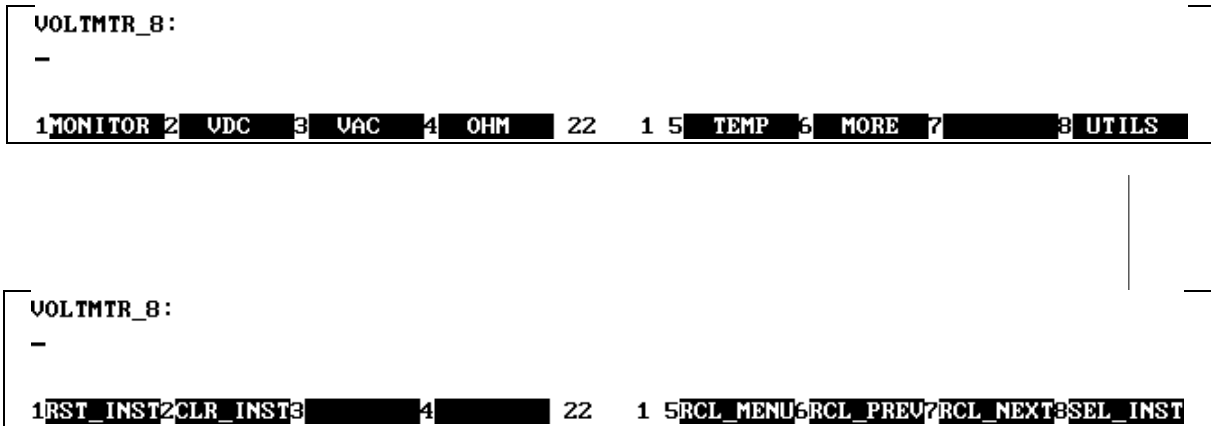

## Using the System Instrument Menu

The System Instrument menu allows you to:

- Set or read the system GPIB address
- Reset (reboot) the mainframe
- Display the logical addresses of installed instruments
- Display information about installed instruments

### How to Set or Read the System GPIB Address

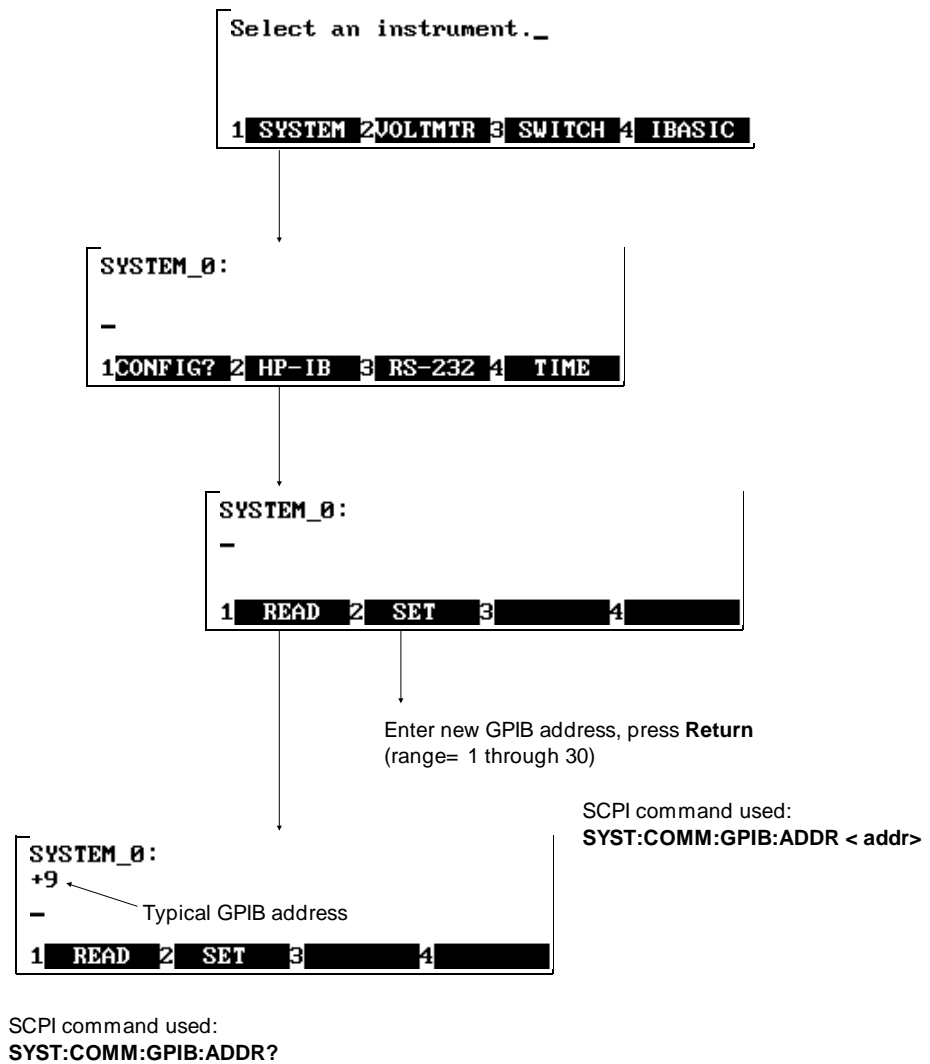

## How to Reset the System

Select an instrument.\_

1 SYSTEM 2 VOLTMR 3 SWITCH 4 IBASIC 21 22 5 6 7 8 UTILS

SYSTEM\_0:

-

1 CONFIG? 2 HP-IB 3 RS-232 4 TIME 23 1 5 DATE 6 MORE 7 8 UTILS

SYSTEM\_0:

-

1 RESET 2 3 4 23 1 5 6 MORE 7 8 UTILS

Press f1 to Reset

**Note:** The **RESET** menu selection is equivalent to executing the **DIAG:BOOT** command which has the same effect as cycling the mainframe's power. Pressing **RST\_INST** from the System Instrument menu is the equivalent to sending the **\*RST** command to the System Instrument.

## How to Display Logical Addresses and Instrument Information

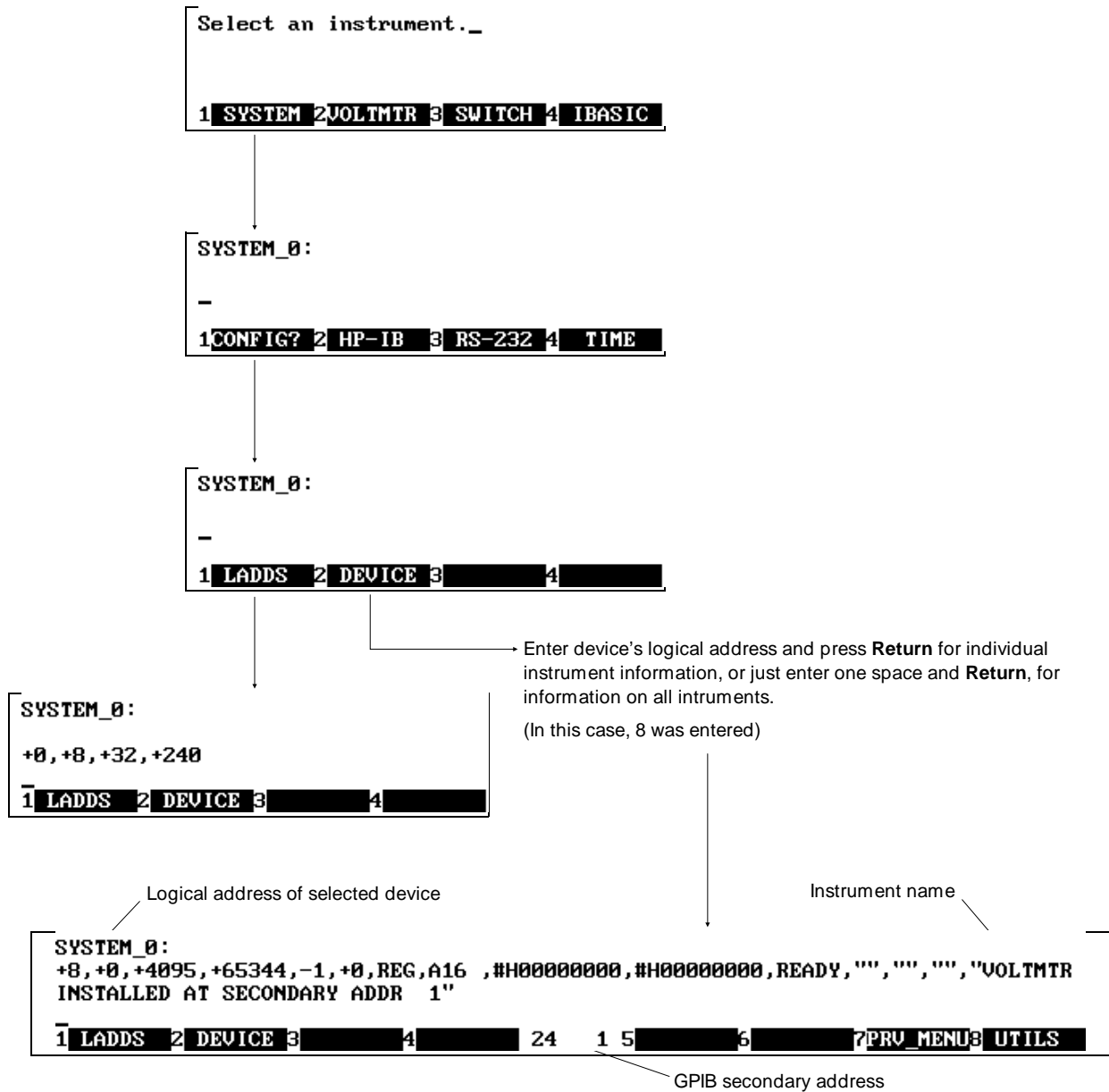

**Note:** For a description of each field of the instrument information, see **VXI:CONF:DLIS?** in the SCPI Command Reference section.

## Using the Other Instrument Menus

The instrument menus allow you to access the most-used instrument functions or to monitor an instrument (monitor mode) while it is being controlled from remote. We'll use the Switchbox menu to show you how to use the instrument menus. Menus are available for many but not all instruments. See "Instrument Menus", later in this chapter, for more information on a particular instrument's menu. The Switchbox menu allows you to:

- Open and Close Channels
- Scan Channels
- Display Module Type and Description
- Monitor a Switchbox
- Reset a selected switch module

### Selecting the Switchbox

To select the Switchbox, press the function key (**f1 - f5**) corresponds to the label **SWITCH** in the "Select an instrument" menu. (If the "Select an instrument" menu is not being displayed press **UTILS** then **SEL\_INST**.)

---

### Note

After you press the function key for **SWITCH**, the screen may show: "*Select SWITCH at logical address: \_*" while the screen labels show two or more logical addresses. This means more than one Switchbox is installed in the mainframe. To select one of the Switchboxes, press the function key for the logical address key label.

---

The charts on the following pages show how to use the Switchbox menu. Keep the following points in mind when using the menu:

- The card number identifies a module within the Switchbox. The module with the lowest logical address is always card number 01. The module with the next successive logical address is card number 02 and so on.
- The @ character is required preceding a channel list when executing a Switchbox command from the terminal interface or remote. When entering a channel list in response to a menu prompt however, do not precede it with the @ character. Doing so causes a syntax error.



## How to Open/Close Channels

Switchbox instrument at logical address 32  
(secondary address = 04)

```
SWITCH_32:  
-  
1 MONITOR 2 OPEN 3 CLOSE 4 SCAN
```

```
SWITCH_32:  
Enter channel list  
1 2 3 4
```

SCPI command used:  
**OPEN < channel\_list >**

Enter Channel List and press **Return**  
(e.g., 102 for channel 2 on card # 1)

```
SWITCH_32:  
Enter channel list  
1 2 3 4
```

SCPI command used:  
**CLOSE < channel\_list >**

## How to Scan Channels

```
SWITCH_32:  
-  
1 MONITOR 2 OPEN 3 CLOSE 4 SCAN
```

```
SWITCH_32:  
-  
1 SET_UP 2 STEP 3 4
```

Press **f2** to advance to the next channel in  
the Scan List (i.e. to trigger the instrument.)

```
SWITCH_32:  
Enter channel list  
1 2 3 4
```

Enter Channel List and press **Return**  
(e.g., 100:115 to scan channels 00 to 15 on card # 1)

## How to Display Module Type , Description, or Reset Module

```
SWITCH_32:
```

```
-
```

```
1 MONITOR 2 OPEN 3 CLOSE 4 SCAN 23 1 5 CARD 6
```

```
SWITCH_32:
```

```
-
```

```
1 TYPE? 2 DESCR? 3 RESET 4
```

```
SWITCH_32:
```

```
Enter card number
```

```
1 2 3 4
```

Enter Card Number and press Return

```
SWITCH_32:
```

```
HEWLETT-PACKARD,E1345A,0,A.03.00
```

```
1 TYPE? 2 DESCR? 3 RESET 4
```

SCPI command used:  
SYST:CTYP? < card\_number >

```
SWITCH_32:
```

```
Enter card number
```

```
1 2 3 4
```

Enter Card Number and press Return

SCPI command used:  
SYST:CPON < card\_number >

```
SWITCH_32:
```

```
Enter card number
```

```
1 2 3 4
```

Enter Card Number and press Return

```
SWITCH_32:
```

```
"16 Channel Relay Mux"
```

```
1 TYPE? 2 DESCR? 3 RESET 4
```

SCPI command used:  
SYST:CDES? < card\_number >

## How to Select Monitor Mode

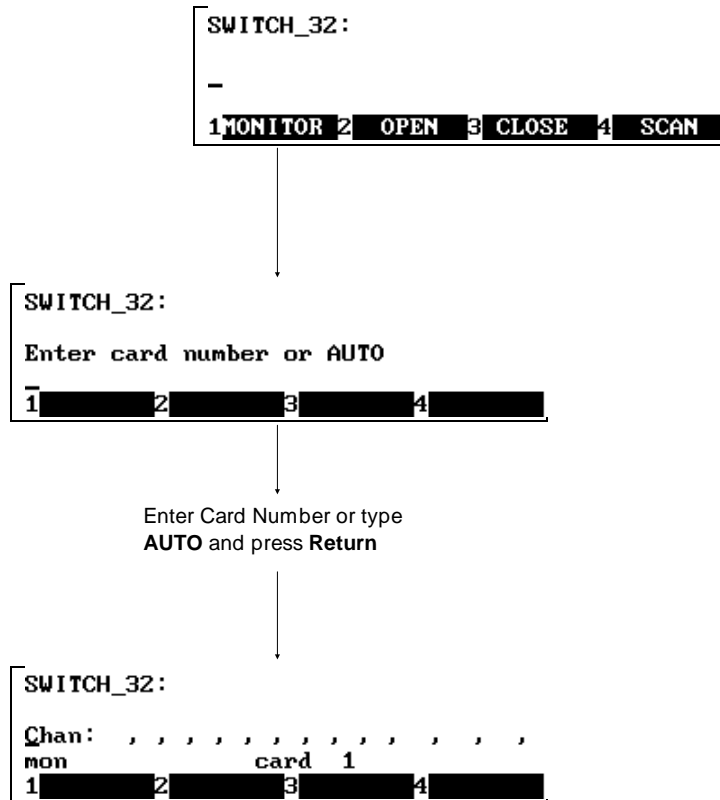

SCPI commands used:  
DISP:MON:CARD < card\_number >  
DISP:MON:STAT ON

### Monitor Mode

Monitor mode displays the status of an instrument while it is being controlled from remote. Monitor mode is useful for debugging programs. You can place an instrument in monitor mode using terminal interface menus, or by executing the DISP:MON:STAT ON command from the terminal interface. Pressing most terminal interface keys will automatically exit monitor mode and return to the instrument menu. However, you can use the left and right arrow keys in monitor mode to view long displays.

---

**Note**

Enabling monitor mode slows instrument operations. If the timing or speed of instrument operations is critical (such as making multimeter readings at a precise time interval), you should not use monitor mode.

---

Table 3-1 shows the status annunciators that may appear in the bottom line of the screen in monitor mode. Some instruments also have device-specific annunciators (see the plug-in module manual for more information).

**Table 3-1. Monitor Mode Display Annunciators**

| <b>Annunciator</b> | <b>Description</b>   |
|--------------------|--|
| mon                | The instrument is in monitor mode                          |
| bsy                | The instrument is executing a command                      |
| err                | An error has occurred (see “Reading Error Messages” below) |
| srq                | A service request has occurred                             |

**Reading Error Messages**

Whenever the screen is showing the *err* annunciator, an error has occurred for the instrument being monitored. You can read the error message, although doing so cancels monitor mode. To read an error message, type the following SCPI command (followed by the **Return** key):

**SYST:ERR?**

The error message will be displayed in the bottom line of the Text Output Area. To see if another error was logged, repeat the above command by pressing **UTILS**, **RCL\_PREV**, then **Return**.

After you have read all the error messages, executing the SYST:ERR? command causes the screen to show: + 0 *No error*. After reading the error message(s), press **f1** to return to monitor mode.

---

## Executing Commands

From the terminal interface, you can type and execute IEEE 488.2 Common Commands and SCPI Commands for the instrument presently selected by the *Select an instrument* menu. (However, you cannot execute a command when the screen is requesting that you input information.) This is particularly useful for accessing functions not available in an instrument's menu. For example, the System Instrument contains a Pacer that can be programmed to output a square wave signal on the mainframe's Pacer Out port. From the System Instrument menu, you can program the Pacer to output 10 square wave cycles with a period of 1 second each by typing the following commands and pressing **Return** after each command (see Chapter 3 for more information on the Pacer).

```
SOUR:PULS:COUN 10
SOUR:PULS:PER 1
TRIG:SOUR IMM
INIT:IMM
```

As another example, after selecting the Switchbox, suppose you must set up and execute a scan list with automatic advance (automatic advance is not available from the menu). You can do this by typing the following command string and pressing **Return** (notice that by linking the commands together with a semicolon and colon you need press **Return** only once).

```
TRIG:SOUR IMM;:SCAN (@100:105);:INIT
```

## Editing

The screen editing keys (shown on the following page) allow you to edit user-entered data or commands. When editing, the screen is in insert mode. That is, typed characters will be inserted into the string at the present cursor position.

---

## Note

The key labels shown are found on all HP terminals (except HP terminals supporting ANSI terminal protocol). See "Using Supported Terminals" for equivalent key functions on your terminal.







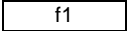

---

---

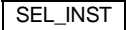
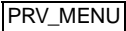

## General Key Descriptions

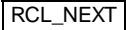
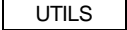
This section explains the function of each of the terminal interface's menu, menu control, and editing keys. If a key is not functional in a particular situation, pressing that key does nothing except to cause a beep.

### Menu and Menu Control Keys

|   |         |   |  |
|---|---------|---|--|
|    | through |    | Label menu choices for corresponding function keys.  |
|    | →       |    | Returns to the <i>Select an instrument</i> menu.   |
|   |         |    | Returns to the previous menu level within an instrument menu or escapes from an input prompt. When you reach the top of an instrument's menu, the <b>PRV_MENU</b> label disappears.  |
|   |         |    | The screen can show a maximum of five menu choices at a time. When there are more than five menu choices, function key <b>f6</b> becomes labeled <b>MORE</b> . Press <b>MORE</b> to display the next group of choices. By repeatedly pressing <b>MORE</b> you can display all groups of choices. After you have displayed all groups of choices, pressing <b>MORE</b> again returns to the first group of choices. |
|    | →       |    | Recalls the last command entered from the terminal interface. After recalling a command, it can be edited or re-executed. You can recall from a stack of previously executed commands by repeatedly pressing <b>RCL_PREV</b> . When you reach the bottom of the stack (the last line in the buffer), pressing <b>RCL_PREV</b> does nothing except to cause a beep.   |
|  | →       |  | Accesses commands in the opposite order to that of <b>RCL_PREV</b> . Pressing <b>RCL_NEXT</b> does nothing until you have pressed <b>RCL_PREV</b> at least twice.  |
|  | →       |  | Recalls the last SCPI command generated by a menu operation. For example, reading the time using the menus (SYSTEM, TIME, READ) generates and executes the SCPI command SYST:TIME?. A recalled command can be executed by pressing the <b>Return</b> key. You can also edit a recalled command before you execute it.  |
|   |         |  | Performs the same function as <b>PRV_MENU</b> .  |

### Editing Keys

|   |   |
|---|---|
|  | (Right arrow key.) Moves the cursor one character space to the right while leaving characters intact. |
|  | (Left arrow key.) Moves the cursor one character space to the left while leaving characters intact.   |
|  | Erases the character at the present cursor position (for user-entered data only).                     |



Erases the character to the left of the cursor (for user-entered data only).



(Clear-to-end key.) Erases all characters from the present cursor position to the end of the input line (for user-entered data only).

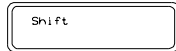

Selects the upper-case alphabetic characters or the character shown on the top half of a key.



Sets all alphabetic keys to uppercase (capitals); does not affect the other keys. To return to lowercase, press **Caps Lock** again.

### Instrument Control Keys



Resets only the selected instrument (equivalent of executing \*RST). **RST\_INST** also clears the instrument's terminal interface and remote input and output buffers. **RST\_INST** is the only terminal interface key that can affect an instrument being operated from remote.

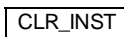
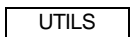

Clears the terminal interface input and output buffers (remote buffers are not cleared) of the selected instrument and returns to the top level of the instrument menu. Press **CLR\_INST** whenever an instrument is busy, is not responding to terminal interface control, or to abort a command being entered from the terminal interface.

### Other Keys

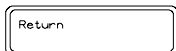

End of line. Enters your responses to menu prompts. Executes commands entered from the terminal keyboard (may be labeled Enter on your terminal emulator).



Selects alternate key definitions. These CTRL key sequences provide short-cuts to some of the menu sequences and also provide some functions not directly available from dedicated terminal keys. Some alternate key definitions are:

**CTRL R** = Instrument Reset

**CTRL C** = Clear Instrument

**CTRL D** = *Select an instrument* menu.

For a complete list of all CTRL Sequences, see Table 3-3 in this chapter. Users of the optional IBASIC interpreter should refer to their IBASIC manual set for additional editing functions.

---

## Using Supported Terminals

The Display Terminal Interface supports several popular terminal brands and models. This chapter will show you how to access all of the terminal interface functions described previously using your supported terminal.

### The Supported Terminals

The following list names the supported terminals and shows where to go for more information. If your terminal isn't named in this list, see "Using Other Terminals" in the next section.

- HP 700/92 ..... Menu tutorial
- HP 700/94 ..... Menu tutorial
- HP 700/22 ..... See page 3-17
- HP 700/43 and WYSE WY-30™..... See page 3-19

The keyboard guides provided for the listed terminals may be removed or copied, and placed near your keyboard while you go through the menu tutorial sections.



## Using the HP 700/22

The HP 700/22 terminal emulates the DEC® VT100® or VT220® terminals. Some functions of the Display Terminal Interface have been mapped into keys with other labels. A keyboard map is provided for each of the emulation models. Use these keyboard maps to help locate the terminal interface functions.

### VT100® Key Map

The symbols shown in the upper left corner of key each are now mapped with the function labeled in the center of each key.

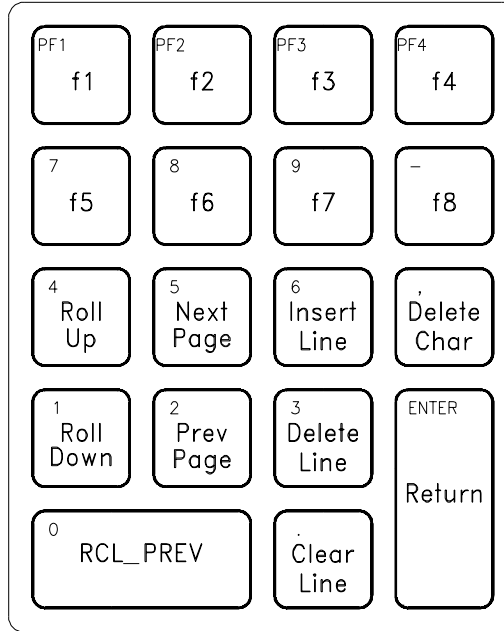

E1405-DL VT100

### Selecting VT100® Mode

To use the HP 700/22 in VT100® mode, press the **Set-Up** key and set the following configuration:

| Fields            | Value              |
|-------------------|--------------------|
| Terminal Mode     | EM100, 7 bit Ctrls |
| Columns           | 80                 |
| EM100 ID          | EM100              |
| Inhibit Auto Wrap | YES                |

**VT220® Key Map** The function keys that are normally labeled **f6** through **f14** are now labeled:

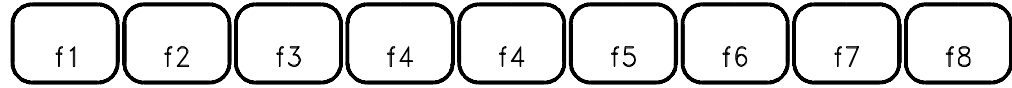

**Note**

Because the HP 700/22 keyboard has nine function keys in the center of the keyboard, f4 is mapped twice

The symbols shown in the upper left corner of key each are now mapped with the function labeled in the center of each key.

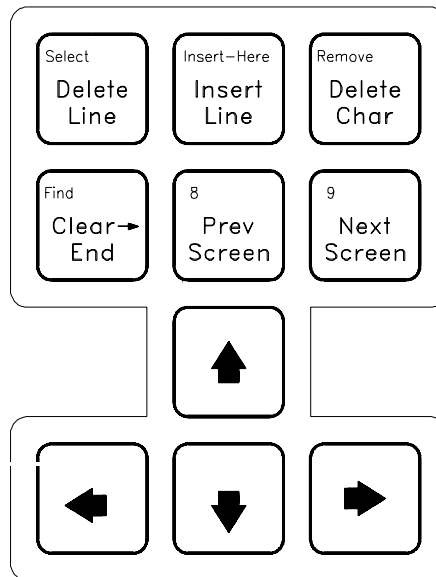

E1405-DL VT220

**Selecting VT220® Mode**

To use the HP 700/22 in VT220® mode, press the **Set-Up** key and set the following configuration:

| Fields            | Value             |
|-------------------|-------------------|
| Terminal Mode     | EM200, 7 bit Ctrl |
| Columns           | 80                |
| EM100 ID          | EM220             |
| Inhibit Auto Wrap | YES               |

## Using the WYSE<sup>®</sup> WY-30<sup>™</sup>

With the WYSE<sup>®</sup> WY-30<sup>™</sup> terminal, some functions of the Display Terminal Interface have been assigned to keys with other labels. Use this keyboard map to help locate these functions.

The symbols shown in the upper left corner of key each are now mapped with the function labeled in the center of each key.

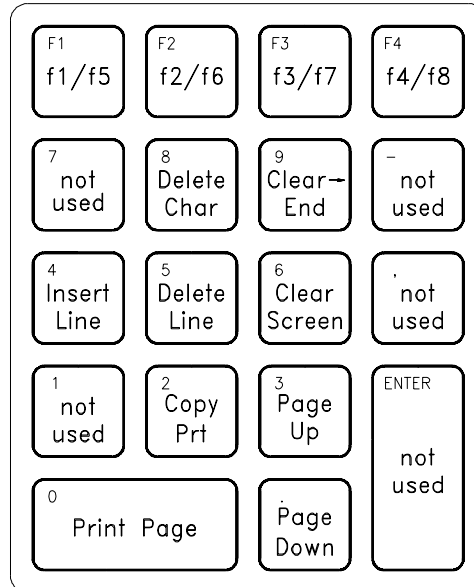

E1405-DL WY30

Where two function key labels are shown, the one following the "/" character is accessed by pressing and holding the CTRL key while pressing the desired function key (e.g. to access the **f6** function, press CTRL-**f2/f6**).

---

## Using Other Terminals

This section discusses using terminals which are not on the Supported Terminals list. Primarily this section is to help you use terminals which do not provide programmable soft keys (function keys). Without this capability, a terminal can not access the Display Terminal Interface's menus. Instead, the terminal interface provides a set of Terminal Interface Commands which allow you to select instruments by name or logical address. Once selected, you can type Common Commands or SCPI commands to the instrument. In addition, keyboard accessible control codes provide display control for terminals which may not have keys dedicated to those functions.

## What “Not Supported” Means

Strictly speaking, a terminal is not supported if it has not been rigorously tested with the Display Terminal Interface. There are several HP terminals which may be compatible with the terminal interface. Terminals such as the DEC<sup>®</sup> VT100<sup>®</sup>, DEC<sup>®</sup> VT220<sup>®</sup>, and WYSE<sup>®</sup> WY-50<sup>™</sup>, or emulations of these may also work properly with the terminal interface. If you have one of these terminals, try it. Here is a list of terminals you should try.

HP 2392A  
HP 2394A  
DEC<sup>®</sup> VT100<sup>®</sup>  
DEC<sup>®</sup> VT220<sup>®</sup>  
WYSE<sup>®</sup> WY-50<sup>™</sup>  
HP AdvanceLink terminal emulation software (configure as HP 2392A)

## Testing Terminals for Compatibility

Here is how you test an unsupported terminal for compatibility with the Display Terminal Interface:

1. Connect your terminal and configure its communication parameters to match the mainframe’s serial interface (see Appendix C)
2. With your terminal turned on and set to “remote mode”, turn on the mainframe. After the mainframe power-on self-test, the display interface sends sequences of characters to your terminal which should cause it to return its identification. If the terminal ID matches one in a list kept by the terminal interface, it will send character sequences to program the function keys and their labels.
3. If you now see the “Select an instrument” prompt *and* the “Select an instrument” menu labels, your terminal is ready to try. Go to the beginning of this chapter and try the menus.
4. If you see only the “Select an instrument” prompt without the “Select an instrument” menu labels, your terminal did not return a recognized ID. To set the terminal type manually, type the Terminal Interface Command:

**ST HP** (followed by **Return** for HP terminals)  
**or**  
**ST VT100** (followed by **Return** for VT100<sup>®</sup> emulators)  
**or**  
**ST VT220** (followed by **Return** for VT220<sup>®</sup> emulators)  
**or**  
**ST WYSE30** (followed by **Return** for WY-30<sup>®</sup> emulators)  
**or**  
**ST WYSE50** (followed by **Return** for WY-50<sup>™</sup> emulators)

---

### NOTE

You can type "ST" without arguments at the "Select an Instrument" menu. The display terminal will attempt to identify the terminal that is connected. This is particularly useful if you are hooking a terminal to a system which already has power, since you do not need to cycle power and wait for the system to reboot.

---

If you now see the “Select an instrument” menu labels:

Go to the beginning of this chapter and try the menus.

**or**

Turn the mainframe off and then on again.

## Using a Terminal Without Menus

You can still control instruments installed in your mainframe without using the terminal interface menus. In this case you will send Common Commands and SCPI commands to your instruments by typing them on your terminal keyboard, or through a computer interface.

## Selecting Instruments

To send commands to, and receive responses from an instrument, you must first select that instrument. Two commands are provided to select instruments. They are; SI (Select Instrument), and SA (Select Address). These commands only work from the “Select an instrument” prompt. The commands can be typed in upper case or lower case.

**SI** SI selects an instrument by its name, exactly as it would appear in the “Select an instrument” menu (see Table 3-2). If your mainframe has more than one instrument with the same name, follow the name with a comma (,) and the desired instrument’s logical address. Here are some examples of SI commands:

**si voltmtr** (selects a voltmeter instrument)

**si switch** (selects a switchbox instrument)

**SI SWITCH** (same as above)

**si switch,16** (selects switchbox at logical address 16)

**Table 3-2. Instrument Names for the SI Command**

| Menu Name | Instrument  |
|-----------|---|
| SYSTEM    | The System Instrument (built-in to the mainframe)                                       |
| VOLTMTR   | Agilent E1326A Standalone, or Agilent E1326A Scanning Voltmeter Modules                 |
| SWITCH    | Switchbox composed of one or more Agilent Multiplexer Modules                           |
| DIG_I/O   | Agilent E1330A Quad 8-Bit Digital Input/Output Module                                   |
| IBASIC    | Optional IBASIC interpreter   |
| COUNTER   | Agilent E1332A 4-Channel Counter/Totalizer, or Agilent E1333A Universal Counter Modules |
| D/A       | Agilent E1328A Digital to Analog Converter Module                                       |

**SA** SA selects an instrument by its logical address. For multiple module instruments, use the logical address of the first module in the instrument. For example; **SA 8** selects the instrument at logical address 8. When you have selected an instrument, the terminal interface will respond with an instrument prompt which is the instrument’s menu name followed by its logical address (e.g. **VOLTMTR\_8**).

To get a list of the logical addresses used in your mainframe, send the SCPI command **VXI:CONF:DLAD?** to the System Instrument. Then to determine what instrument is at each logical address, send the command **VXI:CONF:DLIS? n** for each logical address in the list (where **n** is a logical address).

**Returning to the “Select an Instrument” Prompt**

To return to the “Select an instrument” prompt, press and hold the **CTRL** key then press **D**.

**Control Sequences for Terminal Interface Functions**

The terminal interface provides the keyboard control sequences listed in Table 3-3. These can be thought of as keyboard short-cuts for compatible terminals (those which provide menu capability). Only those functions in the table which are shaded, operate for “UNKNOWN” terminal types (those which do not support menus). An “UNKNOWN” terminal type has very limited editing capability. It will not support the EDIT mode for the optional IBASIC interpreter. In the following table, † = IBASIC only, ‡ = Front Panel only.

**Table 3-3. Control Sequence Functions**

|                 |  |          |
|-----------------|--|----------|
| Del char        | Delete character at the cursor position  | CTRL-X   |
| Clr →end        | Clears line from cursor position to end of line                                    | CTRL-L   |
| Clear line      | Clears line regardless of cursor position  | CTRL-U   |
| Insert line †   | Inserts a blank line at the cursor position  | CTRL-O   |
| Delete line † ‡ | Deletes the line at the current cursor position                                    | CTRL-DEL |
| End of line     | Move cursor to the end of current line   | CTRL-Z   |
| Start of line   | Move cursor to the beginning of current line                                       | CTRL-A   |
| Return          | Terminates user entry  | CTRL-M   |
| RCL_MENU        | Recalls the last command executed via the menu keys                                | CTRL-W   |
| RCL_PREV        | Recalls the last several commands executed via user input                          | CTRL-F   |
| RCL_NEXT        | After RCL_PREV, RCL_NEXT may be used to move forward through the recalled commands | CTRL-B   |
| SEL_INST        | Return to “Select an instrument” menu  | CTRL-D   |
| CLR_INST        | Clear instrument’s input and output buffers  | CTRL-C   |
| RST_INST        | Like CLR_INST plus clears  | CTRL-R   |

## In Case of Difficulty

| Problem:  | Problem Cause/Solution:   |
|---|---|
| Error -113 undefined header error occurs after entering data in response to a menu prompt.  | For some commands used by the menus, the data entered is appended to a command header. For example, if you enter "1" as the port number for a digital I/O module, the command used is DIG:HAND1:MODE NONE where HAND1 indicates the port number. If your entry was invalid or incorrect, error -113 occurs.   |
| <p>Following the power-on sequence or system reset the display shows:</p> <p>Configuration errors. Select SYSTEM<br/>Press any key to continue_</p> | An unassigned device (incorrect logical address) was detected, or the contents of non-volatile memory may have been lost. If you cycle power or perform system reset, the display will show the logical address of the unassigned device. You can also check the logical addresses using the CONFIG? -- LADDS branch of the System Instrument menu. Refer to Chapter 1 of this manual for a discussion of logical addresses and unassigned devices. |
| The display shows: "instrument in local lockout". Menus seem to work but nothing happens when I reach the bottom level or try to execute a command. | The terminal interface has been locked-out (GPIB local lockout). You can re-enable menu operation by cancelling local lockout (from remote) or by cycling mainframe power.  |
| Display cannot be removed from monitor mode.  | Monitor mode was entered from remote (DISP:MON:STAT ON command) and the terminal interface has also been locked out (GPIB local lockout). Either cancel the local lockout or execute DISP:MON:STAT OFF (from remote).   |
| <p>Display shows:</p> <p>Can not connect to instrument<br/>Press any key to continue_</p>   | A hardware or software problem has occurred in the instrument preventing it from responding to terminal interface control.  |
| <p>After selecting an instrument the display shows:</p> <p>"busy".</p>  | The instrument is busy performing an operation. Press <b>Clear Instr</b> to abort the instrument operations and allow the terminal interface to access the instrument.  |
| <p>Display shows:</p> <p>Instrument in use by another display.<br/>Press any key to continue_</p>   | The instrument has already been selected from the Front Panel. An instrument can only be "attached" to one display at a time. At the Front Panel, press <b>Select Instr</b> . The instrument can now be selected from the terminal interface.   |

*Notes*



---

## Instrument Menus

This section contains charts showing the structure and content for all terminal interface instrument menus. Also shown in the charts are the SCPI or Common Commands used and descriptions of menu-controlled instrument operations.

This section contains the following charts:

- System Instrument Menu . . . . . 3-26
- Switchbox Menu . . . . . 3-28
- Scanning Voltmeter Menu . . . . . 3-30
- Agilent E1326A 5 1/2 Digit Multimeter Menu . . . . . 3-32
- Agilent E1328A 4-Channel D/A Converter Menu . . . . . 3-33
- Agilent E1330A Quad 8-Bit Digital I/O Menu . . . . . 3-34
- Agilent E1332A 4-Channel Counter/Totalizer Menu . . . . . 3-36
- Agilent E1333A 3-Channel Universal Counter Menu . . . . . 3-38

### System Instrument Menu

Menu Levels and Content

| Level 1 | Level 2 | Level 3 | Level 4 | Level 5 | Level 6 | User Entry | Command(s) Used                  | Description  |
|---------|---------|---------|---------|---------|---------|------------|----------------------------------|--|
| SYSTEM  | CONFIG? | LADDRS  |         |         |         |            | VXI:CONF:DLIAD?                  | Displays logical addresses of mainframe instruments  |
|         |         | DEVICE  |         |         |         |            | VXI:CONF:DLIS? < log_addr>       | Displays information about the device at the specified logical address. (Refer to the Command Reference for details) |
|         | GPIB    | READ    |         |         |         |            | SYST:COMM:GPIB:ADDR?             | Displays GPIB address  |
|         |         | SET     |         |         |         |            | SYST:COMM:GPIB:ADDR < address>   |  |
|         | RS232   | BAUD    |         |         |         |            | SYST:COMM:SER[n]:BAUD?           | Read current baud rate   |
|         |         | READ    |         |         |         |            | SYST:COMM:SER[n]:BAUD < address> |  |
|         |         | SET     |         |         | 300     |            | SYST:COMM:SER[n]:BAUD 300        | Sets the serial interface baud rate to 300   |
|         |         |         |         |         | 1200    |            | SYST:COMM:SER[n]:BAUD 1200       | Sets the serial interface baud rate to 1200  |
|         |         |         |         |         | 2400    |            | SYST:COMM:SER[n]:BAUD 2400       | Sets the serial interface baud rate to 2400  |
|         |         |         |         |         | 9600    |            | SYST:COMM:SER[n]:BAUD 9600       | Sets the serial interface baud rate to 9600  |
|         |         |         |         |         | 19200   |            | SYST:COMM:SER[n]:BAUD 19200      | Sets the serial interface baud rate to 19200   |
|         |         | PARITY  |         |         |         |            | SYST:COMM:SER[n]:PAR?            | Read current parity type   |
|         |         | READ    |         |         |         |            | SYST:COMM:SER[n]:PAR EVEN        | Sets the serial interface parity to even   |
|         |         | SET     |         |         | EVEN    |            | SYST:COMM:SER[n]:PAR ODD         | Sets the serial interface parity to odd  |
|         |         |         |         |         | ODD     |            | SYST:COMM:SER[n]:PAR ONE         | Sets the serial interface parity to one  |
|         |         |         |         |         | ONE     |            | SYST:COMM:SER[n]:PAR ZERO        | Sets the serial interface parity to zero   |
|         |         |         |         |         | ZERO    |            | SYST:COMM:SER[n]:PAR NONE        | Sets the serial interface parity to none   |
|         |         |         |         |         | NONE    |            | SYST:COMM:SER[n]:BITS?           | Read current data bit width  |
|         |         | BITS    |         |         |         |            | SYST:COMM:SER[n]:BITS 7          | Sets the data width to 7 bits  |
|         |         | READ    |         |         |         |            | SYST:COMM:SER[n]:BITS 8          | Sets the data width to 8 bits  |
|         |         | SET     |         |         | 7       |            | SYST:COMM:SER[n]:PACE?           | Read current pacing type   |
|         |         |         |         |         | 8       |            | SYST:COMM:SER[n]:PACE XON        | Enables XON/ XOFF software handshaking   |
|         |         | PACE    |         |         |         |            | SYST:COMM:SER[n]:PACE NONE       | Disables XON/ XOFF software handshaking  |
|         |         | READ    |         |         |         |            |                                  |  |
|         |         | SET     |         |         | XON/OFF |            |                                  |  |
|         |         |         |         |         | NONE    |            |                                  |  |

(continued on following page)

# System Instrument Menu

Menu Levels and Content

| Level 1                        | Level 2 | Level 3 | Level 4 | Level 5 | Level 6 | User Entry           | Command(s) Used                      | Description   |
|--------------------------------|---------|---------|---------|---------|---------|----------------------|--------------------------------------|---|
| (continued from previous page) |         |         |         |         |         |                      |                                      |   |
|                                |         | CONTROL | DTR     | READ    |         | card number          | SYST:COMM:SER[n]:CONT:DTR?           | Read current setting for DTR line                                       |
|                                |         |         |         | SET     | ON      | card number          | SYST:COMM:SER[n]:CONT:DTR ON         | Set DTR line to static + V  |
|                                |         |         |         |         | OFF     | card number          | SYST:COMM:SER[n]:CONT:DTR OFF        | Set DTR line to static -V   |
|                                |         |         |         |         | IBFULL  | card number          | SYST:COMM:SER[n]:CONT:DTR IBF        | Set DTR for hardware handshaking  |
|                                |         |         |         |         | STANDRD | card number          | SYST:COMM:SER[n]:CONT:DTR STAN       | DTR operates to RS-232 standard   |
|                                |         |         | RTS     | READ    |         | card number          | SYST:COMM:SER[n]:CONT:RTS?           | Read current setting for RTS line                                       |
|                                |         |         |         | SET     | ON      | card number          | SYST:COMM:SER[n]:CONT:RTS ON         | Set RTS line to static + V  |
|                                |         |         |         |         | OFF     | card number          | SYST:COMM:SER[n]:CONT:RTS OFF        | Set RTS line to static -V   |
|                                |         |         |         |         | IBFULL  | card number          | SYST:COMM:SER[n]:CONT:RTS IBF        | Set RTS for hardware handshaking  |
|                                |         |         |         |         | STANDRD | card number          | SYST:COMM:SER[n]:CONT:RTS STAN       | RTS operates to RS-232 standard   |
|                                |         |         | STORE   |         |         | card number          | DIAG:COMM:SER[n]:STORE               | Store current serial communications settings into non-volatile storage. |
|                                | DEBUG   |         | READ    |         |         | laddr, reg_num       | VXI:READ? < laddr> , < reg>          | Read register in A16 address space.                                     |
|                                |         |         | WRITE   |         |         | laddr, reg_num, data | VXI:WRIT < laddr> , < reg> , < data> | Write data to register in A16 address space.                            |
|                                | TIME    |         | READ    |         |         | time                 | SYST:TIME?                           | Read the current system clock   |
|                                |         |         | SET     |         |         |                      | SYST:TIME < time>                    | Set the system clock  |
|                                | DATE    |         | READ    |         |         | date                 | SYST:DATE?                           | Read the current system calendar  |
|                                |         |         | SET     |         |         |                      | SYST:DATE < date>                    | Set the system calendar   |
|                                | RESET   |         |         |         |         |                      | DIAG:BOOT                            | Resets mainframe using the configuration stored in non-volatile memory  |

### Switchbox Menu

Menu Levels and Content

| Level 1 | Level 2 | Level 3 | User Entry            | Command(s) Used                             | Description  |
|---------|---------|---------|-----------------------|---|--|
| SWITCH  | MONITOR |         | card number ‡ or AUTO | DISP:MON:CARD < card_number> ;STAT ON       | Monitor instrument operations  |
|         | OPEN    |         | channel list †        | OPEN (@channel_list)                        | Open channel(s)  |
|         | CLOSE   |         | channel list †        | CLOS (@channel_list)                        | Close channel(s)   |
|         | SCAN    | SET_UP  | channel list †        | TRIG:SOUR HOLD::SCAN < channel_list> ::INIT | Set up channels to scan  |
|         |         | STEP    | channel list †        | TRIG  | Step to next channel in scan list                                    |
|         | CARD    | TYPE?   | card number ‡         | SYST:CTYP? < card_number>                   | Display module ID information  |
|         |         | DESCR?  | card number ‡         | SYST:CDES? < card_number>                   | Display module description   |
|         |         | RESET   | card number ‡         | SYST:CPON < card_number>                    | Return module to power-on state                                      |
|         |         | TEST    |                       | *TST?                                       | Runs self-test, displays results (+ 0= pass; any other number= fail) |

† Channel lists are of the form "ccnn" (single channel), "ccnn,ccnn" (two or more channels), or "ccnn:ccnn" (range of channels); where "cc" is the card number and "nn" is the channel number. For example, to access channel 2 on card number 1 specify 102.

‡ The card number identifies a module within the Switchbox. The switch module with the lowest logical address is always card number 01. The switch module with the next successive logical address is card number 02 and so on.

*Notes*

### Scanning Voltmeter Menu

Menu Levels and Content

| Level 1 | Level 2 | Level 3 | Level 4 | User Entry                   | Command(s) Used                        | Description                                     |
|---------|---------|---------|---------|------------------------------|--|---|
| VOLTMTR | MONITOR |         |         | channel list † or 0 for auto | DISP:MON:CHAN < channel_list> ;STAT ON | Monitor instrument operations                   |
|         | VDC     |         |         | channel list †               | MEAS:VOLT:DC? < channel_list>          | Measure DC voltage on each channel              |
|         | VAC     |         |         | channel list †               | MEAS:VOLT:AC? < channel_list>          | Measure AC voltage on each channel              |
|         | OHM     |         |         | channel list †               | MEAS:RES? < channel_list>              | Measure 2-wire resistance on each channel       |
|         | TEMP    | TCOUPLE | B       | channel list †               | MEAS:TEMP? TC,B, < channel_list>       | Measure °C of B thermocouple on each channel    |
|         |         |         | E       | channel list †               | MEAS:TEMP? TC,E, < channel_list>       | Measure °C of E thermocouple on each channel    |
|         |         |         | J       | channel list †               | MEAS:TEMP? TC,J, < channel_list>       | Measure °C of J thermocouple on each channel    |
|         |         |         | K       | channel list †               | MEAS:TEMP? TC,K, < channel_list>       | Measure °C of K thermocouple on each channel    |
|         |         |         | N14     | channel list †               | MEAS:TEMP? TC,N14, < channel_list>     | Measure °C of N14 thermocouple on each channel  |
|         |         |         | N28     | channel list †               | MEAS:TEMP? TC,N28, < channel_list>     | Measure °C of N28 thermocouple on each channel  |
|         |         |         | R       | channel list †               | MEAS:TEMP? TC,R, < channel_list>       | Measure °C of R thermocouple on each channel    |
|         |         |         | S       | channel list †               | MEAS:TEMP? TC,S, < channel_list>       | Measure °C of S thermocouple on each channel    |
|         |         |         | T       | channel list †               | MEAS:TEMP? TC,T, < channel_list>       | Measure °C of T thermocouple on each channel    |
|         |         |         | THERMIS | channel list †               | MEAS:TEMP? THER,2252,< channel_list>   | Measure °C of 2252 Ω thermistor on each channel |
|         |         |         | 5K      | channel list †               | MEAS:TEMP? THER,5000,< channel_list>   | Measure °C of 5k Ω thermistor on each channel   |
|         |         |         | 10K     | channel list †               | MEAS:TEMP? THER,10000,< channel_list>  | Measure °C of 10k Ω thermistor on each channel  |
|         |         |         | 385     | channel list †               | MEAS:TEMP? RTD,85,< channel_list>      | Measure °C of 385 RTD on each channel (4-wire)  |
|         |         |         | 392     | channel list †               | MEAS:TEMP? RTD,92,< channel_list>      | Measure °C of 392 RTD on each channel (4-wire)  |
|         | STRAIN  | QUARTER |         | channel list †               | MEAS:STR:QUAR? < channel_list>         | Measure strain with quarter bridge              |
|         |         | HALF    | BENDING | channel list †               | MEAS:STR:HBEN? < channel_list>         | Measure strain with bending half bridge         |
|         |         |         | POISSON | channel list †               | MEAS:STR:HPO? < channel_list>          | Measure strain with Poisson half bridge         |
|         |         | FULL    | BENDING | channel list †               | MEAS:STR:FBEN? < channel_list>         | Measure strain with bending full bridge         |
|         |         |         | BENPOIS | channel list †               | MEAS:STR:FBP? < channel_list> ,        | Measure strain with Bending Poisson full bridge |
|         |         |         | POISSON | channel list †               | MEAS:STR:FPO? < channel_list>          | Measure strain with Poisson full bridge         |

(continued on following page)

## Scanning Voltmeter Menu

Menu Levels and Content

| Level 1                        | Level 2 | Level 3 | Level 4 | User Entry     | Command(s) Used                 | Description  |
|--------------------------------|---------|---------|---------|----------------|---------------------------------|--|
| (continued from previous page) |         |         |         |                |                                 |  |
|                                |         | UNSTRN  |         | channel list † | MEAS:STR:UNST? < channel_list > | Measure bridge unstrained  |
|                                |         | DIAG    | COMPRES | channel list † | MEAS:STR:QCOM? < channel_list > | Compression shunt diagnostic   |
|                                |         |         | TENSION | channel list † | MEAS:STR:QTEN? < channel_list > | Tension shunt diagnostic   |
|                                |         | CARD    | TYPE?   | card number ‡  | SYST:CTYP? < card_number >      | Displays module ID information                                       |
|                                |         |         | DESQR?  | card number ‡  | SYST:CDES? < card_number >      | Displays module description  |
|                                |         |         | TEST    |                | *TST?                           | Runs self-test, displays results (+ 0= pass; any other number= fail) |

† Channel lists are of the form "ccnn" (single channel), "conn,conn" (two or more channels), "conn,conn" (range of channels); where "cc" is the card number and "nn" is the channel number. For example, to access channel 2 on card number 1 specify 102.

‡ The card number identifies a module within the Switchbox. The switch module with the lowest logical address is always card number 01. The switch module with the next successive logical address is card number 02 and so on.

### Agilent E1326B/E1411B 5 1/2 Digit Multimeter (Standalone) Menu

Menu Levels and Content

| Level 1 | Level 2 | Level 3 | Level 4 | User Entry | Command(s) Used      | Description  |
|---------|---------|---------|---------|------------|----------------------|--|
| VOLTMTR | MONITOR |         |         |            |                      | Display instrument operations                                    |
|         | VDC     |         |         |            | DISP:MON:STAT ON     | Measure DC volts   |
|         | VAC     |         |         |            | MEAS:VOLT:DC?        | Measure AC volts   |
|         | OHM     |         |         |            | MEAS:VOLT:AC?        | Measure 4-wire ohms  |
|         | TEMP    | THERMIS | 2252    |            | MEAS:TEMP? FTH,2252  | Measure °C of 2252Ω thermistor (4-wire measurement)              |
|         |         |         | 5K      |            | MEAS:TEMP? FTH,5000  | Measure °C of 5kΩ thermistor (4-wire measurement)                |
|         |         |         | 10K     |            | MEAS:TEMP? FTH,10000 | Measure °C of 10kΩ thermistor (4-wire measurement)               |
|         |         | RTD     | 385     |            | MEAS:TEMP FRTD,85?   | Measure °C of 100Ω RTD with alpha = 385 (4-wire measurement)     |
|         |         |         | 392     |            | MEAS:TEMP FRTD,92?   | Measure °C of 100Ω RTD with alpha = 392 (4-wire measurement)     |
|         | TEST    |         |         |            | *TST?                | Run self-test, display results (0= pass; any other number= fail) |

† Channel lists are of the form "ccnn" (single channel), "ccnn,ccnn" (two or more channels), "ccnn:ccnn" (range of channels); where "cc" is the card number and "nn" is the channel number. For example, to access channel 2 on card number 1 specify 102.

‡ The card number identifies a module within the Switchbox. The switch module with the lowest logical address is always card number 01. The switch module with the next successive logical address is card number 02 and so on.



# Agilent E1328A 4-Channel D/A Converter Menu

Menu Levels and Content

| Level 1 | Level 2 | Level 3 | Level 4 | User Entry | Command(s) Used            | Description  |                             |
|---------|---------|---------|---------|------------|----------------------------|--|-----------------------------|
| D/A     | MONITOR | CHAN1   |         |            | DISP:MON:CHAN 1;STAT ON    | Monitor instrument operations on channel 1                         |                             |
|         |         | CHAN2   |         |            | DISP:MON:CHAN 2;STAT ON    | Monitor instrument operations on channel 2                         |                             |
|         |         | CHAN3   |         |            | DISP:MON:CHAN 3;STAT ON    | Monitor instrument operations on channel 3                         |                             |
|         |         | CHAN4   |         |            | DISP:MON:CHAN 4;STAT ON    | Monitor instrument operations on channel 4                         |                             |
|         |         | AUTO    |         |            | DISP:MON:CHAN AUTO;STAT ON | Monitor instrument operations on active channel                    |                             |
|         | OUTPUT  | VOLTAGE | CHAN1   |            | voltage †                  | VOLT1 < voltage>   | Output voltage on channel 1 |
|         |         |         | CHAN2   |            | voltage †                  | VOLT2 < voltage>   | Output voltage on channel 2 |
|         |         |         | CHAN3   |            | voltage †                  | VOLT3 < voltage>   | Output voltage on channel 3 |
|         |         |         | CHAN4   |            | voltage †                  | VOLT4 < voltage>   | Output voltage on channel 4 |
|         |         | CURRENT | CHAN1   |            | current ‡                  | CURR1 < current>   | Output current on channel 1 |
|         |         |         | CHAN2   |            | current ‡                  | CURR2 < current>   | Output current on channel 2 |
|         |         |         | CHAN3   |            | current ‡                  | CURR3 < current>   | Output current on channel 3 |
|         |         |         | CHAN4   |            | current ‡                  | CURR4 < current>   | Output current on channel 4 |
|         | TEST    |         |         |            | *TST?                      | Run self-test, display results (+ 0= pass; any other number= fail) |                             |

†Enter voltage values in volts. Typical examples are: + 3.5, -2, + 500E-3.

‡Enter current values in amps. Typical examples are: .05, + 200E-3.

### Agilent E1330A Quad 8-Bit Digital Input/Output Menu

Menu Levels and Content

| Level 1 | Level 2 | Level 3 | Level 4 | User Entry             | Command(s) Used                              | Description                                      |                                       |
|---------|---------|---------|---------|------------------------|--|--|---------------------------------------|
| DIG_I/O | MONITOR | PORT0   |         |                        | DISP:MON:CHAN 0;STAT ON                      | Monitor instrument operations on port 0          |                                       |
|         |         | PORT1   |         |                        | DISP:MON:CHAN 1;STAT ON                      | Monitor instrument operations on port 1          |                                       |
|         |         | PORT2   |         |                        | DISP:MON:CHAN 2;STAT ON                      | Monitor instrument operations on port 2          |                                       |
|         |         | PORT3   |         |                        | DISP:MON:CHAN 3;STAT ON                      | Monitor instrument operations on port 3          |                                       |
|         |         | AUTO    |         |                        | DISP:MON:CHAN AUTO;STAT ON                   | Monitor instrument operations on any active port |                                       |
|         | READ    | R_BYTE  | PORT0   |                        |  | DIG:HAND0:MODE NONE::MEAS:DIG:DATA0?             | Reads port 0 after handshake          |
|         |         |         | PORT1   |                        |  | DIG:HAND1:MODE NONE::MEAS:DIG:DATA1?             | Reads port 1 after handshake          |
|         |         |         | PORT2   |                        |  | DIG:HAND2:MODE NONE::MEAS:DIG:DATA2?             | Reads port 2 after handshake          |
|         |         |         | PORT3   |                        |  | DIG:HAND3:MODE NONE::MEAS:DIG:DATA3?             | Reads port 3 after handshake          |
|         |         | R_BIT   | PORT0   |                        | bit (0-7)                                    | DIG:HAND0:MODE NONE::MEAS:DIG:DATA0:BITm?        | Reads bit m on port 0 after handshake |
|         |         |         | PORT1   |                        | bit (0-7)                                    | DIG:HAND1:MODE NONE::MEAS:DIG:DATA1:BITm?        | Reads bit m on port 1 after handshake |
|         | WRITE   | W_BYTE  | PORT0   |                        | data (0-255)                                 | DIG:HAND0:MODE NONE::DIG:DATA0 < data>           | Writes data to port 0                 |
|         |         |         | PORT1   |                        | data (0-255)                                 | DIG:HAND1:MODE NONE::DIG:DATA1 < data>           | Writes data to port 1                 |
|         |         |         | PORT2   |                        | data (0-255)                                 | DIG:HAND2:MODE NONE::DIG:DATA2 < data>           | Writes data to port 2                 |
|         |         |         | PORT3   |                        | data (0-255)                                 | DIG:HAND3:MODE NONE::DIG:DATA3 < data>           | Writes data to port 3                 |
| PORT0   |         |         |         | bit (0-7), value (0,1) | DIG:HAND0:MODE NONE::DIG:DATA0:BITm < value> | Writes data to bit m on port 0                   |                                       |
| PORT1   |         |         |         | bit (0-7), value (0,1) | DIG:HAND1:MODE NONE::DIG:DATA1:BITm < value> | Writes data to bit m on port 1                   |                                       |
| W_BIT   |         | PORT2   |         | bit (0-7), value (0,1) | DIG:HAND2:MODE NONE::DIG:DATA2:BITm < value> | Writes data to bit m on port 2                   |                                       |
|         |         | PORT3   |         | bit (0-7), value (0,1) | DIG:HAND3:MODE NONE::DIG:DATA3:BITm < value> | Writes data to bit m on port 3                   |                                       |

*Notes*

### Agilent E1332A 4-Channel Counter/Totalizer Menu

Menu Levels and Content

| Level 1 | Level 2 | Level 3 | Level 4 | Level 5 | User Entry  | Command(s) Used            | Description                                     |
|---------|---------|---------|---------|---------|-------------|----------------------------|---|
| COUNTER | MONITOR | CHAN1   |         |         |             | DISP:MON:CHAN 1;STAT ON    | Monitor instrument operations on channel 1      |
|         |         | CHAN2   |         |         |             | DISP:MON:CHAN 2;STAT ON    | Monitor instrument operations on channel 2      |
|         |         | CHAN3   |         |         |             | DISP:MON:CHAN 3;STAT ON    | Monitor instrument operations on channel 3      |
|         |         | CHAN4   |         |         |             | DISP:MON:CHAN 4;STAT ON    | Monitor instrument operations on channel 4      |
|         |         | AUTO    |         |         |             | DISP:MON:CHAN AUTO;STAT ON | Monitor instrument operations on active channel |
|         | INPUT   | LEVEL   | CHAN1&2 |         | voltage †   | SENS1:EVEN:LEV < value>    | Set level trigger voltage for channels 1 & 2    |
|         |         |         | CHAN3&4 |         | voltage †   | SENS3:EVEN:LEV < value>    | Set level trigger voltage for channels 3 & 4    |
|         |         | SLOPE   | CHAN1   | POS     |             | SENS1:EVEN:SLOP POS        | Positive level trigger slope for channel 1      |
|         |         |         |         | NEG     |             | SENS1:EVEN:SLOP NEG        | Negative level trigger slope for channel 1      |
|         |         |         | CHAN2   | POS     |             | SENS2:EVEN:SLOP POS        | Positive level trigger slope for channel 2      |
|         |         |         |         | NEG     |             | SENS2:EVEN:SLOP NEG        | Negative level trigger slope for channel 2      |
|         |         |         | CHAN3   | POS     |             | SENS3:EVEN:SLOP POS        | Positive level trigger slope for channel 3      |
|         |         |         |         | NEG     |             | SENS3:EVEN:SLOP NEG        | Negative level trigger slope for channel 3      |
|         |         |         | CHAN4   | POS     |             | SENS4:EVEN:SLOP POS        | Positive level trigger slope for channel 4      |
|         |         |         |         | NEG     |             | SENS4:EVEN:SLOP NEG        | Negative level trigger slope for channel 4      |
|         |         | ISOLATE | ON      |         |             | INP:ISOL ON                | Input isolation on                              |
|         |         |         | OFF     |         |             | INP:ISOL OFF               | Input isolation off                             |
|         |         | FILTER  | ON      |         |             | INP:FILT ON                | Input filter on                                 |
|         |         |         | OFF     |         |             | INP:FILT OFF               | Input filter off                                |
|         |         |         | FREQ    |         | frequency ‡ | INP:FILT:FREQ < value>     | Set input filter frequency                      |
|         | FREQ    | CHAN1   |         |         |             | TRIG:SOUR IMM::MEAS1:FREQ? | Frequency measurement on channel 1              |
|         |         | CHAN3   |         |         |             | TRIG:SOUR IMM::MEAS3:FREQ? | Frequency measurement on channel 3              |
|         | PERIOD  | CHAN1   |         |         |             | TRIG:SOUR IMM::MEAS1:PER?  | Period measurement on channel 1                 |
|         |         | CHAN3   |         |         |             | TRIG:SOUR IMM::MEAS3:PER?  | Period measurement on channel 3                 |

(continued on following page)

# Agilent E1332A 4-Channel Counter/Totalizer Menu

Menu Levels and Content

| Level 1 | Level 2 | Level 3 | Level 4 | Level 5 | User Entry                     | Command(s) Used                 | Description  |
|---------|---------|---------|---------|---------|--------------------------------|---------------------------------|--|
|         |         |         |         |         | (continued from previous page) |                                 |  |
|         | TIMEINT | CHAN1   |         |         |                                | TRIG:SOUR IMM::MEAS1:TINT?      | Time interval measurement on channel 1                             |
|         |         | CHAN3   |         |         |                                | TRIG:SOUR IMM::MEAS3:TINT?      | Time interval measurement on channel 3                             |
|         | POS_PW  | CHAN2   |         |         |                                | TRIG:SOUR IMM::MEAS2:PWID?      | Positive pulse width measurement on channel 2                      |
|         |         | CHAN4   |         |         |                                | TRIG:SOUR IMM::MEAS4:PWID?      | Positive pulse width measurement on channel 4                      |
|         | NEG_PW  | CHAN2   |         |         |                                | TRIG:SOUR IMM::MEAS2:NWID?      | Negative pulse width measurement on channel 2                      |
|         |         | CHAN4   |         |         |                                | TRIG:SOUR IMM::MEAS4:NWID?      | Negative pulse width measurement on channel 4                      |
|         | UDCOUNT | CHAN1   | START   |         |                                | TRIG:SOUR IMM::CONF1:UDC::INIT1 | Up/ down count, subtract ch. 2 count from ch. 1 count              |
|         |         |         | READ    |         |                                | FETC1?                          | Get up/ down count from channels 1 & 2                             |
|         |         | CHAN3   | START   |         |                                | TRIG:SOUR IMM::CONF3:UDC::INIT3 | Up/ down count, subtract ch. 4 count from ch. 3 count              |
|         |         |         | READ    |         |                                | FETC3?                          | Get up/ down count from channels 3 & 4                             |
|         | TOTALIZ | CHAN1   | START   |         |                                | TRIG:SOUR IMM::CONF1:TOT::INIT1 | Totalize on channel 1  |
|         |         |         | READ    |         |                                | FETC1?                          | Get totalize count on channel 1                                    |
|         |         | CHAN2   | START   |         |                                | TRIG:SOUR IMM::CONF2:TOT::INIT2 | Totalize on channel 2  |
|         |         |         | READ    |         |                                | FETC2?                          | Get totalize count on channel 2                                    |
|         |         | CHAN3   | START   |         |                                | TRIG:SOUR IMM::CONF3:TOT::INIT3 | Totalize on channel 3  |
|         |         |         | READ    |         |                                | FETC3?                          | Get totalize count on channel 3                                    |
|         |         | CHAN4   | START   |         |                                | TRIG:SOUR IMM::CONF4:TOT::INIT4 | Totalize on channel 4  |
|         |         |         | READ    |         |                                | FETC4?                          | Get totalize count on channel 4                                    |
|         | TEST    |         |         |         |                                | * TST?                          | Run self-test, display results (+ 0= pass; any other number= fail) |

†Enter voltage values in volts. Typical examples are: + 3.5, -2, + 500E-3.

#Enter frequency value in hertz. Typical examples are: 60, 120, 1E3.

# Agilent E1333A 3-Channel Universal Counter Menu

Menu Levels and Content

| Level 1 | Level 2 | Level 3 | Level 4 | Level 5 | User Entry | Command(s) Used             | Description                                     |
|---------|---------|---------|---------|---------|------------|-----------------------------|---|
| COUNTER | MONITOR | CHAN1   |         |         |            | DISP:MON:CHAN 1;STAT ON     | Monitor instrument operations on channel 1      |
|         |         | CHAN2   |         |         |            | DISP:MON:CHAN 2;STAT ON     | Monitor instrument operations on channel 2      |
|         |         | CHAN3   |         |         |            | DISP:MON:CHAN 3;STAT ON     | Monitor instrument operation on channel 3       |
|         |         | AUTO    |         |         |            | DISP:MON:CHAN AUTO;STAT ON  | Monitor instrument operations on active channel |
|         | INPUT   | LEVEL   | CHAN1   |         | voltage †  | SENS1:EVEN:LEV< value>      | Set trigger level voltage for channel 1         |
|         |         |         | CHAN2   |         | voltage †  | SENS2:EVEN:LEV< value>      | Set trigger level voltage for channel 2         |
|         |         | SLOPE   | CHAN1   | POS     |            | SENS1:EVEN:SLOP POS         | Positive trigger slope for channel 1            |
|         |         |         |         | NEG     |            | SENS1:EVEN:SLOP NEG         | Negative trigger slope for channel 1            |
|         |         |         | CHAN2   | POS     |            | SENS2:EVEN:SLOP POS         | Positive trigger slope for channel 2            |
|         |         |         |         | NEG     |            | SENS2:EVEN:SLOP NEG         | Negative trigger slope for channel 2            |
|         |         | COUPLE  | AC      |         |            | INP:COUP AC                 | AC-coupled input (channels 1 & 2 only)          |
|         |         |         | DC      |         |            | INP:COUP DC                 | DC-coupled input (channels 1&2)                 |
|         |         | IMPED   | 50_OHM  |         |            | INP:IMP 50                  | 50Ω input resistance (channels 1 & 2 only)      |
|         |         |         | 1_MOHM  |         |            | INP:IMP 1e6                 | 1MΩ input resistance (channels 1 & 2 only)      |
|         |         | ATTEN   | 0dB     |         |            | INP:ATT 0                   | No input attenuation (channels 1 & 2 only)      |
|         |         |         | 20dB    |         |            | INP:ATT 20                  | 20dB input attenuation (channels 1 & 2 only)    |
|         |         | FILTER  | ON      |         |            | INP:FILT ON                 | Input filter on (channels 1 & 2 only)           |
|         |         |         | OFF     |         |            | INP:FILT OFF                | Input filter off (channels 1 & 2 only)          |
|         | FREQ    | CHAN1   |         |         |            | TRIG: SOUR IMM;:MEAS1:FREQ? | Frequency measurement on channel 1              |
|         |         | CHAN2   |         |         |            | TRIG: SOUR IMM;:MEAS2:FREQ? | Frequency measurement on channel 2              |
|         |         | CHAN3   |         |         |            | TRIG: SOUR IMM;:MEAS3:FREQ? | Frequency measurement on channel 3              |
|         | PERIOD  | CHAN1   |         |         |            | TRIG: SOUR IMM;:MEAS1:PER?  | Period measurement on channel 1                 |
|         |         | CHAN2   |         |         |            | TRIG: SOUR IMM;:MEAS2:PER?  | Period measurement on channel 2                 |

(continued on following page)

# Agilent E1333A 3-Channel Universal Counter Menu

Menu Levels and Content

| Level 1                        | Level 2 | Level 3  | Level 4 | Level 5 | User Entry | Command(s) Used  | Description  |
|--------------------------------|---------|--|---------|---------|------------|--|--|
| (continued from previous page) | TIMEINT | CHAN1<br>└─┬─<br>CHAN2                                       |         |         |            | TRIG: SOUR IMM;:MEAS1:TINT?<br>TRIG: SOUR IMM;:MEAS2:TINT?   | Time interval measurement on channel 1<br>Time interval measurement on channel 2   |
|                                | POS_PW  | CHAN1<br>└─┬─<br>CHAN2                                       |         |         |            | TRIG: SOUR IMM;:MEAS1:PWID?<br>TRIG: SOUR IMM;:MEAS2:PWID?   | Positive pulse width measurement on channel 1<br>Positive pulse width measurement on channel 2   |
|                                | NEG_PW  | CHAN1<br>└─┬─<br>CHAN2                                       |         |         |            | TRIG: SOUR IMM;:MEAS1:NWID?<br>TRIG: SOUR IMM;:MEAS2:NWID?   | Negative pulse width measurement on channel 1<br>Negative pulse width measurement on channel 2   |
|                                | RATIO   | CHAN1<br>└─┬─<br>CHAN2                                       |         |         |            | TRIG: SOUR IMM;:MEAS1:RAT?<br>TRIG: SOUR IMM;:MEAS2:RAT?   | Ratio of channel 1/ channel 2<br>Ratio of channel 2/ channel 1   |
|                                | TOTALIZ | CHAN1 ─┬─ START<br>└─┬─ READ<br>CHAN2 ─┬─ START<br>└─┬─ READ |         |         |            | TRIG: SOUR IMM;:CONF1:TOT;:INIT1<br>FETC1?<br>TRIG: SOUR IMM;:CONF2:TOT;:INIT2<br>FETC2?<br>* TST? | Totalize on channel 1<br>Display totalize count<br>Totalize on channel 2<br>Display totalize count<br>Run self-test, display results (+ 0= pass; any other number= fail) |
|                                | TEST    |  |         |         |            |  |  |

†Enter voltage values in volts. Typical examples are: + 3.5, -2, + 500E-3.

*Notes*



## Using the Mainframe

---

### Using this Chapter

This chapter shows how to use the mainframe's Pacer function, how to change the primary GPIB address, and how to synchronize internal and external instruments using the mainframe's Event In and Trigger Out ports. This chapter also discusses how mainframe memory is used by installed instruments. Where possible, examples show only the command string sent to the instrument (no information about a computer language or interface is shown). Examples that require showing a computer language are written for HP 9000 Series 200/300 Computers using BASIC language and the GPIB interface. This chapter contains the following sections:

- Using the Pacer. . . . . 4-1
- Changing the Primary GPIB Address . . . . . 4-3
- Synchronizing Internal and External Instruments . . . . . 4-3
- Mainframe Data Memory . . . . . 4-6

---

### Using the Pacer

The Pacer generates a square wave signal on the mainframe's rear panel Pacer Out connector. The signal levels are standard TTL levels (0V to 5V). The Pacer signal can be used to trigger or pace external equipment such as scanners or voltmeters. Figure 4-1 shows a single cycle of the Pacer output with a specified period of 1 second.

The following SCPI commands control the Pacer:

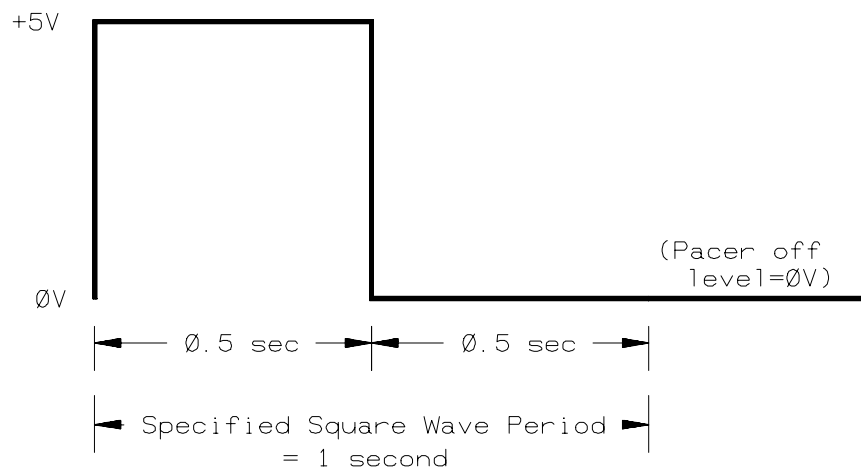

Figure 4-1. Pacer Out Square Wave

E1300A F. 3. 1

- SOUR:PULS:COUN sets the number of Pacer cycles. Specify from 1 to 8388607 cycles or specify INF for a continuous output.
- SOUR:PULS:PER sets the period of each Pacer cycle. You can specify periods from 500ns to 8.3 seconds.
- TRIG:SOUR sets the trigger source. The Pacer signal is output whenever the trigger event occurs (specified by the TRIG:SOUR command) and the INIT:IMM command has been executed.

**Example: Pacing an External Scanner** This example paces an external scanner connected to the mainframe's Pacer Out port. Each negative-going transition of the square wave advances to the next channel in the scanner's channel list. In this example, the Pacer outputs 10 periods of 1 second each.

|                   |   |
|-------------------|---|
| ABORT             | <i>Set Pacer trigger system to Idle State</i> |
| SOUR:PULS:COUN 10 | <i>Configure Pacer for 10 cycles</i>          |
| SOUR:PULS:PER 1   | <i>Square wave period = 1 second</i>          |
| TRIG:SOUR IMM     | <i>Trigger Pacer (when INIT is executed)</i>  |
| INIT:IMM          | <i>Place Pacer in Wait for Trigger State</i>  |

**Example: Continuous Pacer Out Signal** This example generates a continuous signal with a period of 250ms. The signal will begin when the trigger event (EXT) occurs (a negative-going transition on the mainframe's Event In connector).

|                      |   |
|----------------------|---|
| ABORT                | <i>Set Pacer trigger system to Idle State</i> |
| SOUR:PULS:COUN INF   | <i>Configure Pacer for continuous output</i>  |
| SOUR:PULS:PER 250E-3 | <i>Square wave period = 250 milliseconds</i>  |
| TRIG:SOUR EXT        | <i>Trigger Pacer on external signal</i>       |
| INIT:IMM             | <i>Place Pacer in Wait for Trigger State</i>  |

## Pacer Trigger States

Figure 4-2 shows that the Pacer's trigger system has an Idle State, a Wait for Trigger State, and a Pacer Action State. When you apply power, reset the system, or execute the ABORT command, the trigger system goes to the Idle State. You can configure the Pacer (SOURCE subsystem) and specify the trigger source (TRIG:SOUR command) while in the Idle State. Executing the INIT:IMM command places the Pacer in the Wait for Trigger State. Now when the trigger event occurs, the Pacer will move to the Pacer Action State and begin outputting the specified number of square wave cycles. Once the Pacer has begun outputting, the trigger system returns to the Idle State.

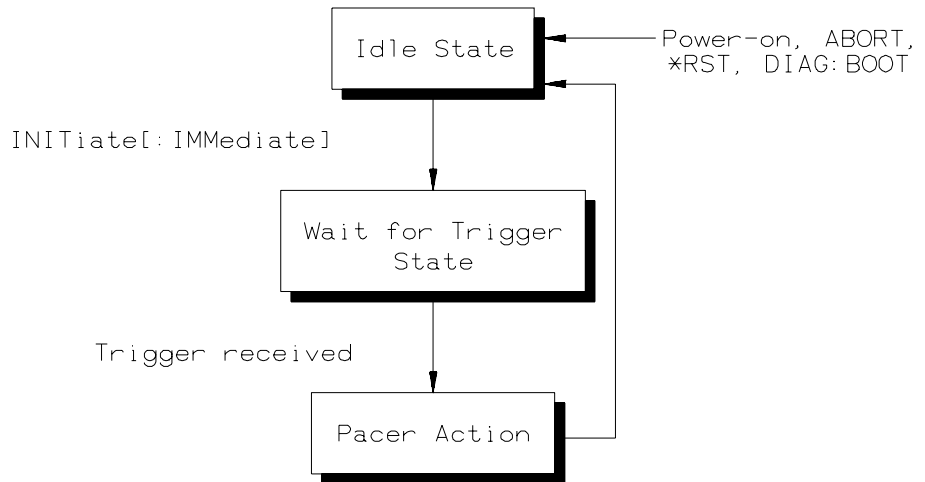

E1300A F. 3. 2

**Figure 4-2. Pacer Trigger States**

---

## Changing the Primary GPIB Address

You can set the mainframe's primary GPIB address to any integer value between 0 and 30. The address is set to 9 at the factory. (See Chapter 2 for instructions on setting/reading the GPIB address from the front panel.) The following command sets the mainframe's primary GPIB address to 12.

```
SYST:COMM:GPIB:ADDR 12
```

---

## Synchronizing Internal and External Instruments

The mainframe's Trig Out and Event In ports allow you to synchronize external equipment to instruments operating within the mainframe. The Trig Out port allows an instrument in the mainframe to output a negative-going pulse to indicate the occurrence of some event such as a multiplexer channel closure. The signal levels are standard TTL (0V to 5V). You direct the pulse from the appropriate instrument to the Trig Out port by sending the `OUTP:STAT ON` command to that instrument.

The Event In port allows an instrument in the mainframe to be armed or triggered from an external negative-going signal. The signal levels are standard TTL (0V to 5V). Send the `ARM:SOUR:EXT` command or the `TRIG:SOUR:EXT` command to an instrument to direct the signal on the Event In port to that instrument.

The following examples use an external Agilent 3457A Multimeter and an internal Agilent E1345A 16-Channel Multiplexer to demonstrate the use of the Trig Out and Event In ports.

**Example: Synchronizing an Internal Instrument to an External Instrument**

This example uses the mainframe's Trig Out and Event In ports to synchronize an external multimeter to a multiplexer installed in the mainframe. Connections are shown in Figure 4-3. The multimeter's Voltmeter Complete port outputs a pulse whenever the multimeter has finished a reading. The multimeter's External Trigger port allows the multimeter to be triggered by a negative going TTL pulse. Since the synchronization is independent of the GPIB bus and the computer, readings must be stored in the multimeter's reading memory. The sequence of operation is:

1. INIT (line 50) closes channel number 100.
2. The channel closure causes a pulse on Trig Out which triggers the multimeter to take a reading.
3. When the reading is complete it is stored in multimeter memory and the multimeter outputs a pulse on its Voltmeter Complete port. This signals the multiplexer to advance to the next channel in the scan list.
4. Steps 2 and 3 are repeated until all channels have been scanned and readings taken.

10 OUTPUT 722;"TRIG EXT;DCV;MEM FIFO"

*Set multimeter to external trigger, DC volts, enable reading memory*

20 OUTPUT 70914;"OUTP ON"

*Enable Trig Out port*

30 OUTPUT 70914;"TRIG:SOUR EXT"

*Set multiplexer to advance scan on external signal*

40 OUTPUT 70914;"SCAN (@100:115)"

*Specify scan list (channels 100 to 115)*

50 OUTPUT 70914;"INIT"

*Close first channel (starts scanning cycle)*

60 END

**Example: Synchronizing Internal/External Instruments and the Computer** This example uses the mainframe's Trig Out port to synchronize an external

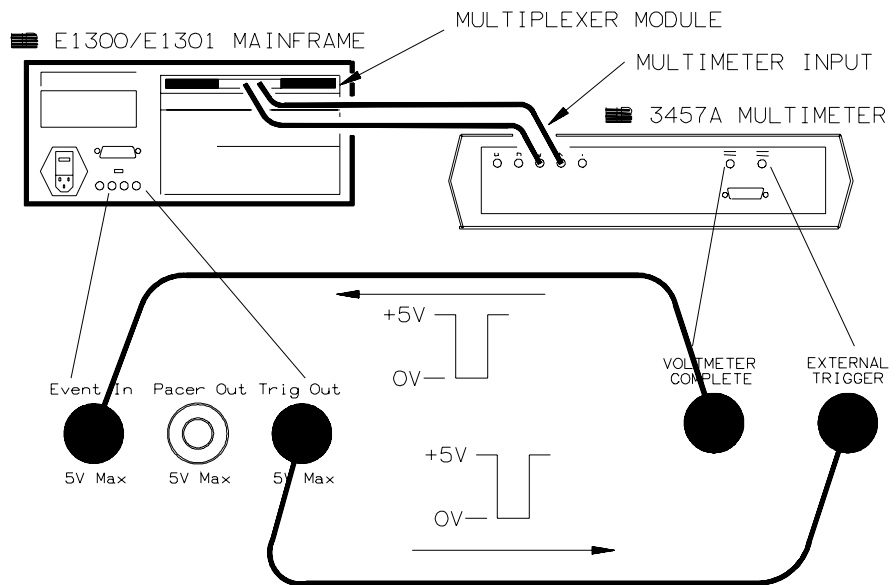

E1300A F. 3. 3

**Figure 4-3. Synchronizing Internal/External Instruments**

multimeter to an internal multiplexer. Connections are shown in Figure 4-4. This method synchronizes the computer to the instruments and relies on the computer to enter each reading and advance to the next channel in the scan list. The sequence of operation is:

1. INIT (line 50) closes channel number 100.
2. The channel closure causes a pulse on Trig Out which triggers the multimeter to take a reading.
3. When the reading is complete it is sent to the computer (lines 60 to 80).
4. The computer sends Group Execute Trigger to the multiplexer (line 90); this advances to the next channel in the scan list.
5. Steps 2 through 4 are repeated until all channels have been scanned and readings taken.

```
10 OUTPUT 722;"TRIG EXT;DCV"
```

*Set multimeter to external trigger, DC voltage measurements*

```
20 OUTPUT 70914;"OUTP ON"           Enable Trig Out port
```

```
30 OUTPUT 70914;"TRIG:SOUR BUS"
```

*Set multiplexer to advance scan on Group Execute Trigger or \*TRG*

```
40 OUTPUT 70914;"SCAN (@100:115)"  Specify scan list (channels 100 to 115)
```

```
50 OUTPUT 70914;"INIT"             Close first channel (starts scanning cycle)
```

```
60 FOR I= 1 TO 16                  Loop through following lines 16 times
```

```
70 ENTER 722;A                     Enter reading (computer waits until reading taken & received)
```

```
80 PRINT A                          Print reading
```

```
90 TRIGGER 70914                   Trigger multiplexer; advances to next channel
```

```
100 NEXT I
```

```
110 END
```

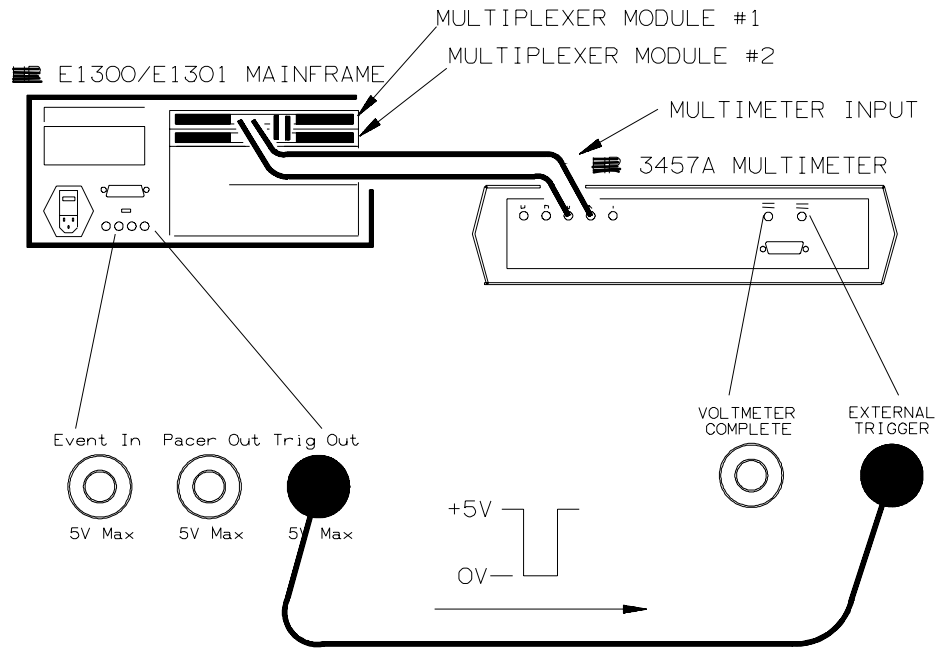

Figure 4-4. Synchronizing Internal/External Instruments and Computer 75K1G F. 3. 5

## Mainframe Data Memory

When power is applied or the system rebooted (DIAG:BOOT command), mainframe memory is automatically configured to provide a predefined amount of memory for any installed instruments that require memory space. For example, each multimeter instrument within the mainframe is allocated enough memory to store 100 readings.

Mainframe memory is also automatically re-allocated upon demand while programming. For example, if greater than 100 readings are requested for a multimeter, the mainframe computes the amount of memory required for these extra readings. If enough memory space is available, an additional amount is allocated to the multimeter and the readings are stored. If enough memory is not available, an error message occurs and the command is aborted. The memory allocated to an instrument above the initial power-on amount remains dedicated to that instrument until that instrument is reset (\*RST command) or until power is cycled. Once de-allocated, the memory is available to other instruments.

## Using Mainframe Data Memory

Commands that generate data and do not have a question mark (?) in their syntax store the data in mainframe memory. Faster instrument reading rates are possible when using reading memory versus sending data directly to an external computer. Storing readings in memory can also help to ensure that the period between paced readings is maintained at a constant value. When instrument data is stored in memory, it overwrites any data previously stored by that instrument. You can retrieve data stored in mainframe memory using the FETCh? command.

**Example: Storing and Retrieving Data From Mainframe Memory.** This example shows how to use mainframe memory to store 15 readings made using an Agilent E 1326A Multimeter. After the readings are stored, they are retrieved by the computer and displayed.

|  |  |
|--|--|
| 10 REAL OHM_RGS(1:15)                  | <i>Create computer array for 15 readings</i>                               |
| 20 OUTPUT 70903;"CONF:FRES (@105:109)" | <i>Configure multimeter for 4-wire resistance, scan channels 105 - 109</i> |
| 30 OUTPUT 70903;"RES:OCOM ON"          | <i>Enable offset compensation</i>  |
| 40 OUTPUT 70903;"TRIG:COUN 3"          | <i>Cycle through scan list 3 times</i>                                     |
| 50 OUTPUT 70903;"INIT"                 | <i>Trigger multimeter, store the readings in mainframe memory</i>          |
| 60 OUTPUT 70903;"FETCH?"               | <i>Get readings from mainframe memory</i>                                  |
| 70 ENTER 70903;OHM_RGS(*)              | <i>Enter readings into computer</i>  |
| 80 PRINT OHM_RGS (*)                   | <i>Display readings on computer</i>  |
| 90 END                                 |  |

---

## Non-Volatile User Memory

The System Instrument provides a way to allocate a segment of its non-volatile memory for storage and retrieval of user data. The structure and content of the data you store in this memory segment is up to you. The commands provided for data access merely store or retrieve a specified number of bytes. Commands for allocating and accessing the memory segment are implemented by the System Instrument (logical address, and GPIB secondary address 0).

### Allocating a User Memory Segment

The SCPI command `DIAGnostic:NRAM:CREate < size>` is used to allocate a segment of User non-volatile RAM. The amount of memory allocated is controlled by the *size* parameter. The `DIAG:NRAM:CRE` command informs the system of your request for a User RAM segment. The segment is not allocated until the system is reset (`DIAG:BOOT` command, or `RESET` from the front panel). Once the NRAM segment is allocated, you can consider it part of your System Instrument's configuration. It will remain through power interruptions and system resets. Only the `DIAG:BOOT:COLD`, or `DIAG:NRAM:CRE 0` commands can de-allocate the NRAM segment.

---

### Note: IBASIC Users

Allocating an NRAM segment will de-allocate a previously allocated RDISK segment. To include both types; allocate them both before a reset, or allocate the NRAM segment, reset the system, then allocate the RDISK segment and again reset the system.

---

### Locating the NRAM segment

Since the system decides where in memory to locate the NRAM segment, you must execute the `DIAG:NRAM:ADDRESS?` query to determine its starting

address. You will then know the starting address , and (from the ...NRAM:CRE < size> command) the length of the NRAM segment.

**Example: Allocating an NRAM segment and locating it.** This example shows how to allocate a small 128 byte NRAM segment. In addition, it shows how to determine the starting address of that segment.

```

    define variables
10  REAL Addr,Size
    128 byte NRAM segment
20  OUTPUT 70900;"DIAG:NRAM:CRE 128"
    reset the system
30  OUTPUT 70900;"DIAG:BOOT"
    allow time for reset to begin
40  WAIT 5
    wait for self-test to complete
50  ON TIMEOUT 7,.1 GOTO Complete
60 Complete:B= SPOLL(70900)
    query starting addr
70  OUTPUT 70900;"DIAG:NRAM:ADDR?"
    enter starting addr
80  ENTER 70900;Addr
    print it
90  PRINT USING "31X,""Addr= """,8D";Addr
```



## Using :DOWNload and :UPLoad? to Access Data

The command `DIAG:DOWNload < address> ,< data_block>` is used to store data into the NRAM segment. The command `DIAG:UPLoad? < address> ,< byte_count>` is used to retrieve data from the NRAM segment. The *address* parameter in ...DOWNload and ...UPLoad? can specify any address within the capability of the System Instrument's control processor. The system does not restrict you from storing or retrieving data which is outside of the NRAM segment.

---

### Caution

This capability to store (DOWNload) data to any location in mainframe memory means that you could inadvertently change the contents of memory being used by the mainframe control processor. This will occur if:

- you specify a starting address for DOWNload which is outside the NRAM segment
- you specify a starting address for DOWNload which is inside the NRAM segment, but the data block you send extends past the end of the NRAM segment.

If either of these occur, operation of the mainframe will be disrupted. To restore operation:

1. turn the mainframe off and then back on.
2. while the mainframe is "Testing ROM", press the **Reset Instr** button on the front panel or, for terminal users, press the **CTRL** and **R** keys.

This operation is the same as executing `DIAG:BOOT:COLD`

---

## Data Formats for :DOWNload

Data stored into NRAM using :DOWNload can be sent in either Definite, or Indefinite Length Arbitrary Block Program Data formats (see Parameter Types in the beginning of Chapter 5). The *Definite Length* block format is recommended since the format includes a data length count which positively terminates the :DOWNload command when that count is reached. If the *Indefinite Length* format's termination sequence (< newline> with END) is not received correctly, commands sent after the :DOWNload command will be interpreted as more data and sent to memory, possibly overwriting system memory and disrupting mainframe operation.

The following example program will use the small NRAM segment created in the previous example. It will show how to store and retrieve:

- 64 ASCII characters
- thirty-two, 8 bit data bytes
- sixteen, 16 bit data words

**Example: Storing and Retrieving data using DOWNload and UPLoad.**

```

    define variables for DOWNload and UPLoad
90 DIM Chars$(64),Chars_back$(80)
100 INTEGER Words(1:16),Bytes(1:32),Words_back(1:16),
    Bytes_back(1:32)
    create string of characters
110 Chars$= "1234567890123456789012345678901234567890
123456789012345678901234"
    create array of 16 bit data words
120 FOR I= 1 TO 16
130 Words(I)= 32700+ I
140 NEXT I
    create array of 8 bit data bytes
150 FOR I= 1 TO 32
160 Bytes(I)= 63+ I
170 NEXT I
    DOWNload 16 words to NRAM segment
180 OUTPUT 70900 USING ""DIAG:DOWN "",8D,"",# 232"",16(W)";
    Addr+ 96,Words(*)
    DOWNload 32 bytes to NRAM segment
190 OUTPUT 70900 USING ""DIAG:DOWN "",8D,"",# 232"",32(B)";
    Addr+ 64,Bytes(*)
    Download 64 characters to NRAM segment
200 OUTPUT 70900 USING ""DIAG:DOWN "",8D,"",# 264"",64A";
    Addr,Chars$

    UPLoad 64 characters from NRAM segment
210 OUTPUT 70900 USING ""DIAG:UPL? "",8D,"",64"";Addr
220 ENTER 70900 USING "4X,64A";Chars_back$
230 PRINT TAB(5);Chars_back$

    UPLoad 32 data bytes from NRAM segment
240 OUTPUT 70900 USING ""DIAG:UPL? "",8D,"",32"";Addr+ 64
250 ENTER 70900 USING "4X,32(B);Bytes_back(*)
260 PRINT Bytes_back(*)

    UPLoad 16 data words from NRAM segment
270 OUTPUT 70900 USING ""DIAG:UPL? "",8D,"",32"";Addr+ 96
280 ENTER 70900 USING "4X,16(W);Words_back(*)
290 PRINT Words_back(*)
300 END
```

## Downloading Device Drivers

---

### About this Chapter

This chapter describes the procedure for using downloadable device drivers with the Agilent E1405 Command Module. This functionality was added so that SCPI capability for new register based devices could be added to the Command Module without having to update an internal set of ROMs. This chapter contains the following sections:

- About this Chapter . . . . . 5-1
- What You Will Need . . . . . 5-1
- Memory Configuration . . . . . 5-3
- Download Program Configuration . . . . . 5-4
- Downloading Drivers in MS-DOS systems . . . . . 5-6
- Downloading Drivers in IBASIC Systems . . . . . 5-7
- Downloading Drivers from Other BASIC Systems . . . . . 5-8
- Downloading Multiple Drivers . . . . . 5-9
- Checking Driver Status . . . . . 5-9
- Manually Downloading Drivers . . . . . 5-10

---

### What You Will Need

The downloadable device drivers and the software necessary to download the drivers into Agilent mainframes are provided on 3.5" floppy disks which ship with the device driver manual. Disks are provided in both LIF and DOS format for your convenience. Drivers and appropriate downloading software are provided for use in MS-DOS systems downloading over an RS-232 link and for use in systems using BASIC or IBASIC (Instrument BASIC) and downloading over an GPIB (IEEE 488.2) link. The procedures for both types of downloaders are detailed later in this chapter.

Figure 5-1 shows the files and documents that will be needed for each type of download supported.

For RS-232 downloads you will need appropriate cables to connect your computer to the Command Module. If your computer has a 25 pin serial output connector, you can use an Agilent 24542G cable to make the connection. If your computer has a 9 pin serial output connector, you can use an Agilent 24542M *and* an Agilent 24542H cable (connected end to end) to make the connection.

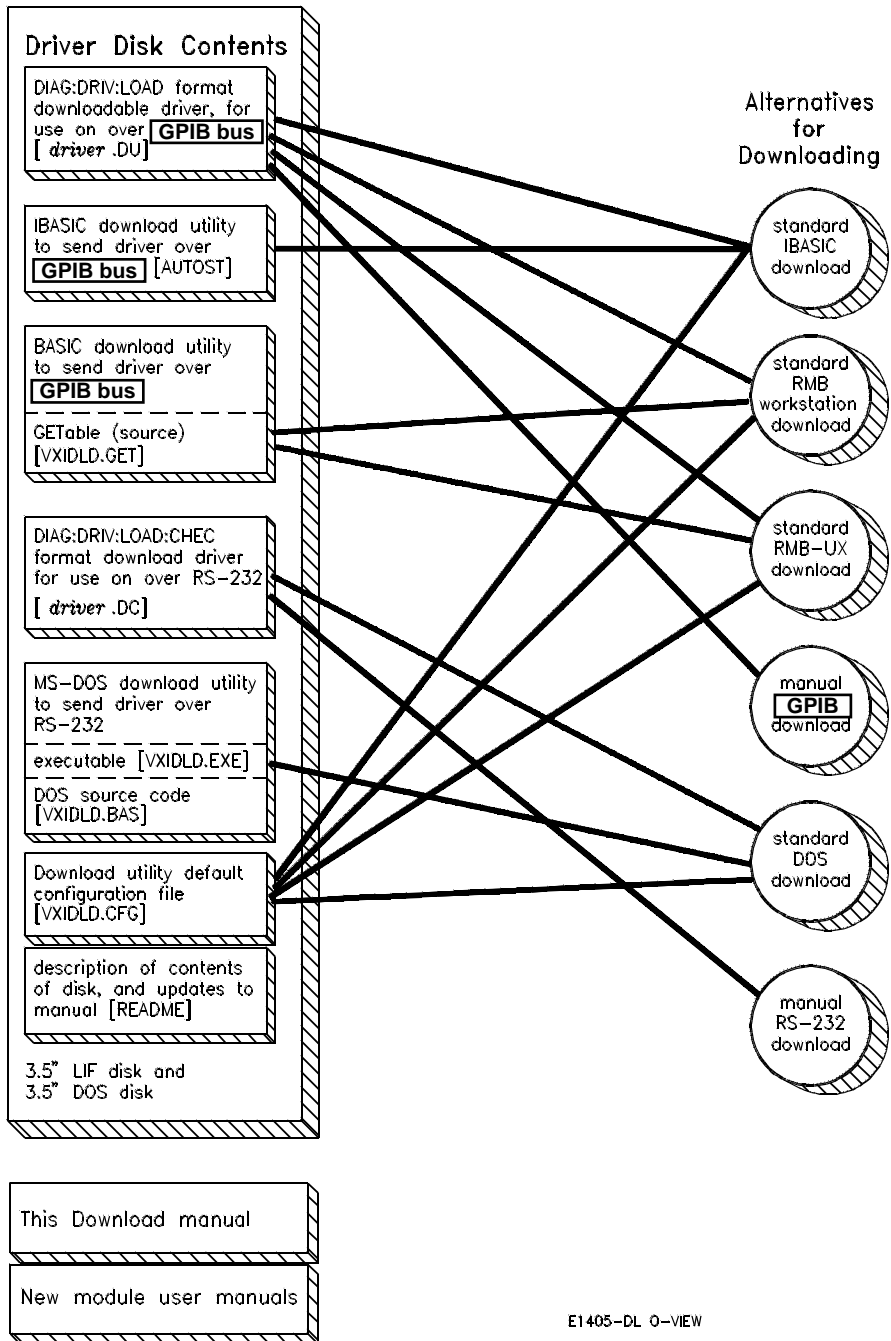

Figure 5-1. Driver and Documentation Usage

---

## Memory Configuration

Before attempting to download any device drivers you should understand how memory is affected when you specify a size for one or more types of RAM. There are three types of RAM that you can allocate in the mainframe:

- RAM disk (RDISK)
- Non-volatile RAM (NRAM)
- Driver RAM (DRAM)

Figure 5-2 shows the positioning of these areas in memory. User Non-volatile RAM and RAM Disk both occupy higher memory addresses than the Driver RAM. Because the actual size of these three areas is variable, they do not have a fixed starting position. At creation time, the lowest unused memory address becomes the starting address for the requested type of RAM. Memory areas set at higher addresses can be created without affecting any previously created lower memory areas, but creating a new memory area causes any areas *above it* to be removed.

---

### NOTE

If you wish to use RDISK or NRAM, you can modify the configuration file so that the download program sets up the required memory segments.

---

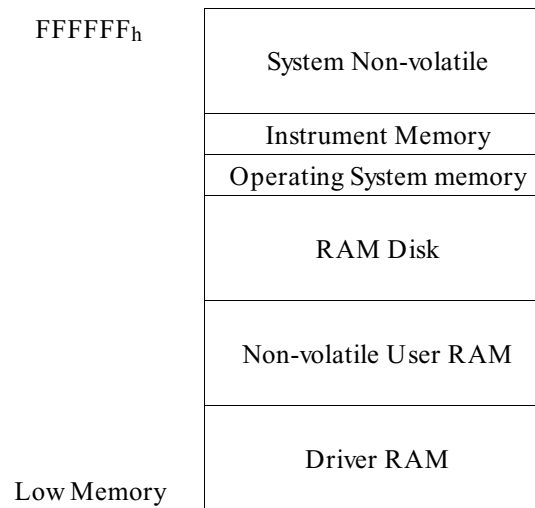

The Low Address depends on the amount of memory installed. It is equal to the highest address plus 1 (1000000<sub>h</sub>) minus the size of memory installed. The boot time messages will tell you how much RAM you have installed in your system. In a system with 512Kbytes of memory the Low Address is low address = 1000000<sub>h</sub> - 80000<sub>h</sub> = F80000<sub>h</sub>, or 16,252,928 decimal.

**Figure 5-2. Positioning of Allocatable RAM**

**Example** *If you create a RAM Disk area without creating any User Non-volatile RAM or Driver RAM, the starting address for the RAM Disk will be at the lowest address (F80000<sub>h</sub> for a command module with 512Kbytes of memory). If you now create a Driver RAM area, the RAM Disk area will be removed since the new area has to be at a lower address than the RAM Disk area.*

---

## Download Program Configuration

If you will not be using the default configurations for downloading, you will need to edit the configuration file to match your system configuration. If the default values shown below are correct for your setup, you can proceed to the appropriate downloading instructions.

The configuration defaults for MS-DOS systems are:

- Download program searches for drivers in current directory.
- Execution Log is OFF (log to screen only).
- All drivers in current directory will be downloaded.
- COM1 is used for output.
- Baud rate is 9600.
- 1 stop bit is used
- NRAM size is zero.
- RDISK size is zero.

The configuration defaults for GPIB systems are:

- Download program searches for drivers in current directory.
- Execution Log is OFF (log to screen only).
- All drivers in current directory will be downloaded.
- 80900 is used for the interface address when running from IBASIC. 70900 is used as the interface address when running in any BASIC environment other than IBASIC.
- NRAM size is zero.
- RDISK size is zero.

### Editing the Configuration File

The configuration file (VXIDLD.CFG or VXIDLD\_CFG) on your driver distribution disk is shipped with all entries commented out. In this state, the download programs will use the default values shown above. To activate or change an entry, you must edit the file manually. The file is set up so that it can be edited either by a standard text editor or word processor, or with a Basic language editor. Comments and instructions are included in the file.

- The beginning of the useful information on each line is the part following "*linenumber* REM" (the "*linenumber* REM" is ignored).
- All lines beginning with "# " are comments.
- Lines that start with "# # " are intended to remain comments.
- Lines that start with "# " are example lines that you may wish to activate and/or modify. These are the actual configuration statements.
- Setting labels are not case sensitive, and should be separated from the associated value by an equal sign ("= ").
- Unrecognized settings are ignored.
- If you activate more than one line for a setting that can take only one value, the first value found for the setting will be used.

**DIRECTORY=** specifies the directory where you store your drivers and where the driver programs will log information about their progress. The default is the current directory. The directory specified must be writeable if you are doing downloads using IBASIC or logging progress.

**EXECUTION LOG =** specifies the place to log information about the program's progress. The default location for this function is the screen. If you

specify a file name here, the driver downloader will log to the screen and to the specified file.

**DRIVER FILE** = specifies the driver file or files to download. The default is to download all device driver files found in the directory specified by **DIRECTORY** = . If the driver downloader finds one line in this format, it will assume that you are specifying entries and will only download the listed entries. This configuration item can have multiple lines.

**ADDRESS** = specifies the I/O interface that you will be using. The default interface address when running in IBASIC over GPIB is 80900. The default address when running over GPIB in any other BASIC environment is 70900. The default address when running in DOS is 1 (for COM1:).

The communication interface you will be using when running from any of the BASIC environments is the "GPIB" interface (also known as IEEE 488.1). Selection of a specific GPIB interface consists of an address in the form "spp00" where:

**ss** is the select code of the GPIB interface card.

**pp** is the primary GPIB address used for the VXI mainframe.

**00** is the secondary GPIB address used for the SYSTEM instrument.

The communication interface you will be using when running from DOS is the "RS-232" interface. When Using the RS-232 interface the serial cable must be connected to either the built-in RS-232 connection of the VXI mainframe or an RS-232 module (Agilent E1324A) that is set to interrupt at the default interrupt level (level 1). Selection of the address for the RS-232 interface consists of an address that is 1 for COM1 or 2 for COM2:.

**BAUD**= specifies the baud rate of the transmission if you are using RS-232. The default is 9600 (which is also the default for the VXI mainframe after a DIAG:BOOT:COLD command). Allowed values are 300, 1200, 2400, 4800, 7200, or 9600 (19,200 is not supported by DOS).

**STOP BITS**= specifies the number of stop bits per byte if you are using RS-232. The default is 1 (which is also the default for the VXI mainframe after a DIAG:BOOT:COLD command). Allowed values are 1 or 2.

**NRAM**= specifies the size in bytes of the non-volatile user RAM area you wish to set up. The default value is zero bytes. You may change this value later independent of the downloaded drivers, but changing it will always affect any RAM disk (RDISK) you have specified.

**RDISK** = specifies the size in bytes of the RAM disk segment you wish to set up. The default value is zero bytes. You can change this value later without affecting either the downloaded device drivers or the user non-volatile RAM (NRAM).

---

## Downloading Drivers in MS-DOS Systems

The device driver download program VXIDLD.EXE provided on the disk with the driver files for use with an RS-232 interface must be run from MS-DOS. It will set up the the required device driver memory and any other memory partitions defined in the configuration file, reboot the system, and download the device driver. If there are device drivers present, or you already have memory allocated for NRAM (User Non-volatile RAM) or RDISK (RAM Disk), a warning will be issued and the downloading process aborted. You must first clear any existing drivers from the system, and then download all of the required drivers together. You may redefine any NRAM or RDISK areas after downloading the device drivers.

1. Make sure that your computer can talk to the E1405 Command Module. If you have changed the communications protocol for the Command Module or mainframe, you must change them back to 9600 BAUD, 8 data bits, 1 stop bit, and no parity before this download will work correctly.

These are the defaults after cold boot. If necessary, you can change the baud rate and number of stop bits in the configuration file, but since the special formatting required for downloading over RS-232 requires all 8 data bits in each byte, you must make sure that the data bits are set to 8 and parity checking is OFF. The download program handles its own pacing, so the setting for pacing does not matter.

2. Put the floppy disk into an appropriate drive.
3. Make sure that the floppy disk is your current drive (for example, type "A:" and press ENTER).
4. Execute the device downloader program (type "VXIDLD" and press ENTER).
5. The downloader program will check to make sure that there are no device drivers already loaded, and no memory has been allocated for NRAM or RDISK. If either condition exists, the program will issue a warning and abort. If not, it will create the required RAM partitions, reboot the system, and download the device driver on the supplied disk.

Any errors encountered while downloading will be reported.

6. The download program will check to make sure that the driver has been downloaded and is in memory.

---

### WARNING

**Terminate and Stay Resident programs in your MS-DOS system may interfere with the timing of RS-232 transfers and cause errors in the downloading. If you encounter errors indicating that the download program did not receive back what it expected, and the driver is not loaded, remove all of your TSRs from memory and try the download procedure again.**

---



---

## Downloading Drivers in GPIB Systems with IBASIC

The device driver download program AUTOST provided on the disk with the driver files for use with GPIB must be run from IBASIC (Instrument Basic). It will set up the the required device driver memory and any other memory partitions defined in the configuration file, reboot the system, and download the device driver. This program will issue a warning and abort if any errors are encountered. If there are device drivers present, or if you already have memory allocated for NRAM (User Non-volatile RAM) or RDISK (RAM Disk), you must first clear any existing drivers from the system, and then download all of the required drivers together. You may redefine any NRAM or RDISK areas after downloading the device drivers.

---

### NOTE

If you wish to see the messages that the download program generates, you need to have a terminal connected to the IBASIC display port. If you have not changed this from its default value of NONE, messages are sent to the built-in RS-232 port.

---

1. Make sure that your Command Module (E1405) *is* set to System Controller mode.
2. Put the floppy disk into an appropriate drive.
3. Make sure that the floppy disk is your current drive (for example, type 'MSI ":",700,1"' and press ENTER).
4. Load the device download program into IBASIC (type 'GET "AUTOST"' and press ENTER) and run the program (type "RUN" and press ENTER).
5. The download program will check to make sure that there are no device drivers already loaded, and no memory has been allocated for NRAM or RDISK. If either condition exists, the program will issue a warning and abort. If not, it will create the required RAM partitions, reboot the system, and download the device driver on the supplied disk.

Any errors encountered while downloading will be reported and will cause the program to abort.

6. The download program will check to make sure that the driver has been downloaded and is in memory.

---

### NOTE

If you are using IBASIC but controlling the system over the GPIB, you must put all commands in quotes and prefix them with "PROG:EXEC". A typical command would be:

```
PROG:EXEC 'MSI ":",700,1"'
```

---

---

## Downloading Drivers in GPIB Systems with BASIC

The device driver download program VXIDLD\_GET provided on the disk with the driver files for use with GPIB must be run from a BASIC other than IBASIC. It will set up the the required device driver memory and any other memory partitions defined in the configuration file, reboot the system, and download the device driver. If there are device drivers present, or you already have memory allocated for NRAM (User Non-volatile RAM) or RDISK (RAM Disk), a warning will be issued and the downloading process aborted. You must first clear any existing drivers from the system, and then download all of the required drivers together. You may redefine any NRAM or RDISK areas after downloading the device drivers.

1. Make sure that your Command Module (E1405) *is not* set to System Controller mode.
2. Put the floppy disk into an appropriate drive.
3. Make sure that the floppy disk is your current drive (for example, type 'MSI ",700,1"' and press ENTER).
4. Load the device download program into BASIC (type 'GET "VXIDLD\_GET"' and press ENTER) and run the program (type "RUN" and press ENTER).
5. The download program will check to make sure that there are no device drivers already loaded, and no memory has been allocated for NRAM or RDISK. If not, it will create the required RAM partitions, reboot the system, and download the device driver on the supplied disk.  
  
Any errors encountered while downloading will be reported and will cause the program to abort.
6. The download program will check to make sure that the device driver was successfully downloaded.

---

## Downloading Multiple Drivers

The driver downloader software automatically checks for the existence of other drivers when it is run. If there are device drivers present, it will abort the process and inform you that you must first clear the other device drivers out of the mainframe and then download all of the required drivers at once. The easiest way to accomplish this is to place copies of all of the device drivers into a single directory on your hard disk along with the downloader, or onto the same floppy disk. The download program will look in its own directory first, and download any device drivers it finds.

1. Move all of your device drivers into a single directory with the downloaders.
2. Clear the DRAM memory in the mainframe (send "DIAG:DRAM:CRE 0" and "DIAG:BOOT" to the System Instrument).
3. Execute or load and run the appropriate device driver software, as described above.

All device drivers in the directory or on the same floppy disk as the driver downloader will be downloaded automatically after the system checks to make sure that there are no other device drivers already loaded. You can change several aspects of the downloading procedure by editing the configuration file .

---

## Checking Driver Status

Once your drivers are downloaded, you can use the System Instrument command `DIAG:DRIV:LIST?` to check their status. In the format shown, this command lists all types of drivers. You can specify the *type* (ALL, RAM or ROM) by using `DIAG:DRIV:LIST:type?`

NOTE:

- **DIAG:DRIV:LIST?** lists all drivers in the system.
- **DIAG:DRIV:LIST:RAM?** lists all drivers found in the RAM driver table DRAM. These are the drivers which you just downloaded into the system.
- **DIAG:DRIV:LIST:ROM?** lists all drivers found in the ROM driver table. These drivers are always present in the system. If one of these is meant for an instrument which also has a driver in RAM, the driver in RAM will be used by the system.

---

## Manually Downloading a Driverdown manual

Download programs are supplied for use with the system setups described earlier in this chapter. If you have a system setup that does not allow the use of one of the supplied download programs (for instance, if you are using a Macintosh® computer), you will need to manually download the driver. The details of this process will be different for different system setups, but the basic procedures are outlined below.

## Preparing Memory for Manual Downloading

Before you can manually download any drivers using either RS-232 or GPIB, you must define the DRAM (Driver RAM) into which the drivers will be transferred. DRAM memory is non-volatile.

1. Calculate the required total DRAM size. This is the total amount of memory required by the mainframe for all of the device drivers you are going to download.

Typical driver size will range from 40Kbytes to 100Kbytes. If you are in doubt about the amount of memory needed for downloading your device drivers, use the size of the GPIB driver file (ends in "DU") on the driver disks. Remember that you must add the amount of memory necessary for all of the device drivers you plan to download. You can see how much RAM is available by using the DIAG:DRAM:CRE? MAX, DEF query.

---

### NOTE

Each driver will need additional system RAM at run time. Although this is not part of the RAM necessary for the DRAM calculations, you should make sure that you have enough DRAM to download the drivers, and enough system RAM left after downloading to run the drivers. Most drivers will need less than 15Kbytes of additional RAM (per driver) at run time. If IBASIC is in the system, it will take at least 150Kbytes to 200Kbytes of system RAM in addition to the RAM used by the device drivers.

- 
2. Create the appropriate DRAM partition using the DIAG:DRAM:CRE command. Unless you have more than eight drivers to download, you do not need to specify the second parameter.

---

### WARNING

**Creating this memory partition will delete any NRAM or RDISK partitions that you have defined, and any data in NRAM or RDISK memory. You must redefine any such memory blocks after you have defined the Driver RAM.**

---

3. Reboot the system

## Manually Downloading Over GPIB

Manually downloading a driver over GPIB is fairly straightforward. This discussion assumes that the downloadable device driver has been supplied by Agilent. Drivers supplied by Agilent are formatted so that you just need to transfer the driver to command module memory. You must also have the driver on media that is accessible to the host computer that will be controlling the download.

You should send a \*RST command and a \*CLS command to the SYSTEM instrument to put it in a known state before beginning your download.

On most computers, a program will be required for the actual download process. Since the driver file contains the System Instrument command to start the downloading and the actual data to download, this program just needs to transfer the bytes in the driver file to the System Instrument, one byte at a time.

This file contains the SCPI command DIAG:DRIV:LOAD followed by the IEEE 488.2 arbitrary definite block header, and then the actual driver. The definite block starts with the # character, followed by a single digit that shows how many digits are in the length field, followed in turn by the length field. For instance, a block that is 1000 bytes long would have a block header of # 800001000.

When your transfer program is complete you should send the SCPI query SYST:ERR? to make sure that there were no errors during the download, and reboot the system (send DIAG:BOOT). You can make sure that all of your drivers have been properly loaded into Driver RAM by sending the SCPI command DIAG:DRIV:LIST:RAM?

## Manually Downloading Over RS-232

Manually downloading a driver over RS-232 is similar in concept to downloading over GPIB. Drivers supplied by Agilent are formatted so that you just need to transfer them to command module memory. You must also have the driver on media that is accessible to the host computer that will be controlling the download.

However, the RS-232 interface of the E 1405 uses special control characters (e.g., < CTRL-C> to implement the equivalent of the GPIB "device clear" function) that would cause havoc in the download process if sent as part of the driver. The driver file on the distribution disk that ends in "DC" is specially formatted for RS-232 downloading to avoid this problem (see Appendix E "Formatting Binary Data for RS-232" for more information on the data format of these files).

### Transmission Format

You need to make sure that the transmission format of your computer matches the format used at the System Instrument. The default configuration for the System Instrument after a DIAG:BOOT:COLD command has been issued is

- 9600 BAUD
- 8 data bits
- 1 stop bit
- Parity checking is OFF
- XON/XOFF pacing

If you are going to use any other setting, you must set up the appropriate settings in the System Instrument using the following commands

|  |  |
|--|--|
| COMM:SER[ <i>n</i> ]:REC:BAUD < <i>rate</i> >  | <i>sets BAUD rate</i>  |
| COMM:SER[ <i>n</i> ]:REC:SBITS < <i>bits</i> > | <i>sets number of stop bits</i>                              |
| DIAG:COMM STOR                                 | <i>saves settings so they will be kept through a reboot.</i> |

---

## NOTE

Because the special formatting for binary files uses all 8 bits, the number of data bits must be set to 8 and parity checking must remain OFF for the driver files to transfer properly.

---

## Pacing the Data

Since the RS-232 interface is asynchronous, it is possible for the computer that is doing the download to overrun the System Instrument. This would cause part of the driver to be lost. To prevent this from happening, you should enable hardware handshake (either RTS or DTR) or software handshake (XON/XOFF).

The default configuration for the E1405 Command Module is for software handshake enabled and hardware handshake disabled. To make sure that software handshake is enabled for the command module use the SYST:COMM:SER:PACE? query. To set up software handshake you can use the following commands:

```
SYST:COMM:SER:PACE:THR:STOP? MAX
    to find the maximum number of characters to fill the input
    buffer.
SYST:COMM:SER:PACE:THR:STOP < max-20>
    to set the threshold for stopping data to the maximum size of
    the input buffer minus 20 characters.
SYST:COMM:SER:PACE:THR:STAR 0
    to set the start buffer level to zero. This makes sure that the
    input buffer is completely flushed whenever transmissions are
    stopped.
SYST:COMM:SER:PACE:XON
    to enable the software handshake protocol.
```

The start threshold is not critical as long as it is less than the stop threshold. The stop threshold must be set low enough to handle the maximum number of characters that are likely to be received at the System Instrument after it sends the XOFF signal.

Hardware handshake can be set up to use either the DTR (Data Terminal Ready) line or the RTS (Ready to Send) line. These modes can be set with the SYST:COMM:SER:CONT:DTR IBFULL command (to set for DTR) or SYST:COMM:SER:CONT:RTS IBFULL command (to set for RTS). You may wish to turn software handshake OFF using the SYST:COMM:SER:PACE NONE command, though the system will operate with both protocols enabled. When the input buffer of the System Instrument is not full (number of characters in the input buffer is less than the high threshold), the specified hardware line will be asserted. When either hardware

handshake mode is enabled, the System Instrument will not transmit characters when either the CTS (Clear to Send) or the DSR (Data Set Ready) lines are not asserted. This acts to pace the System Instrument output.

---

## NOTE

The E 1405 Command Module RS-232 interface is implemented as a DTE (Data Terminating Equipment). Since most computer RS-232 interfaces are also implemented as DTEs, a cable that does line swapping (null modem cable) is usually used to connect the computer to the instrument. This cable typically swaps the receive and transmit lines. It will usually connect the DTR line of one interface to the CTS and DSR lines of the other. It will connect the RTS line of one interface to the DCD (Data Carrier Detect) line of the other.

---

## CAUTION

The RS-232 interface of the E 1405 Command Module will echo any characters received with an ASCII value greater than 32 and less than 128. Carriage returns are echoed as carriage return/linefeed. When transferring the driver file, these echoes can fill up the RS-232 receive buffer of your computer if they are not read. If receive pacing is enabled for your computer this could cause the computer to send the "Stop Transmitting" signal to the System Instrument, which could block the remaining downloaded bytes or other commands sent after the download. Since the driver file contains command strings and many carriage returns that will be echoed by the system, your program should read the returning echo characters from the RS-232 line. This will also let you determine if there are any error messages coming back.

---

## Transmitting Using a COPY Command

On some computers it is possible to use an RS-232 or GPIB port and the copy command to transfer the device driver. Hardware or software handshake must be used by the copy command on the computer doing the downloading, and the same handshake mode must be enabled on the System Instrument.

1. Set the required handshake mode and data format (e.g., on DOS systems use the MODE command).
  2. Type "COPY *filename port*" to transfer the file through the RS-232 port to the System Instrument (e.g., on a DOS system you might use "COPY /B *filename*.DC COM1:"). This command may be slightly different depending on the type of computer being used.
- 

## NOTE

Since errors are echoed immediately, this method of transfer has no means of trapping errors.

---

### **Transmitting Using a CAT Command**

On HP-UX systems you can use the *cat* command to transfer the device driver. The appropriate device file must exist. All shell commands are assumed to be executed from either the */bin/sh* or */bin/ksh* shell.

1. Start a process that opens the device file to be used. This process should keep the device file open long enough for the transfer to begin. This step is done so that the following command to set the device file configurations will remain in effect for the transfer. A command that will do this is:

```
(cat < device file > /dev/null; sleep 1000) &
```

2. Set the required configuration of the device file using the *stty* command. The following command will set the device file to work with the default System Instrument configuration.

```
stty -opost 9600 ixon -ixoff cs8 -cstopb ignpar < device file
```

3. Transfer the file to the System instrument with the *cat* command.

```
cat filename > device file
```

### **Transmitting Using Custom Software**

If the COPY command on your computer cannot directly implement handshaking, or if you wish to trap errors and abort or otherwise modify the transmission process, you must use a program to handle the download process.

This procedure assumes that your computer has some means of looking at data being echoed from the System Instrument, and can check for a return character without having to have a character returned. Since the actual driver file bytes sent over the RS-232 interface are not echoed, the lack of ability to do this would put the system into an infinite wait at the first byte that was not echoed.

1. Set up the appropriate handshake mode and data format on your system, and the matching handshake mode in the System Instrument.
2. Transfer the driver file over the RS-232 interface using a program that follows the outline in figure 5-3.

### **Check Driver Status**

Make sure that the drivers were properly downloaded by checking their status using the *DIAG:DRIV:LIST:RAM?* command. This will give you a list of all the drivers currently found in DRAM.



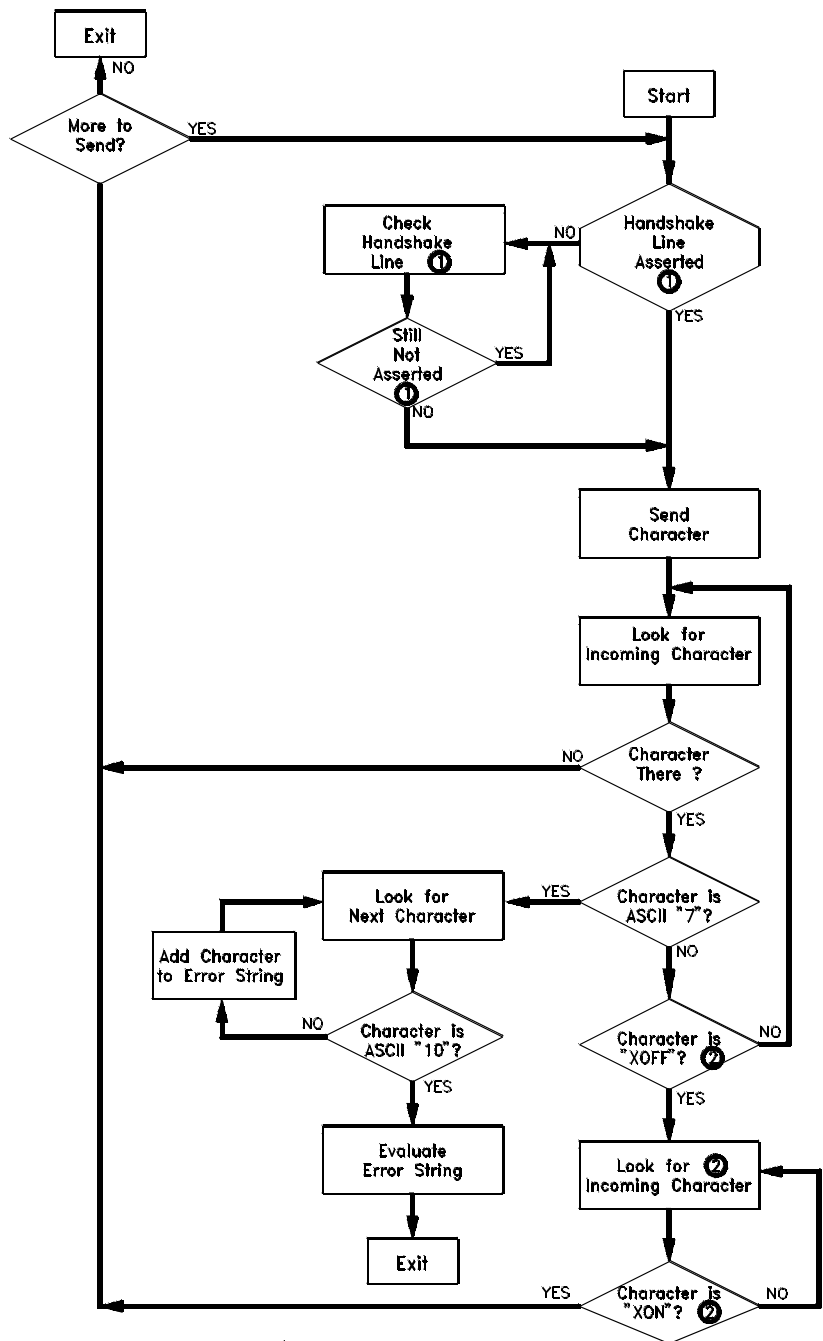

- ① Skip these steps if using software handshake.
- ② Skip these steps if using hardware handshake.

E1405-DL FIG5-3

Figure 5-3. Manually Downloading a Device Driver



## Controlling Instruments Using GPIB

---

### About this Chapter

This chapter shows how to control instruments in the mainframe from an external computer using IEEE 488.2 Common Commands and the GPIB interface. This includes how to monitor instrument status, interrupt the computer, and synchronize one or more instruments to an external computer.

Command references for the supported IEEE 488.2 Common Commands and IEEE 488.2 GPIB Messages are located near the end of this chapter. This chapter contains the following sections:

- Programming Hints ..... 6-1
- Instrument Status ..... 6-2
- Clearing Status ..... 6-10
- Interrupting the External Computer ..... 6-10
- Synchronizing an External Computer and Instruments. .... 6-12

---

### Note

Examples that require showing a computer language are written for HP 9000 Series 200/300 Computers using BASIC language.

---

---

### Programming Hints

- Only one instrument in the mainframe can be the addressed listener (i.e., receiving commands) on the GPIB at any one time.
- After executing a query command (any command that generates data), do not attempt to execute another command until you have read the data generated by the query command. Doing so causes the -410: Query INTERRUPTED error. You can however, send a command following a query command if they are combined in the same command string (joined by semicolon and colon).
- Instruments in the mainframe have 128 character input buffers. Do not send a command string containing a query command that is longer than 128 characters. Doing so may cause a deadlock situation which can only be resolved by setting a timeout on the computer's enter statements and then reading the error(s) after the timeout occurs.

---

## Status System Structure

The instrument status structure monitors important events for an instrument such as when an error occurs or when a reading is available. All instruments have the following status groups and registers within those groups:

- Status Byte Status Group
  - status byte register
  - service request enable register
- Standard Event Status Group
  - standard event status register
  - standard event status enable register
- Operation Status Group
  - condition register
  - event register
  - enable register
- Questionable Data Status Group
  - condition register
  - event register
  - enable register

You read and configure the registers in the Status Byte and Standard Event groups using Common Commands. These are the most commonly used instrument registers. The registers in the Standard Operation Status group and Questionable Data status group are configured using the commands in the STATus subsystem.

---

### NOTE

The Status Byte, Standard Event, and Operation Status groups are the only groups covered in this chapter. The Questionable Data status group is supported by the system instrument (Command Module) but is not used by the system instrument. Commands affecting this status group (Chapter 5) are accepted but have no effect.

---

Refer to the STATus subsystem in the Command Reference of the individual plug-in module manuals to determine how a module uses the Operation Status group and Questionable Data status groups. If the STAT:OPER or STAT:QUES commands are not documented in the plug-in module manual, that module does not use the registers.

## The Status Byte Register

As shown in Figure 4-1, the Status Byte register is the highest-level register in the status structure. This register contains bits which summarize information from the other status groups.

### NOTE

The bits in the other status group registers must be specifically enabled to be reported in the Status Byte register. Refer to "Unmasking Standard Event Status Bits" (later in this chapter) for more information.

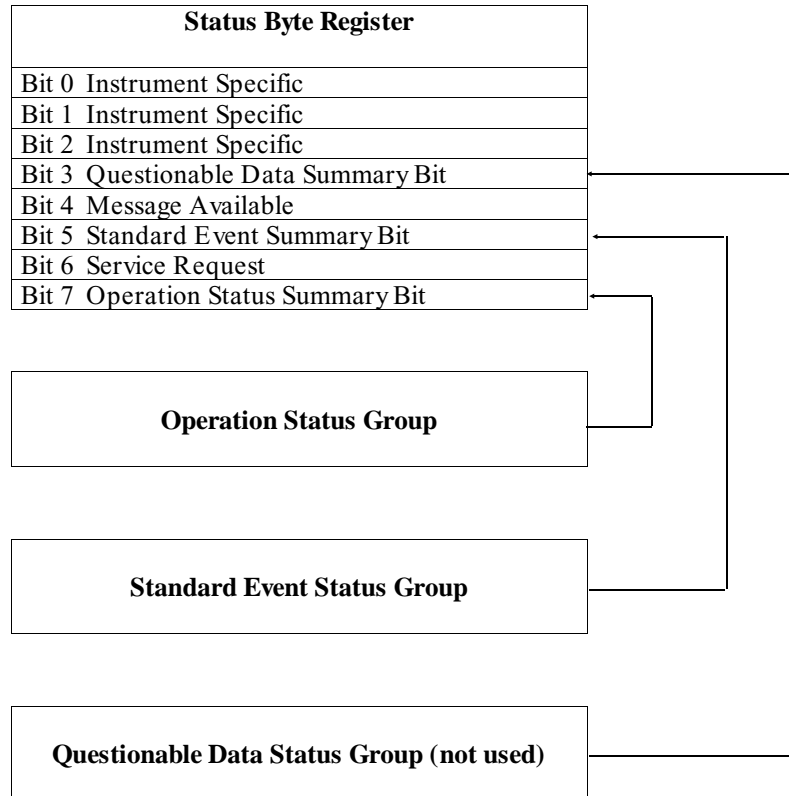

Figure 6-1. Status Structure

Table 4-1 shows each of the Status Byte register bits and describes the event that will set each bit.

**Table 4-1. Status Byte Register**

| Bit Number | Decimal Weight | Description  |
|------------|----------------|--|
| 0          | 1              | Instrument Specific (not used by most instruments)   |
| 1          | 2              | Instrument Specific (not used by most instruments)   |
| 2          | 4              | Instrument Specific (not used by most instruments)   |
| 3          | 8              | Questionable Data Status Group Summary Bit. One or more events in the Questionable Data Status group have occurred and set bit(s) in those registers.  |
| 4          | 16             | Message Available. The instrument's output queue contains information. This bit can be used to synchronize data exchange with an external computer. For example, you can send a query command to the instrument and then wait for this bit to be set. The GPIB is then available for other use while the program is waiting for the instrument to respond. |
| 5          | 32             | Standard Event Status Group Summary Bit. One or more enabled events in the Standard Event Status Register have occurred and set bit(s) in that register.   |
| 6          | 64             | Service Request--Service is requested by the instrument and the GPIB SRQ line is set true. This bit will be set when any other bit of the Status Byte Register is set and has been enable to assert SRQ by the *SRE command.   |
| 7          | 128            | Operation Status Group Summary Bit. One or more events in the Operation Status Group have occurred and set bit(s) in those registers.  |

### Reading the Status Byte Register

You can read the Status Byte register using either the \*STB? command or an GPIB serial poll. Both methods return the decimal weighted sum of all set bits in the register. The difference between the two methods is that \*STB? does not clear bit 6 (Service Request); serial poll does clear bit 6. No other status register bits are cleared by either method with the exception of the Message Available bit (bit 4) which may be cleared as a result of reading the response to \*STB?. In addition, using an GPIB serial poll lets you read the status byte without interrupting the instrument parser. The \*STB? method requires the instrument to process the command. This can generate interrupt query errors if the instrument is executing another query.

The following program uses the \*STB? command to read the contents of the system instrument's (Command Module's) Status Byte register.

```

10 OUTPUT 70900;"* STB?"           Read Status Byte Register
20 ENTER 70900; A                 Enter weighted sum
30 PRINT A                        Print weighted sum
40 END

```

For example, assume bit 3 (weight = 8) and bit 7 (weight = 128) are set. The above program returns the sum of the two weights (136).

The following program reads the system instrument's Status Byte register using the GPIB Serial Poll command.

```
10 P= SPOLL(70900)           Read Status Byte Register using  
                               Serial Poll, place weighted sum  
                               in P  
20 PRINT P                   Print weighted sum  
30 END
```

### **Service Request Enable Register**

The Service Request Enable register is used to "unmask" bits in the Status Byte register. When an unmasked Status Byte register bit is set to '1', a service request is sent to the computer over GPIB.

The command used to unmask Status Byte register bits is:

```
*SRE < mask>
```

where < mask> is the decimal weight of the bit to be unmasked, or is the sum of the decimal weights if multiple bits are to be unmasked. For example, executing:

```
*SRE 16
```

unmasks the *message available* (MAV) bit in the Status Byte register. Sending:

```
*SRE 48
```

unmasks the *message available* (MAV) and *event status bit* (ESB).

You can determine which bits in the Status Byte register are unmasked by sending the command:

```
*SRE?
```

This command returns the decimal weighted sum of all unmasked bits.

### **The Service Request Bit**

Note that the Service Request bit (bit 6) in the Status Byte register does not have a mask. Bit 6 is set any time another Status Byte register bit is set. If the other bit which is set is unmasked, a service request is generated.

### **Clearing the Service Request Enable Register**

The Service Request Enable register mask is cleared (each bit masked except bit 6) by sending the command:

```
*SRE 0
```

If \*PSC 1 has been executed, the Service Request Enable register mask is cleared when power is cycled. If \*PSC 0 has been executed, the mask is unchanged when power is cycled. (\*PSC? queries the setting.)

## Standard Event Status Register

The Standard Event Status Register in the Standard Event status group monitors the instrument status events shown in Table 4-2. When one of these events occurs, it sets a corresponding bit in the Standard Event Status Register.

### NOTE

The Standard Event Status Register bits are not reported in the Status Byte Register unless unmasked by the Standard Event Status Enable Register. Refer to the section "Unmasking Standard Event Status Bits" for more information.

**Table 4-2. Standard Event Status Register**

| Bit Number | Decimal Weight | Description   |
|------------|----------------|---|
| 0          | 1              | Operation Complete. The instrument has completed all pending operations. This bit is set in response to the *OPC command.   |
| 1          | 2              | Request Control. An instrument is requesting permission to become the active GPIB controller.   |
| 2          | 4              | Query Error. A problem has occurred in the instrument's output queue.   |
| 3          | 8              | Device Dependent Error. An instrument operation did not complete possibly because of an abnormal hardware or firmware condition (overload occurred, self-test failure, loss of calibration or configuration memory, etc.)             |
| 4          | 16             | Execution Error. The instrument cannot do the operation(s) requested by a command.  |
| 5          | 32             | Command Error. The instrument cannot understand or execute the command.   |
| 6          | 64             | User Request. The instrument is under local (front panel) control.  |
| 7          | 128            | Power-On. Power has been applied to the instrument. You must execute the *PSC 0 command to the System Instrument to allow this bit to remain enabled when power is cycled. See the *PSC command later in this chapter for an example. |
| 8-15       |                | Reserved for future use (always return zero).   |

## Unmasking Standard Event Status Bits

To allow any of the Standard Event Status register bits to set bit 5 (ESB) of the Status Byte register, you must first unmask the bit(s) using the Standard Event Status Enable register with the command:

\*ESE

For example, suppose your application requires an interrupt whenever any type of error occurs. The error related bits in the Standard Event Status register are bits 2 through 5. The sum of the decimal weights of these bits is 60. You can enable any one of these bits to set bit 5 in the Status Byte Register by sending:

\*ESE 60

If you want to generate a service request following any one of these errors, you can do so by unmasking bit 5 (ESB) in the Status Byte register:

\*SRE 32

\*ESE 60

Now, whenever an error occurs, it will set one of the bits 2 - 5 in the Standard Event Status register which will set bit 5 in the Status Byte register. Since bit 5 is



unmasked, an GPIB service request (SRQ) will be generated. ("Interrupting the External Computer", later in this chapter contains an example program which demonstrates this sequence).

Note that the Standard Event Status Register bits that are not unmasked still respond to their corresponding conditions. They do not, however, set bit 5 in the Status Byte Register.

### Reading the Standard Event Status Enable Register Mask

You can determine which bits in the Standard Event Status register are **unmasked** with the command:

\*ESE?

This command returns the decimal weighted sum of all unmasked bits.

The Standard Event Status Enable register is cleared (all bits masked) by sending the command:

\*ESE 0

### Reading the Standard Event Status Register

You can determine which bits in the Standard Event Status register are **set** using the command:

\*ESR?

This command returns the decimal weighted sum of all set bits. \*ESR? clears the register. \*CLS also clears the register.

Both of these commands return the decimal weighted sum of all set or enabled bits.

### Operation Status Group

The registers in the Standard Operation Status Group provide information about the state of measurement functions within an instrument. These functions are represented by bits in the Condition register which is described in Table 4-3.

The System Instrument (Command Module) only uses bit 8 in the Condition register. Bit 8 (when set) indicates that an interrupt set up by the DIAGnostic:INTerrupt commands has occurred and has been acknowledged.

---

### NOTE

The registers in the Operation Status Group and the DIAGnostic:INTerrupt commands are only used when, for a specific VXIbus interrupt line, it is necessary to replace the operating system's interrupt service routine with the System Instrument's service routine. Agilent VXIbus devices used with the Command Module use the operating system service routine. The VXIbus interrupt line that is used by these devices (primarily line 1), should not be used with the DIAGnostic:INTerrupt commands. The DIAGnostic:INTerrupt commands are covered in Chapter 5.

---

**Table 4-3. Operation Status Group - Condition Register**

| Bit Number | Decimal Weight | Description                                |
|------------|----------------|--|
| 0          | 1              | Calibrating                                |
| 1          | 2              | Settling                                   |
| 2          | 4              | Ranging                                    |
| 3          | 8              | Sweeping                                   |
| 4          | 16             | Measuring                                  |
| 5          | 32             | Waiting for TRG                            |
| 6          | 64             | Waiting for ARM                            |
| 7          | 128            | Correcting                                 |
| 8          | 256            | Interrupt acknowledged (System Instrument) |
| 9-12       |                | Instrument Dependent                       |
| 13-14      |                | Reserved                                   |
| 15         |                | Always zero                                |

### Reading the Condition Register

When an event monitored by the Condition register has occurred or is occurring, a corresponding bit in the register is set. The bit which is **set** can be determined with the command:

STATus:OPERation:CONDition?

The data which is returned is the decimal weighted sum of the set bit. Since bit 8 is the only bit used by system instrument, 256 is returned if the bit is set.

Bit 8 in the Condition register is **cleared** with the command:

DIAGnostic:INTerrupt:RESPonse?

### Unmasking the Operation Event Register Bits

When a condition monitored by the condition register occurs, a corresponding bit in the Operation Status Group Event register is automatically set. In order for this condition to generate a service request, the bit in the Event register must be unmasked using the Operation Status Group Enable register. This is done using the command:

STATus:OPERation:ENABLE < *event* >

where *event* is the decimal weight of the bit to be unmasked. Since the system instrument only uses bit 8, the only useful value of *event* is 256.

When bit 8 is set and is unmasked, it sets bit 7 in the Status Byte register in the Status Byte Group.

Bits in the Operation Status Group Event register which are **unmasked** can be determined with the command:

STATus:OPERation:ENABLE?

The command returns the decimal weighted sum of the unmasked bit(s).

Bits in the Operation Status Group Event register which are **set** can be determined with the command:

```
STATus:OPERation:EVENT?
```

This command returns the decimal weighted sum of the set bit(s).

## Clearing the Operation Event Register Bits

Bits in the Operation Status Group Event register are **cleared** with the command:

```
STATus:OPERation:EVENT?
```

or the bits can be cleared with the command:

```
*CLS
```

The Operation Status Group Enable register is cleared (all bits masked) by sending the command:

```
STATus:OPERation:ENABLE 0
```

## Using the Operation Status Group Registers

The following example shows the sequence of commands used to setup and respond to an interrupt using the system instrument interrupt servicing routine.

---

### NOTE

An interrupt handler must be assigned to handle the interrupt on the VXIbus backplane interrupt line specified. See "Interrupt Line Allocation" in Chapter 2 for more information.

---

```
!Call computer subprogram Intr_resp when a service request  
! is received due to an interrupt on a VXIbus backplane  
! interrupt line.  
ON INTR 7 CALL Intr_resp  
ENABLE INTR 7;2  
!Unmask bit 7 in the Status Byte register so that a service  
! request (SRQ) will occur when an interrupt occurs.  
!Unmask bit 8 in the Operation Status Group Enable register  
!so that when the interrupt occurs it will set bit 7 in the  
!Status Byte register.  
OUTPUT 70900; "*" SRE 128"  
OUTPUT 70900; "STAT:OPER:ENAB 256"  
!Set up interrupt line 5 and enable interrupt response data  
!to be generated.  
OUTPUT 70900; "DIAG:INT:SETUP5 ON"  
OUTPUT 70900; "DIAG:INT:ACT ON"  
  
.  
. (Program which executes until interrupt occurs)  
.  
  
!Computer service request routine which does an SPOLL  
!to determine the cause of the interrupt, then reads  
!(and clears) the Operation Event register to determine which  
!event occurred, and then reads the interrupt acknowledge  
! response (which also clears condition register bit 8).
```

```
SUB Intr_resp
  B= SPOLL(70900)
  OUTPUT 70900; "STAT:OPER:EVEN?"
  ENTER 70900; E
  OUTPUT 70900; "DIAG:INTR:RESP?"
  ENTER 70900; R
  .
  .
  .
SUBEND
```

---

## Clearing Status

The \*CLS command clears all status registers (Standard Event Status Register, Standard Operation Status Event Register, Questionable Data Status Event Register) and the error queue for an instrument. This clears the corresponding summary bits (bits 3, 5, & 7) and the instrument-specific bits (bits 0, 1, & 2) in the Status Byte Register. \*CLS does not affect which bits are enabled to be reflected in the Status Byte Register or enabled to assert SRQ.

---

## Interrupting an External Computer

When a bit in the status byte register is set and has been enabled to assert SRQ (\*SRE command), the instrument sets the GPIB SRQ line true. Interrupts can be used to alert an external computer to suspend its present operation and find out what service the instrument requires. (Refer to your computer/language manuals for information on how to program the computer to respond to the interrupt.)

To allow any of the status byte register bits to set the SRQ line true, you must first enable the bit(s) with the \*SRE command. For example, suppose your application requires an interrupt whenever a message is available in the instrument's output queue (status byte register bit 4). The decimal weight of this bit is 16. You can enable bit 4 to assert SRQ by sending:

```
*SRE 16
```

---

### NOTE

You can determine which bits are enabled in the Status Register using \*SRE?. This command returns the decimal weighted sum of all enabled bits.

---

### Example: Interrupting when an Error Occurs

This program shows how to interrupt an external computer whenever an error occurs for the instrument being programmed which, in this example, is a multimeter at secondary address 03.

```
10 OPTION BASE 1                                !Array numbering starts with 1
20 ON INTR 7 CALL Errmsg                          !When SRQ occurs on interface 7, call subprogram
30 ENABLE INTR 7;2                                !Enable SRQ interrupt, interface 7
40 OUTPUT 70903;"* SRE 32"                        !Enable bit 5 (Standard Event Status Bit) in Status Byte Register
50 OUTPUT 70903;"* ESE 60"                        !Enable error bits (bits 2-5) in Standard Event Status Register to be reflected
60 OUTPUT 70903;"MEAS:TEMP? TC,T,(@104)"          ! in Status Byte Register
70 WAIT 2                                         !Measure temperature with voltmeter
80 ENTER 70903;Tmp_rdg                            !Enter temperature reading
90 PRINT Tmp_rdg                                  !Print temperature reading
100 END
110 SUB Errmsg
120 DIM Message$(256)                             !Create array for error message
130 CLEAR 70903                                   !Clear multimeter
140 B= SPOLL(70903)                               !Serial poll multimeter (clears SRQ)
150 REPEAT                                        !Repeat next 3 lines until error number = 0
160   OUTPUT 70903;"SYST:ERR?"                   !Read error from queue
170   ENTER 70903;Code,Message$                 !Enter error number & message
180   PRINT Code,Message$                       !Print error number & message
190 UNTIL Code= 0
200 OUTPUT 70903;"* CLS"                          !Clear status structures
210 STOP
220 SUBEND
```

---

## Synchronizing an External Computer and Instruments

The \*OPC? and \*OPC commands (operation complete commands) allow you to maintain synchronization between an external computer and an instrument. The \*OPC? query places an ASCII character 1 into the instrument's output queue when all pending instrument operations are finished. By requiring the computer to read this response before continuing program execution, you can ensure synchronization between one or more instruments and an external computer.

The \*OPC command sets bit 0 (Operation Complete Message) in the Standard Event Status Register when all pending instrument operations are finished. By enabling this bit to be reflected in the Status Byte Register, you can ensure synchronization using the GPIB serial poll function.

### Example: Synchronizing an External Computer and Two Instruments using the OPC? query.

This example uses a D to A Converter module (DAC) at secondary address 09 and a Scanning Voltmeter at secondary address 03. The application requires the DAC to output a voltage to a device under test. After the voltage is applied, the voltmeter measures the response from the device under test. The \*OPC? command ensures that the voltage measurement will be made only after the voltage is applied by the DAC.

```
10 OUTPUT 70909;"SOUR:VOLT1 5;* OPC?"  
    !Configure DAC to output 5 volts on channel 1; place 1 in  
    output  
    !queue when done  
20 ENTER 70909;A  
    !Wait for *OPC? response  
30 OUTPUT 70903;"MEAS:VOLT:DC? (@104)"  
    !Measure DC voltage on device under test  
40 ENTER 70903;A  
    !Enter voltage reading  
50 PRINT A  
    !Print reading  
60 END
```

**Example: Synchronizing an External Computer and Two Instruments using the \*OPC command.**

This example uses the \*OPC command and serial poll to synchronize an external computer and two instruments (DAC at secondary address 09; Scanning Voltmeter at secondary address 03). The advantage to using this method over \*OPC? query method is that the computer can do other operations while it is waiting for the instrument(s) to complete operations. When using this method, the Operation Complete bit (bit 0) must be the only enabled bit in the Standard Event Status Register (\*ESE 1 command). If other bits (such as error bits) are enabled, you must make sure that bit 0 causes the interrupt.

```
10 OUTPUT 70909;"* CLS"  
    !Clear all status structures on instrument at secondary address  
    09  
20 OUTPUT 70909;"* ESE 1"  
    !Enable Operation Complete to be reflected in bit 5 of the  
    Status Byte Register  
30 OUTPUT 70909;"SOUR:VOLT1 5;* OPC"  
    !Configure instrument # 1, set Operation Complete bit when  
    done  
40 WHILE NOT BIT(SPOLL(70909),5)  
    !While waiting for bit 5 in instrument's Status Byte Register to  
    be set,  
    !computer can do other operations  
50 !(Computer does other operations here)  
60 END WHILE  
70 OUTPUT 70903;"MEAS:VOLT:DC? (@104)"  
    !Measure DC voltage using instrument # 2  
80 END
```





# System Instrument Command Reference

---

## About This Chapter

This chapter describes the **Standard Commands for Programmable Instruments** (SCPI) command set and the **IEEE 488.2 Common Commands** for the System Instrument. The System Instrument is part of the Agilent E 1300/E 1301 Mainframe's internal control processor and is therefore always present in a Mainframe. This chapter contains the following sections:

- Command Types. . . . . 7-1
- SCPI Command Reference. . . . . 7-4
- Common Command Reference . . . . . 7-65
- GPIB Message Reference. . . . . 7-72
- Command Quick Reference . . . . . 7-75

---

## Command Types

Commands are separated into two types: IEEE 488.2 Common Commands and SCPI Commands.

### Common Command Format

The IEEE 488.2 standard defines the Common commands that perform functions like reset, self-test, status byte query, etc. Common commands are four or five characters in length, always begin with the asterisk character (\*), and may include one or more parameters. The command keyword is separated from the first parameter by a space character. Some examples of Common commands are shown below:

```
*RST, *ESE < mask> , *STB?
```

### SCPI Command Format

The SCPI commands perform functions like closing switches, making measurements, and querying instrument states or retrieving data. A subsystem command structure is a hierarchical structure that usually consists of a top level (or root) command, one or more lower level commands, and their parameters. The following example shows part of a typical subsystem:

```
[ROUTE:]
  CLOSe < channel_list>
  SCAN < channel_list>
  :MODE?
```

ROUTE: is the root command, CLOSe and SCAN are second level commands with parameters, and :MODE? is a third level command.

**Command Separator** A colon (:) always separates one command from the next lower level command as shown below:

ROUTe:SCAN:MODE?

Colons separate the root command from the second level command (ROUTe:SCAN) and the second level from the third level (SCAN:MODE?).

**Abbreviated Commands** The command syntax shows most commands as a mixture of upper and lower case letters. The upper case letters indicate the abbreviated spelling for the command. For shorter program lines, send the abbreviated form. For better program readability, you may send the entire command. The instrument will accept either the abbreviated form or the entire command.

For example, if the command syntax shows MEASure, then MEAS and MEASURE are both acceptable forms. Other forms of MEASure, such as MEASU or MEASUR will generate an error. You may use upper or lower case letters. Therefore, MEASURE, measure, and MeAsUrE are all acceptable.

**Implied Commands** Implied commands appear in square brackets ([ ]) in the command syntax. (The brackets are not part of the command, and are not sent to the instrument.) Suppose you send a second level command but do not send the preceding implied command. In this case, the instrument assumes you intend to use the implied command and it responds as if you had sent it. Examine the SOURce subsystem shown below:

```
[SOURce:]
  PULSe
    :COUNT
    :COUNT?
    :PERiod
    :PERiod?
```

The root command SOURce: is an implied command. To set the instrument's pulse count to 25, you can send either of the following command statements:

SOUR:PULS:COUN 25    *or*    PULS:COUN 25

**Variable Command Syntax** Some commands have what appears to be a variable syntax. For example:

DIAG:INT:SETup[n]? and SYST:COMM:SERial[n]:BAUD?

In these commands, the "n" is replaced by a number. No space is left between the command and the number because the number is not a parameter. The number is part of the command syntax. The purpose of this notation is to save a great deal of space in the command reference. In the case of ...SETup[n], n could range from 1 through 7. In ...SERial[n]..., n can be from 0 through 7. You can send the command without the [n] and a default value will be used by the instrument. Some examples:

DIAG:INT:SETUP2?, DIAG:INT:PRI2 5, SYST:COMM:SER1:BAUD 9600

**Parameters** **Parameter Types.** The following list contains explanations and examples of parameter types you will see later in this chapter.

- **Numeric Parameters** are commonly used decimal representations of numbers including optional signs, decimal points, and scientific notation

(e.g., 123, 123E2, -123, -1.23E2, .123, 1.23E-2, 1.23000E-01). Special cases include MIN, MAX, and INFINITY. The Comments section within the Command Reference will state whether a numeric parameter can also be specified in hex, octal, and/or binary. # H7B, # Q173, # B1111011

- **Boolean parameters** represent a single binary condition that is either true or false (e.g., ON, OFF, 1, 0). Any non-zero value is considered true.

Discrete parameters select from a finite number of values. These parameters use mnemonics to represent each valid setting. An example is the TRIGGER:SOURCE < source> command where source can be BUS, EXT, HOLD, or IMM.

- **Arbitrary Block Program Data parameters** are used to transfer blocks of data in the form of bytes. The block of data bytes is preceded by a preamble which indicates either 1) the number of data bytes which follow, or 2) that the following data block will be terminated upon receipt of a New Line message with the EOI signal true. The syntax is:

#### Definite Length Block

# < non-zero digit> < digit(s)> < data byte(s)>

Where the value of < non-zero digit> equals the number of < digit(s)> . The value of < digit(s)> taken as a decimal integer indicates the number of < data byte(s)> in the block.

#### Indefinite Length Block

# 0< data byte(s)> < NL^ END>

Examples of sending 4 data bytes:

```
# 14< byte> < byte> < byte> < byte>
# 3004< byte> < byte> < byte> < byte>
# 0< byte> < byte> < byte> < byte> < NL^ END>
```

**Optional Parameters.** Parameters shown within square brackets ([ ]) are optional parameters. (Note that the brackets are not part of the command, and are not sent to the instrument.) If you do not specify a value for an optional parameter, the instrument chooses a default value. For example, consider the ARM:COUNT? [< MIN| MAX> ] command. If you send the command without specifying a parameter, the present ARM:COUNT value is returned. If you send the MIN parameter, the command returns the minimum count available. If you send the MAX parameter, the command returns the maximum count available. Be sure to place a space between the command and the parameter.

## Linking Commands

**Linking IEEE 488.2 Common Commands with SCPI Commands.** Use a semicolon between the commands. For example:

```
*RST;OUTP ON or TRIG:SOUR HOLD;*TRG
```

Linking Multiple SCPI commands. Use both a semicolon and a colon between the commands. For example:

```
ARM:COUN 1;:TRIG:SOUR EXT
```

## SCPI Command Reference

This section describes the SCPI commands for the System Instrument. Commands are listed alphabetically by subsystem and also within each subsystem. A command guide is printed in the top margin of each page. The guide indicates the first command listed on that page.

### ABORt

The ABORt subsystem is a part of the System Instrument’s trigger system. **ABORt** resets the trigger system from its Wait For Trigger state to its Idle state and aborts any pacer pulse train in progress. ABORt performs the opposite function of the INITiate:IMMEDIATE command. INITiate enables the trigger system, while ABORt disables it.

**Subsystem Syntax** ABORt

- Comments**
- ABORt does not affect any other settings of the trigger system. When the INITiate command is sent, the trigger system will respond just as it did before the ABORt command was sent.
  - **Related Commands:** INITiate, TRIGger
  - **\*RST Condition:** ABORt

**Example** Stopping Pacer pulses with ABORt

|                    |   |
|--------------------|---|
| TRIG:SOUR HOLD     | <i>trigger source is TRIG command</i>                 |
| SOUR:PULS:COUN 1E3 | <i>output 1000 Pacer pulses</i>                       |
| SOUR:PULS:PER .1 S | <i>pulse period set to .1 second</i>                  |
| INIT               | <i>go to Wait For Trigger state</i>                   |
| TRIG               | <i>trigger the Pacer to output pulses</i>             |
| .                  |   |
| .                  |   |
| <b>ABORt</b>       | <i>go to Trigger-Idle state and stop Pacer pulses</i> |

## DIAGnostic

The DIAGnostic subsystem allows control over the System Instrument's internal processor system (:BOOT, and :INTerrupt), the allocation and contents of User RAM, and, disc volume RAM (:NRAM, and :RDISk), and allocation of the built-in serial interface (:COMM:SER:OWNer).

**Subsystem Syntax**

```

DIAGnostic
:BOOT
:COLD
[:WARM]
:COMMunicate
:SERial[0]
    [:OWNer] [SYSTEM| IBASic| NONE]
    [:OWNer]?
:SERial[n]
:STORE
:DOWNload
:CHECKed
    [:MADDRESS] < address> ,< data>
    :SADDRESS < address> ,< data>
    [:MADDRESS] < address> ,< data>
    :SADDRESS < address> ,< data>
:DRAM
:AVAlable?
:CREate < size> < num_drivers>
:CREate? < MIN| MAX> ,< MIN| MAX| DEF>
:DRIVER
:LOAD < driver_block>
:CHECKed < driver_block>
:LIST
:ALL?
:RAM?
:ROM?
:INTerrupt
:ACTivate [ON| OFF| 1| 0]
:SETup[n] [ON| OFF| 1| 0]
:SETUP[n]?
:PRIority[n] [< priority> | MIN| MAX| DEF]
:PRIority[n]? [MIN| MAX| DEF]
:RESPonse?
:NRAM
:ADDRESS?
:CREate < size> | MIN| MAX
:CREate? [MAX MIN]
:PEEK? < address> ,< width>
:POKE < address> ,< width> ,< data>
:RDISk
:ADDRESS?
:CREate < size> | MIN| MAX
:CREate? [MIN| MAX]
:UPLoad
[:MADDRESS]? < address> ,< byte_count>
SADDRESS? < address> ,< byte_count>

```

---

**:BOOT:COLD** **DIAGnostic:BOOT:COLD** causes the System Instrument to restart (re-boot). Configurations stored in non-volatile memory and RS-232 configurations are reset to their default states:

- DRAM, NRAM, and RDISk memory segments are cleared
- Serial Interface parameters set to:
  - BAUD 9600
  - BITS 8
  - PARity NONE
  - SBITs 1
  - DTR ON
  - RTS ON
  - PACE XON
- Serial 0 Owner = system

---

**NOTE**

Resetting the serial interface parameters takes about 0.01 seconds for the built-in serial port and 0.75 seconds per serial plug-in card. While this is taking place the System Instrument will still respond to serial polls. If you are using a serial poll to determine when the cold boot cycle is complete, you should insert a delay of 1 second per plug-in serial card (E 1324) before polling the system instrument. This will prevent incorrectly determining that the system instrument has completed its boot cycle.

---

- Comments**
- The System Instrument goes through its power-up self tests.
  - **Related Commands:** DIAG:BOOT:WARM

**Example** Re-booting the System Instrument (cold)

**DIAG:BOOT:COLD** *force boot*

**:BOOT[:WARM]** **DIAGnostic:BOOT[:WARM]** causes the System Instrument to restart (re-boot) using the current configuration stored in non-volatile memory. The effect is the same as cycling power.

- Comments**
- The System Instrument goes through its power-up self tests.
  - The non-volatile system state is used for configuration wherever applicable.
  - **Related Commands:** DIAG:BOOT:COLD

**Example** **Booting the System Instrument (warm)**

**DIAG:BOOT:WARM** *force boot*

**:COMMunicate :SERial[0][:OWNer]** **DIAGnostic:COMMunicate:SERial[0][:OWNer]** < owner > Allocates the built-in serial interface to the System Instrument, the optional IBASIC interpreter, or to neither.

**Parameters**

| Parameter Name | Parameter Type | Range of Values      | Default Units |
|----------------|----------------|----------------------|---------------|
| <i>owner</i>   | discrete       | SYSTem  IBASic  NONE | none          |

- Comments**
- While the serial interface is allocated to the Command Module (SYSTem), it can function as the mainframe user interface when connected to a terminal or computer running terminal emulation software.
  - When the built-in serial interface is allocated to IBASIC, it is controlled only by IBASIC. The serial interface is given a select code of 9, and any RS-232 device connected to the (Command Module) RS-232 port is programmed accordingly.
  - If the built-in serial interface is not needed, specifying NONE will release memory for use by other instruments.
  - Once the new serial interface owner has been specified (DIAG:COMM:SER:OWN), the change will not take effect until you re-boot (warm) the system.
  - **Related Commands:** DIAGnostic:COMMunicate:SERial[:OWNer]

**Example** **Give the serial interface to IBASIC.**

**DIAG:COMM:SER IBAS** *Note; :OWNer is implied*  
**DIAG:BOOT:WARM** *Complete the allocation*

## DIAGnostic:COMMunicate :SERial[0][:OWNer]?

### :COMMunicate :SERial[0][:OWNer]?

**DIAGnostic:COMMunicate:SERial[0][:OWNer]?** Returns the current "owner" of the built-in serial interface. The values returned will be; "SYST", "IBAS", or "NONE".

- Comments**
- **Related Commands:** DIAGnostic:SERial[:OWNer]

**Example** Determine which instrument has the serial interface.

**DIAG:COMM:SER?**

enter statement

*Note; :OWNer is implied  
statement returns the string  
SYST, IBAS, or NONE*

### :COMMunicate :SERial[n]:STORE

**DIAGnostic:COMMunicate:SERial[n]:STORE** Stores the serial communications parameters (e.g. BAUD, BITS, PARity etc.) into non-volatile storage for the serial interface specified by [n] in SERial[n].

- Comments**
- Until ...STORE is executed, communication parameter values are stored in *volatile* memory, and a power failure will cause the settings to be lost.
  - DIAG:COMM:SER(1-7):STOR causes an Agilent E1324A (B-size RS-232 card) to store its settings in an on-board EEROM. This EEROM write cycle takes nearly one second to complete. Wait for this operation to complete before attempting to use that serial interface.
  - The Agilent E1324A's EEROM used to store its serial communication settings has a finite lifetime of approximately ten thousand write cycles. Even if your application program sent the ...STORE command once every day, the lifetime of the EEROM would still be over 27 years. Be careful that your application program sends the ...STORE command to an Agilent E1324A no more often than is necessary.
  - **Related Commands:** all SYST:COMM:SER[n]... commands

**Example** Store the serial communications settings in the third Agilent E1324A.

**DIAG:COMM:SER3:STOR**



**:DOWNload:CHECked  
[:MADDRESS]**

**DIAGnostic:CHECked:DOWNload[:MADDRESS]** < *address* > ,< *data* > writes *data* into a non-volatile User RAM segment starting at *address* using error correction. The User RAM segment is allocated by the DIAG:NRAM:CREate or DIAG:DRAM:CREate command.

**Parameters**

| Parameter Name | Parameter Type               | Range of Values   | Default Units |
|----------------|------------------------------|---|---------------|
| <i>address</i> | numeric                      | 0 to 16,777,215 (# HFFFFFFE)                            | none          |
| <i>data</i>    | arbitrary block program data | See "Parameter Types", in the beginning of this chapter | none          |

**Comments**

- This command is typically used to send a block of data to a block of user RAM. It is the only way to send binary data to multiple addresses over a serial (RS232C) line.
- **CAUTION:** Be certain that *all* of the data you download will be contained entirely within the allocated NRAM segment. Writing data outside of the NRAM segment will disrupt the operation of the Command Module. Most computers terminate an OUTPUT, PRINT, or WRITE statement with a carriage return or carriage return and line feed. These End-Of-Line characters must be either accounted for (NRAM segment sized to accommodate them), or suppressed using an appropriate IMAGE or FORMAT statement. Some helpful methods:
  - Size the NRAM segment a little larger than the expected data block
  - Control the End-Of-Line characters with format statements.
  - Use the *Definite Length Arbitrary Block Program Data* format (see example) to send your data rather than the *Indefinite Length Arbitrary Block Program Data* format.
- *Address* may be specified in decimal, hex (# H), octal (# Q), or binary (# B) formats. DOWNload is done by word (16 bit) access so *address* must be even.
- **Be certain that** *address* specifies a location within the User RAM segment allocated using DIAG:NRAM:CREate if you are downloading a configuration table. DIAG:DOWNload can change the contents of System RAM causing unpredictable results.
- This command can also be used to write data to a device with registers in the A16 address space. See :DOWNload:SADDRESS.
- **Related Commands:** DIAG:NRAM:CREate, DIAG:NRAM:ADDRESS?, DIAG:UPLoad?, VXI:CONF:CTABLE, VXI:CONF:DCTable, VXI:CONF:ITABLE, VXI:CONF:MTABLE

## DIAGnostic:DOWNload:CHECKed [:MADDRESS]

**Byte Format** Each byte sent with this command is expected to be in the following format:

|       |                    |                   |   |   |                  |   |   |   |
|-------|--------------------|-------------------|---|---|------------------|---|---|---|
| Bit # | 7                  | 6                 | 5 | 4 | 3                | 2 | 1 | 0 |
|       | <i>Control Bit</i> | <i>Check Bits</i> |   |   | <i>Data Bits</i> |   |   |   |

- *Control Bit* is used to indicate the serial driver information such as clear, reset, or end of transmission. This bit is ignored by the regular 488.2 driver . The control bit should be one for regular data.
- *Check Bits* are used to detect and correct a single bit error. The control bit is not included in the check. The check bits are a Hamming single bit error correction code, as specified by the following table:

| Data Value | Check Bits |
|------------|------------|
| 0          | 0          |
| 1          | 7          |
| 2          | 6          |
| 3          | 1          |
| 4          | 5          |
| 5          | 2          |
| 6          | 3          |
| 7          | 4          |
| 8          | 3          |
| 9          | 4          |
| 10         | 5          |
| 11         | 2          |
| 12         | 6          |
| 13         | 1          |
| 14         | 0          |
| 15         | 7          |

- *Data bits* are the actual data being transferred (four bits at a time). Each word to be written requires four data bytes for transmission. The significance of the data is dependant on the order received. The first data byte received contains the most significant nibble of the 16 bit word to be written (bits 15-12) . The next data byte received contains the least significant nibble of the most significant byte of the word (bits 11-8). The third data byte received contains the most significant nibble of the least significant byte of the word (bits 7-4). The fourth data byte received contains the least significant nibble of the least significant byte of the word to be written (bits 3-0). Once all four bytes have been received the word will be written.

**:DOWNload:CHECKed  
:SADDress**

**DIAGnostic:CHECKed:DOWNload:SADDress** < *address* > ,< *data* > writes *data* to non-volatile User RAM at a single address specified by *address* using error correction. It can also write to devices with registers in the A16 address space.

**Parameters**

| Parameter Name | Parameter Type               | Range of Values   | Default Units |
|----------------|------------------------------|---|---------------|
| <i>address</i> | numeric                      | 0 to 16,777,215 (# HFFFFFFE)                            | none          |
| <i>data</i>    | arbitrary block program data | See "Parameter Types", in the beginning of this chapter | none          |

**Comments**

- This command is typically used to send data to a device which accepts data at a single address. It is the only way to send binary data to single addresses over a serial (RS232C) line.
- Most computers terminate an OUTPUT, PRINT, or WRITE statement with a carriage return or carriage return and line feed. These End-Of-Line characters must be either accounted for (NRAM segment sized to accommodate them), or suppressed using an appropriate IMAGE or FORMAT statement. Some helpful methods:
  - Control the End-Of-Line characters with format statements.
  - Use the *Definite Length Arbitrary Block Program Data* format (see example) to send your data rather than the *Indefinite Length Arbitrary Block Program Data* format.
- A register address in A16 address space can be determined by:
 
$$1FC00_{16} + (LADDR * 64) + register\_number$$
 where  $1FC00_{16}$  is the base address in the System Instrument A16 space, LADDR is the device logical address, 64 is the number of address bytes per device, and register\_number is the register to which the data is written.
 

If the device is an A24 device, the address can be determined using the VXI:CONF:DLISr command to find the base address in A24, and then adding the register\_number to that value. A24 memory between address  $200000_{16}$  and address  $E00000_{16}$  is directly addressable by the Controller.
- *Address* may be specified in decimal, hex (# H), octal (# Q), or binary (# B) formats. DOWNload is done by word (16 bit) access so *address* must be even.
- **Related Commands:** DIAG:UPLoad:SADDress?

## DIAGnostic:DOWNload:CHECKed :SADDRESS

**Byte Format** Each byte sent with this command is expected to be in the following format:

|       |                    |                   |   |   |                  |   |   |   |
|-------|--------------------|-------------------|---|---|------------------|---|---|---|
| Bit # | 7                  | 6                 | 5 | 4 | 3                | 2 | 1 | 0 |
|       | <i>Control Bit</i> | <i>Check Bits</i> |   |   | <i>Data Bits</i> |   |   |   |

- *Control Bit* is used to indicate the serial driver information such as clear, reset, or end of transmission. This bit is ignored by the regular 488.2 driver. The control bit should be one for regular data.
- *Check Bits* are used to detect and correct a single bit error. The control bit is not included in the check. The check bits are a Hamming single bit error correction code, as specified by the following table:

| Data Value | Check Bits |
|------------|------------|
| 0          | 0          |
| 1          | 7          |
| 2          | 6          |
| 3          | 1          |
| 4          | 5          |
| 5          | 2          |
| 6          | 3          |
| 7          | 4          |
| 8          | 3          |
| 9          | 4          |
| 10         | 5          |
| 11         | 2          |
| 12         | 6          |
| 13         | 1          |
| 14         | 0          |
| 15         | 7          |

- *Data bits* are the actual data being transferred (four bits at a time). Each word to be written requires four data bytes for transmission. The significance of the data is dependant on the order received. The first data byte received contains the most significant nibble of the 16 bit word to be written (bits 15-12) . The next data byte received contains the least significant nibble of the most significant byte of the word (bits 11-8). The third data byte received contains the most significant nibble of the least significant byte of the word (bits 7-4). The fourth data byte received contains the least significant nibble of the least significant byte of the word to be written (bits 3-0). Once all four bytes have been received the word will be written.

**:DOWNload  
[:MADDRESS]**

DIAGnostic:DOWNload[:MADDRESS] < *address* > ,< *data* > writes *data* into a non-volatile User RAM segment starting at *address*. The User RAM segment is allocated by the DIAG:NRAM:CREate command.

**Parameters**

| Parameter Name | Parameter Type               | Range of Values   | Default Units |
|----------------|------------------------------|---|---------------|
| <i>address</i> | numeric                      | 0 to 16,777,215 (# HFFFFFFE)                            | none          |
| <i>data</i>    | arbitrary block program data | See "Parameter Types", in the beginning of this chapter | none          |

**Comments**

- **CAUTION:** Be certain that *all* of the data you download will be contained entirely within the allocated NRAM segment. Writing data outside of the NRAM segment will disrupt the operation of the Command Module. Most computers terminate an OUTPUT, PRINT, or WRITE statement with a carriage return or carriage return and line feed. These End-Of-Line characters must be either accounted for (NRAM segment sized to accommodate them), or suppressed using an appropriate IMAGE or FORMAT statement. Some helpful methods:
  - Size the NRAM segment a little larger than the expected data block
  - Control the End-Of-Line characters with format statements.
  - Use the *Definite Length Arbitrary Block Program Data* format (see example) to send your data rather than the *Indefinite Length Arbitrary Block Program Data* format.
- This command is generally used to download data into User Configuration Tables. These tables allow the user to control the system's dynamic configuration DOWNload uses word writes.
- *Address* may be specified in decimal, hex (# H), octal (# Q), or binary (# B) formats. DOWNload is done by word (16 bit) access so *address* must be even.
- **Be certain that** *address* specifies a location within the User RAM segment allocated using DIAG:NRAM:CREate if you are downloading a configuration table. DIAG:DOWNload can change the contents of System RAM causing unpredictable results.
- This command can also be used to write data to a device with registers in the A16 address space. See :DOWNload:SADDRESS.
- **Related Commands:** DIAG:NRAM:CREate, DIAG:NRAM:ADDRESS?, DIAG:UPLoad?, VXI:CONF:CTABLE, VXI:CONF:DCTable, VXI:CONF:ITABLE, VXI:CONF:MTABLE

## DIAGnostic:DOWNload:SADdress

### Example Loading Dynamic Configuration information into an allocated RAM segment.

```

DIAG:NRAM:CRE 6           Allocate a segment of user
                           RAM
DIAG:BOOT:WARM           Re-boot system to complete
                           allocation
DIAG:NRAM:ADDR?         query starting address
enter value to variable X get starting address into X
DIAG:DOWN < value of X> ,table data download table data
VXI:CONF:DCTAB < value of X> link configuration table to
                           configuration algorithm
DIAG:BOOT:WARM           Re-boot to set new
                           configuration
    
```

## :DOWNload:SADdress

**DIAGnostic:DOWNload:SADdress** < *address*> ,< *data*> writes *data* to non-volatile User RAM at a single address specified by *address*, and writes data to devices with registers in A16 address space.

### Parameters

| Parameter Name | Parameter Type               | Range of Values   | Default Units |
|----------------|------------------------------|---|---------------|
| <i>address</i> | numeric                      | 0 to 16,777,215 (# HFFFFFFE)                            | none          |
| <i>data</i>    | arbitrary block program data | See "Parameter Types", in the beginning of this chapter | none          |

### Comments

- Most computers terminate an OUTPUT, PRINT, or WRITE statement with a carriage return or carriage return and line feed. These End-Of-Line characters must be accounted for or suppressed using an appropriate IMAGE or FORMAT statement. Some helpful methods:
  - Control the End-Of-Line characters with format statements.
  - Use the *Definite Length Arbitrary Block Program Data* format to send your data rather than the *Indefinite Length Arbitrary Block Program Data* format.
- A register address in A16 address space can be determined by:
 
$$1FC000_{16} + (LADDR * 64) + register\_number$$
 where  $1FC000_{16}$  is the base address in the System Instrument A16 address space, LADDR is the device logical address, 64 is the number of address bytes per device, and register\_number is the register to which the data is written.
 

If the device is an A24 device, the address can be determined using the VXI:CONF:DLIS command to find the base address in A24, and then adding the register\_number to that value. A24 memory between address  $200000_{16}$  and address  $E00000_{16}$  is directly addressable by the Controller.
- *Address* may be specified in decimal, hex (# H), octal (# Q), or binary (# B) formats. DOWNload is done by word (16 bit) access so *address* must be even.
- **Related Commands:** DIAG:UPload:SADdress?

**Example Downloading Data to a Single Address Location**

This program downloads an array with the data 1, 2, 3, 4, 5 to register 32 on a device with logical address 40 in VXIbus A16 address space.

```
DIM Dnld_data(1:5)           Dimension controller array
DATA 1,2,3,4,5
READ Dnld_data(*)          Load data into controller array
"DIAG:DOWN:SADD # H1FCA20,# 210";
    This line is sent without termination.
Send Dnld_data as 16-bit words Terminate after last word with
                                EOI or LF and EOI
```

**:DRAM:AVailable?**

**DIAGnostic:DRAM:AVailable?** Returns the amount of RAM remaining (available) in the DRAM (Driver RAM) segment, which is the amount of RAM in the segment minus any previously loaded drivers.

**Comments**

- DIAG:DRAM:CREate does not allocate the RAM segment until after a subsequent re-boot.
- **Related Commands:** DIAG:DRAM:CREate, DIAG:DRIVER:LOAD, DIAG:DRIVER:LIST?

**Example Determine amount of space left for drivers in the DRAM segment.**

```
DIAG:DRAM:AVA?
enter statement           statement returns available
                          DRAM in bytes.
```

**:DRAM:CREate** **DIAGnostic:DRAM:CREate** < *size*> < *num\_drivers*> creates a non-volatile RAM area for loading instrument drivers. **DIAGnostic:DRAM:CREate 0** removes the RAM segment when the system is re-booted.

| Parameter Name     | Parameter Type | Range of Values                     | Default Units |
|--------------------|----------------|-------------------------------------|---------------|
| <i>size</i>        | numeric        | 0 to available RAM or MIN  MAX      | none          |
| <i>num_drivers</i> | numeric        | 0 to available RAM or MIN  MAX  DEF | 8             |

- Comments**
- *size* is the number of bytes to be allocated to DRAM use. A *size* of zero will remove the DRAM segment.
  - *num\_drivers* is the maximum number of drivers to be loaded.
  - The DRAM segment will be created only after the System Instrument has been re-booted (cycle power or execute DIAG:BOOT).
  - Based on the *size* specified, DIAG:DRAM:CRE rounds the *size* up to an even value.
  - DRAM will de-allocate previously allocated NRAM and RDISK segments.
  - Using all of the available RAM (MAX) for the DRAM segment will limit some functions such as IBASIC program space, instrument reading storage space, and full functionality of the Display Terminal Interface.
  - Use DIAG:DRIVER:LOAD... and, DIAG:DRIVER:LIST...? to load and manage DRAM.
  - **Related Commands:**DIAG:DRAM:AVailable?, DIAG:DRIVER:LOAD..., DIALG:DRIVER:LIST...?.

**Example** Allocate a 15 Kbyte non-volatile Driver Ram segment.

**DIAG:DRAM:CREate 15360** *allocate 15 Kbyte segment of Driver Ram.*

**:DRAM:CREate?** **DIAGnostic:DRAM:CREate?** [< MIN| MAX> ,< MIN| MAX| DEF> ] returns the size (in bytes) of a previously created non-volatile RAM area for loading instrument drivers, and the number of drivers currently loaded.

- *size* is the number of bytes currently allocated to DRAM use.
- *num\_drivers* is the number of drivers currently loaded.



**:DRIVER:LOAD  
< driver\_block>**

**DIAGnostic:DRIVER:LOAD < driver\_block>** loads the instrument driver contained in the driver\_block into a previously created DRAM segment.

**Parameters**

| Parameter Name      | Parameter Type               | Range of Values   | Default Units |
|---------------------|------------------------------|---|---------------|
| <i>driver_block</i> | arbitrary block program data | See "Parameter Types" at the beginning of this chapter. | none          |

**Comments**

- *driver\_block* is the actual binary driver data to be transferred.
- **Related Commands:**DIAG:DRAM:AVailable?, DIAG:DRAM:CREate, DIAG:DRIVER:LIST...?.

**Example**

**Download a driver block.**

**DIAG:DRIV:LOAD**

*downloads the driver < driver\_block> to DRAM memory.*

**:DRIVER :LOAD:  
CHECKED  
< driver\_block>**

**DIAGnostic:DRIVER:LOAD:CHECKED < driver\_block>** loads the instrument driver contained in the driver\_block into a previously created DRAM segment. The driver\_block is formatted in the same data byte format used by DOWNload:CHECKed.

**Parameters**

| Parameter Name      | Parameter Type               | Range of Values   | Default Units |
|---------------------|------------------------------|---|---------------|
| <i>driver_block</i> | arbitrary block program data | See "Parameter Types" at the beginning of this chapter. | none          |

**Comments**

- *driver\_block* is the actual binary driver data to be transferred.
- This is the only way to download a device driver over a serial (RS232C) line.
- **Related Commands:**DIAG:DRAM:AVailable?, DIAG:DRAM:CREate, DIAG:DRIVER:LIST...?.

**Example**

**Download the driver named DIGITAL.DC.**

**DIAG:DRIVER:LOAD:CHEC**

*downloads the driver < driver\_block> to DRAM memory.*

## DIAGnostic:DRIVER :LIST[:type]?

### :DRIVER :LIST[:type]?

**DIAGnostic:DRIVER:LIST[:type]?** lists all drivers from the specified table found on the system. If no parameter is specified, all driver tables are searched and the data from each driver table is separated from the others by a semicolon.

#### Parameters

| Parameter Name | Parameter Type | Range of Values | Default Units |
|----------------|----------------|-----------------|---------------|
| <i>type</i>    | discrete       | ALL  RAM  ROM   | ALL           |

For each driver listed, the following items are returned:

NAME, IDN\_MODEL, REV\_CODE, TABLE

| Parameter        | Description  |
|------------------|--|
| <i>NAME</i>      | The instrument name. This is the same label that appears on the instrument selection menu. |
| <i>IDN_MODEL</i> | The model name. This is the same model name as used in the response to the *IDN? command.  |
| <i>REV_CODE</i>  | The revision code. It is in the form A.nn.nn where A as an alpha character                 |
| <i>TABLE</i>     | The name of the table the driver was found in. This will be RAM or ROM.                    |

#### Comments

- **DIAGnostic:DRIVER:LIST?** lists all drivers found in the system.
- **DIAGnostic:DRIVER:LIST:RAM?** lists all drivers found in the RAM driver table DRAM.
- **DIAGnostic:DRIVER:LIST:ROM?** lists all drivers found in the ROM driver table.
- **Related Commands:**DIAG:DRAM:AVailable?, DIAG:DRAM:CREate, DIAG:DRIVER:LOAD...

**Example** List all drivers in the system.

**DIAG:DRIV:LIST?**

*lists all drivers currently loaded.*

**Example** List all drivers in ROM.

**DIAG:DRIV:LIST:ROM?**

*lists all of the drivers currently loaded in ROM.*

**:INTerrupt:ACTivate**

**DIAGnostic:INTerrupt:ACTivate** < *mode*> enables an interrupt on the VXI backplane interrupt line specified by DIAG:INT:SET[n] to be acknowledged.

**Parameters**

| Parameter Name | Parameter Type | Range of Values | Default Units |
|----------------|----------------|-----------------|---------------|
| <i>mode</i>    | boolean        | 0  1  OFF  ON   | none          |

**Comments**

- When an interrupt occurs and has been acknowledged, the response is read with the DIAGnostic:INTerrupt:RESPonse? command.
- If an interrupt occurs on a VXIbus backplane interrupt line and the interrupt acknowledgement has not been enabled, there is no interrupt acknowledgement response. The interrupt will be held off until the interrupt acknowledge is enabled by either the DIAG:INT:ACT command or DIAG:INT:RESP? command.
- ON or 1 enable interrupt acknowledgement. OFF or 0 disables interrupt acknowledgement.
- Bit 8 in the Operation Status register can be used to indicate when an interrupt has been acknowledged. See chapter 6 for more details about this register.
- Interrupt acknowledgement must be re-enabled every time an interrupt is acknowledged
- **Related Commands:** DIAG:INT:PRiority[n], DIAG:INT:RESP?, DIAG:INT:SET[n]
- **\*RST Condition:** DIAG:INT:ACTivate OFF (for all lines)

**Example Enable an Interrupt Acknowledgement on Line 2.**

```
DIAG:INT:SET2           Set up interrupt line 2
DIAG:INT:ACT ON        Enable interrupt to be
                        acknowledged
```

**:INTerrupt:SETup[n]**

**DIAGnostic:INTerrupt:SETup[n]** < *mode*> specifies that an interrupt on VXI backplane interrupt line [n] will be serviced by the System Instrument service routine (DIAGnostic:INTerrupt commands) rather than the operating system service routine.

**Parameters**

| Parameter Name | Parameter Type | Range of Values | Default Units |
|----------------|----------------|-----------------|---------------|
| <i>mode</i>    | boolean        | 0  1  OFF  ON   | none          |

**Comments**

- ...SETup1 through ...SETup7 specify the VXI interrupt lines 1 through 7.
- Sending SETup without an [n] value specifies VXI interrupt line 1.

## DIAGnostic:INTerrupt:SETup[n]?

- ON or 1 specify that interrupt handling is to be set up for the specified interrupt line. OFF or 0 indicate that interrupt handling of the specified line is to be done by the operating system.
- **Related Commands:** DIAG:INT:ACT, DIAG:INT:PRiority[n], DIAG:INT:RESP?
- **\*RST Condition:** DIAG:INT:SETup[n] OFF (for all lines)

### Example Setup and wait for VXI interrupt response on line 2.

|                           |                                      |
|---------------------------|--------------------------------------|
| DIAG:INT:PRI2 5           | <i>set priority to 5 on line 2</i>   |
| <b>DIAG:INT:SETUP2 ON</b> | <i>handle interrupt on line 2</i>    |
| .                         | <i>code which will</i>               |
| .                         | <i>initiate an action</i>            |
| .                         | <i>resulting in an interrupt</i>     |
| DIAG:INT:RESP?            | <i>Read the acknowledge response</i> |

---

## :INTerrupt:SETup[n]?

**DIAGnostic:INTerrupt:SETup[n]?** Returns the current state set by DIAG:INT:SETUP[n] < mode> , for the VXI interrupt line specified by [n] in ...SETup[n]?

### Comments

- ...SETup1? through ...SETup7? specify the VXI interrupt lines 1 through 7.
- Sending SETup? without an [n] value specifies VXI interrupt line 1.
- If 1 is returned, interrupt handling is set up for the specified interrupt line using the System Instrument (DIAGnostic:INTerrupt commands). If 0 is returned, interrupt handling is done by the operating system.
- **Related Commands:** DIAG:INT:SETup[n], DIAG:INT:PRiority[n], DIAG:INT:ACT, DIAG:INT:RESP?

### Example Determine interrupt setup for line 4.

|                         |                                 |
|-------------------------|---------------------------------|
| <b>DIAG:INT:SETUP4?</b> |                                 |
| enter statement         | <i>statement returns 0 or 1</i> |

**:INTerrupt:PRiority[n]**

**DIAGnostic:INTerrupt:PRiority[n]** [*< level>* ] gives a priority level to the VXI interrupt line specified by [n] in ...PRiority[n].

**Parameters**

| Parameter Name | Parameter Type | Range of Values            | Default Units |
|----------------|----------------|----------------------------|---------------|
| <i>level</i>   | numeric        | 1 through 7  MIN  MAX  DEF | none          |

**Comments**

- The priority of an interrupt line determines which line will be acknowledged first in the event that more than one line is interrupting.
- For *level*, lower values have lower priority (level 1 is lower priority than level 2).
- No parameter, or DEF (default) sets priority to 1.
- ...PRiority1 through ...PRiority7 specify the VXI interrupt lines 1 through 7.
- Sending PRiority without an [n] value specifies VXI interrupt line 1.
- This command has no effect if only one interrupt is to be set up.
- **Related Commands:** DIAG:INT:ACT, DIAG:INT:SETup[n], DIAG:INT:RESP?

**Example Setup, set a priority, and wait for VXI interrupt response on line 2.**

```
DIAG:INT:PRI2 5           handle interrupt on line 2
DIAG:INT:PRI2 5       set priority to 5 on line 2
.                          code which will
.                          initiate an action
.                          resulting in an interrupt
DIAG:INT:RESP?          Read the acknowledge response
```

**:INTerrupt:PRiority[n]?**

**DIAGnostic:INTerrupt:PRiority[n]?** Returns the current priority level set for the VXI interrupt line specified by [n] in ...PRiority[n]?

**Comments**

- ...PRiority?1 through ...PRiority?7 specify the VXI interrupt lines 1 through 7.
- Sending PRiority? without an [n] value specifies VXI interrupt line 1.
- **Related Commands:** DIAG:INT:PRiority[n], DIAG:INT:SETup[n], DIAG:INT:RESP?

**Example Determine interrupt priority for line 4.**

```
DIAG:INT:PRI4?
enter statement           statement returns 1 through 7
```

**:INTerrupt:RESPonse?** **DIAGnostic:INTerrupt:RESPonse?** Returns the interrupt acknowledge response (STATUS/ID word) from the highest priority VXI interrupt line.

- Comments**
- The value returned is the response from the interrupt acknowledge cycle (STATUS/ID word) of a device interrupting on one of the interrupt lines set up with the DIAG:INT:SET[n] command.
  - Bits 0 through 7 of the STATUS/ID word are the interrupting device's logical address. Bits 8 through 15 are Cause/Status bits. Bits 16 through 31 (D32 Extension) are not read by the System Instrument.
  - If only bits 0 through 7 are used by the device (bits 8 - 15 are FF), the logical address can be determined by adding 256 to the value returned by DIAG:INT:RESP?. If bits 0 - 15 are used, the logical address address is determined by adding 65536 to the value returned (if the number returned is negative).
  - Only the interrupt lines previously configured with the DIAG:INT:SET[n] commands generate responses for this command.
  - If there are interrupts on multiple lines when this command is received, or when the acknowledgement was enabled with DIAG:INT:ACT, the response data returned will be from the line with the highest priority set using the DIAG:INT:PRI [n] command.
  - If interrupt acknowledge has not been enabled with DIAG:INT:ACT, then it will be enabled by DIAG:INT:RESP?. System Instrument execution is halted until the interrupt acknowledgement response is received.
  - DIAG:INT:WAIT? can also be used to wait for the interrupt response.
  - **Related Commands:** DIAG:INT:ACT, DIAG:INT:SETup[n], DIAG:INT:PRiority[n]

**Example** Setup and wait for VXI interrupt response on line 2.

|                       |                                      |
|-----------------------|--------------------------------------|
| DIAG:INT:PRI2 5       | <i>set priority to 5 on line 2</i>   |
| DIAG:INT:SETUP2 ON    | <i>handle interrupt on line 2</i>    |
| .                     | <i>code which will</i>               |
| .                     | <i>initiate an action</i>            |
| .                     | <i>resulting in an interrupt</i>     |
| <b>DIAG:INT:RESP?</b> | <i>read the acknowledge response</i> |

**:NRAM:ADDRess?** **DIAGnostic:NRAM:ADDRess?** Returns the starting address of the non-volatile User RAM segment allocated using DIAG:NRAM:CREate.

- Comments**
- DIAG:NRAM:CREate does not allocate the RAM segment until after a subsequent re-boot. To get accurate results, execute DIAG:NRAM:ADDRess? after the re-boot.
  - **Related Commands:** DIAG:NRAM:CREate, DIAG:NRAM:CREate?, DIAG:DOWNload, DIAG:UPload?

**Example** **Determine address of the most recently created User RAM segment**

**DIAG:NRAM:ADDR?**  
 enter statement *statement returns decimal numeric address*

**:NRAM:CREate** **DIAGnostic:NRAM:CREate < size>** allocates a segment of non-volatile User RAM for a user-defined table.

**Parameters**

| Parameter Name | Parameter Type | Range of Values                | Default Units |
|----------------|----------------|--------------------------------|---------------|
| <i>size</i>    | numeric        | 0 to available RAM or MIN  MAX | none          |

- Comments**
- The RAM segment will be created only after the System Instrument has been re-booted (cycle power or execute DIAG:BOOT).
  - Based on the *size* specified, DIAG:NRAM:CRE rounds the *size* up to an even value.
  - NRAM will de-allocate a previously allocated RDISk segment.
  - Using all of the available RAM (MAX) for the NRAM segment will limit some functions such as IBASIC program space, instrument reading storage space, and full functionality of the Display Terminal Interface.
  - Use DIAG:NRAM:ADDR? to determine the starting address of the RAM segment.
  - Use DIAG:DOWNload, DIAG:UPload?, DIAG:PEEK, or DIAG:POKE to store and retrieve information in the non-volatile RAM segment.
  - Use DIAG:NRAM:CRE? MAX to find maximum available segment size.
  - **Related Commands:** DIAG:NRAM:CREate?, DIAG:NRAM:ADDRess?, DIAG:DOWNload, DIAG:UPload?

**Example** **Allocate a 15 Kbyte User Non-volatile Ram segment.**

**DIAG:NRAM:CREate 15360** *allocate 15 Kbyte segment of User Ram.*

**:NRAM:CREate?** **DIAGnostic:NRAM:CREate?** [**MIN** | **MAX**] Returns the current or allowable (MIN | MAX) size of the User non-volatile RAM segment.

- Comments**
- DIAG:NRAM:CRE does not allocate driver RAM until a subsequent re-boot. To get accurate results, execute DIAG:NRAM:CRE? after the re-boot.
  - **Related Commands:** DIAG:NRAM:ADDRes?, DIAG:NRAM:CREate

**Example** Check the size of the User RAM segment.

**DIAG:NRAM:CREate?**  
 enter statement *statement enters size in bytes*

**:PEEK?** **DIAGnostic:PEEK?** < *address* > , < *width* > reads the data (number of bits given by *width*) starting at *address*.

| Parameter Name | Parameter Type | Range of Values             | Default Units |
|----------------|----------------|-----------------------------|---------------|
| <i>address</i> | numeric        | 0 to 16,777,215 (# HFFFFFF) | none          |
| <i>width</i>   | numeric        | 8  16  32                   | none          |

- Comments**
- *Address* specifies a location within the range of the control processor's addressing capability.
  - *Address* may be specified in decimal, hex (# H), octal (# Q), or binary (# B) formats.
  - **Related Commands:** DIAG:POKE

**Example** Read byte from User non-volatile RAM

**DIAG:PEEK? 16252928,8** *ask for byte*  
 enter statement *return value of byte*



**:POKE** **DIAGnostic:POKE** < *address* > , < *width* > , < *data* > writes *data* (number of bits given by *width*) starting at *address*.

**Parameters**

| Parameter Name | Parameter Type | Range of Values             | Default Units |
|----------------|----------------|-----------------------------|---------------|
| <i>address</i> | numeric        | 0 to 16,777,215 (# HFFFFFF) | none          |
| <i>width</i>   | numeric        | 8  16  32                   | none          |
| <i>data</i>    | numeric        | 8 to 32 bit integer         | none          |

**Comments**

- *Address* specifies a location within the range of the control processor's addressing capability.
- Address and *data* may be specified in decimal, hex (# H), octal (# Q), or binary (# B) formats.
- **CAUTION:** DIAG:POKE can change the contents of any address in RAM. Changing the contents of RAM used by the Command Module's control processor can cause unpredictable results.
- **Related Commands:** DIAG:PEEK?

**Example**

**Store byte in User non-volatile RAM**

**DIAG:POKE 16252928,8,255**

**:RDISk:ADDRess?**

**DIAGnostic:RDISk:ADDRess?** Returns the starting address of the RAM disc volume previously defined with the DIAG:RDISk:CREate command. The RAM disc volume is defined for use only by the IBASIC option.

**Comments**

- DIAG:RDISk:CREate does not allocate the RAM volume segment until after a subsequent re-boot. To get accurate results, execute DIAG:RDISk:ADDRess? after the re-boot.
- **Related Commands:** DIAG:RDISk:CREate, DIAG:RDISk:CREate?

**Example**

**Return the starting address of the IBASIC RAM volume.**

**DIAG:RDIS:ADDR?**

enter statement

*statement returns decimal  
numeric address*

**:RDISk:CREate** **DIAGnostic:RDISk:CREate** < *size*> Allocates memory for a RAM disc volume. The RAM disc volume is defined for use only by the IBASIC option.

**Parameters**

| Parameter Name | Parameter Type | Range of Values                | Default Units |
|----------------|----------------|--------------------------------|---------------|
| <i>size</i>    | numeric        | 0 to available RAM or MIN  MAX | none          |

**Comments**

- The RAM disc segment will only be created after the System Instrument has been re-booted (cycle power or execute DIAG:BOOT).
- Based on the *size* specified, DIAG:RDIS:CRE rounds the *size* up to an even value.
- Using all of the available RAM (MAX) for the disc volume segment will limit some functions such as IBASIC program space, instrument reading storage space, and full functionality of the Display Terminal Interface.
- **Related Commands:** DIAG:RDISk:ADDress?, DIAG:RDISk:CREate?

**Example**

Allocate a 64 Kbyte segment for the IBASIC option's RAM volume.  
**DIAG:RDIS:CRE 65536**

**:RDISk:CREate?** **DIAGnostic:RDISk:CREate?** [MIN | MAX] Returns the current or allowable (MIN | MAX) size of the RAM disc volume segment.

**Comments**

- DIAG:RDIS:CRE does not allocate driver RAM until a subsequent re-boot. To get accurate results, execute DIAG:RDIS:CRE? after the re-boot.
- **Related Commands:** DIAG:RDISk:CREate, DIAG:RDISk:ADDR?

**Example**

Return the size of the current RAM disc volume.  
**DIAG:RDIS:CRE?**  
 enter statement *returns numeric size*

**:UPLoad[:MADDRESS]?**

**DIAGnostic:UPLoad[:MADDRESS]?** < *address* > , < *byte\_count* > Returns the number of bytes specified by *byte\_count*, starting at *address*.

**Parameters**

| Parameter Name    | Parameter Type | Range of Values              | Default Units |
|-------------------|----------------|------------------------------|---------------|
| <i>address</i>    | numeric        | 0 to 16,777,215 (# HFFFFFFE) | none          |
| <i>byte_count</i> | numeric        | 0 to (999,999,998)           | none          |

**Comments**

- *Address* may be specified in decimal, hex (# H), octal (# Q), or binary (# B) formats.
- UPLoad is done by word (16 bit) access so *address* and *byte\_count* must be even.
- Data is returned in the Definite Block Response Data format:  
  
# < non-zero digit> < digit(s)> < data byte(s)>  
  
Where the value of < non-zero digit> equals the number of < digit(s)> . The value of < digit(s)> taken as a decimal integer indicates the number of < data byte(s)> to expect in the block.
- This command can also be used to retrieve data from a device with registers in A16 address space. See DIAG:UPLoad:SADDRESS?
- **Related Commands:** DIAG:NRAM:ADDRESS?, DIAG:NRAM:CREATE, DIAG:DOWNLOAD

**Example Upload data stored on non-volatile User RAM.**

```

DIM HEADER$[6],DATA(1024)
    6 chars for "# 41024" header
    1024 chars for data bytes
DIAG:NRAM:ADDR?
    get starting address of NRAM
enter ADD
    address into ADD
OUTPUT "DIAG:UPL? < value of ADD> ,1024"
    request 1 Kbyte from address in ADD
enter HEADER$
    strip "# 41024" from data
enter DATA
    get 1024 data bytes into string; use enter format so statement
    won't terminate on CRs or LFs etc. Line Feed (LF) and EOI
    follow the last character retrieved.
    
```

**:UPload:SADdress?** **DIAGnostic:UPLoad:SADdress?** < *address*> ,< *byte\_count*> Returns the number of bytes specified by *byte\_count*, at *address*.

| Parameter Name    | Parameter Type | Range of Values              | Default Units |
|-------------------|----------------|------------------------------|---------------|
| <i>address</i>    | numeric        | 0 to 16,777,215 (# HFFFFFFE) | none          |
| <i>byte_count</i> | numeric        | 0 to (999,999,998)           | none          |

- Comments**
- *Address* may be specified in decimal, hex (# H), octal (# Q), or binary (# B) formats.
  - UPLoad is done by word (16 bit) access so *address* and *byte\_count* must be even.
  - The register address in A16 address space can be determined by:  

$$1FC000_{16} + (LADDR * 64) + register\_number$$
 where  $1FC000_{16}$  is the base address in the VXIbus A16 address space, *LADDR* is the device logical address, 64 is the number of address bytes per device, and *register\_number* is the register from which data is retrieved.  
  
 If the device is an A24 device, the address can be determined using the VXI:CONF:DLISt command to find the base address in A24, and then adding the *register\_number* to that value. A24 memory between address  $2000000_{16}$  and address  $E00000_{16}$  is directly accessible by the Controller.
  - Data is returned in the Definite Block Response Data format:  

$$\# < \text{non-zero digit} > < \text{digit(s)} > < \text{data byte(s)} >$$
 Where the value of < non-zero digit> equals the number of < digit(s)> . The value of < digit(s)> taken as a decimal integer indicates the number of < data byte(s)> to expect in the block.
  - **Related Commands:** DIAG:DOWNload:SADdress

**Example Upload data stored in non-volatile User RAM.**

This program reads 1024 data bytes from register 32 on a device with logical address 40 in Command Module A16 address space.

```

DIM HEADER${6},DATA(1024)
    6 chars for "# 41024" header
    1024 chars for data bytes
OUTPUT "DIAG:UPL:SADD? # H1FCA20,1024"
    request 1 Kbyte from device
    register 32
enter HEADER$
    strip "# 41024" from data
enter DATA
    get 1024 data bytes into string; use enter format so statement
    won't terminate on CRs or LFs etc. Line Feed (LF) and EOI
    follow the last character retrieved.
    
```

## INITiate

The INITiate command subsystem controls the initiation of the trigger system for one or more trigger cycles. INITiate enables while ABORt disables the trigger system. The TRIGger command subsystem controls the behavior of the trigger system while it is enabled.

**Subsystem Syntax** INITiate  
[:IMMediate]

---

**[:IMMediate]** **INITiate:IMMediate** changes the trigger system from the Idle state to the Wait For Trigger state.

- Comments**
- If TRIGger:SOURce is IMMediate, the Pacer starts. If TRIG:SOURce is BUS, EXT, or HOLD, the Pacer will start when that trigger condition is satisfied.
  - Sending the ABORt command will reset the trigger system back to its Idle state and terminate any pacer pulse train in progress.
  - Sending INIT while the system is still in the Wait for Trigger state (already INITiated) will cause an error -213,"Init ignored".
  - **Related Commands:** ABORt, TRIGger
  - **\*RST Condition:** Trigger system is in the Idle state.

**Example** **Initiating the trigger system (Wait For Trigger state).**

|                    |  |
|--------------------|--|
| TRIG:SOUR HOLD     | <i>trigger source is TRIG command</i>                    |
| SOUR:PULS:COUN 1E3 | <i>output 1000 Pacer pulses</i>                          |
| SOUR:PULS:PER .1 S | <i>pulse period set to .1 second</i>                     |
| <b>INIT</b>        | <i>go to Wait For Trigger state</i>                      |
| TRIG               | <i>trigger the Pacer to output pulses</i>                |
| .                  |  |
| .                  |  |
| <b>INIT</b>        | <i>must re-initiate system before each trigger cycle</i> |
| TRIG               |  |
| .                  |  |
| .                  |  |

[SOURce]:PULSe:COUNT

## [SOURce]

The System Instrument contains a Pacer which produces TTL level pulses. The SOURCE command subsystem controls the number and period of these pulses. The output of the Pacer is available at the rear-panel BNC connector labeled “Pacer Out”.

**Subsystem Syntax** [SOURce]  
:PULSe  
:COUNT < count>  
:COUNT? [MIN | MAX]  
:PERiod < period>  
:PERiod? [MIN | MAX]

---

**:PULSe:COUNT** SOURce:PULSe:COUNT < count> sets the number of Pacer pulses that are generated when the trigger condition is satisfied.

### Parameters

| Parameter Name | Parameter Type | Range of Values                            | Default Units |
|----------------|----------------|--|---------------|
| count          | numeric        | 1 to 8,388,607  9.9E37  INFINITY  MIN  MAX | none          |

### Comments

- When *count* is set to INFINITY or 9.9E37, pulses are continuous.
- **Related Commands:** ABORT, INIT, TRIG
- **\*RST Condition:** SOUR:COUNT 1

### Example Setting the Pacer pulse count.

|                    |   |
|--------------------|---|
| TRIG:SOUR HOLD     | <i>trigger source is TRIG command</i>     |
| SOUR:PULS:COUN 1E3 | <i>output 1000 Pacer pulses</i>           |
| SOUR:PULS:PER .1 S | <i>pulse period set to .1 second</i>      |
| INIT               | <i>go to Wait For Trigger state</i>       |
| TRIG               | <i>trigger the Pacer to output pulses</i> |

---

**:PULSe:COUNT?** SOURce:PULSe:COUNT? [MIN | MAX] returns:

- The current count if no parameter is sent.
- The maximum allowable count if MAX is sent.
- The minimum allowable count if MIN is sent.

### Example Querying the pulse count.

|                    |                                     |
|--------------------|-------------------------------------|
| SOUR:PULS:COUN 1E3 | <i>output 1000 Pacer pulses</i>     |
| SOUR:PULS:COUN?    | <i>query system for pulse count</i> |
| retrieve value     |                                     |

**:PULSe:PERiod** **SOURce:PULSe:PERiod** < *period*> sets the period of the pulse(s) to be generated by the Pacer.

**Parameters**

| Parameter Name | Parameter Type | Range of Values                | Default Units |
|----------------|----------------|--------------------------------|---------------|
| <i>pweiod</i>  | numeric        | 500E-9 to 8.388607 or MIN  MAX | second        |

**Comments**

- The resolution of *period* is 500E-9 seconds.
- The Pacer waveform is a square wave with the output high for the first half of the period, and low for the final half.
- **Related Commands:** SOUR:PULS:COUN, ABORT, INIT,TRIG
- **\*RST Condition:** SOUR:PULS:PER 1E-6

**Example** **Setting the Pacer pulse period.**

|                           |   |
|---------------------------|---|
| TRIG:SOUR HOLD            | <i>trigger source is TRIG command</i>     |
| SOUR:PULS:COUN 1E3        | <i>output 1000 Pacer pulses</i>           |
| <b>SOUR:PULS:PER .1 S</b> | <i>pulse period set to .1 second</i>      |
| INIT                      | <i>go to Wait For Trigger state</i>       |
| TRIG                      | <i>trigger the Pacer to output pulses</i> |

**:PULSe:PERiod?** **SOURce:PULSe:PERiod?** [MIN | MAX] returns :

- The current period if no parameter is sent.
- The maximum allowable period if MAX is sent.
- The minimum allowable period if MIN is sent.

**Example** **Querying the Pacer pulse period.**

|                       |   |
|-----------------------|---|
| <b>SOUR:PULS:PER?</b> | <i>ask for pulse period</i>               |
| enter statement       | <i>statement to enter value of period</i> |

## STATus :OPERation :CONDition?

### STATus

The STATus subsystem commands access the condition, event, and enable registers in the Operation Status group and the Questionable Data group.

**Subsystem Syntax** STATus  
 :OPERation  
 :CONDition?  
 :ENABLE < event>  
 :ENABLE?  
 [:EVENT]?  
 :PRESet  
 :QUEStionable  
 :CONDition?  
 :ENABLE < event>  
 :ENABLE?  
 [:EVENT]?

**:OPERation :CONDition?** STATus:OPER:COND? returns the state of the condition register in the Operation Status group. The state represents conditions which are part of an instrument's operation.

- Comments**
- Bit 8 in the register is used by the System Instrument (Command Module) to indicate when an interrupt set up by the DIAG:INTerrupt commands has been acknowledged.
  - Reading the condition register does not change the setting of bit 8. Bit 8 is cleared by the DIAG:INT:RESP? command.
  - **Related Commands:** STAT:OPER:ENABLE, STAT:OPER:EVENT?

**Example** Reading the contents of the condition register

```
STAT:OPER:COND?           query register
enter statement
```

**:OPERation:ENABLE < event>** STATus:OPER:ENABLE < event> sets an enable mask to allow events monitored by the condition register and recorded in the event register, to send a summary bit to the Status Byte register (bit 7).

**Parameters**

| Parameter Name | Parameter Type | Range of Values | Default Units |
|----------------|----------------|-----------------|---------------|
| event          | numeric        | 256             | none          |

- Comments**
- Bit 8 in the condition register is used by the system instrument (Command Module) to indicate when an interrupt set up by the DIAG:INTerrupt commands has been acknowledged.



## STATus :OPERation:ENABLE?

- Bit 8 is the only bit used in the condition register (by the System Instrument), therefore, it is the only bit which needs to be unmasked in the event register. Specifying the "bit weight" for the *event* unmask the bit. The bit weight is 256 and can be specified in decimal, hexadecimal (# H), Octal (# Q) or binary (# B).
- When the summary bit is sent, it sets bit 7 in the Status Byte register.
- **Related Commands:** STAT:OPER:ENABLE?

### Example Unmasking bit 8 in the Event Register

```
STAT:OPER:ENAB 256           unmask bit 8
```

---

**:OPERation:ENABLE?** **STATus:OPER:ENABLE?** returns which bits in the event register (standard operation status group) are unmasked.

- Comments**
- Bit 8 in the condition register is used by the system instrument (Command Module) to indicate when an interrupt set up by the DIAG:INTerrupt commands has been acknowledged.
  - Bit 8 in the event register generally is the only bit which will be unmasked. If this bit is unmasked when STAT:OPER:ENAB? is sent, 256 is returned.
  - Reading the event register mask does not change the mask setting (STAT:OPER:ENAB < event> ).
  - **Related Commands:** STAT:OPER:ENABLE

### Example Reading the Event Register Mask

```
STAT:OPER:ENAB?           query register mask  
enter statement
```

---

**:OPERation[:EVENT]?** **STATus:OPER:EVENT?** returns which bits in the event register (standard operation status group) are set. The event register indicates when there has been a positive transition in the condition register.

- Comments**
- Bit 8 in the condition register is used by the system instrument (Command Module) to indicate when an interrupt set up by the DIAG:INTerrupt commands has been acknowledged.
  - Bit 8 in the event register generally is the only bit which is used. If this bit is set when STAT:OPER:EVEN? is sent, 256 is returned.
  - Reading the event register clears the contents of the register. If the event register is to be used to generate a service request (SRQ), you should clear the register before enabling the SRQ (\*SRE). This prevents an SRQ from occurring due to a previous event.
  - **Related Commands:** STAT:OPER:ENABLE, STAT:OPER:ENABLE?

## STATus :PRESet

**Example**    **Reading the Event Register**

STAT:OPER:EVEN?  
enter statement

*query if bit(s) is set*

---

**:PRESet**    **STATus:PRESet** sets each bit in the enable register (standard operation status group) to '0'.

**Example**    **Presetting the Enable Register**

STAT:PRES

*preset enable register*

---

**:QUESTionable**    The **STATus:QUESTionable** commands are supported by the system instrument, however, they are not used by the System Instrument. Queries of the Questionable Data condition and event registers will always return + 0.

## SYSTem

The SYSTem command subsystem for the System Instrument provides for:

- Configuration of the RS-232 interface
- Control and access of the System Instrument's real time clock/calendar (SYST:TIME, SYST:TIME?, SYST:DATE, SYST:DATE?).
- Access to the System Instrument's error queue (SYST:ERR?).
- Configuring the communication ports (GPIB and serial).

### Subsystem Syntax

```

SYSTem
:BEETPer
  [:IMMEDIATE]
:COMMunicate
  :GPIB
    :ADDRESS < address> | MIN | MAX
    :ADDRESS? [MIN | MAX]
  :SERial[n]
    :CONTRol
      :DTR ON | OFF | STANdard | IBFull
      :DTR?
      :RTS ON | OFF | STANdard | IBFull
      :RTS?
    [:RECEive]
      :BAUD < baud_rate> | MIN | MAX
      :BAUD? [MIN | MAX]
      :BITS 7 | 8 | MIN | MAX
      :BITS? [MIN | MAX]
      :PACE
        [:PROTocol] XON | NONE
        [:PROTocol]?
        :THReshold
          :STARt < characters> | MIN | MAX
          :STARt? [MIN | MAX]
          :STOP < characters> | MIN | MAX
          :STOP? [MIN | MAX]
      :PARity
        :CHECK 1 | 0 | ON | OFF
        :CHECK?
        [:TYPE] EVEN | ODD | ZERO | ONE | NONE
        [:TYPE]?
      :SBITs 1 | 2 | MIN | MAX
      :SBITs? [MIN | MAX]
  :TRANsmit
    :AUTO 1 | 0 | ON | OFF
    :AUTO?
    :PACE
      [:PROTocol] XON | NONE
      [:PROTocol]?
  :DATE < year> ,< month> ,< day>
  :DATE? [MIN | MAX,MIN | MAX,MIN | MAX]
  :ERRor?
  :TIME < hour> ,< minute> ,< second>
  :TIME? [MIN | MAX,MIN | MAX,MIN | MAX]
  :VERSion?

```

---

**:BEEPer[:IMMEDIATE]** **SYSTem:BEETPer:IMMEDIATE** causes the system beeper to sound momentarily.

**Example**      **Sound the Beeper**

**SYST:BEEP:IMM**

**:COMMunicate  
:GPIB:ADDRess**

SYSTem:COMMunicate:GPIB:ADDRess < *address*> sets the primary address of the Instrument's GPIB port.

**Parameters**

| Parameter Name | Parameter Type | Range of Values       | Default Units |
|----------------|----------------|-----------------------|---------------|
| <i>address</i> | numeric        | must round to 0 to 30 | none          |

**Comments**

- The value of < *address*> is effective after the System Instrument has received a < new line> following the SYST:COMM:GPIB:ADDR command. < new line> can be a line-feed or END (EOI signal).
- **Related Commands:** SYST:COMM:GPIB:ADDR?, DIAG:BOOT:COLD
- **\*RST Condition:** \*RST does not change the System Instrument's primary GPIB address.

**Example**

Set the GPIB port's primary address

**SYST:COMM:GPIB:ADDR 9** *sets the primary address to 9*

**:COMMunicate  
:GPIB:ADDRess?**

SYSTem:COMMunicate:GPIB:ADDRess? returns the Command Module primary GPIB address.

**Example**

Read the Primary GPIB Address.

**SYST:COMM:GPIB:ADDR?** *Read the GPIB address*  
 enter statement *Enter the GPIB address*

**:COMMunicate  
:SERial[n]: ...**

The SYSTem:COMMunicate:SERial[n]: ... commands set and/or modify the configuration of the serial interface(s) that are under control of the System Instrument. The interface to be affected by the command is specified by a number (zero through seven) which replaces the [n] in the :SERial[n] command. The number is the interface's **card number**. Card number zero specifies the E 1300/E 1301 mainframe's built-in interface while one through seven specify one of up to seven E 1324 B-size plug-in serial interface modules. The serial interface installed at logical address 1 becomes card number 1, the serial interface installed at the next sequential logical address becomes card number 2 and so on. The logical addresses used by plug-in serial interfaces must start at 1 and be contiguous (no unused logical addresses).

**Comments**

- Serial communication commands take effect *after* the end of the program message containing the command.
- Serial communication settings for the built-in RS-232 interface can be stored in its non-volatile RAM *only* after the DIAG:COMM:SER[n]:STORE command is executed. These settings are used at power-up and DIAG:BOOT[:WARM].

## SYSTem :COMMunicate :SERial[n] :CONTrol :DTR

- Serial communication settings for the Agilent E1324A Datacomm interface can be stored in its on-board non-volatile EEROM *only* after the DIAG:COMM:SER[n]:STORE command is executed. These settings are used at power-up and DIAG:BOOT[:WARM].
- DIAG:BOOT:COLD will set the serial communication parameters to the following defaults:
  - BAUD 9600
  - BITS 8
  - PARity NONE
  - SBITS 1
  - DTR ON
  - RTS ON
  - PACE XON

**Example** Setting baud rate for plug-in card 2.

**SYST:COMM:SER2:BAUD 9600** (must be a card number 1 also)

### :COMMunicate :SERial[n] :CONTrol :DTR

**SYSTem:COMMunicate:SERial[n]:CONTrol:DTR < dtr\_cntrl>** controls the behavior of the Data Terminal Ready output line. DTR can be set to a static state (ON | OFF), can operate as a modem control line (STANDARD), or can be used as a hardware handshake line (IBFull).

#### Parameters

| Parameter Name   | Parameter Type | Range of Values           | Default Units |
|------------------|----------------|---------------------------|---------------|
| <i>dtr_cntrl</i> | discrete       | ON  OFF  STANDARD  IBFull | none          |

#### Comments

- The following table defines each value of *dtr\_cntrl*:

| Value    | Definition  |
|----------|---|
| ON       | DTR line is asserted  |
| OFF      | DTR Line is unasserted  |
| STANDARD | DTR will be asserted when the serial interface is ready to send <i>output</i> data. Data will be sent if the connected device asserts DSR and CTS.    |
| IBFull   | While the input buffer is not yet at the :STOP threshold, DTR is asserted. When the input buffer reaches the :STOP threshold, DTR will be unasserted. |

- DIAG:BOOT:COLD will set ...DTR to ON.
- **Related Commands:** SYST:COMM:SER[n]:CONT:RTS, SYST:COMM:SER[n]:PACE:THR:START, SYST:COMM:SER[n]:PACE:THR:STOP
- **\*RST Condition:** No change

**Example** Asserting the DTR line.

**SYST:COMM:SER0:CONT:DTR ON**

**SYSTem:COMMunicate :SERial[n] :CONTrol :DTR?**

**:COMMunicate  
:SERial[n] :CONTrol  
:DTR?**

**SYSTem:COMMunicate:SERial[n]:CONTrol:DTR?** returns the current setting for DTR line control.

**Example**      **Checking the setting of DTR control.**

**SYST:COMM:SER0:CONT:DTR?**

enter statement

*statement enters the string "ON", "OFF", "STAN", or "IBF"*

**:COMMunicate  
:SERial[n] :CONTrol  
:RTS**

**SYSTem:COMMunicate:SERial[n]:CONTrol:RTS < Rts\_cntrl>** controls the behavior of the Request To Send output line. RTS can be set to a static state (ON | OFF), can operate as a modem control line (STANdard), or can be used as a hardware handshake line (IBFull).

**Parameters**

| Parameter Name   | Parameter Type | Range of Values           | Default Units |
|------------------|----------------|---------------------------|---------------|
| <i>rts_cntrl</i> | discrete       | ON  OFF  STANdard  IBFull | none          |

**Comments**

- The following table defines each value of *rts\_cntrl*:

| Value    | Definition  |
|----------|---|
| ON       | RTS line is asserted  |
| OFF      | RTS Line is unasserted  |
| STANdard | RTS will be asserted when the serial interface is ready to send <i>output</i> data. Data will be sent if the connected device asserts CTS and DSR.    |
| IBFull   | While the input buffer is not yet at the :STOP threshold, RTS is asserted. When the input buffer reaches the :STOP threshold, RTS will be unasserted. |

- DIAG:BOOT:COLD will set ...RTS to ON.
- **Related Commands:** SYST:COMM:SER[n]:CONT:DTR, SYST:COMM:SER[n]:PACE:THR:START, SYST:COMM:SER[n]:PACE:THR:STOP
- **\*RST Condition:** No change

**Example**      **Unasserting the RTS line.**

**SYST:COMM:SER0:CONT:RTS OFF**

**:COMMunicate  
:SERial[n] :CONTrol  
:RTS?**

SYSTem:COMMunicate:SERial[n]:CONTrol:RTS? returns the current setting for RTS line control.

**Example** Checking the setting of RTS control.

**SYST:COMM:SER0:CONT:RTS?**

enter statement

*statement enters the string "ON", "OFF", "STAN", or "IBF"*

**:COMMunicate  
:SERial[n] [:RECEive]  
:BAUD**

SYSTem:COMMunicate:SERial[n][:RECEive]:BAUD < *baud\_rate* > Sets the baud rate for the serial port.

**Parameters**

| Parameter Name | Parameter Type | Range of Values                                     | Default Units |
|----------------|----------------|---|---------------|
| <i>baud</i>    | numeric        | 300   1200   2400   4800   9600   19200   MIN   MAX | none          |

**Comments**

- Attempting to set *baud* to other than those values shown will result in an error -222.
- DIAG:BOOT:COLD will set ...BAUD to 9600.
- **\*RST condition:** No change.

**Example** Setting the baud rate to 1200.

**SYST:COMM:SER0:BAUD 1200**

**:COMMunicate  
:SERial[n] [:RECEive]  
:BAUD?**

SYSTem:COMMunicate:SERial[n][:RECEive]:BAUD? [MIN | MAX] returns:

- The current baud rate setting if no parameter is sent.
- The maximum allowable setting if MAX is sent.
- The minimum allowable setting if MIN is sent.

**Example** Querying the current baud rate.

**SYST:COMM:SER0:BAUD?**

enter statement

*statement enters a numeric value*

**SYSTem:COMMunicate :SERial[n] [:RECeive] :BITS**

**:COMMunicate  
:SERial[n] [:RECeive]  
:BITS**

**SYSTem:COMMunicate:SERial[n] [:RECeive]:BITS < bits>** Sets the number of bits to be used to transmit and receive data.

**Parameters**

| Parameter Name | Parameter Type | Range of Values | Default Units |
|----------------|----------------|-----------------|---------------|
| <i>bits</i>    | numeric        | 7  8  MIN  MAX  | none          |

**Comments**

- Attempting to set *bits* to other than those values shown will result in an error -222.
- While this command operates independently of either the ...PARity:TYPE or ...SBITs commands, there are two combinations which are disallowed because of their data frame bit width. The following table shows the possible combinations:

| ...BITS | ...PARity:TYPE | ...SBITs | Frame Bits      |
|---------|----------------|----------|-----------------|
| 7       | NONE           | 1        | 9 - disallowed  |
| 7       | NONE           | 2        | 10              |
| 7       | Yes            | 1        | 10              |
| 7       | Yes            | 2        | 11              |
| 8       | NONE           | 1        | 10              |
| 8       | NONE           | 2        | 11              |
| 8       | Yes            | 1        | 11              |
| 8       | Yes            | 2        | 12 - disallowed |

- DIAG:BOOT:COLD will set ...BITS to 8.
- **Related Commands:** SYST:COMM:SER[n]:PARity
- **\*RST Condition:** No change

**Example** Configuring data width to 7 bits.

**SYST:COMM:SER0:BITS 7**

**:COMMunicate  
:SERial[n] [:RECeive]  
:BITS?**

**SYSTem:COMMunicate:SERial[n] [:RECeive]:BITS? [MIN | MAX]** returns:

- The current data width if no parameter is sent.
- The maximum allowable setting if MAX is sent.
- The minimum allowable setting if MIN is sent.

**Example** Querying the current data width.

**SYST:COMM:SER0:BITS?**

enter statement

*statement enters 7 or 8*



**:COMMunicate  
:SERial[n] [:RECeive]  
:PACE [:PROTocol]**

**SYSTem:COMMunicate:SERial[n] [:RECeive]:PACE[:PROTocol]**  
< *protocol* > enables or disables receive pacing (XON/XOFF) protocol.

**Parameters**

| Parameter Name  | Parameter Type | Range of Values | Default Units |
|-----------------|----------------|-----------------|---------------|
| <i>protocol</i> | discrete       | XON  NONE       | none          |

**Comments**

- While ...PROT is XON, the serial interface will send XOFF when the buffer reaches the ...STOP threshold, and XON when the buffer reaches the ...STARt threshold.
- For an Agilent E1324A, AUTO is always ON. In this case ...[:RECeive]:PACE will also set ...TRAN:PACE
- The XON character is control Q (ASCII 17<sub>10</sub>, 11<sub>16</sub>), The XOFF character is control S (ASCII 19<sub>10</sub>, 13<sub>16</sub>).
- DIAG:BOOT:COLD will set ...PACE to XON.
- **Related Commands:** ...PROTocol:THReshold:STARt, ...PROTocol:THReshold:STOP, ...TRAN:AUTO
- **\*RST Condition:** No change

**Example**

**Enabling XON/XOFF handshaking.**

**SYST:COMM:SER0:PACE:PROT XON**

**:COMMunicate  
:SERial[n] [:RECeive]  
:PACE [:PROTocol]?**

**SYSTem:COMMunicate:SERial[n] [:RECeive]:PACE[:PROTocol]?** returns the current receive pacing protocol.

**Example**

**See if XON/XOFF protocol is enabled.**

**SYST:COMM:SER0:PACE:PROT?**

enter statement

*statement enters the string "XON" or "NONE"*

**SYSTem:COMMunicate :SERial[n] [:RECeive] :PACE :THReshold :STARt**

**:COMMunicate  
:SERial[n] [:RECeive]  
:PACE :THReshold  
:STARt**

**SYSTem:COMMunicate:SERial[n] [:RECeive] :PACE:THReshold:STARt** < *char\_count* > configures the input buffer level at which the specified interface may send the XON character (ASCII 11<sub>16</sub>), assert the DTR line, and/or assert the RTS line.

**Parameters**

| Parameter Name    | Parameter Type | Range of Values  | Default Units |
|-------------------|----------------|--|---------------|
| <i>char_count</i> | numeric        | 1 through 99 for built-in<br>1 through 8191 for E1324A | none          |

**Comments**

- To determine the size of the input buffer of the serial interface you are using, send SYST:COMM:SER[n]:PACE:THR:STARt? MAX. The returned value will be the buffer size less one.
- ...STARt must be set to less than ...STOP.
- The ...THR:STAR command has no effect unless ...PACE:PROT XON, ...CONT:DTR IBF, or ...CONT:DTR IBF has been sent.
- **Related Commands:** ...PACE:PROT XON | NONE, ...CONT:DTR, ...CONT:RTS
- **\*RST Condition:** No change

**Example**

**Set interface to send XON when input buffer contains 10 characters.**

```
SYST:COMM:SER0:PACE:PROT XON
SYST:COMM:SER0:PACE:THR:STAR 10
```

**:COMMunicate  
:SERial[n] [:RECeive]  
:PACE :THReshold  
:STARt?**

**SYSTem:COMMunicate:SERial[n] [:RECeive] :PACE:THReshold:STARt?** [MIN | MAX] returns:

- The current start threshold if no parameter is sent.
- The maximum allowable setting if MAX is sent.
- The minimum allowable setting if MIN is sent.

**Comments**

- To determine the size of the input buffer of the serial interface you are using, send SYST:COMM:SER[n]:PACE:THR:STARt? MAX. The returned value will be the buffer size.

**Example**

**Return current start threshold**

```
SYST:COMM:SER0:PACE:THR:STAR? query for threshold value
enter statement statement enters a numeric value
```

**:COMMunicate  
:SERial[n] [:RECeive]  
:PACE :THReshold  
:STOP**

SYSTem:COMMunicate:SERial[n] [:RECeive] :PACE:THReshold:STOP

< *char\_count* > configures the input buffer level at which the specified interface may send the XOFF character (ASCII 13<sub>16</sub>), de-assert the DTR line, and/or de-assert the RTS line.

**Parameters**

| Parameter Name    | Parameter Type | Range of Values  | Default Units |
|-------------------|----------------|--|---------------|
| <i>char_count</i> | numeric        | 1 through 99 for built-in<br>1 through 8191 for E1324A | none          |

**Comments**

- To determine the size of the input buffer of the serial interface you are using, send SYST:COMM:SER[n]:PACE:THR:STOP? MAX. The returned value will be the buffer size.
- ...STOP must be set to greater than ...START.
- The ...THR:STOP command has no effect unless ...PACE:PROT XON, ...CONT:DTR IBF, or ...CONT:DTR IBF has been sent.
- **Related Commands:** ...PACE:PROT XON | NONE, ...CONT:DTR, ...CONT:RTS
- **\*RST Condition:** No change

**Example**

Set interface to send XOFF when input buffer contains 80 characters.

**SYST:COMM:SER0:PACE:THR:STOP 80**

**:COMMunicate  
:SERial[n] [:RECeive]  
:PACE :THReshold  
:STOP?**

SYSTem:COMMunicate:SERial[n] [:RECeive] :PACE:THReshold:STOP?

[MIN | MAX] returns:

- The current stop threshold if no parameter is sent.
- The maximum allowable setting if MAX is sent.
- The minimum allowable setting if MIN is sent.

**Comments**

- To determine the size of the input buffer of the serial interface you are using, send SYST:COMM:SER[n]:PACE:THR:STOP? MAX. The returned value will be the buffer size.

**Example**

Return current stop threshold

**SYST:COMM:SER0:PACE:THR:STOP?** *query for threshold*

enter statement

*statement enters a numeric value*

**SYSTem:COMMunicate :SERial[n] [:RECeive] :PARity :CHECK**

**:COMMunicate  
:SERial[n] [:RECeive]  
:PARity :CHECK**

**SYSTem:COMMunicate:SERial[n] [:RECeive] :PARity:CHECK < check\_cntrl>**  
controls whether or not the parity bit in received serial data frames will be considered significant.

**Parameters**

| Parameter Name     | Parameter Type | Range of Values | Default Units |
|--------------------|----------------|-----------------|---------------|
| <i>check_cntrl</i> | boolean        | 0  1  OFF  ON   | none          |

**Comments**

- When *check\_cntrl* is set to 0 or OFF, received data is not checked for correct parity. Transmitted data still includes the type of parity configured with ...PARity:TYPE.
- DIAG:BOOT:COLD will set ...CHECK to OFF.
- **Related Commands:** SYST:COMM:SER[n]:PARity:TYPE
- **\*RST Condition:** No change

**Example**

Set parity check to ON  
**SYST:COMM:SER0:PAR:CHEC ON**

**:COMMunicate  
:SERial[n] [:RECeive]  
:PARity :CHECK?**

**SYSTem:COMMunicate:SERial[n] [:RECeive] :PARity:CHECK?** returns the state of parity checking.

**Example**

Is parity checking on or off?  
**SYST:COMM:SER0:PAR:CHEC?**  
enter statement *statement enters 0 or 1*

**:COMMunicate:  
SERial[n] [:RECeive]  
:PARity [:TYPE]**

**SYSTem:COMMunicate:SERial[n] [:RECeive] :PARity[:TYPE] < type>**  
Configures the type of parity to be checked for received data, and generated for transmitted data.

**Parameters**

| Parameter Name | Parameter Type | Range of Values            | Default Units |
|----------------|----------------|----------------------------|---------------|
| <i>type</i>    | discrete       | EVEN  ODD  ZERO  ONE  NONE | none          |

**Comments**

- Attempting to set *type* to other than those values shown will result in an error -222.

**SYSTem :COMMunicate: SERIAL[n] [:RECeive] :PARity [:TYPE]**

- The following table defines each value of *type*:

| Value | Definition   |
|-------|--|
| EVEN  | If ...PARity:CHECK is ON, the received parity bit must maintain even parity. The transmitted parity bit will maintain even parity. |
| ODD   | If ...PARity:CHECK is ON, the received parity bit must maintain odd parity. The transmitted parity bit will maintain odd parity.   |
| ZERO  | If ...PARity:CHECK is ON, the received parity bit must be a zero. The transmitted parity bit will be a zero.                       |
| ONE   | If ...PARity:CHECK is ON, the received parity bit must be a logic one. The transmitted parity bit will be a logic one.             |
| NONE  | A parity bit must not be received in the serial data frame. No parity bit will be transmitted.                                     |

- While this command operates independently of either the ...BITS or ...SBITs commands, there are two combinations which are disallowed because of their data frame bit width. The following table shows the possible combinations:

| ...BITS | ...PARity:TYPE | ...SBITs | Frame Bits      |
|---------|----------------|----------|-----------------|
| 7       | NONE           | 1        | 9 - disallowed  |
| 7       | NONE           | 2        | 10              |
| 7       | Yes            | 1        | 10              |
| 7       | Yes            | 2        | 11              |
| 8       | NONE           | 1        | 10              |
| 8       | NONE           | 2        | 11              |
| 8       | Yes            | 1        | 11              |
| 8       | Yes            | 2        | 12 - disallowed |

- Received parity will not be checked unless ...PAR:CHEC ON is has been sent. Transmitted data will include the specified parity whether ...PAR:CHEC is ON or OFF.
- DIAG:BOOT:COLD will set ...PARity to NONE.
- Related Commands:** ...PAR:CHEC 1 | 0 | ON | OFF, ...SER[n]:BITS 7 | 8, ...SER[n]:SBITs 1 | 2
- \*RST Condition:** No change

**Example Set parity check/generation to ODD.**

**SYST:COMM:SER0:PAR ODD** *Set parity type*  
**SYST:COMM:SER0:PAR:CHEC ON** *Enable parity check/gen.*

**SYSTem:COMMunicate :SERial[n] [:RECeive] :PARity [:TYPE]?**

**:COMMunicate  
:SERial[n] [:RECeive]  
:PARity [:TYPE]?**

**SYSTem:COMMunicate:SERial[n] [:RECeive] :PARity[:TYPE]?** returns the type of parity checked and generated.

**Example**      **What type of parity checking is set?**

**SYST:COMM:SER0:PAR?**  
enter statement

*ask for parity type  
returns the string EVEN, ODD,  
ZERO, ONE, or NONE*

**:COMMunicate  
:SERial[n] [:RECeive]  
:SBITS**

**SYSTem:COMMunicate:SERial[n] [:RECeive] :SBITS < sbits>** Sets the number of stop bits to be used to transmit and receive data.

**Parameters**

| Parameter Name | Parameter Type | Range of Values | Default Units |
|----------------|----------------|-----------------|---------------|
| <i>sbits</i>   | numeric        | 1  2  MIN  MAX  | none          |

**Comments**

- Attempting to set *sbits* to other than those values shown will result in an error -222.
- While this command operates independently of either the ...BITS or ...PARity:TYPE commands, there are two combinations which are disallowed because of their data frame bit width. The following table shows the possible combinations:

| ...BITS | ...PARity:TYPE | ...SBITS | Frame Bits      |
|---------|----------------|----------|-----------------|
| 7       | NONE           | 1        | 9 - disallowed  |
| 7       | NONE           | 2        | 10              |
| 7       | Yes            | 1        | 10              |
| 7       | Yes            | 2        | 11              |
| 8       | NONE           | 1        | 10              |
| 8       | NONE           | 2        | 11              |
| 8       | Yes            | 1        | 11              |
| 8       | Yes            | 2        | 12 - disallowed |

- DIAG:BOOT:COLD will set ...SBITS to 1.
- **Related Commands:** SYST:COMM:SER[n]:BAUD
- **\*RST Condition:** No change

**Example**      **Configuring for 2 stop bits.**

**SYST:COMM:SER0:SBITS 2**

**:COMMunicate  
:SERial[n] [:RECeive]  
:SBITs?**

SYSTem:COMMunicate:SERial[n] [:RECeive] :SBITs? [MIN | MAX] returns:

- The current stop bit setting if no parameter is sent.
- The maximum allowable setting if MAX is sent.
- The minimum allowable setting if MIN is sent.

**Example** Querying the current stop bit configuration.

**SYST:COMM:SER0:SBITs?** *:REC is implied*  
 enter statement *statement enters 1 or 2*

**:COMMunicate  
:SERial[n] :TRANsmitt  
:AUTO**

SYSTem:COMMunicate:SERial[n]:TRANsmitt:AUTO < auto\_ctrl> when ON, sets the transmit pacing mode to be the same as that set for receive pacing. When OFF, the transmit pacing mode may be set independently of the receive pacing mode.

**Parameters**

| Parameter Name | Parameter Type | Range of Values | Default Units |
|----------------|----------------|-----------------|---------------|
| auto_ctrl      | boolean        | 0  1  OFF  ON   | none          |

**Comments**

- For an Agilent E1324A, AUTO is always ON. Trying to set OFF or 0 will generate an error.
- DIAG:BOOT:COLD will set ...AUTO to ON.
- **Related Commands:** SYST:COMM:SER[n]:REC:PACE:PROT, SYST:COMM:SER[n]:TRAN:PACE:PROT
- **\*RST Condition:** ...TRAN:AUTO ON

**Example** Link transmit pacing with receive pacing

**SYST:COMM:SER0:TRAN:AUTO ON**

**:COMMunicate  
:SERial[n] :TRANsmitt  
:AUTO?**

SYSTem:COMMunicate:SERial[n]:TRANsmitt:AUTO? returns the current state of receive to transmit pacing linkage.

**Comments**

- For an Agilent E1324A, AUTO is always ON. In this case ...AUTO? will always return a 1.

**Example** Is AUTO ON or OFF?

**SYST:COMM:SER0:TRAN:AUTO?**  
 enter statement *statement enters the number 1 or 0*

**SYSTem:COMMunicate :SERial[n]:TRANsmit :PACE [:PROTOcol]**

**:COMMunicate  
:SERial[n]:TRANsmit  
:PACE [:PROTOcol]**

**SYSTem:COMMunicate:SERial[n]:TRANsmit:PACE[:PROTOcol]**  
*< protocol >* enables or disables the transmit pacing (XON/XOFF) protocol.

**Parameters**

| Parameter Name  | Parameter Type | Range of Values | Default Units |
|-----------------|----------------|-----------------|---------------|
| <i>protocol</i> | discrete       | XON  NONE       | none          |

**Comments**

- For an Agilent E1324A, AUTO is always ON. In this case ...TRAN:PACE will also set ...[RECeive]:PACE
- Receipt of an XOFF character (ASCII 19<sub>10</sub>, 13<sub>16</sub>) will hold off transmission of data until an XON character (ASCII 17<sub>10</sub>, 11<sub>16</sub>) is received.
- DIAG:BOOT:COLD will set ...PACE to XON.
- **Related Commands:** SYST:COMM:SER[n]:TRAN:AUTO
- **\*RST Condition:** No change

**Example**

Set XON/XOFF transmit pacing

**SYST:COMM:SER0:TRAN:PACE:PROT XON**

**:COMMunicate  
:SERial[n] :TRANsmit  
:PACE [:PROTOcol]?**

**SYSTem:COMMunicate:SERial[n]:TRANsmit:PACE[:PROTOcol]?** returns the current transmit pacing protocol.

**Example**

Check transmit pacing protocol

**SYST:COMM:SER0:TRAN:PACE:PROT?**

enter statement

*statement enters the string "XON" or "NONE"*

**:DATE**

**SYSTem:DATE < year > , < month > , < day >** sets the E1300/E1301 mainframe's internal calendar.

**Parameters**

| Parameter Name | Parameter Type | Range of Values                           | Default Units |
|----------------|----------------|---|---------------|
| <i>year</i>    | numeric        | must round to 1980 to 2079                | none          |
| <i>month</i>   | numeric        | must round to 1 to 12                     | none          |
| <i>day</i>     | numeric        | must round to 1 through last day of month | none          |

**Comments**

- The upper limit on the day parameter is dependent on the month parameter and may be dependent on the year parameter in the case of a leap year.



## SYSTem :DATE?

- **Related Commands:** SYST:TIME, SYST:TIME?, SYST:DATE?
- **\*RST Condition:** \*RST does not change the setting of the calendar.

### Example Setting the system Date

**SYST:DATE 1991,09,08** *set SEP 8, 1991*

---

**:DATE?** SYSTem:DATE? [MIN| MAX,MIN| MAX,MIN| MAX] returns:

- **When no parameter is sent:** the current system date in the form + YYYY,+ MM,+ DD, where YYYY can be the year 1980 through 2079, MM can be the month 1 through 12, and DD can be the day 1 through 31.
- **When parameters are sent:** the minimum or maximum allowable values for each of the three parameters. The parameter count must be three.

### Example Querying the system date

**SYST:DATE?** *ask for current date*  
input values of year,month,day *read back date*

---

**:ERRor?** SYSTem:ERR? queries the system's error queue. The response format is:  
< error number> , '< error description string> '.

### Comments

- As system errors are detected, they are placed in the System Instrument error queue. The error queue is first in, first out. This means that if several error messages are waiting in the queue, each SYST:ERR? query will return the oldest error message, and that message will be deleted from the queue.
- If the error queue fills to 30 entries, the last error in the queue is replaced with error **-350,'Too may errors'**. No further errors are accepted by the queue until space becomes available using SYST:ERR?, or the queue is cleared using \*CLS.
- The SYST:ERR? command can be used to determine if any configuration errors occurred during the power-on sequence.
- When SYST:ERR? is sent while the error queue is empty, the System Instrument responds with + **0,'No error'**.
- **Related Commands:** \*ESE, \*ESR?, \*SRE
- **\*RST Condition:** Error queue is cleared

### Example Read all error messages from, and empty the error queue.

loop statement *loop to read all errors*  
**SYST:ERR?** *ask for error message*  
enter statement *input the error (a number), and*  
*error message (a string)*  
until statement *until error number is 0*

**:TIME** SYSTem:TIME < *hour* > , < *minute* > , < *second* > sets the E 1300/E 1301 mainframe's internal clock.

**Parameters**

| Parameter Name | Parameter Type | Range of Values       | Default Units |
|----------------|----------------|-----------------------|---------------|
| <i>hour</i>    | numeric        | must round to 0 to 23 | none          |
| <i>minute</i>  | numeric        | must round to 0 to 59 | none          |
| <i>second</i>  | numeric        | must round to 0 to 60 | none          |

**Comments**

- **Related Commands:** SYST:DATE, SYST:DATE?, SYST:TIME?
- **\*RST Condition:** \*RST does not change the Command Module's real time clock.

**Example**

Setting the system time

**SYST:TIME 14,30,20** *set 2:30:20 PM*

**:TIME?**

SYSTem:TIME? [MAX| MIN,MAX| MIN,MAX| MIN] returns:

- **When no parameter is sent;** the current system time in the form + HH,+ MM,+ SS, where HH can be 0 through 23 hours, MM can be 0 through 59 minutes, and SS can be 0 through 60 seconds.
- **When parameters are sent;** the minimum or maximum allowable values for each of the three parameters. The parameter count must be three.

**Example**

Querying the system time

**SYST:TIME?** *ask for current time*  
 input values of hour,min,sec *read back time*

**:VERSion?**

SYSTem:VERSion? Returns the SCPI version for which this instrument complies.

**Comments**

- The returned information is in the format: YYYY.R; where YYYY is the year, and R is the revision number within that year.
- **Related Commands:** \*IDN?

**Example**

Determine compliance version for this instrument.

SYST:VERS?  
 enter statement *Statement enters 1990.0*

## TRIGger

The TRIGger command subsystem controls the behavior of the trigger system once it is initiated (see INITiate command subsystem). The trigger command subsystem controls:

- The delay between trigger and first Pacer pulse (TRIG:DELay)
- An immediate software trigger (TRIG:IMM)
- The source of the trigger (TRIG:SOUR BUS| EXT| HOLD| IMM)

### Subsystem Syntax

```
TRIGger
:DELay < delay>
:DELay? [MIN | MAX]
[:IMMEDIATE]
:SLOPe < slope>
:SLOPe?
:SOURce BUS | EXT | HOLD | IMM
:SOURce?
```

### :DELay

**TRIGger:DELay < delay>** sets the delay between receipt of trigger and first Pacer pulse.

### Parameters

| Parameter Name | Parameter Type | Range of Values                       | Default Units |
|----------------|----------------|---------------------------------------|---------------|
| <i>delay</i>   | numeric        | 250E-9s to 4.19430375s or<br>MIN  MAX | second        |

### Comments

- The resolution for *delay* is 250E-9 seconds.
- **Related Commands:** ABORt, INITiate
- **\*RST Condition:** TRIG:DELay 2.5E-9

### Example

**Setting delay between trigger and Pacer output.**

```
TRIG:SOUR HOLD           trigger is TRIG command
SOUR:PULS:COUN 100       set Pacer to output 100 pulses
SOUR:PULS:PER .1 S      pulse period set to .1 second
TRIG:DELAY .75 S       start Pacer .75 sec after trigger
INIT                     go to Wait For Trigger state
TRIG                     trigger Pacer to output pulses
```

### :DELay?

**TRIGger:DELay? [MIN | MAX]** returns:

- The current delay if no parameter is sent.
- The maximum allowable delay if MAX is sent.
- The minimum allowable delay if MIN is sent.

### Example

**Querying the trigger delay setting.**

```
TRIG:DEL .75 S           start Pacer .75 sec after trigger
TRIG:DEL?             command System Instrument
                        to send TRIG:DEL value.
enter statement          input value of trigger delay
```

## TRIGger[:IMMediate]

**[:IMMediate]** TRIGger:IMMediate will cause a trigger cycle to occur immediately, provided that the trigger system has been initiated (INITiate).

- Comments**
- **Related Commands:** ABORt, INITiate
  - **\*RST Condition:** This command is an event and has no \*RST condition.

**Example** Triggering the Pacer.

|                    |  |
|--------------------|--|
| TRIG:SOUR HOLD     | <i>trigger source is TRIG command</i>    |
| SOUR:PULS:COUN 1E3 | <i>output 1000 Pacer pulses</i>          |
| SOUR:PULS:PER .1 S | <i>pulse period set to .1 second</i>     |
| TRIG:DELAY .75 S   | <i>start Pacer .75 sec after trigger</i> |
| INIT               | <i>go to Wait For Trigger state</i>      |
| TRIG               | <i>trigger Pacer to output pulses.</i>   |

**:SLOPe** TRIGger:SLOPe < *slope* > is for SCPI compatibility. The mainframe's "Event In" signal only triggers on a negative going edge.

**Parameters**

| Parameter Name | Parameter Type | Range of Values | Default Units |
|----------------|----------------|-----------------|---------------|
| <i>slope</i>   | discrete       | NEGative        | none          |

- Comments**
- Trying to set ...SLOPe to other than NEG will generate an error.
  - **Related Commands:** ABORt, INITiate,

**:SLOPe?** TRIGger:SLOPe? returns the current trigger slope setting. Since the mainframe's "Event In" signal only triggers on a negative going edge, TRIG:SLOP? will always return "NEG".

**:SOURce** TRIGger:SOURce < *trig\_source* > configures the trigger system to respond to the specified source.

**Parameters**

| Parameter Name     | Parameter Type | Range of Values  | Default Units |
|--------------------|----------------|------------------|---------------|
| <i>trig_source</i> | character      | BUS EXT HOLD IMM | none          |

**Comments**

- The following table explains the possible choices.

| Parameter Value | Source of Trigger   |
|-----------------|---|
| BUS             | Group Execute Trigger (GET) bus command, *TRG common command, or TRIGger command. |
| EXTernal        | “Event In” signal at rear panel BNC connector, or TRIGger command.                |
| HOLD            | Only the TRIGger command will cause trigger.                                      |
| IMMEDIATE       | The trigger signal is always true (continuous triggering).                        |

- While an instrument which uses the "Event In" signal has EXT set, no other instrument which uses the "Event In" signal may set EXT, or an error 1500 "External trigger source already allocated" will result.
- While TRIG:SOUR is IMM, you need only INITiate the trigger system to start the Pacer.
- Related Commands:** ABORt, INITiate, \*TRG
- \*RST Condition:** TRIG:SOUR IMM

**Example Specifying the Trigger Source.**

**TRIG:SOUR HOLD**

SOUR:PULS:COUN 1E3

SOUR:PULS:PER .1 S

TRIG:DELAY .75 S

INIT

TRIG

*trigger source is TRIG  
command*

*output 1000 Pacer pulses*

*pulse period set to .1 second*

*start Pacer .75 sec after trigger*

*go to Wait For Trigger state*

*trigger the Pacer to output  
pulses.*

**:SOURce?**

**TRIGger:SOURce?** returns the current trigger source configuration. Response data can be one of; BUS, EXT, HOLD, or IMM. See the TRIG:SOUR command for more response data information.

**Example Querying the Trigger Source.**

TRIG:SOUR HOLD

**TRIG:SOUR?**

enter statement

*trigger source is TRIG  
command*

*ask System Instrument to  
return trigger source  
configuration*

*input selection of trigger source*

## VXI:CONFigure :DLADdress?

### VXI

The VXI command subsystem provides for:

- Determining the number, type, and logical address of the devices (instruments) installed in the E 1300/E 1301 mainframe.
- Direct access to VXIbus A16 registers within devices installed in the Mainframe.

#### Subsystem Syntax

VXI  
:CONFigure  
:DeviceLADd?  
:DeviceLIST?  
:DeviceNUMBER?  
:HEIRarchy  
  :ALL?  
:INFormation?  
  :ALL?  
:LADdress?  
:NUMber?  
:READ? < logical\_addr> ,< register\_num>  
:REGister  
  :READ? < numeric\_value.> | < register\_name>  
  :WRITe < numeric\_value> | < register\_name>  
:RESet?  
:SElect < numeric\_value>  
:WRITe < logical\_addr> ,< register\_num> ,< data>

---

#### :CONFigure :DLADdress?

**VXI:CONF:DLAD?** returns a comma separated decimal numeric list of device logical addresses currently installed in the mainframe. If the Command Module is not the resource manager, it only returns the logical addresses of the devices in its servant area.

#### Comments

- Use the VXI:CONF:DNUM? command to determine the number of values which will be returned by VXI:CONF:DLAD?.
- Use each of the logical addresses returned by VXI:CONF:DLAD? with VXI:CONF:DLIS? to determine the types of devices installed.
- VXI:CONF:DEVICELAD? is also accepted.
- This command has been retained for compatibility with existing programs. For new programs you should use the VXI:CONF:LADD? command.
- **Related Commands:** VXI:CONF:DLIS?, VXI:CONF:DNUM?, VXI:CONF:LADD?

#### Example Determining the device addresses within the system

|                       |                                     |
|-----------------------|-------------------------------------|
| <b>VXI:CONF:DLAD?</b> | <i>query for list of addresses.</i> |
| enter statement       | <i>list of addresses.</i>           |

**:CONFigure:DLIS?**

**VXI:CONF:DLIS?** [*< logical\_addr >* ] returns information about the device specified by *logical\_addr*. Response data is in the form:

**n1, n2, n3, n4, n5, n6, c1, c2, c3, c4, c5, s1, s2, s3, s4**

Where the fields above are defined as:

- n** fields      Indicate numeric data response fields.
- c** fields      Indicate character data response fields.
- s** fields      Indicate string data response fields.
- n1**    **Device's Logical Address.** A number from 0 to 255.
- n2**    **Commander's Logical Address.** A number from -1 to 255; -1 means this device has no commander.
- n3**    **Manufacturer's ID.** A number from 0 to 4095.
- n4**    **Model Code.** A number from 0 to 65535, chosen by the manufacturer to signify the model of this device.
- n5**    **Slot Number.** A number between -1 and the number of slots in this mainframe; -1 indicates that the slot associated with this device is unknown. This is always -1 for B size mainframes.
- n6**    **Slot 0 Logical Address.** A number from 0 to 255.
- c1**    **Device Class.** 3 data characters; EXT| HYB| MEM| MSG| REG| VME.  
EXT = Extended device, HYB = hybrid device (e.g. IBASIC),  
MEM = memory device, MSG = Message-based device,  
REG = Register-based device, VME = VME device
- c2**    **Memory Space.** Up to 4 data characters; A16| A24| A32| NONE| RES.  
A16 = A16 addressing mode, A24 = A24 addressing mode, A32 =  
A32 addressing mode, NONE = no addressing mode, RES = reserved.
- c3**    **Memory Offset.** 10 data characters which define the base address of the A24 or A32 address space on the device. This value is expressed in hex format (first two characters are # H).
- c4**    **Memory Size.** 10 data characters which define the size of the A24 or A32 address space in bytes. This value is expressed in hex format (first two characters are # H).
- c5**    **Pass/Failed.** Up to 5 data characters which define the status of the device; FAIL | IFAIL | PASS | READY. FAIL = failed self-test, IFAIL = configuration register initialization fails, PASS = self-test passed, READY = ready to receive commands
- s1**    **Extended Field 1.** Not currently used; returns ""
- s2**    **Extended Field 2.** Not currently used; returns ""
- s3**    **Extended Field 3.** Not currently used; returns ""
- s4**    **Manufacturer's Specific Comments.** Up to 80 character string contains manufacturer specific data in string response data format. This field is sent with a 488.2 string response data format, and will contain the instrument name and its IEEE 488.1 secondary address unless a start-up error is detected. In that case, this field will contain one or more error codes in the form "CNFG ERROR: n, m, ...,z". See Appendix B, Table B-3 for a complete list of these codes.

## VXI:CONFigure :DNUMber?

### Parameters

| Parameter Name      | Parameter Type | Range of Values    | Default Units |
|---------------------|----------------|--------------------|---------------|
| <i>logical_addr</i> | numeric        | 0-255 (or nothing) | none          |

### Comments

- When *logical\_addr* is not specified, VXI:CONF:DLIS? returns information for each of the devices installed, separated by semicolons. If the Command Module is not the resource manager, it returns information on only the devices in its servant area.
- Cards which are part of a combined instrument such as a switchbox or scanning voltmeter always return the same manufacturer's comments as the first card in the instrument. Information in the other fields correspond to the card for which the Logical Address was specified.
- This command has been retained for compatibility with existing programs. For new programs you should use the VXI:CONF:INF? command.
- **Related Commands:** VXI:CONF:DLAD?, VXI:CONF:DNUM?, VXI:CONF:INF?, CONF:HEIR?

### Example Querying the device list for the System Instrument

```

dimension string[1000]           string size large in case of
                                  multiple device list
VXI:CONF:DLIS? 0                Ask for the device list for the
                                  System Instrument
enter string                     enter return data into string

```

**Example response data (no error):**+ 0, -1, + 4095, + 1301, + 0, + 0, HYB, NONE,  
# H00000000, # H00000000, READY, "", "", "", "SYSTEM INSTALLED AT SECONDARY  
ADDR 0"

**Example response data (with error):**+ 255, + 0, + 4095, + 65380, -1, + 0, REG, A16,  
# H00000000, # H00000000, READY, "", "", "", "CNFG ERROR: 11"

## :CONFigure :DNUMber?

**VXI:CONF:DNUM?** returns the number of devices installed in the mainframe (including the System Instrument itself). If the Command Module is not the resource manager, it returns the number of devices in its servant area.

### Comments

- Use the VXI:CONF:DNUM? command to determine the number of values which will be returned by VXI:CONF:DLAD?.
- This command has been retained for compatibility with existing programs. For new programs you should use VXI:CONF:NUMB?.
- **Related Commands:** VXI:CONF:DLAD?, VXI:CONF:DLIS?

### Example Determining the number of devices within the system

```

VXI:CONF:DNUM?                 query the number of devices
enter statement                input number of devices

```



**:CONFigure  
:HIERarchy?**

**VXI:CONF:HIER?** Returns current hierarchy configuration information about the selected logical address. The individual fields of the response are comma separated. If the information about the selected logical address is not available from the destination device (i.e., the requested device is not in the mainframe) then Error -224 ("parameter error") will be set and no response data will be sent.

**NOTE**

This command is included in the E 1300/E 1301 because it is a required SCPI command. Since there are no message based devices in the E 1300/E 1301, most of these fields will be null valued for the E 1300/E 1301.

**Comments**

- This command returns the following values:

**Logical address:** an integer between -1 and 255 inclusive. -1 indicates that the device has no logical address.

**Commander's logical address:** an integer between -1 and 255 inclusive. -1 indicates that the device has no commander or that the commander is unknown. This value is always 0 for the E 1300/E 1301.

**Interrupt handlers:** a comma separated list of seven integers between 0 and 7 inclusive. Interrupt lines 1–7 are mapped to the individual return values. 0 is used to indicate that the particular interrupt handler is not configured. A set of return values of 0,0,0,5,2,0,6 would indicate that:

- handler 4 is configured to handle interrupts on line 5
- handler 5 is configured to handle interrupts on line 2
- handler 7 is configured to handle interrupts on line 6
- handlers 1, 2, 3, and 6 are not configured

**Interrupters:** a comma separated list of seven integers between 0 and 7 inclusive. Interrupt lines 1–7 are mapped to the individual return values. 0 is used to indicate that the particular interrupter is not configured. A set of return values of 0,0,0,5,2,0,6 would indicate that:

- interrupter 4 is configured to handle interrupts on line 5
- interrupter 5 is configured to handle interrupts on line 2
- interrupter 7 is configured to handle interrupts on line 6
- interrupters 1, 2, 3, and 6 are not configured

**Pass/Failed:** an integer which contains the pass/fail status of the specified device encoded as follows:

**0 = FAIL, 1 = IFAIL, 2 = PASS, 3 = READY**

**Manufacturer's Specific Comments.** Up to 80 character string contains manufacturer specific data in string response data format. This field is sent with a 488.2 string response data format, and will contain the instrument name and its IEEE 488.1 secondary address unless a start-up error is detected. In that case, this field will contain one or more error codes in the form "CNFG ERROR: n, m, ...,z". See Appendix B, Table B-3 for a complete list of these codes.

## VXI:CONFigure :HIERarchy:ALL?

- Cards which are part of a combined instrument such as a switchbox or scanning voltmeter always return the same manufacturer's comments as the first card in the instrument. Information in the other fields correspond to the card for which the Logical Address was specified.
- **Related Commands:** VXI:SEL, VXI:CONF:HEIR:ALL?, VXI:CONF:LADD?

---

### :CONFigure :HIERarchy:ALL?

**VXI:CONF:HIER:ALL?** Returns the configuration information about all logical addresses in the E 1300/E 1301 mainframe. The information is returned in the order specified in the response to VXI:CONF:LADD?. The information about multiple logical addresses will be semicolon separated and follow the IEEE 488.2 response message format. Individual fields of the output are comma separated.

---

### NOTE

This command is included in the E 1300/E 1301 because it is a required SCPI command. Since there are no message based devices in the E 1300/E 1301, most of these fields will be null valued for this E 1300/E 1301.

---

### Comments

- **Related Commands:** VXI:CONF:HEIR?, VXI:SEL, VXI:CONF:LADD?

---

### :CONFigure :INFormation?

**VXI:CONF:INF?** Returns the static information about the selected logical address (see VXI:SElect). The individual fields of the response are comma separated. If the information about the selected logical address is not available from the destination device (i.e., the requested device is not in the mainframe) then Error -224 ("parameter error") will be set and no response data will be sent. The command returns the following values:

- **Logical address:** an integer between -1 and 255 inclusive. -1 indicates that the device has no logical address.
- **Manufacturer ID:** an integer between -1 and 4095 inclusive. -1 indicates that the device has no Manufacturer ID.
- **Model code:** an integer between -1 and 65535 inclusive. -1 indicates that the device has no model code.
- **Device class:** an integer between 0 and 5 inclusive. 0 = VXIbus memory device, 1 = VXIbus extended device, 2 = VXIbus message based device, 3 = VXIbus register based device, 4 = Hybrid device, 5 = Non-VXIbus device.
- **Address space:** an integer between 0 and 15 inclusive, which is the sum of the binary weighted codes of the address space(s) occupied by the device. 1 = The device has A 16 registers, 2 = The device has A 24 registers, 4 = The device has A 32 registers, 8 = The device has A 64 registers.
- **A16 memory offset:** an integer between -1 and 65535 inclusive. Indicates the base address for any A 16 registers (other than the VXIbus defined

## VXI :CONFigure :INFormation?

registers) which are present on the device. -1 indicates that the device has no A16 memory.

- **A24 memory offset:** an integer between -1 and 16777215 inclusive. Indicates the base address for any A24 registers which are present on the device. -1 indicates that the device has no A24 memory.
- **A32 memory offset:** an integer between -1 and 4294967295 inclusive. Indicates the base address for any A32 registers which are present on the device. -1 indicates that the device has no A32 memory.
- **A16 memory size:** an integer between -1 and 65535 inclusive. Indicates the the number of bytes reserved for any A16 registers (other than the VXIbus defined registers) which are present on the device. -1 indicates that the device has no A16 memory.
- **A24 memory size:** an integer between -1 and 16777215 inclusive. Indicates the number of bytes reserved for any A24 registers which are present on the device. -1 indicates that the device has no A24 memory.
- **A32 memory seze:** an integer between -1 and 4294967295 inclusive. Indicates the number of bytes reserved for any A32 registers which are present on the device. -1 indicates that the device has no A32 memory.
- **Slot number:** an integer between -1 and the number of slots which exist in the cage. -1 indicates that the slot which contains this device is unknown.
- **Slot 0 logical address:** an integer between -1 and 255 inclusive. -1 indicates that the Slot 0 device associated with this device is unknown.
- **Subclass:** an integer representing the contents of the subclass register. -1 indicates that the subclass register is not defined for this device.
- **Attribute:** an integer representing the contents of the attribute register. -1 indicates that the attribute register is not defined for this device.
- **Manufacturer's Specific Comments.** Up to 80 character string contains manufacturer specific data in string response data format. This field is sent with a 488.2 string response data format, and will contain the instrument name and its IEEE 488.1 secondary address unless a start-up error is detected. In that case, this field will contain one or more error codes in the form "CNFG ERROR: n, m, ...,z". See Appendix B, Table B-3 for a complete list of these codes.

### Comments

- **Related Commands:** VXI:SEL, VXI:CONF:INF:ALL?, VXI:CONF:LADD?

### Example

Query information on logical address 0.

VXI:SEL 0

*select the logical address*

VXI:CONF:INF?

*ask for data*

enter statement

*return data*

## VXI:CONFigure :INFormation:ALL?

### :CONFigure :INFormation:ALL?

**VXI:CONF:INF:ALL?** Returns the static information about all logical addresses. The information is returned in the order specified in the response to VXI:CONF:LADD?. The information about multiple logical addresses will be semicolon separated and follow the IEEE 488.2 response message format. Individual fields of the output are comma separated.

#### Comments

- **Related Commands:** VXI:SEL, VXI:CONF:INF?, VXI:CONF:LADD?

### :CONFigure :LADdress?

**VXI:CONF:LADD?** Returns a comma separated list of logical addresses of devices in the mainframe. This is an integer between 1 and 256 inclusive. The logical address of the device responding to the command will be the first entry in the list.

#### Comments

- **Related Commands:** VXI:CONF:NUMB?

### :CONFigure :NUMBer?

**VXI:CONF:NUMB?** Returns the number of devices in the system. This is an integer between 1 and 256 inclusive.

#### Comments

- **Related Commands:** VXI:CONF:LADD?

### :READ?

**VXI:READ? < logical\_addr> ,< register\_addr>** allows access to the entire 64 byte A16 register address space for the device specified by *logical\_addr*. Since the VXIbus system is byte-addressed, while the registers are 16 bits wide, registers are specified by even addresses only. This method of identifying registers follows the VXIbus standard format.

#### Parameters

| Parameter Name       | Parameter Type  | Range of Values   | Default Units |
|----------------------|-----------------|---|---------------|
| <i>logical_addr</i>  | decimal numeric | must round to 0 through 255                                       | none          |
| <i>register_addr</i> | numeric         | must round to an even value from 0 through 62 (3E <sub>16</sub> ) | none          |

#### Comments

- Specifying an odd register address will cause an error 2003, "Invalid word address".
- Specifying a logical address not currently in the system will cause an error 2005, "No card at logical address".
- *Logical\_addr* **must** be specified in decimal. *Register\_addr* **may** be specified in decimal, hex (# H), octal (# Q), or binary (# B).
- This command has been retained for compatibility with existing programs. For new programs you should use the VXI:REG:READ? command.
- Accesses are 16-bit non-privileged data accesses.

- **Related Commands:** VXI:WRITE, VXI:REG:READ?

**Example** Read from one of a device’s configuration registers

**VXI:READ? 8,0** *read ID register on device at Logical Address 8*  
 enter statement *enter value from device register*

**:REGister:READ?**

**VXI:REG:READ? < register>** returns the contents of the specified 16 bit register at the selected logical address as an integer (see VXI:SElect). The register is specified as the byte address of the desired register or optionally as the register name.

**Parameters**

| Parameter Name  | Parameter Type | Range of Values  | Default Units |
|-----------------|----------------|--|---------------|
| <i>register</i> | numeric        | even numbers from 0 to 62 or register name (see below) | none          |

**Comments**

- The register parameter can be all even numbers from 0 to 62 inclusive (as a < numeric\_value> ) or the following (optional) words:  
**A24Low:** A24 Pointer Low register (18)  
**A24High:** A24 Pointer High register (16)  
**A32Low:** A32 Pointer Low register (22)  
**A32High:** A32 Pointer High register (20)  
**ATTRibute:** Attribute register (8)  
**DHIGH:** Data High register (12)  
**DLOW:** Data Low register (14)  
**DTYPe:** Device Type register (2)  
**ICONtrol:** Interrupt control register (28)  
**ID:** ID register (0)  
**ISTatus:** Interrupt Status register (26)  
**MODId:** MODID register (8)  
**OFFSet:** Offset register (6)  
**PROTOcol:** Protocol register (8)  
**RESPonse:** Response register (10)  
**SNHigh:** Serial Number High register (10)  
**SNLow:** Serial Number Low register (12)  
**STATus:** Status register (4)  
**SUBClass:** Subclass register (30)  
**VNUMBER:** Version Number register (14)
- **Related Commands:** VXI:SEL, VXI:REG:WRIT

**Example** Read from a register on the currently selected device

**VXI:READ? CONT** *Read from the control register of the currently selected device*

**:REGister:WRITe**

**VXI:REG:WRITe?** < register> , < data> writes to the specified 16 bit register at the selected logical address (see VXI:SElect). The data is a 16 bit value specified as a numeric value in the range of -32768 to 32767 or 0 to 65535. The register is specified as the byte address of the desired register or optionally as the register name.

**Parameters**

| Parameter Name  | Parameter Type | Range of Values  | Default Units |
|-----------------|----------------|--|---------------|
| <i>register</i> | numeric        | even numbers from 0 to 62 or register name (see below) | none          |
| <i>data</i>     | numeric        | -32768 to 65535  | none          |

**Comments**

- The register parameter can be all even numbers from 0 to 62 inclusive (as a < numeric\_value> ) or the following (optional) words:  
**CONTRol:** Control Register (4)  
**DEXTended:** Data Extended register (10)  
**DHIGH:** Data High register (12)  
**DLOW:** Data Low register (14)  
**ICONTrol:** Interrupt Control register (28)  
**MODid:** MODID register (8)  
**LADDRESS:** Logical Address register (0)  
**OFFSet:** Offset register (6)  
**SIGNAL:** Signal register (8)
- **Related Commands:** VXI:SEL, VXI:REG:READ?

**Example**

**Write to a register on the currently selected device**

**VXI:REG:WRIT? DHIG,64** *writes '64' to the Data High register*

**Reset?**

VXI:RESET? resets the selected logical address. SYSFAIL generation is inhibited while the device is in the self test state. The command waits for 5 seconds or until the selected device has indicated passed (whichever occurs first). If the device passes its self test SYSFAIL generation is re-enabled. If the device fails its self test SYSFAIL generation remains inhibited. The return value from this command is the state of the selected device after it has been reset. The command returns an integer encoded as followed.

- 0 = FAIL
- 2 = PASS
- 3 = READY

The state of the A24/A32 enable bit is not altered by this command

**Comments**

- **Related Commands:** VXI:SEL

---

**:SElect** **VXI:SElect** < *logical\_addr*> specifies the logical address which is to be used by many subsequent commands in the VXI subsystem.

**Parameters**

| Parameter Name      | Parameter Type | Range of Values | Default Units |
|---------------------|----------------|-----------------|---------------|
| <i>logical_addr</i> | numeric        | 0 through 255   | none          |

**Comments**

- The \*RST default value for *logical\_addr* is that no logical address is selected (i.e., -1). All other commands which require a logical address to be selected will respond with Error -221 ("settings conflict") if no logical address is selected.
- When a command encounters an Error -240 ("Hardware Error") the equivalent of a \*RST is executed. This will cause the selected logical address to be set to -1.
- **Related Commands:** VXI:CONF:LADD?

**Example** Select a logical address

**VXI:SEL 64**

*sets the logical address to be used by subsequent VXI subsystem commands to 64.*

---

**:SElect?** **VXI:SElect?** returns the logical address which will be used by many subsequent commands in the VXI subsystem. If no logical address has been selected, this query will return -1.

**:WRITE** **VXI:WRITE** < *logical\_addr* > , < *register\_addr* > , < *data* > allows access to the entire 64 byte A16 register address space for the device specified by *logical\_addr*. Since the VXIbus system is byte-addressed, while the registers are 16 bits wide, registers are specified by even addresses only. This method of identifying registers follows the VXIbus standard format.

**Parameters**

| Parameter Name       | Parameter Type  | Range of Values  | Default Units |
|----------------------|-----------------|--|---------------|
| <i>logical_addr</i>  | decimal numeric | Must round to 0 through 255                                      | none          |
| <i>register_addr</i> | numeric         | must round to an even value from 0 through 62 (3E <sub>h</sub> ) | none          |
| data                 | numeric         | must round to -32768 to 32767 (0 to FFFF <sub>h</sub> )          | none          |

**Comments**

- Specifying an odd register address will cause an error 2003, "Invalid word address".
- Specifying a logical address not currently in use in the system will cause an error 2005, "No card at logical address".
- *Logical\_addr* **must** be specified in decimal. *Register\_addr* and *data* **may** be specified in decimal, hex (# H), octal (# Q), or binary (# B).
- This command has been retained for compatibility with existing programs. For new programs you should use the VXI:REG:WRIT command.
- Accesses are 16-bit non-privileged data accesses.
- **Related Commands:** VXI:READ?, VXI:REG:WRIT

**Example** Write a value into a device's device dependent register.

**VXI:WRIT 8,24,# H4200**

*write hex 4200 (16,896 decimal) to register 24 of device at Logical Address 8*



## Common Command Reference

This section describes the IEEE-488.2 Common Commands that can be used to program instruments in the mainframe. Commands are listed by command groups in the summary table below, and alphabetically in the rest of this section. Examples are shown when the command has parameters or returns a response; otherwise the command string is as shown in the headings in this section. For additional information on any Common Commands, refer to the *IEEE Standard 488.2-1987* (see "Related Documentation" in the front of this manual for more information on this standard).

| IEEE 488.2 Common Commands Functional Groupings |              |                                      |
|---|--------------|--------------------------------------|
| Category  | Command      | Title                                |
| General   | *IDN         | Identification Query                 |
|   | *RST         | Reset Command                        |
|   | *TST?        | Self-Test Query                      |
| Instrument Status                               | *CLS         | Clear Status Command                 |
|   | *ESE < mask> | Standard Event Status Enable Command |
|   | *ESE?        | Standard Event Status Enable Query   |
|   | *ESR?        | Standard Event Status Register Query |
|   | *PSC         | Power-On Status Clear Command        |
|   | *PSC?        | Power-On Status Clear Query          |
|   | *SRE < mask> | Service Request Enable Command       |
|   | *SRE?        | Service Request Enable Query         |
|   | *STB?        | Status Byte Query                    |
|   | Macros       | *DMC < name> ,< cmds>                |
| *EMC < state>                                   |              | Enable Macros Command                |
| *EMC?   |              | Enable Macro Query                   |
| *GMC? < name>                                   |              | Get Macro Query                      |
| *LMC?   |              | Learn Macro Query                    |
| *PMC  |              | Purge all Macros Command             |
| *RMC < name>                                    |              | Remove individual Macro Command      |
| Synchronization                                 | *OPC         | Operation Complete Command           |
|   | *OPC?        | Operation Complete Query             |
|   | *WAI         | Wait-to-Continue Command             |
|   |              |                                      |

**\*CLS** Clear Status Command. The \*CLS command clears all status registers (Standard Event Status Register, Standard Operation Event Status Register, Questionable Data Event Register) and the error queue for an instrument. This clears the corresponding summary bits (bits 3, 5, & 7) and the instrument-specific bits (bits 0, 1, & 2) in the Status Byte Register. \*CLS does not affect the enabling of bits in any of the status registers (Status Byte Register, Standard Event Status Register, Standard Operation Event Status Register, or Questionable Data Event Status Register). (The SCPI command STATus:PRESet *does* clear the Standard Operation Status Enable and Questionable Status Enable registers.) \*CLS disables the Operation Complete function (\*OPC command) and the Operation Complete Query function (\*OPC? command).

**\*DMC < name\_string> ,  
< command\_block>** Define Macro Command. Assigns one, or a sequence of commands to a macro name.

The command sequence may be composed of SCPI and/or Common commands.

The name given to the macro may be the same as a SCPI command, but may not be the same as a Common command. When a SCPI named macro is executed, the macro rather than the SCPI command is executed. To regain the function of the SCPI command, execute the \*EMC 0 command.

#### Example

*Create a macro to return the System Instrument's Device list.*  
OUTPUT 70900;"\* DMC 'LIST',# 0VXI:CONF:DLIS?"

Note that the name LIST is in quotes. The second parameter type is *arbitrary block program data*. The characters that define a command message are prefixed by the characters # 0 (pound zero). For a more information on this parameter type, see Parameter Types in the first part of this chapter.

**\*EMC < enable>** Enable Macros Command. When *enable* is non-zero, macros are enabled. When *enable* is zero, macros are disabled.

**\*EMC?** Enable Macros Query. Returns either 1 (macros are enabled), or 0 (macros are disabled) for the selected instrument.

**\*ESE < mask>** Standard Event Status Enable Register Command. Enables one or more events in the Standard Event Status Register to be reported in bit 5 (the Standard Event Status Summary Bit) of the Status Byte Register. You enable an event by specifying its decimal weight for < mask> . To enable more than one event, specify the sum of the decimal weights. Refer to "Standard Event Status Register" earlier in this chapter for a table showing the contents of the Standard Event Status Register.

**Example**                    OUTPUT 70900;"\* ESE 60"                    *Enables bits 2, 3, 4, & 5.  
Respective weights are 4 + 8  
+ 16 + 32 = 60*

**\*ESE?** Standard Event Status Enable Query. Returns the weighted sum of all enabled (unmasked) bits in the Standard Event Status Register.

|                |                         |                                    |
|----------------|-------------------------|------------------------------------|
| <b>Example</b> | 10 OUTPUT 70900;"*ESE?" | <i>Sends status enable query</i>   |
|                | 20 ENTER 70900;A        | <i>Places response in variable</i> |
|                | 30 PRINT A              | <i>Prints response</i>             |
|                | 40 END                  |                                    |

**\*ESR?** Standard Event Status Register Query. Returns the weighted sum of all set bits in the Standard Event Status Register. After reading the register, \*ESR? clears the register. The events recorded in the Standard Event Status Register are independent of whether or not those events are enabled with the \*ESE command.

|                |                         |   |
|----------------|-------------------------|---|
| <b>Example</b> | 10 OUTPUT 70900;"*ESR?" | <i>Sends Standard Event Status Register query</i> |
|                | 20 ENTER 70900;A        | <i>Places response in variable</i>                |
|                | 30 PRINT A              | <i>Prints response</i>                            |
|                | 40 END                  |   |

**\*GMC? < name\_string >** Get Macro Query. Returns *arbitrary block response data* which contains the command or command sequence defined by *name\_string*. The command sequence will be prefixed with characters which indicate the number of characters that follow the prefix.

|                |                                |   |
|----------------|--------------------------------|---|
| <b>Example</b> | 10 OUTPUT 70900;"*GMC? 'LIST'" | <i>ask for definition of macro from *DMC example</i>        |
|                | 20 ENTER 70900;Cmds\$          | <i>enter into Cmds\$ the definition of the macro "LIST"</i> |
|                | 30 PRINT Cmds\$                | <i>Cmds\$= # 214VXI:CONF:DLIS?</i>                          |
|                | 40 END                         |   |

In this case, the prefix consists of "# 214". The 2 says to expect two character-counting digits. The 14 says that 14 characters of data follow. Had the returned macro been shorter, such as # 15\*EMC?, we would read this as 1 counting digit indicating 5 data characters.

**\*IDN?** Identity. Returns the device identity. The response consists of the following four fields (fields are separated by commas):

- Manufacturer
- Model Number
- Serial Number (returns 0 if not available)
- Firmware Revision (returns 0 if not available)

The \*IDN? command returns the following command string for the E1301B:

```
AGILENT,E1301B,0,A,07.00
```

This command will return the following string for the E1300B:

```
AGILENT,E1300B,0,A,07.00
```

---

## NOTE

The revision will vary with the revision of the ROM installed in the system. This is the only indication of which version of ROM is in the box. The major number (01 in the examples) indicates whether there have been functional changes made in this ROM. The minor number (00 in the examples) indicates whether only bug fixes and minor changes were made.

---

### Example Get the ID fields from the system and print them.

|                         |                                      |
|-------------------------|--------------------------------------|
| 10 DIM A\$[50]          | <i>Dimension array for ID fields</i> |
| 20 OUTPUT 70900;"*IDN?" | <i>Queries identity</i>              |
| 30 ENTER 70900;A\$      | <i>Places ID fields in array</i>     |
| 40 PRINT A\$            | <i>Print ID fields</i>               |
| 50 END                  |                                      |

**\*LMC?** Learn Macros Query. Returns a quoted string *name* for each currently defined macro. If more than one macro is defined, the quoted strings are separated by commas (.). If no macro is defined, then a quoted null string ("") is returned.

**\*LRN?** Learn query command. \*LRN? causes the instrument to respond with a string of SCPI commands which define the instrument's current state. Your application program can enter the \*LRN? response data into a string variable, later to be sent back to the instrument to restore that configuration.

### Example response from an Agilent E1326B voltmeter in the power-on state:

```
*RST::CAL:ZERO:AUTO 1; :CAL:LFR + 60; VAL + 0.00000000E+ 000;
:DISP:MON:STAT 0; CHAN (@0); :FORM ASC,+ 7; :FUNC "VOLT";
:MEM:VME:ADDR + 2097152; SIZE + 0; STAT 0; :RES:APER
+ 1.666667E-002; OCOM 0; RANG + 1.638400E+ 004; RANG:AUTO
1; VOLT:APER + 1.666667E-002; RANG + 8.000000E+ 000; RANG:AUTO
1; :TRIG:COUN + 1; DEL + 0.00000000E+ 000; DEL:AUTO 1; :TRIG:SOUR
IMM; :SAMP:COUN + 1; SOUR IMM;TIM + 5.000000E-002 S
```

---

**NOTE**

The System Instrument no longer implements the \*LRN? command. Attempting to have the System Instrument execute this command will generate an error -113 "Undefined header".

---

- \* OPC** Operation Complete. Causes an instrument to set bit 0 (Operation Complete Message) in the Standard Event Status Register when all pending operations have been completed. By enabling this bit to be reflected in the Status Byte Register (\*ESE 1 command), you can ensure synchronization between the instrument and an external computer or between multiple instruments. (Refer to "Synchronizing an External Computer and Instruments" earlier in this chapter for an example).
- \* OPC?** Operation Complete Query. Causes an instrument to place an ASCII 1 into the instrument's output queue when all pending instrument operations are finished. By requiring the computer to read this response before continuing program execution, you can ensure synchronization between one or more instruments and the computer. (Refer to "Synchronizing an External Computer and Instruments" earlier in this chapter for an example).
- \* PMC** Purge Macros Command. Purges all currently defined macros in the selected instrument.
- \* PSC < flag>** Power-on Status Clear Command. Controls the automatic power-on clearing of the Service Request Enable register and Standard Event Status Enable register. Executing \*PSC 1 disables any previously enabled bits at power-on, preventing the System Instrument from requesting service when power is cycled. Executing \*PSC 0 causes any previously enabled bits to remain enabled at power-on which allows the System Instrument to request service (if it has been enabled - \*SRE) when power is cycled. The value of *flag* is stored in non-volatile memory.

**Example** This example configures the System Instrument to request service from the external computer whenever power is cycled.

```
Status Byte register and Standard Event Status register bits  
remain enabled (unmasked) after cycling power  
10 OUTPUT 70900;"* PSC 0"  
Enable bit 5 (Standard Event Status Register Summary Bit)  
in the Status Byte Register  
20 OUTPUT 70900;"* SRE 32"  
Enable bit 7 (Power-on bit) in the Standard Event Status  
Register to be reflected as bit 5 in the Status Byte Register  
30 OUTPUT 70900;"* ESE 128"
```

- \* PSC?** Power-on status clear query. Returns a response indicating whether an instrument's Status Byte Register and Standard Event Status Register bits remain enabled or become disabled at power-on. A "1" means the bits are disabled at power-on; a "0" means the bits remain enabled at power-on.

**\*RCL < state number>** Recall stored state. Recalls a stored state from memory and configures the instrument to that state. States are stored using the \*SAV command.

**Example**                    OUTPUT 70900;"\* RCL 4"                    *Recalls instrument state number 4*

**\*RMC < name\_string>** Remove Individual Macro Command. Purges an individual macro identified by the *name\_string* parameter.

**Example**                    output 70900;"\* RMC 'LIST'"                    *remove macro command from \*DMC example*

NOTE: At printing time, \*RMC is a command proposed for a revision and re-designation of ANSI/IEEE Std 488.2-1987.

**\*RST** Reset. Resets an instrument as follows:

- Sets the instrument to a known state (usually the power-on state)
- Aborts all pending operations
- Disables the \*OPC and \*OPC? modes.

\*RST does not affect:

- The state of the GPIB interface
- The GPIB address
- The output queue
- The Service Request Enable Register
- The Standard Event Status Enable Register
- The power-on flag
- Calibration data
- Protected user data

**\*SAV < state number>** Store state. Stores an instrument's present state in a numbered memory location (< state number> parameter). State numbers can range from 0 to 9.

**Example**                    OUTPUT 70900;"\* SAV 4"                    *Saves present instrument state as state number 4*

**\*SRE < mask>** Service Request Enable. When a service request event occurs, it sets a corresponding bit in the Status Byte Register (this happens whether or not the event has been enabled (unmasked) by \*SRE). The \*SRE command allows you to identify which of these events will assert an GPIB service request (SRQ). When an event is enabled by \*SRE and that event occurs, it sets a bit in the Status Byte Register and issues an SRQ to the computer (sets the GPIB SRQ line true). You enable an event by specifying its decimal weight for < mask> . To enable more than one event, specify the sum of the decimal weights. Refer to "The Status Byte Register" earlier in this chapter for a table showing the contents of the Status Byte Register.

**Example**                    OUTPUT 70900;"\* SRE 160"                    *Enables bits 5 & 7. Respective weights are 32 + 128 = 160*

**\*SRE?** Status Register Enable Query. Returns the weighted sum of all enabled (unmasked) events (those enabled to assert SRQ) in the Status Byte Register.

|                |                         |   |
|----------------|-------------------------|---|
| <b>Example</b> | 10 OUTPUT 70900;"*SRE?" | <i>Sends Status Register Enable query</i> |
|                | 20 ENTER 70900;A        | <i>Places response in variable</i>        |
|                | 30 PRINT A              | <i>Prints response</i>                    |
|                | 40 END                  |   |

**\*STB?** Status Byte Register Query. Returns the weighted sum of all set bits in the Status Byte Register. Refer to "The Status Byte Register" earlier in this chapter for a table showing the contents of the Status Byte Register.

**Comments** You can read the Status Byte Register using either the \*STB? command or an GPIB serial poll (IEEE 488.1 message). Both methods return the weighted sum of all set bits in the register. The difference between the two methods is that \*STB? does not clear bit 6 (Service Request); serial poll does clear bit 6. No other status byte register bits are cleared by either method with the exception of the Message Available bit (bit 4) which may be cleared as a result of reading the response to \*STB?.

|                |                         |   |
|----------------|-------------------------|---|
| <b>Example</b> | 10 OUTPUT 70900;"*STB?" | <i>Sends Status Byte Register query</i> |
|                | 20 ENTER 70900;A        | <i>Places response in variable</i>      |
|                | 30 PRINT A              | <i>Prints response</i>                  |
|                | 40 END                  |   |

**\*TRG** Trigger. Triggers an instrument when the trigger source is set to bus (TRIG:SOUR BUS command) and the instrument is in the Wait for Trigger state.

**\*TST?** Self-Test. Causes an instrument to execute an internal self-test and returns a response showing the results of the self-test. A zero response indicates that self-test passed. A value other than zero indicates a self-test failure or error.

|                |                         |  |
|----------------|-------------------------|--|
| <b>Example</b> | 10 OUTPUT 70900;"*TST?" | <i>Execute self-test, return response</i>    |
|                | 20 ENTER 70900;A        | <i>Places self-test response in variable</i> |
|                | 30 PRINT A              | <i>Prints response</i>                       |
|                | 40 END                  |  |

**\*WAI** Wait-to-continue. Prevents an instrument from executing another command until the operation caused by the previous command is finished (sequential operation). Since all instruments normally perform sequential operations, executing the \*WAI command causes no change to the instrument's operation.

---

## GPIB Message Reference

This section describes IEEE-488.1 defined messages and their affect on instruments installed in the mainframe. The examples shown are specifically for HP 9000 Series 200/300 computers using BASIC language. Any IEEE-488 controller can send these messages; however, the syntax may be different from that shown here.

### Go To Local (GTL)

Places an instrument in local state.

#### Comments

- Refer to the Local Lockout message, later in this chapter, for information on how GTL affects front panel lockout.

#### Examples

LOCAL 7

*Sets GPIB remote enable line false (all instruments go to local). (You must now execute REMOTE 7 to return to remote mode).*

LOCAL 70900

*Issues GPIB GTL to System Instrument. (The instrument will return to remote mode when it is listen addressed.)*

### Group Execute Trigger (GET)

Executing a group execute trigger will trigger an instrument assuming the following conditions are true:

- The instrument's trigger source is set to Bus (TRIG:SOUR BUS command), and:
- The instrument is in the Wait For Trigger state, and:
- The instrument is addressed to listen (can be done by sending any command, the REMOTE 709ss (ss = secondary address) command, or with the LISTEN command).

#### Comments

- For instruments in an Agilent E1300B/E1301B Mainframe, only one instrument at a time can be programmed to respond to GET. This is because only one instrument can be addressed to listen at any one time.

#### Example

```
10 OUTPUT 70900;"TRIG:SOUR BUS"  
20 OUTPUT 70900;"INIT:IMM"  
30 TRIGGER 70900  
40 END
```

*Sets trigger source to bus  
Places System Instrument's  
Pacer in Wait For Trigger state  
Triggers Pacer*

### Interface Clear (IFC)

Unaddresses all instruments in the mainframe and breaks any bus handshaking in progress.

#### Example

ABORT 7



## Device Clear (DCL) or Selected Device Clear (SDC)

DCL clears all instruments in the mainframe. SDC clears a specific instrument. The purpose of DCL or SDC is to prepare one or more instruments to receive and execute commands (usually \*RST). DCL or SDC do the following to each instrument:

- Clear the input buffer and output queue.
- Reset the command parser.
- Disable any operation that would prevent \*RST from being executed.
- Disable the Operation Complete and Operation Complete Query modes.

DCL or SDC do not affect:

- Any settings or stored data in the instrument (except the Operation Complete and Operation Complete Query modes)
- Front panel operation
- Any instrument operation in progress (except as stated above)
- The status byte (except for clearing the Message Available bit as a result of clearing the output queue).

### Examples

CLEAR 7

*Clears all instruments*

CLEAR 70900

*Clears the System Instrument*

## Local Lockout (LLO)

When an instrument is in remote mode, Local Lockout prevents an instrument from being operated from the mainframe's front panel.

### Comments

- Certain front panel operations such as menu control and display scrolling are still active in Local Lockout mode.
- If the instrument is in the local state when you send LOCAL LOCKOUT, it remains in local. If the instrument is in the remote state when you send LOCAL LOCKOUT, front panel control is disabled immediately for that instrument.
- After executing LOCAL LOCKOUT, you can enable the keyboard by sending the LOCAL 7 command or by cycling power. The LOCAL 709ss (ss = secondary address) command enables the front panel for that instrument but a subsequent remote command disables it. Sending the LOCAL 7 command removes lockout for all instruments and places them in the local state.

### Examples

10 REMOTE 70900

*Sets the System Instrument remote state*

20 LOCAL LOCKOUT 7

*Disables front panel control for the System Instrument and all other instruments that were in the remote state.*

30 END

**Remote** Sets the GPIB remote enable line (REN) true which places an instrument in the remote state.

- Comments**
- The REMOTE 709ss (ss = secondary address) command places the instrument in the remote state. The REMOTE 7 command, does not, by itself, place the instrument in the remote state. After sending the REMOTE 7 command, the instrument will only go into the remote state when it receives its listen address.
  - In most cases, you will only need the REMOTE command after using the LOCAL command. REMOTE is independent of any other GPIB activity and toggles a single bus line called REN. Most controllers set the REN line true when power is applied or when reset.

**Examples**

|              |   |
|--------------|---|
| REMOTE 7     | <i>Sets GPIB REN line true</i>                            |
| REMOTE 70900 | <i>Sets REN line true and addresses System Instrument</i> |

**Serial Poll (SPOLL)** The SPOLL command, like the \*STB? Common Command, returns the weighted sum of all set bits in an instrument's Status Register (status byte). Refer to "The Status Register" earlier in this chapter for a table showing the contents of the Status Register.

- Comments**
- The SPOLL command differs from the \*STB? command in that SPOLL clears bit 6 (RQS). Executing \*STB? does not clear bit 6.

**Examples**

|                     |  |
|---------------------|--|
| 10 P= SPOLL (70900) | <i>Sends Serial Poll, places response into P</i> |
| 20 DISP P           | <i>Displays response</i>                         |
| 30 END              |  |

## Command Quick Reference

The following tables summarize SCPI and IEEE 488.2 Common (\*) commands for the Agilent E1300/E1031 Mainframe System Instrument.

| SCPI Commands Quick Reference              |  |
|--|--|
| Command                                    | Description  |
| ABORt<br>[IMMediate]                       | Abort Pacer output.  |
| DIAGnostic                                 |  |
| :BOOt                                      |  |
| :COLD                                      | Restarts System processor, clears stored configurations.   |
| [:WARM]                                    | Same as cycling power.   |
| :COMMunicate                               |  |
| :SERial[0]                                 |  |
| [:OWNer] [SYSTem  IBASic  NONE]            | Allocates the built-in serial interface.   |
| [:OWNer]?                                  | Returns SYST, IBAS, or NONE.   |
| :SERial[n]                                 |  |
| :STORe                                     | Stores serial communication parameters into non-volatile storage.  |
| :DOWNload                                  |  |
| :CHECKed                                   |  |
| [:MADDress]                                | Write data to non-volatile user RAM starting at the specified address using error correction.                                      |
| :SADDress                                  | Write data to non-volatile user RAM at the specified address using error correction.   |
| [:MADDress] < address> , < data>           | Write data to non-volatile user RAM starting at the specified address.   |
| :SADDress < address> , < data>             | Write data to non-volatile user RAM at the specified address.  |
| :DRAM                                      |  |
| :AVAIlable?                                | Returns the amount of RAM remaining in the DRAM (Driver RAM) segment.  |
| :CREate < size> ,< num_drivers>            | Creates a non-volatile RAM area for loading instrument drivers.  |
| :DRIVER                                    |  |
| :LOAD < driver_block>                      | Loads the instrument driver contained in the specified driver_block into a previously created DRAM segment.                        |
| :LOAD                                      |  |
| :CHECKed                                   | Loads the instrument driver contained in the specified driver_block into a previously created DRAM segment using error correction. |
| :LIST                                      |  |
| [:ALL]                                     | Lists all drivers from all driver tables (RAM and ROM)   |
| :RAM                                       | Lists all drivers found in the RAM driver table.   |
| :ROM                                       | Lists all drivers found in the ROM driver table.   |
| :INTerrupt                                 |  |
| :ACTivate [ON  OFF  1  0]                  | Enable VXIbus interrupt acknowledgement.   |
| :SETup[n] [ON  OFF  0  1]                  | Enables or disables System Instrument control of VXI interrupt line [n].   |
| :SETup[n]?                                 | Returns current state of SETup[n].   |
| :PRIority[n] [< priority>   MIN  MAX  DEF] | Specifies the priority level of VXI interrupt line [n].  |
| :PRIority[n]? [MIN  MAX  DEF]              | Returns priority level of VXI interrupt line [n].  |
| :RESPonse?                                 | Returns response from the highest priority interrupt line.   |

## System Instrument

| SCPI Commands Quick Reference  |  |
|--|--|
| Command  | Description  |
| :NRAM<br>:ADDRESS?<br>:CREate < size>   MIN  MAX<br>:CREate? [MIN  MAX]<br>:PEEK? < address>   MIN  MAX,< width><br>:POKE < address>   MIN  MAX,< width> ,< data><br>:RDISK<br>:ADDRESS?<br>:CREate < size>   MIN  MAX<br>:CREate? [MIN  MAX]<br>:UPLoad<br>[:MADDRESS]? < address> ,< byte_count><br>:SADDRESS? < address> ,< byte_count> | Returns starting address of the User non-volatile RAM.<br>Creates a User non-volatile RAM segment.<br>Returns the current or allowable size of User NVRAM.<br>Returns an 8, 16, or 32 bit value from memory.<br>Stores an 8, 16, or 32 bit value to RAM.<br>Returns the starting address of an IBASIC RAM volume.<br>Allocates RAM for an IBASIC RAM volume.<br>Returns the current or allowable size of the RAM vol.<br>Returns data from non-volatile user RAM starting at address.<br>Returns data from non-volatile user RAM at address. |
| INITiate<br>[:Immediate]   | Enables trigger system to start Pacer.   |
| [SOURCE]<br>:PULSE<br>COUNT < numeric value><br>COUNT? [MIN  MAX]<br>:PERiod < numeric value<br>:PERiod? [MIN\ MAX]  | Sets number of Pacer pulses per trigger.<br>Returns current count, or MIN  MAX allowed value.<br>Sets Pacer pulse period in seconds.<br>Returns the current or allowable period value.   |
| STATus<br>:OPERation<br>:CONDition?<br>:ENABle 256<br>:ENABle?<br>[:EVENT]?<br>:PRESet<br>:QUEStionable<br>:CONDition?<br>:ENABle < mask><br>:ENABle?<br>[:EVENT]?   | Returns the state of the condition register.<br>Set Standard Operation Enable Register mask.<br>Returns value of enable mask.<br>Returns value of the bit set in the Event register (Standard Operation Status Group).<br>Presets status registers<br>Always returns + 0.<br>Set Questionable Status Register enable mask.<br>Returns value of enable mask.<br>Always returns + 0.   |

| SCPI Commands Quick Reference  |   |
|--|---|
| Command  | Description   |
| SYSTEM<br>:BEEPer<br>[:IMMediate]<br>:COMMunicate<br>:GPIB<br>:ADDRESS<br>:ADDRESS?<br>:SERial[n]<br>:CONTRol<br>:DTR ON  OFF  STANdard  IBFull<br>:DTR?<br>:RTS ON  OFF  STANdard  IBFull<br>:RTS?<br>[:RECeive]<br>:BAUD < baud_rate>   MIN  MAX<br>:BAUD? [MIN  MAX]<br>:BITS 7  8  MIN  MAX<br>:BITS? [MIN  MAX]<br>:PACE<br>[:PROTocol] XON  NONE<br>[:PROTocol]?<br>:THReshold<br>:START < char_count><br>:START? [MIN  MAX]<br>:STOP < char_count><br>:STOP? [MIN  MAX]<br>:PARity<br>:CHECK 1  0  ON  OFF<br>:CHECK?<br>[:TYPE] EVEN  ODD  ZERO <br>ONE  NONE<br>[:TYPE]?<br>:SBITs 1  2  MIN  MAX<br>:SBITs? MIN  MAX<br>:TRANsmit<br>:AUTO 1  0  ON  OFF<br>:AUTO?<br>:PACE<br>[:PROTocol] XON  NONE<br>[:PROTocol]?<br>:DATE < year> ,< month> ,< day><br>:DATE? [MIN  MAX,MIN  MAX,MIN  MAX]<br>:ERRor?<br>:TIME < hour> ,< minute> ,< second><br>:TIME? [MIN  MAX,MIN  MAX,MIN  MAX]<br>:VERSion? | Sound beeper (fixed duration and tone).<br><br>Sets the primary address of the communications port.<br>Returns GPIB address or min  max allowed value.<br><br>Sets mode for modem control line DTR.<br>Returns current mode of DTR line.<br>Sets mode for modem control line RTS.<br>Returns current mode of RTS line.<br><br>Sets transmit and receive baud rate of serial interface.<br>Returns the current or allowable baud setting.<br>Sets the number of data bits in the serial data frame.<br>Returns the current or allowable BITS setting.<br><br>Sets the receive pacing protocol to XON/XOFF or none.<br>Returns the state of receive pacing protocol.<br><br>Sets the input buffer start threshold for input pacing.<br>Returns current or allowable START threshold level.<br>Sets the input buffer stop threshold for input pacing.<br>Returns the current or allowable STOP threshold level.<br><br>Enables/disables receive parity checking.<br>Returns the current state of receive parity checking.<br>Sets the type of receive and transmit parity.<br><br>Returns the current parity type setting.<br>Sets the number of stop bits for receive and transmit.<br>Returns the number of stop bits set.<br>Note: Agilent E1324A is always ...TRAN:AUTO ON<br>Links/unlinks the transmit and receive pacing protocol.<br>Returns the current transmit/receive pacing linkage.<br><br>Sets the transmit pacing protocol to XON/XOFF or none.<br>Returns the state of transmit pacing protocol.<br><br>Sets system calendar.<br>Returns current date or min  max allowable values.<br>Returns oldest error message in Error Queue.<br>Sets the system clock.<br>Returns current time or min  max allowable values.<br>Returns SCPI version for which this instrument complies. |

## System Instrument

| SCPI Commands Quick Reference   |   |
|---|---|
| Command   | Description   |
| TRIGger<br>:DELay < numeric value><br>:DELAy? [MIN  MAX]<br>[:IMMediate]<br>:SLOPe [NEGATIVE]<br>:SLOPe?<br>:SOURce EXTernal  IMMEDIATE  BUS  HOLD<br>:SOURce?  | Sets delay between trigger and first Pacer pulse.<br>Returns current trigger delay or MIN  MAX allowable value.<br>Sets trigger source for timer/pacer.<br>For compatibility only. Accepts only NEGATIVE.<br>Returns the string NEG.<br>Trigger source is GET or *TRIG.<br>Returns current trigger source.  |
| VXI<br>:CONFigure<br>:DeviceLADd?<br>:DeviceLIST?<br>:DeviceNUMber?<br>:INformation<br>:ALL?<br>:HIERarchy<br>:ALL?<br>:NUMber?<br>:LADDRESS?<br>:READ? < logical_addr> ,< register_num><br>:REGister<br>:READ? < numeric_value  < reg_name><br>:WRITE < numeric_value  < reg_name> ,< data><br>:RESet?<br>:SElect < numeric_value><br>:WRITE < logical_addr> ,< register_num> ,< data> | Returns a list of the logical addresses in the system.<br>Returns information about one or all installed devices.<br>Returns the number of installed devices.<br>Gets the static information about the selected logical address (see VXI:SElect).<br>Gets the static information about all logical addresses.<br>Gets the current hierarchy configuration data for the selected logical address (see VXI:SElect).<br>Gets the current hierarchy configuration data for all logical addresses.<br>Gets the number of devices in the system when issued to a Resource Manager.<br>Gets a comma separated list of all logical addresses of devices in the system when issued to a Resource Manager.<br>Read the contents of the device register at register_num.<br>Returns the contents of the specified 16 bit register at the selected logical address (see VXI:SElect).<br>Writes to the specified 16 bit register at the selected logical address (see VXI:SElect).<br>Resets the device at the selected logical address (see VXI:SElect).<br>Specifies the logical address to be used by all subsequent commands in the VXI subsystem.<br>Write data to the device register at logical_addr. |

| IEEE 488.2 Comman Commands Quick Reference |                           |   |
|--|---------------------------|---|
| Category                                   | Command                   | Title   |
| <b>General</b>                             | *IDN?                     | Identification Query                          |
|  | *RST                      | Reset Command                                 |
|  | *TST?                     | Self Test Query                               |
| <b>Instrument Status</b>                   | *CLS                      | Clear Status Command                          |
|  | *ESE < mask>              | Standard Event Status Enable Register Command |
|  | *ESE?                     | Standard Event Status Enable Query            |
|  | *ESR?                     | Standard Event Status Register Query          |
|  | *PSC < flag>              | Power-on Status Clear Command                 |
|  | *PSC?                     | Power-on Status Clear Query                   |
|  | *SRE < mask>              | Service Request Enable Command                |
|  | *SRE?                     | Service Request Enable Query                  |
|  | *STB?                     | Status Byte Register Query                    |
| <b>Macros</b>                              | *DMC < name> ,< cmd_data> | Define Macro Command                          |
|  | *EMC < enable>            | Enable Macro Command                          |
|  | *EMC?                     | Enable Macro Query                            |
|  | *GMC? < name>             | Get Macro Query                               |
|  | *LMC?                     | Learn Macro Query                             |
|  | *PMC                      | Purge all Macros Command                      |
|  | *RMC < name>              | Remove individual Macro Command               |
| <b>Synchronization</b>                     | *OPC                      | Operation Complete Command                    |
|  | *OPC?                     | Operation Complete Query                      |
|  | *WAI                      | Wait-to-Continue Command                      |





## Specifications

---

### Mainframe Specifications

**Pacer (50% duty cycle):** Programmable intervals: 500 nsec to 8.389 sec with 500 nsec resolution.  
 Accuracy:  
     First pulse after trigger: 0.01% of programmed time + 600 to 850 nsec.  
     Additional pulses: 0.01% of programmed time  $\pm$  50 nsec.  
 Number of pulses: 1 through 8388607 or continuous.  
 Drive capability:  
      $V_{LO} \leq 0.75 \text{ V @ } 4 \text{ mA}$   
      $V_{HI} \geq 3.4 \text{ V @ } -4 \text{ mA}$   
 Rise Time/Fall Time: 320 nsec/90 nsec.

**Real-time Clock:** Accuracy: 0.01% of elapsed time since last sset  $\pm$  1 sec @ 25° C.  
 Temperature variation:  $\pm$  0.01% of elapsed time since last set, over full temperature range.  
 Resolution: 1 sec.  
 Non-volatile lifetime: 60 days without additional RAM.  
 Battery life: 1 year typical, NiCd battery.

**Trigger Input:** TTL compatible, minimum pulse width 300 nsec.

**Non-volatile added memory storage lifetime:** Non-volatile added storage is backed up by NiCd battery. The table below shows minimum and typical lifetimes, which vary according to the amount of memory installed.

| RAM (MBytes) | MIN Lifetime (hours) | Typical lifetime (days) |
|--------------|----------------------|-------------------------|
| 0.5          | 240                  | 320                     |
| 1.0          | 130                  | 180                     |
| 1.5          | 90                   | 120                     |
| 2.0          | 72                   | 90                      |

**Slots:** 7 B-size and 3 A-size

**EMC, RFI, Safety:** See Declaration of Conformity.

**Size:**

|                            | inches | mm  |
|----------------------------|--------|-----|
| Height without feet        | 6.97   | 177 |
| Height with feet           | 7.44   | 189 |
| Width                      | 16.75  | 426 |
| Depth                      | 20.1   | 510 |
| Depth with terminal blocks | 22.38  | 569 |

**Weight:**

|                 | E1300B | E1301B |
|-----------------|--------|--------|
| Net             | 7.4 kg | 7.8 kg |
| Max per modules | 1.3 kg | 1.3 kg |

**Power:** Line voltage: 115 or 230 Vac @ 50 to 400 Hz  
 Fused at: 3 A @ 115 Vac  
 1.5 A @ 230 Vac  
 Consumption: E 1300B (empty) 27 W, 52 VA  
 E 1301B (empty) 31 W, 57 VA

Any combination of Agilent Series B modules can be powered and cooled by the Agilent 75000 Series B mainframe. Configuration using non-Agilent modules (e.g., VME modules) should be checked to assure the power consumption does not exceed 12.25 A on + 5 V, 4.65 A on + 12 V, and 0.95 A on -12 V supplies. The Agilent 75000 Series B mainframe will provide ample cooling for configurations that stay within these limits.

**Cooling:** 25 Watts / Slot (with 10° rise in temperature)

**Note:** Agilent Series B mainframes provide VXIbus connector P1. Modules may not be masters.

**Humidity:** 65% 0° to 40° C

**Operating temperature:** 0° to 55° C

**Storage temperature:** -40° to 75° C

**Battery:** The internal battery consists of a 6.3V NiCd battery pack.

**Altitude:** The instrument may be operated at a maximum altitude of 3000 meters.

**Installation Category:** 2

## SCPI Conformance Information

The Agilent E 1300/1301B conforms to SCPI-1990.0

In documentation produced prior to June 1990, these SCPI commands are labeled as TMSL commands.

The following tables list all the SCPI conforming, approved, and non-SCPI commands that the E 1300/1301B can execute. Individual commands may not execute without having the proper plug-in module installed in the E 1300/13301B. Each plug-in module manual describes the commands that apply to that module.

### Switchbox Configuration

The following Agilent plug-in modules can be configured as switchbox modules. Refer to the individual plug-in User's Manual for configuration information.

|         |         |         |
|---------|---------|---------|
| E 1345A | E 1353A | E 1366A |
| E 1346A | E 1357A | E 1367A |
| E 1347A | E 1358A | E 1368A |
| E 1351A | E 1361A | E 1369A |
| E 1352A | E 1364A | E 1370A |

**Table A-1. Switchbox SCPI-1990.0 Confirmed Commands**

|              |               |
|--------------|---------------|
| ABORt        | STATus        |
|              | :QUEStionable |
| ARM          | :CONDition?   |
| :COUNt       | [:EVENt]?     |
|              | :ENABle       |
| INITiate     | :ENABle?      |
| [:IMMediate] | :OPERation    |
| :CONTinuous  | :CONDition?   |
|              | [:EVENt]?     |
| OUTPut       | :ENABle       |
| :ECLTrg      | :ENABle?      |
| [:STATe]     | :PRESet       |
| :TTLTrg      |               |
| [:STATe]     | SYSTem        |
|              | :ERRor?       |
| [ROUTe]      | :CPON         |
| :OPEN        | :CTYPe?       |
| :OPEN?       | :VERSion?     |
| :CLOSe       |               |
| :CLOSe?      | TRIGger       |
| :SCAN        | [:IMMediate]  |
|              | :SOURce       |
|              | :SLOPe        |

**Table A-2. Switchbox Non-SCPI Commands**

|                |           |
|----------------|-----------|
| DISPlay        | [ROUTe]   |
| :MONitor       | :SCAN     |
| [:STATe]       | [:LIST]   |
| :CARD          | :MODE     |
|                | :PORT     |
| SYSTem         | :SETTling |
| :CDEscription? | [:TIME]   |
|                | :TIME?    |

## Multimeter Commands

The following tables apply to the Agilent E 1326A and E 1326B.

**Table A-3. Multimeter SCPI-1990.0 Confirmed Commands**

|               |               |
|---------------|---------------|
| ABORt         | [SENSe]       |
| CALibration   | :FUNctIon     |
| :ZERO         | :FUNctIon?    |
| :AUTO         | :RESistance   |
| :AUTO?        | :APERture     |
| :VALue        | :APERture?    |
|               | :RANGe        |
|               | :AUTO         |
| CONFigure     | :AUTO?        |
| :FREStance    | :RANGe?       |
| :RESistance   | :RESolution   |
| :TEMPerature  | :RESolution?  |
| :VOLtage      | :VOLtage      |
| :AC           | :AC           |
| [:DC]         | :RANGe        |
|               | :RANGe?       |
| CONFigure?    | [:DC]         |
|               | :RANGe        |
| FETCh?        | :AUTO         |
|               | :AUTO?        |
| FORMat        | :RANGe?       |
| [:DATA]       | :RESolution   |
|               | :RESolution?  |
| INITiate      |               |
| [:IMMediate]  | STATus        |
|               | :QUEStionable |
| MEASure       | :CONDition?   |
| :FREStance?   | [:EVENT]?     |
| :RESistance?  | :ENABle       |
| :TEMPerature? | :ENABle?      |
| :VOLtage      | :OPERation    |
| :AC?          | CONDition?    |
| [:DC]?        | [:EVENT]?     |
|               | :ENABle       |
| READ?         | :ENABle?      |
|               | :PREset       |
|               |               |
|               | SYSTem        |
|               | :ERRor?       |
|               | :CTYPe?       |
|               | :VERsion?     |
|               |               |
|               | TRIGger       |
|               | :COUNT        |
|               | :COUNT?       |
|               | :DELay?       |
|               | :AUTO         |
|               | :AUTO?        |
|               | :DELay?       |
|               | [:IMMediate]  |
|               | :SOURce       |
|               | :SOURce?      |

**Table A-4. Multimeter SCPI Approved (not confirmed) Commands**

|             |
|-------------|
| [SENSe]     |
| :RESistance |
| :NPLC       |
| :NPLC?      |
| :VOLtage    |
| :NPLC       |
| :NPLC?      |

**Table A-5. Multimeter Non-SCPI Commands**

|                |                |
|----------------|----------------|
| CALibration    | MEMory         |
| :LFRequency    | :VME           |
| :LFRequency?   | :ADDRess       |
| :STRain        | :ADDRess?      |
| CONFigure      | :SIZE          |
| :STRain        | :SIZE?         |
| :QUARter       | :STATe         |
| :HBENding      | :STATe?        |
| :HPOisson      | [ROUTe]        |
| :FBENding      | :FUNCTion      |
| :FPOisson      | SAMPle         |
| :FBPoisson     | :COUNT         |
| :QTENsion      | :COUNT?        |
| :QCOMpression  | :SOURce        |
| :UNSTrained    | :SOURce?       |
| DISPlay        | :TIMer         |
| :MONitor       | :TIMer?        |
| :CHANnel       | [SENSe]        |
| :CHANnel?      | :RESsitance    |
| [:STATe]       | :OCOMpensated  |
| [:STATe]?      | :OCOMpensated? |
| MEASure        | :STRain        |
| :STRain        | :GFACTor       |
| :QUARter?      | :POISSon       |
| :HBENding?     | :UNSTrained    |
| :HPOisson?     | SYSTem         |
| :FBENding?     | :CDEscription  |
| :FPOisson?     |                |
| :FBPoisson?    |                |
| :QTENsion?     |                |
| :QCOMpression? |                |
| :UNSTrained?   |                |

## Counter Commands

The following tables apply to the Agilent E1332A 4 Channel Counter/Totalizer and the Agilent E1333A 3 Channel Universal Counter.

**Table A-6. Agilent E1332A SCPI-1990.0 Confirmed Commands**

|              |               |
|--------------|---------------|
| ABORt        | READ?         |
| CONFigure    | [SENSe]       |
| :FREQuency   | :FUNcTION     |
| :PERiod      | :FREQuency    |
| :PWIDth      | :PERiod       |
| :NWIDth      | :FREQuency    |
| CONFigure?   | :APERture     |
|              | :APERture?    |
| FETCh?       | STATus        |
| FORMat       | :QUEStionable |
| [:DATA]      | [:EVENT]?     |
|              | :CONDition?   |
| INITiate     | :ENABle       |
| [:IMMEDIATE] | :ENABle?      |
|              | :OPERation    |
| INPut        | [:EVENT]?     |
| :FILTer      | :CONDition?   |
| [:LPASS]     | :ENABle       |
| [:STATe]     | :ENABle?      |
| [:STATe]?    | :PREset       |
| :FREQuency   | SYSTEM        |
| :FREQuency?  | :ERRor?       |
|              | :VERSion?     |
| MEASure      | TRIGger       |
| :FREQuency?  | [:IMMEDIATE]  |
| :PERiod?     | :SOURCe       |
| :PWIDth?     | :SOURCe?      |
| :NWIDth      |               |

**Table A-7. Agilent E1332A Non-SCPI Commands**

|                      |                      |
|----------------------|----------------------|
| CONF[< channel> ]    | [SENSe[< channel> ]] |
| :TOTalize            | :PERiod              |
| :TINTerval           | :NPERiods            |
| :UDCount             | :NPERiods?           |
| DISPlay              | :TOTalize            |
| :MONitor             | :GATE                |
| :CHANnel             | [:STATe]             |
| :CHANnel?            | [:STATe]?            |
| [:STATe]             | :POLarity            |
| [:STATe]?            | :POLarity?           |
| INPut                | :EVENT               |
| :ISOLate             | :LEVel               |
| :ISOLate?            | :LEVel?              |
|                      | :SLOPe               |
|                      | :SLOPe?              |
| MEASure[< channel> ] |                      |
| :TINTerval?>         |                      |

**Table A-8. Agilent E1333A SCPI-1990.0 Confirmed Commands**

|                |                |
|----------------|----------------|
| ABORt          | READ?          |
| FETCh?         | [SENSe]        |
| CONFigure      | :FUNction      |
| :FREQuency     | :FREQuency     |
| :PERiod        | :PERiod        |
| :PWIDth        | :FREQuency     |
| :NWIDth        | :APERture      |
|                | :APERture?     |
| CONFigure?     | STATUs         |
| FORMat         | :QUEStionable  |
| [ :DATA ]      | :[EVENT]?      |
|                | :CONDition?    |
|                | :ENABle        |
| INITiate       | :ENABle?       |
| [ :IMMediate ] | :OPERation     |
|                | :[EVENT]?      |
| INPut          | :CONDition?    |
| :ATTenuation   | :ENABle        |
| :ATTenuation?  | :ENABle?       |
| :COUPling      | :PREset        |
| :COUPling?     |                |
| :FILTer        | SYSTem         |
| [ :LPASs ]     | :ERRor?        |
| [ :STATe ]     | :VERsion?      |
| [ :STATe ]?    |                |
| :IMPedance     | TRIGger        |
| :IMPedance?    | [ :IMMediate ] |
|                | :SOURCe        |
| MEASure        | :SOURCe?       |
| :FREQuency?    |                |
| :PERiod?       |                |
| :PWIDth?       |                |
| :NWIDth?       |                |

**Table A-9. Agilent E1333A Non-SCPI Commands**

|                      |                      |
|----------------------|----------------------|
| CONF[< channel> ]    | [SENSe[< channel> ]] |
| :TOTalize            | :PERiod              |
| :TINTerval           | :NPERiods            |
| :RATio               | :NPERiods?           |
|                      | :RATio               |
| DISPlay              | :NPERiods            |
| :MONitor             | :NPERiods?           |
| :CHANnel             | :TINTerval           |
| :CHANnel?            | :NPERiods            |
| [ :STATe ]           | :NPERiods?           |
| [ :STATe ]?          | :EVENT               |
|                      | :LEVel               |
| MEASure[< channel> ] | :LEVel?              |
| :TINTerval?          | :SLOPe               |
| :RATio?              | :SLOPe?              |

## D/A Converter Commands

The following tables apply to the Agilent E1328A 4 Channel D/A Converter.

**Table A-10. Agilent E1328A SCPI-1990.0 Confirmed Commands**

|             |               |
|-------------|---------------|
| CALibration | STATus        |
| :STATe      | :QUEStionable |
| :STATe?     | :CONDition?   |
|             | [:EVENT]?     |
| SYSTem      | :ENABle       |
| :ERRor?     | :ENABle?      |
| :VERSiOn?   | :OPERation    |
|             | :CONDition?   |
|             | [:EVENT]?     |
|             | :ENABle       |
|             | :ENABle?      |

**Table A-11. Agilent E1328A Non-SCPI Commands**

|             |                       |
|-------------|-----------------------|
| CALibration | SOURce                |
| :VOLTagE    | :VOLTagE< channel>    |
| :CURRent    | :VOLTagE< channel> ?  |
|             | :CURRent< channel>    |
| DISPlay     | :CURRent< channel> ?  |
| :MONitor    | :FUNCTion< channel> ? |
| :CHANnel    |                       |
| :CHANnel?   |                       |
| [:STATe]    |                       |
| :STRing?    |                       |



## Digital I/O Commands

The following tables apply to the Agilent E1330A Quad 8-bit Digital I/O Module.

**Table A-12. Agilent E1330A SCPI-1990.0 Confirmed Commands**

|               |           |
|---------------|-----------|
| STATus        | SYSTem    |
| :QUEStionable | :ERRor?   |
| :CONDition?   | :VERsion? |
| [:EVENT]?     |           |
| :ENABle       |           |
| :ENABle?      |           |
| :OPERation    |           |
| :CONDition?   |           |
| [:EVENT]?     |           |
| :ENABle       |           |
| :ENABle?      |           |
| :PREset       |           |

**Table A-13. Agilent E1330A Non-SCPI Commands**

|                 |                   |
|-----------------|-------------------|
| DISPlay         | [SOURce]          |
| :MONitor        | :DIGital          |
| [:STATe]        | :TRACe            |
| :PORT           | :CATalog          |
| :PORT?          | [:DATA]           |
| :STRing?        | [:DATA]?          |
|                 | :DEFine           |
| MEASure         | :DELete           |
| :DIGital        | :CONTrol< port>   |
| :DATA< port> ?  | :POLarity         |
| :BIT< number> ? | :POLarity?        |
| :BLOCK?         | [:VALue]          |
| :FLAG< port> ?  | :DATA< port>      |
|                 | [:VALue]          |
| MEMory          | :BIT< number>     |
| :DELete         | :TRACe            |
| MACRO           | :HANDshake        |
| :VME            | :DELay            |
| :ADDRESS        | [:MODE]           |
| :ADDRESS?       | [:MODE]?          |
| :SIZE           | :POLarity         |
| :SIZE?          | :POLarity?        |
| :STATe          | :FLAG< port>      |
| :STATe?         | :POLarity         |
|                 | :POLarity?        |
|                 | :HANDshake< port> |
|                 | :DELay            |
|                 | [:MODE]           |
|                 | [:MODE]?          |

## System Instrument Commands

**Table A-14. System Instrument SCPI-1990.0 Confirmed Commands**

|               |              |
|---------------|--------------|
| ABORt         | SYSTem       |
| INITiate      | :BEEPer      |
| [:IMMediate]  | [:IMMediate] |
| [SOURce]      | :COMMunicate |
| :PULSe        | :GPIB        |
| :COUNT        | :ADdRes      |
| :COUNT?       | :ADdRes?     |
| :PERiod       | :SERial      |
| :PERiod?      | [:RECeive]   |
| STATus        | :BAUD        |
| :QUEStionable | :BAUD?       |
| :CONDition?   | :BITS        |
| [:EVENT?]     | :BITS?       |
| :ENABle       | :PARity      |
| :ENABle?      | [:TYPE]      |
| :OPERation    | :CHECK       |
| :CONDition?   | :CHECK?      |
| [:EVENT?]     | :SBITS       |
| :ENABle       | :SBITS?      |
| :ENABle?      | :TRANsmit    |
| :PREset       | :AUTO        |
| TRIGger       | :AUTO?       |
| [:IMMediate]  | :ERRor?      |
| :SOURce       | :TIME        |
| :SOURce?      | :TIME?       |
| :SLOPe        | :DATE        |
| :SLOPe?       | :DATE?       |
|               | :VERsion?    |
|               | VXI          |
|               | :CONFigure   |
|               | :DNUMBer?    |

**Table A-15. System Instrument SCPI-1991.0 Confirmed Commands**

|              |              |
|--------------|--------------|
| SYSTem       | SYSTem       |
| :COMMunicate | :COMMunicate |
| :SERial      | :SERial      |
| [:RECeive]   | :TRANsmit    |
| :PACE        | :PACE        |
| [:PROTOcol]  | [:PROTOcol]  |
| [:PROTOcol]? | [:PROTOcol]? |
| :THReshold   | :CONTRol     |
| :STARt       | :RTS         |
| :STARt?      | :RTS?        |
| :STOP        | :DTR         |
| :STOP?       | :DTR?        |

**Table A-16. System Instrument SCPI-1992.0 Approved Commands**

|              |
|--------------|
| VXI          |
| :SElect      |
| :CONFigure   |
| :INFormation |
| :ALL         |
| :HEIRarchy   |
| :ALL         |
| :LADdRes?    |
| :NUMBer?     |
| :REGister    |
| :READ?       |
| :WRITe       |
| :RESet?      |

**Table A-17. System Instrument Non-SCPI Commands**

|               |                |
|---------------|----------------|
| DIAGnostic    | MEMory         |
| :AUTstart     | :DELete        |
| :AUTostart?   | :MACRo         |
| :CHEcksum     |                |
| :COMMunicate  | TRIGger        |
| :SERial       | :DELay         |
| [:OWNer]      | [:MINimum]     |
| [:OWNer]?     | [:MINimum]?    |
| :BOOT         | VXI            |
| :COLD         | :CONFigure     |
| [:WARM]       | :DLADdress?    |
| :UPLoad?      | :DEVICELADd?   |
| :DOWNload     | :DLIST?        |
| :INTerrupt    | :DEVICELISt?   |
| :ACT          | :DEVICENUMber? |
| :SETup(n)     | :READ?         |
| :SETup(n)?    | :WRITe         |
| :PRIority(n)  |                |
| :PRIority(n)? |                |
| :WAIT?        |                |
| :JSR          |                |
| :CALL         |                |
| :DRIVer       |                |
| :LOAD         |                |
| :LIST?        |                |
| :DRAM         |                |
| :CREate       |                |
| :CREate?      |                |
| :AVAIlable?   |                |
| :NRAM         |                |
| :CREate       |                |
| :CREate?      |                |
| :AVAIlable?   |                |
| :RDISK        |                |
| :CREate       |                |
| :CREate?      |                |
| :ADDRes?      |                |
| :PEEK         |                |
| :POKE         |                |

**Table A-18. Common Commands SCPI-1990.0 Confirmed**

|       |       |
|-------|-------|
| *IDN  | *RCL  |
| *RST  | *SAV  |
| *TST  | *TRG  |
| *CLS  | *DMC  |
| *ESE  | *GMC? |
| *ESE? | *PMC  |
| *ESR  | *LMC? |
| *SRE  | *EMC  |
| *SRE? | *EMC? |
| *STB  | *OPC  |
| *PSC  | *OPC? |
| *PSC? | *WAI  |



## Error Messages

---

### Using This Appendix

This appendix shows how to read an instrument's error queue, discusses the types of command language-related error messages, and provides a table of all of the System Instrument's error messages and their probable causes.

- Reading an Instrument's Error Queue ..... B-1
- Error Types ..... B-2
- Start-up Error Messages ..... B-5

---

### Reading an Instrument's Error Queue

Executing the SYST:ERR? command reads the oldest error message from the instrument's error queue and erases that error from the error queue. The SYST:ERR? command returns response data in the form:

`< error number> , '< error description string> '!`

Example error message; `-113,'Undefined header'`

Positive error numbers are specific to an instrument. Negative error numbers are command language-related and discussed in the next section "Error Messages". Command language-related errors also set a corresponding bit in the Standard Event Status Register (refer to "Instrument Status" in Chapter 4 for more information).

### Example: Reading the Error Queue

This program reads all errors (one error at a time, oldest to newest) from the System Instrument's error queue. After reading each error, that error is automatically erased from the queue. When the error queue is empty, this program returns: `+ 0,"No error"`.

```
10 OPTION BASE 1
20 DIM Message$(256)           Create array for error message
30 REPEAT                     Repeat next 3 lines until error
                               number = 0
40  OUTPUT 70900;"SYST:ERR?"   Read error number & message
50  ENTER 70900;Code,Message$ Enter error number & message
60  PRINT Code,Message$       Print error number & message
70  UNTIL Code= 0
80 END
```

---

## Error Types

Negative error numbers are language-related and categorized as shown below. Positive error numbers are instrument specific and for the System Instrument are summarized in Table B-2. For other instruments, refer to their own user's manual for a description of error messages.

**Table B-1. Negative Error Numbers**

| Error Number | Error Type             |
|--------------|------------------------|
| -199 to -100 | Command Errors         |
| -299 to -200 | Execution Errors       |
| -399 to -300 | Device-Specific Errors |
| -499 to -400 | Query Errors           |

### Command Errors

A command error means the instrument cannot understand or execute the command. When a command error occurs, it sets the Command Error Bit (bit 5) in the Event Status Register. Command errors can be caused by:

- A syntax error was detected in a received command or message. Possible errors include a data element which violates the instrument's listening formats or is of the wrong type (binary, numeric, etc.) for the instrument.
- An unrecognizable command header was received. Unrecognizable headers include incorrect SCPI headers and incorrect or unimplemented Common Commands.
- A Group Execute Trigger (GET) was entered into the input buffer inside of a Common Command.

### Execution Errors

An execution error indicates the instrument is incapable of doing the action or operation requested by a command. When an execution error occurs, it sets the Execution Error Bit (bit 4) in the Event Status Register. Execution errors can be caused by the following:

- A parameter within a command is outside the limits or inconsistent with the capabilities of an instrument.
- A valid command could not be executed because of an instrument failure or other condition.

### Device-Specific Errors

A device-specific error indicates an instrument operation did not complete, possibly due to an abnormal hardware or firmware condition (self-test failure, loss of calibration or configuration memory, etc.). When a device-specific error occurs, it sets the Device-Specific Error Bit (bit 3) in the Event Status Register.

### Query Errors

A query error indicates a problem has occurred in the instrument's output queue. When a query error occurs, it sets the Query Error Bit (bit 2) in the Event Status Register. Query errors can be caused by the following:

- An attempt was made to read the instrument's output queue when no output was present or pending.
- Data in the instrument's output queue has been lost for some reason.

**Table B-2. Error Messages and Causes**

| <b>Error Messages and Causes</b> |   |  |
|----------------------------------|---|--|
| <b>Code</b>                      | <b>Message</b>                            | <b>Cause</b>   |
| -101                             | Invalid character                         | Unrecognized character in specified parameter.   |
| - 102                            | Syntax error                              | Command is missing a space or comma between parameters   |
| - 103                            | Invalid separator                         | Command parameter is separated by some character other than a comma.   |
| - 104                            | Data type error                           | The wrong data type (i.e. number, character, string expression) was used when specifying a parameter.  |
| - 108                            | Parameter not allowed                     | Parameter specified in a command which does not require one.   |
| - 109                            | Missing parameter                         | No parameter specified in the command in which a parameter is required.  |
| - 113                            | Undefined header                          | Command header was incorrectly specified.  |
| - 123                            | Numeric overflow                          | A parameter specifies a value greater than the command allows.   |
| - 128                            | Numeric data not allowed                  | A number was specified for a parameter when a letter is required.  |
| - 131                            | Invalid suffix                            | Parameter suffix incorrectly specified (e.g. .SSECOND rather than .5S or .5SEC).   |
| - 138                            | Suffix not allowed                        | Parameter suffix is specified when one is not allowed.   |
| - 141                            | Invalid character data                    | The discrete parameter specified is not allowed (e.g. TRIG:SOUR INT - INT is not a choice.)  |
| - 178                            | Expression data not allowed               | A parameter other than the channel list is enclosed in parentheses.  |
| - 211                            | Trigger ignored                           | Trigger occurred while the Pacer is in the idle state, or a trigger occurred from a source other than the specified source.                        |
| - 222                            | Data out of range                         | The parameter value specified is too large or too small.   |
| - 224                            | Illegal parameter value                   | The numeric value specified is not allowed.  |
| - 240                            | Hardware error                            | Hardware error detected during power-on cycle. Return multimeter to Agilent for repair.  |
| - 310                            | System error                              | If caused by *DMC, then macro memory is full.  |
| - 350                            | Too many errors                           | The error queue is full as more than 30 errors have occurred.  |
| - 410                            | Query interrupted                         | Data is not read from the output buffer before another command is executed.  |
| - 420                            | Query unterminated                        | Command which generates data not able to finish executing due to a multimeter configuration error.   |
| - 430                            | Query deadlocked                          | Command execution cannot continue since the mainframe's command input, and data output buffers are full. Clearing the instrument restores control. |
| 1500                             | External trigger source already allocated | "Event In" signal already allocated to another instrument such as a Switchbox.   |
| 2002                             | Invalid logical address                   | A value less than 0 or greater than 255 was specified for logical address.   |
| 2003                             | Invalid word address                      | An odd address was specified for a 16 bit read or write. Always use even addresses for 16 bit (word) accesses.                                     |
| 2005                             | No card at logical address                | A non-existent logical address was specified with the VXI:READ? or VXI:WRITE command.  |
| 2101                             | Failed Device                             | VXI device failed its self test.   |
| 2102                             | Unable to combine device                  | Device type can not be combined into an instrument such as a scanning voltmeter or a switchbox.  |
| 2103                             | Config warning, Device driver not found   | ID of device does not match list of drivers available. Warning only.   |
| 2105                             | Config error 5, A24 memory overflow       | More A24 memory installed in the mainframe than can be configured into the available A24 memory space.   |
| 2108                             | Config error 8, Inaccessible A24 memory   | A24 memory device overlaps memory space reserved by the mainframe's operating system.  |

| <b>Error Messages and Causes</b> |  |   |
|----------------------------------|--|---|
| <b>Code</b>                      | <b>Message</b>   | <b>Cause</b>  |
| 2110                             | Config error 10, Insufficient system memory                    | Too many instruments installed for the amount of RAM installed in the mainframe. Cannot configure instruments. Only the system instrument is started. |
| 2111                             | Config error 11, Invalid instrument address                    | A device's logical address is not a multiple of 8 and the device is not part of a combined instrument.  |
| 2113                             | Config error 13, Logical address or IACK switch set wrong      | Duplicate logical addresses set or interrupt bypass switches set improperly. Only the system instrument is started.                                   |
| 2129                             | Config warning, Sysfail detected                               | A device was asserting SYSFAIL on the backplane during startup.   |
| 2130                             | Config error 30, Pseudo instrument logical address unavailable | A physical device has the same logical address as IBASIC (240)  |
| 2131                             | Config error 32, File system start up failed                   | Insufficient system resources to allow the IBASIC file system to start.   |
| 2145                             | Config warning, Non-volatile RAM contents lost                 | NVRAM was corrupted or a cold boot was executed.  |
| 2148                             | Config warning, Driver RAM contents lost                       | Driver RAM was corrupted or a cold boot was executed.   |
| 2202                             | Unexpected interrupt from non-message based card               | A register based card interrupted when an interrupt service routine had not been set up.  |
| 2809                             | Interrupt line has not been set up                             | A DIAG:INT:ACT or DIAG:INT:RESP command was executed before setting the interrupt with DIAG:INT:SET.  |



## Start-up Error Messages

Start-up errors are most often generated just after the mainframe is powered-up or re-booted (DIAG:BOOT command). If you have an Agilent E 1301B, or an Agilent E 1300B with a terminal connected to the Display Terminal Interface (built-in RS-232 only), you can read these errors on the front panel or terminal. If you have an Agilent E 1300B and no terminal, then you must access this error information by sending the VXI:CONF:DLIS? command over GPIB. We recommend that users of either model include a routine at the beginning of their application program which checks for start-up errors before the program tries to access individual instruments. See your Installation and Getting Started Guide for an example program.

**Table B-3. Start-up Error Messages and Warnings**

| Start-Up Error Messages and Warnings |  |   |
|--------------------------------------|--|---|
| Code                                 | Message  | Cause   |
| 1                                    | Failed Device  | VXI device failed its self test.  |
| 2                                    | Unable to combine device                                       | Device type can not be combined into an instrument such as a scanning voltmeter or a switchbox.   |
| 3                                    | Config warning, Device driver not found                        | ID of device does not match list of drivers available. Warning only.  |
| 5                                    | Config error 5, A24 memory overflow                            | More A24 memory installed in the mainframe than can be configured into the available A24 memory space.  |
| 8                                    | Config error 8, Inaccessible A24 memory                        | An A24 memory device overlaps a memory space reserved by the mainframe's operating system.  |
| 10                                   | Config error 10, Insufficient system memory                    | Too many instruments installed for the amount of RAM installed in the mainframe. Cannot configure instruments. Only the system instrument is started. |
| 11                                   | Config error 11, Invalid instrument address                    | A device's logical address is not a multiple of 8 and the device is not part of a combined instrument.  |
| 13                                   | Config error 13, Logical address or IACK switch set wrong      | Duplicate logical addresses set or interrupt bypass switches set improperly. Only the system instrument is started.                                   |
| 29                                   | Config warning, Sysfail detected                               | A device was asserting SYSFAIL on the backplane during startup.   |
| 30                                   | Config error 30, Pseudo instrument logical address unavailable | A physical device has the same logical address as IBASIC (240)  |
| 31                                   | Config error 32, File system start up failed                   | Insufficient system resources to allow the IBASIC file system to start.   |
| 45                                   | Config warning, Non-volatile RAM contents lost                 | NVRAM was corrupted or a cold boot was executed.  |
| 48                                   | Config warning, Driver RAM contents lost                       | Driver RAM was corrupted or a cold boot was executed.   |



## Connecting and Configuring a Display Terminal

---

### Using this Appendix

This appendix shows you how to configure the mainframe and a supported terminal to operate with the Display Terminal Interface. Using the Display Terminal Interface is discussed in Chapter 3.

- Overview ..... C-1
- Connecting a Terminal to the Mainframe ..... C-1
- Configuring a Terminal for the Mainframe ..... C-3
- Configuring the Mainframe with Menus ..... C-4

---

### Overview

The basic steps to configure a terminal to operate with the mainframe are:

1. Choosing the proper cable to connect the terminal to the mainframe. The cable connects the appropriate data and control signals from the terminal to the mainframe.
2. Configuring the terminal's serial interface parameters to match those of the mainframe. The terminal and mainframe can only communicate with each other when they are using the same data rate, data word width, error checking scheme, and overall data frame width.
3. Using the terminal interface menus to configure mainframe's serial interface parameters. Once the terminal is communicating with the mainframe, the terminal can be used to adjust (if necessary) the mainframe's serial interface parameters for best operation.

---

### Connecting a Terminal to the Mainframe

The easiest way to connect the terminal to the mainframe is by using off-the-shelf cables which have been tested to work with your supported terminal. In the following figures you will find Agilent cables specified (by part number) for each of the supported terminals. If you plan to have the mainframe far from the terminal, you may need a custom built cable. The equivalent wiring diagram for each cable or cable combination is also provided.

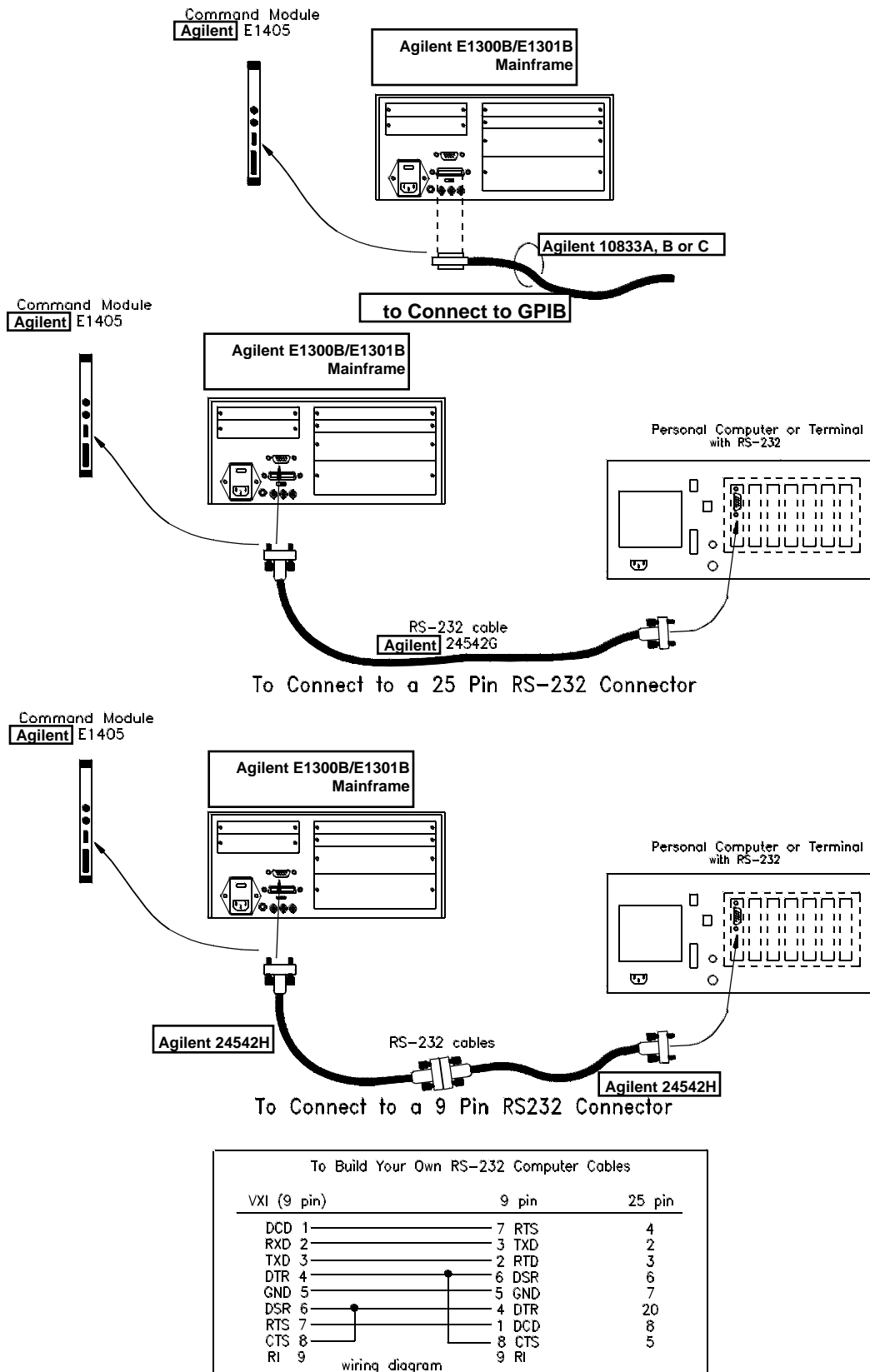

E1445A fig1-1a

Figure C-1 Connecting a Terminal to the Mainframe

C-2 Connecting and Configuring a Display Terminal

---

## Configuring a Terminal for the Mainframe

We'll first set the terminal's serial communication parameters to match the mainframe's default settings. If the mainframe is new and its factory default values are still set, the terminal will be ready to use. If the settings have been changed and you don't know what they are (Agilent E1300 with no front panel), you will restore them to their default values.

### Starting with Default Mainframe Settings

The mainframe leaves the factory with these default serial communication settings:

- Baud rate; 9600
- Data word width; 8 bits
- Parity type; NONE
- Parity checking; OFF
- Number of stop bits; 1
- Pacing; XON (for both receive and transmit)
- DTR and RTS ON (signal level high)

If your mainframe is new, or you know these default settings are still in effect you can go on to "Configuring the Terminal". If you are unsure of the current settings, continue on with the following section "Restoring the Default Configuration".

### Restoring the Default Configuration

There is an easy way to restore the factory default settings. While the mainframe is performing its power-up self-test, the built-in serial interface always uses the factory default settings listed above. With your terminal set to the default settings, turn on the mainframe. While the mainframe is "Testing ROM", press and hold the **CTRL** key and press the **R** key. The mainframe will reset its stored serial communication settings to the factory default values. It is important that you press **CTRL-R** *during* the "Testing ROM" portion of the self-test. The terminal should now display "Select an instrument".

---

### Note

Restoring the default serial communication settings also clears both the User and System non-volatile RAM areas.

---

### Configuring the Terminal

Using your terminal owner's manual, set the terminal's communication parameters to the values shown in the list above. For DTR and RTS, set your terminal to DTR or Hardware handshake OFF. In addition, make sure your terminal is configured to "Transmit Functions" or "Transmit Codes". This means that when you press one of the editing keys (e.g. right arrow key) the terminal will send to the mainframe, the code which corresponds to the key. If this not set properly, the cursor will appear to respond to the keys, but the mainframe will not know that you moved the cursor.

**Trying it** Turn on the mainframe while watching the terminal's display. After the mainframe finishes its self-test, the terminal should display "Select an instrument". If not, the mainframe's communication parameters are not set to the default values. Go back to "Restoring the Default Configuration".

---

## Configuring the Mainframe with Menus

After you have your terminal communicating with your mainframe at the default settings you may want to change to settings which are better for your installation. You can make these changes to the serial interface configuration using the Display Terminal Interface menus. Several of the changes you can make using the menus will cause communication between the terminal and mainframe to be lost. You will have to match each change in the mainframe configuration with a corresponding change in your terminal's configuration. Use the following procedure:

1. Change the mainframe configuration (see the menu example on page C-5).
2. Change the terminal's configuration to match the change from step one. Repeat steps one and two for each desired configuration change.

Any changes you make to the mainframe configuration are only temporary (lost when power is removed) until you put them into non-volatile storage. To store the current configuration, follow the menu example on page C-6.

## How to Use the Serial Interface Menus

```

SYSTEM_0:
-
1 CONFIG? 2 HP-IB 3 RS-232 4 TIME 23
    
```

```

SYSTEM_0:
-
1 BAUD 2 PARITY 3 BITS 4 PACE 22 1 5 CONTROL 6 MOR
    
```

Press READ to find out the current setting

Press SET to change the current setting

```

SYSTEM_0:
-
1 READ 2 SET 3 4 33
    
```

Each SET Menu will have two or more choices

```

SYSTEM_0:
Enter card number
1 2 3
    
```

Enter Card Number press **Return**  
(0 for built-in, 1-7 for a plug-in)

```

SYSTEM_0:
+9600
-
1 READ 2 SET 3
    
```

Read the BAUD rate

```

SYSTEM_0:
-
1 300 2 1200 3 2400 4 9600 33 1 5 19200 6
    
```

```

SYSTEM_0:
Enter card number
1 2 3 4 24 1 5 6
    
```

Enter Card Number press **Return**  
(0 for built-in, 1-7 for a plug-in)

The setting is now in volatile RAM storage.  
See the "How to Store Interface Settings"  
Menu Chart for non-volatile storage which  
maintains settings through power cycles.

## How to Store the Serial Interface Configuration

```
SYSTEM_0:  
-  
1 CONFIG? 2 HP-IB 3 RS-232 4 TIME 23
```

```
SYSTEM_0:  
-  
1 BAUD 2 PARITY 3 BITS 4 PACE 22 1 5 CONTROL 6 MORE 7 PRU_MENU 8 UTILS
```

```
SYSTEM_0:  
-  
1 STORE 2 3 4 22 1 5 6 MORE 7 8 UTILS
```

```
SYSTEM_0:  
Enter card number  
1 2 3 4
```

Enter Card Number press **Return**. Card Number 0 for built-in stores settings into non\_volatile RAM. Card Number 1-7 for Agilent E1324A stores settings into its on-board EEROM)



## Sending Binary Data Over RS-232

---

### About this Appendix

This appendix describes the procedure for sending pure binary data over an RS-232 interface. The formatting described is used in the DIAG:DOWN:CHEC:MADD, DIAG:DOWN:CHEC:SADD, and DIAG:DRIV:LOAD:CHEC commands. this appendix contains the following main sections.

- About this Appendix . . . . . D-1
- Formatting Binary Data for RS-232 Transmission. . . . . D-1
- Sending Binary Data Over RS-232. . . . . D-2

---

### Formatting Binary Data for RS-232 Transmission

The most straightforward way to send a block of data is to open the data file, read the next byte from the file, and send it to the System Instrument until you reach the end of file. However, binary data cannot be sent to the System Instrument as is. It must be converted into a format that will not conflict with the special characters that the RS-232 interface recognizes. This is done by sending only one half byte (a nibble) at a time. To prevent this nibble from being confused with a special character, bit 7 of the nibble is set to one. This gives all data bytes in the block values greater than 127 so they are not confused with ASCII characters. It also doubles the size of the file to be sent and the transmission time for the file. Since a transmission error that required retransmission of the entire data block would be very time consuming, a 3-bit error code (which allows for correction of single bit errors) is added to the transmission byte. The following format is sent for each nibble:

| Bit # | 7        | 6                      | 5 | 4 | 3           | 2 | 1 | 0 |
|-------|----------|------------------------|---|---|-------------|---|---|---|
|       | <i>1</i> | <i>Correction Code</i> |   |   | <i>Data</i> |   |   |   |

The error correction code is based on the nibble of data sent. The easiest way to implement this code is to use table D-1. It is indexed based on the value of the nibble to send out, so there are 16 elements to the table.

**Table D-1. Correction Codes for RS-232 Transmission**

| Data Value | Correction Code | Byte in Hex     | Byte in Decimal |
|------------|-----------------|-----------------|-----------------|
| 0          | 0               | 80 <sub>h</sub> | 128             |
| 1          | 7               | F1 <sub>h</sub> | 241             |
| 2          | 6               | E2 <sub>h</sub> | 226             |
| 3          | 1               | 93 <sub>h</sub> | 147             |
| 4          | 5               | D4 <sub>h</sub> | 212             |
| 5          | 2               | A5 <sub>h</sub> | 165             |
| 6          | 3               | B6 <sub>h</sub> | 182             |
| 7          | 4               | C7 <sub>h</sub> | 199             |
| 8          | 3               | B8 <sub>h</sub> | 184             |
| 9          | 4               | C9 <sub>h</sub> | 201             |
| 10         | 5               | DA <sub>h</sub> | 218             |
| 11         | 2               | AB <sub>h</sub> | 171             |
| 12         | 6               | EC <sub>h</sub> | 236             |
| 13         | 1               | 9D <sub>h</sub> | 157             |
| 14         | 0               | 8E <sub>h</sub> | 142             |
| 15         | 7               | FF <sub>h</sub> | 255             |

---

## **Sending Binary Data Over RS-232**

The RS-232 interface differs from the GPIB interface in that there is no device addressing built into the interface definition. Device addressing must be done on top of the RS-232 functions. This addressing is done through the same mechanism as the terminal-based front panel, and must be done either by the transfer program or manually before starting the transfer program.

### **Setting Up the Mainframe**

There are two commands (SI - Select and Instrument and SA - Select Address) that can be used at the "Select an Instrument" interface. The "Select an Instrument" interface can always be reached by sending the < CTRL-D> character (ASCII 4) over the RS-232 line. Once there, the System Instrument can be reached by sending the command "SI SYSTEM" followed by a carriage return. All output after this command will be directed to/from the System Instrument until another < CTRL-D> is received. The following sequence will make sure that the mainframe is set up and ready.

1. Send < CTRL-D> (ASCII 4) to get to the "Select and Instrument" interface.
2. Send "ST UNKNOWN" and a carriage return to insure that the terminal is set to dumb terminal mode.

3. Send "SI SYSTEM" and a carriage return to get the attention of the System Instrument.
4. Send < CTRL-C> to clear the system.
5. Send "\*RST" and a carriage return to put the System Instrument in a known state.

The program must then send the binary data. This block of data should include the command "DIAG:DOWN:CHEC" followed by the address to download to and an IEEE 488.2 arbitrary block header. This block header can be either definite or indefinite. The advantage of using an indefinite block header is that you do not need to know the length of the data block. The indefinite block header is # 0. With the DIAG:DOWN:CHEC command an indefinite block is terminated with the "!" character followed by a carriage return. The "!" character is not considered part of the block. A definite block only requires the ASCII carriage return character as terminator. The definite block starts with # . This is followed by a single digit that shows the number of digits in the length field, which is followed by the actual length of the block, not counting the header. For instance, a block of 1000 bytes would have a definite block header of # 41000. Due to the formatting required, the size of the block when using the DIAG:DOWN:CHEC command is twice the length of the data in bytes.

Once the block header has been sent, the actual data is sent. Since the buffer size of the System Instrument RS-232 Interface is limited to 79 bytes, the buffer must be flushed (passed to an instrument parser) before it reaches 79 bytes. This can be done by sending a carriage return. The first carriage return should be included in the binary file after the buffer header. Sending it before this would result in the parser determining that there are not enough parameters and producing an error condition. Once transmission of the actual data begins, a carriage return should be included after every 78 bytes.

---

**NOTE**

The carriage returns are not considered part of the block count.

---

After the last byte of data, there must be a carriage return to terminate the transmission for a definite block or a "!" and carriage return for an indefinite block.



# Index

---

## !

- 3-Channel Universal Counter
  - Menu (front panel), 2-26 - 2-27
  - Menu (terminal interface), 3-38 - 3-39
- 4-Channel Counter/Totalizer
  - Menu (front panel), 2-24 - 2-25
  - Menu (terminal interface), 3-36 - 3-37
- 4-Channel D/A Converter
  - Menu (front panel), 2-21
  - Menu (terminal interface), 3-33
- 5 1/2 Digit Multimeter
  - Menu (front panel), 2-20
  - Menu (terminal interface), 3-32
- 60-second menu tutorial
  - front panel, 2-2
  - terminal interface, 3-3
- :DRIVER:LOAD, 7-17
- :DRIVER:LOAD:CHECKed, 7-17

## A

- Abbreviated Commands, 7-2
- ABORt subsystem, 7-4
- Allocating a user memory segment, 4-7

## B

- Back Space key
  - terminal interface, 3-15
- Back Space key (front panel), 2-11
- BEEP:IMMEDIATE, 7-35
- BOOT
  - :COLD, 7-6
  - :WARM, 7-7

## C

- Cable
  - RS-232, 5-1
- Caps Lock key
  - terminal interface, 3-15
- Caps Lock key (front panel), 2-11
- Changing the primary GPIB address, 4-3
- Clear-to-end key
  - terminal interface, 3-15
- Clear-to-end key (front panel), 2-11
- Clearing Standard Operation Event Register Bits, 6-9
- Clearing status, 6-10
- Close channels

- terminal interface, 3-8
- Close channels (front panel), 2-5
- Command
  - Abbreviated, 7-2
  - Implied, 7-2
  - Linking, 7-3
  - Separator, 7-2
  - Types, 7-1
- Command Errors, B-2
- Command Quick Reference, 7-75
- Command Reference, SCPI
  - ABORt subsystem, 7-4
  - Common Commands, 7-65
  - DIAGnostic subsystem, 7-5 - 7-28
  - INITiate subsystem, 7-29
  - INITiate:IMMEDIATE, 7-29
  - SOURce subsystem, 7-30 - 7-31
  - SOURce:PULSe:COUNT, 7-30
  - SOURce:PULSe:COUNT?, 7-30
  - SOURce:PULSe:PERiod, 7-31
  - SOURce:PULSe:PERiod?, 7-31
  - STATus subsystem, 7-32 - 7-34
  - SYSTEM subsystem, 7-35 - 7-50
  - SYSTEM:BEEP:IMMEDIATE, 7-35
  - SYSTEM:COMMunicate:GPIB:ADDRess, 7-36
  - TRIGger subsystem, 7-51 - 7-53
  - TRIGger:DELay, 7-51
  - TRIGger:IMMEDIATE, 7-52
  - TRIGger:SLOPe, 7-52
  - TRIGger:SLOPe?, 7-52
  - TRIGger:SOURce, 7-52
  - TRIGger:SOURce?, 7-53
  - VXI subsystem, 7-54 - 7-64
- Commands
  - executing (front panel), 2-9
  - executing (terminal interface), 3-13
  - terminal interface, 3-19
- Common Command Format, 7-1
- Common Command reference, 7-65
- Common Command reference, all instruments
  - \*CLS, 7-66
  - \*ESE, 7-66
  - \*ESE?, 7-67
  - \*ESR?, 7-67
  - \*IDN?, 7-68
  - \*LRN?, 7-68
  - \*OPC, 7-69
  - \*OPC?, 7-69
  - \*PSC, 7-69
  - \*PSC?, 7-69
  - \*RCL, 7-70
  - \*RST, 7-70

- \*SAV, 7-70
- \*SRE, 7-70
- \*SRE?, 7-71
- \*STB?, 7-71
- \*TRG, 7-71
- \*TST?, 7-71
- \*WAI, 7-71
- Common Commands functional groupings, 7-65
- COMMunicate:GPIB
  - :ADDRess, 7-36
  - :ADDRess?, 7-36
- COMMunicate:SERial[0]
  - :OWNer, 7-7
  - :OWNer?, 7-8
- COMMunicate:SERial[n]
  - :CONTrol:DTR, 7-37
  - :CONTrol:DTR?, 7-38
  - :CONTrol:RTS, 7-38
  - :CONTrol:RTS?, 7-39
  - :RECeive:BAUD, 7-39
  - :RECeive:BAUD?, 7-39
  - :RECeive:BITS, 7-40
  - :RECeive:BITS?, 7-40
  - :RECeive:PACe:PROTOcol, 7-41
  - :RECeive:PACe:PROTOcol?, 7-41
  - :RECeive:PACe:THReshold:STARt, 7-42
  - :RECeive:PACe:THReshold:STARt?, 7-42
  - :RECeive:PACe:THReshold:STOP, 7-43
  - :RECeive:PACe:THReshold:STOP?, 7-43
  - :RECeive:PARity:CHECk, 7-44
  - :RECeive:PARity:CHECk?, 7-44
  - :RECeive:PARity:TYPE, 7-44 - 7-45
  - :RECeive:PARity[:TYPE?], 7-46
  - :RECeive:SBITs, 7-46
  - :RECeive:SBITs?, 7-47
  - :STORE, 7-8
  - :TRANsmit:AUTO, 7-47
  - :TRANsmit:AUTO?, 7-47
  - :TRANsmit:PACe:PROTOcol, 7-48
  - :TRANsmit:PACe:PROTOcol?, 7-48
- COMMunicate:SERial[n] ..., 7-36
- Condition register, reading, 6-8
- CONFigure
  - :DLADdress?, 7-54
  - :DNUMber?, 7-56
  - :HIERarchy:ALL?, 7-58
  - :HIERarchy?, 7-57
  - :INformation:ALL?, 7-60
  - :INformation?, 7-58 - 7-59
  - :NUMBer?, 7-60
- CONFigure:DLISt?, 7-55
- Configuring a Terminal, C-1 - C-5
- Connecting a terminal, C-1 - C-5
- Control keys, menu (terminal interface), 3-14

## D

- Data memory, mainframe, 4-6
- DATE, 7-48
  - SYST:DATE, 7-48
  - SYST:DATE?, 7-49
- Date, reading or setting, 1-5
- DATE?, 7-49
- DCL (device clear), 7-73
- Definition, instrument, 1-3
- DELay, 7-51
  - TRIG:DELay, 7-51
  - TRIG:DELay?, 7-51
- DELay?, 7-51
- Delete key
  - terminal interface, 3-14
- Delete key (front panel), 2-11
- Device clear (DCL), 7-73
- Device Driver
  - manual download over GPIB, 5-11
  - manual download over RS-232, 5-11
  - preparing memory for download, 5-10
- Device driver RAM, 5-3
- Device Drivers
  - checking status, 5-9
- Disks, 5-1
  - download program configuration, 5-4
  - downloading in GPIB systems with BASIC, 5-8
  - downloading in GPIB systems with IBASIC, 5-7
  - downloading in MS-DOS systems, 5-6
  - downloading multiple drivers, 5-9
  - editing the configuration file, 5-4
  - memory configuration, 5-3
- Device-Specific Errors, B-2
- DIAGnostic subsystem, 7-5 - 7-28
  - DIAG:BOOT:COLD, 7-6
  - DIAG:BOOT:WARM, 7-7
  - DIAG:COMM:SER[0]:OWN, 7-7
  - DIAG:COMM:SER[0]:OWN?, 7-8
  - DIAG:COMM:SER[n]:STOR, 7-8
  - DIAG:DOWN:CHEC:SADD, 7-11 - 7-12
  - DIAG:DOWN:CHEC[:MADD], 7-9 - 7-10
  - DIAG:DOWN:SADD, 7-14
  - DIAG:DOWN[:MADD], 7-13
  - DIAG:DRAM:AVA?, 7-15
  - DIAG:DRAM:CRE, 7-16
  - DIAG:DRIVer:LOAD, 7-17
  - DIAG:DRIVer:LOAD:CHEC, 7-17
  - DIAG:INT:ACT, 7-19
  - DIAG:INT:PRI[n], 7-21
  - DIAG:INT:PRI[n]?, 7-21
  - DIAG:INT:RESP?, 7-22
  - DIAG:INT:SET[n], 7-19
  - DIAG:INT:SET[n]?, 7-20
  - DIAG:NRAM:ADDR?, 7-23
  - DIAG:NRAM:CRE, 7-23
  - DIAG:NRAM:CRE?, 7-24

- DIAG:PEEK?, 7-24
- DIAG:POKE, 7-25
- DIAG:RDIS:ADD?, 7-25
- DIAG:RDIS:CRE, 7-26
- DIAG:RDIS:CRE?, 7-26
- DIAG:UPL:SADD?, 7-28
- DIAG:UPL[:MADD]?, 7-27
- DRIV:LIST:ROM?, 7-18
- DRIV:LIST?, 7-18
- DIAGnostic:DRIVer:LIST:RAM?, 7-18
- DIAGnostic:DRIVer:LIST:ROM?, 7-18
- DIAGnostic:DRIVer:LIST?, 7-18
- Display
  - instrument information (terminal interface), 3-5
  - control/editing keys (front panel), 2-10
  - instrument information (front panel), 2-3
  - instrument logical addresses (front panel), 2-3
  - instrument logical addresses (terminal interface), 3-5
  - module type & description (front panel), 2-5
  - module type & description (term. interface), 3-8
- DOWNload
  - :CHECKed:SADDRESS, 7-11 - 7-12
  - :CHECKed[:MADDRESS], 7-9 - 7-10
  - :SADDRESS, 7-14
  - [:MADDRESS], 7-13
- Download program, 5-4
- DOWNload, using, 4-9
- Downloading device drivers
  - checking status, 5-9
  - hardware handshake, 5-12
  - in GPIB systems with BASIC, 5-8
  - in GPIB systems with IBASIC, 5-7
  - in MS-DOS systems, 5-6
  - manually over GPIB, 5-11
  - manually over RS-232, 5-11
  - manually using hardware handshake, 5-13
  - manually using software handshake, 5-14
  - multiple device drivers, 5-9
  - pacing data, 5-12
  - preparing memory, 5-10
  - software handshake, 5-12
- DRAM, 5-3
  - :AVAILable?, 7-15
  - :CREate, 7-16
  - :CREate?, 7-16
- Drivers
  - listing, 7-18

## E

- Editing
  - VXIDLD.CFG, 5-4
- Editing keys
  - front panel, 2-10
- Editing keys (terminal interface), 3-14
- Editing:the configuration file, 5-4
- Error
  - messages, reading, 3-12

- messages, reading (front panel), 2-8
- SYST:ERR?, 7-49
- Error Messages, B-1 - B-6
- Error Queue ,reading, B-1
- Error Types, B-2
- ERRor?, 7-49
- Errors
  - Command, B-2
  - Device-Specific, B-2
  - Execution, B-2
  - Query, B-2
- Example
  - Storing and retrieving data from mainframe memory, 4-7
  - Allocating an NRAM segment, 4-8
  - Continuous pacer out signal, 4-2
  - interrupting when an error occurs, 6-11
  - Pacing an external scanner, 4-2
  - reading the date, 1-5
  - reading the time, 1-5
  - setting the date, 1-5
  - setting the time, 1-5
  - Synchronizing an internal instrument to an external instrument, 4-4
    - synchronizing computers using \*OPC, 6-13
    - synchronizing computers using \*OPC?, 6-12
  - Synchronizing internal/external instruments and the computer, 4-4
    - Using the Operation Status Group Registers, 6-9
    - Using UPLoad and DOWNload, 4-10
- Example: Reading Error Queue, B-1
- Executing commands (front panel), 2-9
- Executing commands (terminal interface), 3-13
- Execution Errors, B-2
- External computer, interrupting, 6-10
- External computer/instruments, synchronizing, 6-12

## F

- Files:VXIDLD.CFG, 5-4
- Format
  - Common Command, 7-1
  - SCPI Command, 7-1
- Front panel
  - features, 2-1
  - menu tutorial, 2-2
  - menus, 2-2

## G

- GET (group execute trigger), 7-72
- Go to local (GTL), 7-72
- Group execute trigger (GET), 7-72
- GTL (go to local), 7-72

## H

- Hints, programming, 6-1
- How to
  - display instrument information (front panel), 2-3
  - display instrument information (terminal interface), 3-5
  - display instrument ladd (terminal interface), 3-5
  - display instrument ladd (front panel), 2-3
  - reset (reboot) the mainframe (front panel), 2-3
  - reset (reboot) the mainframe (terminal interface), 3-5
  - set or read the system GPIB address, 3-5
  - set or read the system GPIB address (front panel), 2-3
- GPIB message reference, 7-72

## I

- IBASIC, Users Note, 4-7
- IFC (interface clear), 7-72
- IMMEDIATE
  - BEEP:IMM, 7-35
  - INIT:IMM, 7-29
  - TRIG:IMM, 7-52
- Implied Commands, 7-2
- In case of difficulty
  - terminal interface, 3-23
- In case of difficulty (front panel), 2-12
- INITiate subsystem, 7-29
- Instrument
  - Control Keys (front panel), 2-11
  - Control Keys (terminal interface), 3-15
  - definition, 1-3
  - logical addresses, 1-4
  - menus (front panel), 2-13
  - menus (terminal interface), 3-25
  - menus, using, 3-8
  - menus, using (front panel), 2-5
- Instrument secondary addresses, 1-4
- Instruments, synchronizing, 4-3

- Interface clear (IFC), 7-72
- Internal/external instruments, synchronizing, 4-3
- INTerrupt
  - :ACTivate, 7-19
  - :PRiority[n], 7-21
  - :PRiority[n]?, 7-21
  - :RESPonse?, 7-22
  - :SETup[n], 7-19
  - :SETup[n]?, 7-20
- Interrupting external computer, 6-10
- Introductory programming examples, 1-4

## K

- Key descriptions (front panel), 2-10
- Key descriptions, General, 3-14
- Keys
  - editing (terminal interface), 3-14
  - menu (front panel), 2-10
  - menu (terminal interface), 3-14
  - menu control (terminal interface), 3-14

## L

- Left arrow key
  - terminal interface, 3-14
- Left arrow key (front panel), 2-10
- Linking Commands, 7-3
- LLO (local lockout), 7-73
- Local lockout (LLO), 7-73
- Logical addresses
  - displaying (front panel), 2-3
  - displaying (terminal interface), 3-5
  - instrument, 1-4

## M

- Mainframe
  - data memory, 4-6
  - description, 1-1
  - memory, optional, 1-1
- Memory
  - device driver RAM, 5-3
- Memory, mainframe, 4-6
- Menu
  - using a terminal without, 3-21
- Menu (front panel)
  - 3-Channel Universal Counter, 2-26 - 2-27
  - 4-Channel Counter/Totalizer, 2-24 - 2-25
  - Quad 8-Bit Digital Input/Output, 2-22
  - 4-Channel D/A Converter, 2-21
  - 5 1/2 Digit Multimeter, 2-20
  - instrument (front panel), 2-13
  - keys, 2-10
  - Scanning Voltmeter, 2-18 - 2-19
  - Switchbox, 2-16
  - System Instrument, 2-14 - 2-15



- tutorial, 2-2
- Menu (terminal interface)
  - 3-Channel Universal Counter, 3-38 - 3-39
  - 4-Channel Counter/Totalizer, 3-36 - 3-37
  - Quad 8-Bit Digital Input/Output, 3-34
  - 4-Channel D/A Converter, 3-33
  - 5 1/2 Digit Multimeter, 3-32
  - control keys, 3-14
  - instrument, 3-25
  - keys, 3-14
  - Scanning Voltmeter, 3-30 - 3-31
  - Switchbox, 3-28
  - System Instrument, 3-26 - 3-27
  - tutorial, 3-3
- Mode, monitor, 3-11
- Mode, monitor (front panel), 2-8
- Modules, unassigned, 1-4
- Monitor
  - a Switchbox (front panel), 2-5
  - a Switchbox (terminal interface), 3-8
  - mode, 3-11
  - mode (front panel), 2-8
- Multiple device drivers, 5-9

## N

- Non-volatile user memory, 4-7
- NRAM, 5-5
  - :ADDRess?, 7-23
  - :CREate, 7-23
  - :CREate?, 7-24
  - address, 4-7
  - allocating a segment, 4-7
  - locating the segment, 4-7
  - user non-volatile memory, 4-7

## O

- Open and close channels
  - terminal interface, 3-8
- Open and close channels (front panel), 2-5
- OPERation
  - :CONDition?, 7-32
  - :ENABle, 7-32
  - :ENABle?, 7-33
  - [:EVENT]?, 7-33
- Optional mainframe memory, 1-1
- Other Terminals, non-supported, 3-19

## P

- Pacer, using, 4-1
- Pacing data for manual download, 5-12
- PEEK?, 7-24
- POKE, 7-25
- PRESet, 7-34
- Primary GPIB address, changing, 4-3

- Programming examples, introductory, 1-4
- Programming hints, 6-1
- PULSe
  - :COUNT, 7-30
  - :COUNT?, 7-30
  - :PERiod, 7-31
  - :PERiod?, 7-31

## Q

- Quad 8-Bit Digital Input/Output
  - Menu (front panel), 2-22
  - Menu (terminal interface), 3-34
- Query Errors, B-2
- QUEStionable, 7-34
- Quick Reference, Command, 7-75

## R

- RDISK, 5-5
  - :ADDRess?, 7-25
  - :CREate, 7-26
  - :CREate?, 7-26
- READ?, 7-60
- Reading
  - error messages (front panel), 2-8
  - error messages (terminal interface), 3-12
  - the Condition register, 6-8
  - the Status Byte register, 6-4
  - the system GPIB address, 3-5
  - the system GPIB address (front panel), 2-3
- Reading Instrument's Error Queue, B-1
- Reading the date, 1-5
- Reading the time, 1-5
- Readings
  - retrieving from mainframe memory, 4-7
  - storing in mainframe memory, 4-7
- Reboot the mainframe
  - terminal interface, 3-5
- Reboot the mainframe (front panel), 2-3
- Reference, Common Commands, 7-65
- register
  - :READ?, 7-61
  - :WRITe?, 7-62
  - VXI:READ?, 7-60
  - VXI:WRIT, 7-64
- Register, Status Byte, 6-4
- Remote (GPIB message), 7-74
- Reset
  - (reboot) the mainframe (front panel), 2-3
  - (reboot) the mainframe (terminal interface), 3-5
  - a switch module (front panel), 2-5
  - a switch module (terminal interface), 3-8
- Retrieving data from mainframe memory, 4-7
- Right arrow key
  - terminal interface, 3-14
- RS-232 Cable, 5-1

## S

- SA, terminal interface command, 3-21
- Scan channels
  - (front panel), 2-5
  - Switchbox, terminal interface, 3-8
- Scanning
  - Voltmeter Menu (front panel), 2-18 - 2-19
  - Voltmeter Menu (terminal interface), 3-30 - 3-31
- SCPI Commands, 7-1
  - Format, 7-1
  - Reference, 7-4
- SDC (selected device clear), 7-73
- Secondary addresses, instrument, 1-4
- SElect, 7-63
- Select Address command (terminal interface), 3-21
- Select Instrument command (terminal interface), 3-21
- SElect?, 7-63
- Selected device clear (SDC), 7-73
- Selecting
  - instruments, without menus, 3-21
  - the Switchbox (front panel), 2-5
  - the Switchbox (terminal interface), 3-8
- Separator
  - Command, 7-2
- Serial poll (SPOLL), 7-74
- Service request
  - enable register, 6-5
- Service request enable register, 6-5
  - clearing, 6-5
- Set or read the system GPIB address
  - terminal interface, 3-5
- Set or read the system GPIB address (front panel), 2-3
- Setting the date, 1-5
- Setting the time, 1-5
- Shift key
  - terminal interface, 3-15
- Shift key (front panel), 2-11
- SI, terminal interface command, 3-21
- SLOPe, TRIGger:SLOPe, 7-52
- SLOPe?, TRIGger:SLOPe?, 7-52
- SOURce subsystem, 7-30 - 7-31
- SOURce, TRIG:SOUR, 7-52
- SOURce?, TRIG:SOUR?, 7-53
- SPOLL (serial poll), 7-74
- ST, terminal interface command, 3-20
- Standard Commands for Programmable Instruments, SCPI, 7-4
- Standard Event Status bits, unmasking, 6-6
- Standard Event Status Register, 6-6
  - reading, 6-7
- Standard Event Status Register (table), 6-6
- Standard Operation Status Group
  - Condition register, 6-7
  - Condition register (table), 6-8
- Status Byte register, 6-3 - 6-4
- Status Byte Register, reading, 6-4
- STATus subsystem, 7-32 - 7-34
  - STAT:OPER:COND?, 7-32
  - STAT:OPER:ENAB, 7-32
  - STAT:OPER:ENAB?, 7-33
  - STAT:OPER[:EVEN]?, 7-33
  - STAT:PRES, 7-34
  - STAT:QUES, 7-34
- Status system structure, 6-2
- Status, clearing, 6-10
- Status, system structure, 6-2
- Storing and retrieving data from mainframe memory, 4-7
- Subsystem
  - ABORT, 7-4
  - DIAGnostic, 7-5 - 7-28
  - INITiate, 7-29
  - SOURce, 7-30 - 7-31
  - STATus, 7-32 - 7-34
  - SYSTem, 7-35 - 7-50
  - TRIGger, 7-51 - 7-53
  - VXI, 7-54 - 7-64
- Switchbox
  - close channels (front panel), 2-5
  - close channels (terminal interface), 3-8
  - display module type & description (front panel), 2-5
  - display module type & description (term. interface), 3-8
  - Menu (front panel), 2-16
  - Menu (terminal interface), 3-28
  - monitoring (front panel), 2-5
  - monitoring (terminal interface), 3-8
  - open and close channels (front panel), 2-5
  - open and close channels (terminal interface), 3-8
  - scan channels (front panel), 2-5
  - scan channels (terminal interface), 3-8
  - selecting (front panel), 2-5
  - selecting (terminal interface), 3-8
- Synchronizing
  - internal/external instruments, 4-3
- Synchronizing external computer/instruments, 6-12
- Syntax, Variable Command, 7-2
- System Instrument, 7-1
  - Menu (front panel), 2-14 - 2-15
  - Menu (terminal interface), 3-26 - 3-27
- System Instrument menu, 3-5
- System Instrument menu (front panel), 2-3
- SYSTem subsystem, 7-35 - 7-50
  - SYST:COMM:GPIB:ADDR?, 7-36
  - SYST:COMM:SER[n]:REC:PAR:TYPE, 7-44 - 7-45
  - SYST:COMM:SER[n]:CONT:DTR, 7-37
  - SYST:COMM:SER[n]:CONT:DTR?, 7-38
  - SYST:COMM:SER[n]:CONT:RTS?, 7-39
  - SYST:COMM:SER[n]:REC:BAUD, 7-39
  - SYST:COMM:SER[n]:REC:BAUD?, 7-39
  - SYST:COMM:SER[n]:REC:BITS, 7-40
  - SYST:COMM:SER[n]:REC:BITS?, 7-40
  - SYST:COMM:SER[n]:REC:PACE:PROT, 7-41
  - SYST:COMM:SER[n]:REC:PACE:PROT?, 7-41
  - SYST:COMM:SER[n]:REC:PACE:THR:STAR, 7-42
  - SYST:COMM:SER[n]:REC:PACE:THR:STAR?, 7-42

SYST:COMM:SER[n]:REC:PACE:THR:STOP, 7-43  
 SYST:COMM:SER[n]:REC:PACE:THR:STOP?, 7-43  
 SYST:COMM:SER[n]:REC:PAR:CHEC, 7-44  
 SYST:COMM:SER[n]:REC:PAR:CHEC?, 7-44  
 SYST:COMM:SER[n]:REC:PAR[:TYPE?], 7-46  
 SYST:COMM:SER[n]:REC:SBIT, 7-46  
 SYST:COMM:SER[n]:REC:SBIT?, 7-47  
 SYST:COMM:SER[n]:TRAN:AUTO, 7-47  
 SYST:COMM:SER[n]:TRAN:AUTO?, 7-47  
 SYST:COMM:SER[n]:TRAN:PACE:PROT, 7-48  
 SYST:COMM:SER[n]:TRAN:PACE:PROT?, 7-48  
 SYST:COMM:SERial[n]:CONT:RTS, 7-38  
 SYST:DATE, 7-48  
 SYST:DATE?, 7-49  
 SYST:ERROr?, 7-49  
 SYST:TIME, 7-50  
 SYST:TIME?, 7-50  
 SYST:VERS?, 7-50

## T

### Terminal

configuring, C-1 - C-5  
 connecting, C-1 - C-5

### Terminal interface

commands, 3-19  
 commands, SA, 3-21  
 commands, SI, 3-21  
 commands, ST, 3-20  
 features, 3-2  
 menu tutorial, 3-3  
 menus, 3-3

### TIME, 7-50

SYST:TIME, 7-50  
 SYST:TIME?, 7-50

### Time, reading or setting, 1-5

TIME?, 7-50

TRIG:SOURce, 7-52

TRIG:SOURce?, 7-53

TRIGger subsystem, 7-51 - 7-53

### trigger system

ABORt subsystem, 7-4  
 INITiate subsystem, 7-29  
 TRIGger subsystem, 7-51 - 7-53

TRIGger:IMMediate, 7-52

TRIGger:SLOPe, 7-52

TRIGger:SLOPe?, 7-52

## U

Unassigned modules, 1-4

Unmasking Standard Event Status bits, 6-6

Unmasking Standard Operation Event Register Bits, 6-8

### UPLoad

:SADDress?, 7-28  
 [:MADDress]?, 7-27

UPLoad, using, 4-9

User memory, non-volatile, 4-7

### Using

:DOWNload and :UPLoad, 4-9  
 a terminal without menus, 3-21  
 instrument menus (front panel), 2-5  
 instrument menus (terminal interface), 3-8  
 menus, 2-2, 3-3  
 Operation Status Group Registers, 6-9  
 Other Terminals, 3-19  
 Supported Terminals, 3-16  
 the Pacer, 4-1

## V

Variable Command Syntax, 7-2

VERSIon?, 7-50

VXI subsystem, 7-54 - 7-64

VXI:CONF:DLAD?, 7-54  
 VXI:CONF:DLIS?, 7-55  
 VXI:CONF:DNUM?, 7-56  
 VXI:CONF:HIER:ALL?, 7-58  
 VXI:CONF:HIER?, 7-57  
 VXI:CONF:INF:ALL?, 7-60  
 VXI:CONF:INF?, 7-58 - 7-59  
 VXI:CONF:NUMB?, 7-60  
 VXI:READ?, 7-60  
 VXI:REG:READ?, 7-61  
 VXI:SEL, 7-63  
 VXI:SEL?, 7-63  
 VXI:WRIT, 7-64

VXI Subsystem, 7-62

VXIDLD.CFG, 5-4

## W

WRITe, 7-64

