

User Guide

Keysight
N4962A
Serial BERT
12.5 Gb/s

Notices

© Keysight Technologies, Inc. 2012-2014

No part of this manual may be reproduced in any form or by any means (including electronic storage and retrieval or translation into a foreign language) without prior agreement and written consent from Keysight Technologies, Inc. as governed by United States and international copyright laws.

Manual Part Number

N4962-91021

Edition

Edition 6.0, September 2014

Printed in Germany

Keysight Technologies, Inc.
Agilent Technologies R&D and Marketing-
GmbH & Co. KG
Herrenberger Str. 130
71034 Böblingen, Germany

Warranty

THE MATERIAL CONTAINED IN THIS DOCUMENT IS PROVIDED "AS IS," AND IS SUBJECT TO BEING CHANGED, WITHOUT NOTICE, IN FUTURE EDITIONS. FURTHER, TO THE MAXIMUM EXTENT PERMITTED BY APPLICABLE LAW, KEYSIGHT DISCLAIMS ALL WARRANTIES, EITHER EXPRESS OR IMPLIED WITH REGARD TO THIS MANUAL AND ANY INFORMATION CONTAINED HEREIN, INCLUDING BUT NOT LIMITED TO THE IMPLIED WARRANTIES OF MERCHANTABILITY AND FITNESS FOR A PARTICULAR PURPOSE. KEYSIGHT SHALL NOT BE LIABLE FOR ERRORS OR FOR INCIDENTAL OR CONSEQUENTIAL DAMAGES IN CONNECTION WITH THE FURNISHING, USE, OR PERFORMANCE OF THIS DOCUMENT OR ANY INFORMATION CONTAINED HEREIN. SHOULD KEYSIGHT AND THE USER HAVE A SEPARATE WRITTEN AGREEMENT WITH WARRANTY TERMS COVERING THE MATERIAL IN THIS DOCUMENT THAT CONFLICT WITH THESE TERMS, THE WARRANTY TERMS IN THE SEPARATE AGREEMENT WILL CONTROL.

Technology Licenses

The hardware and/or software described in this document are furnished under a license and may be used or copied only in accordance with the terms of such license.

Restricted Rights Legend

If software is for use in the performance of a U.S. Government prime contract or subcontract, Software is delivered and licensed as "Commercial computer software" as defined in DFAR 252.227-7014 (June 1995), or as a "commercial item" as defined in FAR 2.101(a) or as "Restricted computer software" as defined in FAR 52.227-19 (June 1987) or any equivalent agency regulation or contract clause. Use, duplication or disclosure of Software is subject to Keysight Technologies' standard commercial license terms, and non-DOD Departments and

Agencies of the U.S. Government will receive no greater than Restricted Rights as defined in FAR 52.227-19(c)(1-2) (June 1987). U.S. Government users will receive no greater than Limited Rights as defined in FAR 52.227-14 (June 1987) or DFAR 252.227-7015 (b)(2) (November 1995), as applicable in any technical data.

Safety Notices

CAUTION

A CAUTION notice denotes a hazard. It calls attention to an operating procedure, practice, or the like that, if not correctly performed or adhered to, could result in damage to the product or loss of important data. Do not proceed beyond a CAUTION notice until the indicated conditions are fully understood and met.

WARNING

A WARNING notice denotes a hazard. It calls attention to an operating procedure, practice, or the like that, if not correctly performed or adhered to, could result in personal injury or death. Do not proceed beyond a WARNING notice until the indicated conditions are fully understood and met.

Safety Summary

The following general safety precautions must be observed during all phases of operation of this instrument. Failure to comply with these precautions or with specific warnings or operating instructions in the product manuals violates safety standards of design, manufacture, and intended use of the instrument. Keysight Technologies assumes no liability for the customer's failure to comply with these requirements. Product manuals are provided with your instrument on CD-ROM and/or in printed form. Printed manuals are an option for many products. Manuals may also be available on the Web. Go to www.keysight.com and type in your product number in the Search field at the top of the page.

General This product is a Safety Class 1 instrument (provided with a protective earth terminal). The protective features of this product may be impaired if it is used in a manner not specified in the operation instructions.

All Light Emitting Diodes (LEDs) used in this product are Class 1 LEDs as per IEC 60825-1.

Environment Conditions This instrument is intended for indoor use in an installation category II, pollution degree 2 environment. It is designed to operate at a maximum relative humidity of 95% and at altitudes of up to 2000 meters.

Refer to the specifications tables for the ac mains voltage requirements and ambient operating temperature range.

Before Applying Power Verify that all safety precautions are taken. The power cable inlet of the instrument serves as a device to disconnect from the mains in case of hazard. The instrument must be positioned so that the operator can easily access the power cable inlet. When the instrument is rack mounted the rack must be provided with an easily accessible mains switch.

Ground the Instrument To minimize shock hazard, the instrument chassis and cover must be connected to an electrical protective earth ground. The instrument must be connected to the ac power mains through a grounded power cable, with the ground wire firmly connected to an electrical ground (safety ground) at the power outlet. Any interruption of the protective (grounding) conductor or disconnection of the protective earth terminal will cause a potential shock hazard that could result in personal injury.













Do Not Operate in an Explosive Atmosphere Do not operate the instrument in the presence of flammable gases or fumes.

Do Not Remove the Instrument Cover Operating personnel must not remove instrument covers. Component replacement and internal adjustments must be made only by qualified personnel.

Instruments that appear damaged or defective should be made inoperative and secured against unintended operation until they can be repaired by qualified service personnel.

Safety Symbols

Table 1. Safety Symbol

Symbol	Description
	Indicates warning or caution. If you see this symbol on a product, you must refer to the manuals for specific Warning or Caution information to avoid personal injury or damage to the product.
	Frame or chassis ground terminal. Typically connects to the equipment's metal frame.
	Indicates hazardous voltages and potential for electrical shock.
	Indicates that antistatic precautions should be taken.
	Indicates hot surface. Please do not touch.
	CSA is the Canadian certification mark to demonstrate compliance with the Safety requirements.
	CE compliance marking to the EU Safety and EMC Directives. ISM GRP-1A classification according to the international EMC standard. ICES/NMB-001 compliance marking to the Canadian EMC standard.
	The RCM mark indicates that this product meets EMS/Product Safety Requirements and may be imported to Australia and New Zealand.
	This mark indicates compliance with the Canadian EMC regulations.
	This text denotes the instrument is an Industrial Scientific and Medical Group 1 Class A product.
	China RoHS regulations include requirements related to packaging, and require compliance to China standard GB18455-2001. This symbol indicates compliance with the China RoHS regulations for paper/fiberboard packaging.
	Indicates the time period during which no hazardous or toxic substance elements are expected to leak or deteriorate during normal use. Forty years is the expected useful life of the product.
	The South Korean Class A EMC declaration (KC) mark indicates that this product is Class A suitable for professional use and is for use in electromagnetic environments outside of the home. The KC mark includes the marking's identifier code that has up to 26 digits and follows this format: KCC-VWX-YYY-ZZZZZZZZZZZZ.

Compliance and Environmental Information

Table 2. Compliance and Environmental Information

Safety Symbol	Description
	<p>This product complies with WEEE Directive (2002/96/EC) marking requirements. The affixed label indicates that you must not discard this electrical/electronic product in domestic household waste.</p> <p>Product Category: With reference to the equipment types in WEEE Directive Annex I, this product is classed as a “Monitoring and Control instrumentation” product.</p> <p>Do not dispose in domestic household waste.</p> <p>To return unwanted products, contact your local Keysight office, or see www.keysight.com/environment/product/ for more information.</p>

Contents

1	Getting Started	9
1.1	General	9
1.1.1	Key Features	9
1.1.2	Internal clock system	9
1.1.3	PRBS generator	10
1.1.4	Error detector	10
1.1.5	Operating modes	10
1.1.6	Display	10
1.1.7	Data entry / interface	10
1.2	N4962A Operation Overview	11
1.3	Getting Started with the N4962A Serial BERT 12.5 Gb/s	12
1.3.1	Unpacking and Installation	12
1.3.2	Safety and Regulatory	13
1.3.3	Declaration of Conformity	13
1.3.4	Important Notes	13
1.3.5	Performance Recommendations	14
1.4	Connect the Hardware	14
1.5	Turn It On	14
1.6	Align Clock and Data	15
1.7	Make the Measurement	15
2	N4962A System Overview	17
2.1	Front Panel Quick Reference	18
2.2	Rear Panel Quick Reference	21
2.3	Connector Care	22
3	System Details and Performance Specifications	23
3.1	General	23
3.2	Safety and Regulatory	24
3.3	Internal Clock	24
3.4	PRBS Generator	27
3.5	Error Detector	29
3.6	Data Path	32

4	Operation.....	33
4.1	General Information.....	33
4.1.1	Performance Recommendations.....	34
4.1.2	Connector Care.....	34
4.2	Front Panel Interface.....	35
4.2.1	Front Panel – Display Panel.....	36
4.2.2	Front Panel – Local, Receiver, and Data Path Controls.....	37
4.2.3	Front Panel – Configuration Adjustment Controls.....	39
4.2.4	Front Panel – Display Selection Controls.....	44
4.3	Rear Panel Interface.....	46
4.4	Power-On State.....	48
4.5	System Verification.....	49
4.5.1	Self Test Mode.....	49
4.5.2	Error Free Test.....	50
4.5.3	High BER Test.....	50
4.5.4	Low BER Test.....	51
4.6	BER Detector Clock Phase Adjustment.....	51
4.7	Basic BER Measurement.....	53
5	Remote GPIB Interface.....	55
5.1	GPIB Capabilities.....	56
5.2	GPIB Command Syntax.....	57
5.2.1	Command Structure.....	58
5.3	IEEE Common Commands.....	59
5.4	SCPI Mandated Commands.....	60
5.5	N4962A Device Commands.....	60
5.5.1	Internal Clock Commands.....	61
5.5.2	PRBS Pattern Commands.....	65
5.5.3	Measurement Commands.....	70
5.6	Examples.....	80
6	Returning the N4962A Serial BERT to Keysight Technologies.....	85

1 Getting Started

1.1 General

The N4962A serial BERT 12.5 Gb/s operates from 500 Mb/s – 12.5 Gb/s referencing an external clock, and from 9.90 – 11.35 Gb/s with the programmable internal clock.

The N4962A includes:

- Internal clock system
- PRBS generator
- Error detector

1.1.1 Key Features

- Low cost, high performance
- Programmable output amplitude control
- Electronic receiver clock phase adjust
- Differential inputs and outputs
- Synchronous clock & pattern triggers
- Selectable pattern lengths, mark density
- Data Thru switch on Receiver for use with Oscilloscope on received data
- Controlled with GPIB control bus format

1.1.2 Internal clock system

- Internal clock 9.90 to 11.35 GHz
- External clock input for 0.5 to 12.5 GHz operation

1.1.3 PRBS generator

- Selectable PRBS patterns:
 - Lengths: 2^7-1 , $2^{10}-1$, $2^{15}-1$, $2^{23}-1$, $2^{31}-1$
 - Mark densities: 1/2, 1/4, 1/8
- Adjustable PRBS amplitude:
 - Voltage: 0.3 - 1.8 V pp per output
 - Step size: 10 mV

1.1.4 Error detector

- Automatic sampling point adjustment
- Elapsed time BER measurements
- Manual threshold adjustment)

1.1.5 Operating modes

- Disabled ('safe mode': no output)
- Enabled (PRBS output enabled)
- Thru (no detector; inputs connected to Data Thru connectors on back panel)

1.1.6 Display

- LED indicators
- Multifunction alphanumeric display

1.1.7 Data entry / interface

- Push-button control (local)
- Remote GPIB (IEEE 488.2-1992)
- Compatible with N4980A multi-instrument BERT software user interface

1.2 N4962A Operation Overview

The Keysight Technologies N4962A is a cost-effective serial BERT 12.5 Gb/s, consisting of an internal clock system, PRBS generator, and error detector. It is designed for automated production-line testing, manufacturing, characterization, and R&D lab use. The N4962A features high-UI jitter injection and programmable output amplitude.

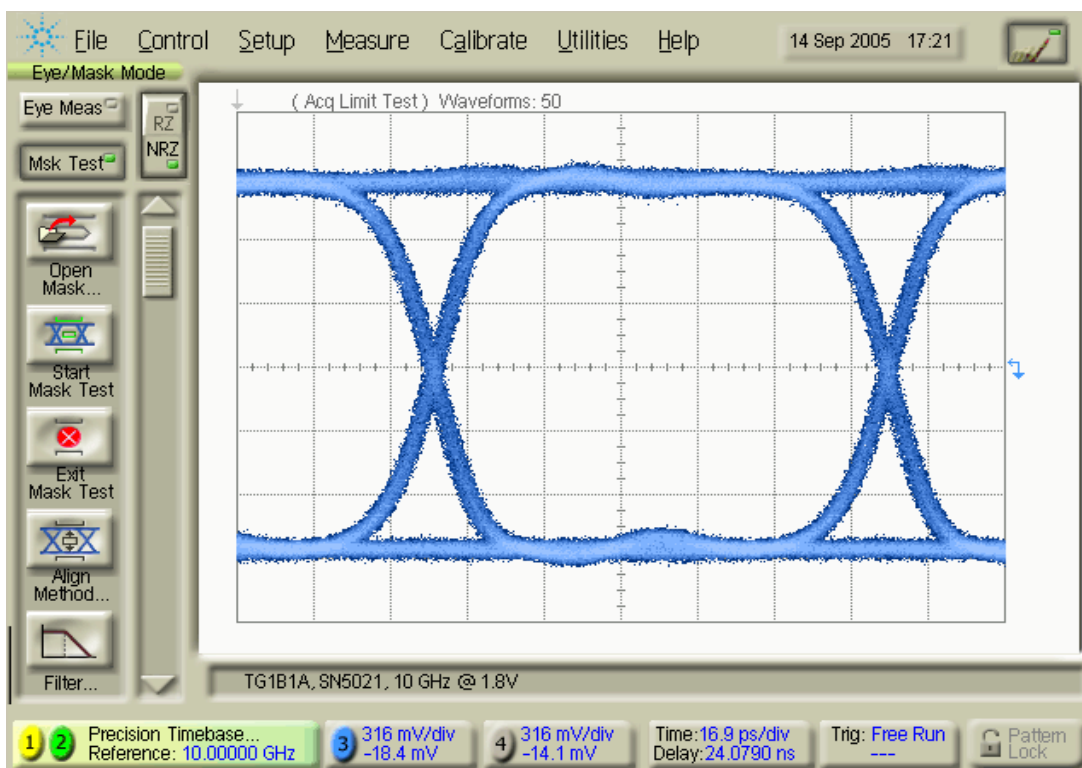

Figure 1. Eye waveform

The N4962A generates a continuous bit pattern that is applied to the DUT then fed back into the error detector. The input is automatically synchronized and compared with the original bit stream. The bit error rate is calculated by comparing the number of bit errors to the total number of bits transmitted. The BER can be shown on the display and can be captured through the remote GPIB interface.

1.3 Getting Started with the N4962A Serial BERT 12.5 Gb/s

1.3.1 Unpacking and Installation

The N4962A serial BERT 12.5 Gb/s is shipped with all the accessories required for the self-test mode and verification. The contents includes:

- N4962A serial BERT 12.5 Gb/s
- Two coax cables to connect rear-panel clocks (TX CKO, RX CKO to TX CKI, RX CKI)
- Two phase balanced 50 Ω coaxial cables for self-test mode (IN, /IN to OUT, /OUT)
- Four 2.92 mm male-female adapters
- AC power converter module
- AC power cord
- CD containing the N4962A User Guide and N4962A Data Sheet

Refer to the N4960-90030 N495xA through N498xA Connector Care Reference Guide at www.Keysight.com/find/N4962A.

WARNING

If this product is not used as specified, the protection provided by the equipment could be impaired. This product must be used in a normal condition (in which all means for protection are intact) only.

CAUTION

Before switching on this instrument, make sure the supply voltage is in the specified range.

CAUTION

This instrument has autoranging line voltage input. Be sure the supply voltage is within the specified range.

In an ESD-safe environment, carefully remove the N4962A. Install on a flat surface with unobstructed air flow to the back panel. Plug the AC power cord into the power converter module and a wall socket, then plug the converter module into the N4962A.

1.3.2 Safety and Regulatory

This product has been designed and tested in accordance with accepted industry standards, and has been supplied in a safe condition. The documentation contains information and warnings that must be followed by the user to ensure safe operation and to maintain the product in a safe condition.

WARNING

Do not remove instrument covers. There are no user serviceable parts within. Operation of the instrument in a manner not specified by Keysight Technologies may result in personal injury or loss of life.

WARNING

For continued protection against fire hazard, replace fuses, and or circuit breakers only with same type and ratings. The use of other fuses, circuit breakers or materials is prohibited.

WARNING

To prevent electrical shock, disconnect instrument from mains before cleaning. Use a dry cloth or one slightly dampened with water to clean the external case parts. Do not attempt to clean internally.

CAUTION

The Mains wiring and connectors shall be compatible with the connector used in the premise electrical system. Failure, to ensure adequate earth grounding by not using the correct components may cause product damage, and serious injury.

1.3.3 Declaration of Conformity

A EU declaration of conformity is available at
<http://regulations.about.Keysight.com/doc/search.htm>

1.3.4 Important Notes

- Use ESD protection at all times when using the instrument
- Review min/max specifications before applying input signals
- Use only K-connectors on the OUT and /OUT ports
- Handle the pair of self-test and clock loop coaxial cables with care
- Leave dust jackets on unused back panel connectors
- Situate the instrument away from heat sources, do not block the fan

1.3.5 Performance Recommendations

- When using differential-mode connections, ensure the cables are phase balanced
- Differential connectors may be used single-ended if unused ports are terminated in 50 Ω
- Use high quality cables and connector savers (or adaptors)
- Keep cable lengths short and minimize number of cable bends
- Use a 7-10 in-lbs torque wrench when attaching connectors
- Terminate all unused RF connectors with 50 Ω terminations

1.4 Connect the Hardware

- Connect power cord to adaptor to N4962A; plug in the power cord
- Connect TX CKO to TX CKI with included coaxial cable
- Connect RX CKO to RX CKI with included coaxial cable
- Connect the OUT (and optionally /OUT to your DUT input
- Connect your DUT output to IN (and optionally /IN)

1.5 Turn It On

- Turn on the power switch from the back panel
- Press the Data Path > **Select Path** button and select **Enabled**
 - This will turn on the PRBS output; when Disabled is selected, the instrument is in a 'safe mode' and no output is generated
- Press the Display > **Scroll ↓** button and select **Ampl (V)**
- Press the Adjust > **Ampl +/-** buttons to set the single-ended output voltage

1.6 Align Clock and Data

- Press the Data Path > PRBS button only if the DUT is inverting
 - When on, the PRBS will generate an inverted output signal
- Press the Display > **Scroll ↓** button and select **Ø**
- Press the Adjust > **Config State +** button to auto-set the detector phase
- Observe the Error **e** light
 - The light indicates errors are being measured by the error detector, if the light is on, no error-free sampling point could be found

1.7 Make the Measurement

- Press the Receiver > **On** button and ensure the light is on
- Press the Display > **Scroll ↓** button and view **Err** (error counter)
- Press the Display > **Scroll ↓** button and view **BER**
- Press the Display > **Scroll ↓** button and view **e time (sec)**
- Press the Receiver > **On** button to end the measurement

2 N4962A System Overview

The N4962A consists of three functional blocks:

- Internal/external clock system with analog jitter injection
- PRBS generator (TX) with variable output amplitude control
- Error detector (RX) with electronic clock phase adjustment

The N4962A is controlled by front-panel buttons and remote GPIB (IEEE 488.2) commands; information is conveyed with LED indicators and a display on the front panel, along with GPIB data communication.

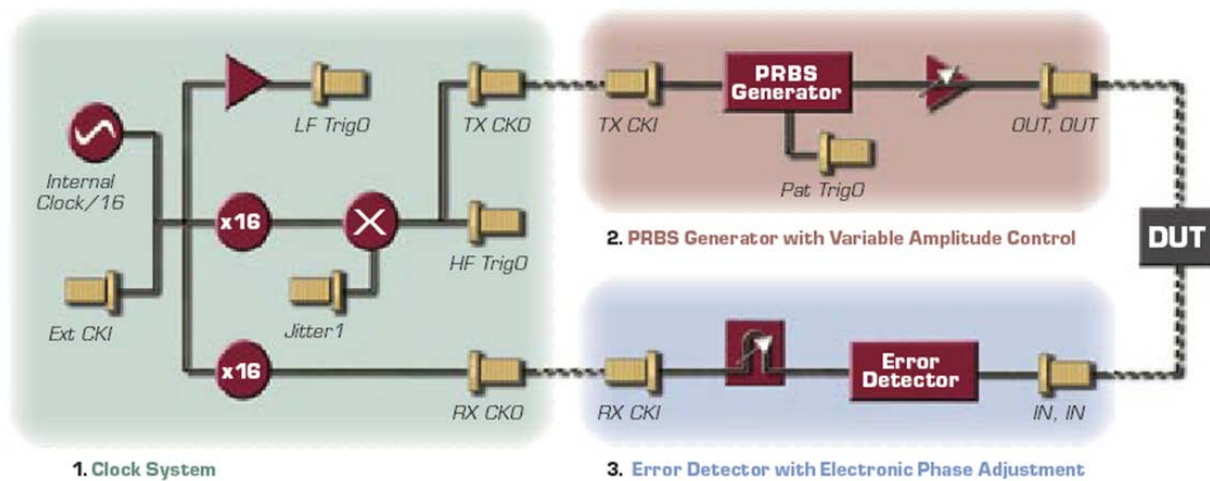

Figure 2. N4962A simplified block diagram; system overview

The clock system features an internal generator that creates a 9.90 to 11.35 GHz system clock from an internal 1/16th-rate clock generator. The internal clock/16 can also be phase locked to an external 1/16th clock if desired. The high-frequency TX clock and trigger output can be FM-modulated with an optional external jitter signal. Alternatively, external 500 Mb/s to 12.5 Gb/s clocks can be used in place of the internal high-frequency clocks for the PRBS generator and error detector.

The PRBS generator creates a continuous bit stream triggered by the input clock rate, configured by the selectable pattern length, mark space density, data inversion, and error injection settings. The output is amplified by a programmable gain stage.

The error detector compares the input to an automatically-synchronized bit stream generated with the same system settings. The clock input features an electronic phase adjuster to correctly align the clock and data sampling point.

The system settings can be set by the local push-button interface or remote GPIB (IEEE 488.2) interface. All settings can be accessed through the menu system or through GPIB commands. The N4962A is compatible with the N4980A multi-instrument BERT software which is available through Keysight Technologies to help speed up programming time.

2.1 Front Panel Quick Reference



Figure 3. N4962A front panel

Connectors	<p><i>RECEIVER:</i> IN, /IN (SMA) – input to error detector (differential or single-ended)</p> <p><i>SOURCE:</i> OUT, /OUT (2.92 mm K) – PRBS generator output (differential or single-ended)</p>
Display	<p>(display panel) – eight-character display to show display status and configure system</p> <p>Error ε (light) – indicates errors are being detected by the error detector</p>

Controls

Local (button & light) – indicates local (vs. remote) control; button selects local control

Receiver >

On (button & light) – indicates detector state; button toggles & resets BER

Data Path >

PRBS (button & light) – indicates inversion of PRBS signal; button toggles

Select Path (button & 3 lights) – data path (disabled, enabled, thru); button cycles

Adjust >

Freq (2 buttons) – adjust the internal clock frequency up or down (shown on display)

Ampl (2 buttons) – adjust the PRBS output amplitude up or down (shown on display)

∅ (2 buttons) – adjust the detector clock phase up or down (shown on display)

Config State (2 buttons) – change value of the currently-displayed configuration state.

Display >

Scroll (2 buttons & 6 lights) – select which feature is shown on the display panel:

- BER – measured BER (# bit errors / total # bits)
- ϵ time (sec) – elapsed time of BER measurement, in seconds
- Ampl (V) – single-ended PRBS generator output amplitude, in volts per side
- Freq (GHz) – internal clock frequency, in GHz (10 GHz corresponds to 10 Gb/s)
- ∅ – BER clock phase adjustment, in degrees (360-degrees = 1 UI)
- Config State – selects one of the configuration states shown in *Table 3*.

Table 3. Configuration state details (shown on display panel, default in BOLD)

Config State	Description	Options
PAT 2E31	PRBS generator pattern length	<i>2E31</i> , 2E23, 2E15, 2E10, 2E7
MS <i>0.500</i>	PRBS generator mark space density	0.500 (1/2), 0.250 (1/4), 0.125 (1/8)
Jitter <i>0</i>	Jitter injection mode	0 (low-jitter mode), 1 (external jitter on)
Synth <i>1</i>	Internal clock mode	<i>0</i> (internal clock off), 1 (Internal clock on)
Err00000	Lowest digits of error counter	
ErAd <i>OFF</i>	PRBS digital error injection	OFF , 1E0, 1E1, ..., 1E7 (errors per second)
NoData <i>0</i>	Error detector data sense	0 (data sense off), 1 (data sense on)
TD= 0010	Time delay for measurement start (for long length DUT)	10-9999 (1/10 th of a microsecond)
APT=0010	Autophase procedure measurement time	0-5000 (1/10 th of a millisecond per phase step; default 10 (1ms time per step))
1234R567	Serial number and FW revision (only the last four digits of the serial number are shown on the front panel display)	none

(Display > Scroll to select state; Adjust > Config State to change value)

2.2 Rear Panel Quick Reference



Figure 4. N4962A rear panel

Connectors	<p>DataThru, DataThru (SMA) – connected to IN, IN when ‘thru’ data path selected.</p> <p>PatTrigO (SMA) – PRBS pattern trigger output</p> <p>TX CKI (SMA) – PRBS generator clock input (default connected to TX CKO)</p> <p>RX CKI (SMA) – error detector clock input (default connected to RX CKO)</p> <p>RX CKO (SMA) – internal clock output for error detector</p> <p>TX CKO (SMA) – internal clock output for PRBS generator</p> <p>HF TrigO (SMA) – high-frequency (9.90 – 11.35 GHz) clock output</p> <p>LF TrigO (SMA) – low-frequency (619 – 709 MHz) clock output</p> <p>Ext CKI (SMA) – low-frequency (619 – 709 MHz) clock input; used to phase lock with external clock source</p> <p>JitterI (SMA) – jitter signal input (DC-100 MHz); turn jitter mode on before use</p> <p>(GPIB) – GPIB connector, conforms to IEEE 488.1 mechanical specification</p>
Label	<p>SN (white area) – N4962A serial number</p>
Controls	<p>GPIB (switch panel) – N4962A GPIB address (down is ‘0’, up is ‘1’, LSB is on the left)</p> <p>(Default GPIB address as shipped from the factory is 25)</p> <p>Power (switch) – N4962A is powered when switch is toggled up towards ‘Power’ label</p> <p>Power connector – connects with AC/DC adapter. Use only the supplied AC/DC adapter.</p>

2.3 Connector Care

Refer to the N4960–90030 N495xA through N498xA Connector Care Reference Guide at www.Keysight.com/find/N4962A.

Inspect the connectors for the following:

- Worn or damaged threads
- Scratches to mating surface
- Burrs and loose metal particles
- Dust or foreign material in the space surrounding the center pin (type K only)
- Ensure that female contacts are straight and aligned

Clean the connectors as described in the following procedure. Cleaning connectors with alcohol shall only be done with the instruments power cord removed, and in a well-ventilated area. Allow all residual alcohol moisture to evaporate, and the fumes to dissipate prior to energizing the instrument.

1. Remove any dust or loose particles using a low-pressure air source.
2. Moisten a lint-free swab with isopropyl alcohol. Do not saturate the swab.
3. Minimize the wicking of the alcohol into the connector structure.
4. Clean the mating plane surfaces and threads.
5. Allow alcohol to evaporate, and then use a low-pressure air source to blow surfaces clean.
6. Make sure no particles or residue remains.
7. Inspect connector for damage.

3 System Details and Performance Specifications

Specifications describe the instrument's warranted performance. Non-warranted values are stated as typical. All specifications are valid in a range from 10°C to 40°C ambient temperature after a 30 minute warm-up phase. If not otherwise stated, all unused RF inputs and outputs must be terminated with the included 50 Ω -terminated connectors.

3.1 General

Table 4. General and mechanical parameters of N4962A

Operating Temperature	+10°C to +40°C
Storage Temperature	-40°C to +70°C
Power Requirements	42 W External AC Adaptor (included) <ul style="list-style-type: none"> • 100 to 240 VAC, 47 to 63 Hz
Physical Dimensions	Width: 254 mm (10 in), Height: 63.5 mm (2.5 in), Depth: 254 mm (10 in)
Weight	3.4 kg (7.5 lbs)
EMC	Complies with European EMC Directive 2004/108/EC <ul style="list-style-type: none"> • IEC/EN 61326-1 • CISPR Pub 11 Group 1, class A • AS/NZS CISPR 11 • ICES/NMB-001 <p>This ISM device complies with Canadian ICES-001. Cet appareil ISM est conforme a la norme NMB-001 du Canada.</p>

3.2 Safety and Regulatory

WARNING

Do not remove instrument covers. There are no user serviceable parts within. Operation of the instrument in a manner not specified by Keysight Technologies may result in personal injury or loss of life.

WARNING

To prevent electrical shock, disconnect instrument from mains before cleaning. Use a dry cloth or one slightly dampened with water to clean the external case parts. Do not attempt to clean internally.

WARNING

For continued protection against fire hazard, replace fuses, and or circuit breakers only with same type and ratings. The use of other fuses, circuit breakers or materials is prohibited.

CAUTION

The Mains wiring and connectors shall be compatible with the connector used in the premise electrical system. Failure, to ensure adequate earth grounding by not using the correct components may cause product damage, and serious injury.

3.3 Internal Clock

The internal clock is generated from a low-frequency (LF) 1/16th-rate clock signal that is multiplied up to the high-frequency (HF) clock rate, 9.90 to 11.35 GHz. The internal HF clock or an external 500 MHz to 12.5 GHz clock is required to trigger the PRBS generator and error detector. The generator and detector operate at 1 bit per clock cycle (10 Gb/s at a clock speed of 10 GHz).

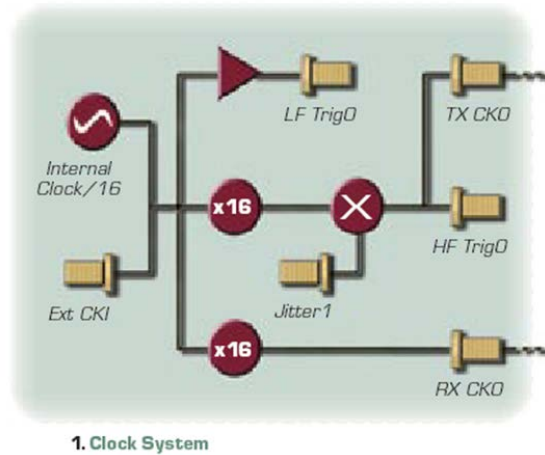

Figure 5. N4962A block diagram – internal clock system

The internal LF 1/16th-rate clock can be phase locked to an external source in order to synchronize the N4962A with the external device. To synchronize the clocks, follow the procedure detailed below. The internal or external LF clock is available from the buffered LF TrigO connector.

To ensure phase lock of an external LF clock applied to the ExtCKI port, the following procedure must be used:

1. Turn off the external signal generator RF output
2. Set external signal generator to new 1/16th-rate RF frequency
3. Set N4962A to new HF frequency value (or nearest value)
4. Turn on the external signal generator RF output
5. Turn off the N4962A internal synthesizer (change "synth" to 0)

Users wanting to change frequency from this condition should:

1. Turn on the internal synthesizer (synth to 1)
2. Turn off the external signal generator RF output
3. Set the external signal generator to the new 1/16th-rate frequency
4. Set the N4962A to new HF frequency value (or nearest value)
5. Turn on the external signal generator RF output
6. Turn off the N4962A internal synthesizer (synth to 0)

The clocks should now be phase locked to the new frequency.

Table 5. Parameters for N4962A internal low-frequency clock (LF TrigO, Ext CKI)

Frequency	618.75 to 709.375 MHz
Max input amplitude	Ext CKI: 2.0 Vpp (+10 dBm)
Output power	LF TrigO, 0.5 V pp typical
Connector	Female SMA, single-ended, AC coupled, 50 Ω impedance

NOTE

The LF 1/16th rate clock must phase lock to the data rate clock.

The LF clock is multiplied up to HF clock frequencies and is split into two output paths: a transmit clock for the PRBS generator, TX CKO, which can be modulated with an external jitter input signal, and a receive clock for the error detector, RX CKO. Both outputs are buffered. The clock outputs are connected by default to the input clock connectors for the PRBS generator and error detector, TX CKI and RX CKI, with a pair of coaxial cable loops.

To trigger the PRBS generator and error detector with an external 500 MHz to 12.5 GHz clock, remove the coax loops and apply the external source to TX CKI and RX CKI. The generator and detector must be triggered with the same phase-synchronous clock. Ensure that at least 0 dBm (630 mV pp) is applied to the TXCKI and the RXCKI input. Do not apply more than +5 dBm (1.1 V pp) to these inputs.

Table 6. Parameters for N4962A internal clock (TX CKO, RX CKO, HF TrigO)

Frequency	9.90 to 11.35 GHz, over-programmable to 9.98 GHz ¹
Resolution	10 MHz front-panel, 1 MHz GPIB
Output power	TX CKO, Typ: +4 dBm (1 V pp) RX CKO, Typ: +4 dBm (1 V pp) HF TrigO, Typ: +6 dBm (1.3 V pp)
Connector	Female SMA, single-ended, AC coupled, 50 Ω impedance

¹ Internal clock is over-programmable down to 9.98 GHz, but performance below 9.90 GHz is not guaranteed.

The TX clock, available from the buffered HF TrigO and TX CKO connectors, features the optional addition of an external jitter signal.

To add jitter to the PRBS clock, and therefore to the PRBS output signal, switch into jitter-injection mode by changing the Config State “Jitter” setting to 1, and apply a DC to 100 MHz sinusoid to the JitterI connector. The jitter input signal will be FM modulated onto the clock; the amount of added jitter corresponds to the amplitude of the input signal.

The Jitter setting of 0 will still FM modulate any signal under 100 kHz. To properly ensure no jitter is added, disconnect any source from the JitterI connector.

Table 7. Parameters for N4962A internal clock jitter injection (JitterI)

Frequency	Typ: DC to 100 MHz
Input Voltage	2 V pp max
Jitter Added	Up to 5 UI \leq 2 MHz, up to 0.15 UI \geq 10 MHz
Connector	Female SMA, single-ended, DC coupled, 50 Ω impedance

NOTE

Switch to jitter-injection mode before applying a signal to JitterI

3.4 PRBS Generator

The PRBS generator creates a continuous bit stream based on the configuration settings and the TX CKI input clock rate. The internal clock can be used for 9.90 to 11.35 Gb/s operation, or an external clock can be used for 500 Mb/s to 12.5 Gb/s operation. The PRBS generator and error detector must be clocked at the same rate.

The PRBS generator configuration includes selectable pattern length, mark space density ratio, and digital error injection settings. The PRBS also features polarity control to allow for both inverting and non-inverting DUTs. These configuration settings are detailed in Section 4.2.

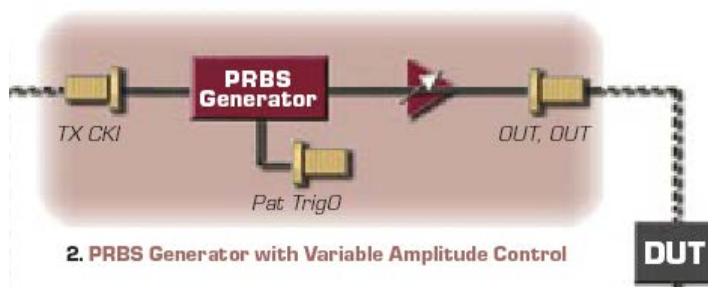

Figure 6. N4962A block diagram – PRBS generator

The PRBS output bit stream is amplified by an adjustable gain stage. The output amplitude ranges from 300 mV pp to 1800 mV pp per output (0.6 V pp to 3.6 V pp differential) in 10 mV pp increments.

The amplified PRBS output signal is available from the single-ended or differential 2.92 mm K-connector OUT and /OUT connectors on the front panel. The PRBS generator also generates a pattern trigger output, available from Pat TrigO on the back panel, which changes state after 32 complete PRBS bit streams have been generated. Pat TrigO has a frequency equal to $(\text{clock_rate}) / (32 * \text{bit_pattern_length})$. Users of Pat TrigO should verify that its output is a square wave in order to ensure proper pattern triggering.

Table 8. Parameters for N4962A PRBS generator (OUT, OUT)

Data rate	0.5 to 12.5 Gb/s
PRBS patterns	$2^n - 1$, $n=7, 10, 15, 23, 31$
Mark space density	1/2, 1/4, 1/8
Pattern invert	available for all patterns
Error injection	selectable uniform rate
Error injection rates	1×10^n errors per second, $n = 1, 2, 3, 4, 5, 6, 7$
Data output amplitude	300 to 1800 mV pp (single-ended)
Data output amplitude resolution	10 mV
Data output jitter	1.1 ps rms typical at 10 Gb/s
Data output rise/fall time (20% to 80%)	18 ps typical, 23 ps maximum
Data output external interface	(May be operated single end without unused output terminated into 50 Ω .)
TXCKI Clock input frequency range	0.5 to 12.5 GHz
TXCKI Clock input amplitude range	0 to +5 dBm (630 mV pp to 1.1 V pp)
TXCKI Clock input external interface	AC coupled, 50 Ω nominal, female SMA

The PRBS bit stream consists of data generated by one of five patterns, listed in Table 9. The pattern length is a system configuration setting, selected by changing the Config State “PAT xxxx” setting, detailed in Section 4.2.3.

Table 9. N4962A PRBS generator patterns

Pattern	Config State	Polynomial	Tone Spacing (10Gb/s)	ITU Standard
$2^{31} - 1$	2E31	$X^{31} + X^{28} + 1 = 0$	4.67 Hz	ITU-T 0.150
$2^{23} - 1$	2E23	$X^{23} + X^{18} + 1 = 0$	1.19 kHz	ITU-T 0.150
$2^{15} - 1$	2E15	$X^{15} + X^{14} + 1 = 0$	305 kHz	ITU-T 0.150
$2^7 - 1$	2E7	$X^7 + X^6 + 1 = 0$	78.7 MHz	ITU-T V.29

3.5 Error Detector

The error detector counts errors in the input bit stream, based on the configuration settings and the RX CKI input clock rate. The internal clock can be used for 9.90 to 11.35 Gb/s operation, or an external clock can be used for 500 Mb/s to 12.5 Gb/s operation. The PRBS generator and error detector must be clocked at the same rate.

The error detector samples the input bit stream on the rising edge of the clock. If the clock transition occurs near the data transition – that is, if the clock and the data are changing at the same time – the sampled data value is uncertain, which may result in high BER. This is illustrated in Figure 13.

To ensure the clock and data transition points are correctly offset, the error detector features a user-adjustable 360-degree electronic phase shifter. The phase shifter delays the clock input to the detector, allowing the user to select the optimal sampling point. The N4962A can automatically adjust the receiver phase to the best sampling point, detailed in Section 4.6.

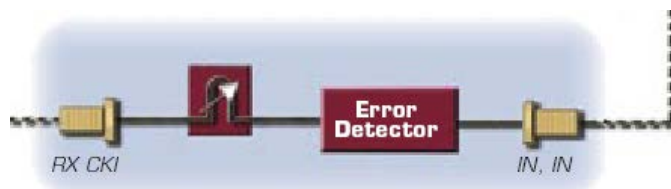

3. Error Detector with Electronic Phase Adjustment

Figure 7. N4962A block diagram – error detector

The error detector compares the sampled input bit stream to a separate internal PRBS signal generated with the same configuration settings as the PRBS generator. The error detector automatically synchronizes its internal PRBS with the incoming bit stream, in a process called ‘training’. The error detector is in training mode when off, and switches to error-counting mode when the detector is turned on. Assuming the training was successful, and the error detector was able to synchronize with the input bit stream, the detector starts counting errors less than 1 us after turning on.

Training the error detector takes approximately 50 us, and requires a somewhat error-free input bit stream. If the detector is unable to synchronize with the incoming bit stream, the measured BER will be very high. This is only an issue for bit error rates higher than 5E-01 (50% of incoming bits are errors); for most applications with high BER, the detector will auto-synchronize very rapidly.

The phase adjustment offers 2 degree resolution capability from 5 Gb/s to 12.5 Gb/s. The linearity accuracy of phase is limited to 10 degree steps for operation from 5 Gb/s to 12.5 Gb/s. For external clock rates below 5 GHz the specific values of 0, 90, 180 or 270 degrees are required for the receiver clock phase alignment in order to obtain correct BER results. Employing the receiver’s auto-phase feature or manual adjustment to the receiver phase resulting in any other phase values may lead to receive errors. Users requiring greater precision in receiver clock and data alignment below 5 GHz can achieve this result using external means such as a mechanical phase-shifter.

Table 10. Parameters for N4962A error detector (IN, /IN)

Data rate	0.5 to 12.5 Gb/s
PRBS patterns	$2^n - 1$, $n=7, 10, 15, 23, 31$
Data input sensitivity (single ended)	0.1 V pp typical
Data input voltage range	2 Vpp max (single-ended) ± 0.5 V DC common mode voltage max
Data input phase adjust	0 to 360°
Data input phase adjust resolution	2° for data rates ≥ 5 Gb/s 90° for data rates < 5 Gb/s
Data input external interface	Differential. DC coupled, 50 Ω nominal, female SMA (May be operated single end without unused input terminated into 50 Ω)
RXCKI Clock input frequency range	0.5 to 12.5 GHz
RXCKI Clock input amplitude range	0 to +5 dBm (630 mV to 1.1 V pp)
RXCKI Clock input external interface	AC coupled, 50 Ω nominal, female SMA

After the error detector synchronizes with the incoming bit stream, and is turned on, it compares the sampled input bit stream against the synchronized comparison signal. The detector counts the number of bit errors and the total number of bits, and generates the BER measurement (# bit errors / total # bits). The error detector counter sizes have been selected to enable long-term BER measurements without counter overflow, detailed in Table 11. The measurement will stop if one of these counters reaches the maximum value.

Table 11. N4962A error detector counter specifications

Counter	Counter Size	Overflow Time at 12.5 Gb/s
Bit errors	48 bits	~12.5 hours (0.5 BER), 2606 days (1E-4 BER)
Total bits	56 bits	1601 hours (67 days)
Elapsed time bits	22 bits	4194304 seconds (48.5 days)

3.6 Data Path

The N4962A can operate in one of three data path configurations. The data path can be set from the front panel, detailed in Section 4.2.2, or through GPIB remote commands.

The current data path is indicated with the front panel lights. One of the three lights will be lit. The lights are labeled Disabled, Enabled, and Thru.

The Disabled data path is selected by default; this disables the PRBS output and can be considered a 'safe mode' to be used to avoid DUT damage. The Enabled data path turns on the PRBS output. The Thru data path connects the IN/IN signals directly to the DataThru and /DataThru output connectors on the back panel, with an associated switching loss in the data path. Errors are not counted. The data path configurations are summarized in Table 12.

The Thru feature allows users to ensure the quality and amplitude of the received signal is measured with a sampling scope without disconnecting the cables from the N4962A. Once the path loss is determined, an accurate estimate of the eye quality and amplitude can be determined for every test.

Table 12. N4962A data path configurations

Data Path light	Configuration	PRBS generator	Additional path loss
Disabled	IN/IN connected to error detector, default	Disabled	
Enabled	IN/IN connected to error detector	Enabled	
Thru	IN/IN connected to DataThru/DataThru	Enabled	Typ. 4 dB

4 Operation

The following section provides detailed information regarding the use of the N4962A serial BERT 12.5 Gb/s. Please refer to the front and rear panel quick reference, in Section 2, for abbreviated information.

4.1 General Information

The N4962A serial BERT 12.5 Gb/s should be used in accordance with the following:

- Read and follow operating instructions; do not exceed min/max specifications.
- Use ESD protection at all times, but especially when handling RF input/outputs; ground coaxial cable conductor pins before use to remove static buildup.
- Situate the instrument away from heat sources.
- Do not block airflow to the fan; do not allow foreign material into enclosure.
- Always use provided AC adaptor. Do not power the unit with a different adaptor. Do not modify the power plug or wall outlet to remove the third (ground) pin.
- Do not drop or shake the instrument; minimize vibration; handle with care.
- There are no user-serviceable parts within. Return damaged instruments for factory-authorized repair. Refer to instrument warranty for more information.

4.1.1 Performance Recommendations

Follow the following recommendations for best performance:

- When using differential mode connection for IN and /IN, OUT and /OUT, or DataThru and /DataThru, ensure the cables are phase balanced. If the electrical length of one cable is a significant fraction of a unit interval longer than the other, the quality of the differential signal will be degraded and BER will increase.
- Keep cable lengths short and minimize number of cable bends.
- Terminate all unused RF connectors with 50 Ω terminations.

4.1.2 Connector Care

The N4962A serial BERT 12.5 Gb/s features high-quality SMA connectors, and two 2.92 mm K-connectors for the front-panel OUT and /OUT interface. Keysight Technologies does not recommend using male SMA connectors with the female K-connectors; the male SMA pin has looser tolerances than the female K sleeve, and may damage the connector. Connector damage will degrade signal fidelity.

Refer to the N4960-90030 N495xA through N498xA Connector Care Reference Guide at www.Keysight.com/find/N4962A.

Keysight Technologies also recommends the following:

- Use a 7-10 in-lbs torque wrench when attaching connectors.
- Consider using connector savers to prolong performance and minimize damage.
- Differential connectors may be used single-ended if second end terminated in 50 Ω .
- Terminate all unused RF connectors with 50 Ω terminations.

4.2 Front Panel Interface



Figure 8. N4962A front panel

The N4962A front panel indicates system configuration, and can be used for local operation of the instrument. The front panel contains three groupings of buttons and lights (local, receiver, and data path controls; configuration adjustment controls; and display selection controls), a display panel and error light, and the PRBS generator (SOURCE) and error detector (RECEIVER) connectors.

The PRBS generator connectors, labeled SOURCE, are 2.92 mm K-connectors. The PRBS output is available in single-ended or differential form from these connectors. The output signal is specified in Section 3.3.

The error detector connectors, labeled RECEIVER, are SMA connectors. The input bit stream (from the output of the DUT) can be connected in single-ended or differential form to these connectors. The input signal requirements are specified in Section 3.4.

To use either the SOURCE or RECEIVER connector pairs in a single-ended configuration, terminate the unused RF connector in a 50 Ω termination. To use the connectors differentially, ensure the cables used are phase balanced – the same electrical length – to avoid errors caused by out-of-phase differential signals.

4.2.1 Front Panel – Display Panel

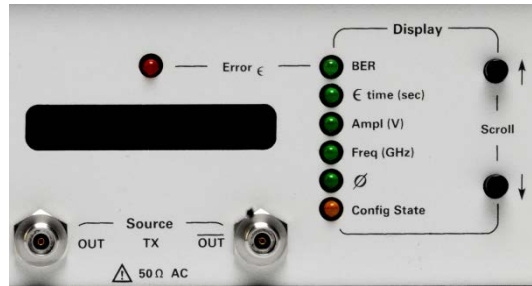

Figure 9. N4962A front panel – display panel

Table 13. N4962A front panel – display panel

Text	Type	Description	Default
Error e	light	The error light is lit for a short period of time when the error detector identifies a bit error. If the error light is solid red, many errors are being detected.	N/A
	display panel	<p>The eight-character display shows the current configuration option selected by using the <i>Display</i>-><i>Scroll UP</i> and <i>DOWN</i> buttons.</p> <p>When one of the configuration <i>Adjust</i> buttons (<i>Freq</i>, <i>Ampl</i>, <i>∅</i>) are pressed, the display will briefly show the corresponding configuration setting.</p>	Freq (GHz)

4.2.2 Front Panel – Local, Receiver, and Data Path Controls



Figure 10. N4962A front panel – local, receiver, and data path controls

Table 14. N4962A front panel – local, receiver, and data path controls

Text	Type	Description	Default
Local	button & light	<p>Light indicates local control:</p> <ul style="list-style-type: none"> ON when front-panel control is enabled; OFF when remote GPIB interface is in use. <p>Button switches to local control.</p>	ON
Receiver -> On	button & light	<p>Light indicates error detector is ON, and:</p> <ul style="list-style-type: none"> Elapsed time is accumulating; Total bits and errors are being counted; BER measurement is being calculated. <p>If detector is ON, pressing button:</p> <ul style="list-style-type: none"> Saves state (# bits, errors, & seconds); Turns off detector; Puts detector into training mode (for auto-synchronization of incoming bit stream). <p>If detector is OFF, pressing button:</p> <ul style="list-style-type: none"> Resets state (# bits, errors, & seconds); Turns on detector. 	OFF

Text	Type	Description	Default
<p><i>Data Path</i> -> PRBS Invert</p>	<p>button & light</p>	<p>Light indicates inverted PRBS generator output:</p> <ul style="list-style-type: none"> • OFF when PRBS bit stream is not inverted; • ON when PRBS bit stream is inverted. <p>Button toggles the output inversion ON and OFF.</p> <p>Inverting the bit stream after training and turning on the detector will result in a BER measurement approaching 1E0.</p>	<p>OFF</p>
<p><i>Data Path</i> -> Disabled Enabled Thru (none)</p>	<p>button & 3 lights</p>	<p>Light indicates which data path is selected:</p> <ul style="list-style-type: none"> • Disabled: IN and /IN connected to error detector, PRBS generator is disabled; • Enabled: IN and /IN connected to error detector, PRBS generator is enabled; • Thru: IN and /IN connected to DataThru and /DataThru with some path loss, PRBS generator is enabled; <p>Button cycles between the data path options.</p>	<p>Disabled</p>

4.2.3 Front Panel – Configuration Adjustment Controls



Figure 11. N4962A front panel – configuration adjustment controls

Table 15. N4962A front panel – configuration adjustment controls

Text	Type	Description	Default
Adjust -> Freq	UP and DOWN buttons	Buttons adjust internal clock frequency by 0.01 GHz: <ul style="list-style-type: none"> • UP increases frequency (max 11.35 GHz); • DOWN decreases frequency (min 9.90 GHz)¹. Display will briefly show new frequency setting after pressing either button, and then switches back to previously-displayed setting. When using an external clock (Synth = 0), the Freq adjust range is increased to 500 MHz min, 12.5 GHz max. The N4962A frequency setting should be set to the frequency of the external clock so that the N4962A frequency dependent parameters are correctly set.	10.0 GHz
Adjust -> Ampl	UP and DOWN buttons	Buttons adjust PRBS output amplitude by 10 mV: <ul style="list-style-type: none"> • UP increases amplitude (max 1800 mV); • DOWN decreases amplitude (min 300 mV). Display will briefly show new amplitude setting after pressing either button, and then switches back to previously-displayed setting.	500 mV

Text	Type	Description	Default
Adjust -> Ø	UP and DOWN buttons	<p>Buttons adjust BER clock phase by 2 degrees from 5 to 12.5 GHz, and in 90-degree increments below 5 GHz:</p> <ul style="list-style-type: none"> • UP increases phase offset (max 358, min 0) • DOWN decreases phase offset <p>Display will briefly show new clock phase setting after pressing either button, and then switches back to previously-displayed setting.</p>	0 degrees
Adjust -> Config State	PLUS and MINUS buttons	<p>Buttons adjust the value of the currently-displayed Config State (use the Display->Scroll buttons to select the current state):</p> <ul style="list-style-type: none"> • PAT 2E31 <ul style="list-style-type: none"> ○ options: 2E31, 2E23, 2E15, 2E10, 2E7 <p>PRBS output pattern length setting, where pattern lengths are 2^n-1, and n has a value in [31, 23, 15, 10, 7]. $2^{31}-1$ is the longest pattern, and repeats every 0.2 seconds at a clock speed of 10 GHz.</p> <ul style="list-style-type: none"> • MS 0.500 <ul style="list-style-type: none"> ○ options: 0.500, 0.250, 0.125 <p>PRBS output mark space density setting, which is the ratio of logic 1's to the total of logic 1's and logic 0's. A mark space density of 0.5 (1/2) indicates an equal number of 1's and 0's.</p> <ul style="list-style-type: none"> • Jitter 0 <ul style="list-style-type: none"> ○ options: 0, 1 <p>Jitter injection mode setting: 0 for normal operation, 1 for jittered operation. This setting is for optionally applying the DC-100 MHz jitter input signal. When 1, the modulator bandwidth is increased to allow the jitter input to be FM modulated onto the clock signals. The jitter added is proportional to the amplitude of the jitter input signal. For low jitter operation, set the Jitter command to 0, and remove any signal from the Jitter1 port.</p>	PAT 2E31 MS 0.500 Jitter 0 Synth 1 Err00000 ErAd OFF NoData 0 1234R567

Text	Type	Description	Default
		<ul style="list-style-type: none"> • Synth 1 <ul style="list-style-type: none"> ○ options: 0, 1 <p>Internal clock setting: 0 = use external clock (internal clock turned off); 1 = use internal clock.</p> <ul style="list-style-type: none"> • Err00000 <p>Five-digit error detector error counter, included for low BER applications, or for testing external error injection. The counter accumulates errors since the detector was reset, and wraps around 99999. This counter should not be used as the authoritative number of errors counted.</p> <ul style="list-style-type: none"> • ErAd OFF <ul style="list-style-type: none"> ○ options: OFF, 1E0, 1E1, 1E2, ..., 1E7 <p>Digital error injection setting, which indicates how many bit inversions occur per second. OFF indicates no bit errors are injected, 1E0 indicates 1 error per second, 1E7 indicates 10 million errors per second. To find the injected BER, divide by the clock frequency. For example, at a setting of 1E2 (100) errors per second, the BER will be 1E-8 at a clock rate of 10 GHz, or 8E-9 at 12.5 GHz. See Table 16.</p> <p>When Display->∅ is selected from the display selector, pressing the Adjust->Config State PLUS button will prompt the N4962A to automatically determine the optimum detector clock phase. This is detailed further in Section 4.6.</p> <ul style="list-style-type: none"> • NoData 0 <ul style="list-style-type: none"> ○ options: 0, 1 <p>NoData option helps with the initialization sequence. When the source is used with the error detector, this value should be set to 1. This helps with a condition when all zeros are loaded into the error detector's input, which can erroneously cause bad error rate numbers. This should be set to 0</p>	

Text	Type	Description	Default
		<p>when using a different manufacturer’s pattern generator, or a known good signal is used with the N4962A source.</p> <ul style="list-style-type: none"> • TD= 0010 <ul style="list-style-type: none"> ○ Min 0010 (1 μs), max 6500 (650 μs) <p>The TD (“Training Delay”) option delays the start of the error detector after the BER measurement has been initiated. This feature is used in conjunction with the NoData function. This delay, listed in 1/10th microseconds (default 1 us), allows the PRBS pattern time to transition through the DUT before measurement start. This can be very important for DUTs containing a long electrical length or an optical loop.</p> <ul style="list-style-type: none"> • APT=0010 <ul style="list-style-type: none"> ○ Min 0001 (0.1 ms), max 5000 (500 ms) <p>The APT (“Autophase Time”) option specifies the autophase search algorithm measurement time at each 2-degree phase point. This option allows the user to specify the measurement depth of the autophase algorithm.</p> <p>APT allows a tradeoff between the search time and positioning accuracy of the autophase algorithm. Because 180 phase points are measured, this option may increase the autophase time to a total of 90+ seconds.</p> <p>The confidence interval of a BER measurement, with frequency (GHz), gate time (seconds), and measurement depth (BER) is:</p> $CI = 1 - e^{-Freq(GHz) \times time(s) \times MeasDepth(BER)}$ <ul style="list-style-type: none"> • 1234R111 <ul style="list-style-type: none"> ○ options: none <p>This is the serial number and firmware revision</p>	

Text	Type	Description	Default
		code of the instrument (only the last four digits of the serial number are shown on the front panel display).	

¹ Internal clock is over-programmable down to 9.85 GHz, but performance below 9.90 GHz is not guaranteed.

Table 16. ErAd settings and expected BER measurements for 10 Gb/s operation

ErAd Setting (added errors per second)	Expected BER (10 GHz clock; no other errors)	Expected BER (12.5 GHz clock; no other errors)
OFF	0	0
1E0	1E-10	8E-11
1E1	1E-9	8E-10
1E2	1E-8	8E-9
1E3	1E-7	8E-8
1E4	1E-6	8E-7
1E5	1E-5	8E-6
1E6	1E-4	8E-5
1E7	1E-3	8E-4

4.2.4 Front Panel – Display Selection Controls

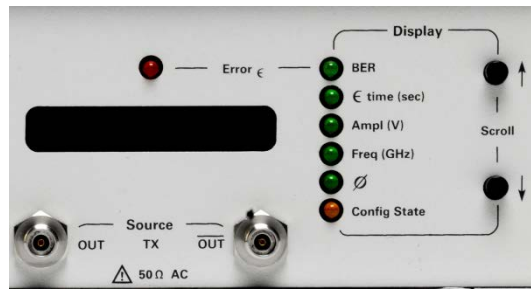

Figure 12. N4962A front panel – display selection controls

Table 17. N4962A front panel – display selection controls

Text	Type	Description	Default
<p>Display -> Scroll</p>	<p>UP and DOWN buttons and 6 lights</p>	<p>Buttons select the measurement or configuration option to display on the display panel:</p> <ul style="list-style-type: none"> • UP selects the previous display item; • DOWN selects the next display item. <p>The selection process wraps around the display options (pressing DOWN at the last item selects the first item).</p> <p>The display options are:</p> <ul style="list-style-type: none"> • BER <p>Displays the current measured bit error rate (BER), defined as the total number of bit errors divided by the total number of bits (bit counters detailed in Table 11).</p> <p>If the error detector is on (Receiver->On light is ON), the BER shown is a measurement that is being calculated in real time. If the detector is off, the BER shown is from the previous session (captured while the detector was previously on).</p> <ul style="list-style-type: none"> • ε time (sec) <p>Displays the elapsed time of the BER measurement, in seconds. If the error detector is on, the elapsed time will</p>	<p>Freq (GHz)</p>

Text	Type	Description	Default
		<p>increment in real time. If the error detector is off, the elapsed time shown is from the previous session.</p> <ul style="list-style-type: none"> • Ampl (V) Displays the single-ended PRBS output amplitude, in volts. This voltage is per side, multiply by 2 when the output is used differentially. • Freq (GHz) Displays the internal clock frequency, in GHz. When using an external clock (Synth = 0), then the Freq adjust range is increased to 500 MHz min, 12.5 GHz max. The N4962A Frequency setting should be set to the frequency of the external clock so that the N4962A frequency dependent parameters are correctly set. • Ø Displays the error detector electronic clock phase shift setting, in degrees. The phase shift amount ranges from 0 to +358 degrees (one unit interval). <p>When Ø is shown on the display, pressing the Adjust->Config State PLUS button will prompt the N4962A to automatically determine the optimum detector clock phase. This is detailed in Section 4.6.</p> <ul style="list-style-type: none"> • Config State Displays one of ten configuration states that can be modified with the Adjust->Config State PLUS or MINUS buttons. <p>Different state can be selected with the Scroll UP or DOWN buttons, but the light will remain on the Config State display item. For example, the first state shown is the PAT 2Exx, and the Config State light is lit. Pressing Scroll DOWN selects the MS 0.xxx state, and the Config State light remains lit.</p> <p>The Config State currently selected is indicated by the display text. There is no</p>	

Text	Type	Description	Default
		indicator for the different states. States are described in Table 15, and detailed in Section 0.	

4.3 Rear Panel Interface



Figure 13. N4962A rear panel

The N4962A rear panel features connectors for the internal and external clock system, as well as a PRBS pattern trigger, and a differential pair of connectors for a unique data path (DataThru). The rear panel also includes a 5-bit GPIB address switch, and a GPIB connector. The panel also features the N4962A power switch, and a built-in cooling fan.

The DataThru and /DataThru connectors (both SMA) are connected to the IN/IN connectors when the Data Path option is set to Thru (detailed in Section 2.5). The PRBS generator is enabled and is available from the OUT and /OUT connectors when this data path is selected. The input signal is not processed by the error detector, and errors are not counted.

The Pat TrigO connector is an output pattern trigger from the PRBS generator. The Pat TrigO signal changes state after 32 complete PRBS bit streams have been generated. Pat TrigO has a frequency equal to $(\text{clock_rate}) / (32 * \text{bit_pattern_length})$; With a clock speed of 10 GHz, the Pat TrigO frequency is 2.4 MHz with a pattern length of 2^7-1 , and 0.15 Hz with a pattern length of $2^{31}-1$.

TX CKI and RX CKI are the transmit (PRBS generator) and receiver (error detector) clock inputs. To use an external 500 Mb/s to 12.5 Gb/s clock signal, connect the external clock to both TX CKI and RX CKI. To prevent damage or incorrect operation for the N4962A, be sure to provide a clock signal within the specified clock input power limits as described in Sections 3.4 and 3.5, respectively.

TX CKO and RX CKO are the internal clock output ports. These are connected to TX CKI and RX CKI when the internal clock is used to trigger the PRBS generator and error detector. The clock output ports are detailed in Section 3.3.

HF TrigO and LF TrigO are clock trigger outputs from the internal clock system, detailed in Section 3.3.

Ext CKI is a low-frequency 1/16th-rate clock input used when synchronizing the internal clock system with a LF external signal. The Ext CKI port is detailed in Section 3.3.

JitterI is a DC-100 MHz input that is FM modulated onto the TX CKO and HF TrigO clock. A sinusoid should be applied to the input port, and the resulting PRBS output jitter will be proportional to the sinusoid amplitude. This is detailed in Section 3.3.

The GPIB connector and 5-bit address switch is accessible from the rear panel. All GPIB devices on the same GPIB bus must have different addresses to function together. GPIB devices are programmed by referencing the address of the device, as well as the bus type. This is detailed in Section 5. The factory default address is 25.

4.4 Power-On State

The power-on state of the N4962A is set after turning the rear Power switch on. The internal clock is active and generates a 10.0 GHz clock. The PRBS generator is off. The error detector is off, in training mode, and will not accumulate errors. The error detector light may indicate errors if the default sampling position is incompatible with the cable length, or if the OUT and /OUT port(s) are not connected to the IN and /IN port(s).

Table 18. N4962A power-on state

Setting	Display	Description	Value
Local	Light	Local push-button (vs GPIB) control	On
Receiver On	Light	Error detector	Off
PRBS	Light	PRBS output inverted	Off
Data Path	3 lights	Data path	Disabled
Error e	Light	Bit error detected	Undetermined
Freq	Display	Internal clock speed	10.0 GHz
Ampl	Not shown	PRBS output amplitude	0.500 V
∅	Not shown	Error detector clock phase adjustment	0 (degrees)
PAT 2E31	Not shown	PRBS pattern length	$2^{31}-1$
MS 0.500	Not shown	PRBS mark space density	0.500
Jitter 0	Not shown	Jitter-injection mode	Off (0)
Synth 1	Not shown	Internal clock	On (1)
Err00000	Not shown	Measured BER errors	0
ErAd OFF	Not shown	PRBS errors added per second	Off (none)
NoData	Not shown	Error detector data sense	0 (off)

4.5 System Verification

When first using the N4962A and before using the machine to test an external DUT, first confirm that the system is generating a PRBS bit stream and can detect bit errors.

4.5.1 Self Test Mode

Verify the PRBS generator and error detector are both functioning by configuring the system in self-test mode as follows: connect the OUT and /OUT ports directly to the IN and /IN ports with the Keysight Technologies-supplied phase balanced 50 Ω coaxial cables, use the internal clock at the default setting, power the system, turn on the PRBS output, and adjust the error detector clock phase, as follows:

- Connect TX CKO to TX CKI with coaxial cable (included; default)
- Connect RX CKO to RX CKI with coaxial cable (included; default)
- Connect OUT to IN with phase-balanced coax cable (included)
- Optionally connect /OUT to /IN with phase-balanced coax cable (included)
- Terminate all unused RF connectors with 50 Ω terminations
- Turn on the power switch from the back panel
- Press the Data Path->Select Path button and select Enabled
- Press the Display->Scroll \downarrow button and select \emptyset
- Press the Adjust->Config State + button to auto-select the detector phase
- Observe the Error ϵ light (should remain off, indicating no errors detected)

4.5.2 Error Free Test

When the error detector clock phase is correctly adjusted, the default settings will result in error-free operation. The Error **e** light will be off, and the measured BER will be zero. Check the error-free operation as follows:

- Put the system in self test mode, described in Section 4.5.1.
- Press the Receiver > **On** button and ensure the light is on
- Press the Display > **Scroll ↓** button and select **Err** (should show zero errors)
- Press the Display > **Scroll ↓** button and select **BER** (should show zero)
- Press the Display > **Scroll ↓** button and select **e time (sec)** (should be increasing)

4.5.3 High BER Test

To verify that the error detector can correctly count a large number of errors, first allow the detector to synchronize with a clear input signal by adjusting the detector clock phase to an error-free operating point. Once the detector has been trained, turn the detector on and invert the PRBS signal to generate 100% errors, as follows:

- Put the system in self test mode, described in Section 4.5.1.
- Press the Receiver > **On** button and ensure the light is on
- Press the Data Path > **/PRBS** button and ensure the light is on
- Press the Display > **Scroll ↓** button and select **Err** (should show many errors)
- Press the Display > **Scroll ↓** button and select **BER** (should show high BER)
- Press the Display > **Scroll ↓** button and select **e time (sec)** (should be increasing)

4.5.4 Low BER Test

To verify that the error detector can correctly count a small number of errors, use the PRBS error injection capability to insert a known number of errors into the bit stream, as follows:

- Put the system in self test mode, described in Section 4.5.1.
- Press the Display > Scroll ↓ button and select ErAd OFF
- Press the Adjust > Config State + button and select ErAd 1E0
- Press the Receiver > On button and ensure the light is on
- Observe the Error **e** light (should blink once per second)
- Press the Display > Scroll ↑ button and select Err (should show 1 per second)
- Press the Display > Scroll ↓ button and select BER (should show 1E-10)
- Press the Display > Scroll ↓ button and select **e** time (sec) (should be increasing)

4.6 BER Detector Clock Phase Adjustment

The error detector clock phase can be electronically controlled to adjust the detector sampling point; the periodic point at which the detector interprets the incoming bit stream. Due to the unknown delay associated with cables and the DUT in the data path, the incoming bit stream may not be sampled at the optimal point.

The detector must be adjusted to find the optimal sampling point; an incorrect sampling point will yield an artificially-high BER measurement, shown in Figure 14.

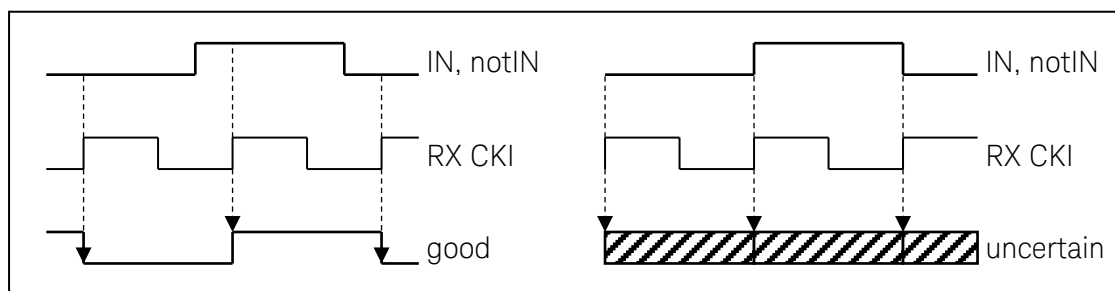

Figure 14. Sampling uncertainty due to clock phase misadjustment

If the sampling point occurs near the PRBS transition point, the sampled value is uncertain and many bit errors will be measured by the detector. Adjusting the phase away from the transition point will optimally position the sampling point and allow the best chance of measuring error-free operation.

The N4962A can automatically detect and set the detector clock phase for the best sampling point. It requires that the system settings and data path allow error-free operation. This is best achieved by putting the system into self-test mode, described in Section 4.5.1.

If the configuration settings result in high errors (eg: PRBS output amplitude set low), or the cabling or DUT result in poor eye quality, the automatic detector clock phase adjustment will not work. It will also be difficult to set the clock phase adjustment manually.

To automatically set the detector clock phase adjustment:

With the N4962A powered, clocks connected, and data path connected:

- Ensure the Data Path > Enabled option is selected (PRBS output must be on)
- Ensure the Receiver > On is not selected (the error detector must be off)
- Press the Display > Scroll ↓ button and select Ø
- Press the Adjust > Config State + button to auto-select the detector phase
- Observe the Error **e** light (should remain off, indicating no errors detected)

To manually set the detector clock phase adjustment:

With the N4962A powered, clocks connected, and data path connected:

- Ensure the Data Path > Enabled option is selected (PRBS output must be on)
- Ensure the Receiver > On is not selected (the error detector must be off)
- Press the Display > Scroll ↓ button and select Ø

Find the optimal sampling point as follows:

- If the Error **e** light is off, press the Adjust > Ø + button until the light is on
- Press the Adjust > Ø + button until the Error **e** light remains off
- Record the clock phase adjustment value
- Press the Adjust > Ø + button until the Error **e** light remains on

- Record the second phase value; the optimum point is halfway between the two values
- Press the Adjust > Ø - button and adjust the phase offset to the optimal point
- Observe the Error **e** light (should remain off, indicating no errors detected)

Depending on the DUT characteristics, the optimal sampling point may occur at different detector phase adjustment values. You may need to repeat the phase adjustment procedure when changing the DUT use characteristics, or if you change the operating frequency.

4.7 Basic BER Measurement

The N4962A can quickly be used for basic BER measurements as follows: connect the OUT/OUT ports to the DUT input, connect the IN/IN ports to the DUT output, use the internal clock, power the system, enable the PRBS output, adjust the detector clock phase, and turn on the error detector.

When connecting the OUT/OUT, and IN/IN ports, use a short 50 Ω coaxial cable. To test single-ended DUTs, terminate the OUT and IN ports with 50 Ω terminations.

- Connect TX CKO to TX CKI with coaxial cable (included; default)
- Connect RX CKO to RX CKI with coaxial cable (included; default)
- Connect OUT to DUT input with short 50 Ω coax cable
- Optionally connect /OUT to DUT /input with short phase-balanced 50 Ω coax cable
- Connect DUT output to IN with short 50 Ω coax cable
- Optionally connect DUT /output to /IN with short phase-balanced 50 Ω coax cable

NOTE

Add appropriate attenuation or gain to DUT output, /output signals

- Terminate all unused RF connectors with 50 Ω terminations
- Turn on the power switch from the back panel
- Adjust the DUT for the best chance for error-free operation (turn attenuators off, etc)
- Press the Data Path > Select Path button and select Enabled
- If the DUT is inverting, press the Data Path > /PRBS button to invert the output
- Press the Display > Scroll ↓ button and select Ø

- Press the Adjust > Config State + button to auto-select the detector phase
- Observe the Error **e** light (should remain off, indicating no errors detected)
- Press the Receiver > On button and ensure the light is on
- Press the Display > Scroll ↑ button and select **e** time (sec) (should be increasing)
- Press the Display > Scroll ↑ button and select BER
- Press the Receiver > On button and ensure the light is off when complete

5 Remote GPIB Interface

The N4962A can be controlled and queried with the rear-panel GPIB interface. The GPIB interface complies with IEEE standard 488.2-1992. To learn more about the GPIB interface, consult the following books from the IEEE:

- The International Institute of Electrical and Electronic Engineers. IEEE Standard 488.1-1987, IEEE Standard Digital Interface for Programmable Instrumentation. New York, NY, 1987.
- .The International Institute of Electrical and Electronic Engineers. IEEE Standard 488.2-1987, IEEE Stand Codes, Formats, Protocols and Communication Commands for Use with ANSI/IEEE Std 488.1-1987. New York, NY, 1987.

A GPIB interface requires that all devices on a common bus have different addresses; the 5-bit address control switch is located on the back panel next to the GPIB connector. The factory default address is 25. The address uses a three digit format. The first digit is always set to “7”, and the last two digits are programmed by the 5 bit control switch located on the back of the instrument.

The N4980A multi-instrument BERT software is available from Keysight Technologies for fast GPIB programming of the N4962A.

5.1 GPIB Capabilities

The GPIB interface capabilities are described in Table 19.

Table 19. N4962A GPIB capabilities

Mnemonic	Function
SH1	Complete source handshake capability
AH1	Complete acceptor handshake capability
T6	Basic talker; serial poll; unaddressed to talk if addressed to listen; no talk only
L4	Basic listener; unaddressed to listen if addressed to talk; no listen only
SR1	Complete service request capability
RL2	Remote/local capability with local lockout (LLO)
PP0	No parallel port capability
DC1	Device clear capability
DT1	Device trigger capability (accepted but ignored)
C0	No controller capability
E2	Tristate outputs (except the handshake line)

5.2 GPIB Command Syntax

The N4962A can be controlled through the GPIB interface using commands and queries. The commands and queries are documented in the Backus-Naur Form notation, detailed in Table 20.

Table 20. N4962A GPIB command and query syntax

Symbol	Meaning
<>	Defined element (eg: <arg>)
::=	Is defined as (eg: <arg> ::= argument)
	Exclusive OR
{ }	One of this group is required
[]	Optional item
...	Previous elements may be repeated

5.2.1 Command Structure

The GPIB interface allows commands, which tell the instrument to take a specific action, and queries, which ask the instrument to return information.

Commands are composed of syntactic elements:

- Header – the command name; if it ends with a question mark, the command is a query.
- Delimiter – a space, colon (:), comma (,), or semi-colon (;) which breaks the message into segments for the instrument to process.
- Link – a command sub-function. Not all commands have links.
- Argument – a quantity, quality, restriction, or limit associated with the header or link.

Commands are case insensitive, although they are documented in an uppercase and lowercase manner that indicates which minimum characters are required to make the command. The commands can be shortened to the minimum length illustrated by the uppercase letters in the documentation.

- The command
 - :SOURce:PRBS:INVert ON
- Can be written in lowercase
 - :source:prbs:invert on
- And it can be shortened
 - :sour:prbs:inv ON

5.3 IEEE Common Commands

The IEEE 488.2 standard has a list of reserved commands that must be implemented by all instruments using the standard. The N4962A implements all of the required commands, listed in Table 21.

Table 21. N4962A IEEE common commands

Command	Function
*CLS	Clear status command
*RST	Reset command
*WAI	Wait to continue
*TRG	Trigger
*IDN?	Identification Query
*STB?	Status Byte Query
*TST?	Self Test Query
*ESR?	Event Status Register Query
*ESE	Event Status Enable Register Set
*ESE?	Event Status Enable Register Query
*OPC	Operation Complete clear flag
*OPC?	Operation Complete Query
*SRE	Service Request Enable Set
*SRE?	Service Request Enable Query
IEEE optional commands	
*SAV	Save
*RCL	Recall

5.4 SCPI Mandated Commands

The N4962A also conforms to the Standard Commands for Programmable Instrumentation (SCPI 1999.0) command set. Two SCPI mandated commands are implemented, listed in Table 22.

Table 22. N4962A SCPI mandated commands

Command	Function
:SYSTEM:ERROR?	Returns event/error number and message from error queue
:SYSTEM:VERSION?	Returns SCPI protocol version number (1999.0)

5.5 N4962A Device Commands

The N4962A device commands are summarized in Table 23. The following descriptions and examples assume the user is programming with Keysight BASIC, a simple interpretative language that is convenient for instrument programming.

For the examples below, the device being programmed is located at GPIB device address 725. The actual address varies according to how you have configured the GPIB bus for your own application. For information to change the bus address see Section 5.

Table 23. N4962A device commands

Command	Parameters / Results
:SOURce:ROSCillator:SOURce	{? INTernal EXTernal}
:SOURce:ROSCillator:[INTernal]:FREQuency	{? {9900 <= value <= 11350}}
:SOURce:ROSCillator:JITTer	{? ON OFF}
:SOURce:PATTern	{? PRBS{7 10 15 23 31}}
:SOURce:PRBS:MARKspace	{? MS{2 4 8}}
:SOURce:PRBS:INVert	{? ON OFF}
:SOURce:PRBS:IERR:RATE	{? OFF ERR1E{0 <= value <= 7}}
:SOURce:VOLTage:[LEVel]:[AMPLitude]	{? {300 <= value <= 1800}}
:MODE	{? NORMal THRU OFF}

Command	Parameters / Results
:SENSe:NOData	{? ON OFF}
:SYSTem:STATus?	{BITERROR NODATA NORXCLK}
:SENSe:APTime	{? {1 <= value <= 5000}}
:SENSe:ROSCillator:PHASe	{? AUTO {0 <= value <= 360}}
:SENSe:SWEp:TIME	{? 0.001 <= value <= 4194303.999}
:SENSe:TRAln	{? {10 <= value <= 6500}}
:STATus:OPERation:MEASurement:CONDition?	
:INITiate:BER	
:TRIGger:INITiate	
:TRIGger:ABORT	
:TRIGger:SAMple	
:SENSe:DATA?	[BCOunt ECOunt ETIMe BER ALL]
:FETCh:BER?	[BCOunt ECOunt ETIMe BER ALL]

5.5.1 Internal Clock Commands

Command

:SOURce:ROSCillator:SOURce?

Type

Query

Description

Returns the state of the internal low-frequency clock.

Result

{INT | EXT}

Example

See Below

Command

:SOURce:ROSCillator:SOURce {INTernal | EXTernal}

Type

Command

Description

Selects the low-frequency clock to be used. INTernal selects and powers the internally-generated clock, EXTernal selects the external clock connected to Ext CKI, and powers down the internal clock.

Parameters

{INTernal | EXTernal}

Example

```
OUTPUT 725; ":SOUR:ROSC:SOUR INT"  
OUTPUT 725; ":SOUR:ROSC:SOUR?"  
ENTER 725; value$  
PRINT value$ ! should be "INT"
```

Command

:SOURce:ROSCillator:[INTernal]:FREQuency?

Type

Query

Description

Returns the current value of the programmable high-frequency clock, in MHz.

Results

{9900 <= value <= 11350} (if INT clock selected)¹
{500 to 12500} (if EXT clock selected)

Example

See below

¹ The internal clock is actually programmable from 9850 to 11350, but performance is only guaranteed from 9900 to 11350.

Command

:SOURce:ROSCillator:[INTernal]:FREQuency {9900 <= value <= 11350}¹

Type

Command

Description

Sets the frequency of the internal high-frequency clock, in MHz. The internal clock source must be selected for this feature to work.

Parameters

{9900 <= value <= 11350} (if INT clock selected)

{500 to 12500} (if EXT clock selected)

Example

OUTPUT 725; ":SOUR:ROSC:SOUR INT"

OUTPUT 725; ":SOUR:ROSC:INT:FREQ 10500"

OUTPUT 725; ":SOUR:ROSC:FREQ?"

ENTER 725; value\$

PRINT value\$! should be "10500"

Command

:SOURce:ROSCillator:JITTer?

Type

Query

Description

Returns the current jitter injection mode.

Results

{ON | OFF}

Example

See below

¹ The internal clock is actually programmable from 9850 to 11350, but performance is only guaranteed from 9900 to 11350.

Command

:SOURce:ROSCillator:JITTer {ON| OFF}

Type

Command

Description

Sets the jitter injection mode. If 1, the high-jitter mode will be enabled and the jitter input signal Jitter1 will be FM modulated onto the TX CKO and HF TrigO outputs. This feature requires the internal clock be selected. On Jitter 0, a low bandwidth modulator mode is selected, lowering the noise floor, and filtering jitter above 100 kHz.

Parameters

{ON | OFF}

Example

```
OUTPUT 725; ":SOUR:ROSC:SOUR INT"
```

```
OUTPUT 725; ":SOUR:ROSC:JITT ON"
```

```
OUTPUT 725; ":SOUR:ROSC:JITT?"
```

```
ENTER 725; value$
```

```
PRINT value$ ! should be "ON"
```

5.5.2 PRBS Pattern Commands

Command

:SOURce:PATTern?

Type

Query

Description

Returns the current PRBS pattern length.

Results

PRBS{7 | 10 | 15 | 23 | 31}

Example

See below

Command

:SOURce:PATTern {PRBS{7 | 10 | 15 | 23 | 31}}

Type

Command

Description

Sets PRBS pattern length to the value indicated in the command line. PRBSn selects a pattern with length 2^{n-1} .

Parameters

PRBS{7 | 10 | 15 | 23 | 31}

Example

OUTPUT 725; ":SOUR:PATT PRBS10"

OUTPUT 725; ":SOUR:PATT?"

ENTER 725; value\$

PRINT value\$! should be "PRBS10"

Command

:SOURce:PRBS:MARKspace?

Type

Query

Description

Returns the current PRBS pattern mark space density.

Results

MS{2 | 4 | 8}

Example

See below

Command

:SOURce:PRBS:MARKspace {MS{2 | 4 | 8}}

Type

Command

Description

Sets PRBS pattern mark space density to the value indicated in the command line. MSn selects a pattern with mark space density of 1/n.

Parameters

MS{2 | 4 | 8}

Example

OUTPUT 725; ":SOUR:PRBS:MARK MS2"

OUTPUT 725; ":SOUR:PRBS:MARK?"

ENTER 725; value\$

PRINT value\$! should be "MS2"

Command

:SOURce:PRBS:INVert?

Type

Query

Description

Returns the current PRBS invert setting.

Results

{ON | OFF}

Example

See below

Command

:SOURce:PRBS:INVert {ON | OFF}

Type

Command

Description

Sets PRBS invert setting to the value indicated in the command line. If ON, the PRBS signal is inverted.

Parameters

{ON | OFF}

Example

OUTPUT 725; ":SOUR:PRBS:INV ON"

OUTPUT 725; ":SOUR:PRBS:INV?"

ENTER 725; value\$

PRINT value\$! should be "ON"

Command

:SOURce:PRBS:IERR:RATE?

Type

Query

Description

Returns the current error injection rate

Results

{OFF | ERR1E{0 <= value <= 7}}

Example

See below

Command

:SOURce:PRBS:IERR:RATE {OFF | ERR1E{0 <= value <= 7}}

Type

Command

Description

Sets the digital error injection rate to 10^n errors injected per second. If OFF, no errors are injected.

Parameters

{OFF | ERR1E{0 <= value <= 7}}

Example

OUTPUT 725; ":SOUR:PRBS:IERR:RAT ERR1E3"

OUTPUT 725; ":SOUR:PRBS:IERR:RAT?"

ENTER 725; value\$

PRINT value\$! should be "ERR1E3"

Command

:SOURce:VOLTage:AMPLitude?

Type

Query

Description

Returns the current single-ended PRBS output amplitude, in mVpp per side (double this number for differential).

Results

{300 <= value <= 1800}

Example

See below

Command

:SOURce:VOLTage:AMPLitude {300 <= value <= 1800}

Type

Command

Description

Sets the single-ended PRBS output amplitude, in mVpp per side.

Parameters

{300 <= value <= 1800}

Example

OUTPUT 725; ":SOUR:VOLT:LEV:AMPL 350"

OUTPUT 725; ":SOUR:VOLT:AMPL?"

ENTER 725; value\$

PRINT value\$! should be "350"

5.5.3 Measurement Commands

Command

:MODE?

Type

Query

Description

Returns the current data path.

Results

{NORM | THRU | OFF}

Example

See below

Command

:MODE {NORMal | THRU | OFF}

Type

Command

Description

Sets the instrument data path:

NORMal	Normal operation, IN and /IN connected to error detector, PRBS generator enabled.
THRU	Input through, IN and /IN connected to DataThru and /DataThru PRBS generator enabled.
OFF	Disabled, IN and /IN connected to the error detector, only the PRBS generator disabled.

Parameters

{NORM | THRU | OFF}

Example

```
OUTPUT 725; ":MOD THRU"
OUTPUT 725; ":MOD?"
ENTER 725; value$
PRINT value$ ! should be "THRU"
```

Command

:SENSe:NOData?

Type

Query

Description

Returns the state of the data sense option.

Results

{ON | OFF}

Example

See below

Command

:SENSe:NOData {ON | OFF}

Type

Command

Description

Sets the NoData sense function. When used with the N4962A source, helps to detect all-zeros' data.

Parameters

{ON | OFF}

Example

OUTPUT 725; ":SENS:NOData OFF"

OUTPUT 725; ":SENS:NOData?"

ENTER 725; value\$

PRINT value\$! should be "OFF"

Command

:SYSTem:STATus? {BITERROR | NODATA | NORXCLK}

Type

Query

Description

Returns the state of the output indicator:

BITERROR	Indicates the current status of the BERT error light; the light is lit when errors are counted; the query returns 0 when the light is lit
NODATA	Indicates the current status of the NoData flag determined by the instrument (only if NODATA is turned on, see above); the query returns 0 when the NoData condition is met
NORXCLK	Indicates the current status of the NoRXClk flag; the query returns 0 when no clock input is detected at the RX CKI port

Results

{0 | 1}

Example

None

Command

:SENSe:APTime?

Type

Query

Description

Returns the current autophase measurement time setting; how long to measure BER at each of the 180 phase points when performing an autophase alignment, in 1/10ths of a millisecond.

Results

{1 <= value <= 5000}

Example

See below

Command

```
:SENSe:APTime {1 <= value <= 5000}
```

Type

Command

Description

Sets the desired autophase measurement time, in 1/10ths of a millisecond. The lowest number is 1 (0.1 ms). The highest number is 5000 (500 ms).

Parameters

```
{1 <= value <= 5000}
```

Example

```
OUTPUT 725; ":SENS:APT 300"
OUTPUT 725; ":SENS:APT?"
ENTER 725; value$
PRINT value$ ! should be "300"
```

Command

```
:SENSe:ROSCillator:PHASe?
```

Type

Query

Description

Returns the error detector clock phase.

Phase is selected in 2 degree increments for data rates greater than 5 GHz to 12.5 GHz. Data rates between 500 MHz and less than 5 GHz offer values of 0, 90, 180, 270 degrees only.

Results

```
{0 <= value <= 358}
```

Example

See below

Command

:SENSe:ROSCillator:PHASe {AUTO | {0 <= value <= 360}}

Type

Command

Description

Sets the error detector clock phase for sampling point. If AUTO, the N4962A will automatically determine the optimum phase for best sampling point once, and set the phase to that value. For data rates less than 5 GHz, the phase detector is limited to 0, 90, 180, or 270 degree increments.

Parameters

{AUTO | {0 <= value <= 358}}

Example

```
OUTPUT 725; ":SENS:ROSC:PHAS AUTO"  
OUTPUT 725; ":SENS:ROSC:PHAS?"  
ENTER 725; value$  
PRINT value$ ! should be a number 0-360
```

Command

:SENSe:SWEep:TIME?

Type

Query

Description

Returns the current measurement time setting; how long the measurement is intended to run for, in seconds.

Results

{0.001 <= value <= 4194303.999}

Example

See below

Command

```
:SENSe:SWEep:TIME {0.001 <= value <= 4194303.999}
```

Type

Command

Description

Sets the desired measurement time, in seconds. The lowest number is 0.001 seconds. The highest number is 4194303.999 seconds.

Parameters

```
{0.001 <= value <= 4194303.999}
```

Example

```
OUTPUT 725; ":SENS:SWE:TIME 120"
OUTPUT 725; ":SENS:SWE:TIME?"
ENTER 725; value$
PRINT value$ ! should be "120"
```

Example

```
OUTPUT 725; ":SENS:SWE:TIME 10550"
OUTPUT 725; ":SENS:SWE:TIME?"
ENTER 725; value$
PRINT value$ ! should be "10550"
```

Command

```
:SENSe:TRAIIn?
```

Type

Query

Description

Returns the current training delay time setting; how long to pause for the transit time of the DUT before the measurement starts, in 1/10ths of a microsecond.

Results

```
{10 <= value <= 6500}
```

Example

See below

Command

:SENSe:TRAI{n {10 <= value <= 6500}}

Type

Command

Description

Sets the desired training delay time, in 1/10ths of a microsecond. The lowest number is 10 (1 us). The highest number is 6500 (650 us).

Parameters

{10 <= value <= 6500}

Example

```
OUTPUT 725; ":SENS:TRAI 120"  
OUTPUT 725; ":SENS:TRAI?"  
ENTER 725; value$  
PRINT value$ ! should be "120"
```

Command

:STATus:OPERation:MEASurement:CONDition?

Type

Query

Description

Returns 1 if measurement is in progress.

Results

{0 | 1}

Example

```
OUTPUT 725; ":SENS:SWE:TIME 10"  
OUTPUT 725; ":TRIG:INIT"  
WAIT 2  
OUTPUT 725; ":STAT:OPER:MEAS:COND?"  
ENTER 725; value$  
PRINT value$ ! should be "1"
```

Command

:INITiate:BER

Type

Command

Description

Latches data on BERT board; equivalent to turning on the receiver.

Results

none

Example

none

Command

:TRIGger:INITiate

Type

Command

Description

Initiates data acquisition (begins testing); equivalent to turning on the receiver.

Example

See below

Command

:TRIGger:ABORt

Type

Command

Description

Aborts data acquisition (ends testing); equivalent to turning off the receiver.

Example

See below

Command

:TRIGger:SAMPle

Type

Command

Description

Takes sample of current measurement. Does not return any values, but allows the values to be queried by other commands.

Example

See below

Command

:SENSe:DATA? [BCOunt | ECOunt | ETIMe | BER | ALL]

Type

Query

Description

Returns the selected parameter from the current instrument sample, or returns all parameters as a vector if ALL or no parameter is specified.

BCOunt	Total number of bits counted
ECOunt	Total number of errors counted
ETIMe	Elapsed time (seconds)
BER	Calculated Bit Error Rate

The vector is as follows: BCOunt,ECOunt,ETIMe,BER

Parameters

[BCOunt | ECOunt | ETIMe | BER | ALL]

Note

Need to run ":TRIG:INIT" and ":TRIG:SAMPLE" first.

Result

Described above

Example

```

OUTPUT 725; ":SENS:SWE:TIME 10"
OUTPUT 725; ":TRIG:INIT"
WAIT 2
OUTPUT 725; ":TRIG:SAMPLE"
OUTPUT 725; ":SENS:DATA? BER"
ENTER 725; value$
PRINT value$ ! BER value after 2 seconds

```

Command

```
:FETCh:BER? [BCOunt | ECOunt | ETIMe | BER | ALL]
```

Type

Query

Description

Returns the selected parameter from the memory stored on the FPGA, or returns all parameters as a vector if ALL or no parameter is specified. Does not require the measurement to currently be running. This command can only be used if the set-up measurement time from the command ":SENSe:SWEp:TIME value" is completed. See examples 470-580.

BCOunt	Total number of bits counted
ECOunt	Total number of errors counted
ETIMe	Elapsed time (seconds)
BER	Calculated Bit Error Rate, or NAN if measurement not ready

The vector is as follows: BCOunt,ECOunt,ETIMe,BER

Parameters

```
[BCOunt | ECOunt | ETIMe | BER | ALL]
```

Result

Described above

Example

```

OUTPUT 725; ":SENS:SWE:TIME 10"
OUTPUT 725; ":TRIG:INIT"
WAIT 2
OUTPUT 725; ":TRIG:SAMPLE"
OUTPUT 725; ":SENS:DATA? BER"
ENTER 725; value$
PRINT value$ ! BER value after 2 seconds
WAIT 3
OUTPUT 725; ":TRIG:ABOR"
OUTPUT 725; ":FETC:BER?"
ENTER 725; result$
PRINT result$ ! BER value after 5 seconds

```

5.6 Examples

The following programming example assumes the user is programming with Keysight BASIC, a simple interpretative language that is convenient for instrument programming.

For the example programs below, the device being programmed is located at GPIB device address 725. The actual address varies according to how you have configured the GPIB bus for your own application. For information to change the bus address see Section 5.

This first block of code shows how to initialize the instrument and check the GPIB subsystem for errors.

```

10 OUTPUT 725; "**IDN?"           ! request the instrument ID string
20 ENTER 725; result$           ! read the return string
30 PRINT result$                ! print the results to stdout
30 OUTPUT 725; ":SYSTEM:ERROR?" ! check for errors
40 OUTPUT 725; "**RST"           ! reset the BERT

```

The next block of code shows how to save the instrument state in one of the save/recall registers (0-9), how to change the value of the internal HF clock, and how to restore the previous instrument state saved in the save/recall register.

```

50 OUTPUT 725; "**SAV 1"           ! save current inst. state in reg 1
60 OUTPUT 725; ":SOURCE:ROSC:FREQ 11111" ! change the BERT freq to 11111MHz
70 OUTPUT 725; ":SOURCE:ROSC:INT:FREQ?" ! query the source frequency
80 ENTER 725; freq$               ! read the result
90 PRINT freq$                    ! print the frequency results
100 OUTPUT 725; "**RCL 1"         ! recall the prior state (frequency)

```

The next block of code shows how to get the SCPI version number.

```

110 OUTPUT 725; ":SYSTEM:VERSION?" ! query the control version
120 ENTER 725; version$            ! read the result
130 PRINT version$                ! print the version

```

This block shows how to manually set the error detector phase, and how to use the automatic detector phase adjust feature via GPIB control.

```

140 OUTPUT 725; ":SENSE:ROSC:PHASE 100" ! set detector phase to 100 degrees
150 OUTPUT 725; ":SENSE:ROSC:PHASE?" ! query the value of detector phase
160 ENTER 725; phase$                ! read the result
170 PRINT phase$                     ! print the phase value

180 OUTPUT 725; ":SENSE:ROSC:PHASE AUTO" ! auto-select the best phase
190 OUTPUT 725; ":SENSE:ROSC:PHASE?" ! query the value of detector phase
200 ENTER 725; phase$                ! read the result
200 PRINT phase$                     ! print the optimum phase value

```

This block of code shows how to change system configuration settings, such as the PRBS pattern length, PRBS mark space density, internal clock power, and jitter injection mode.

```

210 OUTPUT 725; ":SOURCE:PATTERN PRBS31"           ! set the PRBS pattern to 2^31-1
220 OUTPUT 725; ":SOURCE:PATTERN?"               ! query the value of the pattern
230 ENTER 725; pattern$                          ! read the result
240 PRINT pattern$                               ! print the pattern value

250 OUTPUT 725; ":SOURCE:ROSC:SOURCE EXT"        ! use an external source as clock
260 OUTPUT 725; ":SOURCE:ROSC:SOURCE INT"       ! use the internal 10GHz source
270 OUTPUT 725; ":SOURCE:ROSC:SOURCE?"         ! query the current source setting
280 ENTER 725; source$                          ! read the result
290 PRINT source$                               ! print the source value

300 OUTPUT 725; ":SOURCE:ROSC:JITT ON"          ! turn jitter injection on
310 OUTPUT 725; ":SOURCE:ROSC:JITT?"           ! query the jitter injection mode
320 ENTER 725; jit$                             ! read the result
330 PRINT jit$                                  ! print the jitter mode

340 OUTPUT 725; ":SOURCE:PRBS:MARK MS8"         ! set the mark-space density to 1/8
350 OUTPUT 725; ":SOURCE:PRBS:MARK MS2"        ! reset to 1/2
360 OUTPUT 725; ":SOURCE:PRBS:MARK?"          ! query the density setting
370 ENTER 725; mrk$                             ! read the result
380 PRINT mrk$                                  ! print "markspace density" setting

```

The N4962A has a programmable PRBS output level which can be set from 300 mV to 1800 mV in 10 mV steps. This block of code demonstrates how to program this feature.

```

390 OUTPUT 725; ":SOURCE:VOLTAGE:AMPLITUDE 500" ! set PRBS amplitude to 500mV
400 OUTPUT 725; ":SOURCE:VOLTAGE:AMPLITUDE?"  ! query the amplitude
410 ENTER 725; vamp$                          ! read the result
420 PRINT vamp$                               ! print the amplitude value

```

The N4962A has a programmable error injection that can be set from 1 error/sec to 1E7 errors/sec in logarithmic steps of 10. This is detailed in Table 16.

```

430 OUTPUT 725; ":SOURCE:PRBS:IERR:RATE ERR1E3"      ! set err inject rate=1E3/sec
430 OUTPUT 725; ":SOURCE:PRBS:IERR:RATE OFF"         ! turn error injection OFF
440 OUTPUT 725; ":SOURCE:PRBS:IERR:RATE?"           ! query the result
450 ENTER 725; result$                               ! read the result
460 PRINT result$                                    ! print the query result

```

The next block of code shows how to set up a timed Bit Error Measurement of 5 seconds and report the BER at the end of the measurement interval.

```

470 OUTPUT 725; ":SENSE:SWEEP:TIME 5"                ! set up a 5 second BER measurement
480 OUTPUT 725; ":SENSE:SWEEP:TIME?"                ! query the measurement time
490 ENTER 725; result$                               ! read the result
500 PRINT result$                                    ! print the query result

510 OUTPUT 725; ":TRIGGER:INITIATE"                 ! start the 5 sec measurement
520 PRINT "Starting 5s measurement"                  ! display
530 OUTPUT 725; ":STATUS:OPERATION:MEASUREMENT:CONDITION?" ! check if done
540 ENTER 725; result$                               ! read the result
550 PRINT result$                                    ! print the query result
560 OUTPUT 725; ":FETCH:BER?"                       ! query BER statistics
570 ENTER 725; result$                               ! read the result
580 PRINT result$                                    ! print the query result

```

After running for 5 seconds, the program outputs a string with TOTAL-BITS, TOTAL-ERRORS, ELAPSED-SECONDS, BIT-ERROR-RATE.

An alternative method of measuring BER is to use the sample command. The SAMPLE command allows the user to "sample" the Bit Error Rate any number of times during a measurement period.

```
590 OUTPUT 725; ":SENSE:SWEEP:TIME 10"           ! set up a 10s BER measurement
600 OUTPUT 725; ":TRIGGER:INITIATE"             ! start the 10s measurement
610 WAIT 2                                       ! wait 2 seconds
610 OUTPUT 725; ":TRIGGER:SAMPLE"               ! trigger BER sample
620 OUTPUT 725; ":SENSE:DATA?"                  ! query a sample of the BER data
630 ENTER 725; result$                           ! read the result
640 PRINT result$                               ! print the BER sample result
650 WAIT 3                                       ! wait 3 seconds
660 OUTPUT 725; ":TRIGGER:ABORT"                ! cancel the measurement
670 OUTPUT 725; ":FETCH:BER?"                  ! query the final BER data
680 ENTER 725; result$                           ! read the result
690 PRINT result$                               ! print the BER sample result
```

6 Returning the N4962A Serial BERT to Keysight Technologies

If the N4962A serial BERT 12.5 Gb/s fails system verification and you cannot correct the problem, return it to Keysight Technologies for repair following the steps shown below.

1. Record all symptoms.
2. Contact Keysight Technologies using the “Request an RMA” form at <http://www.Keysight.com/find/assist>.
3. Use the original packing material or comparable packing material to ship the instrument to Keysight Technologies.

This information is subject to change without notice.

© Copyright Keysight Technologies 2012-2014

Edition 6.0, September 2014



N4962-91021

www.keysight.com