

Keysight X-Series Signal Analyzer

This manual provides documentation for the following

X-Series Analyzers:

PXA Signal Analyzer N9030A

MXA Signal Analyzer N9020A

EXA Signal Analyzer N9010A

CXA Signal Analyzer N9000A

N6149A
iDEN/WiDEN/Moto
Talk Analyzer
Measurement
Application User's &
Programmer's
Reference

Notices

© Keysight Technologies, Inc.
2008-2014

No part of this manual may be reproduced in any form or by any means (including electronic storage and retrieval or translation into a foreign language) without prior agreement and written consent from Keysight Technologies, Inc. as governed by United States and international copyright laws.

Acknowledgments

Adobe Acrobat® and Reader® are U.S. registered trademarks of Adobe Systems Incorporated.

Manual Part Number

N6149-90001

Edition

August 2014

Printed in USA

Keysight Technologies, Inc.
1400 Fountaingrove Parkway
Santa Rosa, CA 95403

Warranty

The material contained in this document is provided “as is,” and is subject to being changed, without notice, in future editions. Further, to the maximum extent permitted by applicable law, Keysight disclaims all warranties, either express or implied, with regard to this manual and any information contained herein, including but not limited to the implied warranties of merchantability and fitness for a particular purpose. Keysight shall not be liable for errors or for incidental or consequential

damages in connection with the furnishing, use, or performance of this document or of any information contained herein. Should Keysight and the user have a separate written agreement with warranty terms covering the material in this document that conflict with these terms, the warranty terms in the separate agreement shall control.

Technology Licenses

The hardware and/or software described in this document are furnished under a license and may be used or copied only in accordance with the terms of such license.

Restricted Rights

Legend

If software is for use in the performance of a U.S. Government prime contract or subcontract, Software is delivered and licensed as “Commercial computer software” as defined in DFAR 252.227-7014 (June 1995), or as a “commercial item” as defined in FAR 2.101(a) or as “Restricted computer software” as defined in FAR 52.227-19 (June 1987) or any equivalent agency regulation or contract clause. Use, duplication or disclosure of Software is subject to Keysight Technologies’ standard commercial license terms, and non-DOD Departments and Agencies of the U.S. Government will receive no greater than Restricted Rights as defined in FAR 52.227-19(c)(1-2) (June 1987). U.S. Government users will

receive no greater than Limited Rights as defined in FAR 52.227-14 (June 1987) or DFAR 252.227-7015 (b)(2) (November 1995), as applicable in any technical data.

Safety Notices

CAUTION

A CAUTION notice denotes a hazard. It calls attention to an operating procedure, practice, or the like that, if not correctly performed or adhered to, could result in damage to the product or loss of important data. Do not proceed beyond a CAUTION notice until the indicated conditions are fully understood and met.

WARNING

A WARNING notice denotes a hazard. It calls attention to an operating procedure, practice, or the like that, if not correctly performed or adhered to, could result in personal injury or death. Do not proceed beyond a WARNING notice until the indicated conditions are fully understood and met.

Table of Contents

N6149A iDEN/WiDEN/MotoTalk Analyzer Measurement Application User's & Programmer's Reference	i
Table of Contents	iii
1 About the Analyzer	53
Installing Application Software	54
Viewing a License Key	54
Obtaining and Installing a License Key	54
Updating Measurement Application Software	54
X-Series Options and Accessories	56
Front-Panel Features	57
Display Annotations	58
Rear-Panel Features	59
Window Control Keys	60
Multi-Window	60
Zoom	60
Next Window	61
Full Screen	62
Display Enable (Remote Command Only)	62
Mouse and Keyboard Control	64
Right-Click	64
PC Keyboard	66
Instrument Security & Memory Volatility	69
2 About the iDEN/WiDEN/MotoTalk Analyzer Measurement Application	71
What Does the iDEN/WiDEN/MotoTalk Analyzer Measurement Application Do?	72
3 Programming the Analyzer	73
What Programming Information is Available?	74
List of SCPI Commands	75
STATus Subsystem	94
Detailed Description	96
What Are Status Registers	97
What Are Status Register SCPI Commands	97
How to Use the Status Registers	98
Using a Status Register	99
Using the Service Request (SRQ) Method	100
Generating a Service Request	100
Status Register System	101
The Status Byte Register	102
Standard Event Status Register	104
Operation and Questionable Status Registers	106
Operation Status Register	106

Questionable Status Register	106
STATus Subsystem Command Descriptions	107
Operation Register	107
Operation Condition Query	107
Operation Enable	108
Operation Event Query	108
Operation Negative Transition	108
Operation Positive Transition	109
Preset the Status Byte	109
Questionable Register	110
Questionable Condition	110
Questionable Enable	110
Questionable Event Query	111
Questionable Negative Transition	111
Questionable Positive Transition	111
Questionable Calibration Register	112
Questionable Calibration Condition	112
Questionable Calibration Enable	112
Questionable Calibration Event Query	113
Questionable Calibration Negative Transition	113
Questionable Calibration Positive Transition	114
Questionable Calibration Skipped Register	114
Questionable Calibration Skipped Condition	114
Questionable Calibration Skipped Enable	115
Questionable Calibration Skipped Event Query	115
Questionable Calibration Skipped Negative Transition	116
Questionable Calibration Skipped Positive Transition	116
Questionable Calibration Extended Failure Register	116
Questionable Calibration Extended Failure Condition	117
Questionable Calibration Extended Failure Enable	117
Questionable Calibration Extended Failure Event Query	117
Questionable Calibration Extended Failure Negative Transition	118
Questionable Calibration Extended Failure Positive Transition	118
Questionable Calibration Extended Needed Register	119
Questionable Calibration Extended Needed Condition	119
Questionable Calibration Extended Needed Enable	119
Questionable Calibration Extended Needed Event Query	120
Questionable Calibration Extended Needed Negative Transition	120
Questionable Calibration Extended Needed Positive Transition	121
Questionable Frequency Register	121
Questionable Frequency Condition	121
Questionable Frequency Enable	122
Questionable Frequency Event Query	122

Questionable Frequency Negative Transition	122
Questionable Frequency Positive Transition	123
Questionable Integrity Register	123
Questionable Integrity Condition	123
Questionable Integrity Enable	124
Questionable Integrity Event Query	124
Questionable Integrity Negative Transition	125
Questionable Integrity Positive Transition	125
Questionable Integrity Signal Register	125
Questionable Integrity Signal Condition	126
Questionable Integrity Signal Enable	126
Questionable Integrity Signal Event Query	127
Questionable Integrity Signal Negative Transition	127
Questionable Integrity Signal Positive Transition	127
Questionable Integrity Uncalibrated Register	128
Questionable Integrity Uncalibrated Condition	128
Questionable Integrity Uncalibrated Enable	128
Questionable Integrity Uncalibrated Event Query	129
Questionable Integrity Uncalibrated Negative Transition	129
Questionable Integrity Uncalibrated Positive Transition	130
Questionable Power Register	130
Questionable Power Condition	130
Questionable Power Enable	131
Questionable Power Event Query	131
Questionable Power Negative Transition	132
Questionable Power Positive Transition	132
Questionable Temperature Register	132
Questionable Temperature Condition	133
Questionable Temperature Enable	133
Questionable Temperature Event Query	133
Questionable Temperature Negative Transition	134
Questionable Temperature Positive Transition	134
IEEE 488.2 Common Commands	136
All	136
Clear Status	138
Standard Event Status Enable	138
Standard Event Status Register Query	139
Identification Query	139
Operation Complete	140
Query Instrument Options	141
Recall Instrument State	141
*RST (Remote Command Only)	142
Save Instrument State	142

Service Request Enable	142
Status Byte Query	143
Trigger	143
Self Test Query	143
Wait-to-Continue	144
4 Input/Output Functions	145
Input/Output	146
Input/Output variables - Preset behavior	147
RF Input	148
Input Z Correction	148
RF Coupling	149
I/Q	150
Baseband I/Q (Option BBA)	150
Baseband I/Q Remote Language Compatibility	152
I/Q Path	153
I+jQ	154
I Only	154
Q Only	155
I Setup	155
I Differential Input	155
I Input Z	156
I Skew	157
I Probe	157
Combined Differential/Input Z (Remote Command Only)	159
Q Setup	160
Q Same as I	160
Q Differential Input	161
Q Input Z	162
Q Skew	162
Q Probe	163
Reference Z	165
I/Q Probe Setup	165
Attenuation	166
Offset	167
Coupling	167
Calibrate	168
Clear Calibration	169
RF Calibrator	169
50 MHz	170
4.8 GHz	170
Off	171
External Gain	171
Ext Preamp	171

More Information	172
MS	173
BTS	174
I Ext Gain	175
Q Ext Gain	175
Restore Input/Output Defaults	176
Freq Ref In	176
Sense	178
Internal	178
External	179
Ext Ref Freq	179
External Reference Lock BW	180
External Ref Coupling	181
I/Q Guided Calibration	182
I/Q Isolation Calibration	183
Next	183
Exit	183
I/Q Isolation Calibration Time (Remote Command Only)	183
I/Q Cable Calibrate...	184
I Port	184
I-bar Port	185
Q Port	186
Q-bar Port	187
I/Q Cable Calibration Time (Remote Command Only)	188
I/Q Probe Calibration	188
I Port	189
I-bar Port	190
Q Port	192
Q-bar Port	193
Show Adapter Screen	194
I/Q Probe Calibration Time (Remote Command Only)	194
Exit Confirmation	194
5 Mode Functions	195
Mode	196
More Information	197
Spectrum Analyzer	198
EMI Receiver	199
IQ Analyzer (Basic)	199
W-CDMA with HSPA+	199
GSM/EDGE/EDGE Evo	200
802.16 OFDMA (WiMAX/WiBro)	200
Vector Signal Analyzer (VXA)	200
Phase Noise	201

Noise Figure	201
Analog Demod	201
TD-SCDMA with HSPA/8PSK	202
cdma2000	202
1xEV-DO	202
LTE	202
LTE TDD	203
DVB-T/H with T2	203
DTMB (CTTB)	203
ISDB-T	204
CMMB	204
Combined WLAN	204
Combined Fixed WiMAX	205
802.16 OFDM (Fixed WiMAX)	205
iDEN/WiDEN/MOTOtalk	205
Remote Language Compatibility	206
SCPI Language Compatibility	206
89601 VSA	206
Bluetooth	207
Digital Cable TV	207
WLAN	208
MSR	208
Application Mode Number Selection (Remote Command Only)	208
Application Mode Catalog Query (Remote Command Only)	210
Application Identification (Remote Commands Only)	210
Current Application Model	211
Current Application Revision	211
Current Application Options	211
Application Identification Catalog (Remote Commands Only)	212
Application Catalog Number of Entries	212
Application Catalog Model Numbers	212
Application Catalog Revision	212
Application Catalog Options	213
Detailed List of Modes	213
1xEV-DO	213
802.16 OFDMA (WiMAX/WiBro)	214
802.16 OFDM (Fixed WiMAX)	214
89601 VSA	214
Analog Demod	215
Bluetooth	215
cdma2000	216
CMMB	216
Combined WLAN	216

Combined Fixed WiMAX	217
Digital Cable TV	217
DTMB (CTTB)	217
DVB-T/H with T2	217
EMI Receiver	218
GSM/EDGE/EDGE Evo	218
iDEN/WiDEN/MOTOTalk	218
IQ Analyzer (Basic)	219
ISDB-T	219
LTE	219
LTE TDD	220
MSR	220
Noise Figure	220
Phase Noise	221
Remote Language Compatibility	221
SCPI Language Compatibility	221
Spectrum Analyzer	222
TD-SCDMA with HSPA/8PSK	222
Vector Signal Analyzer (VXA)	222
W-CDMA with HSPA+	223
WLAN	223
Global Settings	223
Global Center Freq	224
Restore Defaults	224
Mode Setup	226
Spectrum	226
Fixed Equalization	227
Fixed EQ Mode	227
Freq Response Register	227
Fixed Equalization Mapping	228
Radio Standards	228
MQAM Format	228
M4QAM	229
M16QAM	229
M64QAM	229
Slot Format	229
Full Slot Reserved (Inbound)	230
Random Access (Inbound)	231
New 6:1 Reserved Pseudo (Inbound)	231
Full Slot Enhanced 6:1 (Inbound)	231
WiDEN (Inbound)	231
Full Slot Reserved (Outbound)	232
New 6:1 Reserved (Outbound)	232

Color Code	232
Carrier Config	232
25 kHz	233
50 kHz	233
50 kHz Outer	233
75 kHz	234
100 kHz	234
Global Settings	234
6 System Functions	235
File	236
File Explorer	236
Print	237
Maximize/Restore Down	237
Maximize	237
Restore Down	237
Page Setup	237
Print	238
Maximize	239
Restore Down	239
Minimize	239
Exit	240
Print	241
System	242
Show	242
Errors	242
Previous Page	243
Next Page	244
History	244
Verbose SCPI On/Off	244
Refresh	245
Clear Error Queue	245
Status	245
Input Overload Enable (Remote Command Only)	245
System	246
Show System contents (Remote Command Only)	247
Hardware	247
LXI	248
Power On	248
Mode and Input/Output Defaults	249
User Preset	249
Last State	250
Power On Application	250
Configure Applications	251

Preloading Applications	252
Access to Configure Applications utility	252
Virtual memory usage	252
Select All	253
Deselect All	253
Move Up	253
Move Down	253
Select/Deselect	253
Save Changes and Exit	254
Exit Without Saving	254
Restore Power On Defaults	254
Configure Applications - Instrument boot-up	255
Configure Applications - Windows desktop	255
Configure Applications - Remote Commands	255
Configuration list (Remote Command Only)	256
Configuration Memory Available (Remote Command Only)	256
Configuration Memory Total (Remote Command Only)	256
Configuration Memory Used (Remote Command Only)	256
Configuration Application Memory (Remote Command Only)	257
Alignments	257
Auto Align	257
Normal	258
Partial	259
Off	259
All but RF	260
Alert	260
Execute Expired Alignments (Remote Command Only)	263
Align Now	264
All	264
All but RF	266
RF	267
Show Alignment Statistics	268
Restore Align Defaults	273
Backup or Restore Align Data...	274
Alignment Data Wizard	274
Perform Backup (Remote Command Only)	279
Perform Restore (Remote Command Only)	280
Advanced	280
Characterize Preselector	280
Timebase DAC	281
Calibrated	282
User	282
I/O Config	283

GPIB	283
GPIB Address	283
GPIB Controller	284
SCPI LAN	285
SCPI Telnet	285
SCPI Socket	286
SICL Server	286
HiSLIP Server	287
SCPI Socket Control Port (Remote Command Only)	287
Reset Web Password	288
LXI	288
LAN Reset	288
System IDN Response	289
Factory	289
User	289
Query USB Connection (Remote Command Only)	290
USB Connection Status (Remote Command Only)	290
USB Packet Count (Remote Command Only)	291
Restore Defaults	291
Restore Input/Output Defaults	291
Restore Power On Defaults	292
Restore Align Defaults	292
Restore Misc Defaults	293
Restore Mode Defaults (All Modes)	294
All	295
Control Panel...	296
Licensing...	297
Security	299
USB	299
Read-Write	299
Read only	299
Diagnostics	300
Show Hardware Statistics	300
SCPI for Show Hardware Statistics (Remote Commands Only)	301
Service	304
Internet Explorer...	304
System Remote Commands (Remote Commands Only)	304
System Powerdown (Remote Command Only)	305
List installed Options (Remote Command Only)	305
Lock the Front-panel keys (Remote Command Only)	305
List SCPI Commands (Remote Command Only)	306
SCPI Version Query (Remote Command Only)	306
Date (Remote Command Only)	306

Time (Remote Command Only)	307
7 Trigger Functions	309
Trigger	310
Free Run	310
Video (IF Envelope)	310
Trigger Level	311
Trig Slope	311
Trig Delay	312
Trig Holdoff	312
Holdoff Type	313
External 1	314
Trigger Level	314
Trig Slope	315
Trig Delay	315
Trig Holdoff	316
Holdoff Type	316
Trig Reference Line	317
8 Vector Analysis	319
AMPTD Y Scale (Amplitude)	322
Y Auto Scale	322
Range	322
Range	323
Range Auto/Man	323
I Range	324
Q Range Value	325
I/Q Gain Ranges	327
μ W Path Control	328
Standard Path	329
μ W Preselector Bypass	329
Select Trace	330
Couple Ref to Range	332
Y Reference Value	332
Y Scale Per Division	333
Y Reference: Position	333
Reference Line	334
Y Unit Preference	334
Y Log Ratio	335
Vector Horiz Center	335
Copy Y Scale	336
Auto Couple	337
More Information	337
Auto/Man Active Function keys	337

Table of Contents

Auto/Man 1-of-N keys	337
BW (Bandwidth)	339
Res BW	339
Res BW Coupling	340
FFT Window	341
Cont (Continuous Measurement/Sweep)	343
File	345
FREQ Channel	346
Center Freq	346
Start Freq	347
Stop Freq	347
CF Step	348
Input/Output	349
Marker	350
Select Marker	350
Control Mode	351
Normal (Position)	351
Delta	352
Fixed	352
Off	353
Coupling of Delta and Reference Markers	353
Marker Properties	354
Select Marker	354
Relative To	354
Complex Format	355
Marker Trace	356
Marker Count	356
Marker Table	357
Marker Position	357
Marker X	358
SCPI only X position commands	359
Marker Z	360
Marker Y	361
Marker Y Imag (Imaginary)	362
Couple Markers	363
All Markers Off	364
Coupling of Delta and Reference Markers	364
Marker -> (Marker To)	366
Mkr -> CF (Center Frequency)	366
Mkr -> CF Step	366
Mkr -> Start	367
Mkr -> Stop	367
Mkr Delta -> Span	367

Mkr -> Ref Lvl	367
Counter -> CF (Center Frequency)	368
Mkr Delta -> CF (Center Frequency)	368
Marker Function	369
Select Marker	369
Band/Interval Power	370
Frequency-domain data	370
Time-domain data	370
Band Power Calculation	370
Band/Interval Density	372
Frequency-domain data	372
Time-domain data	372
Band Density Calculation	372
Band Adjust	373
Band/Interval Center	373
Band/Interval Span	374
Band/Interval Left	374
Band/Interval Right	375
Band Power and Delta Markers	375
Meas	377
Remote Measurement Functions	377
Measurement Group of Commands	378
Current Measurement Query (Remote Command Only)	380
Limit Test Current Results (Remote Command Only)	380
Data Query (Remote Command Only)	380
Calculate/Compress Trace Data Query (Remote Command Only)	381
Calculate Peaks of Trace Data (Remote Command Only)	386
Format Data: Numeric Data (Remote Command Only)	387
Format Data: Byte Order (Remote Command Only)	388
Meas Setup	389
Avg Number	389
Average Mode	390
Average Setup	390
Average Type	391
Fast Average	391
Update Rate	392
PhNoise Opt	393
Best Close-in F Noise	393
Best Wide-offset F Noise	394
Meas Preset	394
Mode	395
Mode Preset	396
How-To Preset	397

Table of Contents

Mode Setup	399
Peak Search	400
Select Marker	400
Next Peak (Next Lower Amptd)	401
Next Higher Amptd	401
Next Right	402
Next Left	402
Mkr -> CF (Center Frequency)	402
Continuous Peak Search	403
Min Search	403
Mkr -> Ref Lvl (Reference Level)	404
Print	405
Quick Save	406
Recall	408
State	408
More Information	410
From File...	410
Edit Register Names	412
Register 1 thru Register 16	412
Register 1 thru Register 16	413
Trace	414
Import Trace Data	415
Data 1	415
Data 2	416
Data 3	416
Data 4	416
Data 5	416
Data 6	416
Display in Selected Trace	416
Open...	417
Restart	418
More Information	418
Save	420
State	420
To File . . .	421
Edit Register Names	423
More Information	423
Register 1 thru Register 16	424
Register 1 thru Register 16	424
Mass Storage Catalog (Remote Command Only)	425
Mass Storage Change Directory (Remote Command Only)	425
Mass Storage Copy (Remote Command Only)	426
Mass Storage Device Copy (Remote Command Only)	426

Mass Storage Delete (Remote Command Only)	426
Mass Storage Data (Remote Command Only)	427
Mass Storage Make Directory (Remote Command Only)	427
Mass Storage Move (Remote Command Only)	427
Mass Storage Remove Directory (Remote Command Only)	428
Data (Export)	428
Export Trace Data	429
Trace 1	429
Trace 2	430
Trace 3	430
Trace 4	430
Trace 5	430
Trace 6	430
Include Header	431
Save As . . .	431
Screen Image	431
Themes	433
3D Color	433
3D Monochrome	433
Flat Color	433
Flat Monochrome	434
Save As...	434
Single (Single Measurement/Sweep)	435
More Information	435
Source	436
SPAN X Scale	437
Span	437
Full Span	437
Signal Track	438
Select Trace	438
X Scale	440
X Reference Value	440
X Width	441
X Reference Position	441
Freq Annotation	442
All Frequency Points	442
Copy X Scale	443
Sweep/Control	444
Main Time	444
Pause / Resume	445
Gate	445
Gate	445
Gate Length	446

Table of Contents

Gate Delay	446
Freq Points	447
System	448
Trace/Detector	449
Select Trace	449
Data	450
Channel 1	451
Spectrum	451
Inst Spectrum	453
Main Time	453
Gate Time	455
Inst Main Time	455
Raw Main Time	456
PSD (Power Spectral Density)	457
Auto Correlation	458
Statistical	461
CCDF (Complementary, Cumulative Density Function)	461
CDF (Cumulative Density Function)	462
PDF (Probability Density Function)	463
ACP (Adjacent Channel Power)	463
ACP Summary for Trace 1	464
ACP Summary for Trace 2	464
ACP Summary for Trace 3	464
ACP Summary for Trace 4	464
ACP Summary for Trace 5	465
ACP Summary for Trace 6	465
OBW (Occupied Bandwidth)	465
OBW Summary for Trace 1	465
OBW Summary for Trace 2	465
OBW Summary for Trace 3	466
OBW Summary for Trace 4	466
OBW Summary for Trace 5	466
OBW Summary for Trace 6	466
Register	467
Data 1	467
Data 2	467
Data 3	467
Data 4	468
Data 5	468
Data 6	468
No Data	468
Format	469
Digital Demod Trace Setup	470

Symbol Shape	470
Ideal State Shape	471
Ideal State Size	471
Symbol Table Format	472
Time Unit	473
Freq Unit	473
Eye Length	474
Avg Line	474
Copy to Data Register	474
Phase/Delay Properties	476
Phase/Trellis Offset	476
Unwrap Phase Ref	476
Group Delay Aperture	477
ACP Setup	478
ACP On/Off	479
Carrier Freq	480
Carrier Meas Noise BW	480
Carrier RRC Weighting	481
Carrier Filter Alpha	481
Offsets	482
Offsets	482
RRC Weighting (All Offsets)	485
OBW Setup (Occupied Bandwidth)	486
OBW Power	487
OBW Centroid > CF	487
BW Limit	488
Trace Indicator Info	488
Trigger	490
Free Run	490
Video	490
Trigger Level	490
Trig Slope	490
Trig Delay	490
Trig Holdoff	490
Holdoff Type	490
External 1	490
Trigger Level	490
Trig Slope	490
Trig Delay	490
Trig Holdoff	490
Holdoff Type	490
Trig Reference Line	491
User Preset	492

Table of Contents

User Preset	492
User Preset All Modes	493
Save User Preset	494
View/Display	495
Display	495
Annotation	495
Meas Bar On/Off	496
Screen	497
Active Function Values On/Off	497
Title	498
Change Title	498
Clear Title	499
Graticule	500
System Display Settings	500
Annotation Local Settings	500
Themes	501
Backlight	502
Backlight Intensity	502
Layout	503
Preset View: Spectrum/Time	505
Preset View: Statistics	505
Remote SCPI Commands and Data Queries	507
:READ and :FETCh Commands	507
:CALCulate:DATA	510
:CALCulate:DATA:RAW	511
:CALCulate:DATA:RAW:COMPLex	512
:CALCulate:DATA:POINts commands	512
:CALCulate:DATA:TABL commands	513
Query Table Data as Number	514
Query Table Data as String	514
Query Table Names	515
Query Table Units	515
:CALCulate:DATA:HEADer commands	517
Query Header Names	517
Query Header Type	517
Query Header as String	518
Query Numeric Header	518
:CALC:CLIMits:FAIL?	519
IQ Data Transfers	519
Fast Capture Length	520
Fast Capture Word Length	521
Initiate Fast Capture	521
Fast Capture Block	521

Fast Capture Pointer	522
Fetch Fast Capture	522
Input Sample Rate Query	523
Parameter Update Enable	523
9 Monitor Spectrum Measurement	525
AMPTD Y Scale	528
Ref Value	528
Attenuation	528
Dual Attenuator Configurations:	529
Single Attenuator Configuration:	529
(Mech) Atten	530
Attenuator Configurations and Auto/Man	531
Enable Elec Atten	532
More Information	533
Mechanical Attenuator Transition Rules	533
When the Electronic Attenuation is enabled from a disabled state:	533
Examples in the dual attenuator configuration:	533
When the Electronic Attenuation is disabled from an enabled state:	533
Using the Electronic Attenuator: Pros and Cons	534
Elec Atten	534
Adjust Atten for Min Clip	535
Pre-Adjust for Min Clip	535
Off	536
Elec Atten Only	536
Mech + Elec Atten	537
(Mech) Atten Step	537
Scale/Div	537
Presel Center	538
Proper Preselector Operation	539
Preselector Adjust	539
μ W Path Control	540
Standard Path	542
μ W Preselector Bypass	542
Internal Preamp	543
Off	544
Low Band	544
Full Range	545
Ref Position	545
Auto Scaling	545
Auto Couple	547
More Information	547
Auto/Man Active Function keys	547
Auto/Man 1-of-N keys	547

Table of Contents

BW	549
Res BW	549
Video BW	550
VBW:3dB RBW	552
Span:3dB RBW	552
Cont (Continuous Measurement/Sweep)	554
File	556
FREQ Channel	557
Center Freq	557
Center Frequency Presets	558
RF Center Freq	560
Ext Mix Center Freq	561
I/Q Center Freq	562
CF Step	562
Input/Output	564
Marker	565
Select Marker	565
Properties	565
Select Marker	565
Relative To	565
Marker Trace	566
Couple Markers	566
All Markers Off	567
Marker X Axis Value (Remote Command only)	567
Marker X Axis Position (Remote Command only)	568
Marker Y Axis Value (Remote Command only)	568
Marker Function	569
Select Marker	569
Marker Function Type	569
Band Adjust	569
Band/Interval Span for Frequency Domain	570
Band/Interval Left for Frequency Domain	570
Band/Interval Right for Frequency Domain	571
Marker To	572
Meas	573
Remote Measurement Functions	573
Measurement Group of Commands	574
Current Measurement Query (Remote Command Only)	576
Limit Test Current Results (Remote Command Only)	576
Data Query (Remote Command Only)	576
Calculate/Compress Trace Data Query (Remote Command Only)	577
Calculate Peaks of Trace Data (Remote Command Only)	582
Format Data: Numeric Data (Remote Command Only)	583

Format Data: Byte Order (Remote Command Only)	584
Meas Setup	585
Avg/Hold Num	585
Avg Mode	585
Meas Preset	586
Mode	587
Mode Preset	588
How-To Preset	589
Mode Setup	591
Peak Search	592
Print	593
Quick Save	594
Recall	596
State	596
More Information	598
From File...	598
Edit Register Names	600
Register 1 thru Register 16	600
Register 1 thru Register 16	601
Trace	602
Import Trace Data	603
Data 1	603
Data 2	604
Data 3	604
Data 4	604
Data 5	604
Data 6	604
Display in Selected Trace	604
Open...	605
Restart	606
More Information	606
Save	608
State	608
To File . . .	609
Edit Register Names	611
More Information	611
Register 1 thru Register 16	612
Register 1 thru Register 16	612
Mass Storage Catalog (Remote Command Only)	613
Mass Storage Change Directory (Remote Command Only)	613
Mass Storage Copy (Remote Command Only)	614
Mass Storage Device Copy (Remote Command Only)	614
Mass Storage Delete (Remote Command Only)	614

Table of Contents

Mass Storage Data (Remote Command Only)	615
Mass Storage Make Directory (Remote Command Only)	615
Mass Storage Move (Remote Command Only)	615
Mass Storage Remove Directory (Remote Command Only)	616
Data (Export)	616
Export Trace Data	617
Trace 1	617
Trace 2	618
Trace 3	618
Trace 4	618
Trace 5	618
Trace 6	618
Include Header	619
Save As . . .	619
Screen Image	619
Themes	621
3D Color	621
3D Monochrome	621
Flat Color	621
Flat Monochrome	622
Save As...	622
Single (Single Measurement/Sweep)	623
More Information	623
Source	624
Span X Scale	625
Span	625
IDEN Mode Span Preset for Monitor Spectrum	626
Full Span	626
Last Span	626
Sweep/Control	628
Sweep Time	628
Pause	628
Gate	629
Gate On/Off	629
Gate View On/Off	630
Gate View Setup	633
Gate View Sweep Time	634
Gate View Start Time	634
Gate Delay	635
Gate Length	635
Gate Source	636
External 1	637
External 2	638

RF Burst	640
Control Edge/Level	643
Gate Holdoff	643
Gate Delay Compensation	645
More Information	646
Min Fast Position Query (Remote Command Only)	646
Gate Preset (Remote Command Only)	647
Gate Level (Remote Command Only)	647
Gate Polarity (Remote Command Only)	647
Points	648
System	649
Trace/Detector	650
Select Trace	650
Trace Type	650
Update	651
Display	651
Detector	652
Auto	653
Clear Trace	653
Clear All Traces	653
Trigger	655
Free Run	655
External 1	655
Trigger Level	655
Trig Slope	655
Trig Delay	655
External 2	655
Trigger Level	655
Trig Slope	655
Trig Delay	655
RF Burst	655
Absolute Trigger	655
Relative Trigger	655
Trig Slope	655
Trig Delay	656
Auto/Holdoff	656
Auto Trig	656
Trig Holdoff	656
User Preset	657
User Preset	657
User Preset All Modes	658
Save User Preset	659
View/Display	660

Display	660
Annotation	660
Meas Bar On/Off	661
Screen	662
Active Function Values On/Off	662
Title	663
Change Title	663
Clear Title	664
Graticule	665
System Display Settings	665
Annotation Local Settings	665
Themes	666
Backlight	667
Backlight Intensity	667
Remote SCPI Commands and Data Queries	669
:READ and :FETCh Commands	669
:CALCulate:DATA	672
:CALCulate:DATA:RAW	673
:CALCulate:DATA:RAW:COMPLex	674
:CALCulate:DATA:POINts commands	674
:CALCulate:DATA:TABL commands	675
Query Table Data as Number	676
Query Table Data as String	676
Query Table Names	677
Query Table Units	677
:CALCulate:DATA:HEADer commands	679
Query Header Names	679
Query Header Type	679
Query Header as String	680
Query Numeric Header	680
:CALC:CLIMits:FAIL?	681
IQ Data Transfers	681
Fast Capture Length	682
Fast Capture Word Length	683
Initiate Fast Capture	683
Fast Capture Block	683
Fast Capture Pointer	684
Fetch Fast Capture	684
Input Sample Rate Query	685
Parameter Update Enable	685
10 Measurement Functions	687
10 iDEN Power Measurement	687
AMPTD Y Scale (Amplitude)	691

Y Auto Scale	691
Range	691
Range	692
Range Auto/Man	692
I Range	693
Q Range Value	694
I/Q Gain Ranges	696
Select Trace	697
Couple Ref to Range	698
Y Reference Value	698
Y Scale Per Division	699
Y Reference: Position	699
Reference Line	700
Y Unit Preference	700
Y Log Ratio	701
Vector Horiz Center	702
Copy Y Scale	702
Auto Couple	704
More Information	704
Auto/Man Active Function keys	704
Auto/Man 1-of-N keys	704
BW (Bandwidth)	706
Res BW	706
Res BW Coupling	707
FFT Window	708
Cont (Continuous Measurement/Sweep)	710
File	712
FREQ Channel	713
Center Freq	713
Start Freq	714
Stop Freq	714
CF Step	715
Input/Output	716
Marker	717
Control Mode	717
Normal (Position)	718
Delta	718
Fixed	719
Off	719
Coupling of Delta and Reference Markers	720
Select Marker	720
Marker Properties	721
Select Marker	721

Relative To	721
Complex Format	722
Marker Trace	723
Marker Count	723
Marker Table	724
Marker Position	724
Marker X	725
SCPI only X position commands	726
Marker Z	727
Marker Y	728
Marker Y Imag (Imaginary)	729
Couple Markers	730
All Markers Off	731
Coupling of Delta and Reference Markers	731
Marker -> (Marker To)	733
Mkr -> CF (Center Frequency)	733
Mkr -> CF Step	733
Mkr -> Start	734
Mkr -> Stop	734
Mkr Delta -> Span	734
Mkr -> Ref Lvl	734
Counter -> CF (Center Frequency)	735
Mkr Delta -> CF (Center Frequency)	735
Marker Function	736
Select Marker	736
Band/Interval Power	737
Frequency-domain data	737
Time-domain data	737
Band Power Calculation	737
Band/Interval Density	739
Frequency-domain data	739
Time-domain data	739
Band Density Calculation	739
Band Adjust	740
Band/Interval Center	740
Band/Interval Span	741
Band/Interval Left	741
Band/Interval Right	742
Band Power and Delta Markers	742
Meas	744
Remote Measurement Functions	744
Measurement Group of Commands	745
Current Measurement Query (Remote Command Only)	747

Limit Test Current Results (Remote Command Only)	747
Data Query (Remote Command Only)	747
Calculate/Compress Trace Data Query (Remote Command Only)	748
Calculate Peaks of Trace Data (Remote Command Only)	753
Format Data: Numeric Data (Remote Command Only)	754
Format Data: Byte Order (Remote Command Only)	755
Meas Setup	756
More Information about Meas Setup:	756
Test Selection	756
OBW	756
ACP	757
Test Preset	757
Power Calc Uses	758
Modulation	758
Full Signal	758
ACP Setup	759
More Information about ACP Setup	759
Offsets	760
Offset Freq	760
Offset Meas Noise BW	761
Offset Relative Limit	762
Carrier Meas Noise BW	763
OBW Centroid -> CF	763
Avg Number	763
Average Mode	764
Average Setup	765
Average Type	765
Fast Average	766
Update Rate	766
OBW % Power	767
OBW Limit	767
Mode	769
Mode Preset	770
How-To Preset	771
Mode Setup	773
Peak Search	774
Select Marker	774
Next Peak (Next Lower Amptd)	775
Next Higher Amptd	775
Next Right	776
Next Left	776
Mkr -> CF (Center Frequency)	776
Continuous Peak Search	777

Table of Contents

Min Search	777
Mkr -> Ref Lvl (Reference Level)	778
Print	779
Quick Save	780
Recall	782
State	782
More Information	784
From File...	784
Edit Register Names	786
Register 1 thru Register 16	786
Register 1 thru Register 16	787
Trace	788
Import Trace Data	789
Data 1	789
Data 2	790
Data 3	790
Data 4	790
Data 5	790
Data 6	790
Display in Selected Trace	790
Open...	791
Restart	792
More Information	792
Save	794
State	794
To File . . .	795
Edit Register Names	797
More Information	797
Register 1 thru Register 16	798
Register 1 thru Register 16	798
Mass Storage Catalog (Remote Command Only)	799
Mass Storage Change Directory (Remote Command Only)	799
Mass Storage Copy (Remote Command Only)	800
Mass Storage Device Copy (Remote Command Only)	800
Mass Storage Delete (Remote Command Only)	800
Mass Storage Data (Remote Command Only)	801
Mass Storage Make Directory (Remote Command Only)	801
Mass Storage Move (Remote Command Only)	801
Mass Storage Remove Directory (Remote Command Only)	802
Data (Export)	802
Export Trace Data	803
Trace 1	803
Trace 2	804

Trace 3	804
Trace 4	804
Trace 5	804
Trace 6	804
Include Header	805
Save As . . .	805
Screen Image	805
Themes	807
3D Color	807
3D Monochrome	807
Flat Color	807
Flat Monochrome	808
Save As...	808
Single (Single Measurement/Sweep)	809
More Information	809
Source	810
SPAN X Scale	811
Span	811
Full Span	811
Signal Track	812
Select Trace	812
X Scale	814
X Reference Value	814
X Width	815
X Reference Position	815
Freq Annotation	816
All Frequency Points	816
Copy X Scale	817
Sweep/Control	818
Main Time	818
Pause / Resume	819
Gate	819
Gate	819
Gate Length	820
Gate Delay	820
Freq Points	821
System	822
Trace/Detector	823
Select Trace	823
Data	824
Channel 1	825
Spectrum	825
Inst Spectrum	827

Main Time	827
Gate Time	829
Inst Main Time	829
Raw Main Time	830
PSD (Power Spectral Density)	831
Auto Correlation	832
ACP (Adjacent Channel Power)	835
ACP Summary for Trace 1	835
ACP Summary for Trace 2	835
ACP Summary for Trace 3	836
ACP Summary for Trace 4	836
ACP Summary for Trace 5	836
ACP Summary for Trace 6	836
OBW (Occupied Bandwidth)	836
OBW Summary for Trace 1	837
OBW Summary for Trace 2	837
OBW Summary for Trace 3	837
OBW Summary for Trace 4	837
OBW Summary for Trace 5	838
OBW Summary for Trace 6	838
Register	838
Data 1	838
Data 2	839
Data 3	839
Data 4	839
Data 5	839
Data 6	839
No Data	840
Format	840
Digital Demod Trace Setup	841
Symbol Shape	841
Ideal State Shape	842
Ideal State Size	843
Symbol Table Format	843
Time Unit	844
Freq Unit	844
Eye Length	845
Avg Line	845
Copy to Data Register	846
Phase/Delay Properties	847
Phase/Trellis Offset	847
Unwrap Phase Ref	848
Group Delay Aperture	848

ACP Setup	849
ACP On/Off	850
Carrier Freq	851
Carrier Meas Noise BW	851
Carrier RRC Weighting	852
Carrier Filter Alpha	852
Offsets	853
Offsets	853
RRC Weighting (All Offsets)	856
OBW Setup (Occupied Bandwidth)	857
OBW Power	858
OBW Centroid > CF	858
BW Limit	859
Trace Indicator Info	859
Trigger	861
Free Run	861
Video	861
Trigger Level	861
Trig Slope	861
Trig Delay	861
Trig Holdoff	861
Holdoff Type	861
External 1	861
Trigger Level	861
Trig Slope	861
Trig Delay	861
Trig Holdoff	861
Holdoff Type	861
Trig Reference Line	862
User Preset	863
User Preset	863
User Preset All Modes	864
Save User Preset	865
View/Display	866
Display	866
Annotation	866
Meas Bar On/Off	867
Screen	868
Active Function Values On/Off	868
Title	869
Change Title	869
Clear Title	870
Graticule	871

System Display Settings	871
Annotation Local Settings	871
Themes	872
Backlight	873
Backlight Intensity	873
Layout	874
Preset View: Test Standard	876
Preset View: ACP	876
Preset View: ACP & OBW	876
Preset View: OBW & Burst	877
Measurement Views	877
Preset View: Test Standard	877
Preset View: ACP	878
Preset View: OWB & ACP	879
Preset View: ACP & Burst	880
Front Panel Results	881
Occupied Bandwidth Results	882
Adjacent Channel Power Results	882
Remote SCPI Commands and Data Queries	883
:READ and :FETCh Commands	883
:CALCulate:DATA	886
:CALCulate:DATA:RAW	887
:CALCulate:DATA:RAW:COMPLex	888
:CALCulate:DATA:POINts commands	888
:CALCulate:DATA:TABL commands	889
Query Table Data as Number	890
Query Table Data as String	890
Query Table Names	891
Query Table Units	891
:CALCulate:DATA:HEADer commands	893
Query Header Names	893
Query Header Type	893
Query Header as String	894
Query Numeric Header	894
:CALC:CLIMits:FAIL?	895
IQ Data Transfers	895
Fast Capture Length	896
Fast Capture Word Length	897
Initiate Fast Capture	897
Fast Capture Block	897
Fast Capture Pointer	898
Fetch Fast Capture	898
Input Sample Rate Query	899

Parameter Update Enable	899
11 Measurement Functions	901
11 iDEN Demod Measurement	901
AMPTD Y Scale (Amplitude)	908
Y Auto Scale	908
Range	908
Range	909
Range Auto/Man	909
I Range	910
Q Range Value	911
I/Q Gain Ranges	913
Select Trace	914
Couple Ref to Range	915
Y Reference Value	915
Y Scale Per Division	916
Y Reference: Position	916
Reference Line	917
Y Unit Preference	917
Y Log Ratio	918
Vector Horiz Center	919
Copy Y Scale	919
Auto Couple	921
More Information	921
Auto/Man Active Function keys	921
Auto/Man 1-of-N keys	921
BW (Bandwidth)	923
FFT Window	923
Cont (Continuous Measurement/Sweep)	925
File	927
FREQ Channel	928
Center Freq	928
Start Freq	929
Stop Freq	929
CF Step	930
Input/Output	931
Marker	932
Select Marker	932
Control Mode	933
Normal (Position)	933
Delta	934
Fixed	934
Off	935

Coupling of Delta and Reference Markers	935
Marker Properties	936
Select Marker	936
Relative To	936
Complex Format	937
Marker Trace	938
Marker Count	938
Marker Table	939
Marker Position	939
Marker X	940
SCPI only X position commands	941
Marker Z	942
Marker Y	943
Marker Y Imag (Imaginary)	944
Couple Markers	945
All Markers Off	946
Coupling of Delta and Reference Markers	946
Marker -> (Marker To)	948
Mkr -> CF (Center Frequency)	948
Mkr -> CF Step	948
Mkr -> Start	949
Mkr -> Stop	949
Mkr Delta -> Span	949
Mkr -> Ref Lvl	949
Counter -> CF (Center Frequency)	950
Mkr Delta -> CF (Center Frequency)	950
Marker Function	951
Select Marker	951
Band/Interval Power	952
Frequency-domain data	952
Time-domain data	952
Band Power Calculation	952
Band/Interval Density	954
Frequency-domain data	954
Time-domain data	954
Band Density Calculation	954
Band Adjust	955
Band/Interval Center	955
Band/Interval Span	956
Band/Interval Left	956
Band/Interval Right	957
Band Power and Delta Markers	957
Meas	959

Remote Measurement Functions	959
Measurement Group of Commands	960
Current Measurement Query (Remote Command Only)	962
Limit Test Current Results (Remote Command Only)	962
Data Query (Remote Command Only)	962
Calculate/Compress Trace Data Query (Remote Command Only)	963
Calculate Peaks of Trace Data (Remote Command Only)	968
Format Data: Numeric Data (Remote Command Only)	969
Format Data: Byte Order (Remote Command Only)	970
Meas Setup	971
More Information about Meas Setup:	971
Test Selection	971
EVM	971
PvT	972
BER	972
Test Preset	973
More Information about Test Preset:	973
EVM Setup	973
Analysis Subchannel	974
0 (LO)	974
1 (LI)	974
2 (RI)	974
3 (RO)	975
WiDEN Carrier	975
EVM Test Limit	975
BER Setup	976
BER Slots	976
BER Test Limit	977
Search Length	977
Analysis Slot	978
Avg Number	978
Average Mode	979
Average Setup	980
Average Type	980
Fast Average	981
Update Rate	981
Extend Freq Lock Range	982
Normalize	983
Advanced	983
Filter Alpha	983
Time Scale Factor	984
Sync/Pilot Symbols	984
Droop	985

Table of Contents

Pilot Tracking	985
Mode	986
Mode Preset	987
How-To Preset	988
Mode Setup	990
Peak Search	991
Select Marker	991
Next Peak (Next Lower Amptd)	992
Next Higher Amptd	992
Next Right	993
Next Left	993
Mkr -> CF (Center Frequency)	993
Continuous Peak Search	994
Min Search	994
Mkr -> Ref Lvl (Reference Level)	995
Print	996
Quick Save	997
Recall	999
State	999
More Information	1001
From File...	1001
Edit Register Names	1003
Register 1 thru Register 16	1003
Register 1 thru Register 16	1004
Trace	1005
Import Trace Data	1006
Data 1	1006
Data 2	1007
Data 3	1007
Data 4	1007
Data 5	1007
Data 6	1007
Display in Selected Trace	1007
Open...	1008
Restart	1009
More Information	1009
Save	1011
State	1011
To File . . .	1012
Edit Register Names	1014
More Information	1014
Register 1 thru Register 16	1015
Register 1 thru Register 16	1015

Mass Storage Catalog (Remote Command Only)	1016
Mass Storage Change Directory (Remote Command Only)	1016
Mass Storage Copy (Remote Command Only)	1017
Mass Storage Device Copy (Remote Command Only)	1017
Mass Storage Delete (Remote Command Only)	1017
Mass Storage Data (Remote Command Only)	1018
Mass Storage Make Directory (Remote Command Only)	1018
Mass Storage Move (Remote Command Only)	1018
Mass Storage Remove Directory (Remote Command Only)	1019
Data (Export)	1019
Export Trace Data	1020
Trace 1	1020
Trace 2	1021
Trace 3	1021
Trace 4	1021
Trace 5	1021
Trace 6	1021
Include Header	1022
Save As . . .	1022
Screen Image	1022
Themes	1024
3D Color	1024
3D Monochrome	1024
Flat Color	1024
Flat Monochrome	1025
Save As...	1025
Single (Single Measurement/Sweep)	1026
More Information	1026
Source	1027
SPAN X Scale	1028
Span	1028
Full Span	1028
Select Trace	1029
X Scale	1030
X Reference Value	1030
X Width	1031
X Reference Position	1032
Freq Annotation	1032
All Frequency Points	1033
Copy X Scale	1033
Sweep/Control	1035
Pause / Resume	1035
System	1036

Trace/Detector	1037
Select Trace	1037
Data	1038
Pre Demod	1039
Spectrum	1039
Inst Spectrum	1040
Search Time	1040
Time	1040
Raw Main Time	1040
PvT	1040
PvT Time	1041
PvT Summary	1041
WiDEN Carr0 PvT Time	1041
WiDEN Carr1 PvT Time	1041
WiDEN Carr2 PvT Time	1042
WiDEN Carr3 PvT Time	1042
BER	1042
BER Overall Summary	1042
BER Slot Summary	1042
Overlaid Demod	1043
Overlaid IQ Meas Time	1043
Overlaid IQ Ref Time	1043
Overlaid Error Vector Time	1043
Overlaid Error Vector Spectrum	1043
Overlaid IQ Mag Error	1044
Overlaid IQ Phase Error	1044
Subchannel Demod	1044
Subchannel IQ Meas Time	1044
Subchannel IQ Ref Time	1045
Subchannel Error Vector Time	1045
Subchannel IQ Mag Error	1045
Subchannel IQ Phase Error	1045
Tables	1045
Composite Error Summary	1046
Composite Symbols	1046
Subchannel Error Summary	1046
MQAM Summary	1046
ACP (Adjacent Channel Power)	1046
ACP Summary for Trace 1	1047
ACP Summary for Trace 2	1047
ACP Summary for Trace 3	1047
ACP Summary for Trace 4	1047
ACP Summary for Trace 5	1048

ACP Summary for Trace 6	1048
OBW (Occupied Bandwidth)	1048
OBW Summary for Trace 1	1048
OBW Summary for Trace 2	1048
OBW Summary for Trace 3	1049
OBW Summary for Trace 4	1049
OBW Summary for Trace 5	1049
OBW Summary for Trace 6	1049
Register	1050
Data 1	1050
Data 2	1050
Data 3	1050
Data 4	1051
Data 5	1051
Data 6	1051
No Data	1051
Format	1052
Digital Demod Trace Setup	1053
Symbol Shape	1053
Ideal State Shape	1054
Ideal State Size	1054
Symbol Table Format	1055
Time Unit	1056
Freq Unit	1056
Eye Length	1057
Avg Line	1057
Copy to Data Register	1057
Phase/Delay Properties	1059
Phase/Trellis Offset	1059
Unwrap Phase Ref	1059
Group Delay Aperture	1060
ACP Setup	1061
ACP On/Off	1062
Carrier Freq	1063
Carrier Meas Noise BW	1063
Carrier RRC Weighting	1064
Carrier Filter Alpha	1064
Offsets	1065
Offsets	1065
RRC Weighting (All Offsets)	1068
OBW Setup (Occupied Bandwidth)	1069
OBW Power	1070
OBW Centroid > CF	1070

Table of Contents

BW Limit	1071
Trace Indicator Info	1071
Trigger	1073
Free Run	1073
Video	1073
Trigger Level	1073
Trig Slope	1073
Trig Delay	1073
Trig Holdoff	1073
Holdoff Type	1073
External 1	1073
Trigger Level	1073
Trig Slope	1073
Trig Delay	1073
Trig Holdoff	1073
Holdoff Type	1073
Trig Reference Line	1074
User Preset	1075
User Preset	1075
User Preset All Modes	1076
Save User Preset	1077
View / Display	1078
Display	1078
Annotation	1078
Meas Bar On/Off	1079
Screen	1080
Active Function Values On/Off	1080
Title	1081
Change Title	1081
Clear Title	1082
Graticule	1083
System Display Settings	1083
Annotation Local Settings	1083
Themes	1084
Backlight	1085
Backlight Intensity	1085
Layout	1086
Preset View: Test Standard	1088
Preset View: PvT Rise & Fall	1088
Preset View: EVM (Quad)	1088
Preset View: EVM & Symbols	1089
Preset View: WiDEN PvT	1089
Remote SCPI Commands and Data Queries	1091

:READ and :FETCh Commands	1091
:CALCulate:DATA	1094
:CALCulate:DATA:RAW	1095
:CALCulate:DATA:RAW:COMPlEx	1096
:CALCulate:DATA:POINts commands	1096
:CALCulate:DATA:TABL commands	1097
Query Table Data as Number	1098
Query Table Data as String	1098
Query Table Names	1099
Query Table Units	1099
:CALCulate:DATA:HEADer commands	1101
Query Header Names	1101
Query Header Type	1101
Query Header as String	1102
Query Numeric Header	1102
:CALC:CLIMits:FAIL?	1103
IQ Data Transfers	1103
Fast Capture Length	1104
Fast Capture Word Length	1105
Initiate Fast Capture	1105
Fast Capture Block	1105
Fast Capture Pointer	1106
Fetch Fast Capture	1106
Input Sample Rate Query	1107
Parameter Update Enable	1107
12 Measurement Functions	1109
12 MotoTalk Measurement	1109
AMPTD Y Scale (Amplitude)	1114
Y Auto Scale	1114
Range	1114
Range	1115
Range Auto/Man	1115
I Range	1116
Q Range Value	1117
I/Q Gain Ranges	1119
Select Trace	1120
Couple Ref to Range	1121
Y Reference Value	1121
Y Scale Per Division	1122
Y Reference: Position	1122
Reference Line	1123
Y Unit Preference	1123

Table of Contents

Y Log Ratio	1124
Vector Horiz Center	1125
Copy Y Scale	1125
Auto Couple	1127
More Information	1127
Auto/Man Active Function keys	1127
Auto/Man 1-of-N keys	1127
BW (Bandwidth)	1129
FFT Window	1129
Cont (Continuous Measurement/Sweep)	1131
File	1133
FREQ Channel	1134
Center Freq	1134
Start Freq	1135
Stop Freq	1135
CF Step	1136
Input/Output	1137
Marker	1138
Select Marker	1138
Control Mode	1139
Normal (Position)	1139
Delta	1140
Fixed	1140
Off	1141
Coupling of Delta and Reference Markers	1141
Marker Properties	1142
Select Marker	1142
Relative To	1142
Complex Format	1143
Marker Trace	1144
Marker Count	1144
Marker Table	1145
Marker Position	1145
Marker X	1146
SCPI only X position commands	1147
Marker Z	1148
Marker Y	1149
Marker Y Imag (Imaginary)	1150
Couple Markers	1151
All Markers Off	1152
Coupling of Delta and Reference Markers	1152
Marker -> (Marker To)	1154
Mkr -> CF (Center Frequency)	1154

Mkr -> CF Step	1154
Mkr -> Start	1155
Mkr -> Stop	1155
Mkr Delta -> Span	1155
Mkr -> Ref Lvl	1155
Counter -> CF (Center Frequency)	1156
Mkr Delta -> CF (Center Frequency)	1156
Marker Function	1157
Select Marker	1157
Band/Interval Power	1158
Frequency-domain data	1158
Time-domain data	1158
Band Power Calculation	1158
Band/Interval Density	1160
Frequency-domain data	1160
Time-domain data	1160
Band Density Calculation	1160
Band Adjust	1161
Band/Interval Center	1161
Band/Interval Span	1162
Band/Interval Left	1162
Band/Interval Right	1163
Band Power and Delta Markers	1163
Meas	1165
Remote Measurement Functions	1165
Measurement Group of Commands	1166
Current Measurement Query (Remote Command Only)	1168
Limit Test Current Results (Remote Command Only)	1168
Data Query (Remote Command Only)	1168
Calculate/Compress Trace Data Query (Remote Command Only)	1169
Calculate Peaks of Trace Data (Remote Command Only)	1174
Format Data: Numeric Data (Remote Command Only)	1175
Format Data: Byte Order (Remote Command Only)	1176
Meas Setup	1177
Test Preset	1177
Search Length	1177
Analysis Slot	1178
Avg Number	1178
Average Mode	1179
Average Setup	1180
Average Type	1180
Fast Average	1181
Update Rate	1181

Table of Contents

Normalize	1182
Advanced	1182
Gaussian BT	1182
Symbol Rate	1183
Burst Search	1183
Mode	1185
Mode Preset	1186
How-To Preset	1187
Mode Setup	1189
Peak Search	1190
Select Marker	1190
Next Peak (Next Lower Amptd)	1191
Next Higher Amptd	1191
Next Right	1192
Next Left	1192
Mkr -> CF (Center Frequency)	1192
Continuous Peak Search	1193
Min Search	1193
Mkr -> Ref Lvl (Reference Level)	1194
Print	1195
Quick Save	1196
Recall	1198
State	1198
More Information	1200
From File...	1200
Edit Register Names	1202
Register 1 thru Register 16	1202
Register 1 thru Register 16	1203
Trace	1204
Import Trace Data	1205
Data 1	1205
Data 2	1206
Data 3	1206
Data 4	1206
Data 5	1206
Data 6	1206
Display in Selected Trace	1206
Open...	1207
Restart	1208
More Information	1208
Save	1210
State	1210
To File . . .	1211

Edit Register Names	1213
More Information	1213
Register 1 thru Register 16	1214
Register 1 thru Register 16	1214
Mass Storage Catalog (Remote Command Only)	1215
Mass Storage Change Directory (Remote Command Only)	1215
Mass Storage Copy (Remote Command Only)	1216
Mass Storage Device Copy (Remote Command Only)	1216
Mass Storage Delete (Remote Command Only)	1216
Mass Storage Data (Remote Command Only)	1217
Mass Storage Make Directory (Remote Command Only)	1217
Mass Storage Move (Remote Command Only)	1217
Mass Storage Remove Directory (Remote Command Only)	1218
Data (Export)	1218
Export Trace Data	1219
Trace 1	1219
Trace 2	1220
Trace 3	1220
Trace 4	1220
Trace 5	1220
Trace 6	1220
Include Header	1221
Save As . . .	1221
Screen Image	1221
Themes	1223
3D Color	1223
3D Monochrome	1223
Flat Color	1223
Flat Monochrome	1224
Save As...	1224
Single (Single Measurement/Sweep)	1225
More Information	1225
Source	1226
SPAN X Scale	1227
Span	1227
Full Span	1227
Select Trace	1228
X Scale	1229
X Reference Value	1229
X Width	1230
X Reference Position	1231
Freq Annotation	1231
All Frequency Points	1232

Table of Contents

Copy X Scale	1232
Sweep/Control	1234
Pause / Resume	1234
System	1235
Trace/Detector	1236
Select Trace	1236
Data	1237
Pre Demod	1238
Spectrum	1238
Inst Spectrum	1239
Search Time	1239
Time	1239
Raw Main Time	1239
Error Vector Time	1239
Slot Error Vector Time	1240
Error Summary	1240
Slot Error Summary	1240
ACP (Adjacent Channel Power)	1241
ACP Summary for Trace 1	1241
ACP Summary for Trace 2	1241
ACP Summary for Trace 3	1241
ACP Summary for Trace 4	1242
ACP Summary for Trace 5	1242
ACP Summary for Trace 6	1242
OBW (Occupied Bandwidth)	1242
OBW Summary for Trace 1	1243
OBW Summary for Trace 2	1243
OBW Summary for Trace 3	1243
OBW Summary for Trace 4	1243
OBW Summary for Trace 5	1244
OBW Summary for Trace 6	1244
Register	1244
Data 1	1244
Data 2	1245
Data 3	1245
Data 4	1245
Data 5	1245
Data 6	1245
No Data	1246
Format	1246
Digital Demod Trace Setup	1247
Symbol Shape	1247
Ideal State Shape	1248

Ideal State Size	1249
Symbol Table Format	1249
Time Unit	1250
Freq Unit	1250
Eye Length	1251
Avg Line	1251
Copy to Data Register	1252
Phase/Delay Properties	1253
Phase/Trellis Offset	1253
Unwrap Phase Ref	1254
Group Delay Aperture	1254
ACP Setup	1255
ACP On/Off	1256
Carrier Freq	1257
Carrier Meas Noise BW	1257
Carrier RRC Weighting	1258
Carrier Filter Alpha	1258
Offsets	1259
Offsets	1259
RRC Weighting (All Offsets)	1262
OBW Setup (Occupied Bandwidth)	1263
OBW Power	1264
OBW Centroid > CF	1264
BW Limit	1265
Trace Indicator Info	1265
Trigger	1267
Free Run	1267
Video	1267
Trigger Level	1267
Trig Slope	1267
Trig Delay	1267
Trig Holdoff	1267
Holdoff Type	1267
External 1	1267
Trigger Level	1267
Trig Slope	1267
Trig Delay	1267
Trig Holdoff	1267
Holdoff Type	1267
Trig Reference Line	1268
User Preset	1269
User Preset	1269
User Preset All Modes	1270

Table of Contents

Save User Preset	1271
View/Display	1272
Display	1272
Annotation	1272
Meas Bar On/Off	1273
Screen	1274
Active Function Values On/Off	1274
Title	1275
Change Title	1275
Clear Title	1276
Graticule	1277
System Display Settings	1277
Annotation Local Settings	1277
Themes	1278
Backlight	1279
Backlight Intensity	1279
Layout	1280
Preset View: Test Standard	1282
Preset View: Slot	1282
Measurement Views	1282
Front Panel Results	1284
Remote SCPI Commands and Data Queries	1285
:READ and :FETCh Commands	1285
:CALCulate:DATA	1288
:CALCulate:DATA:RAW	1289
:CALCulate:DATA:RAW:COMPLex	1290
:CALCulate:DATA:POINTs commands	1290
:CALCulate:DATA:TABL commands	1291
Query Table Data as Number	1292
Query Table Data as String	1292
Query Table Names	1293
Query Table Units	1293
:CALCulate:DATA:HEADer commands	1295
Query Header Names	1295
Query Header Type	1295
Query Header as String	1296
Query Numeric Header	1296
:CALC:CLIMits:FAIL?	1297
IQ Data Transfers	1297
Fast Capture Length	1298
Fast Capture Word Length	1299
Initiate Fast Capture	1299
Fast Capture Block	1299

Fast Capture Pointer	1300
Fetch Fast Capture	1300
Input Sample Rate Query	1301
Parameter Update Enable	1301

1 About the Analyzer

The X-Series signal analyzer measures and monitors complex RF and microwave signals. Analog baseband analysis is available on MXA. The analyzer integrates traditional spectrum measurements with advanced vector signal analysis to optimize speed, accuracy, and dynamic range. The analyzer has Windows 7[®] built in as an operating system, which expands its usability.

With a broad set of applications and demodulation capabilities, an intuitive user interface, outstanding connectivity and powerful one-button measurements, the analyzer is ideal for both R&D and manufacturing engineers working on cellular, emerging wireless communications, general purpose, aerospace and defense applications.

Installing Application Software

If you want to install a measurement application after your initial hardware purchase, you need only to license it. All of the available applications are loaded in your analyzer at the time of purchase.

Thus, when you purchase a new application, you will receive an entitlement certificate that you can use to obtain a license key for that application. To activate the new measurement application, enter the license key that you obtain into the Signal Analyzer.

For the latest information on Keysight Signal Analyzer measurement applications and upgrade kits, visit the following internet URL.

http://www.agilent.com/find/sa_upgrades

Viewing a License Key

Measurement applications that you purchased with your instrument have been installed and activated at the factory before shipment. The instrument requires a unique License Key for every measurement application purchased. The license key is a hexadecimal string that is specific to your measurement application, instrument model number and serial number. It enables you to install, or reactivate, that particular application.

Press **System, Show, System** to display the measurement applications that are currently licensed in your analyzer.

Go to the following location to view the license keys for the installed measurement applications:

C:\Program Files\Agilent\Licensing

You may want to keep a copy of your license key in a secure location. To do this, you can print out a copy of the display showing the license numbers. If you should lose your license key, call your nearest Keysight Technologies service or sales office for assistance.

Obtaining and Installing a License Key

If you purchase an additional application that requires installation, you will receive an "Entitlement Certificate", which may be redeemed for a license key for one instrument. To obtain your license key, follow the instructions that accompany the certificate.

Installing a license key for the selected application can be done automatically using a USB memory device. To do this, you copy the license file to the USB memory device, at the root level. Follow the instructions that come with your software installation kit.

Installing a license key can also be done manually using the built-in license management application, which may be found via the instrument front panel keys at **System, Licensing. . .**, or on-disk at:

C:\Programming Files\Agilent\Licensing

You can also use these procedures to reinstall a license key that has been accidentally deleted, or lost due to a memory failure.

Updating Measurement Application Software

All the software applications were loaded at the time of original instrument manufacture. It is a good idea to regularly update your software with the latest available version. This helps to ensure that you receive

any improvements and expanded functionality.

Because the software was loaded at the initial purchase, further additional measurement applications may now be available. If the application you are interested in licensing is not available, you will need to do a software update. (To display a list of installed applications, press **System, Show, System.**)

Check the appropriate page of the Keysight web site for the latest available software versions, according to the name of your instrument, as follows:

http://www.agilent.com/find/pxa_software

http://www.agilent.com/find/mxa_software

http://www.agilent.com/find/exa_software

http://www.agilent.com/find/cxa_software

You can load the updated software package into the analyzer from a USB drive, or directly from the internet. An automatic loading program is included with the files.

X-Series Options and Accessories

You can view an online list of available Options and Accessories for your instrument as follows:

1. Browse to one of the following URLs, according to the product name of your analyzer:

www.agilent.com/find/cxa

www.agilent.com/find/exa

www.agilent.com/find/mxa

www.agilent.com/find/pxa

2. The home page for your instrument appears (in some cases, you may see an initial splash screen containing a button named View the Webpage, which you should click to display the home page).
3. Locate the Options tab, as highlighted in the example below, which shows the home page for the MXA.



4. Click the Options tab, to display a list of available options and accessories for your instrument.

Front-Panel Features

The instrument's Front-panel features are fully detailed in the section "Front-Panel Features" (under the chapter "Front and Rear Panel Features") of the document:

[Getting Started Guide](#)

If you are viewing this information as a Help file in the instrument, then you can click on the link above to open the PDF document.

Display Annotations

Display Annotations are fully detailed under the chapter "Front and Rear Panel Features" of the document:

[Getting Started Guide](#)

If you are viewing this information as a Help file in the instrument, then you can click on the link above to open the PDF document.

Rear-Panel Features

The instrument's Rear-panel features are fully detailed in the section "Rear-Panel Features" (under the chapter "Front and Rear Panel Features") of the document:

[Getting Started Guide](#)

If you are viewing this information as a Help file in the instrument, then you can click on the link above to open the PDF document.

Window Control Keys

The instrument provides three front-panel keys for controlling windows. They are Multi Window, Zoom, and Next Window. These are all “immediate action” keys.

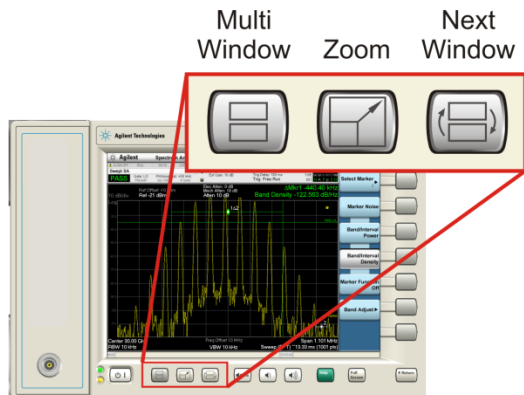

Multi-Window



The Multi Window front-panel key will toggle you back and forth between the Normal View and the last Multi Window View (Zone Span, Trace Zoom or Spectrogram) that you were in, when using the Swept SA measurement of the Spectrum Analyzer Mode. It remembers which View you were in through a Preset. This “previous view” is set to Zone Span on a Restore Mode Defaults.

Key Path	Front-panel key
Initial S/W Revision	Prior to A.02.00

Zoom

Zoom is a toggle function. Pressing this key once increases the size of the selected window. Pressing the key again returns the window to the original size.

When Zoom is on for a window, that window will get the entire primary display area. The zoomed window, since it is the selected window, is outlined in green.

Zoom is local to each Measurement. Each Measurement remembers its Zoom state. The Zoom state of each Measurement is part of the Mode’s state.

NOTE

Data acquisition and processing for the other windows continues while a window is zoomed, as does all SCPI communication with the other windows.

Remote Command	:DISPlay:WINDow:FORMat:ZOOM
----------------	-----------------------------

Remote Command	:DISPlay:WINDow:FORMat:TILE
Example	:DISP:WIND:FORM:ZOOM sets zoomed :DISP:WIND:FORM:TILE sets un-zoomed
Preset	TILE
Initial S/W Revision	Prior to A.02.00

Next Window

Selects the next window of the current view. When the Next Window key is pressed, the next window in the order of precedence becomes selected. If the selected window was zoomed, the next window will also be zoomed.

The window numbers are as follows. Note that these numbers also determine the order of precedence (that is, Next Window goes from 1 to 2, then 2 to 3, etc.):

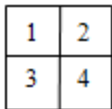

Four window display

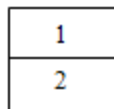

Two window display

RTSA measurements:

Only two windows are available in the Spectrogram view under the Spectrum measurement and up to three windows are available in the Power vs. Time measurement, depending on the view set up.

Remote Command	:DISPlay:WINDow[:SElect] <number> :DISPlay:WINDow[:SElect]?
Example	:DISP:WIND 1
Preset	1
Min	1
Max	If <number> is greater than the number of windows, limit to <number of windows>
Initial S/W Revision	Prior to A.02.00

One and only one window is always selected. The selected window has the focus; this means that all window-specific key presses apply only to that window. You can tell which window is selected by the thick green border around it. If a window is not selected, its boundary is gray.

If a window in a multi-window display is zoomed it is still outlined in green. If there is only one window, the green outline is not used. This allows the user to distinguish between a zoomed window and a display with only one window.

The selected window is local to each Measurement. Each Measurement remembers which window is selected. The selected window for each Measurement is remembered in Mode state.

NOTE

When this key is pressed in Help Mode, it toggles focus between the table of contents window and the topic pane window.

Full Screen

When Full Screen is pressed the measurement window expands horizontally over the entire instrument display. The screen graticule area expands to fill the available display area.

It turns off the display of the softkey labels, however the menus and active functions still work. (Though it would obviously be very hard to navigate without the key labels displayed.) Pressing Full Screen again while Full Screen is in effect cancels Full Screen.

Note that the banner and status lines are unaffected. You can get even more screen area for your data display by turning off the Meas Bar (in the Display menu) which also turns off the settings panel.

Full Screen is a Meas Global function. Therefore it is cancelled by the Preset key.

Key Path	Display
Remote Command	:DISPlay:FSCReen[:STAtE] OFF ON 0 1 :DISPlay:FSCReen[:STAtE]?
Preset	Unaffected by Preset but set to Off by Restore Misc Defaults or shutdown and restart
State Saved	Not saved in instrument state.
Backwards Compatibility SCPI	:DISPlay:MENU[:STAtE] OFF ON 0 1 This emulates ESA full screen functionality, which is the same as the FSCReen command in PSA except that the sense of on/off is reversed (that is, OFF means the menus are OFF, so Fullscreen is ON) and the default is ON (meaning Fullscreen is OFF).
Backwards Compatibility Notes	In ESA/PSA, Full Screen was turned on with a softkey, so pressing any other key turned Full Screen off. In the X-Series, because a hardkey is provided to turn this function on and off, pressing any other key no longer turns off Full Screen
Initial S/W Revision	Prior to A.02.00

Display Enable (Remote Command Only)

Turns the display on/off, including the display drive circuitry. The backlight stays lit so you can tell that the instrument is on. The display enable setting is mode global. The reasons for turning the display off are three:

- To increase speed as much as possible by freeing the instrument from having to update the display
- To reduce emissions from the display, drive circuitry
- For security purposes

If you have turned off the display:

- and you are in local operation, the display can be turned back on by pressing any key or by sending the SYSTem:DEFaults MISC command or the DISPlay:ENABle ON (neither *RST nor SYSTem:PRESet enable the display.)
- and you are in remote operation, the display can be turned back on by pressing the Local or Esc keys or by sending the SYSTem:DEFaults MISC command or the DISPlay:ENABle ON (neither *RST nor SYSTem:PRESet enable the display.)

and you are using either the SYSTem:KLOCK command or GPIB local lockout, then no front-panel key press will turn the display back on. You must turn it back on remotely.

Remote Command	:DISPlay:ENABle OFF ON 0 1 :DISPlay:ENABle?
Example	DISP:ENAB OFF
Couplings	DISP:ENAB OFF turns Backlight OFF and DISP:ENAB ON turns Backlight ON. However, settings of Backlight do not change the state of DISP:ENAB
Preset	On Set by SYST:DEF MISC, but Not affected by *RST or SYSTem:PRESet.
State Saved	Not saved in instrument state.
Backwards Compatibility Notes	SYST:PRES no longer turns on DISPlay:ENABle as it did in legacy analyzers
Initial S/W Revision	Prior to A.02.00

Mouse and Keyboard Control

If you do not have access to the instrument front-panel, there are several ways that a mouse and PC Keyboard can give you access to functions normally accessed using the front-panel keys.

Right-Click

If you plug in a mouse and right-click on the analyzer screen, a menu will appear as below:

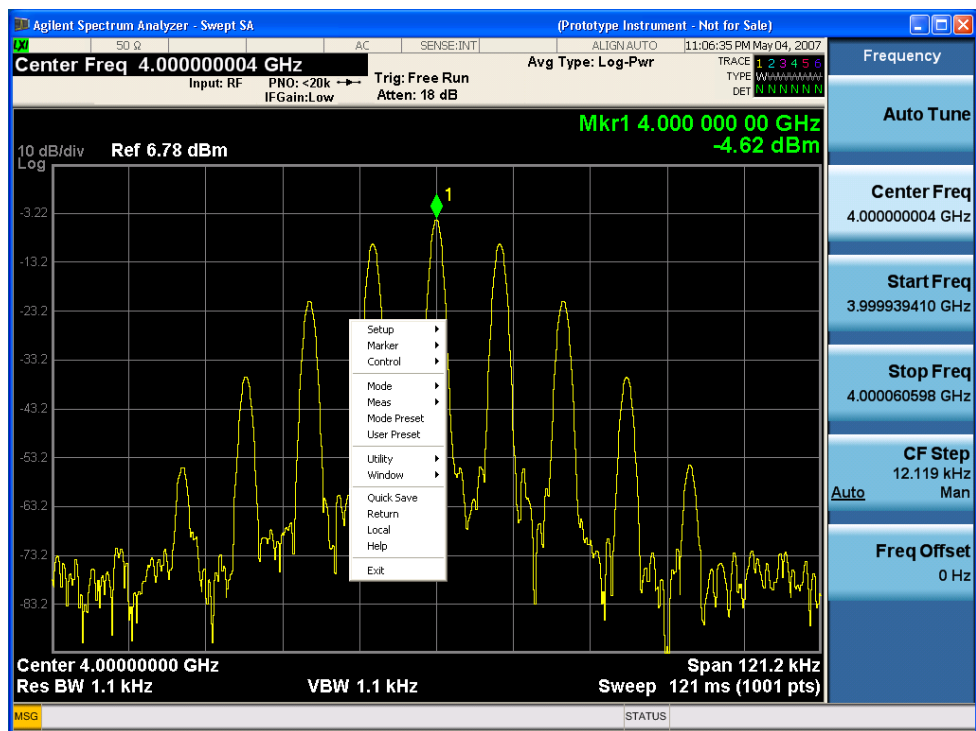

Placing the mouse on one of the rows marked with a right arrow symbol will cause that row to expand, as for example below where the mouse is hovered over the “Utility” row:

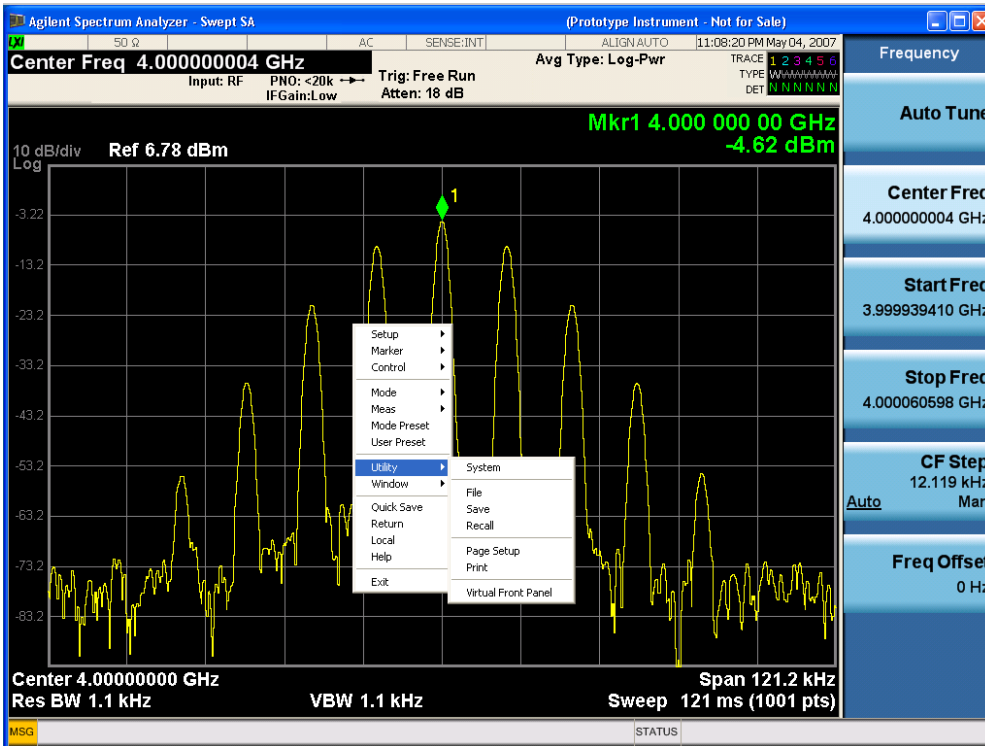

This method can be used to access any of the front-panel keys by using a mouse; as for example if you are accessing the instrument through Remote Desktop.

The array of keys thus available is shown below:

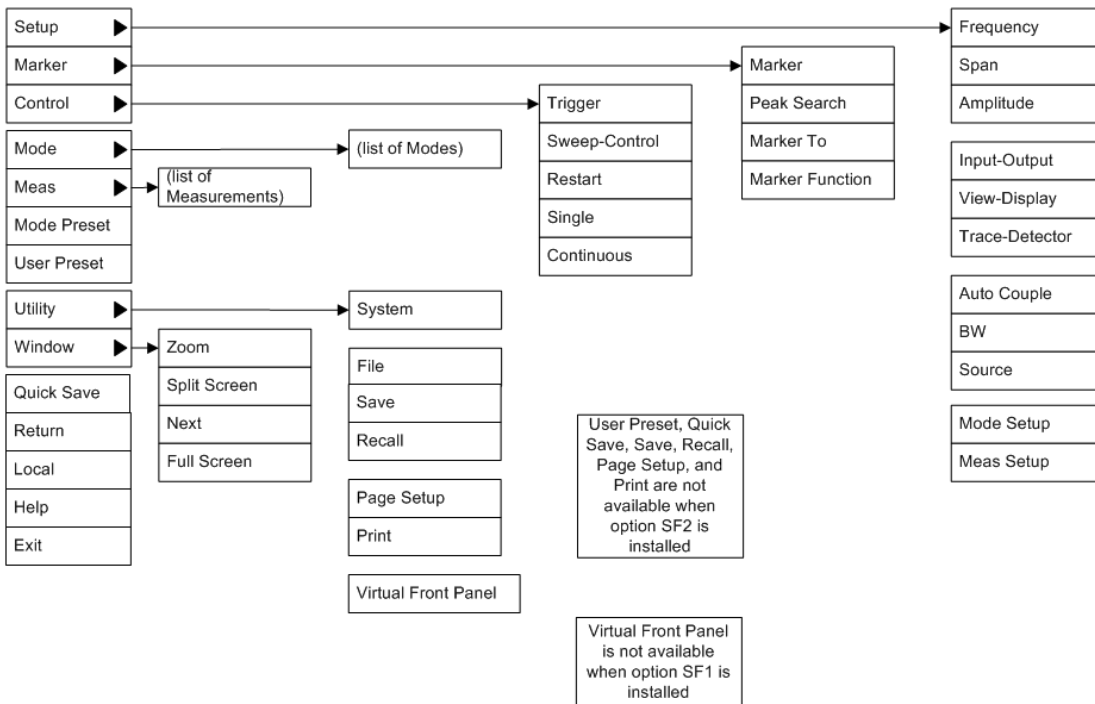

PC Keyboard

If you have a PC keyboard plugged in (or via Remote Desktop), certain key codes on the PC keyboard map to front-panel keys on the GPSA front panel. These key codes are shown below:

Front-panel key	Key code
Frequency	CTRL+SHIFT+F
Span	CTRL+SHIFT+S
Amplitude	CTRL+SHIFT+A
Input/Output	CTRL+SHIFT+O
View/Display	CTRL+SHIFT+V
Trace/Detector	CTRL+ALT+T
Auto Couple	CTRL+SHIFT+C
Bandwidth	CTRL+ALT+B
Source	CTRL+ALT-U
Marker	CTRL+ALT+K
Peak Search	CTRL+ALT+P
Marker To	CTRL+ALT+N
Marker Function	CTRL+ALT+F
System	CTRL+SHIFT+Y
Quick Save	CTRL+Q
Save	CTRL+S
Recall	CTRL+R
Mode Preset	CTRL+M
User Preset	CTRL+U
Print	CTRL+P
File	CTRL+SHIFT+L
Mode	CTRL+SHIFT+M
Measure	CTRL+ALT+M
Mode Setup	CTRL+SHIFT+E
Meas Setup	CTRL+ALT+E
Trigger	CTRL+SHIFT+T
Sweep/Control	CTRL+SHIFT+W
Restart	CTRL+ALT+R
Single	CTRL+ALT+S
Cont	CTRL+ALT+C
Zoom	CTRL+SHIFT+Z
Next Window	CTRL+SHIFT+N
Split Screen	CTRL+L

Front-panel key	Key code
Full Screen	CTRL+SHIFT+B
Return	CTRL+SHIFT+R
Mute	Mute
Inc Audio	Volume Up
Dec Audio	Volume Down
Help	F1
Control	CTRL
Alt	ALT
Enter	Return
Cancel	Esc
Del	Delete
Backspace	Backspace
Select	Space
Up Arrow	Up
Down Arrow	Down
Left Arrow	Left
Right Arrow	Right
Menu key 1	CTRL+SHIFT+F1
Menu key 2	CTRL+SHIFT+F2
Menu key 3	CTRL+SHIFT+F3
Menu key 4	CTRL+SHIFT+F4
Menu key 5	CTRL+SHIFT+F5
Menu key 6	CTRL+SHIFT+F6
Menu key 7	CTRL+SHIFT+F7
Backspace	BACKSPACE
Enter	ENTER
Tab	Tab
1	1
2	2
3	3
4	4
5	5
6	6
7	7
8	8
9	9
0	0

1 About the Analyzer
 Mouse and Keyboard Control

This is a pictorial view of the table:

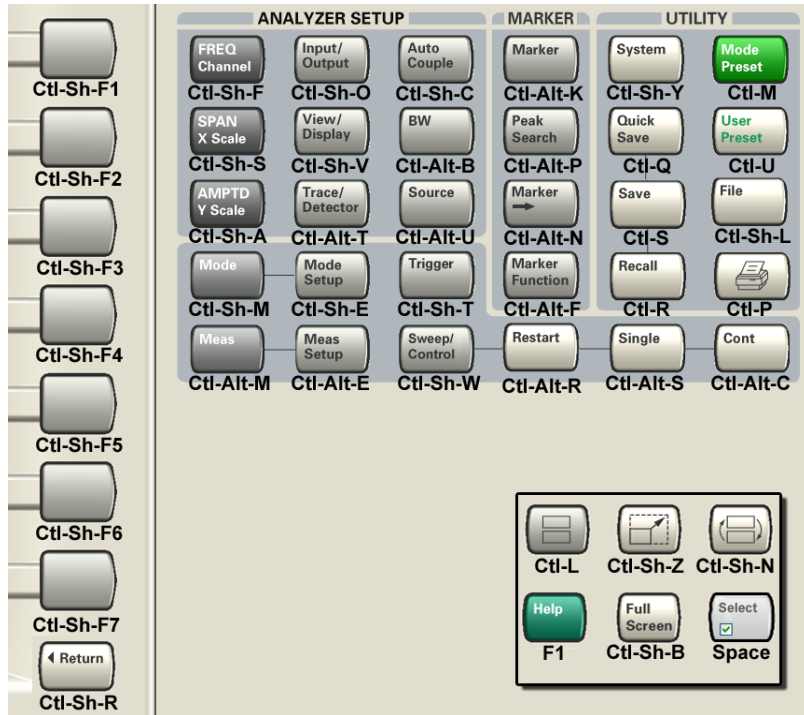

Instrument Security & Memory Volatility

If you are using the instrument in a secure environment, you may need details of how to clear or sanitize its memory, in compliance with published security standards of the United States Department of Defense, or other similar authorities.

For X-Series analyzers, this information is contained in the document "Security Features and Document of Volatility". This document is not included in the Documentation CD, or the instrument's on-disk library, but it may be downloaded from Keysight's web site.

To obtain a copy of the document, click on or browse to the following URL:

<http://www.agilent.com/find/security>

To locate and download the document, select Model Number "N9020A", then click "Submit". Then, follow the on-screen instructions to download the file.

2 About the iDEN/WiDEN/MotoTalk Analyzer Measurement Application

This chapter provides overall information on the Agilent N6149A iDEN/WiDEN/MotoTalk Analyzer Measurement Application and describes the measurements made by the analyzer.

What Does the iDEN/WiDEN/MotoTalk Analyzer Measurement Application Do?

N6149A is a full-featured iDEN/WiDEN/MotoTalk signal analyzer that can help determine whether a modulated source or transmitter is working correctly. There are standard and optional settings to enable complete analysis of iDEN/WiDEN/MotoTalk signals.

The iDEN/WiDEN/MotoTalk Analyzer measurement application offers the following measurements:

- iDEN Power Measurement
- iDEN Demod Measurement
- MotoTalk Measurement
- VSA Vector Analysis Measurement
- Monitor Spectrum Measurement

The iDEN/WiDEN/MotoTalk Analyzer measurement application supports the following standards:

- iDEN RF Interface Specification: Layer 1, version R02.00.06
- Requirement to Modify WiDEN Power Versus Time Mask
- Motorola TalkAround: RF Interface, Talk Around Protocol (8/19/2002)

3 Programming the Analyzer

This section provides introductory information about the programming documentation included with your product.

- ["What Programming Information is Available?" on page 74](#)
- ["STATus Subsystem " on page 94](#)
- ["IEEE 488.2 Common Commands" on page 136](#)

What Programming Information is Available?

The X-Series Documentation can be accessed through the Additional Documentation page in the instrument Help system and is included on the Documentation DVD shipped with the instrument. It can also be found online at: http://www.agilent.com/find/mxa_manuals.

The following resources are available to help you create programs for automating your X-Series measurements:

Resource	Description
X-Series Programmer's Guide	<p>Provides general SCPI programming information on the following topics:</p> <ul style="list-style-type: none">• Programming the X-Series Applications• Programming fundamentals• Programming examples <p>Note that SCPI command descriptions for measurement applications are not in this book, but are in the User's and Programmer's Reference.</p>
User's and Programmer's Reference manuals	<p>Describes all front-panel keys and softkeys, including SCPI commands for a measurement application. Note that:</p> <ul style="list-style-type: none">• Each measurement application has its own User's and Programmer's Reference.• The content in this manual is duplicated in the instrument's Help (the Help that you see for a key is identical to what you see in this manual).
Embedded Help in your instrument	<p>Describes all front-panel keys and softkeys, including SCPI commands, for a measurement application. Note that the content that you see in Help when you press a key is identical to what you see in the User's and Programmer's Reference.</p>
X-Series Getting Started Guide	<p>Provides valuable sections related to programming including:</p> <ul style="list-style-type: none">• Licensing New Measurement Application Software - After Initial Purchase• Configuring instrument LAN Hostname, IP Address, and Gateway Address• Using the Windows Remote Desktop to connect to the instrument remotely• Using the Embedded Web Server Telnet connection to communicate SCPI <p>This printed document is shipped with the instrument.</p>
Keysight Application Notes	<p>Printable PDF versions of pertinent application notes.</p>
Keysight VISA User's Guide	<p>Describes the Keysight Virtual Instrument Software Architecture (VISA) library and shows how to use it to develop I/O applications and instrument drivers on Windows PCs.</p>

List of SCPI Commands

```

*CAL?
*CLS
*ESE <integer>
*ESE?
*ESR?
*IDN?
*OPC
*OPC?
*OPT?
*RCL <register#>
*RST
*SAV <register#>
*SRE <integer>
*SRE?
*STB?
*TRG
*TST?
*WAI
CALCulate:<meas>:DATA[1] | 2 | ...4?[Y | X | XY[, OFF | ON | 0 | 1] | LL |
UL]
CALCulate:<meas>:DATA[1] | 2 | ...4:HEADer:NAMEs?
CALCulate:<meas>:DATA[1] | 2 | ...4:HEADer[:NUMBer]? <string>
CALCulate:<meas>:DATA[1] | 2 | ...4:HEADer:STRing? <string>
CALCulate:<meas>:DATA[1] | 2 | ...4:HEADer:TYPE? <string>
CALCulate:<meas>:DATA[1] | 2 | ...4:NAMEs?
CALCulate:<meas>:DATA[1] | 2 | ...4:POINts? [OFF | ON | 0 | 1]
CALCulate:<meas>:DATA[1] | 2 | ...4:RAW?
CALCulate:<meas>:DATA[1] | 2 | ...4:RAW:COMPLex?
CALCulate:<meas>:DATA[1] | 2 | ...4:RAW:POINts?
CALCulate:<meas>:DATA[1] | 2 | ...4:TABLE:NAMEs?
CALCulate:<meas>:DATA[1] | 2 | ...4:TABLE[:NUMBer]? [<string>]
CALCulate:<meas>:DATA[1] | 2 | ...4:TABLE:STRing? [<string>]
CALCulate:<meas>:DATA[1] | 2 | ...4:TABLE:UNIT?
CALCulate:<meas>:MARKer:AOff
CALCulate:<meas>:MARKer[1] | 2 | ...12:CFORmat RECTangular | POLar
CALCulate:<meas>:MARKer[1] | 2 | ...12:CFORmat?
CALCulate:<meas>:MARKer:COUple[:STATE] OFF | ON | 0 | 1
CALCulate:<meas>:MARKer:COUple[:STATE]?
CALCulate:<meas>:MARKer[1] | 2 | ...12:CPSeArch[:STATE] ON | OFF | 1 | 0
CALCulate:<meas>:MARKer[1] | 2 | ...12:CPSeArch[:STATE]?
CALCulate:<meas>:MARKer[1] | 2 | ...12:FCOunt[:STATE] OFF | ON | 0 | 1
CALCulate:<meas>:MARKer[1] | 2 | ...12:FCOunt[:STATE]?
CALCulate:<meas>:MARKer[1] | 2 | ...12:FCOunt:X?
CALCulate:<meas>:MARKer[1] | 2 | ...12:FUNCTion BPOWer | BDENsity | =OFF
CALCulate:<meas>:MARKer[1] | 2 | ...12:FUNCTion?
CALCulate:<meas>:MARKer[1] | 2 | ...12:FUNCTion:BAND:CENTer <real>
CALCulate:<meas>:MARKer[1] | 2 | ...12:FUNCTion:BAND:CENTer?
CALCulate:<meas>:MARKer[1] | 2 | ...12:FUNCTion:BAND:LEFT <real>
CALCulate:<meas>:MARKer[1] | 2 | ...12:FUNCTion:BAND:LEFT?
CALCulate:<meas>:MARKer[1] | 2 | ...12:FUNCTion:BAND:RIGHT <real>

```

3 Programming the Analyzer

List of SCPI Commands

```
CALCulate:<meas>:MARKer[1]|2|...12:FUNCTION:BAND:RIGHT?
CALCulate:<meas>:MARKer[1]|2|...12:FUNCTION:BAND:SPAN <real>
CALCulate:<meas>:MARKer[1]|2|...12:FUNCTION:BAND:SPAN?
CALCulate:<meas>:MARKer[1]|2|...12:FUNCTION:BDENSITY:CTYPE MEAN | RMS
CALCulate:<meas>:MARKer[1]|2|...12:FUNCTION:BDENSITY:CTYPE?
CALCulate:<meas>:MARKer[1]|2|...12:FUNCTION:BPOWER:CTYPE MEAN | RMS
CALCulate:<meas>:MARKer[1]|2|...12:FUNCTION:BPOWER:CTYPE?
CALCulate:<meas>:MARKer[1]|2|...12:MAXimum
CALCulate:<meas>:MARKer[1]|2|...12:MAXimum:LEFT
CALCulate:<meas>:MARKer[1]|2|...12:MAXimum:NEXT
CALCulate:<meas>:MARKer[1]|2|...12:MAXimum:PREVIOUS
CALCulate:<meas>:MARKer[1]|2|...12:MAXimum:RIGHT
CALCulate:<meas>:MARKer[1]|2|...12:MINimum
CALCulate:<meas>:MARKer[1]|2|...12:MODE POSITION | DELTA | FIXED | =OFF
CALCulate:<meas>:MARKer[1]|2|...12:MODE?
CALCulate:<meas>:MARKer[1]|2|...12:REFERENCE <integer>
CALCulate:<meas>:MARKer[1]|2|...12:REFERENCE?
CALCulate:<meas>:MARKer:TABLE[:STATE] OFF | ON | 0 | 1
CALCulate:<meas>:MARKer:TABLE[:STATE]?
CALCulate:<meas>:MARKer[1]|2|...12:TRACE <integer>
CALCulate:<meas>:MARKer[1]|2|...12:TRACE?
CALCulate:<meas>:MARKer[1]|2|...12:X <real>
CALCulate:<meas>:MARKer[1]|2|...12:X?
CALCulate:<meas>:MARKer[1]|2|...12[:X]:POSITION <real>
CALCulate:<meas>:MARKer[1]|2|...12[:X]:POSITION?
CALCulate:<meas>:MARKer[1]|2|...12:X:UNIT?
CALCulate:<meas>:MARKer[1]|2|...12:Y:IMAGINARY <real>
CALCulate:<meas>:MARKer[1]|2|...12:Y:IMAGINARY?
CALCulate:<meas>:MARKer[1]|2|...12:Y[:REAL] <real>
CALCulate:<meas>:MARKer[1]|2|...12:Y[:REAL]?
CALCulate:<meas>:MARKer[1]|2|...12:Y:UNIT?
CALCulate:<meas>:MARKer[1]|2|...12:Z <real>
CALCulate:<meas>:MARKer[1]|2|...12:Z?
CALCulate:<meas>:MARKer[1]|2|...12:Z:UNIT?
CALCulate:<meas>:TRACE[1]
|2|...4:ACPower:CARRIER:BANDwidth|BWIDth:INTEgration <bandwidth>
CALCulate:<meas>:TRACE[1]
|2|...4:ACPower:CARRIER:BANDwidth|BWIDth:INTEgration?
CALCulate:<meas>:TRACE[1]|2|...4:ACPower:CARRIER:FILTER:RRC:ALPHA <real>
CALCulate:<meas>:TRACE[1]|2|...4:ACPower:CARRIER:FILTER:RRC:ALPHA?
CALCulate:<meas>:TRACE[1]|2|...4:ACPower:CARRIER:FILTER:RRC:STATE OFF | ON
| 0 | 1
CALCulate:<meas>:TRACE[1]|2|...4:ACPower:CARRIER:FILTER:RRC:STATE?
CALCulate:<meas>:TRACE[1]|2|...4:ACPower:CARRIER:FREQUENCY <freq>
CALCulate:<meas>:TRACE[1]|2|...4:ACPower:CARRIER:FREQUENCY?
CALCulate:<meas>:TRACE[1]|2|...4:ACPower:OFFSET:FILTER:RRC:STATE OFF | ON
| 0 | 1
CALCulate:<meas>:TRACE[1]|2|...4:ACPower:OFFSET:FILTER:RRC:STATE?
CALCulate:<meas>:TRACE[1]
|2|...4:ACPower:OFFSET:LIST:BANDwidth|BWIDth:INTEgration <bandwidth>, ...
CALCulate:<meas>:TRACE[1]
|2|...4:ACPower:OFFSET:LIST:BANDwidth|BWIDth:INTEgration?
```

```

CALCulate:<meas>:TRACe[1]|2|...4:ACPowEr:OFFSet:LIST:FILTer:RRC:ALPHa
<real>, ...
CALCulate:<meas>:TRACe[1]|2|...4:ACPowEr:OFFSet:LIST:FILTer:RRC:ALPHa?
CALCulate:<meas>:TRACe[1]|2|...4:ACPowEr:OFFSet:LIST:FREQuency <freq>, ...
CALCulate:<meas>:TRACe[1]|2|...4:ACPowEr:OFFSet:LIST:FREQuency?
CALCulate:<meas>:TRACe[1]|2|...4:ACPowEr:OFFSet:LIST:RCARrier <reall>, ...
CALCulate:<meas>:TRACe[1]|2|...4:ACPowEr:OFFSet:LIST:RCARrier?
CALCulate:<meas>:TRACe[1]|2|...4:ACPowEr:OFFSet:LIST:RCARrier:TEST OFF |
ON | 0 | 1, ...
CALCulate:<meas>:TRACe[1]|2|...4:ACPowEr:OFFSet:LIST:RCARrier:TEST?
CALCulate:<meas>:TRACe[1]|2|...4:ACPowEr:OFFSet:LIST:STATe OFF | ON | 0 |
1, ...
CALCulate:<meas>:TRACe[1]|2|...4:ACPowEr:OFFSet:LIST:STATe?
CALCulate:<meas>:TRACe[1]|2|...4:ACPowEr:STATe OFF | ON | 0 | 1
CALCulate:<meas>:TRACe[1]|2|...4:ACPowEr:STATe?
CALCulate:<meas>:TRACe[1]|2|...4:OBWidth:CENTroid?
CALCulate:<meas>:TRACe[1]|2|...4:OBWidth:LIMit:FBLimit <freq>
CALCulate:<meas>:TRACe[1]|2|...4:OBWidth:LIMit:FBLimit?
CALCulate:<meas>:TRACe[1]|2|...4:OBWidth:LIMit[:TEST] OFF | ON | 0 | 1
CALCulate:<meas>:TRACe[1]|2|...4:OBWidth:LIMit[:TEST]?
CALCulate:<meas>:TRACe[1]|2|...4:OBWidth:PERCent <real>
CALCulate:<meas>:TRACe[1]|2|...4:OBWidth:PERCent?
CALCulate:<meas>:TRACe[1]|2|...4:OBWidth:STATe OFF | ON | 0 | 1
CALCulate:<meas>:TRACe[1]|2|...4:OBWidth:STATe?
CALCulate:CLIMits:FAIL?
CALCulate:DATA<n>:COMPRESS? BLOCK | CFIT | MAXimum | MINimum | MEAN |
DMEan | RMS | RMSCubed | SAMPLE | SDEviation | PPHase[, <soffset>[,
<length>[, <roffset>[, <rlimit>]]]]
CALCulate:DATA[n]?
CALCulate:DATA[1]|2|...|6:PEAKs? <threshold>, <excursion>[, AMPLitude |
FREQuency | TIME]
CALCulate:DATA[1]|2|...|6:PEAKs? <threshold>, <excursion>[, AMPLitude |
FREQuency | TIME[, ALL | GTDLine | LTDLine]]
CALCulate:DATA:REGister:ALL:REMOve
CALCulate:DATA:REGister[1]|2|...6:EMPTy?
CALCulate:DATA:REGister[1]|2|...6:REMOve
CALCulate:IDEMod:BERate:LIMit:ERATe
CALCulate:IDEMod:BERate:LIMit:ERATe <real>
CALCulate:IDEMod:EVMagnitude:LIMit:EVMLimit <real>
CALCulate:IDEMod:EVMagnitude:LIMit:EVMLimit?
CALCulate:IPowEr:PCALculation MOD | FULL
CALCulate:IPowEr:PCALculation?
CALCulate:MONitor:MARKer:AOff
CALCulate:MONitor:MARKer:COUPle[:STATe] ON | OFF | 1 | 0
CALCulate:MONitor:MARKer:COUPle[:STATe]?
CALCulate:MONitor:MARKer[1]|2|...|12:FUNCTion NOISe | BPOWer | BDENSity |
OFF
CALCulate:MONitor:MARKer[1]|2|...|12:FUNCTion?
CALCulate:MONitor:MARKer[1]|2|...|12:FUNCTion:BAND:LEFT <freq>
CALCulate:MONitor:MARKer[1]|2|...|12:FUNCTion:BAND:LEFT?
CALCulate:MONitor:MARKer[1]|2|...|12:FUNCTion:BAND:RIGHT <freq>
CALCulate:MONitor:MARKer[1]|2|...|12:FUNCTion:BAND:RIGHT?

```

3 Programming the Analyzer

List of SCPI Commands

```
CALCulate:MONitor:MARKer[1]|2|...|12:FUNCTION:BAND:SPAN <freq>
CALCulate:MONitor:MARKer[1]|2|...|12:FUNCTION:BAND:SPAN?
CALCulate:MONitor:MARKer[1]|2|...|12:FUNCTION:RESult?
CALCulate:MONitor:MARKer[1]|2|...|12:MAXimum
CALCulate:MONitor:MARKer[1]|2|...|12:REFerence <integer>
CALCulate:MONitor:MARKer[1]|2|...|12:REFerence?
CALCulate:MONitor:MARKer[1]|2|...|12:TRACe <integer>
CALCulate:MONitor:MARKer[1]|2|...|12:TRACe?
CALCulate:MONitor:MARKer[1]|2|...|12:X <freq>
CALCulate:MONitor:MARKer[1]|2|...|12:X?
CALCulate:MONitor:MARKer[1]|2|...|12:X:POSition <real>
CALCulate:MONitor:MARKer[1]|2|...|12:X:POSition?
CALCulate:MONitor:MARKer[1]|2|...|12:Y?
CALibration[:ALL]
CALibration[:ALL]?
CALibration:AUTO ALERT
CALibration:AUTO ON | PARTial | OFF
CALibration:AUTO?
CALibration:AUTO:ALERT TEMperature | DAY | WEEK | NONE
CALibration:AUTO:ALERT?
CALibration:AUTO:MODE ALL | NRF
CALibration:AUTO:MODE?
CALibration:AUTO:TIME:OFF?
CALibration:DATA:BACKup <filename>
CALibration:DATA:DEFault
CALibration:DATA:REStore <filename>
CALibration:EXPIred?
CALibration:FREQuency:REFerence:COARse <integer>
CALibration:FREQuency:REFerence:COARse
CALibration:FREQuency:REFerence:COARse?
CALibration:FREQuency:REFerence:FINE <integer>
CALibration:FREQuency:REFerence:FINE?
CALibration:FREQuency:REFerence:MODE CALibrated | USER
CALibration:FREQuency:REFerence:MODE?
CALibration:IQ:FLATness:I
CALibration:IQ:FLATness:IBAR
CALibration:IQ:FLATness:I|IBAR|Q|QBAR:TIME?
CALibration:IQ:FLATness:Q
CALibration:IQ:FLATness:QBAR
CALibration:IQ:ISOLation
CALibration:IQ:ISOLation:TIME?
CALibration:IQ:PROBE:I
CALibration:IQ:PROBE:IBar
CALibration:IQ:PROBE:I|IBAR|Q|QBAR:TIME?
CALibration:IQ:PROBE:I|Q:CLEAr
CALibration:IQ:PROBE:Q
CALibration:IQ:PROBE:QBar
CALibration:NRF
CALibration:NRF?
CALibration:RF
CALibration:RF?
CALibration:RFPSelector:SCHeduler:TIME:NEXT?
CALibration:SOURce:STATe OFF | ON | 0 | 1
```

```

CALibration:SOURce:STATe?
CALibration:TEMPerature:CURRent?
CALibration:TEMPerature:LALL?
CALibration:TEMPerature:LPReselector?
CALibration:TEMPerature:LRF?
CALibration:TEMPerature:RFPSelector:LCONducted?
CALibration:TEMPerature:RFPSelector:LRADiated?
CALibration:TIME:LALL?
CALibration:TIME:LPReselector?
CALibration:TIME:LRF?
CALibration:TIME:RFPSelector:LCONducted?
CALibration:TIME:RFPSelector:LRADiated?
CALibration:YTF
CALibration:YTF?
CONF FSC
CONF:IDEMod
CONF:IDEMod
CONFigure?
CONFigure:MONitor
CONFigure:MONitor
CONFigure:MONitor:NDEFault
CONFigure:MOTotalk
CONFigure:MOTotalk:NDEFault
CONFigure:VECTor
CONFigure:VECTor:NDEFault
CONF:IPower
CONF:IPower
CONF:MOTotalk
COUple ALL | NONE
DISPlay:<meas>:AFPoints OFF | ON | 0 | 1
DISPlay:<meas>:AFPoints?
DISPlay:<meas>:FANNotation CSPAN | SSTOP
DISPlay:<meas>:FANNotation?
DISPlay:<meas>:TRACe[1]|2|...4:COpy D1 | D2 | D3 | D4 | D5 | D6
DISPlay:<meas>:TRACe[1]|2|...4:DDEMod:ALIN?
DISPlay:<meas>:TRACe[1]|2|...4:DDEMod:ALINe OFF | ON | 0 | 1
DISPlay:<meas>:TRACe[1]|2|...4:DDEMod:EYE:COUNT <real>
DISPlay:<meas>:TRACe[1]|2|...4:DDEMod:EYE:COUNT?
DISPlay:<meas>:TRACe[1]|2|...4:DDEMod:SYMBOL BARS | DOTS | OFF
DISPlay:<meas>:TRACe[1]|2|...4:DDEMod:SYMBOL?
DISPlay:<meas>:TRACe[1]|2|...4:DDEMod:SYMBOL:FORMat HEXadecimal | BINary
DISPlay:<meas>:TRACe[1]|2|...4:DDEMod:SYMBOL:FORMat?
DISPlay:<meas>:TRACe[1]|2|...4:DDEMod:SYMBOL:SHAPE CIRCLE | CROSS | OFF
DISPlay:<meas>:TRACe[1]|2|...4:DDEMod:SYMBOL:SHAPE?
DISPlay:<meas>:TRACe[1]|2|...4:DDEMod:SYMBOL:SIZE <real>
DISPlay:<meas>:TRACe[1]|2|...4:DDEMod:SYMBOL:SIZE?
DISPlay:<meas>:TRACe[1]|2|...4:DDEMod:UNIT:FREQuency CARRIER | HZ
DISPlay:<meas>:TRACe[1]|2|...4:DDEMod:UNIT:FREQuency?
DISPlay:<meas>:TRACe[1]|2|...4:DDEMod:UNIT:TIME SEC | SYMBOL
DISPlay:<meas>:TRACe[1]|2|...4:DDEMod:UNIT:TIME?
DISPlay:<meas>:TRACe[1]|2|...4:FEED <string>
DISPlay:<meas>:TRACe[1]|2|...4:FEED?

```

3 Programming the Analyzer

List of SCPI Commands

```

DISPlay:<meas>:TRACe[1]|2|...4:FORMat MLOG | MLINear | REAL | IMAGinary |
VECTor | CONS | PHASe | UPHase | IEYE | QEYE | TRELlis | GDElay |
MLGLinear
DISPlay:<meas>:TRACe[1]|2|...4:FORMat?
DISPlay:<meas>:TRACe[1]|2|...4:FORMat:DElay:APERture <real>
DISPlay:<meas>:TRACe[1]|2|...4:FORMat:DElay:APERture?
DISPlay:<meas>:TRACe[1]|2|...4:FORMat:PHASe:OFFSet <real>
DISPlay:<meas>:TRACe[1]|2|...4:FORMat:PHASe:OFFSet?
DISPlay:<meas>:TRACe[1]|2|...4:FORMat:PHASe:UNWRap:REFerence <real>
DISPlay:<meas>:TRACe[1]|2|...4:FORMat:PHASe:UNWRap:REFerence?
DISPlay:<meas>:TRACe[1]|2|...4:RLINE OFF | ON | 0 | 1:DISPlay:<meas>:TRACe
[1] | 2 | ...4:RLINE?
DISPlay:<meas>:TRACe[1]|2|...4:VHCenter <real>
DISPlay:<meas>:TRACe[1]|2|...4:VHCenter?
DISPlay:<meas>:TRACe[1]|2|...4:X[:SCALE]:COUple OFF | ON | 0 | 1
DISPlay:<meas>:TRACe[1]|2|...4:X[:SCALE]:COUple?
DISPlay:<meas>:TRACe[1]|2|...4:X[:SCALE]:RLEVel <real>
DISPlay:<meas>:TRACe[1]|2|...4:X[:SCALE]:RLEVel?
DISPlay:<meas>:TRACe[1]|2|...4:X[:SCALE]:RPOsition LEFT | CENTer | RIGHT
DISPlay:<meas>:TRACe[1]|2|...4:X[:SCALE]:RPOsition?
DISPlay:<meas>:TRACe[1]|2|...4:X[:SCALE]:SPAN <real>
DISPlay:<meas>:TRACe[1]|2|...4:X[:SCALE]:SPAN?
DISPlay:<meas>:TRACe[1]|2|...4:Y:LRATio <real>
DISPlay:<meas>:TRACe[1]|2|...4:Y:LRATio?
DISPlay:<meas>:TRACe[1]|2|...4:Y[:SCALE]:AUTO:ONCE
DISPlay:<meas>:TRACe[1]|2|...4:Y[:SCALE]:PDIVision <real>
DISPlay:<meas>:TRACe[1]|2|...4:Y[:SCALE]:PDIVision?
DISPlay:<meas>:TRACe[1]|2|...4:Y[:SCALE]:RLEVel <real>
DISPlay:<meas>:TRACe[1]|2|...4:Y[:SCALE]:RLEVel?
DISPlay:<meas>:TRACe[1]|2|...4:Y[:SCALE]:RLEVel:AUTO OFF | ON | 0 | 1
DISPlay:<meas>:TRACe[1]|2|...4:Y[:SCALE]:RLEVel:AUTO?
DISPlay:<meas>:TRACe[1]|2|...4:Y[:SCALE]:RPOsition TOP | CENTer | BOTTom
DISPlay:<meas>:TRACe[1]|2|...4:Y[:SCALE]:RPOsition?
DISPlay:<meas>:TRACe[1]|2|...4:Y:UNIT?
DISPlay:<meas>:TRACe[1]|2|...4:Y:UNIT:PREFerence AUTO | PEAK | RMS | POWer
| MRMS
DISPlay:<meas>:TRACe[1]|2|...4:Y:UNIT:PREFerence?
DISPlay:<meas>:WINDow:FORMat SINGLE | TWO | TRI | QUAD | GR2X3 | GR3X2
DISPlay:<meas>:WINDow:FORMat SINGLE | TWO | TRI | QUAD
DISPlay:<meas>:WINDow:FORMat?
DISPlay:<meas>:WINDow:FORMat?
DISPlay:<measurement>:ANNotation:TITLe:DATA <string>
DISPlay:<measurement>:ANNotation:TITLe:DATA?
DISPlay:ACTivefunc[:STATe] ON | OFF | 1 | 0
DISPlay:ACTivefunc[:STATe]?
DISPlay:ANNotation:MBAR[:STATe] OFF | ON | 0 | 1
DISPlay:ANNotation:MBAR[:STATe]?
DISPlay:ANNotation:SCReen[:STATe] OFF | ON | 0 | 1
DISPlay:ANNotation:SCReen[:STATe]?
DISPlay:BACKlight ON | OFF
DISPlay:BACKlight?
DISPlay:BACKlight:INTensity <integer>

```



```

DISPlay:BACKlight:INTensity?
DISPlay:ENABLE OFF | ON | 0 | 1
DISPlay:ENABLE?
DISPlay:FSCreen[:STATe] OFF | ON | 0 | 1
DISPlay:FSCreen[:STATe]?
DISPlay:IDEMod:VIEW:PRESet TSTD | PVTBOTH | EVMQUAD | EVMSYMS | WPVT
DISPlay:IPower:VIEW:PRESet TSTD | ACP | ACPOBW | ACPBURST
DISPlay:MENU[:STATe] OFF | ON | 0 | 1
DISPlay:MONitor:VIEW:WINDow:TRACe[1]|2|3:CLEAr
DISPlay:MONitor:VIEW:WINDow:TRACe:CLEAr:ALL
DISPlay:MONitor:VIEW:WINDow:TRACe[1]|2|3:TYPE
DISPlay:MONitor:VIEW[1]:WINDow[1]:TRACe:Y[:SCALe]:COUPlE 0 | 1 | OFF | ON
DISPlay:MONitor:VIEW[1]:WINDow[1]:TRACe:Y[:SCALe]:COUPlE?
DISPlay:MONitor:VIEW[1]:WINDow[1]:TRACe:Y[:SCALe]:PDIVision <rel_ampl>
DISPlay:MONitor:VIEW[1]:WINDow[1]:TRACe:Y[:SCALe]:PDIVision?
DISPlay:MONitor:VIEW[1]:WINDow[1]:TRACe:Y[:SCALe]:RLEVel <real>
DISPlay:MONitor:VIEW[1]:WINDow[1]:TRACe:Y[:SCALe]:RLEVel?
DISPlay:MONitor:VIEW[1]:WINDow[1]:TRACe:Y[:SCALe]:RPOSition TOP | CENTER |
BOTTom
DISPlay:MONitor:VIEW[1]:WINDow[1]:TRACe:Y[:SCALe]:RPOSition?
DISPlay:MOTotalk:VIEW:PRESet TSTD | SLOT
DISPlay:VECTor:VIEW:PRESet SPECTrum | STATistics
DISPlay:WINDow[1]:ANNotation[:ALL] OFF | ON | 0 | 1
DISPlay:WINDow[1]:ANNotation[:ALL]?
DISPlay:WINDow:FORMat:TILE
DISPlay:WINDow:FORMat:ZOOM
DISPlay:WINDow[:SElect] <number>
DISPlay:WINDow[:SElect]?
DISPlay:WINDow[1]:TRACe:GRATICule:GRID[:STATe] OFF | ON | 0 | 1
DISPlay:WINDow[1]:TRACe:GRATICule:GRID[:STATe]?
FETCh:<meas>[n]?
FETCh:FCAPture?
FETCh:IDEMod [n]?
FETCh:IPower [n]?
FETCh:MONitor[n]?
FETCh:MOTotalk[n]?
FETCh:VECTor[n]?
FORMat:BORDER NORMAl | SWAPped
FORMat:BORDER?
FORMat[:TRACe][:DATA] ASCii | INTeger, 32 | REAL, 32 | REAL, 64
FORMat[:TRACe][:DATA]?
GLOBal:DEFault
GLOBal:FREQuency:CENTer[:STATe] 1 | 0 | ON | OFF
GLOBal:FREQuency:CENTer[:STATe]?
HCOPY:ABORT
HCOPY[:IMMediate]
INITiate:CONTinuous OFF | ON | 0 | 1
INITiate:CONTinuous?
INITiate:FCAPture
INITiate:IDEMod
INITiate[:IMMediate]
INITiate:IPower
INITiate:MONitor

```

3 Programming the Analyzer

List of SCPI Commands

```
INITiate:MOTotalk
INITiate:REStart
INITiate:VECTor
INPut:COUPling AC | DC
INPut:COUPling?
INPut:COUPling:I|Q DC | LFR1 | LFR2
INPut:COUPling:I|Q?
INPut:IMPedance:IQ U50 | B50 | U1M | B1M
INPut:IMPedance:IQ?
INPut:IMPedance:REFErence <integer>
INPut:IMPedance:REFErence?
INPut[1]:IQ:BALEnced[:STATE] OFF | ON | 0 | 1
INPut[1]:IQ:BALEnced[:STATE]?
INPut:IQ[:I]:DIFFerential OFF | ON | 0 | 1
INPut:IQ[:I]:DIFFerential?
INPut[1]:IQ[:I]:IMPedance LOW | HIGH
INPut[1]:IQ[:I]:IMPedance?
INPut:IQ:MIRROred OFF | ON | 0 | 1
INPut:IQ:MIRROred?
INPut:IQ:Q:DIFFerential OFF | ON | 0 | 1
INPut:IQ:Q:DIFFerential?
INPut[1]:IQ:Q:IMPedance LOW | HIGH
INPut[1]:IQ:Q:IMPedance?
INPut[1]:IQ:TYPE IQ | I | Q
INPut[1]:IQ:TYPE?
INPut:MIXer EXTErnal | INTernal
INPut:MIXer?
INPut:OFFSet:I|Q <voltage>
INPut:OFFSet:I|Q?
INSTRument:CATalog?
INSTRument:COUple:DEFault
INSTRument:COUple:FREQuency:CENTEr ALL | NONE
INSTRument:COUple:FREQuency:CENTEr?
INSTRument:NSElect <integer>
INSTRument:NSElect?
INSTRument[:SElect] SA | RTSA | SEQAN | EMI | BASIC | WCDMA | EDGE GSM |
WIMAXOFDMA | VSA | PNOISE | NFIGure | ADEMOD | BTooth | TDSCDMA | CDMA2K |
CDMA1XEV | LTE | LTETDD | LTEAFDD | LTEATDD | MSR | DVB | DTMB | DCATV |
ISDBT | CMMB | WLAN | CWLAN | CWIMAXOFDM | WIMAXFIXED | IDEN | RLC |
SCPILC | VSA89601
INSTRument[:SElect] 'SA' | 'PNOISE' | 'EDGE' | 'GSM' | 'BASIC'
INSTRument[:SElect] SANalyzer
INSTRument[:SElect] RECEiver
INSTRument[:SElect] GSM
INSTRument[:SElect]?
INST:SEL EMI
INST:SEL SCPILC
MEASure:IDEMod [n]?
MEASure:IPower [n]?
MEASure:MONitor[n]?
MEASure:MOTotalk[n]?
MMEMory:CATalog? [<directory_name>]
```

```

MMEMory:CDIRectory [<directory_name>]
MMEMory:CDIRectory?
MMEMory:COpy <string>, <string>[, <string>, <string>]
MMEMory:COpy:DEvIce <source_string>, <dest_string>
MMEMory:DATA <file_name>, <data>
MMEMory:DATA? <file_name>
MMEMory:DELEte <file_name>[, <directory_name>]
MMEMory:LOAD:STATE <filename>
MMEMory:LOAD:STATE 1, <filename>
MMEMory:LOAD:TRACE:DATA D1 | D2 | D3 | D4 | D5 | D6, <filename>[, CSV |
TXT | SDF | MAT4 | MAT | HDF5 | BIN]
MMEMory:LOAD:TRACE:DATA TRACE1 | TRACE2 | TRACE3 | TRACE4 | TRACE5 |
TRACE6, <filename>
MMEMory:MDIRectory <directory_name>
MMEMory:MOVE <string>, <string>[, <string>, <string>]
MMEMory:RDIRectory <directory_name>
MMEMory:REGister:STATE:LABel <regnumber>, "label"
MMEMory:REGister:STATE:LABel? <regnumber>
MMEMory:STORE:SCREen <filename>
MMEMory:STORE:SCREen:THEME TDColor | TDMonochrome | FCOLOR | FMONochrome
MMEMory:STORE:SCREen:THEME?
MMEMory:STORE:STATE 1, <filename>
MMEMory:STORE:STATE <filename>
MMEMory:STORE:TRACE:DATA TRACE1 | TRACE2 | TRACE3 | TRACE4 | TRACE5 |
TRACE6, "<filename>"[, CSV | TXT | SDF | MAT4 | MAT | HDF5 | BIN[, OFF |
ON | 0 | 1]]
READ:<meas>[n]?
READ:IDEMod [n]
READ:IPower [n]?
READ:MONitor[n]?
READ:MOtotaLk[n]?
READ:VECTor[n]?
[:SENSE]:<meas>:AVERage:COUNT <integer>
[:SENSE]:<meas>:AVERage:COUNT?
[:SENSE]:<meas>:AVERage:FAST OFF | ON | 0 | 1
[:SENSE]:<meas>:AVERage:FAST?
[:SENSE]:<meas>:AVERage:FAST:URATE <integer>
[:SENSE]:<meas>:AVERage:FAST:URATE?
[:SENSE]:<meas>:AVERage:FAST:URATE:AUTO OFF | ON | 0 | 1
[:SENSE]:<meas>:AVERage:FAST:URATE:AUTO?
[:SENSE]:<meas>:AVERage[:STATE] OFF | ON | 0 | 1
[:SENSE]:<meas>:AVERage[:STATE]?
[:SENSE]:<meas>:AVERage:TCONtrol EXPonential | REPeat
[:SENSE]:<meas>:AVERage:TCONtrol?
[:SENSE]:<meas>:AVERage:TYPE RMS | TIME | MAXimum
[:SENSE]:<meas>:AVERage:TYPE?
[:SENSE]:<meas>:BANDwidth|BWIDth[:RESolution] <bandwidth>
[:SENSE]:<meas>:BANDwidth|BWIDth[:RESolution]?
[:SENSE]:<meas>:BANDwidth|BWIDth[:RESolution]:COUple SPAN | MIN | FIXEd
[:SENSE]:<meas>:BANDwidth|BWIDth[:RESolution]:COUple?
[:SENSE]:<meas>:FFT:WINDow[:TYPE] UNIFORM | HANNing | GAUSSian | FLATtop
[:SENSE]:<meas>:FFT:WINDow[:TYPE]?

```

3 Programming the Analyzer

List of SCPI Commands

```
[ :SENSe ] : < meas > : FREQuency : SYNThesis [ : STATE ] 1 | 2 | 3
[ :SENSe ] : < meas > : FREQuency : SYNThesis [ : STATE ] ?
[ :SENSe ] : < meas > : PUPDate : ENABle OFF | ON | 0 | 1
[ :SENSe ] : < meas > : PUPDate : ENABle ?
[ :SENSe ] : < meas > : SWEEp : EGATE : DELay < time >
[ :SENSe ] : < meas > : SWEEp : EGATE : DELay ?
[ :SENSe ] : < meas > : SWEEp : EGATE [ : SPAN ] < time >
[ :SENSe ] : < meas > : SWEEp : EGATE [ : SPAN ] ?
[ :SENSe ] : < meas > : SWEEp : EGATE : STATE OFF | ON | 0 | 1
[ :SENSe ] : < meas > : SWEEp : EGATE : STATE ?
[ :SENSe ] : < meas > : SWEEp : ISRate ?
[ :SENSe ] : < meas > : SWEEp : POINTs < integer >
[ :SENSe ] : < meas > : SWEEp : POINTs ?
[ :SENSe ] : < meas > : SWEEp : POINTs : AUTO OFF | ON | 0 | 1
[ :SENSe ] : < meas > : SWEEp : POINTs : AUTO ?
[ :SENSe ] : < meas > : SWEEp : TIME < time >
[ :SENSe ] : < meas > : SWEEp : TIME ?
[ :SENSe ] : CORRection : BTS [ : RF ] : GAIN < rel _ ampl >
[ :SENSe ] : CORRection : BTS [ : RF ] : GAIN ?
[ :SENSe ] : CORRection : BTS [ : RF ] : LOSS < rel _ ampl >
[ :SENSe ] : CORRection : BTS [ : RF ] : LOSS ?
[ :SENSe ] : CORRection : FEQualizer OFF | NORMAl | INVert
[ :SENSe ] : CORRection : FEQualizer ?
[ :SENSe ] : CORRection : FEQualizer : REGister D1 | D2 | D3 | D4 | D5 | D6
[ :SENSe ] : CORRection : FEQualizer : REGister ?
[ :SENSe ] : CORRection : FEQualizer : RELative ?
[ :SENSe ] : CORRection : IMPedance [ : INPut ] [ : MAGNitude ] 50 | 75
[ :SENSe ] : CORRection : IMPedance [ : INPut ] [ : MAGNitude ] ?
[ :SENSe ] : CORRection : IQ : I : GAIN < rel _ ampl >
[ :SENSe ] : CORRection : IQ : I : GAIN ?
[ :SENSe ] : CORRection : IQ : I | Q : ATTenuation < rel _ ampl >
[ :SENSe ] : CORRection : IQ : I | Q : ATTenuation ?
[ :SENSe ] : CORRection : IQ : I | Q : ATTenuation : RATio < real >
[ :SENSe ] : CORRection : IQ : I | Q : ATTenuation : RATio ?
[ :SENSe ] : CORRection : IQ [ : I ] : SKEW < seconds >
[ :SENSe ] : CORRection : IQ [ : I ] : SKEW ?
[ :SENSe ] : CORRection : IQ : Q : GAIN < rel _ ampl >
[ :SENSe ] : CORRection : IQ : Q : GAIN ?
[ :SENSe ] : CORRection : IQ : Q : SKEW < seconds >
[ :SENSe ] : CORRection : IQ : Q : SKEW ?
[ :SENSe ] : CORRection : MS [ : RF ] : GAIN < rel _ ampl >
[ :SENSe ] : CORRection : MS [ : RF ] : GAIN ?
[ :SENSe ] : CORRection : MS [ : RF ] : LOSS < rel _ ampl >
[ :SENSe ] : CORRection : MS [ : RF ] : LOSS ?
[ :SENSe ] : CORRection : OFFSet [ : MAGNitude ]
[ :SENSe ] : CORRection : SA [ : RF ] : GAIN < rel _ ampl >
[ :SENSe ] : CORRection : SA [ : RF ] : GAIN ?
[ :SENSe ] : FCAPture : BLOCk < integer >
[ :SENSe ] : FCAPture : BLOCk ?
[ :SENSe ] : FCAPture : LENGth < integer >
[ :SENSe ] : FCAPture : LENGth ?
[ :SENSe ] : FCAPture : POINter < integer >
[ :SENSe ] : FCAPture : POINter ?
```

```

[:SENSe]:FCAPture:WLENgth AUTO | BIT32 | BIT64
[:SENSe]:FCAPture:WLENgth?
[:SENSe]:FEED RF | AIQ | EMIXer
[:SENSe]:FEED AREFERENCE
[:SENSe]:FEED IQ | IONLy | QONLy
[:SENSe]:FEED?
[:SENSe]:FEED?
[:SENSe]:FEED:AREFERENCE REF50 | REF4800 | OFF
[:SENSe]:FEED:AREFERENCE?
[:SENSe]:FEED:IQ:TYPE IQ | IONLy | QONLy
[:SENSe]:FEED:IQ:TYPE?
[:SENSe]:FREQuency:CENTer <freq>
[:SENSe]:FREQuency:CENTer <freq>
[:SENSe]:FREQuency:CENTer?
[:SENSe]:FREQuency:CENTer?
[:SENSe]:FREQuency:CENTer:STEP:AUTO OFF | ON | 0 | 1
[:SENSe]:FREQuency:CENTer:STEP:AUTO OFF | ON | 0 | 1
[:SENSe]:FREQuency:CENTer:STEP:AUTO?
[:SENSe]:FREQuency:CENTer:STEP:AUTO?
[:SENSe]:FREQuency:CENTer:STEP[:INCRement] <freq>
[:SENSe]:FREQuency:CENTer:STEP[:INCRement] <freq>
[:SENSe]:FREQuency:CENTer:STEP[:INCRement]?
[:SENSe]:FREQuency:CENTer:STEP[:INCRement]?
[:SENSe]:FREQuency:EMIXer:CENTer <freq>
[:SENSe]:FREQuency:EMIXer:CENTer?
[:SENSe]:FREQuency:IQ:CENTer <freq>
[:SENSe]:FREQuency:IQ:CENTer?
[:SENSe]:FREQuency:RF:CENTer <freq>
[:SENSe]:FREQuency:RF:CENTer?
[:SENSe]:FREQuency:SPAN <freq>
[:SENSe]:FREQuency:SPAN?
[:SENSe]:FREQuency:SPAN:FULL
[:SENSe]:FREQuency:STARt <freq>
[:SENSe]:FREQuency:STARt?
[:SENSe]:FREQuency:STOP <freq>
[:SENSe]:FREQuency:STOP?
[:SENSe]:IDEMod:ADRoop:COMPensation OFF | ON | 0 | 1
[:SENSe]:IDEMod:ADRoop:COMPensation?
[:SENSe]:IDEMod:ALPHa <real>
[:SENSe]:IDEMod:ALPHa?
[:SENSe]:IDEMod:ASCHannel LO | LI | RI | RO
[:SENSe]:IDEMod:ASCHannel?
[:SENSe]:IDEMod:ASLot <integer>
[:SENSe]:IDEMod:ASLot?
[:SENSe]:IDEMod:EFLock OFF | ON | 0 | 1
[:SENSe]:IDEMod:EFLock?
[:SENSe]:IDEMod:NORMalize:STATe OFF | ON | 0 | 1
[:SENSe]:IDEMod:NORMalize:STATe?
[:SENSe]:IDEMod:PILot:TRACk OFF | ON | 0 | 1
[:SENSe]:IDEMod:PILot:TRACk?
[:SENSe]:IDEMod:SLOTs <integer>
[:SENSe]:IDEMod:SLOTs?
[:SENSe]:IDEMod:SPSYmbols:INCLude OFF | ON | 0 | 1

```

3 Programming the Analyzer

List of SCPI Commands

```
[ :SENSe]:IDEMod:SPSYmbols:INCLude?
[ :SENSe]:IDEMod:SYNC:SLENgth <time>
[ :SENSe]:IDEMod:SYNC:SLENgth?
[ :SENSe]:IDEMod:TSCale <real>
[ :SENSe]:IDEMod:TSCale?
[ :SENSe]:IDEMod:TSEL:BERate OFF | ON | 0 | 1
[ :SENSe]:IDEMod:TSEL:BERate?
[ :SENSe]:IDEMod:TSEL:EVMagnitude OFF | ON | 0 | 1
[ :SENSe]:IDEMod:TSEL:EVMagnitude?
[ :SENSe]:IDEMod:TSEL:PVTime OFF | ON | 0 | 1
[ :SENSe]:IDEMod:TSEL:PVTime?
[ :SENSe]:IDEMod:WCARrier <integer>
[ :SENSe]:IDEMod:WCARrier?
[ :SENSe]:IPOWER:TSEL:ACPower OFF | ON | 0 | 1
[ :SENSe]:IPOWER:TSEL:ACPower?
[ :SENSe]:IPOWER:TSEL:OBWidth OFF | ON | 0 | 1
[ :SENSe]:IPOWER:TSEL:OBWidth?
[ :SENSe]:MONitor:AVERage:COUNT <integer>
[ :SENSe]:MONitor:AVERage:COUNT?
[ :SENSe]:MONitor:AVERage[:STATe] OFF | ON | 0 | 1
[ :SENSe]:MONitor:AVERage[:STATe]?
[ :SENSe]:MONitor:AVERage:TCONtrol EXPonential | REPeat
[ :SENSe]:MONitor:AVERage:TCONtrol?
[ :SENSe]:MONitor:BANDwidth[:RESolution] <freq>
[ :SENSe]:MONitor:BANDwidth[:RESolution]?
[ :SENSe]:MONitor:BANDwidth[:RESolution]:AUTO OFF | ON | 0 | 1
[ :SENSe]:MONitor:BANDwidth[:RESolution]:AUTO?
[ :SENSe]:MONitor:BANDwidth:VIDeo <bandwidth>
[ :SENSe]:MONitor:BANDwidth:VIDeo?
[ :SENSe]:MONitor:BANDwidth:VIDeo:AUTO ON | OFF | 1 | 0
[ :SENSe]:MONitor:BANDwidth:VIDeo:AUTO?
[ :SENSe]:MONitor:BANDwidth:VIDeo:RATio <real>
[ :SENSe]:MONitor:BANDwidth:VIDeo:RATio?
[ :SENSe]:MONitor:BANDwidth:VIDeo:RATio:AUTO OFF | ON | 0 | 1
[ :SENSe]:MONitor:BANDwidth:VIDeo:RATio:AUTO?
[ :SENSe]:MONitor:BWIDth[:RESolution]
[ :SENSe]:MONitor:BWIDth:VIDeo
[ :SENSe]:MONitor:BWIDth:VIDeo:RATio
[ :SENSe]:MONitor:DETEctor:AUTO ON | OFF | 1 | 0
[ :SENSe]:MONitor:DETEctor:AUTO?
[ :SENSe]:MONitor:DETEctor[:FUNction]
[ :SENSe]:MONitor:DETEctor:TRACe AVERage | NEGative | NORMal | POSitive |
SAMPle
[ :SENSe]:MONitor:DETEctor:TRACe?
[ :SENSe]:MONitor:FREQUency:SPAN <freq>
[ :SENSe]:MONitor:FREQUency:SPAN?
[ :SENSe]:MONitor:FREQUency:SPAN:BANDwidth[:RESolution]:RATio <integer>
[ :SENSe]:MONitor:FREQUency:SPAN:BANDwidth[:RESolution]:RATio?
[ :SENSe]:MONitor:FREQUency:SPAN:BANDwidth[:RESolution]:RATio:AUTO OFF | ON
| 0 | 1
[ :SENSe]:MONitor:FREQUency:SPAN:BANDwidth[:RESolution]:RATio:AUTO?
[ :SENSe]:MONitor:FREQUency:SPAN:BWIDth[:RESolution]:RATio
[ :SENSe]:MONitor:FREQUency:SPAN:FULL
```

```

[:SENSe]:MONitor:FREQuency:SPAN:PREVious
[:SENSe]:MONitor:SWEep:POINts <integer>
[:SENSe]:MONitor:SWEep:POINts?
[:SENSe]:MONitor:SWEep:TIME <time>
[:SENSe]:MONitor:SWEep:TIME?
[:SENSe]:MONitor:SWEep:TIME:AUTO OFF | ON | 0 | 1
[:SENSe]:MONitor:SWEep:TIME:AUTO?
[:SENSe]:MOTotalk:ANALysis:SLOT <integer>
[:SENSe]:MOTotalk:ANALysis:SLOT?
[:SENSe]:MOTotalk:BT <real>
[:SENSe]:MOTotalk:BT?
[:SENSe]:MOTotalk:NORMalize:STATE OFF | ON | 0 | 1
[:SENSe]:MOTotalk:NORMalize:STATE?
[:SENSe]:MOTotalk:SRATE <real>
[:SENSe]:MOTotalk:SRATE?
[:SENSe]:MOTotalk:SYNC:BURSt:STATE OFF | ON | 0 | 1
[:SENSe]:MOTotalk:SYNC:BURSt:STATE?
[:SENSe]:MOTotalk[:SYNC]:SLENgth <time>
[:SENSe]:MOTotalk[:SYNC]:SLENgth?
[:SENSe]:POWER:IQ[:I]:RANGe[:UPPer] <ampl>
[:SENSe]:POWER:IQ[:I]:RANGe[:UPPer]?
[:SENSe]:POWER:IQ:Q:RANGe[:UPPer] <ampl>
[:SENSe]:POWER:IQ:Q:RANGe[:UPPer]?
[:SENSe]:POWER:IQ:RANGe:AUTO OFF | ON | 0 | 1
[:SENSe]:POWER:IQ:RANGe:AUTO?
[:SENSe]:POWER[:RF]:ATTenuation <rel_ampl>
[:SENSe]:POWER[:RF]:ATTenuation?
[:SENSe]:POWER[:RF]:ATTenuation:AUTO OFF | ON | 0 | 1
[:SENSe]:POWER[:RF]:ATTenuation:AUTO?
[:SENSe]:POWER[:RF]:ATTenuation:STEP[:INCRement] 10 dB | 2 dB
[:SENSe]:POWER[:RF]:ATTenuation:STEP[:INCRement]?
[:SENSe]:POWER[:RF]:EATTenuation <rel_ampl>
[:SENSe]:POWER[:RF]:EATTenuation?
[:SENSe]:POWER[:RF]:EATTenuation:STATE OFF | ON | 0 | 1
[:SENSe]:POWER[:RF]:EATTenuation:STATE?
[:SENSe]:POWER[:RF]:GAIN:BAND LOW | FULL
[:SENSe]:POWER[:RF]:GAIN:BAND?
[:SENSe]:POWER[:RF]:GAIN[:STATE] OFF | ON | 0 | 1
[:SENSe]:POWER[:RF]:GAIN[:STATE]?
[:SENSe]:POWER[:RF]:MMW:PADJust
[:SENSe]:POWER[:RF]:MW:PADJust
[:SENSe]:POWER[:RF]:MW:PATH STD | LNPath | MPBypass | FULL
[:SENSe]:POWER[:RF]:MW:PATH?
[:SENSe]:POWER[:RF]:MW:PRESelector[:STATE] ON | OFF | 0 | 1
[:SENSe]:POWER[:RF]:MW:PRESelector[:STATE]?
[:SENSe]:POWER[:RF]:PADJust <freq>
[:SENSe]:POWER[:RF]:PADJust?
[:SENSe]:POWER[:RF]:PADJust:PRESelector MWAVe | MMWave | EXTernal
[:SENSe]:POWER[:RF]:PADJust:PRESelector?
[:SENSe]:POWER[:RF]:PCENter
[:SENSe]:POWER[:RF]:RANGe <real>
[:SENSe]:POWER[:RF]:RANGe?
[:SENSe]:POWER[:RF]:RANGe:AUTO ON | OFF | 1 | 0

```

3 Programming the Analyzer

List of SCPI Commands

```
[ :SENSe]:POWER[:RF]:RANGe:AUTO?
[ :SENSe]:POWER[:RF]:RANGe:OPTimize IMMEDIATE
[ :SENSe]:POWER[:RF]:RANGe:OPTimize:ATTenuation OFF | ELEctrical | COMBined
[ :SENSe]:POWER[:RF]:RANGe:OPTimize:ATTenuation?
[ :SENSe]:RADio:IDEN:CCODE <integer>
[ :SENSe]:RADio:IDEN:CCODE?
[ :SENSe]:RADio:IDEN:FORMat M4QAM | M16QAM | M64QAM
[ :SENSe]:RADio:IDEN:FORMat?
[ :SENSe]:RADio:IDEN:SLOT TCHFull | RAP | TCHN61 | TCHN61T | TCHE61 | WIDen
| OTCFull | OTCN61
[ :SENSe]:RADio:IDEN:SLOT?
[ :SENSe]:RADio:IDEN:WCARrier I25 | I50 | O50 | I75 | I100
[ :SENSe]:RADio:IDEN:WCARrier?
[ :SENSe]:ROSCillator:BANDwidth WIDE | NARROW
[ :SENSe]:ROSCillator:BANDwidth?
[ :SENSe]:ROSCillator:COUpling NORMAL | NACquisition
[ :SENSe]:ROSCillator:COUpling?
[ :SENSe]:ROSCillator:EXTernal:FREQuency <freq>
[ :SENSe]:ROSCillator:EXTernal:FREQuency?
[ :SENSe]:ROSCillator:SOURce INTernal | EXTernal
[ :SENSe]:ROSCillator:SOURce?
[ :SENSe]:ROSCillator:SOURce:TYPE INTernal | EXTernal | SENSE | PULSE
[ :SENSe]:ROSCillator:SOURce:TYPE?
[ :SENSe]:SPECTrum NORMAL | INVert
[ :SENSe]:SPECTrum?
[ :SENSe]:SWEep:EGATE:CONTRol EDGE | LEVEL
[ :SENSe]:SWEep:EGATE:CONTRol?
[ :SENSe]:SWEep:EGATE:DELay <time>
[ :SENSe]:SWEep:EGATE:DELay?
[ :SENSe]:SWEep:EGATE:DELay:COMPensation:TYPE OFF | SETTled | GDELay
[ :SENSe]:SWEep:EGATE:DELay:COMPensation:TYPE?
[ :SENSe]:SWEep:EGATE:EXTernal[1]|2:LEVEL <voltage>
[ :SENSe]:SWEep:EGATE:EXTernal[1]|2:LEVEL?
[ :SENSe]:SWEep:EGATE:HOLDoff <time>
[ :SENSe]:SWEep:EGATE:HOLDoff?
[ :SENSe]:SWEep:EGATE:HOLDoff:AUTO OFF | ON | 0 | 1
[ :SENSe]:SWEep:EGATE:HOLDoff:AUTO?
[ :SENSe]:SWEep:EGATE:LENGth <time>
[ :SENSe]:SWEep:EGATE:LENGth?
[ :SENSe]:SWEep:EGATE:MINFast?
[ :SENSe]:SWEep:EGATE:POLarity NEGative | POSitive
[ :SENSe]:SWEep:EGATE:POLarity?
[ :SENSe]:SWEep:EGATE:SOURce EXTernal1 | EXTernal2 | LINE | FRAME | RFBurst
[ :SENSe]:SWEep:EGATE:SOURce?
[ :SENSe]:SWEep:EGATE[:STATE] OFF | ON | 0 | 1
[ :SENSe]:SWEep:EGATE[:STATE]?
[ :SENSe]:SWEep:EGATE:TIME <time>
[ :SENSe]:SWEep:EGATE:TIME?
[ :SENSe]:SWEep:EGATE:VIEW ON | OFF | 1 | 0
[ :SENSe]:SWEep:EGATE:VIEW?
[ :SENSe]:SWEep:EGATE:VIEW:START <time>
[ :SENSe]:SWEep:EGATE:VIEW:START?
[ :SENSe]:SWEep:TIME:GATE:LEVEL HIGH | LOW
```



```

[:SENSE]:SWEep:TIME:GATE:LEVel?
[:SENSE]:VECTor|ADEMod:FREQuency:CENTer:TRACk OFF | ON | 0 | 1
[:SENSE]:VECTor|ADEMod:FREQuency:CENTer:TRACk?
[:SENSE]:VOLTage:IQ[:I]:RANGe[:UPPer] <voltage>
[:SENSE]:VOLTage:IQ[:I]:RANGe[:UPPer]?
[:SENSE]:VOLTage:IQ:Q:RANGe[:UPPer] <voltage>
[:SENSE]:VOLTage:IQ:Q:RANGe[:UPPer]?
[:SENSE]:VOLTage:IQ:RANGe:AUTO OFF | ON | 0 | 1
[:SENSE]:VOLTage:IQ:RANGe:AUTO?
[:SENSE]:VOLTage|POWER:IQ:MIRRored OFF | ON | 0 | 1
[:SENSE]:VOLTage|POWER:IQ:MIRRored?
STATus:OPERation:CONDition?
STATus:OPERation:ENABle <integer>
STATus:OPERation:ENABle?
STATus:OPERation[:EVENT]?
STATus:OPERation:NTRansition <integer>
STATus:OPERation:NTRansition?
STATus:OPERation:PTRansition <integer>
STATus:OPERation:PTRansition?
STATus:PRESet
STATus:QUEStionable:CALibration:CONDition?
STATus:QUEStionable:CALibration:ENABle <integer>
STATus:QUEStionable:CALibration:ENABle?
STATus:QUEStionable:CALibration[:EVENT]?
STATus:QUEStionable:CALibration:EXTended:FAILure:CONDition?
STATus:QUEStionable:CALibration:EXTended:FAILure:ENABle <integer>
STATus:QUEStionable:CALibration:EXTended:FAILure:ENABle?
STATus:QUEStionable:CALibration:EXTended:FAILure[:EVENT]?
STATus:QUEStionable:CALibration:EXTended:FAILure:NTRansition <integer>
STATus:QUEStionable:CALibration:EXTended:FAILure:NTRansition?
STATus:QUEStionable:CALibration:EXTended:FAILure:PTRansition <integer>
STATus:QUEStionable:CALibration:EXTended:FAILure:PTRansition?
STATus:QUEStionable:CALibration:EXTended:NEEDed:CONDition?
STATus:QUEStionable:CALibration:EXTended:NEEDed:ENABle <integer>
STATus:QUEStionable:CALibration:EXTended:NEEDed:ENABle?
STATus:QUEStionable:CALibration:EXTended:NEEDed[:EVENT]?
STATus:QUEStionable:CALibration:EXTended:NEEDed:NTRansition <integer>
STATus:QUEStionable:CALibration:EXTended:NEEDed:NTRansition?
STATus:QUEStionable:CALibration:EXTended:NEEDed:PTRansition <integer>
STATus:QUEStionable:CALibration:EXTended:NEEDed:PTRansition?
STATus:QUEStionable:CALibration:NTRansition <integer>
STATus:QUEStionable:CALibration:NTRansition?
STATus:QUEStionable:CALibration:PTRansition <integer>
STATus:QUEStionable:CALibration:PTRansition?
STATus:QUEStionable:CALibration:SKIPPed:CONDition?
STATus:QUEStionable:CALibration:SKIPPed:ENABle <integer>
STATus:QUEStionable:CALibration:SKIPPed:ENABle?
STATus:QUEStionable:CALibration:SKIPPed[:EVENT]?
STATus:QUEStionable:CALibration:SKIPPed:NTRansition <integer>
STATus:QUEStionable:CALibration:SKIPPed:NTRansition?
STATus:QUEStionable:CALibration:SKIPPed:PTRansition <integer>
STATus:QUEStionable:CALibration:SKIPPed:PTRansition?
STATus:QUEStionable:CONDition?

```

```
STATus:QUEStionable:ENABle <integer>
STATus:QUEStionable:ENABle?
STATus:QUEStionable[:EVENT]?
STATus:QUEStionable:FREQuency:CONDition?
STATus:QUEStionable:FREQuency:ENABle <integer>
STATus:QUEStionable:FREQuency:ENABle?
STATus:QUEStionable:FREQuency[:EVENT]?
STATus:QUEStionable:FREQuency:NTRansition <integer>
STATus:QUEStionable:FREQuency:NTRansition?
STATus:QUEStionable:FREQuency:PTRansition <integer>
STATus:QUEStionable:FREQuency:PTRansition?
STATus:QUEStionable:INTEgrity:CONDition?
STATus:QUEStionable:INTEgrity:ENABle <integer>
STATus:QUEStionable:INTEgrity:ENABle?
STATus:QUEStionable:INTEgrity[:EVENT]?
STATus:QUEStionable:INTEgrity:NTRansition <integer>
STATus:QUEStionable:INTEgrity:NTRansition?
STATus:QUEStionable:INTEgrity:PTRansition <integer>
STATus:QUEStionable:INTEgrity:PTRansition?
STATus:QUEStionable:INTEgrity:SIGNAL:CONDition?
STATus:QUEStionable:INTEgrity:SIGNAL:ENABle <integer>
STATus:QUEStionable:INTEgrity:SIGNAL:ENABle?
STATus:QUEStionable:INTEgrity:SIGNAL[:EVENT]?
STATus:QUEStionable:INTEgrity:SIGNAL:NTRansition <integer>
STATus:QUEStionable:INTEgrity:SIGNAL:NTRansition?
STATus:QUEStionable:INTEgrity:SIGNAL:PTRansition <integer>
STATus:QUEStionable:INTEgrity:SIGNAL:PTRansition?
STATus:QUEStionable:INTEgrity:UNCalibrated:CONDition?
STATus:QUEStionable:INTEgrity:UNCalibrated:ENABle
STATus:QUEStionable:INTEgrity:UNCalibrated:ENABle?
STATus:QUEStionable:INTEgrity:UNCalibrated[:EVENT]?
STATus:QUEStionable:INTEgrity:UNCalibrated:NTRansition <integer>
STATus:QUEStionable:INTEgrity:UNCalibrated:NTRansition?
STATus:QUEStionable:INTEgrity:UNCalibrated:PTRansition <integer>
STATus:QUEStionable:INTEgrity:UNCalibrated:PTRansition?
STATus:QUEStionable:NTRansition <integer>
STATus:QUEStionable:NTRansition?
STATus:QUEStionable:POWER:CONDition?
STATus:QUEStionable:POWER:ENABle <integer>
STATus:QUEStionable:POWER:ENABle?
STATus:QUEStionable:POWER[:EVENT]?
STATus:QUEStionable:POWER:NTRansition <integer>
STATus:QUEStionable:POWER:NTRansition?
STATus:QUEStionable:POWER:PTRansition <integer>
STATus:QUEStionable:POWER:PTRansition?>
STATus:QUEStionable:PTRansition <integer>
STATus:QUEStionable:PTRansition?
STATus:QUEStionable:TEMPerature:CONDition?
STATus:QUEStionable:TEMPerature:ENABle <integer>
STATus:QUEStionable:TEMPerature:ENABle?
STATus:QUEStionable:TEMPerature[:EVENT]?
STATus:QUEStionable:TEMPerature:NTRansition <integer>
STATus:QUEStionable:TEMPerature:NTRansition?
```

```

STATus:QUEStionable:TEMPerature:PTRansition <integer>
STATus:QUEStionable:TEMPerature:PTRansition?
SYSTem:APPLication:CATalog[:NAME]?
SYSTem:APPLication:CATalog[:NAME]:COUNT?
SYSTem:APPLication:CATalog:OPTion? <model>
SYSTem:APPLication:CATalog:REVision? <model>
SYSTem:APPLication[:CURRent][:NAME]?
SYSTem:APPLication[:CURRent]:OPTion?
SYSTem:APPLication[:CURRent]:REVision?
SYSTem:COMMunicate:GPIB[1][:SELF]:ADDReSS <integer>
SYSTem:COMMunicate:GPIB[1][:SELF]:ADDReSS?
SYSTem:COMMunicate:GPIB[1][:SELF]:CONTRoller[:ENABle] ON | OFF | 0 | 1
SYSTem:COMMunicate:GPIB[1][:SELF]:CONTRoller[:ENABle]?
SYSTem:COMMunicate:LAN:SCPI:HISLip:ENABle OFF | ON | 0 | 1
SYSTem:COMMunicate:LAN:SCPI:HISLip:ENABle?
SYSTem:COMMunicate:LAN:SCPI:SICL:ENABle OFF | ON | 0 | 1
SYSTem:COMMunicate:LAN:SCPI:SICL:ENABle?
SYSTem:COMMunicate:LAN:SCPI:SOCKeT:CONTRoll?
SYSTem:COMMunicate:LAN:SCPI:SOCKeT:ENABle OFF | ON | 0 | 1
SYSTem:COMMunicate:LAN:SCPI:SOCKeT:ENABle?
SYSTem:COMMunicate:LAN:SCPI:TELNet:ENABle OFF | ON | 0 | 1
SYSTem:COMMunicate:LAN:SCPI:TELNet:ENABle?
SYSTem:COMMunicate:USB:CONNection?
SYSTem:COMMunicate:USB:PACKets?
SYSTem:COMMunicate:USB:STATus?
SYSTem:CONFIgure[:SYSTem]?
SYSTem:DATE "<year>, <month>, <day>"
SYSTem:DATE?
SYSTem:DEFault [ALL] | ALIGn | INPut | MISC | MODes | PON
SYSTem:ERRor[:NEXT]?
SYSTem:ERRor:OVERload[:STATe] 0 | 1 | OFF | ON
SYSTem:ERRor:VERBoSe OFF | ON | 0 | 1
SYSTem:ERRor:VERBoSe?
SYSTem:HELP:HEADers?
SYSTem:HID?
SYSTem:IDN <string>
SYSTem:IDN?
SYSTem:KLOCK OFF | ON | 0 | 1
SYSTem:KLOCK?
SYSTem:LKEY <"OptionInfo">, <"LicenseInfo">
SYSTem:LKEY? <"OptionInfo">
SYSTem:LKEY:DELete <"OptionInfo">, <"LicenseInfo">
SYSTem:LKEY:LIST?
SYSTem:MRELay:COUNT?
SYSTem:OPTions?
SYSTem:PDOWN [NORMal | FORCe]
SYSTem:PON:APPLication:LLIST <stringofINSTRument:SElectnames>
SYSTem:PON:APPLication:LLIST?
SYSTem:PON:APPLication:VMEMory[:AVAILable]?
SYSTem:PON:APPLication:VMEMory:TOTAL?
SYSTem:PON:APPLication:VMEMory:USED?
SYSTem:PON:APPLication:VMEMory:USED:NAME? <INSTRument:SElectname>
SYSTem:PON:ETIME?

```

3 Programming the Analyzer

List of SCPI Commands

```
SYSTem:PON:MODE SA | BASIC | ADEMOD | NFIGURE | PNOISE | CDMA2K | TDSCDMA
| VSA | VSA89601 | WCDMA | WIMAXOFDMA
SYSTem:PON:MODE?
SYSTem:PON:TIME?
SYSTem:PON:TYPE MODE | USER | LAST
SYSTem:PON:TYPE PRESet
SYSTem:PON:TYPE?
SYSTem:PRESet
SYSTem:PRESet:USER
SYSTem:PRESet:USER:ALL
SYSTem:PRESet:USER:SAVE
SYSTem:PRINT:THEME TDColor | TDMonochrome | FColor | FMONochrome
SYSTem:PRINT:THEME?
SYSTem:PUP:PROcEss
SYSTem:SECurity:USB:WPRotect[:ENABLE] ON | OFF | 0 | 1
SYSTem:SECurity:USB:WPRotect[:ENABLE]?
SYSTem:SHOW OFF | ERROR | SYSTem | HARDware | LXI | HWStatistics |
ALIGNment | SOFTware | CAPplication
SYSTem:SHOW?
SYSTem:TEMPerature:HEXTreme?
SYSTem:TEMPerature:LEXTreme?
SYSTem:TIME "<hour>, <minute>, <second>"
SYSTem:TIME?
SYSTem:VERSion?
TRACe:MONitor:CLear [TRACE1] | TRACE2 | TRACE3
TRACe:MONitor:CLear:ALL
TRACe[1]|2|3:MONitor:DISPlay[:STATE] ON | OFF | 0 | 1
TRACe[1]|2|3:MONitor:DISPlay[:STATE]?
TRACe[1]|2|3:MONitor:TYPE WRITE | AVERage | MAXHold | MINHold
TRACe[1]|2|3:MONitor:TYPE?
TRACe[1]|2|3:MONitor:UPDate[:STATE] ON | OFF | 0 | 1
TRACe[1]|2|3:MONitor:UPDate[:STATE]?
TRIGger[:SEQUence]:EXTernal1:DELay <time>
TRIGger[:SEQUence]:EXTernal1:DELay?
TRIGger[:SEQUence]:EXTernal1:DELay:STATE OFF | ON | 0 | 1
TRIGger[:SEQUence]:EXTernal1:DELay:STATE?
TRIGger[:SEQUence]:EXTernal1:HOLDoff <time>
TRIGger[:SEQUence]:EXTernal1:HOLDoff?
TRIGger[:SEQUence]:EXTernal1:HOLDoff:STATE OFF | ON | 0 | 1
TRIGger[:SEQUence]:EXTernal1:HOLDoff:STATE?
TRIGger[:SEQUence]:EXTernal1:HOLDoff:TYPE BELOW | ABOVE
TRIGger[:SEQUence]:EXTernal1:HOLDoff:TYPE?
TRIGger[:SEQUence]:EXTernal1:LEVEL <voltage>
TRIGger[:SEQUence]:EXTernal:LEVEL
TRIGger[:SEQUence]:EXTernal2:LEVEL
TRIGger[:SEQUence]:EXTernal1:LEVEL <level>
TRIGger[:SEQUence]:EXTernal1:LEVEL?
TRIGger[:SEQUence]:EXTernal1:LEVEL?
TRIGger[:SEQUence]:EXTernal2:LEVEL?
TRIGger[:SEQUence]:EXTernal1:SLOPe POSitive | NEGative
TRIGger[:SEQUence]:EXTernal1:SLOPe POSitive | NEGative
TRIGger[:SEQUence]:EXTernal2:SLOPe POSitive | NEGative
TRIGger[:SEQUence]:EXTernal:SLOPe
```

```
TRIGger[:SEQuence]:EXTErnal1:SLOPe?  
TRIGger[:SEQuence]:EXTErnal1:SLOPe?  
TRIGger[:SEQuence]:EXTErnal2:SLOPe?  
TRIGger[:SEQuence]:FRAMe:EXTErnal1:LEVel  
TRIGger[:SEQuence]:FRAMe:EXTErnal2:LEVel  
TRIGger[:SEQuence]:FRAMe:EXTErnal1:SLOPe  
TRIGger[:SEQuence]:FRAMe:EXTErnal2:SLOPe  
TRIGger[:SEQuence]:FRAMe:RFBurst:LEVel:ABSolute  
TRIGger[:SEQuence]:FRAMe:RFBurst:SLOPe  
TRIGger[:SEQuence]:RFBurst:LEVel  
TRIGger[:SEQuence]:RFBurst:LEVel:ABSolute <ampl>  
TRIGger[:SEQuence]:RFBurst:LEVel:ABSolute?  
TRIGger[:SEQuence]:RFBurst:LEVel:RELative <rel_ampl>  
TRIGger[:SEQuence]:RFBurst:LEVel:RELative?  
TRIGger[:SEQuence]:RFBurst:LEVel:TYPE ABSolute | RELative  
TRIGger[:SEQuence]:RFBurst:LEVel:TYPE?  
TRIGger[:SEQuence]:RFBurst:SLOPe POSitive | NEGative  
TRIGger[:SEQuence]:RFBurst:SLOPe?  
TRIGger[:SEQuence]:RLINE OFF | ON | 0 | 1  
TRIGger[:SEQuence]:RLINE?  
TRIGger[:SEQuence]:VIDeo:DELay <time>  
TRIGger[:SEQuence]:VIDeo:DELay?  
TRIGger[:SEQuence]:VIDeo:DELay:STATE OFF | ON | 0 | 1  
TRIGger[:SEQuence]:VIDeo:DELay:STATE?  
TRIGger[:SEQuence]:VIDeo:HOLDoFF <time>  
TRIGger[:SEQuence]:VIDeo:HOLDoFF?  
TRIGger[:SEQuence]:VIDeo:HOLDoFF:STATE OFF | ON | 0 | 1  
TRIGger[:SEQuence]:VIDeo:HOLDoFF:STATE?  
TRIGger[:SEQuence]:VIDeo:HOLDoFF:TYPE BELOw | ABOVe  
TRIGger[:SEQuence]:VIDeo:HOLDoFF:TYPE?  
TRIGger[:SEQuence]:VIDeo:LEVel <voltage>  
TRIGger[:SEQuence]:VIDeo:LEVel?  
TRIGger[:SEQuence]:VIDeo:SLOPe POSitive | NEGative  
TRIGger[:SEQuence]:VIDeo:SLOPe?
```

STATus Subsystem

The following diagram provides a graphical overview of the entire X-Series Status Register System.

For readability, the diagram is split into two sections:

- ["X-Series Status Register System \(1\) " on page 95](#)
- ["X-Series Status Register System \(2\) " on page 96](#)

X-Series Status Register System (1)

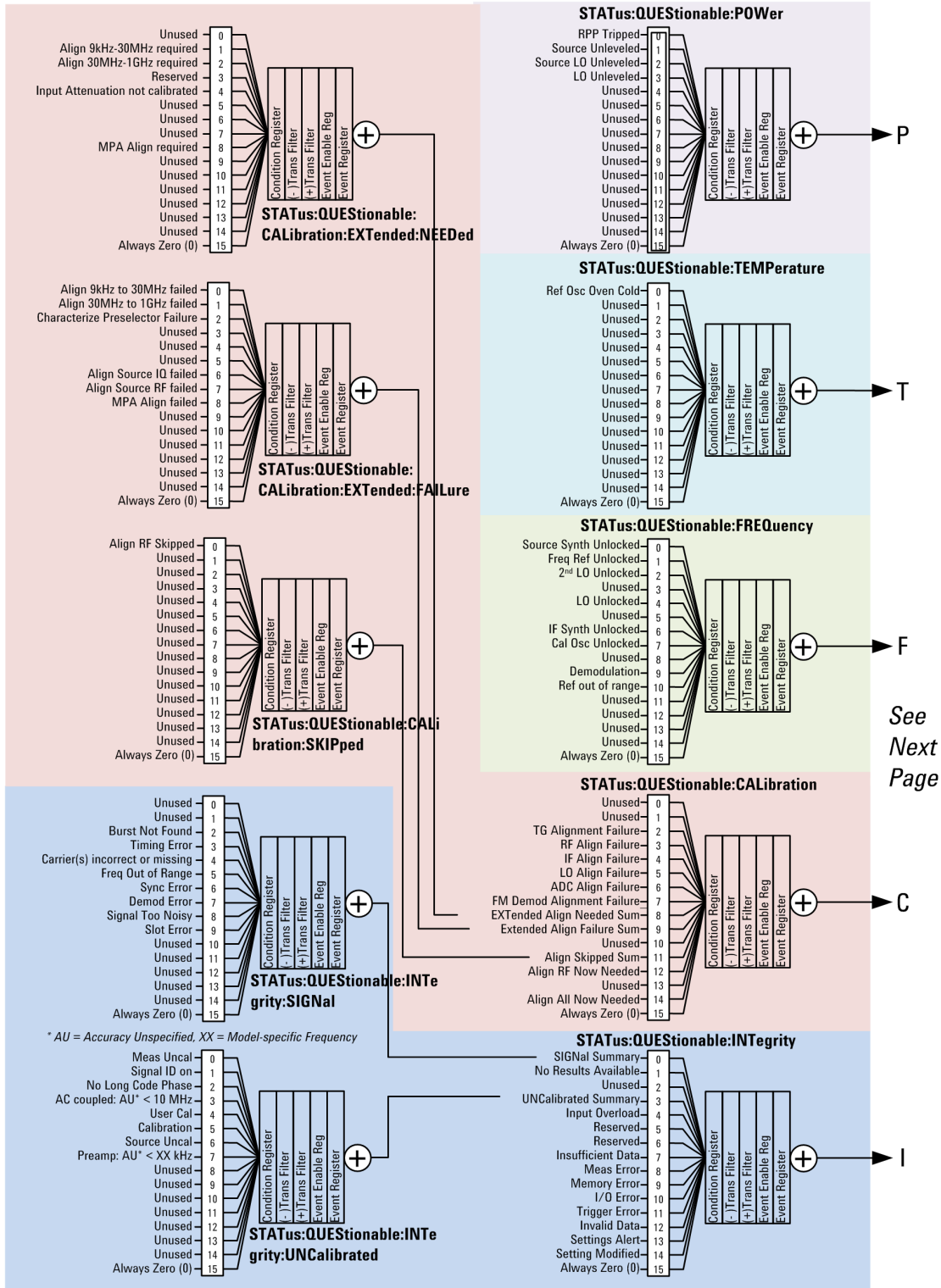

X-Series Status Register System (2)

See
 Previous
 Page

P
 T
 F
 C
 I

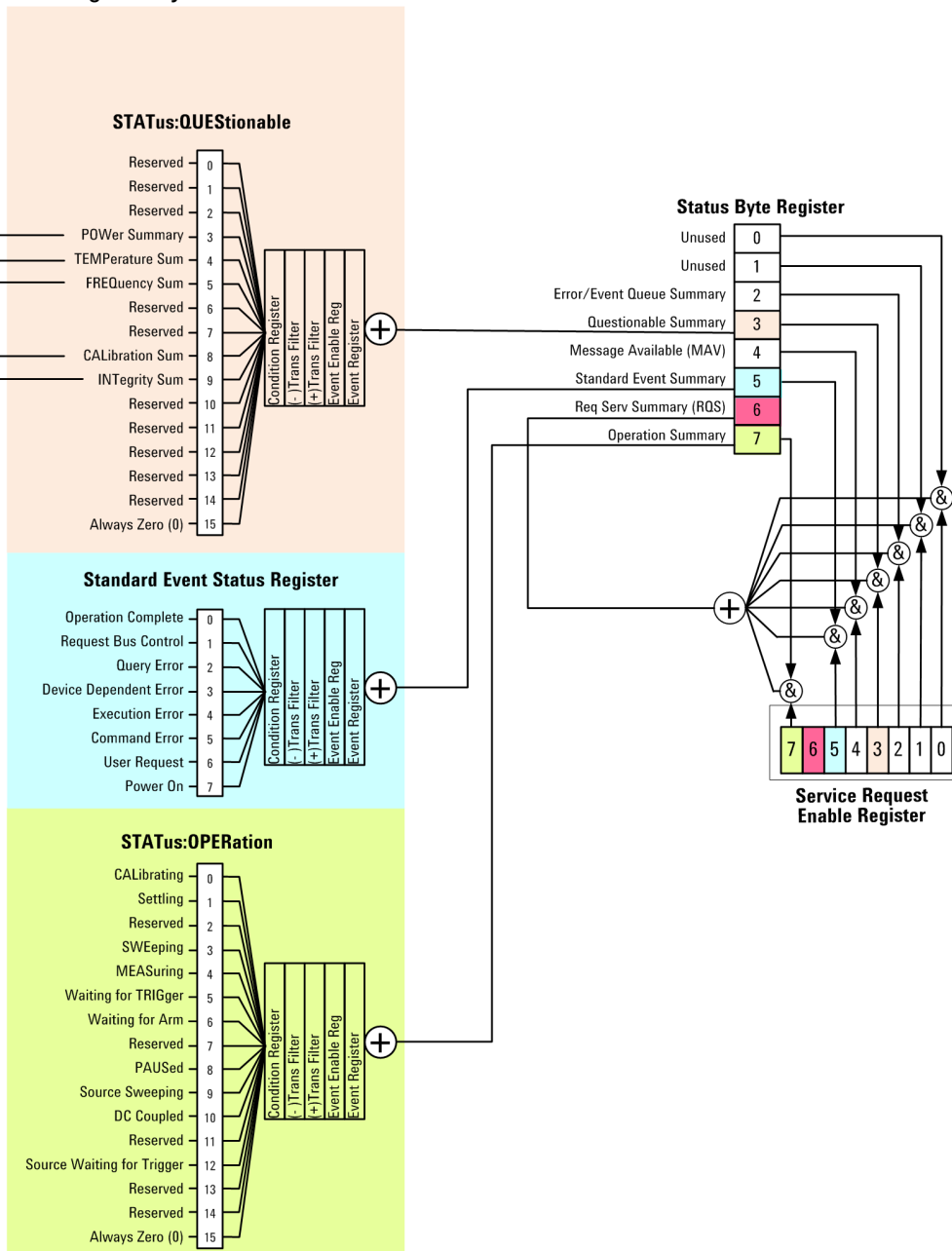

Detailed Description

The STATus subsystem remote commands set and query the status hardware registers. This system of registers monitors various events and conditions in the instrument. Software written to control the instrument may need to monitor some of these events and conditions.

NOTE

All status register commands are sequential. Most commands can be started immediately and will overlap with any existing commands that are already running. This is not true of status commands. All the commands in the spectrum analyzer are assumed to be overlapped unless a command description specifically says that it is sequential.

What Are Status Registers

The status system contains multiple registers that are arranged in a hierarchical order. The lower-level status registers propagate their data to the higher-level registers in the data structures by means of summary bits. The status byte register is at the top of the hierarchy and contains general status information for the instrument's events and conditions. All other individual registers are used to determine the specific events or conditions. For a diagram of the registers and their interconnections, see above.

The operation and questionable status registers are sets of registers that monitor the overall instrument condition. They are accessed with the STATus:OPERation and STATus:QUEStionable commands in the STATus command subsystem. Each register set is made up of five registers:

- Condition Register—It reports the real-time state of the signals monitored by this register set. There is no latching or buffering for a condition register.
- Positive Transition Register—This filter register controls which signals will set a bit in the event register when the signal makes a low to high transition (when the condition bit changes from 0 to 1).
- Negative Transition Register—This filter register controls which signals will set a bit in the event register when the signal makes a high to low transition (when the condition bit changes from 1 to 0).
- Event Register—It latches any signal state changes, in the way specified by the filter registers. Bits in the event register are never cleared by signal state changes. Event registers are cleared when read. They are also cleared by *CLS and by presetting the instrument.
- Event Enable Register—It controls which of the bits, being set in the event register, will be summarized as a single output for the register set. Summary bits are then used by the next higher register.

The STATus:QUEStionable registers report abnormal operating conditions. The status register hierarchy is:

1. The summary outputs from the six STATus:QUEStionable:<keyword> detail registers are inputs to the STATus:QUEStionable register.
2. The summary output from the STATus:QUEStionable register is an input to the Status Byte Register. See the overall system in Figure at the beginning of this section.

The STATus:OPERation register set has no summarized inputs. The inputs to the STATus:OPERation:CONDition register indicate the real time state of the instrument. The STATus:OPERation:EVENT register summary output is an input to the Status Byte Register.

What Are Status Register SCPI Commands

Most monitoring of the instrument conditions is done at the highest level using the IEEE common commands indicated below. Complete command descriptions are available in the IEEE commands section at the beginning of the language reference. Individual status registers can be set and queried using the commands in the STATus subsystem of the language reference.

- *CLS (clear status) clears the status byte by emptying the error queue and clearing all the event registers.
- *ESE, *ESE? (event status enable) sets and queries the bits in the enable register part of the standard event status register.
- *ESR? (event status register) queries and clears the event register part of the standard event status register.

- *OPC, *OPC? (operation complete) sets the standard event status register to monitor the completion of all commands. The query stops any new commands from being processed until the current processing is complete, then returns a '1'.
- *PSC, *PSC? (power-on state clear) sets the power-on state so that it clears the service request enable register and the event status enable register at power on.
- *SRE, *SRE? (service request enable) sets and queries the value of the service request enable register.
- *STB? (status byte) queries the value of the status byte register without erasing its contents.

How to Use the Status Registers

A program often needs to be able to detect and manage error conditions or changes in instrument status. There are two methods you can use to programmatically access the information in status registers:

- The polling method
- The service request (SRQ) method

In the polling method, the instrument has a passive role. It only tells the controller that conditions have changed when the controller asks the right question. In the SRQ method, the instrument takes a more active role. It tells the controller when there has been a condition change without the controller asking. Either method allows you to monitor one or more conditions.

The polling method works well if you do not need to know about changes the moment they occur. The SRQ method should be used if you must know immediately when a condition changes. To detect a change using the polling method, the program must repeatedly read the registers.

Use the SRQ method when:

- you need time-critical notification of changes
- you are monitoring more than one device which supports SRQs
- you need to have the controller do something else while waiting
- you can't afford the performance penalty inherent to polling

Use polling when:

- your programming language/development environment does not support SRQ interrupts
- you want to write a simple, single-purpose program and don't want the added complexity of setting up an SRQ handler
- To monitor a condition:
 - a. Determine which register contains the bit that reports the condition.
 - b. Send the unique SCPI query that reads that register.
 - c. Examine the bit to see if the condition has changed.

You can monitor conditions in different ways.

- Check the current instrument hardware and firmware status.

Do this by querying the condition registers which continuously monitor status. These registers represent the current state of the instrument. Bits in a condition register are updated in real time. When the condition monitored by a particular bit becomes true, the bit is set to 1. When the condition becomes false, the bit is reset to 0.

- Monitor a particular condition (bit).

You can enable a particular bit(s), using the event enable register. The instrument will then monitor that particular condition(s). If the bit becomes true (0 to 1 transition) in the event register, it will stay set until the event register is cleared. Querying the event register allows you to detect that this condition occurred even if the condition no longer exists. The event register can only be cleared by querying it or sending the *CLS command.

- Monitor a particular type of change in a condition (bit).
 - The transition registers are preset to register if the condition goes from 0 to 1 (false to true, or a positive transition).
 - This can be changed so the selected condition is detected if the bit goes from 1 to 0 (true to false, or a negative transition).
 - It can also be set for both types of transitions occurring.
 - Or it can be set for neither transition. If both transition registers are set to 0 for a particular bit position, that bit will not be set in the event register for either type of change.

Using a Status Register

Each bit in a register is represented by a numerical value based on its location. See figure below. This number is sent with the command to enable a particular bit. If you want to enable more than one bit, you would send the sum of all the bits that you want to monitor.

Figure: Status Register Bit Values

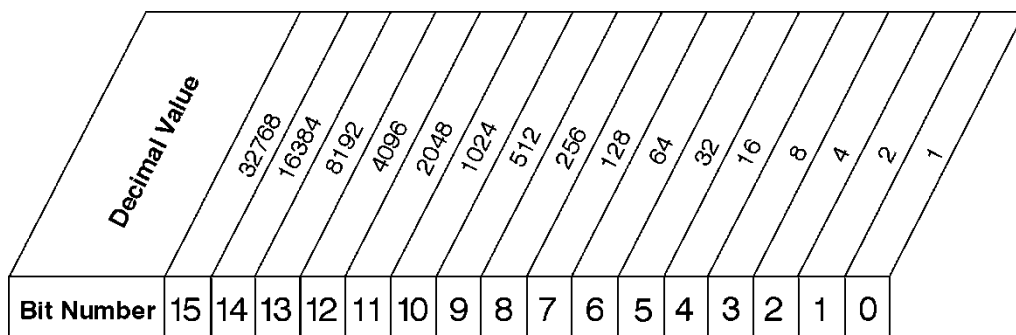

STATUS:OPERation:ENABLE <num>
 STATUS:OPERation:ENABLE?

Standard Operation Event Enable Register

ck730a

Bit 15 is not used to report status.

Example 1:

1. To enable bit 0 and bit 6 of standard event status register, you would send the command *ESE 65 because 1 + 64 = 65.

2. The results of a query are evaluated in a similar way. If the *STB? command returns a decimal value of 140, ($140 = 128 + 8 + 4$) then bit 7 is true, bit 3 is true and bit 2 is true.

Example 2:

1. Suppose you want to know if an Auto-trigger Timeout occurs, but you only cared about that specific condition. So you would want to know what was happening with bit 10 in the Status Questionable Integrity register, and not about any other bits.
2. It's usually a good idea to start by clearing all the status registers with *CLS.
3. Sending the STAT:QUES:INT:ENAB 1024 command lets you monitor only bit 10 events, instead of the default monitoring all the bits in the register. The register default is for positive transition events (0 to 1 transition). That is, when an auto-trigger timeout occurs. If instead, you wanted to know when the Auto-trigger timeout condition is cleared, then you would set the STAT:QUES:INT:PTR 0 and the STAT:QUES:INT:NTR 32767.
4. So now the only output from the Status Questionable Integrity register will come from a bit 10 positive transition. That output goes to the Integrity Sum bit 9 of the Status Questionable register.
5. You can do a similar thing with this register to only look at bit 9 using, STAT:QUES:ENAB 512.
6. The Status Questionable register output goes to the "Status Questionable Summary" bit 3 of the Status Byte Register. The output from this register can be enabled using the *SRE 8 command.
7. Finally, you would use the serial polling functionality available for the particular bus/software that you are using to monitor the Status Byte Register. (You could also use *STB? to poll the Status Byte Register.)

Using the Service Request (SRQ) Method

Your language, bus, and programming environment must be able to support SRQ interrupts. (For example, BASIC used with VXI-11.3 (GPIB over LAN). When you monitor a condition with the SRQ method, you must:

1. Determine which bit monitors the condition.
2. Determine how that bit reports to the request service (RQS) bit of the status byte.
3. Send SCPI commands to enable the bit that monitors the condition and to enable the summary bits that report the condition to the RQS bit.
4. Enable the controller to respond to service requests.

When the condition changes, the instrument sets its RQS bit. The controller is informed of the change as soon as it occurs. As a result, the time the controller would otherwise have used to monitor the condition can be used to perform other tasks. Your program determines how the controller responds to the SRQ.

Generating a Service Request

To use the SRQ method, you must understand how service requests are generated. Bit 6 of the status byte register is the request service (RQS) bit. The *SRE command is used to configure the RQS bit to report changes in instrument status. When such a change occurs, the RQS bit is set. It is cleared when the status byte register is queried using *SRE? (with a serial poll.) It can be queried without erasing the contents with *STB?.

When a register set causes a summary bit in the status byte to change from 0 to 1, the instrument can initiate the service request (SRQ) process. However, the process is only initiated if both of the following conditions are true:

- The corresponding bit of the service request enable register is also set to 1.
- The instrument does not have a service request pending. (A service request is considered to be pending between the time the instrument's SRQ process is initiated and the time the controller reads the status byte register.)

The SRQ process sets the SRQ true. It also sets the status byte's request service (RQS) bit to 1. Both actions are necessary to inform the controller that the instrument requires service. Setting the SRQ line only informs the controller that some device on the bus requires service. Setting the RQS bit allows the controller to determine which instrument requires service.

If your program enables the controller to detect and respond to service requests, it should instruct the controller to perform a serial poll when the SRQ is set true. Each device on the bus returns the contents of its status byte register in response to this poll. The device who's RQS bit is set to 1 is the device that requested service.

When you read the instrument's status byte register with a serial poll, the RQS bit is reset to 0. Other bits in the register are not affected.

If the status register is configured to SRQ on end-of-measurement and the measurement is in continuous mode, then restarting a measurement (INIT command) can cause the measuring bit to pulse low. This causes an SRQ when you have not actually reached the "end-of-measurement" condition. To avoid this:

1. Set INITiate:CONTinuous off.
2. Set/enable the status registers.
3. Restart the measurement (send INIT).

Status Register System

The hardware status registers are combined to form the instrument status system. Specific status bits are assigned to monitor various aspects of the instrument operation and status. See the diagram of the status system above for information about the bit assignments and status register interconnections.

The Status Byte Register

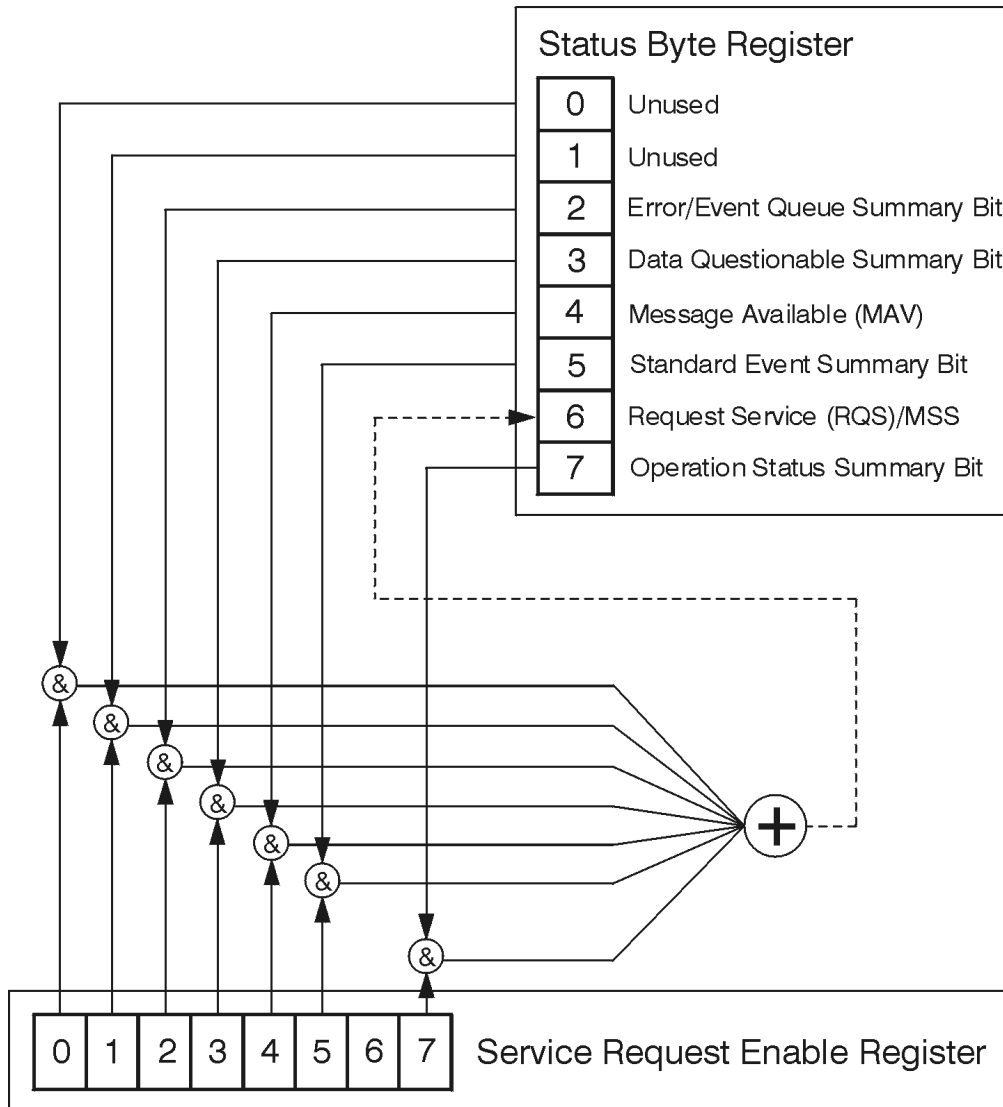

ck776a

The RQS bit is read and reset by a serial poll. The same bit position (MSS) is read, non-destructively by the *STB? command. If you serial poll bit 6 it is read as RQS, but if you send *STB it reads bit 6 as MSS. For more information refer to IEEE 488.2 standards, section 11.

Bit Number	7	6	5	4	3	2	1	0
	Standard Operation Status Summary Bit	Request Service (RQS) Summary Bit	Standard Event Status Summary Bit	Message Available (MAV)	Data Questionable Status Summary Bit	Error/Event Queue Summary Bit	Unused	Unused

*STB?

Status Byte Register

ck725a

Bit	Description
0, 1	These bits are always set to 0.
2	A 1 in this bit position indicates that the SCPI error queue is not empty which means that it contains at least one error message.
3	A 1 in this bit position indicates that the data questionable summary bit has been set. The data questionable event register can then be read to determine the specific condition that caused this bit to be set.
4	A 1 in this bit position indicates that the instrument has data ready in the output queue. There are no lower status groups that provide input to this bit.
5	A 1 in this bit position indicates that the standard event summary bit has been set. The standard event status register can then be read to determine the specific event that caused this bit to be set.
6	A 1 in this bit position indicates that the instrument has at least one reason to report a status change. This bit is also called the master summary status bit (MSS).
7	A 1 in this bit position indicates that the standard operation summary bit has been set. The standard operation event register can then be read to determine the specific condition that caused this bit to be set.

To query the status byte register, send the command *STB?. The response will be the decimal sum of the bits which are set to 1. For example, if bit number 7 and bit number 3 are set to 1, the decimal sum of the 2 bits is 128 plus 8. So the decimal value 136 is returned. The *STB command does not clear the status register.

In addition to the status byte register, the status byte group also contains the service request enable register. This register lets you choose which bits in the status byte register will trigger a service request.

Send the *SRE <integer> command where <integer> is the sum of the decimal values of the bits you want to enable plus the decimal value of bit 6. For example, assume that you want to enable bit 7 so that whenever the standard operation status register summary bit is set to 1 it will trigger a service request. Send the command *SRE 192 (because 192 = 128 + 64). You must always add 64 (the numeric value of RQS

bit 6) to your numeric sum when you enable any bits for a service request. The command *SRE? returns the decimal value of the sum of the bits previously enabled with the *SRE <integer> command.

The service request enable register presets to zeros (0).

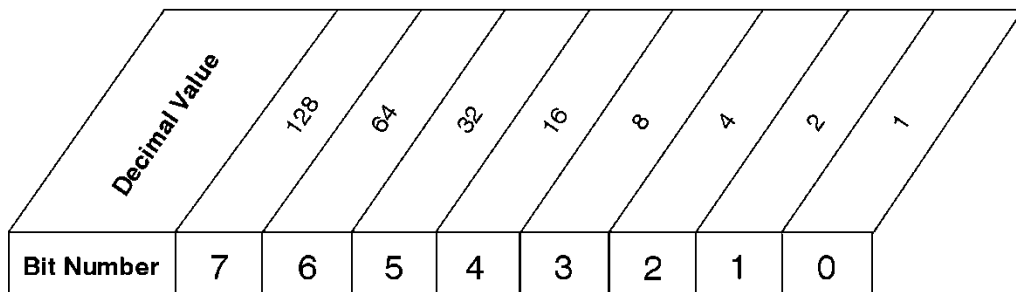

*SRE <num>
 *SRE?

Service Request Enable Register

ck726a

Standard Event Status Register

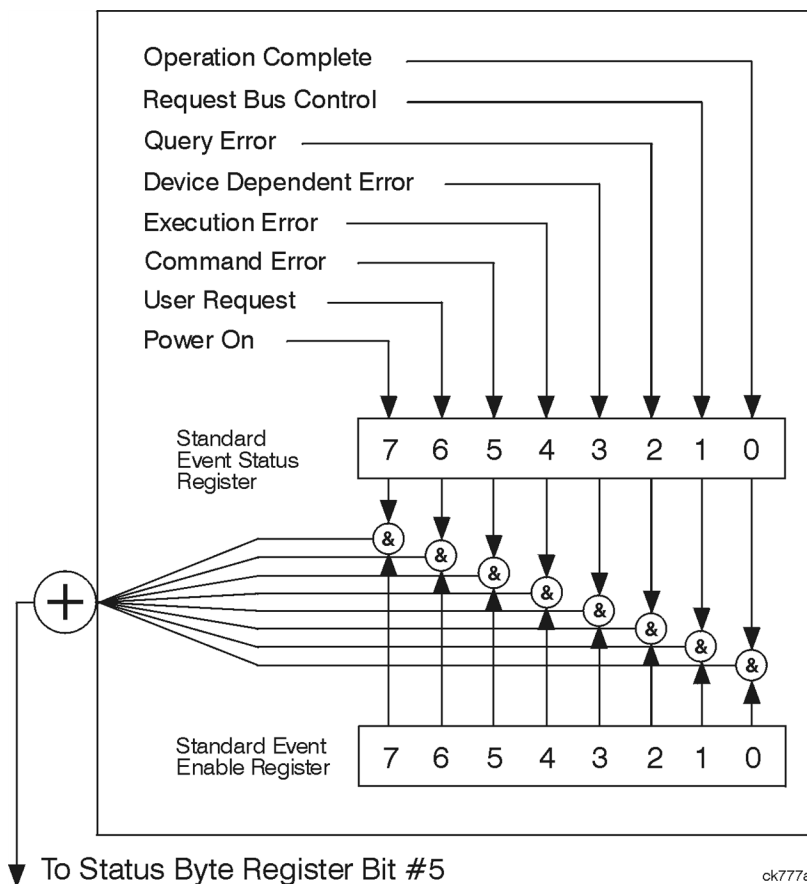

ck777a

The standard event status register contains the following bits:

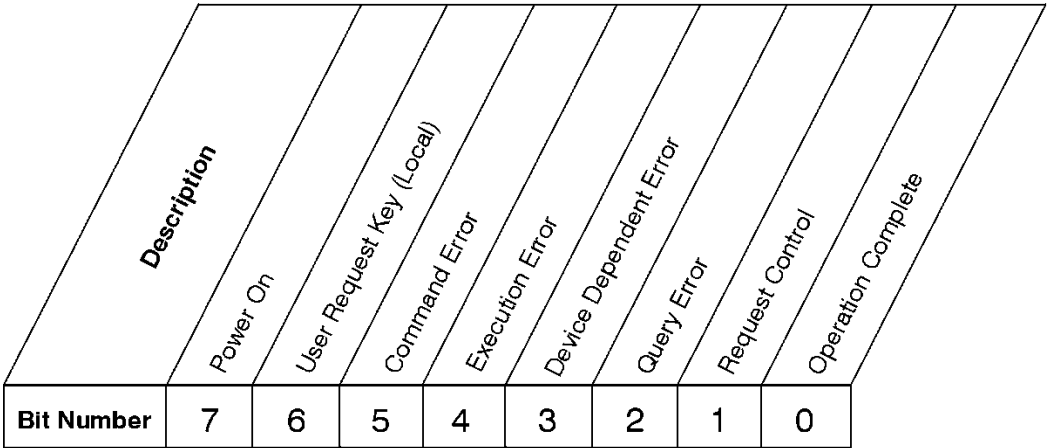

*ESR?

Standard Event Status Register

ck727a

Bit	Description
0	A 1 in this bit position indicates that all pending operations were completed following execution of the *OPC command.
1	This bit is for GPIB handshaking to request control. Currently it is set to 0 because there are no implementations where the spectrum analyzer controls another instrument.
2	A 1 in this bit position indicates that a query error has occurred. Query errors have SCPI error numbers from -499 to -400.
3	A 1 in this bit position indicates that a device dependent error has occurred. Device dependent errors have SCPI error numbers from -399 to -300 and 1 to 32767.
4	A 1 in this bit position indicates that an execution error has occurred. Execution errors have SCPI error numbers from -299 to -200.
5	A 1 in this bit position indicates that a command error has occurred. Command errors have SCPI error numbers from -199 to -100.
6	A 1 in this bit position indicates that the LOCAL key has been pressed. This is true even if the instrument is in local lockout mode.
7	A 1 in this bit position indicates that the instrument has been turned off and then on.

The standard event status register is used to determine the specific event that set bit 5 in the status byte register. To query the standard event status register, send the command *ESR?. The response will be the decimal sum of the bits which are enabled (set to 1). For example, if bit number 7 and bit number 3 are enabled, the decimal sum of the 2 bits is 128 plus 8. So the decimal value 136 is returned.

In addition to the standard event status register, the standard event status group also contains a standard event status enable register. This register lets you choose which bits in the standard event status register will set the summary bit (bit 5 of the status byte register) to 1. Send the *ESE <integer> command where <integer> is the sum of the decimal values of the bits you want to enable. For example, to enable bit 7 and bit 6 so that whenever either of those bits is set to 1, the standard event status summary bit of the status

byte register will be set to 1, send the command *ESE 192 (128 + 64). The command *ESE? returns the decimal value of the sum of the bits previously enabled with the *ESE <integer> command.

The standard event status enable register presets to zeros (0).

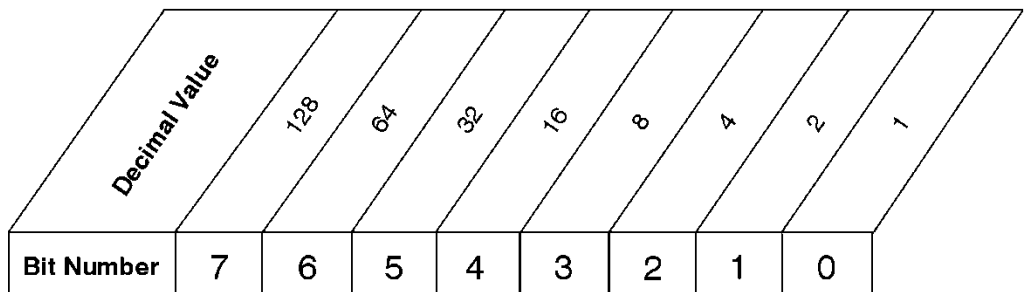

*ESE <num>
 *ESE?

Standard Event Status Enable Register

ck728a

Operation and Questionable Status Registers

The operation and questionable status registers are registers that monitor the overall instrument condition. They are accessed with the STATus:OPERation and STATus:QUEStionable commands in the STATus command subsystem. See the figure at the beginning of this chapter.

Operation Status Register

The operation status register monitors the current instrument measurement state. It checks to see if the instrument is calibrating, sweeping, or waiting for a trigger. For more information see the *OPC? command located in the IEEE Common Commands section.

Bit	Condition	Operation
0	Calibrating	The instrument is busy executing its Align Now process
3	Sweeping	The instrument is busy taking a sweep.
4	Measuring	The instrument is busy making a measurement. Measurements often require multiple sweeps. They are initiated by keys under the MEASURE key or with the MEASure group of commands. The bit is valid for most X-Series Modes.
5	Waiting for trigger	The instrument is waiting for the trigger conditions to be met, then it will trigger a sweep or measurement.

Questionable Status Register

The questionable status register monitors the instrument's condition to see if anything questionable has happened to it. It is looking for anything that might cause an error or a bad measurement like a hardware problem, an out of calibration situation, or a unusual signal. All the bits are summary bits from lower-level event registers.

Bit	Condition	Operation
-----	-----------	-----------

3	Power summary	The instrument hardware has detected a power unlevelled condition.
4	Temperature summary	The instrument is still warming up.
5	Frequency summary	The instrument hardware has detected an unlocked condition or a problem with the external frequency reference.
8	Calibration summary	The instrument has detected a hardware problem while doing the automatic internal alignment process.
9	Integrity summary	The instrument has detected a questionable measurement condition such as: bad timing, bad signal/data, timeout problem, signal overload, or "meas uncal".

STATus Subsystem Command Descriptions

The STATus subsystem controls the SCPI-defined instrument status reporting structures. Each status register has a set of five commands used for querying or masking that particular register.

Numeric values for bit patterns can be entered using decimal or hexadecimal representations. (i.e. 0 to 32767 is equivalent to #H0 to #H7FFF. It is also equal to all ones, 111111111111111) See the SCPI Basics information about using bit patterns for variable parameters.

Operation Register

"Operation Condition Query" on page 107

"Operation Enable" on page 108

"Operation Event Query" on page 108

"Operation Negative Transition" on page 108

"Operation Positive Transition" on page 109

Operation Condition Query

This query returns the decimal value of the sum of the bits in the Status Operation Condition register.

NOTE The data in this register is continuously updated and reflects the current conditions.

Mode	All
Remote Command	:STATus:OPERation:CONDition?
Example	STAT:OPER:COND?
Preset	0
Status Bits/OPC dependencies	Sequential command
Initial S/W Revision	Prior to A.02.00

Operation Enable

This command determines which bits in the Operation Event register, will set the Operation Status Summary bit (bit 7) in the Status Byte Register. The variable <integer> is the sum of the decimal values of the bits you want to enable.

NOTE The preset condition is to have all bits in this enable register set to 0. To have any Operation Events reported to the Status Byte Register, one or more bits need to be set to 1.

Mode	All
Remote Command	:STATus:OPERation:ENABle <integer> :STATus:OPERation:ENABle?
Example	STAT:OPER:ENAB 1 Sets the register so that Align Now operation will be reported to the Status Byte Register.
Preset	0
Min	0
Max	32767
Status Bits/OPC dependencies	Sequential command
Initial S/W Revision	Prior to A.02.00

Operation Event Query

This query returns the decimal value of the sum of the bits in the Operation Event register.

NOTE The register requires that the associated PTR or NTR filters be set before a condition register bit can set a bit in the event register. The data in this register is latched until it is queried. Once queried, the register is cleared.

Mode	All
Remote Command	:STATus:OPERation[:EVENT]?
Example	STAT:OPER?
Preset	0
Status Bits/OPC dependencies	Sequential command
Initial S/W Revision	Prior to A.02.00

Operation Negative Transition

This command determines which bits in the Operation Condition register will set the corresponding bit in the Operation Event register when the condition register bit has a negative transition (1 to 0). The variable <integer> is the sum of the decimal values of the bits that you want to enable.

Mode	All
Remote Command	:STATus:OPERation:NTRansition <integer> :STATus:OPERation:NTRansition?
Example	STAT:OPER:NTR 1 Align Now operation complete will be reported to the Status Byte Register.
Preset	0
Min	0
Max	32767
Status Bits/OPC dependencies	Sequential command
Initial S/W Revision	Prior to A.02.00

Operation Positive Transition

This command determines which bits in the Operation Condition register will set the corresponding bit in the Operation Event register when the condition register bit has a positive transition (0 to 1). The variable <integer> is the sum of the decimal values of the bits that you want to enable.

Mode	All
Remote Command	:STATus:OPERation:PTRansition <integer> :STATus:OPERation:PTRansition?
Example	STAT:OPER:PTR 1 Align Now operation beginning will be reported to the Status Byte Register.
Preset	32767
Min	0
Max	32767
Status Bits/OPC dependencies	Sequential command
Initial S/W Revision	Prior to A.02.00

Preset the Status Byte

Sets bits in most of the enable and transition registers to their default state. It presets all the Transition Filters, Enable Registers, and the Error/Event Queue Enable. It has no effect on Event Registers, Error/Event QUEUE, IEEE 488.2 ESE, and SRE Registers as described in IEEE Standard 488.2–1992, IEEE Standard Codes, Formats, Protocols, and Common Commands for Use with ANSI/IEEE Std 488.1–1987. New York, NY, 1992.

Remote Command	:STATus:PRESet
Example	STAT:PREs
Initial S/W Revision	Prior to A.02.00

Questionable Register

"Questionable Condition " on page 110

"Questionable Enable " on page 110

"Questionable Event Query " on page 111

"Questionable Negative Transition " on page 111

"Questionable Positive Transition" on page 111

Questionable Condition

This query returns the decimal value of the sum of the bits in the Questionable Condition register.

NOTE The data in this register is continuously updated and reflects the current conditions.

Mode	All
Remote Command	:STATus:QUEStionable:CONDition?
Example	STAT:QUES:COND?
Preset	0
Status Bits/OPC dependencies	Sequential command
Initial S/W Revision	Prior to A.02.00

Questionable Enable

This command determines which bits in the Questionable Event register will set the Questionable Status Summary bit (bit3) in the Status Byte Register. The variable <integer> is the sum of the decimal values of the bits you want to enable.

NOTE The preset condition is all bits in this enable register set to 0. To have any Questionable Events reported to the Status Byte Register, one or more bits need to be set to 1. The Status Byte Event Register should be queried after each measurement to check the Questionable Status Summary (bit 3). If it is equal to 1, a condition during the test may have made the test results invalid. If it is equal to 0, this indicates that no hardware problem or measurement problem was detected by the analyzer.

Mode	All
Remote Command	:STATus:QUEStionable:ENABle <integer> :STATus:QUEStionable:ENABle?
Example	STAT:OPER:PTR 1 Align Now operation beginning will be reported to the Status Byte Register.
Preset	0
Min	0
Max	32767
Status Bits/OPC dependencies	Sequential command
Initial S/W Revision	Prior to A.02.00

Questionable Event Query

This query returns the decimal value of the sum of the bits in the Questionable Event register.

NOTE

The register requires that the associated PTR or NTR filters be set before a condition register bit can set a bit in the event register. The data in this register is latched until it is queried. Once queried, the register is cleared.

Mode	All
Remote Command	:STATus:QUESTionable[:EVENT]?
Example	STAT:QUES?
Preset	0
Status Bits/OPC dependencies	Sequential command
Initial S/W Revision	Prior to A.02.00

Questionable Negative Transition

This command determines which bits in the Questionable Condition register will set the corresponding bit in the Questionable Event register when the condition register bit has a negative transition (1 to 0). The variable <integer> is the sum of the decimal values of the bits that you want to enable.

Mode	All
Remote Command	:STATus:QUESTionable:NTRansition <integer> :STATus:QUESTionable:NTRansition?
Example	STAT:QUES:NTR 16 Temperature summary 'questionable cleared' will be reported to the Status Byte Register.
Preset	0
Min	0
Max	32767
Status Bits/OPC dependencies	Sequential command
Initial S/W Revision	Prior to A.02.00

Questionable Positive Transition

This command determines which bits in the Questionable Condition register will set the corresponding bit in the Questionable Event register when the condition register bit has a positive transition (0 to 1). The variable <integer> is the sum of the decimal values of the bits that you want to enable.

Mode	All
------	-----

Remote Command	:STATus:QUEStionable:PTRansition <integer> :STATus:QUEStionable:PTRansition?
Example	STAT:QUES:PTR 16 Temperature summary 'questionable asserted' will be reported to the Status Byte Register.
Preset	32767
Min	0
Max	32767
Status Bits/OPC dependencies	Sequential command
Initial S/W Revision	Prior to A.02.00

Questionable Calibration Register

"Questionable Calibration Condition " on page 112

"Questionable Calibration Enable " on page 112

"Questionable Calibration Event Query " on page 113

"Questionable Calibration Negative Transition " on page 113

"Questionable Calibration Positive Transition " on page 114

Questionable Calibration Condition

This query returns the decimal value of the sum of the bits in the Questionable Calibration Condition register.

NOTE The data in this register is continuously updated and reflects the current conditions.

Mode	All
Remote Command	:STATus:QUEStionable:CALibration:CONDition?
Example	STAT:QUES:CAL:COND?
Preset	0
Status Bits/OPC dependencies	Sequential command
Initial S/W Revision	Prior to A.02.00

Questionable Calibration Enable

This command determines which bits in the Questionable Calibration Condition Register will set bits in the Questionable Calibration Event register, which also sets the Calibration Summary bit (bit 8) in the Questionable Register. The variable <integer> is the sum of the decimal values of the bits you want to enable.

Mode	All
Remote Command	:STATus:QUESTionable:CALibration:ENABle <integer> :STATus:QUESTionable:CALibration:ENABle?
Example	STAT:QUES:CAL:ENAB 16384 Can be used to query if an alignment is needed, if you have turned off the automatic alignment process.
Min	0
Max	32767
Status Bits/OPC dependencies	Sequential command
Initial S/W Revision	Prior to A.02.00

Questionable Calibration Event Query

This query returns the decimal value of the sum of the bits in the Questionable Calibration Event register.

NOTE

The register requires that the associated PTR or NTR filters be set before a condition register bit can set a bit in the event register. The data in this register is latched until it is queried. Once queried, the register is cleared.

Mode	All
Remote Command	:STATus:QUESTionable:CALibration[:EVENT]?
Example	STAT:QUES:CAL?
Preset	0
Status Bits/OPC dependencies	Sequential command
Initial S/W Revision	Prior to A.02.00

Questionable Calibration Negative Transition

This command determines which bits in the Questionable Calibration Condition register will set the corresponding bit in the Questionable Calibration Event register when the condition register bit has a negative transition (1 to 0). The variable <integer> is the sum of the decimal values of the bits that you want to enable.

Mode	All
Remote Command	:STATus:QUESTionable:CALibration:NTRansition <integer> :STATus:QUESTionable:CALibration:NTRansition?
Example	STAT:QUES:CAL:NTR 16384 Alignment is not required.
Preset	0
Min	0

Max	32767
Status Bits/OPC dependencies	Sequential command
Initial S/W Revision	Prior to A.02.00

Questionable Calibration Positive Transition

This command determines which bits in the Questionable Calibration Condition register will set the corresponding bit in the Questionable Calibration Event register when the condition register bit has a positive transition (0 to 1). The variable <integer> is the sum of the decimal values of the bits that you want to enable.

Mode	All
Remote Command	:STATus:QUESTionable:CALibration:PTRansition <integer> :STATus:QUESTionable:CALibration:PTRansition?
Example	STAT:QUES:CAL:PTR 16384 Alignment is required.
Preset	32767
Min	0
Max	32767
Status Bits/OPC dependencies	Sequential command
Initial S/W Revision	Prior to A.02.00

Questionable Calibration Skipped Register

"Questionable Calibration Skipped Condition " on page 114

"Questionable Calibration Skipped Enable " on page 115

"Questionable Calibration Skipped Event Query " on page 115

"Questionable Calibration Skipped Negative Transition " on page 116

"Questionable Calibration Skipped Positive Transition " on page 116

Questionable Calibration Skipped Condition

This query returns the decimal value of the sum of the bits in the Questionable Calibration Skipped Condition register.

NOTE The data in this register is continuously updated and reflects the current conditions.

Mode	All
Remote Command	:STATus:QUESTionable:CALibration:SKIpped:CONDition?

Example	STAT:QUES:CAL:SKIP:COND?
Preset	0
Status Bits/OPC dependencies	Sequential command
Initial S/W Revision	Prior to A.02.00

Questionable Calibration Skipped Enable

This command determines which bits in the Questionable Calibration Skipped Condition Register will set bits in the Questionable Calibration Skipped Event register, which also sets bit 11 of the Questionable Calibration Register. The variable <integer> is the sum of the decimal values of the bits you want to enable.

Mode	All
Remote Command	:STATus:QUESTionable:CALibration:SKIPped:ENABle <integer> :STATus:QUESTionable:CALibration:SKIPped:ENABle?
Example	STAT:QUES:CAL:SKIP:ENAB 1 Can be used to query if an EMI alignment skipped condition is detected
Preset	32767
Min	0
Max	32767
Status Bits/OPC dependencies	Sequential command
Initial S/W Revision	Prior to A.02.00

Questionable Calibration Skipped Event Query

This query returns the decimal value of the sum of the bits in the Questionable Calibration Event register.

NOTE The register requires that the associated PTR or NTR filters be set before a condition register bit can set a bit in the event register. The data in this register is latched until it is queried. Once queried, the register is cleared.

Mode	All
Remote Command	:STATus:QUESTionable:CALibration:SKIPped[:EVENT]?
Example	STAT:QUES:CAL:SKIP?
Preset	0
Status Bits/OPC dependencies	Sequential command
Initial S/W Revision	Prior to A.02.00

Questionable Calibration Skipped Negative Transition

This command determines which bits in the Questionable Calibration Skipped Condition register will set the corresponding bit in the Questionable Calibration Skipped Event register when the condition register bit has a negative transition (1 to 0). The variable <integer> is the sum of the decimal values of the bits that you want to enable.

Mode	All
Remote Command	:STATus:QUEStionable:CALibration:SKIpped:NTRansition <integer> :STATus:QUEStionable:CALibration:SKIpped:NTRansition?
Example	STAT:QUES:CAL:SKIP:NTR 1 Align RF skipped is not required.
Preset	0
Min	0
Max	32767
Status Bits/OPC dependencies	Sequential command
Initial S/W Revision	Prior to A.02.00

Questionable Calibration Skipped Positive Transition

This command determines which bits in the Questionable Calibration Skipped Condition register will set the corresponding bit in the Questionable Calibration Skipped Event register when the condition register bit has a positive transition (0 to 1). The variable <integer> is the sum of the decimal values of the bits that you want to enable.

Mode	All
Remote Command	:STATus:QUEStionable:CALibration:SKIpped:PTRansition <integer> :STATus:QUEStionable:CALibration:SKIpped:PTRansition?
Example	STAT:QUES:CAL:SKIP:PTR 1 Align RF skipped is required.
Preset	32767
Min	0
Max	32767
Status Bits/OPC dependencies	Sequential command
Initial S/W Revision	Prior to A.02.00

Questionable Calibration Extended Failure Register

"Questionable Calibration Extended Failure Condition " on page 117

"Questionable Calibration Extended Failure Enable " on page 117

"Questionable Calibration Extended Failure Event Query " on page 117

"Questionable Calibration Extended Failure Negative Transition " on page 118

"Questionable Calibration Extended Failure Positive Transition " on page 118

Questionable Calibration Extended Failure Condition

This query returns the decimal value of the sum of the bits in the Questionable Calibration Extended Failure Condition register.

NOTE The data in this register is continuously updated and reflects the current conditions.

Mode	All
Remote Command	:STATus:QUEStionable:CALibration:EXTended:FAILure:CONDition?
Example	STAT:QUES:CAL:EXT:FAIL:COND?
Preset	0
Status Bits/OPC dependencies	Sequential command
Initial S/W Revision	Prior to A.02.00

Questionable Calibration Extended Failure Enable

This command determines which bits in the Questionable Calibration Extended Failure Condition Register will set bits in the Questionable Calibration Extended Failure Event register, which also sets bit 9 of the Questionable Calibration Register. The variable <integer> is the sum of the decimal values of the bits you want to enable.

Mode	All
Remote Command	:STATus:QUEStionable:CALibration:EXTended:FAILure:ENABle <integer> :STATus:QUEStionable:CALibration:EXTended:FAILure:ENABle?
Example	STAT:QUES:CAL:EXT:FAIL:ENAB 1 Can be used to query if an EMI conducted alignment is needed.
Preset	32767
Min	0
Max	32767
Status Bits/OPC dependencies	Sequential command
Initial S/W Revision	Prior to A.02.00

Questionable Calibration Extended Failure Event Query

This query returns the decimal value of the sum of the bits in the Questionable Calibration Extended Failure Event register.

NOTE The register requires that the associated PTR or NTR filters be set before a condition register bit can set a bit in the event register. The data in this register is latched until it is queried. Once queried, the register is cleared.

Mode	All
Remote Command	:STATus:QUESTionable:CALibration:EXTended:FAILure[:EVENT]?
Example	STAT:QUES:CAL:EXT:FAIL?
Preset	0
Status Bits/OPC dependencies	Sequential command
Initial S/W Revision	Prior to A.02.00

Questionable Calibration Extended Failure Negative Transition

This command determines which bits in the Questionable Calibration Extended Failure Condition register will set the corresponding bit in the Questionable Calibration Extended Failure Event register when the condition register bit has a negative transition (1 to 0). The variable <integer> is the sum of the decimal values of the bits that you want to enable.

Mode	All
Remote Command	:STATus:QUESTionable:CALibration:EXTended:FAILure:NTRansition <integer> :STATus:QUESTionable:CALibration:EXTended:FAILure:NTRansition?
Example	STAT:QUES:CAL:EXT:FAIL:NTR 1 EMI conducted align failure is not required.
Preset	0
Min	0
Max	32767
Status Bits/OPC dependencies	Sequential command
Initial S/W Revision	Prior to A.02.00

Questionable Calibration Extended Failure Positive Transition

This command determines which bits in the Questionable Calibration Extended Failure Condition register will set the corresponding bit in the Questionable Calibration Extended Failure Event register when the condition register bit has a positive transition (0 to 1). The variable <integer> is the sum of the decimal values of the bits that you want to enable.

Mode	All
Remote Command	:STATus:QUESTionable:CALibration:EXTended:FAILure:PTRansition <integer> :STATus:QUESTionable:CALibration:EXTended:FAILure:PTRansition?
Example	STAT:QUES:CAL:EXT:FAIL:PTR 1 EMI conducted align failure is required.
Preset	32767
Min	0
Max	32767

Status Bits/OPC dependencies	Sequential command
Initial S/W Revision	Prior to A.02.00

Questionable Calibration Extended Needed Register

"Questionable Calibration Extended Needed Condition " on page 119

"Questionable Calibration Extended Needed Enable " on page 119

"Questionable Calibration Extended Needed Event Query " on page 120

"Questionable Calibration Extended Needed Negative Transition " on page 120

"Questionable Calibration Extended Needed Positive Transition " on page 121

Questionable Calibration Extended Needed Condition

This query returns the decimal value of the sum of the bits in the Questionable Calibration Extended Needed Condition register.

NOTE The data in this register is continuously updated and reflects the current conditions.

Mode	All
Remote Command	:STATus:QUESTionable:CALibration:EXTended:NEEDED:CONDition?
Example	STAT:QUES:CAL:EXT:NEED:COND?
Preset	0
Status Bits/OPC dependencies	Sequential command
Initial S/W Revision	Prior to A.02.00

Questionable Calibration Extended Needed Enable

This command determines which bits in the Questionable Calibration Extended Needed Condition Register will set bits in the Questionable Calibration Extended Needed Event register, which also sets bit 14 of the Questionable Calibration Register. The variable <integer> is the sum of the decimal values of the bits you want to enable.

Mode	All
Remote Command	:STATus:QUESTionable:CALibration:EXTended:NEEDED:ENABle <integer> :STATus:QUESTionable:CALibration:EXTended:NEEDED:ENABle?
Example	STAT:QUES:CAL:EXT:NEED:ENAB 2 Can be used to query if an EMI conducted alignment is needed.
Preset	32767
Min	0

Max	32767
Status Bits/OPC dependencies	Sequential command
Initial S/W Revision	Prior to A.02.00

Questionable Calibration Extended Needed Event Query

This query returns the decimal value of the sum of the bits in the Questionable Calibration Extended Needed Event register.

NOTE

The register requires that the associated PTR or NTR filters be set before a condition register bit can set a bit in the event register. The data in this register is latched until it is queried. Once queried, the register is cleared.

Mode	All
Remote Command	:STATus:QUESTionable:CALibration:EXTended:NEEDed[:EVENT]?
Example	STAT:QUES:CAL:EXT:NEED?
Preset	0
Status Bits/OPC dependencies	Sequential command
Initial S/W Revision	Prior to A.02.00

Questionable Calibration Extended Needed Negative Transition

This command determines which bits in the Questionable Calibration Extended Needed Condition register will set the corresponding bit in the Questionable Calibration Extended Needed Event register when the condition register bit has a negative transition (1 to 0). The variable <integer> is the sum of the decimal values of the bits that you want to enable.

Mode	All
Remote Command	:STATus:QUESTionable:CALibration:EXTended:NEEDed:NTRansition <integer> :STATus:QUESTionable:CALibration:EXTended:NEEDed:NTRansition?
Example	STAT:QUES:CAL:EXT:NEED:NTR 2 Align EMI conducted is not required.
Preset	0
Min	0
Max	32767
Status Bits/OPC dependencies	Sequential command
Initial S/W Revision	Prior to A.02.00

Questionable Calibration Extended Needed Positive Transition

This command determines which bits in the Questionable Calibration Extended Needed Condition register will set the corresponding bit in the Questionable Calibration Extended Needed Event register when the condition register bit has a positive transition (0 to 1). The variable <integer> is the sum of the decimal values of the bits that you want to enable.

Mode	All
Remote Command	:STATus:QUEStionable:CALibration:EXTended:NEEDED:PTRansition <integer> :STATus:QUEStionable:CALibration:EXTended:NEEDED:PTRansition?
Example	STAT:QUES:CAL:EXT:NEED:PTR 2 Align EMI conducted is required.
Preset	32767
Min	0
Max	32767
Status Bits/OPC dependencies	Sequential command
Initial S/W Revision	Prior to A.02.00

Questionable Frequency Register

"Questionable Frequency Condition " on page 121

"Questionable Frequency Enable " on page 122

"Questionable Frequency Event Query " on page 122

"Questionable Frequency Negative Transition " on page 122

"Questionable Frequency Positive Transition " on page 123

Questionable Frequency Condition

This query returns the decimal value of the sum of the bits in the Questionable Frequency Condition register.

NOTE The data in this register is continuously updated and reflects the current conditions.

Mode	All
Remote Command	:STATus:QUEStionable:FREQuency:CONDition?
Example	STAT:QUES:FREQ:COND?
Preset	0
Status Bits/OPC dependencies	Sequential command
Initial S/W Revision	Prior to A.02.00

Questionable Frequency Enable

This command determines which bits in the Questionable Frequency Condition Register will set bits in the Questionable Frequency Event register, which also sets the Frequency Summary bit (bit 5) in the Questionable Register. The variable <integer> is the sum of the decimal values of the bits you want to enable.

Mode	All
Remote Command	:STATus:QUEStionable:FREQuency:ENABle <integer> :STATus:QUEStionable:FREQuency:ENABle?
Example	STAT:QUES:FREQ:ENAB 2 Frequency Reference Unlocked will be reported to the Frequency Summary of the Status Questionable register.
Preset	32767
Min	0
Max	32767
Status Bits/OPC dependencies	Sequential command
Initial S/W Revision	Prior to A.02.00

Questionable Frequency Event Query

This query returns the decimal value of the sum of the bits in the Questionable Frequency Event register.

NOTE

The register requires that the associated PTR or NTR filters be set before a condition register bit can set a bit in the event register. The data in this register is latched until it is queried. Once queried, the register is cleared.

Mode	All
Remote Command	:STATus:QUEStionable:FREQuency[:EVENT]?
Example	STAT:QUES:FREQ?
Preset	0
Status Bits/OPC dependencies	Sequential command
Initial S/W Revision	Prior to A.02.00

Questionable Frequency Negative Transition

This command determines which bits in the Questionable Frequency Condition register will set the corresponding bit in the Questionable Frequency Event register when the condition register bit has a negative transition (1 to 0). The variable <integer> is the sum of the decimal values of the bits that you want to enable.

Mode	All
------	-----

Remote Command	:STATus:QUESTionable:FREQuency:NTRansition <integer> :STATus:QUESTionable:FREQuency:NTRansition?
Example	STAT:QUES:FREQ:NTR 2 Frequency Reference 'regained lock' will be reported to the Frequency Summary of the Status Questionable register.
Preset	0
Min	0
Max	32767
Status Bits/OPC dependencies	Sequential command
Initial S/W Revision	Prior to A.02.00

Questionable Frequency Positive Transition

This command determines which bits in the Questionable Frequency Condition register will set the corresponding bit in the Questionable Frequency Event register when the condition register bit has a positive transition (0 to 1). The variable <integer> is the sum of the decimal values of the bits that you want to enable.

Mode	All
Remote Command	:STATus:QUESTionable:FREQuency:PTRansition <integer> :STATus:QUESTionable:FREQuency:PTRansition?
Example	STAT:QUES:FREQ:PTR 2 Frequency Reference 'became unlocked' will be reported to the Frequency Summary of the Status Questionable register.
Preset	32767
Min	0
Max	32767
Status Bits/OPC dependencies	Sequential command
Initial S/W Revision	Prior to A.02.00

Questionable Integrity Register

"Questionable Integrity Condition " on page 123

"Questionable Integrity Enable " on page 124

"Questionable Integrity Event Query " on page 124

"Questionable Integrity Negative Transition " on page 125

"Questionable Integrity Positive Transition " on page 125

Questionable Integrity Condition

This query returns the decimal value of the sum of the bits in the Questionable Integrity Condition register.

NOTE

The data in this register is continuously updated and reflects the current conditions.

Mode	All
Remote Command	:STATus:QUESTionable:INTEgrity:CONDition?
Example	STAT:QUES:INT:COND?
Preset	0
Status Bits/OPC dependencies	Sequential command
Initial S/W Revision	Prior to A.02.00

Questionable Integrity Enable

This command determines which bits in the Questionable Integrity Condition Register will set bits in the Questionable Integrity Event register, which also sets the Integrity Summary bit (bit 9) in the Questionable Register. The variable <integer> is the sum of the decimal values of the bits you want to enable.

Mode	All
Remote Command	:STATus:QUESTionable:INTEgrity:ENABle <integer> :STATus:QUESTionable:INTEgrity:ENABle?
Example	STAT:QUES:INT:ENAB 8 Measurement Uncalibrated Summary will be reported to the Integrity Summary of the Status Questionable register.
Preset	32767
Min	0
Max	32767
Status Bits/OPC dependencies	Sequential command
Initial S/W Revision	Prior to A.02.00

Questionable Integrity Event Query

This query returns the decimal value of the sum of the bits in the Questionable Integrity Event register.

NOTE

The register requires that the associated PTR or NTR filters be set before a condition register bit can set a bit in the event register. The data in this register is latched until it is queried. Once queried, the register is cleared.

Mode	All
Remote Command	:STATus:QUESTionable:INTEgrity[:EVENT]?
Example	STAT:QUES:INT?
Preset	0
Status Bits/OPC dependencies	Sequential command
Initial S/W Revision	Prior to A.02.00

Questionable Integrity Negative Transition

This command determines which bits in the Questionable Integrity Condition register will set the corresponding bit in the Questionable Integrity Event register when the condition register bit has a negative transition (1 to 0)

The variable <integer> is the sum of the decimal values of the bits that you want to enable.

Mode	All
Remote Command	:STATus:QUEStionable:INTEgrity:NTRansition <integer> :STATus:QUEStionable:INTEgrity:NTRansition?
Example	STAT:QUES:INT:NTR 8 Measurement 'regained calibration' Summary will be reported to the Integrity Summary of the Status Questionable register.
Preset	0
Min	0
Max	32767
Status Bits/OPC dependencies	Sequential command
Initial S/W Revision	Prior to A.02.00

Questionable Integrity Positive Transition

This command determines which bits in the Questionable Integrity Condition register will set the corresponding bit in the Questionable Integrity Event register when the condition register bit has a positive transition (0 to 1). The variable <integer> is the sum of the decimal values of the bits that you want to enable.

Mode	All
Remote Command	:STATus:QUEStionable:INTEgrity:PTRansition <integer> :STATus:QUEStionable:INTEgrity:PTRansition?
Example	STAT:QUES:INT:PTR 8 Measurement 'became uncalibrated' Summary will be reported to the Integrity Summary of the Status Questionable register.
Preset	32767
Min	0
Max	32767
Status Bits/OPC dependencies	Sequential command
Initial S/W Revision	Prior to A.02.00

Questionable Integrity Signal Register

"Questionable Integrity Signal Condition" on page 126

"Questionable Integrity Signal Enable" on page 126

"Questionable Integrity Signal Event Query" on page 127

"Questionable Integrity Signal Negative Transition" on page 127

"Questionable Integrity Signal Positive Transition" on page 127

Questionable Integrity Signal Condition

This query returns the decimal value of the sum of the bits in the Questionable Integrity Signal Condition register.

NOTE

The data in this register is continuously updated and reflects the current conditions.

Mode	All
Remote Command	:STATus:QUESTionable:INTEgrity:SIGNal:CONDition?
Example	STAT:QUES:INT:SIGN:COND?
Preset	0
Status Bits/OPC dependencies	Sequential command
Initial S/W Revision	Prior to A.02.00

Questionable Integrity Signal Enable

This command determines which bits in the Questionable Integrity Signal Condition Register will set bits in the Questionable Integrity Signal Event register, which also sets the Integrity Summary bit (bit 9) in the Questionable Register. The variable <integer> is the sum of the decimal values of the bits you want to enable.

Mode	All
Remote Command	:STATus:QUESTionable:INTEgrity:SIGNal:ENABle <integer> :STATus:QUESTionable:INTEgrity:SIGNal:ENABle?
Example	STAT:QUES:INT:SIGN:ENAB 4 Burst Not Found will be reported to the Integrity Summary of the Status Questionable register.
Preset	32767
Min	0
Max	32767
Status Bits/OPC dependencies	Sequential command
Initial S/W Revision	Prior to A.02.00

Questionable Integrity Signal Event Query

This query returns the decimal value of the sum of the bits in the Questionable Integrity Signal Event register.

NOTE

The register requires that the associated PTR or NTR filters be set before a condition register bit can set a bit in the event register. The data in this register is latched until it is queried. Once queried, the register is cleared.

Mode	All
Remote Command	:STATus:QUESTionable:INTEgrity:SIGNal[:EVENT]?
Example	STAT:QUES:INT:SIGN?
Preset	0
Status Bits/OPC dependencies	Sequential command
Initial S/W Revision	Prior to A.02.00

Questionable Integrity Signal Negative Transition

This command determines which bits in the Questionable Integrity Signal Condition register will set the corresponding bit in the Questionable Integrity Signal Event register when the condition register bit has a negative transition (1 to 0). The variable <integer> is the sum of the decimal values of the bits that you want to enable.

Mode	All
Remote Command	:STATus:QUESTionable:INTEgrity:SIGNal:NTRansition <integer> :STATus:QUESTionable:INTEgrity:SIGNal:NTRansition?
Example	STAT:QUES:INT:SIGN:NTR 4 Burst found will be reported to the Integrity Summary of the Status Questionable register.
Preset	0
Min	0
Max	32767
Status Bits/OPC dependencies	Sequential command
Initial S/W Revision	Prior to A.02.00

Questionable Integrity Signal Positive Transition

This command determines which bits in the Questionable Integrity Signal Condition register will set the corresponding bit in the Questionable Integrity Signal Event register when the condition register bit has a positive transition (0 to 1). The variable <integer> is the sum of the decimal values of the bits that you want to enable.

Mode	All
Remote Command	:STATus:QUEStionable:INTEgrity:SIGNal:PTRansition <integer> :STATus:QUEStionable:INTEgrity:SIGNal:PTRansition?
Example	STAT:QUES:INT:SIGN:PTR 4 Burst not found will be reported to the Integrity Summary of the Status Questionable register.
Preset	32767
Min	0
Max	32767
Status Bits/OPC dependencies	Sequential command
Initial S/W Revision	Prior to A.02.00

Questionable Integrity Uncalibrated Register

"Questionable Integrity Uncalibrated Condition " on page 128

"Questionable Integrity Uncalibrated Enable " on page 128

"Questionable Integrity Uncalibrated Event Query " on page 129

"Questionable Integrity Uncalibrated Negative Transition " on page 129

"Questionable Integrity Uncalibrated Positive Transition " on page 130

Questionable Integrity Uncalibrated Condition

This query returns the decimal value of the sum of the bits in the Questionable Integrity Uncalibrated Condition register.

NOTE

The data in this register is continuously updated and reflects the current conditions.

Mode	All
Remote Command	:STATus:QUEStionable:INTEgrity:UNCalibrated:CONDition?
Example	STAT:QUES:INT:UNC:COND?
Preset	0
Status Bits/OPC dependencies	Sequential command
Initial S/W Revision	Prior to A.02.00

Questionable Integrity Uncalibrated Enable

This command determines which bits in the Questionable Integrity Uncalibrated Condition Register will set bits in the Questionable Integrity Uncalibrated Event register, which also sets the Data Uncalibrated Summary bit (bit 3) in the Questionable Integrity Register. The variable <integer> is the sum of the decimal values of the bits you want to enable.

Mode	All
Remote Command	:STATus:QUESTionable:INTEgrity:UNCalibrated:ENABle :STATus:QUESTionable:INTEgrity:UNCalibrated:ENABle?
Example	STAT:QUES:INT:UNC:ENAB 1 Oversweep (Meas Uncal) will be reported to the Integrity Summary of the Status Questionable register.
Preset	32767
Min	0
Max	32767
Status Bits/OPC dependencies	Sequential command
Initial S/W Revision	Prior to A.02.00

Questionable Integrity Uncalibrated Event Query

This query returns the decimal value of the sum of the bits in the Questionable Integrity Uncalibrated Event register.

NOTE

The register requires that the associated PTR or NTR filters be set before a condition register bit can set a bit in the event register. The data in this register is latched until it is queried. Once queried, the register is cleared.

Mode	All
Remote Command	:STATus:QUESTionable:INTEgrity:UNCalibrated[:EVENT]?
Example	STAT:QUES:INT:UNC?
Preset	0
Status Bits/OPC dependencies	Sequential command
Initial S/W Revision	Prior to A.02.00

Questionable Integrity Uncalibrated Negative Transition

This command determines which bits in the Questionable Integrity Uncalibrated Condition register will set the corresponding bit in the Questionable Integrity Uncalibrated Event register when the condition register bit has a negative transition (1 to 0). The variable <integer> is the sum of the decimal values of the bits that you want to enable.

Mode	All
Remote Command	:STATus:QUESTionable:INTEgrity:UNCalibrated:NTRansition <integer> :STATus:QUESTionable:INTEgrity:UNCalibrated:NTRansition?
Example	STAT:QUES:INT:UNC:NTR 1 Oversweep cleared will be reported to the Integrity Summary of the Status Questionable register.

Preset	0
Min	0
Max	32767
Status Bits/OPC dependencies	Sequential command
Initial S/W Revision	Prior to A.02.00

Questionable Integrity Uncalibrated Positive Transition

This command determines which bits in the Questionable Integrity Uncalibrated Condition register will set the corresponding bit in the Questionable Integrity Uncalibrated Event register when the condition register bit has a positive transition (0 to 1). The variable <integer> is the sum of the decimal values of the bits that you want to enable.

Mode	All
Remote Command	:STATus:QUEStionable:INTEgrity:UNCalibrated:PTRansition <integer> :STATus:QUEStionable:INTEgrity:UNCalibrated:PTRansition?
Example	STAT:QUES:INT:UNC:PTR 1 Oversweep (Meas Uncal) occurred will be reported to the Integrity Summary of the Status Questionable register.
Preset	32767
Min	0
Max	32767
Status Bits/OPC dependencies	Sequential command
Initial S/W Revision	Prior to A.02.00

Questionable Power Register

"Questionable Power Condition " on page 130

"Questionable Power Enable " on page 131

"Questionable Power Event Query " on page 131

"Questionable Power Negative Transition " on page 132

"Questionable Power Positive Transition " on page 132

Questionable Power Condition

This query returns the decimal value of the sum of the bits in the Questionable Power Condition register.

NOTE

The data in this register is continuously updated and reflects the current conditions.

Mode	All
Remote Command	:STATus:QUESTionable:POWer:CONDition?
Example	STAT:QUES:POW:COND?
Preset	0
Status Bits/OPC dependencies	Sequential command
Initial S/W Revision	Prior to A.02.00

Questionable Power Enable

This command determines which bits in the Questionable Power Condition Register will set bits in the Questionable Power Event register, which also sets the Power Summary bit (bit 3) in the Questionable Register. The variable <integer> is the sum of the decimal values of the bits you want to enable.

Mode	All
Remote Command	:STATus:QUESTionable:POWer:ENABle <integer> :STATus:QUESTionable:POWer:ENABle?
Example	STAT:QUES:POW:ENAB 32 50 MHz Input Pwr too High for Cal will be reported to the Power Summary of the Status Questionable register.
Preset	32767
Min	0
Max	32767
Status Bits/OPC dependencies	Sequential command
Initial S/W Revision	Prior to A.02.00

Questionable Power Event Query

This query returns the decimal value of the sum of the bits in the Questionable Power Event register.

NOTE

The register requires that the associated PTR or NTR filters be set before a condition register bit can set a bit in the event register. The data in this register is latched until it is queried. Once queried, the register is cleared.

Mode	All
Remote Command	:STATus:QUESTionable:POWer[:EVENT]?
Example	STAT:QUES:POW?
Preset	0
Status Bits/OPC dependencies	Sequential command
Initial S/W Revision	Prior to A.02.00

Questionable Power Negative Transition

This command determines which bits in the Questionable Power Condition register will set the corresponding bit in the Questionable Power Event register when the condition register bit has a negative transition (1 to 0). The variable <integer> is the sum of the decimal values of the bits that you want to enable.

Mode	All
Remote Command	:STATus:QUESTionable:POWer:NTRansition <integer> :STATus:QUESTionable:POWer:NTRansition?
Example	STAT:QUES:POW:NTR 32 50 MHz Input Power became OK for Cal will be reported to the Power Summary of the Status Questionable register.
Preset	0
Min	0
Max	32767
Status Bits/OPC dependencies	Sequential command
Initial S/W Revision	Prior to A.02.00

Questionable Power Positive Transition

This command determines which bits in the Questionable Power Condition register will set the corresponding bit in the Questionable Power Event register when the condition register bit has a positive transition (0 to 1). The variable <integer> is the sum of the decimal values of the bits that you want to enable.

Mode	All
Remote Command	:STATus:QUESTionable:POWer:PTRansition <integer> :STATus:QUESTionable:POWer:PTRansition?>
Example	STAT:QUES:POW:PTR 32 50 MHz Input Power became too high for Cal will be reported to the Power Summary of the Status Questionable register.
Preset	32767
Min	0
Max	32767
Status Bits/OPC dependencies	Sequential command
Initial S/W Revision	Prior to A.02.00

Questionable Temperature Register

"Questionable Temperature Condition" on page 133

"Questionable Temperature Enable" on page 133

"Questionable Temperature Event Query" on page 133

"Questionable Temperature Negative Transition" on page 134

"Questionable Temperature Positive Transition" on page 134

Questionable Temperature Condition

This query returns the decimal value of the sum of the bits in the Questionable Temperature Condition register.

NOTE The data in this register is continuously updated and reflects the current conditions.

Mode	All
Remote Command	:STATus:QUEStionable:TEMPerature:CONDition?
Example	STAT:QUES:TEMP:COND?
Preset	0
Status Bits/OPC dependencies	Sequential command
Initial S/W Revision	Prior to A.02.00

Questionable Temperature Enable

This command determines which bits in the Questionable Temperature Condition Register will set bits in the Questionable Temperature Event register, which also sets the Temperature Summary bit (bit 4) in the Questionable Register. The variable <integer> is the sum of the decimal values of the bits you want to enable.

Mode	All
Remote Command	:STATus:QUEStionable:TEMPerature:ENABle <integer> :STATus:QUEStionable:TEMPerature:ENABle?
Example	STAT:QUES:TEMP:ENAB 1 Reference Oscillator Oven Cold will be reported to the Temperature Summary of the Status Questionable register.
Preset	32767
Min	0
Max	32767
Status Bits/OPC dependencies	Sequential command
Initial S/W Revision	Prior to A.02.00

Questionable Temperature Event Query

This query returns the decimal value of the sum of the bits in the Questionable Temperature Event register.

NOTE

The register requires that the associated PTR or NTR filters be set before a condition register bit can set a bit in the event register. The data in this register is latched until it is queried. Once queried, the register is cleared

Mode	All
Remote Command	:STATus:QUEStionable:TEMPerature[:EVENT]?
Example	STAT:QUES:TEMP?
Preset	0
Status Bits/OPC dependencies	Sequential command
Initial S/W Revision	Prior to A.02.00

Questionable Temperature Negative Transition

This command determines which bits in the Questionable Temperature Condition register will set the corresponding bit in the Questionable Temperature Event register when the condition register bit has a negative transition (1 to 0). The variable <integer> is the sum of the decimal values of the bits that you want to enable.

Mode	All
Remote Command	:STATus:QUEStionable:TEMPerature:NTRansition <integer> :STATus:QUEStionable:TEMPerature:NTRansition?
Example	STAT:QUES:TEMP:NTR 1 Reference Oscillator Oven not cold will be reported to the Temperature Summary of the Status Questionable register.
Preset	0
Min	0
Max	32767
Status Bits/OPC dependencies	Sequential command
Initial S/W Revision	Prior to A.02.00

Questionable Temperature Positive Transition

This command determines which bits in the Questionable Temperature Condition register will set the corresponding bit in the Questionable Temperature Event register when the condition register bit has a positive transition (0 to 1). The variable <integer> is the sum of the decimal values of the bits that you want to enable.

Mode	All
Remote Command	:STATus:QUEStionable:TEMPerature:PTRansition <integer> :STATus:QUEStionable:TEMPerature:PTRansition?
Example	STAT:QUES:TEMP:PTR 1 Reference Oscillator Oven became cold will be reported to the

	Temperature Summary of the Status Questionable register.
Preset	32767
Min	0
Max	32767
Status Bits/OPC dependencies	Sequential command
Initial S/W Revision	Prior to A.02.00

IEEE 488.2 Common Commands

The instrument supports the following subset of IEEE 488.2 Common Commands, as defined in Chapter 10 of [IEEE Standard 488.2-1992](#). As indicated in the detailed descriptions, some of these commands correspond directly to instrument front-panel key functionality, while others are available only as remote commands.

Command	Description
*CAL?	Align Now "All " on page 264
*CLS	"Clear Status " on page 138
*ESE	"Standard Event Status Enable " on page 138
*ESE?	
*ESR?	"Standard Event Status Register Query " on page 139
*IDN?	"Identification Query " on page 139
*OPC	"Operation Complete " on page 140
*OPC?	
*OPT?	"Query Instrument Options " on page 141
*RCL	"Recall Instrument State " on page 141
*RST	"*RST (Remote Command Only)" on page 142
*SAV	"Save Instrument State " on page 142
*SRE	"Service Request Enable " on page 142
*SRE?	
*STB?	"Status Byte Query " on page 143
*TRG	"Trigger " on page 143
*TST?	"Self Test Query " on page 143
*WAI	"Wait-to-Continue " on page 144

All

(In MXE the key label is "All (plus RF Presel 20 Hz – 3.6 GHz)")Immediately executes an alignment of all subsystems In MXE, the Align Now All is followed by additionally aligning the RF Preselector section, so in MXE, the key label contains the parenthetical note "(plus RF Presel 20 Hz – 3.6 GHz)". The instrument stops any measurement currently underway, performs the alignment, then restarts the measurement from the beginning (similar to pressing the Restart key).

If an interfering user signal is present at the RF Input, the alignment is performed on all subsystems except the RF. After completion, the Error Condition message "Align skipped: 50 MHz interference" or "Align skipped: 4.8 GHz interference" is generated. In addition the Error Condition message "Align Now, RF required" is generated, and bits 11 and 12 are set in the Status Questionable Calibration register.

The query form of the remote commands (:CALibration[:ALL]? or *CAL?) invokes the alignment of all subsystems and returns a success or failure value. An interfering user signal is not grounds for failure; if the

alignment was able to succeed on all portions but unable to align the RF because of an interfering signal, the resultant will be the success value.

Successful completion of Align Now, All will clear the “Align Now, All required” Error Condition, and clear bit 14 in the Status Questionable Calibration register. It will also begin the elapsed time counter for Last Align Now, All Time, and capture the Last Align Now, All Temperature.

In the MXE, successful completion will also clear the “Align 20 Hz to 30 MHz required” Error Condition, the “Align 30 MHz to 3.6 GHz required” Error Condition, and the “Align 20 Hz to 3.6 GHz required” Error Condition, and clear bits 1 and bit 2 and clear the bit 1 in the Status Questionable Calibration Extended Needed register.

If the Align RF subsystem succeeded in aligning (no interfering signal present), the elapsed time counter begins for Last Align Now, RF Time, and the temperature is captured for the Last Align Now, RF Temperature. In addition the Error Conditions “Align skipped: 50 MHz interference” and “Align skipped: 4.8 GHz interference” are cleared, the Error Condition “Align Now, RF required” is cleared, and bits 11 and 12 are cleared in the Status Questionable Calibration register

Align Now, All can be interrupted by pressing the Cancel (ESC) front-panel key or remotely with Device Clear followed by the :ABORt SCPI command. When this occurs the Error Condition message “Align Now, All required” is generated, and bit 14 is set in the Status Questionable Condition register. This is because new alignment data may be employed for an individual subsystem, but not a cohesive set of data for all subsystems.

In many cases, you might find it more convenient to change alignments to Normal, instead of executing Align Now, All. When the Auto Align process transitions to Normal, the analyzer will immediately start to update only the alignments that have expired, thus efficiently restoring the alignment process.

Key Path	System, Alignments, Align Now
Mode	All
Remote Command	:CALibration[:ALL] :CALibration[:ALL]?
Example	:CAL
Notes	:CALibration[:ALL]? returns 0 if successful :CALibration[:ALL]? returns 1 if failed :CALibration[:ALL]? is the same as *CAL? While Align Now, All is performing the alignment, bit 0 in the Status Operation register is set. Completion, or termination, will clear bit 0 in the Status Operation register. This command is sequential; it must complete before further SCPI commands are processed. Interrupting the alignment from remote is accomplished by invoking Device Clear followed by the :ABORt command. Successful completion will clear bit 14 in the Status Questionable Calibration register. An interfering user signal is not grounds for failure of Align Now, All. However, bits 11 and 12 are set in the Status Questionable Calibration register to indicate Align Now, RF is required. An interfering user supplied signal will result in the instrument requiring an Align Now, RF with the interfering signal removed.
Couplings	Initializes the time for the Last Align Now, All Time. Records the temperature for the Last Align Now, All Temperature.

	If Align RF component succeeded, initializes the time for the Last Align Now, RF Time. If Align RF component succeeded, records the temperature for the Last Align Now, RF Temperature.
Status Bits/OPC dependencies	Bits 11, 12, or 14 may be set in the Status Questionable Calibration register.
Initial S/W Revision	Prior to A.02.00

Mode	All
Remote Command	*CAL?
Example	*CAL?
Notes	*CAL? returns 0 if successful *CAL? returns 1 if failed :CALibration[:ALL]? is the same as *CAL? See additional remarks described with :CALibration[:ALL]? Everything about :CALibration[:ALL]? is synonymous with *CAL? including all conditions, status register bits, and couplings
Initial S/W Revision	Prior to A.02.00

Clear Status

Clears the status byte register. It does this by emptying the error queue and clearing all bits in all of the event registers. The status byte register summarizes the states of the other registers. It is also responsible for generating service requests.

Key Path	No equivalent key. Related key System, Show Errors, Clear Error Queue
Remote Command	*CLS
Example	*CLS Clears the error queue and the Status Byte Register.
Notes	For related commands, see the SYSTem:ERRor[:NEXT]? command. See also the STATus:PRESet command and all commands in the STATus subsystem.
Status Bits/OPC dependencies	Resets all bits in all event registers to 0, which resets all the status byte register bits to 0 also.
Backwards Compatibility Notes	In general the status bits used in the X-Series status system will be backwards compatible with ESA and PSA. However, note that all conditions will generate events that go into the event log, and some will also generate status bits.
Initial S/W Revision	Prior to A.02.00

Standard Event Status Enable

Selects the desired bits from the standard event status enable register. This register monitors I/O errors and synchronization conditions such as operation complete, request control, query error, device

dependent error, status execution error, command error, and power on. The selected bits are OR'd to become a summary bit (bit 5) in the byte register which can be queried.

The query returns the state of the standard event status enable register.

Key Path	No equivalent key. Related key System, Show Errors, Clear Error Queue
Remote Command	*ESE <integer> *ESE?
Example	*ESE 36 Enables the Standard Event Status Register to monitor query and command errors (bits 2 and 5). *ESE? Returns a 36 indicating that the query and command status bits are enabled.
Notes	For related commands, see the STATus subsystem and SYSTem:ERRor[:NEXT]? commands.
Preset	255
State Saved	Not saved in state.
Min	0
Max	255
Status Bits/OPC dependencies	Event Enable Register of the Standard Event Status Register.
Initial S/W Revision	Prior to A.02.00

Standard Event Status Register Query

Queries and clears the standard event status event register. (This is a destructive read.) The value returned is a hexadecimal number that reflects the current state (0/1) of all the bits in the register.

Remote Command	*ESR?
Example	*ESR? Returns a 1 if there is either a query or command error, otherwise it returns a zero.
Notes	For related commands, see the STATus subsystem commands.
Preset	0
Min	0
Max	255
Status Bits/OPC dependencies	Standard Event Status Register (bits 0 – 7).
Initial S/W Revision	Prior to A.02.00

Identification Query

Returns a string of instrument identification information. The string will contain the model number, serial number, and firmware revision.

The response is organized into four fields separated by commas. The field definitions are as follows:

- Manufacturer

- Model
- Serial number
- Firmware version

Key Path	No equivalent key. See related key System, Show System.
Remote Command	*IDN?
Example	*IDN? Returns instrument identification information, such as: Keysight Technologies, N9020A, US01020004, A.01.02
Initial S/W Revision	Prior to A.02.00

Operation Complete

The *OPC command sets bit 0 in the standard event status register (SER) to “1” when pending operations have finished, that is when all overlapped commands are complete. It does not hold off subsequent operations. You can determine when the overlapped commands have completed either by polling the OPC bit in SER, or by setting up the status system such that a service request (SRQ) is asserted when the OPC bit is set.

The *OPC? query returns a “1” after all the current overlapped commands are complete. So it holds off subsequent commands until the “1” is returned, then the program continues. This query can be used to synchronize events of other instruments on the external bus.

Remote Command	*OPC *OPC?
Example	INIT:CONT 0 Selects single sweeping. INIT:IMM Initiates a sweep. *OPC? Holds off any further commands until the sweep is complete.
Status Bits/OPC dependencies	Not global to all remote ports or front panel. *OPC only considers operation that was initiated on the same port as the *OPC command was issued from. *OPC is an overlapped command, but *OPC? is sequential.
Backwards Compatibility Notes	<ol style="list-style-type: none"> 1. The ESA/PSA/VSA products do not meet all the requirements for the *OPC command specified by IEEE 488.2. This is corrected for X-Series. This will sometimes cause behavior that is not backward compatible, but it will work as customers expect. 2. Commands such as, *OPC/*OPC?/*WAI/*RST used to be global. They considered front panel operation in conjunction with the GPIB functionality. Now they are evaluated on a per channel basis. That is, the various rear panel remote ports and the front panel i/o are all considered separately. Only the functionality initiated on the port where the *OPC was sent, is considered for its operation. 3. *OPC used to hold off until the operation bits were cleared. Now it holds off until all overlapping commands are completed. Also, earlier instruments did not wait for completion of all processes, only the ones identified here (in the STATus:OPERation register): Calibrating: monitored by PSA, ESA, VSA (E4406A) Sweeping: monitored by PSA, ESA, VSA (E4406A) Waiting for Trigger: monitored by PSA, ESA, VSA (E4406A)

	Measuring: monitored by PSA and ESA (but not in all Modes). Paused: monitored by VSA (E4406A). Printing: monitored by VSA (E4406A). Mass memory busy: monitored by VSA (E4406A).
Initial S/W Revision	Prior to A.02.00

Query Instrument Options

Returns a string of all the installed instrument options. It is a comma separated list with quotes, such as: "503,P03,PFR".

To be IEEE compliant, this command should return an arbitrary ascii variable that would not begin and end with quotes. But the quotes are needed to be backward compatible with previous SA products and software. So, the actual implementation will use arbitrary ascii. But quotes will be sent as the first and last ascii characters that are sent with the comma-separated option list.

Remote Command	*OPT?
Initial S/W Revision	Prior to A.02.00

Recall Instrument State

This command recalls the instrument state from the specified instrument memory register.

- If the state being loaded has a newer firmware revision than the revision of the instrument, no state is recalled and an error is reported
- If the state being loaded has an equal firmware revision than the revision of the instrument, the state will be loaded.
- If the state being loaded has an older firmware revision than the revision of the instrument, the instrument will only load the parts of the state that apply to the older revision.

Remote Command	*RCL <register #>
Example	*RCL 7 Recalls the instrument state that is currently stored in register 7.
Notes	Registers 0 through 6 are accessible from the front panel in menu keys for Recall Registers.
Min	0
Max	127
Status Bits/OPC dependencies	The command is sequential.
Initial S/W Revision	Prior to A.02.00

*RST (Remote Command Only)

*RST is equivalent to :SYST:PRES;:INIT:CONT OFF, which is a Mode Preset in the Single measurement state. This remote command is preferred over Mode Preset remote command - :SYST:PRES, as optimal remote programming occurs with the instrument in the single measurement state.

Remote Command	*RST
Example	*RST
Notes	Sequential Clears all pending OPC bits and the Status Byte is set to 0.
Couplings	A *RST will cause the currently running measurement to be aborted and cause the default measurement to be active. *RST gets the mode to a consistent state with all of the default couplings set.
Backwards Compatibility Notes	In legacy analyzers *RST did not set the analyzer to Single, but in the X-Series it does, for compliance with the IEEE 488.2 specification. In the X-Series, *RST does not do a *CLS (clear the status bits and the error queue). In legacy analyzers, *RST used to do the equivalent of SYSTem:PRESet, *CLS and INITiate:CONTinuous OFF. But to be 488.2 compliant, *RST in the X-Series does not do a *CLS.
Initial S/W Revision	Prior to A.02.00

Save Instrument State

This command saves the current instrument state and mode to the specified instrument memory register.

Remote Command	*SAV <register #>
Example	*SAV 9 Saves the instrument state in register 9.
Notes	Registers 0 through 6 are accessible from the front panel in menu keys for Save Registers.
Min	0
Max	127
Status Bits/OPC dependencies	The command is sequential.
Initial S/W Revision	Prior to A.02.00

Service Request Enable

This command enables the desired bits of the service request enable register.

The query returns the value of the register, indicating which bits are currently enabled.

Remote Command	*SRE <integer> *SRE?
Example	*SRE 22 Enables bits 1, 2, and 4 in the service request enable register.

Notes	For related commands, see the STATus subsystem and SYSTem:ERRor[:NEXT]? commands.
Preset	0
Min	0
Max	255
Status Bits/OPC dependencies	Service Request Enable Register (all bits, 0 - 7).
Initial S/W Revision	Prior to A.02.00

Status Byte Query

Returns the value of the status byte register without erasing its contents.

Remote Command	*STB?
Example	*STB? Returns a decimal value for the bits in the status byte register. For example, if a 16 is returned, it indicates that bit 5 is set and one of the conditions monitored in the standard event status register is set.
Notes	See related command *CLS.
Status Bits/OPC dependencies	Status Byte Register (all bits, 0 - 7).
Initial S/W Revision	Prior to A.02.00

Trigger

This command triggers the instrument. Use the :TRIGger[:SEQuence]:SOURce command to select the trigger source.

Key Path	No equivalent key. See related keys Single and Restart.
Remote Command	*TRG
Example	*TRG Triggers the instrument to take a sweep or start a measurement, depending on the current instrument settings.
Notes	See related command :INITiate:IMMediate.
Initial S/W Revision	Prior to A.02.00

Self Test Query

This query performs the internal self-test routines and returns a number indicating the success of the testing. A zero is returned if the test is successful, 1 if it fails.

Remote Command	*TST?
Example	*TST? Runs the self-test routines and returns 0=passed, 1=some part failed.
Initial S/W Revision	Prior to A.02.00

Wait-to-Continue

This command causes the instrument to wait until all overlapped commands are completed before executing any additional commands. There is no query form for the command.

Remote Command	*WAI
Example	INIT:CONT OFF; INIT;*WAI Sets the instrument to single sweep. Starts a sweep and waits for its completion.
Status Bits/OPC dependencies	Not global to all remote ports or front panel. *OPC only considers operation that was initiated on the same port as the *OPC command was issued from.
Initial S/W Revision	Prior to A.02.00

4 Input/Output Functions

Input/Output

The Input/Output features are common across multiple Modes and Measurements. These common features are described in this section. See the Measurement description for information on features that are unique.

The Input/Output key accesses the keys that control the Input/Output parameters of the instrument. In general, these are functions associated with external connections to the analyzer, either to the inputs or the outputs. Since these connections tend to be fairly stable within a given setup, in general, the input/output settings do not change when you Preset the analyzer.

Other functions related to the input/output connections, but which tend to change on a measurement by measurement basis, can be found under the Trigger and AMPTD Y Scale keys. In addition, some of the digital I/O bus configurations can be found under the System key.

NOTE

The functions in the Input/Output menu are "global" (common) to all Modes (applications). But individual Input/Output functions only appear in a Mode if they apply to that Mode. Functions that apply to a Mode but not to all measurements in the Mode may be grayed-out in some measurements.

["Input/Output variables - Preset behavior" on page 147](#)

The Input Port selection is the first menu under the Input/Output key:

Key Path	Front-panel key
Remote Command	<code>[:SENSe] :FEED RF AIQ EMIXer</code> <code>[:SENSe] :FEED?</code>
Example	<code>:FEED RF</code> <code>:FEED?</code>
Couplings	The <code>[:SENSe] :FEED RF</code> command turns the calibrator OFF
Preset	This setting is unaffected by a Preset or power cycle. It survives a Mode Preset and mode changes. It is set to RF on a "Restore Input/Output Defaults" or "Restore System Defaults->All"
State Saved	Saved in instrument state
Backwards Compatibility SCPI	<code>[:SENSe] :FEED AREFERENCE</code> In the PSA the calibrator was one of the inputs and selected using the AREF parameter to the same <code>:FEED</code> command that switched the inputs. In the X-Series it is controlled in a separate menu and overrides the input selection. For code compatibility the <code>[:SENSe] :FEED AREFERENCE</code> command is provided, and is aliased to <code>[:SENSe] :FEED :AREF REF50</code> , which causes the input to be switched to the 50 MHz calibrator. The <code>[:SENSe] :FEED RF</code> command switches the input back to the RF port and turns the calibrator OFF, thus providing full compatibility with the PSA calibrator function. Note that after sending this, the query <code>[:SENSe] :FEED?</code> will NOT return "AREF" but instead the currently selected input.
Backwards Compatibility SCPI	<code>[:SENSe] :FEED IQ IONLy QONLy</code> <code>[:SENSe] :FEED?</code> The parameters <code>IQ IONLy QONLy</code> are supported for backwards compatibility with the E44406A. <code>[:SENSe] :FEED IQ</code> aliases to <code>[:SENSe] :FEED :IQ :TYPE IQ</code> <code>[:SENSe] :FEED IONLy</code> aliases to <code>[:SENSe] :FEED :IQ :TYPE IONLy</code>

	<p>[;SENSe]:FEED QONLy aliases to [;SENSe]:FEED:IQ:TYPE QONLy</p> <p>The query [;SENSe]:FEED? will always returns AIQ whatever the type of legacy parameters IQ IONLy QONLy has been used.</p>
Backwards Compatibility Notes	<p>Most of the settings in the X-Series Input/Output system, including External Gain, Amplitude Corrections settings and data, etc., are shared by all modes and are not changed by a mode switch. Furthermore, most variables in the Input/Output system key are not affected by Mode Preset. Both of these behaviors represent a departure from legacy behavior.</p> <p>In the X-Series. Input/Output settings are reset by using the "Restore Input/Output Defaults" function. They can also be reset to their default values through the System->Restore System Defaults-> In/Out Config key or through the System ->Restore System Defaults -> All key (and corresponding SCPI).</p> <p>While this matches most use cases better, it does create some code compatibility issues. For example, Amplitude Corrections are no longer turned off by a Mode Preset, but instead by using the "Restore Input/Output Defaults" key/SCPI.</p> <p>Although Input/Output settings are not part of each Mode's State, they are saved in the Save State files, so that all of the instrument settings can be recalled with Recall State, as in legacy instruments.</p>
Initial S/W Revision	Prior to A.02.00
Remote Command	<p>:INPut:MIXer EXTernal INTernal</p> <p>:INPut:MIXer?</p>
Example	<p>INP:MIX INT</p> <p>INP:MIX?</p>
Notes	<p>In legacy analyzers you choose between the Internal mixer or an External Mixer. In the X-Series, the External Mixer is one of the choices for the Input and is selected using the FEED command (:SENSe:FEED EXTMIxer).</p> <p>For compatibility, the INPut:MIXer EXTernal INTernal legacy command is mapped as follows:</p> <ol style="list-style-type: none"> 1. When INPut:MIXer EXTernal is received, SENSe:FEED EMIXer is executed. 2. When INPut:MIXer INTernal is received, SENSe:FEED RF is executed. 3. When INPut:MIXer? is received, the response will be INT if any input other than the external mixer is selected and EXT if the external mixer is selected
Preset	INT
Backwards Compatibility Notes	<p>PSA supports the following SCPI Command :</p> <p>:INPut:MIXer:TYPE PRESelected UNPReselect</p> <p>:INPut:MIXer:TYPE?</p> <p>PXA does not support the :INPut:MIXer:TYPE command.</p>
Initial S/W Revision	A.08.01

Input/Output variables - Preset behavior

Virtually all the input/output settings are NOT a part of mode preset. They can be set to their default value

by one of the three ways:

- by using the Restore Input/Output Defaults key on the first page of the input/output menu,
- by using the System->Restore System Defaults->Input/Output Settings or,
- by using the System -> Restore System Defaults->All. Also, they survive a Preset and a Power cycle.

A very few of the Input/Output settings do respond to a Mode Preset; for example, if the Calibrator is on it turns off on a Preset, and if DC coupling is in effect it switches to AC on a Preset. These exceptions are made in the interest of reliability and usability, which overrides the need for absolute consistency. Exceptions are noted in the SCPI table for the excepted functions.

RF Input

Selects the front-panel RF input port to be the analyzer signal input. If RF is already selected, pressing this key accesses the RF input setup functions.

Key Path	Input/Output
Example	[:SENSe]:FEED RF
Couplings	The act of connecting the U7227A USB Preamplifier to one of the analyzer's USB ports will cause the Input to automatically switch to the RF Input. If the RF Calibrator is on, it is turned off. Subsequently disconnecting the USB Preamp from USB does not change the Input selection nor restore the previous selection.
Readback	The RF input port, RF coupling, and current input impedance settings appear on this key as: "XX, YY, ZZ" where XX is RF, RF2, RFIO1, RFIO2, depending on what input is selected (only appears on analyzers with multiple RF inputs) YY is AC or DC ZZ is 50Ω or 75Ω
Initial S/W Revision	Prior to A.02.00
Modified at S/W Revision	A.14.00

Input Z Correction

Sets the input impedance for unit conversions. This affects the results when the y-axis unit is voltage or current units (dBmV, dBμV, dBμA, V, A), but not when it is power units (dBm, W). The impedance you select is for computational purposes only, since the actual impedance is set by internal hardware to 50 ohms. Setting the computational input impedance to 75 ohms is useful when using a 75 ohm to 50 ohm adapter to measure a 75 ohm device on an analyzer with a 50 ohm input impedance.

There are a variety of ways to make 50 to 75 ohm transitions, such as impedance transformers or minimum loss pads. The choice of the solution that is best for your measurement situation requires balancing the amount of loss that you can tolerate with the amount of measurement frequency range that you need. If you are using one of these pads/adaptors with the Input Z Corr function, you might also want to use the Ext Gain key. This function is used to set a correction value to compensate for the gain (loss) through your pad. This correction factor is applied to the displayed measurement values.

Key Path	Input/Output, RF Input
Remote Command	[:SENSe] :CORRection:IMPedance [:INPut] [:MAGNitude] 50 75 [:SENSe] :CORRection:IMPedance [:INPut] [:MAGNitude] ?
Example	CORR:IMP 75 sets the input impedance correction to 75 ohms. CORR:IMP?
Couplings	In the N9000A option C75, when RF Input 2 is selected, the Input Z Correction will automatically change to 75 ohms. You may then change it to whatever is desired. When the main RF Input is selected, the Input Z Correction will automatically change to 50 ohms. You may then change it to whatever is desired.
Preset	This is unaffected by a Preset but is set to 50 ohms on a "Restore Input/Output Defaults" or "Restore System Defaults->All" Some instruments/options may have 75 ohms available.
State Saved	Saved in instrument state
Readback	50 Ω or 75 Ω . Current setting reads back to the RF key.
Initial S/W Revision	Prior to A.02.00

RF Coupling

Specifies alternating current (AC) or direct current (DC) coupling at the analyzer RF input port. Selecting AC coupling switches in a blocking capacitor that blocks any DC voltage present at the analyzer input. This decreases the input frequency range of the analyzer, but prevents damage to the input circuitry of the analyzer if there is a DC voltage present at the RF input.

In AC coupling mode, you can view signals below the corner frequency of the DC block, but below a certain frequency the amplitude accuracy is not specified. The frequency below which specifications do not apply is:

X-Series Model	Lowest Freq for meeting specs when AC coupled	Lowest Freq for meeting specs when DC coupled
N9000A-503/507	100 kHz	n/a
N9000A-C75 Input 2	1 MHz	n/a
N9000A-513/526	10 MHz	9 kHz
N9010A	10 MHz	9 kHz
N9020A	10 MHz	20 Hz
N9030A	10 MHz	3 Hz

Some amplitude specifications apply only when coupling is set to DC. Refer to the appropriate amplitude specifications and characteristics for your analyzer.

When operating in DC coupled mode, ensure protection of the analyzer input circuitry by limiting the DC part of the input level to within 200 mV of 0 Vdc. In AC or DC coupling, limit the input RF power to +30 dBm (1 Watt).

Key Path	Input/Output, RF Input
Remote Command	:INPut:COUPling AC DC :INPut:COUPling?
Example	INP:COUP DC
Dependencies	This key does not appear in models that are always AC coupled. When the SCPI command to set DC coupling is sent to these models, it results in the error "Illegal parameter value; This model is always AC coupled" In these models, the SCPI query INP:COUP? always returns AC. This key does not appear in models that are always DC coupled. When the SCPI command to set AC coupling is sent to these models, it results in the error "Illegal parameter value; This instrument is always DC coupled" In these models, the SCPI query INP:COUP? always returns DC.
Preset	AC on models that support AC coupling On models that are always DC coupled, such as millimeter wave models (frequency ranges 30 GHz and above), the preset is DC.
State Saved	Saved in instrument state.
Initial S/W Revision	Prior to A.02.00
Modified at S/W Revision	A.03.00

I/Q

This feature is not available unless the "Baseband I/Q (Option BBA)" on page 150 is installed.

Selects the front-panel I/Q input ports to be the analyzer signal input. If I/Q is already selected, pressing this key accesses the I/Q setup menu.

Key Path	Input/Output
Mode	BASIC, CDMA2K, EDGE GSM, TDSCMDA, VSA89601, WIMAXOFDMA, LTE, LTETDD, LTEAFDD, LTEATDD, DCATV, DTMB (CTTB), DVB-T/H with T2, CMMB, ISDBT, WCDMA, VXA, CDMA1XEV
Example	FEED AIQ
Notes	Not all measurements support the use of the I/Q signal input. When I/Q is selected in a measurement that does not support it, the "No Result; Meas invalid with I/Q inputs" error condition message appears. This is error 135
Initial S/W Revision	Prior to A.02.00

Baseband I/Q (Option BBA)

The Baseband I/Q functionality is a hardware option. It is option BBA. If the option is not installed, none of the I/Q functionality is enabled.

The Baseband I/Q has four input ports and one output port. The input ports are I, I-bar, Q, and Q-bar. The I and I-bar together compose the I channel and the Q and Q-bar together compose the Q channel. Each channel has two modes of operation, Single-Ended (also called "unbalanced") and Differential Input (also called "balanced"). When in Single-Ended operation, only the main port (I or Q) is used and the complementary port (I-bar or Q-bar) is ignored. When in Differential Input mode, both main and complementary ports are used.

The input settings (range, attenuation, skew, impedance, external gain) apply to the channels, not the individual ports.

The system supports a variety of 1 M Ω input passive probes as well as the Agilent 113x Series active differential probes using the Infinimax probe interface.

The Agilent 113x Series active probes can be used for both single ended and differential measurements. In either case a single connection is made for each channel (on either the I or Q input). The input is automatically configured to 50 Ω single ended and the probe power is supplied through the Infinimax interface. The probe can be configured for a variety of input coupling and low frequency rejection modes. In addition, a wide range of offset voltages and probe attenuation accessories are supported at the probe interface. The active probe has the advantage that it does not significantly load the circuit under test, even with unity gain probing.

With passive 1 M Ω probes, the probe will introduce a capacitive load on the circuit, unless higher attenuation is used at the probe interface. Higher attenuation reduces the signal level and degrades the signal-to-noise-ratio of the measurement. Passive probes are available with a variety of attenuation values for a moderate cost. Most Agilent passive probes can be automatically identified by the system, setting the input impedance setting required as well as the nominal attenuation. For single ended measurements a single probe is used for each channel. Other passive probes can be used, with the attenuation and impedance settings configured manually.

For full differential measurements, the system supports probes on each of the four inputs. The attenuation of the probes should be the same for good common mode rejection and channel match.

Both active and passive probes in single ended and differential configurations can be calibrated. This calibration uses the Cal Out BNC connection and a probe connection accessory. The calibration achieves excellent absolute gain flatness in a probed measurement. It matches both the gain and frequency response of the I and Q channels as well as any delay skew, resulting in high accuracy in derived measurements such as Error Vector Magnitude (EVM).

When a probe is connected a status message will be displayed. The message will indicate if calibration data is available or not. Calibration data is saved for each type of probe (including "none") for each port and will be reapplied whenever that type of probe is re-connected to the same port. For probes with EEPROM identification, the calibration data will be stored based on the unique probe identifier and will reapply data for that particular probe if it is available. The data will not follow a probe from one port to another. For probes without EEPROM identification, the instrument cannot distinguish between different probes of the same type and it will use the data from the last calibration for that probe type on that port.

When in differential mode, both the main and complementary probes are expected to be of the same type.

In some situations, the I and Q channels should be configured identically. In other situations it is convenient to control them independently. Some menus have a "Q Same as I" setting that will cause the Q channel configuration to mirror the I channel configuration, avoiding the overhead of double data entry when the channels should be the same.

The output port is for calibrating the I/Q input ports, although it can also be manually controlled.

There are two types of calibrations available: cable calibration and probe calibration. The cable calibration will guide the user through connecting each input port in turn. All ports must be calibrated together. The probe calibration is done for a specific channel (I or Q). If in Single-Ended mode, only the main port is calibrated. When in Differential Input mode, the user is guided through calibrating both main and complementary ports.

The front panel I/Q port LEDs indicate the current state of that port. On (green) indicates it is active, and off (dark) indicates it is not in use. For example, the Cal Out port LED is on if and only if there is signal coming out of that port.

The input is a context and some parameters have separate values for each context. The SCPI for these parameters has an optional "[:RF|IQ]" node. If the specific context is omitted, the command acts on the current input context's value. Here are the parameters that are input context sensitive:

- Center Frequency
- Trigger Source

It is important to distinguish between the I and Q input ports and the displayed I and Q data values. The I and Q input ports feed into a digital receiver that does digital tuning and filtering. The I and Q data seen by the user (either on the display or through SCPI) corresponds to the real ("I") and the imaginary ("Q") output from the digital receiver. When the input path is I+jQ or I Only and the center frequency is 0 Hz the I input ends up in as the real output from the receiver and appears as "I" data. Likewise, when the input path is I+jQ and the center frequency is 0 Hz, the Q input ends up as the imaginary output from the receiver and appears as "Q" data. However, when the input path is Q Only, the Q input is sent to the receiver as Q+j0, so the receiver output has the Q input coming out on the real output, and so in Q Only, the signal from the Q input port appears as the "I" data. Another situation where the I and Q data do not necessarily correspond directly to the I and Q inputs is when the center frequency is non-zero. The digital processing involved in the tuning is a complex operation. This will result in I Only data appearing as both "I" and "Q" data, the same as that signal would appear if seen through the RF input port.

Baseband I/Q Remote Language Compatibility

For the Agilent E4406A VSA Series Transmitter Tester, Option B7C provided baseband I/Q inputs. Code compatibility has been provided to allow many of the commands for option B7C to function properly with the X-Series. The X-Series has hardware differences and additional capabilities (e.g., E4406A does not have independent settings of I & Q nor does it provide for probe calibrations) which make 100% compatibility impossible.

1. The following commands are supported:

```
:CALibration:IQ:FLATness
```

```
:INPut:IMPedance:IQ U50|B50|U1M|B1M
```

```
:INPut:IMPedance:REFerence <integer>
```

2. The [:SENSe]:FEED RF|IQ|IONLY|QONLY|AREFERENCE|IFALIGN command supports all parameters except IFALIGN. The FEED? query will return only RF|AIQ|AREF.

3. The following commands are not supported:

```
:CALibration:GIQ
```

```
:CALibration:IQ:CMR
```

:INPut:IQ:ALIGn OFF|ON|0|1

The Rohde & Schwarz FSQ-B71 also provides baseband I/Q inputs. A certain amount of code compatibility is provided in the X-Series, however hardware differences make this a somewhat limited set.

Supported:

The "<1|2>" is supported as "[1]".

INPut<1|2>:IQ:BALanced[:STATe] ON | OFF

INPut<1|2>:IQ:TYPE I | Q | IQ

INPut<1|2>:IQ:IMPedance LOW | HIGH

Not Supported:

INPut<1|2>:SELEct AIQ | RF

TRACe<1|2>:IQ:DATA:FORMat COMPatible | IQBLock | IQPair>

TRACe<1|2>:IQ:DATA:MEMory? <offset samples>, <# of samples>

TRACe<1|2>:IQ:DATA?

TRACe<1|2>:IQ:SET <filter type>, <rbw>, <sample rate>, <trigger source>, <trigger slope>, <pretrigger samples>, <# of samples>

TRACe<1|2>:IQ:SRATe 10.0kHz to 81.6MHz

TRACe<1|2>:IQ[:STATe] ON|OFF

The Rohde & Schwarz FMU has the following SCPI, which is not supported (these commands start/abort the probe calibration procedure, which is manually interactive from the front panel):

CALibration:ABORt

CALibration:PROBe[:STARt]

I/Q Path

Selects which I/Q input channels are active. The LED next to each I/Q input port will be on when that port is active.

The analysis bandwidth for each channel is the same as that of the instrument. For example, the base N9020A has a bandwidth of 10 MHz. With I/Q input the I and Q channels would each have an analysis bandwidth of 10 MHz, giving 20 MHz of bandwidth when the I/Q Path is I+jQ. With option B25, the available bandwidth becomes 25 MHz, giving 25 MHz each to I and Q and 50 MHz to I+jQ.

I/Q voltage to power conversion processing is dependent on the I/Q Path selected.

- With I+jQ input we know that the input signal may not be symmetrical about 0 Hz, because it has a complex component. Therefore, above 0 Hz only the positive frequency information is displayed, and below 0 Hz only the negative frequency information is displayed.
- With all other Input Path selections, the input signal has no complex component and therefore is always symmetrical about 0 Hz. In this case, by convention, the power conversion shows the combined voltage for both the positive and negative frequencies. The information displayed below 0 Hz is the mirror of the

information displayed above 0 Hz. This results in a power reading 6.02 dB higher (for both) than would be seen with only the positive frequency voltage. Note also that, in this case the real signal may have complex modulation embedded in it, but that must be recovered by further signal processing.

Key Path	Input/Output, I/Q
Remote Command	[:SENSe] :FEED:IQ:TYPE IQ IONLy QONLy [:SENSe] :FEED:IQ:TYPE?
Example	Set the input to be both the I and Q channels, combined as $I + j * Q$. FEED:IQ:TYPE IQ
Preset	IQ
State Saved	Yes This is unaffected by a Preset but is set to the default value on a "Restore Input/Output Defaults" or "Restore System Defaults->All"
Range	I+jQ I Only Q Only
Readback Text	I+jQ I Only Q Only
Initial S/W Revision	Prior to A.02.00

Remote Command	:INPut [1] :IQ:TYPE IQ I Q :INPut [1] :IQ:TYPE?
Notes	For R&S FSQ-B71 compatibility
Preset	IQ
Initial S/W Revision	Prior to A.02.00

I+jQ

Sets the signal input to be both the I and Q channels. The I and Q channel data will be combined as $I + j * Q$.

Key Path	Input/Output, I/Q, I/Q Path
Example	Set the input to be both the I and Q channels, combined as $I + j * Q$. FEED:IQ:TYPE IQ
Initial S/W Revision	Prior to A.02.00

I Only

Sets the signal input to be only the I channel. The Q channel will be ignored. The data collected is still complex. When the center frequency is 0 the imaginary part will always be zero, but for any other center frequency both the real and imaginary parts will be significant.

Key Path	Input/Output, I/Q, I/Q Path
Example	Set the input to be only the I channel.

	FEED:IQ:TYPE IONL
Initial S/W Revision	Prior to A.02.00

Q Only

Sets the signal input to be only the Q channel. The I channel will be ignored. The Q channel will be sent to the digital receiver block as $Q+j0$. The receiver's output is still complex. When the center frequency is 0 the imaginary part will always be zero, but for any other center frequency both the real and imaginary parts will be significant. Note that since the receiver's real output is displayed as the "I" data, when the center frequency is 0, the Q Only input appears as the "I" data.

Key Path	Input/Output, I/Q, I/Q Path
Example	Set the input to be only the Q channel. FEED:IQ:TYPE QONL
Initial S/W Revision	Prior to A.02.00

I Setup

Access the channel setup parameters for the I channel.

Key Path	Input/Output, I/Q
Initial S/W Revision	Prior to A.02.00

I Differential Input

Selects differential input on or off for the I channel. For differential input (also called balanced input), the analyzer uses both main and complementary ports. When differential input is off (also called single-ended or unbalanced input), the analyzer uses only the main port.

Key Path	Input/Output, I/Q, I Setup
Remote Command	:INPut:IQ[:I]:DIFFerential OFF ON 0 1 :INPut:IQ[:I]:DIFFerential?
Example	Put the I channel in Differential Input mode INP:IQ:DIFF ON
Notes	When I Differential Input = On, the analyzer will check for attenuation mismatches between the I and I-bar ports. If the difference in attenuation values exceeds 0.5 dB a Settings Alert error condition, error 159 will be set. When I Differential Input = On, and IQ Path is I+jQ, the Q Differential input must also be On. Similarly, when I Differential Input = Off, and IQ Path is I+jQ, the Q Differential input must also be Off. If the states of the two inputs do not match, an error condition message is generated, 159;Settings Alert;I/Q mismatch:Differential.

Couplings	Some active probes include built-in differential capability. When one of these probes is sensed, this key is disabled. Since the differential capability is handled in the probe, the Analyzer will use only the main port and the key will show that the Analyzer's Differential Input mode is Off (indicating that the complementary port is not in use). When Q Same as I is On, the value set for I will also be copied to Q.
Preset	Off
State Saved	Yes This is unaffected by a Preset but is set to the default value on a "Restore Input/Output Defaults" or "Restore System Defaults->All"
Range	Off On
Initial S/W Revision	Prior to A.02.00

Remote Command	:INPut [1] :IQ:BAALanced [:STATe] OFF ON 0 1 :INPut [1] :IQ:BAALanced [:STATe] ?
Notes	For R&S FSQ-B71 compatibility, with no independent settings for the I and Q channels. Therefore, it is tied only to the I channel and does not provide an equivalent for the Q channel. For proper operation of the backwards compatibility command Q Same as I should be set to On.
Preset	OFF
Initial S/W Revision	Prior to A.02.00

I Input Z

Selects the input impedance for the I channel. The impedance applies to both the I and I-bar ports.

The input impedance controls the hardware signal path impedance match. It is not used for converting voltage to power. The voltage to power conversion always uses the Reference Z parameter. The Reference Z parameter applies to both I and Q channels.

Key Path	Input/Output, I/Q, I Setup
Remote Command	:INPut [1] :IQ[:I] :IMPedance LOW HIGH :INPut [1] :IQ[:I] :IMPedance?
Example	Set the I channel input impedance to 1 M Ω INP:IQ:IMP HIGH
Notes	LOW = 50 Ω , HIGH = 1 M Ω When IQ Path is I+jQ, the I Input Z setting must be the same as the Q Input Z setting. If the settings of the two inputs do not match, an error condition message is generated, 159;Settings Alert;I/Q mismatch:Input Z.
Couplings	Input impedance is a built-in characteristic of a probe. Therefore, whenever a probe is sensed, this key is disabled and the value is set to match the probe. When no probe is sensed on Q and Q Same as I is On, the value set for I will also be copied to Q.
Preset	LOW

State Saved	Yes This is unaffected by a Preset but is set to the default value on a "Restore Input/Output Defaults" or "Restore System Defaults->All"
Range	50 Ω 1 M Ω
Initial S/W Revision	Prior to A.02.00

I Skew

Sets the skew factor for the I channel. The skew will shift the channel's data in time. Use this to compensate for differences in the electrical lengths of the input paths due to cabling.

Key Path	Input/Output, I/Q, I Setup
Remote Command	<code>[:SENSe] :CORRection:IQ[:I]:SKEW <seconds></code> <code>[:SENSe] :CORRection:IQ[:I]:SKEW?</code>
Example	Delay the data for the I channel by 10 ns. CORR:IQ:SKEW 10 ns
Preset	0
State Saved	Yes This is unaffected by Preset but is set to the default value on a "Restore Input/Output Defaults" or "Restore System Defaults->All"
Range	0 s to 100 ns
Min	0 s
Max	+100 ns
Initial S/W Revision	Prior to A.02.00

I Probe

Access the probe setup parameters for the I channel. See ["I/Q Probe Setup" on page 165](#).

Key Path	Input/Output, I/Q, I Setup
State Saved	No
Readback Text	<code>[<I port probe id>]</code> This is reporting the type of probe sensed on the I port. There is no parameter for overriding what is sensed.
Initial S/W Revision	Prior to A.02.00

Attenuation

The attenuation is part of the calibration data stored with the probe type and is initially the value that was returned by the last calibration. You can modify this value and any changes will be stored with the

calibration data and will survive power cycles and presets. When a probe calibration is performed the attenuation value will be overwritten by the calibration.

Key Path	Input/Output, I/Q, I Setup Q Setup, I Probe Q Probe
Remote Command	[:SENSe] :CORRection:IQ:I Q:ATTenuation:RATio <real> [:SENSe] :CORRection:IQ:I Q:ATTenuation:RATio?
Example	Set the attenuation for the current I probe to 100.00:1. CORR:IQ:I:ATT:RAT 100
Notes	Each probe type has its own attenuation setting. As probes are changed the attenuation value will reflect the new probe's setting. Changing the attenuation affects only the current probe type's setting and leaves all others unchanged. When the IQ Path is I+jQ, the Q probe attenuation setting must match the I Probe attenuation setting within 1 dB. If this is not the case, an error condition message is generated, 159;Settings Alert;I/Q mismatch:Attenuation.
Preset	Each probe type has its own default. The default for the "Unknown" probe type is 1:1.
State Saved	Saved with probe calibration data. It survives a power cycle and is not affected by a Preset or Restore.
Range	0.001 to 10000
Min	0.001
Max	10000
Initial S/W Revision	Prior to A.02.00

This is an alternate form of the SCPI that allows input as a power instead of a ratio.

Remote Command	[:SENSe] :CORRection:IQ:I Q:ATTenuation <rel_ampl> [:SENSe] :CORRection:IQ:I Q:ATTenuation?
Example	Set the attenuation for the current I probe type to 100.00:1. CORR:IQ:I:ATT 20 dB
Range	-60 dB to +80 dB
Min	-60 dB
Max	+80 dB
Initial S/W Revision	Prior to A.02.00

Calibrate

Invokes the guided probe calibration. The guided probe calibration is context sensitive and depends on the channel (I or Q) and the Differential Input state. The calibration is only performed on the selected channel. When Differential Input is on, both the probe attached to the main port and the probe attached to the complementary port are calibrated. When Differential Input is off, only the probe attached to the main port is calibrated. See "[I/Q Guided Calibration](#)" on page 182.

Key Path	Input/Output, I/Q, I Setup Q Setup, I Probe Q Probe, Coupling
Readback Text	The last calibration date, or if no calibration exists, "(empty)". Last: <cal date> <cal time> Example: Last: 8/22/2007 1:02:49 PM
Initial S/W Revision	Prior to A.02.00

Clear Calibration

Clears the calibration data for the current port and probe. It does not clear the data for other probe types or other ports. If the sensed probe has EEPROM identification, only the data for that specific probe is cleared. After this command has completed, the probe calibration state will be the same as if no probe calibration had ever been performed for the specified channel and probe. The probe attenuation will be the default value for that probe type and the Cable Calibration frequency response corrections will be used. This command is dependent on the Differential Input state. When Differential Input is on, both the data for the probe attached to the main port and the data for the probe attached to the complementary port are cleared. When Differential Input is off, only data for the probe attached to the main port is cleared.

Key Path	Input/Output, I/Q, I Setup Q Setup, I Probe Q Probe
Remote Command	:CALibration:IQ:PROBe:I Q:CLEar
Example	Clear the calibration data for the I channel and the current probe (with EEPROM identification) or probe type (without EEPROM identification). :CAL:IQ:PROBe:I:CLE
Initial S/W Revision	Prior to A.02.00

Combined Differential/Input Z (Remote Command Only)

This is Remote Command only (no front panel) and is for backwards compatibility only. It combines the Differential Input and Input Z selections into a single SCPI command.

Remote Command	:INPut:IMPedance:IQ U50 B50 U1M B1M :INPut:IMPedance:IQ?
Example	:INPut:IMPedance:IQ U50 This is equivalent to the following two SCPI commands: :INP:IQ:DIFF OFF :INP:IQ:IMP 50
Notes	Provided for E4406A code compatibility. The enum values translate as follows: U50: Differential Input = Off, Input Z = 50Ω

	<p>B50: Differential Input = On, Input Z = 50Ω U1M: Differential Input = Off, Input Z = 1 MΩ B1M: Differential Input = On, Input Z = 1 MΩ</p> <p>This command is for backwards compatibility. It combines the Input Z (50Ω or 1 MΩ) parameter with the Differential Input (Off = "Unbalanced", On = "Balanced") parameter into a single enumeration.</p> <p>This backwards compatibility SCPI command was for an instrument without independent settings for the I and Q channels. Therefore, it is tied only to the I channel and does not provide an equivalent for the Q channel. For proper operation of the backwards compatibility command Q Same as I should be set to On.</p> <p>Also, note the subtle difference between this SCPI command and the backwards compatibility command for Input Z. The Input Z SCPI has "IQ" before "IMP" while this command has that order reversed.</p>
Couplings	This command does not have an independent parameter, but instead is tied to the Differential Input and Input Z parameters. The coupling for those parameters apply to this command too.
Preset	U50
Initial S/W Revision	Prior to A.02.00

Q Setup

Access the channel setup parameters for the Q channel.

Key Path	Input/Output, I/Q
Readback Text	When Q Same as I is On the readback is "Q Same as I".
Initial S/W Revision	Prior to A.02.00

Q Same as I

Many, but not all, usages require the I and Q channels have an identical setup. To simplify channel setup, the Q Same as I will cause the Q channel parameters to be mirrored from the I channel. That way you only need to set up one channel (the I channel). The I channel values are copied to the Q channel, so at the time Q Same as I is turned off the I and Q channel setups will be identical. This does not apply to Probe settings or to parameters that are determined by the probe.

Key Path	Input/Output, I/Q, Q Setup
Remote Command	:INPut:IQ:MIRRored OFF ON 0 1 :INPut:IQ:MIRRored?
Example	Turn off the mirroring of parameters from I to Q. INP:IQ:MIRR OFF
Couplings	Only displayed for the Q channel. When Yes, the I channel values for some parameters are mirrored (copied) to the Q channel. However, when a parameter is determined by the type of probe and a probe is sensed, the probe setting is always used and the I channel setting is ignored. The following

	parameters are mirrored: Differential Input (when not determined by probe) Input Z (when not determined by probe)
Preset	This is unaffected by a Preset but is set to the default value (Q Same as I set to "On") on a "Restore Input/Output Defaults" or "Restore System Defaults->All"
State Saved	Saved in instrument state
Range	On Off
Readback Text	"Q Same as I" when On, otherwise none.
Initial S/W Revision	Prior to A.02.00

Q Differential Input

Selects differential input on or off for the Q channel. For differential input (also called balanced input), the analyzer uses both the Q and Q-bar ports. When differential input is off (also called single-ended or unbalanced input), the analyzer uses only the Q port.

Key Path	Input/Output, I/Q, Q Setup
Remote Command	:INPut:IQ:Q:DIFFerential OFF ON 0 1 :INPut:IQ:Q:DIFFerential?
Example	Put the Q channel in Differential Input mode INP:IQ:Q:DIFF ON
Notes	When Differential Input = On, the analyzer will check for attenuation mismatches between the Q and Q-bar ports. If the difference in attenuation values exceeds 0.5 dB a Settings Alert error condition, error 159 will be set. When Q Differential Input = On, and IQ Path is I+jQ, the I Differential input must also be On. Similarly, when Q Differential Input = Off, and IQ Path is I+jQ, the I Differential input must also be Off. If the states of the two inputs do not match, an error condition message is generated, 159;Settings Alert;I/Q mismatch:Differential.
Couplings	Some active probes include built-in differential capability. When one of these probes is sensed, this key is disabled. Since the differential capability is handled in the probe, the Analyzer will use only the main port and the key will show that the Analyzer's Differential Input mode is Off (indicating that the complementary port not in use). When a differential probe is not sensed and Q Same as I is On, the value set for I will be copied to Q. This key is disabled when Q Same as I is On.
Preset	Off
State Saved	Yes This is unaffected by a Preset but is set to the default value on a "Restore Input/Output Defaults" or "Restore System Defaults->All"
Range	Off On
Initial S/W Revision	Prior to A.02.00

Q Input Z

Selects the input impedance for the Q channel. The impedance applies to both the Q and Q-bar ports.

The input impedance controls the hardware signal path impedance match. It is not used for converting voltage to power. The voltage to power conversion always uses the Reference Z parameter. The Reference Z parameter applies to both I and Q channels.

Key Path	Input/Output, I/Q, Q Setup
Remote Command	:INPut [1] :IQ:Q:IMPedance LOW HIGH :INPut [1] :IQ:Q:IMPedance?
Example	Set the Q channel input impedance to 1 M Ω INP:IQ:Q:IMP HIGH
Notes	LOW = 50 Ω , HIGH = 1 M Ω When IQ Path is I+jQ, the I Input Z setting must be the same as the Q Input Z setting. If the settings of the two inputs do not match, an error condition message is generated, 159;Settings Alert;I/Q mismatch:Input Z.
Couplings	Input impedance is a built-in characteristic of a probe. Therefore, whenever a probe is sensed, this key is disabled and the value is set to match the probe. When no probe is sensed and Q Same as I is On, the value set for I will also be copied to Q. This key is disabled when Q Same as I is On.
Preset	LOW
State Saved	Yes This is unaffected by Preset but is set to the default value on a "Restore Input/Output Defaults" or "Restore System Defaults->All"
Range	50 Ω 1 M Ω
Initial S/W Revision	Prior to A.02.00

Q Skew

Sets the skew factor for the Q channel. The skew will shift the channel's data in time. Use this to compensate for differences in the electrical lengths of the input paths due to cabling and probes.

Key Path	Input/Output, I/Q, Q Setup
Remote Command	[:SENSe]:CORRection:IQ:Q:SKEW <seconds> [:SENSe]:CORRection:IQ:Q:SKEW?
Example	Delay the data for the Q channel by 10 ns. CORR:IQ:Q:SKEW 10 ns
Preset	0
State Saved	Yes This is unaffected by a Preset but is set to the default value on a "Restore Input/Output Defaults" or "Restore System Defaults->All"
Range	0 s to 100 ns

Min	0 s
Max	+100 ns
Initial S/W Revision	Prior to A.02.00

Q Probe

Accesses the probe setup parameters for the Q channel. See "[I/Q Probe Setup](#)" on page 165.

Key Path	Input/Output, I/Q, Q Setup
State Saved	No
Readback Text	[<Q port probe id> This is reporting the type of probe sensed on the Q port. There is no parameter for overriding what is sensed.
Initial S/W Revision	Prior to A.02.00

Attenuation

The attenuation is part of the calibration data stored with the probe type and is initially the value that was returned by the last calibration. You can modify this value and any changes will be stored with the calibration data and will survive power cycles and presets. When a probe calibration is performed the attenuation value will be overwritten by the calibration.

Key Path	Input/Output, I/Q, I Setup Q Setup, I Probe Q Probe
Remote Command	[:SENSE] :CORREction:IQ:I Q:ATTenuation:RATio <real> [:SENSE] :CORREction:IQ:I Q:ATTenuation:RATio?
Example	Set the attenuation for the current I probe to 100.00:1. CORR:IQ:I:ATT:RAT 100
Notes	Each probe type has its own attenuation setting. As probes are changed the attenuation value will reflect the new probe's setting. Changing the attenuation affects only the current probe type's setting and leaves all others unchanged. When the IQ Path is I+jQ, the Q probe attenuation setting must match the I Probe attenuation setting within 1 dB. If this is not the case, an error condition message is generated, 159;Settings Alert;I/Q mismatch:Attenuation.
Preset	Each probe type has its own default. The default for the "Unknown" probe type is 1:1.
State Saved	Saved with probe calibration data. It survives a power cycle and is not affected by a Preset or Restore.
Range	0.001 to 10000
Min	0.001
Max	10000
Initial S/W Revision	Prior to A.02.00

This is an alternate form of the SCPI that allows input as a power instead of a ratio.

Remote Command	<code>[:SENSe] :CORRection:IQ:I Q:ATTenuation <rel_amp1></code> <code>[:SENSe] :CORRection:IQ:I Q:ATTenuation?</code>
Example	Set the attenuation for the current I probe type to 100.00:1. <code>CORR:IQ:I:ATT 20 dB</code>
Range	-60 dB to +80 dB
Min	-60 dB
Max	+80 dB
Initial S/W Revision	Prior to A.02.00

Calibrate

Invokes the guided probe calibration. The guided probe calibration is context sensitive and depends on the channel (I or Q) and the Differential Input state. The calibration is only performed on the selected channel. When Differential Input is on, both the probe attached to the main port and the probe attached to the complementary port are calibrated. When Differential Input is off, only the probe attached to the main port is calibrated. See "[I/Q Guided Calibration](#)" on page 182.

Key Path	Input/Output, I/Q, I Setup Q Setup, I Probe Q Probe, Coupling
Readback Text	The last calibration date, or if no calibration exists, "(empty)". Last: <cal date> <cal time> Example: Last: 8/22/2007 1:02:49 PM
Initial S/W Revision	Prior to A.02.00

Clear Calibration

Clears the calibration data for the current port and probe. It does not clear the data for other probe types or other ports. If the sensed probe has EEPROM identification, only the data for that specific probe is cleared. After this command has completed, the probe calibration state will be the same as if no probe calibration had ever been performed for the specified channel and probe. The probe attenuation will be the default value for that probe type and the Cable Calibration frequency response corrections will be used. This command is dependent on the Differential Input state. When Differential Input is on, both the data for the probe attached to the main port and the data for the probe attached to the complementary port are cleared. When Differential Input is off, only data for the probe attached to the main port is cleared.

Key Path	Input/Output, I/Q, I Setup Q Setup, I Probe Q Probe
Remote Command	<code>:CALibration:IQ:PROBE:I Q:CLEar</code>
Example	Clear the calibration data for the I channel and the current probe (with EEPROM identification) or probe type (without EEPROM identification).

	:CAL:IQ:PROBe:I:CLE
Initial S/W Revision	Prior to A.02.00

Reference Z

Sets the value of the impedance to be used in converting voltage to power for the I and Q channels. This does not change the hardware's path impedance (see "[I Input Z](#)" on page 156).

Key Path	Input/Output, I/Q
Remote Command	:INPut:IMPedance:REFeRence <integer> :INPut:IMPedance:REFeRence?
Example	Set the I/Q reference impedance to 50 Ω INP:IMP:REF 50
Preset	50 Ω
State Saved	Yes This is unaffected by a Preset but is set to the default value on a "Restore Input/Output Defaults" or "Restore System Defaults->All"
Range	1 Ω to 1 M Ω
Min	1 Ω
Max	1 M Ω
Initial S/W Revision	Prior to A.02.00

I/Q Probe Setup

The set of I/Q probe setup parameters will change based on the type of probe that is sensed. All probe types have the Attenuation parameter, and all probe types can be calibrated. The remaining parameters are only available for some probe types and will not be shown when not available. The probe type is determined by and reported for only for the I and Q ports, never the I-bar or Q-bar ports. The menu title will be "<ch>: <probe id>", where "<ch>" is either "I" or "Q" and "<probe id>" is the type of probe. For example, for the I Probe setup with an Agilent 1130A probe connected to the I port, the title will be "I: 1130A".

Probe calibration data is stored for each probe type for each channel. When no probe is sensed, the probe type "Unknown" is used, and this is also treated like a probe type with its own calibration data. When a probe is changed, the calibration data for that probe type for that port is restored. An advisory message will be displayed showing the new probe type and the calibration status. The calibration data is stored permanently (survives a power cycle) and is not affected by a Preset or any of the Restore commands. When the probe has EEPROM identification (most newer Agilent probes have this), the calibration data is stored by probe serial number and port, so if you have two probes of the same type, the correct calibration data will be used for each. For probes that do not have EEPROM identification, the calibration data is stored by probe type and port and the instrument cannot distinguish between different probes of the same type. In all cases (with or without EEPROM identification), the calibration data is port specific, so it will not follow a specific probe from port to port if the probe is moved.

The "Unknown" probe type is used whenever no probe is sensed. When no calibration data exists for "Unknown" the latest cable calibration data is used (see "[I/Q Guided Calibration](#)" on page 182).

Attenuation

The attenuation is part of the calibration data stored with the probe type and is initially the value that was returned by the last calibration. You can modify this value and any changes will be stored with the calibration data and will survive power cycles and presets. When a probe calibration is performed the attenuation value will be overwritten by the calibration.

Key Path	Input/Output, I/Q, I Setup Q Setup, I Probe Q Probe
Remote Command	[:SENSe] :CORRection:IQ:I Q:ATTenuation:RATio <real> [:SENSe] :CORRection:IQ:I Q:ATTenuation:RATio?
Example	Set the attenuation for the current I probe to 100.00:1. CORR:IQ:I:ATT:RAT 100
Notes	Each probe type has its own attenuation setting. As probes are changed the attenuation value will reflect the new probe's setting. Changing the attenuation affects only the current probe type's setting and leaves all others unchanged. When the IQ Path is I+jQ, the Q probe attenuation setting must match the I Probe attenuation setting within 1 dB. If this is not the case, an error condition message is generated, 159;Settings Alert;I/Q mismatch:Attenuation.
Preset	Each probe type has its own default. The default for the "Unknown" probe type is 1:1.
State Saved	Saved with probe calibration data. It survives a power cycle and is not affected by a Preset or Restore.
Range	0.001 to 10000
Min	0.001
Max	10000
Initial S/W Revision	Prior to A.02.00

This is an alternate form of the SCPI that allows input as a power instead of a ratio.

Remote Command	[:SENSe] :CORRection:IQ:I Q:ATTenuation <rel_amp1> [:SENSe] :CORRection:IQ:I Q:ATTenuation?
Example	Set the attenuation for the current I probe type to 100.00:1. CORR:IQ:I:ATT 20 dB
Range	-60 dB to +80 dB
Min	-60 dB
Max	+80 dB
Initial S/W Revision	Prior to A.02.00

Offset

Some active probes have DC offset capability. When one of these probes is connected this control will be visible. The signal is adjusted for the DC offset before entering the analyzer's port. This allows for removal of a DC offset before reaching the analyzer's input port voltage limits. For example, a signal that varies 1 V peak-to-peak with a DC offset equal to the analyzer's max input voltage would exceed the input limits of the analyzer for half its cycle. Removing the DC offset allows the analyzer to correctly process the entire signal.

Key Path	Input/Output, I/Q, I Setup Q Setup, I Probe Q Probe
Remote Command	:INPut:OFFSet:I Q <voltage> :INPut:OFFSet:I Q?
Example	Remove a DC offset of -0.5 V from the I channel input. INP:OFFS:I -0.5
Notes	Only some probe types support Offset. For those that do, each probe type has its own Offset setting. As probes are changed the Offset value will reflect the new probe's setting. Changing the Offset affects only the current probe type's setting and leaves all others unchanged.
Preset	0 V
State Saved	Saved with probe calibration data. It survives power cycle and is not affected by Preset or Restore.
Range	-18 V to +18 V
Min	-18 V
Max	+18 V
Initial S/W Revision	Prior to A.02.00

Coupling

Some probe types allow coupling to reject low frequencies. This will filter out the DC component of a signal that is composed of a DC bias plus some AC signal. This control is visible only for probe types that have this capability.

Key Path	Input/Output, I/Q, I Setup Q Setup, I Probe Q Probe
Remote Command	:INPut:COUPling:I Q DC LFR1 LFR2 :INPut:COUPling:I Q?
Example	Set the probe to low frequency rejection below 1.7 Hz. INP:COUP:I LFR1
Notes	Only some probe types support Coupling. For those that do, each probe type has its own Coupling setting. As probes are changed the Coupling value will reflect the new probe's setting. Changing the Coupling affects only the current probe type's setting and leaves all others unchanged.
Preset	DC
State Saved	Saved with probe calibration data. It survives a power cycle and is not affected by a Preset or Restore.
Range	DC AC 1.7 Hz LFR1 AC 0.14 Hz LFR2
Readback Text	DC LFR1 LFR2
Initial S/W Revision	Prior to A.02.00

DC

Turns off low frequency rejection, allowing signals down to DC.

Key Path	Input/Output, I/Q, I Setup Q Setup, I Probe Q Probe, Coupling
Example	Turn off low frequency rejection on the I channel INP:COUP:I DC
Initial S/W Revision	Prior to A.02.00

LFR1

Turns on low frequency rejection, rejecting signal component lower than 1.7 Hz.

Key Path	Input/Output, I/Q, I Setup Q Setup, I Probe Q Probe, Coupling
Example	Turn on low frequency rejection on the I channel for frequencies lower than 1.7 Hz INP:COUP:I LFR1
Initial S/W Revision	Prior to A.02.00

LFR2

Turns on low frequency rejection, rejecting signal component lower than 0.14 Hz.

Key Path	Input/Output, I/Q, I Setup Q Setup, I Probe Q Probe, Coupling
Example	Turn on low frequency rejection on the I channel for frequencies lower than 0.14 Hz INP:COUP:I LFR2
Initial S/W Revision	Prior to A.02.00

Calibrate

Invokes the guided probe calibration. The guided probe calibration is context sensitive and depends on the channel (I or Q) and the Differential Input state. The calibration is only performed on the selected channel. When Differential Input is on, both the probe attached to the main port and the probe attached to the complementary port are calibrated. When Differential Input is off, only the probe attached to the main port is calibrated. See "[I/Q Guided Calibration](#)" on page 182.

Key Path	Input/Output, I/Q, I Setup Q Setup, I Probe Q Probe, Coupling
Readback Text	The last calibration date, or if no calibration exists, "(empty)". Last: <cal date> <cal time> Example: Last: 8/22/2007

	1:02:49 PM
Initial S/W Revision	Prior to A.02.00

Clear Calibration

Clears the calibration data for the current port and probe. It does not clear the data for other probe types or other ports. If the sensed probe has EEPROM identification, only the data for that specific probe is cleared. After this command has completed, the probe calibration state will be the same as if no probe calibration had ever been performed for the specified channel and probe. The probe attenuation will be the default value for that probe type and the Cable Calibration frequency response corrections will be used. This command is dependent on the Differential Input state. When Differential Input is on, both the data for the probe attached to the main port and the data for the probe attached to the complementary port are cleared. When Differential Input is off, only data for the probe attached to the main port is cleared.

Key Path	Input/Output, I/Q, I Setup Q Setup, I Probe Q Probe
Remote Command	:CALibration:IQ:PROBe:I Q:CLEar
Example	Clear the calibration data for the I channel and the current probe (with EEPROM identification) or probe type (without EEPROM identification). :CAL:IQ:PROBe:I:CLE
Initial S/W Revision	Prior to A.02.00

RF Calibrator

Lets you choose a calibrator signal to look at or turns the calibrator "off".

Key Path	Input/Output
Remote Command	[:SENSe] :FEED:AREFference REF50 REF4800 OFF [:SENSe] :FEED:AREFference?
Example	FEED:AREF REF50 selects the 50 MHz amplitude reference as the signal input. FEED:AREF REF4800 selects the 4.8 GHz amplitude reference as the signal input FEED:AREF OFF turns the calibrator "off" (switches back to the selected input – RF or I/Q)
Dependencies	Selecting an input (RF or I/Q) turns the Calibrator OFF. This is true whether the input is selected by the keys or with the [:SENSe]:FEED command. The 4.8 GHz internal reference is only available in some models and frequency range options. If the 4.8 GHz reference is not present, the 4.8 GHz softkey will be blanked, and if the REF4800 parameter is sent, the analyzer will generate an error.
Couplings	When one of the calibrator signals is selected, the analyzer routes that signal (an internal amplitude reference) to the analyzer, and changes the main input selection to RF so the calibrator signal can be seen. When you turn the calibrator off it does not switch back to the previously selected input.
Preset	OFF

State Saved	Saved in instrument state
Readback	Off, 50 MHz, 4.8 GHz
Initial S/W Revision	Prior to A.02.00

Remote Command	:CALibration:SOURce:STATe OFF ON 0 1 :CALibration:SOURce:STATe?
Notes	For ESA backwards compatibility. In the ESA the calibrator was a separate output which you connected to the input and switched on with this command. In the X-Series, the ON parameter is aliased to the [SENSe]:FEED:AREF REF50 command and the OFF parameter is aliased to [SENSe]:FEED:AREF OFF. When CALibration:SOURce:STATe? is received, 1 will be returned if any of the references is selected and 0 if the Calibrator is "Off"
Preset	OFF
Initial S/W Revision	Prior to A.02.00

50 MHz

Selects the 50 MHz internal reference as the input signal.

Key Path	Input/Output, RF Calibrator
Example	:FEED:AREF REF50
Readback	50 MHz
Initial S/W Revision	Prior to A.02.00

4.8 GHz

Selects the 4.8 GHz internal reference as the input signal.

Key Path	Input/Output, RF Calibrator
Example	:FEED:AREF REF4800
Dependencies	The 4.8 GHz internal reference is only available in some models and frequency range options. If the 4.8 GHz reference is not present, the 4.8 GHz softkey will be blanked, and if the REF4800 parameter is sent, the analyzer will generate an error.
Readback	4.8 GHz
Initial S/W Revision	Prior to A.02.00
Modified at S/W Revision	A.03.00

Off

Switches the input back to the selected input (RF or I/Q)

Key Path	Input/Output, RF Calibrator
Example	:FEED:AREF OFF
Readback	Off
Initial S/W Revision	Prior to A.02.00

External Gain

Compensates for gain or loss in the measurement system outside the spectrum analyzer. The External Gain is subtracted from the amplitude readout (or the loss is added to the amplitude readout). So, the displayed signal level represents the signal level at the output of the device-under-test, which can be the input of an external device that provides gain or loss.

Entering an External Gain value does not affect the Reference Level, therefore the trace position on screen changes, as do all of the values represented by the trace data. Thus, the values of exported trace data, queried trace data, marker amplitudes, trace data used in calculations such as N dB points, trace math, peak threshold, etc., are all affected by External Gain. Changing the External Gain, even on a trace that is not updating, will immediately change all of the above, without new data needing to be taken.

NOTE

Changing the External Gain causes the analyzer to immediately stop the current sweep and prepare to begin a new sweep. The data will not change until the trace data updates because the offset is applied to the data as it is taken. If a trace is exported with a nonzero External Gain, the exported data will contain the trace data with the offset applied.

In the Spectrum Analyzer mode, a Preamp is the common external device providing gain or loss. In a measurement application mode like GSM or W-CDMA, the gain or loss could be from a BTS (Base Transceiver Station) or an MS (Mobile Station). So in the Spectrum Analyzer mode MS and BTS would be grayed out and the only choice would be Ext Preamp. Similarly in some of the digital communications applications, Ext Preamp will be grayed out and you would have a choice of MS or BTS.

Key Path	Input/Output
Couplings	The Ext Preamp, MS, and BS keys may be grayed out depending on which measurement is currently selected. If any of the grayed out keys are pressed, or the equivalent SCPI command is sent, an advisory message is generated.
Readback	1-of-N selection [variable]
Initial S/W Revision	Prior to A.02.00

Ext Preamp

This function is similar to the reference level offset function. Both affect the displayed signal level. Ref Lvl Offset is a mathematical offset only, no analyzer configuration is affected. Ext Preamp gain is used when determining the auto-coupled value of the Attenuator. The External Gain value and the Maximum Mixer

Level settings are both part of the automatic setting equation for the RF attenuation setting. (10 dB of Attenuation is added for every 10 dB of External Gain.)

Note that the Ref Lvl Offset and Maximum Mixer Level are described in the Amplitude section. They are reset by the instrument Preset. The External Preamp Gain is reset by the "Restore Input/Output Defaults" or "Restore System Defaults->All functions. . The External Gain is subtracted from the amplitude readout so that the displayed signal level represents the signal level at the output of the device-under-test, which is the input of the external device that is providing gain or loss.

"More Information" on page 172

Key Path	Input/Output, External Gain
Remote Command	<code>[:SENSe] :CORRection:SA[:RF]:GAIN <rel_ampl></code> <code>[:SENSe] :CORRection:SA[:RF]:GAIN?</code>
Example	CORR:SA:GAIN 10 sets the Ext Gain value to 10 dB CORR:SA:GAIN -10 sets the Ext Gain value to -10 dB (that is, an attenuation of 10 dB)
Notes	Does not auto return.
Dependencies	The reference level limits are determined in part by the External Gain/Atten, Max Mixer Level, and RF Atten. This key is grayed out in Modes that do not support External Gain
Preset	This is unaffected by Preset but is set to 0 dB on a "Restore Input/Output Defaults" or "Restore System Defaults->All"
State Saved	Saved in instrument state
Min	-120 dB
Max	120 dB
Readback	Preamp Gain, <Ext Gain value> dB
Backwards Compatibility SCPI	<code>[:SENSe] :CORRection:OFFSet[:MAGNitude]</code> The legacy "Ext Preamp Gain" key is now called "Ext Gain" and the sub-menu has choices of Ext Preamp MS BTS for backwards compatibility.
Initial S/W Revision	Prior to A.02.00
Modified at S/W Revision	A.14.00

More Information

The U7227A USB Preamplifier is an accessory for the X-Series Signal Analyzer that provides gain externally, and whose gain settings are automatically loaded into the analyzer over USB whenever it is connected to one of the analyzer's USB ports.

While the USB Preamplifier is plugged into one of the analyzer's USB ports, the analyzer will consider it to be in the signal path of the RF Input and will apply the calibration data from the USB Preamp to measurements taken at the RF Input (on 2 input boxes, it will be considered to be in the signal path of RF Input 1; it is not supported for RF Input 2).

The USB Preamplifier contains its own cal data. This includes a noise trace suitable for use with NFE, for those models which support NFE. The act of connecting the Preamp to USB will cause the cal data to be downloaded from the preamp. When this happens an informational message is provided saying "Cal data loaded from USB Preamp". The analyzer will then automatically apply the calibration factors loaded from the Preamp in any measurement that supports the USB Preamp.

The External Preamp Gain setting may still be used, even though it is not required for the USB Preamp (since the USB Preamp supplies its own gain data to the analyzer which is applied automatically). Connecting the USB Preamp does not change the External Preamp Gain setting, however unless you have another gain or attenuation element in the signal path, the appropriate setting for External Preamp Gain is 0 dB.

Overload detection and reporting will apply when the USB preamplifier is connected to USB. The USB Preamplifier has its own overload detector which reports overloads to the instrument over USB. This generates an error condition, "Input Overload;USB Preamp."

If, while the USB Preamp is connected to USB, a measurement is selected that does not support the USB preamplifier, the "No result; Meas invalid with Preamp" error condition is generated.

MS

Sets an external gain/attenuation value for MS (Mobile Station) tests.

Key Path	Input/Output, External Gain
Remote Command	<code>[:SENSe] :CORRection:MS[:RF]:GAIN <rel_ampl></code> <code>[:SENSe] :CORRection:MS[:RF]:GAIN?</code>
Example	CORR:MS:GAIN 10 sets the Ext Gain value to 10 dB CORR:MS:GAIN -10 sets the Ext Gain value to -10 dB (that is, a loss of 10 dB.)
Notes	Does not auto return.
Dependencies	The reference level limits are determined in part by the External Gain, Max Mixer Level, RF Atten This key is grayed out in modes that do not support MS.
Preset	This is unaffected by a Preset but is set to 0 dB on a "Restore Input/Output Defaults" or "Restore System Defaults->All"
State Saved	Saved in instrument state.
Min	-100 dB
Max	100 dB
Readback	MS, <Ext Gain value> dB
Initial S/W Revision	Prior to A.02.00

Remote Command	<code>[:SENSe] :CORRection:MS[:RF]:LOSS <rel_ampl></code> <code>[:SENSe] :CORRection:MS[:RF]:LOSS?</code>
Example	CORR:MS:LOSS 10 sets the Ext Gain value to -10 dB, and subsequently querying :LOSS will give 10 dB CORR:MS:LOSS -10 sets the Ext Gain value to 10 dB, and subsequently querying :LOSS will give -10

	dB
Notes	A positive value of <rel_ampl> in the above command means a loss and a negative value indicates a gain. Anytime :LOSS is set it sets :GAIN to the negative value of the parameter sent. Anytime :LOSS is queried it gives the negative of :GAIN
Preset	This is unaffected by a Preset but is set to 0 dB on a "Restore Input/Output Defaults" or "Restore System Defaults->All"
Min	100 dB
Max	-100 dB
Initial S/W Revision	Prior to A.02.00

BTS

Sets an external attenuation value for BTS (Base Transceiver Station) tests.

Key Path	Input/Output, External Gain
Remote Command	<code>[:SENSE] :CORRection:BTS [:RF] :GAIN <rel_ampl></code> <code>[:SENSE] :CORRection:BTS [:RF] :GAIN?</code>
Example	<code>CORR:BTS:GAIN 10</code> sets the Ext Gain value to 10 dB <code>CORR:BTS:GAIN -10</code> sets the Ext Gain value to -10 dB (that is, a loss of 10 dB.)
Notes	Does not auto return.
Dependencies	The reference level limits are determined in part by the External Gain, Max Mixer Level, RF Atten This key is grayed out in modes that do not support BTS.
Preset	This is unaffected by a Preset but is set to 0 dB on a "Restore Input/Output Defaults" or "Restore System Defaults->All"
State Saved	Saved in instrument state.
Min	-100 dB
Max	100 dB
Readback	BTS, <Ext Gain value> dB
Initial S/W Revision	Prior to A.02.00

Remote Command	<code>[:SENSE] :CORRection:BTS [:RF] :LOSS <rel_ampl></code> <code>[:SENSE] :CORRection:BTS [:RF] :LOSS?</code>
Example	<code>CORR:BTS:LOSS 10</code> sets the Ext Gain value to -10 dB, and subsequently querying :LOSS will give 10 dB <code>CORR:BTS:LOSS -10</code> sets the Ext Gain value to 10 dB, and subsequently querying :LOSS will give -10 dB
Notes	A positive value of <rel_ampl> in the above command means a loss and a negative value indicates a

	gain. Anytime :LOSS is set it sets :GAIN to the negative value of the parameter sent. Anytime :LOSS is queried it gives the negative of :GAIN
Preset	This is unaffected by a Preset but is set to 0 dB on a "Restore Input/Output Defaults" or "Restore System Defaults->All"
Min	100 dB
Max	-100 dB
Initial S/W Revision	Prior to A.02.00

I Ext Gain

This function affects the I channel input. However, when Q Gain in I+jQ is set to Same as I Gain, this value is applied to both I and Q channel inputs.

Key Path	Input/Output, External Gain
Remote Command	<code>[:SENSe] :CORRection:IQ:I:GAIN <rel_ampl></code> <code>[:SENSe] :CORRection:IQ:I:GAIN?</code>
Example	Set the I Ext Gain to 10 dB <code>CORR:IQ:I:GAIN 10</code> Set the I Ext Gain to -10 dB (that is, a loss of 10 dB.) <code>CORR:IQ:I:GAIN -10</code>
Dependencies	Not available unless option BBA is installed
Preset	0 dB This is unaffected by a Preset but is set to 0 dB on a "Restore Input/Output Defaults" or "Restore System Defaults->All"
State Saved	Saved in instrument state.
Min	-100 dB
Max	100 dB
Readback Text	I Gain, <I Ext Gain> dB
Initial S/W Revision	Prior to A.02.00

Q Ext Gain

This function affects the Q channel input.

Key Path	Input/Output, External Gain
Remote Command	<code>[:SENSe] :CORRection:IQ:Q:GAIN <rel_ampl></code> <code>[:SENSe] :CORRection:IQ:Q:GAIN?</code>

Example	Set the Q Ext Gain to 10 dB CORR:IQ:Q:GAIN 10 Set the Q Ext Gain to -10 dB (that is, a loss of 10 dB.) CORR:IQ:Q:GAIN -10
Dependencies	Not available unless option BBA is installed.
Preset	0 dB This is unaffected by a Preset but is set to 0 dB on a "Restore Input/Output Defaults" or "Restore System Defaults->All"
State Saved	Saved in instrument state
Min	-100 dB
Max	100 dB
Readback Text	Q Gain, <l Ext Gain> dB
Initial S/W Revision	Prior to A.02.00

Restore Input/Output Defaults

This selection causes the group of settings and data associated with the Input/Output key to be a reset to their default values. In addition, when a Source is installed, licensed and selected, Restore Input/Output defaults will initiate a Source Preset.

This level of Restore System Defaults does not affect any other system settings or mode settings and does not cause a mode switch. All the features described in this section are reset using this key, including Input Corrections and Data (described in the Corrections section).

Key Path	Input/Output
Example	:SYST:DEF INP presets all the Input/Output variables to their factory default values.
Notes	Refer to the Utility Functions for information about Restore System Defaults and the complete description of the :SYSTem:DEFAult INPut: command.
Initial S/W Revision	Prior to A.02.00

Freq Ref In

Specifies the frequency reference as being the internal reference at the rear panel input labeled EXT REF IN, a 1 pulse per second signal at the EXT REF IN input,, external reference or sensing the presence of a signal at the EXT REF IN input.

When the frequency reference is set to internal, the internal 10 MHz reference is used even if an external reference is connected.

When the frequency reference is set to external, the instrument will use the external reference. However, if there is no external signal present, or it is not within the proper amplitude range, a condition error message is generated. When the external signal becomes valid, the error is cleared.

When the frequency reference is set to Pulse, the instrument expects a 1 pulse per second signal at the EXT REF IN input. The instrument uses this signal to adjust the frequency of the internal reference.

If Sense is selected, the instrument checks whether a signal is present at the external reference connector. If it senses a signal within 5 ppm of the External Ref Freq (as set on the External Ref Freq softkey), it will automatically switch to the external reference. If it senses a 1 pulse per second signal, it enters Pulse mode, wherein the signal is used to adjust the internal reference. When no signal is present, it automatically switches to the internal reference. No message is generated as the reference switches between pulse, external and internal. The monitoring of the external reference occurs approximately on 1 millisecond intervals, and never occurs in the middle of a measurement acquisition, only at the end of the measurement (end of the request).

If for any reason the instrument's frequency reference is not able to obtain lock, Status bit 1 in the Questionable Frequency register will be true and a condition error message is generated. When lock is regained, Status bit 1 in the Questionable Frequency register will be cleared and the condition error will be cleared.

If an external frequency reference is being used, you must enter the frequency of the external reference if it is not exactly 10 MHz. The External Ref Freq key is provided for this purpose.

Key Path	Input/Output
Remote Command	<code>[[:SENSe]:ROSCillator:SOURce:TYPE INTernal EXTernal SENSE PULSe [:SENSe]:ROSCillator:SOURce:TYPE?</code>
Dependencies	The PULSe parameter, and support of the 1 pps signal at the EXT REF IN input, are not available in firmware prior to A.13.00. They are also not available in some model numbers. If not available, the Pulse key will be blank, and sending the PULSe parameter via SCPI will generate an error:
Preset	This is unaffected by a Preset but is set to SENSE on a "Restore Input/Output Defaults" or "Restore System Defaults->All".
State Saved	Saved in instrument state.
Status Bits/OPC dependencies	STATus:QUEStionable:FREQUency bit 1 set if unlocked.
Backwards Compatibility Notes	Freq Ref In was not saved in state in the legacy instruments. It is a part of state in the X-Series.
Initial S/W Revision	Prior to A.02.00
Modified at S/W Revision	A.14.00

Remote Command	<code>[[:SENSe]:ROSCillator:SOURce?</code>
Notes	<p>The query <code>[SENSe]:ROSCillator:SOURce?</code> returns the current switch setting. This means:</p> <ol style="list-style-type: none"> 1. If it was set to SENSE but there is no external reference nor 1 pps signal so the instrument is actually using the internal reference, then this query returns INTernal and not SENSE. 2. If it was set to SENSE and there is an external reference present, the query returns EXTernal and not SENSE. 3. If it was set to SENSE and there is a 1 pps signal present, the query returns PULSe and not SENSE. 4. If it was set to EXTernal, then the query returns "EXTernal" 5. If it was set to INTernal, then the query returns "INTernal".

	6. If it was set to PULSe, then the query returns "PULSe"
Preset	SENSe
Backwards Compatibility Notes	The query [:SENSe]:ROSCillator:SOURce? was a query-only command in ESA which always returned whichever reference the instrument was using. The instrument automatically switched to the ext ref if it was present. In PSA (which had no sensing) the command [:SENSe]:ROSCillator:SOURce set the reference (INT or EXT), so again its query returned the actual routing. Thus the query form of this command is 100% backwards compatible with both instruments.
Initial S/W Revision	Prior to A.02.00
Remote Command	<code>[:SENSe]:ROSCillator:SOURce INTernal EXTernal</code>
Notes	For PSA compatibility the command form is provided and is directly mapped to [:SENSe]:ROSCillator:SOURce:TYPE
Initial S/W Revision	Prior to A.02.00

Sense

If Sense is selected, the instrument checks whether a signal is present at the external reference connector. If it senses a signal within 5 ppm of the External Ref Freq (as set on the External Ref Freq softkey), it will use this signal as an External Reference. If it senses a 1 pulse per second signal, it will use this signal to adjust the internal reference by adjusting the User setting of the Timebase DAC. When no signal is present, it automatically switches to the internal reference.

Key Path	Input/Output, Freq Ref In
Example	:ROSC:SOUR:TYPE SENS
Couplings	If set to SENSe and the analyzer senses a 1 pulse per second signal, it sets the System, Alignments, Timebase DAC setting to "User". This setting survives Preset and Power Cycle but is set to "Calibrated" on a System, Restore Defaults, Align or a System, Restore Defaults, All
Readback	Sense
Initial S/W Revision	Prior to A.02.00
Modified at S/W Revision	A.14.00

Internal

The internal reference is used. A 1 pps signal at the EXT REF IN port, or a signal there between 1 and 50 MHz, will cause a warning triangle to appear in the settings panel next to the word "INTERNAL", but will otherwise be ignored.

Key Path	Input/Output, Freq Ref In
Example	:ROSC:SOUR:TYPE INT
Readback	Internal
Initial S/W Revision	Prior to A.02.00
Modified at S/W Revision	A.14.00

External

The external reference is used.

Key Path	Input/Output, Freq Ref In
Example	:ROSC:SOUR:TYPE EXT
Readback	External
Initial S/W Revision	Prior to A.02.00

Ext Ref Freq

This key tells the analyzer the frequency of the external reference. When the external reference is in use (either because the reference has been switched to External or because the Reference has been switched to Sense and there is a valid external reference present) this information is used by the analyzer to determine the internal settings needed to lock to that particular external reference signal.

For the instrument to stay locked, the value entered must be within 5 ppm of the actual external reference frequency. So it is important to get it close, or you risk an unlock condition.

Note that this value only affects the instrument's ability to lock. It does not affect any calculations or measurement results. See "Freq Offset" in the Frequency section for information on how to offset frequency values.

Key Path	Input/Output, Freq Ref In
Remote Command	[:SENSe] :ROSCillator:EXTernal:FREQuency <freq> [:SENSe] :ROSCillator:EXTernal:FREQuency?
Example	ROSC:EXT:FREQ 20 MHz sets the external reference frequency to 20 MHz, but does not select the external reference. ROSC:SOUR:TYPE EXT selects the external reference.
Dependencies	Still available with Internal or Pulse selected, to allow setup for when External is in use. However, the setting has no effect if the Internal Reference is in use (Freq Ref In set to Internal, Pulse, or SENSE:INT or SENSE:PULSE).
Preset	This is unaffected by a Preset but is set to 10 MHz on a "Restore Input/Output Defaults" or "Restore System Defaults->All"
Min	CXA: 10 MHz

	EXA: 10 MHz MXA: 1 MHz PXA: 1 MHz N8973B, N8974B, N8975B, or N8976B: 10 MHz
Max	CXA: 10 MHz EXA: 10 MHz EXA with option R13: 20 MHz MXA: 50 MHz PXA: 50 MHz N8973B, N8974B, N8975B, or N8976B: 10 MHz
Default Unit	Hz
Initial S/W Revision	Prior to A.02.00
Modified at S/W Revision	A.14.00

External Reference Lock BW

This control lets you adjust the External Reference phase lock bandwidth. This control is available in some models of the X-Series.

The PXA variable reference loop bandwidth allows an external reference to be used and have the analyzer close-in phase noise improved to match that of the reference. This could result in an improvement of tens of decibels. The choice of “Wide” or “Narrow” affects the phase noise at low offset frequencies, especially 4 to 400 Hz offset. When using an external reference with superior phase noise, we recommend setting the external reference phase-locked-loop bandwidth to wide (60 Hz), to take advantage of that superior performance. When using an external reference with inferior phase noise performance, we recommend setting that bandwidth to narrow (15 Hz). In these relationships, inferior and superior phase noise are with respect to -134 dBc/Hz at 30 Hz offset from a 10 MHz reference. Because most reference sources have phase noise behavior that falls off at a rate of 30 dB/decade, this is usually equivalent to -120 dBc/Hz at 10 Hz offset.

Key Path	Input/Output, Freq Ref In
Scope	Mode Global
Remote Command	<code>[:SENSe] :ROSCillator :BANDwidth WIDE NARRow</code> <code>[:SENSe] :ROSCillator :BANDwidth ?</code>
Example	ROSC:BAND WIDE
Dependencies	Still available with Internal or Pulse selected, to allow setup for when External is in use. However, the setting has no effect if the Internal Reference is in use (Freq Ref In set to Internal, Pulse, or SENSE:INT or SENSE:PULSE). This key only appears in analyzers equipped with the required hardware.

Preset	This is unaffected by a Preset but is set to Narrow on a "Restore Input/Output Defaults" or "Restore System Defaults -> All"
State Saved	Saved in Input/Output state.
Initial S/W Revision	A.04.00
Modified at S/W Revision	A.14.00

External Ref Coupling

Only appears with option ERC installed and licensed.

This function lets you couple the sweep system of the analyzer to the state of the External Reference. If Normal is selected, data acquisition proceeds regardless of the state of the External Reference. When you select Ext Ref Out Of Range Stops Acquisition, the data acquisition (sweep or measurement) stops when either the "521, External ref out of range" or the "503, Frequency Reference unlocked" error message is asserted. Note that this will only take place if the Freq Ref In selection is External.

With the acquisition stopped, the data display will stop updating (even if this occurs in the middle of a sweep or measurement) and no data will be returned to a READ? or MEASure? query; that is, these queries will not complete because the analyzer will not respond to them. Furthermore, no response will be generated to a *WAI? or *OPC? query.

Proper SCPI sequences are shown below, which will always fail to return if the acquisition stops during the requested sweep or measurement. Note that, for predictable operation of this function, it is best to operate the analyzer in single measurement mode (INIT:CONT OFF), because if operating in continuous mode, the analyzer may respond to the above queries even after the acquisition stops, with data left over from the previous acquisition.

```
:INIT:CONT OFF
```

```
:INIT:IMM;*OPC?
```

```
--
```

```
:INIT:CONT OFF
```

```
:INIT:IMM;*WAI?
```

```
--
```

```
:INIT:CONT OFF
```

```
:READ?
```

```
--
```

```
:INIT:CONT OFF
```

```
:MEASure?
```

When the acquisition ceases, in addition to the error condition(s) described above, a popup error message will be generated informing you that the acquisition has ceased due to an invalid external reference. This message will stay on the screen while the acquisition is suspended.

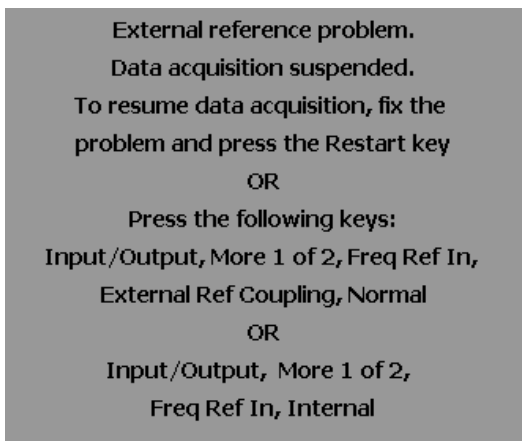

If you press the Restart key this message will be taken off the screen and a new acquisition will be attempted. If the External Reference problem persists the message will re-appear. You can also remove the message by changing back to the Normal setting of Sweep/Ext Ref Coupling, or by pressing Freq Ref In, Internal, or Freq Ref In, Sense, or Restore Input/Output Defaults.

The setting of External Ref Coupling is persistent across power-cycling and is not reset with a Preset. It is reset to the default state (Normal) when Restore Input/Output Defaults is invoked, which will also restart normal data acquisition.

The detection of invalid external reference is under interrupt processing. If the external reference becomes invalid then returns to valid in too short a time, no error condition will be detected or reported and therefore the acquisition will not be stopped.

Key Path	Input/Output, Freq Ref In
Mode	All
Remote Command	[:SENSe] :ROSCillator :COUPling NORMal NACQuisition [:SENSe] :ROSCillator :COUPling ?
Preset	This setting is persistent: it survives power-cycling or a Preset and is reset with Restore Input/Output defaults.
State Saved	Not saved in instrument state
Readback	Normal Stop Acq
Initial S/W Revision	A.02.00

I/Q Guided Calibration

Calibrating the Baseband I/Q ports requires several steps and manual connections. The Guided Calibration will interactively step you through the required steps, displaying diagrams to help with the connections. The steps will vary depending on the setup.

In the Guided Calibration windows, the date and time of the last calibration are displayed. If any of the items listed are displayed in yellow, this indicates that the calibration for that item is inconsistent with the latest calibration, and you should complete the entire calibration process before you exit the calibration.

I/Q Isolation Calibration

The I/Q Isolation Calibration must be run before calibrating any port with either the I/Q Cable Calibration or I/Q Probe Calibration. This calibration is performed with nothing connected to any of the front panel I/Q ports. This is the first step in both the I/Q Cable Calibration and the I/Q Probe Calibration.

Next

Perform the I/Q Isolation calibration.

Key Path	Input/Output, I/Q, I/Q Cable Calibration
Remote Command	:CALibration:IQ:ISOLation
Example	CAL:IQ:ISOL
Notes	All front panel I/Q ports must not be connected to anything.
Notes	All cables and probes should be disconnected from the I/Q ports before issuing the SCPI command.
State Saved	No.
Initial S/W Revision	Prior to A.02.00

Exit

Exits the calibration procedure. All ports calibrated before pressing Exit will use the newly acquired calibration data.

Key Path	Input/Output, I/Q, I/Q Cable Calibration
Notes	Using the Exit button will not restore the calibration data to the state prior to entering the guided calibration. Once a port is calibrated the data is stored immediately and the only way to change it is to redo the calibration step. When the calibration may be left in an inconsistent state, a confirmation dialog will be displayed (see "Exit Confirmation" on page 194).
Initial S/W Revision	Prior to A.02.00

I/Q Isolation Calibration Time (Remote Command Only)

Returns the last date and time that the I/Q Isolation Calibration was performed. This is a remote query command only.

Remote Command	:CALibration:IQ:ISOLation:TIME?
Example	:CAL:IQ:ISOL:TIME?
Notes	This returns 6 integer values: year, month, day, hour, minute, second. When no calibration has been performed, all values will be 0.
Initial S/W Revision	A.02.00

I/Q Cable Calibrate...

The I/Q cable calibration creates correction data for each of the front panel I/Q ports. This calibration data is used whenever no probe specific calibration data is available. It is important that all ports are calibrated using the same short BNC cable so that the data is comparable from port to port.

The guided calibration (front panel only) will show connection diagrams and guide you through the isolation calibration and calibrating each port. The calibration data for each port is stored separately, so as soon as a port is calibrated that data is saved and will be used. If you press "Exit" to exit the calibration process, the data for the ports already completed will still be used. It is recommended that a calibration be completed once started, or if exited, that it be properly done before the next use of the I/Q ports. The "Next" button will perform the calibration for the current port and then proceed to the next step in the calibration procedure. The "Back" button will return to the prior port in the procedure. Both keys and dialog buttons are supplied for ease of use. The dialog buttons are for mouse use and the softkeys for front panel use.

The calibration can also be done via SCPI, but no connection diagrams will be shown. You will have to make the correct connections before issuing each port calibration command. Again, it is recommended that all ports be calibrated at the same time.

The instrument state remains as it was prior to entering the calibration procedure except while a port is actually being calibrated. Once a port is calibrated it returns to the prior state. A port calibration is in process only from the time the "Next" button is pressed until the next screen is shown. For SCPI, this corresponds to the time from issuing the CAL:IQ:FLAT:|I|B|Q|QB command until the operation is complete.

For example, if the prior instrument state is Cal Out = Off, Input = I+jQ, and Differential = Off, then up until the time the "Next" button is pressed the I Input and Q Input LEDs are on and the Cal Out, I-bar Input and Q-bar Input LEDs are off. Once the "Next" button is pressed for the I port calibration, only the Cal Out and I Input LEDs will be on and the others will be off. When the screen progresses to the next step ("Next" button again enabled), the prior state is restored and only the I Input and Q Input LEDs are on (Cal Out is off again).

The last calibration date and time for each port will be displayed. Any calibrations that are more than a day older than the most recent calibration will be displayed with the color amber.

Key Path	Input/Output, I/Q
Initial S/W Revision	Prior to A.02.00

I Port

The I port calibration is performed with the front panel's I port connected via a short BNC cable to the Cal Out port. The guided calibration will show a diagram of the required connections.

Back

Return to the prior step in the calibration procedure.

Key Path	Input/Output, I/Q, Q Setup, Q Probe, Calibrate
Initial S/W Revision	Prior to A.02.00

Next

Perform the I port calibration.

Key Path	Input/Output, I/Q, I/Q Cable Calibrate...
Remote Command	:CALibration:IQ:FLATness:I
Example	CAL:IQ:FLAT:I
Notes	The recommended procedure is to use the same BNC cable to calibrate all I/Q ports. All I/Q ports should be calibrated sequentially during the procedure. The calibration data is saved as soon as the port is calibrated and will survive power cycles. It is not reset by any preset or restore data commands.
Notes	The I port must be connected to the Cal Out port before issuing the SCPI command.
State Saved	No.
Initial S/W Revision	Prior to A.02.00

Exit

Exit the calibration procedure. All ports calibrated before pressing Exit will use the newly acquired calibration data.

Key Path	Input/Output, I/Q, I/Q Cable Calibrate...
Notes	Using the Exit button will not restore the calibration data to the state prior to entering the guided calibration. Once a port is calibrated the data is stored immediately and the only way to change it is to redo the calibration step. When the calibration may be left in an inconsistent state, a confirmation dialog will be displayed (see "Exit Confirmation" on page 194).
Initial S/W Revision	Prior to A.02.00

I-bar Port

The I-bar port calibration is performed with the front panel's I-bar port connected via a short BNC cable to the Cal Out port. The guided calibration will show a diagram of the required connections.

Back

Return to the prior step in the calibration procedure.

Key Path	Input/Output, I/Q, I/Q Cable Calibration
Notes	Using the Back button will not restore the calibration data to a prior state. Once a port is calibrated the data is stored immediately and the only way to change it is to redo the calibration step. The Back button allows the user to go back to a prior step to redo that calibration step.
Initial S/W Revision	Prior to A.02.00

Next

Perform the I-bar port calibration.

Key Path	Input/Output, I/Q, I/Q Cable Calibrate...
Remote Command	:CALibration:IQ:FLATness:IBAR
Example	CAL:IQ:FLAT:IBAR
Notes	The recommended procedure is to use the same BNC cable to calibrate all I/Q ports. All I/Q ports should be calibrated sequentially during the procedure. The calibration data is saved as soon as the port is calibrated and will survive power cycles. It is not reset by any preset or restore data commands.
Notes	The I-bar port must be connected to the Cal Out port before issuing the SCPI command.
State Saved	No
Initial S/W Revision	Prior to A.02.00

Exit

Exit the calibration procedure. All ports calibrated before pressing Exit will use the newly acquired calibration data.

Key Path	Input/Output, I/Q, I/Q Cable Calibrate...
Notes	Using the Exit button will not restore the calibration data to the state prior to entering the guided calibration. Once a port is calibrated the data is stored immediately and the only way to change it is to redo the calibration step. When the calibration may be left in an inconsistent state, a confirmation dialog will be displayed (see "Exit Confirmation" on page 194).
Initial S/W Revision	Prior to A.02.00

Q Port

The Q port calibration is performed with the front panel's Q port connected via a short BNC cable to the Cal Out port. The guided calibration will show a diagram of the required connections.

Back

Return to the prior step in the calibration procedure.

Key Path	Input/Output, I/Q, I/Q Cable Calibrate...
Notes	Using the Back button will not restore the calibration data to a prior state. Once a port is calibrated the data is stored immediately and the only way to change it is to redo the calibration step. The Back button allows the user to go back to a prior step to redo that calibration step.
Initial S/W Revision	Prior to A.02.00

Next

Perform the Q port calibration.

Key Path	Input/Output, I/Q, I/Q Cable Calibrate...
Remote Command	:CALibration:IQ:FLATness:Q
Example	CAL:IQ:FLAT:Q
Notes	The recommended procedure is to use the same BNC cable to calibrate all I/Q ports. All I/Q ports should be calibrated sequentially during the procedure. The calibration data is saved as soon as the port is calibrated and will survive power cycles. It is not reset by any preset or restore data commands.
Notes	The Q port must be connected to the Cal Out port before issuing the SCPI command.
State Saved	No
Initial S/W Revision	Prior to A.02.00

Exit

Exit the calibration procedure. All ports calibrated before pressing Exit will use the newly acquired calibration data.

Key Path	Input/Output, I/Q, I/Q Cable Calibrate...
Notes	Using the Exit button will not restore the calibration data to the state prior to entering the guided calibration. Once a port is calibrated the data is stored immediately and the only way to change it is to redo the calibration step. When the calibration may be left in an inconsistent state, a confirmation dialog will be displayed (see "Exit Confirmation" on page 194).
Initial S/W Revision	Prior to A.02.00

Q-bar Port

The Q-bar port calibration is performed with the front panel's Q-bar port connected via a short BNC cable to the Cal Out port. The guided calibration will show a diagram of the required connections.

Back

Return to the prior step in the calibration procedure.

Key Path	Input/Output, I/Q, I/Q Cable Calibrate...
Notes	Using the Back button will not restore the calibration data to a prior state. Once a port is calibrated the data is stored immediately and the only way to change it is to redo the calibration step. The Back button allows the user to go back to a prior step to redo that calibration step.
Initial S/W Revision	Prior to A.02.00

Next

Perform the Q-bar port calibration.

Key Path	Input/Output, I/Q, I/Q Cable Calibrate...
Remote Command	:CALibration:IQ:FLATness:QBAR
Example	CAL:IQ:FLAT:QBAR
Notes	The recommended procedure is to use the same BNC cable to calibrate all I/Q ports. All I/Q ports should be calibrated sequentially during the procedure. The calibration data is saved as soon as the port is calibrated and will survive power cycles. It is not reset by any preset or restore data commands.
Notes	The Q-bar port must be connected to the Cal Out port before issuing the SCPI command.
State Saved	No
Initial S/W Revision	Prior to A.02.00

Exit

Exit the calibration procedure. All ports calibrated before pressing Exit will use the newly acquired calibration data.

Key Path	Input/Output, I/Q, I/Q Cable Calibrate...
Notes	Using the Exit button will not restore the calibration data to the state prior to entering the guided calibration. Once a port is calibrated the data is stored immediately and the only way to change it is to redo the calibration step. When the calibration may be left in an inconsistent state, a confirmation dialog will be displayed (see " Exit Confirmation " on page 194).
Initial S/W Revision	Prior to A.02.00

I/Q Cable Calibration Time (Remote Command Only)

Returns the last date and time that the I/Q Cable Calibration was performed for a specific port. This is a remote query command only.

Remote Command	:CALibration:IQ:FLATness:I IBAR Q QBAR:TIME?
Example	:CAL:IQ:FLAT:I:TIME?
Notes	This returns 6 integer values: year, month, day, hour, minute, second. When no calibration has been performed, all values will be 0.
Initial S/W Revision	A.02.00

I/Q Probe Calibration

The I/Q probe calibration creates correction data for one of the front panel I/Q channels. When the probe has EEPROM identification, the data is unique to that specific probe. When the probe does not have

EEPROM identification, the data will be used for all probes of the same type. The data is also unique to the channel, so calibration data for the I channel will not be used for the Q channel and vice versa.

The guided calibration (front panel only) will show connection diagrams and guide the user through the I/Q Isolation Calibration and through calibrating each port. The calibration data for each port is stored separately, so as soon as a port is calibrated that data is saved and will be used. If a user presses "Exit" to exit the calibration process, the data for the port already completed will still be used. It is recommended that a calibration be completed once started, or if exited, that it be properly done before the next use of the probe. The "Next" button will perform the calibration for the current port and then proceed to the next step in the calibration procedure. The "Back" button will return to the prior port in the procedure. Both softkeys and dialog buttons are supplied for ease of use. The dialog buttons are for mouse use and the softkeys for front panel use.

The calibration can also be done via SCPI, but no connection diagrams will be shown. The user will have to make the correct connections before issuing each port calibration command. Again, it is recommended that all ports be calibrated at the same time.

For Active probes or when Differential is Off, only the main port is calibrated, otherwise both the main and complementary ports are calibrated.

The instrument state remains as it was prior to entering the calibration procedure except while a port is actually being calibrated. Once a port is calibrated it returns to the prior state. A port calibration is in process only from the time the "Next" button is pressed until the next screen is shown. For SCPI, this corresponds to the time from issuing the CAL:IQ:PROB:|I|B|Q|QB command until the operation is complete.

For example, if the prior instrument state is Cal Out = Off, Input = I+jQ, and Differential = Off, then up until the time the "Next" button is pressed the I Input and Q Input LEDs are on and the Cal Out, I-bar Input and Q-bar Input LEDs are off. Once the "Next" button is pressed for the I port calibration, only the Cal Out and I Input LEDs will be on and the others will be off. When the screen progresses to the next step ("Next" button again enabled), the prior state is restored and only the I Input and Q Input LEDs are on (Cal Out is off again).

The last calibration date and time for each relevant port will be displayed. For passive probes with Differential On, any calibration that is more than a day older than the most recent calibration will be displayed with the color amber.

I Port

The I port calibration is performed with the probe body attached to the front panel's I port and the probe tip connected via an adapter to the Cal Out port. The guided calibration will show a diagram of the required connections.

Show Adapter

Show a connection diagram and instructions for the probe and adapter. See ["Show Adapter Screen" on page 194](#).

Key Path	Input/Output, I/Q, I Setup, I Probe, Calibrate
Notes	Either a passive or an active probe adapter diagram will be shown, depending on the type of probe attached.
Initial S/W Revision	Prior to A.02.00

Back

Return to the prior step in the calibration procedure.

Key Path	Input/Output, I/Q, Q Setup, Q Probe, Calibrate
Initial S/W Revision	Prior to A.02.00

Next

Perform the I port calibration.

Key Path	Input/Output, I/Q, I Setup, I Probe, Calibrate
Remote Command	:CALibration:IQ:PROBE:I
Example	CAL:IQ:PROB:I
Notes	The I port must be connected to the Cal Out port before issuing the SCPI command. The calibration data is saved as soon as the port is calibrated and will survive power cycles. It is not reset by any preset or restore data commands.
State Saved	No
Initial S/W Revision	Prior to A.02.00

Exit

Exit the calibration procedure. All ports calibrated before pressing Exit will use the newly acquired calibration data.

Key Path	Input/Output, I/Q, I Setup, I Probe, Calibrate
Notes	Using the Exit button will not restore the calibration data to the state prior to entering the guided calibration. Once a port is calibrated the data is stored immediately and the only way to change it is to redo the calibration step. When the calibration may be left in an inconsistent state, a confirmation dialog will be displayed (see "Exit Confirmation" on page 194).
Initial S/W Revision	Prior to A.02.00

I-bar Port

The I-bar port calibration is performed with the probe body attached to the front panel's I-bar port and the probe tip connected via an adapter to the Cal Out port. The I-bar probe calibration is only available for passive probes with Differential On. The guided calibration will show a diagram of the required connections.

Show Adapter

Show a connection diagram and instructions for the probe and adapter. See ["Show Adapter Screen" on page 194](#).

Key Path	Input/Output, I/Q, I Setup, I Probe, Calibrate
Notes	Either a passive or an active probe adapter diagram will be shown, depending on the type of probe attached.
Initial S/W Revision	Prior to A.02.00

Back

Return to the prior step in the calibration procedure.

Key Path	Input/Output, I/Q, I Setup, I Probe, Calibrate
Notes	Using the Back button will not restore the calibration data to a prior state. Once a port is calibrated the data is stored immediately and the only way to change it is to redo the calibration step. The Back button allows the user to go back to a prior step to redo that calibration step.
Initial S/W Revision	Prior to A.02.00

Next

Perform the I-bar port calibration.

Key Path	Input/Output, I/Q, I Setup, I Probe, Calibrate
Remote Command	:CALibration:IQ:PROBe:IBar
Example	CAL:IQ:PROB:IB
Notes	The I-bar port must be connected to the Cal Out port before issuing the SCPI command. The calibration data is saved as soon as the port is calibrated and will survive power cycles. It is not reset by any preset or restore data commands.
State Saved	No
Initial S/W Revision	Prior to A.02.00

Exit

Exit the calibration procedure. All ports calibrated before pressing Exit will use the newly acquired calibration data.

Key Path	Input/Output, I/Q, I Setup, I Probe, Calibrate
Notes	Using the Exit button will not restore the calibration data to the state prior to entering the guided calibration. Once a port is calibrated the data is stored immediately and the only way to change it is to redo the calibration step. When the calibration may be left in an inconsistent state, a confirmation dialog will be displayed (see " Exit Confirmation " on page 194).
Initial S/W Revision	Prior to A.02.00

Q Port

The Q port calibration is performed with the probe body attached to the front panel's Q port and the probe tip connected via an adapter to the Cal Out port. The guided calibration will show a diagram of the required connections.

Show Adapter

Show a connection diagram and instructions for the probe and adapter. See ["Show Adapter Screen" on page 194](#).

Key Path	Input/Output, I/Q, Q Setup, Q Probe, Calibrate
Notes	Either a passive or an active probe adapter diagram will be shown, depending on the type of probe attached.
Initial S/W Revision	Prior to A.02.00

Back

Return to the prior step in the calibration procedure.

Key Path	Input/Output, I/Q, Q Setup, Q Probe, Calibrate
Initial S/W Revision	Prior to A.02.00

Next

Perform the Q port calibration.

Key Path	Input/Output, I/Q, Q Setup, Q Probe, Calibrate
Remote Command	:CALibration:IQ:PROB:Q
Example	CAL:IQ:PROB:Q
Notes	The Q port must be connected to the Cal Out port before issuing the SCPI command. The calibration data is saved as soon as the port is calibrated and will survive power cycles. It is not reset by any preset or restore data commands.
State Saved	No
Initial S/W Revision	Prior to A.02.00

Exit

Exit the calibration procedure. All ports calibrated before pressing Exit will use the newly acquired calibration data.

Key Path	Input/Output, I/Q, Q Setup, Q Probe, Calibrate
Notes	Using the Exit button will not restore the calibration data to the state prior to entering the guided calibration. Once a port is calibrated the data is stored immediately and the only way to change it is

to redo the calibration step.

When the calibration may be left in an inconsistent state, a confirmation dialog will be displayed (see ["Exit Confirmation" on page 194](#)).

Initial S/W Revision	Prior to A.02.00
----------------------	------------------

Q-bar Port

The Q-bar port calibration is performed with the probe body attached to the front panel's Q-bar port and the probe tip connected via an adapter to the Cal Out port. The Q-bar probe calibration is only available for passive probes with Differential On. The guided calibration will show a diagram of the required connections.

Show Adapter

Show a connection diagram and instructions for the probe and adapter. See ["Show Adapter Screen" on page 194](#).

Key Path	Input/Output, I/Q, Q Setup, Q Probe, Calibrate
Notes	Either a passive or an active probe adapter diagram will be shown, depending on the type of probe attached.
Initial S/W Revision	Prior to A.02.00

Back

Return to the prior step in the calibration procedure.

Key Path	Input/Output, I/Q, Q Setup, Q Probe, Calibrate
Notes	Using the Back button will not restore the calibration data to a prior state. Once a port is calibrated the data is stored immediately and the only way to change it is to redo the calibration step. The Back button allows the user to go back to a prior step to redo that calibration step.
Initial S/W Revision	Prior to A.02.00

Next

Perform the Q-bar port calibration.

Key Path	Input/Output, I/Q, Q Setup, Q Probe, Calibrate
Remote Command	:CALibration:IQ:PROBe:QBar
Example	CAL:IQ:PROB:QB
Notes	The Q-bar port must be connected to the Cal Out port before issuing the SCPI command. The calibration data is saved as soon as the port is calibrated and will survive power cycles. It is not reset by any preset or restore data commands.
State Saved	No
Initial S/W Revision	Prior to A.02.00

Exit

Exit the calibration procedure. All ports calibrated before pressing Exit will use the newly acquired calibration data.

Key Path	Input/Output, I/Q, Q Setup, Q Probe, Calibrate
Notes	Using the Exit button will not restore the calibration data to the state prior to entering the guided calibration. Once a port is calibrated the data is stored immediately and the only way to change it is to redo the calibration step. When the calibration may be left in an inconsistent state, a confirmation dialog will be displayed (see "Exit Confirmation" on page 194).
Initial S/W Revision	Prior to A.02.00

Show Adapter Screen

When one of the Probe Calibration Show Adapter buttons is pressed, a diagram of the probe with its adapter will be shown. Depending on the type of probe attached, either the Passive Probe Adapter or the Active Probe Adapter diagram will be shown.

I/Q Probe Calibration Time (Remote Command Only)

Return the last date and time that the I/Q Probe Calibration was performed for a specific port. This is a remote query command only.

Remote Command	:CALibration:IQ:PROBe:I IBAR Q QBAR:TIME?
Example	:CAL:IQ:PROB:I:TIME?
Notes	This returns 6 integer values: year, month, day, hour, minute, second. When no calibration has been performed, all values will be 0. The value is specific to both the port and probe, so the value will change as probes are connected or disconnected.
Initial S/W Revision	A.02.00

Exit Confirmation

When Exit is pressed during one of the calibration routines, the calibration may be in an inconsistent state with some of the ports having newly measured calibration data and others with old data. If this is the case, a dialog box will appear to confirm that the user really wants to exit. A "Yes" answer will exit the calibration procedure, leaving potentially inconsistent calibration data in place. A "No" answer will return to the calibration procedure.

5 Mode Functions

Mode

The Mode key allows you to select the available measurement applications or “Modes”. Modes are a collection of measurement capabilities packaged together to provide an instrument personality that is specific to your measurement needs. Each application software product is ordered separately by Model Number and must be licensed to be available. Once an instrument mode is selected, only the commands that are valid for that mode can be executed.

NOTE

Key operation can be different between modes. The information displayed in Help is about the current mode.

To access Help for a different Mode you must first exit Help (by pressing the Cancel (Esc) key). Then select the desired mode and re-access Help.

For more information on Modes, preloading Modes, and memory requirements for Modes,

see ["More Information" on page 197](#)

Key Path	Front-panel key
Remote Command	:INSTrument[:SElect] SA RTSA SEQAN EMI BASIC WCDMA EDGE GSM WIMAXOFDMA VSA PNOISE NFIGure ADEMODO BTooth TDSCDMA CDMA2K CDMA1XEV LTE LTE TDD LTEAFDD LTEATDD MSR DVB DTMB DCATV ISDBT CM MB WLAN CWLAN CWIMAXOFDM WIMAXFIXED IDEN RLC SCPI LC VSA89601 :INSTrument[:SElect]?
Example	:INST SA
Notes	The available parameters are dependent upon installed and licensed applications resident in the instrument. Parameters given here are an example, specific parameters are in the individual Application. A list of the valid mode choices is returned with the INST:CAT? Query.
Preset	This is unaffected by a Preset but is set on a “Restore System Defaults->All” to: For N9038A: EMI For N8973B, N8974B, N8975B, or N8976B: NFIG For all other models: SA
State Saved	Saved in instrument state
Backwards Compatibility SCPI	:INSTrument[:SElect] GSM provided for backwards compatibility. Mapped to EDGE GSM.
Backwards Compatibility SCPI	:INSTrument[:SElect] SANalyzer provided for ESU compatibility. When this command is received, the analyzer aliases it to the following: INST:SEL SCPI LC This results in the analyzer being placed in SCPI Language Compatibility Mode, in order to emulate

	the ESU Spectrum Analyzer Mode.
Backwards Compatibility SCPI	:INSTrument[:SElect] RECeiver provided for ESU compatibility. When this command is received, the analyzer aliases it to the following: :INST:SEL EMI :CONF FSC This results in the analyzer being placed in the EMI Receiver Mode, running the Frequency Scan measurement, in order to emulate the ESU Receiver Mode.
Initial S/W Revision	Prior to A.02.00
Modified at S/W Revision	A.13.00

Example	:INST 'SA'
Notes	The query is not a quoted string. It is an enumeration as indicated in the Instrument Select table above. The command must be sequential: i.e. continued parsing of commands cannot proceed until the instrument select is complete and the resultant SCPI trees are available.
Backwards Compatibility SCPI	:INSTrument[:SElect] `SA' 'PNOISE' 'EDGE' 'GSM' 'BASIC'
Initial S/W Revision	Prior to A.02.00

More Information

The Mode name appears on the banner after the word “Agilent” followed by the Measurement Title. For example, for the Spectrum Analyzer mode with the Swept SA measurement running:



It is possible to specify the order in which the Modes appear in the Mode menu, using the Configure Applications utility (System, Power On, Configure Applications). It is also possible, using the same utility, to specify a subset of the available applications to load into memory at startup time, which can significantly decrease the startup time of the analyzer. During runtime, if an application that is not loaded into memory is selected (by either pressing that applications Mode key or sending that applications :INST:SEL command over SCPI), there will be a pause while the Application is loaded. During this pause a message box that says “Loading application, please wait...” is displayed.

Each application (Mode) that runs in the X-Series signal analyzers consumes virtual memory. The various applications consume varying amounts of virtual memory, and as more applications run, the memory consumption increases. Once an application is run, some of its memory remains allocated even when it is not running, and is not released until the analyzer program (xSA.exe) is shut down.

Agilent characterizes each Mode and assigns a memory usage quantity based on a conservative estimate. There is a limited amount of virtual memory available to applications (note that this is virtual memory and is independent of how much physical RAM is in the instrument). The instrument keeps track of how much

memory is being used by all loaded applications – which includes those that preloaded at startup, and all of those that have been run since startup.

When you request a Mode that is not currently loaded, the instrument looks up the memory estimate for that Mode, and adds it to the residual total for all currently loaded Modes. If there is not enough virtual memory to load the Mode, a dialog box and menu will appear that gives you four options:

1. Close and restart the analyzer program without changing your configured preloads. This may free up enough memory to load the requested Mode, depending on your configured preloads
2. Clear out all preloads and close and restart the analyzer program with only the requested application preloaded, and with that application running. This choice is guaranteed to allow you to run the requested application; but you will lose your previously configured preloads. In addition, there may be little or no room for other applications, depending on the size of the requested application.
3. Bring up the Configure Applications utility in order to reconfigure the preloaded apps to make room for the applications you want to run (this will then require restarting the analyzer program with your new configuration). This is the recommended choice because it gives you full flexibility to select exactly what you want.
4. Exit the dialog box without doing anything, which means you will be unable to load the application you requested.

In each case except 4, this will cause the analyzer software to close, and you will lose all unsaved traces and results.

If you attempt to load a mode via SCPI that will exceed memory capacity, the Mode does not load and an error message is returned:

```
-225,"Out of memory;Insufficient resources to load Mode (mode name)"
```

where “mode name” is the SCPI parameter for the Mode in question, for example, SA for Spectrum Analyzer Mode.

Spectrum Analyzer

Selects the Spectrum Analyzer mode for general purpose measurements. There are several measurements available in this mode. General spectrum analysis measurements, in swept and zero span, can be done using the first key in the Meas menu, labeled Swept SA. Other measurements in the Meas Menu are designed to perform specialized measurement tasks, including power and demod measurements.

If you are using the Help feature, this mode must be currently active to access its detailed information. If it is not active, exit the Help feature (Esc key), select the mode, and re-access Help.

Key Path	Mode
Example	INST:SEL SA INST:NSEL 1
Initial S/W Revision	Prior to A.02.00

EMI Receiver

The EMI Receiver Mode makes EMC measurements. Several measurements are provided to aid the user in characterizing EMC performance of their systems, including looking at signals with CISPR-16 compliant detectors, performing scans for interfering signals, and determining and charting interfering signals over time.

If you are using the Help feature, this mode must be currently active to access its detailed information. If it is not active, exit the Help feature (Esc key), select the mode, and re-access Help.

Key Path	Mode
Example	INST:SEL EMI INST:NSEL 141
Initial S/W Revision	A.07.01

IQ Analyzer (Basic)

The IQ Analyzer Mode makes general purpose frequency domain and time domain measurements. These measurements often use alternate hardware signal paths when compared with a similar measurement in the Signal Analysis Mode using the Swept SA measurement. These frequency domain and time domain measurements can be used to output I/Q data results when measuring complex modulated digital signals.

If you are using the Help feature, this mode must be currently active to access its detailed information. If it is not active, exit the Help feature (Esc key), select the mode, and re-access Help.

Key Path	Mode
Example	INST:SEL BASIC INST:NSEL 8
Initial S/W Revision	Prior to A.02.00

W-CDMA with HSPA+

Selects the W-CDMA with HSPA+ mode for general purpose measurements of signals following this standard. There are several measurements available in this mode.

If you are using the Help feature, this mode must be currently active to access its detailed information. If it is not active, exit the Help feature (Esc key), select the mode, and re-access Help.

Key Path	Mode
Example	INST:SEL WCDMA INST:NSEL 9
Initial S/W Revision	Prior to A.02.00

GSM/EDGE/EDGE Evo

Selects the GSM with EDGE mode for general purpose measurements of signals following this standard. There are several measurements available in this mode.

If you are using the Help feature, this mode must be currently active to access its detailed information. If it is not active, exit the Help feature (Esc key), select the mode, and re-access Help.

Key Path	Mode
Example	INST:SEL EDGEGSM INST:NSEL 13
Initial S/W Revision	Prior to A.02.00
Modified at S/W Revision	A.02.00

802.16 OFDMA (WiMAX/WiBro)

Selects the OFDMA mode for general purpose measurements of WiMAX signals. There are several measurements available in this mode.

If you are using the Help feature, this mode must be currently active to access its detailed information. If it is not active, exit the Help feature (Esc key), select the mode, and re-access Help.

Key Path	Mode
Example	INST:SEL WIMAXOFDMA INST:NSEL 75
Initial S/W Revision	Prior to A.02.00

Vector Signal Analyzer (VXA)

The N9064A (formerly 89601X) VXA Vector signal and WLAN modulation analysis application provides solutions for basic vector signal analysis, analog demodulation, and digital demodulation. The digital demodulation portion of N9064A allows you to perform measurements on standard-based formats such as cellular, wireless networking and digital video as well as general purpose flexible modulation analysis for wide range of digital formats, FSK to 1024QAM, with easy-to-use measurements and display tools such as constellation and eye diagram, EVM traces and up to four simultaneous displays. Analog baseband analysis is available using the MXA and PXA with option BBA. Option 3FP WLAN has been discontinued.

N9064A honors existing 89601X licenses with all features and functionalities found on X-Series software versions prior to A.06.00. Specifically:

N9064A-1 is equivalent to 89601X-205

N9064A-2 is equivalent to 89601X-AYA

If you are using the Help feature, this mode must be currently active to access its detailed information. If it is not active, exit the Help feature (Esc key), select the mode, and re-access Help.

Key Path	Mode
Example	INST:SEL VSA INST:NSEL 100
Initial S/W Revision	Prior to A.02.00

Phase Noise

The Phase Noise mode provides pre-configured measurements for making general purpose measurements of device phase noise.

If you are using the Help feature, this mode must be currently active to access its detailed information. If it is not active, exit the Help feature (Esc key), select the mode, and re-access Help.

Key Path	Mode
Example	INST:SEL PNOISE or INST:NSEL 14
Initial S/W Revision	Prior to A.02.00

Noise Figure

The Noise Figure mode provides pre-configured measurements for making general purpose measurements of device noise figure.

If you are using the Help feature, this mode must be currently active to access its detailed information. If it is not active, exit the Help feature (Esc key), select the mode, and re-access Help.

Key Path	Mode
Example	INST:SEL NFIGURE INST:NSEL 219
Initial S/W Revision	Prior to A.02.00

Analog Demod

Selects the Analog Demod mode for making measurements of AM, FM and phase modulated signals.

If you are using the Help feature, this mode must be currently active to access its detailed information. If it is not active, exit the Help feature (Esc key), select the mode, and re-access Help.

Key Path	Mode
Example	INST:SEL ADEMOM INST:NSEL 234
Initial S/W Revision	Prior to A.02.00

TD-SCDMA with HSPA/8PSK

Selects the TD-SCDMA mode for general purpose measurements of signals following this standard. There are several measurements available in this mode.

If you are using the Help feature, this mode must be currently active to access its detailed information. If it is not active, exit the Help feature (Esc key), select the mode, and re-access Help.

Key Path	Mode
Example	INST:SEL TDSCDMA INST:NSEL 211
Initial S/W Revision	Prior to A.02.00

cdma2000

Selects the cdma2000 mode for general purpose measurements of signals following this standard. There are several measurements available in this mode.

If you are using the Help feature, this mode must be currently active to access its detailed information. If it is not active, exit the Help feature (Esc key), select the mode, and re-access Help.

Key Path	Mode
Example	INST:SEL CDMA2K INST:NSEL 10
Initial S/W Revision	Prior to A.02.00

1xEV-DO

Selects the 1xEV-DO mode for general purpose measurements of signals following this standard. There are several measurements available in this mode.

If you are using the Help feature, this mode must be currently active to access its detailed information. If it is not active, exit the Help feature (Esc key), select the mode, and re-access Help.

Key Path	Mode
Example	INST:SEL CDMA1XEV INST:NSEL 15
Initial S/W Revision	Prior to A.02.00

LTE

Selects the LTE mode for general purpose measurements of signals following the LTE FDD standard. There are several measurements available in this mode.

If you are using the Help feature, this mode must be currently active to access its detailed information. If it is not active, exit the Help feature (Esc key), select the mode, and re-access Help.

Key Path	Mode
Example	INST:SEL LTE INST:NSEL 102
Initial S/W Revision	Prior to A.02.00

LTE TDD

Selects the LTE TDD mode for general purpose measurements of signals following the LTE TDD standard. There are several measurements available in this mode.

If you are using the Help feature, this mode must be currently active to access its detailed information. If it is not active, exit the Help feature (Esc key), select the mode, and re-access Help.

Key Path	Mode
Example	INST:SEL LTETDD INST:NSEL 105
Initial S/W Revision	A.03.00

DVB-T/H with T2

Selects the DVB-T/H mode for measurements of digital video signals using this format. There are several power and demod measurements available in this mode.

If you are using the Help feature, this mode must be currently active to access its detailed information. If it is not active, exit the Help feature (Esc key), select the mode, and re-access Help.

Key Path	Mode
Example	INST:SEL DVB INST:NSEL 235
Initial S/W Revision	A.02.00
Modified at S/W Revision	A.07.00

DTMB (CTTB)

Selects the DTMB (CTTB) mode for measurements of digital video signals using this format. There are several power and demod measurements available in this mode.

If you are using the Help feature, this mode must be currently active to access its detailed information. If it is not active, exit the Help feature (Esc key), select the mode, and re-access Help.

Key Path	Mode
Example	INST:SEL DTMB INST:NSEL 236
Initial S/W Revision	A.02.00

ISDB-T

Selects the ISDB-T mode for measurements of digital video signals using this format. There are several power and demod measurements available in this mode.

If you are using the Help feature, this mode must be currently active to access its detailed information. If it is not active, exit the Help feature (Esc key), select the mode, and re-access Help.

Key Path	Mode
Example	INST:SEL ISDBT INST:NSEL 239
Initial S/W Revision	A.03.00

CMMB

Selects the CMMB mode for measurements of digital video signals using this format. There are several power and demod measurements available in this mode.

If you are using the Help feature, this mode must be currently active to access its detailed information. If it is not active, exit the Help feature (Esc key), select the mode, and re-access Help.

Key Path	Mode
Example	INST:SEL CMMB INST:NSEL 240
Initial S/W Revision	A.03.00

Combined WLAN

Selects the CWLAN mode for general purpose measurements of signals following this standard. There are several measurements available in this mode.

If you are using the Help feature, this mode must be currently active to access its detailed information. If it is not active, exit the Help feature (Esc key), select the mode, and re-access Help.

Key Path	Mode
Example	INST:SEL CWLAN INST:NSEL 19
Initial S/W Revision	A.02.00

Combined Fixed WiMAX

Selects the Combined Fixed WiMAX mode for general purpose measurements of signals following this standard. There are several measurements available in this mode.

If you are using the Help feature, this mode must be currently active to access its detailed information. If it is not active, exit the Help feature (Esc key), select the mode, and re-access Help.

Key Path	Mode
Example	INST:SEL CWIMAXOFDM INST:NSEL 81
Initial S/W Revision	A.02.00

802.16 OFDM (Fixed WiMAX)

Selects the 802.16 OFDM (Fixed WiMAX) mode. This mode allows modulation quality measurements of signals that comply with IEEE 802.16a–2003 and IEEE 802.16–2004 standards, with flexibility to measure nonstandard OFDM formats. Along with the typical digital demodulation measurement results, several additional 802.16 OFDM unique trace data formats and numeric error data results provide enhanced data analysis.

If you are using the Help feature, this mode must be currently active to access its detailed information. If it is not active, exit the Help feature (Esc key), select the mode, and re-access Help.

Key Path	Mode
Example	INST:SEL WIMAXFIXED INST:NSEL 104
Initial S/W Revision	A.02.00

iDEN/WiDEN/MOTOTalk

Selects the iDEN/WiDEN/MOTOTalk mode for general purpose measurements of iDEN and iDEN-related signals. There are several measurements available in this mode.

If you are using the Help feature, this mode must be currently active to access its detailed information. If it is not active, exit the Help feature (Esc key), select the mode, and re-access Help.

Key Path	Mode
Example	INST:SEL IDEN INST:NSEL 103
Initial S/W Revision	A.02.00

Remote Language Compatibility

The Remote Language Compatibility (RLC) mode provides remote command backwards compatibility for the 8560 series of spectrum analyzers, known as legacy spectrum analyzers.

NOTE After changing into or out of this mode, allow a 1 second delay before sending any subsequent commands.

If you are using the Help feature, this mode must be currently active to access its detailed information. If it is not active, exit the Help feature (Esc key), select the mode, and re-access Help.

Key Path	Mode
Example	INST:SEL RLC Or INST:NSEL 266
Initial S/W Revision	Prior to A.02.00

SCPI Language Compatibility

The SCPI Language Compatibility mode provides remote language compatibility for SCPI-based instruments, such as the Rohde and Schwartz FSP and related series of spectrum analyzers.

NOTE After changing into or out of this mode, allow a 1 second delay before sending any subsequent commands.

If you are using the Help feature, this mode must be currently active to access its detailed information. If it is not active, exit the Help feature (Esc key), select the mode, and re-access Help.

Key Path	Mode
Example	INST:SEL SCPILC Or INST:NSEL 270
Initial S/W Revision	A.06.00

89601 VSA

Selecting the 89601 VSA mode will start the 89600 VSA software. The 89600 VSA software is powerful, PC-based software, offering the industry's most sophisticated general purpose and standards specific signal evaluation and troubleshooting tools for R&D engineers. Even for proprietary and non-standard signals in SATCOM or MILCOM applications, you can make signal quality measurements with customized IQ constellation. Reach deeper into signals, gather more data on signal problems, and gain greater insight.

- Over 35 general-purpose analog and digital demodulators ranging from 2FSK to 4096QAM
- Flexible and custom IQ and OFDM signal analysis for single carrier
- Standards specific modulation analysis including:
 - Cellular: GSM/EDGE, cdma2000, W-CDMA, TD-SCDMA, LTE(FDD/TDD),

- LTE-Advanced and more
- Wireless networking: 802.11a/b/g, 802.11n, 802.ac, 802.16 WiMAX (fixed/mobile), WiSUN (MR-FSK PHY)
- RFID
- Digital satellite video and other satellite signals, radar, LMDS
- Up to 400K bin FFT, for the highest resolution spectrum analysis
- A full suite of time domain analysis tools, including signal capture and playback, time gating, and CCDF measurements
- 20 simultaneous trace displays and the industry's most complete set of marker functions
- Easy-to-use Microsoft® Windows® graphical user interface

For more information see the Agilent 89600 Series VSA web site at www.agilent.com/find/89600vsa

To learn more about how to use the 89600 VSA running in the X-Series, after the 89600 VSA software is running, open the 89600 VSA Help and open the "About Agilent X-Series Signal Analyzer with 89600 VSA Software" help topic.

Key Path	Mode
Example	INST:SEL VSA89601 INST:NSEL 101
Initial S/W Revision	Prior to A.02.00

Bluetooth

Selects the Bluetooth mode for Bluetooth specific measurements. There are several measurements available in this mode.

If you are using the Help feature, this mode must be currently active to access its detailed information. If it is not active, exit the Help feature (Esc key), select the mode, and re-access Help.

Key Path	Mode
Example	INST:SEL BT INST:NSEL 228
Initial S/W Revision	A.06.01

Digital Cable TV

Selects the Digital Cable TV mode for measurements of digital cable television systems. There are several power and demod measurements available in this mode.

If you are using the Help feature, this mode must be currently active to access its detailed information. If it is not active, exit the Help feature (Esc key), select the mode, and re-access Help.

Key Path	Mode
Example	INST:SEL DCATV INST:NSEL 238
Initial S/W Revision	A.07.00

WLAN

Selects the WLAN mode for general purpose measurements of signals following this standard. There are several measurements available in this mode.

If you are using the Help feature, this mode must be currently active to access its detailed information. If it is not active, exit the Help feature (Esc key), select the mode, and re-access Help.

Key Path	Mode
Example	INST:SEL WLAN INST:NSEL 217
Initial S/W Revision	A.09.491

MSR

Selects the MSR mode. The MSR mode makes several measurements for Cellular Communication devices that can be configured with multiple radio formats simultaneously following the 3GPP standard of Multi-Standard Radio, including GSM/EDGE, WCDMA/HSPA+ and LTE.

If you are using the Help feature, this mode must be currently active to access its detailed information. If it is not active, exit the Help feature (Esc key), select the mode, and re-access Help.

Key Path	Mode
Example	INST:SEL MSR INST:NSEL 106
Initial S/W Revision	A.09.491

Application Mode Number Selection (Remote Command Only)

Select the measurement mode by its mode number. The actual available choices depend upon which applications are installed in your instrument. The modes appear in this table in the same order they appear in the Mode menu (if the order is not changed by the Configure Applications utility found in the System, Power On menu). See "[Detailed List of Modes](#)" on page 213 for Mode details.

The Mode Number is the parameter for use with the :INSTrument:NSElect command. The Mode Parameter is the parameter for use with the :INSTrument[:SElect] command.

Mode	Mode	Mode Parameter
------	------	----------------

	Number	
Spectrum Analyzer	1	SA
Real Time Spectrum Analyzer	107	RTSA
Sequence Analyzer	400	SEQAN
EMI Receiver	141	EMI
I/Q Analyzer (Basic)	8	BASIC
WCDMA with HSPA+	9	WCDMA
GSM/EDGE/EDGE Evo	13	EDGE GSM
802.16 OFDMA (WiMAX/WiBro)	75	WIMAX OFDMA
Vector Signal Analyzer (VXA)	100	VSA
Phase Noise	14	PNOISE
Noise Figure	219	NFIGURE
Analog Demod	234	ADEMODO
Bluetooth	228	BTTOOTH
TD-SCDMA with HSPA/8PSK	211	TDSCDMA
cdma2000	10	CDMA2K
1xEV-DO	15	CDMA1XEV
LTE	102	LTE
LTE TDD	105	LTETDD
LTE-Advanced FDD	107	LTEAFDD
LTE-Advanced TDD	108	LTEATDD
MSR	106	MSR
DVB-T/H with T2	235	DVB
DTMB (CTTB)	236	DTMB
Digital Cable TV	238	DCATV
ISDB-T	239	ISDBT
CMMB	240	CMMB
WLAN	217	WLAN
Combined WLAN	19	CWLAN
Combined Fixed WiMAX	81	CWIMAX OFDM
802.16 OFDM (Fixed WiMAX)	104	WIMAX FIXED
iDEN/WiDEN/MotoTalk	103	IDEN
Remote Language Compatibility	266	RLC
SCPI Language Compatibility	270	SCPI LC
89601 VSA	101	VSA89601

Remote Command	:INSTrument:NSElect <integer> :INSTrument:NSElect?
Example	:INST:NSEL 1
Notes	SA mode is 1 The command must be sequential: i.e. continued parsing of commands cannot proceed until the instrument select is complete and the resultant SCPI trees are available.
Preset	Not affected by Preset. Set to default mode (1 for SA mode) following Restore System Defaults.
State Saved	Saved in instrument state
Initial S/W Revision	Prior to A.02.00

Application Mode Catalog Query (Remote Command Only)

Returns a string containing a comma separated list of names of all the installed and licensed measurement modes (applications). These names can only be used with the :INSTrument[:SElect] command.

Remote Command	:INSTrument:CATalog?
Example	:INST:CAT?
Notes	Query returns a quoted string of the installed and licensed modes separated with a comma. Example: "SA,PNOISE,WCDMA"
Backwards Compatibility Notes	VSA (E4406A) :INSTrument:CATalog? returned a list of installed INSTrument:SELECT items as a comma separated list of string values: "BASIC","GSM","EDGE GSM","CDMA","NADC","PDC","WCDMA","CDMA2K","CDMA1XEV","IDEN","WIDEN","WLAN","SERVICE" X-Series uses the ESA/PSA compatible query of a string contain comma separated values: "SA,PNOISE,NFIGURE,BASIC,CDMA,CDMA2K,WCDMA,CDMA1XEV,EDGE GSM,GSM,NADC,PDC,TDSCDMA,DMODULATION,WLAN"
Initial S/W Revision	Prior to A.02.00

Application Identification (Remote Commands Only)

Each entry in the Mode Menu will have a Model Number and associated information: Version, and Options. This information is displayed in the Show System screen. The corresponding SCPI remote commands are defined here.

"Current Application Model " on page 211

"Current Application Revision" on page 211

"Current Application Options" on page 211

Current Application Model

Returns a string that is the Model Number of the currently selected application (mode).

Remote Command	:SYSTem:APPLication[:CURRent][:NAME]?
Example	:SYST:APPL?
Notes	Query returns a quoted string that is the Model Number of the currently selected application (Mode). Example: "N9060A" String length is 6 characters.
Preset	Not affected by Preset
State Saved	Not saved in state, the value will be the selected application when a Save is done.
Initial S/W Revision	Prior to A.02.00

Current Application Revision

Returns a string that is the Revision of the currently selected application (mode).

Remote Command	:SYSTem:APPLication[:CURRent]:REVersion?
Example	:SYST:APPL:REV?
Notes	Query returns a quoted string that is the Revision of the currently selected application (Mode). Example: "1.0.0.0" String length is a maximum of 23 characters. (each numeral can be an integer + 3 decimal points)
Preset	Not affected by a Preset
State Saved	Not saved in state, the value will be the selected application when a Save is done.
Initial S/W Revision	Prior to A.02.00

Current Application Options

Returns a string that is the Options list of the currently selected application (Mode).

Remote Command	:SYSTem:APPLication[:CURRent]:OPTion?
Example	:SYST:APPL:OPT?
Notes	Query returns a quoted string that is the Option list of the currently selected application (Mode). The format is the name as the *OPT? or SYSTem:OPTion command: a comma separated list of option identifiers. Example: "1FP,2FP" String length is a maximum of 255 characters.
Preset	Not affected by a Preset
State Saved	Not saved in state per se, the value will be the selected application when a Save is invoked.
Initial S/W Revision	Prior to A.02.00

Application Identification Catalog (Remote Commands Only)

A catalog of the installed and licensed applications (Modes) can be queried for their identification.

"Application Catalog Number of Entries" on page 212

"Application Catalog Model Numbers" on page 212

"Application Catalog Revision" on page 212

"Application Catalog Options" on page 213

Application Catalog Number of Entries

Returns the number of installed and licensed applications (Modes).

Remote Command	:SYSTem:APPLication:CATalog[:NAME]:COUNT?
Example	:SYST:APPL:CAT:COUN?
Preset	Not affected by Preset
State Saved	Not saved in instrument state.
Initial S/W Revision	Prior to A.02.00

Application Catalog Model Numbers

Returns a list of Model Numbers for the installed and licensed applications (Modes).

Remote Command	:SYSTem:APPLication:CATalog[:NAME]?
Example	:SYST:APPL:CAT?
Notes	Returned value is a quoted string of a comma separated list of Model Numbers. Example, if SAMS and Phase Noise are installed and licensed: "N9060A,N9068A" String length is COUNT * 7 - 1. (7 = Model Number length + 1 for comma. -1 = no comma for the 1st entry.)
Preset	Not affected by a Preset
State Saved	Not saved in instrument state.
Initial S/W Revision	Prior to A.02.00

Application Catalog Revision

Returns the Revision of the provided Model Number.

Remote Command	:SYSTem:APPLication:CATalog:REVision? <model>
Example	:SYST:APPL:CAT:REV? 'N9060A'
Notes	Returned value is a quoted string of revision for the provided Model Number. The revision will be a

	null-string ("") if the provided Model Number is not installed and licensed. Example, if SAMS is installed and licensed: "1.0.0.0"
Preset	Not affected by a Preset.
State Saved	Not saved in instrument state.
Initial S/W Revision	Prior to A.02.00

Application Catalog Options

Returns a list of Options for the provided Model Number

Remote Command	:SYSTem:APPLication:CATalog:OPTion? <model>
Example	:SYST:APPL:CAT:OPT? 'N9060A'
Notes	Returned value is a quoted string of a comma separated list of Options, in the same format as *OPT? or :SYSTem:OPTion?. If the provided Model Number is not installed and licensed a null-string ("") will be returned. Example, if SAMS is installed and licensed: "2FP" String length is a maximum of 255 characters.
Preset	Not affected by a Preset
State Saved	Not saved in instrument state.
Initial S/W Revision	Prior to A.02.00

Detailed List of Modes

This section contains an alphabetical list of Modes available in the X-Series, along with a brief description of each Mode.

Note that with the exception of the 89601 VSA, only licensed applications appear in the Mode menu. The 89601 will always appear, because it's licensing is handled differently.

1xEV-DO

Selects the 1xEV-DO mode for general purpose measurements of signals following this standard. There are several measurements available in this mode.

If you are using the Help feature, this mode must be currently active to access its detailed information. If it is not active, exit the Help feature (Esc key), select the mode, and re-access Help.

Key Path	Mode
Example	INST:SEL CDMA1XEV INST:NSEL 15
Initial S/W Revision	Prior to A.02.00

802.16 OFDMA (WiMAX/WiBro)

Selects the OFDMA mode for general purpose measurements of WiMAX signals. There are several measurements available in this mode.

If you are using the Help feature, this mode must be currently active to access its detailed information. If it is not active, exit the Help feature (Esc key), select the mode, and re-access Help.

Key Path	Mode
Example	INST:SEL WIMAXOFDMA INST:NSEL 75
Initial S/W Revision	Prior to A.02.00

802.16 OFDM (Fixed WiMAX)

Selects the 802.16 OFDM (Fixed WiMAX) mode. This mode allows modulation quality measurements of signals that comply with IEEE 802.16a–2003 and IEEE 802.16–2004 standards, with flexibility to measure nonstandard OFDM formats. Along with the typical digital demodulation measurement results, several additional 802.16 OFDM unique trace data formats and numeric error data results provide enhanced data analysis.

If you are using the Help feature, this mode must be currently active to access its detailed information. If it is not active, exit the Help feature (Esc key), select the mode, and re-access Help.

Key Path	Mode
Example	INST:SEL WIMAXFIXED INST:NSEL 104
Initial S/W Revision	A.02.00

89601 VSA

Selecting the 89601 VSA mode will start the 89600 VSA software. The 89600 VSA software is powerful, PC-based software, offering the industry's most sophisticated general purpose and standards specific signal evaluation and troubleshooting tools for R&D engineers. Even for proprietary and non-standard signals in SATCOM or MILCOM applications, you can make signal quality measurements with customized IQ constellation. Reach deeper into signals, gather more data on signal problems, and gain greater insight.

- Over 35 general-purpose analog and digital demodulators ranging from 2FSK to 4096QAM
- Flexible and custom IQ and OFDM signal analysis for single carrier
- Standards specific modulation analysis including:
 - Cellular: GSM/EDGE, cdma2000, W-CDMA, TD-SCDMA, LTE(FDD/TDD),
 - LTE-Advanced and more

- Wireless networking: 802.11a/b/g, 802.11n, 802.ac, 802.16 WiMAX (fixed/mobile), WiSUN (MR-FSK PHY)
- RFID
- Digital satellite video and other satellite signals, radar, LMDS
- Up to 400K bin FFT, for the highest resolution spectrum analysis
- A full suite of time domain analysis tools, including signal capture and playback, time gating, and CCDF measurements
- 20 simultaneous trace displays and the industry's most complete set of marker functions
- Easy-to-use Microsoft ® Windows ® graphical user interface

For more information see the Agilent 89600 Series VSA web site at www.agilent.com/find/89600vsa

To learn more about how to use the 89600 VSA running in the X-Series, after the 89600 VSA software is running, open the 89600 VSA Help and open the "About Agilent X-Series Signal Analyzer with 89600 VSA Software" help topic.

Key Path	Mode
Example	INST:SEL VSA89601 INST:NSEL 101
Initial S/W Revision	Prior to A.02.00

Analog Demod

Selects the Analog Demod mode for making measurements of AM, FM and phase modulated signals.

If you are using the Help feature, this mode must be currently active to access its detailed information. If it is not active, exit the Help feature (Esc key), select the mode, and re-access Help.

Key Path	Mode
Example	INST:SEL ADEMODO INST:NSEL 234
Initial S/W Revision	Prior to A.02.00

Bluetooth

Selects the Bluetooth mode for Bluetooth specific measurements. There are several measurements available in this mode.

If you are using the Help feature, this mode must be currently active to access its detailed information. If it is not active, exit the Help feature (Esc key), select the mode, and re-access Help.

Key Path	Mode
Example	INST:SEL BT

	INST:NSEL 228
Initial S/W Revision	A.06.01

cdma2000

Selects the cdma2000 mode for general purpose measurements of signals following this standard. There are several measurements available in this mode.

If you are using the Help feature, this mode must be currently active to access its detailed information. If it is not active, exit the Help feature (Esc key), select the mode, and re-access Help.

Key Path	Mode
Example	INST:SEL CDMA2K INST:NSEL 10
Initial S/W Revision	Prior to A.02.00

CMMB

Selects the CMMB mode for measurements of digital video signals using this format. There are several power and demod measurements available in this mode.

If you are using the Help feature, this mode must be currently active to access its detailed information. If it is not active, exit the Help feature (Esc key), select the mode, and re-access Help.

Key Path	Mode
Example	INST:SEL CMMB INST:NSEL 240
Initial S/W Revision	A.03.00

Combined WLAN

Selects the CWLAN mode for general purpose measurements of signals following this standard. There are several measurements available in this mode.

If you are using the Help feature, this mode must be currently active to access its detailed information. If it is not active, exit the Help feature (Esc key), select the mode, and re-access Help.

Key Path	Mode
Example	INST:SEL CWLAN INST:NSEL 19
Initial S/W Revision	A.02.00

Combined Fixed WiMAX

Selects the Combined Fixed WiMAX mode for general purpose measurements of signals following this standard. There are several measurements available in this mode.

If you are using the Help feature, this mode must be currently active to access its detailed information. If it is not active, exit the Help feature (Esc key), select the mode, and re-access Help.

Key Path	Mode
Example	INST:SEL CWIMAXOFDM INST:NSEL 81
Initial S/W Revision	A.02.00

Digital Cable TV

Selects the Digital Cable TV mode for measurements of digital cable television systems. There are several power and demod measurements available in this mode.

If you are using the Help feature, this mode must be currently active to access its detailed information. If it is not active, exit the Help feature (Esc key), select the mode, and re-access Help.

Key Path	Mode
Example	INST:SEL DCATV INST:NSEL 238
Initial S/W Revision	A.07.00

DTMB (CTTB)

Selects the DTMB (CTTB) mode for measurements of digital video signals using this format. There are several power and demod measurements available in this mode.

If you are using the Help feature, this mode must be currently active to access its detailed information. If it is not active, exit the Help feature (Esc key), select the mode, and re-access Help.

Key Path	Mode
Example	INST:SEL DTMB INST:NSEL 236
Initial S/W Revision	A.02.00

DVB-T/H with T2

Selects the DVB-T/H mode for measurements of digital video signals using this format. There are several power and demod measurements available in this mode.

If you are using the Help feature, this mode must be currently active to access its detailed information. If it is not active, exit the Help feature (Esc key), select the mode, and re-access Help.

Key Path	Mode
Example	INST:SEL DVB INST:NSEL 235
Initial S/W Revision	A.02.00
Modified at S/W Revision	A.07.00

EMI Receiver

The EMI Receiver Mode makes EMC measurements. Several measurements are provided to aid the user in characterizing EMC performance of their systems, including looking at signals with CISPR-16 compliant detectors, performing scans for interfering signals, and determining and charting interfering signals over time.

If you are using the Help feature, this mode must be currently active to access its detailed information. If it is not active, exit the Help feature (Esc key), select the mode, and re-access Help.

Key Path	Mode
Example	INST:SEL EMI INST:NSEL 141
Initial S/W Revision	A.07.01

GSM/EDGE/EDGE Evo

Selects the GSM with EDGE mode for general purpose measurements of signals following this standard. There are several measurements available in this mode.

If you are using the Help feature, this mode must be currently active to access its detailed information. If it is not active, exit the Help feature (Esc key), select the mode, and re-access Help.

Key Path	Mode
Example	INST:SEL EDGE GSM INST:NSEL 13
Initial S/W Revision	Prior to A.02.00
Modified at S/W Revision	A.02.00

iDEN/WiDEN/MOTOTalk

Selects the iDEN/WiDEN/MOTOTalk mode for general purpose measurements of iDEN and iDEN-related signals. There are several measurements available in this mode.

If you are using the Help feature, this mode must be currently active to access its detailed information. If it is not active, exit the Help feature (Esc key), select the mode, and re-access Help.

Key Path	Mode
Example	INST:SEL IDEN INST:NSEL 103
Initial S/W Revision	A.02.00

IQ Analyzer (Basic)

The IQ Analyzer Mode makes general purpose frequency domain and time domain measurements. These measurements often use alternate hardware signal paths when compared with a similar measurement in the Signal Analysis Mode using the Swept SA measurement. These frequency domain and time domain measurements can be used to output I/Q data results when measuring complex modulated digital signals.

If you are using the Help feature, this mode must be currently active to access its detailed information. If it is not active, exit the Help feature (Esc key), select the mode, and re-access Help.

Key Path	Mode
Example	INST:SEL BASIC INST:NSEL 8
Initial S/W Revision	Prior to A.02.00

ISDB-T

Selects the ISDB-T mode for measurements of digital video signals using this format. There are several power and demod measurements available in this mode.

If you are using the Help feature, this mode must be currently active to access its detailed information. If it is not active, exit the Help feature (Esc key), select the mode, and re-access Help.

Key Path	Mode
Example	INST:SEL ISDBT INST:NSEL 239
Initial S/W Revision	A.03.00

LTE

Selects the LTE mode for general purpose measurements of signals following the LTE FDD standard. There are several measurements available in this mode.

If you are using the Help feature, this mode must be currently active to access its detailed information. If it is not active, exit the Help feature (Esc key), select the mode, and re-access Help.

Key Path	Mode
Example	INST:SEL LTE INST:NSEL 102
Initial S/W Revision	Prior to A.02.00

LTE TDD

Selects the LTE TDD mode for general purpose measurements of signals following the LTE TDD standard. There are several measurements available in this mode.

If you are using the Help feature, this mode must be currently active to access its detailed information. If it is not active, exit the Help feature (Esc key), select the mode, and re-access Help.

Key Path	Mode
Example	INST:SEL LTETDD INST:NSEL 105
Initial S/W Revision	A.03.00

MSR

Selects the MSR mode. The MSR mode makes several measurements for Cellular Communication devices that can be configured with multiple radio formats simultaneously following the 3GPP standard of Multi-Standard Radio, including GSM/EDGE, WCDMA/HSPA+ and LTE.

If you are using the Help feature, this mode must be currently active to access its detailed information. If it is not active, exit the Help feature (Esc key), select the mode, and re-access Help.

Key Path	Mode
Example	INST:SEL MSR INST:NSEL 106
Initial S/W Revision	A.09.491

Noise Figure

The Noise Figure mode provides pre-configured measurements for making general purpose measurements of device noise figure.

If you are using the Help feature, this mode must be currently active to access its detailed information. If it is not active, exit the Help feature (Esc key), select the mode, and re-access Help.

Key Path	Mode
Example	INST:SEL NFIGURE INST:NSEL 219
Initial S/W Revision	Prior to A.02.00

Phase Noise

The Phase Noise mode provides pre-configured measurements for making general purpose measurements of device phase noise.

If you are using the Help feature, this mode must be currently active to access its detailed information. If it is not active, exit the Help feature (Esc key), select the mode, and re-access Help.

Key Path	Mode
Example	INST:SEL PNOISE or INST:NSEL 14
Initial S/W Revision	Prior to A.02.00

Remote Language Compatibility

The Remote Language Compatibility (RLC) mode provides remote command backwards compatibility for the 8560 series of spectrum analyzers, known as legacy spectrum analyzers.

NOTE After changing into or out of this mode, allow a 1 second delay before sending any subsequent commands.

If you are using the Help feature, this mode must be currently active to access its detailed information. If it is not active, exit the Help feature (Esc key), select the mode, and re-access Help.

Key Path	Mode
Example	INST:SEL RLC Or INST:NSEL 266
Initial S/W Revision	Prior to A.02.00

SCPI Language Compatibility

The SCPI Language Compatibility mode provides remote language compatibility for SCPI-based instruments, such as the Rohde and Schwartz FSP and related series of spectrum analyzers.

NOTE After changing into or out of this mode, allow a 1 second delay before sending any subsequent commands.

If you are using the Help feature, this mode must be currently active to access its detailed information. If it is not active, exit the Help feature (Esc key), select the mode, and re-access Help.

Key Path	Mode
Example	INST:SEL SCPI LC Or INST:NSEL 270
Initial S/W Revision	A.06.00

Spectrum Analyzer

Selects the Spectrum Analyzer mode for general purpose measurements. There are several measurements available in this mode. General spectrum analysis measurements, in swept and zero span, can be done using the first key in the Meas menu, labeled Swept SA. Other measurements in the Meas Menu are designed to perform specialized measurement tasks, including power and demod measurements.

If you are using the Help feature, this mode must be currently active to access its detailed information. If it is not active, exit the Help feature (Esc key), select the mode, and re-access Help.

Key Path	Mode
Example	INST:SEL SA INST:NSEL 1
Initial S/W Revision	Prior to A.02.00

TD-SCDMA with HSPA/8PSK

Selects the TD-SCDMA mode for general purpose measurements of signals following this standard. There are several measurements available in this mode.

If you are using the Help feature, this mode must be currently active to access its detailed information. If it is not active, exit the Help feature (Esc key), select the mode, and re-access Help.

Key Path	Mode
Example	INST:SEL TDSCDMA INST:NSEL 211
Initial S/W Revision	Prior to A.02.00

Vector Signal Analyzer (VXA)

The N9064A (formerly 89601X) VXA Vector signal and WLAN modulation analysis application provides solutions for basic vector signal analysis, analog demodulation, and digital demodulation. The digital demodulation portion of N9064A allows you to perform measurements on standard-based formats such as cellular, wireless networking and digital video as well as general purpose flexible modulation analysis for wide range of digital formats, FSK to 1024QAM, with easy-to-use measurements and display tools such as constellation and eye diagram, EVM traces and up to four simultaneous displays. Analog baseband analysis is available using the MXA and PXA with option BBA. Option 3FP WLAN has been discontinued.

N9064A honors existing 89601X licenses with all features and functionalities found on X-Series software versions prior to A.06.00. Specifically:

N9064A-1 is equivalent to 89601X-205

N9064A-2 is equivalent to 89601X-AYA

If you are using the Help feature, this mode must be currently active to access its detailed information. If it is not active, exit the Help feature (Esc key), select the mode, and re-access Help.

Key Path	Mode
Example	INST:SEL VSA INST:NSEL 100
Initial S/W Revision	Prior to A.02.00

W-CDMA with HSPA+

Selects the W-CDMA with HSPA+ mode for general purpose measurements of signals following this standard. There are several measurements available in this mode.

If you are using the Help feature, this mode must be currently active to access its detailed information. If it is not active, exit the Help feature (Esc key), select the mode, and re-access Help.

Key Path	Mode
Example	INST:SEL WCDMA INST:NSEL 9
Initial S/W Revision	Prior to A.02.00

WLAN

Selects the WLAN mode for general purpose measurements of signals following this standard. There are several measurements available in this mode.

If you are using the Help feature, this mode must be currently active to access its detailed information. If it is not active, exit the Help feature (Esc key), select the mode, and re-access Help.

Key Path	Mode
Example	INST:SEL WLAN INST:NSEL 217
Initial S/W Revision	A.09.491

Global Settings

Opens a menu that allows you to switch certain Meas Global parameters to a Mode Global state. These switches apply to all Modes that support global settings. No matter what Mode you are in when you set the “Global Center Frequency” switch to on, it applies to all Modes that support Global Settings.

Key Path	Mode Setup
Initial S/W Revision	Prior to A.02.00

Global Center Freq

The software maintains a Mode Global value called “Global Center Freq”.

When the Global Center Freq key is switched to On in any mode, the current mode’s center frequency is copied into the Global Center Frequency, and from then on all modes that support global settings use the Global Center Frequency. So you can switch between any of these modes and the Center Freq will remain unchanged.

Adjusting the Center Freq of any mode which supports Global Settings, while Global Center Freq is On, will modify the Global Center Frequency.

When Global Center Freq is turned Off, the Center Freq of the current mode is unchanged, but now the Center Freq of each mode is once again independent.

When Mode Preset is pressed while Global Center Freq is On, the Global Center Freq is preset to the preset Center Freq of the current mode.

This function is reset to Off when the Restore Defaults key is pressed in the Global Settings menu, or when System, Restore Defaults, All Modes is pressed.

Key Path	Mode Setup, Global Settings
Scope	Mode Global
Remote Command	:INSTRUMENT:COUPLE:FREQUENCY:CENTER ALL NONE :INSTRUMENT:COUPLE:FREQUENCY:CENTER?
Example	INST:COUP:FREQ:CEN ALL INST:COUP:FREQ:CEN?
Preset	Set to Off on Global Settings, Restore Defaults and System, Restore Defaults, All Modes
Range	On Off
Initial S/W Revision	Prior to A.02.00

Remote Command	:GLOBAL:FREQUENCY:CENTER[:STATE] 1 0 ON OFF :GLOBAL:FREQUENCY:CENTER[:STATE]?
Preset	Off
Initial S/W Revision	Prior to A.02.00

Restore Defaults

This key resets all of the functions in the Global Settings menu to Off. This also occurs when System, Restore Defaults, All Modes is pressed.

Key Path	Mode Setup, Global Settings
Remote Command	:INSTRUMENT:COUPLE:DEFAULT

Example	INST:COUP:DEF
Backwards Compatibility SCPI	:GLOBal:DEFault
Initial S/W Revision	Prior to A.02.00

Mode Setup

The Mode Setup menu contains setup functions that are global across the entire Mode. These functions are independent of which measurement is currently running - they are global to all measurements in the mode, or "Meas Global." The Mode Setup functions are not the only Meas Global functions in the analyzer; for example, the Trigger Setup functions are Meas Global, and there are even Mode Global functions (that is, the same for all Modes) in the Input/Output menu, but the fact that they are all Meas Global is a distinguishing characteristic of the Mode Setup functions.

The Mode Setup menu also contains the Restore Mode Defaults key. Most Meas Global functions are restored to their preset values by Mode Preset, however some variables are more persistent and are not preset until the Restore Mode Defaults key is pressed.

There are also a few Meas Global variables (for example, Global Center Frequency) that can be switched to be Mode Global, that is, the same for all modes. The keys under the Global Settings key control whether these variables are Mode Global or not.

In the Spectrum Analyzer mode, the Mode Setup functions include which radio standard and/or EMC standard is in use and how it is configured. A set of CISPR EMC presets is available as well.

The EMC keys require either the N6141A or W6141A application or Option EMC to be installed and licensed.

Key Path	Front-panel key
Initial S/W Revision	Prior to A.02.00

Spectrum

Determines if the spectrum of the incoming data is mirrored or not. The actual mirroring is accomplished by conjugating the complex time data.

Key Path	Mode
Mode	IDEN
Remote Command	[:SENSe] :SPEctrum NORMal INVert [:SENSe] :SPEctrum?
Example	SPEC INV SPEC?
Preset	NORM
State Saved	Saved in instrument state.
Range	Normal Invert
Initial S/W Revision	A.02.00

Fixed Equalization

Enables you to apply a fixed FIR (finite-impulse-response) equalization filter to the time data, before it is used in further analysis. You define the filter by its frequency response rather than by its impulse response. The frequency response must be stored in a data register.

Key Path	Mode Setup
Mode	IDEN
Initial S/W Revision	A.02.00

Fixed EQ Mode

Enables you to turn fixed equalization OFF, ON in normal mode, or ON in inverted mode. The effect of Normal mode is to divide the spectrum of the unequalized data by the frequency response in the data register. Invert mode multiplies instead of dividing.

Key Path	Mode Setup, Fixed Equalization
Mode	IDEN
Remote Command	<code>[:SENSe] :CORRection:FEQualizer OFF NORMal INVert</code> <code>[:SENSe] :CORRection:FEQualizer?</code>
Example	<code>CORR:FEQ NORM</code> <code>CORR:FEQ?</code>
Preset	OFF
State Saved	Saved in instrument state.
Range	Off Normal Invert
Initial S/W Revision	A.02.00

Freq Response Register

Enables you to choose a register that contains the frequency response information for fixed equalization.

Key Path	Mode Setup, Fixed Equalization
Mode	IDEN
Remote Command	<code>[:SENSe] :CORRection:FEQualizer:REGister D1 D2 D3 D4 D5 D6</code> <code>[:SENSe] :CORRection:FEQualizer:REGister?</code>
Example	<code>CORR:FEQ:REG D2</code> <code>CORR:FEQ:REG?</code>
Preset	D1
State Saved	Saved in instrument state.
Range	Data 1 Data 2 Data 3 Data 4 Data 5 Data 6
Initial S/W Revision	A.02.00

Fixed Equalization Mapping

This read-only SCPI function enables you to determine if fixed equalization is applied using relative or absolute frequency mapping between the current measurement span and the span of the frequency response data in the chosen register.

If possible, the equalizer response is defined using the portion of the register data that falls within the current measurement span. For example, if the data register covers frequencies from 200 MHz to 236 MHz, and the measurement span is 6 MHz wide centered at 210 MHz, then the register data from 207 MHz to 213 MHz is used to define the equalizer response. This is an example of absolute frequency mapping.

If the same register data is used but the measurement center frequency is changed to 70 MHz, then relative frequency mapping must be used. The center frequency of the register data is mapped to the measurement center frequency, and an equivalent span of data is taken. In this example, register data from 215 MHz to 221 MHz is used as though it covered a frequency span of 67 MHz to 73 MHz.

Relative frequency mapping is used if part or the entire measurement span falls outside the data register's frequency span. It can be desirable when measuring across frequency converters, but should be used with caution. Be careful to use a measurement span that is equal to or narrower than the span of the data register.

Mode	IDEN
Remote Command	[:SENSe] :CORRection:FEQualizer:RELative?
Example	CORR:FEQ:REL?
Notes	Returns 1 if fixed equalizer frequency mapping is relative; 0 otherwise.
Initial S/W Revision	A.02.00

Radio Standards

Accesses the modulation format selections and global parameters for the iDEN/WiDEN standards. The iDEN/WiDEN/MotoTalk Analyzer is used for testing iDEN, WiDEN and MotoTalk radio standards.

Key Path	Mode Setup
Initial S/W Revision	A.02.00

MQAM Format

Selects the submenu for the MQAM modulation format.

Key Path	Mode Setup, iDEN/WiDEN
Mode	IDEN
Remote Command	[:SENSe] :RADio:IDEN:FORMat M4QAM M16QAM M64QAM [:SENSe] :RADio:IDEN:FORMat?

Example	:RAD:IDEN:FORM M16QAM
Couplings	No
Preset	M16QAM
State Saved	Saved in instrument state.
Range	M4QAM M16QAM M64QAM
Initial S/W Revision	A.02.00

M4QAM

Selects M4QAM MQAM Modulation Format.

Key Path	Mode Setup, iDEN/WiDEN, MQAM Format
Mode	IDEN
Initial S/W Revision	A.02.00

M16QAM

Selects M16QAM MQAM Modulation Format.

Key Path	Mode Setup, iDEN/WiDEN, MQAM Format
Mode	IDEN
Initial S/W Revision	A.02.00

M64QAM

Selects M64QAM MQAM Modulation Format.

Key Path	Mode Setup, iDEN/WiDEN, MQAM Format
Mode	IDEN
Initial S/W Revision	A.02.00

Slot Format

Selects the submenu for the iDEN or WiDEN slot format.

Key Path	Mode Setup, iDEN/WiDEN
Mode	IDEN
Remote Command	[:SENSe] :RADio :IDEN :SLOT TCHFull RAP TCHN61 TCHN61T TCHE61 WiDen OTCFull OTCN61

	[:SENSe] :RADio:IDEN:SLOT?
Example	:RAD:IDEN:SLOT TCHF
Couplings	Changing this to/from iDEN and WiDEN slot formats when the WiDEN Carrier Config is wider than 25 kHz will cause the Span to be changed to accommodate the different bandwidth signal. Changing to an Outbound Slot Format from an Inbound Slot Format will cause the Free Run trigger to be selected and Search Length preset to accommodate slot latency. The X Scaling of the PvT Rise & Fall displays may also be changed as necessary for proper viewing of these regions.
Preset	TCHFull
State Saved	Saved in instrument state.
Range	Full Slot Reserved (Inbound) Random Access (Inbound) New 6:1 Reserved Pseudo (Inbound) New 6:1 Reserved Training (Inbound) Full Slot Enhanced 6:1 (Inbound) WiDEN (Inbound) Full Slot Reserved (Outbound) New 6:1 Reserved (Outbound)
Readback Text	In Full Slot Reserved In Random Access In New 6:1 Res Pseudo In New 6:1 Res Training In Full Slot Enhanced 6:1 In WiDEN Out Full Slot Reserved Out New 6:1 Reserved
Initial S/W Revision	A.02.00

Mapping between the Key Name and the SCPI parameter:

Key Name	SCPI
Full Slot Reserved (Inbound)	TCHFull
Full Slot Random Access (Inbound)	RAPFull
New 6:1 Reserved Pseudo (Inbound)	TCHN61
New 6:1 Reserved Training (Inbound)	TCHN61T
Full Slot Enhanced 6:1 (Inbound)	TCHE61
WiDEN (Inbound)	WiDEN
Full Slot Reserved (Outbound)	OTCFull
New 6:1 Reserved (Outbound)	OTCN61

Full Slot Reserved (Inbound)

Selects the Full Slot Reserved Access iDEN Inbound Slot Format.

Key Path	Mode Setup, iDEN/WiDEN, Slot Format
Mode	IDEN
Initial S/W Revision	A.02.00

Full Slot Enhanced 6:1 (Inbound)

Selects the Full Slot Enhanced iDEN Inbound Slot Format.

Key Path	Mode Setup, iDEN/WiDEN, Slot Format
Mode	IDEN
Initial S/W Revision	A.02.00

Random Access (Inbound)

Selects the Random Access iDEN Inbound Slot Format.

Key Path	Mode Setup, iDEN/WiDEN, Slot Format
Mode	IDEN
Initial S/W Revision	A.02.00

New 6:1 Reserved Pseudo (Inbound)

Selects the New 6:1 Reserved Access iDEN Inbound Slot Format.

Key Path	Mode Setup, iDEN/WiDEN, Slot Format
Mode	IDEN
Initial S/W Revision	A.02.00

New 6:1 Reserved Training (Inbound)

Selects the Full Slot Reserved with Training iDEN Inbound Slot Format.

Key Path	Mode Setup, iDEN/WiDEN, Slot Format
Mode	IDEN
Initial S/W Revision	A.02.00

Full Slot Enhanced 6:1 (Inbound)

Selects the Full Slot Enhanced iDEN Inbound Slot Format.

Key Path	Mode Setup, iDEN/WiDEN, Slot Format
Mode	IDEN
Initial S/W Revision	A.02.00

WiDEN (Inbound)

Selects the Inbound WiDEN Slot Format.

Key Path	Mode Setup, iDEN/WiDEN, Slot Format
Mode	IDEN
Initial S/W Revision	A.02.00

Full Slot Reserved (Outbound)

Selects the Full Slot Reserved Access iDEN Outbound Slot Format.

Key Path	Mode Setup, iDEN/WiDEN, Slot Format, More
Mode	IDEN
Initial S/W Revision	A.02.00

New 6:1 Reserved (Outbound)

Selects the New 6:1 Reserved Access iDEN Outbound Slot Format.

Key Path	Mode Setup, iDEN/WiDEN, Slot Format, More
Mode	IDEN
Initial S/W Revision	A.02.00

Color Code

An integer denoting the 16 value color and the color code extension.

Key Path	Mode Setup, iDEN/WiDEN
Mode	IDEN
Remote Command	<code>[:SENSe] :RADio :IDEN :CCODE <integer></code> <code>[:SENSe] :RADio :IDEN :CCODE?</code>
Example	<code>:RAD:IDEN:CCOD 0</code>
Notes	Set this parameter to Color Code Extension*16 + Color Code
Preset	0
State Saved	Saved in instrument state.
Min	0
Max	95
Initial S/W Revision	A.02.00

Carrier Config

Only used when WiDEN slot formats are active and ignored (grayed out) for other slot formats.

Key Path	Mode Setup, iDEN/WiDEN
Mode	IDEN
Remote Command	[:SENSe] :RADio :IDEN :WCARrier I25 I50 O50 I75 I100 [:SENSe] :RADio :IDEN :WCARrier ?
Example	:RAD:IDEN:WCAR I25
Couplings	The Span is adjusted to accommodate the WiDEN carriers.
Preset	I25
State Saved	Saved in instrument state.
Range	25 kHz 50 kHz 50 kHz Outer 75 kHz 100 kHz
Initial S/W Revision	A.02.00

25 kHz

Selects the 25 kHz WiDEN Carrier Config.

Key Path	Mode Setup, iDEN/WiDEN, Carrier Config
Mode	IDEN
Example	:RAD:IDEN:WCAR I25
Initial S/W Revision	A.02.00

50 kHz

Selects the 50 kHz WiDEN Carrier Config.

Key Path	Mode Setup, iDEN/WiDEN, Carrier Config
Mode	IDEN
Example	:RAD:IDEN:WCAR I50
Initial S/W Revision	A.02.00

50 kHz Outer

Selects the 50 kHz Outer WiDEN Carrier Config (sometimes called 100 kHz Outer WiDEN Carrier Config).

Key Path	Mode Setup, iDEN/WiDEN, Carrier Config
Mode	IDEN
Example	:RAD:IDEN:WCAR O50
Initial S/W Revision	A.02.00

75 kHz

Selects the 75 kHz WiDEN Carrier Config.

Key Path	Mode Setup, iDEN/WiDEN, Carrier Config
Mode	IDEN
Example	:RAD:IDEN:WCAR I75
Initial S/W Revision	A.02.00

100 kHz

Selects the 100 kHz WiDEN Carrier Config.

Key Path	Mode Setup, iDEN/WiDEN, Carrier Config
Mode	IDEN
Example	:RAD:IDEN:WCAR I100
Initial S/W Revision	A.02.00

Global Settings

Opens a menu that allows you to switch certain Meas Global parameters to a Mode Global state.

See "[Global Settings](#)" on page 223 for more information.

6 System Functions

File

Opens a menu that enables you to access various standard and custom Windows functions. Press any other front-panel key to exit

Key Path	Front-panel key
Initial S/W Revision	Prior to A.02.00

File Explorer

Opens the standard Windows File Explorer. The File Explorer opens in the My Documents directory for the current user.

The File Explorer is a separate Windows application, so to return to the analyzer once you are in the File Explorer, you may either:

Exit the File Explorer by clicking on the red X in the upper right corner, with a mouse

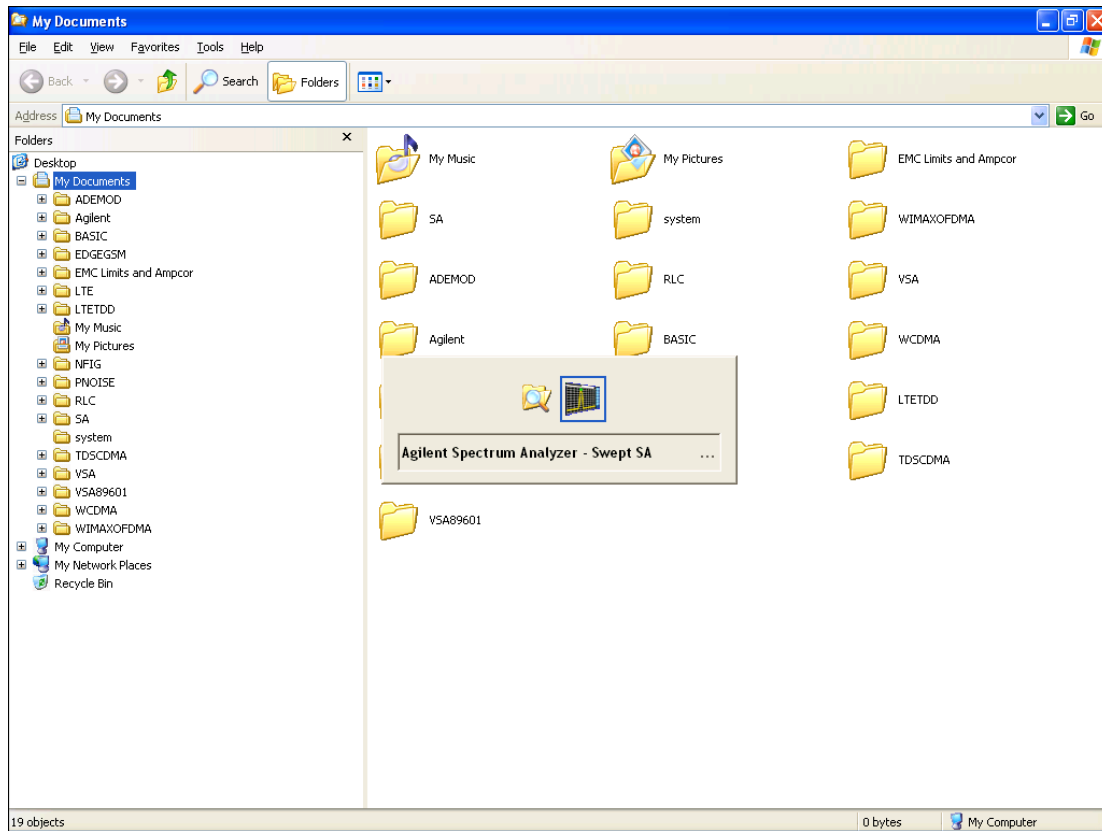

Or use Alt-Tab: press and hold the Alt key and press and release the Tab key until the Analyzer logo is showing in the window in the center of the screen, as shown above, then release the Alt key.

The ability to access File Explorer is not available if Option SF1 is installed.

Key Path	File
Initial S/W Revision	Prior to A.02.00

Print

The Print key opens a Print dialog for configured printing (for example, to the printer of your choice). Refer to your Microsoft Windows Operating System manual for more information.

Maximize/Restore Down

These keys allow the Instrument Application to be maximized and then restored to its prior state. Only one of the two keys is visible at a time. When not already maximized the Maximize Application key is visible, and when maximized, the Restore Down Application key is visible and replaces the Maximize Application key.

Maximize

This key allows you to Maximize the Instrument Application, which causes the analyzer display to fill the screen. Once the application is maximized, this key is replaced by the Restore Down key.

Key Path	File
Mode	All
Notes	No equivalent remote command for this key.
State Saved	No
Initial S/W Revision	A.05.01

Restore Down

This key allows you to Restore Down the Instrument Application and reverses the action taken by Maximize. This key is only visible when the application has been maximized, and after the Restore Down action has been completed this key is replaced by the Maximize key.

Key Path	File
Mode	All
Notes	No equivalent remote command for this key.
State Saved	No
Initial S/W Revision	A.05.01

Page Setup

The Page Setup key brings up a Windows Page Setup dialog that allows you to control aspects of the pages sent to the printer when the PRINT hardkey is pressed.

Key Path	File
Initial S/W Revision	Prior to A.02.00

Paper size, the printer paper source, the page orientation and the margins are all settable. Just like any standard Windows dialog, you may navigate the dialog using the front-panel keys, or a mouse. There are no SCPI commands for controlling these parameters.

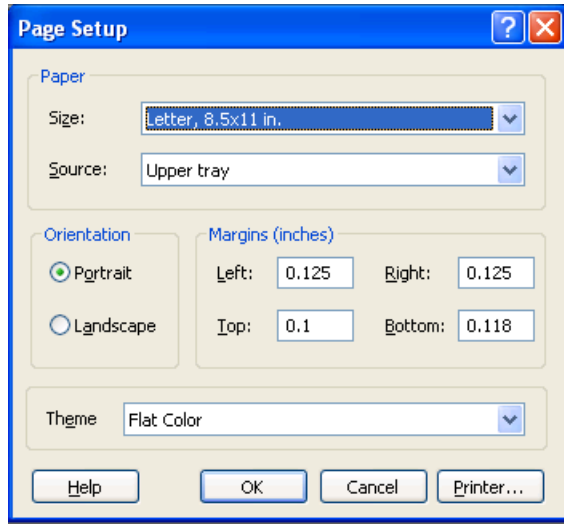

Also contained in this dialog is a drop-down control that lets you select the Theme to use when printing. For more on Themes, see information under View/Display, Display, System Display Settings, Theme. The Theme control has a corresponding SCPI command.

Parameter Name	Print Themes
Parameter Type	Enum
Mode	All
Remote Command	:SYSTem:PRINt:THEMe TDCOLOR TDMonochrome FCOLOR FMONochrome :SYSTem:PRINt:THEMe?
Example	:SYST:PRIN:THEM FCOL
Setup	:SYSTem:DEFault MISC
Preset	FCOL; not part of Preset, but is reset by Restore Misc Defaults or Restore System Defaults All and survives subsequent running of the modes.
State Saved	No
Initial S/W Revision	Prior to A.02.00

Print

This front-panel key is equivalent to performing a File, Print, OK. It immediately performs the currently configured Print to the Default printer.

The :HCOPY command is equivalent to pressing the PRINT key. The HCOpy:ABORt command can be used to abort a print which is already in progress. Sending HCOpy:ABORt will cause the analyzer to stop sending data to the printer, although the printer may continue or even complete the print, depending on how much data was sent to the printer before the user sent the ABORt command.

Key Path	Front-panel key
Remote Command	:HCOPY[:IMMediate]
Initial S/W Revision	Prior to A.02.00

Key Path	SCPI command only
Remote Command	:HCOpy:ABORt
Initial S/W Revision	Prior to A.02.00

Maximize

This key allows you to Maximize the Instrument Application, which causes the analyzer display to fill the screen. Once the application is maximized, this key is replaced by the Restore Down key.

Key Path	File
Mode	All
Notes	No equivalent remote command for this key.
State Saved	No
Initial S/W Revision	A.05.01

Restore Down

This key allows you to Restore Down the Instrument Application and reverses the action taken by Maximize. This key is only visible when the application has been maximized, and after the Restore Down action has been completed this key is replaced by the Maximize key.

Key Path	File
Mode	All
Notes	No equivalent remote command for this key.
State Saved	No
Initial S/W Revision	A.05.01

Minimize

The Minimize key causes the analyzer display to disappear down into the task bar, allowing you to see the Windows Desktop. You can use Alt-Tab (press and hold the Alt



key and press and release the Tab key) to restore the analyzer display.

Key Path	File
Mode	All
Notes	No equivalent remote command for this key.
State Saved	No
Initial S/W Revision	A.05.01

Exit

This key, when pressed, will exit the Instrument Application. A dialog box is used to confirm that you intended to exit the application:

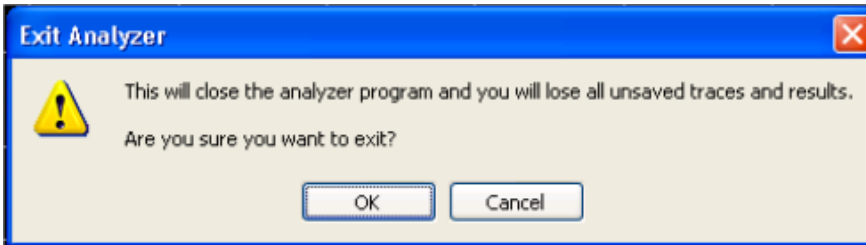

Key Path	File
Mode	All
Notes	The Instrument Application will close. No further SCPI commands can be sent. Use with caution!
Initial S/W Revision	Prior to A.02.00

Print

This front-panel key is equivalent to performing a File, Print, OK. It immediately performs the currently configured Print to the Default printer.

The :HCOPY command is equivalent to pressing the PRINT key. The HCOPY:ABORT command can be used to abort a print which is already in progress. Sending HCOPY:ABORT will cause the analyzer to stop sending data to the printer, although the printer may continue or even complete the print, depending on how much data was sent to the printer before the user sent the ABORT command.

Key Path	Front-panel key
Remote Command	:HCOPY[:IMMEDIATE]
Initial S/W Revision	Prior to A.02.00

Key Path	SCPI command only
Remote Command	:HCOPY:ABORT
Initial S/W Revision	Prior to A.02.00

System

Opens a menu of keys that access various configuration menus and dialogs.

Key Path	Front-panel key
Notes	No remote command for this key specifically.
Initial S/W Revision	Prior to A.02.00

Show

Accesses a menu of choices that enable you to select the information window you want to view.

Key Path	System
Mode	All
Remote Command	:SYSTem:SHOW OFF ERRor SYSTem HARDware LXI HWSTatistics ALIGNment SOFTware CAPplication :SYSTem:SHOW?
Example	:SYST:SHOW SYST
Notes	This command displays (or exits) the various System information screens.
Preset	OFF
State Saved	No
Range	OFF ERRor SYSTem HARDware LXI HWSTatistics ALIGNment SOFTware CAPplication
Initial S/W Revision	Prior to A.02.00

Errors

There are two modes for the Errors selection, History and Status.

The list of errors displayed in the Errors screen does not automatically refresh. You must press the Refresh key or leave the screen and return to it to refresh it.

History brings up a screen displaying the event log in chronological order, with the newest event at the top. The history queue can hold up to 100 messages (if a message has a repeat count greater than 1 it only counts once against this number of 100). Note that this count bears no relation to the size of the SCPI queue. If the queue extends onto a second page, a scroll bar appears to allow scrolling with a mouse. Time is displayed to the second.

Status brings up a screen summarizing the status conditions currently in effect. Note that the time is displayed to the second.

The fields on the Errors display are:

Type (unlabeled) - Displays the icon identifying the event or condition as an error or warning.

ID - Displays the error number.

Message - Displays the message text.

Repeat (RPT) - This field shows the number of consecutive instances of the event, uninterrupted by other events. If an event occurs 5 times with no other intervening event, the value of repeat will be 5.

If the value of Repeat is 1 the field does not display. If the value of Repeat is >1, the time and date shown are those of the most recent occurrence. If the value of repeat reaches 999,999 it stops there.

Time - Shows the most recent time (including the date) at which the event occurred.

Key Path	System, Show
Mode	All
Remote Command	:SYSTem:ERRor[:NEXT]?
Example	:SYST:ERR?
Notes	The return string has the format: “<Error Number>,<Error>” Where <Error Number> and <Error> are those shown on the Show Errors screen
Backwards Compatibility Notes	In some legacy analyzers, the Repeat field shows the number of times the message has repeated since the last time the error queue was cleared. In the X-Series, the Repeat field shows the number of times the error has repeated since the last intervening error. So the count may very well be different than in the past even for identical signal conditions Unlike previous analyzers, in the X-Series all errors are reported through the Message or Status lines and are logged to the event queue. They never appear as text in the graticule area (as they sometimes do in previous analyzers) and they are never displayed in the settings panel at the top of the screen (as they sometimes do, by changing color, in previous analyzers). As a consequence of the above, the user can only see one status condition (the most recently generated) without looking at the queue. In the past, at least in the Spectrum Analyzer, multiple status conditions might display on the right side of the graticule. In general, there is no backwards compatibility specified or guaranteed between the error numbers in the X-Series and those of earlier products. Error, event, and status processing code in customers' software will probably need to be rewritten to work with X-Series. In the legacy analyzers, some conditions report as errors and others simply turn on status bits. Conditions that report as errors often report over and over as long as the condition exists. In the X-series, all conditions report as start and stop events. Consequently, software that repeatedly queries for a condition error until it stops reporting will have to be rewritten for the X-series.
Initial S/W Revision	Prior to A.02.00

Previous Page

See ["Next Page" on page 244.](#)

Key Path	System, Show, Errors
Initial S/W Revision	Prior to A.02.00

Next Page

Next Page and Previous Page menu keys move you between pages of the log, if it fills more than one page. These keys are grayed out in some cases:

- If on the last page of the log, the Next Page key is grayed-out
- If on the first page of the log, the Previous Page key is grayed-out.
- If there is only one page, both keys are grayed out.

Key Path	System, Show, Errors
Initial S/W Revision	Prior to A.02.00

History

The History and Status keys select the Errors view. The Status key has a second line that shows a number in [square brackets]. This is the number of currently open status items.

Key Path	System, Show, Errors
Initial S/W Revision	Prior to A.02.00

Verbose SCPI On/Off

When you turn Verbose SCPI on, additional information is returned when you send the :SYSTem:ERRor? query. The additional information consists of the characters that stimulated the error. This can aid you in debugging your test programs by indicating where in the parsing of a SCPI command the instrument encountered an invalid command or query.

Specifically, with Verbose SCPI on, the SYSTem:ERRor? query is expanded to show the SCPI data received, with the indicator <Err> at the point in the stream that the error occurred.

Verbose SCPI has no effect on the Show Errors screen or front panel Message Line; it only changes the response to the :SYST:ERR? query.

See the example below, where the invalid command "SENS:BOGUS" is sent:

Normal response to :SYST:ERR (using the Telnet window):

```
SCPI> SENS:BOGUS
```

```
SCPI> SYST:ERR?
```

```
-113,"Undefined header"
```

Now after turning on Verbose SCPI:

```
SCPI> SYST:BOGUS
```

```
SCPI> SYST:ERR?
```

```
-113,"Undefined header;SYST:BOGUS<Err>"
```

Key Path	System, Show, Errors
Mode	All
Remote Command	:SYSTem:ERRor:VERBoSe OFF ON 0 1 :SYSTem:ERRor:VERBoSe?
Example	:SYST:ERR:VERB ON
Preset	This is unaffected by Preset but is set to OFF on a "Restore System Defaults->Misc"
State Saved	No
Range	On Off
Initial S/W Revision	Prior to A.02.00

Refresh

When pressed, refreshes the Show Errors display.

Key Path	System, Show, Errors
Initial S/W Revision	Prior to A.02.00

Clear Error Queue

This clears all errors in all error queues.

Note the following:

- Clear Error Queue does not affect the current status conditions.
- Mode Preset does not clear the error queue.
- Restore System Defaults will clear all error queues.
- *CLS only clears the queue if it is sent remotely and *RST does not affect any error queue.
- Switching modes does not affect any error queues.

Key Path	System, Show, Errors
Initial S/W Revision	Prior to A.02.00

Status

See "[History](#)" on page 244.

Input Overload Enable (Remote Command Only)

Input Overload errors are reported using the Input Overload status bit (bit 12 in the Measurement Integrity status register). Input Overloads (for example, ADC Overload errors) can come and go with great frequency, generating many error events (for example, for signals just on the verge of overload), and so are

not put into the SCPI error queue by default. Normally the status bit is the only way for detecting these errors remotely.

It is possible to enable Input Overload reporting to the SCPI queue, by issuing the :SYSTem:ERRor:OVERload ON command. To return to the default state, issue the :SYSTem:ERRor:OVERload OFF command. In either case, Input Overloads always set the status bit.

NOTE

For versions of firmware before A.10.01, the Input Overload was only a Warning and so was never available in the SCPI queue, although it did set the status bit. For A.10.01 and later, the Input Overload is an error and can be enabled to the SCPI queue using this command.

Key Path	SCPI only
Remote Command	:SYSTem:ERRor:OVERload[:STATe] 0 1 OFF ON
Example	:SYST:ERR:OVER 1 Enable overload errors
Preset	Set to OFF by Restore Misc Defaults (no Overload errors go to SCPI)
State Saved	Saved in instrument state.
Initial S/W Revision	A.10.01

System

The System screen is formatted into three groupings: product descriptive information, options tied to the hardware, and software products:

```

<Product Name> <Product Description>
Product Number: N9020A
Serial Number: US46220924
Firmware Revision: A.01.01
Computer Name: <hostname>
Host ID: N9020A,US44220924

N9020A-503      Frequency Range to 3.6 GHz
N9020A-PFR     Precision Frequency Reference
N9020A-P03     Preamp 3.6 GHz

N9060A-2FP     Spectrum Analysis Measurement Suite  1.0.0.0
N9073A-1FP     WCDMA                               1.0.0.0
N9073A-2FP     WCDMA with HSDPA                       1.0.0.0
    
```

The Previous Page is grayed-out if the first page of information is presently displayed. The Next Page menu key is grayed-out if the last page is information is presently displayed.

Key Path	System, Show
----------	--------------

Mode	All
Example	SYST:SHOW SYST
Backwards Compatibility Notes	The hardware statistics that are displayed in the PSA Show System screen have been moved to a dedicated Show Hardware Statistics screen in the Service Menu.
Initial S/W Revision	Prior to A.02.00

Show System contents (Remote Command Only)

A remote command is available to obtain the contents of the Show System screen (the entire contents, not just the currently displayed page).

Remote Command	:SYSTem:CONFigure[:SYSTem]?
Example	:SYST:CONF?
Notes	The output is an IEEE Block format of the Show System contents. Each line is separated with a new-line character.
Initial S/W Revision	Prior to A.02.00

Hardware

The show hardware screen is used to view details of the installed hardware. This information can be used to determine versions of hardware assemblies and field programmable devices, in the advent of future upgrades or potential repair needs.

The screen is formatted into two groupings: product descriptive information and hardware information. The hardware information is listed in a table format:

Hardware Information							
MXA Signal Analyzer							
Product Number: N9020A							
Serial Number: US46220107							
Firmware Revision: A.01.14							
Assembly Name	Part #	Serial #	Mat Rev	Rev	OF Rev	Hw Id	Misc
Analog IF	E441060104	78060200131	003	0	C	15	
YIG Tuned Filter	50877305	11061500550	005	0	A	11	
Digital IF	E441060105	78060100559	003	0	F	14	
Front End Controller	E441060101	78060100147	004	2	A	8	
Low Band Switch	E441060170	78060800346	005	1	A	10	
LO Synthesizer	E441060102	78060100226	003	3	G	2	
Reference	E441060108	78060300420	004	1	C	16	
Front End	E441060154	13062800820	010	2	B	9	

The Previous Page is grayed-out if the first page of information is presently displayed. The Next Page menu is grayed-out if the last page is information is presently displayed.

Key Path	System, Show
Mode	All
Example	SYST:SHOW HARD
Initial S/W Revision	Prior to A.02.00

LXI

This key shows you the product number, serial number, firmware revision, computer name, IP address, Host ID, LXI Class, LXI Version, MAC Address, and the Auto-MDIX Capability.

Key Path	System, Show
Initial S/W Revision	Prior to A.02.00

Power On

Enables you to select how the instrument should power on. The options are: Mode and Input/Output Defaults, User Preset and Last State.

Key Path	System
Mode	All
Remote Command	:SYSTem:PON:TYPE MODE USER LAST :SYSTem:PON:TYPE?
Example	:SYST:PON:TYPE MODE
Preset	This is unaffected by a Preset but is set to Mode on a “Restore System Defaults->All”
State Saved	No
Backwards Compatibility SCPI	:SYSTem:PON:TYPE PRESet the “PRESet” parameter is supported for backward compatibility only and behaves the same as MODE.
Backwards Compatibility Notes	The Preset Type key in legacy analyzers has been removed, and the Power On toggle key has been replaced by this 1-of-N key in the System menu.
Initial S/W Revision	Prior to A.02.00

Mode and Input/Output Defaults

When the analyzer is powered on in Mode and Input/Output Defaults, it performs a Restore Mode Defaults to all modes in the instrument and also performs a Restore Input/Output Defaults.

Persistent parameters (such as Amplitude Correction tables or Limit tables) are not affected at power on, even though they are normally cleared by Restore Input/Output Defaults and/or Restore Mode Defaults.

Key Path	System, Power On
Mode	All
Example	SYST:PON:TYPE MODE
Readback Text	Defaults
Initial S/W Revision	Prior to A.02.00

User Preset

Sets Power On to User Preset. When the analyzer is powered on in User Preset, it will User Preset each mode and switch to the power-on mode. Power On User Preset will not affect any settings beyond what a normal User Preset affects.

NOTE

An instrument could never power up for the first time in User Preset.

Key Path	System, Power On
Mode	All
Example	SYST:PON:TYPE USER
Readback Text	User Preset

Backwards Compatibility Notes	Power On User Preset will cause the instrument to power up in the power-on mode, not the last mode the instrument was in prior to shut down. Also, Power On User Preset will User Preset all modes. This does not exactly match legacy behavior.
Initial S/W Revision	Prior to A.02.00

Last State

Sets Power On to **Last**. When the analyzer is powered on, it will put all modes in the last state they were in prior to when the analyzer was put into Power Standby and it will wake up in the mode it was last in prior to powering off the instrument. The saving of the active mode prior to shutdown happens behind the scenes when a controlled shutdown is requested by using the front panel power Standby key or by using the remote command SYSTem:PDOWn. The non-active modes are saved as they are deactivated and recalled by Power On Last State.

NOTE

An instrument can never power up for the first time in Last.

If line power to the analyzer is interrupted, for example by pulling the line cord plug or by switching off power to a test rack, Power On Last State may not work properly. For proper operation, Power On Last State depends on you shutting down the instrument using the Standby key or the SYSTem:PDOWn SCPI command. This will ensure the last state of each mode is saved and can be recalled during a power up.

Key Path	System, Power On
Mode	All
Example	SYST:PON:TYPE LAST
Notes	Power on Last State only works if you have done a controlled shutdown prior to powering on in Last. If a controlled shutdown is not done when in Power On Last State, the instrument will power up in the last active mode, but it may not power up in the active mode's last state. If an invalid mode state is detected, a Mode Preset will occur. To control the shutdown under remote control use the :SYSTem:PDOWn command.
Readback Text	Last State
Backwards Compatibility Notes	It is no longer possible to power-up the analyzer in the last mode the analyzer was running with that mode in the preset state. (ESA/PSA SYST:PRESET:TYPE MODE with SYST:PON:PRESET) You can power-on the analyzer in the last mode the instrument was running in its last state (SYST:PON:TYPE LAST), or you can specify the mode to power-up in its preset state (SYST:PON:MODE <mode>).
Initial S/W Revision	Prior to A.02.00

Power On Application

Accesses a menu that lists the available Modes and lets you select which Mode is to be the power-on application.

This application is used for Power On Type “Mode and Input/Output Defaults” and Restore System Defaults All.

Key Path	System, Power On
Mode	All
Remote Command	:SYSTem:PON:MODE SA BASIC ADEMOD NFIGURE PNOISE CDMA2K TDSCDMA VSA VSA89601 WCDMA WIMAXOFDMA :SYSTem:PON:MODE?
Example	SYST:PON:MODE SA
Notes	The list of possible modes (and remote parameters) to choose from is dependent on which modes are installed in the instrument.
Preset	This is unaffected by a Preset but is set on a "Restore System Defaults->All" to: For N9038A: EMI For N8973B, N8974B, N8975B, or N8976B: NFIG For all other models: SA
State Saved	No
Initial S/W Revision	Prior to A.02.00

Configure Applications

The Configure Applications utility can be used to:

- select applications for preload
- determine how many applications can fit in memory at one time
- specify the order of the Modes in the Mode menu.

This utility consists of a window with instructions, a set of "Select Application" checkboxes, a "fuel bar" style memory gauge, and keys that help you set up your configuration.

For more information, see the following topics:

["Preloading Applications" on page 252](#)

["Access to Configure Applications utility" on page 252](#)

["Virtual memory usage" on page 252](#)

Key Path	System, Power On
Example	:SYST:SHOW CAPP Displays the Config Applications screen
Initial S/W Revision	A.02.00

Preloading Applications

During runtime, if a Mode that is not preloaded is selected using the Mode menu or sending SCPI commands, there will be a pause while the Application is loaded. During this pause a message that says “Loading application, please wait ...” is displayed. Once loaded, the application stays loaded, so the next time you select it during a session, there is no delay.

Preloading enables you to “preload” at startup, to eliminate the runtime delay. Preloading an application will cause it to be loaded into the analyzer’s memory when the analyzer program starts up. If you do this, the delay will increase the time it takes to start up the analyzer program, but this may be preferable to having to wait the first time you select an application. Note that, once an application is loaded into memory, it cannot be unloaded without exiting and restarting the analyzer program.

Note that there are more applications available for the X-Series than can fit into Windows Virtual Memory. By allowing you to choose which licensed applications to load at startup, the Configure Applications utility allows you to make optimal use of your memory.

Access to Configure Applications utility

A version of the utility runs the first time you power up the analyzer after purchasing it from Agilent. The utility automatically configures preloads so that as many licensed applications as possible are preloaded while keeping the total estimated virtual memory usage below the limit. This auto-configuration only takes place at the very first run, and after analyzer software upgrades.

You may, at any time, manually call up the Configure Applications utility by pressing System, Power On, Configure Applications, to find a configuration that works best for you, and then restart the analyzer program.

The utility may also be called if, during operation of the analyzer, you attempt to load more applications than can fit in memory at once.

Virtual memory usage

There are more applications available for the X-Series than can fit into memory at any one time, so the Configure Applications utility includes a memory tracker that serves two purposes:

1. It will not let you preload more applications than will fit into memory at once.
2. You can determine how many of your favorite applications can reside in memory at one time.

The utility provides a graphical representation of the amount of memory (note that the memory in question here is Virtual memory and is a limitation imposed by the operating system, not by the amount of physical memory you have in your analyzer). You select applications to preload by checking the boxes on the left. Checked applications preload at startup. The colored fuel bar indicates the total memory required when all the checked applications are loaded (either preloaded or selected during runtime).

Here is what the fuel bar colors mean:

RED: the applications you have selected cannot all fit into the analyzer’s memory. You must deselect applications until the fuel bar turns yellow.

YELLOW: the applications you have selected can all fit into the analyzer’s memory, but there is less than 10% of the memory left, probably not enough to load any other applications, either via preload or by selecting a Mode while the analyzer is running..

GREEN: The indicator is green when <90% of the memory limit is consumed. This means the applications you have selected can all fit into the analyzer's memory with room to spare. You will likely be able to load one or more other applications without running out of memory.

Select All

Marks all applications in the selection list. This allows you to enable all applications licensed on the instrument for pre-loading, or is a convenience for selecting all applications in one operation and then letting you deselect individual applications.

Key Path	System, Power On, Configure Applications
Initial S/W Revision	A.02.00

Deselect All

Clears the marks from all applications in the selection list, except the Power On application. The Power On application cannot be eliminated from the pre-load list.

Key Path	System, Power On, Configure Applications
Initial S/W Revision	A.02.00

Move Up

The application list is the order that applications appear in the Mode Menu. This key enables you to shift the selected application up in the list, thus moving the selected application earlier in the Mode Menu.

Key Path	System, Power On, Configure Applications
Initial S/W Revision	A.02.00

Move Down

The application list is the order that applications appear in the Mode Menu. This key enables you to shift the selected application down in the list, thus moving the selected application later in the Mode Menu.

Key Path	System, Power On, Configure Applications
Initial S/W Revision	A.02.00

Select/Deselect

Toggles the currently highlighted application in the list.

Key Path	System, Power On, Configure Applications
Initial S/W Revision	A.02.00

Save Changes and Exit

Applies the configuration of the applications list. The marked applications will be pre-loaded in memory the next time the instrument application is started, and the order of the applications in the list will be the order of the applications in the Mode Menu.

After saving your changes, the analyzer asks you if you would like it to restart so that your changes can take effect (see dialog box, below). If you choose not to restart, the changes will not take affect until the next time you shut down and restart the analyzer.

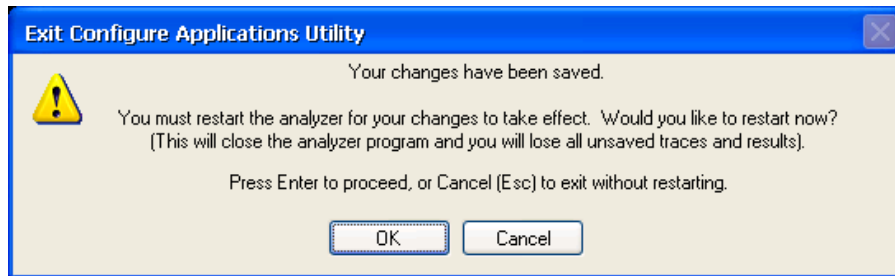

Key Path	System, Power On, Configure Applications
Remote Command	:SYSTem:PUP:PROcess
Example	:SYST:PUP:PROC This is the SCPI command for restarting the analyzer. You must Wait after this command for the instrument application to restart
Notes	The softkey will be grayed-out when the virtual memory of the selected applications exceeds 100% of the limit.
Notes	You cannot use *WAI or *OPC? to synchronize operation after a restart. This command stops and restarts the instrument application, thus the SCPI operation is terminated and restarted. A remote program must use fixed wait time to resume sending commands to the instrument. The wait time will be dependent upon which applications are pre-loaded.
Initial S/W Revision	A.02.00
Modified at S/W Revision	A.04.00

Exit Without Saving

Pressing this key will exit the Configure Applications utility without saving your changes.

Key Path	System, Power On, Configure Applications
Initial S/W Revision	A.02.00
Modified at S/W Revision	A.04.00

Restore Power On Defaults

This selection causes the Power On Type and Power On Application settings to be a reset to their default values. This level of Restore System Defaults does not affect any other system settings, mode settings and

does not cause a mode switch. The Power On key, under the Restore System Defaults menu, causes the same action.

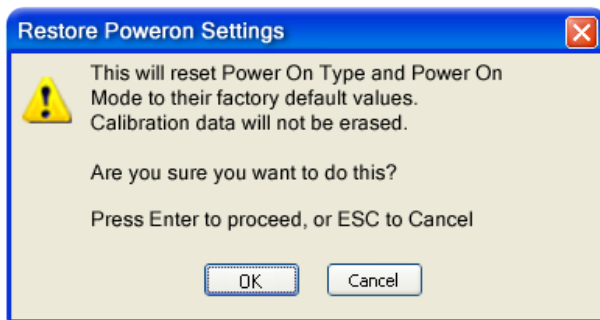

If you press any key other than OK or Enter, it is construed as a Cancel, because the only path that will actually cause the reset to be executed is through OK or Enter.

Key Path	System, Power On
Example	:SYST:DEF PON
Initial S/W Revision	Prior to A.02.00

Configure Applications - Instrument boot-up

At start-up of the analyzer program a dialog box similar to the one under the System, Power On, Configure Applications key will be displayed allowing you to choose which licensed applications are to be loaded. This dialog will only be displayed if the memory required to pre-load all of the licensed applications exceeds the Virtual Memory available.

Configure Applications - Windows desktop

The Configure Applications Utility may be run from the Windows Desktop. The utility is launched by double-

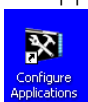

clicking the icon on the desktop, which brings-up a dialog box similar to the one under the System, Power On, Configure Applications key, allowing you to choose which licensed applications are to be loaded when the analyzer program starts up. This dialog box has mouse buttons on it that do the job the softkeys normally do in the System, Power On, Configure Applications menu.

Configure Applications - Remote Commands

The following topics provide details on using remote commands to configure the list of applications you want to load into the instrument memory or query the Virtual Memory utilization for your applications.

- ["Configuration list \(Remote Command Only\)" on page 256](#)
- ["Configuration Memory Available \(Remote Command Only\)" on page 256](#)
- ["Configuration Memory Total \(Remote Command Only\)" on page 256](#)
- ["Configuration Memory Used \(Remote Command Only\)" on page 256](#)

- "Configuration Application Memory (Remote Command Only)" on page 257

Configuration list (Remote Command Only)

This remote command is used to set or query the list of applications to be loaded in-memory.

Remote Command	:SYSTem:PON:APPLication:LLISt <string of INSTRument:SElect names> :SYSTem:PON:APPLication:LLISt?
Example	:SYST:PON:APPL:LLIS "SA,BASIC,WCDMA"
Notes	<string of INSTRument:SElect names> are from the enums of the :INSTRument:SElect command. The order of the <INSTRument:SElect names> is the order that the applications are loaded into memory, and the order that they appear in the Mode Menu. Error message -225 "Out of Memory" is reported when more applications are listed than can reside in Virtual Memory. When this occurs, the existing applications load list is unchanged.
Preset	Not affected by Preset
State Saved	Not saved in instrument state
Initial S/W Revision	A.02.00

Configuration Memory Available (Remote Command Only)

This remote command is used to query the amount of Virtual Memory remaining.

Remote Command	:SYSTem:PON:APPLication:VMEMory[:AVAIlable]?
Example	:SYST:PON:APPL:VMEM?
Preset	Not affected by Preset
Initial S/W Revision	A.02.00

Configuration Memory Total (Remote Command Only)

This remote command is used to query the limit of Virtual Memory allowed for applications.

Remote Command	:SYSTem:PON:APPLication:VMEMory:TOTal?
Example	:SYST:PON:APPL:VMEM:TOT?
Preset	Not affected by Preset
Initial S/W Revision	A.02.00

Configuration Memory Used (Remote Command Only)

This remote command is a query of the amount of Virtual Memory used by all measurement applications.

Remote Command	:SYSTem:PON:APPLication:VMEMory:USED?
Example	:SYST:PON:APPL:VMEM:USED?

Preset	Not affected by Preset
Initial S/W Revision	A.02.00

Configuration Application Memory (Remote Command Only)

This remote command is used to query the amount of Virtual Memory a particular application consumes.

Remote Command	:SYSTem:PON:APPLication:VMEMory:USED:NAME? <INSTRument:SElect name>
Example	:SYST:PON:APPL:VMEM:USED:NAME? CDMA2K
Notes	<INSTRument:SElect name> is from the enums of the :INSTRument:SElect command Value returned will be 0 (zero) if the name provided is invalid.
Preset	Not affected by Preset
Initial S/W Revision	Prior to A.02.00

Alignments

The Alignments Menu controls and displays the automatic alignment of the instrument, and provides the ability to restore the default alignment values.

The current setting of the alignment system is displayed in the system Settings Panel along the top of the display, including a warning icon for conditions that may cause specifications to be impacted.



Key Path	System
Initial S/W Revision	Prior to A.02.00

Auto Align

Configures the method for which the automatic background alignment is run.

Automatic background alignments are run periodically between measurement acquisitions. The instrument's software determines when alignments are to be performed to maintain warranted operation. The recommended setting for Auto Align is Normal.

An Auto Align execution cannot be aborted with the Cancel (ESC) key. To interrupt an Auto Align execution, select Auto Align Off.

Key Path	System, Alignments
Mode	All
Remote Command	:CALibration:AUTO ON PARTial OFF :CALibration:AUTO?
Example	:CAL:AUTO ON

Notes	While Auto Align is executing, bit 0 of Status Operation register is set.
Couplings	Auto Align is set to Off if Restore Align Data is invoked.
Preset	This is unaffected by Preset but is set to ON upon a “Restore System Defaults->Align”.
State Saved	No
Status Bits/OPC dependencies	When Auto Align is executing, bit 0 in the Status Operational register is set.
Backwards Compatibility SCPI	:CALibration:AUTO ALERt Parameter ALERt is for backward compatibility only and is mapped to PARTial
Backwards Compatibility Notes	<ol style="list-style-type: none"> 1. ESA SCPI for Auto Align is :CALibration:AUTO <Boolean>. The command for X-Series is an enumeration. Thus the parameters of “0” and “1” are not possible in X-Series. 2. Similarly, the ESA SCPI for :CALibration:AUTO? returned the Boolean value 1 or 0, in X-Series it is an Enumeration (string). Thus, queries by customer applications into numeric variables will result in an error 3. In PSA Auto Align OFF was not completely off, it is equivalent to PARTial in X-Series. In X-Series, OFF will be fully OFF. This means users of PSA SCPI who choose OFF may see degraded performance and should migrate their software to use PARTial.
Initial S/W Revision	Prior to A.02.00

Normal

Auto Align, Normal turns on the automatic alignment of all measurement systems. The Auto Align, Normal selection maintains the instrument in warranted operation across varying temperature and over time.

If the condition “Align Now, All required” is set, transition to Auto Align, Normal will perform the required alignments and clear the “Align Now, All required” condition and then continue with further alignments as required to maintain the instrument adequately aligned for warranted operation.

When Auto Align, Normal is selected the Auto Align Off time is set to zero.

When Auto Align, Normal is selected the Settings Panel indicates ALIGN AUTO.

Key Path	System, Alignments, Auto Align
Mode	All
Example	:CAL:AUTO ON
Notes	<p>Alignment processing as a result of the transition to Normal will be executed sequentially. Thus, *OPC? or *WAI following CAL:AUTO ON will return when the alignment processing is complete.</p> <p>The presence of an external signal may interfere with the RF portion of the alignment. If so, the Error Condition message “Align skipped: 50 MHz interference” or “Align skipped: 4.8 GHz interference” is reported, and bit 11 is set in the Status Questionable Calibration register. After the interfering signal is removed, subsequent alignment of the RF will clear the condition, and clear bit 11 in the Status Questionable Calibration register.</p>
Readback Text	Normal
Status Bits/OPC dependencies	An interfering user signal may prevent automatic alignment of the RF subsystem. If this occurs, the Error Condition message “Align skipped: 50 MHz interference” or “Align skipped: 4.8 GHz

interference” is reported, the Status Questionable Calibration bit 11 is set, and the alignment proceeds. When a subsequent alignment of the RF subsystem succeeds, either by the next cycle of automatic alignment or from an Align Now, RF, the Error Condition and Status Questionable Calibration bit 11 are cleared.

Initial S/W Revision	Prior to A.02.00
----------------------	------------------

Partial

Auto Align, Partial disables the full automatic alignment and the maintenance of warranted operation for the benefit of improved measurement throughput. Accuracy is retained for the Resolution Bandwidth filters and the IF Passband, which is critical to FFT accuracy, demodulation, and many measurement applications. With Auto Align set to Partial, you are now responsible for maintaining warranted operation by updating the alignments when they expire. The Auto Align, Alert mechanism will notify you when alignments have expired. One solution to expired alignments is to perform the Align All, Now operation. Another is to return the Auto Align selection to Normal.

Auto Align, Partial is recommended for measurements where the throughput is so important that a few percent of improvement is more valued than an increase in the accuracy errors of a few tenths of a decibel. One good application of Auto Align, Partial would be an automated environment where the alignments can be called during overhead time when the device-under-test is exchanged.

When Auto Align, Partial is selected the elapsed time counter begins for Auto Align Off time.

When Auto Align, Partial is selected the Settings Panel indicates ALIGN PARTIAL with a warning icon. The warning icon is to inform the operator that they are responsible for maintaining the warranted operation of the instrument

Key Path	System, Alignments, Auto Align
Mode	All
Example	:CAL:AUTO PART
Notes	Auto Align Partial begins the elapsed time counter for Auto Align Off time.
Readback Text	Partial
Initial S/W Revision	Prior to A.02.00

Off

Auto Align, Off disables automatic alignment and the maintenance of warranted operation, for the benefit of maximum measurement throughput. With Auto Align set to Off, you are now responsible for maintaining warranted operation by updating the alignments when they expire. The Auto Align, Alert mechanism will notify you when alignments have expired. One solution to expired alignments is to perform the Align All, Now operation. Another is to return the Auto Align selection to Normal.

The Auto Align, Off setting is rarely the best choice, because Partial gives almost the same improvement in throughput while maintaining the warranted performance for a much longer time. The choice is intended for unusual circumstances such as the measurement of radar pulses where you might like the revisit time to be as consistent as possible.

When Auto Align, Off is selected the Auto Align Off time is initialized and the elapsed time counter begins.

When Auto Align, Off is selected the Settings Panel indicates ALIGN OFF with a warning icon. The warning icon is to inform the operator that they are responsible for maintaining the warranted operation of the instrument:

Key Path	System, Alignments, Auto Align
Mode	All
Example	:CAL:AUTO OFF
Notes	Auto Align Off begins the elapsed time counter for Auto Align Off time.
Couplings	Auto Align is set to Off if Restore Align Data is invoked.
Readback Text	Off
Initial S/W Revision	Prior to A.02.00

All but RF

Auto Align, All but RF, configures automatic alignment to include or exclude the RF subsystem. (Eliminating the automatic alignment of the RF subsystem prevents the input impedance from changing. The normal input impedance of 50 ohms can change to an open circuit when alignments are being used. Some devices under test do not behave acceptably under such circumstances, for example by showing instability.) When Auto Align, All but RF ON is selected, the operator is responsible for performing an Align Now, RF when RF-related alignments expire. The Auto Align, Alert mechanism will notify the operator to perform an Align Now, All when the combination of time and temperature variation is exceeded.

When Auto Align, All but RF ON is selected the Settings Panel indicates ALIGN AUTO/NO RF with a warning icon (warning icon is intended to inform the operator they are responsible for the maintaining the RF alignment of the instrument):

Key Path	System, Alignments, Auto Align
Mode	All
Remote Command	:CALibration:AUTO:MODE ALL NRF :CALibration:AUTO:MODE?
Example	:CAL:AUTO:MODE NRF
Preset	This is unaffected by Preset but is set to ALL on a "Restore System Defaults->Align".
State Saved	No
Readback Text	RF or NRF
Initial S/W Revision	Prior to A.02.00

Alert

The instrument will signal an Alert when conditions exist such that you will need to perform a full alignment (for example, Align Now, All). The Alert can be configured in one of four settings; Time & Temperature, 24 hours, 7 days, or None. A confirmation is required when a selection other than Time & Temperature is chosen. This prevents accidental deactivation of alerts.

With Auto Align set to Normal, the configuration of Alert is not relevant because the instrument's software maintains the instrument in warranted operation.

Key Path	System, Alignments, Auto Align
Mode	All
Remote Command	:CALibration:AUTO:ALERT TTEMperature DAY WEEK NONE :CALibration:AUTO:ALERT?
Example	:CAL:AUTO:ALERT TEM
Notes	The alert that alignment is needed is the setting of bit 14 in the Status Questionable Calibration register.
Preset	This is unaffected by Preset but is set to TTEMperature on a "Restore System Defaults->Align".
State Saved	No
Status Bits/OPC dependencies	The alert is the Error Condition message "Align Now, All required" and bit 14 is set in the Status Questionable Calibration register.
Initial S/W Revision	Prior to A.02.00

Time & Temperature

With Auto Align Alert set to Time & Temperature the instrument will signal an alert when alignments expire due to the combination of the passage of time and changes in temperature. The alert is the Error Condition message "Align Now, All required". If this choice for Alert is selected, the absence of an alert means that the analyzer alignment is sufficiently up-to-date to maintain warranted accuracy.

Key Path	System, Alignments, Auto Align, Alert
Mode	All
Example	:CAL:AUTO:ALERT TEM
Readback Text	Time & Temp
Status Bits/OPC dependencies	Bit 14 is set in the Status Questionable Calibration register.
Initial S/W Revision	Prior to A.02.00

24 hours

With Auto Align Alert set to 24 Hours the instrument will signal an alert after a time span of 24 hours since the last successful full alignment (for example, Align Now, All or completion of a full Auto Align). You may choose this selection in an environment where the temperature is stable on a daily basis at a small risk of accuracy errors in excess of the warranted specifications. The alert is the Error Condition message "Align Now, All required".

For front-panel operation, confirmation is required to transition into this setting of Alert. The confirmation dialog is:

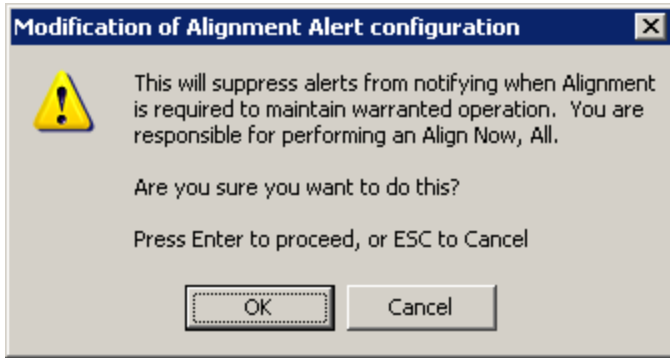

No confirmation is required when Alert is configured through a remote command.

Key Path	System, Alignments, Auto Align, Alert
Mode	All
Example	:CAL:AUTO:ALER DAY
Readback Text	24 hours
Status Bits/OPC dependencies	Bit 14 is set in the Status Questionable Calibration register.
Initial S/W Revision	Prior to A.02.00

7 days

With Auto Align Alert is set to 7 days the instrument will signal an alert after a time span of 168 hours since the last successful full alignment (for example, Align Now, All or completion of a full Auto Align). You may choose this selection in an environment where the temperature is stable on a weekly basis, at a modest risk of accuracy degradations in excess of warranted performance. The alert is the Error Condition message “Align Now, All required”.

For front panel operation, confirmation is required for the customer to transition into this setting of Alert. The confirmation dialog is:

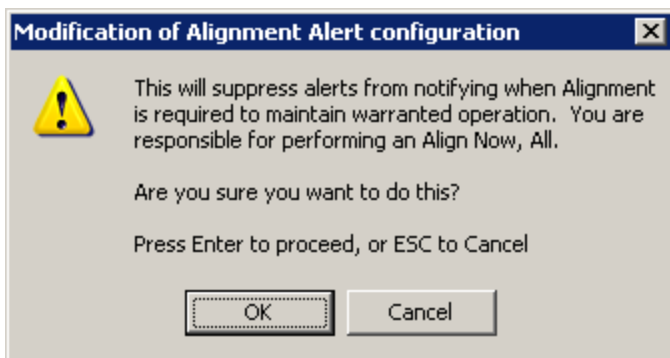

No confirmation is required when Alert is configured through a remote command.

Key Path	System, Alignments, Auto Align, Alert
Mode	All
Example	:CAL:AUTO:ALER WEEK
Readback Text	7 days
Status Bits/OPC dependencies	Bit 14 is set in the Status Questionable Calibration register.
Initial S/W Revision	Prior to A.02.00

None

With Auto Align Alert set to None the instrument will not signal an alert. This is provided for rare occasions where you are making a long measurement which cannot tolerate Auto Align interruptions, and must have the ability to capture a screen image at the end of the measurement without an alert posted to the display. Agilent does not recommends using this selection in any other circumstances, because of the risk of accuracy performance drifting well beyond expected levels without the operator being informed.

For front panel operation, confirmation is required to transition into this setting of Alert. The confirmation dialog is:

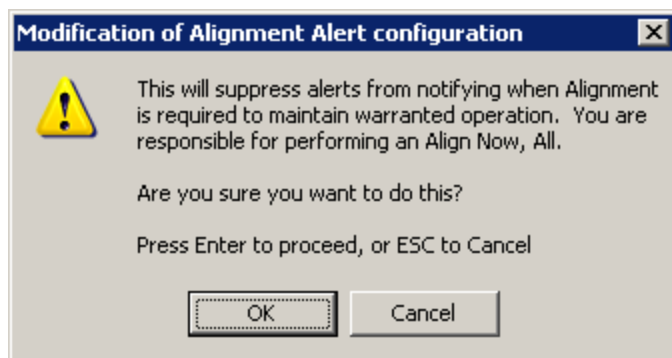

No confirmation is required when Alert is configured through a remote command.

Key Path	System, Alignments, Auto Align, Alert
Mode	All
Example	:CAL:AUTO:ALER NONE
Initial S/W Revision	Prior to A.02.00

Execute Expired Alignments (Remote Command Only)

Alignments can be expired in the situation where Auto Align is in the state of Partial or Off. This feature runs the alignments that have expired. This is different than performing an Align All, Now operation. Align All, Now performs an alignment of all subsystems regardless of whether they are needed or not, with Execute Expired Alignments, only the individual subsystems that have become due are aligned.

Mode	All
Remote Command	:CALibration:EXPIred?
Example	:CAL:EXP?
Notes	:CALibration:EXPIred? returns 0 if successful :CALibration:EXPIred? returns 1 if failed
Initial S/W Revision	Prior to A.02.00

Align Now

Accesses alignment processes that are immediate action operations. They perform complete operations and run until they are complete.

Key Path	System, Alignments
Initial S/W Revision	Prior to A.02.00

All

(In MXE the key label is “All (plus RF Presel 20 Hz – 3.6 GHz)”)Immediately executes an alignment of all subsystems In MXE, the Align Now All is followed by additionally aligning the RF Preselector section, so in MXE, the key label contains the parenthetical note “(plus RF Presel 20 Hz – 3.6 GHz)”. The instrument stops any measurement currently underway, performs the alignment, then restarts the measurement from the beginning (similar to pressing the Restart key).

If an interfering user signal is present at the RF Input, the alignment is performed on all subsystems except the RF. After completion, the Error Condition message “Align skipped: 50 MHz interference” or “Align skipped: 4.8 GHz interference” is generated. In addition the Error Condition message “Align Now, RF required” is generated, and bits 11 and 12 are set in the Status Questionable Calibration register.

The query form of the remote commands (:CALibration[:ALL]? or *CAL?) invokes the alignment of all subsystems and returns a success or failure value. An interfering user signal is not grounds for failure; if the alignment was able to succeed on all portions but unable to align the RF because of an interfering signal, the resultant will be the success value.

Successful completion of Align Now, All will clear the “Align Now, All required” Error Condition, and clear bit 14 in the Status Questionable Calibration register. It will also begin the elapsed time counter for Last Align Now, All Time, and capture the Last Align Now, All Temperature.

In the MXE, successful completion will also clear the “Align 20 Hz to 30 MHz required” Error Condition, the “Align 30 MHz to 3.6 GHz required” Error Condition, and the “Align 20 Hz to 3.6 GHz required” Error Condition, and clear bits 1 and bit 2 and clear the bit 1 in the Status Questionable Calibration Extended Needed register.

If the Align RF subsystem succeeded in aligning (no interfering signal present), the elapsed time counter begins for Last Align Now, RF Time, and the temperature is captured for the Last Align Now, RF Temperature. In addition the Error Conditions “Align skipped: 50 MHz interference” and “Align skipped: 4.8

GHz interference” are cleared, the Error Condition “Align Now, RF required” is cleared, and bits 11 and 12 are cleared in the Status Questionable Calibration register

Align Now, All can be interrupted by pressing the Cancel (ESC) front-panel key or remotely with Device Clear followed by the :ABORt SCPI command. When this occurs the Error Condition message “Align Now, All required” is generated, and bit 14 is set in the Status Questionable Condition register. This is because new alignment data may be employed for an individual subsystem, but not a cohesive set of data for all subsystems.

In many cases, you might find it more convenient to change alignments to Normal, instead of executing Align Now, All. When the Auto Align process transitions to Normal, the analyzer will immediately start to update only the alignments that have expired, thus efficiently restoring the alignment process.

Key Path	System, Alignments, Align Now
Mode	All
Remote Command	:CALibration[:ALL] :CALibration[:ALL]?
Example	:CAL
Notes	:CALibration[:ALL]? returns 0 if successful :CALibration[:ALL]? returns 1 if failed :CALibration[:ALL]? is the same as *CAL? While Align Now, All is performing the alignment, bit 0 in the Status Operation register is set. Completion, or termination, will clear bit 0 in the Status Operation register. This command is sequential; it must complete before further SCPI commands are processed. Interrupting the alignment from remote is accomplished by invoking Device Clear followed by the :ABORt command. Successful completion will clear bit 14 in the Status Questionable Calibration register. An interfering user signal is not grounds for failure of Align Now, All. However, bits 11 and 12 are set in the Status Questionable Calibration register to indicate Align Now, RF is required. An interfering user supplied signal will result in the instrument requiring an Align Now, RF with the interfering signal removed.
Couplings	Initializes the time for the Last Align Now, All Time. Records the temperature for the Last Align Now, All Temperature. If Align RF component succeeded, initializes the time for the Last Align Now, RF Time. If Align RF component succeeded, records the temperature for the Last Align Now, RF Temperature.
Status Bits/OPC dependencies	Bits 11, 12, or 14 may be set in the Status Questionable Calibration register.
Initial S/W Revision	Prior to A.02.00

Mode	All
Remote Command	*CAL?
Example	*CAL?
Notes	*CAL? returns 0 if successful

	<p>*CAL? returns 1 if failed :CALibration[:ALL]? is the same as *CAL? See additional remarks described with :CALibration[:ALL]? Everything about :CALibration[:ALL]? is synonymous with *CAL? including all conditions, status register bits, and couplings</p>
Initial S/W Revision	Prior to A.02.00

All but RF

(In MXE the key label is “All but RF (not including RF Presel)”)

Immediately executes an alignment of all subsystems except the RF subsystem . The instrument will stop any measurement currently underway, perform the alignment, and then restart the measurement from the beginning (similar to pressing the Restart key). This can be used to align portions of the instrument that are not impacted by an interfering user input signal.

This operation might be chosen instead of All if you do not want the device under test to experience a large change in input impedance, such as a temporary open circuit at the analyzer input.

The query form of the remote commands (:CALibration:NRF?) will invoke the alignment and return a success or failure value.

Successful completion of Align Now, All but RF will clear the “Align Now, All required” Error Condition, and clear bit 14 in the Status Questionable Calibration register. If “Align Now, All required” was in effect prior to executing the All but RF, the Error Condition message “Align Now, RF required” is generated and bit 12 in the Status Questionable Calibration register is set. It will also begin the elapsed time counter for Last Align Now, All Time, and capture the Last Align Now, All Temperature.

Align Now, All but RF can be interrupted by pressing the Cancel (ESC) front-panel key or remotely with Device Clear followed by the :ABORt SCPI command. When this occurs the Error Condition message “Align Now, All required” is generated, and bit 14 is set in the Status Questionable Condition register. This is because new alignment data may be used for an individual subsystem, but not a full new set of data for all subsystems.

In models with the RF Preselector, such as the N9038A, the “All but RF” alignment will execute an alignment of all subsystems except the RF subsystem of the Spectrum Analyzer, as well as the system gain of the RF Preselector.

Key Path	System, Alignments, Align Now
Mode	All
Remote Command	:CALibration:NRF :CALibration:NRF?
Example	:CAL:NRF
Notes	:CALibration:NRF? returns 0 if successful :CALibration:NRF? returns 1 if failed While Align Now, All but RF is performing the alignment, bit 0 in the Status Operation register is set. Completion, or termination, will clear bit 0 in the Status Operation register.

	This command is sequential; it must complete before further SCPI commands are processed. Interrupting the alignment from remote is accomplished by invoking Device Clear followed by the :ABORt command. Successful completion will clear bit 14 in the Status Questionable Calibration register and set bit 12 if invoked with “Align Now, All required”.
Couplings	Initializes the time for the Last Align Now, All Time. Records the temperature for the Last Align Now, All Temperature.
Status Bits/OPC dependencies	Bits 12 or 14 may be set in the Status Questionable Calibration register.
Initial S/W Revision	Prior to A.02.00

RF

(In MXE the key label is “RF Only”)

Immediately executes an alignment of the RF subsystem . The instrument stops any measurement currently underway, performs the alignment, then restarts the measurement from the beginning (similar to pressing the Restart key).

This operation might be desirable if the alignments had been set to not include RF alignments, or if previous RF alignments could not complete because of interference which has since been removed.

If an interfering user signal is present at the RF Input, the alignment will terminate and generate the Error Condition message “Align skipped: 50 MHz interference” or “Align skipped: 4.8 GHz interference”, and Error Condition “Align Now, RF required”. In addition, bits 11 and 12 will be set in the Status Questionable Calibration register.

The query form of the remote commands (:CALibration:RF?) will invoke the alignment of the RF subsystem and return a success or failure value. An interfering user signal is grounds for failure.

Successful completion of Align Now, RF will begin the elapsed time counter for Last Align Now, RF Time, and capture the Last Align Now, RF Temperature.

Align Now, RF can be interrupted by pressing the Cancel (ESC) front-panel key or remotely with Device Clear followed by the :ABORt SCPI command. When this occurs, the Error Condition message “Align Now, RF required” is generated, and bit 12 is set in the Status Questionable Condition register. None of the new alignment data is used.

In models with the RF Preselector, such as the N9038A, the RF alignment will execute an alignment of the RF subsystem of the Spectrum Analyzer, as well as the RF subsystem on RF Preselector path.

Key Path	System, Alignments, Align Now
Mode	All
Remote Command	:CALibration:RF :CALibration:RF?
Example	:CAL:RF
Notes	:CALibration:RF? returns 0 if successful

:CALibration:RF?	<p>returns 1 if failed (including interfering user signal)</p> <p>While Align Now, RF is performing the alignment, bit 0 in the Status Operation register is set. Completion, or termination, will clear bit 0 in the Status Operation register.</p> <p>This command is sequential; it must complete before further SCPI commands are processed. Interrupting the alignment from remote is accomplished by invoking Device Clear followed by the :ABORt command.</p> <p>Successful completion clears the Error Conditions “Align skipped: 50 MHz interference” and “Align skipped: 4800 MHz interference” and the Error Conditions “Align RF failed” and “Align Now, RF required”, and clears bits 3, 11, and 12 in the Status Questionable Calibration register.</p> <p>A failure encountered during alignment will generate the Error Condition message “Align RF failed” and set bit 3 in the Status Questionable Calibration register.</p> <p>An interfering user signal will result in bits 11 and 12 to be set in the Status Questionable Calibration register to indicate Align Now, RF is required.</p> <p>An interfering user supplied signal will result in the instrument requiring an Align Now, RF with the interfering signal removed.</p>
Couplings	<p>Initializes the time for the Last Align Now, RF Time.</p> <p>Records the temperature for the Last Align Now, RF Temperature.</p>
Status Bits/OPC dependencies	<p>Bits 11, 12, or 14 may be set in the Status Questionable Calibration register.</p>
Initial S/W Revision	<p>Prior to A.02.00</p>

Show Alignment Statistics

Shows alignment information you can use to ensure that the instrument is operating in a specific manner. The Show Alignment Statistics screen is where you can view time and temperature information.

Values which are displayed are only updated when the Show Alignment Statistics screen is invoked, they are not updated while the Show Alignment Statistics screen is being displayed. The remote commands that access this information obtain current values.

An example of the Show Alignment Statistics screen would be similar to:

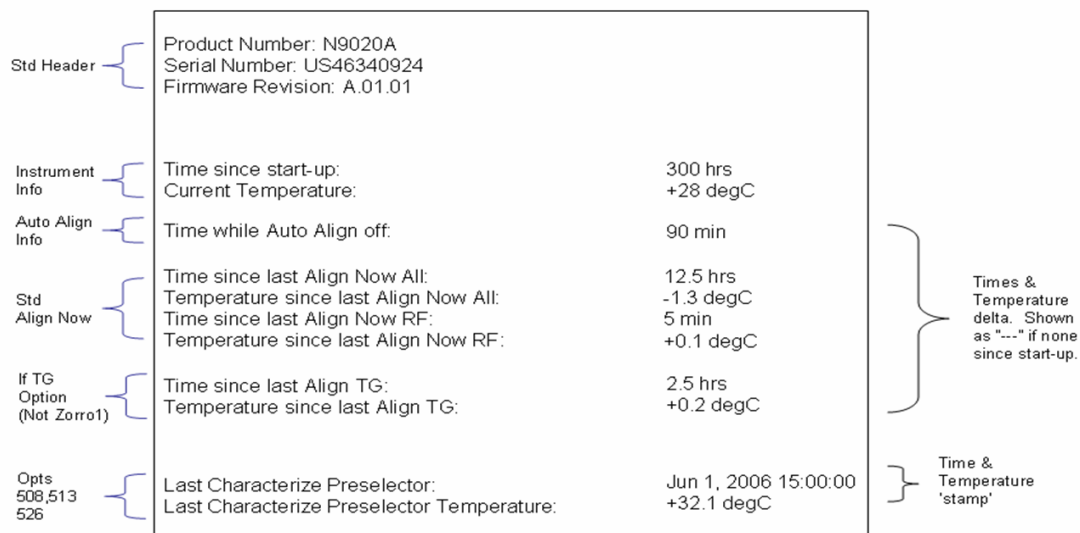

A successful Align Now, RF will set the Last Align RF temperature to the current temperature, and reset the Last Align RF time. A successful Align Now, All or Align Now, All but RF will set the Last Align Now All temperature to the current temperature, and reset the Last Align Now All time. A successful Align Now, All will also reset the Last Align RF items if the RF portion of the Align Now succeeded.

Key Path	System, Alignments
Mode	All
Notes	The values displayed on the screen are only updated upon entry to the screen and not updated while the screen is being displayed.
Initial S/W Revision	Prior to A.02.00

Key Path	Visual annotation in the Show Alignment Statistics screen
Mode	All
Remote Command	:SYSTem:PON:TIME?
Example	:SYST:PON:TIME?
Notes	Value is the time since the most recent start-up in seconds.
State Saved	No
Initial S/W Revision	Prior to A.02.00

Key Path	Visual annotation in the Show Alignment Statistics screen
Mode	All
Remote Command	:CALibration:TEMPerature:CURREnt?
Example	:CAL:TEMP:CURR?

Notes	Value is in degrees Centigrade. Value is invalid if using default alignment data (Align Now, All required)
State Saved	No
Initial S/W Revision	Prior to A.02.00

Key Path	Visual annotation in the Show Alignment Statistics screen
Mode	All
Remote Command	:CALibration:TIME:LALL?
Example	:CAL:TIME:LALL?
Notes	Value is the elapsed time, in seconds, since the last successful Align Now, All or Align Now, All but RF was executed.
State Saved	No
Initial S/W Revision	Prior to A.02.00

Key Path	Visual annotation in the Show Alignment Statistics screen
Mode	All
Remote Command	:CALibration:TEMPerature:LALL?
Example	:CAL:TEMP:LALL?
Notes	Value is in degrees Centigrade at which the last successful Align Now, All or Align Now, All but RF was executed.
State Saved	No
Initial S/W Revision	Prior to A.02.00

Key Path	Visual annotation in the Show Alignment Statistics screen
Mode	All
Remote Command	:CALibration:TIME:LRF?
Example	:CAL:TIME:LRF?
Notes	Value is the elapsed time, in seconds, since the last successful Align Now, RF was executed, either individually or as a component of Align Now, All.
State Saved	No
Initial S/W Revision	Prior to A.02.00

Key Path	Visual annotation in the Show Alignment Statistics screen
Mode	All

Remote Command	:CALibration:TEMPerature:LRF?
Example	:CAL:TEMP:LRF?
Notes	Value is in degrees Centigrade at which the last successful Align Now, RF was executed, either individually or as a component of Align Now, All.
State Saved	No
Initial S/W Revision	Prior to A.02.00

Key Path	Visual annotation in the Show Alignment Statistics screen
Mode	All
Remote Command	:CALibration:TIME:LPreselector?
Example	:CAL:TIME:LPR?
Notes	Value is the date and time the last successful Characterize Preselector was executed. The date is separated from the time by a space character. Returns "" if no Characterize Preselector has ever been performed on the instrument.
Dependencies	In models that do not include preselectors, this command is not enabled and any attempt to set or query will yield an error.
State Saved	No
Initial S/W Revision	Prior to A.02.00

Key Path	Visual annotation in the Show Alignment Statistics screen
Mode	All
Remote Command	:CALibration:TEMPerature:LPreselector?
Example	:CAL:TEMP:LPR?
Notes	Value is in degrees Centigrade at which the last successful Characterize Preselector was executed.
Dependencies	In models that do not include preselectors, this command is not enabled and any attempt to set or query will yield an error.
State Saved	No
Initial S/W Revision	Prior to A.02.00

Key Path	Visual annotation in the Show Alignment Statistics screen
Mode	All
Remote Command	:CALibration:AUTO:TIME:OFF?
Example	:CAL:AUTO:TIME:OFF?
Notes	Value is the elapsed time, in seconds, since Auto Align has been set to Off or Off with Alert. The value is 0 if Auto Align is ALL or NORF.
State Saved	No
Initial S/W Revision	Prior to A.02.00

Key Path	Visual annotation in the Show Alignment Statistics screen
Mode	All
Remote Command	:CALibration:TIME:RFPSselector:LCONducted?
Example	:CAL:TIME:RFPS:LCON?
Notes	Values are the date and time the last successful Align Now, 20 Hz – 30 MHz was executed. The date is separated from the time by a semi-colon character.
State Saved	No

Key Path	Visual annotation in the Show Alignment Statistics screen
Mode	All
Remote Command	:CALibration:TEMPerature:RFPSselector:LCONducted?
Example	:CAL:TEMP:RFPS:LCON?
Notes	Value is in degrees Centigrade at which the last successful Align Now, 20 Hz – 30 MHz was executed.
State Saved	No

Key Path	Visual annotation in the Show Alignment Statistics screen
Mode	All
Remote Command	:CALibration:TIME:RFPSselector:LRADiated?
Example	:CAL:TIME:RFPS:LRAD?
Notes	Value is the date and time the last successful Align Now, 30 MHz – 3.6 GHz was executed. The date is separated from the time by a semi-colon character.
State Saved	No

Key Path	Visual annotation in the Show Alignment Statistics screen
Mode	All
Remote Command	:CALibration:TEMPerature:RFPSselector:LRADiated?
Example	:CAL:TEMP:RFPS:LRAD?
Notes	Value is in degrees Centigrade at which the last successful Align Now, 30 MHz – 3.6 GHz was executed.
State Saved	No

Key Path	Visual annotation in the Show Alignment Statistics screen
----------	---

Mode	All
Remote Command	:CALibration:RFPSelector:SCHeuler:TIME:NEXT?
	This query returns data using the following format “YYYY/MM/DD; HH:MM:SS”
Example	:CAL:RFPS:SCH:TIME:NEXT?
Notes	<p>The next run time will be updated based on the start date/time and recurrence set by the users.</p> <p>“date” is representation of the date the task will run in the form of “YYYY/MM/DD” where:</p> <ul style="list-style-type: none"> –YYYY is the four digit representation of year. (for example, 2009) –MM is the two digit representation of month. (for example, 01 to 12) –DD is the two digit representation of the day. (for example, 01 to 28, 29, 30 or 31 depending on the month and year) <p>“time” is a representation of the time of day the task will run in the form of “HH:MM:SS” where:</p> <ul style="list-style-type: none"> –HH is the two digit representation of the hour in 24 hour format –MM is the two digit representation of minute –SS is the two digit representation of seconds <p>For model N9038A only.</p>
State Saved	No

Restore Align Defaults

Initializes the alignment user interface settings, not alignment data, to the factory default values. Align Now, All must be executed if the value of the Timebase DAC results in a change.

For front panel operation, you are prompted to confirm action before setting the alignment parameters to factory defaults:

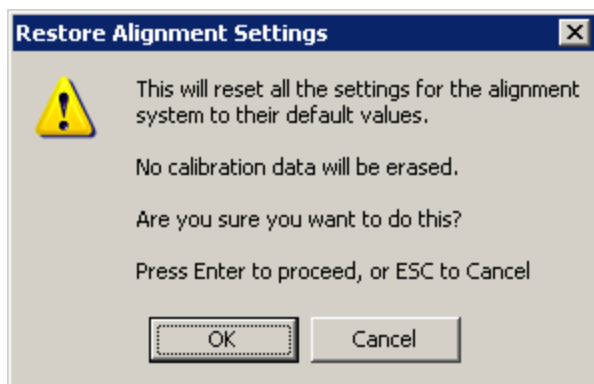

The parameters affected are:

Parameter	Setting
Timebase DAC	Calibrated
Timebase DAC setting	Calibrated value
Auto Align State	Normal (if the instrument is not operating with default alignment data, Off otherwise)

Auto Align All but RF	Off
Auto Align Alert	Time & Temperature

Key Path	System, Alignments
Mode	All
Example	:SYST:DEF ALIG
Notes	Alignment processing that results as the transition to Auto Alignment Normal will be executed sequentially; thus *OPC? or *WAI will wait until the alignment processing is complete.
Initial S/W Revision	Prior to A.02.00

Backup or Restore Align Data...

Opens the utility for backing-up or restoring the alignment data.

Alignment data for the instrument resides on the hard drive in a database. Agilent uses high quality hard drives; however it is highly recommended the alignment data be backed-up to storage outside of the instrument. Additionally, for customers who use multiple CPU Assemblies or multiple disk drives, the alignment that pertains to the instrument must be transferred to the resident hard drive after a CPU or hard drive is replaced. This utility facilitates backing-up and restoring the alignment data.

NOTE

This utility allows the operator to navigate to any location of the Windows file system. It is intended that the operator use a USB memory device or Mapped Network Drive to back up the alignment data to storage outside of the instrument.

Key Path	System, Alignments
Initial S/W Revision	A.02.00

Key Path	System, Alignments
Mode	All
Remote Command	:CALibration:DATA:DEFault
Example	:CAL:DATA:DEF
Couplings	Sets Auto Align to Off. Sets bit 14 in the Status Questionable Calibration register. The Error Condition message "Align Now, All required" is generated.
Initial S/W Revision	Prior to A.02.00

Alignment Data Wizard

The Backup or Restore Alignment Data wizard guides you through the operation of backing-up or restoring the alignment data.

The following dialogue boxes operates without a mouse or external keyboard when you use the default file names.

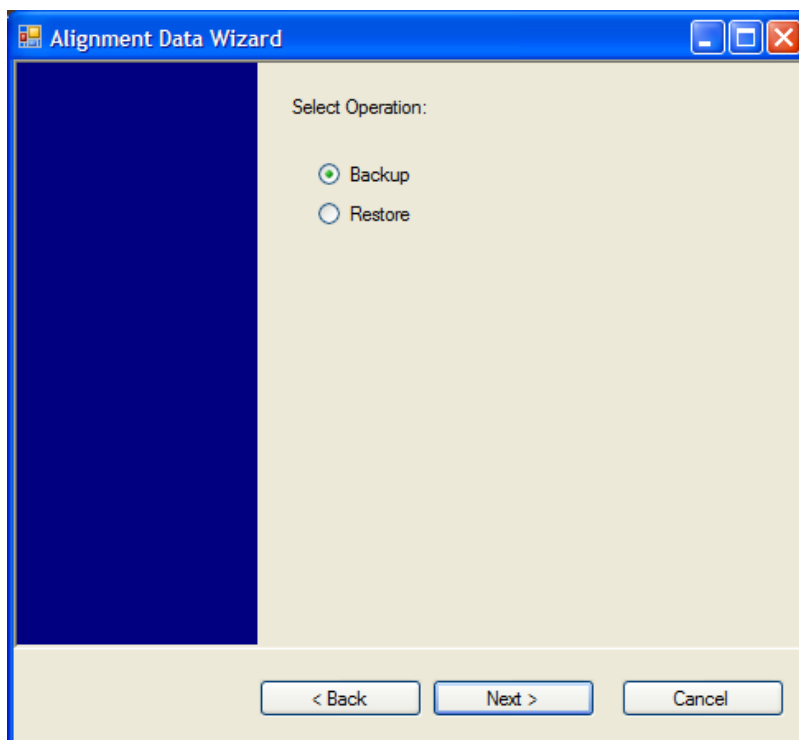
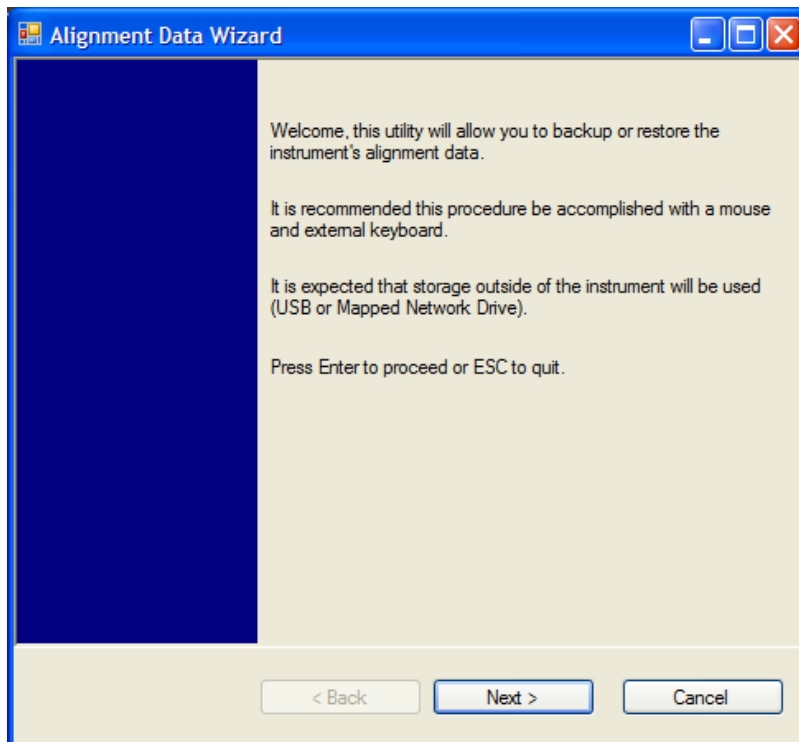

The backup screen indicates the approximate amount of space required to contain the backup file.

The default file name will be AlignDataBackup_<model number>_<serial number>_<date in YYYYMMDDHHMMSS>.bak.

The default backup location will be first drive identified as an external drive (USB or LAN) if such is available; if not, the internal D: partition will be selected.

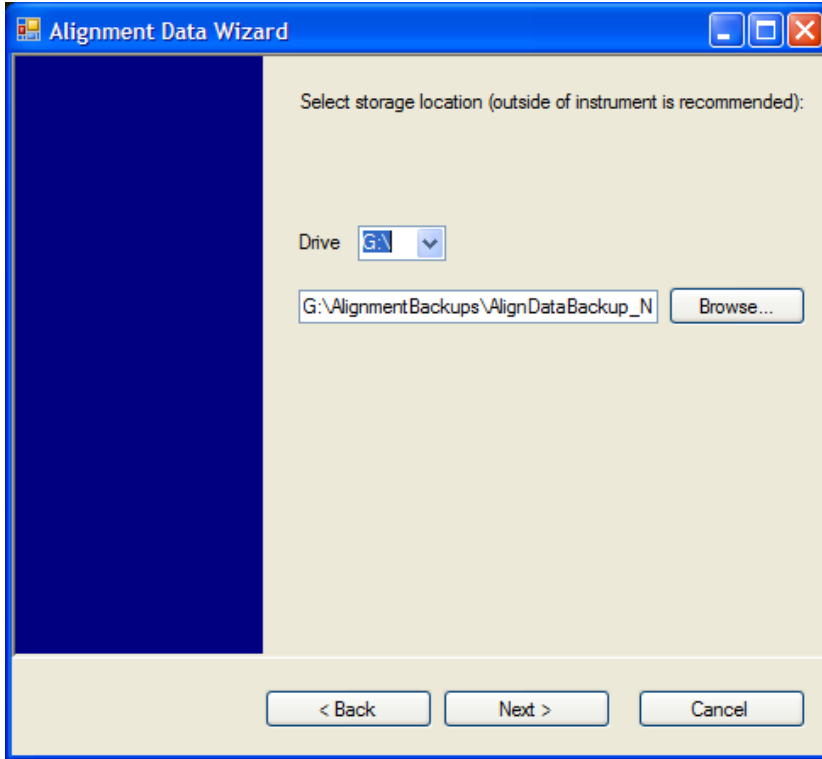

Changing the drive letter will also modify the path displayed in the box below. When this step is first loaded, the drive drop-down menu is populated with connected drives, which provide the user with write access. If there are many unreachable network drives connected to the instrument, this step can take a few seconds. If a USB drive is present, it will be selected by default. The path defaults to the AlignmentBackups folder, and a filename is automatically created in the form of AlignDataBackup_<model>_<serial number>_<date>_<time>. When the "Next >" button is pressed, you will be prompted to create a new folder if the chosen path does not yet exist.

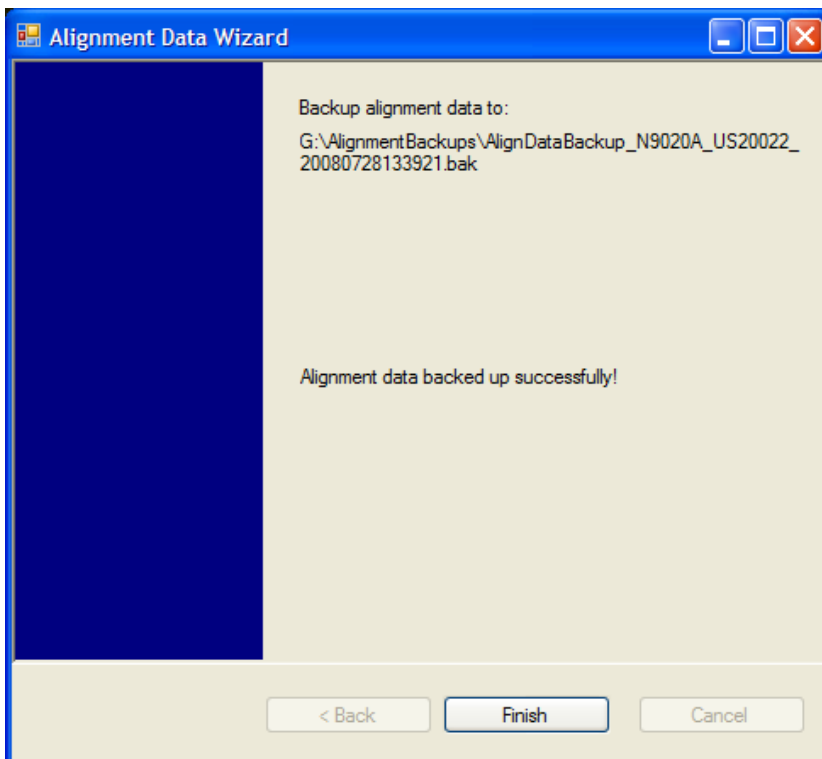
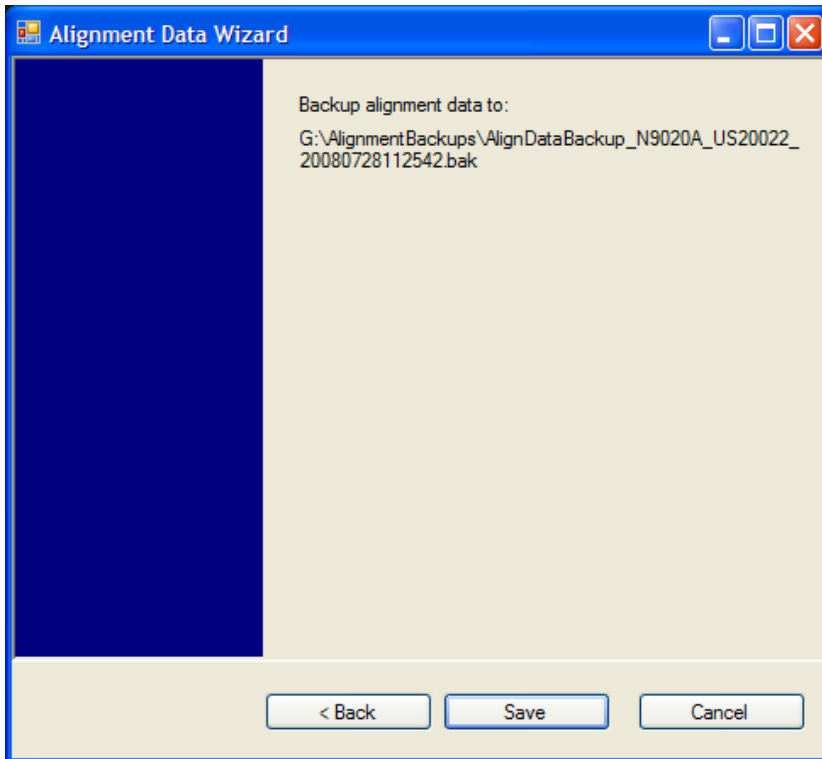

The restore operation checks the validity of the restore file using the database's built-in file validation. If the restore file is corrupt, the existing alignment data will remain in use.

If the serial number information in the backup file being restored is different from that of the instrument, the following message appears (the serial number shown are examples):

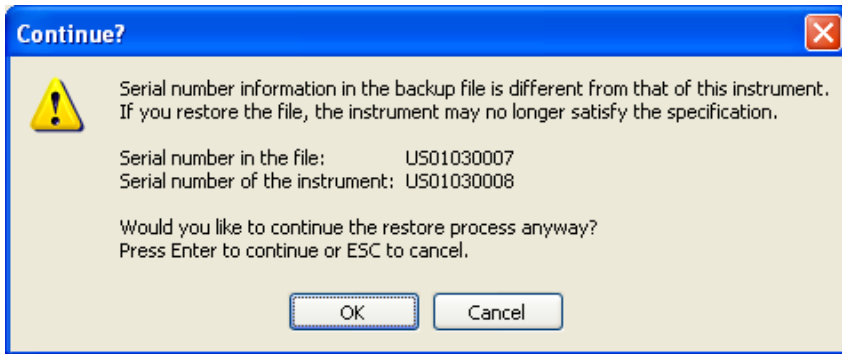

The default restore location will be first drive identified as an external drive (USB or LAN) if such is available; if not, the internal D: partition will be selected. The default restore file will be the most recent file that matches the default backup file name format: AlignDataBackup_<model number>_<serial number>_<date>.bak

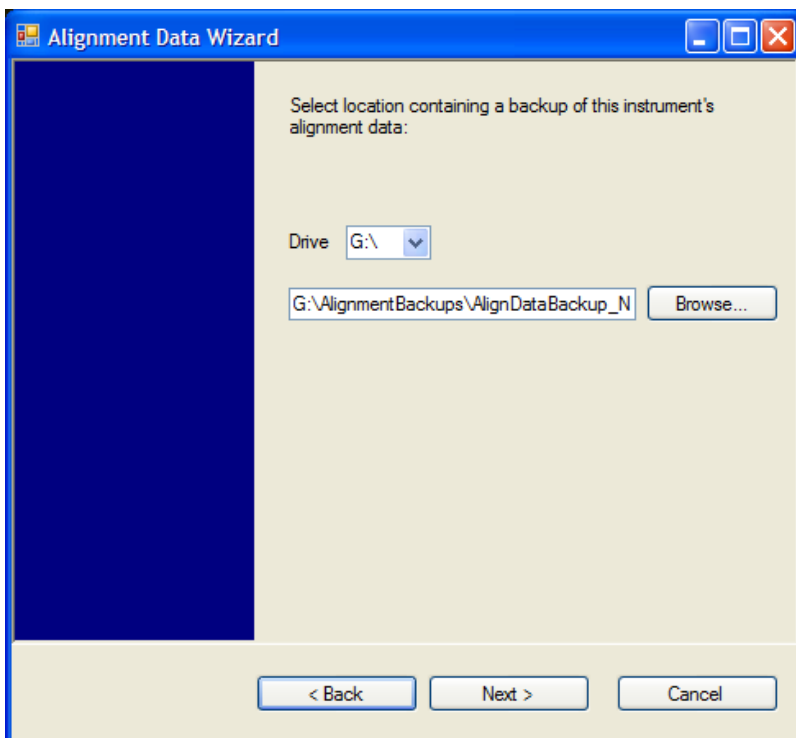

Changing the drive letter also modifies the path displayed in the box below. When this step is first loaded, the drive drop-down menu is populated with connected drives, which provide you with read access. The path defaults to the AlignBackups folder. The most recent *.bak file in the folder will also be selected by default.

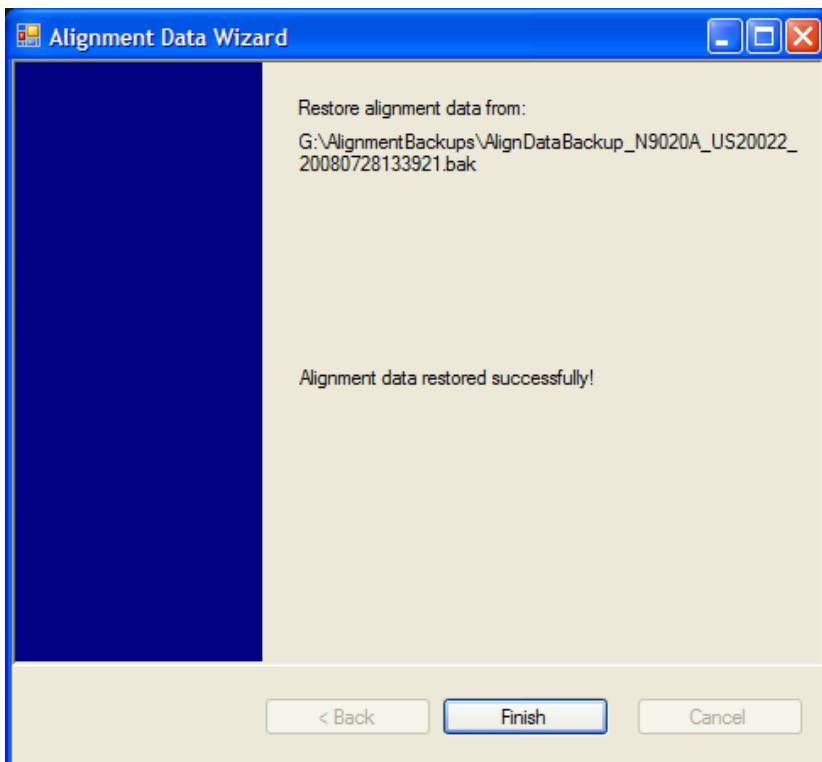
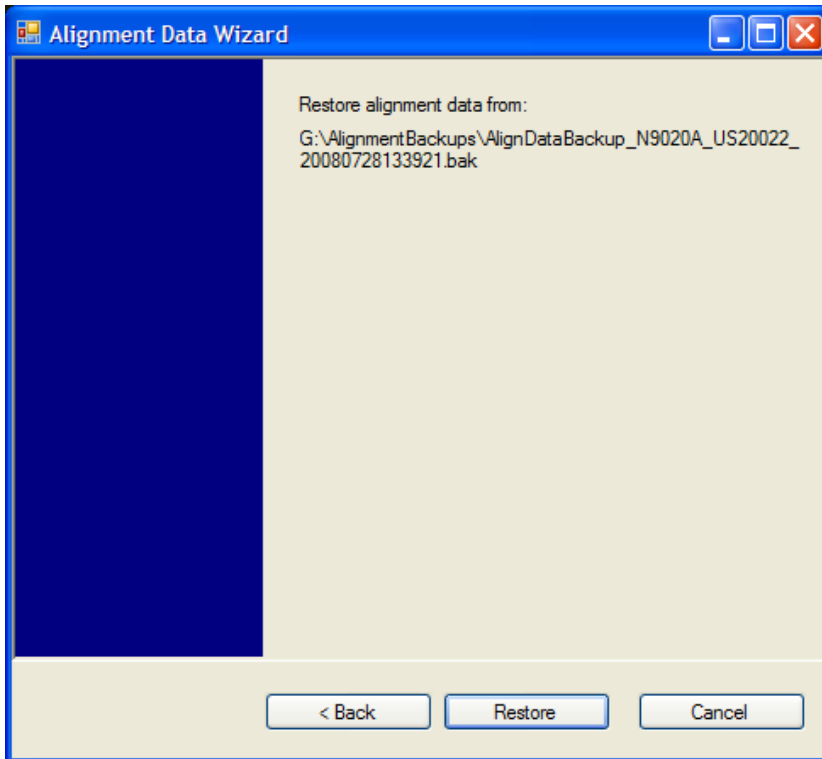

Perform Backup (Remote Command Only)

Invokes an alignment data backup operation to the provided Folder.

NOTE

It is recommended that the Folder provided is outside of the instrument (USB or Mapped Network Drive).

Remote Command	:CALibration:DATA:BACKup <filename>
Example	:CAL:DATA:BACK "F:\AlignDataBackup_N9020A_US00000001_2008140100.bak"
Initial S/W Revision	A.02.00

Perform Restore (Remote Command Only)

Invokes an alignment data restore operation from the provided filename.

Remote Command	:CALibration:DATA:RESTore <filename>
Example	:CAL:DATA:REST "F:\AlignDataBackup_N9020A_US00000001_2008140100.bak "
Initial S/W Revision	A.02.00

Advanced

Accesses alignment processes that are immediate action operations that perform operations that run until complete. Advanced alignments are performed on an irregular basis, or require additional operator interaction

Key Path	System, Alignments
Initial S/W Revision	Prior to A.02.00

Characterize Preselector

The Preselector tuning curve drifts over temperature and time. Recognize that the Amplitude, Presel Center function adjusts the preselector for accurate amplitude measurements at an individual frequency. Characterize Preselector improves the amplitude accuracy by ensuring the Preselector is approximately centered at all frequencies without the use of the Amplitude, Presel Center function. Characterize Preselector can be useful in situations where absolute amplitude accuracy is not of utmost importance, and the throughput savings or convenience of not performing a Presel Center is desired. Presel Center is required prior to any measurement for best (and warranted) amplitude accuracy.

Agilent recommends that the Characterize Preselector operation be performed yearly as part of any calibration, but performing this operation every three months can be worthwhile.

Characterize Preselector immediately executes a characterization of the Preselector, which is a YIG-tuned filter (YTF). The instrument stops any measurement currently underway, performs the characterization, then restarts the measurement from the beginning (similar to pressing the Restart key).

The query form of the remote commands (:CALibration:YTF?) will invoke the alignment of the YTF subsystem and return a success or failure value.

A failure encountered during alignment will generate the Error Condition message "Characterize Preselector failure" and set bit 3 in the STATus:QUESTionable:CALibration:EXTended:FAILure status register. Successful completion of Characterize Preselector will clear this Condition. It will also begin the

elapsed time counter for Last Characterize Preselector Time, and capture the Last Characterize Preselector Temperature.

The last Characterize Preselector Time and Temperature survives across the power cycle as this operation is performed infrequently.

NOTE

The Characterize Preselector function can be interrupted by pressing the Cancel (ESC) front-panel key or remotely with Device Clear followed by the :ABORt SCPI command. None of the new characterization data is then used. However, since the old characterization data is purged at the beginning of the characterization, you now have an uncharacterized preselector. You should re-execute this function and allow it to finish before making any further preselected measurements.

Key Path	System, Alignments, Advanced
Mode	All
Remote Command	:CALibration:YTF :CALibration:YTF?
Example	:CAL:YTF
Notes	:CALibration:YTF? returns 0 if successful :CALibration:YTF? returns 1 if failed (including interfering user signal) While Advanced, Characterize Preselector is performing the alignment, bit 0 in the Status Operation register is set. Completion, or termination, will clear bit 0 in the Status Operation register. This command is sequential; it must complete before further SCPI commands are processed. Interrupting the alignment from remote is accomplished by invoking Device Clear followed by the :ABORt command. Successful completion will clear bit 9 in the Status Questionable Calibration register. A failure encountered during alignment will generate the Error Condition message "Characterize Preselector failed" and set bit 9 in the Status Questionable Calibration register. For Options that support frequencies > 3.6 GHz only.
Dependencies	This key does not appear in models that do not contain preselectors. In these models the SCPI command is accepted without error but no action is taken.
Couplings	Initializes the time for the Last Characterize Preselector Time. Records the temperature for the Last Characterize Preselector Temperature.
Initial S/W Revision	Prior to A.02.00

Timebase DAC

Allows control of the internal 10 MHz reference oscillator timebase. This may be used to adjust for minor frequency alignment between the signal and the internal frequency reference. This adjustment has no effect if the instrument is operating with an External Frequency Reference.

If the value of the Timebase DAC changes (by switching to Calibrated from User with User set to a different value, or in User with a new value entered) an alignment may be necessary. The alignment system will take appropriate action; which will either invoke an alignment or cause an Alert.

Key Path	System, Alignments
----------	--------------------

Mode	All
Remote Command	:CALibration:FREQuency:REFeRence:MODE CALibrated USER :CALibration:FREQuency:REFeRence:MODE?
Example	:CAL:FREQ:REF:MODE CAL
Notes	If the value of the timebase is changed the alignment system automatically performs an alignment or alerts that an alignment is due. If the value of the timebase is changed the alignment system automatically performs an alignment or alerts that an alignment is due.
Preset	This is unaffected by Preset but is set to CALibrated on a "Restore System Defaults->Align".
State Saved	No
Initial S/W Revision	Prior to A.02.00

Calibrated

Sets the Timebase DAC to the value established during factory or field calibration. The value displayed on the menu key is the calibrated value.

Key Path	System, Alignments, Timebase DAC
Mode	All
Example	:CAL:FREQ:REF:MODE CAL
Readback Text	[xxx] < where xxx is the calibrated value
Initial S/W Revision	Prior to A.02.00

User

Allows setting the Timebase DAC to a value other than the value established during the factory or field calibration. The value displayed on the menu key is the calibrated value.

Key Path	System, Alignments, Timebase DAC
Mode	All
Example	:CAL:FREQ:REF:MODE USER
Readback Text	xxx < where xxx is the Timebase DAC setting
Initial S/W Revision	Prior to A.02.00

Key Path	System, Alignments, Timebase DAC
Mode	All
Remote Command	:CALibration:FREQuency:REFeRence:FINE <integer> :CALibration:FREQuency:REFeRence:FINE?

Example	:CAL:FREQ:REF:FINE 8191
Notes	If the value of the timebase is changed the alignment system automatically performs an alignment or alerts that an alignment is due.
Couplings	Setting :CAL:FREQ:REF:FINE sets :CAL:FREQ:REF:MODE USER
Preset	This is unaffected by Preset but is set to the factory setting on a “Restore System Defaults->Align”.
State Saved	No
Min	0
Max	16383
Backwards Compatibility SCPI	:CALibration:FREQuency:REFerence:COARse ESA hardware contained two DAC controls for the Timebase. In X-Series the command :CALibration:FREQuency:REFerence:FINE is the method for adjusting the timebase. The :COARse command is provided as an alias to :FINE.
Initial S/W Revision	Prior to A.02.00

Remote Command	:CALibration:FREQuency:REFerence:COARse <integer> :CALibration:FREQuency:REFerence:COARse?
Example	:CAL:FREQ:REF:COAR 8191
Notes	This is an alias for CAL:FREQ:REF:FINE any change to COARse is reflected in FINE and vice-versa. See CAL:FREQ:REF:FINE for description of functionality.
Couplings	Setting :CAL:FREQ:REF:COAR sets :CAL:FREQ:REF:MODE USER
Initial S/W Revision	Prior to A.02.00

I/O Config

Activates a menu for identifying and changing the I/O configuration for remote control.

Key Path	System
Initial S/W Revision	Prior to A.02.00

GPIB

Activates a menu for configuring the GPIB I/O port.

Key Path	System, I/O Config
Initial S/W Revision	A.02.00

GPIB Address

Select the GPIB remote address.

Key Path	System, I/O Config, GPIB
Mode	All
Remote Command	:SYSTem:COMMunicate:GPIB[1][:SELF]:ADDRess <integer> :SYSTem:COMMunicate:GPIB[1][:SELF]:ADDRess?
Example	:SYST:COMM:GPIB:ADDR 17
Notes	Changing the Address on the GPIB port requires all further communication to use the new address.
Preset	This is unaffected by Preset but is set to 18 on a “Restore System Defaults->Misc”
State Saved	No
Range	0 to 30
Min	0
Max	30
Initial S/W Revision	Prior to A.02.00

GPIB Controller

Sets the GPIB port into controller or device mode. In the normal state, GPIB controller is disabled, which allows the analyzer to be controlled by a remote computer. When GPIB Controller is enabled, the instrument can run software applications that use the instrument's computer as a GPIB controller; controlling devices connected to the instrument's GPIB port.

NOTE

When GPIB Controller is enabled, the analyzer application itself cannot be controlled over GPIB. In this case it can easily be controlled via LAN or USB. The GPIB port cannot be a controller and device at the same time. Only one controller can be active on the GPIB bus at any given time. If the analyzer is the controller, an external PC cannot be a controller.

To control the instrument from the software that is performing GPIB controller operation, you can use an internal TCP/IP connection to the analyzer application. Use the address TCPIP0:localhost:inst0:INSTR to send SCPI commands to the analyzer application.

Key Path	System, I/O Config, GPIB
Mode	All
Scope	Mode Global
Remote Command	:SYSTem:COMMunicate:GPIB[1][:SELF]:CONTroller[:ENABLE] ON OFF 0 1 :SYSTem:COMMunicate:GPIB[1][:SELF]:CONTroller[:ENABLE]?
Example	:SYST:COMM:GPIB:CONT ON Will set GPIB port to Controller
Notes	When the instrument becomes the Controller bit 0 in the Standard Event Status Register is set (and when the instrument relinquishes Controller capability bit 0 is cleared in the Standard Event Status Register).
Preset	This is unaffected by Preset but is set to OFF on a “Restore System Defaults->Misc”
State Saved	No
Range	Disabled Enabled
Initial S/W Revision	A.02.00

Disabled

Disables the GPIB Controller capability, this is the default (or normal) setting.

Key Path	System, I/O Config, GPIB, GPIB Controller
Example	:SYST:COMM:GPIB:CONT OFF Will set GPIB port to Device
Initial S/W Revision	A.02.00

Enabled

Enables the GPIB Controller capability.

Key Path	System, I/O Config, GPIB, GPIB Controller
Example	:SYST:COMM:GPIB:CONT ON Will set GPIB port to Controller
Initial S/W Revision	A.02.00

SCPI LAN

Activates a menu for identifying and changing the SCPI over a LAN configuration. There are a number of different ways to send SCPI remote commands to the instrument over LAN. It can be a problem to have multiple users simultaneously accessing the instrument over the LAN. These keys limit that somewhat by disabling the telnet, socket, and/or SICL capability.

Key Path	System, I/O Config
Initial S/W Revision	Prior to A.02.00

SCPI Telnet

Turns the SCPI LAN telnet capability On or Off allowing you to limit SCPI access over LAN through telnet.

Key Path	System, I/O Config, SCPI LAN
Mode	All
Remote Command	:SYSTem:COMMunicate:LAN:SCPI:TELNet:ENABle OFF ON 0 1 :SYSTem:COMMunicate:LAN:SCPI:TELNet:ENABle?
Example	:SYST:COMM:LAN:SCPI:TELN:ENAB OFF
Preset	This is unaffected by Preset but is set to ON with a "Restore System Defaults->Misc"
State Saved	No
Range	On Off
Initial S/W Revision	Prior to A.02.00

SCPI Socket

Turns the capability of establishing Socket LAN sessions On or Off. This allows you to limit SCPI access over LAN through socket sessions.

Key Path	System, I/O Config, SCPI LAN
Mode	All
Remote Command	:SYSTem:COMMunicate:LAN:SCPI:SOCKet:ENABle OFF ON 0 1 :SYSTem:COMMunicate:LAN:SCPI:SOCKet:ENABle?
Example	:SYST:COMM:LAN:SCPI:SOCK:ENAB OFF
Preset	This is unaffected by a Preset but is set to ON with a “Restore System Defaults->Misc”
State Saved	No
Range	On Off
Initial S/W Revision	Prior to A.02.00

SICL Server

Turns the SICL server capability On or Off, enabling you to limit SCPI access over LAN through the SICL server. (SICL IEEE 488.2 protocol.)

Parameter	Description	Setting
Maximum Connections	The maximum number of connections that can be accessed simultaneously	5
Instrument Name	The name (same as the remote SICL address) of your analyzer	inst0
Instrument Logical Unit	The unique integer assigned to your analyzer when using SICL LAN	8
Emulated GPIB Name	The name (same as the remote SICL address) of the device used when communicating with your analyzer	gpib7
Emulated GPIB Logical Unit	The unique integer assigned to your device when it is being controlled using SICL LAN	8
Emulated GPIB Address	The emulated GPIB address assigned to your transmitter tester when it is a SICL server (the same as your GPIB address)	18

Key Path	System, I/O Config, SCPI LAN
Mode	All
Remote Command	:SYSTem:COMMunicate:LAN:SCPI:SICL:ENABle OFF ON 0 1 :SYSTem:COMMunicate:LAN:SCPI:SICL:ENABle?
Example	:SYST:COMM:LAN:SCPI:SICL:ENAB OFF
Preset	This is unaffected by Preset, but is set to ON with a “Restore System Defaults->Misc”
State Saved	No
Range	On Off
Initial S/W Revision	Prior to A.02.00

HiSLIP Server

Turns the HiSLIP server capability On or Off, enabling you to limit SCPI access over LAN through the HiSLIP server.

HiSLIP stands for High Speed LAN Instrument Protocol and is part of the IVI–6.1 specification.

Here is an example of a VISA connection string used to connect to the HiSLIP Server on an X-Series Spectrum Analyzer:

```
TCPIP0::a-n9030a-93016::hislip0::INSTR
```

In the example above, hislip0 is the HiSLIP device name that VISA users must include in their HiSLIP VISA Address strings. Your HiSLIP device name may be different depending on your VISA settings.

Key Path	System, I/O Config, SCPI LAN
Mode	All
Remote Command	:SYSTem:COMMunicate:LAN:SCPI:HISLip:ENABle OFF ON 0 1 :SYSTem:COMMunicate:LAN:SCPI:HISLip:ENABle?
Example	:SYST:COMM:LAN:SCPI:HISL:ENAB OFF
Preset	This is unaffected by Preset, but is set to ON with a “Restore System Defaults->Misc”
State Saved	No
Range	On Off
Initial S/W Revision	A.11.00

SCPI Socket Control Port (Remote Command Only)

Returns the TCP/IP port number of the control socket associated with the SCPI socket session. This query enables you to obtain the unique port number to open when a device clear is to be sent to the instrument. Every time a connection is made to the SCPI socket, the instrument creates a peer control socket. The port number for this socket is random. The user must use this command to obtain the port number of the control socket. To force a device clear on this socket, open the port and send the string “DCL ” to the instrument.

If this SCPI command is sent to a non SCPI Socket interface, then 0 is returned.

Mode	All
Remote Command	:SYSTem:COMMunicate:LAN:SCPI:SOCKet:CONTrol?
Example	:SYST:COMM:LAN:SCPI:SOCK:CONT?
Preset	This is unaffected by Preset or “Restore System Defaults->Misc”.
State Saved	No
Range	0 to 65534
Min	0
Max	65534
Initial S/W Revision	Prior to A.02.00

Reset Web Password

The embedded web server contains certain capability which are password protected; modifying the LAN configuration of the instrument, and access to web pages that can change the settings of the instrument. The default password from the factory is 'agilent' (without the quotes). The control provided here is the means to set the web password as the user desires, or to reset the password to the factory default.

Selecting Reset web password brings up a control for resetting the password as the user desires, or to the factory default. A keyboard is required to change the password from the factory default of 'agilent' or to set a new password that contains alphabetic characters. The control is:

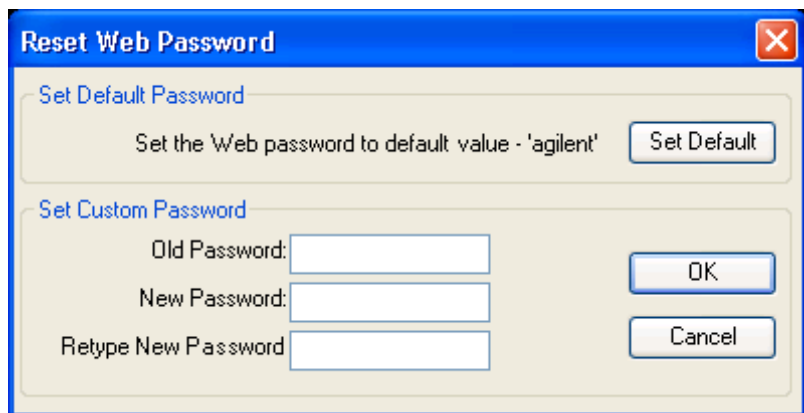

If this control is entered without an external keyboard or mouse connected, you can cancel the control by pressing the Cancel (ESC) front-panel key.

Key Path	System, I/O Config
Mode	All
Initial S/W Revision	Prior to A.02.00

LXI

Opens a menu that allows you to access the various LXI configuration properties.

Key Path	System, I/O Config
Initial S/W Revision	Prior to A.02.00

LAN Reset

Resets the LAN connection.

Key Path	System, I/O Config, LXI
Initial S/W Revision	Prior to A.02.00

System IDN Response

This key allows you to specify a response to the *IDN? query, or to return the analyzer to the Factory response if you have changed it.

To choose the factory-set response, press the Factory key.

To specify your own response, press the User key, and enter your desired response.

Key Path	System, I/O Config
Mode	All
Remote Command	:SYSTem:IDN <string> :SYSTem:IDN?
Notes	<ul style="list-style-type: none"> • This affects the response given in all Modes of the Analyzer, unless the current Mode has also specified a custom response, in which case the current Mode's custom IDN response takes precedence over the System's, but only while that Mode is the current Mode.. • It survives shutdown and restart of the software and therefore survives a power cycle • Null string as parameter restores the Factory setting
Preset	This is unaffected by Preset but is set to the original factory setting on a "Restore System Defaults->Misc"
State Saved	No
Initial S/W Revision	A.06.00

Factory

This key selects the factory setting, for example:

"Agilent Technologies,N9020A,MY00012345,A.05.01"

where the fields are manufacturer, model number, serial number, firmware revision.

Key Path	System, I/O Config, IDN Response
Example	:SYST:IDN "" null string, restores the factory setting
Initial S/W Revision	A.06.0

User

This key allows you to specify your own response to the *IDN? query. You may enter your desired response with the Alpha Editor or a plugin PC keyboard.

When you press this key, the active function becomes the current User string with the cursor at the end. This makes it easy to edit the existing string.

If you enter a null string (for example, by clearing the User String while editing and then pressing Done) the analyzer automatically reverts to the Factory setting.

Key Path	System, I/O Config, IDN Response
Example	:SYST:IDN "XYZ Corp, Model 12, 012345, A.01.01" user specified response
Initial S/W Revision	A.06.00

Query USB Connection (Remote Command Only)

Enables you to determine the speed of the USB connection.

Mode	All
Remote Command	:SYSTem:COMMunicate:USB:CONNecTION?
Example	:SYST:COMM:USB:CONN?
Notes	NONE - Indicates no USB connection has been made. LSPeed - Indicates a USB low speed connection (1.5 Mbps). This is reserved for future use, the T+M488 protocol is not supported on low speed connections. HSPeed - Indicates that a USB high speed connection (480 Mbps) has been negotiated. FSPeed - Indicates that a USB full speed connection (12 Mbps) has been negotiated.
State Saved	No
Range	NONE LSPeed HSPeed FSPeed
Initial S/W Revision	Prior to A.02.00

USB Connection Status (Remote Command Only)

Enables you to determine the current status of the USB connection.

Mode	All
Remote Command	:SYSTem:COMMunicate:USB:STATus?
Example	:SYST:COMM:USB:STAT?
Notes	SUSPended - Indicates that the USB bus is currently in its suspended state. The bus is in the suspended state when: <ul style="list-style-type: none"> • The bus is not connected to any controller • The controller is currently powered off • The controller has explicitly placed the USB device into the suspended state. When in the suspended state, no USB activity, including start of frame packets are received. ACTive - Indicates that the USB device is in the active state. When the device is in the active state, it is receiving periodic start of frames but it isn't necessarily receiving or transmitting data.
State Saved	No
Range	SUSPended ACTive
Initial S/W Revision	Prior to A.02.00

USB Packet Count (Remote Command Only)

Enables you to determine the number of packets received and transmitted on the USB bus.

Mode	All
Remote Command	:SYSTem:COMMunicate:USB:PACKets?
Example	:SYST:COMM:USB:PACK?
Notes	Two integers are returned. The first is the number of packets received since application invocation, the second is the number of packets transmitted since application invocation. If no packets have been received or transmitted the response is 0,0. The packet count is initialized to 0,0 when the instrument application is started.
State Saved	No
Initial S/W Revision	Prior to A.02.00

Restore Defaults

Provides incremental initialization of the system setting groups along with supporting a comprehensive reset of the entire instrument back to a factory default state. The menu selections are the groups of system settings and when one is selected, that particular group of system settings is reset back to their default values.

Key Path	System
Mode	All
Remote Command	:SYSTem:DEFault [ALL] ALIGn INPut MISC MODes PON
Example	SYST:DEF
State Saved	No
Initial S/W Revision	Prior to A.02.00

Restore Input/Output Defaults

Causes the group of settings and data associated with Input/Output front-panel key to be a reset to their default values. This level of Restore System Defaults does not affect any other system settings, mode settings and does not cause a mode switch. .

Confirmation is required to restore the Input/Output setting. The confirmation dialog is:

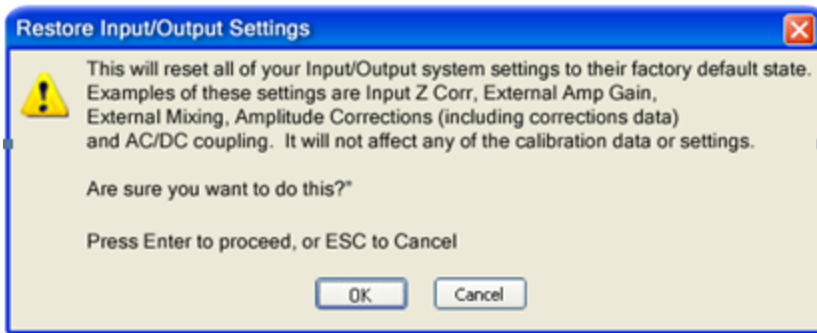

Key Path	System, Restore System Defaults
Example	:SYST:DEF INP
Initial S/W Revision	Prior to A.02.00

Restore Power On Defaults

This selection causes the Power On settings to be a reset to their default value. This level of Restore System Defaults does not affect any other system settings, mode settings and does not cause a mode switch. The Power On settings and their default values are Power On Type reset to Mode and Input/Output Defaults and Power On Application reset to whatever the factory set as its default value.

Confirmation is required to restore the factory default values. The confirmation dialog is:

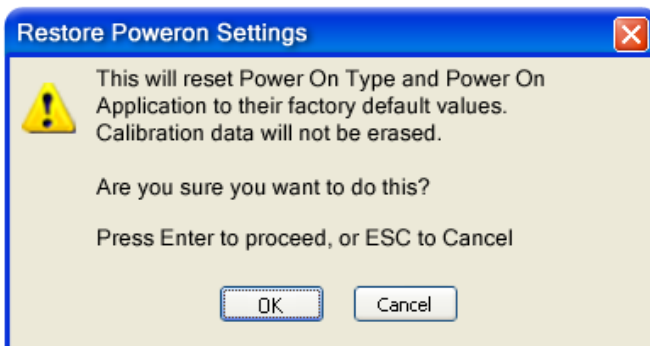

Key Path	System, Restore System Defaults
Example	:SYST:DEF PON
Initial S/W Revision	Prior to A.02.00

Restore Align Defaults

This selection causes the Alignment system settings to be a reset to their default values. This does not affect any Alignment data stored in the system. This level of Restore System Defaults does not affect any other system settings, mode settings and does not cause a mode switch.

After performing this function, it may impact the auto-alignment time of the instrument until a new alignment baseline has been established.

Confirmation is required to restore the factory default values. The confirmation dialog is:

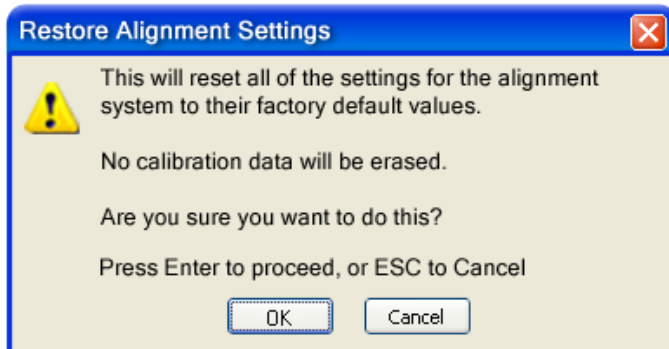

Key Path	System, Restore System Defaults
Example	:SYST:DEF ALIG
Initial S/W Revision	Prior to A.02.00

Restore Misc Defaults

This selection causes miscellaneous system settings to be reset to their default values. With this reset, you lose the GPIB address and it is reset to 18, so this should be used with caution. This level of Restore System Defaults does not affect any other system settings, mode settings and does not cause a mode switch. This miscellaneous group contains the rest of the settings that have not been part of the other Restore System Defaults groups. The following table is a complete list of settings associated with this group:

Miscellaneous Setting	Default Value
Verbose SCPI	Off
The SYST:PRES:TYPE	MODE
Auto File Name Number	000
Save Type	State
State Save To	Register 1
Screen Save To	SCREEN000.png
DISP:ENABLE	ON
Full Screen	Off
SCPI Telnet	ON
SCPI Socket	ON
SICL Server	ON
Softkey Language	English

Miscellaneous Setting	Default Value
System Annotation	ON
Display Theme	TDColor
System IDN Response	Factory result of *IDN?
Display Intensity	100
Display Backlight	ON
GPIB Address	18

Confirmation is required to restore the factory default values. The confirmation dialog is:

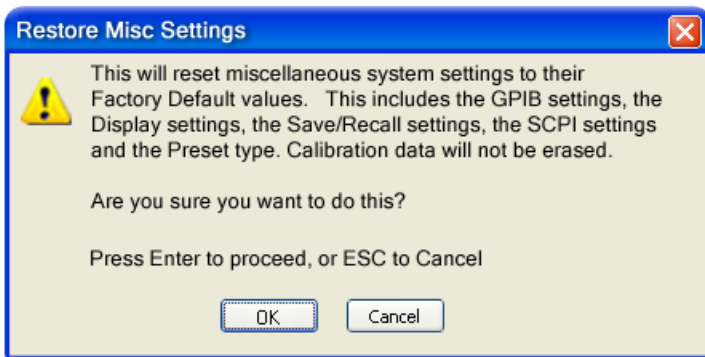

Key Path	System, Restore System Defaults
Example	:SYST:DEF MISC
Initial S/W Revision	Prior to A.02.00

Restore Mode Defaults (All Modes)

This selection resets all of the modes in the instrument back to their default state just as a Restore Mode Defaults does and it switches the instrument to the power-on mode and causes the default measurement for the power-on mode to be active. This level of Restore System Defaults does not affect any system settings, but it does affect the state of all modes and does cause a mode switch unless the instrument was already in the power-on mode.

Confirmation is required to restore the factory default values. The confirmation dialog is:

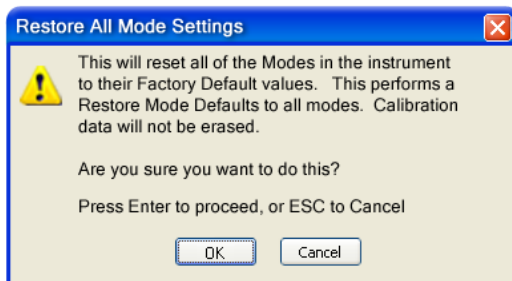

Key Path	System, Restore System Defaults
Example	:SYST:DEF MOD
Couplings	An All Mode will cause the currently running measurement to be aborted, mode switch to the power-on mode and activate the default measurement for the power-on mode.. It gets the mode to a consistent state with all of the default couplings set.
Initial S/W Revision	Prior to A.02.00

All

This performs a comprehensive reset of ALL analyzer settings to their factory default values. It resets all of the system setting groups, causes a Restore Mode Defaults for all modes in the instrument, and switches back to the power-on mode. It does not affect the User Preset file or any user saved files.

Confirmation is required to restore the factory default values. The confirmation dialog is:

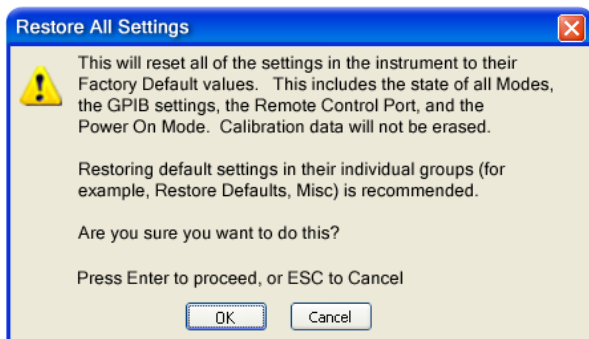

NOTE

If you are using an Agilent USB External Mixer, then you will need to perform a Refresh USB Mixer Connection after Restoring All Defaults.

Key Path	System, Restore System Defaults
Example	:SYST:DEF ALL
Notes	If using Agilent USB External Mixer, perform a Refresh USB Mixer Connection (SCPI command :MIX:BAND USB) following a Restore All Defaults.
Couplings	An All will cause the currently running measurement to be aborted and get all modes to a consistent state, so it is unnecessary to couple any settings.
Initial S/W Revision	Prior to A.02.00
Modified at S/W Revision	A.14.00

Control Panel...

Opens the Windows Control Panel. The Control Panel is used to configure certain elements of Windows that are not configured through the hardkey/softkey System menus.

NOTE This feature is not available if option SF1 is installed.

The Control Panel is a separate Windows application, so to return to the analyzer once you are in the Control Panel, you may either:

Exit the Control Panel by clicking on the red X in the upper right hand corner, with a mouse

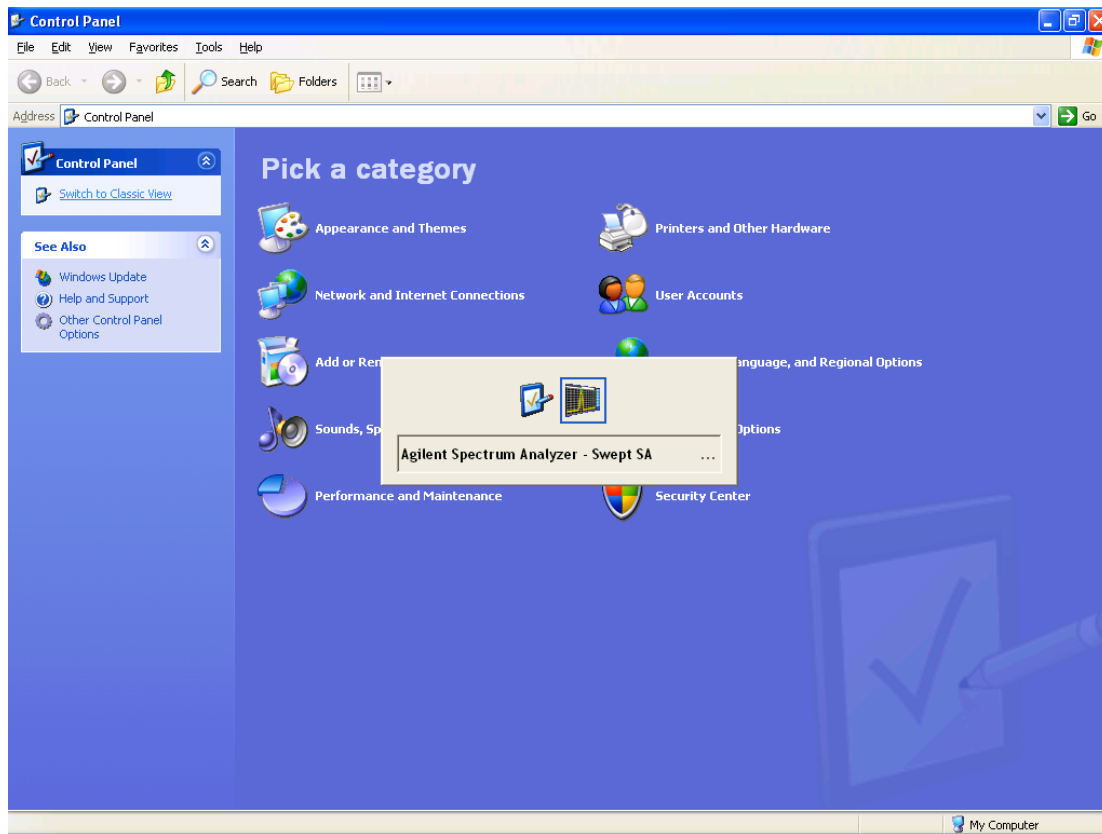

Or use Alt-Tab: press and hold the Alt key and press and release the Tab key until the Analyzer logo is showing in the window in the center of the screen, as above, then release the Alt key.

Key Path	System
Notes	No remote command for this key.
Initial S/W Revision	Prior to A.02.00

Licensing...

Opens the license explorer.

NOTE This feature is not available if option SF1 is installed.

For Help on this key, select Help in the menu bar at the top of the license explorer window.

Key Path	System
Notes	No equivalent remote command for this key.
Backwards Compatibility Notes	In ESA the SCPI command for displaying the Show Licenses screen is: :SYSTem:CONFIgure:LKEY:STATe OFF ON 0 1 :SYSTem:CONFIgure:LKEY:STATe? There are no equivalent SCPI commands in the X-Series for displaying the License Explorer.
Initial S/W Revision	Prior to A.02.00

Remote Command :SYSTem:LKEY <"OptionInfo">, <"LicenseInfo">

Example SYST:LKEY "N9073A-1FP",
"027253AD27F83CDA5673A9BA5F427FDA5E4F25AEB1017638211AC9F60D9C639FE539735909C551DE0A91"

Notes The <"OptionInfo"> contains the feature and the version. You must specify the feature but can omit the version. If you omit the version, the system regards it as the latest one, since the system knows which version is supported for each feature.

The <"LicenseInfo"> contains the signature, the expiration date, and serial number for transport if transportable. You must specify the signature, but you can omit the other information. If you omit the expiration date, the system regards it as permanent. If you omit the serial number, the system regards it as non-transportable. As a result, this supports reverse compatibility.

Initial S/W Revision Prior to A.02.00

Remote Command :SYSTem:LKEY:DELeTe <"OptionInfo">,<"LicenseInfo">

Example SYST:LKEY:DEL 'N9073A-1FP',
"027253AD27F83CDA5673A9BA5F427FDA5E4F25AEB1017638211AC9F60D9C639FE539735909C551DE0A91"

Notes The <"OptionInfo"> contains the feature and the version. You must specify the feature but can omit the version. If you omit the version, the system regards it as the latest one, if more than one version is installed.

The <"LicenseInfo"> contains the signature, the expiration date, and whether or not be transportable. You must specify the signature, but you can omit the other information. If you omit the expiration date, the system regards it as permanent. If you omit the transportability, the system regards it as non-transportable. As a result, this supports reverse compatibility.

Initial S/W Revision Prior to A.02.00

Remote Command	:SYSTem:LKEY:LIST?
Notes	<p>Return Value: An <arbitrary block data> of all the installed instrument licenses. The format of each license is as follows. <Feature>,<Version>,<Signature>,<Expiration Date>,<Serial Number for Transport> Return Value Example: #3136 N9073A-1FP,1.000,B043920A51CA N9060A-2FP,1.000,4D1D1164BE64 N9020A-508,1.000,389BC042F920 N9073A-1F1,1.000,5D71E9BA814C,13-aug-2005 <arbitrary block data> is: #NMMM<data> Where: N is the number of digits that describes the number of MMM characters. For example if the data was 55 bytes, N would be 2. MMM would be the ASCII representation of the number of bytes. In the previous example, N would be 55. <data> ASCII contents of the data</p>
Initial S/W Revision	Prior to A.02.00

Remote Command	:SYSTem:LKEY? <"OptionInfo">
Example	SYST:LKEY? "N9073A-1FP"
Notes	<p>The <"OptionInfo"> contains the feature and the version. You must specify the feature but can omit the version. If you omit the version, the system regards it as the latest one. Return Value: <"LicenseInfo"> if the license is valid, null otherwise. <"LicenseInfo"> contains the signature, the expiration date, and serial number if transportable. Return Value Example: "B043920A51CA"</p>
Initial S/W Revision	Prior to A.02.00

Remote Command	:SYSTem:HID?
Notes	Return value is the host ID as a string
Initial S/W Revision	Prior to A.02.00

Security

Accesses capabilities for operating the instrument in a security controlled environment.

Key Path	System
Initial S/W Revision	A.04.00

USB

The Windows operating system can be configured to disable write access to the USB ports for users who are in a secure environment where transferring data from the instrument is prohibited. This user interface is a convenient way for the customer to disable write access to USB.

Key Path	System, Security
Mode	All
Scope	Mode Global
Remote Command	:SYSTem:SECurity:USB:WPRotect[:ENABLE] ON OFF 0 1 :SYSTem:SECurity:USB:WPRotect[:ENABLE]?
Example	:SYST:SEC:USB:WPR ON Will set USB ports to Read-only
Notes	When the USB ports are in Read-only mode then no data can be stored to USB, including the internal USB memory used for a back-up location for the calibration data.
Dependencies	This key is grayed-out unless the current user has administrator privileges.
Preset	This is unaffected by Preset or any Restore System Defaults. An Agilent Recovery will set the USB to write protect OFF
State Saved	No
Range	Read-Write Read only
Initial S/W Revision	A.04.00

Read-Write

Selection for allowing full read-write access to the USB ports.

Key Path	System, Security, USB
Example	:SYST:SEC:USB:WPR OFF Will set USB ports to Read-Write
Initial S/W Revision	A.04.00

Read only

Selection for disabling write access to the USB ports.

Key Path	System, Security, USB	
Example	:SYST:SEC:USB:WPR ON	Will set USB ports to Read only
Initial S/W Revision	A.04.00	

Diagnostics

The Diagnostics key in the System menu gives you access to basic diagnostic capabilities of the instrument.

Key Path	System
Initial S/W Revision	Prior to A.02.00

Show Hardware Statistics

Provides a display of various hardware statistics. The statistics include the following:

- Mechanical relay cycles
- High and Low temperature extremes
- Elapsed time that the instrument has been powered-on (odometer)

The display should appear listing the statistics, product number, serial number, and firmware revision.

Hardware Statistical Information	
Agilent MXA Signal Analyzer	
Product Number: N9020A	
Serial Number: US00061145	
Instrument S/W Revision: A.12.00	
Revision Date: 7/11/2012 12:11:10 PM	
Component Name	Value
MechAtten #1 Count Total	457304
Calibrator Switch Cycles	105953
AC/DC Switch Cycles	114240
2 dB #1 Mechanical Atten Cycles	112655
2 dB #2 Mechanical Atten Cycles	124456
MechAtten #2 Count Total	472265
6 dB Mechanical Atten Cycles	115302
10 dB Mechanical Atten Cycles	93602
20 dB Mechanical Atten Cycles	144781
30 dB Mechanical Atten Cycles	118580
Low Noise Path Switch	45668
Preselector Bypass Cycles	31133
High temperature operating extreme	45.75
Low temperature operating extreme	-23.9375
Elapsed Time (On-Time)(hours)	134164

In some CXA models this field is called "Fixed Aten"

Some CXA models omit these fields

Only shown if LNP installed

Only shown if MPB installed

The CXA models in which the AC/DC Switch field is called Fixed Aten and that omit the mechanical attenuation fields are the N9000A–503/507 models.

Modular HWs only have time and temperature information in Show Hardware Statistics.

The data will be updated only when the Show Hardware Statistics menu key is pressed, it will not be updated while the screen is displayed.

The tabular data should be directly printable.

Key Path	System, Diagnostics
Mode	All
Notes	The values displayed on the screen are only updated upon entry to the screen and not updated while the screen is being displayed.
Initial S/W Revision	Prior to A.02.00

SCPI for Show Hardware Statistics (Remote Commands Only)

Each of the hardware statistic items can be queried via SCPI.

- "Query the Mechanical Relay Cycle Count" on page 302
- "Query the Operating Temperature Extremes" on page 302
- "Query the Elapsed Time since 1st power on" on page 302

Query the Mechanical Relay Cycle Count

Return the count of mechanical relay cycles. For N9038A model, there are additional 2 Mechanical Relays which are <N9038A Input2>, <N9038A Bypass>.

Remote Command	:SYSTem:MRELay:COUNT?
Example	:SYST:MREL:COUN?
Notes	<p>Query Only</p> <p>The return value is a comma separated list of the individual counts for each mechanical relay. The position of the relays in the list is:</p> <p>“<Cal Signal>,<AC/DC>,<2dB #1 Atten>,<2dB #2 Atten>,<6dB Atten>,<10dB Atten>,<20dB Atten>,<30dB Atten>,<Fixed Atten>,<Low Noise Path Switch>,<Presel Bypass>,<N9038A Input2>,<N9038A Bypass>”</p> <p>Items in the list not pertaining to your particular hardware configuration will return as -999 for those items.</p>
Initial S/W Revision	Prior to A.02.00
Modified at S/W Revision	A.08.00

Query the Operating Temperature Extremes

Returns the low operating temperature extreme value. The value survives a power-cycle and is the temperature extreme encountered since the value was reset by the factory or service center.

Mode	All
Remote Command	:SYSTem:TEMPerature:LEXTreme?
Example	:SYST:TEMP:LEXT?
Notes	Value is in degrees Celsius at which the lowest operating temperature has been recorded since 1st power-up.
State Saved	No
Initial S/W Revision	Prior to A.02.00

Mode	All
Remote Command	:SYSTem:TEMPerature:HEXTreme?
Example	:SYST:TEMP:HEXT?
Notes	Value is in degrees Celsius at which the highest operating temperature has been recorded since 1st power-up.
State Saved	No
Initial S/W Revision	Prior to A.02.00

Query the Elapsed Time since 1st power on

Returns the elapsed on-time in minutes since 1st power-on.

Remote Command	:SYSTem:PON:ETIMe?
Example	:SYST:PON:ETIM?
Notes	Query Only
Initial S/W Revision	Prior to A.02.00

Advanced

Accesses advanced diagnostic capabilities performed in the factory or under instructions from repair procedures. This menu key is only visible when the logged-in user is “saservice”.

NOTE This feature is not available if option SF1 is installed.

The first access to the Advanced Diagnostic Menu after invoking the instrument application will require an authentication, which is to enter the Service Code. Subsequent accesses to the Advanced Diagnostic Menu are unimpeded. The Authentication dialog looks like:

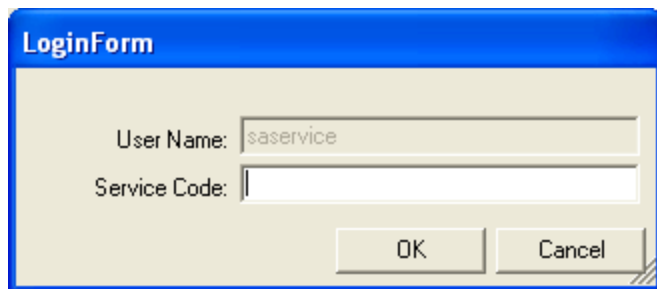

“OK” is the default key thus the Enter key is used to complete the entry. If invalid Service Code is entered authentication is not granted and you are provided the following dialog:



Key Path	System, Diagnostics
Notes	Password is required to access this menu.
Initial S/W Revision	Prior to A.02.00

	Agilent Converged	PSA
IP Address	SYSTem:COMMunicate:LAN:ADDRes <string> SYSTem:COMMunicate:LAN:ADDRes?	:SYSTem:COMMunicate:LAN[SELF]:IP <string> :SYSTem:COMMunicate:LAN[SELF]:IP?
Gateway	SYSTem:COMMunicate:LAN:DGATeway <string>	:SYSTem:COMMunicate:LAN[SELF]:GATEway <string>

	SYSTem:COMMunicate:LAN:DGATeway?	:SYSTem:COMMunicate:LAN[:SELF]:GATEway?
Subnet Mask	SYSTem:COMMunicate:LAN:SMASK <string> SYSTem:COMMunicate:LAN:SMASK?	:SYSTem:COMMunicate:LAN[:SELF]:SUBNetmask <string> :SYSTem:COMMunicate:LAN[:SELF]:SUBNetmask?

Service

Accesses capabilities performed in the factory or under instructions from repair procedures. This menu key is only visible when the logged-in user is “advanceduser” or “saservice”. The first access to the Service Menu after invoking the instrument application will require an authentication Service Code.

Key Path	System
Initial S/W Revision	Prior to A.02.00

Internet Explorer...

This key launches Microsoft Internet Explorer. A mouse and external keyboard are highly desired for using Internet Explorer. When Internet Explorer is running, close Internet Explorer to return focus to the Instrument Application (or use Alt-Tab).

NOTE This feature is not available if option SF1 is installed.

Key Path	System
Mode	All
Notes	No equivalent remote command for this key.
Initial S/W Revision	A.05.01

System Remote Commands (Remote Commands Only)

The commands in this section have no front-panel key equivalent.

- "System Powerdown (Remote Command Only)" on page 305
- "List installed Options (Remote Command Only)" on page 305
- "Lock the Front-panel keys (Remote Command Only)" on page 305
- "List SCPI Commands (Remote Command Only)" on page 306
- "SCPI Version Query (Remote Command Only)" on page 306
- "Date (Remote Command Only)" on page 306
- "Time (Remote Command Only)" on page 307

Initial S/W Revision	Prior to A.02.00
----------------------	------------------

System Powerdown (Remote Command Only)

Remote Command	SYSTem:PDOWn [NORMal FORCe]
Notes	Shuts down the instrument in the normal way (NORMal) or forced way (FORCe). In case there is another application with modified data pending for saving, the application prompt the user. The system waits until the user responds in the normal mode. It will go off after 20 seconds of wait in the force mode and all data will be lost.

List installed Options (Remote Command Only)

Lists the installed options that pertain to the instrument (signal analyzer). .

Mode	All
Remote Command	:SYSTem:OPTions?
Example	:SYST:OPT?
Notes	The return string is a comma separated list of the installed options. For example: "503,P03,PFR" :SYSTem:OPTions? and *OPT? are the same.
State Saved	No
Initial S/W Revision	Prior to A.02.00

Lock the Front-panel keys (Remote Command Only)

Disables the instrument keyboard to prevent local input when the instrument is controlled remotely. Annunciation showing a "K" for 'Klock" (keyboard lock) alerts the local user that the keyboard is locked. Klock is similar to the GPIB Local Lockout function; namely that no front-panel keys are active with the exception of the Power Standby key. (The instrument is allowed to be turned-off if Klock is ON.) The Klock command is used in remote control situations where Local Lockout cannot be used.

Although primary intent of Klock is to lock-out the front panel, it will lock-out externally connected keyboards through USB. Klock has no effect on externally connected pointing devices (mice).

The front panel 'Local' key (Cancel/Esc) has no effect if Klock is ON.

Mode	All
Remote Command	:SYSTem:KLOCK OFF ON 0 1 :SYSTem:KLOCK?
Example	:SYST:KLOC ON
Notes	Keyboard lock remains in effect until turned-off or the instrument is power-cycled
Preset	Initialized to OFF at startup, unaffected by Preset
State Saved	No
Initial S/W Revision	Prior to A.02.00

List SCPI Commands (Remote Command Only)

Outputs a list of the valid SCPI commands for the currently selected Mode.

Remote Command	:SYSTem:HELP:HEADers?
Example	:SYST:HELP:HEAD?
Notes	The output is an IEEE Block format with each command separated with the New-Line character (hex 0x0A)
Initial S/W Revision	Prior to A.02.00

SCPI Version Query (Remote Command Only)

Returns the SCPI version number with which the instrument complies. The SCPI industry standard changes regularly. This command indicates the version used when the instrument SCPI commands were defined.

Remote Command	:SYSTem:VERSion?
Example	:SYST:VERS?
Initial S/W Revision	Prior to A.02.00

Date (Remote Command Only)

The recommended access to the Date, Time, and Time zone of the instrument is through the Windows native control (Control Panel or accessing the Task Bar). You may also access this information remotely, as shown in this command and Time (below).

Sets or queries the date in the instrument.

Mode	All
Remote Command	:SYSTem:DATE "<year>,<month>,<day>" :SYSTem:DATE?
Example	:SYST:DATE "2006,05,26"
Notes	<year> is the four digit representation of year. (for example, 2006) <month> is the two digit representation of year. (for example. 01 to 12) <day> is the two digit representation of day. (for example, 01 to 28, 29, 30, or 31) depending on the month and year Unless the current account has Power User or Administrator privileges, an error will be generated by this command and no action will be taken.
Initial S/W Revision	Prior to A.02.00

Time (Remote Command Only)

Sets or queries the time in the instrument.

Mode	All
Remote Command	:SYSTem:TIME "<hour>, <minute>, <second>" :SYSTem:TIME?
Example	:SYST:TIME "13,05,26"
Notes	<hour> is the two digit representation of the hour in 24 hour format <minute> is the two digit representation of minute <second> is the two digit representation of second Unless the current account has Power User or Administrator privileges, an error will be generated by this command and no action will be taken.
Initial S/W Revision	Prior to A.02.00

7 Trigger Functions

Trigger

Determines when a measurement should start taking data. There are several available trigger sources. For each trigger source, there are associated setup parameters. Typically, a trigger event is generated when a signal (or a characteristic of the signal) crosses a defined trigger level (or threshold) on a rising or falling slope. The measurement begins at a specified time delay from the trigger point. The delay can be negative, enabling pre-trigger data to be taken. Each trigger source has associated its own trigger level, slope, and delay settings.

Trigger Holdoff – Some form of trigger holdoff is available for most trigger types. Hold off can be defined in different ways, with possible variations depending on trigger slope setting.

Normal: This is the holdoff type that scopes typically use. After a trigger event, for the duration of the holdoff time, no additional trigger events are recognized.

Below Level: If the trigger slope is positive, a trigger event is generated only if the signal characteristic of interest crosses the trigger threshold (with positive slope) after having been below the threshold for at least the holdoff time. For negative slope, the trigger event is generated if the signal characteristic crosses the threshold (with negative slope) and then remains below the threshold for at least the holdoff time. In either case, the trigger event is associated with the time the level was crossed.

Above Level: If the trigger slope is positive, a trigger event is generated only if the signal characteristic of interest crosses the trigger threshold (with positive slope) and then remains above the threshold for at least the holdoff time. For negative slope, the trigger event is generated if the signal characteristic crosses the threshold (with negative slope) after having been above the threshold for at least the holdoff time. In either case, the trigger event is associated with the time the level was crossed.

Key Path	Front Panel
Mode	VSA, LTE, LTETDD, IDEN
Initial S/W Revision	Prior to A.02.00
Modified at S/W Revision	A.02.00

Free Run

Starts each measurement scan as soon as possible without regard to any signal characteristics or external triggering signal.

Key Path	Trigger
Mode	VSA, LTE, LTETDD, IDEN
Initial S/W Revision	Prior to A.02.00
Modified at S/W Revision	A.02.00

Video (IF Envelope)

Selects Video (IF Envelope) triggering. The trigger condition is met when the magnitude of the signal you are measuring crosses the defined trigger level while satisfying the slope and holdoff conditions.

Specifically, the source for the trigger calculation is the IF signal, filtered only by the brickwall filter that defines the information bandwidth of the signal – signal energy outside the information bandwidth does not affect the triggering.

NOTE

This is called Video triggering due to its similarity with swept analyzer zero span measurements being triggered on the video signal. However, in this case there is no video signal. Since the trigger condition applies to the full IF signal, this is also called IF envelope triggering.

If Video triggering is already selected, pressing this softkey accesses the video trigger setup functions and changes the active function to Video Trigger Level.

Key Path	Trigger
Mode	VSA, LTE, LTETDD, IDEN
Initial S/W Revision	Prior to A.02.00
Modified at S/W Revision	A.02.00

Trigger Level

Sets a level (in volts) that the magnitude of the IF signal must cross (with the correct slope) in order to generate a trigger. (Holdoff conditions must also be met.)

Key Path	Trigger, Video
Mode	VSA, LTE, LTETDD, IDEN
Remote Command	:TRIGger[:SEquence]:VIDeo:LEVel <voltage> :TRIGger[:SEquence]:VIDeo:LEVel?
Example	TRIG:VID:LEV 10 MV TRIG:VID:LEV?
Notes	:TRIGger[:SEquence]:IF:LEVel <voltage> can be used as an alias
Preset	10 mV
State Saved	Saved in instrument state.
Min	0
Max	9.9E+37
Initial S/W Revision	Prior to A.02.00
Modified at S/W Revision	A.02.00

Trig Slope

Controls the trigger polarity. Positive means the trigger occurs when the rising magnitude crosses the trigger level. Negative means the trigger occurs when the falling magnitude crosses the trigger level.

Key Path	Trigger, Video
Mode	VSA, LTE, LTETDD, IDEN

Remote Command	:TRIGger[:SEquence]:VIDeo:SLOPe POSitive NEGative :TRIGger[:SEquence]:VIDeo:SLOPe?
Example	TRIG:VID:SLOP POS TRIG:VID:SLOP?
Notes	:TRIGger[:SEquence]:IF:SLOPe POSitive NEGative can also be used
Preset	POS
State Saved	Saved in instrument state.
Range	Pos Neg
Initial S/W Revision	Prior to A.02.00
Modified at S/W Revision	A.02.00

Trig Delay

Controls the time delay from the trigger point to the actual start of the measurement data. This can be negative to get pre-trigger data.

Key Path	Trigger, Video
Mode	VSA, LTE, LTETDD, IDEN
Remote Command	:TRIGger[:SEquence]:VIDeo:DELay <time> :TRIGger[:SEquence]:VIDeo:DELay? :TRIGger[:SEquence]:VIDeo:DELay:STATe OFF ON 0 1 :TRIGger[:SEquence]:VIDeo:DELay:STATe?
Example	TRIG:VID:DEL 10 MS TRIG:VID:DEL? TRIG:VID:DEL:STAT ON TRIG:VID:DEL:STAT?
Notes	:TRIGger[:SEquence]:IF:DELay <time> can be used as an alias :TRIGger[:SEquence]:IF:DELay:STATe can also be used as an alias
Preset	0 OFF
State Saved	Saved in instrument state.
Min	-9.9E+37
Max	9.9E+37
Initial S/W Revision	Prior to A.02.00
Modified at S/W Revision	A.02.00

Trig Holdoff

Sets the trigger holdoff time.

Key Path	Trigger, Video
Mode	VSA, LTE, LTETDD, IDEN
Remote Command	:TRIGger[:SEquence]:VIDeo:HOLDoff <time> :TRIGger[:SEquence]:VIDeo:HOLDoff? :TRIGger[:SEquence]:VIDeo:HOLDoff:STATe OFF ON 0 1 :TRIGger[:SEquence]:VIDeo:HOLDoff:STATe?
Example	TRIG:VID:HOLD 1 US TRIG:VID:HOLD? TRIG:VID:HOLD:STAT ON TRIG:VID:HOLD:STAT?
Notes	:TRIGger[:SEquence]:IF:HOLDoff can be used as an alias :TRIGger[:SEquence]:IF:HOLDoff:STATe can be used as an alias
Preset	0 OFF
State Saved	Saved in instrument state.
Min	-9.9E+37
Max	9.9E+37
Initial S/W Revision	Prior to A.02.00
Modified at S/W Revision	A.02.00

Holdoff Type

Sets the trigger holdoff type. Some form of trigger holdoff is available for most trigger types. Hold off can be defined in different ways, with possible variations depending on trigger slope setting.

Below Level: If the trigger slope is positive, a trigger event is generated only if the signal characteristic of interest crosses the trigger threshold (with positive slope) after having been below the threshold for at least the holdoff time. For negative slope, the trigger event is generated if the signal characteristic crosses the threshold (with negative slope) and then remains below the threshold for at least the holdoff time. In either case, the trigger event is associated with the time the level was crossed.

Above Level: If the trigger slope is positive, a trigger event is generated only if the signal characteristic of interest crosses the trigger threshold (with positive slope) and then remains above the threshold for at least the holdoff time. For negative slope, the trigger event is generated if the signal characteristic crosses the threshold (with negative slope) after having been above the threshold for at least the holdoff time. In either case, the trigger event is associated with the time the level was crossed.

Key Path	Trigger, Video
Mode	VSA, LTE, LTETDD, IDEN
Remote Command	:TRIGger[:SEquence]:VIDeo:HOLDoff:TYPE BELow ABOve :TRIGger[:SEquence]:VIDeo:HOLDoff:TYPE?
Example	TRIG:VID:HOLD:TYPE BEL

	TRIG:VID:HOLD:TYPE?
Notes	:TRIGger[:SEQuence]:IF:HOLDoff:TYPE can be used as an alias
Preset	BEL
State Saved	Saved in instrument state.
Range	Below Level Above Level
Initial S/W Revision	Prior to A.02.00
Modified at S/W Revision	A.02.00

External 1

Selects the signal on the Trigger 1 input as the trigger signal. The trigger condition is met when the level of the external trigger signal crosses the defined trigger level while satisfying the slope and holdoff conditions.

Note that currently, the VSA based measurements do not support External 2 triggering.

If External 1 triggering is already selected, pressing this softkey accesses the external 1 trigger setup functions and changes the active function to Ext 1 Trigger Level.

Key Path	Trigger
Mode	VSA, LTE, LTETDD, IDEN
Initial S/W Revision	Prior to A.02.00
Modified at S/W Revision	A.02.00

Trigger Level

Sets a level (in volts) that the Trigger signal must cross (with the correct slope) in order to generate a trigger. Holdoff conditions must also be met.

Key Path	Trigger, External 1
Mode	VSA, LTE, LTETDD, IDEN
Remote Command	:TRIGger[:SEQuence]:EXTernal1:LEVel <voltage> :TRIGger[:SEQuence]:EXTernal1:LEVel?
Example	TRIG:EXT1:LEV 10 MV TRIG:EXT1:LEV?
Preset	1 V
State Saved	Saved in instrument state.
Min	-9.9E+37
Max	9.9E+37
Initial S/W Revision	Prior to A.02.00
Modified at S/W Revision	A.02.00

Trig Slope

Controls the trigger polarity. Positive means the trigger occurs on a rising edge. Negative means the trigger occurs on a falling edge.

Key Path	Trigger, External 1
Mode	VSA, LTE, LTETDD, IDEN
Remote Command	:TRIGger[:SEquence]:EXTernal1:SLOPe Positive NEGative :TRIGger[:SEquence]:EXTernal1:SLOPe?
Example	TRIG:EXT1:SLOP POS TRIG:EXT1:SLOP?
Preset	POS
State Saved	Saved in instrument state.
Range	Pos Neg
Initial S/W Revision	Prior to A.02.00
Modified at S/W Revision	A.02.00

Trig Delay

Controls the time delay from the trigger point to the actual start of the measurement data. This can be negative to get pre-trigger data.

Key Path	Trigger, External 1
Mode	VSA, LTE, LTETDD, IDEN
Remote Command	:TRIGger[:SEquence]:EXTernal1:DELAy <time> :TRIGger[:SEquence]:EXTernal1:DELAy? :TRIGger[:SEquence]:EXTernal1:DELAy:STATe OFF ON 0 1 :TRIGger[:SEquence]:EXTernal1:DELAy:STATe?
Example	TRIG:EXT1:DEL 10 MS TRIG:EXT1:DEL? TRIG:EXT1:DEL:STAT ON TRIG:EXT1:DEL:STAT?
Preset	0 0
State Saved	Saved in instrument state.
Min	-9.9E+37
Max	9.9E+37
Initial S/W Revision	Prior to A.02.00
Modified at S/W Revision	A.02.00

Trig Holdoff

Sets the trigger holdoff time.

Key Path	Trigger, External 1
Mode	VSA, LTE, LTETDD, IDEN
Remote Command	:TRIGger[:SEquence]:EXTernal1:HOLDoff <time> :TRIGger[:SEquence]:EXTernal1:HOLDoff? :TRIGger[:SEquence]:EXTernal1:HOLDoff:STATe OFF ON 0 1 :TRIGger[:SEquence]:EXTernal1:HOLDoff:STATe?
Example	TRIG:EXT1:HOLD 1 US TRIG:EXT1:HOLD? TRIG:EXT1:HOLD:STAT ON TRIG:EXT1:HOLD:STAT?
Preset	0 0
State Saved	Saved in instrument state.
Min	-9.9E+37
Max	9.9E+37
Initial S/W Revision	Prior to A.02.00
Modified at S/W Revision	A.02.00

Holdoff Type

Sets the trigger holdoff type. Some form of trigger holdoff is available for most trigger types. Holdoff can be defined in different ways, with possible variations depending on trigger slope setting.

Below Level: If the trigger slope is positive, a trigger event is generated only if the signal characteristic of interest crosses the trigger threshold (with positive slope) after having been below the threshold for at least the holdoff time. For negative slope, the trigger event is generated if the signal characteristic crosses the threshold (with negative slope) and then remains below the threshold for at least the holdoff time. In either case, the trigger event is associated with the time the level was crossed.

Above Level: If the trigger slope is positive, a trigger event is generated only if the signal characteristic of interest crosses the trigger threshold (with positive slope) and then remains above the threshold for at least the holdoff time. For negative slope, the trigger event is generated if the signal characteristic crosses the threshold (with negative slope) after having been above the threshold for at least the holdoff time. In either case, the trigger event is associated with the time the level was crossed.

Key Path	Trigger, External 1
Mode	VSA, LTE, LTETDD, IDEN
Remote Command	:TRIGger[:SEquence]:EXTernal1:HOLDoff:TYPE BELOW ABOVE

	:TRIGger[:SEquence]:EXTernal1:HOLDoff:TYPE?
Example	TRIG:EXT1:HOLD:TYPE BEL TRIG:EXT1:HOLD:TYPE?
Preset	BEL
State Saved	Saved in instrument state.
Range	Below Level Above Level
Initial S/W Revision	Prior to A.02.00
Modified at S/W Revision	A.02.00

Trig Reference Line

Appears (if enabled) when the trigger source is related to the measured signal. It shows the trigger level relative to the signal. This control enables you to show or hide the trigger reference line.

The trigger reference line, only appears on appropriately formatted time traces. For example, if Video (IF Envelope) trigger is selected, the trigger level line would appear on Main Time, Inst Main Time, or Raw Main Time traces that are formatted as Log Mag or Linear Mag.

Key Path	Trigger
Mode	VSA, LTE, LTETDD, IDEN,LTEAFDD,LTEATDD
Remote Command	:TRIGger[:SEquence]:RLINe OFF ON 0 1 :TRIGger[:SEquence]:RLINe?
Example	TRIG:RLIN ON TRIG:RLIN?
Preset	1
State Saved	Saved in instrument state.
Range	Show Hide
Initial S/W Revision	Prior to A.02.00
Modified at S/W Revision	A.02.00

8 Vector Analysis

The Vector Analysis measurement is accessed from the Meas hardkey. The Vector Analysis measurement bases its results on a set of periodic time samples of a channel. The channel is defined by a combined bank of hardware and DSP filters whose overall frequency response has a flat top and steep rolloff at the band edges. The time record is operated upon by a number of mathematical functions, including the FFT to produce spectrum results and statistical functions, including complementary cumulative distribution function (CCDF). Any of these results may be displayed in a flexible layout, with the Y data formatted in a variety of ways, and results scaled as desired. Many of these analysis results are also available in optional VSA demodulation measurements. For measurement results and views, see ["View/Display" on page 495](#).

This topic contains the following sections:

["Remote Command Results for Vector Analysis Measurement" on page 320](#)

["Front Panel Results" on page 321](#)

Remote Command Results for Vector Analysis Measurement

The Vector Analysis measurement is invoked remotely by the following:

```
:CONFigure:VECTor
```

```
:CONFigure:VECTor:NDEFault
```

Remote results may be obtained using the following:

```
:FETCh:VECTor [n] ?
```

Only table results may be obtained using FETCh. The tables available for the Vector Analysis measurement are ACP and OccBW tables, which are available to any VSA measurement.

```
:INITiate:VECTor
```

```
:READ:VECTor [n] ?
```

NOTE

The MEASure? command is not supported by the Vector Analysis measurement.

For more information and remote commands, see ["Remote SCPI Commands and Data Queries" on page 1285](#).

Also see ["Data" on page 1237](#) for more measurement SCPI commands.

Front Panel Results

Vector Analysis results may be displayed in any trace, and the traces viewed in a variety of layouts that show 1, 2, 3, or 4 traces at a time. Each trace may be scaled as desired regardless of measurement settings, or auto-scaled to reflect measurement settings. Data may be formatted in a variety of ways. (For example, you may view the log magnitude of complex data, the real or imaginary part, etc.) You may use View Presets to view frequently used results, or to provide a familiar starting point from which you may customize your own view.

Key Path	Meas
Mode	VSA

AMPTD Y Scale (Amplitude)

Accesses a menu that enables you to control input signal conditioning as well as the Y-scaling of trace data. Input signal conditioning actually affects the input signal and the associated measurement quality, whereas Y-scaling is non-destructive of data. Even if the data is scaled so as to be clipped or completely off the display, the marker readouts are still correct and accurate data can still be retrieved via SCPI.

Key Path	Front Panel
Initial S/W Revision	Prior to A.02.00

Y Auto Scale

Changes the Y reference value and Scale per Division so the full trace is displayed without clipping.

Key Path	AMPTD Y Scale
Mode	VSA, LTE, LTETDD, IDEN, LTEAFDD, LTEATDD
Measurement	<meas>:=VECTor ADEMod DDEMod W11A W11B EVM IPOWER IDEMod MOTotalk
Remote Command	:DISPlay:<meas>:TRACe[1] 2 ...4:Y[:SCALE]:AUTO:ONCE
Example	:DISP:VECT:TRAC1:Y:AUTO:ONCE
Initial S/W Revision	Prior to A.02.00
Modified at S/W Revision	A.02.00

Range

Represents the amplitude of the largest sinusoidal signal that could be present within the IF without being clipped by the ADC. For signals with high peak-to-rms ratios, the range may need to exceed the rms signal power by a fair amount to avoid clipping.

Key Path	AMPTD Y Scale
Mode	VSA, LTE, LTETDD, IDEN
Remote Command	[:SENSe] :POWeR [:RF] :RANGe <real> [:SENSe] :POWeR [:RF] :RANGe?
Example	POW:RANG 25 POW:RANG?
Notes	The parameter is interpreted as dBm
Preset	20
State Saved	Saved in instrument state.
Min	depends on model and preamp options
Max	depends on model and preamp options
Initial S/W Revision	Prior to A.02.00
Modified at S/W Revision	A.02.00

Range

This key is only available when I/Q is the selected input. It replaces the Attenuation key in that case.

Each input channel (I and Q) has four internal gain ranges. The maximum allowed voltage in each gain range is slightly more than the nominal value, so the break point between ranges is a couple of millivolts higher than the nominal (setting a peak voltage of 0.502 mV will still map to the 0.5 V Peak range).

Gain Setting	Volts RMS	Volts Peak	Volts Peak - Peak	dBm (50Ω)	Break Point
0 dB	0.7071	1.0	2.0	10	n/a
6 dB	0.3536	0.5	1.0	4	0.502 V Peak
12 dB	0.1768	0.25	0.5	-2	0.252 V Peak
18 dB	0.0884	0.125	0.25	-8	0.127 V Peak

Key Path	AMPTD Y Scale
Notes	Visible only when the selected input is I/Q.
State Saved	No
Readback Text	When Range is Auto, "[Auto]" When Range is Man and I & Q are the same, "[<range value>]" When Range is Man and I & Q are different: "[I: <I range value> Q: <Q range value>]" See I Range and Q Range for the <range value> enumeration definition.
Initial S/W Revision	Prior to A.02.00

Range Auto/Man

The Auto setting for Range causes the range to be set based on the Y Scale settings. When Range is "Auto", the I & Q Range are set based on the top of the Y Scale when the Y scale is in dB units (for example, power), or to the max(abs(top), abs(bottom)) when the Y scale reference is not at the top of the screen.

Not all measurements support Range Auto/Man. If Auto is not supported in the current measurement, this key is grayed out and shows "Man" and MAN is returned to a SCPI query, but this does NOT change the Auto/Man setting for Range. When you go to a measurement that supports Auto, it goes back to Auto if it was previously in Auto mode.

Key Path	AMPTD Y Scale, Range
Scope	Meas Global
Remote Command	[:SENSe] :VOLTagE:IQ:RANGe:AUTO OFF ON 0 1 [:SENSe] :VOLTagE:IQ:RANGe:AUTO?
Example	Put the I Range and Q Range in manual.

	VOLT:IQ:RANG:AUTO OFF
Dependencies	If Auto is not supported, sending the SCPI command will generate an error.
Couplings	When in Auto, both I Range and Q Range are set to the same value, computed as follows: Maximum absolute value is computed for the Y Scale. The top and bottom of the graph are computed based on Ref Value, Scale/Div, and Ref Position. Formula: YMax = max(abs(top), abs(bottom)). The I Range and Q Range are then set to YMax.
Preset	ON
State Saved	Saved in instrument state
Range	Auto Man
Initial S/W Revision	Prior to A.02.00

Remote Command	[:SENSe] : POWer : IQ : RANGe : AUTO OFF ON 0 1 [:SENSe] : POWer : IQ : RANGe : AUTO ?
Example	Put the I Range and Q Range in manual. POW:IQ:RANG:AUTO OFF
Notes	The POW:IQ:RANG:AUTO is an alternate form of the VOLT:IQ:RANG:AUTO command. This is to maintain consistency with I Range and Q Range, which support both the POWer and VOLTage forms of the command.
Preset	ON
Range	Auto Man
Initial S/W Revision	Prior to A.02.00

I Range

This is the internal gain range for the I channel when Input Path is I Only or I and I/Q, and it is used for both the I and Q channels when the Input Path is I+jQ. See "[I/Q Gain Ranges](#)" on page 1119.

Key Path	AMPTD Y Scale, Range
Remote Command	[:SENSe] : VOLTage : IQ [: I] : RANGe [: UPPer] <voltage> [:SENSe] : VOLTage : IQ [: I] : RANGe [: UPPer] ?
Example	Set the I Range to 0.5 V Peak VOLT:IQ:RANG 0.5 V
Notes	The numeric entries are mapped to the smallest gain range whose break point is greater than or equal to the value, or 1 V Peak if the value is greater than 1 V.
Couplings	When Q Same as I is On, the I Range value will be copied to the Q Range. Changing the value will also set Range = Man.
Preset	1 V Peak
State Saved	Saved in instrument state

Range	1 V Peak 0.5 V Peak 0.25 V Peak 0.125 V Peak
Min	0.125 V
Max	1 V
Initial S/W Revision	Prior to A.02.00

Remote Command	<code>[:SENSe] :POWer :IQ [:I] :RANGe [:UPPer] <ampl></code> <code>[:SENSe] :POWer :IQ [:I] :RANGe [:UPPer] ?</code>
-----------------------	---

Example	Set the I Range to 0.5 V Peak when Reference Z is 50Ω, and to 1.0 V Peak when Reference Z is 75Ω. POW:IQ:RANG 4 dBm
----------------	--

Notes	The POWER form of the command is provided for convenience. It maps to the same underlying gain range parameter as the VOLTage form of the command. The Reference Z (not the I channel Input Z) is used to convert the power to peak voltage, which is then used to set the I Range as with the VOLTage form of the command. The power values of the 4 range states (1V Peak, 0.5V Peak, 0.25V Peak, and 0.125V Peak) will vary with Reference Z. Here are some examples: 50Ω: 10, 4, -2, -8 75Ω: 8.2, 2.2, -3.8, -9.8 600Ω: -0.8, -6.8, -12.8, -18.9
-------	--

Preset	10.0 dBm
Range	-20 dBm to 10 dBm
Min	-20 dBm
Max	10 dBm
Initial S/W Revision	Prior to A.02.00

Q Range Value

This is the internal gain range for the Q channel. See "[I/Q Gain Ranges](#)" on page 1119. The Q Range only applies to Input Path Q Only and Ind I/Q. For input I+jQ the I Range determines both I and Q channel range settings.

Key Path	AMPTD Y Scale, Range
----------	----------------------

Remote Command	<code>[:SENSe] :VOLTage :IQ :Q :RANGe [:UPPer] <voltage></code> <code>[:SENSe] :VOLTage :IQ :Q :RANGe [:UPPer] ?</code>
-----------------------	--

Example	Set the Q Range to 0.5 V Peak VOLT:IQ:Q:RANG 0.5 V
----------------	---

Notes	The numeric entries are mapped to the smallest gain range whose break point is greater than or equal to the value, or 1 V Peak if the value is greater than 1 V. The Q Range is only used for Input Path Q Only and Ind I/Q. For input I+jQ the I Range determines both I and Q channel range settings.
-------	--

Couplings	When Q Same as I is On, the I Range value will be copied to the Q Range and the range value keys are disabled. Changing the value will also set Range = Man.
Preset	1 V Peak
State Saved	Saved in instrument state
Range	1 V Peak 0.5 V Peak 0.25 V Peak 0.125 V Peak
Min	0.125 V
Max	1 V
Initial S/W Revision	Prior to A.02.00

Remote Command	<code>[:SENSe] :POWer:IQ:Q:RANGe[:UPPer] <ampl></code> <code>[:SENSe] :POWer:IQ:Q:RANGe[:UPPer]?</code>
-----------------------	--

Example	Will set the Q Range to 0.5 V Peak when Reference Z is 50Ω, and to 1.0 V Peak when Reference Z is 75Ω. POW:IQ:Q:RANG 4 dBm
----------------	---

Notes	The POWER form of the command is provided for convenience. It maps to the same underlying gain range parameter as the VOLTage form of the command. The Reference Z (not the Q channel Input Z) is used to convert the power to peak voltage, which is then used to set the Q Range as with the VOLTage form of the command. The power values of the 4 range states (1V Peak, 0.5V Peak, 0.25V Peak, and 0.125V Peak) will vary with Reference Z. Here are some examples: 50Ω: 10, 4, -2, -8 75Ω: 8.2, 2.2, -3.8, -9.8 600Ω: -0.8, -6.8, -12.8, -18.9
-------	--

Preset	10.0 dBm
Range	-20 dBm to 10 dBm
Min	-20 dBm
Max	10 dBm
Initial S/W Revision	Prior to A.02.00

Q Same as I

Many, but not all, usages require the I and Q channels to have an identical setup. To simplify channel setup, the Q Same as I will cause the Q channel range to be mirrored from the I channel. That way you only need to set up one channel (the I channel). The I channel values are copied to the Q channel, so at the time Q Same as I is Off, the I and Q channel setups will be identical.

Key Path	AMPTD Y Scale, Range, Q Range
Remote Command	<code>[:SENSe] :VOLTage POWer:IQ:MIRRored OFF ON 0 1</code> <code>[:SENSe] :VOLTage POWer:IQ:MIRRored?</code>

Example	Turn off the mirroring of I Range to Q Range. VOLT:IQ:MIRR OFF POW:IQ:MIRR OFF
Couplings	When On, the I Range value is mirrored (copied) to the Q Range.
Preset	On
State Saved	Saved in instrument state.
Range	On Off
Readback Text	"Q Same as I" when On, otherwise none.
Initial S/W Revision	Prior to A.02.00

I/Q Gain Ranges

See the following sections:

["1 V Peak" on page 1119](#)

["0.5 V Peak" on page 1119](#)

["0.25 V Peak" on page 1119](#)

["0.125 V Peak" on page 1120](#)

1 V Peak

Set the channel gain state to 1 Volt Peak.

Key Path	AMPTD Y Scale, I Range Q Range
Initial S/W Revision	Prior to A.02.00

0.5 V Peak

Set the channel gain state to 0.5 Volt Peak.

Key Path	AMPTD Y Scale, I Range Q Range
Initial S/W Revision	Prior to A.02.00

0.25 V Peak

Set the channel gain state to 0.25 Volt Peak.

Key Path	AMPTD Y Scale, I Range Q Range
Initial S/W Revision	Prior to A.02.00

0.125 V Peak

Set the channel gain state to 0.125 Volt Peak.

Key Path	AMPTD Y Scale, I Range Q Range
Initial S/W Revision	Prior to A.02.00

μW Path Control

The μW Path Control functions include the μW Preselector Bypass (Option MPB) and Low Noise Path (Option LNP) controls in the High Band path circuits.

When the μW Preselector is bypassed, the user has better flatness, but will be subject to spurs from out of band interfering signals. When the Low Noise Path is enabled, the analyzer automatically switches around certain circuitry in the high frequency bands which can contribute to noise, when it is appropriate based on other analyzer settings.

For most applications, the preset state is Standard Path, which gives the best remote-control throughput, minimizes acoustic noise from switching and minimizes the risk of wear out in the hardware switches. For applications that utilize the wideband IF paths, the preset state is the μW Preselector Bypass path, if option MPB is present. This is because, when using a wideband IF such as the 140 MHz IF, the μW Preselector's bandwidth can be narrower than the available IF bandwidth, causing degraded amplitude flatness and phase linearity, so it is desirable to bypass the preselector in the default case.

Users may choose Low Noise Path Enable. It gives a lower noise floor, especially in the 21–26.5 GHz region, though without improving many measures of dynamic range, and without giving the best possible noise floor. The preamp, if purchased and used, gives better noise floor than does the Low Noise Path, however its compression threshold and third-order intercept are much poorer than that of the non-preamp Low Noise Path. There are some applications, typically for signals around –30 dBm, for which the third-order dynamic range of the standard path is good enough, but the noise floor is not low enough even with 0 dB input attenuation. When the third-order dynamic range of the preamp path is too little and the noise floor of the standard path is too high, the Low Noise Path can provide the best dynamic range.

Key Path	AMPTD Y Scale
Mode	SA, BASIC, PNOISE, VSA , LTE, LTETDD
Scope	Meas Global
Remote Command	[:SENSe] :POWer [:RF] :MW:PATH STD LNPath MPBypass FULL [:SENSe] :POWer [:RF] :MW:PATH?
Example	:POW:MW:PATH LNP Enables the Low Noise path
Notes	If a Presel Center is performed, the analyzer will momentarily switch to the Standard Path, regardless of the setting of μW Path Control The DC Block will always be switched in when the low noise path is switched in, to protect succeeding circuitry from DC. Note that this does not mean “when the low noise path is enabled” but when, based on the Low Noise Path rules, the path is actually switched in. This can happen when the selection is Low Noise Path Enable . In the case where the DC Block is switched in the analyzer is now AC coupled. However, if the user has selected DC coupling, the UI will still behave as though it were DC coupled, including all annunciation, warnings, status bits, and responses to SCPI queries.

	This is because, based on other settings, the analyzer could switch out the low noise path at any time and hence go back to being DC coupled. Alignment switching ignores the settings in this menu, and restores them when finished.
Dependencies	Unavailable in BBIQ and External Mixing
Preset	All modes other than IQ Analyzer mode and VXA: STD IQ Analyzer, VXA and WLAN mode: MPB option present and licensed: MPB MPB option not present and licensed: STD
State Saved	Save in instrument state
Readback	Value selected in the submenu
Initial S/W Revision	A.04.00
Modified at S/W Revision	A.10.00

Standard Path

This path gives the best remote-control throughput, minimizes acoustic noise from switching and minimizes the risk of wear in the hardware switches, particularly in remote test scenarios where both low band and high band setups will follow in rapid succession.

In this path, the bypass of the low band/high band switch and microwave preamp is never activated, which can cause some noise degradation but preserves the life of the bypass switch.

Key Path	AMPTD Y Scale, μ W Path Control
Example	:POW:MW:PATH STD
Readback Text	Standard Path
Initial S/W Revision	A.04.00

μ W Preselector Bypass

This key toggles the preselector bypass switch for band 1 and higher. When the microwave preselect is on, the signal path is preselected. When the microwave preselector is off, the signal path is not preselected. The preselected path is the normal path for the analyzer.

The preselector is a tunable bandpass filter which prevents signals away from the frequency of interest from combining in the mixer to generate in-band spurious signals (images). The consequences of using a preselector filter are its limited bandwidth, the amplitude and phase ripple in its passband, and any amplitude and phase instability due to center frequency drift.

Option MPB or pre-selector bypass provides an unpreselected input mixer path for certain X-Series signal analyzers with frequency ranges above 3.6 GHz. This signal path allows a wider bandwidth and less amplitude variability, which is an advantage when doing modulation analysis and broadband signal analysis. The disadvantage is that, without the preselector, image signals will be displayed. Another disadvantage of bypassing the preselector is increased LO emission levels at the front panel input port.

Image responses are separated from the real signal by twice the 1st IF. For IF Paths of 10 MHz and 25 MHz, the 1st IF is 322.5 MHz, so the image response and the real signal will be separated by 645 MHz. The 1st IF will be different for other IF Path settings. When viewing a real signal and its corresponding image response in internal mixing, the image response will be to the left of the real signal.

Also, the image response and the real signal typically have the same amplitude and exhibit the same shape factor.

However, if Option FS1, Fast Sweep Capability, is enabled, the image response in the Swept SA measurement will appear lower in amplitude and have a much wider shape factor compared to the real signal.

Key Path	AMPTD Y Scale, μ W Path Control
Example	:POW:MW:PATH MPB
Dependencies	Key is blanked if current mode does not support it. Key is grayed out if mode supports it but current measurement does not support it. Key is blank unless Option MPB is present and licensed. If SCPI command sent when MPB not present, error -241, "Hardware missing; Option not installed" is generated.
Readback Text	μ W Preselector Bypass
Initial S/W Revision	A.04.00

Remote Command	[:SENSe] :POWer [:RF] :MW:PRESelector [:STATe] ON OFF 0 1 [:SENSe] :POWer [:RF] :MW:PRESelector [:STATe] ?
Example	:POW:MW:PRES OFF Bypasses the microwave preselector
Notes	The ON parameter sets the STD path (:POW:MW:PATH STD) The OFF parameter sets path MPB (:POW:MW:PATH MPB)
Preset	ON

Select Trace

Displays a menu that enables you to select the trace that is to receive the action of all successive trace-specific commands like scaling, assignment of trace data, and so on. The selected trace is outlined in green and is always visible. While the Select Trace menu is showing, each visible trace is annotated in the middle with its own trace number, as shown in the following figure. The trace number annotations disappear when any other menu is showing.

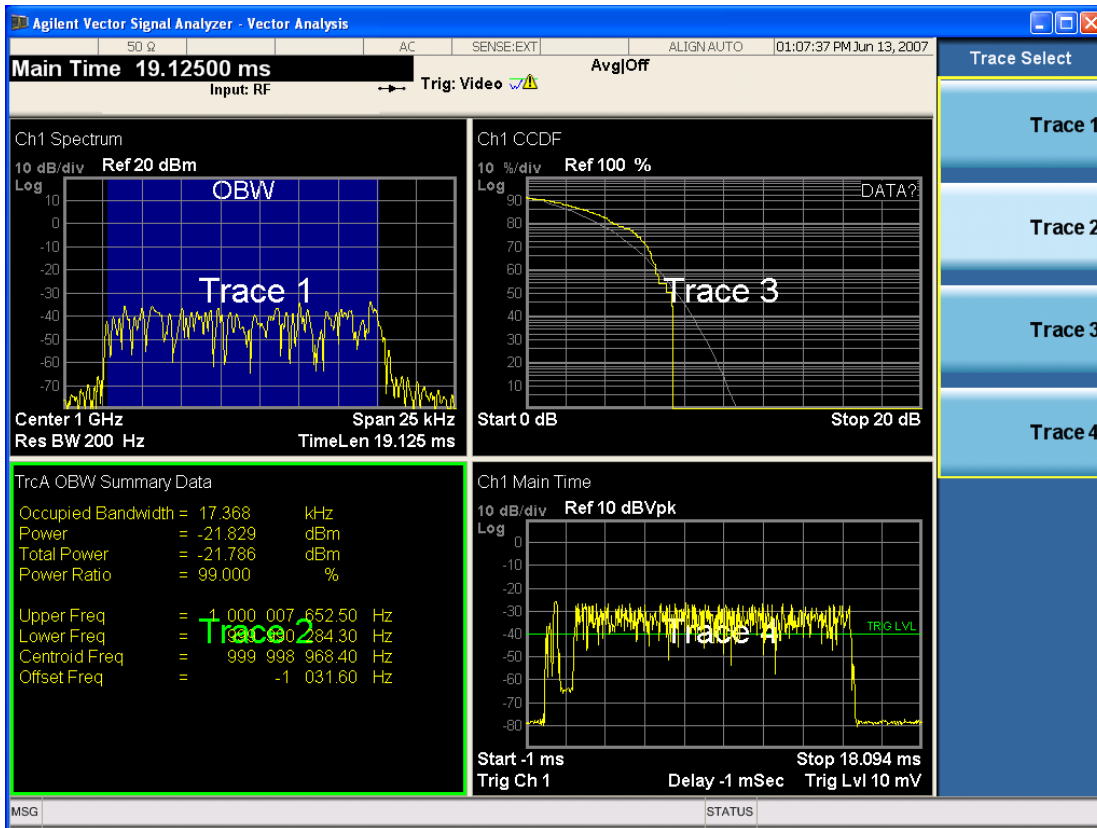

Grid 2x2 layout showing trace annotations when Trace Select dialog is active

This softkey also appears in the X and Y scaling menus. There is only one selected trace at any time. If you change which trace is selected, that change is reflected in this softkey/menu wherever it appears. Other ways to select a trace include use of the Next Window key, clicking within a trace window with a mouse cursor, and issuing a trace-specific SCPI command.

There is no SCPI command associated with this function. Instead, SCPI commands that are trace-specific have an index on the TRACe node that determines the selected trace. Using such a command has the side effect that the trace addressed by the SCPI command becomes the selected trace for any front panel interaction.

Key Path	Trace/Detector or Span X Scale or AMPTD Y Scale
Mode	VSA, LTE, LTETDD, IDEN, LTEAFDD, LTEATDD
Notes	No SCPI. Front panel only.
Couplings	Affects any trace-specific commands
Range	Trace 1 Trace 2 Trace 3 Trace 4 Trace 5 Trace 6
Readback Text	Trace <n>
Initial S/W Revision	Prior to A.02.00
Modified at S/W Revision	A.02.00

Couple Ref to Range

When Couple Ref to Range is on, Y scaling is adjusted when the Range changes. For example, on traces with Y units of dBm, the reference value changes by the same amount in dB as the Range does. On a trace with Y units of Volts, the Per Division setting changes by a factor of approximately 1.25 when the Range changes by 2 dB. This function can be turned on or off for each individual trace.

Key Path	AMPTD Y Scale
Mode	VSA, LTE, LTETDD, IDEN, LTEAFDD, LTEATDD
Measurement	<meas>:=VECTor ADEMod DDEMod W11A W11B EVM IPOWER IDEMod MOTotalk
Remote Command	:DISPlay:<meas>:TRACe [1] 2 ...4:Y[:SCALE]:RLEVel:AUTO OFF ON 0 1 :DISPlay:<meas>:TRACe [1] 2 ...4:Y[:SCALE]:RLEVel:AUTO?
Example	DISP:VECT:TRAC1:Y:RLEV:AUTO ON DISP:VECT:TRAC1:Y:RLEV:AUTO?
Notes	Range coupling is not available for Phase and Group delay traces.
Preset	1
State Saved	Saved in instrument state.
Range	On Off
Initial S/W Revision	Prior to A.02.00
Modified at S/W Revision	A.02.00

Y Reference Value

Controls the Y value of the selected trace at the Reference Position. It has no effect on hardware input settings.

See "[Y Reference: Position](#)" on page 1122 for more details.

Key Path	AMPTD Y Scale
Mode	VSA, LTE, LTETDD, IDEN, LTEAFDD, LTEATDD
Measurement	<meas>:=VECTor ADEMod DDEMod W11A W11B EVM IPOWER IDEMod MOTotalk
Remote Command	:DISPlay:<meas>:TRACe [1] 2 ...4:Y[:SCALE]:RLEVel <real> :DISPlay:<meas>:TRACe [1] 2 ...4:Y[:SCALE]:RLEVel?
Example	DISP:VECT:TRAC:Y:RLEV 20 DISP:VECT:TRAC:Y:RLEV?
Couplings	None. This does not affect any hardware input settings.
Preset	Depends on trace
State Saved	Saved in instrument state.
Min	-9.9E+37
Max	9.9E+37
Initial S/W Revision	Prior to A.02.00
Modified at S/W Revision	A.02.00

Y Scale Per Division

Controls the Y scale per division of the selected trace.

Key Path	AMPTD Y Scale
Mode	VSA, LTE, LTETDD, IDEN, LTEAFDD, LTEATDD
Measurement	<meas>:=VECTor ADEMod DDEMod W11A W11B EVM IPOWER IDEMod MOTotalk
Remote Command	:DISPlay:<meas>:TRACe[1] 2 ...4:Y[:SCALE]:PDIVision <real> :DISPlay:<meas>:TRACe[1] 2 ...4:Y[:SCALE]:PDIVision?
Example	DISP:VECT:TRAC:Y:PDIV 10 DISP:VECT:TRAC:Y:PDIV?
Couplings	None.
Preset	Depends on trace
State Saved	Saved in instrument state.
Min	-9.9E+37
Max	9.9E+37
Initial S/W Revision	Prior to A.02.00
Modified at S/W Revision	A.02.00

Y Reference: Position

Sets the position of the reference line for Y scaling for the selected trace. It can be set to the top, bottom, or center of the grid.

Key Path	AMPTD Y Scale
Mode	VSA, LTE, LTETDD, IDEN, LTEAFDD, LTEATDD
Measurement	<meas>:=VECTor ADEMod DDEMod W11A W11B EVM IPOWER IDEMod MOTotalk
Remote Command	:DISPlay:<meas>:TRACe[1] 2 ...4:Y[:SCALE]:RPOSition TOP CENTER BOTTom :DISPlay:<meas>:TRACe[1] 2 ...4:Y[:SCALE]:RPOSition?
Example	DISP:VECT:TRAC1:Y:RPOS TOP DISP:VECT:TRAC1:Y:RPOS?
Couplings	Changing trace format or data can affect this. Each format "remembers" its reference position.
Preset	Depends on trace format and trace data. Top for LogMag or most LinearMag traces, middle for Real, Imaginary, Vector displays, Eye diagrams, Phase, Delay, Bottom for Linear Mag EVM.
State Saved	Saved in instrument state.
Range	Top Ctr Bottom
Initial S/W Revision	Prior to A.02.00
Modified at S/W Revision	A.02.00

Reference Line

Controls whether the Y reference line is visible or not.

Key Path	AMPTD Y Scale
Mode	VSA, LTE, LTETDD, IDEN, LTEAFDD, LTEATDD
Measurement	<meas>:=VECTor ADEMod DDEMod W11A W11B EVM IPOWER IDEMod MOTotalk
Remote Command	:DISPlay:<meas>:TRACe[1] 2 ...4:RLINe OFF ON 0 1 :DISPlay:<meas>:TRACe[1] 2 ...4:RLINe?
Example	DISP:VECT:TRAC1:RLIN ON DISP:VECT:TRAC1:RLIN?
Preset	OFF
State Saved	Saved in instrument state.
Initial S/W Revision	Prior to A.02.00
Modified at S/W Revision	A.02.00

Y Unit Preference

Displays a menu that enables you to set the preferred Y unit for the selected trace. You can select Peak, RMS, Power units, or an automatic selection. The automatic selection uses Power units for frequency domain data and Peak units for time domain data.

Key Path	AMPTD Y Scale
Mode	VSA, LTE, LTETDD, IDEN, LTEAFDD, LTEATDD
Measurement	<meas>:=VECTor ADEMod DDEMod W11A W11B EVM IPOWER IDEMod MOTotalk
Remote Command	:DISPlay:<meas>:TRACe[1] 2 ...4:Y:UNIT:PREFeRence AUTO PEAK RMS POWER MRMS :DISPlay:<meas>:TRACe[1] 2 ...4:Y:UNIT:PREFeRence?
Example	DISP:VECT:TRAC1:Y:UNIT:PREF PEAK DISP:VECT:TRAC1:Y:UNIT:PREF?
Preset	AUTO
State Saved	Saved in instrument state.
Range	AUTO PEAK RMS POW MRMS
Readback Text	Auto Peak RMS Power mRMS
Initial S/W Revision	Prior to A.02.00
Modified at S/W Revision	A.02.00

The following SCPI only command can be used to determine exactly which Y unit was chosen based on the setting of the above:

Key Path	AMPTD Y Scale
Mode	VSA, LTE, LTETDD, IDEN
Measurement	<meas>:=VECTor ADEMod DDEMod W11A W11B EVM IPOWER IDEMod MOTotalk
Remote Command	:DISPlay:<meas>:TRACe[1] 2 ...4:Y:UNIT?
Example	DISP:VECT:TRAC1:Y:UNIT?
Initial S/W Revision	Prior to A.02.00
Modified at S/W Revision	A.02.00

Y Log Ratio

Enabled if the Trace Format is set to LogMag (Linear Unit). In this format type, you set the Y Log Ratio instead of Y Scale Per Division to determine Y scaling. It sets the ratio of the top of the Y axis to the bottom.

Key Path	AMPTD Y Scale
Mode	VSA, LTE, LTETDD, IDEN, LTEAFDD, LTEATDD
Measurement	<meas>:=VECTor ADEMod DDEMod W11A W11B EVM IPOWER IDEMod MOTotalk
Remote Command	:DISPlay:<meas>:TRACe[1] 2 ...4:Y:LRATio <real> :DISPlay:<meas>:TRACe[1] 2 ...4:Y:LRATio?
Example	DISP:VECT:TRAC1:Y:LRAT 10000 DISP:VECT:TRAC1:Y:LRAT?
Notes	This is grayed out if the trace format is not Log Mag (linear unit).
Preset	100000
State Saved	Saved in instrument state.
Min	1.001
Max	100e6
Initial S/W Revision	Prior to A.02.00
Modified at S/W Revision	A.02.00

Vector Horiz Center

Sets the position of the origin for Vector trace formats such as I-Q and Constellation. When using one of these formats, you set the vertical (imaginary) axis scaling with the Y Reference Value, Y Reference Position, and Y Scale Per Division properties. The scaling of the horizontal axis is set to maintain an aspect ratio of 1:1.

Key Path	AMPTD Y Scale
Mode	VSA, LTE, LTETDD, IDEN, LTEAFDD, LTEATDD
Measurement	<meas>:=VECTor ADEMod DDEMod W11A W11B EVM IPOWER IDEMod MOTotalk
Remote Command	:DISPlay:<meas>:TRACe[1] 2 ...4:VHCenter <real>

	:DISPlay:<meas>:TRACe[1] 2 ...4:VHCenter?
Example	DISP:DDEM:TRAC1:VHC 0.2 DISP:DDEM:TRAC1:VHC?
Preset	0
State Saved	Saved in instrument state.
Min	-9.9e37
Max	9.9e37
Initial S/W Revision	Prior to A.02.00
Modified at S/W Revision	A.02.00

Copy Y Scale

Copies the following Y scaling information from the selected trace to another:

- Y reference Position
- Y Reference Value
- Y Unit Preference
- Vector Horiz Center
- Couple Ref to Range
- Y Log Ratio
- Y Reference Line

This is a front-panel only function.

Key Path	AMPTD Y Scale, Y Axis Scaling
Mode	VSA, LTE, LTETDD, IDEN, LTEAFDD, LTEATDD
Initial S/W Revision	Prior to A.02.00
Modified at S/W Revision	A.02.00

Auto Couple

The Auto Couple feature provides a quick and convenient way to automatically couple multiple instrument settings. This helps ensure accurate measurements and optimum dynamic range. When the Auto Couple feature is activated, either from the front panel or remotely, all parameters of the current measurement that have an Auto/Manual mode are set to Auto mode and all measurement settings dependent on (or coupled to) the Auto/Man parameters are automatically adjusted for optimal performance.

However, the Auto Couple key actions are confined to the current measurement only. It does not affect other measurements in the mode, and it does not affect markers, marker functions, or trace or display attributes.

See "[More Information](#)" on page 337

Key Path	Front-panel key
Remote Command	:COUPle ALL NONE
Example	:COUP ALL
Notes	:COUPle ALL puts all Auto/Man parameters in Auto mode (equivalent to pressing the Auto Couple key). :COUPLE NONE puts all Auto/Man parameters in manual mode. It decouples all the coupled instrument parameters and is not recommended for making measurements.
Initial S/W Revision	Prior to A.02.00

More Information

There are two types of functions that have Auto/Manual modes.

Auto/Man Active Function keys

An Auto/Man toggle key controls the binary state associated with an instrument parameter by toggling between Auto (where the parameter is automatically coupled to the other parameters it is dependent upon) and Man (where the parameter is controlled independent of the other parameters), as well as making the parameter the active function. The current mode is indicated on the softkey with either Auto or Man underlined as illustrated below.



Auto/Man 1-of-N keys

An Auto/Man 1-of-N key allows you to manually pick from a list of parameter values, or place the function in Auto, in which case the value is automatically selected (and indicated) as shown below. If in Auto, Auto is underlined on the calling key. If in manual operation, manual is indicated on the calling key. But the calling key does not actually toggle the function, it simply opens the menu.

8 Vector Analysis
Auto Couple

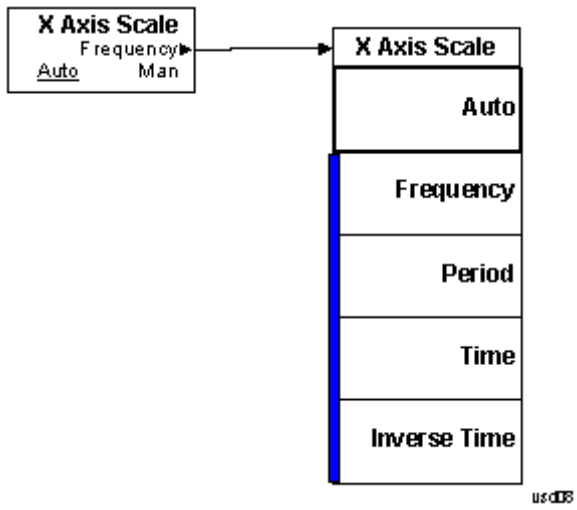

BW (Bandwidth)

Displays a menu that enables you to control the resolution bandwidth of the spectrum measurement result, as well as the shape of the resolution bandwidth filter (controlled by the FFT windowing function).

Key Path	Front Panel
Mode	VSA, LTE, LTETDD, IDEN
Initial S/W Revision	Prior to A.02.00
Modified at S/W Revision	A.02.00

Res BW

Enables you to select the resolution bandwidth of the measurement. Res BW is mathematically related to Time length and Window type, so changing one of these, directly or indirectly, must change at least one other.

Res BW and Time length are related by the following equation:

$$\text{Res BW} = \text{ENBW} / T$$

where:

ENBW is the normalized effective noise bandwidth of the Window. See ["FFT Window" on page 1129](#) for more details).

T is the time record length.

Therefore, **if you change Res BW, Main Time must also change**, and vice versa. (If the Gate function is on, then it is Gate Length, not Main Time, that is related to Res BW by the above equation.)

For convenience, Res BW is by default also coupled to Span (but not vice versa). This coupling can be turned off. See ["Res BW Coupling" on page 707](#) for more details.

Limits:

- The minimum Res Bw to Span ratio is related to the maximum Main Time length, and is given by:

$$\text{ENBW} / 409600 \text{ if Freq points state parameter is set to Auto}$$

$$\text{ENBW} / (\text{Freq Points} - 1) \text{ if Freq points parameter is manually set}$$

- The maximum Res BW to Span ratio is related to the minimum time record size (16 points for most windows, 17 points for Flat Top), and is given by:

$$\text{ENBW} / 12.5$$

$$(\text{ENBW} / 13.28125 \text{ for Flat Top window})$$

See ["Main Time" on page 818](#) for more on relationships between Res BW and time.

Key Path	BW
Mode	VSA

Measurement	<meas>:=VECTor ADEMod IPOWER IDEMod MOTotalk
Remote Command	[:SENSe] :<meas>:BANDwidth BWIDth [:RESolution] <bandwidth> [:SENSe] :<meas>:BANDwidth BWIDth [:RESolution] ?
Example	VECT:BWID 200 KHZ VECT:BWID?
Notes	Key blanked in any other measurement than Vector or Analog Demod
Couplings	Changing Main Time or Gate Length changes Res BW. See Res BW Coupling for other changes that can affect (or be affected by) Res BW
Preset	300 kHz
State Saved	Saved in instrument state.
Min	-9.9e37
Max	9.9e37
Initial S/W Revision	Prior to A.02.00
Modified at S/W Revision	A.02.00

Res BW Coupling

Enables you to control how Res BW is affected by other parameters. The three possible settings are:

Span: (default) This setting keeps the ratio of Res BW:Span constant whenever the Span is changed. However, you can change the Res BW at will, and doing so establishes a new Res BW:Span ratio.

Min: This setting is only available when the Freq Points property is manually set, and is disabled (forceful grey out) when Freq Points is Auto. It maintains the RBW at the minimum possible value given the settings for Freq Points, Span, and Window. Res BW coupling is changed from Min to Span if you manually set Res BW.

Fixed: This setting attempts to keep the Res BW setting fixed as Span, Freq Points, or FFT Window type change. Changing FFT Window causes Main Time (or Gate) length to change in order to keep the Res BW Fixed. Res BW coupling is forced to Fixed mode any time you turn the Gate function on or manually set Main Time length. See ["Main Time" on page 818](#) for details.

If a requested change to Res BW or Time Length (Main or Gate) causes the Res BW to go outside the minimum or maximum Res BW: Span limits (see ["Res BW" on page 706](#) for specifics), the Res BW is clipped at the appropriate limit. The Time length is then set according to the limited Res BW.

In Fixed coupling mode, if increasing the Span causes the new Res BW:Span to drop below the minimum, or if decreasing Span would cause the new Res BW:Span to exceed the maximum, the requested Span is accepted and then the Res BW is changed to the limiting value. The associated Time length is updated.

In Fixed or Span coupling, increasing Freq Points does not cause the Main (or Gate) Time Length to increase. It only adds zero padding to the array that is used in the FFT to calculate the Spectrum. Therefore, it does not affect Res BW. If decreasing Freq Points decreases the maximum time length below the current Main Time, then the Main Time length is clipped to the new limits. If Gating is on, the Gate Delay is first limited, then the Gate Length. The Res BW is then updated as a result of the Time changes.

In Fixed or Span coupling, changing the Window Type does not affect RBW unless it falls outside the limits calculated using the new window. Then the Res BW is clipped at the appropriate limit. The associated Time length is also updated.

Key Path	BW
Mode	VSA
Measurement	<meas>:=VECTor ADEMod IPOWER IDEMod MOTotalk
Remote Command	[:SENSe] : <meas> : BANDwidth BWIDth [:RESolution] : COUPle SPAN MIN FIXed [:SENSe] : <meas> : BANDwidth BWIDth [:RESolution] : COUPle?
Example	VECT:BWID:COUP FIX VECT:BWID:COUP?
Notes	Blanked when in any other measurement than Vector or Analog Demod MIN is not available if Freq Points is set to Auto and trying to set it generates error -221 Settings conflict
Couplings	See narrative above table and also "Res BW" on page 706
Preset	SPAN
State Saved	Saved in instrument state.
Range	Span Min Fixed
Initial S/W Revision	Prior to A.02.00
Modified at S/W Revision	A.02.00

FFT Window

Displays a menu that enables you to choose the Window function that is applied to the time data prior to the FFT calculation used for Spectrum and PSD displays. Four windows are available.

Window name	Common usage	Normalized ENBW (Hz-s)
Uniform	Transient or self-windowing signals, signals that are periodic within a time record length.	1.0
Hanning	Frequency resolution	1.5
Gaussian	High dynamic range	2.21536
Flat Top	High amplitude accuracy	3.8194

The normalized ENBW is the equivalent noise bandwidth, that is, the width of a rectangular filter that passes the same amount of white noise as the window. It is used to define the resolution bandwidth.

Key Path	BW
Mode	VSA, LTE, LTETDD, IDEN
Measurement	<meas>:=VECTor ADEMod DDEMod W11A W11B EVM IPOWER IDEMod MOTotalk
Remote Command	[:SENSe] : <meas> : FFT:WINDow [:TYPE] UNIFORM HANNing GAUSSian

	FLATtop [:SENSe]:<meas>:FFT:WINDow[:TYPE]?
Example	VECT:FFT:WIND GAUS VECT:FFT:WIND?
Couplings	See Res BW and Res BW Coupling
Preset	FLAT
State Saved	Saved in instrument state.
Range	Uniform Hanning Gaussian (High Dyn Rng) Flat Top (High Amptd Accy)
Readback Text	Uniform Hanning Gaussian Flat Top
Initial S/W Revision	Prior to A.02.00
Modified at S/W Revision	A.02.00

Cont (Continuous Measurement/Sweep)

Sets the analyzer for Continuous measurement operation. The single/continuous state is Meas Global so the setting will affect all measurements. If you are Paused, pressing Cont does a Resume.

Key Path	Front-panel key
Remote Command	:INITiate:CONTinuous OFF ON 0 1 :INITiate:CONTinuous?
Example	:INIT:CONT 0 puts analyzer in Single measurement operation. :INIT:CONT 1 puts analyzer in Continuous measurement operation
Preset	ON (Note that SYST:PRESet sets INIT:CONT to ON but *RST sets INIT:CONT to OFF)
State Saved	Saved in instrument state
Backwards Compatibility Notes	For Spectrum Analysis mode in ESA and PSA, there is no Cont hardkey, instead there is a Sweep Single/Cont key. In these analyzers, switching the Sweep Single/Cont key from Single to Cont restarts averages (displayed average count reset to 1), but does not restart Max Hold and Min Hold. The X-Series has Single and Cont keys in place of the SweepSingleCont key. In the X-Series, if in single measurement, the Cont key (and INIT:CONT ON) switches to continuous measurement, but never restarts a measurement and never resets a sweep.
Initial S/W Revision	Prior to A.02.00

In Swept SA Measurement (Spectrum Analysis Mode):

The analyzer takes repetitive sweeps, averages, measurements, etc., when in Continuous mode. When the average count reaches the Average/Hold Number the count stops incrementing, but the analyzer keeps sweeping. See the Trace/Detector section for the averaging formula used both before and after the Average/Hold Number is reached. The trigger condition must be met prior to each sweep. The type of trace processing for multiple sweeps, is set under the Trace/Detector key, with choices of Trace Average, Max Hold, or Min Hold.

In Other Measurements/Modes:

With Avg/Hold Num (in the Meas Setup menu) set to Off or set to On with a value of 1, a sweep is taken after the trigger condition is met; and the analyzer continues to take new sweeps after the current sweep has completed and the trigger condition is again met. However, with Avg/Hold Num set to On with a value >1, multiple sweeps (data acquisitions) are taken for the measurement. The trigger condition must be met prior to each sweep. The sweep is not stopped when the average count k equals the number N set for Avg/Hold Num is reached, but the number k stops incrementing. A measurement average usually applies to all traces, marker results, and numeric results. But sometimes it only applies to the numeric results.

If the analyzer is in Single measurement, pressing the Cont key does not change k and does not cause the sweep to be reset; the only action is to put the analyzer into Continuous measurement operation.

If it is already in continuous sweep:

the INIT:CONT 1 command has no effect

8 Vector Analysis

Cont (Continuous Measurement/Sweep)

the INIT:CONT 0 command will place the analyzer in Single Sweep but will have no effect on the current sequence until $k = N$, at which point the current sequence will stop and the instrument will go to the idle state.

File

See "File" on page 236

FREQ Channel

Displays a menu that enables you to set center frequency, start frequency, stop frequency, and center frequency step. Pressing the Freq hardkey changes the active function to Center Frequency.

The frequency parameters for any vector measurement consist of two pairs of properties: Center Frequency and Span or Start Frequency and Stop Frequency. These behave much as they do in any other application, but there is the additional constraint that the span is limited to much less than the center frequency range.

If you change center frequency, the start and stop frequencies change by the same amount.

If you change span, start frequency and stop frequency are changed by 1/2 the span change.

If you change start frequency, stop frequency remains fixed and span and center frequency are refigured accordingly. Changing stop frequency has similar behavior.

Limits:

If you change the start frequency such that it equals or exceeds the stop frequency, the new start frequency is accepted if possible and the stop frequency is set to min span above the start. Similarly if you attempt to set the stop below the start, the start frequency moves to a min span below the new stop frequency.

If you reduce the start frequency beyond a max span below the stop, the stop frequency is "dragged along" such that it is a max span above the new start frequency, and similarly increasing the stop frequency drags the start frequency along if you attempt to increase the span beyond the maximum.

Stop frequency can be 1/2 span above the maximum center frequency, but frequency-domain traces are blanked above the maximum center frequency.

Start frequency can be 1/2 span below the minimum center frequency, but frequency-domain traces are blanked below the minimum center frequency.

Key Path	Front Panel
Mode	VSA, LTE, LTETDD, IDEN
Initial S/W Revision	Prior to A.02.00
Modified at S/W Revision	A.02.00

Center Freq

Sets the frequency of the display Center.

Key Path	FREQ Channel
Mode	VSA, LTE, LTETDD, IDEN
Remote Command	[:SENSe] :FREQuency:CENTer <freq> [:SENSe] :FREQuency:CENTer?
Example	FREQ:CENT 985 MHZ FREQ:CENT?

Couplings	Start Freq, Stop Freq, and Span. See " FREQ Channel " on page 1134 for more details.
Preset	1 GHz
State Saved	Saved in instrument state.
Min	0 Hz
Max	Depends on frequency range option.
Initial S/W Revision	Prior to A.02.00
Modified at S/W Revision	A.02.00

Start Freq

Sets the frequency of the display Start.

Key Path	FREQ Channel
Mode	VSA, IDEN
Remote Command	<code>[:SENSe] :FREQuency:STARt <freq></code> <code>[:SENSe] :FREQuency:STARt?</code>
Example	FREQ:STAR 980 MHz FREQ:STAR?
Couplings	Stop Freq, Center Freq, and Span. See " FREQ Channel " on page 1134 for more details.
Preset	Depends on span option. It is 1/2 max span below 1 GHz.
State Saved	Saved in instrument state.
Min	-9.9e37
Max	9.9e37
Initial S/W Revision	Prior to A.02.00
Modified at S/W Revision	A.02.00

Stop Freq

Sets the frequency of the display Stop.

Key Path	FREQ Channel
Mode	VSA, IDEN
Remote Command	<code>[:SENSe] :FREQuency:STOP <freq></code> <code>[:SENSe] :FREQuency:STOP?</code>
Example	FREQ:STOP 990 MHz FREQ:STOP?
Couplings	Start Freq, Center Freq, and Span. See " FREQ Channel " on page 1134 for more details.
Preset	Depends on span option. It is 1/2 max span above 1 GHz.

State Saved	Saved in instrument state.
Min	-9.9e37
Max	9.9e37
Initial S/W Revision	Prior to A.02.00
Modified at S/W Revision	A.02.00

CF Step

Sets the amount the center frequency changes if it is the active function when you press the Up or Down arrow key. Note: the start and stop frequency also changes by the amount of the CF Step if the Up/Down arrow keys are used to change them; but the key is mainly used in connection with stepping the center frequency, so the legacy key name has been retained. The step size in Auto mode is 1/10th the span. It can be set to any value in manual mode.

Key Path	FREQ Channel
Mode	VSA, LTE, LTETDD, IDEN
Remote Command	[:SENSe]:FREQuency:CENTer:STEP[:INCRement] <freq> [:SENSe]:FREQuency:CENTer:STEP[:INCRement]? [:SENSe]:FREQuency:CENTer:STEP:AUTO OFF ON 0 1 [:SENSe]:FREQuency:CENTer:STEP:AUTO?
Example	FREQ:CENT:STEP 1 MHZ FREQ:CENT:STEP? FREQ:CENT:STEP:AUTO ON FREQ:CENT:STEP:AUTO?
Couplings	1/10th Span when auto is turned on.
Preset	Depends on span option; 1/10th default span.
State Saved	Saved in instrument state.
Min	-9.9e37
Max	9.9e37
Initial S/W Revision	Prior to A.02.00
Modified at S/W Revision	A.02.00

Input/Output

See "Input/Output" on page 146

Marker

Displays the Marker menu. A marker can be placed on a trace to precisely determine the value of the trace data at the marker position. Markers can also be used in pairs to read the difference (or delta) between two data points. They can also be used to make power calculations over a band of frequencies or a time interval. See "[Marker Function](#)" on page 1157 for more details.

The functions in this menu include a 1-of-N selection of the control mode **Normal**, **Delta**, **Fixed**, or **Off** for the selected marker. The control mode is described below.

Pressing **Marker** always makes the selected maker's X position the active function.

If the currently selected marker is **Off**, pressing **Marker** sets it to **Normal** mode and places it at the center of the screen on the currently selected trace.

As a convenience, if there are no markers displayed on the current trace, pressing the marker hardkey (whenever the marker menu is already showing) selects the lowest numbered marker that is currently off and turns it on in normal mode on the selected trace. In other words, pressing the Marker hardkey twice always turns on a marker on the selected trace if none was turned on before.

Key Path	Front Panel
Mode	VSA, LTE, LTETDD, IDEN,LTEAFDD,LTEATDD
Initial S/W Revision	Prior to A.02.00
Modified at S/W Revision	A.02.00

Select Marker

Specifies the selected marker. The selected marker is the one that is affected by the marker position and properties settings, peak search, and other marker functions. Several menus have a Select Marker key for convenience. Marker selection using any one of these is reflected in all others, in other words, there is only one selected marker for the whole measurement. If all markers are off, then marker 1 becomes the selected marker.

As a convenience, if no markers are displayed on the selected trace, selecting a marker that is off automatically turns it on in normal mode on the selected trace.

There is no SCPI function for selecting a marker. Instead, SCPI functions can explicitly include the index of the marker for which they are to apply. (Most SCPI marker functions that affect the state of a marker also make it the selected marker for front panel commands.)

Key Path	Marker or Marker> or Marker Function or Peak Search
Mode	VSA, LTE, LTETDD, IDEN,LTEAFDD,LTEATDD
State Saved	No
Range	1 2 3 4 5 6 7 8 9 10 11 12
Initial S/W Revision	Prior to A.02.00
Modified at S/W Revision	A.02.00

Control Mode

Pressing **Normal**, **Delta**, **Fixed**, or **Off** sets the control mode of the selected marker. The current control mode is shown by highlighting the appropriate key.

The SCPI command in the table below selects the marker and sets the marker control mode as described under "[Normal \(Position\)](#)" on page 1139, "[Delta](#)" on page 1140, "[Fixed](#)" on page 1140 and "[Off](#)" on page 1141. All interactions and dependencies detailed under the key description are enforced when the remote command is sent.

Key Path	Marker
Mode	VSA, LTE, LTETDD, IDEN,LTEAFDD,LTEATDD
Measurement	<meas>:=VECTor ADEMod DDEMod W11A W11B EVM IPOWER IDEMod MOTotalk
Remote Command	:CALCulate:<meas>:MARKer[1] 2 ...12:MODE POSition DELTA FIXEd =OFF :CALCulate:<meas>:MARKer[1] 2 ...12:MODE?
Example	CALC:VECT:MARK1:MODE POS CALC:VECT:MARK1:MODE?
Couplings	When Delta mode is selected or when the mode is changed from Delta to Off, the marker relative to the selected marker can be affected as described in the text descriptions below.
Preset	=OFF
State Saved	Saved in instrument state.
Range	Normal Delta Fixed Off
Initial S/W Revision	Prior to A.02.00
Modified at S/W Revision	A.02.00

Normal (Position)

Reports the trace data value (Y value) at a particular point on a trace. The marker's absolute X (and Z) position is specified by you in displayed units. The marker symbol appears on the trace at the specified position and tracks the absolute Y value at that position as it changes from scan to scan. The absolute Y value is displayed in the marker readout area. In older instruments this was called Position mode, and the designation can still be used for backward compatibility.

For Control Mode SCPI command information see: "[Control Mode](#)" on page 1139

Key Path	Marker
Mode	VSA, LTE, LTETDD, IDEN,LTEAFDD,LTEATDD
Initial S/W Revision	Prior to A.02.00
Modified at S/W Revision	A.02.00

Delta

Reports the difference between Y values at two points. A delta marker is relative to an associated reference marker on the same trace. (The reference marker can be set on the Marker, Properties, Relative To menu). The reference marker is usually fixed, but can also be normal or delta. The X (and Z) position of a delta marker is specified as an offset from the reference marker position. The delta marker symbol tracks the absolute Y value just like a normal marker, but the marker readout displays the difference between the absolute Y values of the delta marker and its reference marker (absolute units are used even if the reference is itself a delta marker). Usually this is a straight difference in the current displayed units. For example, if the trace format is LogMag (dBm), the delta marker displays the difference in dB, thus showing a power ratio. But if the trace format is Real, then the delta marker shows a voltage difference, not a ratio. Exceptions for this are:

- When the trace format is **Linear Mag** or **Log Mag (linear unit)** the delta marker displays a voltage ratio or (if the Y Axis unit is Power) a power ratio, rather than a difference.
- When either the marker or its reference has a marker function turned on, the delta marker always displays a ratio or its decibel equivalent. See ["Marker Function" on page 1157](#) for more details on how delta markers work with marker functions. The type of ratio calculated (power or voltage) depends on the delta marker units; the reference marker value is converted as needed so it has compatible units.
- When the trace format is **Wrap Phase**, the delta marker readout is constrained to the wrapped phase display range, which is usually $(-180, +180]$ degrees. For example, if the absolute phase at marker 1 is 170 deg and its reference has phase of -170 deg, the delta does not show 340 deg, but -20 deg. Note that the Wrap Phase display range can be changed (see ["Phase/Trellis Offset" on page 1253](#)).

There is no current support for calculating deltas across traces (and this cannot be done at all unless the traces have the same domain and ranges).

By default, the reference marker for marker 1 is marker 2; for marker 2 is 3 and so on, but the reference marker can be changed. See ["Relative To" on page 1142](#).

For coupling rules, see ["Coupling of Delta and Reference Markers" on page 1152](#).

For Control Mode SCPI command information see: ["Control Mode" on page 1139](#)

Key Path	Marker
Mode	VSA, LTE, LTETDD, IDEN, LTEAFDD, LTEATDD
Initial S/W Revision	Prior to A.02.00
Modified at S/W Revision	A.02.00

Fixed

Mainly used as reference markers for Delta markers. A fixed marker's X and Y Axis values can be directly or indirectly specified by you, and they remain fixed once specified, in other words, they do not follow the trace data value. These markers are represented on the display by an "X" rather than a diamond. If a marker is changed from off to fixed, the X and Y (and Z) values are chosen to put it in the center of the display. If the marker is changed from some other type to fixed, the current X and Z values of the marker remain unchanged. The Y value is taken from the current trace data value and must be changed manually thereafter.

For Control Mode SCPI command information see: ["Control Mode" on page 1139](#)

Key Path	Marker
Mode	VSA, LTE, LTETDD, IDEN,LTEAFDD,LTEATDD
Initial S/W Revision	Prior to A.02.00
Modified at S/W Revision	A.02.00

Off

Turning a marker off makes it invisible, and also its annotation.

Turning a marker on (i.e., changing its control mode from Off to any other control mode) assigns the marker to the currently selected trace.

For Control Mode SCPI command information see: ["Control Mode" on page 1139](#)

Key Path	Marker
Mode	VSA, LTE, LTETDD, IDEN,LTEAFDD,LTEATDD
Initial S/W Revision	Prior to A.02.00
Modified at S/W Revision	A.02.00

Coupling of Delta and Reference Markers

The following coupling rules apply from the front panel and also if the equivalent SCPI commands are sent.

Pressing the Delta key causes the selected marker to become a delta marker if it is not already. Also, the selected marker's reference is affected as follows:

- If the reference marker was off, it is turned on as a fixed marker.
- The reference marker is moved to the trace of the selected marker and set to the same position as the selected marker.
- If the delta marker has a marker function turned on, the reference marker takes on the same function (with the same band limits).

Exception: Pressing Delta when the selected marker's mode is not yet Delta does not move or change a reference marker that is already turned on (Normal, Delta, or Fixed) and on the same trace as the selected marker. It merely changes the selected marker's mode to Delta and shows the current offset between it and the reference. If you press Delta again (when the selected marker is already in Delta mode) then the reference is moved and modified as described above.

When a delta marker is changed to any other control mode, if its reference marker is fixed then the reference marker is also turned off.

If you move a delta marker to a different trace, it is forced to Normal mode and if its reference is fixed, the reference is turned off.

A delta marker is forced to Normal mode if you turn its reference off or if you move its reference to another trace. (In the latter case the reference is not turned off even if it is fixed.)

If you change the selected marker's reference (using the Marker, Properties, Relative To), the selected marker is forced to Delta mode. This change of the selected marker to Delta mode causes its new reference's control mode and position to change as described above.

Marker Properties

Accesses a menu of common marker properties.

Key Path	Marker
Mode	VSA, LTE, LTETDD, IDEN,LTEAFDD,LTEATDD
Initial S/W Revision	Prior to A.02.00

Select Marker

Specifies the selected marker. The selected marker is the one that is affected by the marker position and properties settings, peak search, and other marker functions. Several menus have a Select Marker key for convenience. Marker selection using any one of these is reflected in all others, in other words, there is only one selected marker for the whole measurement. If all markers are off, then marker 1 becomes the selected marker.

As a convenience, if no markers are displayed on the selected trace, selecting a marker that is off automatically turns it on in normal mode on the selected trace.

There is no SCPI function for selecting a marker. Instead, SCPI functions can explicitly include the index of the marker for which they are to apply. (Most SCPI marker functions that affect the state of a marker also make it the selected marker for front panel commands.)

Key Path	Marker or Marker> or Marker Function or Peak Search
Mode	VSA, LTE, LTETDD, IDEN,LTEAFDD,LTEATDD
State Saved	No
Range	1 2 3 4 5 6 7 8 9 10 11 12
Initial S/W Revision	Prior to A.02.00
Modified at S/W Revision	A.02.00

Relative To

Enables you to specify which marker is used as a reference for the selected marker when the selected marker's control mode is set to Delta. By default, the reference marker is numerically one higher than the selected marker, that is, marker 1 is relative to marker 2, marker 2 to marker 3, and so on. Marker 12 by default is relative to marker 1. This key enables you to change the reference marker from the default. Note that a marker cannot be made relative to itself.

Key Path	Marker, Properties
Mode	VSA, LTE, LTETDD, IDEN,LTEAFDD,LTEATDD
Measurement	<meas>:=VECTor ADEMod DDEMod W11A W11B EVM IPOWER IDEMod MOTotalk
Remote Command	:CALCulate:<meas>:MARKer [1] 2 . . . 12:REFerence <integer> :CALCulate:<meas>:MARKer [1] 2 . . . 12:REFerence?
Example	CALC:VECT:MARK2:REF 4 CALC:VECT:MARK2:REF?
Notes	The reference marker cannot be the same value as the selected marker, that is, a marker cannot be relative to itself. The currently selected marker is not an available choice in the relative to selection (i.e., the selected marker appears grayed out). When queried, a single value is returned (the specified marker numbers relative marker).
Couplings	See " Coupling of Delta and Reference Markers " on page 1152. The old reference remains as it was.
Preset	2 3 4 5 6 7 8 9 10 11 12 1
State Saved	Saved in instrument state.
Range	1 2 3 4 5 6 7 8 9 10 11 12
Initial S/W Revision	Prior to A.02.00
Modified at S/W Revision	A.02.00

Complex Format

Determines the format for the readout when a marker is placed on a complex display (vector or constellation). The choices are to read out in rectangular or polar coordinates. The readout format applies to the marker display and marker table only; there is no SCPI for reading out the marker value in polar form.

Key Path	Marker, Properties
Mode	VSA, LTE, LTETDD, IDEN,LTEAFDD,LTEATDD
Measurement	<meas>:=VECTor ADEMod DDEMod W11A W11B EVM IPOWER IDEMod MOTotalk
Remote Command	:CALCulate:<meas>:MARKer [1] 2 . . . 12:CFORmat RECTangular POLar :CALCulate:<meas>:MARKer [1] 2 . . . 12:CFORmat?
Example	CALC:VECT:MARK1:CFOR RECT CALC:VECT:MARK1:CFOR?
Preset	RECT
State Saved	Saved in instrument state.
Range	Rect Polar
Initial S/W Revision	Prior to A.02.00
Modified at S/W Revision	A.02.00

Marker Trace

Enables you to determine the trace to which a marker is assigned. By default, when a marker is turned on it is assigned to the currently selected trace. You can change that assignment using this control.

Key Path	Marker, Properties
Mode	VSA, LTE, LTE-TDD, IDEN, LTE-AFDD, LTE-ATDD
Measurement	<meas>:=VECTor ADEMod DDEMod W11A W11B EVM IPOWER IDEMod MOTotalk
Remote Command	:CALCulate:<meas>:MARKer[1] 2 ...12:TRACe <integer> :CALCulate:<meas>:MARKer[1] 2 ...12:TRACe?
Example	CALC:VECT:MARK3:TRAC 2 CALC:VECT:MARK3:TRAC?
Couplings	See " Coupling of Delta and Reference Markers " on page 1152.
Preset	Marker is assigned to currently selected trace when turned on.
State Saved	Saved in instrument state.
Range	Trace 1 Trace 2 Trace 3 Trace 4
Min	1
Max	4
Initial S/W Revision	Prior to A.02.00
Modified at S/W Revision	A.02.00

Marker Count

Enables the frequency counter algorithm on the selected marker. This algorithm can more precisely determine the frequency of a peak. The marker must be on a frequency domain trace, with data coming from hardware. Place the marker on a peak and enable the frequency counter. The marker readout then shows the calculated frequency rather than the marker X position. Only one marker can be counted at any time. Turning on marker count for any marker turns it off for all other markers.

Key Path	Marker, Properties
Mode	VSA, IDEN, LTE-AFDD, LTE-ATDD
Measurement	<meas>:=VECTor ADEMod DDEMod W11A W11B EVM IPOWER IDEMod MOTotalk
Remote Command	:CALCulate:<meas>:MARKer[1] 2 ...12:FCOunt[:STATe] OFF ON 0 1 :CALCulate:<meas>:MARKer[1] 2 ...12:FCOunt[:STATe]?
Example	CALC:VECT:MARK:FCO ON CALC:VECT:MARK:FCO?
Notes	Marker must be on a frequency-domain trace and data must be live, not recorded or simulated.
Preset	OFF
State Saved	Saved in instrument state.
Range	Off On
Initial S/W Revision	Prior to A.02.00
Modified at S/W Revision	A.02.00

The frequency counter result must be read back with the following SCPI command. The Marker X query command only gets the marker's data point position, which is not as accurate as the frequency counter result.

Mode	VSA, IDEN,LTEAFDD,LTEATDD
Measurement	<meas>:=VECTor ADEMod DDEMod W11A W11B EVM IPOWER IDEMod MOTotalk
Remote Command	:CALCulate:<meas>:MARKer[1] 2 ...12:FCOUNT:X?
Example	CALC:VECT:MARK:FCO:X?
Notes	Query only. If the marker counter result is unavailable, NaN is returned.
Initial S/W Revision	Prior to A.02.00
Modified at S/W Revision	A.02.00

Marker Table

Displays the marker data display window below the measurement window. For each marker that is on, information is displayed in the data display window, which includes the marker number, control mode, trace number, X axis scale, X axis value, and the Y-axis result. Additional information is shown for markers that have marker functions turned on.

Key Path	Marker
Mode	VSA, LTE, LTETDD, IDEN,LTEAFDD,LTEATDD
Measurement	<meas>:=VECTor ADEMod DDEMod W11A W11B EVM IPOWER IDEMod MOTotalk
Remote Command	:CALCulate:<meas>:MARKer:TABLE[:STATE] OFF ON 0 1 :CALCulate:<meas>:MARKer:TABLE[:STATE]?
Example	CALC:VECT:MARK:TABL ON CALC:VECT:MARK:TABL?
Preset	OFF
State Saved	No
Range	Off On
Initial S/W Revision	Prior to A.02.00
Modified at S/W Revision	A.02.00

Marker Position

Selects which data point in a trace to read out with the marker (or where to locate a fixed marker). The marker position is primarily set in terms of the domain units, not trace points (although it can be set in terms of points via SCPI). The default active function when you press a marker hard key is the X position for the currently selected marker. The exception to this is when the selected marker is fixed. In that case there is no default active function (to prevent inadvertently changing a fixed marker's location).

Marker position is not defined when a marker's control mode is Off. When a marker is turned on in Normal or Delta mode, its X (and Z) values are set to the center of the trace data. If a marker is turned on in Fixed mode, its position is set so that it appears in the middle of the trace grid.

The Marker Position key branches to the Marker Position menu, which enables you to set any position variable relevant to the selected marker's control mode and trace format.

For Normal and Delta markers, usually only Marker X is available. Marker Z is available for trace data with 2-dimensional domain. For Fixed markers, Y can also be set. If the trace format is Vector or Constellation, **Marker Y** controls the real (horizontal axis) value and **Marker Y Imag** controls the imaginary (vertical axis) value. The key (or the keys below it) is grayed out if the selected marker is off.

Key Path	Marker
Mode	VSA, LTE, LTETDD, IDEN, LTEAFDD, LTEATDD
Initial S/W Revision	Prior to A.02.00
Modified at S/W Revision	A.02.00

Marker X

Sets the selected marker's X Axis value position in the current X Axis Scale unit. If the control mode is Off, the SCPI command has no affect other than to cause the marker to become selected. Note that the X value can change if the marker is moved to a trace with a different domain.

The Marker X position is absolute if the marker control mode is Normal or Fixed. If the control mode is Delta, then the X position is relative to the reference marker. The valid X positions are the actual data points in the trace; the marker cannot be located between points. If a SCPI command attempts to place the marker between two points, the X value snaps to the closest point.

Note that for Vector or Constellation format, the X axis is perpendicular to the screen (because the screen axes are used to show the real and imaginary parts of the Y value), so adjusting the X value in this case only causes the marker to move horizontally if the real Y value changes. For Fixed markers on a trace with one of these formats, adjusting the X value does not cause horizontal motion of the marker at all. Instead, use the Marker Y and Marker Y (imag) controls to move the marker horizontally and vertically.

Key Path	Marker, Marker Position
Mode	VSA, LTE, LTETDD, IDEN, LTEAFDD, LTEATDD
Measurement	<meas>:=VECTor ADEMod DDEMod W11A W11B EVM IPOWER IDEMod MOTotalk
Remote Command	:CALCulate:<meas>:MARKer[1] 2 ...12:X <real> :CALCulate:<meas>:MARKer[1] 2 ...12:X?
Example	CALC:VECT:MARK:X 0.325 CALC:VECT:MARK:X?
Notes	Marker X does not go outside the bounds of the data unless it is Fixed. If you attempt to set it to a value outside the bounds, it is clipped at the closest limit and error -222 Data Out of Range is generated. If suffix is sent, it must match the X units for the trace the marker is on. Otherwise, error -138, "Suffix not allowed" is generated.

	If you try to read or set the position of a Delta marker, remember that the position is in relative units.
Couplings	See "Coupling of Delta and Reference Markers" on page 1152 . See also: "Couple Markers" on page 1151
Preset	None until marker is turned on.
State Saved	Saved in instrument state.
Min	Depends on trace data
Max	Depends on trace data
Initial S/W Revision	Prior to A.02.00
Modified at S/W Revision	A.02.00

SCPI only X position commands

Via SCPI, the marker position can also be set or queried in trace points. In this case, the position setting or reading is absolute regardless of control mode.

NOTE

The entered value in Trace Points is immediately translated into the current domain units for setting the value of the marker. The marker's value in domain units, NOT trace points, is preserved if a change is made to the X Axis scale settings. Thus, if you use this command to place a marker on point 500, which happens at that time to correspond to 13 GHz, and then you change the Start Frequency so that point 500 is no longer 13 GHz, the marker stays at 13 GHz, NOT at point 500.

If the trace the marker is on has a 2-dimensional domain, then the points are numbered in the following way:

Starting at the minimum X and Z position, this point is numbered 0. Each time you increment the point number, increment the X value to the next available value. When X reaches the maximum X position, then reset X to the minimum and increment the Z value. Then continue incrementing the X position in the same manner as before.

Note that for symbol tables, which have no axes, incrementing the X position in points moves the marker consecutively through all table entries.

Mode	VSA, LTE, LTETDD, IDEN, LTEAFDD, LTEATDD
Measurement	<meas>:=VECTor ADEMod DDEMod W11A W11B EVM IPOWER IDEMod MOTotalk
Remote Command	:CALCulate:<meas>:MARKer[1] 2 ...12[:X]:POSition <real> :CALCulate:<meas>:MARKer[1] 2 ...12[:X]:POSition?
Example	CALC:VECT:MARK:POS 25 CALC:VECT:MARK:POS?
Notes	When a marker control mode is changed from off to any other mode, the X position is set to mid-screen.
Couplings	See "Coupling of Delta and Reference Markers" on page 1152 . See also: "Couple Markers" on page 1151
Preset	None until marker is turned on.

State Saved	Saved in instrument state.
Min	Depends on trace data
Max	Depends on trace data
Initial S/W Revision	Prior to A.02.00
Modified at S/W Revision	A.02.00

Marker X Unit can be queried via SCPI

Mode	VSA, LTE, LTETDD, IDEN, LTEAFDD, LTEATDD
Measurement	<meas>:=VECTor ADEMod DDEMod W11A W11B EVM IPOWER IDEMod MOTotalk
Remote Command	:CALCulate:<meas>:MARKer[1] 2 ...12:X:UNIT?
Example	CALC:VECT:MARK:X:UNIT?
Notes	Query Only
Initial S/W Revision	Prior to A.02.00
Modified at S/W Revision	A.02.00

Marker Z

Sets the selected markers Z Axis value in the current Z Axis Scale unit for markers on traces with a 2-dimensional domain. In each case the marker that is addressed becomes the selected marker. It has no affect (other than to cause the marker to become selected) if the control mode is **Off** or if the trace has no Z domain. Note that the Z value can change or become irrelevant if the marker is moved to a trace with a different Z domain or no Z domain.

Note that this Z value is affected if the SCPI command to set marker point position is used.

Key Path	Marker, Marker Position
Mode	VSA, LTE, LTETDD, IDEN, LTEAFDD, LTEATDD
Measurement	<meas>:=VECTor ADEMod DDEMod W11A W11B EVM IPOWER IDEMod MOTotalk
Remote Command	:CALCulate:<meas>:MARKer[1] 2 ...12:Z <real> :CALCulate:<meas>:MARKer[1] 2 ...12:Z?
Example	CALC:OFDM:MARK:Z 12 CALC:OFDM:MARK:Z?
Notes	Marker Z does not go outside the bounds of the data unless it is Fixed. If you attempt to set it to a value outside the bounds it is clipped at the closest limit, and error -222 Data Out of Range is generated. If suffix is sent, it must match the Z units for the trace the marker is on. Otherwise, error -138, "Suffix not allowed" is generated.
Couplings	See "Coupling of Delta and Reference Markers" on page 1152 . See also: "Couple Markers" on page 1151

Preset	None until marker is turned on.
State Saved	Saved in instrument state.
Min	Depends on trace data
Max	Depends on trace data
Initial S/W Revision	Prior to A.02.00
Modified at S/W Revision	A.02.00

Marker Z Unit can be queried via SCPI.

Mode	VSA, LTE, LTETDD, IDEN,LTEAFDD,LTEATDD
Measurement	<meas>:=VECTor ADEMod DDEMod W11A W11B EVM IPOWER IDEMod MOTotalk
Remote Command	:CALCulate:<meas>:MARKer[1] 2 ...12:Z:UNIT?
Example	CALC:OFDM:MARK:Z:UNIT?
Notes	Query Only
Initial S/W Revision	Prior to A.02.00
Modified at S/W Revision	A.02.00

Marker Y

Enables you to set or read back the selected marker's Y Axis value in the current Y Axis Scale unit. Setting the Y value has no affect (other than to cause the marker to become selected) if the control mode is other than fixed. The query form generates an error if the control mode is Off. Note that the Y value can change if the Y-axis units change, either from a change in format of the trace the marker is on or if the marker is moved to a different trace.

If the selected marker is on a trace that is displayed with Vector or Constellation format, this function controls only the real part of the Y value (i.e., the horizontal axis value). Use the **Marker Y (imag)** control to change the imaginary (vertical) value. Marker Y and Marker Y Imag always set or get the rectangular form of Y, regardless of whether the marker readout is polar or rectangular.

Key Path	Marker, Marker Position
Mode	VSA, LTE, LTETDD, IDEN,LTEAFDD,LTEATDD
Measurement	<meas>:=VECTor ADEMod DDEMod W11A W11B EVM IPOWER IDEMod MOTotalk
Remote Command	:CALCulate:<meas>:MARKer[1] 2 ...12:Y[:REAL] <real> :CALCulate:<meas>:MARKer[1] 2 ...12:Y[:REAL]?
Example	CALC:VECT:MARK2:Y 0.325 CALC:VECT:MARK2:Y?
Notes	You cannot set Y unless the marker type is fixed. If the marker becomes fixed after a marker function is turned on, it is set to whatever the Y value was when the marker became fixed. If suffix is sent, it must match the Y units for the trace the marker is on. Otherwise, error -138, "Suffix not allowed" is generated.

Couplings	Changes if marker is relative to a Delta marker that is turned on or re-zeroed (see " Coupling of Delta and Reference Markers " on page 1152).
Preset	None until marker is turned on.
State Saved	Saved in instrument state.
Min	-9.9E+37
Max	9.9E+37
Initial S/W Revision	Prior to A.02.00
Modified at S/W Revision	A.02.00

Marker Y Unit can be queried via SCPI.

Mode	VSA, LTE, LTETDD, IDEN, LTEAFDD, LTEATDD
Measurement	<meas>:=VECTor ADEMod DDEMod W11A W11B EVM IPOWER IDEMod MOTotalk
Remote Command	:CALCulate:<meas>:MARKer[1] 2 ...12:Y:UNIT?
Example	CALC:VECT:MARK:Y:UNIT?
Notes	Query Only
Initial S/W Revision	Prior to A.02.00
Modified at S/W Revision	A.02.00

Marker Y Imag (Imaginary)

Enables you to set or read back the selected marker's quadrature (imaginary) Y value in the current Y Axis Scale unit. It has no affect (other than to cause the marker to become selected) if the control mode is other than fixed or if the current trace format is not complex (Vector or Constellation). The query form generates an error if it is used for a marker that is not on a complex trace. Marker Y Imag is not affected by whether the marker readout is polar or rectangular.

Key Path	Marker, Marker Position
Mode	VSA, LTE, LTETDD, IDEN, LTEAFDD, LTEATDD
Measurement	<meas>:=VECTor ADEMod DDEMod W11A W11B EVM IPOWER IDEMod MOTotalk
Remote Command	:CALCulate:<meas>:MARKer[1] 2 ...12:Y:IMAGinary <real> :CALCulate:<meas>:MARKer[1] 2 ...12:Y:IMAGinary?
Example	CALC:DDEM:MARK1:Y:IMAG 0.435 CALC:DDEM:MARK1:Y:IMAG?
Notes	Grayed out unless the marker is fixed and on a vector display. If suffix is sent, it must match the Y units for the trace the marker is on. Otherwise, an Invalid Suffix error is generated. Otherwise, error -138, "Suffix not allowed" is generated. If query is sent while the marker is on a trace whose format is not vector or constellation, NaN (9.91E+37) is returned.
Preset	None until marker is turned on.

State Saved	Saved in instrument state.
Min	Depends on trace format
Max	Depends on trace format
Initial S/W Revision	Prior to A.02.00
Modified at S/W Revision	A.02.00

Couple Markers

Affects all currently displayed markers. In general, when coupling is turned on then all Normal or Delta markers with the same (or equivalent) domain as the selected marker move in the same manner as the selected marker. Coupling is relative between markers on the same trace (so that their relative positions in the domain are maintained). Coupling can be absolute between markers on different traces that have equivalent domains. That is, they have the same position in the domain, if possible. (As an example of equivalent domains, demodulated symbol positions can be derived from time by using the current symbol rate). When you move the selected marker, then others on related traces track it. This enables you to correlate different measurement results. For example, you can place a marker at a particular symbol time on an error vector magnitude display, have tracking markers on the symbol table and pre-demod time trace showing you the symbol value, and the actual time-varying signal value at the same point in time.

Absolute coupling is performed only for the lowest numbered Normal or Delta marker on each trace. All other markers on a trace couple relatively. When you turn on marker coupling, the subset of markers that have the same domain as the selected marker track it and all other markers remain at their current location. The absolutely coupled markers within this subset is moved at this time to match the domain setting of the selected marker, with the relatively coupled markers following accordingly to maintain offsets within their respective traces. Those markers with different domains remain at their current location. When you select a marker with a different domain than the previously selected marker, then the subset of markers with that domain go through the same procedure.

Any marker that coupling would move outside its range of X values, remains at the closest limiting value until the selected marker moves in such a way as to bring the coupled X value back into range. If the coupled markers are on data that do not have the same domain resolution, then they are positioned as close to each other as possible.

If markers change mode or trace, or trace data is changed below them, the coupling rules are immediately applied to the new set.

Key Path	Marker
Mode	VSA, LTE, LTETDD, IDEN, LTEAFDD, LTEATDD
Measurement	<meas>:=VECTor ADEMod DDEMod W11A W11B EVM IPOWER IDEMod MOTotalk
Remote Command	:CALCulate:<meas>:MARKer:COUPle[:STATe] OFF ON 0 1 :CALCulate:<meas>:MARKer:COUPle[:STATe]?
Example	CALC:VECT:MARK:COUP ON CALC:VECT:MARK:COUP?
Preset	OFF

State Saved	Saved in instrument state.
Range	Off On
Initial S/W Revision	Prior to A.02.00
Modified at S/W Revision	A.02.00

All Markers Off

Turns all markers off and sets the selected marker to 1.

Key Path	Marker
Mode	VSA, LTE, LTETDD, IDEN, LTEAFDD, LTEATDD
Measurement	<meas>:=VECTor ADEMod DDEMod W11A W11B EVM IPOWER IDEMod MOTotalk
Remote Command	:CALCulate:<meas>:MARKer:AOff
Example	CALC:VECT:MARK:AOff:
Initial S/W Revision	Prior to A.02.00
Modified at S/W Revision	A.02.00

Coupling of Delta and Reference Markers

The following coupling rules apply from the front panel and also if the equivalent SCPI commands are sent.

Pressing the Delta key causes the selected marker to become a delta marker if it is not already. Also, the selected marker's reference is affected as follows:

- If the reference marker was off, it is turned on as a fixed marker.
- The reference marker is moved to the trace of the selected marker and set to the same position as the selected marker.
- If the delta marker has a marker function turned on, the reference marker takes on the same function (with the same band limits).

Exception: Pressing Delta when the selected marker's mode is not yet Delta does not move or change a reference marker that is already turned on (Normal, Delta, or Fixed) and on the same trace as the selected marker. It merely changes the selected marker's mode to Delta and shows the current offset between it and the reference. If you press Delta again (when the selected marker is already in Delta mode) then the reference is moved and modified as described above.

When a delta marker is changed to any other control mode, if its reference marker is fixed then the reference marker is also turned off.

If you move a delta marker to a different trace, it is forced to Normal mode and if its reference is fixed, the reference is turned off.

A delta marker is forced to Normal mode if you turn its reference off or if you move its reference to another trace. (In the latter case the reference is not turned off even if it is fixed.)

If you change the selected marker's reference (using the Marker, Properties, Relative To), the selected marker is forced to Delta mode. This change of the selected marker to Delta mode causes its new reference's control mode and position to change as described above.

Marker -> (Marker To)

Provides access to some convenient functions for copying the marker position to a number of frequency and Y-axis scaling parameters. These functions are available from the front panel only. No SCPI is provided, because you can already read the marker position via SCPI and then set any frequency or scaling parameter accordingly, with full accuracy.

Pressing the Marker -> hardkey always makes the selected marker's X position the active function.

If the selected marker is off, pressing the Marker -> hardkey turns on the selected marker in normal mode on the currently selected trace.

Key Path	Front Panel
Mode	VSA, LTE, LTETDD, IDEN,LTEAFDD,LTEATDD
Initial S/W Revision	Prior to A.02.00
Modified at S/W Revision	A.02.00

Mkr -> CF (Center Frequency)

Sets the center frequency equal to the selected marker's absolute frequency. The marker must be on a frequency-domain trace. The absolute marker frequency is used regardless of whether its control mode is Normal, Delta, or Fixed.

If the currently selected marker is not on when this key is pressed, it is turned on at the center of the screen as a normal type marker.

Key Path	Marker To
Mode	VSA, LTE, LTETDD, IDEN,LTEAFDD,LTEATDD
Initial S/W Revision	Prior to A.02.00
Modified at S/W Revision	A.02.00

Mkr -> CF Step

Sets the center frequency step size equal to the selected marker's frequency. The marker must be on a frequency-domain trace. The absolute marker frequency is used regardless of whether its control mode is Normal, Delta, or Fixed.

If the currently selected marker is not on when this key is pressed, it is turned on at the center of the screen as a normal type marker.

Key Path	Marker To
Mode	VSA, LTE, LTETDD, IDEN,LTEAFDD,LTEATDD
Initial S/W Revision	Prior to A.02.00
Modified at S/W Revision	A.02.00

Mkr -> Start

Sets the start frequency equal to the selected marker's frequency. The marker must be on a frequency-domain trace. The absolute marker frequency is used regardless of whether its control mode is Normal, Delta, or Fixed.

If the currently selected marker is not on when this key is pressed, it is turned on at the center of the screen as a normal type marker.

Key Path	Marker To
Mode	VSA, LTE, LTETDD, IDEN,LTEAFDD,LTEATDD
Initial S/W Revision	Prior to A.02.00
Modified at S/W Revision	A.02.00

Mkr -> Stop

Sets the stop frequency equal to the selected marker's frequency. The marker must be on a frequency-domain trace. The absolute marker frequency is used regardless of whether its control mode is Normal, Delta, or Fixed.

If the currently selected marker is not on when this key is pressed, it is turned on at the center of the screen as a normal type marker.

Key Path	Marker To
Mode	VSA, LTE, LTETDD, IDEN,LTEAFDD,LTEATDD
Initial S/W Revision	Prior to A.02.00
Modified at S/W Revision	A.02.00

Mkr Delta -> Span

Sets the start and stop frequencies equal to the selected marker's frequency and that of its reference. That is, the measurement span is "zoomed in" so that the selected marker and its associated reference appear on the extreme left and right of the display. The marker must be on a frequency-domain trace and its control mode must be Delta.

Key Path	Marker To
Mode	VSA, LTE, LTETDD, IDEN,LTEAFDD,LTEATDD
Initial S/W Revision	Prior to A.02.00
Modified at S/W Revision	A.02.00

Mkr -> Ref Lvl

Sets the Y axis reference value equal to the selected marker's Y value. For example, if the reference position is at the top of the screen, the whole trace is moved up so that the marker appears at the top of

the screen. Note that this is a display scaling function only. The input range remains the same.

Key Path	Marker To
Mode	VSA, LTE, LTETDD, IDEN,LTEAFDD,LTEATDD
Initial S/W Revision	Prior to A.02.00
Modified at S/W Revision	A.02.00

Counter -> CF (Center Frequency)

Sets the frequency of the marker counter to the center frequency. The marker counter function must be on.

Key Path	Marker To
Mode	VSA, IDEN,LTEAFDD,LTEATDD
Initial S/W Revision	Prior to A.02.00
Modified at S/W Revision	A.02.00

Mkr Delta -> CF (Center Frequency)

Sets the center frequency equal to the difference in frequency between the selected Delta marker and its reference. The marker must be on a frequency-domain trace and the selected marker's control mode must be Delta.

Key Path	Marker To
Mode	VSA, LTE, LTETDD, IDEN,LTEAFDD,LTEATDD
Initial S/W Revision	Prior to A.02.00
Modified at S/W Revision	A.02.00

Marker Function

Accesses a menu of selectable marker functions for VSA based measurements.

Marker Functions perform post-processing operations on marker data. Band Functions are Marker Functions that enable you to define a band of frequencies around the marker. The band defines the region of data used for the numerical calculations. These marker functions also enable you to perform mathematical calculations on trace and marker data and report the results of these calculations in place of the normal marker result.

Unlike regular markers, marker function markers are not placed directly on the trace. They are placed at a location that is relative to the result of the function calculation.

The Marker Function menu provides access to power calculations in bands of frequencies or time intervals centered on a marker. It also enables you to make calculations like carrier to noise by combining delta markers with marker functions. Marker functions are generally available for time and frequency domain traces, and not for others. If the marker function calculation is undefined for particular trace data, then "---" is shown in place of a number in the result display and marker table, and `CALC:<meas>:MARK[n]:Y?` returns `9.91E+37 (NaN)`.

Pressing Marker Function always makes the selected marker's X position the active function.

If the selected marker is off, pressing the Marker Function hardkey turns on the selected marker in normal mode on the currently selected trace.

Key Path	Front Panel
Mode	VSA, LTE, LTETDD, IDEN, LTEAFDD, LTEATDD
Measurement	<meas>:=VECTor ADEMod DDEMod W11A W11B EVM IPOWER IDEMod MOTotalk
Remote Command	:CALCulate:<meas>:MARKer[1] 2 ...12:FUNction BPOwer BDENsity =OFF :CALCulate:<meas>:MARKer[1] 2 ...12:FUNction?
Example	CALC:VECT:MARK1:FUNC BPOW CALC:VECT:MARK1:FUNC?
Notes	:CALC:<meas>:MARK1:FUNC? returns the current function type for marker 1. To return the result, use :CALC:<meas>:MARK1:Y?
Preset	=OFF
State Saved	Saved in instrument state.
Range	Band Power Band Density Off
Initial S/W Revision	Prior to A.02.00
Modified at S/W Revision	A.02.00

Select Marker

Specifies the selected marker. The selected marker is the one that is affected by the marker position and properties settings, peak search, and other marker functions. Several menus have a Select Marker key for convenience. Marker selection using any one of these is reflected in all others, in other words, there is only

one selected marker for the whole measurement. If all markers are off, then marker 1 becomes the selected marker.

As a convenience, if no markers are displayed on the selected trace, selecting a marker that is off automatically turns it on in normal mode on the selected trace.

There is no SCPI function for selecting a marker. Instead, SCPI functions can explicitly include the index of the marker for which they are to apply. (Most SCPI marker functions that affect the state of a marker also make it the selected marker for front panel commands.)

Key Path	Marker or Marker> or Marker Function or Peak Search
Mode	VSA, LTE, LTETDD, IDEN,LTEAFDD,LTEATDD
State Saved	No
Range	1 2 3 4 5 6 7 8 9 10 11 12
Initial S/W Revision	Prior to A.02.00
Modified at S/W Revision	A.02.00

Band/Interval Power

Turns on the Band/Interval Power function for the selected marker. This function calculates the power within the band centered on the marker. The function works generally with frequency spectra, PSD, and time traces. On traces where band power is undefined, the result display shows "---" and CALC:<meas>:MARK[n]:Y? returns 9.91E+37 (NaN), although the band interval can still be defined.

Frequency-domain data

If the marker is on a frequency-domain trace, the result is total power within the band. This is true whether the underlying trace data is a power spectrum or power spectral density.

Time-domain data

If the marker is on a time-domain trace, the result is average power within the time interval, that is, the power at each time sample in the time interval is calculated, the powers are summed and the total divided by the number of samples.

Key Path	Marker Function
Mode	VSA, LTE, LTETDD, IDEN,LTEAFDD,LTEATDD
Initial S/W Revision	Prior to A.02.00
Modified at S/W Revision	A.02.00

Band Power Calculation

Shows results in dBm, dBVrms, Watts, Volts RMS Squared or Volts RMS. The table below shows the choice of display units if **Band Power Calculation** is set to **Mean**, depending on the current format and Y units of the trace the marker is on.

Trace data type	Trace Format	Y Unit	Result format
Spectrum, PSD, Time record	LogMag (dB)	Auto, Power	dBm
		Peak, RMS	dBVrms
		mRMS	dBmVrms
	Linear Mag, Real, Imag, Log Mag (lin)	Auto, Peak, RMS, mRMS	Vrms ²
	Linear Mag, Real, Imag, Log Mag(lin)	Power	W
	Wrap Phase, Unwrap Phase, Delay	Any	Vrms ²
Dimensionless (e.g., Frequency response, Impulse response, various Demodulation error types)	LogMag (dB)	Any	dBrms
	Linear Mag, Real, Imag, Wrap Phase, Unwrap Phase, Delay, Log Mag (lin)	Any	rms ²
General dimensions(e.g., Hz, %)	LogMag (dB)	Any	dB<unit>rms
	Linear Mag, Real, Imag, Wrap Phase, Unwrap Phase, Delay, Log Mag (lin)	Any	<unit>rms ²

If the **Band Power Calculation** is set to **RMS**, then the readout unit does not depend on trace format or Y unit. For Spectrums, PS, and Time record traces, the displayed unit is "Vrms". For general units, the unit abbreviation is shown followed by "rms".

The Band Power Calculation only controls the readout format for Normal and Fixed markers. For Delta markers, see "[Band Power and Delta Markers](#)" on page 1163.

Key Path	Marker Function, Band/Interval Power
Mode	VSA, LTE, LTETDD, IDEN, LTEAFDD, LTEATDD
Measurement	<meas>:=VECTor ADEMod DDEMod W11A W11B EVM POWER IDEMod MOTotalk
Remote Command	:CALCulate:<meas>:MARKer[1] 2 ...12:FUNCTION:BPOWER:CTYPe MEAN RMS :CALCulate:<meas>:MARKer[1] 2 ...12:FUNCTION:BPOWER:CTYPe?
Example	CALC:VECT:MARK1:FUNC:BPOW:CTYP MEAN CALC:VECT:MARK1:FUNC:BPOW:CTYP?
Preset	MEAN
State Saved	Saved in instrument state.
Range	Mean RMS
Initial S/W Revision	Prior to A.02.00
Modified at S/W Revision	A.02.00

Band/Interval Density

Calculates the average power density within the band centered on the marker. The function works generally with frequency spectra, PSD, and time traces. On traces where band power cannot reasonably be defined, the result display shows "---" and CALC:<meas>:MARK[n]:Y? returns NaN (9.91E+37), although the band interval can still be defined.

Frequency-domain data

If the marker is on a frequency-domain trace, the result is the band power (as computed above) divided by the bandwidth over which it is measured. This is true whether the underlying trace data is a power spectrum or power spectral density.

Time-domain data

If the marker is on a time-domain trace, the result is average power within the time interval (as computed above) divided by the equivalent noise bandwidth of the span.

Key Path	Marker Function
Mode	VSA, LTE, LTETDD, IDEN, LTEAFDD, LTEATDD
Initial S/W Revision	Prior to A.02.00
Modified at S/W Revision	A.02.00

Band Density Calculation

Turns on the Band/Interval Density function for the selected marker. If the selected marker is off, it is turned on in **Normal** marker mode and is located at the center of the screen.

If **Band/Interval Density** is selected while in the **Marker Function Off** state, the **Band Span** or **Interval Span** is initialized to 5% of the screen width.

If the detector mode for the detector on the marker's trace is set to Auto, the average detector is selected. If the Average type is set to Auto, Power Averaging is selected. Other choices for the detector or Average type usually cause measurement inaccuracy.

A band/interval density calculation result can be shown in dBm/Hz, Volts RMS Squared, or Volts RMS. The following table shows the choice of display units if **Band Density Calculation** is set to **Mean**, depending on the current format of the trace the marker is on.

Trace data type	Trace Format	Result format
Spectrum, PSD, Time record	LogMag (dB)	dBm/Hz
	Linear Mag, Real, Imag, Wrap Phase, Unwrap Phase, Delay, Log Mag (lin)	Vrms ² /Hz
Dimensionless (e.g., Frequency response, Impulse response, various Demodulation error types)	LogMag (dB)	dBrms/Hz
	Linear Mag, Real, Imag, Wrap Phase, Unwrap Phase, Delay, Log Mag (lin)	rms ² /Hz

General dimensions (e.g., Hz, %)	LogMag (dB)	dB<unit>rms/Hz
	Linear Mag, Real, Imag, Wrap Phase, Unwrap Phase, Delay, Log Mag (lin)	<unit>rms^2/Hz

If the **Band Density Calculation** is set to **RMS**, then the readout unit does not depend on trace format. For Spectrum, PSD, and Time record traces, the displayed unit is "Vrms/rtHz". For general units, the unit abbreviation is shown followed by "rms/rtHz".

The Band Density Calculation only controls the readout format for Normal and Fixed markers. For Delta markers, see ["Band Power and Delta Markers" on page 1163](#).

Key Path	Marker Function, Band/Interval Power
Mode	VSA, LTE, LTETDD, IDEN,LTEAFDD,LTEATDD
Measurement	<meas>:=VECTor ADEMod DDEMod W11A W11B EVM IPOWER IDEMod MOTotalk
Remote Command	:CALCulate:<meas>:MARKer[1] 2 ...12:FUNction:BDENsity:CTYPe MEAN RMS :CALCulate:<meas>:MARKer[1] 2 ...12:FUNction:BDENsity:CTYPe?
Example	CALC:VECT:MARK1:FUNC:BDEN:CTYP RMS CALC:VECT:MARK1:FUNC:BDEN:CTYP?
Preset	MEAN
State Saved	Saved in instrument state.
Range	Mean RMS
Initial S/W Revision	Prior to A.02.00
Modified at S/W Revision	A.02.00

Band Adjust

Enables you to define the bandwidth around the marker. The band is always centered on the marker position. Entering the menu always sets Band/Interval Span as the active function.

Key Path	Marker Function
Mode	VSA, LTE, LTETDD, IDEN,LTEAFDD,LTEATDD
Initial S/W Revision	Prior to A.02.00
Modified at S/W Revision	A.02.00

Band/Interval Center

Enables you to define the center of the band. That is, it enables you to adjust the marker position in absolute units (regardless of whether the marker mode is Normal or Delta).

Key Path	Marker Function, Band Adjust
----------	------------------------------

Mode	VSA, LTE, LTETDD, IDEN, LTEAFDD, LTEATDD
Measurement	<meas>:=VECTor ADEMod DDEMod W11A W11B EVM IPOWER IDEMod MOTotalk
Remote Command	:CALCulate:<meas>:MARKer[1] 2 ...12:FUNCTION:BAND:CENTer <real> :CALCulate:<meas>:MARKer[1] 2 ...12:FUNCTION:BAND:CENTer?
Example	CALC:VECT:MARK2:FUNC:BAND:CENT 1.23E+09 CALC:VECT:MARK2:FUNC:BAND:CENT?
Preset	Center of screen
State Saved	Saved in instrument state.
Min	-9.9E+37
Max	9.9E+37
Initial S/W Revision	Prior to A.02.00
Modified at S/W Revision	A.02.00

Band/Interval Span

Sets the width of the span for the selected marker. This function defines the span of frequencies or time. The marker position does not change when you adjust the span.

Key Path	Marker Function, Band Adjust
Mode	VSA, LTE, LTETDD, IDEN, LTEAFDD, LTEATDD
Measurement	<meas>:=VECTor ADEMod DDEMod W11A W11B EVM IPOWER IDEMod MOTotalk
Remote Command	:CALCulate:<meas>:MARKer[1] 2 ...12:FUNCTION:BAND:SPAN <real> :CALCulate:<meas>:MARKer[1] 2 ...12:FUNCTION:BAND:SPAN?
Example	CALC:VECT:MARK2:FUNC:BAND:SPAN 1.23E+06 CALC:VECT:MARK2:FUNC:BAND:SPAN?
Preset	When marker turned on, 1/20th of current span or displayed time length.
State Saved	Saved in instrument state.
Min	-9.9E+37
Max	9.9E+37
Initial S/W Revision	Prior to A.02.00
Modified at S/W Revision	A.02.00

Band/Interval Left

Enables you to adjust the left side of the band. In order to remain centered in the band, the marker position must also change as you change the left edge. The right edge is unaffected.

Key Path	Marker Function, Band Adjust
----------	------------------------------

Mode	VSA, LTE, LTETDD, IDEN, LTEAFDD, LTEATDD
Measurement	<meas>:=VECTor ADEMod DDEMod W11A W11B EVM IPOWER IDEMod MOTotalk
Remote Command	:CALCulate:<meas>:MARKer[1] 2 ...12:FUNction:BAND:LEFT <real> :CALCulate:<meas>:MARKer[1] 2 ...12:FUNction:BAND:LEFT?
Example	CALC:VECT:MARK2:FUNC:BAND:LEFT 1.23E+06 CALC:VECT:MARK2:FUNC:BAND:LEFT?
Couplings	Changes marker X to keep the marker centered in the band.
Preset	When marker turned on, 1/40th of current span or displayed time length left of the marker position.
State Saved	Saved in instrument state.
Min	-9.9E+37
Max	9.9E+37
Initial S/W Revision	Prior to A.02.00
Modified at S/W Revision	A.02.00

Band/Interval Right

Enables you to adjust the right side of the band. In order to remain centered in the band, the marker position must also change as you change the right edge. The left edge is unaffected.

Key Path	Marker Function, Band Adjust
Mode	VSA, LTE, LTETDD, IDEN, LTEAFDD, LTEATDD
Measurement	<meas>:=VECTor ADEMod DDEMod W11A W11B EVM IPOWER IDEMod MOTotalk
Remote Command	:CALCulate:<meas>:MARKer[1] 2 ...12:FUNction:BAND:RIGHT <real> :CALCulate:<meas>:MARKer[1] 2 ...12:FUNction:BAND:RIGHT?
Example	CALC:VECT:MARK2:FUNC:BAND:RIGHT 1.23E+06 CALC:VECT:MARK2:FUNC:BAND:RIGHT?
Couplings	Changes marker X to keep the marker centered in the band.
Preset	When marker turned on, 1/40th of current span or displayed time length right of the marker position.
State Saved	Saved in instrument state.
Min	-9.9E+37
Max	9.9E+37
Initial S/W Revision	Prior to A.02.00
Modified at S/W Revision	A.02.00

Band Power and Delta Markers

When either a Delta marker or its reference has a band power function turned on, the Delta marker readout always shows a ratio calculation. This enables you to perform common calculations like carrier to noise ratio or adjacent channel power ratio. The form of the ratio depends on the main marker function

calculation type (Mean or RMS). If the main marker function calculation type is Mean, then when you change the marker to Delta the result is a power ratio. If the main marker function calculation type is RMS, then the Delta marker result is a voltage ratio. (If the main marker band power function is off, then the form of the ratio depends on the reference marker calculation type: If it is Mean you get a power ratio and if it is RMS you get a voltage ratio.)

For example, if the main marker function is Band/Interval Power with a calculation type of Mean and the reference marker function is Band/Interval Power with a calculation type of RMS, then the Delta marker shows the ratio of the main marker "Band/Interval Power Mean" value to the reference marker "Band/Interval Power Mean" (not RMS) value.

A dimensionless ratio (for example, Volt/Volt or Watt/Watt) is shown with units of "x". The marker function calculation type indicates whether the ratio is voltage or power (see above). A dimensionless power ratio is shown with units of dB if the trace format is Log Mag (dB).

If the reference marker function is Band/Interval Density and the main marker is either Band/Interval Power or its function is turned off, then the ratio is not dimensionless, but has units of Hz (or dB-Hz) for power calculations or rHz for voltage calculations. When the main marker function is Band/Interval Density and the reference is either Band/interval Power or its function is off, the units are /Hz (or dB/Hz) for power calculations or /rHz for voltage calculations.

Key Path	Marker Function
Mode	VSA, LTE, LTETDD, IDEN,LTEAFDD,LTEATDD
Initial S/W Revision	Prior to A.02.00
Modified at S/W Revision	A.02.00

Meas

The information in this section is common to all measurements. For key and remote command information for a specific measurement, refer to the section that describes the measurement of interest.

Measurements available under the Meas key are specific to the current Mode.

When viewing Help for measurements, note the following:

NOTE

Operation for some keys differs between measurements. The information displayed in Help pertains to the current measurement. To see how a key operates in a different measurement, exit Help (press the Cancel Esc key), select the measurement, then reenter Help (press the Help key) and press that key.

Key Path	Front-panel key
Initial S/W Revision	Prior to A.02.00

Remote Measurement Functions

This section contains the following topics:

["Measurement Group of Commands" on page 1166](#)

["Current Measurement Query \(Remote Command Only\)" on page 1168](#)

["Limit Test Current Results \(Remote Command Only\)" on page 1168](#)

["Data Query \(Remote Command Only\)" on page 1168](#)

["Calculate/Compress Trace Data Query \(Remote Command Only\)" on page 1169](#)

["Calculate Peaks of Trace Data \(Remote Command Only\)" on page 1174](#)

[Hardware-Accelerated Fast Power Measurement \(Remote Command Only\)](#)

["Format Data: Numeric Data \(Remote Command Only\)" on page 1175](#)

["Format Data: Byte Order \(Remote Command Only\)" on page 1176](#)

Initial S/W Revision	Prior to A.02.00
----------------------	------------------

Measurement Group of Commands

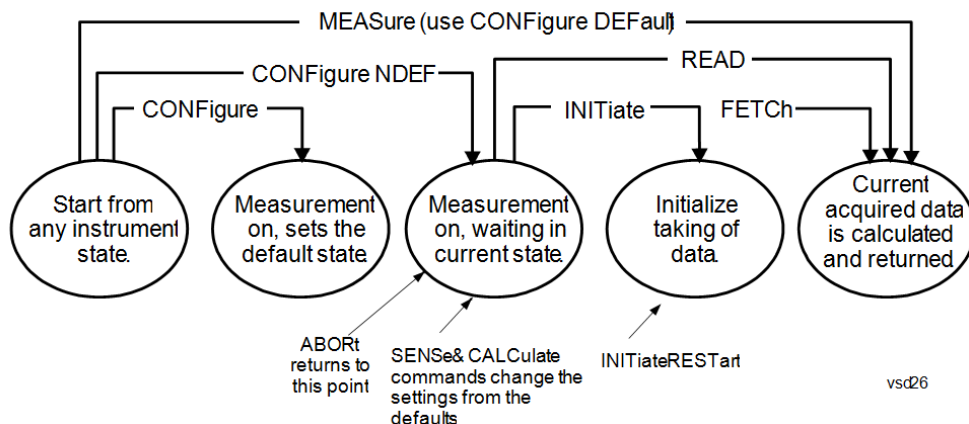

Measure Commands:

:MEASure:<measurement>[n]?

This is a fast single-command way to make a measurement using the factory default instrument settings. These are the settings and units that conform to the Mode Setup settings (e.g. radio standard) that you have currently selected.

- Stops the current measurement (if any) and sets up the instrument for the specified measurement using the factory defaults
- Initiates the data acquisition for the measurement
- Blocks other SCPI communication, waiting until the measurement is complete before returning results.
- If the function does averaging, it is turned on and the number of averages is set to 10.
- After the data is valid it returns the scalar results, or the trace data, for the specified measurement. The type of data returned may be defined by an [n] value that is sent with the command.
- The scalar measurement results will be returned if the optional [n] value is not included, or is set to 1. If the [n] value is set to a value other than 1, the selected trace data results will be returned. See each command for details of what types of scalar results or trace data results are available.
- ASCII is the default format for the data output. (Older versions of Spectrum Analysis and Phase Noise mode measurements only use ASCII.) The binary data formats should be used for handling large blocks of data since they are smaller and faster than the ASCII format. Refer to the FORMat:DATA command for more information.

If you need to change some of the measurement parameters from the factory default settings you can set up the measurement with the CONFigure command. Use the commands in the SENSE:<measurement> and CALCulate:<measurement> subsystems to change the settings. Then you can use the READ? command to initiate the measurement and query the results.

If you need to repeatedly make a given measurement with settings other than the factory defaults, you can use the commands in the SENSE:<measurement> and CALCulate:<measurement> subsystems to set up the measurement. Then use the READ? command to initiate the measurement and query results.

Measurement settings persist if you initiate a different measurement and then return to a previous one. Use READ:<measurement>? if you want to use those persistent settings. If you want to go back to the default settings, use MEASure:<measurement>?.

Configure Commands:

:CONFigure:<measurement>

This command stops the current measurement (if any) and sets up the instrument for the specified measurement using

the factory default instrument settings. It does not initiate the taking of measurement data unless INIT:CONTInuous is ON. If you change any measurement settings after using the CONFigure command, the READ command can be used to initiate a measurement without changing the settings back to their defaults.

In the Swept SA measurement in Spectrum Analyzer mode the CONFigure command also turns the averaging function on and sets the number of averages to 10 for all measurements.

:CONFigure: <measurement>: NDEFault stops the current measurement and changes to the specified measurement. It does not change the settings to the defaults. It does not initiate the taking of measurement data unless INIT:CONTInuous is ON.

The CONFigure? query returns the current measurement name.

The CONFigure:CATalog? query returns a quoted string of all licensed measurement names in the current mode. For example, "SAN, CHP, OBW, ACP, PST, TXP, SPUR, SEM, LIST".

Fetch Commands:

:FETCh:<measurement>[n]?

This command puts selected data from the most recent measurement into the output buffer. Use FETCh if you have already made a good measurement and you want to return several types of data (different [n] values, for example, both scalars and trace data) from a single measurement. FETCh saves you the time of re-making the measurement. You can only FETCh results from the measurement that is currently active, it will not change to a different measurement. An error message is reported if a measurement other than the current one is specified.

If you need to get new measurement data, use the READ command, which is equivalent to an INITiate followed by a FETCh.

The scalar measurement results will be returned if the optional [n] value is not included, or is set to 1. If the [n] value is set to a value other than 1, the selected trace data results will be returned. See each command for details of what types of scalar results or trace data results are available. The binary data formats should be used for handling large blocks of data since they are smaller and transfer faster than the ASCII format. (FORMat:DATA)

FETCh may be used to return results other than those specified with the original READ or MEASure command that you sent.

INITiate Commands:

:INITiate:<measurement>

This command is not available for measurements in all the instrument modes:

- Initiates a trigger cycle for the specified measurement, but does not output any data. You must then use the FETCh<meas> command to return data. If a measurement other than the current one is specified, the instrument will switch to that measurement and then initiate it.
- For example, suppose you have previously initiated the ACP measurement, but now you are running the channel power measurement. If you send INIT:ACP? it will change from channel power to ACP and will initiate an ACP measurement.
- Does not change any of the measurement settings. For example, if you have previously started the ACP measurement and you send INIT:ACP? it will initiate a new ACP measurement using the same instrument settings as the last time ACP was run.
- If your selected measurement is currently active (in the idle state) it triggers the measurement, assuming the trigger conditions are met. Then it completes one trigger cycle. Depending upon the measurement and the number of averages, there may be multiple data acquisitions, with multiple trigger events, for one full trigger cycle. It also holds off additional commands on GPIB until the acquisition is complete.

READ Commands:

:READ:<measurement>[n]?

- Does not preset the measurement to the factory default settings. For example, if you have previously initiated the ACP
-

measurement and you send READ:ACP? it will initiate a new measurement using the same instrument settings.

- Initiates the measurement and puts valid data into the output buffer. If a measurement other than the current one is specified, the instrument will switch to that measurement before it initiates the measurement and returns results.
 - For example, suppose you have previously initiated the ACP measurement, but now you are running the channel power measurement. Then you send READ:ACP? It will change from channel power back to ACP and, using the previous ACP settings, will initiate the measurement and return results.
 - Blocks other SCPI communication, waiting until the measurement is complete before returning the results
 - If the optional [n] value is not included, or is set to 1, the scalar measurement results will be returned. If the [n] value is set to a value other than 1, the selected trace data results will be returned. See each command for details of what types of scalar results or trace data results are available. The binary data formats should be used when handling large blocks of data since they are smaller and faster than the ASCII format. (FORMat:DATA)
-

Initial S/W Revision	Prior to A.02.00
----------------------	------------------

Current Measurement Query (Remote Command Only)

This command returns the name of the measurement that is currently running.

Remote Command	:CONFigure?
-----------------------	-------------

Example	CONF?
----------------	-------

Initial S/W Revision	Prior to A.02.00
----------------------	------------------

Limit Test Current Results (Remote Command Only)

Queries the status of the current measurement limit testing. It returns a 0 if the measured results pass when compared with the current limits. It returns a 1 if the measured results fail any limit tests.

Remote Command	:CALCulate:CLIMits:FAIL?
-----------------------	--------------------------

Example	CALC:CLIM:FAIL? queries the current measurement to see if it fails the defined limits. Returns a 0 or 1: 0 it passes, 1 it fails.
----------------	--

Initial S/W Revision	Prior to A.02.00
----------------------	------------------

Data Query (Remote Command Only)

Returns the designated measurement data for the currently selected measurement and subopcode.

n = any valid subopcode for the current measurement. See the measurement command results table for your current measurement, for information about what data is returned for the subopcodes.

This command uses the data setting specified by the FORMat:BORDER and FORMat:DATA commands and can return real or ASCII data. (See the format command descriptions under Input/Output in the Analyzer Setup section.)

Remote Command	:CALCulate:DATA[n]?
Notes	The return trace depends on the measurement. In CALCulate:<meas>:DATA[n], n is any valid subopcode for the current measurement. It returns the same data as the FETCH:<measurement>? query where <measurement> is the current measurement.
Initial S/W Revision	Prior to A.02.00

Calculate/Compress Trace Data Query (Remote Command Only)

Returns compressed data for the currently selected measurement and sub-opcode [n].

n = any valid sub-opcode for that measurement. See the MEASure:<measurement>? command description of your specific measurement for information on the data that can be returned.

The data is returned in the current Y Axis Unit of the analyzer. The command is used with a sub-opcode <n> (default=1) to specify the trace. With trace queries, it is best if the analyzer is not sweeping during the query. Therefore, it is generally advisable to be in Single Sweep, or Update=Off.

This command is used to compress or decimate a long trace to extract and return only the desired data. A typical example would be to acquire N frames of GSM data and return the mean power of the first burst in each frame. The command can also be used to identify the best curve fit for the data.

Remote Command	:CALCulate:DATA<n>:COMPRESS? BLOCK CFIT MAXimum MINimum MEAN DMEan RMS RMSCubed SAMPLE SDEVIation PPHase [,<soffset> [,<length>[,<roffset>[,<rlimit>]]]]
Example	To query the mean power of a set of GSM bursts: Supply a signal that is a set of GSM bursts. Select the IQ Waveform measurement (in IQ Analyzer Mode). Set the sweep time to acquire at least one burst. Set the triggers such that acquisition happens at a known position relative to a burst. Then query the mean burst levels using, CALC:DATA2:COMP? MEAN, 24e-6, 526e-6 (These parameter values correspond to GSM signals, where 526e-6 is the length of the burst in the slot and you just want 1 burst.)
Notes	The command supports 5 parameters. Note that the last 4 (<soffset>, <length>, <roffset>, <rlimit>) are optional. But these optional parameters must be entered in the specified order. For example, if you want to specify <length>, then you must also specify <soffset>. See details below for a definition of each of these parameters. This command uses the data in the format specified by FORMat:DATA, returning either binary or ASCII data.
Initial S/W Revision	Prior to A.02.00

- BLOCK or block data - returns all the data points from the region of the trace data that you specify. For example, it could be used to return the data points of an input signal over several timeslots, excluding the portions of the trace data that you do not want. (This is x,y pairs for trace data and I,Q pairs for complex data.)

- CFIT or curve fit - applies curve fitting routines to the data. <soffset> and <length> are required to define the data that you want. <roffset> is an optional parameter for the desired order of the curve equation. The query will return the following values: the x-offset (in seconds) and the curve coefficients ((order + 1) values).

MIN, MAX, MEAN, DME, RMS, RMSC, SAMP, SDEV and PPH return one data value for each specified region (or <length>) of trace data, for as many regions as possible until you run out of trace data (using <roffset> to specify regions). Or they return the number of regions you specify (using <rlimit>) ignoring any data beyond that.

- MINimum - returns the minimum data point (y value) for the specified region(s) of trace data. For I/Q trace data, the minimum magnitude of the I/Q pairs is returned.
- MAXimum - returns the maximum data point (y value) for the specified region(s) of trace data. For I/Q trace data, the maximum magnitude of the I/Q pairs is returned.
- MEAN - returns a single value that is the arithmetic mean of the data point values (in dB/ dBm) for the specified region(s) of trace data. For I/Q trace data, the mean of the magnitudes of the I/Q pairs is returned. See the following equations.

NOTE If the original trace data is in dB, this function returns the arithmetic mean of those log values, not log of the mean power which is a more useful value. The mean of the log is the better measurement technique when measuring CW signals in the presence of noise. The mean of the power, expressed in dB, is useful in power measurements such as Channel Power. To achieve the mean of the power, use the RMS option.

Equation 1

Mean Value of Data Points for Specified Region(s)

$$MEAN = \frac{1}{n} \sum_{X_i \in \text{region}(s)} X_i$$

where X_i is a data point value, and n is the number of data points in the specified region(s).

Equation 2

Mean Value of I/Q Data Pairs for Specified Region(s)

$$MEAN = \frac{1}{n} \sum_{X_i \in \text{region}(s)} |X_i|$$

where $|X_i|$ is the magnitude of an I/Q pair, and n is the number of I/Q pairs in the specified region(s).

- DMEan - returns a single value that is the mean power (in dB/ dBm) of the data point values for the specified region(s) of trace data. See the following equation:

Equation 3

DMEan Value of Data Points for Specified Region(s)

$$\text{DME} = 10 \times \log_{10} \left(\frac{1}{n} \sum_{X_i \in \text{region}(s)} 10^{\frac{X_i}{10}} \right)$$

- RMS - returns a single value that is the average power on a root-mean-squared voltage scale (arithmetic rms) of the data point values for the specified region(s) of trace data. See the following equation.

NOTE For I/Q trace data, the rms of the magnitudes of the I/Q pairs is returned. See the following equation. This function is very useful for I/Q trace data. However, if the original trace data is in dB, this function returns the rms of the log values which is not usually needed.

Equation 4

RMS Value of Data Points for Specified Region(s)

$$\text{RMS} = \sqrt{\frac{1}{n} \sum_{X_i \in \text{region}(s)} X_i^2}$$

where X_i is a data point value, and n is the number of data points in the specified region(s).

Equation 5

RMS Value of I/Q Data Pairs for Specified Region(s)

$$\text{RMS} = \sqrt{\frac{1}{n} \sum_{X_i \in \text{region}(s)} X_i X_i^*}$$

where X_i is the complex value representation of an I/Q pair, X_i^* its conjugate complex number, and n is the number of I/Q pairs in the specified region(s).

Once you have the rms value for a region of trace data (linear or I/Q), you may want to calculate the mean power. You must convert this rms value (peak volts) to power in dBm:

$$10 \times \log[10 \times (\text{rms value})^2]$$

- SAMPLe - returns the first data value (x,y pair) for the specified region(s) of trace data. For I/Q trace data, the first I/Q pair is returned.
- SDEViation - returns a single value that is the arithmetic standard deviation for the data point values for the specified region(s) of trace data. See the following equation.
- For I/Q trace data, the standard deviation of the magnitudes of the I/Q pairs is returned. See the following equation.

Equation 6

Standard Deviation of Data Point Values for Specified Region(s)

$$\text{SDEV} = \sqrt{\frac{1}{n} \sum_{X_i \in \text{region}(s)} (X_i - \bar{X})^2}$$

where X_i is a data point value, \bar{X} is the arithmetic mean of the data point values for the specified region (s), and n is the number of data points in the specified region(s).

$$\text{SDEV} = \sqrt{\frac{1}{n} \sum_{|X_i| \in \text{region}(s)} (|X_i| - \bar{X})^2}$$

where $|X_i|$ is the magnitude of an I/Q pair, \bar{X} is the mean of the magnitudes for the specified region(s), and n is the number of data points in the specified region(s).

- PPHase - returns the x,y pairs of both rms power (dBm) and arithmetic mean phase (radian) for every specified region and frequency offset (Hz). The number of pairs is defined by the specified number of regions. This parameter can be used for I/Q vector ($n=0$) in Waveform (time domain) measurement and all parameters are specified by data point in PPHase.

The rms power of the specified region may be expressed as:

$$\text{Power} = 10 \times \log [10 \times (\text{RMS I/Q value})] + 10.$$

The RMS I/Q value (peak volts) is:

$$\sqrt{\frac{1}{n} \sum_{X_i \in \text{region}} X_i X_i^*}$$

where X_i is the complex value representation of an I/Q pair, X_i^* its conjugate complex number, and n is the number of I/Q pairs in the specified region.

The arithmetic mean phase of the specified region may be expressed as:

$$\frac{1}{n} \sum_{Y_i \in \text{region}} Y_i$$

where Y_i is the unwrapped phase of I/Q pair with applying frequency correction and n is the number of I/Q pairs in the specified region.

The frequency correction is made by the frequency offset calculated by the arithmetic mean of every specified region's frequency offset. Each frequency offset is calculated by the least square method against the unwrapped phase of I/Q pair.

Sample Trace Data - Constant Envelope

(See below for explanation of variables.)

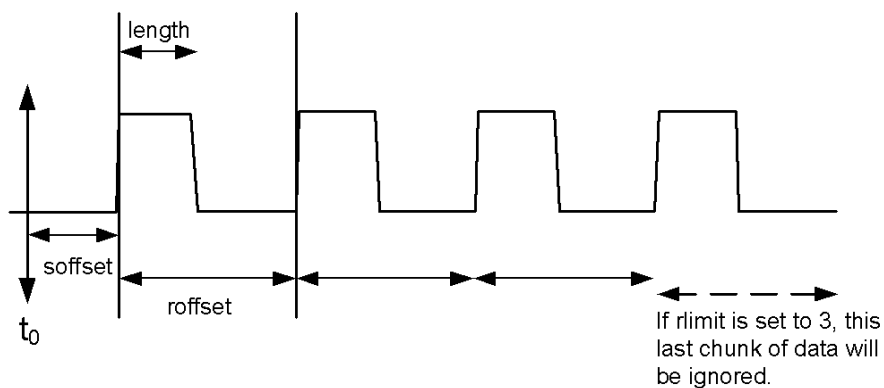

Sample Trace Data - Not Constant Envelope

(See below for explanation of variables.)

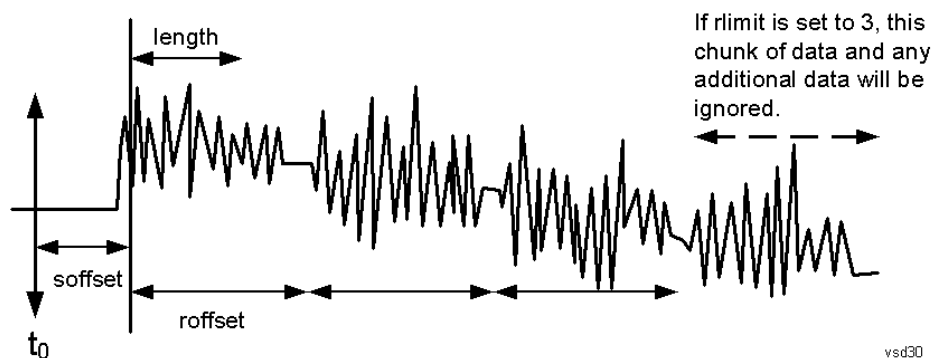

<soffset> - start offset is an optional real number. (It is in seconds for time-domain traces, and is a dimensionless index 0 to Npoints - 1, for frequency-domain traces). It specifies the amount of data at the beginning of the trace that will be ignored before the decimation process starts. It is the time or frequency change from the start of the trace to the point where you want to start using the data. The default value is zero.

<length> - is an optional real number. (It is in seconds for time-domain traces, and is a dimensionless index 0 to Npoints - 1, for frequency-domain traces). It defines how much data will be compressed into one value. This parameter has a default value equal to the current trace length.

<roffset> - repeat offset is an optional real number. (It is in seconds for time-domain traces, and is a dimensionless index 0 to Npoints - 1, for frequency-domain traces). It defines the beginning of the next field of trace elements to be compressed. This is relative to the beginning of the previous field. This parameter has a default value equal to the <length> variable. Note that this parameter is used for a completely different purpose when curve fitting (see CFIT above).

<rlimit> - repeat limit is an optional integer. It specifies the number of data items that you want returned. It will ignore any additional items beyond that number. You can use the Start offset and the Repeat limit to pick out exactly what part of the data you want to use. The default value is all the data.

Calculate Peaks of Trace Data (Remote Command Only)

Returns a list of all the peaks for the currently selected measurement and sub-opcode [n]. The peaks must meet the requirements of the peak threshold and excursion values.

n = any valid sub-opcode for the current measurement. See the MEASure:<measurement> command description of your specific measurement for information on the data that can be returned.

The command can only be used with specific sub-opcodes with measurement results that are trace data. Both real and complex traces can be searched, but complex traces are converted to magnitude in dBm. In many measurements the sub-opcode n=0, is the raw trace data which cannot be searched for peaks. And Sub-opcode n=1, is often calculated results values which also cannot be searched for peaks.

This command uses the data setting specified by the FORMat:BORDER and FORMat:DATA commands and can return real or ASCII data. If the format is set to INT,32, it returns REAL,32 data.

The command has four types of parameters:

- Threshold (in dBm)
- Excursion (in dB)
- Sorting order (amplitude, frequency, time)
- Optional in some measurements: Display line use (all, > display line, < display line)

Remote Command	<p>For Swept SA measurement:</p> <pre>:CALCulate:DATA[1] 2 ... 6:PEAKs? <threshold>,<excursion>[,AMPLitude FREQuency TIME[,ALL GTDLine LTDLine]]</pre> <p>For most other measurements:</p> <pre>:CALCulate:DATA[1] 2 ... 6:PEAKs? <threshold>,<excursion>[,AMPLitude FREQuency TIME]</pre>
-----------------------	--

Example	<p>Example for Swept SA measurement in Spectrum Analyzer Mode:</p> <p>CALC:DATA4:PEAK? -40, 10, FREQ, GTDL This will identify the peaks of trace 4 that are above -40 dBm, with excursions of at least 10 dB. The peaks are returned in order of increasing frequency, starting with the lowest frequency. Only the peaks that are above the display line are returned.</p> <p>Query Results 1:</p> <p>With FORMat:DATA REAL, 32 selected, it returns a list of floating-point numbers. The first value in the list is the number of peak points that are in the following list. A peak point consists of two values: a peak amplitude followed by its corresponding frequency (or time).</p> <p>If no peaks are found the peak list will consist of only the number of peaks, (0).</p>
----------------	---

Notes	<p><n> - is the trace that will be used</p> <p><threshold> - is the level below which trace data peaks are ignored. Note that the threshold value is required and is always used as a peak criterion. To effectively disable the threshold criterion for this command, provide a substantially low threshold value such as -200 dBm. Also note that the threshold value used in this command is independent of and has no effect on the threshold value stored under the Peak Criteria menu.</p> <p><excursion> - is the minimum amplitude variation (rise and fall) required for a signal to be identified as peak. Note that the excursion value is required and is always used as a peak criterion. To effectively disable the excursion criterion for this command, provide the minimum value of 0.0 dB. Also note that the excursion value used in this command is independent of and has no effect on the</p>
--------------	---

excursion value stored under the Peak Criteria menu.

Values must be provided for threshold and excursion. The sorting and display line parameters are optional (defaults are AMPLitude and ALL).

Note that there is always a Y-axis value for the display line, regardless of whether the display line state is on or off. It is the current Y-axis value of the display line which is used by this command to determine whether a peak should be reported. Sorting order:

AMPLitude - lists the peaks in order of descending amplitude, with the highest peak first (default if optional parameter not sent)

FREQUency - lists the peaks in order of occurrence, left to right across the x-axis.

TIME - lists the peaks in order of occurrence, left to right across the x-axis.

Peaks vs. Display Line:

ALL - lists all of the peaks found (default if optional parameter not sent).

GTDLine (greater than display line) - lists all of the peaks found above the display line.

LTDLine (less than display line) - lists all of the peaks found below the display line.

Initial S/W Revision Prior to A.02.00

Format Data: Numeric Data (Remote Command Only)

This command specifies the format of the trace data input and output. It specifies the formats used for trace data during data transfer across any remote port. It affects only the data format for setting and querying trace data for the :TRACe[:DATA], TRACe[:DATA]?, :CALCulate:DATA[n]? and FETCh:SANalyzer[n]? commands and queries.

Remote Command	:FORMat[:TRACe][:DATA] ASCii INTeger,32 REAL,32 REAL,64 :FORMat[:TRACe][:DATA]?
Notes	The query response is: ASCii: ASC,8 REAL,32: REAL,32 REAL,64: REAL,64 INTeger,32: INT,32 When the numeric data format is REAL or ASCii, data is output in the current Y Axis unit. When the data format is INTeger, data is output in units of m dBm (.001 dBm). The INT,32 format returns binary 32-bit integer values in internal units (m dBm), in a definite length block.
Dependencies	Sending a data format spec with an invalid number (for example, INT,48) generates no error. The analyzer simply uses the default (8 for ASCii, 32 for INTeger, 32 for REAL). Sending data to the analyzer which does not conform to the current FORMat specified, results in an error. Sending ASCII data when a definite block is expected generates message -161 "Invalid Block Data" and sending a definite block when ASCII data is expected generates message -121 "Invalid Character in Number".
Preset	ASCii
Backwards Compatibility Notes	Note that the INT,32 format is only applicable to the command, TRACe:DATA. This preserves backwards compatibility for the Swept SA measurement. For all other commands/queries which honor FORMat:DATA, if INT,32 is sent the analyzer will behave as though it were set to REAL,32.
Initial S/W Revision	Prior to A.02.00

The specs for each output type follow:

AScii - Amplitude values are in ASCII, in the current Y Axis Unit, one ASCII character per digit, values separated by commas, each value in the form:

SX.YYYYYEsZZ

Where:

S = sign (+ or -)

X = one digit to left of decimal point

Y = 5 digits to right of decimal point

E = E, exponent header

s = sign of exponent (+ or -)

ZZ = two digit exponent

REAL,32 - Binary 32-bit real values in the current Y Axis Unit, in a definite length block.

REAL,64 - Binary 64-bit real values in the current Y Axis Unit, in a definite length block.

Format Data: Byte Order (Remote Command Only)

This command selects the binary data byte order for data transfer and other queries. It controls whether binary data is transferred in normal or swapped mode. This command affects only the byte order for setting and querying trace data for the :TRACe[:DATA], TRACe[:DATA]? , :CALCulate:DATA[n]? and FETCh:SANalyzer[n]? commands and queries.

By definition any command that says it uses FORMat:DATA uses any format supported by FORMat:DATA.

The NORMal order is a byte sequence that begins with the most significant byte (MSB) first, and ends with the least significant byte (LSB) last in the sequence: 1|2|3|4. SWAPped order is when the byte sequence begins with the LSB first, and ends with the MSB last in the sequence: 4|3|2|1.

Remote Command	:FORMat:BORDER NORMal SWAPped :FORMat:BORDER?
Preset	NORMal
Initial S/W Revision	Prior to A.02.00

Meas Setup

Accesses a menu of keys that select measurement functions for VSA based measurements.

Key Path	Front Panel
Mode	VSA, LTE, LTETDD, IDEN, LTEAFDD, LTEATDD
Initial S/W Revision	Prior to A.02.00
Modified at S/W Revision	A.02.00

Avg Number

Enables you to turn averaging on or off, and set the number of scans (time records) whose measurement results are averaged. Averaging can be done over spectrum results (RMS) or over time records (Time). A third kind of pseudo averaging displays the maximum value seen at each spectral line over the specified number of scans. See ["Average Type" on page 1180](#) for a more detailed description of how measurement results are averaged. For RMS or Time averaging, the process is similar. Each time an averaged result is displayed, it is the sum of the individual results taken since measurement restart, divided by the number of scans. (For Max averaging, there is no actual summation or division.) The Measurement Bar shows the number of scans and the Avg number setting. For example, if 4 scans have been taken and the Avg Number is 10, the Meas Bar shows "4/10". The measurement continues to take new scans until the number of scans is equal to the Avg Number setting, at which time the measurement stops if Sweep control is in Single Mode. Otherwise, the measurement continues, and the Average Mode setting determines how successive scans are added to the averaged result. See ["Average Mode" on page 1179](#) for details.

Key Path	Meas Setup, More
Mode	VSA, LTE, LTETDD, IDEN, LTEAFDD, LTEATDD
Measurement	<meas>:=VECTor ADEMod DDEMod W11A W11B EVM IPOWER IDEMod MOTotalk
Remote Command	[:SENSe] :<meas>:AVERage:COUNT <integer> [:SENSe] :<meas>:AVERage:COUNT? [:SENSe] :<meas>:AVERage [:STATe] OFF ON 0 1 [:SENSe] :<meas>:AVERage [:STATe] ?
Example	VECT:AVER:COUN 20 VECT:AVER:COUN? VECT:AVER ON VECT:AVER?
Notes	If an averaged measurement is idle because the scan count is equal to the Avg Number and the Avg Number is increased, the measurement resumes until the new number of averages is satisfied.
Preset	10 OFF IPOW: ON
State Saved	Saved in instrument state.
Min	1

Max	2147483647
Initial S/W Revision	Prior to A.02.00
Modified at S/W Revision	A.02.00

Average Mode

Determines what happens when the Sweep Mode is Continuous and the number of scans processed exceeds the Average Number (see "Avg Number" on page 1178). If the Sweep Control is in Single mode, this setting has no affect.

When averaging is on and the number of scans is less than or equal to the Avg Number setting, a linear average is calculated as explained in the Avg Number topic. After the scan count exceeds the Avg Number setting, the measurement continues to take new scans. The Measurement Bar average indicator shows ">N/N" where N is the Avg Number.

If Average Mode is Exp then new results are averaged in exponentially. In other words, each succeeding average is the weighted sum of the previous average, weighted by $(N-1)/N$, and the new measurement, weighted by $1/N$, where N is the Average Number setting. (For Max averaging, no weighting occurs; the result continues to be the max value seen at each spectral line for every previous scan since measurement restart.)

If Average Mode is Repeat, then the average buffer is cleared after the average counter reaches the Average Number setting, and the average counter is reset to 0. Then a new set of averages is taken. The measurement bar therefore continues to show "k/N" in the average indicator, where k is the number of scans since the last time the average buffer was cleared and N is the Avg Number. The averaged result is the sum of the last k results divided by k. (For Max averaging, no sum or division takes place, but the buffer is cleared as stated above. The averaged result is the max value seen over the last k scans.)

Key Path	Meas Setup
Mode	VSA, LTE, LTETDD, IDEN, LTEAFDD, LTEATDD
Measurement	<meas>:=VECTor ADEMod DDEMod W11A W11B EVM IPOWER IDEMod MOTotalk
Remote Command	[:SENSe] :<meas>:AVERage:TCONtrol EXPonential REPeat [:SENSe] :<meas>:AVERage:TCONtrol?
Example	VECT:AVER:TCON EXP VECT:AVER:TCON?
Preset	EXP
State Saved	Saved in instrument state.
Range	Exp Repeat
Initial S/W Revision	Prior to A.02.00
Modified at S/W Revision	A.02.00

Average Setup

Accesses a menu enabling you to set Averaging parameters for all VSA based measurements.

Key Path	Meas Setup
Mode	VSA, LTE, LTETDD, IDEN, LTEAFDD, LTEATDD
Initial S/W Revision	Prior to A.02.00
Modified at S/W Revision	A.02.00

Average Type

Enables you to select the type of averaging. The following table shows what measurement results are averaged for each average type. This applies in the Vector Measurement.

Average Type	Measurement result averaged.
RMS	Spectrum, PSD: Power is averaged for each spectral line (i.e., this is a mean-square average of voltage). For the Spectrum result only, if the display transform is linear or real, the RMS result is displayed.
Time	Main Time: Individual time samples in the current time record are averaged vectorially (not RMS) with corresponding points in previous time records. See Main Time for more details.
Max	Spectrum, PSD: Not strictly an average. For each spectral line, power from the current measurement is compared to the average buffer value and the maximum is kept in the average buffer.

Some measurement results are inherently averaged, and are not affected by the Average controls. These are: CCDF, CDF, and PDF. They average continuously until the next measurement restart.

Key Path	Meas Setup, Average Setup
Mode	VSA, LTE, LTETDD, IDEN, LTEAFDD, LTEATDD
Measurement	<meas>:=VECTor ADEMod DDEMod W11A W11B EVM IPOWER IDEMod MOTotalk
Remote Command	[:SENSe] :<meas>:AVERage:TYPE RMS TIME MAXimum [:SENSe] :<meas>:AVERage:TYPE?
Example	VECT:AVER:TYPE RMS VECT:AVER:TYPE?
Preset	RMS
State Saved	Saved in instrument state.
Range	RMS Time Max
Initial S/W Revision	Prior to A.02.00
Modified at S/W Revision	A.02.00

Fast Average

Controls the display of average data. If fast averaging is off, then the display is updated after each time record is processed. If fast averaging is on, then the display is only updated after every M records, where M

is the Update Rate (see ["Update Rate" on page 1181](#)). For example, if the fast average count is 10, then the running average is only displayed every 10th time record.

Key Path	Meas Setup, Average Setup
Mode	VSA, LTE, LTETDD, IDEN, LTEAFDD, LTEATDD
Measurement	<meas>:=VECTor ADEMod DDEMod W11A W11B EVM IPOWER IDEMod MOTotalk
Remote Command	[:SENSe] : <meas> : AVERage : FAST OFF ON 0 1 [:SENSe] : <meas> : AVERage : FAST ?
Example	VECT: AVER: FAST ON VECT: AVER: FAST ?
Preset	OFF
State Saved	Saved in instrument state.
Range	On Off
Initial S/W Revision	Prior to A.02.00
Modified at S/W Revision	A.02.00

Update Rate

Controls how often the display updates when fast averaging is turned on. If the Fast Averaging State is MAX then the display is updated only after the full Average Count is reached. Otherwise, the display is updated whenever the average count is a multiple of the Update Rate.

Key Path	Meas Setup, More, Average Setup
Mode	VSA, LTE, LTETDD, IDEN, LTEAFDD, LTEATDD
Measurement	<meas>:=VECTor ADEMod DDEMod W11A W11B EVM IPOWER IDEMod MOTotalk
Remote Command	[:SENSe] : <meas> : AVERage : FAST : URATe <integer> [:SENSe] : <meas> : AVERage : FAST : URATe ? [:SENSe] : <meas> : AVERage : FAST : URATe : AUTO OFF ON 0 1 [:SENSe] : <meas> : AVERage : FAST : URATe : AUTO ?
Example	VECT: AVER: FAST: URAT 20 VECT: AVER: FAST: URAT ? VECT: AVER: FAST: URAT: AUTO ON VECT: AVER: FAST: URAT: AUTO ?
Preset	10 ON
State Saved	Saved in instrument state.
Min	1
Max	2147483647
Initial S/W Revision	Prior to A.02.00
Modified at S/W Revision	A.02.00

PhNoise Opt

Enables you to adjust the LO phase noise optimization to give better close-in phase noise or better wide-offset phase noise. The definition of what frequency offsets constitute close in or wide offset varies with hardware. (The selection keys provide hardware-specific prompts.)

Key Path	Meas Setup
Mode	VSA, WIMAXFIXED
Measurement	<meas>:=VECTor ADEMod DDEMod W11A W11B EVM
Remote Command	[:SENSe] :<meas>:FREQuency:SYNTHeSis [:STATe] 1 2 3 [:SENSe] :<meas>:FREQuency:SYNTHeSis [:STATe] ?
Example	VECT:FREQ:SYNT 1 VECT:FREQ:SYNT?
Notes	Parameter key: 1 - optimizes phase noise for close-in frequencies 2 - optimizes phase noise for wide-offset frequencies 3 - allows LO for tuning speed The softkey shows the options more explicitly. For MXA/EXA, the selection keys show the options: Best Close-in Φ Noise [offset < 20 kHz] Best Wide-offset Φ Noise [offset > 30 kHz] Fast Tuning [same as Close-in] For PXA the options are: Best Close-in Φ Noise [offset < 140 kHz] Best Wide-offset Φ Noise [offset > 160 kHz] Fast Tuning [single loop]
Preset	all VXA measurements: Best Wide-offset Φ Noise WIMAXFIXED EVM measurement: Best Close-in Φ Noise
State Saved	Saved in instrument state.
Initial S/W Revision	A.04.00

Best Close-in Φ Noise

Optimizes LO phase noise for smaller offsets from the carrier at the expense of phase noise farther out. The crossover frequency below which phase noise gets better versus Best Wide-offset depends on hardware. For example, for an MXA, close in means offsets < 20 kHz, while for a PXA, it means offsets < 140 kHz.

Key Path	Meas Setup, PhNoise Opt
Mode	VSA, WIMAXFIXED

Example	VECT:FREQ:SYNT 1 VECT:FREQ:SYNT?
Readback	Close-in
Initial S/W Revision	A.04.00

Best Wide-offset Φ Noise

Optimizes LO phase noise for wider offsets from the carrier at the expense of phase noise closer in. The crossover frequency beyond which phase noise gets better versus Best Close-in depends on hardware. For example, for an MXA, wide-offset means phase noise is improved for offsets > 30 kHz, while for a PXA, it means for offsets > 160 kHz.

Key Path	Meas Setup, PhNoise Opt
Mode	VSA, WIMAXFIXED
Example	VECT:FREQ:SYNT 2 VECT:FREQ:SYNT?
Readback	Wide-offset
Initial S/W Revision	A.04.00

Meas Preset

Immediately sets all measurement parameters to their Preset values. For more information, see "[Mode Preset](#)" on page 1186.

Key Path	Meas Setup, More
Mode	LTE, LTETDD
Initial S/W Revision	Prior to A.02.00
Modified at S/W Revision	A.03.00

Mode

See "Mode" on page 196

Mode Preset

Returns the active mode to a known state.

Mode Preset does the following for the currently active mode:

- Aborts the currently running measurement.
- Brings up the default menu for the mode, with no active function.
- Sets measurement Global settings to their preset values for the active mode only.
- Activates the default measurement.
- Brings up the default menu for the mode.
- Clears the input and output buffers.
- Sets Status Byte to 0.

Mode Preset does not:

- Cause a mode switch
- Affect mode persistent settings
- Affect system settings

See "[How-To Preset](#)" on page 397 for more information.

Key Path	Front-panel key
Remote Command	:SYSTem:PRESet
Example	:SYST:PRES
Notes	*RST is preferred over :SYST:PRES for remote operation. *RST does a Mode Preset, as done by the :SYST:PRES command, and it sets the measurement mode to Single measurement rather than Continuous for optimal remote control throughput. Clears all pending OPC bits. The Status Byte is set to 0.
Couplings	A Mode Preset aborts the currently running measurement, activates the default measurement, and gets the mode to a consistent state with all of the default couplings set.
Backwards Compatibility Notes	In the X-Series, the legacy "Factory Preset" has been replaced with Mode Preset, which only presets the currently active mode, not the entire instrument. In the X-Series, the way to preset the entire instrument is by using System, Restore System Defaults All, which behaves essentially the same way as restore System Defaults does on ESA and PSA. There is also no "Preset Type" as there is on the PSA. There is a green Mode Preset front-panel key that does a Mode Preset and a white-with-green-letters User Preset front-panel key that does a User Preset. The old PRESet:TYPE command is ignored (without generating an error), and SYST:PRES without a parameter does a Mode Preset, which should cover most backward code compatibility issues. The settings and correction data under the Input/Output front-panel key (examples: Input Z Corr, Ext Amp Gain, etc.) are no longer part of any Mode, so they will not be preset by a Mode Preset. They are preset using Restore Input/Output Defaults, Restore System Defaults All. Note that because User Preset does a Recall State, and all of these settings are saved in State, they ARE recalled when using

	User Preset.
Initial S/W Revision	Prior to A.02.00

How-To Preset

The table below shows all possible presets, their corresponding SCPI commands and front-panel access (key paths). Instrument settings depend on the current measurement context. Some settings are local to the current measurement, some are global (common) across all the measurements in the current mode, and some are global to all the available modes. In a similar way, restoring the settings to their preset state can be done within the different contexts.

Auto Couple - is a measurement local key. It sets all Auto/Man parameter couplings in the measurement to Auto. Any Auto/Man selection that is local to other measurements in the mode will not be affected.

Meas Preset - is a measurement local key. Meas Preset resets all the variables local to the current measurement except the persistent ones.

Mode Preset - resets all the current mode's measurement local and measurement global variables except the persistent ones.

Restore Mode Defaults - resets ALL the Mode variables (and all the Meas global and Meas local variables), including the persistent ones.

Type Of Preset	SCPI Command	Front Panel Access
Auto Couple	:COUPlE ALL	Auto Couple front-panel key
Meas Preset	:CONFIgure:<Measurement>	Meas Setup Menu
Mode Preset	:SYSTem:PRESet	Mode Preset (green key)
Restore Mode Defaults	:INSTrument:DEFault	Mode Setup Menu
Restore All Mode Defaults	:SYSTem:DEFault MODEs	System Menu; Restore System Default Menu
*RST	*RST	not possible (Mode Preset with Single)
Restore Input/Output Defaults	:SYSTem:DEFault INPut	System Menu; Restore System Default Menu
Restore Power On Defaults	:SYSTem:DEFault PON	System Menu; Restore System Default Menu
Restore Alignment Defaults	:SYSTem:DEFault ALIGn	System Menu; Restore System Default Menu
Restore Miscellaneous Defaults	:SYSTem:DEFault MISC	System Menu; Restore System Default Menu
Restore All System Defaults	:SYSTem:DEFault [ALL] :SYSTem:PRESet:PERSistent	System Menu; Restore System Default Menu
User Preset	:SYSTem:PRESet:USER	User Preset Menu
User Preset All Modes	:SYSTem:PRESet:USER:ALL	User Preset Menu

8 Vector Analysis
Mode Preset

Power On Mode Preset	:SYSTem:PON:TYPE MODE	System Menu
Power On User Preset	:SYSTem:PON:TYPE USER	System Menu
Power On Last State	:SYSTem:PON:TYPE LAST	System Menu

Mode Setup

See ["Mode Setup" on page 226](#)

Peak Search

Displays a menu that enables markers to be easily moved among peaks on a trace and also performs the peak search function. Pressing Peak Search also makes the selected marker's X position the active function.

The peak search function causes the marker to move to the highest point in the trace. The highest point is the point with the largest y-axis value in the current trace format. If the format is complex (vector or constellation) then the point with the highest magnitude is chosen.

Pressing the Peak Search hard key always performs a Peak Search, with one exception: if the Peak Search menu is not showing but the selected marker is on (Normal, Delta, or Fixed), then pressing the Peak Search hardkey only displays the Peak Search menu. This enables you to select one of the other peak search functions without disturbing the selected marker's position. If you want to perform a peak search in this case, press the Peak Search hardkey again.

If the selected marker is Off, then pressing the Peak Search hardkey once not only shows the menu, but it turns on the selected marker in Normal mode, assigns it to the selected trace, and performs a peak search.

If any peak search SCPI command is invoked on a marker that is Off, the marker is first turned on in Normal mode and assigned to the selected trace. Then the peak search is performed.

Key Path	Front Panel
Mode	VSA, LTE, LTETDD, IDEN
Measurement	<meas>:=VECTor ADEMod DDEMod W11A W11B EVM IPOWER IDEMod MOTotalk
Remote Command	:CALCulate:<meas>:MARKer[1] 2 ...12:MAXimum
Example	CALC:VECT:MARK2:MAX
Notes	There is no softkey for this function. Instead, you press the Peak Search hardkey twice. (Pressing it once is sufficient if the Peak Search menu is showing, but twice guarantees that the function is invoked) If peak search function is not invoked (because the response to pressing the hardkey was only to show the menu) then the following message is shown: "Press Peak Search again to perform a Peak Search."
Initial S/W Revision	Prior to A.02.00
Modified at S/W Revision	A.02.00

Select Marker

Specifies the selected marker. The selected marker is the one that is affected by the marker position and properties settings, peak search, and other marker functions. Several menus have a Select Marker key for convenience. Marker selection using any one of these is reflected in all others, in other words, there is only one selected marker for the whole measurement. If all markers are off, then marker 1 becomes the selected marker.

As a convenience, if no markers are displayed on the selected trace, selecting a marker that is off automatically turns it on in normal mode on the selected trace.

There is no SCPI function for selecting a marker. Instead, SCPI functions can explicitly include the index of the marker for which they are to apply. (Most SCPI marker functions that affect the state of a marker also make it the selected marker for front panel commands.)

Key Path	Marker or Marker> or Marker Function or Peak Search
Mode	VSA, LTE, LTETDD, IDEN, LTEAFDD, LTEATDD
State Saved	No
Range	1 2 3 4 5 6 7 8 9 10 11 12
Initial S/W Revision	Prior to A.02.00
Modified at S/W Revision	A.02.00

Next Peak (Next Lower Amptd)

Moves the marker to the peak next lower in Y value than the peak it is currently on. If the format is complex (vector or constellation) then the marker moves to the closest point that has a lower magnitude than the marker's current position. If this function is invoked via SCPI on a marker that is off, the result is the same as if you sent a Peak Search command.

Key Path	Peak Search
Mode	VSA, LTE, LTETDD, IDEN
Measurement	<meas>:=VECTor ADEMod DDEMod W11A W11B EVM IPOWER IDEMod MOTotalk
Remote Command	:CALCulate:<meas>:MARKer[1] 2 ...12:MAXimum:NEXT
Example	CALC:VECT:MARK2:MAX:NEXT
Initial S/W Revision	Prior to A.02.00
Modified at S/W Revision	A.02.00

Next Higher Amptd

Moves the marker to the peak next higher in Y value than the peak it is currently on. If the format is complex (vector or constellation) then the marker moves to the closest point that has a higher magnitude than the marker's current position. If this function is invoked via SCPI on a marker that is off, the result is the same as if you sent a Peak Search command.

Key Path	Peak Search
Mode	VSA, LTE, LTETDD, IDEN
Measurement	<meas>:=VECTor ADEMod DDEMod W11A W11B EVM IPOWER IDEMod MOTotalk
Remote Command	:CALCulate:<meas>:MARKer[1] 2 ...12:MAXimum:PREVious
Example	CALC:VECT:MARK2:MAX:PREV
Initial S/W Revision	Prior to A.02.00
Modified at S/W Revision	A.02.00

Next Right

Moves the marker to the next peak to the right of its current position. If the format is complex (vector or constellation) then the marker moves forward in time to the next peak. If this function is invoked via SCPI on a marker that is off, the result is the same as if you sent a Peak Search command.

A valid peak is one for which the displayed Y-axis values drop monotonically on both sides of the local maximum at least 4% of the distance between the top and bottom of the display grid before the values begin to rise again.

Key Path	Peak Search
Mode	VSA, LTE, LTETDD, IDEN
Measurement	<meas>:=VECTor ADEMod DDEMod W11A W11B EVM IPOWER IDEMod MOTotalk
Remote Command	:CALCulate:<meas>:MARKer [1] 2 . . . 12:MAXimum:RIGHT
Example	CALC:VECT:MARK2:MAX:RIGH
Initial S/W Revision	Prior to A.02.00
Modified at S/W Revision	A.02.00

Next Left

Moves the marker to the next peak to the left of its current position. If the format is complex (vector or constellation) then the marker moves back in time to the next peak. If this function is invoked via SCPI on a marker that is off, the result is the same as if you sent a Peak Search command.

A valid peak is one for which the displayed Y-axis values drop monotonically on both sides of the local maximum at least 4% of the distance between the top and bottom of the display grid before the values begin to rise again.

Key Path	Peak Search
Mode	VSA, LTE, LTETDD, IDEN
Measurement	<meas>:=VECTor ADEMod DDEMod W11A W11B EVM IPOWER IDEMod MOTotalk
Remote Command	:CALCulate:<meas>:MARKer [1] 2 . . . 12:MAXimum:LEFT
Example	CALC:VECT:MARK2:MAX:LEFT
Initial S/W Revision	Prior to A.02.00
Modified at S/W Revision	A.02.00

Mkr -> CF (Center Frequency)

Sets the center frequency equal to the selected marker's absolute frequency. The marker must be on a frequency-domain trace. The absolute marker frequency is used regardless of whether its control mode is Normal, Delta, or Fixed.

If the currently selected marker is not on when this key is pressed, it is turned on at the center of the screen as a normal type marker.

Key Path	Marker To
Mode	VSA, LTE, LTETDD, IDEN, LTEAFDD, LTEATDD
Initial S/W Revision	Prior to A.02.00
Modified at S/W Revision	A.02.00

Continuous Peak Search

Turns on Continuous Peak Search for the selected marker. This function can be turned on for any marker independently of any other marker. This function moves the marker to the highest point on the trace each time the trace is updated. If the SCPI command refers to a marker that is off, it is turned on in Normal mode.

It is possible to have Couple Markers and Continuous Peak Search both on. If this is the case, it is recommended that Continuous Peak search be turned on for only one marker in any tracking set (that is, any set of markers with the same or equivalent domain). Otherwise, conflicts over marker position can arise that cause erratic marker movement.

Key Path	Peak Search
Mode	VSA, LTE, LTETDD, IDEN
Measurement	<meas>:=VECTor ADEMod DDEMod W11A W11B EVM IPOWER IDEMod MOTotalk
Remote Command	:CALCulate:<meas>:MARKer[1] 2 ...12:CPSearch[:STATe] ON OFF 1 0 :CALCulate:<meas>:MARKer[1] 2 ...12:CPSearch[:STATe]?
Example	CALC:VECT:MARK1:CPS ON
Couplings	The Continuous Peak Search key is grayed out when the selected marker is a Fixed marker. Also, if Continuous Peak Search is on and the selected marker becomes a fixed marker, then Continuous Peak Search is turned off and the key grayed out. Continuous Peak Search is turned off when the selected marker is turned off.
Preset	OFF
State Saved	Saved in instrument state.
Range	Off On
Initial S/W Revision	Prior to A.02.00
Modified at S/W Revision	A.02.00

Min Search

Moves the marker to the lowest Y value on the trace. If the format is complex (vector or constellation) then the marker moves to the lowest value in magnitude. If the SCPI command refers to a marker that is off, it is first turned on in Normal mode and then set on the minimum point.

Key Path	Peak Search
Mode	VSA, LTE, LTETDD, IDEN

Measurement	<meas>:=VECTor ADEMod DDEMod W11A W11B EVM IPOWER IDEMod MOTotalk
Remote Command	:CALCulate:<meas>:MARKer [1] 2 ... 12:MINimum
Example	CALC:VECT:MARK2:MIN
Initial S/W Revision	Prior to A.02.00
Modified at S/W Revision	A.02.00

Mkr -> Ref Lvl (Reference Level)

Sets the Y axis reference value equal to the selected marker's Y value. For example, if the reference position is at the top of the screen, the whole trace is moved up so that the marker appears at the top of the screen. Note that this is a display scaling function only. The input range remains the same.

Key Path	Peak Search
Mode	VSA, LTE, LTETDD, IDEN
Initial S/W Revision	Prior to A.02.00
Modified at S/W Revision	A.02.00

Print

See "Print" on page 241

Quick Save

The Quick Save front-panel key repeats the most recent save that was performed from the Save menu, with the following exceptions:

- Register saves are not remembered as Saves for the purpose of the Quick Save function
- If the current measurement does not support the last non-register save that was performed, an informational message is generated, “File type not supported for this measurement”

Quick Save repeats the last type of qualified save (that is, a save qualified by the above criteria) in the last save directory by creating a unique filename using the Auto File Naming algorithm described below.

If Quick Save is pressed after startup and before any qualified Save has been performed, the Quick Save function performs a Screen Image save using the current settings for Screen Image saves (current theme, current directory), which then becomes the “last save” for the purpose of subsequent Quick Saves.

The Auto File Naming feature automatically generates a file name for use when saving a file. The filename consists of a prefix and suffix separated by a dot, as is standard for the Windows® file system. A default prefix exists for each of the available file types:

Type	Default Prefix	Menu
State	State_	(Save/Recall)
Trace + State	State_	(Save/Recall)
Screen	Screen_	(Save/Recall)
Amplitude Corrections	Ampcor_	(Import/Export)
Traces	Trace_	(Import/Export)
Limit Lines	LLine_	(Import/Export)
Measurement Result	MeasR_	(Import/Export)
Capture Buffer	CapBuf_	(Import/Export)

A four digit number is appended to the prefix to create a unique file name. The numbering sequence starts at 0000 within each Mode for each file type and updates incrementally to 9999, then wraps to 0000 again. It remembers where it was through a Mode Preset and when leaving and returning to the Mode. It is reset by Restore Misc Defaults and Restore System Defaults and subsequent running of the instrument application. So, for example, the first auto file name generated for State files is State_0000.state. The next is State_0001, and so forth.

One of the key features of Auto File Name is that we guarantee that the Auto File Name will never conflict with an existing file. The algorithm looks for the next available number. If it gets to 9999, then it looks for holes. If it find no holes, that is no more numbers are available, it gives an error.

For example, if when we get to State_0010.state there is already a State_0010.state file in the current directory, it advances the counter to State_0011.state to ensure that no conflict will exist (and then it verifies that State_0011.state also does not exist in the current directory and advances again if it does, and so forth).

If you enter a file name for a given file type, then the prefix becomes the filename you entered instead of the default prefix, followed by an underscore. The last four letters (the suffix) are the 4-digit number.

For example, if you save a measurement results file as “fred.csv”, then the next auto file name chosen for a measurement results save will be fred_0000.csv.

NOTE

Although 0000 is used in the example above, the number that is used is actually the current number in the Meas Results sequence, that is, the number that would have been used if you had not entered your own file name.

NOTE

If the filename you entered ends with _dddd, where d=any number, making it look just like an auto file name, then the next auto file name picks up where you left off with the suffix being dddd + 1.

Key Path	Front-panel key
Notes	No remote command for this key specifically.
Initial S/W Revision	Prior to A.02.00

Recall

The Recall menu lets you choose what you want to recall, and where you want to recall it from. Among the types of files you can recall are **States and Traces**. In addition, an Import (Data) option lets you recall a number of data types stored in CSV files (as used by Excel and other spreadsheet programs).

The default paths for Recall are data type dependent and are the same as for the Save key.

Key Path	Front-panel key
Notes	<p>No remote command for this key specifically, but the :MMEM:LOAD command is available for specific file types. An example is :MMEM:LOAD:STATe <filename>.</p> <p>If you try to recall a State file for a mode that is not licensed or not available in the instrument, an error message will occur and the state will not change.</p>
Backwards Compatibility Notes	<p>In legacy analyzers, it was possible to load a state without affecting the trace data, limit lines or correction data. Similarly (since User Preset is actually loading a state), it was possible to do a User Preset without affecting the trace data, limit lines or correction data.</p> <p>In the X-Series, “state” always includes all of this data; so whenever state is loaded, all of the traces, limit lines and corrections are affected. Although this differs from previous behavior, it is desirable behavior, and should not cause adverse issues for users.</p>
Backwards Compatibility Notes	<p>Recall for the X-Series supports backward compatibility in the sense that you can recall a state file from any X-Series model number and any version of X-Series software. This is only possible if part of the recalling process goes through a limiting step after recalling the mode settings, at least for settings that may vary with version number, model number, option and license differences. If you try to recall a state file onto an instrument with less capability than what was available on the instrument during the save, the recall will ignore the state it doesn't support and it will limit the recalled setting to what it allows.</p> <p>Example: if the saved state includes preamp ON, but the recalling instrument does not have a preamp; the preamp is limited to OFF. Conversely, if you save a state without a preamp, the preamp is OFF in the state file. When this saved file is recalled on an instrument with a licensed preamp, the preamp is changed to OFF. Another example is if the saved state has center frequency set to 20 GHz, but the instrument recalling the saved state is a different model and only supports 13.5 GHz. In this case, the center frequency is limited along with any other frequency based settings. Since the center frequency can't be preserved in this case, the recall limiting tries to at least preserve span to keep the measurement setup as intact as possible.</p> <p>It may be appropriate to issue a warning if the state is limited on the recall; warnings do not go out to SCPI so this would only affect the manual user.</p> <p>Note that there is no state file compatibility outside of the X-Series. For example, you cannot recall a state file from ESA or PSA.</p>
Initial S/W Revision	Prior to A.02.00

State

The Recall State menu lets you choose a register or file from which to recall the state.

The content of a state file includes all of the settings and data required to return the analyzer as closely as possible to the Mode it was in, with the exact settings that were in place, when the save occurred. The Mode settings in each state file include the settings that are affected by Mode Preset, as well as the

additional settings affected by Restore Mode Defaults; all of the Mode's settings. In addition, all of the settings of the Input/Output system are included, even though they are outside of the Mode's state, because they are needed to restore the complete setup. Persistent System settings (for example, GPIB address) are not affected by either a Mode Preset or Restore Mode Defaults, nor are they included in a saved State file.

Since each state file is only for one Mode, the settings for other Modes are unaffected when it is loaded. Recall State will cause a mode switch if the state being recalled is not from the current active mode.

After the recall completes, the message "File <filename> recalled" or "Recalled State Register <register number>" is displayed.

For rapid recalls, the State menu lists 16 registers that you can choose from to recall. Pressing a Register key initiates the recall. You can also select a file from which to recall.

The default path for all State Files is:

My Documents\<<mode name>\state

where <mode name> is the parameter used to select the mode with the INST:SEL command (for example, SA for the Spectrum Analyzer).

See "[More Information](#)" on page 410.

Key Path	Recall
Mode	All
Remote Command	:MMEMory:LOAD:STATe <filename>
Example	:MMEM:LOAD:STAT "myState.state" This recalls the file myState.state on the default path
Example	MMEM:LOAD:STAT "MyStateFile.state" This loads the state file data (on the default file directory path) into the instrument state.
Notes	<p>When you pick a file to recall, the analyzer first verifies that the file is recallable in the current instrument by checking the software version and model number of the instrument. If everything matches, a full recall proceeds by aborting the currently running measurement, clearing any pending operations, and then loading the State from the saved state file. You can open state files from any mode, so recalling a State file switches to the mode that was active when the save occurred. After switching to the mode of the saved state file, mode settings and data (if any for the mode) are loaded with values from the saved file. The saved measurement of the mode becomes the newly active measurement and the data relevant to the measurement (if there is any) is recalled.</p> <p>If there is a mismatch between file version or model number or instrument version or model number, the recall function tries to recall as much as possible and returns a warning message. It may limit settings that differ based on model number, licensing or version number.</p> <p>After recalling the state, the Recall State function does the following:</p> <ul style="list-style-type: none"> • Makes the saved measurement for the mode the active measurement. • Clears the input and output buffers. • Status Byte is set to 0. • Executes a *CLS <p>If the file specified is empty an error is generated. If the specified file does not exist, another error is generated. If there is a mismatch between the file and the proper file type, an error is generated. If</p>

	there is a mismatch between file version or model number or instrument version or model number, a warning is displayed. Then it returns to the State menu and File Open dialog goes away. After the Recall, the analyzer exits the Recall menu and returns to the previous menu.
Backwards Compatibility SCPI	:MMEMory:LOAD:STATe 1,<filename> For backwards compatibility, the above syntax is supported. The "1" is simply ignored.
Initial S/W Revision	Prior to A.02.00

More Information

In measurements that support saving Traces, for example, Swept SA, the Trace data is saved along with the State in the State file. When recalling the State, the Trace data is recalled as well. Traces are recalled exactly as they were stored, including the writing mode and update and display modes. If a Trace was updating and visible when the State was saved, it will come back updating and visible, and its data will be rewritten right away. When you use State to save and recall traces, any trace whose data must be preserved should be placed in View or Blank mode before saving.

The following table describes the Trace Save and Recall possibilities:

You want to recall state and one trace's data, leaving other traces unaffected.	Save Trace+State from 1 trace. Make sure that no other traces are updating (they should all be in View or Blank mode) when the save is performed.	On Recall, specify the trace you want to load the one trace's data into. This trace will load in View. All other traces' data will be unaffected, although their trace mode will be as it was when the state save was performed.
You want to recall all traces	Save Trace+State from ALL traces.	On Recall, all traces will come back in View (or Blank if they were in Blank or Background when saved)
You want all traces to load exactly as they were when saved.	Save State	On recall, all traces' mode and data will be exactly as they were when saved. Any traces that were updating will have their data immediately overwritten.

From File...

When you press "From File", the analyzer brings up a Windows dialog and a menu entitled "File Open." This menu allows you to navigate to the various fields in the Windows dialog without using a keyboard or mouse. The Tab and Arrow keys can also be used for dialog navigation.

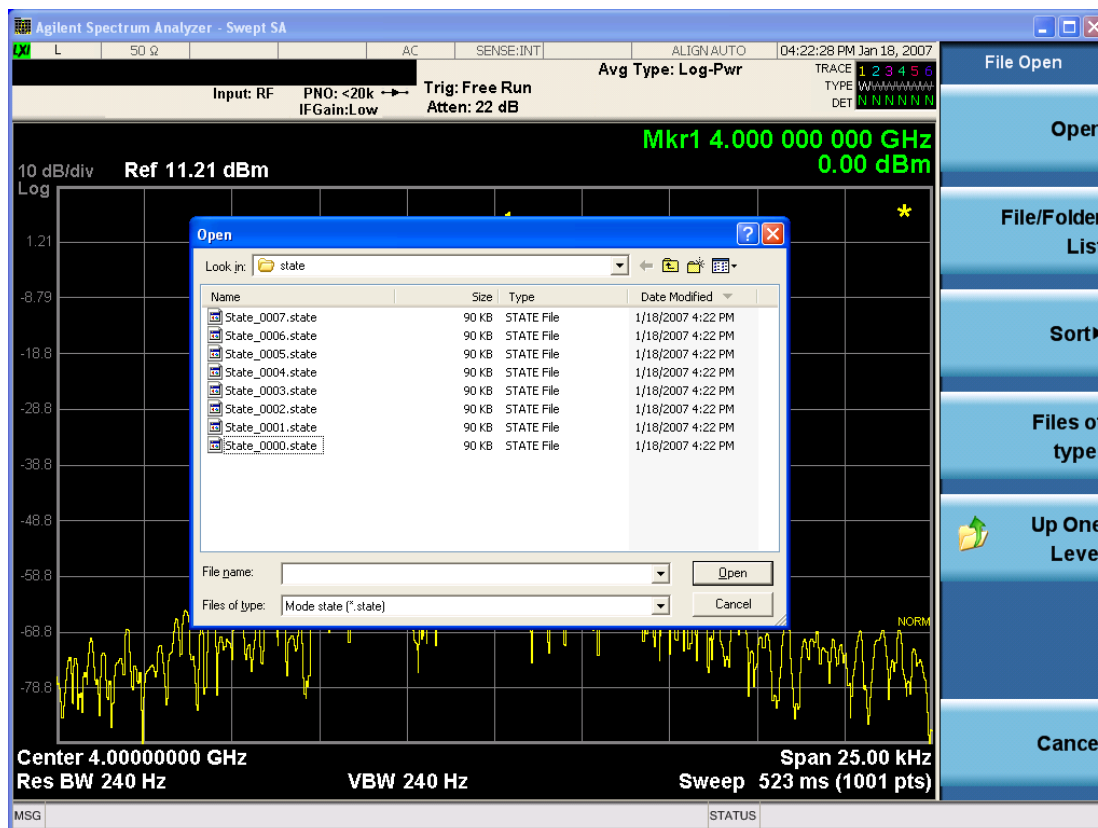

Listed below are the functions of the various fields in the dialog, and the corresponding softkeys:

Open

Performs the recall of the specified file. While the recall is being performed, the floppy icon appears briefly in the Meas bar.

File/Folder List

Enables you to navigate to the center of the dialog that contains the list of files and folders. Once here you can get information about the file and use the tab keys to navigate to the other fields in the dialog, such as Look In.

Look In

The Look In field shows the path from which the file will be recalled and allows you to change the path using the up and down arrow keys to navigate to other paths; the Enter key to open a directory; and the Backspace key to go back one directory. The **Look In field** first uses the last path from the Save As dialog **Save In:** path for that same file type. There is no softkey for directly navigating to the Look In field, but you can use the left tab to get here from the File/Folder List.

User specified paths are remembered when you leave and return to a Mode and are reset back to the default using Restore Mode Defaults.

Sort

Accesses a menu that enables you to sort the files within the File Open dialog. Only one sorting type can be selected at a time and the sorting happens immediately. The sorting types are By Date, By Name, By extension, and By Size.

Files of Type

This field shows the file suffix for the type of file you have selected to recall. For example, if you navigated here while recalling State, "Mode state (*.state)" is in the field. If you navigated here while recalling Trace, ""Mode state (*.trace)" is in the field. If you navigated here while importing a trace data file, "Trace Data (*.csv)" is in the field. For some file types, there is more than one choice in the dropdown menu, which you can select by using the up and down arrow keys and Enter.

Up One Level

This key corresponds to the icon of a folder with the up arrow that is in the tool bar of the dialog. When pressed, it causes the file and folder list to navigate up one level in the directory structure. The Backspace key does the same thing.

Cancel

This key corresponds to the Cancel selection in the dialog. It causes the current **Open** request to be cancelled. The ESC key does the same thing.

Key Path	Recall, State
Notes	Brings up the Open dialog for recalling a State Save Type
Initial S/W Revision	Prior to A.02.00

Edit Register Names

You may enter a custom name on any of the Register keys, to help you remember what you are using that state to save. To do this, press the Edit Register Names key, choose the register whose name you wish to edit, and then enter the desired label using the Alpha Editor or an external PC keyboard.

The maximum number of characters that can be added is 30. In most cases, 30 characters will fit on two lines of the key.

For more information and the SCPI command, see Edit Register Names under the Save, State function.

Key Path	Recall, State
Mode	All
Dependencies	N9060A-7FP or N9060B-2FP license required to edit the register names. When the feature is not licensed, sending the SCPI command generates an error, -221, "Settings conflict;Option not available"
Initial S/W Revision	A.11.00

Register 1 thru Register 16

Selecting any one of these register keys causes the State of the mode from the specified Register to be recalled. Each of the register keys annotates whether it is empty or at what date and time it was last

modified. In addition, you can use the Edit Register Names key under Save, State to enter custom names for each register.

Registers are shared by all modes, so recalling from any one of the registers will cause a mode switch to the mode that was active when the save to the Register occurred.

Although these 16 registers are the only registers available from the front panel, there are 128 state registers available in the instrument. Registers 17–128 are only available from the SCPI interface, using the *RCL command.

After the recall completes, the message "Register <register number> recalled" appears in the message bar. If you are in the Spectrum Analyzer Mode, and you are recalling a register that was saved in the Spectrum Analyzer Mode, then after the recall, you will still be in the Recall Register menu. If the Recall causes you to switch modes, then after the Recall, you will be in the Frequency menu.

If a requested register is empty an error is generated.

Key Path	Recall, State
Example	*RCL 1
Range	1–16 from front panel, 1–128 from SCPI
Readback	Date and time with seconds resolution are displayed on the key OR A custom name of up to 30 characters entered using the Save, State, Edit Register Names key OR “(empty)” if no prior save operation has been performed to this register.
Initial S/W Revision	Prior to A.02.00
Modified at S/W Revision	Prior to A.11.00

Register 1 thru Register 16

Selecting any one of these register keys causes the State of the mode from the specified Register to be recalled. Each of the register keys annotates whether it is empty or at what date and time it was last modified. In addition, you can use the Edit Register Names key under Save, State to enter custom names for each register.

Registers are shared by all modes, so recalling from any one of the registers will cause a mode switch to the mode that was active when the save to the Register occurred.

Although these 16 registers are the only registers available from the front panel, there are 128 state registers available in the instrument. Registers 17–128 are only available from the SCPI interface, using the *RCL command.

After the recall completes, the message "Register <register number> recalled" appears in the message bar. If you are in the Spectrum Analyzer Mode, and you are recalling a register that was saved in the Spectrum Analyzer Mode, then after the recall, you will still be in the Recall Register menu. If the Recall causes you to switch modes, then after the Recall, you will be in the Frequency menu.

If a requested register is empty an error is generated.

Key Path	Recall, State
Example	*RCL 1
Range	1-16 from front panel, 1-128 from SCPI
Readback	Date and time with seconds resolution are displayed on the key OR A custom name of up to 30 characters entered using the Save, State,Edit Register Names key OR “(empty)” if no prior save operation has been performed to this register.
Initial S/W Revision	Prior to A.02.00
Modified at S/W Revision	Prior to A.11.00

Trace

This key selects Trace as the data type to be imported. When pressed a second time, it brings up the Trace Menu, which lets you select the Trace into which the data will be imported.

The trace file contains “meta” data which describes the state of the analyzer when the trace was exported (see Trace File Contents). If the meta data in the file does not match the current SA state, the “invalid data indicator” (*) is displayed.

Key Path	Recall, Data
Remote Command	:MMEMory:LOAD:TRACe:DATA TRACE1 TRACE2 TRACE3 TRACE4 TRACE5 TRACE6,<filename>
Example	:MMEM:LOAD:TRAC DATA TRACE2, "myTrace2.csv" Imports the 2nd trace from the file myTrace2.csv in the current path. The default path is My Documents\SA\data\traces
Dependencies	For SA measurements, a trace cannot be recalled from a trace file that was exported with ALL traces selected. A trace cannot be imported if the number of trace points in the file do not match the number of sweep points currently set for the measurement. If this happens, an error message is generated. Errors are reported if the file is empty or missing, or if the file type does not match, or if there is a mismatch between the file type and the destination data type. If any error occurs while trying to load a file manually (as opposed to during remote operation), the analyzer returns to the Import Data menu and the File Open dialog goes away.
Couplings	When a trace is imported, Trace Update is always turned OFF for that trace and Trace Display is always turned ON.
Readback	Selected Trace
Status Bits/OPC dependencies	Sequential - aborts the current measurement.
Initial S/W Revision	Prior to A.02.00

Import Trace Data

Enables you to import previously saved trace data into a Data Register and optionally display it. Selecting this key displays a menu that enables you to select the destination data register, and also enables you to choose whether or not to display the recalled data in the currently selected trace. After making these selections, select Open... and use the file dialog to select the file you want to recall.

Recalling trace data into an already used Data Register overwrites the previous data. If the data register is displayed on any trace, the display is updated to reflect the new data.

The SCPI command

```
:MMEM:LOAD:TRAC:DATA D1|D2|D3|D4|D5|D6,<filename>
```

recalls data into a specified register, but does not display it in the selected trace. Use the command

```
:DISP:<meas>:TRAC<n>:FEED D1|D2|D3|D4|D5|D6
```

to display the register in the desired trace.

It is possible to recall trace data saved by other VXA measurements, or measurements made using the LTE, LTETDD, iDEN, or 89601 applications.

Key Path	Recall, Data (Import)
Mode	VSA, LTE, LTETDD, IDEN
Remote Command	:MMEMory:LOAD:TRACe:DATA D1 D2 D3 D4 D5 D6,<filename>[,CSV TXT SDF MAT4 MAT HDF5 BIN]
Example	:MMEM:LOAD:TRAC:DATA D1,"Trc1.txt",TXT
Notes	<p>The Open: dialog box has the following filter options when you are recalling trace data::</p> <ul style="list-style-type: none"> • CSV (Comma delimited) (*.csv) • SDF (Fast) (*.sdf;*.dat) • Text (Tab delimited) (*.txt) <p>The file must have the same format as that created by the Export Recorded Data command.</p> <p>The SCPI command has an optional file format parameter. If you do not include this parameter in the SCPI command, the file format is determined by the file name extension. If no file extension is recognized, the file is scanned to determine the format.</p> <p>If you are not licensed to recall a particular file type, then error -203.9010 is returned. If the file format cannot be determined or the file cannot be recalled successfully, then error -250.5290 is returned. If the recall is successful, then advisory 0.1600 is shown.</p>
State Saved	No
Readback	Data 1 Data 2 Data 3 Data 4 Data 5 Data 6

Data 1

Selects the Data 1 register as the destination for the imported data.

Key Path	Recall, Data (Import), Trace (to)
Mode	VSA, LTE, LTETDD, IDEN

Data 2

Selects the Data 2 register as the destination for the imported data.

Key Path	Recall, Data (Import), Trace (to)
Mode	VSA, LTE, LTETDD, IDEN

Data 3

Selects the Data 3 register as the destination for the imported data.

Key Path	Recall, Data (Import), Trace (to)
Mode	VSA, LTE, LTETDD, IDEN

Data 4

Selects the Data 4 register as the destination for the imported data.

Key Path	Recall, Data (Import), Trace (to)
Mode	VSA, LTE, LTETDD, IDEN

Data 5

Selects the Data 5 register as the destination for the imported data..

Key Path	Recall, Data (Import), Trace (to)
Mode	VSA, LTE, LTETDD, IDEN

Data 6

Selects the Data 6 register as the destination for the imported data.

Key Path	Recall, Data (Import), Trace (to)
Mode	VSA, LTE, LTETDD, IDEN

Display in Selected Trace

Enables you to select whether the recalled trace data is displayed in the current Trace.

Key Path	Recall, Data (Import), Trace (to)
----------	-----------------------------------

Mode	VSA, LTE, LTETDD, IDEN
State Saved	No

Open...

When you press “Open”, the analyzer brings up a Windows dialog and a menu entitled “**File Open.**” This menu allows you to navigate to the various fields in the Windows dialog without using a keyboard or mouse. The Tab and Arrow keys can also be used for dialog navigation.

See "[From File...](#)" on page 1200 in Recall, State, for a full description of this dialog and menu.

Key Path	Recall, Data
Notes	The key location is mode-dependent and will vary. Brings up Open dialog for recalling a <mode specific> Save Type
Initial S/W Revision	Prior to A.02.00

Restart

The Restart function restarts the current sweep, or measurement, or set of averaged/held sweeps or measurements. If you are Paused, pressing Restart does a Resume.

The Restart function is accessed in several ways:

- Pressing the Restart key
- Sending the remote command INIT:IMMEDIATE
- Sending the remote command INIT:RESTART

See "[More Information](#)" on page 418

Key Path	Front-panel key
Remote Command	:INITiate[:IMMEDIATE] :INITiate:RESTART
Example	:INIT:IMM :INIT:REST
Notes	:INITiate:RESTART and :INITiate:IMMEDIATE perform exactly the same function.
Couplings	Resets average/hold count k. For the first sweep overwrites all active (update=on) traces with new current data. For application modes, it resets other parameters as required by the measurement.
Status Bits/OPC dependencies	This is an Overlapped command. The STATus:OPERation register bits 0 through 8 are cleared. The STATus:QUESTionable register bit 9 (INTegrity sum) is cleared. The SWEEPING bit is set. The MEASURING bit is set.
Backwards Compatibility Notes	For Spectrum Analysis mode in ESA and PSA, the Restart hardkey and the INITiate:RESTART command restart trace averages (displayed average count reset to 1) for a trace in Clear Write, but did not restart Max Hold and Min Hold. In the X-Series, the Restart hardkey and the INITiate:RESTART command restart not only Trace Average, but MaxHold and MinHold traces as well. For wireless comms modes in ESA and PSA, the Restart hardkey and the INITiate:RESTART command restart every measurement, which includes all traces and numeric results. There is no change to this operation.
Initial S/W Revision	Prior to A.02.00

More Information

The **Restart** function first aborts the current sweep/measurement as quickly as possible. It then resets the sweep and trigger systems, sets up the measurement and initiates a new data measurement sequence with a new data acquisition (sweep) taken once the trigger condition is met.

If the analyzer is in the process of aligning when **Restart** is executed, the alignment finishes before the restart function is performed.

Even when set for Single operation, multiple sweeps may be taken when Restart is pressed (for example, when averaging/holding is on). Thus when we say that **Restart** "restarts a measurement," we may mean:

- It restarts the current sweep
- It restarts the current measurement
- It restarts the current set of sweeps if any trace is in Trace Average, Max Hold or Min Hold
- It restarts the current set of measurements if Averaging, or Max Hold, or Min Hold is on for the measurement
- depending on the current settings.

With **Average/Hold Number** (in **Meas Setup** menu) set to 1, or Averaging off, or no trace in Trace Average or Hold, a single sweep is equivalent to a single measurement. A single sweep is taken after the trigger condition is met; and the analyzer stops sweeping once that sweep has completed. However, with **Average/Hold Number** >1 and at least one trace set to **Trace Average, Max Hold, or Min Hold (SA Measurement)** or **Averaging on (most other measurements)**, multiple sweeps/data acquisitions are taken for a single measurement. The trigger condition must be met prior to each sweep. The sweep is stopped when the average count k equals the number N set for **Average/Hold Number**. A measurement average usually applies to all traces, marker results, and numeric results; but sometimes it only applies to the numeric results.

Once the full set of sweeps has been taken, the analyzer will go to idle state. To take one more sweep without resetting the average count, increment the average count by 1, by pressing the step up key while **Average/Hold Number** is the active function, or sending the remote command `CALC:AVER:TCON UP`.

Save

The Save menu lets you choose what you want to save and where you want to save it. Among the types of files you can save are **States**, **Traces**, and **Screen Images**. In addition, an Export (Data) option lets you save a number of data types as CSV files for easy import into Excel and other spreadsheet programs.

Key Path	Front-panel key
Mode	All
Notes	No remote command for this key specifically, but the :MMEM:STORe command is available for specific file types. An example is :MMEM:STOR:STATe <filename>.
Initial S/W Revision	Prior to A.02.00

State

The Save State menu lets you choose a register or file for saving the state.

The content of a state file includes all of the settings and data required to return the analyzer as closely as possible to the Mode it was in, with the exact settings which were in place, when the save occurred. The Mode settings in each state file include the settings that are affected by Mode Preset, as well as the additional settings affected by Restore Mode Defaults; all of the Mode's settings. In addition, all of the settings of the Input/Output system are included, even though they are outside of the Mode's state, because they are needed to restore the complete setup. Persistent System settings (for example, Verbose SCPI) are not affected by either Mode Preset or Restore Mode Defaults, nor are they included in a saved State file.

After the save completes, the message "File <filename> saved" or "State Register <register number> saved" is displayed.

For rapid saving, the State menu lists 16 registers to save to. Pressing a Register key initiates the save. You can also select a file to save to.

The default path for all State Files is:

My Documents\<<mode name>\state

where <mode name> is the parameter used to select the mode with the INST:SEL command (for example, SA for the Spectrum Analyzer).

Key Path	Save
Mode	All
Remote Command	:MMEMory:STORe:STATe <filename>
Example	MMEM:STOR:STATe "MyStateFile.state" This stores the current instrument state data in the file MyStateFile.state in the default directory.
Notes	Both single and double quotes are supported for any filename parameter over remote. After saving to a register, that register's menu key is updated with the date the time, unless a custom label has been entered for that key. After saving to a register, you remain in the Save State menu, so that you can see the Register key

update. After saving to a file, the analyzer automatically returns to the previous menu and any Save As dialog goes away.

Backwards Compatibility SCPI	:MMEMory:STORe:STATe 1,<filename>
Initial S/W Revision	Prior to A.02.00

To File . . .

When you press “To File”, the analyzer brings up a Windows dialog and a menu entitled “**Save As.**” This menu allows you to navigate to the various fields in the Windows dialog without using a keyboard or mouse. The Tab and Arrow keys can also be used for dialog navigation.

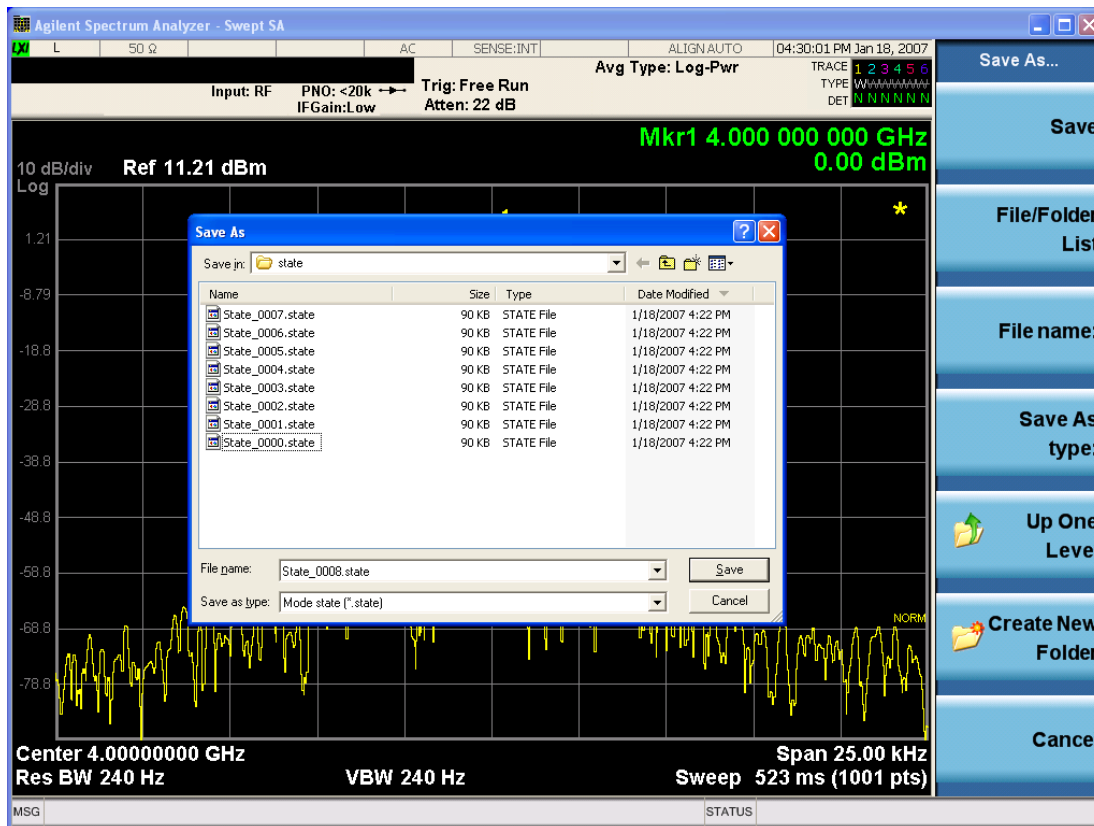

The Listed below

are the functions of the various fields in the dialog, and the corresponding softkeys:

Save

Performs the save to the specified file of the selected type. If the file already exists, a dialog will appear that allows you to replace the existing file by selecting OK, or you can Cancel the request. If you select OK, the file will be overwritten. Using the C: drive is strongly discouraged, since it runs the risk of being overwritten during an instrument software upgrade.

While the save is being performed, the floppy icon appears briefly in the Meas bar.

File/Folder List

Enables you to navigate to the center of the dialog that contains the list of files and folders. Once here you can get information about the file and use the tab keys to navigate to the other fields in the dialog, such as Save In.

Save In

The Save In field shows the path to which the file will be saved and allows you to change the path using the up and down arrow keys to navigate to other paths; the Enter key to open a directory; and the Backspace key to go back one directory. The **Save In field** defaults to the default path for this type of file and remembers the last path you used to save this type of file. There is no softkey for directly navigating to the Save In field but you can use left tab to get here from the File/Folder List.

User specified paths are remembered when you leave and return to a Mode and are reset back to the default using Restore Mode Defaults.

File Name

The File Name field is initially loaded with an automatically generated filename specific to the appropriate Save Type. The automatically generated filename is guaranteed not to conflict with any filename currently in the directory. You may replace or modify this filename using the File Name key. See the ["Quick Save " on page 1196](#) documentation for more on the automatic file naming algorithm.

When you press the File Name key the analyzer displays the Alpha Editor. Use the knob to choose the letter to add and the front-panel Enter key to add the letter to the file name. The BK character moves you back and the FW character moves you forward in the filename. The Select key on the front panel generates a space character. When you are done entering the filename press the Done softkey. This returns back to the **File Open** dialog and menu, but does not cause the save to occur.

Save As Type

This field shows the file suffix for the type of file you have selected to save. For example, if you navigated here while saving State, "Mode state (*.state)" is in the field. If you navigated here from saving Trace, ""Mode state (*.trace)" is in the field. If you navigated here while exporting a trace data file, "Trace Data (*.csv)" is in the field. For some file types, there is more than one choice in the dropdown, which you can select by using the up and down arrow keys and Enter.

Up One Level

This key corresponds to the icon of a folder with the up arrow that is in the tool bar of the dialog. When pressed, it causes the file and folder list to navigate up one level in the directory structure. The Backspace key does the same thing.

Create New Folder

This key corresponds to the icon of a folder with the "*" that is in the tool bar of the dialog. When pressed, a new folder is created in the current directory with the name **New Folder** and you can enter a new folder name using the Alpha Editor.

Cancel

This key corresponds to the Cancel selection in the dialog. It causes the current **Save As** request to be cancelled. The ESC key does the same thing.

Key Path	Save, State
Mode	All
Notes	Brings up Save As dialog for saving a State Save Type
Initial S/W Revision	Prior to A.02.00

Edit Register Names

You may enter a custom name on any of the Register keys, to help you remember what you are using that state to save. To do this, press the Edit Register Names key, choose the register whose name you wish to edit, and then enter the desired label using the Alpha Editor or an external PC keyboard.

The maximum number of characters that can be added is 30. In most cases, 30 characters will fit on two lines of the key.

See ["More Information" on page 423](#)

Key Path	Save, State
Mode	All
Remote Command	:MMEMory:REGister:STATe:LABel <reg number>,"label" :MMEMory:REGister:STATe:LABel? <reg number>
Example	:MMEM:REG:STAT:LAB 1,"my label"
Notes	<reg number> is an integer from 1 to 16. If the SCPI specifies an invalid register number an error message is generated, -222,"Data out of range;Invalid register label number" "label" is a string from 0 to 30 characters in length. If a label exceeds 30 characters, an error message is generated, -150,"String data error;Label clipped to 30 characters" "label" of length 0 erases the custom label and restores the default (time and date) label. E.g.: :MMEM:REG:STAT:LAB 1,""
Dependencies	N9060A-7FP or N9060B-2FP license required to edit the register names. When the feature is not licensed, sending this command generates an error, -221,"Settings conflict;Option not available"
Preset	The names are unaffected by Preset or power cycle but are set to the default label (time and date) on a "Restore System Defaults->Misc"
Initial S/W Revision	A.11.00

More Information

When you edit one of the register names, the time and date field will be replaced by the custom name.

If you delete all the characters in the custom name, it restores the default (time and date).

The register names are stored within the state files, but they are not part of the instrument state; that is, once you have edited a register name, loading a new state will not change that register name. Another consequence of this is that the names will be persistent through a power cycle. Also, if a named state file is transferred to another analyzer, it will bring its custom name along with it.

If you try to edit the name of an empty register, the analyzer will first save the state to have a file to put the name in. If you load a named state file into an analyzer with older firmware it will ignore the metadata.

The *SAV and *RCL commands will not be affected by the custom register names, nor will the MMEM commands.

Register 1 thru Register 16

Selecting any one of these register menu keys causes the State of the currently active mode to be saved to the specified Register. The registers are provided for rapid saving and recalling, since you do not need to specify a filename or navigate to a file. Each of the register menu keys annotates whether it is empty or at what date and time it was last modified. In addition, you can use the Edit Register Names key to enter custom names for each register.

Although these 16 registers are the only registers available from the front panel, there are 128 state registers available in the instrument. Registers 17–128 are only available from the SCPI interface, using the *SAV command.

There is one set of 128 state registers in the instrument, not one set for each Mode. When a state is saved, the Mode it was saved from is saved with it; then when it is recalled, the instrument switches to that Mode.

After the save completes, the corresponding register menu key annotation is updated with the date and time and the message "Register <register number> saved" is displayed.

Key Path	Save, State
Mode	All
Example	*SAV 1
Range	1–16 from front panel, 1–128 from SCPI
Readback	Date and time with seconds resolution are displayed on the key OR A custom name of up to 30 characters entered using the Edit Register Names key OR “(empty)” if no prior save operation has been performed to this register.
Initial S/W Revision	Prior to A.02.00
Modified at S/W Revision	A.11.00

Register 1 thru Register 16

Selecting any one of these register menu keys causes the State of the currently active mode to be saved to the specified Register. The registers are provided for rapid saving and recalling, since you do not need to specify a filename or navigate to a file. Each of the register menu keys annotates whether it is empty or at what date and time it was last modified. In addition, you can use the Edit Register Names key to enter custom names for each register.

Although these 16 registers are the only registers available from the front panel, there are 128 state registers available in the instrument. Registers 17–128 are only available from the SCPI interface, using the *SAV command.

There is one set of 128 state registers in the instrument, not one set for each Mode. When a state is saved, the Mode it was saved from is saved with it; then when it is recalled, the instrument switches to that Mode.

After the save completes, the corresponding register menu key annotation is updated with the date and time and the message "Register <register number> saved" is displayed.

Key Path	Save, State
Mode	All
Example	*SAV 1
Range	1–16 from front panel, 1–128 from SCPI
Readback	Date and time with seconds resolution are displayed on the key OR A custom name of up to 30 characters entered using the Edit Register Names key OR “(empty)” if no prior save operation has been performed to this register.
Initial S/W Revision	Prior to A.02.00
Modified at S/W Revision	A.11.00

Mass Storage Catalog (Remote Command Only)

Key path	SCPI Only
Remote Command	:MMEMory:CATalog? [<directory_name>]
Notes	The string must be a valid logical path. Queries disk usage information (drive capacity, free space available) and obtains a list of files and directories in a specified directory in the following format: <numeric_value>,<numeric_value>,{<file_entry>} It returns two numeric parameters and as many strings as there are files and directories. The first parameter indicates the total amount of storage currently used in bytes. The second parameter indicates the total amount of storage available, also in bytes. The <file_entry> is a string. Each <file_entry> indicates the name, type, and size of one file in the directory list: <file_name>,<file_type>,<file_size> As the windows file system has an extension that indicates file type, <file_type> is always empty. <file_size> provides the size of the file in bytes. For directories, <file_entry> is surrounded by square brackets and both <file_type> and <file_size> are empty
Initial S/W Revision	Prior to A.02.00

Mass Storage Change Directory (Remote Command Only)

Key path	SCPI Only
Remote Command	:MMEMory:CDIRectory [<directory_name>] :MMEMory:CDIRectory?

Notes	<p>The string must be a valid logical path.</p> <p>Changes the default directory for a mass memory file system. The <directory_name> parameter is a string. If no parameter is specified, the directory is set to the *RST value.</p> <p>At *RST, this value is set to the default user data storage area, that is defined as System.Environment.SpecialFolder.Personal.</p> <p>Query returns full path of the default directory.</p>
Initial S/W Revision	Prior to A.02.00

Mass Storage Copy (Remote Command Only)

Key path	SCPI Only
Remote Command	:MMEMory:COpy <string>,<string>[,<string>,<string>]
Notes	<p>The string must be a valid logical path.</p> <p>Copies an existing file to a new file or an existing directory to a new directory.</p> <p>Two forms of parameters are allowed. The first form has two parameters. In this form, the first parameter specifies the source, and the second parameter specifies the destination.</p> <p>The second form has four parameters. In this form, the first and third parameters specify the source. The second and fourth parameters specify the directories. The first pair of parameters specifies the source. The second pair specifies the destination. An error is generated if the source doesn't exist or the destination file already exists.</p> <p>This command will generate an "access denied" error if the destination is a restricted folder (e.g., C:\Windows) and the current user does not have Power User or Administrator privileges.</p>

Mass Storage Device Copy (Remote Command Only)

This command transfers data to/from a file and a peripheral device.

Key path	SCPI Only
Remote Command	:MMEMory:COpy:DEvice <source_string>,<dest_string>
Notes	<p>The strings must be a valid logical path or a valid device keyword. If the dest_string is a device keyword, the data is copied from the source file to the device. If the source_string is a device keyword, the data is copied to the source file from the device.</p> <p>Valid device keywords are:</p> <p>SNS (smart noise source)</p> <p>An error is generated if the file or device is not found.</p>

Mass Storage Delete (Remote Command Only)

Key path	SCPI Only
Remote Command	:MMEMory:DElete <file_name>[,<directory_name>]

Notes	The string must be a valid logical path. Removes a file from the specified directory. The <file_name> parameter specifies the file name to be removed. This command will generate an “access denied” error if the file is in a restricted folder (e.g., C:\Windows) and the current user does not have Power User or Administrator privileges.
Initial S/W Revision	Prior to A.02.00

Mass Storage Data (Remote Command Only)

Creates a file containing the specified data OR queries the data from an existing file.

Key path	SCPI Only
Remote Command	:MMEMory:DATA <file_name>, <data> :MMEMory:DATA? <file_name>
Notes	The string must be a valid logical path. The command form is MMEMory:DATA <file_name>,<data>. It loads <data> into the file <file_name>. <data> is in 488.2 block format. <file_name> is string data. The query form is MMEMory:DATA? <file_name> with the response being the associated <data> in block format.
Initial S/W Revision	Prior to A.02.00

Mass Storage Make Directory (Remote Command Only)

Key path	SCPI Only
Remote Command	:MMEMory:MDIRectory <directory_name>
Notes	The string must be a valid logical path. Creates a new directory. The <directory_name> parameter specifies the name to be created. This command will generate an “access denied” error if the new directory would be in a restricted folder (e.g., C:\Windows) and the current user does not have Power User or Administrator privileges.
Initial S/W Revision	Prior to A.02.00

Mass Storage Move (Remote Command Only)

Key path	SCPI Only
Remote Command	:MMEMory:MOVE <string>,<string>[,<string>,<string>]
Notes	The string must be a valid logical path. Moves an existing file to a new file or an existing directory to a new directory. Two forms of parameters are allowed. The first form has two parameters. In this form, the first parameter specifies the source, and the second parameter specifies the destination. The second form has four parameters. In this form, the first and third parameters specify the source.

	<p>The second and fourth parameters specify the directories. The first pair of parameters specifies the source. The second pair specifies the destination. An error is generated if the source doesn't exist or the destination file already exists.</p> <p>This command will generate an "access denied" error if the destination is a restricted folder (e.g., C:\Windows) and the current user does not have Power User or Administrator privileges.</p>
Initial S/W Revision	Prior to A.02.00

Mass Storage Remove Directory (Remote Command Only)

Key path	SCPI Only
Remote Command	<code>:MMEMory:RDIRECTory <directory_name></code>
Notes	<p>The string must be a valid logical path.</p> <p>Removes a directory. The <directory_name> parameter specifies the directory name to be removed. All files and directories under the specified directory shall also be removed.</p> <p>This command will generate an "access denied" error if the folder is a restricted folder (e.g., C:\Windows) or is in a restricted folder and the current user does not have Power User or Administrator privileges.</p>
Initial S/W Revision	Prior to A.02.00

Data (Export)

Exporting a data file stores data from the current measurement to mass storage files. The Export Menu only contains data types that are supported by the current measurement.

Since the commonly exported data files are in .csv format, the data can be edited by you prior to importing. This allows you to export a data file, manipulate the data in Excel (the most common PC Application for manipulating .csv files) and then import it.

Selecting an Export Data menu key will not actually cause the exporting to occur, since the analyzer still needs to know where you wish to save the data. Pressing the Save As key in this menu brings up the Save As dialog and Save As menu that allows you to specify the destination file and directory. Once a filename has been selected or entered in the Open menu, the export will occur as soon as the Save key is pressed.

Key Path	Save
Mode	All
Notes	<p>The menu is built from whatever data types are available for the mode. So the key locations in the sub menu will vary.</p> <p>No SCPI command directly controls the Data Type that this key controls. The Data Type is included in the MMEM:STORe commands.</p>
Dependencies	If a file type is not used by a certain measurement, that type is grayed out for that measurement. The key for a file type will not show at all if there are no measurements in the Mode that support it.
Preset	Is not affected by a Preset or shutdown, but is reset during Restore Mode Defaults
Readback	The data type that is currently selected
Initial S/W Revision	Prior to A.02.00

Export Trace Data

Enables you to export trace data with (optional) associated headers. Selecting this key displays a menu that enables you to choose which Trace to save (default is the selected Trace) and whether or not to save headers with the data. The header information is used by the VXA application when saved trace data is recalled, and enables it to be displayed with the same formatting and scaling that it had when saved. If headers are not saved, the scaling and format are set to default values when the trace is recalled. After making these selections, press Save As... and use the file dialog to choose a file name and format for the saved data.

Trace data can be exported in several different formats. Text and comma-separated variable (CSV) formats are useful for viewing the data or importing it to a spreadsheet program. The other formats are binary and thus more compact. Trace data files can be recalled for viewing into other VXA, LTE, LTETDD, iDEN, or 89601 measurements.

Key Path	Save, Data (Export)
Mode	VSA, LTE, LTETDD, IDEN
Remote Command	:MMEMory:STORe:TRACe:DATA TRACE1 TRACE2 TRACE3 TRACE4 TRACE5 TRACE6, "<filename>"[,CSV TXT SDF MAT4 MAT HDF5 BIN[,OFF ON 0 1]]
Example	:MMEM:STOR:TRAC:DATA TRACE1, "TRC1.TXT", TXT, ON
Notes	<p>The Save As... dialog box has the following format options when you are saving trace data:</p> <ul style="list-style-type: none"> • CSV (Comma delimited) (*.csv) • SDF (Fast) (*.sdf;*.dat) • Text (Tab delimited) (*.txt) <p>File format saved depends on selection. The appropriate file extension is appended to the filename if it is not supplied by the user.</p> <p>If the SCPI command includes just a file name, the file format is determined by the filename extension, which must be one of the choices above. *.sdf or an unrecognized extension chooses the SDF fast format. If the optional file format enumerator is included in the command, then this determines the file format and the file extension is ignored. The optional binary parameter determines if file headers are saved. The default is ON. If file headers are not wanted, use the optional "OFF" parameter.</p> <p>The optional Boolean parameter determines whether headers are saved in the file. By default the headers are saved.</p> <p>If you are not licensed to save a particular file type, then error -203.9010 is returned. If an invalid file format is specified or the file cannot be saved successfully, then error -25x is returned. If the save is successful, then advisory 0.1500 is shown.</p>
State Saved	No
Readback	(Trace 1 Trace 2 Trace 3 Trace 4 Trace 5 Trace 6)(with without) headers

Trace 1

Selects the Trace 1 register as the destination for the imported data.

Key Path	Save, Data (Export), Trace
Mode	VSA, LTE, LTETDD, IDEN

Trace 2

Selects the Trace 2 register as the destination for the imported data.

Key Path	Save, Data (Export), Trace
Mode	VSA, LTE, LTETDD, IDEN

Trace 3

Selects the Trace 3 register as the destination for the imported data.

Key Path	Save, Data (Export), Trace
Mode	VSA, LTE, LTETDD, IDEN

Trace 4

Selects the Trace 4 register as the destination for the imported data.

Key Path	Save, Data (Export), Trace
Mode	VSA, LTE, LTETDD, IDEN

Trace 5

Selects the Trace 5 register as the destination for the imported data.

Key Path	Save, Data (Export), Trace
Mode	VSA, LTE, LTETDD, IDEN

Trace 6

Selects the Trace 6 register as the destination for the imported data.

Key Path	Save, Data (Export), Trace
Mode	VSA, LTE, LTETDD, IDEN

Include Header

Enables you to select whether or not the saved trace data includes header information describing scaling, formatting, etc.

Key Path	Save, Data (Export), Trace
Mode	VSA, LTE, LTETDD, IDEN
State Saved	No

Save As . . .

When you press “Save As”, the analyzer brings up a Windows dialog and a menu entitled “**Save As.**” This menu allows you to navigate to the various fields in the Windows dialog without using a keyboard or mouse. The Tab and Arrow keys can also be used for dialog navigation.

See ["To File . . ." on page 1211](#) in Save, State for a full description of this dialog and menu.

The default path for saving files is:

For all of the Trace Data Files:

My Documents\`<mode name>`\data\traces

For all of the Limit Data Files:

My Documents\`<mode name>`\data\limits

For all of the Measurement Results Data Files:

My Documents\`<mode name>`\data\`<measurement name>`\results

For all of the Capture Buffer Data Files:

My Documents\`<mode name>`\data\captureBuffer

Key Path	Save, Data
Mode	All
Notes	The key location is mode-dependent and will vary. Brings up the Save As dialog for saving a <code><mode specific></code> Save Type. The save is performed immediately and does not wait until the measurement is complete.
Initial S/W Revision	Prior to A.02.00

Screen Image

Pressing Screen Image accesses a menu of functions that enable you to specify a format and location for the saved screen image. It brings up a menu that allows you to specify the color scheme of the Screen Image (Themes) or navigate to the Save As dialog to perform the actual save.

Screen Image files contain an exact representation of the analyzer display. They cannot be loaded back onto the analyzer, but they can be loaded into your PC for use in many popular applications.

8 Vector Analysis

Save

The image to be saved is actually captured when the Save front panel key is pressed, and kept in temporary storage to be used if you ask for a Screen Image save. When the Screen Image key is pressed, a "thumbnail" of the captured image is displayed, as shown below:

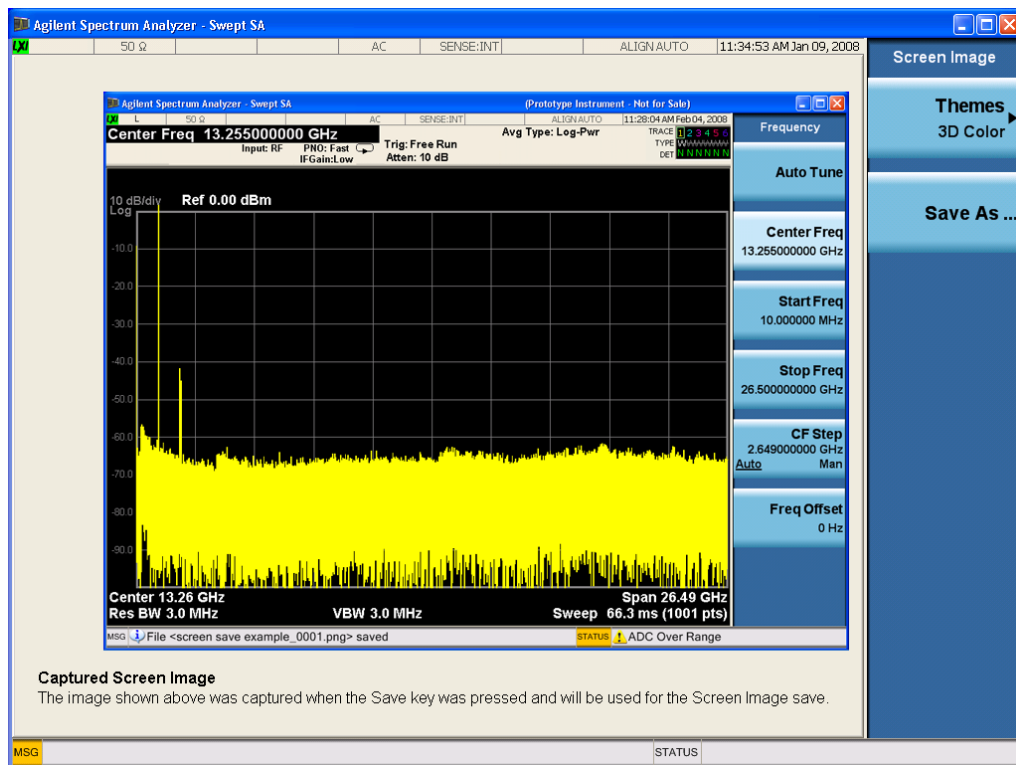

When you continue on into the Save As menu and complete the Screen Image save, the image depicted in the thumbnail is the one that gets saved, showing the menus that were on the screen before going into the Save menus. The save is performed immediately and does not wait until the measurement is complete.

After you have completed the save, the Quick Save front-panel key lets you quickly repeat the last save performed, using an auto-named file, with the current screen data.

NOTE

For versions previous to A.01.55, if you initiate a screen image save by navigating through the Save menus, the image that is saved will contain the Save menu softkeys, not the menus and the active function that were on the screen when you first pressed the Save front panel key.

Key Path	Save
Mode	All
Remote Command	:MMEMory:STORe:SCReen <filename>
Example	:MMEM:STOR:SCR "myScreen.png" This stores the current screen image in the file MyScreenFile.png in the default directory.
Initial S/W Revision	Prior to A.02.00

Themes

Accesses a menu of functions that enable you to choose the theme to be used when saving the screen image.

The **Themes** option is the same as the **Themes** option under the **Display** and **Page Setup** dialogs. It allows you to choose between themes to be used when saving the screen image.

Key Path	Save, Screen Image
Remote Command	:MMEMory:STORe:SCReen:THEMe TDColor TDMonochrome FCOlor FMONochrome :MMEMory:STORe:SCReen:THEMe?
Example	:MMEM:STOR:SCR:THEM TDM
Preset	3D Color; Is not part of Preset, but is reset by Restore Misc Defaults or Restore System Defaults All and survives subsequent running of the modes.
Readback	3D Color 3D Mono Flat Color Flat Mono
Backwards Compatibility Notes	In ESA and PSA we offer the choice of "Reverse Bitmap" or "Reverse Metafile" when saving screen images. This is much like the "Flat Color" theme available in X-Series. Also, if you selected Reverse Bitmap AND a black & white screen image, that would be much like "Flat Monochrome". In other words, each of the X-Series themes has a similar screen image type in ESA/PSA. But they are not identical.
Initial S/W Revision	Prior to A.02.00

3D Color

Selects a standard color theme with each object filled, shaded and colored as designed.

Key Path	Save, Screen Image, Themes
Example	MMEM:STOR:SCR:THEM TDC
Readback	3D Color
Initial S/W Revision	Prior to A.02.00

3D Monochrome

Selects a format that is like 3D color but shades of gray are used instead of colors.

Key Path	Save, Screen Image, Themes
Example	MMEM:STOR:SCR:THEM TDM
Readback	3D Mono
Initial S/W Revision	Prior to A.02.00

Flat Color

Selects a format that is best when the screen is to be printed on an ink printer.

Key Path	Save, Screen Image, Themes
Example	MMEM:STOR:SCR:THEM FCOL
Readback	Flat Color
Initial S/W Revision	Prior to A.02.00

Flat Monochrome

Selects a format that is like Flat Color. But only black is used (no colors, not even gray), and no fill.

Key Path	Save, Screen Image, Themes
Example	MMEM:STOR:SCR:THEM FMON
Readback	Flat Mono
Initial S/W Revision	Prior to A.02.00

Save As...

When you press "Save As", the analyzer brings up a Windows dialog and a menu entitled "**Save As.**" This menu allows you to navigate to the various fields in the Windows dialog without using a keyboard or mouse. The Tab and Arrow keys can also be used for dialog navigation.

See "[To File . . .](#)" on page 1211 in Save, State for a full description of this dialog and menu.

The default path for Screen Images is

My Documents\`<mode name>`\screen.

where `<mode name>` is the parameter used to select the mode with the INST:SEL command (for example, SA for the Spectrum Analyzer).

Key Path	Save, Screen Image
Notes	Brings up Save As dialog for saving a Screen Image Save Type
Initial S/W Revision	Prior to A.02.00

Single (Single Measurement/Sweep)

Sets the analyzer for Single measurement operation. The single/continuous state is Meas Global, so the setting will affect all the measurements. If you are Paused, pressing Single does a Resume.

See "[More Information](#)" on page 435

Key Path	Front-panel key
Example	:INIT:CONT OFF
Notes	See Cont key description.
Backwards Compatibility Notes	<p>For Spectrum Analysis mode in ESA and PSA, the Single hardkey and the INITiate:IMM switched from continuous measurement to single measurement and restarted sweeps and averages (displayed average count reset to 1), but did not restart Max Hold and Min Hold. In the X-Series, the Single hardkey and the INITiate:IMM command initiate a sweep/ measurement/ average sequence/hold sequence including MaxHold and MinHold.</p> <p>For Spectrum Analysis mode in ESA and PSA, the Single hardkey restarted the sweep regardless of whether or not you were in an active sweep or sweep sequence. In the X-Series, Restart does this but Single only restarts the sweep or sweep sequence if you are in the idle state.</p> <p>INIT[:IMM] in ESA & PSA Spectrum Analysis Mode does an implied ABORT. In some other PSA Modes, INIT[:IMM] is ignored if not in the idle state. . The X-Series follows the ESA/PSA SA Mode model, which may cause some Modes to have compatibility problems.</p>
Initial S/W Revision	Prior to A.02.00

More Information

See "[Restart](#)" on page 1208 for details on the INIT:IMMEDIATE (Restart) function.

If you are already in single sweep, the INIT:CONT OFF command has no effect.

If you are already in Single Sweep, then pressing the Single key in the middle of a sweep does not restart the sweep or sequence. Similarly, pressing the Single key does not restart the sweep or sequence if the sweep is not in the idle state (for example, if you are taking a very slow sweep, or the analyzer is waiting for a trigger). Instead, it results in a message. "Already in Single, press Restart to initiate a new sweep or sequence". Even though pressing the Single key in the middle of a sweep does not restart the sweep, sending INIT:IMMEDIATE does reset it.

To take one more sweep without resetting the average count, increment the average count by 1, by pressing the step up key while **Average/Hold Number** is the active function, or sending the remote command CALC:AVER:TCON UP.

Source

There is no Source control functionality for this measurement. When this key is pressed, the screen either displays a blank menu, or the previously-selected menu remains unchanged.

Key Path	Front-panel key
----------	-----------------

SPAN X Scale

Displays a menu for selecting measurement span and also for scaling of the X axis.

Key Path	Front Panel
Mode	VSA, LTE, LTETDD, IDEN, LTEAFDD,LTEATDD
Initial S/W Revision	Prior to A.02.00
Modified at S/W Revision	A.02.00

Span

Controls the frequency span of the measurement. This is the full span that is displayed on a spectrum display. The actual IF bandwidth that the time record detects is 1.28 times the span. See "[FREQ Channel](#)" on page 1134 for details on how this interacts with start, stop, and center frequencies.

Key Path	SPAN X Scale
Mode	VSA, IDEN
Remote Command	[:SENSe] :FREQuency:SPAN <freq> [:SENSe] :FREQuency:SPAN?
Example	FREQ:SPAN 10 MHZ FREQ:SPAN?
Couplings	Start Freq and Stop Freq. See " FREQ Channel " on page 1134 for details.
Preset	depends on span option
State Saved	Saved in instrument state.
Min	2 Hz
Max	depends on span option
Initial S/W Revision	Prior to A.02.00
Modified at S/W Revision	A.02.00

Full Span

Changes the span to the maximum available. The center frequency remains unchanged, regardless of whether the Frequency Annotation property is Start/Stop or Center/Span.

Key Path	SPAN X Scale
Mode	VSA, IDEN
Remote Command	[:SENSe] :FREQuency:SPAN:FULL
Example	FREQ:SPAN:FULL
Notes	The label on the softkey gives the full span available, which depends on span option.
Couplings	Changes span to maximum while keeping the center frequency constant. Start and Stop frequency

	are affected
Readback Text	[25 MHz] If playing back a recording, list the recorded bandwidth here
Initial S/W Revision	Prior to A.02.00
Modified at S/W Revision	A.02.00

Signal Track

Attempts to keep the largest magnitude signal in the center of the screen for a spectrum display. It is the equivalent of manually doing a single acquisition, doing a marker to peak search on a spectrum trace, then copying the marker position to the center frequency and repeating. (It is not necessary to be viewing a spectrum display for this function to work.)

Key Path	SPAN X Scale
Mode	VSA
Remote Command	[:SENSe] :VECTor ADEMod : FREQuency : CENTer : TRACk OFF ON 0 1 [:SENSe] :VECTor ADEMod : FREQuency : CENTer : TRACk ?
Example	VECT:FREQ:CEN:TRAC ON VECT:FREQ:CEN:TRAC?
Couplings	Unavailable if averaging is turned on.
Preset	0
State Saved	Saved in instrument state.
Range	On Off
Initial S/W Revision	Prior to A.02.00

Select Trace

Displays a menu that enables you to select the trace that is to receive the action of all successive trace-specific commands like scaling, assignment of trace data, and so on. The selected trace is outlined in green and is always visible. While the Select Trace menu is showing, each visible trace is annotated in the middle with its own trace number, as shown in the following figure. The trace number annotations disappear when any other menu is showing.

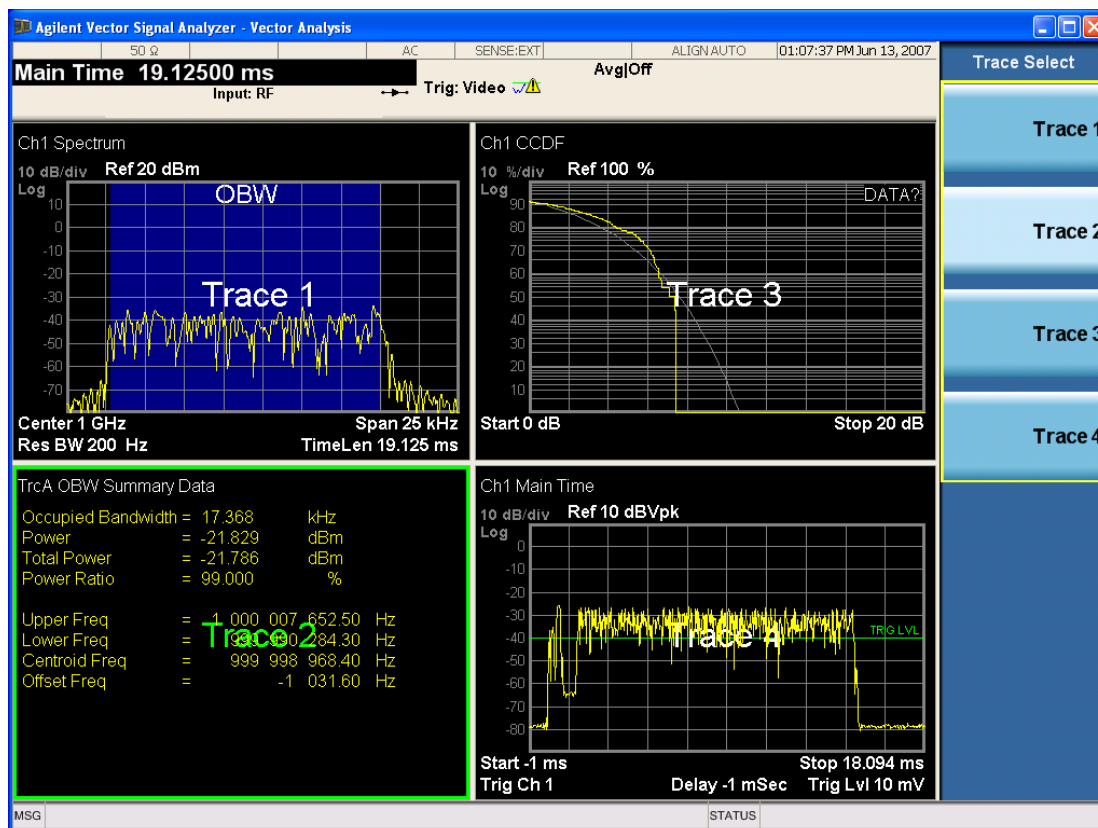

Grid 2x2 layout showing trace annotations when Trace Select dialog is active

This softkey also appears in the X and Y scaling menus. There is only one selected trace at any time. If you change which trace is selected, that change is reflected in this softkey/menu wherever it appears. Other ways to select a trace include use of the Next Window key, clicking within a trace window with a mouse cursor, and issuing a trace-specific SCPI command.

There is no SCPI command associated with this function. Instead, SCPI commands that are trace-specific have an index on the TRACe node that determines the selected trace. Using such a command has the side effect that the trace addressed by the SCPI command becomes the selected trace for any front panel interaction.

Key Path	Trace/Detector or Span X Scale or AMPTD Y Scale
Mode	VSA, LTE, LTETDD, IDEN, LTEAFDD, LTEATDD
Notes	No SCPI. Front panel only.
Couplings	Affects any trace-specific commands
Range	Trace 1 Trace 2 Trace 3 Trace 4 Trace 5 Trace 6
Readback Text	Trace <n>
Initial S/W Revision	Prior to A.02.00
Modified at S/W Revision	A.02.00

X Scale

Causes the trace to display all available trace data when set to Auto. (Exception: the display of the outer edges of a spectrum that can contain aliases is governed by the All Frequency Points function setting – see below.) The annotation is updated as needed, but the X Reference Value and X Width keys are grayed out and not updated. When this function is set to Man, the X Reference Value and X Width softkey readbacks are updated with the current values.

Key Path	SPAN X Scale
Mode	VSA, LTE, LTETDD, IDEN, LTEAFDD,LTEATDD
Measurement	<meas>:=VECTor ADEMod DDEMod W11A W11B EVM IPOWER IDEMod MOTotalk
Remote Command	:DISPlay:<meas>:TRACe [1] 2 ...4:X[:SCALE]:COUPle OFF ON 0 1 :DISPlay:<meas>:TRACe [1] 2 ...4:X[:SCALE]:COUPle?
Example	:DISP:VECT:TRAC1:X:COUP ON DISP:VECT:TRAC1:X:COUP?
Couplings	Forced to Man if X Reference Value or X Width is set by user.
Preset	1
State Saved	Saved in instrument state.
Range	Auto Man
Initial S/W Revision	Prior to A.02.00
Modified at S/W Revision	A.02.00

X Reference Value

Controls the X value of the selected trace at the chosen X Reference Position (see below). It has no effect on hardware input settings.

Key Path	SPAN X Scale
Mode	VSA, LTE, LTETDD, IDEN, LTEAFDD,LTEATDD
Measurement	<meas>:=VECTor ADEMod DDEMod W11A W11B EVM IPOWER IDEMod MOTotalk
Remote Command	:DISPlay:<meas>:TRACe [1] 2 ...4:X[:SCALE]:RLEVel <real> :DISPlay:<meas>:TRACe [1] 2 ...4:X[:SCALE]:RLEVel?
Example	DISP:VECT:TRAC:X:RLEV 1e9 DISP:VECT:TRAC:X:RLEV?
Couplings	If X Scale is set to Auto, the X Reference Value is determined by the trace data and this key is grayed out.
Preset	Depends on trace
State Saved	Saved in instrument state.
Min	-9.9E+37
Max	9.9E+37
Initial S/W Revision	Prior to A.02.00
Modified at S/W Revision	A.02.00

X Width

Sets the width of the X axis that is displayed for the selected trace. The X width can be set less than the Span for frequency-domain traces, enabling you to zoom in on just a portion of the measured values. Likewise, it can be less than time span covered by time-domain data. This plus the X Reference Value and X Reference Position control the range of X values that can be displayed on a trace. For example, if the X Reference position is Center, the X Reference value is 1 GHz and the X Width is 20 MHz.

Key Path	SPAN X Scale
Mode	VSA, LTE, LTETDD, IDEN, LTEAFDD, LTEATDD
Measurement	<meas>:=VECTor ADEMod DDEMod W11A W11B EVM IPOWER IDEMod MOTotalk
Remote Command	:DISPlay:<meas>:TRACe [1] 2 . . . 4 : X [: SCALe] : SPAN <real> :DISPlay:<meas>:TRACe [1] 2 . . . 4 : X [: SCALe] : SPAN?
Example	DISP:VECT:TRAC:X:SPAN 10e6 DISP:VECT:TRAC:X:SPAN?
Couplings	If X Scale is set to Auto, the X Width is determined by the trace data and this key is grayed out.
Preset	Depends on trace
State Saved	Saved in instrument state.
Min	-9.9E+37
Max	9.9E+37
Initial S/W Revision	Prior to A.02.00
Modified at S/W Revision	A.02.00

X Reference Position

Determines the position from which the X scaling is calculated for the selected trace. It can be set to the left side, center, or right side of the grid.

Key Path	SPAN X Scale
Mode	VSA, LTE, LTETDD, IDEN, LTEAFDD, LTEATDD
Measurement	<meas>:=VECTor ADEMod DDEMod W11A W11B EVM IPOWER IDEMod MOTotalk
Remote Command	:DISPlay:<meas>:TRACe [1] 2 . . . 4 : X [: SCALe] : RPOSition LEFT CENTer RIGHT :DISPlay:<meas>:TRACe [1] 2 . . . 4 : X [: SCALe] : RPOSition?
Example	DISP:VECT:TRAC1:X:RPOS LEFT DISP:VECT:TRAC1:X:RPOS?
Couplings	If X Scale is set to Auto, the X Reference Position is determined by the trace data and this key is grayed out.
Preset	CENT
State Saved	Saved in instrument state.

Range	Left Ctr Right
Initial S/W Revision	Prior to A.02.00
Modified at S/W Revision	A.02.00

Freq Annotation

Controls how Spectrum and PSD traces are annotated when their X Scale is set to Auto. If Freq Annotation is set to Center/Span, the X-axes on windows containing frequency domain traces are labeled with the center frequency on the left and the span on the right. If the Freq Annotation is set to Start/Stop, then the start and stop frequencies appear in place of center and span. If the X Scale is manual, then this annotation style does not apply.

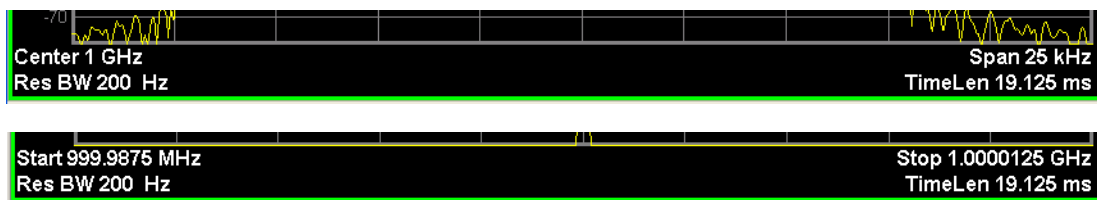

Key Path	SPAN X Scale
Mode	VSA, LTE, LTETDD, IDEN, LTEAFDD, LTEATDD
Measurement	<meas>:=VECTor ADEMod DDEMod W11A W11B EVM IPOWER IDEMod MOTotalk
Remote Command	:DISPlay:<meas>:FANNotation CSPan SSTop :DISPlay:<meas>:FANNotation?
Example	DISP:VECT:FANN CSP DISP:VECT:FANN?
Preset	CSP
State Saved	Saved in instrument state.
Range	Center/Span Start/Stop
Initial S/W Revision	Prior to A.02.00
Modified at S/W Revision	A.02.00

All Frequency Points

Spectrum trace data (and PSD) are based on the FFT algorithm. By default, the outer edges of the spectrum are not displayed because they can show spurious results that are aliases of real signals that are not completely filtered out by the IF filter. For example, in the case of a 1024 point FFT only 801 points are displayed. If you want to view the additional FFT points at the edges of spectral displays, turn this function on. It is global to all traces, not specific to a single trace.

Key Path	SPAN X Scale
----------	--------------

Mode	VSA, LTE, LTETDD, IDEN, LTEAFDD, LTEATDD
Measurement	<meas>:=VECTor ADEMod DDEMod W11A W11B EVM IPOWER IDEMod MOTotalk
Remote Command	:DISPlay:<meas>:AFPpoints OFF ON 0 1 :DISPlay:<meas>:AFPpoints?
Example	DISP:VECT:AFP ON DISP:VECT:AFP?
Notes	ac
Couplings	Only applies if trace is showing Spectrum or PSD results.
Preset	OFF
State Saved	Saved in instrument state.
Range	On Off
Initial S/W Revision	Prior to A.02.00
Modified at S/W Revision	A.02.00

Copy X Scale

Copies the following X scaling information from the selected trace to another:

- X reference Position
- X Reference Value
- X Width
- X Scale (Auto/Man)

This is a front-panel only function.

Key Path	SPAN X Scale, X Axis Scaling
Mode	VSA, LTE, LTETDD, IDEN, LTEAFDD, LTEATDD
Initial S/W Revision	Prior to A.02.00
Modified at S/W Revision	A.02.00

Sweep/Control

Displays a menu that enables you to control time-related measurement parameters and to pause or resume the measurement.

Key Path	Front Panel
Mode	VSA
Initial S/W Revision	A.01060 or later

Main Time

Enables you to control the length of the overall time record used in the measurement. Note that the Gate function (see ["Gate" on page 819](#)) enables you to analyze only a portion of the displayed Main Time. Time length and Res BW are related by the following equation:

$$\text{Res BW} = \text{ENBW} / T$$

where ENBW is the normalized effective noise bandwidth of the Window (see the FFT Window topic under BW for more details) and T is the time record length (in seconds).

Therefore, if you change Main Time, the Resolution bandwidth must also change, and vice versa.

Time record size (in sample points) can vary between 16 points and the full FFT size used for spectrum calculations. The FFT size is indirectly chosen by setting Freq Points (see ["Freq Points" on page 821](#)) and is equal to $(\text{Freq Points} - 1) * 1.28$.

Main Time length (in seconds) is the time record size times the sample period. The sample period for the Main Time result is $1 / (1.28 * \text{Span})$.

Limits:

The maximum Main Time length is:

$$\text{Max FFT size} / (1.28 * \text{Span}) = (409600) / \text{Span} \text{ if Freq points state parameter is set to Auto}$$

$$\text{FFT size} / (1.28 * \text{Span}) = (\text{Freq Points} - 1) / \text{Span} \text{ if Freq points parameter is manually set}$$

Note that the minimum Res BW is related to maximum Main Time length.

The minimum Main Time length is

$$16 \text{ points} / (1.28 * \text{Span}) = 12.5 / \text{Span}$$

See ["Res BW" on page 706](#) and ["Res BW Coupling" on page 707](#) for details on couplings that can change Main Time length due to Res BW changes.

Key Path	Sweep Control
Mode	VSA
Measurement	<meas>:=VECTOR ADEMod
Remote Command	[:SENSE] : <meas> : SWEep:TIME <time> [:SENSE] : <meas> : SWEep:TIME?

Example	VECT:SWE:TIME 3 MS VECT:SWE:TIME?
Notes	This key is not available in measurements other than Vector or Analog Demod. The annotation is shown, however. In other measurements the time length is determined by number of symbols.
Couplings	Affected by Res BW, Span, Freq Points, and Window. See "Res BW" on page 706 and "Res BW Coupling" on page 707 for details.
Preset	12.75e-6
State Saved	Saved in instrument state.
Min	-9.9e37
Max	9.9e37
Initial S/W Revision	A.01060 or later

Pause / Resume

Pauses or resumes acquisition at the end of the current time record acquisition.

Key Path	Sweep Control
Mode	VSA
Initial S/W Revision	A.01060 or later

Gate

Accesses a menu of time gating control functions. Time gating lets you isolate a portion of a Main Time record to be used for downstream spectrum and statistical analysis (instead of the whole time record). The gate position can be changed during a stopped measurement and the instantaneous gate time and spectrum traces update immediately. Averages are restarted when gate properties change. The windowing function used in gated measurements is the same as non-gated measurements.

Key Path	Sweep Control
Mode	VSA
Initial S/W Revision	A.01060 or later

Gate

Turns time gating on or off.

Key Path	Sweep/Control
Mode	VSA
Measurement	<meas>:=VECTor ADEMod
Remote Command	[:SENSe] :<meas>:SWEep:EGATe:STATe OFF ON 0 1

	<code>[:SENSe] : <meas> : SWEEp : EGATe : STATe ?</code>
Example	VECT:SWE:EGAT:STAT ON VECT:SWE:EGAT:STAT?
Preset	0
State Saved	Saved in instrument state.
Initial S/W Revision	A.01060 or later

Gate Length

Adjusts the time between the beginning and the end of the gate.

Key Path	Sweep/Control
Mode	VSA
Measurement	<meas>:=VECTor ADEMod
Remote Command	<code>[:SENSe] : <meas> : SWEEp : EGATe [:SPAN] <time></code> <code>[:SENSe] : <meas> : SWEEp : EGATe [:SPAN] ?</code>
Example	VECT:SWE:EGAT 2 MS VECT:SWE:EGAT?
Couplings	Gate length and delay are limited so that the gate always falls within the current time record. If the time record length decreases, the gate delay is limited first, then the gate length.
Preset	1.28125e-6
State Saved	Saved in instrument state.
Min	16 time samples
Max	Time record length
Initial S/W Revision	A.01060 or later

Gate Delay

Adjusts the time between the start of the time record and the beginning of the gate.

Key Path	Sweep/Control
Mode	VSA
Measurement	<meas>:=VECTor ADEMod
Remote Command	<code>[:SENSe] : <meas> : SWEEp : EGATe : DELay <time></code> <code>[:SENSe] : <meas> : SWEEp : EGATe : DELay ?</code>
Example	VECT:SWE:EGAT:DEL 500 US VECT:SWE:EGAT:DEL?
Couplings	Gate length and delay are limited so that the gate always falls within the current time record. If the time record length decreases, the gate delay is limited first, then the gate length.

Preset	0
State Saved	Saved in instrument state.
Min	0
Max	Time record length – gate length
Initial S/W Revision	A.01060 or later

Freq Points

Enables you to manually enter the number of displayed frequency points. By default, the analyzer chooses the number of Freq Points displayed in Spectrum or PSD displays, depending on the Res BW or Main Time length chosen. Auto mode is recommended. The number of Freq Points is related to the number of FFT points used in spectrum calculations (which is always a power of 2).

$$\text{Freq Points} = (\text{FFT points}) / 1.28 + 1$$

Note that if All Frequency Points is turned on for a selected trace, then all computed FFT points are shown. (See ["All Frequency Points" on page 1232.](#))

Key Path	Sweep Control
Mode	VSA
Measurement	<meas>:=VECTor ADEMod
Remote Command	[:SENSe]:<meas>:SWEep:POINts <integer> [:SENSe]:<meas>:SWEep:POINts? [:SENSe]:<meas>:SWEep:POINts:AUTO OFF ON 0 1 [:SENSe]:<meas>:SWEep:POINts:AUTO?
Example	VECT:SWE:POIN 801 VECT:SWE:POIN? VECT:SWE:POIN:AUTO ON VECT:SWE:POIN:AUTO?
Notes	Keyboard entry or setting this by SCPI forces state to manual. Any entry other than a valid value is rounded up to the next available value (or limited to the maximum). This key is not shown in measurements other than Vector or Analog Demod.
Couplings	See Res BW Coupling section
Preset	801 1
State Saved	Saved in instrument state.
Range	51 101 201 401 801 1601 3201 6401 12801 25601 51201 102401 204801 409601
Initial S/W Revision	A.01060 or later

System

See ["System" on page 242](#)

Trace/Detector

Accesses a menu enabling you to select various trace parameters for all VSA based measurements.

Key Path	Front Panel
Mode	VSA, LTE, LTETDD, IDEN, LTEAFDD, LTEATDD
Initial S/W Revision	Prior to A.02.00
Modified at S/W Revision	A.02.00

Select Trace

Displays a menu that enables you to select the trace that is to receive the action of all successive trace-specific commands like scaling, assignment of trace data, and so on. The selected trace is outlined in green and is always visible. While the Select Trace menu is showing, each visible trace is annotated in the middle with its own trace number, as shown in the following figure. The trace number annotations disappear when any other menu is showing.

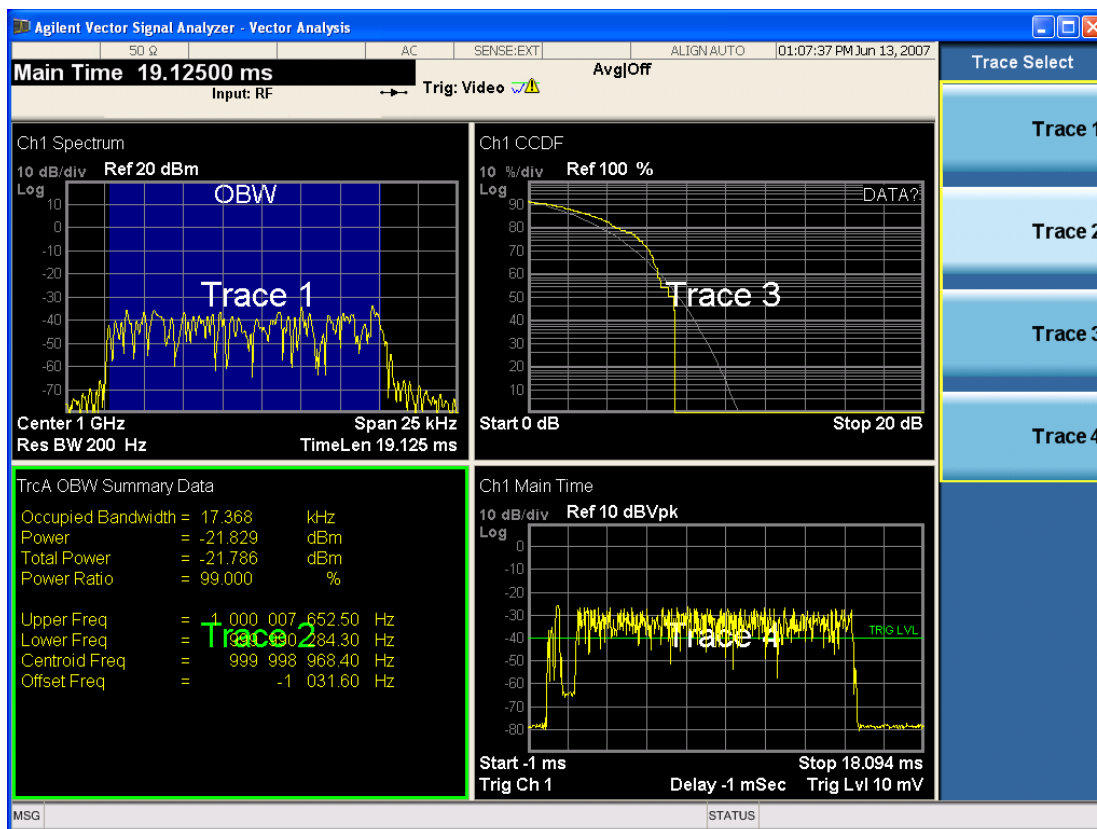

Grid 2x2 layout showing trace annotations when Trace Select dialog is active

This softkey also appears in the X and Y scaling menus. There is only one selected trace at any time. If you change which trace is selected, that change is reflected in this softkey/menu wherever it appears. Other

ways to select a trace include use of the Next Window key, clicking within a trace window with a mouse cursor, and issuing a trace-specific SCPI command.

There is no SCPI command associated with this function. Instead, SCPI commands that are trace-specific have an index on the TRACe node that determines the selected trace. Using such a command has the side effect that the trace addressed by the SCPI command becomes the selected trace for any front panel interaction.

Key Path	Trace/Detector or Span X Scale or AMPTD Y Scale
Mode	VSA, LTE, LTETDD, IDEN, LTEAFDD, LTEATDD
Notes	No SCPI. Front panel only.
Couplings	Affects any trace-specific commands
Range	Trace 1 Trace 2 Trace 3 Trace 4 Trace 5 Trace 6
Readback Text	Trace <n>
Initial S/W Revision	Prior to A.02.00
Modified at S/W Revision	A.02.00

Data

Accesses a menu of Trace data choices for the selected trace. A VSA Measurement can produce many different results from a single scan; either a graph or a table. In addition, the ACP and OBW functions can be enabled on any trace, showing a frequency-domain result, and produce Summary table results. Any of these results can be assigned to a trace and displayed.

The following Trace Data types are available in all measurements:

Soft Key Name	SCPI string form
No Data	"No Data"
Spectrum	"Spectrum1"
Inst Spectrum	"Inst Spectrum1"
Raw Main Time	"Raw Main Time1"
OBW Summary for Trace 1	"Obw Summary Trc1"
OBW Summary for Trace 2	"Obw Summary Trc2"
OBW Summary for Trace 3	"Obw Summary Trc3"
OBW Summary for Trace 4	"Obw Summary Trc4"
ACP Summary for Trace 1	"Acp Summary Trc1"
ACP Summary for Trace 2	" Acp Summary Trc2"
ACP Summary for Trace 3	" Acp Summary Trc3"
ACP Summary for Trace 4	" Acp Summary Trc4"

The following Data Registers are also available for display if there are traces stored in them (see ["Copy to Data Register" on page 1252](#) and ["Import Trace Data" on page 1205](#): "D1", "D2", "D3", "D4", "D5", and "D6")

Key Path	Trace/Detector, Data
Mode	VSA, LTE, LTETDD, IDEN
Measurement	<meas>:=VECTor ADEMod DDEMod W11A W11B EVM IPOWER IDEMod MOTotalk
Remote Command	:DISPlay:<meas>:TRACe[1] 2 ...4:FEED <string> :DISPlay:<meas>:TRACe[1] 2 ...4:FEED?
Example	DISP:VECT:TRAC1:FEED "Spectrum1" DISP:VECT:TRAC1:FEED?
Preset	Depends on trace number and measurement
State Saved	Saved in instrument state.
Initial S/W Revision	Prior to A.02.00
Modified at S/W Revision	A.02.00

The complete list of Trace Data names that can be assigned using the above SCPI can be obtained by using the following SCPI query:

Mode	VSA, LTE, LTETDD, IDEN
Measurement	<meas>:=VECTor ADEMod DDEMod W11A W11B EVM IPOWER IDEMod MOTotalk
Remote Command	:CALCulate:<meas>:DATA[1] 2 ...4:NAMes?
Example	CALC:VECT:DATA:NAM?
Notes	Query only. Returns a comma-separated list of trace data names that can be used in DISPlay:<meas>:TRACe[1]]2 3 4:FEED "<string>". The list is the same regardless of trace index.
Initial S/W Revision	Prior to A.02.00
Modified at S/W Revision	A.02.00

Channel 1

Accesses time domain and frequency domain measurement results and enables you to assign them to traces.

Key Path	Trace/Detector, Data,
Mode	VSA

Spectrum

Displays the Spectrum data result in the selected trace.

The Spectrum trace data displays the spectrum of the selected channel. The spectrum computation displays frequency on the x axis and amplitude on the y axis.

The following formulas show how the analyzer calculates spectrum information:

Key: F = Fast Fourier Transform (FFT)
 AF = Averaged spectra
 AT = Averaged time
 f = Instantaneous spectra
 t = Instantaneous time
 W = Windowing function
 n = Average number
 c = Correction trace (from calibration)
 $f[n]^2 = f[n] \times \text{conjugate}(f[n])$
 \times = multiplication

No Average	$f = F(W \times t) \times c$
rms Average	$AF[n] = \frac{1}{n} \text{sum} (f [n]^2)$
rms Exponential AF[n]Average	$AF[n] = \frac{1}{n} (f [n]^2) + \frac{n-1}{n} AF[n-1]$ where $1 \leq n \leq \text{number of averages}$
Continuous Peak Hold Average	$AF[n] = \text{MAX} (AF[n-1], f [n]^2)$
Time Average	$AF[n] = F\{W \times AT[n]\} \times c$ where $AT[n] = \frac{1}{n} \text{sum} (t [n])$
Time Exponential Average	$AF[n] = F\{W \times AT[n]\} \times c$ where $AT[n] = \frac{1}{n} t [n] + \frac{n-1}{n} AT[n-1]$ and $1 \leq n \leq \text{number of averages}$

As shown in the previous formulas, the spectrum can be a linear spectrum or power spectrum as follows:

If the average is...	then the spectrum is...
Averaging OFF	Linear
rms Average	Power
Continuous peak	Power

Linear spectra contain magnitude and phase (real and imaginary) information. Power spectra contain only magnitude (real) information. This occurs with rms averages, for instance, because the results of the FFT are squared. Remember that the FFT yields both real and imaginary information. When the analyzer squares the results of the FFT, the imaginary part becomes zero.

See also: ["Data" on page 1237](#)

Key Path	Trace/Detector, Data
Mode	VSA, LTE, LTETDD, IDEN
Initial S/W Revision	Prior to A.02.00
Modified at S/W Revision	A.02.00

Inst Spectrum

Displays the Inst Spectrum data result in the selected trace.

Inst Spectrum trace data displays the instantaneous spectrum for the selected input channel. Instantaneous spectrum is computed before data is averaged, which enables you see spectrum data before the data is averaged with other spectrum data.

NOTE Inst Spectrum is not available when analog or digital demodulation is selected.

The following block diagram shows where spectrum and instantaneous spectrum are created.



This measurement calculation is useful for these types of averaged measurements:

- rms
- rms exponential
- Continuous peak hold

If averaging is off, the spectrum and instantaneous spectrum display the same information.

See also: ["Data" on page 1237](#)

Key Path	Trace/Detector, Data
Mode	VSA, LTE, LTETDD, IDEN
Initial S/W Revision	Prior to A.02.00
Modified at S/W Revision	A.02.00

Main Time

Displays the Main Time data result in the selected trace.

Main Time versus Gate Time

The term is used to differentiate between the "main" time record and the "gate" time record when time gating is on.

A time record is the basic building block of the Fast Fourier Transform (FFT). The FFT takes the time-domain information in the time record and transforms it into the frequency domain.

When time gating is on, you can identify a portion of the main time-record to be used by the FFT. The term "main time-record" identifies the entire time record; the term "gate time-record" identifies the portion selected by the gate.

The following block diagram shows the blocks that create main time and gate time.

Note that the Analog Demodulation block is available only when analog demodulation is enabled.

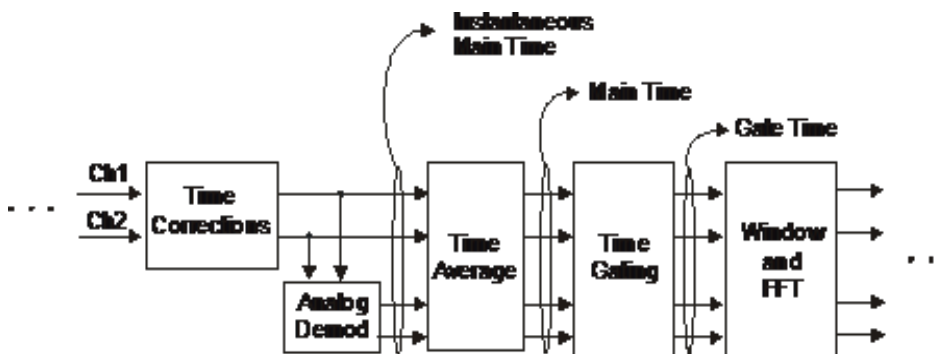

There are many reasons why you may want to view the main time record. Here are just a few:

- To verify that there is an input signal.
- To see the characteristics of the input signal.
- To help in manually setting the input range.

Time Records and Span

If you set the analyzer to full span, the time data you see is the actual input time-record. This is raw input data – the signal from which all subsequent measurements are based.

If you set the instrument to measure a specific bandwidth (something less than full span), the time data you see is the raw input data after it has been filtered (to provide alias protection) and decimated (to obtain the desired span).

Time Records and Averaging

If rms or continuous peak-hold averaging is on, the analyzer displays the most recent time record. The analyzer does not show an averaged time waveform, because all averaging is done after the time data has been transformed to the frequency domain.

If time averaging is on, the analyzer displays the averaged time-record. In other words, the time record has been averaged with previous time records.

How the Analyzer Displays the Time Record

It is important to remember that although the time record looks like an oscilloscope display, the analyzer is not a digital oscilloscope.

The time record represents samples of a waveform. The samples have enough information to accurately reconstruct the input signal – but the human eye may not properly perform the reconstruction. In fact, for frequencies that are higher than about ten percent of the frequency span, there is noticeable visible distortion.

The analyzer's anti-alias filters cause some ringing or distortion of square waves or transients when viewed in the time domain.

See also: ["Data" on page 1237](#)

Key Path	Trace/Detector, Data
Mode	VSA
Initial S/W Revision	Prior to A.02.00
Modified at S/W Revision	A.02.00

Gate Time

Displays the Gate Time data result in the selected trace.

Gate Time trace data displays the selected channel's gate time-record.

Note that Gate Time is not available when analog or digital demodulation is selected.

If time gating is on, Gate Time displays the portion of the main time-record marked by the gate – this portion is called the gate record (if time gating is off, Gate Time displays nothing).

As a reminder, if time gating is on, the Fast Fourier Transform (FFT) uses the gate time-record, which can be all or a portion of the main time-record, to compute frequency information such as spectrum, frequency response, coherence, and correlation.

See also: ["Data" on page 1237](#)

Key Path	Trace/Detector, Data
Mode	VSA, LTE, LTETDD, IDEN
Initial S/W Revision	Prior to A.02.00
Modified at S/W Revision	A.02.00

Inst Main Time

Displays the Inst Main Time data result in the selected trace.

Inst Main Time trace data displays the instantaneous time-domain data for the selected input channel.

Note that Inst Main Time is not available when analog or digital demodulation is selected.

The following block diagram shows how Instantaneous Main Time is derived.

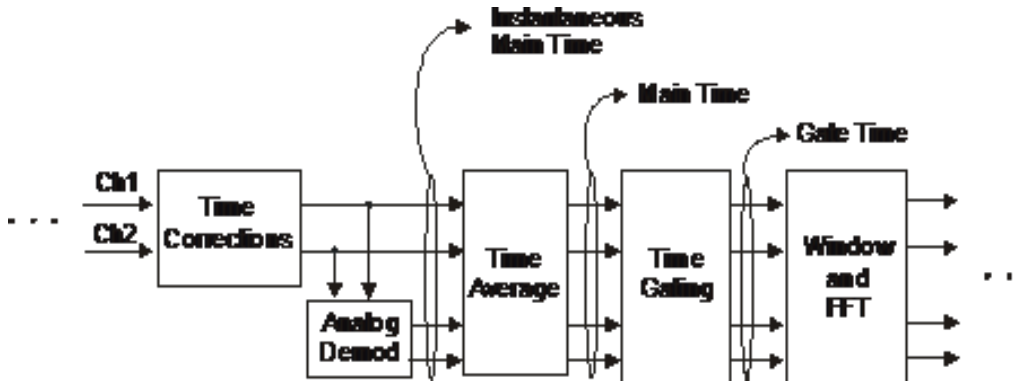

Notice that Instantaneous Main Time shows you time data before time averaging. If time averaging is off, Instantaneous Main Time is identical to Main Time.

See also: ["Data" on page 1237](#)

Key Path	Trace/Detector, Data
Mode	VSA, LTE, LTETDD, IDEN
Initial S/W Revision	Prior to A.02.00
Modified at S/W Revision	A.02.00

Raw Main Time

Displays the Raw Main Time data result in the selected trace.

Raw Main Time is the raw data read from the input hardware or playback file. It is similar to Main Time with the following exceptions:

- This data has not had time corrections applied, so it displays a “CAL?” trace indicator.
- The data has not gone through the analyzer's software resampling filters, so is generally not sampled at the specified sample rate.
- The data has a wider bandwidth than the measurement span would indicate.

Raw Main Time data is useful in the following situations:

- When you use Channel, IF Magnitude, or Magnitude trigger types, the input hardware detects the trigger, so Raw Main Time sometimes gives a better indication of what caused the trigger.
- When you play back a recording, the Raw Main Time measurement data enables you to see the samples that are saved in the recording, with no filtering applied or settling removed.

See also: ["Data" on page 1237](#)

Key Path	Trace/Detector, Data
Mode	VSA, LTE, LTETDD, IDEN
Initial S/W Revision	Prior to A.02.00
Modified at S/W Revision	A.02.00

PSD (Power Spectral Density)

Displays the Power Spectral Density (PSD) data result in the selected trace. PSD trace data displays the power spectral density (PSD) of the selected channel. The definition of PSD yields y-axis units of V_{pk}^2/Hz and x-axis units of frequency:

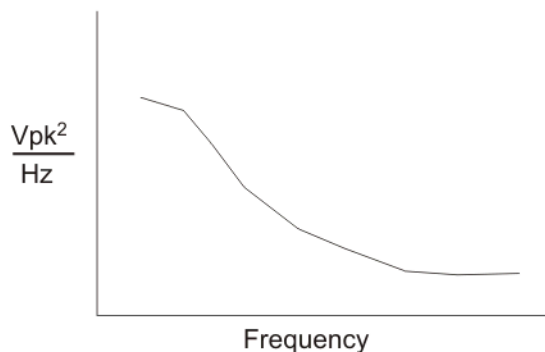

PSD is used for noise measurements. It shows the power density of a signal as a function of frequency. In general, noise can have any arbitrary frequency content, resulting in a variety of possible PSD shapes. Noise that has equal power density at all frequencies is called white noise:

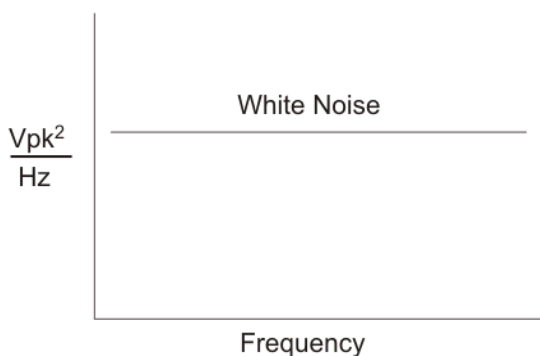

The definition of PSD is power per Hertz. In other words, power is divided by the measurement bandwidth, which in this analyzer is the resolution bandwidth (ResBW), as follows:

$$\frac{V_{pk}^2}{RBW} = \frac{V_{pk}^2}{Hz}$$

Units of V_{pk}^2/Hz assumes the signal is referenced to 1 ohm. That is, because no resistance is specified, the signal is interpreted as a voltage across a one ohm resistor with the power in the resistor equal to V_{pk}^2 .

You can select units of dBm/Hz to take into account the analyzer's input impedance. PSD defaults to these units. The analyzer calculates dBm/Hz as follows:

$$\frac{\text{dBm}}{\text{Hz}} = 10 \log \left[\frac{\frac{V_{\text{rms}}^2}{Z} \times 1000}{\text{RBW}} \right]$$

where:

RBW = resolution bandwidth (Hz)

Z = input impedance

See also: ["Data" on page 1237](#)

Key Path	Trace/Detector, Data
Mode	VSA, LTE, LTETDD, IDEN
Initial S/W Revision	Prior to A.02.00
Modified at S/W Revision	A.02.00

Auto Correlation

Displays the autocorrelation data result in the selected trace. Auto Correlation trace data displays the autocorrelation for the selected input channel. Autocorrelation is a form of correlation, a measure of the similarity between two signals.

Note that Auto Correlation is not available when digital demodulation is selected.

Tips

- Use ac coupling only. Correlation measurements are disturbed by dc offsets in the signal.
- Some types of averaging can be useful – rms averaging does not affect correlation measurements, but you can use time averaging to reduce noise, if you can provide a consistent trigger. However, averaging is usually unnecessary to make good correlation measurements.
- Use appropriate triggering and trigger delays. This is especially true for time averaging.
- Use a random noise source for delay measurements. Correlation measurements provide the ability to resolve time differences between waveforms that appear to be random.
- Waveforms on the correlation trace may not appear as they do in the time trace. This is particularly noticeable when you are using correlation to extract synchronous signals from noise. The different shape of some waveforms is a direct result of the mathematical definition of correlation. For example, a correlated square wave appears as a triangle wave. It's important to remember that the period of the waveform is preserved even if the correlation waveform looks different.
- To avoid wrap-around effects, correlation produces a time record one-half the length of the measurement time-record.

Theory of Operation

Autocorrelation is a form of correlation, a measure of the similarity between two signals. Correlation is performed by multiplying two signals together at each instant in time and summing all the products. If the signals are identical, every product is positive and the resulting sum is large.

If, however, the two signals are dissimilar, then some of the products are positive and some are negative. In this case, the final sum is smaller because the products tend to cancel.

Autocorrelation performs a time-shifted, "averaged" correlation on a single signal. The signal is correlated with time-shifted versions of itself. Furthermore, the products from each time-shift are averaged by dividing each final sum by the number of products contributing to it.

$$R_{xx}(\tau) = \lim_{T \rightarrow \infty} \frac{1}{T} \int \text{conj}[x(t)] \times x(t + \tau) dt$$

where: R_{xx} = autocorrelation function

τ = amount of time shift

∞ = infinity

$x(\tau)$ = signal to be correlated

intgrl = integration

conj = conjugation

T = time

\times = multiplication

That is, the autocorrelation function is found by taking a signal, multiplying it by the same signal displaced (τ) units in time, and averaging the product over all time.

Duality With the Power Spectrum

For simplicity and speed, this analyzer performs the autocorrelation operation by taking advantage of its duality with the power spectrum:

$$R_{xx}(\tau) \leftrightarrow G_{xx}(f)$$

Thus,

$$\begin{aligned} R_{xx}(\tau) &= I_{\text{FFT}} [G_{xx}(f)] \\ &= I_{\text{FFT}} [\text{conj}(F[r \times t]) \times F(t)] \end{aligned}$$

where: I_{FFT} = Inverse FFT

conj = conjugation

\times = multiplication

r = half size of the rectangular window

(thus the result is $\frac{1}{2}$ the original time length)

When to use Auto Correlation

Auto correlation is useful for detecting echoes in a signal. For random noise, an echo appears as an impulse – if there is more than one echo, you can see multiple peaks on the auto correlation trace. Keep in mind that an echo appears as an impulse only if the delayed signal has not been filtered. The impulse broadens as the original random noise signal is filtered – in fact, the width of each peak is inversely proportional to the bandwidth of the signal.

To determine the time delay (in seconds) of an echo, you can move the marker to the peak of the echo. Note that there is always a correlated peak at zero lag – this peak marks the original excitation signal. Any other peaks let you know that the excitation signal also appeared at another time relative to the original signal. The amplitude value at the zero lag point is the total power in the time record.

This function is also useful for isolating low-level periodic signals from noise. A sine wave signal shows up as a sine wave in auto correlation. A square wave signal shows up as a triangular wave of the same frequency.

Auto correlation is a single-channel measurement. If you have the original signal on one channel and the delayed version on another, use cross correlation.

Auto Correlation and Averaging

The following formulas show how the analyzer calculates auto correlation for different averaging functions:

Key: F = Fast Fourier Transform (FFT)

AC = Averaged correlation

AT = Averaged time

t = Instantaneous time

c = Instantaneous correlation

r = 1/2 width rectangular window

× = multiplication

n = Average number

No Average $c = | \text{conj} (F(r \times t)) \times F [t] |$

rms Average $c = | \text{conj} (F(r \times t)) \times F [t] |$

rms Expon. $c = | \text{conj} (F(r \times t)) \times F [t] |$

Average

Continuous

Peak Hold $c = | \text{conj} (F(r \times t)) \times F [t] |$

Average

Time $AC [n] = | \text{conj} (F(r \times AT [n])) \times F (AT [n]) |$

Average

where: $AT [n] = \frac{1}{n} \text{sum} (t [n])$

Time

Expon. $AC[n] = | \text{conj} (F(r \times AT [n])) \times F (AT [n]) |$

Average

$$\text{where: } AT[n] = \frac{1}{n} t[n] + \frac{n-1}{n} AT[n-1]$$

and: $1 < n < \text{number of averages}$

See also: ["Data" on page 1237](#)

Key Path	Trace/Detector, Data
Mode	VSA
Initial S/W Revision	Prior to A.02.00

Statistical

Accesses the Trace Data choices that show the statistical results: CCDF, CDF and PDF.

Key Path	Trace/Detector, Data
Mode	VSA

CCDF (Complementary, Cumulative Density Function)

Displays the CCDF data result in the selected trace. CCDF trace data displays the complementary, cumulative density function (CCDF) for the selected input channel. The complementary, cumulative density function (CCDF) is a statistical-power calculation and can be performed only on time-domain data. As its name suggests, CCDF is the complement of CDF, and is defined as follows:

$$CDF(K) = \text{Probability}(x \leq K)$$

$$CCDF(K) = \text{Probability}(x \geq K)$$

CCDF provides better resolution than CDF for low probability signals, especially when log format is used for the y-axis.

The analyzer plots CCDF using units of percent (%) for the y-axis and power (dB) for the x-axis. Power on the x-axis is relative to the signal average power, so 0 dB is the average power of the signal. Therefore, a marker readout of

Trace A Marker 2 dB 12 %

means there is a 12% probability that the signal power is 2 dB or more above the average power.

CCDF Calculation:

1. Calculate the RMS value for all measured samples; this becomes the 0 dB point at the left end of the x-axis.
2. Normalize all samples to the RMS value in units of dB.

3. Determine which x-axis bin each sample belongs in between 0 and 20 dB.
4. Calculate the total number of samples that are greater than or equal to each x-axis bin and plot as a percent of the number of samples measured.

Samples Used in the Power Measurement

For the Demod Off and Analog demod modes, the analyzer computes CCDF using all samples in the current time record (all points in the active trace). Each successive time record adds additional samples to the CCDF measurement.

Restarting the Power Measurement

Selecting CCDF, restarting the measurement, or changing most measurement parameters restarts the CCDF measurement. For example, changing the range or center frequency resets the number of samples used in the CCDF measurement to zero and restarts the CCDF measurement.

Tips

Note the following when making CCDF measurements:

- For best results, set the analyzer's displayed frequency span to include all the energy of your signal. In other words, make sure the displayed frequency span includes the entire bandwidth of the measured signal.
- The CCDF measurement does not restart:
 - After a calibration
 - After you continue a paused measurement
- Many channel specific changes restart the CCDF measurement on both channels, such as changing the gate delay, or input coupling.
- The analyzer displays DATA? if the average power drifts 8 to 10 dB from the average power measured in the first time record. For example, the analyzer would display DATA? if you measured a transmitter signal that was off when the CCDF measurement started but then turned on later in the measurement.
- CCDF measurements are disabled during time averaging.

See also: ["Data" on page 1237](#)

Key Path	Trace/Detector, Data
Mode	VSA, LTE, LTETDD, IDEN
Initial S/W Revision	Prior to A.02.00
Modified at S/W Revision	A.02.00

CDF (Cumulative Density Function)

Displays the CDF data result in the selected trace. CDF trace data displays the Cumulative Density Function (CDF) for the selected input channel. CDF is computed by integrating the PDF (Probability Density Function).

See also: ["CCDF \(Complementary, Cumulative Density Function\)" on page 461](#) and ["Data" on page 1237](#)

Key Path	Trace/Detector, Data
Mode	VSA, LTE, LTETDD, IDEN
Initial S/W Revision	Prior to A.02.00
Modified at S/W Revision	A.02.00

PDF (Probability Density Function)

Display the PDF data result in the selected trace. PDF trace data displays the Probability Density Function of the selected channel. PDF indicates the probability that a given level has occurred.

PDF is equivalent to a normalized histogram. A histogram shows how the amplitude of a signal is distributed between its maximum and minimum values. Amplitude is displayed on the X-axis, and number of counts on the Y-axis.

The number of averages for a histogram determines the number of counts in the histogram; in other words, how many records are measured – the records are not "averaged". If averaging is off or if exponential averaging is selected, the measurement continues indefinitely. Keep in mind that the accuracy of the histogram is dependent on the frequency span, time-record length, and number of averages (if averaging is on).

Histograms are used for such things as determining the statistical properties of noise and monitoring the performance of electromechanical positioning systems.

PDF trace data is normalized by multiplying the number of averages by the number of points in the time record, then dividing this value by the DV spacing on the X-axis. The probability of a signal falling between two points is equal to the integral of the curve between those points.

PDF trace data displays the number of points used in its computation above the trace (Pts:). It also displays the average level (Avg:) above the trace.

See also: ["Data" on page 1237](#)

Key Path	Trace/Detector, Data
Mode	VSA, LTE, LTETDD, IDEN
Initial S/W Revision	Prior to A.02.00
Modified at S/W Revision	A.02.00

ACP (Adjacent Channel Power)

Provides access to ACP summary table data. These results are available when the ACP function is enabled for a particular trace, and it enables you to display the results in another trace.

Key Path	Trace/Detector, Data
Mode	VSA, LTE, LTETDD, IDEN
Initial S/W Revision	Prior to A.02.00
Modified at S/W Revision	A.02.00

ACP Summary for Trace 1

Displays results for the ACP function on Trace 1 in the selected trace.

See also: ["ACP Setup" on page 1255](#)

Key Path	Trace/Detector, Data, ACP
Mode	VSA, LTE, LTETDD, IDEN
Initial S/W Revision	Prior to A.02.00
Modified at S/W Revision	A.02.00

ACP Summary for Trace 2

Displays results for the ACP function on Trace 2 in the selected trace.

See also: ["ACP Setup" on page 1255](#)

Key Path	Trace/Detector, Data, ACP
Mode	VSA, LTE, LTETDD, IDEN
Initial S/W Revision	Prior to A.02.00
Modified at S/W Revision	A.02.00

ACP Summary for Trace 3

Displays results for the ACP function on Trace 3 in the selected trace.

See also: ["ACP Setup" on page 1255](#)

Key Path	Trace/Detector, Data, ACP
Mode	VSA, LTE, LTETDD, IDEN
Initial S/W Revision	Prior to A.02.00
Modified at S/W Revision	A.02.00

ACP Summary for Trace 4

Displays results for the ACP function on Trace 4 in the selected trace.

See also: ["ACP Setup" on page 1255](#)

Key Path	Trace/Detector, Data, ACP
Mode	VSA, LTE, LTETDD, IDEN
Initial S/W Revision	Prior to A.02.00
Modified at S/W Revision	A.02.00

ACP Summary for Trace 5

Displays results for the ACP function on Trace 5 in the selected trace.

See also: ["ACP Setup" on page 1255](#)

Key Path	Trace/Detector, Data, ACP
Mode	VSA

ACP Summary for Trace 6

Displays results for the ACP function on Trace 6 in the selected trace.

See also: ["ACP Setup" on page 1255](#)

Key Path	Trace/Detector, Data, ACP
Mode	VSA

OBW (Occupied Bandwidth)

Provides access to OBW summary table data. These results are available if the OBW function is enabled for a particular trace, and enable you to display the results in another trace.

Key Path	Trace/Detector, Data
Mode	VSA, LTE, LTETDD, IDEN
Initial S/W Revision	Prior to A.02.00
Modified at S/W Revision	A.02.00

OBW Summary for Trace 1

Displays results for the OBW function on Trace 1 in the selected trace.

See also: ["OBW Setup \(Occupied Bandwidth\)" on page 1263](#)

Key Path	Trace/Detector, Data, OBW
Mode	VSA, LTE, LTETDD, IDEN
Initial S/W Revision	Prior to A.02.00
Modified at S/W Revision	A.02.00

OBW Summary for Trace 2

Displays results for the OBW function on Trace 2 in the selected trace.

See also: ["OBW Setup \(Occupied Bandwidth\)" on page 1263](#)

Key Path	Trace/Detector, Data, OBW
Mode	VSA, LTE, LTETDD, IDEN
Initial S/W Revision	Prior to A.02.00
Modified at S/W Revision	A.02.00

OBW Summary for Trace 3

Displays results for the OBW function on Trace 3 in the selected trace.

See also: ["OBW Setup \(Occupied Bandwidth\)" on page 1263](#)

Key Path	Trace/Detector, Data, OBW
Mode	VSA, LTE, LTETDD, IDEN
Initial S/W Revision	Prior to A.02.00
Modified at S/W Revision	A.02.00

OBW Summary for Trace 4

Displays results for the OBW function on Trace 4 in the selected trace.

See also: ["OBW Setup \(Occupied Bandwidth\)" on page 1263](#)

Key Path	Trace/Detector, Data, OBW
Mode	VSA, LTE, LTETDD, IDEN
Initial S/W Revision	Prior to A.02.00
Modified at S/W Revision	A.02.00

OBW Summary for Trace 5

Displays results for the OBW function on Trace 5 in the selected trace.

See also: ["OBW Setup \(Occupied Bandwidth\)" on page 1263](#)

Key Path	Trace/Detector, Data, OBW
Mode	VSA

OBW Summary for Trace 6

Displays results for the OBW function on Trace 6 in the selected trace.

See also: ["OBW Setup \(Occupied Bandwidth\)" on page 1263](#)

Key Path	Trace/Detector, Data, OBW
Mode	VSA

Register

Accesses a menu that enables you to select registers for assignment of trace data.

Key Path	Trace/Detector, Data
Mode	VSA, LTE, LTETDD, IDEN
Initial S/W Revision	Prior to A.02.00
Modified at S/W Revision	A.02.00

Data 1

Select register 1 for assignment of trace data.

Key Path	Trace/Detector, Data, Register
Mode	VSA, LTE, LTETDD, IDEN
Initial S/W Revision	Prior to A.02.00
Modified at S/W Revision	A.02.00

Data 2

Selects register 2 for assignment of trace data.

Key Path	Trace/Detector, Data, Register
Mode	VSA, LTE, LTETDD, IDEN
Initial S/W Revision	Prior to A.02.00
Modified at S/W Revision	A.02.00

Data 3

Selects register 3 for assignment of trace data.

Key Path	Trace/Detector, Data, Register
Mode	VSA, LTE, LTETDD, IDEN
Initial S/W Revision	Prior to A.02.00
Modified at S/W Revision	A.02.00

Data 4

Selects register 4 for assignment of trace data.

Key Path	Trace/Detector, Data, Register
Mode	VSA, LTE, LTETDD, IDEN
Initial S/W Revision	Prior to A.02.00
Modified at S/W Revision	A.02.00

Data 5

Selects register 5 for assignment of trace data.

Key Path	Trace/Detector, Data, Register
Mode	VSA
Initial S/W Revision	Prior to A.02.00
Modified at S/W Revision	A.02.00

Data 6

Selects register 6 for assignment of trace data.

Key Path	Trace/Detector, Data, Register
Mode	VSA
Initial S/W Revision	Prior to A.02.00
Modified at S/W Revision	A.02.00

No Data

Enables you to turn off trace computations. Measurement results are not computed unless assigned to a trace. No Data lets you increase measurement speed by turning off post-processing calculations that are not needed.

Key Path	Trace/Detector, Data
Mode	VSA, LTE, LTETDD, IDEN
Initial S/W Revision	Prior to A.02.00
Modified at S/W Revision	A.02.00

Format

Accesses a menu that enables you to choose the format of the selected trace. Any format can be assigned to any trace. For symbol tables and tabular data the format choice is ignored. If the data doesn't have defined symbol times, Constellation format is the same as I-Q, Eye formats are the same as Real or Imaginary, and Trellis format is the same as Unwrapped Phase.

The formats are:

Format name	Description
Log Mag (dB)	Data is converted to decibel units and shown on a linear Y axis
Linear Mag (Abs Value)	Magnitude of the data is shown on a linear Y axis
Real (I)	Real part of data is shown on a linear Y axis
Imaginary (Q)	Imaginary part of data is shown on linear Y axis
I-Q	Real part of data is shown on horizontal axis, imaginary part is shown on vertical axis, Independent variable (X axis) is normal to display
Constellation	Same as I-Q, but for data with symbols defined, only the symbol points are shown as dots with no connecting lines.
Wrap Phase	Phase of complex data, limited to ± 180 deg, is shown on Y axis
Unwrap Phase	Phase of complex data is shown "unwrapped", that is, without discontinuities. Not limited to ± 180 degrees.
I-Eye	Real part of data is shown with X axis segmented (generally into 2 symbol segments) and each segment is overlaid to show signal crossings at symbol boundaries
Q-Eye	Same as I-eye but imaginary part of data is shown
Trellis	Same as I-eye but uses unwrapped phase of data
Group Delay	Useful for frequency response displays. Shows the derivative of phase response with respect to frequency.
Log Mag (Linear Unit)	Displays data with a logarithmic Y axis, but marker read outs are in linear magnitude units.

Key Path	Trace/Detector, Format
Mode	VSA, LTE, LTETDD, IDEN
Measurement	<meas>:=VECTor ADEMod DDEMod W11A W11B EVM IPOWER IDEMod MOTotalk
Remote Command	:DISPlay:<meas>:TRACe[1] 2 ...4:FORMat MLOG MLINear REAL IMAGinary VECTor CONS PHASE UPHase IEYE QEYE TRELLis GDElay MLGLinear :DISPlay:<meas>:TRACe[1] 2 ...4:FORMat?
Example	DISP:DDEM:TRAC2:FORM MLIN DISP:DDEM:TRAC2:FORM?
Preset	Depends on trace and measurement
State Saved	Saved in instrument state.

Range	Log Mag (dB) Linear Mag (Abs Value) Real (I) (Lin) Imaginary (Q) (Lin) I-Q Constellation Wrap Phase Unwrap Phase I-Eye Q-Eye Trellis-Eye Group Delay Log Mag (Linear Unit)
Readback Text	Log Mag (dB) Linear Mag Real (I) Imaginary (Q) I-Q Constellation Wrap Phase Unwrap Phase I-Eye Q-Eye Trellis-Eye Group Delay Log Mag
Initial S/W Revision	Prior to A.02.00
Modified at S/W Revision	A.02.00

Digital Demod Trace Setup

Accesses a menu of settings that control certain elements of displays of digitally demodulated trace data.

Key Path	Trace/Detector
Mode	VSA, LTE, LTETDD, IDEN
Initial S/W Revision	Prior to A.02.00
Modified at S/W Revision	A.02.00

Symbol Shape

Enables you to display dots, bars, or nothing (none) at symbol locations (if the trace contains demodulated time-domain data) for all time-domain displays except IQ diagrams. This key enables you to select the symbol shape for the selected trace.

If you select bars, vertical lines (bars) are drawn from the baseline to the symbol location on the trace. The baseline is 0 for all traces that have coordinates other than log (dB). The baseline is the bottom of the trace box for traces that have log (dB) coordinates.

With IQ diagrams, displaying vertical bars is meaningless. Therefore, selecting bars displays dots in IQ diagrams.

With constellation diagrams, selecting none is the same as selecting bars – you cannot turn off the dots in a constellation diagram.

Key Path	Trace/Detector, Digital Demod Trace Setup
Mode	VSA, LTE, LTETDD, IDEN
Measurement	<meas>:=VECTor ADEMod DDEMod W11A W11B EVM IPOWER IDEMod MOTotalk
Remote Command	:DISPlay:<meas>:TRACe [1] 2 . . . 4 :DDEMod:SYMBol BARS DOTS OFF :DISPlay:<meas>:TRACe [1] 2 . . . 4 :DDEMod:SYMBol ?
Example	DISP:DDEM:TRAC2:DDEM:SYMB DOTS DISP:DDEM:TRAC2:DDEM:SYMB?
Preset	BARS
State Saved	Saved in instrument state.
Range	Bars Dots None

Initial S/W Revision	Prior to A.02.00
Modified at S/W Revision	A.02.00

Ideal State Shape

Enables you to choose between a cross, circle, or none to represent the ideal state on the selected trace. Digital Demodulation shows you the location of all ideal symbol states in an I-Q or constellation diagram.

Key Path	Trace/Detector, Digital Demod Trace Setup
Mode	VSA, LTE, LTETDD, IDEN
Measurement	<meas>:=VECTor ADEMod DDEMod W11A W11B EVM IPOWER IDEMod MOTotalk
Remote Command	:DISPlay:<meas>:TRACe[1] 2 ...4:DDEMod:SYMBol:SHAPE CIRCle CROSS OFF :DISPlay:<meas>:TRACe[1] 2 ...4:DDEMod:SYMBol:SHAPE?
Example	DISP:DDEM:TRAC2:DDEM:SYMB:SHAP CIRC DISP:DDEM:TRAC2:DDEM:SYMB:SHAP?
Preset	CIRC
State Saved	Saved in instrument state.
Range	Circle Cross None
Initial S/W Revision	Prior to A.02.00
Modified at S/W Revision	A.02.00

Ideal State Size

Determines the ideal state size, as a percentage of the maximum ideal state distance from the origin (the same way Error Vector Magnitude is defined). Ideal states are shown as circles or crosses in Vector and constellation diagrams, as determined by the Ideal State Shape setting.

The ideal state is where symbols occur if your signal is without error. Showing the ideal states gives a visual indication of the quality of your signal.

You can use this feature to determine if symbols have an EVM above a specified Value. For example, to see if any symbols have an EVM greater than 10%, set the state size to 10% and select Circle as the shape. Any symbols that fall outside of the circle (other than SYNC or PILOT symbols) have an EVM greater than 10%.

Key Path	Trace/Detector, Digital Demod Trace Setup
Mode	VSA, LTE, LTETDD, IDEN
Measurement	<meas>:=VECTor ADEMod DDEMod W11A W11B EVM IPOWER IDEMod MOTotalk
Remote Command	:DISPlay:<meas>:TRACe[1] 2 ...4:DDEMod:SYMBol:SIZE <real> :DISPlay:<meas>:TRACe[1] 2 ...4:DDEMod:SYMBol:SIZE?
Example	DISP:DDEM:TRAC2:DDEM:SYMB:SIZE 10

	DISP:DDEM:TRAC2:DDEM:SYMB:SIZE?
Notes	Parameter is interpreted as a percent, e.g., if you want the ideal size to be 10% send 10, not 0.1
Preset	5
State Saved	Saved in instrument state.
Min	0.1
Max	50
Initial S/W Revision	Prior to A.02.00
Modified at S/W Revision	A.02.00

Symbol Table Format

Enables you to choose the format in which symbol table data is displayed, when the modulation format encodes 4 or more bits per symbol. You can choose binary or hexadecimal. Binary symbol data is padded with leading zeros to make a multiple of 4 bits before conversion to hexadecimal. For example, for 16 QAM format, each 4-bit symbol is displayed as 2 hex digits.

Binary Format: The symbol data bit format is binary and each character represents a binary digit. The number to the left of each row indicates the bit offset of the first bit in the row.

Hexadecimal Format: The symbol data bit format is hexadecimal and each character represents a hexadecimal digit. The number to the left of each row indicate the symbol offset of the first symbol in the row.

NOTE

There must be at least 4 bits/symbol to use the hexadecimal format, that is, symbols that have less than 4 bits/symbol are only displayed in binary format regardless of the Symbol Table Format setting.

This parameter is valid only when:

- The active trace is a symbol table, and
- The current demodulation format supports hexadecimal, the demodulation format's bits/symbol is equal to or greater than four.

Key Path	Trace/Detector, Digital Demod Trace Setup
Mode	VSA, LTE, LTETDD, IDEN
Measurement	<meas>:=VECTor ADEMod DDEMod W11A W11B EVM IPOWER IDEMod MOTotalk
Remote Command	:DISPlay:<meas>:TRACe [1] 2 . . . 4 : DDEMod : SYMBol : FORMat HEXadecimal BINary :DISPlay:<meas>:TRACe [1] 2 . . . 4 : DDEMod : SYMBol : FORMat?
Example	DISP:DDEM:TRAC2:DDEM:SYMB:FORM BIN DISP:DDEM:TRAC2:DDEM:SYMB:FORM?
Preset	HEX
Range	Hex Binary
Initial S/W Revision	Prior to A.02.00
Modified at S/W Revision	A.02.00

Time Unit

Enables you to select the time units that are applied to x-axis annotations and marker readouts for the selected trace, whenever it is assigned data with (demodulation) symbol information. The available measurement units are sym (symbols) or sec (seconds).

Key Path	Trace/Detector, Digital Demod Trace Setup
Mode	VSA, LTE, LTETDD, IDEN
Measurement	<meas>:=VECTor ADEMod DDEMod W11A W11B EVM IPOWER IDEMod MOTotalk
Remote Command	:DISPlay:<meas>:TRACe[1] 2 ...4:DDEMod:UNIT:TIME SEC SYMBOL :DISPlay:<meas>:TRACe[1] 2 ...4:DDEMod:UNIT:TIME?
Example	DISP:VECT:TRAC2:DDEM:UNIT:TIME SYMB DISP:VECT:TRAC2:DDEM:UNIT:TIME?
Preset	SYMB
State Saved	Saved in instrument state.
Range	sym sec
Initial S/W Revision	Prior to A.02.00
Modified at S/W Revision	A.02.00

Freq Unit

Enables you to select the frequency units that are applied to x-axis annotations and marker readouts for the selected trace, whenever it is assigned data with (demodulation) carrier information. The available measurement units are carrier or Hz.

Key Path	Trace/Detector, Digital Demod Trace Setup
Mode	VSA, LTE, LTETDD, IDEN
Measurement	<meas>:=VECTor ADEMod DDEMod W11A W11B EVM IPOWER IDEMod MOTotalk
Remote Command	:DISPlay:<meas>:TRACe[1] 2 ...4:DDEMod:UNIT:FREQuency CARRier HZ :DISPlay:<meas>:TRACe[1] 2 ...4:DDEMod:UNIT:FREQuency?
Example	DISP:VECT:TRAC2:DDEM:UNIT:FREQ CARR DISP:VECT:TRAC2:DDEM:UNIT:FREQ?
Preset	CARR
State Saved	Saved in instrument state.
Range	carrier Hz
Initial S/W Revision	Prior to A.02.00
Modified at S/W Revision	A.02.00

Eye Length

Controls how wide (in symbol periods) the eye and trellis diagrams are, for the selected trace.

Key Path	Trace/Detector, Digital Demod Trace Setup
Mode	VSA, LTE, LTETDD, IDEN
Measurement	<meas>:=VECTor ADEMod DDEMod W11A W11B EVM IPOWER IDEMod MOTotalk
Remote Command	:DISPlay:<meas>:TRACe [1] 2 . . . 4:DDEMod:EYE:COUNT <real> :DISPlay:<meas>:TRACe [1] 2 . . . 4:DDEMod:EYE:COUNT?
Example	DISP:DDEM:TRAC2:DDEM:EYE:COUN 3 DISP:DDEM:TRAC2:DDEM:EYE:COUN?
Preset	2
State Saved	Saved in instrument state.
Min	0.1
Max	40
Initial S/W Revision	Prior to A.02.00
Modified at S/W Revision	A.02.00

Avg Line

Controls whether or not the average line is visible on certain demodulation analysis traces such as Error Vector Time and Error Vector Spectrum in Digital Demod measurements. These traces have 2-dimensional domains; typically subcarriers (frequency) and symbol times. Since the result can only be shown with one of these dimensions on the x-axis, the other dimension is placed on the z-axis. Since all the z-axis values are overlapped, an average is calculated for all z values at each x value and the average is normally displayed as a line in front of trace. The average line display can be turned on or off using this control.

Key Path	Trace/Detector, Digital Demod Trace Setup
Mode	VSA, LTE, LTETDD, IDEN
Measurement	<meas>:=VECTor ADEMod DDEMod W11A W11B EVM IPOWER IDEMod MOTotalk
Remote Command	:DISPlay:<meas>:TRACe [1] 2 . . . 4:DDEMod:ALINE OFF ON 0 1 :DISPlay:<meas>:TRACe [1] 2 . . . 4:DDEMod:ALIN?
Example	DISP:W11A:TRAC:DDEM:ALIN OFF
Preset	1
State Saved	Saved in instrument state.
Initial S/W Revision	A.03.00 or later

Copy to Data Register

Accesses a menu of immediate execute keys, each of which copies the selected trace to a particular data register. Data registers can be displayed in any trace. They are measurement global, so you can copy data

to a register while in the Digital Demod measurement and view it later while in the Vector measurement. Data registers are cleared when the VSA Application is exited and reentered, but not when you change Modes and return.

Key Path	Trace/Detector
Mode	VSA, LTE, LTETDD, IDEN
Measurement	<meas>:=VECTor ADEMod DDEMod W11A W11B EVM IPOWER IDEMod MOTotalk
Remote Command	:DISPlay:<meas>:TRACe [1] 2 . . . 4 : COPY D1 D2 D3 D4 D5 D6
Example	DISP:VECT:TRAC:COPY D1
Readback Text	Last: <date_time> Empty
Initial S/W Revision	Prior to A.02.00
Modified at S/W Revision	A.02.00

The following SCPI provides means to determine if a Data Register is empty, and to erase the data from any or all Data Registers.

Mode	VSA, LTE, LTETDD, IDEN
Remote Command	:CALCulate:DATA:REGister [1] 2 . . . 6 : EMPTy?
Example	:CALC:DATA:REG2:EMPT?
Notes	Query only: returns 1 if a Data Register has no trace data assigned to it.
Initial S/W Revision	Prior to A.02.00
Modified at S/W Revision	A.02.00

Mode	VSA, LTE, LTETDD, IDEN
Remote Command	:CALCulate:DATA:REGister [1] 2 . . . 6 : REMove
Example	:CALC:DATA:REG2:REM
Notes	Removes trace data assigned to specified Data Register.
Couplings	If Data Register is assigned to a trace, the trace data is changed to No Data
Initial S/W Revision	Prior to A.02.00
Modified at S/W Revision	A.02.00

Mode	VSA, LTE, LTETDD, IDEN
Remote Command	:CALCulate:DATA:REGister:ALL:REMove
Example	:CALC:DATA:REG:ALL:REM
Notes	Removes trace data assigned to all Data Registers.
Couplings	If Data Register is assigned to a trace, the trace data is changed to No Data
Initial S/W Revision	Prior to A.02.00
Modified at S/W Revision	A.02.00

Phase/Delay Properties

Accesses a menu of properties that affect the selected trace when displayed using phase or delay formats.

Key Path	Trace/Detector
Mode	VSA, LTE, LTETDD, IDEN
Initial S/W Revision	Prior to A.02.00
Modified at S/W Revision	A.02.00

Phase/Trellis Offset

Only used if the trace format is Wrap Phase, Unwrap Phase, or Trellis. For Unwrap Phase or Trellis traces, the phase offset value is added to the existing phase at each point. For example, if you are viewing an Unwrapped Phase trace, setting the Phase/Trellis Offset to 5 degrees moves the entire trace up 5 degrees (and changes the value displayed by a marker by the same amount). For Wrap Phase traces the phase offset only affects the phase wrap point, not the underlying data. The point at which the phase wraps is 180 degrees plus the phase offset. For example, suppose you have a marker on a Wrap Phase trace whose phase offset is 0 and the marker is showing -3 degrees. The trace data is all confined within (-180, 180] degrees. If you then change the phase offset to 180 degrees, then the Wrap Phase trace shows values within the interval (0, 360] degrees and the marker value is displayed as 357 degrees, which is the wrapped equivalent of -3 degrees.

Key Path	Trace/Detector, Phase Delay Properties
Mode	VSA, LTE, LTETDD, IDEN
Measurement	<meas>:=VECTor ADEMod DDEMod W11A W11B EVM IPOWER IDEMod MOTotalk
Remote Command	:DISPlay:<meas>:TRACe[1] 2 ...4:FORMat:PHASe:OFFSet <real> :DISPlay:<meas>:TRACe[1] 2 ...4:FORMat:PHASe:OFFSet?
Example	DISP:DDEM:TRAC3:FORM:PHAS:OFFS 31 DISP:DDEM:TRAC3:FORM:PHAS:OFFS?
Preset	0
State Saved	Saved in instrument state.
Min	-1E+8
Max	1E+8
Initial S/W Revision	Prior to A.02.00
Modified at S/W Revision	A.02.00

Unwrap Phase Ref

Enables you to designate the point (x-axis) value about which phase values are to be unwrapped. That is, the phase at the designated reference is within -180 to 180 degrees, and phase varies smoothly without jumps around that point.

Key Path	Trace/Detector, Phase Delay Properties
Mode	VSA, LTE, LTETDD, IDEN
Measurement	<meas>:=VECTor ADEMod DDEMod W11A W11B EVM IPOWER IDEMod MOTotalk
Remote Command	:DISPlay:<meas>:TRACe[1] 2 ...4:FORMat:PHASe:UNWRap:REFerence <real> :DISPlay:<meas>:TRACe[1] 2 ...4:FORMat:PHASe:UNWRap:REFerence?
Example	DISP:DDEM:TRAC3:FORM:PHAS:UNWR:REF 24.5E6 DISP:DDEM:TRAC3:FORM:PHAS:UNWR:REF?
Preset	0
State Saved	Saved in instrument state.
Min	-9.9e37
Max	9.9e37
Initial S/W Revision	Prior to A.02.00
Modified at S/W Revision	A.02.00

Group Delay Aperture

Used when the trace format is Group Delay. The aperture is specified as a percentage of the current frequency span for frequency-domain data. It is specified as a percentage of the time-record length for time-domain data.

When group delay is calculated for a given point (which can be a time- or frequency-domain point), the aperture is centered at that point. Larger apertures decrease resolution, but they increase the smoothing of the group-delay trace.

The point plotted for group delay is located between the data points used to calculate it. For example, in the frequency domain, the group delay for 100 Hz can be calculated by measuring the change in phase between 90 and 110 Hz. If you had specified a start frequency of 90 Hz, 100 Hz would be the first point with group delay data. This results in a trace that does not extend to the edges of the screen (more noticeable as the delay aperture increases).

Note that the smallest aperture that you can select depends on the number of frequency points. If you select an invalid aperture, the analyzer automatically selects the smallest valid aperture.

Key Path	Trace/Detector, Phase Delay Properties
Mode	VSA, LTE, LTETDD, IDEN
Measurement	<meas>:=VECTor ADEMod DDEMod W11A W11B EVM IPOWER IDEMod MOTotalk
Remote Command	:DISPlay:<meas>:TRACe[1] 2 ...4:FORMat:DELAy:APERture <real> :DISPlay:<meas>:TRACe[1] 2 ...4:FORMat:DELAy:APERture?
Example	DISP:DDEM:TRAC3:FORM:DEL:APER 1 DISP:DDEM:TRAC3:FORM:DEL:APER?
Notes	Parameter is interpreted as a percent, e.g., if you want the group delay aperture to be 1% send 1, not 0.01

Preset	0.5
State Saved	Saved in instrument state.
Min	0.00390625
Max	16
Initial S/W Revision	Prior to A.02.00
Modified at S/W Revision	A.02.00

ACP Setup

Accesses a menu of functions that enable you to define and turn on the ACP function on the selected trace. One reference channel and up to 5 offset frequencies can be defined, and ACP is calculated for bands both above and below the reference frequency for each offset.

The adjacent channel power (ACP) function calculates the power in a reference band of frequencies as well as bands of frequencies offset from the reference, and calculates the ratio of each offset band to the reference band power.

An ACP measurement can be defined for each trace, although it is only active on frequency-domain trace data. The reference and offset frequency bands defined by the ACP measurement are shown as gold bars overlaying the trace display. To see tabular data showing power and power ratio results, you can assign the ACP Summary (Trace n) to a different trace. For example, you can assign Spectrum data to trace 1, turn on and define an ACP measurement on trace 1, assign the ACP Summary (Trace 1) to trace 2, and use a 2x2 display to view both at the same time, as shown below.

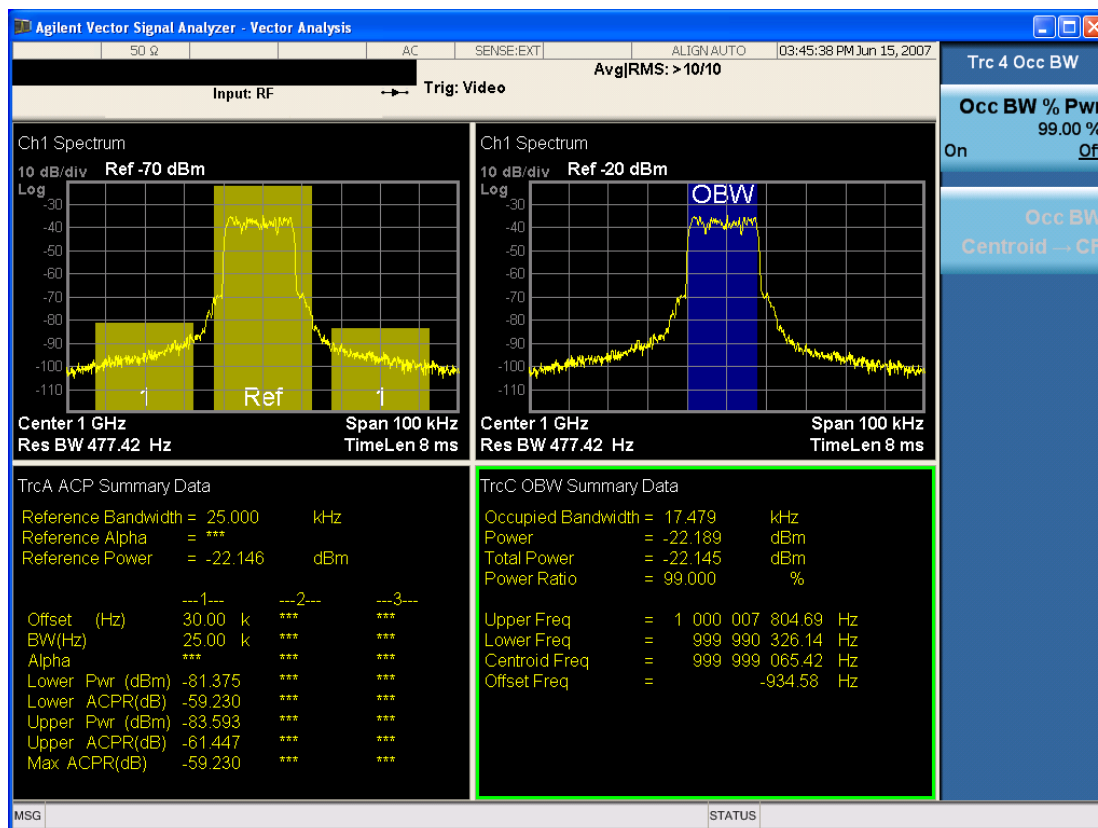

The summary data can be retrieved programmatically using FETCH? or the CALCulate:<meas>:DATA:TABLE commands. See "[:CALCulate:DATA:TABLE commands](#)" on page 1291 for more details.

Key Path	Trace/Detector
Mode	VSA, LTE, LTETDD, IDEN
Readback Text	[On Off,]
Initial S/W Revision	Prior to A.02.00
Modified at S/W Revision	A.02.00

ACP On/Off

Turns the ACP function on or off for the selected trace.

Key Path	Trace/Detector, ACP
Mode	VSA, LTE, LTETDD, IDEN
Measurement	<meas>:=VECTor ADEMod DDEMod W11A W11B EVM IPOWER IDEMod MOTotalk
Remote Command	:CALCulate:<meas>:TRACe[1] 2 ...4:ACPpower:STATE OFF ON 0 1 :CALCulate:<meas>:TRACe[1] 2 ...4:ACPpower:STATE?
Example	CALC:VECT:TRAC1:ACP:STATE ON

	CALC:VECT:TRAC1:ACP:STATE?
Preset	0
State Saved	Saved in instrument state.
Initial S/W Revision	Prior to A.02.00
Modified at S/W Revision	A.02.00

Carrier Freq

Enables you to enter the carrier frequency of the reference channel for the ACP measurement. The carrier frequency is relative to the center frequency of the measurement. There is only one available reference carrier.

Key Path	Trace/Detector, ACP
Mode	VSA, LTE, LTETDD, IDEN
Measurement	<meas>:=VECTor ADEMod DDEMod W11A W11B EVM IPOWER IDEMod MOTotalk
Remote Command	:CALCulate:<meas>:TRACe[1] 2 ...4:ACPpower:CARRier:FREQuency <freq> :CALCulate:<meas>:TRACe[1] 2 ...4:ACPpower:CARRier:FREQuency?
Example	CALC:VECT:TRAC1:ACP:CARR:FREQ 100 KHZ CALC:VECT:TRAC1:ACP:CARR:FREQ?
Preset	0
State Saved	Saved in instrument state.
Min	-9.9e37
Max	9.9e37
Initial S/W Revision	Prior to A.02.00
Modified at S/W Revision	A.02.00

Carrier Meas Noise BW

Enables you to define the measurement noise bandwidth of the reference channel.

Key Path	Trace/Detector, ACP
Mode	VSA, LTE, LTETDD, IDEN
Measurement	<meas>:=VECTor ADEMod DDEMod W11A W11B EVM IPOWER IDEMod MOTotalk
Remote Command	:CALCulate:<meas>:TRACe[1] 2 ...4:ACPpower:CARRier:BANDwidth BWIth:INTegration <bandwidth> :CALCulate:<meas>:TRACe[1] 2 ...4:ACPpower:CARRier:BANDwidth BWIth:INTegration?
Example	CALC:VECT:TRAC1:ACP:CARR:BAND:INT 1 MHZ CALC:VECT:TRAC1:ACP:CARR:BAND:INT?

Preset	1000000
State Saved	Saved in instrument state.
Min	-9.9e37
Max	9.9e37
Initial S/W Revision	Prior to A.02.00
Modified at S/W Revision	A.02.00

Carrier RRC Weighting

Turns on or off RRC weighting for the reference (carrier) power measurement.

Key Path	Trace/Detector, ACP
Mode	VSA, LTE, LTETDD, IDEN
Measurement	<meas>:=VECTor ADEMod DDEMod W11A W11B EVM IPOWER IDEMod MOTotalk
Remote Command	:CALCulate:<meas>:TRACe[1] 2 ...4:ACPowEr:CARRier:FILTer:RRC:STATe OFF ON 0 1 :CALCulate:<meas>:TRACe[1] 2 ...4:ACPowEr:CARRier:FILTer:RRC:STATe?
Example	CALC:VECT:TRAC1:ACP:CARR:FILT:RRC:STAT ON CALC:VECT:TRAC1:ACP:CARR:FILT:RRC:STAT?
Preset	0
State Saved	Saved in instrument state.
Initial S/W Revision	Prior to A.02.00
Modified at S/W Revision	A.02.00

Carrier Filter Alpha

Enables you to adjust the alpha of the RRC filter for the reference (carrier) power measurement.

Key Path	Trace/Detector, ACP
Mode	VSA, LTE, LTETDD, IDEN
Measurement	<meas>:=VECTor ADEMod DDEMod W11A W11B EVM IPOWER IDEMod MOTotalk
Remote Command	:CALCulate:<meas>:TRACe[1] 2 ...4:ACPowEr:CARRier:FILTer:RRC:ALPHa <real> :CALCulate:<meas>:TRACe[1] 2 ...4:ACPowEr:CARRier:FILTer:RRC:ALPHa?
Example	CALC:VECT:TRAC1:ACP:CARR:FILT:RRC:ALPH 0.22 CALC:VECT:TRAC1:ACP:CARR:FILT:RRC:ALPH?
Preset	0.35
State Saved	Saved in instrument state.

Min	0
Max	1
Initial S/W Revision	Prior to A.02.00
Modified at S/W Revision	A.02.00

Offsets

Accesses a menu that has a key for each offset, and also an Offset RRC weighting on/off key. Each offset key shows a summary of its current parameters. Pressing one of the Offset A|B|C|D|E keys accesses a menu for adjusting its parameters.

The ACP measurement compares power in frequency bands offset from the carrier to power in the reference channel (centered on the carrier). Up to 5 offsets can be defined. The offsets are designated by letters A through E. Each offset is defined by an offset frequency, bandwidth, and optional RRC weighting. An offset actually defines two bands, one above the reference frequency and one below. Each band is used individually in the ACP calculation. RRC weighting can only be turned on or off for all offsets, but each offset can have its own RRC filter alpha. A filter alpha of 0 is the same as no RRC weighting.

Key Path	Trace/Detector,ACP,Offsets
Mode	VSA, LTE, LTETDD, IDEN
Initial S/W Revision	Prior to A.02.00
Modified at S/W Revision	A.02.00

Offsets

Accesses a menu that has a key for each offset, and also an Offset RRC weighting on/off key. Each offset key shows a summary of its current parameters. Pressing one of the Offset A|B|C|D|E keys accesses a menu for adjusting its parameters.

The ACP measurement compares power in frequency bands offset from the carrier to power in the reference channel (centered on the carrier). Up to 5 offsets can be defined. The offsets are designated by letters A through E. Each offset is defined by an offset frequency, bandwidth, and optional RRC weighting. An offset actually defines two bands, one above the reference frequency and one below. Each band is used individually in the ACP calculation. RRC weighting can only be turned on or off for all offsets, but each offset can have its own RRC filter alpha. A filter alpha of 0 is the same as no RRC weighting.

Key Path	Trace/Detector,ACP,Offsets
Mode	VSA, LTE, LTETDD, IDEN
Initial S/W Revision	Prior to A.02.00
Modified at S/W Revision	A.02.00

Offset Freq

Turns ACP analysis on or off for a selected offset and sets the offset frequency, which is relative to the carrier frequency.

Key Path	Trace/Detector, ACP, Offsets, Offset A B C D E
Mode	VSA, LTE, LTETDD, IDEN
Measurement	<meas>:=VECTor ADEMod DDEMod W11A W11B EVM IPOWER IDEMod MOTotalk
Remote Command	:CALCulate:<meas>:TRACe[1] 2 ...4:ACPpower:OFFSet:LIST:FREQuency <freq>, ... :CALCulate:<meas>:TRACe[1] 2 ...4:ACPpower:OFFSet:LIST:FREQuency? :CALCulate:<meas>:TRACe[1] 2 ...4:ACPpower:OFFSet:LIST:STATe OFF ON 0 1, ... :CALCulate:<meas>:TRACe[1] 2 ...4:ACPpower:OFFSet:LIST:STATe?
Example	CALC:VECT:TRAC1:ACP:OFFS:LIST:FREQ 1 MHZ, 1 MHZ, 500 KHZ, 500 KHZ, 1 MHZ CALC:VECT:TRAC1:ACP:OFFS:LIST:FREQ? :CALC:VECT:TRAC1:ACP:OFFS:LIST:STAT ON, OFF, OFF, ON, OFF
Notes	If you send fewer than 5 frequencies in the parameter list, then the remaining offsets frequencies are set to 0. You can send a single on/off parameter or a comma-separated list of up to 5 parameters. These enable/disable each of the Offsets in sequence. Any remaining Offsets are disabled
Preset	3000000,0,0,0,0 1,0,0,0,0
State Saved	Saved in instrument state.
Min	-9.9E+37
Max	9.9E+37
Initial S/W Revision	Prior to A.02.00
Modified at S/W Revision	A.02.00

Offset Meas Noise BW

Enables you to set the measurement noise bandwidth for the power measurement of a selected offset band.

Key Path	Trace/Detector, ACP, Offsets, Offset A B C D E
Mode	VSA, LTE, LTETDD, IDEN
Measurement	<meas>:=VECTor ADEMod DDEMod W11A W11B EVM IPOWER IDEMod MOTotalk
Remote Command	:CALCulate:<meas>:TRACe[1] 2 ...4:ACPpower:OFFSet:LIST:BANDwidth BWiDth:INTEgration <bandwidth>, ... :CALCulate:<meas>:TRACe[1] 2 ...4:ACPpower:OFFSet:LIST:BANDwidth BWiDth:INTEgration?
Example	CALC:VECT:TRAC1:ACP:OFFS:LIST:BAND:INT 1 MHZ, 2 MHZ, 3 MHZ, 4 MHZ, 5 MHZ CALC:VECT:TRAC1:ACP:OFFS:LIST:BAND:INT?

Notes	If you send fewer than 5 bandwidth parameters in the list, then Measurement Noise Bandwidths for the remaining Offsets are set to 0.
Preset	1000000,0,0,0,0
State Saved	Saved in instrument state.
Min	-9.9e37
Max	9.9e37
Initial S/W Revision	Prior to A.02.00
Modified at S/W Revision	A.02.00

Offset Filter Alpha

Enables you to adjust the alpha of the RRC filter for the power measurement of the selected offset band.

Key Path	Trace/Detector, ACP, Offsets, Offset A B C D E
Mode	VSA, LTE, LTETDD, IDEN
Measurement	<meas>:=VECTor ADEMod DDEMod W11A W11B EVM IPOWER IDEMod MOTotalk
Remote Command	:CALCulate:<meas>:TRACe[1] 2 ...4:ACP:OFFSet:LIST:FILTer:RRC:ALPHA <real>, ... :CALCulate:<meas>:TRACe[1] 2 ...4:ACP:OFFSet:LIST:FILTer:RRC:ALPHA?
Example	CALC:VECT:TRAC1:ACP:OFFS:LIST:FILT:RRC:ALPH 0.22, 0.22, 0.22, 0.22, 0.22 CALC:VECT:TRAC1:ACP:OFFS:LIST:FILT:RRC:ALPH?
Notes	You can send a single Filter Alpha for Offset A or a comma-separated list of up to 5 Filter Alpha parameters. These are assigned in sequence to the Offsets. Alpha for any remaining Offsets are set to 0.
Preset	0.35,0.35,0.35,0.35,0.35
State Saved	Saved in instrument state.
Min	0
Max	1.0
Initial S/W Revision	Prior to A.02.00
Modified at S/W Revision	A.02.00

Offset Relative Limit

Enables you to turn on/off a relative limit test and set the limit for the selected offset. The test shows a failure if the power in either the upper or lower band at the selected offset exceeds the reference power plus the relative test limit. For example, if the test limit is -60, the reference power is -4.5 dBm, a test failure would be shown if the power in the lower or upper band exceeds -64.5 dBm.

Key Path	Trace/Detector, ACP, Offsets
Mode	VSA, LTE, LTETDD, IDEN

Measurement	<meas>:=VECTor ADEMod DDEMod W11A W11B EVM IPOWER IDEMod MOTotalk
Remote Command	:CALCulate:<meas>:TRACe[1] 2 ...4:ACPoweR:OFFSet:LIST:RCARrier <reall>, ... :CALCulate:<meas>:TRACe[1] 2 ...4:ACPoweR:OFFSet:LIST:RCARrier? :CALCulate:<meas>:TRACe[1] 2 ...4:ACPoweR:OFFSet:LIST:RCARrier:TEST OFF ON 0 1, ... :CALCulate:<meas>:TRACe[1] 2 ...4:ACPoweR:OFFSet:LIST:RCARrier:TEST?
Example	CALC:VECT:TRAC1:ACP:OFFS:LIST:RCAR -50, -55, -60, -65, -80 CALC:VECT:TRAC1:ACP:OFFS:LIST:RCAR? CALC:VECT:TRAC1:ACP:OFFS:LIST:RCAR:TEST 1, 1, 1, 1, 1 CALC:VECT:TRAC1:ACP:OFFS:LIST:RCAR:TEST?
Notes	You can send a single Limit for Offset A or a comma-separated list of up to 5 limit parameters. These are assigned in sequence to the Offset frequencies with the remaining limits being set to 0. You can send a single on/off parameter or a comma-separated list of up to 5 parameters. These turn the Limit Test on or off for each of the Offsets in sequence. For any remaining Offsets, the Limit test is turned off.
Preset	-120,-120,-120,-120,-120 0,0,0,0,0
State Saved	Saved in instrument state.
Min	50
Max	-200
Initial S/W Revision	Prior to A.02.00
Modified at S/W Revision	A.02.00

RRC Weighting (All Offsets)

Turns on or off RRC weighting for the power measurement for all offsets. If RRC weighting is turned on, but you want to exclude RRC weighting for a particular offset, set its filter alpha to 0.

Key Path	Trace/Detector,ACP,Offsets
Mode	VSA, LTE, LTETDD, IDEN
Measurement	<meas>:=VECTor ADEMod DDEMod W11A W11B EVM IPOWER IDEMod MOTotalk
Remote Command	:CALCulate:<meas>:TRACe[1] 2 ...4:ACPoweR:OFFSet:FILTer:RRC:STATe OFF ON 0 1 :CALCulate:<meas>:TRACe[1] 2 ...4:ACPoweR:OFFSet:FILTer:RRC:STATe?
Example	CALC:VECT:TRAC1:ACP:OFFS:FILT:RRC:STAT ON CALC:VECT:TRAC1:ACP:OFFS:FILT:RRC:STAT?
Preset	0
State Saved	Saved in instrument state.
Initial S/W Revision	Prior to A.02.00
Modified at S/W Revision	A.02.00

OBW Setup (Occupied Bandwidth)

Accesses a menu of functions that enable you to define and turn on the OBW function on the selected trace.

The occupied bandwidth (OBW) function finds and displays the band of frequencies that contain a specified percentage of the total power within the measurement span.

An OBW measurement can be defined for each trace, although it is only active on frequency-domain trace data. The band defined by the OBW measurement is shown as a blue bar overlaying the trace display. To see tabular data showing the frequencies of the band limits, the total power, and so on, you can assign the OBW Summary (Trace n) to a different trace. For example, you can assign Spectrum data to trace 3, turn on OBW on trace 3, and assign the OBW Summary (Trace 3) to trace 4, as shown below.

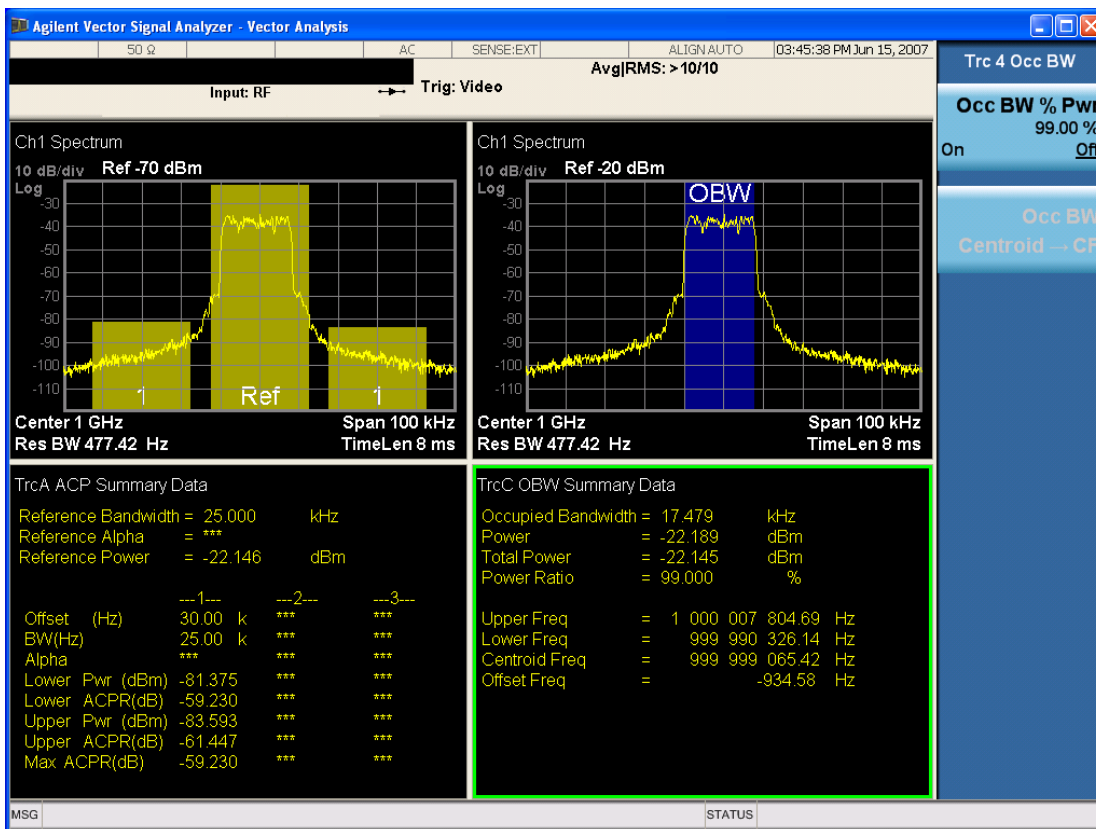

The summary data can be retrieved programmatically using FETCH? or the CALCulate:<meas>:DATA:TABLE commands. See "[CALCulate:DATA:TABLE commands](#)" on page 1291 for more details.

Key Path	Trace/Detector
Mode	VSA, LTE, LTETDD, IDEN
Readback Text	[On Off, <num>%]
Initial S/W Revision	Prior to A.02.00
Modified at S/W Revision	A.02.00

OBW Power

Specifies the percentage of power for determining the occupied BW, and turns the OBW function on or off for the selected trace.

Key Path	Trace/Detector, OBW
Mode	VSA, LTE, LTETDD, IDEN
Measurement	<meas>:=VECTor ADEMod DDEMod W11A W11B EVM IPOWER IDEMod MOTotalk
Remote Command	:CALCulate:<meas>:TRACe[1] 2 ...4:OBWidth:PERCent <real> :CALCulate:<meas>:TRACe[1] 2 ...4:OBWidth:PERCent? :CALCulate:<meas>:TRACe[1] 2 ...4:OBWidth:STATE OFF ON 0 1 :CALCulate:<meas>:TRACe[1] 2 ...4:OBWidth:STATE?
Example	CALC:VECT:TRAC1:OBW:PERC 99 CALC:VECT:TRAC1:OBW:PERC? CALC:VECT:TRAC1:OBW:STAT ON CALC:VECT:TRAC1:OBW:STAT?
Notes	Parameter is interpreted as a percent, e.g., if you want the OBW to be 95% send 95, not 0.95
Preset	99.0 0
State Saved	Saved in instrument state.
Min	0
Max	100
Initial S/W Revision	Prior to A.02.00
Modified at S/W Revision	A.02.00

OBW Centroid > CF

Copies the centroid of the occupied bandwidth to the Center Frequency. It only works if the currently selected trace has data compatible with the OBW function and OBW is turned on.

This is a front-panel function only.

You can read the OBW centroid using the following SCPI-only query and use the result to set the center frequency.

Mode	VSA, LTE, LTETDD, IDEN
Measurement	<meas>:=VECTor ADEMod DDEMod W11A W11B EVM IPOWER IDEMod MOTotalk
Remote Command	:CALCulate:<meas>:TRACe[1] 2 ...4:OBWidth:CENTroid?
Example	CALC:VECT:TRAC1:OBW:CENT?
Notes	Query only. Returns NaN (9.91E+37) if the OBW function is not active for the selected trace or is not supported for the trace data assigned to the selected trace.

Initial S/W Revision	Prior to A.02.00
Modified at S/W Revision	A.02.00

BW Limit

Turns on or off limit testing for the Occupied BW test for the selected trace, and enables you to define the limit. Test pass or fail status appears in the OBW Summary table associated with the trace.

Key Path	Trace/Detector, OBW
Mode	VSA, LTE, LTETDD, IDEN
Measurement	<meas>:=VECTor ADEMod DDEMod W11A W11B EVM IPOWER IDEMod MOTotalk
Remote Command	:CALCulate:<meas>:TRACe[1] 2 ...4:OBWidth:LIMit:FBLimit <freq> :CALCulate:<meas>:TRACe[1] 2 ...4:OBWidth:LIMit:FBLimit? :CALCulate:<meas>:TRACe[1] 2 ...4:OBWidth:LIMit[:TEST] OFF ON 0 1 :CALCulate:<meas>:TRACe[1] 2 ...4:OBWidth:LIMit[:TEST]?
Example	CALC:VECT:TRAC1:OBW:LIMIT:FBL 10 MHZ CALC:VECT:TRAC1:OBW:LIMIT:FBL? CALC:VECT:TRAC1:OBW:LIMIT:TEST ON CALC:VECT:TRAC1:OBW:LIMIT:TEST?
Preset	1000000 0
State Saved	Saved in instrument state.
Min	1 Hz
Max	9.9e37 (Infinity) Hz
Initial S/W Revision	Prior to A.02.00
Modified at S/W Revision	A.02.00

Trace Indicator Info

Enables you to get more information about why a trace indicator is showing. A trace indicator appears in the upper right corner of a trace display to announce exceptional conditions. When such an indicator is showing on the selected trace, pressing this key causes more information about the condition to appear in the message area. This is a front-panel only function. The SCPI commands for querying the Trace Indicator and the Trace Indicator Info for a particular trace are:

CALC:<meas>:DATA[1]]2|3|4:HEAD:STR? "TrcLedStr"

CALC:<meas>:DATA[1]]2|3|4:HEAD:STR? "TrcLedReason"

Key Path	Trace/Detector
Mode	VSA, LTE, LTETDD, IDEN

Initial S/W Revision	Prior to A.02.00
Modified at S/W Revision	A.02.00

Trigger

See ["Trigger" on page 310](#)

Free Run

See ["Free Run" on page 310](#)

Video

See ["Video \(IF Envelope\)" on page 310](#)

Trigger Level

See ["Trigger Level" on page 311](#)

Trig Slope

See ["Trig Slope" on page 311](#)

Trig Delay

See ["Trig Delay" on page 312](#)

Trig Holdoff

See ["Trig Holdoff" on page 312](#)

Holdoff Type

See ["Holdoff Type" on page 313](#)

External 1

See ["External 1" on page 314](#)

Trigger Level

See ["Trigger Level" on page 314](#)

Trig Slope

See ["Trig Slope" on page 315](#)

Trig Delay

See ["Trig Delay" on page 315](#)

Trig Holdoff

See ["Trig Holdoff" on page 316](#)

Holdoff Type

See ["Holdoff Type" on page 316](#)

Trig Reference Line

See "Trig Reference Line" on page 317

User Preset

Accesses a menu that gives you the following three choices:

- User Preset – recalls a state previously saved using the Save User Preset function.
- User Preset All Modes – presets all of the modes in the analyzer
- Save User Preset– saves the current state for the current mode

Key Path	Front-panel key
Backwards Compatibility Notes	<p>User Preset is actually loading a state, and in legacy analyzers, it was possible to load a state without affecting the trace data, limit lines or correction data. Similarly it was possible to do a User Preset without affecting the trace data, limit lines or correction data.</p> <p>In the X-Series, “state” always includes all of this data; so whenever state is loaded, or User Preset is executed, all of the traces, limit lines and corrections are affected. Although this differs from previous behavior, it is desirable behavior, and should not cause adverse issues for users.</p> <p>On ESA and PSA, User Preset affected the entire instrument’s state. In the X-Series, User Preset only recalls the state for the active mode. There is a User Preset file for each mode. User Preset can never cause a mode switch as it can in legacy analyzers. If you want to recall all modes to their user preset file state, you will need to do a User Preset after mode switching into each mode.</p> <p>User Preset recalls mode state which can now include data like traces; whereas on ESA and PSA, User Preset did not affect data.</p>
Initial S/W Revision	Prior to A.02.00

User Preset

User Preset sets the state of the currently active mode back to the state that was previously saved for this mode using the Save User Preset menu key or the SCPI command, SYST:PRES:USER:SAV. It not only recalls the Mode Preset settings, but it also recalls all of the mode persistent settings, and the Input/Output system setting that existed at the time Save User Preset was executed.

If a Save User Preset has not been done at any time, User Preset recalls the default user preset file for the currently active mode. The default user preset files are created if, at power-on, a mode detects there is no user preset file. There will never be a scenario when there is no user preset file to restore. For each mode, the default user preset state is the same state that would be saved if a Save User Preset is performed in each mode right after doing a Restore Mode Default and after a Restore Input/Output Defaults.

The User Preset function does the following:

- Aborts the currently running measurement.
- Sets the mode State to the values defined by Save User Preset.
- Makes the saved measurement for the currently running mode the active measurement.
- Brings up the saved menu for the power-on mode.
- Clears the input and output buffers.
- Sets the Status Byte to 0.

Key Path	User Preset
Remote Command	:SYSTem:PRESet:USER
Example	:SYST:PRES:USER:SAVE:SYST:PRES:USER
Notes	:SYST:PRES:USER:SAVE is used to save the current state as the user preset state. Clears all pending OPC bits. The Status Byte is set to 0. Pressing the User Preset front-panel key while already in the User Preset menu will cause the User Preset to get executed
Couplings	A user preset will cause the currently running measurement to be aborted and cause the saved measurement to be active. Recalling a User Preset file has the same issues that recalling a Save State file has. Some settings may need to be limited and therefore re-coupled, since the capabilities of the mode may have changes when the User Preset file was last saved.
Initial S/W Revision	Prior to A.02.00

User Preset All Modes

Recalls all of the User Preset files for each mode, switches to the power-on mode, and activates the saved measurement from the power-on mode User Preset file.

NOTE

When the instrument is secured, all of the user preset files are converted back to their default user preset files.

The User Preset function does the following:

- Aborts the currently running measurement.
- Switches the Mode to the power-on mode.
- Restores the User Preset files for each mode.
- Makes the saved measurement for the power-on mode the active measurement.
- Brings up the saved menu for the power-on mode.
- Clears the input and output buffers.
- Sets the Status Byte to 0.

Key Path	User Preset
Remote Command	:SYSTem:PRESet:USER:ALL
Example	:SYST:PRES:USER:SAVE:SYST:PRES:USER:ALL
Notes	Clears all pending OPC bits. The Status Byte is set to 0. :SYST:PRES:USER:SAVE is used to save the current state as the user preset state.
Couplings	A user preset will cause the currently running measurement to be aborted, cause a mode switch to the power-on mode, and cause the saved measurement to be active in the power-on mode. Recalling a User Preset file has the same issues that recalling a Save State file has. Some settings may need to be limited and therefore re-coupled, since the capabilities of the mode may have changes when the User Preset file was last saved.
Initial S/W Revision	Prior to A.02.00

Save User Preset

Saves the currently active mode and its State. You can recall this User Preset file by pressing the User Preset menu key or sending the SYST:PRES:USER remote command. This same state is also saved by the Save State function.

Key Path	User Preset
Remote Command	:SYSTem:PRESet:USER:SAVE
Example	:SYST:PRES:USER:SAVE
Notes	:SYST:PRES:SAVE creates the same file as if the user requested a *SAV or a MMEM:STOR:STAT, except User Preset Save does not allow the user to specify the filename or the location of the file.
Initial S/W Revision	Prior to A.02.00

View/Display

Provides access to a menu that enable you to select display parameters for the current measurement.

View Presets affect the trace layout, trace data assignment, scaling and formatting but do not affect hardware measurement setup.

Key Path	Front Panel
Mode	VSA
Remote Command	:DISPlay:VECTor:VIEW:PRESet SPECTrum STATistics
Example	:DISP:VECT:VIEW:PRES SPEC

Display

The Display menu is common to most measurements, and is used for configuring items on the display. Some Display menu settings apply to all the measurements in a mode, and some only to the current measurement. Those under the System Display Settings key apply to all measurements in all modes.

Key Path	Display
Key Path	View/Display
Initial S/W Revision	Prior to A.02.00

Annotation

Turns on and off various parts of the display annotation. The annotation is divided up into four categories:

1. Meas Bar: This is the measurement bar at the top of the screen. It does not include the settings panel or the Active Function. Turning off the Meas Bar turns off the settings panel and the Active Function. When the Meas Bar is off, the graticule area expands to fill the area formerly occupied by the Meas Bar.
2. Screen Annotation: this is the annotation and annunciation around the graticule, including any annotation on lines (such as the display line, the threshold line, etc.) This does NOT include the marker number or the N dB result. When off, the graticule expands to fill the entire graticule area.
3. Trace annotation: these are the labels on the traces, showing their detector (or their math mode).
4. Active Function annotation: this is the active function display in the meas bar, and all of the active function values displayed on softkeys.

See the figure below. Each type of annotation can be turned on and off individually.

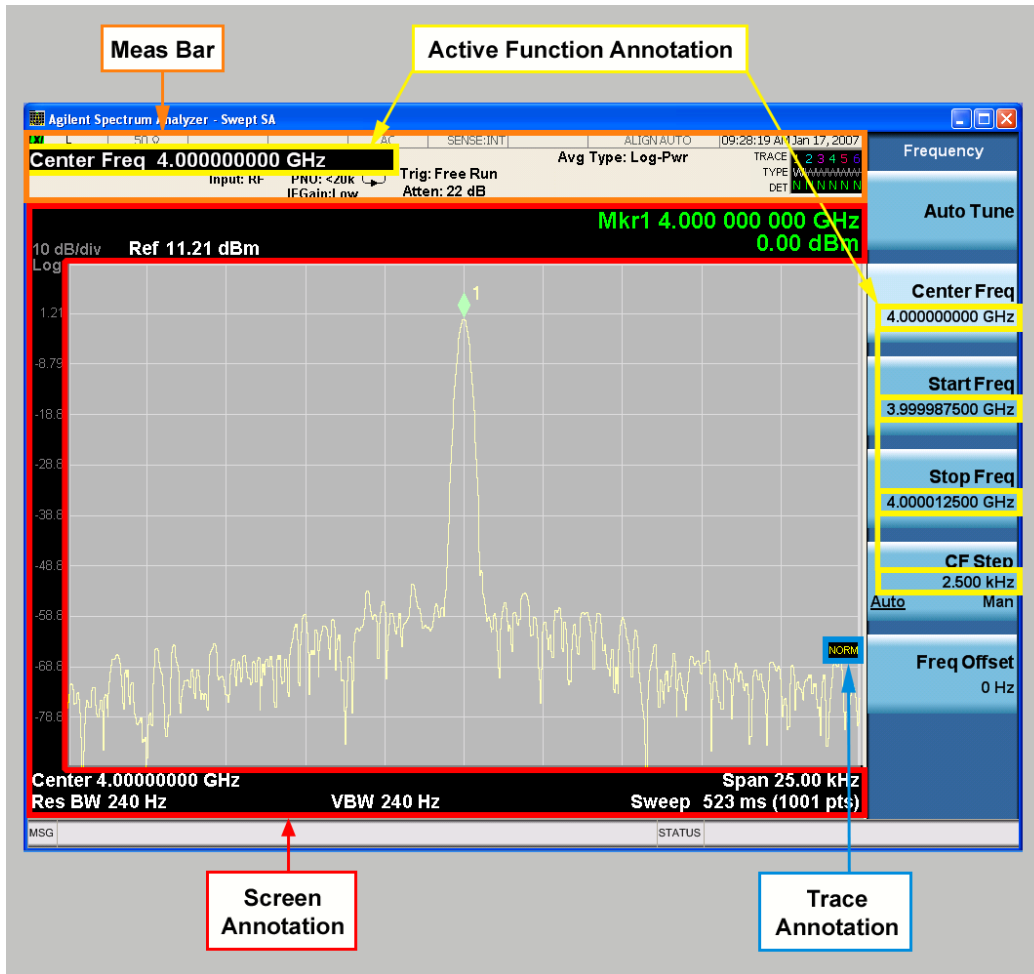

Key Path	View/Display, Display
Initial S/W Revision	Prior to A.02.00

Meas Bar On/Off

This function turns the Measurement Bar on and off, including the settings panel. When off, the graticule area expands to fill the area formerly occupied by the Measurement Bar.

Key Path	View/Display, Display, Annotation
Remote Command	:DISPlay:ANNOtation:MBAR[:STATe] OFF ON 0 1 :DISPlay:ANNOtation:MBAR[:STATe]?
Example	DISP:ANN:MBAR OFF
Dependencies	Grayed out and forced to OFF when System Display Settings, Annotation is set to Off.
Preset	On This should remain Off through a Preset when System DisplaySettings, Annotation is set to Off.
State Saved	Saved in instrument state.
Initial S/W Revision	Prior to A.02.00

Screen

This controls the display of the annunciation and annotation around the graticule, including any annotation on lines (such as the display line, the threshold line, etc.) and the y-axis annotation. This does NOT include marker annotation (or the N dB result). When off, the graticule expands to fill the entire graticule area, leaving only the 1.5% gap above the graticule as described in the Trace/Detector chapter.

Key Path	View/Display, Display, Annotation
Remote Command	:DISPlay:ANNotation:SCReen[:STATe] OFF ON 0 1 :DISPlay:ANNotation:SCReen[:STATe]?
Example	DISP:ANN:SCR OFF
Dependencies	Grayed-out and forced to OFF when System Display Settings, Annotation is set to Off.
Preset	On This should remain Off through a Preset when System DisplaySettings, Annotation is set to Off
State Saved	Saved in instrument state.
Initial S/W Revision	Prior to A.02.00

Active Function Values On/Off

Turns on and off the active function display in the Meas Bar, and all of the active function values displayed on the softkeys.

Note that all of the softkeys that have active functions have these numeric values blanked when this function is on. This is a security feature..

8 Vector Analysis
View/Display

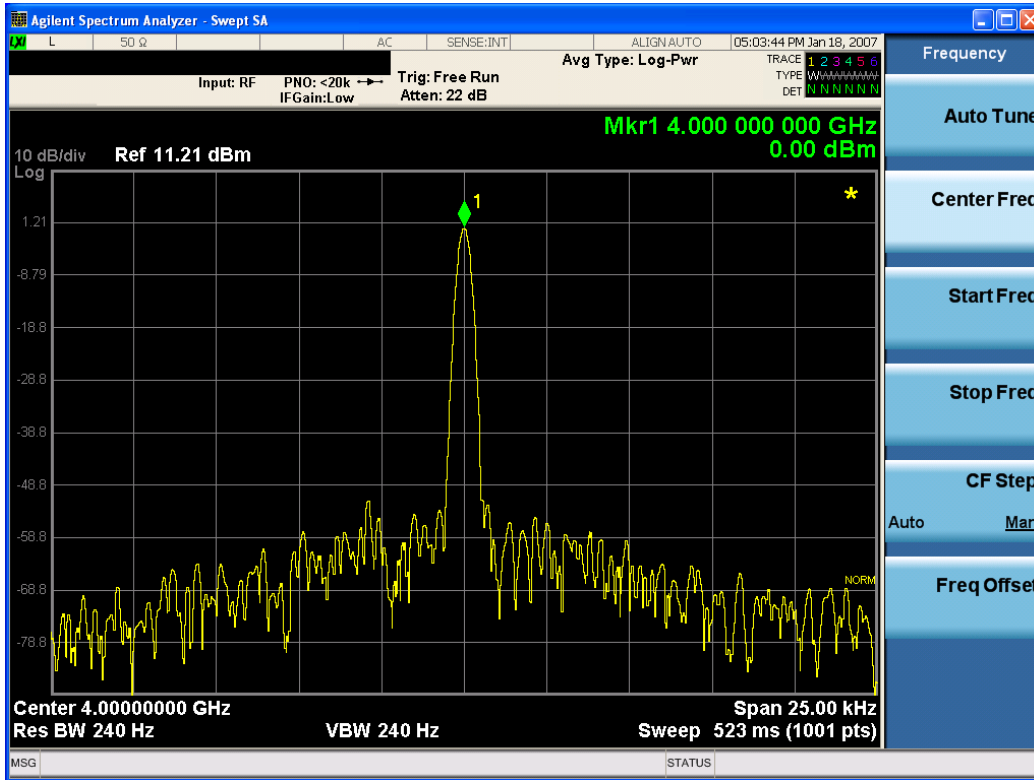

Key Path	View/Display, Display, Annotation
Remote Command	:DISPlay:ACTivefunc[:STATE] ON OFF 1 0 :DISPlay:ACTivefunc[:STATE]?
Example	DISP:ACT OFF
Dependencies	Grayed out and forced to OFF when System Display Settings, Annotation is set to Off.
Preset	On This should remain Off through a Preset when System DisplaySettings, Annotation is set to Off
State Saved	Saved in instrument state.
Initial S/W Revision	Prior to A.02.00

Title

Displays menu keys that enable you to change or clear a title on your display.

Key Path	View/Display, Display
Initial S/W Revision	Prior to A.02.00

Change Title

Writes a title into the "measurement name" field in the banner, for example, "Swept SA".

Press Change Title to enter a new title through the alpha editor. Press Enter or Return to complete the entry. Press ESC to cancel the entry and preserve your existing title.

The display title will replace the measurement name. It remains for this measurement until you press Change Title again, or you recall a state, or a Preset is performed. A title can also be cleared by pressing Title, Clear Title.

NOTE

Notice the inclusion of the <measurement> parameter in the command below. Because each measurement remembers the Display Title, the command must be qualified with the measurement name. For the Swept SA measurement this is not the case; no <measurement> parameter is used when changing the Display Title for the Swept SA measurement.

Key Path	View/Display, Display, Title
Mode	All
Remote Command	:DISPlay:<measurement>:ANNotation:TITLe:DATA <string> :DISPlay:<measurement>:ANNotation:TITLe:DATA?
Example	DISP:ANN:TITL:DATA "This Is My Title" This example is for the Swept SA measurement in the Spectrum Analyzer mode. The SANalyzer <measurement> name is not used. DISP:ACP:ANN:TITL:DATA "This Is My Title" This example is for Measurements other than Swept SA. Both set the title to: This Is My Title
Notes	Pressing this key cancels any active function. When a title is edited the previous title remains intact (it is not cleared) and the cursor goes at the end so that characters can be added or BKSP can be used to go back over previous characters.
Preset	No title (measurement name instead)
State Saved	Saved in instrument state.
Initial S/W Revision	Prior to A.02.00

Clear Title

Clears a title from the front-panel display. Once cleared, the title cannot be retrieved. After the title is cleared, the current Measurement Name replaces it in the title bar.

Key Path	View/Display, Display, Title
Example	The following commands clear the title and restore the measurement's original title: DISP:ANN:TITL:DATA "" This example is for the Swept SA measurement in the Spectrum Analyzer mode. The SANalyzer <measurement> name is not used. DISP:ACP:ANN:TITL:DATA "" This example is for ACP; in measurements other than Swept SA the measurement name is required.
Notes	Uses the :DISPlay:<measurement>:ANNotation:TITLe:DATA <string> command with an empty string (in the Swept SA, the <measurement> is omitted).
Preset	Performed on Preset.
Initial S/W Revision	Prior to A.02.00

Graticule

Pressing Graticule turns the display graticule On or Off. It also turns the graticule y-axis annotation on and off.

Key Path	View/Display, Display
Remote Command	:DISPlay:WINDow[1]:TRACe:GRATicule:GRID[:STATe] OFF ON 0 1 :DISPlay:WINDow[1]:TRACe:GRATicule:GRID[:STATe]?
Example	DISP:WIND:TRAC:GRAT:GRID OFF
Notes	The graticule is the set of horizontal and vertical lines that make up the grid/divisions for the x-axis and y-axis.
Preset	On
State Saved	Saved in instrument state
Initial S/W Revision	Prior to A.02.00

System Display Settings

These settings are "Mode Global" – they affect all modes and measurements and are reset only by Restore Misc Defaults or Restore System Defaults under System.

Key Path	View/Display, Display
Initial S/W Revision	Prior to A.02.00

Annotation Local Settings

This is a Mode Global override of the meas local annotation settings. When it is All Off, it forces ScreenAnnotation, Meas Bar, Trace, and Active Function Values settings to be OFF for all measurements in all modes. This provides the security based "annotation off" function of previous analyzers; hence it uses the legacy SCPI command.

When it is All Off, the Screen, Meas Bar, Trace, and Active Function Values keys under the Display, Annotation menu are grayed out and forced to Off. When Local Settings is selected, you are able to set the local annotation settings on a measurement by measurement basis.

Key Path	View/Display, Display, System Display Settings
Remote Command	:DISPlay:WINDow[1]:ANNotation[:ALL] OFF ON 0 1 :DISPlay:WINDow[1]:ANNotation[:ALL]?
Example	:DISP:WIND:ANN OFF
Preset	On (Set by Restore Misc Defaults)
State Saved	Not saved in instrument state.
Backwards Compatibility Notes	The WINDow parameter and optional subopcode is included for backwards compatibility but ignored – all windows are equally affected.
Initial S/W Revision	Prior to A.02.00

Themes

Accesses a menu of functions that enable you to choose the theme to be used when saving the screen image.

The **Themes** option is the same as the **Themes** option under the **Display** and **Page Setup** dialogs. It allows you to choose between themes to be used when saving the screen image.

Key Path	Save, Screen Image
Remote Command	:MMEMory:STORe:SCReen:THEMe TDColor TDMonochrome FCOlor FMONochrome :MMEMory:STORe:SCReen:THEMe?
Example	:MMEM:STOR:SCR:THEM TDM
Preset	3D Color; Is not part of Preset, but is reset by Restore Misc Defaults or Restore System Defaults All and survives subsequent running of the modes.
Readback	3D Color 3D Mono Flat Color Flat Mono
Backwards Compatibility Notes	In ESA and PSA we offer the choice of "Reverse Bitmap" or "Reverse Metafile" when saving screen images. This is much like the "Flat Color" theme available in X-Series. Also, if you selected Reverse Bitmap AND a black & white screen image, that would be much like "Flat Monochrome". In other words, each of the X-Series themes has a similar screen image type in ESA/PSA. But they are not identical.
Initial S/W Revision	Prior to A.02.00

3D Color

Selects a standard color theme with each object filled, shaded and colored as designed.

Key Path	Save, Screen Image, Themes
Example	MMEM:STOR:SCR:THEM TDC
Readback	3D Color
Initial S/W Revision	Prior to A.02.00

3D Monochrome

Selects a format that is like 3D color but shades of gray are used instead of colors.

Key Path	Save, Screen Image, Themes
Example	MMEM:STOR:SCR:THEM TDM
Readback	3D Mono
Initial S/W Revision	Prior to A.02.00

Flat Color

Selects a format that is best when the screen is to be printed on an ink printer.

Key Path	Save, Screen Image, Themes
Example	MMEM:STOR:SCR:THEM FCOL
Readback	Flat Color
Initial S/W Revision	Prior to A.02.00

Flat Monochrome

Selects a format that is like Flat Color. But only black is used (no colors, not even gray), and no fill.

Key Path	Save, Screen Image, Themes
Example	MMEM:STOR:SCR:THEM FMON
Readback	Flat Mono
Initial S/W Revision	Prior to A.02.00

Backlight

Accesses the display backlight on/off keys. This setting may interact with settings under the Windows "Power" menu.

When the backlight is off, pressing ESC, TAB, SPACE, ENTER, UP, DOWN, LEFT, RIGHT, DEL, BKSP, CTRL, or ALT turns the backlight on without affecting the application. Pressing any other key will turn backlight on and could potentially perform the action as well.

Key Path	View/Display, Display, System Display Settings
Remote Command	:DISPlay:BACKlight ON OFF :DISPlay:BACKlight?
Preset	ON (Set by Restore Misc Defaults)
Initial S/W Revision	Prior to A.02.00

Backlight Intensity

An active function used to set the backlight intensity. It goes from 0 to 100 where 100 is full on and 0 is off. This value is independent of the values set under the Backlight on/off key.

Key Path	View/Display, Display, System Display Settings
Remote Command	:DISPlay:BACKlight:INTensity <integer> :DISPlay:BACKlight:INTensity?
Example	DISP:BACK:INT 50

Preset	100 (Set by Restore Misc Defaults)
Min	0
Max	100
Initial S/W Revision	Prior to A.02.00

Layout

Enables you to choose the number and position of windows on the screen. Each window contains one trace. The selected trace is always visible and its window outlined in green. The Window zoom key toggles between multiple windows and a single window mode without changing the setting for Layout.

Single layout has one window.

Stack 2 layout has two windows, one on top of the other, that display either traces 1 (top) and 2 (bottom) or traces 3 and 4. The pair that is showing always includes the selected trace.

Stack 3 layout has three windows that display, top to bottom, traces 1, 2, 3 or traces 2, 3, 4.

Grid 2x2 layout has 4 windows, arranged 2x2. They display (in order top to bottom, left to right) traces 1, 2, 3, and 4.

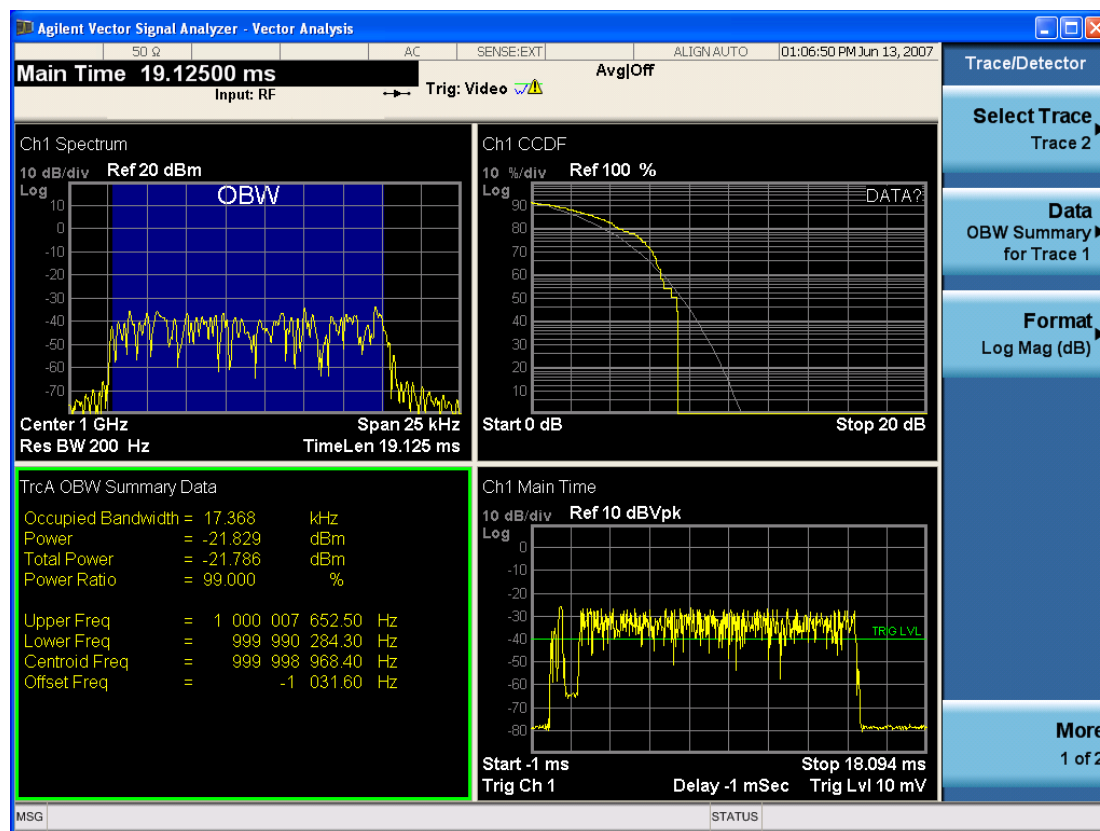

Grid 2x2 layout with Trace 2 selected

There are two other layouts that are available for iDEN Power, iDEN Demod, and MOTOTalk measurements since these enable 6 traces.

Grid 2x3 layout has 2 rows of 3 windows that display all 6 traces in order, top to bottom, then left to right.

Grid 3x2 layout has 3 rows of 2 windows that display all 6 traces in order, top to bottom, then left to right.

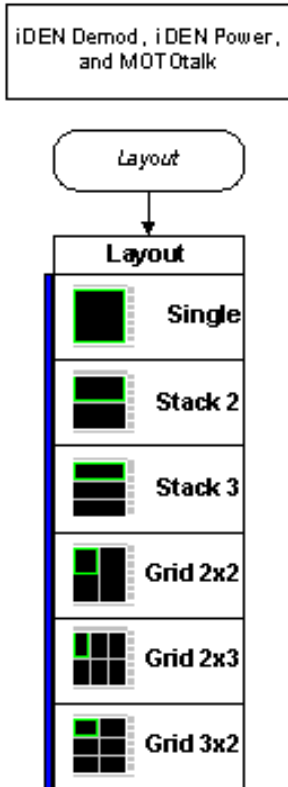

Key Path	View/Display
Mode	VSA, LTE, LTETDD, IDEN, LTEAFDD, LTEATDD
Measurement	<meas>:=VECTor ADEMod DDEMod W11A W11B EVM IPOWER iDEMod MOTotalk
Remote Command	:DISPlay:<meas>:WINDow:FORMat SINGLE TWO TRI QUAD :DISPlay:<meas>:WINDow:FORMat? For iDEN Power, iDEN Demod and MotoTalk measurements: :DISPlay:<meas>:WINDow:FORMat SINGLE TWO TRI QUAD GR2X3 GR3X2 :DISPlay:<meas>:WINDow:FORMat?
Example	DISP:VECT:WIND:FORM TWO DISP:IPOW:WIND:FORM GR2X3 DISP:VECT:WIND:FORM?
Couplings	If the window is currently zoomed, selecting a layout (even the current one) switches it to tiled mode.
Preset	TWO QUAD QUAD QUAD QUAD QUAD QUAD QUAD GR2X3 TRI

State Saved	Saved in instrument state.
Range	Single Stack 2 Stack 3 Grid 2x2 Grid 2x2 Grid 2x3 Stack 3
Initial S/W Revision	Prior to A.02.00
Modified at S/W Revision	A.02.00

Preset View: Spectrum/Time

Displays the Stack 2 layout style (see "[Layout](#)" on page 1280) with Spectrum in trace 1 and Main Time in trace 2

Key Path	View/Display
Mode	VSA

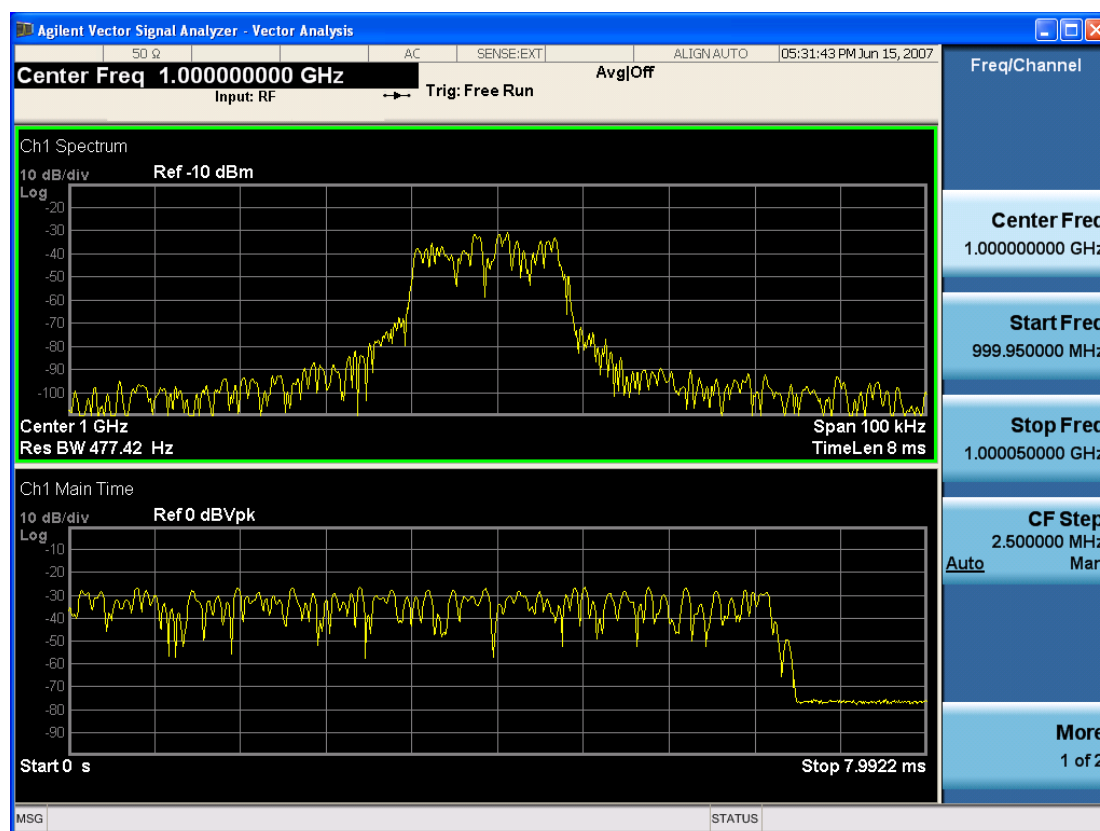

Preset View: Statistics

Displays the Stack 2 layout style (see "[Layout](#)" on page 1280) with the CCDF in trace 1 and Main Time in trace 2.

Key Path	View/Display
Mode	VSA

8 Vector Analysis
View/Display

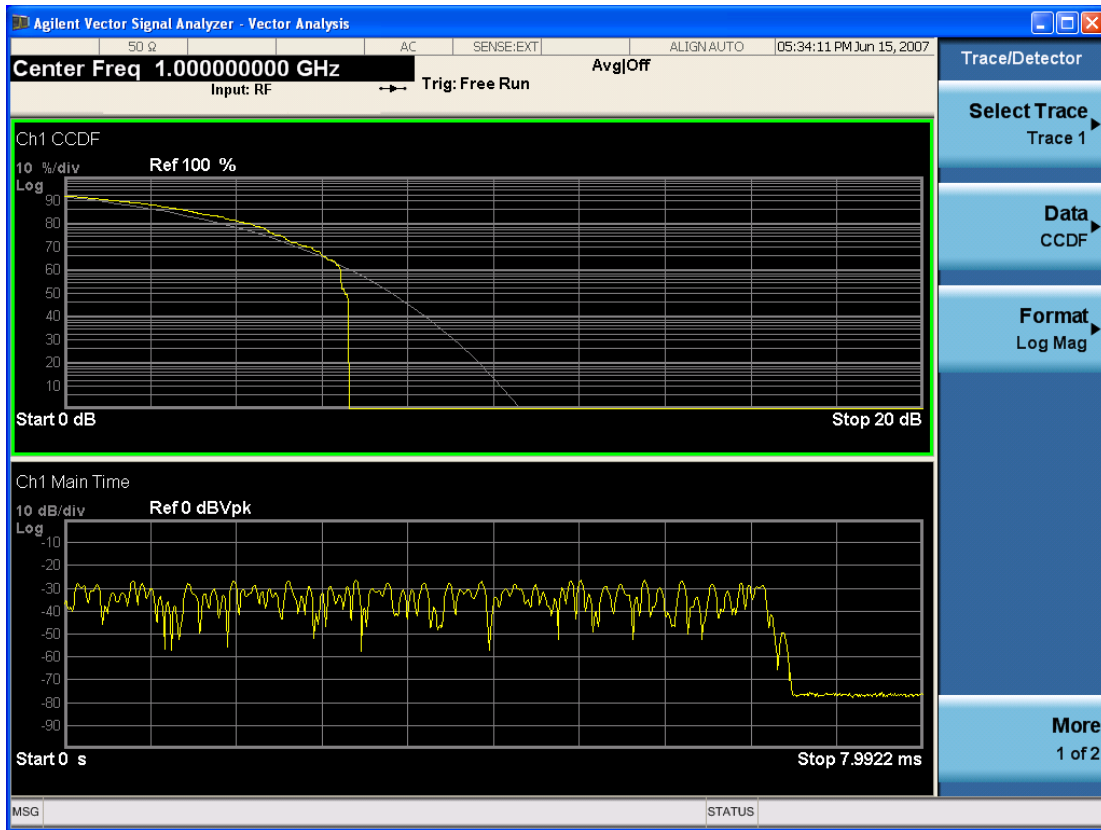

Remote SCPI Commands and Data Queries

Remote SCPI Results described in this section include:

[":READ and :FETCh Commands" on page 1285](#)

[":CALCulate:DATA" on page 1288](#)

[":CALCulate:DATA:RAW" on page 1289](#)

[":CALCulate:DATA:RAW:COMPLex" on page 1290](#)

[":CALCulate:DATA:POINTs commands" on page 1290](#)

[":CALCulate:DATA:TABL commands" on page 1291](#)

[":CALCulate:DATA:HEADer commands" on page 1295](#)

[":CALC:CLIMits:FAIL?" on page 1297](#)

["IQ Data Transfers " on page 1297](#)

VSA based Measurements produce a rich variety of results that can be displayed in any of 4 traces. A result can consist of an array of X,Y trace data that is typically shown as a graph or scalar results that are displayed as a table. The Symbol/Error result that is part of many demodulation measurements actually displays both a trace table (the error statistics) and trace data (the symbol information, which is not graphed but listed). The CALC:<meas>:DATA<n> commands enable you to retrieve any trace data or trace table. This family of commands also enable you to get information about the names of data results available and the units associated with them, as well as names and results of meta-data associated with traces.

Selected results are available via the FETCh and READ SCPI interfaces. These commands refer to data results by arbitrary index number rather than by trace number.

Key Path	SCPI Only
Mode	LTE, LTETDD, IDEN, VSA

:READ and :FETCh Commands

The SCPI MEASure, READ, and FETCh are typically offered by applications with focus on manufacturing test, where a fixed set of desired results is known in advance and seldom changes. The VSA based measurements are many, due to a focus on development. Thus, for most VSA based measurements there is no standard configuration that yields a useful measurement 90% of the time. Thus, the MEASure function is not offered for most measurements in the VSA Application. However, READ and FETCh can be implemented for select results. Note that these results are also still available using the CALC:<meas>:DATA:TABLE family of commands.

ACP and OBW are available in all VSA based measurements. To retrieve the ACP or OBW data, the function must be enabled on a frequency-domain trace and the associated summary data table must be assigned to another trace. Note however, the index n in the following commands is not trace number but an index picked out of the tables shown below.

:FETCh:<meas> [n] ?

:READ:<meas>[n]?

The results available for various values of n are shown below:

Condition	N	Results Returned
Mode = VSA LTE IDEN	Not specified or n=1	Reserved for selected results of VSA measurements. If not used for a particular measurement, no result is returned and error -114 Header suffix out of range is generated.
Mode = VSA LTE IDEN	2 - 50	Reserved for selected results of VSA measurements. If not used for a particular measurement, no result is returned and error -114 Header suffix out of range is generated.
Mode = VSA LTE IDEN, ACP on trace 1	51	ACP Summary for trace 1 Returns 28 comma-separated scalar results, corresponding to the swept ACP results where possible; n/a elsewhere: Returns 28 comma-separated scalar results, in the following order. 1. 0.0 2. Total carrier power (dBm) (same as item 4, because only 1 carrier supported) 3. 0.0 4. Reference carrier power (dBm) 5. Lower offset A - relative power (dB) 6. Lower offset A - absolute power (dBm) 7. Upper offset A - relative power (dB) 8. Upper offset A - absolute power (dBm) 9. Lower offset B - relative power (dB) 10. Lower offset B - absolute power (dBm) 11. Upper offset B - relative power (dB) 12. Upper offset B - absolute power (dBm) ... 21. Lower offset E - relative power (dB) 22. Lower offset E - absolute power (dBm) 23. Upper offset E - relative power (dB) 24. Upper offset E - absolute power (dBm) 25. n/a 26. n/a 27. n/a 28. n/a 29. Overall ACP test result summary (0 indicates at least 1 failure, 1 indicates all passed) If any result is not available, NaN (9.91 E 37) is returned. This can happen if ACP is turned off (all results unavailable) or when an offset is entirely off-screen. In the case where it is partially off-screen, the measured result is returned even though its validity is questionable.
Mode = VSA LTE IDEN, ACP on trace 2	52	ACP Summary for trace 2 see list for trace 1 summary

Mode = VSA LTE IDEN, ACP on trace 3	53	ACP Summary for trace 3 see list for trace 1 summary
Mode = VSA LTE IDEN, ACP on trace 4	54	ACP Summary for trace 4 see list for trace 1 summary
Mode = VSA LTE IDEN, ACP on trace 5	55	ACP Summary for trace 5 see list for trace 1 summary
Mode = VSA LTE IDEN, ACP on trace 6	56	ACP Summary for trace 6 see list for trace 1 summary
	57-60	no result returned; error -114, Header suffix out of range generated
Mode = VSA LTE IDEN, OBW on trace 1	61	OBW Summary for trace 1 Returns 9 comma-separated scalar results corresponding exactly to the items in the OBW Summary trace: 1. OBW (Hz) 2. Pwr (dBm) 3. Total Pwr (dBm) 4. Pwr Ratio (no unit, E.g. 0.99) 5. OBW upper freq (Hz) 6. OBW lower freq (Hz) 7. Centroid freq (Hz) 8. Offset freq (Hz) 9. OBW Test Result (0 for fail, 1 for pass) If the results are not available, NaN (9.91 E 37) is returned.
Mode = VSA LTE IDEN, OBW on trace 2	62	OBW Summary for trace 2 see list for trace 1 summary
Mode = VSA LTE IDEN, OBW on trace 3	63	OBW Summary for trace 3 see list for trace 1 summary
Mode = VSA LTE IDEN, OBW on trace 4	64	OBW Summary for trace 4 see list for trace 1 summary
Mode = VSA LTE IDEN, OBW on trace 5	65	OBW Summary for trace 5 see list for trace 1 summary
Mode = VSA LTE IDEN, OBW on trace 6	66	OBW Summary for trace 6 see list for trace 1 summary

Key Path	SCPI Only
Mode	LTE, LTETDD, IDEN, VSA

:CALCulate:DATA

Once measurement data result is assigned to a trace, the data can be retrieved by using one of the following commands (where <n> is the trace number and <meas> is the current VSA based measurement).

:CALC:<meas>:DATA<n>?

:CALC:<meas>:DATA<n>:RAW?

The first form of the command retrieves the data as formatted on the display. For example, if (in a vector measurement) you have the Spectrum result in LogMag format on trace 1, then

:CALC:VECT:DATA1?

returns an array of spectrum amplitude (Y data) in units of dBm, and

:CALC:VECT:DATA1:RAW?

returns the Y data in its underlying units of Volts (peak) squared.

(To get data from displayed tables, see "[:CALCulate:DATA:TABL commands](#)" on page 1291.)

The CALC:<meas>:DATA commands get data from traces. There are many results available from a VSA based measurement and only 4 traces in which to view them. View Preset commands are one way of displaying frequently-used results in standard trace locations. Or you can assign any measurement result to any trace using the softkeys under Trace/Detector, Data. The SCPI command for doing this is:

:DISP:<meas>:TRAC<n>:FEED "<data_name>"

For example, if (in a vector measurement) you want to view the CCDF result in trace 4, you send:

:DISP:VECT:TRAC4:FEED "CCDF1"

(If the measurement has not run yet, use INIT:IMM to run it.) Then the CCDF data can be retrieved using

CALC:VECT:DATA4?

or

CALC:VECT:DATA4:RAW?

Key Path	SCPI Only
Mode	VSA, LTE, LTETDD, IDEN
Measurement	<meas>:=VECTor ADEMod DDEMod W11A W11B EVM IPOWER IDEMod MOTotalk
Remote Command	:CALCulate:<meas>:DATA[1] 2 ...4? [Y X XY[,OFF ON 0 1] LL UL]
Example	CALC:VECT:DATA1? CALC:VECT:DATA1? Y,ON

	CALC:VECT:DATA1? X CALC:VECT:DATA1? XY
Notes	<p>Query only. This retrieves the data in the designated trace as displayed.</p> <p>For example, if Trace 1 is assigned Spectrum data and formatted as LogMag, then :CALC:VECT:DATA1? returns the Y data in dBm. If the X axis is scaled to show only a portion of the trace data, only the data shown is returned.</p> <p>The numeric format of the returned data is controlled by FORMat[:TRACe][:DATA] command</p> <p>The optional parameters control what data is returned.</p> <p>:CALC:VECT:DATA1? Y is the same as :CALC:VECT:DATA1? with no parameter. It returns an array of Y values.</p> <p>:CALC:VECT:DATA1? X returns an array of X values that correspond to the Y values above.</p> <p>:CALC:VECT:DATA1? XY returns interleaved X and Y data. That is: <x1> <y1> <x2> <y2>...</p> <p>Normally, this command only returns the data between the current X scale limits. If the optional ",OFF" or ",0" switch is included at the end of the command, then all data is returned (regardless of X scaling or the state of All Frequency Points).</p> <p>:CALC:EVM:DATA1? LL UL returns an array of Lower/Upper Limit values when Limit Test is enabled and the trace includes limit values. When Limit Test is disabled or the trace does not include limit value, this query is the same as :CALC:EVM:DATA1? with no parameter.</p> <p>Note: LL and UL are available only for the EVM measurement in the LTE/LTE TDD modes.</p> <p>Note: the X and Y parameters in this command refer to the display's horizontal and vertical axes. Normally the X axis is the independent variable, but if the display format is Constellation or IQ, then CALC:<meas>:DATA<n>? [Y] returns the imaginary part of the data and CALC:<meas>:DATA<n>? X returns the real part of the data. If you want the values of the independent variable, change to a non-vector format (such as Log Mag) and use CALC:<meas>:DATA<n>? X</p>
Initial S/W Revision	Prior to A.02.00
Modified at S/W Revision	A.02.00, A.08.00

:CALCulate:DATA:RAW

Retrieves trace data in its underlying units, before the formatting calculation that converts it to displayed units. Underlying units are typically Volts peak (for signal results) or Volts peak squared (for power results). All data points are returned, whether or not they are displayed.

Key Path	SCPI Only
Mode	VSA, LTE, LTETDD, IDEN
Measurement	<meas>:=VECTor ADEMod DDEMod W11A W11B EVM IPOWER IDEMod MOTotalk
Remote Command	:CALCulate:<meas>:DATA[1] 2 ...4:RAW?
Example	CALC:VECT:DATA1:RAW?
Notes	Query only. This retrieves the unformatted Y data in the designated trace. If Y data is complex, it is returned as <y_real1> <y_imag1> <y_real2> <y_imag2> etc.
Initial S/W Revision	Prior to A.02.00
Modified at S/W Revision	A.02.00

:CALCulate:DATA:RAW:COMPLex

Determines if the data retrieved by CALC:<meas>:DATA:RAW<n>? is complex.

Key Path	SCPI Only
Mode	VSA, LTE, LTETDD, IDEN
Measurement	<meas>:=VECTor ADEMod DDEMod W11A W11B EVM IPOWER IDEMod MOTotalk
Remote Command	:CALCulate:<meas>:DATA[1] 2 ...4:RAW:COMPLex?
Example	CALC:VECT:DATA1:RAW:COMP?
Notes	Query only. Returns 1 if the trace data is complex, 0 if it is real.
Initial S/W Revision	Prior to A.02.00
Modified at S/W Revision	A.02.00

:CALCulate:DATA:POINTs commands

Returns the number of points that are returned by

CALCulate:<meas>:DATA<n>?

X axis scaling and whether All Frequency Points is on or off can affect this number.

NOTE

For the CALCulate:<meas>:DATA<n>? XY command there are 2 numbers returned per data point.

Key Path	SCPI Only
Mode	VSA, LTE, LTETDD, IDEN
Measurement	<meas>:=VECTor ADEMod DDEMod W11A W11B EVM IPOWER IDEMod MOTotalk
Remote Command	:CALCulate:<meas>:DATA[1] 2 ...4:POINTs? [OFF ON 0 1]
Example	CALC:VECT:DATA1:POINTs?
Notes	<p>Query only.</p> <p>Use the optional "OFF 0" parameter to determine the number of points that are returned by the optional command form:</p> <p>:CALCulate:<meas>:DATA<n>? Y X XY,OFF 0</p> <p>Note that this is points, not array size. If the XY parameter is included, there are 2 numbers returned per point.</p> <p>(ON or 0, which means use the X-scaled version, is the default and the result is the same as if the parameter is omitted).</p>
Initial S/W Revision	Prior to A.02.00
Modified at S/W Revision	A.02.00

This query returns the number of points that are returned by

CALCulate:<meas>:DATA:RAW<n>?

NOTE

For complex trace data, there are 2 numbers returned per data point.

Key Path	SCPI Only
Mode	VSA, LTE, LTETDD, IDEN
Measurement	<meas>:=VECTor ADEMod DDEMod W11A W11B EVM IPOWER IDEMod MOTotalk
Remote Command	:CALCulate:<meas>:DATA [1] 2 . . . 4:RAW:POINts?
Example	CALC:VECT:DATA1:RAW:POINts?
Notes	Query only.
Initial S/W Revision	Prior to A.02.00
Modified at S/W Revision	A.02.00

:CALCulate:DATA:TABL commands

Some traces have tabular data associated with them. In fact, there may be only a table and no trace data. Each entry in the table consists of a name, a measured value, and units. The units are sometimes not shown. You can programmatically retrieve arrays of all the names, all the values, and all the units of a table. These arrays are all ordered so that corresponding indices have associated values, for example, the 4th name in the names array corresponds to the 4th value in the results array. (Note that the array order cannot be the same as the displayed order.) You can also get a particular result from the table by name. Here is a summary of the remote table data commands.

Command	Returns	Example
CALCulate:<meas>:DATA<n>:TABLe?	All table data results (as an array)	CALC:DDEM:DATA4:TABL?
CALCulate:<meas>:DATA<n>:TABLe? "<name>"	The table data result referred to by name	CALC:DDEM:DATA4:TABL? "EvmPeak"
CALCulate:<meas>:DATA<n>:TABLe:NAMes?	Comma-separated list of all table data names	CALC:DDEM:DATA4:TABL:NAM?
CALCulate:<meas>:DATA<n>:TABLe:UNIT?	Comma-separated list of all table data units	CALC:DDEM:DATA4:TABL:UNIT?

For example, if within the Vector Analysis measurement, you have an OBW Summary Table displayed in trace 2, CALC:DDEM:DATA2:TABL:NAM? would return the table names as follows:

"Obw,Pwr,TotalPwr,PwrRatio,ObwUpper,ObwLower,Centroid,Offset"

and CALC:DDEM:DATA2:TABL:UNIT? would return the units. (A null string means the result is unitless.)

"Hz,Vrms^2,Vrms^2,,Hz,HZ,HZ,HZ"

You can then get all the table results by sending

CALC:DDEM:DATA2:TABL?

Result number 1 is Obw and has units of Hz, result number 2 is Pwr with units of Vrms^2, and so on.

You can also get individual table entries by asking for them by name. Any name returned from the CALC:DDEM:DATA2:TABL:NAM? query can be used. For example, to get TotalPwr you can send the following query:

CALC:DDEM:DATA2:TABL? "TotalPwr"

Query Table Data as Number

Gets data from a table shown in the designated trace. Tables shown on the display typically have the name of a parameter followed by its measured value

Key Path	SCPI Only
Mode	VSA, LTE, LTETDD, IDEN
Measurement	<meas>:=VECTor ADEMod DDEMod W11A W11B EVM IPOWER IDEMod MOTotalk
Remote Command	:CALCulate:<meas>:DATA[1] 2 ...4:TABLe[:NUMBer]? [<string>]
Example	CALC:DDEM:DATA2:TABL? "Obw"
Notes	Query only. If sent without a string specifier, this returns the entire table for the designated trace. If sent with a string specifier, returns a specific table entry in the designated trace. The string specifier must be delimited by single or double quotes. A list of valid strings can be obtained using CALC:<meas>:DATA:TABL:NAM? If an invalid string is sent, an error is generated. The returned results are in numeric format, under control of the FORMat[:TRACe][:DATA] command. For table data that is non-numeric, NaN is returned. To get the value of these data, use the CALC:<meas>:DATA2:TABL:STR? command.
Initial S/W Revision	Prior to A.02.00
Modified at S/W Revision	A.02.00

Query Table Data as String

Some tables have string data. The above Trace Table Data query cannot return it and sends NaN in its place. Here is a form of Trace Table Data query that can return string data from tables.

Key Path	SCPI Only
Mode	VSA, LTE, LTETDD, IDEN

Measurement	<meas>:=VECTor ADEMod DDEMod W11A W11B EVM IPOWER IDEMod MOTotalk
Remote Command	:CALCulate:<meas>:DATA[1] 2 ...4:TABLE:STR? [<string>]
Example	CALC:DDEM:DATA2:TABL:STR? "Obw"
Notes	Query only. If sent without a string specifier, this returns the entire table for the designated trace in comma-separated format. If sent with a string specifier, returns a specific table entry in the designated trace. The string specifier must be delimited by single or double quotes. A list of valid strings can be obtained using CALC:<meas>:DATA:TABL:NAM? If an invalid string is sent, an error is generated.
Initial S/W Revision	Prior to A.02.00
Modified at S/W Revision	A.02.00

Query Table Names

Returns a comma-separated list of names of the table data entries for the designated trace. Each of the names can be used (surrounded by quotes or double quotes) as a parameter in the Trace Table Data commands. The names appear in the same order as the corresponding data values returned by the CALC:<meas>:DATA<n>:TABL[:NUMB|STR]? query.

Key Path	SCPI Only
Mode	VSA, LTE, LTETDD, IDEN
Measurement	<meas>:=VECTor ADEMod DDEMod W11A W11B EVM IPOWER IDEMod MOTotalk
Remote Command	:CALCulate:<meas>:DATA[1] 2 ...4:TABLE:NAMes?
Example	CALC:VECT:DATA1:TABL:NAM?
Notes	Query only. This retrieves the names of the table entries for the designated trace. Each of these names can be used in the CALC:<meas>:DATA:TABL? '<name>' command to access a single table entry.
Initial S/W Revision	Prior to A.02.00
Modified at S/W Revision	A.02.00

Query Table Units

Returns a comma-separated list of all the units for the table data entries for the designated trace. If a data result is unitless, an empty string appears in the list for that result. The units appear in the same order as the corresponding data values returned by the CALC:<meas>:DATA<n>:TABL[:NUMB|STR]? query.

Key Path	SCPI Only
Mode	VSA, LTE, LTETDD, IDEN
Measurement	<meas>:=VECTor ADEMod DDEMod W11A W11B EVM IPOWER IDEMod MOTotalk
Remote Command	:CALCulate:<meas>:DATA[1] 2 ...4:TABLE:UNIT?

Example	CALC:VECT:DATA1:TABL:UNIT?
Notes	Query only. This retrieves a list of units for table entries for the designated trace. The units are given in the order that the entries are sent from the :CALC:<meas>:DATA:TABL? command.
Initial S/W Revision	Prior to A.02.00
Modified at S/W Revision	A.02.00

The following table data is available in all measurements when the ACP function is turned on and the associated summary table is shown in a trace:

Result name	Displayed Unit	Remote Name	Remote Unit
Reference Bandwidth	Hz	RefBw	Hz
Reference Alpha		RefAlpha	
Reference Power	dBm	RefPwr	Vrms ²
Offset	Hz	Offset1, Offset2, Offset3, Offset4, Offset5	Hz
BW	Hz	Bw1, Bw2, Bw3, Bw4, Bw5	Hz
Alpha		Alpha1, Alpha2, Alpha3, Alpha4, Alpha5	
Lower Pwr	dBm	LowPwr1, LowPwr2, LowPwr3, LowPwr4, LowPwr5	Vrms ²
Lower ACPR	dB	LowRatio1, LowRatio2, LowRatio3, LowRatio4, LowRatio5	
Upper Pwr	dBm	HiPwr1, HiPwr2, HiPwr3, HiPwr4, HiPwr5	Vrms ²
Upper ACPR	dB	HiRatio1, HiRatio2, HiRatio3, HiRatio4, HiRatio5	
Max ACPR	dB	MaxRatio1, MaxRatio2, MaxRatio3, MaxRatio4, MaxRatio5	

The following table data is available in all measurements when the OBW function is turned on and the associated summary table is shown in a trace:

Result name	Displayed Unit	Remote Name	Remote Unit
Occupied Bandwidth	Hz	Obw	Hz
Power	dBm	Pwr	Vrms ²

Total Power	dBm	TotalPwr	Vrms^2
Power Ratio	%	PwrRatio	
Upper Freq	Hz	ObwUpper	Hz
Lower Freq	Hz	ObwLower	Hz
Centroid Freq	Hz	Centroid	Hz
Offset Freq	Hz	Offset	Hz

:CALCulate:DATA:HEADer commands

Trace data also has meta-data associated with it, called headers, which is visible if you export trace data in text format. The headers have a name and a value that can be obtained from any trace by using the CALCulate:<meas>:DATA:HEADer commands described in this section.

The following Remote Commands are described in this section:

["Query Header Names" on page 1295](#)

["Query Header Type" on page 1295](#)

["Query Header as String" on page 1296](#)

["Query Numeric Header" on page 1296](#)

[":CALC:CLIMits:FAIL?" on page 1297](#)

Query Header Names

Returns a comma-separated list of all the header names associated with the designated trace. Each of the names can be used (surrounded by quotes or double quotes) as a parameter in the other CALC:<meas>:DATA<n>:HEAD queries.

Key Path	SCPI Only
Mode	VSA, LTE, LTETDD, IDEN
Measurement	<meas>:=VECTor ADEMod DDEMod W11A W11B EVM IPOWER IDEMod MOTotalk
Remote Command	:CALCulate:<meas>:DATA[1] 2 ...4:HEADer:NAMes?
Example	CALC:VECT:DATA1:HEAD:NAM?
Notes	Query only. Returns a comma-separated list of header names.
Initial S/W Revision	Prior to A.02.00
Modified at S/W Revision	A.02.00

Query Header Type

Returns whether the designated header on the designated trace can be queried as a number or by a string only.

Key Path	SCPI Only
Mode	VSA, LTE, LTETDD, IDEN
Measurement	<meas>:=VECTor ADEMod DDEMod W11A W11B EVM IPOWER IDEMod MOTotalk
Remote Command	:CALCulate:<meas>:DATA[1] 2 ...4:HEADer:TYPE? <string>
Example	CALC:VECT:DATA1:HEAD:TYPE? 'XDelta'
Notes	Query only. This retrieves the type of the named header for the designated trace. The name (delimited by single or double quotes) is one of the names returned by CALC:<meas>:DATA:HEAD:NAMES? If a valid header name is passed in, the return value from this query is either STR or NUMB. NONE is returned if there is no such header.
Initial S/W Revision	Prior to A.02.00
Modified at S/W Revision	A.02.00

Query Header as String

Gets a header by name from the designated trace and returns its value as a string.

Key Path	SCPI Only
Mode	VSA, LTE, LTETDD, IDEN
Measurement	<meas>:=VECTor ADEMod DDEMod W11A W11B EVM IPOWER IDEMod MOTotalk
Remote Command	:CALCulate:<meas>:DATA[1] 2 ...4:HEADer:STRing? <string>
Example	CALC:VECT:DATA1:HEAD:STR? 'WindowType'
Notes	Query only. This retrieves the named header for the designated trace. The name (delimited by single or double quotes) is one of the names returned by the CALC:<meas>:DATA:HEAD:NAMES? The return value is a string. If the requested header value is a numeric or if there is no such header, an empty string is returned.
Initial S/W Revision	Prior to A.02.00
Modified at S/W Revision	A.02.00

Query Numeric Header

Gets a numeric header by name from the designated trace and returns its value in a format determined by the last FORM command.

Key Path	SCPI Only
Mode	VSA, LTE, LTETDD, IDEN
Measurement	<meas>:=VECTor ADEMod DDEMod W11A W11B EVM IPOWER IDEMod MOTotalk
Remote Command	:CALCulate:<meas>:DATA[1] 2 ...4:HEADer[:NUMBer]? <string>
Example	CALC:VECT:DATA1:HEAD? 'XDelta'
Notes	Query only. This retrieves the named header for the designated trace. This form of the HEAD? query is for headers whose type is NUMB (as determined by :CALC:<meas>:DATA:HEAD:TYPE?).

	The name parameter (delimited by single or double quotes) is one of the names returned by CALC:<meas>:DATA:HEAD:NAMes? The format of the return data is determined by the FORMat [:TRACe][:DATA] command. If used to query a header whose type is STR or there is no such header, NaN (9.91e37) is returned
Initial S/W Revision	Prior to A.02.00
Modified at S/W Revision	A.02.00

:CALC:CLIMits:FAIL?

If one or more ACP or OBW limit tests are active, then the CALC:CLIMits:FAIL? command returns the aggregate pass or fail status.

IQ Data Transfers

Fast capture/transfer of a large amount of IQ data is supported over SCPI. To do this, first set up the desired measurement range, center frequency, span, triggering, and so on. Use a time length that is convenient for setting up the measurement. The time length for the captured data is set indirectly as shown below.

To perform the capture, a typical SCPI sequence is as follows:

```
FCAP:LENG <num_samples>
```

This command sets the length for the next capture in samples. The sample rate is proportional to the current span and can be determined by a SCPI query, for example, in the Vector measurement the query:

```
VECT:SWE:ISR?
```

returns the input sample rate. For the IQAnalyzer (Basic) mode, the sample rate SCPI query is defined as follows:

```
:SPEC:SRAT? (Complex spectrum measurement)
```

```
:WAV:SRAT? (Waveform measurement)
```

Multiply the time length desired for the captured data by this sample rate to get the number of samples needed.

```
INIT:FCAP
```

pauses the current measurement and starts capturing IQ data using the current setup and trigger conditions. (The instrument front panel display does not change nor show the captured data.)

To read the captured data via SCPI in blocks, set the read block size using the command:

```
FCAP:BLOC <num_points_per_read_block>
```

The maximum read block size is typically less than the total fast capture buffer size and can be determined by the query "FCAP:BLOC? MAX". Now you can repeatedly use the following query to read out successive blocks of data:

```
FETC:FCAP?
```

The returned data is formatted according to the most recent :FORMat[:DATA] and :FORMat:BORDER commands. A read pointer that indicates the next sample to be transferred is advanced automatically following each FETC:FCAP? query. This pointer position can be read or manually set via the SCPI commands:

FCAP:POIN?

FCAP:POIN <read_pointer_position>

The fast capture data can be read as long as you use only the commands to set read block size and pointer position, or queries that return the state of the current measurement. The capture data is cleared by any command that changes the measurement state or initiates a new measurement, or via SCPI device clear or :ABORT commands.

Fast capture data word size can be set to either 32 bit or 64 bit via the FCAP:WLEN command. This enables you to trade off precision for total capture length.

Note: when the word size is 32 bit, points can only be retrieved on even sample number boundaries, that is, the pointer and block length should be even numbers. Therefore, when the word size is set to auto, it is recommended that the pointer and block size be only set to even numbers.

Fast Capture Length

Sets the length of the SCPI Fast Capture in samples (points). This is constrained to be an even number.

Query returns the most recent length setting.

Key Path	SCPI Only
Mode	VSA, BASIC
Remote Command	[[:SENSe]:FCAPture:LENGth <integer> [:SENSe]:FCAPture:LENGth?
Example	FCAP:LENG 1000 FCAP:LENG?
Notes	This is affected by the IF path currently used, which can in turn be affected by span. It is also affected by the internal Fast Capture Word Length. The current maximum fast capture length can be found by using the query: FCAP:LENG? MAX Changing the Capture Length after initiating a fast capture clears the capture memory in preparation for a new fast capture of a different length. No Front panel access; SCPI only
Preset	1048576 Samples
Min	2
Max	536 870 908 Samples for internal 40 MHz and 140 MHz options with FCAP:WLEN BIT32
Initial S/W Revision	A.04.00

Fast Capture Word Length

Enables choice of internal fast capture word length. Shorter word length enables twice the time length to be captured at the cost of quantization noise. Note that this does not affect the format of data returned by FETCh:FCAPture, only the internal representation.

Key Path	SCPI Only
Mode	VSA, BASIC
Remote Command	[:SENSe] :FCAPture:WLENgth AUTO BIT32 BIT64 [:SENSe] :FCAPture:WLENgth?
Example	FCAP:WLEN AUTO FCAP:WLEN?
Notes	No Front panel access; SCPI only.
Preset	AUTO
Initial S/W Revision	A.04.00

Initiate Fast Capture

Waits for the sweep to trigger and then captures the fast capture data. Sweep is then set to pause. The amount of data captured is controlled by the Fast Capture Length command (FCAP:LENG).

Key Path	SCPI Only
Mode	VSA, BASIC
Remote Command	:INITiate:FCAPture
Example	INIT:FCAP
Notes	This is an overlapped command. It returns immediately, but the capture may not be complete. Use *OPC?, *WAI, or *OPC to determine when the capture is complete.
Notes	No Front panel access; SCPI only This command resets the Fast Capture Pointer to 0
Initial S/W Revision	A.04.00

Fast Capture Block

Sets the block size for the Fast Capture transfer in samples (points). This is the number of points that are returned from the Capture buffer by the FETC:FCAP? command. This is constrained to be an even number.

Query returns most recent block size setting.

Key Path	SCPI Only
Mode	VSA, BASIC
Remote Command	[:SENSe] :FCAPture:BLOCK <integer>

	<code>[:SENSe] :FCAPture:BLOCK?</code>
Example	<code>FCAP:BLOC 100</code> <code>FCAP:BLOC?</code>
Notes	No Front panel access. SCPI only.
Preset	1024 Samples
Min	0
Max	131072 or Fast Capture Length, whichever is smaller
Initial S/W Revision	A.04.00

Fast Capture Pointer

Sets the pointer position for the Fast Capture transfer in samples (points). The pointer is incremented by the block size each time the fetch is performed. Preset value (0) is the first sample in the record. Thus repetitive fetches result in contiguous data without needing to increment the pointer over SCPI. This is constrained to be an even number. Query returns most recent pointer setting.

Key Path	SCPI Only
Mode	VSA, BASIC
Remote Command	<code>[:SENSe] :FCAPture:POINter <integer></code> <code>[:SENSe] :FCAPture:POINter?</code>
Example	<code>FCAP:POIN 100</code> <code>FCAP:POIN?</code>
Notes	INIT:FCAP or FCAP:ABOR resets the pointer to 0. No front panel access; SCPI only.
Preset	0 Samples
Min	0
Max	Must be less than the Fast Capture length
Initial S/W Revision	A.04.00

Fetch Fast Capture

Transfers the block of data starting at the pointer. The number of samples transferred is set with the block size. The pointer is incremented by the block size after the fetch.

Key Path	SCPI Only
Mode	VSA, BASIC
Remote Command	<code>:FETCh:FCAPture?</code>
Example	<code>FETC:FCAP?</code>
Notes	The returned data is formatted according to the most recent <code>:FORMat[:DATA]</code> and <code>:FORMat:BORDER</code>

commands.

If the read pointer position plus read block size exceeds the Fast Capture Length, only the data between the pointer and the end of the fast capture buffer are returned, and error -200 is reported.

If Fetch is attempted before an INIT:FCAP or if the captured data is cleared by some other operation (e.g., REC), error -230 is reported and no data is returned.

No front panel access; SCPI only.

Initial S/W Revision	A.04.00
----------------------	---------

Input Sample Rate Query

Returns the complex sample rate in Hz for the current VXA measurement setup conditions. The sample rate can be used to convert between time and number of sample points when using the Fast Capture feature.

Sample rate depends on the settings for `FREQ:SPAN` and `IFPath`. You need to set these before making this query. Though the measurement name is specified in the query, you can only query the currently configured measurement. That is, if you have sent `CONF:VECT`, the query `ADEM:SWE:ISR?` generates an error.

Key Path	SCPI Only
Mode	VSA
Measurement	<meas>:=VECTor ADEMod DDEMod W11A W11B
Remote Command	[:SENSe] :<meas>:SWEp:ISRate?
Example	VECT:SWE:ISR?
Notes	<p>Query returns the complex sample rate in Hz for the current VXA Vector measurement setup conditions.</p> <p>If the measurement in the query is not the active measurement, error -230 is reported and no data is returned.</p> <p>This query is SCPI only, no Front Panel softkey.</p>
Preset	Depends on the licensed IF path
Initial S/W Revision	A.04.00

Parameter Update Enable

Refers only to measurements that use the VSA measurement engine. These are all the measurements in the Vector Signal Analyzer (VXA) Application and the EVM measurement in the LTE Applications.

When a measurement parameter is changed, the new value is used to update any dependent parameters and measurement results. This update process is normally done after every parameter change. This enables visual feedback during interactive GUI operation. However, with SCPI controlled measurements, typically a lot of parameter changes are done at once with the measurement stopped and then the measurement is run once and data retrieved. Here, is not necessary, and the accumulated update time for

each parameter change can become significant. The Parameter Update Enable command enables you to postpone update while sending setup commands and then enable one update to occur just before the measurement.

For example, if you are programmatically setting up a complex LTE measurement, you could save some setup time by first sending EVM:PUPD:ENAB OFF, then sending the whole group of measurement setup commands. When you are done with the setup, send EVM:PUPD:ENAB:ON. This causes the measurement state to be updated with all dependencies resolved. After this, you can read back the parameters' actual values. As a convenience, starting or continuing a measurement (INITiate:REStart, INITiate:IMMEDIATE, INITiate:<meas> or INITiate:RESume) automatically sets <meas>:PUPD:ENAB to ON. So does CONFigure:<meas> or any of the reset and recall state commands.

This command should be used with caution.

It is only valid to turn <meas>:PUPD:ENAB OFF when <meas> is the currently active measurement and the measurement is paused (i.e., INIT:CONT is OFF).

If you try to set and then read back a parameter value while Parameter Update Enable is off, you are not guaranteed to get back the true value that is used in the measurement because no parameter limiting is being done nor are any dependencies between parameters being resolved.

If you try to set coupled parameters independently when Parameter Update Enable is off, then when it is turned on, at most one of the parameter settings remain the same and the others change due to dependency resolution.

Key Path	SCPI Only
Mode	VSA, LTE, LTETDD, IDEN
Measurement	<meas>:=VECTor ADEMod DDEMod W11A W11B EVM IPOWER IDEMod MOTotalk
Remote Command	[:SENSe] : <meas> : PUPDate : ENABle OFF ON 0 1 [:SENSe] : <meas> : PUPDate : ENABle ?
Example	EVM:PUPD:ENAB OFF
Notes	Commands that cause a measurement to run, that switch measurements, or that preset or recall measurement state, set Parameter Update state to ON. These include INIT:IMM, INIT:REST, INIT:RES, INIT:<meas>, and CONF:<meas>.
Preset	1
State Saved	No
Initial S/W Revision	A.03.00

9 Monitor Spectrum Measurement

The monitor spectrum measurement is used as a quick, convenient means of looking at the entire spectrum. While the look and feel are similar to the Spectrum Analyzer mode, the functionality is greatly reduced for easy operation. The main purpose of the measurement is to show the spectrum. The default span should cover an appropriate frequency range of the application.

For measurement results and views, see [View/Display](#).

This topic contains the following sections:

["Measurement Commands for Monitor Spectrum" on page 526](#)

["Remote Command Results for Monitor Spectrum Measurement" on page 527](#)

Measurement Commands for Monitor Spectrum

The following commands can be used to retrieve the measurement results:

`:CONFigure:MONitor`

`:CONFigure:MONitor:NDEFault`

`:INITiate:MONitor`

`:FETCh:MONitor[n]?`

`:READ:MONitor[n]?`

`:MEASure:MONitor[n]?`

For more measurement related commands, see the SENSE subsystem, and the section "[Remote Measurement Functions](#)" on page 1165.

Remote Command Results for Monitor Spectrum Measurement

The following table describes the results returned by the queries listed above, according to the index value n .

n	Results Returned
1 (or not specified)	Returns trace1 data with comma separated floating numbers
2	Returns trace2 data with comma separated floating numbers
3	Returns trace3 data with comma separated floating numbers

Key Path	Meas
Initial S/W Revision	Prior to A.02.00

AMPTD Y Scale

Accesses a menu of functions that enable you to set the vertical scale parameters. These functions control how data on the vertical (Y) axis is displayed and control instrument settings that affect the vertical axis.

Key Path	Front-panel key
Initial S/W Revision	Prior to A.02.00

Ref Value

Sets the absolute power reference value. However, since Auto Scaling defaults to On, this value is automatically determined by the measurement result. When you set a value manually, Auto Scaling automatically changes to Off.

Key Path	AMPTD Y Scale
Mode	All except SA and BASIC
Remote Command	:DISPlay:MONitor:VIEW[1]:WINDow[1]:TRACe:Y[:SCALe]:RLEVel <real> :DISPlay:MONitor:VIEW[1]:WINDow[1]:TRACe:Y[:SCALe]:RLEVel?
Example	DISP:MON:VIEW:WIND:TRAC:Y:RLEV 2.0 DISP:MON:VIEW:WIND:TRAC:Y:RLEV?
Couplings	When the Auto Scaling is On, this value is automatically determined by the measurement result. When you set a value manually, Auto Scaling automatically changes to Off.
Preset	10.00 dBm
State Saved	Saved in instrument state.
Min	-250.00 dBm
Max	250.00 dBm
Initial S/W Revision	Prior to A.02.00

Attenuation

This menu controls the attenuator functions and interactions between the attenuation system components.

There are two attenuator configurations in the X-Series. One is a dual attenuator configuration consisting of a mechanical attenuator and an optional electronic attenuator. The other configuration uses a single attenuator with combined mechanical and electronic sections that controls all the attenuation functions. Different models in the X-Series come with different configurations.

See ["Dual Attenuator Configurations:" on page 529](#)

See ["Single Attenuator Configuration:" on page 529](#)

Most Attenuation settings are the same for all measurements – they do not change as you change measurements. Settings like these are called “Meas Global” and are unaffected by Meas Preset.

Key Path	AMPTD Y Scale
Scope	Meas Global
Dependencies	In measurements that support the I/Q inputs, this key is unavailable when I/Q is the selected input, and is replaced by the Range key in that case.
Readback Line	Contains a summary in [] brackets of the current total attenuation. See the descriptions of the , " (Mech) Atten " on page 530, and " Enable Elec Atten " on page 532 keys for more detail on the contributors to the total attenuation. Note that when "Pre-Adjust for Min Clip" is on, this value can change at the start of every measurement.
Initial S/W Revision	Prior to A.02.00
Modified at S/W Revision	A.03.00

Dual Attenuator Configurations:

Configuration 1: Mechanical attenuator + optional electronic attenuator

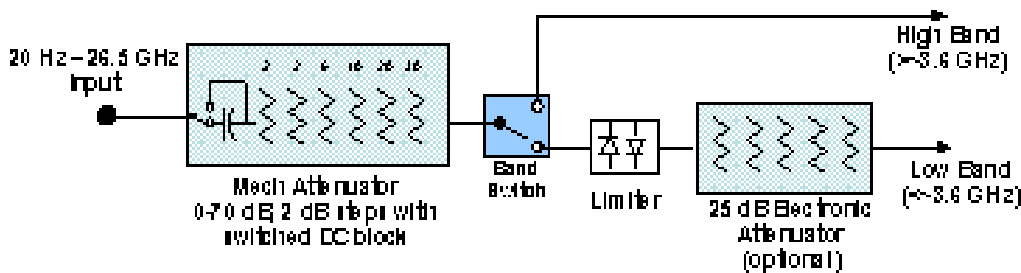

Configuration 2: Mechanical attenuator, no optional electronic attenuator

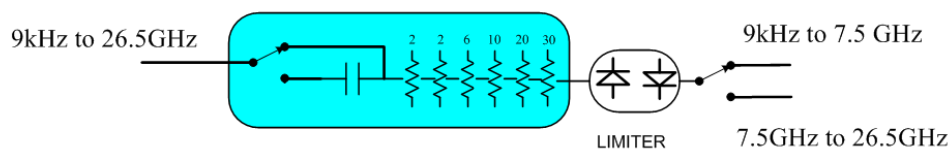

(note that Configuration 2 is not strictly speaking a dual-section attenuator, since there is no electronic section available. However, it behaves exactly like Configuration 1 without the Electronic Attenuator option EA3, therefore for the sake of this document it is grouped into the "Dual Attenuator" configuration)

Single Attenuator Configuration:

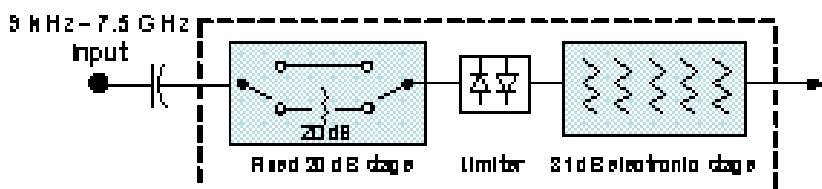

You can tell which attenuator configuration you have by pressing the Attenuation key, which (in most Modes) opens the Attenuation menu. If the first key in the Attenuation menu says Mech Atten you have the dual attenuator configuration. If the first key says Atten you have the single attenuator configuration.

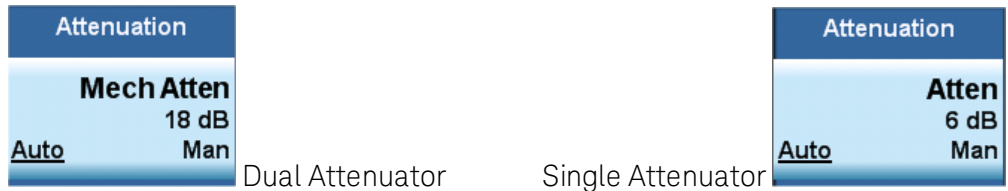

In the single attenuator configuration, you control the attenuation with a single control, as the fixed stage has only two states. In the dual attenuator configuration, both stages have significant range so you are given separate control of the mechanical and electronic attenuator stages.

When you have the dual attenuator configuration, you may still have only a single attenuator, because unless option EA3 (the Electronic Attenuator option) is available, and you purchase it, you will have only the mechanical attenuator.

(Mech) Atten

This key is labeled Mech Atten in dual attenuator models and Atten in single attenuator models. In the dual attenuator configuration, this key only affects the mechanical attenuator.

This key lets you modify the attenuation applied to the RF input signal path. This value is normally auto coupled to the Ref Level, the Internal Preamp Gain, any External Gain that is entered, and the Max Mixer Level, as described in the table below.

See "[Attenuator Configurations and Auto/Man](#)" on page 531

Key Path	AMPTD Y Scale, Attenuation
Remote Command	[:SENSe]:POWer[:RF]:ATTenuation <rel_ampl> [:SENSe]:POWer[:RF]:ATTenuation? [:SENSe]:POWer[:RF]:ATTenuation:AUTO OFF ON 0 1 [:SENSe]:POWer[:RF]:ATTenuation:AUTO?
Example	POW:ATT 20 Dual attenuator configuration: sets the mechanical attenuator to 20 dB Single attenuator mode: sets the main attenuation to 20 dB (see below for definition of "main" attenuation). If the attenuator was in Auto, it sets it to Manual.
Dependencies	Some measurements do not support the Auto setting of (Mech) Atten. In these measurements, the Auto/Man selection is not available, and the Auto/Man line on the key disappears. In dual attenuator configurations, when the electronic attenuator is enabled, the mechanical attenuator has no auto setting and the Auto/Man line on the key disappears. The state of Auto/Man is remembered and restored when the electronic attenuator is once again disabled. This is described in more detail in the " Enable Elec Atten " on page 532 key description. See " Attenuator Configurations and Auto/Man " on page 531 for more information on the Auto/Man functionality of Attenuation.

Couplings

	<p>When (Mech) Atten is in Auto, it uses the following algorithm to determine a value: If the USB Preamp is connected to USB, use 0 dB. Otherwise, Atten = ReferenceLevel + PreAmpGain + ExternalGain – RefLevelOffset - MaxMixerLevel + IF Gain. Limit this value to be between 6 dB and the Max value. No value below 6 dB can ever be chosen by Auto. The resulting value is rounded up to the largest value possible given the attenuation step setting. That is, 50.01 dB would change to 60 dB (for a 10 dB attenuation step). The “IF Gain” term in the equation above is either 0 dB or +10 dB, depending on the settings of FFT IF Gain, Swept IF Gain, max Ref Level and the Auto/Man setting of Mech Atten. In External Mixing and BBIQ, where the Attenuator is not in the signal path, the Attenuator setting changes as described above when (Mech) Atten is in Auto, but no changes are made to the actual attenuator hardware setting until the input is changed back to the RF Input.</p>
Preset	<p>The preset for Mech Attenuation is “Auto.” The Auto value of attenuation is: CXA, EXA, MXA and PXA: 10 dB</p>
State Saved	<p>Saved in instrument state</p>
Min	<p>0 dB The attenuation set by this key cannot be decreased below 6 dB with the knob or step keys. To get to a value below 6 dB it has to be directly entered from the keypad or via SCPI. This protects from adjusting the attenuation to a dangerously small value which can put the instrument at risk of damage to input circuitry. However, if the current mechanical attenuation is below 6 dB it can be increased with the knob and step keys, but not decreased.</p>
Max	<p>CXA N9000A–503/507: 50 dB CXA N9000A–513/526: 70dB EXA: 60 dB MXA and PXA: 70 dB In the single attenuator configuration, the total of ATT and EATT cannot exceed 50 dB, so if the EATT is set to 24 dB first, the main attenuation cannot be greater than 26 dB and will be reduced accordingly; if the main attenuator is set to 40 dB first, EATT cannot be greater than 10 dB.</p>
Initial S/W Revision	<p>Prior to A.02.00</p>
Modified at S/W Revision	<p>A.03.00</p>

Attenuator Configurations and Auto/Man

As described in the Attenuation key description, there are two distinct attenuator configurations available in the X-Series, the single attenuator and dual attenuator configurations. In dual attenuator configurations, we have the mechanical attenuation and the electronic attenuation, and the current total attenuation is the sum of the electronic + mechanical attenuation. In single attenuator configurations, we refer to the attenuation set using the (Mech) Atten key (or POW:ATT SCPI) as the “main” attenuation; and the attenuation that is set by the SCPI command POW:EATT as the “soft” attenuation (the POW:EATT command is honored even in the single attenuator configuration, for compatibility purposes). Then the

current total attenuation is the sum of the main + soft attenuation. See the Elec Atten key description for more on “soft” attenuation.

In the dual attenuator configuration, when the electronic attenuator is enabled, there is no Auto/Man functionality for the mechanical attenuator, and the third line of the key label (the Auto/Man line) disappears:



Enable Elec Atten

Enables the Electronic Attenuator.

The electronic attenuator offers finer steps than the mechanical attenuator, has no acoustical noise, is faster, and is less subject to wear. These advantages primarily aid in remote operation and are negligible for front panel use. See ["Using the Electronic Attenuator: Pros and Cons" on page 534](#) for a detailed discussion of the pros and cons of using the electronic attenuator.

For the single attenuator configuration, for SCPI backwards compatibility, the “soft” attenuation feature replaces the dual attenuator configuration’s electronic attenuator. All the same couplings and limitations apply. See ["Attenuator Configurations and Auto/Man" on page 531](#)

See ["More Information" on page 533](#)

Key Path	AMPTD Y Scale, Attenuation
Remote Command	[:SENSe] :POWer [:RF] :EATTenuation :STATe OFF ON 0 1 [:SENSe] :POWer [:RF] :EATTenuation :STATe ?
Example	POW:EATT:STAT ON
Dependencies	<p>This key only appears in Dual Attenuator models with an Electronic Attenuator installed. It does not appear in models with the Single Attenuator configuration, as in the single attenuator configuration there is no “electronic attenuator” there is only a single integrated attenuator (which has both a mechanical and electronic stage). However, in the single attenuator configuration, EATT SCPI commands are accepted for compatibility with other X-series instruments and set a “soft” attenuation as described in "Attenuator Configurations and Auto/Man" on page 531.</p> <p>The electronic attenuator (and the “soft” attenuation function provided in single attenuator configurations) is unavailable above 3.6 GHz. Therefore, if the Stop Frequency of the analyzer is > 3.6 GHz then the Enable Elec Atten key will be OFF and grayed out.</p> <p>If the Internal Preamp is on, meaning it is set to Low Band or Full, the electronic attenuator (and the “soft” attenuation function provided in single attenuator configurations) is unavailable. In this case the Enable Elec Atten key will be OFF and grayed out.</p> <p>If either of the above is true, if the SCPI command is sent, an error indicating that the electronic attenuator is unavailable will be sent.</p> <p>If the electronic/soft Attenuator is enabled, then the Stop Freq of the analyzer is limited to 3.6 GHz and the Internal Preamp is unavailable.</p> <p>The SCPI-only “soft” electronic attenuation for the single-attenuator configuration is not available in</p>

	all measurements; in particular, it is not available in the Swept SA measurement.
Couplings	Enabling and disabling the Electronic Attenuator affects the setting of the Mechanical Attenuator (in dual attenuator configurations). This is described in more detail below this table.
Preset	OFF for Swept SA measurement; ON for all other measurements that support the electronic attenuator
State Saved	Saved in instrument state
Initial S/W Revision	Prior to A.02.00
Modified at S/W Revision	A.03.00

More Information

Mechanical Attenuator Transition Rules

When the Electronic Attenuator is enabled, the Mechanical Attenuator transitions to a state that has no Auto function. Below are the rules for transitioning the Mechanical Attenuator. NOTE that the information below ONLY applies to the dual attenuator configurations, and ONLY when the Electronic Attenuator is installed:

When the Electronic Attenuation is enabled from a disabled state:

- The Mechanical Attenuator is initialized to 10 dB (this is its optimal performance setting). You can then set it as desired with SCPI, numeric keypad, step keys, or knob, and it behaves as it normally would in manual mode
- The Auto/Man state of (Mech) Atten is saved
- The Auto/Man line on the (Mech) Atten key disappears and the auto rules are disabled
- The Electronic Attenuator is set to 10 dB less than the previous value of the Mechanical Attenuator, within the limitation that it must stay within the range of 0 to 24 dB of attenuation.

Examples in the dual attenuator configuration:

- Mech Atten at 20 dB. Elec Atten enabled, Mech Atten set to 10 dB, and Elec Atten set to 10 dB. New total attenuation equals the value before Elec Atten enabled.
- Mech Atten at 0 dB. Elec Atten enabled, Mech Atten set to 10 dB, and Elec Atten set to 0 dB. New total attenuation does not equal the value before Elec Atten enabled.
- Mech Atten at 40 dB. Elec Atten enabled, Mech Atten set to 10 dB, and Elec Atten set to 24 dB. New total attenuation does not equal the value before Elec Atten enabled.

When the Electronic Attenuation is disabled from an enabled state:

- The Elec Atten key is grayed out
- The Auto/Man state of (Mech) Atten is restored
- If now in Auto, (Mech) Atten recouples

- If now in Man, (Mech) Atten is set to the value of total attenuation that existed before the Elec Atten was disabled. The resulting value is rounded up to the smallest value possible given the (Mech) Atten Step setting - (That is, 57 dB changes to 58 dB when (Mech) Atten Step is 2 dB.)

Using the Electronic Attenuator: Pros and Cons

The electronic attenuator offers finer steps than the mechanical attenuator, has no acoustical noise, is faster, and is less subject to wear.

The “finer steps” advantage of the electronic attenuator is beneficial in optimizing the alignment of the analyzer dynamic range to the signal power in the front panel as well as remote use. Thus, you can achieve improved relative signal measurement accuracy. Compared to a mechanical attenuator with 2 dB steps, the 1 dB resolution of the electronic attenuator only gives better resolution when the odd-decibel steps are used. Those odd-decibel steps are less accurately calibrated than the even-decibel steps, so one tradeoff for this superior relative accuracy is reduced absolute amplitude accuracy.

Another disadvantage of the electronic attenuator is that the spectrum analyzer loses its “Auto” setting, making operation less convenient.

Also, the relationship between the dynamic range specifications (TOI, SHI, compression and noise) and instrument performance are less well-known with the electrical attenuator. With the mechanical attenuator, TOI, SHI and compression threshold levels increase dB-for-dB with increasing attenuation, and the noise floor does as well. With the electronic attenuator, there is an excess attenuation of about 1 to 3 dB between 0 and 3.6 GHz, making the effective TOI, SHI, and so forth, less well known. Excess attenuation is the actual attenuation relative to stated attenuation. Excess attenuation is accounted for in the analyzer calibration

Elec Atten

Controls the Electronic Attenuator in dual attenuator configurations. This key does not appear in single attenuator configurations, as the control of both the mechanical and electronic stages of the single attenuator is integrated into the single Atten key.

Key Path	AMPTD Y Scale, Attenuation
Remote Command	<code>[:SENSe] :POWer [:RF] :EATTenuation <rel_amp1></code> <code>[:SENSe] :POWer [:RF] :EATTenuation?</code>
Notes	Electronic Attenuation's specification is defined only when Mechanical Attenuation is 6 dB.
Dependencies	This key only appears in Dual Attenuator models with an Electronic Attenuator installed. It does not appear in models with the Single Attenuator configuration, as in the single attenuator configuration there is no “electronic attenuator” there is only a single integrated attenuator (which has both a mechanical and electronic stage). However, in the single attenuator configuration, EATT SCPI commands are accepted for compatibility with other X-series instruments and set a “soft” attenuation as described in "Attenuator Configurations and Auto/Man" on page 531 . The “soft” attenuation is treated as an addition to the “main” attenuation value set by the Atten softkey or the POW:ATT SCPI command and affects the total attenuation displayed on the Attenuation key and the Meas Bar. When Enable Elec Atten is off or grayed out, the Elec Atten key is grayed out.
Preset	0 dB
State Saved	Saved in instrument state

Min	0 dB
Max	Dual attenuator configuration: 24 dB Single attenuator configuration: the total of ATT and EATT cannot exceed 50 dB, so if the EATT is set to 24 dB first, the main attenuation cannot be greater than 26 dB and will be reduced accordingly; if the main attenuator is set to 40 dB first, EATT cannot be greater than 10 dB
Initial S/W Revision	Prior to A.02.00
Modified at S/W Revision	A.03.00

Adjust Atten for Min Clip

Sets the combination of mechanical and electronic attenuation and gain based on the current measured signal level so that clipping will be at a minimum.

This is an "immediate action" function, that is, it executes once, when the key is pressed.

This key is grayed out in measurements that do not support this functionality. The spectrum analyzer measurement, Swept SA, does not support this functionality.

Key Path	AMPTD Y Scale, Attenuation
Remote Command	<code>[:SENSe] :POWer [:RF] :RANGe:OPTimize IMMEDIATE</code>
Initial S/W Revision	Prior to A.02.00
Modified at S/W Revision	A.03.00

Pre-Adjust for Min Clip

If this function is on, it does the adjustment described under "[Adjust Atten for Min Clip](#)" on page 535 each time a measurement restarts. Therefore, in Continuous measurement mode, it only executes before the first measurement.

In dual attenuator models, you can set Elec+Mech Atten, in which case both attenuators participate in the autoranging, or Elec Atten Only, in which case the mechanical attenuator does not participate in the autoranging. This latter case results in less wear on the mechanical attenuator and is usually faster.

This key is grayed out in measurements that do not support this functionality. The spectrum analyzer measurement, Swept SA, does not support this functionality.

Key Path	AMPTD Y Scale, Attenuation
Remote Command	<code>[:SENSe] :POWer [:RF] :RANGe:OPTimize:ATTenuation OFF ELECTrical COMBined</code> <code>[:SENSe] :POWer [:RF] :RANGe:OPTimize:ATTenuation?</code>
Notes	The SCPI parameter ELECTrical sets this function to On in single attenuator models. The SCPI parameter COMBined is mapped to ELECTrical in single attenuator models; if you send COMBined, it sets the function to On and returns ELEC to a query.
Dependencies	This key only appears in Dual Attenuator models with an Electronic Attenuator installed.

	In instruments with Dual Attenuator model, when Enable Elec Atten is off or grayed out, the Pre-Adjust for Min Clip key is grayed out.
Preset	OFF for Swept SA measurement; ON for all other measurements that support Pre-Adjust for Min Clip
State Saved	Saved in instrument state
Range	Dual attenuator models: Off Elec Atten Only Mech + Elec Atten Single attenuator models: Off On
Initial S/W Revision	Prior to A.02.00
Modified at S/W Revision	A.03.00

Remote Command	<code>[:SENSe] :POWer [:RF] :RANGe :AUTO ON OFF 1 0</code> <code>[:SENSe] :POWer [:RF] :RANGe :AUTO?</code>
Notes	ON aliases to "Elec Atten Only" (:POW:RANG:OPT:ATT ELEC) OFF aliases to "Off" (:POW:RANG:OPT:ATT OFF) The query :POW:RANG:AUTO? returns true if :POW:RANG:OPT:ATT is not "Off"
Initial S/W Revision	Prior to A.02.00

Off

Turns Pre-Adjust for Min Clip off. This is the default setting.

This key is grayed out in measurements that do not support this functionality. The spectrum analyzer measurement, Swept SA, does not support this functionality.

Key Path	AMPTD Y Scale, Attenuation, Pre-Adjust for Min Clip
Example	:POW:RANGe:OPT:ATT OFF
Initial S/W Revision	Prior to A.02.00

Elec Atten Only

Selects only the electric attenuator to participate in auto ranging. This offers less wear on the mechanical attenuator and is usually faster.

This key is grayed out in measurements that do not support this functionality. The spectrum analyzer measurement, Swept SA, does not support this functionality.

Key Path	AMPTD Y Scale, Attenuation, Pre-Adjust for Min Clip
Example	:POW:RANGe:OPT:ATT ELEC
Initial S/W Revision	Prior to A.02.00

Mech + Elec Atten

In dual attenuator models, this selects both attenuators participate in the autoranging.

This key is grayed out in measurements that do not support this functionality. The spectrum analyzer measurement, Swept SA, does not support this functionality.

Key Path	AMPTD Y Scale, Attenuation, Pre-Adjust for Min Clip
Example	:POW:RANGe:OPT:ATT COMB
Initial S/W Revision	Prior to A.02.00

(Mech) Atten Step

This controls the step size used when making adjustments to the input attenuation.

This key is labeled Mech Atten Step in dual attenuator models and Atten Step in single attenuator models. In the dual attenuator configuration, this key only affects the step size of the mechanical attenuator.

Key Path	AMPTD Y Scale, Attenuation
Remote Command	<code>[:SENSe] :POWer [:RF] :ATTenuation :STEP [:INCRement] 10 dB 2 dB</code> <code>[:SENSe] :POWer [:RF] :ATTenuation :STEP [:INCRement] ?</code>
Example	POW:ATT:STEP 2
Notes	Note this feature works like a 1-N choice from the front panel, but it takes a specific value (in dB) when used remotely. The only valid values are 2 and 10.
Dependencies	Blanked in CXA and EXA if option FSA (2 dB steps) is not present. If blanked, attempts to set it via SCPI will yield an error.
Couplings	When the attenuation step size changes, the current mechanical attenuation value is adjusted (if necessary) to be quantized to the new step size. That is, if step is set to 10 dB, mech atten is increased if necessary so it is a multiple of 10 dB
Preset	PXA and MXA: 2 dB EXA and CXA: 10 dB (2 dB with option FSA)
State Saved	Saved in instrument state
Initial S/W Revision	Prior to A.02.00
Modified at S/W Revision	A.03.00

Scale/Div

Sets the logarithmic units per vertical graticule division on the display. However, since the Auto Scaling defaults to On, this value is automatically determined by the measurement result. When you set a value manually, Auto Scaling automatically changes to Off.

Key Path	AMPTD Y Scale
Mode	All except SA and BASIC
Remote Command	:DISPlay:MONitor:VIEW[1]:WINDow[1]:TRACe:Y[:SCALe]:PDIVision <rel_ampl> :DISPlay:MONitor:VIEW[1]:WINDow[1]:TRACe:Y[:SCALe]:PDIVision?
Example	DISP:MON:VIEW:WIND:TRAC:Y:PDIV 5.0 dB DISP:MON:VIEW:WIND:TRAC:Y:PDIV?
Couplings	When the Auto Scaling is On, this value is automatically determined by the measurement result. When you set a value manually, Auto Scaling automatically changes to Off.
Preset	10.00 dB
State Saved	Saved in instrument state.
Min	0.10 dB
Max	20.00 dB
Initial S/W Revision	Prior to A.02.00

Presel Center

When this key is pressed, the centering of the preselector filter is adjusted to optimize the amplitude accuracy at the frequency of the selected marker. If the selected marker is not on when Presel Center is pressed, the analyzer will turn on the selected marker, perform a peak search, and then perform centering on the marker's center frequency. If the selected marker is already on and between the start and stop frequencies of the analyzer, the analyzer performs the preselector calibration on that marker's frequency. If the selected marker is already on, but outside the frequency range between Start Freq and Stop Freq, the analyzer will first perform a peak search, and then perform centering on the marker's center frequency.

The value displayed on the Presel Adjust key will change to reflect the new preselector tuning (see Presel Adjust).

A number of considerations should be observed to ensure proper operation. See ["Proper Preselector Operation" on page 539](#).

Key Path	AMPTD Y Scale
Remote Command	[:SENSe]:POWer[:RF]:PCENter
Example	POW:PCEN
Notes	Note that the rules outlined above under the key description apply for the remote command as well as the key. The result of the command is dependent on marker position, and so forth. Any message shown by the key press is also shown in response to the remote command.
Dependencies	<ul style="list-style-type: none"> • Grayed out if the microwave preselector is off.) • If the selected marker's frequency is below Band 1, advisory message 0.5001 is generated and no action is taken. • Grayed out if entirely in Band 0. • Blank in models that do not include a preselector, such as option 503. If the SCPI is sent in these instruments, it is accepted without error, and the query always returns 0.

- Grayed out in the Spectrogram View.

Couplings	The active marker position determines where the centering will be attempted. If the analyzer is in a measurement such as averaging when centering is initiated, the act of centering the preselector will restart averaging but the first average trace will not be taken until the centering is completed.
Status Bits/OPC dependencies	When centering the preselector, *OPC will not return true until the process is complete and a subsequent measurement has completed, nor will results be returned to a READ or MEASURE command. The Measuring bit should remain set while this command is operating and should not go false until the subsequent sweep/measurement has completed.
Initial S/W Revision	Prior to A.02.00
Modified at S/W Revision	A.03.00

Proper Preselector Operation

A number of considerations should be observed to ensure proper operation:

1. If the selected marker is off, the analyzer will turn on a marker, perform a peak search, and adjust the preselector using the selected marker's frequency. It uses the "highest peak" peak search method unqualified by threshold or excursion, so that there is no chance of a 'no peak found' error. It continues with that peak, even if it is the peak of just noise. Therefore, for this operation to work properly, there should be a signal on screen in a preselected range for the peak search to find.
2. If the selected marker is already on, the analyzer will attempt the centering at that marker's frequency. There is no preselector for signals below about 3.6 GHz, therefore if the marker is on a signal below 3.6 GHz, no centering will be attempted and an advisory message generated
3. In some models, the preselector can be bypassed. If it is bypassed, no centering will be attempted in that range and a message will be generated.

Preselector Adjust

Allows you to manually adjust the preselector filter frequency to optimize its response to the signal of interest. This function is only available when "Presel Center" on page 538 is available.

For general purpose signal analysis, using Presel Center is recommended. Centering the filter minimizes the impact of long-term preselector drift. Presel Adjust can be used instead to manually optimize the preselector. One application of manual optimization would be to peak the preselector response, which both optimizes the signal-to-noise ratio and minimizes amplitude variations due to small (short-term) preselector drifting.

Key Path	AMPTD Y Scale
Scope	Meas Global
Remote Command	<code>[:SENSe] :POWer [:RF] :PADJust <freq></code>

	<code>[:SENSe] :POWer [:RF] :PADJust ?</code>
Example	POW:PADJ 100KHz POW:PADJ?
Notes	The value on the key reads out to 0.1 MHz resolution.
Dependencies	<ul style="list-style-type: none"> • Grayed out if microwave preselector is off.) • Grayed out if entirely in Band 0. • Blank in models that do not include a preselector, such as option 503. If the SCPI is sent in these instruments, it is accepted without error, and the query always returns 0. • Grayed out in the Spectrogram View.
Preset	0 MHz
State Saved	The Presel Adjust value set by Presel Center, or by manually adjusting Presel Adjust, is not saved in instrument state, and does not survive a Preset or power cycle.
Min	-500 MHz
Max	500 MHz
Default Unit	Hz
Backwards Compatibility SCPI	<code>[:SENSe] :POWer [:RF] :MW :PADJust</code> <code>[:SENSe] :POWer [:RF] :MMW :PADJust</code> PSA had multiple preselectors, but the X-Series has only one. These commands simply alias to <code>[:SENSe] :POWer [:RF] :PADJust</code>
Initial S/W Revision	Prior to A.02.00
Modified at S/W Revision	A.03.00

Remote Command	<code>[:SENSe] :POWer [:RF] :PADJust :PRESelector MWAVE MMWave EXTERNAL</code> <code>[:SENSe] :POWer [:RF] :PADJust :PRESelector ?</code>
Notes	PSA had multiple preselectors, and you could select which preselector to adjust. Since the X-Series has only one mm/uW preselector, the preselector selection softkey is no longer available. However, to provide backward compatibility, we accept the legacy remote commands. The command form has no effect, the query always returns MWAVE
Initial S/W Revision	Prior to A.02.00

μW Path Control

The μW Path Control functions include the μW Preselector Bypass (Option MPB) and Low Noise Path (Option LNP) controls in the High Band path circuits.

When the μW Preselector is bypassed, the user has better flatness, but will be subject to spurs from out of band interfering signals. When the Low Noise Path is enabled, the analyzer automatically switches around

certain circuitry in the high frequency bands which can contribute to noise, when it is appropriate based on other analyzer settings.

For most applications, the preset state is Standard Path, which gives the best remote-control throughput, minimizes acoustic noise from switching and minimizes the risk of wear out in the hardware switches. For applications that utilize the wideband IF paths, the preset state is the μ W Preselector Bypass path, if option MPB is present. This is because, when using a wideband IF such as the 140 MHz IF, the μ W Preselector's bandwidth can be narrower than the available IF bandwidth, causing degraded amplitude flatness and phase linearity, so it is desirable to bypass the preselector in the default case.

Users may choose Low Noise Path Enable. It gives a lower noise floor, especially in the 21–26.5 GHz region, though without improving many measures of dynamic range, and without giving the best possible noise floor. The preamp, if purchased and used, gives better noise floor than does the Low Noise Path, however its compression threshold and third-order intercept are much poorer than that of the non-preamp Low Noise Path. There are some applications, typically for signals around –30 dBm, for which the third-order dynamic range of the standard path is good enough, but the noise floor is not low enough even with 0 dB input attenuation. When the third-order dynamic range of the preamp path is too little and the noise floor of the standard path is too high, the Low Noise Path can provide the best dynamic range.

Key Path	AMPTD Y Scale
Mode	SA, BASIC, PNOISE, VSA , LTE, LTETDD
Scope	Meas Global
Remote Command	[:SENSe] :POWer [:RF] :MW:PATH STD LNPath MPBypass FULL [:SENSe] :POWer [:RF] :MW:PATH?
Example	:POW:MW:PATH LNP Enables the Low Noise path
Notes	If a Presel Center is performed, the analyzer will momentarily switch to the Standard Path, regardless of the setting of μ W Path Control The DC Block will always be switched in when the low noise path is switched in, to protect succeeding circuitry from DC. Note that this does not mean “when the low noise path is enabled” but when, based on the Low Noise Path rules, the path is actually switched in. This can happen when the selection is Low Noise Path Enable . In the case where the DC Block is switched in the analyzer is now AC coupled. However, if the user has selected DC coupling, the UI will still behave as though it were DC coupled, including all annunciation, warnings, status bits, and responses to SCPI queries. This is because, based on other settings, the analyzer could switch out the low noise path at any time and hence go back to being DC coupled. Alignment switching ignores the settings in this menu, and restores them when finished.
Dependencies	Unavailable in BBIQ and External Mixing
Preset	All modes other than IQ Analyzer mode and VXA: STD IQ Analyzer, VXA and WLAN mode: MPB option present and licensed: MPB MPB option not present and licensed: STD
State Saved	Save in instrument state
Readback	Value selected in the submenu
Initial S/W Revision	A.04.00
Modified at S/W Revision	A.10.00

Standard Path

This path gives the best remote-control throughput, minimizes acoustic noise from switching and minimizes the risk of wear in the hardware switches, particularly in remote test scenarios where both low band and high band setups will follow in rapid succession.

In this path, the bypass of the low band/high band switch and microwave preamp is never activated, which can cause some noise degradation but preserves the life of the bypass switch.

Key Path	AMPTD Y Scale, μ W Path Control
Example	:POW:MW:PATH STD
Readback Text	Standard Path
Initial S/W Revision	A.04.00

μ W Preselector Bypass

This key toggles the preselector bypass switch for band 1 and higher. When the microwave preselect is on, the signal path is preselected. When the microwave preselector is off, the signal path is not preselected. The preselected path is the normal path for the analyzer.

The preselector is a tunable bandpass filter which prevents signals away from the frequency of interest from combining in the mixer to generate in-band spurious signals (images). The consequences of using a preselector filter are its limited bandwidth, the amplitude and phase ripple in its passband, and any amplitude and phase instability due to center frequency drift.

Option MPB or pre-selector bypass provides an unpreselected input mixer path for certain X-Series signal analyzers with frequency ranges above 3.6 GHz. This signal path allows a wider bandwidth and less amplitude variability, which is an advantage when doing modulation analysis and broadband signal analysis. The disadvantage is that, without the preselector, image signals will be displayed. Another disadvantage of bypassing the preselector is increased LO emission levels at the front panel input port.

Image responses are separated from the real signal by twice the 1st IF. For IF Paths of 10 MHz and 25 MHz, the 1st IF is 322.5 MHz, so the image response and the real signal will be separated by 645 MHz. The 1st IF will be different for other IF Path settings. When viewing a real signal and its corresponding image response in internal mixing, the image response will be to the left of the real signal.

Also, the image response and the real signal typically have the same amplitude and exhibit the same shape factor.

However, if Option FS1, Fast Sweep Capability, is enabled, the image response in the Swept SA measurement will appear lower in amplitude and have a much wider shape factor compared to the real signal.

Key Path	AMPTD Y Scale, μ W Path Control
Example	:POW:MW:PATH MPB
Dependencies	Key is blanked if current mode does not support it. Key is grayed out if mode supports it but current measurement does not support it. Key is blank unless Option MPB is present and licensed. If SCPI command sent when MPB not

	present, error -241, "Hardware missing; Option not installed" is generated.
Readback Text	μW Preselector Bypass
Initial S/W Revision	A.04.00
Remote Command	[:SENSE]:POWER[:RF]:MW:PRESelector[:STATE] ON OFF 0 1 [:SENSE]:POWER[:RF]:MW:PRESelector[:STATE]?
Example	:POW:MW:PRES OFF Bypasses the microwave preselector
Notes	The ON parameter sets the STD path (:POW:MW:PATH STD) The OFF parameter sets path MPB (:POW:MW:PATH MPB)
Preset	ON

Internal Preamp

Accesses a menu of keys that control the internal preamps. Turning on the preamp gives a better noise figure, but a poorer TOI to noise floor dynamic range. You can optimize this setting for your particular measurement.

The instrument takes the preamp gain into account as it sweeps. If you sweep outside of the range of the preamp the instrument will also account for that. The displayed result will always reflect the correct gain.

For some measurements, when the preamp is on and any part of the displayed frequency range is below the lowest frequency for which the preamp has specifications, a warning condition message appears in the status line. For example, for a preamp with a 9 kHz lowest specified frequency: "Preamp: Accy unspc'd below 9 kHz".

Key Path	AMPTD Y Scale
Scope	Meas Global
Remote Command	[:SENSE]:POWER[:RF]:GAIN[:STATE] OFF ON 0 1 [:SENSE]:POWER[:RF]:GAIN[:STATE]?
Dependencies	Preamp is not available on all hardware platforms. If the preamp is not present or is unlicensed, the key is not shown. The preamp is not available when the electronic/soft attenuator is enabled.
Couplings	The act of connecting the U7227A USB Preamplifier to one of the analyzer's USB ports will cause the Internal Preamp to be switched on. When this happens an informational message will be generated: "Internal Preamp turned on for optimal operation with USB Preamp." Note that if the Internal Preamp was already on, there will be no change to the setting, but if it was Off it will be switched On, to Full Range. Note that this same action occurs when the SA mode is selected while the USB Preamp is connected to one of the analyzer's USB ports, if it is the first time that the SA mode has run since powerup, or if the last time the SA mode was running the USB Preamp was NOT connected.

	Subsequently disconnecting the USB Preamp from USB does not change the Internal Preamp setting nor restore the previous setting.
Preset	OFF
State Saved	Saved in instrument state
Initial S/W Revision	Prior to A.02.00
Modified at S/W Revision	A.14.00

Key Path	AMPTD Y Scale, Internal Preamp
Scope	Meas Global
Remote Command	[:SENSe] :POWer [:RF] :GAIN:BAND LOW FULL [:SENSe] :POWer [:RF] :GAIN:BAND?
Dependencies	Preamp is not available on all hardware platforms. If the preamp is not present or is unlicensed, the key is not shown. If a POW:GAIN:BAND FULL command is sent when a low band preamp is available, the preamp band parameter is to LOW instead of FULL, and an "Option not installed" message is generated.
Preset	LOW
State Saved	Saved in instrument state
Initial S/W Revision	Prior to A.02.00

Off

Turns the internal preamp off

Key Path	AMPTD Y Scale, Internal Preamp
Example	:POW:GAIN OFF
Readback	Off
Initial S/W Revision	Prior to A.02.00

Low Band

Sets the internal preamp to use only the low band.

The frequency range of the installed (optional) low-band preamp is displayed in square brackets on the Low Band key label.

Key Path	AMPTD Y Scale, Internal Preamp
Example	:POW:GAIN ON :POW:GAIN:BAND LOW
Readback	Low Band
Initial S/W Revision	Prior to A.02.00

Full Range

Sets the internal preamp to use its full range. The low band (0–3.6 GHz or 0–3GHz, depending on the model) is supplied by the low band preamp and the frequencies above low band are supplied by the high band preamp.

The frequency range of the installed (optional) preamp is displayed in square brackets on the Full Range key label. If the high band option is not installed the Full Range key does not appear.

Key Path	AMPTD Y Scale, Internal Preamp
Example	:POW:GAIN ON :POW:GAIN:BAND FULL
Readback	Full Range
Initial S/W Revision	Prior to A.02.00

Ref Position

Positions the reference level at the top, center or bottom of the Y Scale display. Changing the reference position does not change the reference level value.

Key Path	AMPTD Y Scale
Mode	All except SA and BASIC
Remote Command	:DISPlay:MONitor:VIEW[1]:WINDow[1]:TRACe:Y[:SCALe]:RPOSition TOP CENTer BOTTom :DISPlay:MONitor:VIEW[1]:WINDow[1]:TRACe:Y[:SCALe]:RPOSition?
Example	DISP:MON:VIEW:WIND:TRAC:Y:RPOS CENT DISP:MON:VIEW:WIND:TRAC:Y:RPOS?
Preset	TOP
State Saved	Saved in instrument state.
Range	Top Ctr Bot
Initial S/W Revision	Prior to A.02.00

Auto Scaling

Toggles the Auto Scaling function between On and Off.

Key Path	AMPTD Y Scale
Mode	All except SA and BASIC
Remote Command	:DISPlay:MONitor:VIEW[1]:WINDow[1]:TRACe:Y[:SCALe]:COUPlE 0 1 OFF ON :DISPlay:MONitor:VIEW[1]:WINDow[1]:TRACe:Y[:SCALe]:COUPlE?

Example	DISP:MON:VIEW:WIND:TRAC:Y:COUP ON DISP:MON:VIEW:WIND:TRAC:Y:COUP?
Couplings	When Auto Scaling is On, and the Restart front-panel key is pressed, this function automatically determines the scale per division and reference values based on the measurement results. When you set a value to either Scale/Div or Ref Value manually, Auto Scaling automatically changes to Off.
Preset	ON
State Saved	Saved in instrument state.
Range	On Off
Initial S/W Revision	Prior to A.02.00

Auto Couple

The Auto Couple feature provides a quick and convenient way to automatically couple multiple instrument settings. This helps ensure accurate measurements and optimum dynamic range. When the Auto Couple feature is activated, either from the front panel or remotely, all parameters of the current measurement that have an Auto/Manual mode are set to Auto mode and all measurement settings dependent on (or coupled to) the Auto/Man parameters are automatically adjusted for optimal performance.

However, the Auto Couple key actions are confined to the current measurement only. It does not affect other measurements in the mode, and it does not affect markers, marker functions, or trace or display attributes.

See "[More Information](#)" on page 547

Key Path	Front-panel key
Remote Command	:COUPle ALL NONE
Example	:COUP ALL
Notes	:COUPle ALL puts all Auto/Man parameters in Auto mode (equivalent to pressing the Auto Couple key). :COUPLE NONE puts all Auto/Man parameters in manual mode. It decouples all the coupled instrument parameters and is not recommended for making measurements.
Initial S/W Revision	Prior to A.02.00

More Information

There are two types of functions that have Auto/Manual modes.

Auto/Man Active Function keys

An Auto/Man toggle key controls the binary state associated with an instrument parameter by toggling between Auto (where the parameter is automatically coupled to the other parameters it is dependent upon) and Man (where the parameter is controlled independent of the other parameters), as well as making the parameter the active function. The current mode is indicated on the softkey with either Auto or Man underlined as illustrated below.



Auto/Man 1-of-N keys

An Auto/Man 1-of-N key allows you to manually pick from a list of parameter values, or place the function in Auto, in which case the value is automatically selected (and indicated) as shown below. If in Auto, Auto is underlined on the calling key. If in manual operation, manual is indicated on the calling key. But the calling key does not actually toggle the function, it simply opens the menu.

9 Monitor Spectrum Measurement
Auto Couple

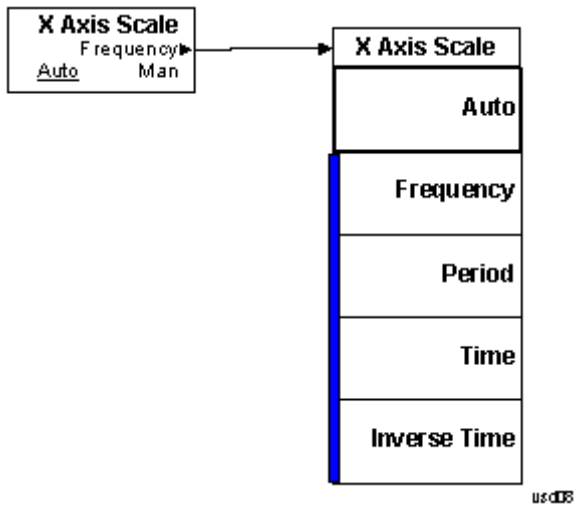

BW

Accesses a menu that enables you to specify the resolution bandwidth functions that control the bandwidth and filter selection.

Key Path	Front-panel key
Initial S/W Revision	Prior to A.02.00

Res BW

Sets the resolution bandwidth for the current measurement. If an unavailable bandwidth is entered with the numeric keypad, the closest available bandwidth is selected.

Key Path	BW
Mode	All except SA and BASIC
Remote Command	[:SENSe]:MONitor:BANDwidth[:RESolution] <freq> [:SENSe]:MONitor:BANDwidth[:RESolution]? [:SENSe]:MONitor:BANDwidth[:RESolution]:AUTO OFF ON 0 1 [:SENSe]:MONitor:BANDwidth[:RESolution]:AUTO?
Example	MON:BAND 2.4 MHz MON:BAND? MON:BAND:AUTO ON MON:BAND:AUTO?
Preset	WCDMA: Automatically calculated WIMAX OFDMA: 100kHz C2K: Automatically calculated BLUETOOTH: Automatically calculated PN: Automatically calculated GSM/EDGE: Automatically calculated TD-SCDMA: Automatically calculated 1xEVDO: 30kHz DVB-T/H: 3.9kHz DTMB (CTTB): 3.9kHz ISDB-T: 3.9kHz CMMB: 3.9kHz LTE: 100 kHz LTETDD: 100 kHz Digital Cable TV: 3.9kHz WLAN: 100 kHz MSR: Automatically calculated LTEAFDD, LTEATDD: 100kHz

	WCDMA: ON
	WIMAX: OFF
	C2K: ON
	BLUETOOTH: ON
	PN: ON
	GSM/EDGE: ON
	TD-SCDMA: ON
	1xEVDO: ON
	DVB-T/H: OFF
	DTMB (CTTB): OFF
	ISDB-T: OFF
	CMMB: OFF
	LTE:OFF
	LTETDD: OFF
	Digital Cable TV: OFF
	WLAN: OFF
	MSR: ON
	LTEAFDD, LTEATDD: OFF
State Saved	Saved in instrument state.
Min	1.0 Hz
Max	8.0 MHz
Backwards Compatibility SCPI	<code>[:SENSe] :MONitor :BWiDth [:RESolution]</code>
Initial S/W Revision	Prior to A.02.00
Modified at S/W Revision	A.02.00
Modified at S/W Revision	A.03.00

Video BW

Changes the analyzer post-detection filter.

Key Path	BW
Mode	All except SA and BASIC
Remote Command	<code>[:SENSe] :MONitor :BANDwidth :VIDeo <bandwidth></code> <code>[:SENSe] :MONitor :BANDwidth :VIDeo?</code> <code>[:SENSe] :MONitor :BANDwidth :VIDeo :AUTO ON OFF 1 0</code> <code>[:SENSe] :MONitor :BANDwidth :VIDeo :AUTO?</code>
Example	MON:BAND:VID 10 MHz MON:BAND:VID? MON:BAND:VID:AUTO OFF

	MON:BAND:VID:AUTO?
Preset	WCDMA: Automatically calculated WIMAX OFDMA: 1 MHz C2K: Automatically calculated BLUETOOTH: Automatically calculated PN: Automatically calculated GSM/EDGE: Automatically calculated TD-SCDMA: Automatically calculated 1xEVDO: 300kHz DVB-T/H: 39kHz DTMB (CTTB): 39kHz ISDB-T: 39kHz CMMB: 39kHz LTE: 1 MHz LTETDD: 1 MHz Digital Cable TV: 39kHz WLAN: 1 MHz MSR: Automatically calculated LTEAFDD, LTEATDD: 1 MHz WCDMA: ON WIMAX: OFF C2K: ON BLUETOOTH: ON PN: ON GSM/EDGE: ON TD-SCDMA: ON 1xEVDO: ON DVB-T/H: OFF DTMB (CTTB): OFF ISDB-T: OFF CMMB: OFF LTE: OFF LTETDD: OFF Digital Cable TV: OFF WLAN: OFF MSR: ON LTEAFDD, LTEATDD: OFF
State Saved	Saved in instrument state.
Min	1 Hz
Max	50 MHz

Backwards Compatibility SCPI	<code>[:SENSe] :MONitor :BWIDth :VIDeo</code>
Initial S/W Revision	Prior to A.02.00
Modified at S/W Revision	A.02.00
Modified at S/W Revision	A.03.00

VBW:3dB RBW

Selects the ratio between the video bandwidth and the equivalent 3 dB resolution bandwidth to be used for setting the VBW when VBW is in Auto.

Key Path	BW
Mode	All except SA and BASIC
Remote Command	<code>[:SENSe] :MONitor :BANDwidth :VIDeo :RATio <real></code> <code>[:SENSe] :MONitor :BANDwidth :VIDeo :RATio?</code> <code>[:SENSe] :MONitor :BANDwidth :VIDeo :RATio :AUTO OFF ON 0 1</code> <code>[:SENSe] :MONitor :BANDwidth :VIDeo :RATio :AUTO?</code>
Example	MON:BAND:VID:RAT 2 MON:BAND:VID:RAT? MON:BAND:VID:RAT:AUTO 0 MON:BAND:VID:RAT:AUTO?
Preset	1 ON
State Saved	Saved in instrument state.
Min	0.00001
Max	3000000
Backwards Compatibility SCPI	<code>[:SENSe] :MONitor :BWIDth :VIDeo :RATio</code>
Initial S/W Revision	Prior to A.02.00

Span:3dB RBW

Selects the ratio between span and resolution bandwidth.

The default setting is Auto with a Span:3 dB RBW ratio of 106:1. You can manually change this ratio by pressing the key, entering a new value, and pressing Enter.

Key Path	BW
Mode	All except SA and BASIC
Remote Command	<code>[:SENSe] :MONitor :FREQuency :SPAN :BANDwidth [:RESolution] :RATio <integer></code>

```
[ :SENSe]:MONitor:FREQuency:SPAN:BANDwidth[:RESolution]:RATio?
[ :SENSe]:MONitor:FREQuency:SPAN:BANDwidth[:RESolution]:RATio:AUTO OFF |
ON | 0 | 1
[ :SENSe]:MONitor:FREQuency:SPAN:BANDwidth[:RESolution]:RATio:AUTO?
```

Example

```
MON:FREQ:SPAN:BAND:RAT 200
MON:FREQ:SPAN:BAND:RAT?
MON:FREQ:SPAN:BAND:RAT:AUTO ON
MON:FREQ:SPAN:BAND:RAT:AUTO?
```

Preset 106
ON

State Saved Saved in instrument state.

Min 2

Max 10000

Backwards Compatibility SCPI [:SENSe]:MONitor:FREQuency:SPAN:BWIDth[:RESolution]:RATio

Initial S/W Revision Prior to A.02.00

Modified at S/W Revision A.04.00

Cont (Continuous Measurement/Sweep)

Sets the analyzer for Continuous measurement operation. The single/continuous state is Meas Global so the setting will affect all measurements. If you are Paused, pressing Cont does a Resume.

Key Path	Front-panel key
Remote Command	:INITiate:CONTinuous OFF ON 0 1 :INITiate:CONTinuous?
Example	:INIT:CONT 0 puts analyzer in Single measurement operation. :INIT:CONT 1 puts analyzer in Continuous measurement operation
Preset	ON (Note that SYST:PRESet sets INIT:CONT to ON but *RST sets INIT:CONT to OFF)
State Saved	Saved in instrument state
Backwards Compatibility Notes	For Spectrum Analysis mode in ESA and PSA, there is no Cont hardkey, instead there is a Sweep Single/Cont key. In these analyzers, switching the Sweep Single/Cont key from Single to Cont restarts averages (displayed average count reset to 1), but does not restart Max Hold and Min Hold. The X-Series has Single and Cont keys in place of the SweepSingleCont key. In the X-Series, if in single measurement, the Cont key (and INIT:CONT ON) switches to continuous measurement, but never restarts a measurement and never resets a sweep.
Initial S/W Revision	Prior to A.02.00

In Swept SA Measurement (Spectrum Analysis Mode):

The analyzer takes repetitive sweeps, averages, measurements, etc., when in Continuous mode. When the average count reaches the Average/Hold Number the count stops incrementing, but the analyzer keeps sweeping. See the Trace/Detector section for the averaging formula used both before and after the Average/Hold Number is reached. The trigger condition must be met prior to each sweep. The type of trace processing for multiple sweeps, is set under the Trace/Detector key, with choices of Trace Average, Max Hold, or Min Hold.

In Other Measurements/Modes:

With Avg/Hold Num (in the Meas Setup menu) set to Off or set to On with a value of 1, a sweep is taken after the trigger condition is met; and the analyzer continues to take new sweeps after the current sweep has completed and the trigger condition is again met. However, with Avg/Hold Num set to On with a value >1, multiple sweeps (data acquisitions) are taken for the measurement. The trigger condition must be met prior to each sweep. The sweep is not stopped when the average count k equals the number N set for Avg/Hold Num is reached, but the number k stops incrementing. A measurement average usually applies to all traces, marker results, and numeric results. But sometimes it only applies to the numeric results.

If the analyzer is in Single measurement, pressing the Cont key does not change k and does not cause the sweep to be reset; the only action is to put the analyzer into Continuous measurement operation.

If it is already in continuous sweep:

the INIT:CONT 1 command has no effect

the INIT:CONT 0 command will place the analyzer in Single Sweep but will have no effect on the current sequence until $k = N$, at which point the current sequence will stop and the instrument will go to the idle state.

9 Monitor Spectrum Measurement
File

File

See "File" on page 236

FREQ Channel

Accesses a menu of keys that allow you to control the Frequency and Channel parameters of the instrument.

Some features in the Frequency menu are the same for all measurements – they do not change as you change measurements. Settings like these are called “Meas Global” and are unaffected by Meas Preset. For example, the Center Freq setting is the same for all measurements – it does not change as you change measurements.

Key Path	Front-panel key
Initial S/W Revision	Prior to A.02.00

Center Freq

Sets the frequency that corresponds to the horizontal center of the graticule (when frequency Scale Type is set to linear). While adjusting the Center Frequency the Span is held constant, which means that both Start Frequency and Stop Frequency will change.

Pressing Center Freq also sets the frequency entry mode to Center/Span. In Center/Span mode, the center frequency and span values are displayed below the graticule, and the default active function in the Frequency menu is Center Freq.

The center frequency setting is the same for all measurements within a mode, that is, it is Meas Global. Some modes are also able to share a Mode Global center frequency value. If this is the case, the Mode will have a Global Settings key in its Mode Setup menu.

The Center Freq function sets (and queries) the Center Frequency for the currently selected input. If your analyzer has multiple inputs, and you select another input, the Center Freq changes to the value for that input. SCPI commands are available to directly set the Center Freq for a specific input.

Center Freq is remembered as you go from input to input. Thus you can set a Center Freq of 10 GHz with the RF Input selected, change to BBIQ and set a Center Freq of 20 MHz, then switch to External Mixing and set a Center Freq of 60 GHz, and when you go back to the RF Input the Center Freq will go back to 10 GHz; back to BBIQ and it is 20 MHz; back to External Mixing and it is 60 GHz.

See ["RF Center Freq" on page 560](#)

See [Ext Mix Center Freq](#)

See ["I/Q Center Freq" on page 562](#)

See ["Center Frequency Presets" on page 558](#)

Key Path	FREQ Channel
Scope	Meas Global
Remote Command	[:SENSe] :FREQuency :CENTer <freq> [:SENSe] :FREQuency :CENTer?

Example	FREQ:CENT 50 MHz FREQ:CENT UP changes the center frequency to 150 MHz if you use FREQ:CENT:STEP 100 MHz to set the center frequency step size to 100 MHz FREQ:CENT?
Notes	This command sets either the RF or I/Q Center Frequency depending on the selected input. For RF input it is equivalent to FREQ:RF:CENT For I/Q input it is equivalent to FREQ:IQ:CENT Preset and Max values are dependent on Hardware Options (5xx) If no terminator (e.g. MHz) is sent the terminator Hz is used. If a terminator with unit other than Frequency is used, an invalid suffix error message is generated.
Dependencies	The Center Frequency can be limited by Start or Stop Freq limits, if the Span is so large that Start or Stop reach their limit.
Couplings	When operating in "swept span", any value of the Center Frequency or Span that is within the frequency range of the analyzer is allowed when the value is being set through the front panel numeric key pad or the SCPI command. The other parameter is forced to a different value if needed, to keep the Start and the Stop Frequencies within the analyzer's frequency range
Preset	Depends on instrument maximum frequency, mode, measurement, and selected input. See "Center Frequency Presets" on page 558 and "RF Center Freq" on page 560 and Ext Mix Center Freq and "I/Q Center Freq" on page 562 .
State Saved	Saved in instrument state
Min	Depends on instrument maximum frequency, mode, measurement, and selected input.. See "Center Frequency Presets" on page 558 and "RF Center Freq" on page 560 and "I/Q Center Freq" on page 562 .
Max	Depends on instrument maximum frequency, mode, measurement, and selected input.. See "Center Frequency Presets" on page 558 and "RF Center Freq" on page 560 and "I/Q Center Freq" on page 562 .
Default Unit	Hz
Status Bits/OPC	Non-overlapped
Dependencies	
Initial S/W Revision	Prior to A.02.00

Center Frequency Presets

The following table provides the Center Frequency Presets for the Spectrum Analyzer mode, and the Max Freq, for the various frequency options:

Freq Option	CF after Mode Preset	Stop Freq after Mode Preset	Max Freq (can't tune)

			above)
503 (all but N9000A)	1.805 GHz	3.6 GHz	3.7 GHz
503 (N9000A)	1.505 GHz	3.0 GHz	3.08 GHz
507 (all but N9000A)	3.505 GHz	7.0 GHz	7.1 GHz
507 (N9000A)	3.755 GHz	7.5 GHz	7.58 GHz
508 (all but N9038A)	1.805 GHz	3.6 GHz	8.5 GHz
508 (N9038A)	4.205 GHz	8.4 GHz	8.5 GHz
513	6.805 GHz	13.6 GHz	13.8 GHz
526 (all but N9000A and N9038A)	13.255 GHz	26.5 GHz	27.0 GHz
526 (N9000A)	13.255 GHz	26.5 GHz	26.55 GHz
526 (N9038A)	1.805 GHz	3.6 GHz	27.0 GHz
532	16.005 GHz	32.0 GHz	32.5 GHz
543	21.505 GHz	43.0 GHz	TBD
544	22.005 GHz	44.0 GHz	44.5 GHz
550	25.005 GHz	50.0 GHz	51 GHz

Input 2:

Model	CF after Mode Preset	Stop Freq after Mode Preset	Max Freq (can't tune above)
N9000A opt C75	0.7505GHz	1.5 GHz	1.58 GHz
N9038A	505 MHz	1 GHz	1.000025 GHz

Tracking Generator Frequency Limits (N9000A only):

Tracking Generator Option	Min Freq (clips to this freq when turn TG on and	If above this Freq, Stop Freq clipped to this Freq when	Max Freq (can't tune above) while TG

	can't tune below while TG on)	TG turned on	on
T03	9 kHz	3.0 GHz	3.08 GHz
T06	9 kHz	6.0 GHz	6.05 GHz

The following table shows the Center Frequency Presets for modes other than Spectrum Analyzer:

Mode	CF Preset for RF
WCDMA	1 GHz
WIMAXOFDMA,	1 GHz
BASIC	1 GHz
ADEMOD	1 GHz
VSA	1 GHz
TDSCDMA	1 GHz
PNOISE	1 GHz
LTE	1 GHz
LTETDD	1 GHz
MSR	1 GHz
GSM	935.2 MHz
NFIGURE	1.505 GHz

RF Center Freq

SCPI command for specifying the RF Center Frequency. This command will set the Center Frequency to be used when the RF input is selected, even if the RF input is not the input that is selected at the time the command is sent. Note that the Center Freq function in the Frequency menu on the front panel always applies to the currently selected input.

Scope	Meas Global
Remote Command	<code>[:SENSe] :FREQuency:RF:CENTer <freq></code> <code>[:SENSe] :FREQuency:RF:CENTer?</code>
Example	FREQ:RF:CENT 30 MHz
Notes	This command is the same in all modes, but the parameter is Measurement Global. So the value is independent in each mode and common across all the measurements in the mode.
Dependencies	If the electronic/soft attenuator is enabled, any attempt to set Center Frequency such that the Stop Frequency would be >3.6 GHz fails and results in an advisory message. If the equivalent SCPI command is sent, this same message is generated as part of a “-221, Settings conflict” warning. If Source Mode is set to Tracking, and the Max or Min Center Freq is therefore limited by the limits of the source, a warning message is generated, “Data out of range;clipped to source max/min” if these limits are exceeded. Note that for an external source, these limits can be affected by the settings of

	Source Numerator, Source Denominator and Power Sweep.
Preset	See table above
State Saved	Saved in instrument state.
Min	-79.999995 MHz, unless Source Mode is set to Tracking, in which case it is limited by the minimum frequency of the Source
Max	See table above. Basically instrument maximum frequency - 5 Hz. Note that, if the Source Mode is set to Tracking, the effective instrument maximum frequency may be limited by the source maximum frequency. If the knob or step keys are being used, also depends on the value of the other three interdependent parameters Span, Start Frequency and Stop Frequency
Initial S/W Revision	Prior to A.02.00
Modified at S/W Revision	A.03.00

Ext Mix Center Freq

SCPI command for specifying the External Mixer Center Frequency. This command will set the Center Frequency to be used when the External Mixer is selected, even if the External Mixer input is not the input which is selected at the time the command is sent. Note that the Center Freq function in the Frequency menu on the front panel always applies to the currently selected input.

Scope	Meas Global
Remote Command	[:SENSe] :FREQuency:EMIXer:CENTer <freq> [:SENSe] :FREQuency:EMIXer:CENTer?
Example	:FREQ:EMIX:CENT 60 GHz :FREQ:EMIX:CENT?
Notes	This command is the same in all modes, but the parameter is Measurement Global. So the value is independent in each mode and common across all the measurements in the mode.
Couplings	When returning to External Mixing after having been switched to one of the other inputs (e.g., RF), you will come back into the settings that you had when you left External Mixing. So you will come back to the band you were in with the Center Frequency that you had. However, Span is not an input-dependent parameter, therefore you will bring the span over from the other input. Therefore, the analyzer comes back with the span from the previous input, limited as necessary by the current mixer setup.
Preset	When a Mode Preset is performed while in External Mixing, the Start frequency of the current Mode is set to the nominal Min Freq of the lowest harmonic range in the Harmonic Table for the current mixer setup. Similarly, the Stop frequency of the current Mode is set to the nominal Max Freq of the highest harmonic range in the Harmonic Table. The Center Freq thus presets to the point arithmetically equidistant from these two frequencies. If the current measurement has a limited Span available to it, and cannot achieve the Span shown in the table (Span=Stop Freq - Start Freq), the analyzer uses the maximum Span the measurement allows, and still sets the Center Freq to the midpoint of the Start and Stop Freq values in the Harmonic Table.

	<p>When Restore Input/Output Defaults is performed, the mixer presets to the 11970A, whose Start and Stop frequencies are 26.5 and 40 GHz respectively. The center of these two frequencies is 33.25 GHz.</p> <p>Therefore, after a Restore Input/Output Defaults, if you go into External Mixing and do a Mode Preset while in the Spectrum Analyzer Mode, the resulting Center Freq is 33.25 GHz.</p>
State Saved	Saved in instrument state.
Min	The minimum frequency in the currently selected mixer band + 5 Hz
Max	The maximum frequency in the currently selected mixer band – 5 Hz If the knob or step keys are being used, also depends on the value of the other three interdependent parameters Span, Start Frequency and Stop Frequency
Initial S/W Revision	A.08.01

I/Q Center Freq

SCPI command for specifying the I/Q Center Frequency. This command will set the Center Frequency to be used when the I/Q input is selected, even if the I/Q input is not the input which is selected at the time the command is sent. Note that the Center Freq function in the Frequency menu on the front panel always applies to the currently selected input.

Scope	Meas Global
Remote Command	<pre>[:SENSe] :FREQuency:IQ:CENTer <freq></pre> <pre>[:SENSe] :FREQuency:IQ:CENTer?</pre>
Example	FREQ:IQ:CENT: 30 MHz
Notes	This command is the same in all modes, but the parameter is Measurement Global. So the value is independent in each mode and common across all the measurements in the mode.
Preset	0 Hz
State Saved	Saved in instrument state.
Min	-40.049995 MHz
Max	40.049995 MHz
Initial S/W Revision	Prior to A.02.00

CF Step

Changes the step size for the center frequency and start and stop frequency functions. Once a step size has been selected and the center frequency function is active, the step keys (and the UP|DOWN parameters for Center Frequency from remote commands) change the center frequency by the step-size value. The step size function is useful for finding harmonics and sidebands beyond the current frequency span of the analyzer.

Note that the start and stop frequencies also step by the CF Step value.

Key Path	FREQ Channel
Remote Command	[:SENSe] :FREQuency:CENTer:STEP [:INCRement] <freq> [:SENSe] :FREQuency:CENTer:STEP [:INCRement] ? [:SENSe] :FREQuency:CENTer:STEP:AUTO OFF ON 0 1 [:SENSe] :FREQuency:CENTer:STEP:AUTO?
Example	FREQ:CENT:STEP:AUTO ON FREQ:CENT:STEP 500 MHz FREQ:CENT UP increases the current center frequency value by 500 MHz FREQ:CENT:STEP? FREQ:CENT:STEP:AUTO?
Notes	Preset and Max values are depending on Hardware Options (503, 507, 508, 513, 526)
Notes	Preset and Max values are dependent on Hardware Options (5xx)
Dependencies	Freq Offset is not available in External Mixing. In this case the Freq Offset key is grayed out and shows a value of zero. It will once again be available, and show the previously set value, when you return to the RF Input.
Dependencies	Span, RBW, Center frequency If the electronic/soft attenuator is enabled, any attempt to change the value of the center frequency >3.6 GHz by pressing the Up-arrow key, fails and results in an advisory message. If the equivalent SCPI command is sent, this same message is generated as part of a “-221, Settings conflict” warning.
Couplings	When auto-coupled in a non-zero span, the center frequency step size is set to 10% of the span. When auto-coupled in zero span, the center frequency step size is set to the equivalent -3 dB RBW value.
Preset	Auto ADEMOD: 1 MHz ON
State Saved	Saved in instrument state
Min	- (the maximum frequency of the instrument). That is, 27 GHz max freq instrument has a CF step range of +/- 27 GHz. Note that this is the maximum frequency given the current settings of the instrument, so in External Mixing, for example, it is the maximum frequency of the current mixer band.
Max	The maximum frequency of the instrument. That is, 27 GHz max freq instrument has a CF step range of +/- 27 GHz. Note that this is the maximum frequency given the current settings of the instrument, so in External Mixing, for example, it is the maximum frequency of the current mixer band.
Default Unit	Hz
Status Bits/OPC dependencies	non-overlapped
Initial S/W Revision	Prior to A.02.00
Modified at S/W Revision	A.03.00

Input/Output

See ["Input/Output" on page 146](#)

Marker

Accesses a menu that enables you to select, set up and control the markers for the current measurement.

For remote-only commands associated with Marker functionality, see:

- "Marker X Axis Value (Remote Command only)" on page 567
- "Marker X Axis Position (Remote Command only)" on page 568
- "Marker Y Axis Value (Remote Command only)" on page 568

Key Path	Front-panel key
Initial S/W Revision	Prior to A.02.00

Select Marker

Displays 12 markers available for selection.

Key Path	Marker
Initial S/W Revision	Prior to A.02.00

Properties

Accesses a menu that enables you to select the active marker, the reference marker and the trace for the current measurement.

Key Path	Marker
Initial S/W Revision	Prior to A.02.00

Select Marker

Displays 12 markers available for selection.

Key Path	Marker
Initial S/W Revision	Prior to A.02.00

Relative To

Selects the desired marker. The selected marker is relative to its reference marker.

Key Path	Marker, Properties
Mode	All except SA and BASIC

Remote Command	:CALCulate:MONitor:MARKer[1] 2 ... 12:REference <integer> :CALCulate:MONitor:MARKer[1] 2 ... 12:REference?
Example	CALC:MON:MARK2:REF 1 CALC:MON:MARK2:REF?
Notes	A marker cannot be relative to itself so that choice is grayed out, and if sent from SCPI generates error -221: "Settings conflict; marker cannot be relative to itself." When queried a single value is returned (the specified marker number's relative marker).
Preset	2 3 4 5 6 7 8 9 10 11 12 1
State Saved	Saved in instrument state.
Min	1
Max	12
Initial S/W Revision	Prior to A.02.00

Marker Trace

Assigns the specified marker to the designated trace.

Key Path	Marker, Properties
Mode	All except SA and BASIC
Remote Command	:CALCulate:MONitor:MARKer[1] 2 ... 12:TRACe <integer> :CALCulate:MONitor:MARKer[1] 2 ... 12:TRACe?
Example	CALC:MON:MARK:TRAC 1 CALC:MON:MARK:TRAC?
Preset	1
State Saved	Saved in instrument state.
Min	1
Max	3
Initial S/W Revision	Prior to A.02.00

Couple Markers

When this function is true, moving any marker causes an equal X Axis movement of every other marker that is not Off. By "equal X Axis movement" we mean that we preserve the difference between each marker's X Axis value (in the fundamental x-axis units of the trace that marker is on) and the X Axis value of the marker being moved (in the same fundamental x-axis units).

Key Path	Marker
Mode	All except SA and BASIC
Remote Command	:CALCulate:MONitor:MARKer:COUPle[:STATe] ON OFF 1 0

	:CALCulate:MONitor:MARKer:COUPle[:STATE]?
Example	CALC:MON:MARK:COUP ON CALC:MON:MARK:COUP?
Preset	OFF
State Saved	Saved in instrument state.
Range	On Off
Initial S/W Revision	Prior to A.02.00

All Markers Off

Turns off all markers on the current measurement.

Key Path	Marker
Mode	All except SA and BASIC
Remote Command	:CALCulate:MONitor:MARKer:AOff
Example	CALC:MON:MARK:AOff
Initial S/W Revision	Prior to A.02.00

Marker X Axis Value (Remote Command only)

Sets the marker X Axis value in the current marker X Axis Scale unit. It has no effect if the control mode is Off, but is the SCPI equivalent of entering an X value if the control mode is Normal or Delta.

Mode	All except SA and BASIC
Remote Command	:CALCulate:MONitor:MARKer[1] 2 ... 12:X <freq> :CALCulate:MONitor:MARKer[1] 2 ... 12:X?
Example	CALC:MON:MARK3:X 0 CALC:MON:MARK3:X?
Notes	If no suffix is sent, uses the fundamental units for the current marker X Axis Scale. If a suffix is sent that does not match the current marker X Axis Scale unit, an error "Invalid suffix" is generated. The query returns the marker's absolute X Axis value if the control mode is Normal, or the offset from the marker's reference marker if the control mode is Delta. The query is returned in the fundamental units for the current marker X Axis scale: Hz for Frequency and Inverse Time, seconds for Period and Time. If the marker is Off the response is not a number.
Preset	After a preset, all markers are turned OFF, so Marker X Axis Value query returns a not a number (NAN).
State Saved	No
Min	-9.9E+37
Max	9.9E+37
Initial S/W Revision	Prior to A.02.00

Marker X Axis Position (Remote Command only)

Sets the marker X position in trace points. It has no effect if the control mode is Off, but is the SCPI equivalent of entering a value if the control mode is Normal or Delta – except in trace points rather than X Axis Scale units. The entered value is immediately translated into the current X Axis Scale units for setting the value of the marker.

Mode	All except SA and BASIC
Remote Command	:CALCulate:MONitor:MARKer[1] 2 ... 12:X:POSition <real> :CALCulate:MONitor:MARKer[1] 2 ... 12:X:POSition?
Example	CALC:MON:MARK:X:POS 0 CALC:MON:MARK:X:POS?
Notes	The query returns the marker's absolute X Axis value in trace points if the control mode is Normal, or the offset from the marker's reference marker in trace points if the control mode is Delta. The value is returned as a real number, not an integer, corresponding to the translation from X Axis Scale units to trace points. If the marker is Off the response is not a number.
Preset	After a preset, all markers are turned OFF, so Marker X Axis Value query returns a not a number (NAN).
State Saved	No
Min	-9.9E+37
Max	9.9E+37
Initial S/W Revision	Prior to A.02.00

Marker Y Axis Value (Remote Command only)

Returns the marker Y Axis value in the current marker.

Mode	All except SA and BASIC
Remote Command	:CALCulate:MONitor:MARKer[1] 2 ... 12:Y?
Example	CALC:MON:MARK11:Y?
Preset	Result dependent on markers setup and signal source
Backwards Compatibility SCPI	:CALCulate:MONitor:MARKer[1] 2 ... 12:FUNCTion:RESult?
Initial S/W Revision	Prior to A.02.00

Marker Function

Accesses special marker functions such as marker noise, and power in a specified bandwidth or time interval.

Key Path	Front-panel key
Initial S/W Revision	Prior to A.02.00

Select Marker

Displays 12 markers available for selection.

Key Path	Marker
Initial S/W Revision	Prior to A.02.00

Marker Function Type

Sets the marker control function type to one of the following:

NOISe	Marker Noise
BPOWer	Band/Interval Power
BDENsity	Band Interval Density
OFF	Marker Function Off

Key Path	Marker Function
Mode	All except SA and BASIC
Remote Command	:CALCulate:MONitor:MARKer[1] 2 ... 12:FUNCtion NOISe BPOWer BDENsity OFF :CALCulate:MONitor:MARKer[1] 2 ... 12:FUNCtion?
Example	CALC:MON:MARK:FUNC NOISCALC:MON:MARK:FUNC?
Preset	OFF
State Saved	Saved in instrument state.
Range	Marker Noise Band/Interval Power Band Interval Density Marker Function Off
Initial S/W Revision	Prior to A.02.00

Band Adjust

Accesses a menu that enables you to set the frequency span width and the left and right edge, or time values, for the band or interval of the selected marker.

Key Path	Marker Function
Initial S/W Revision	Prior to A.02.00

Band/Interval Span for Frequency Domain

Sets the width of the frequency span for the selected marker.

Key Path	Marker Function
Mode	All except SA and BASIC
Remote Command	:CALCulate:MONitor:MARKer[1] 2 ... 12:FUNction:BAND:SPAN <freq> :CALCulate:MONitor:MARKer[1] 2 ... 12:FUNction:BAND:SPAN?
Example	CALC:MON:MARK12:FUNC:BAND:SPAN 20 MHz CALC:MON:MARK12:FUNC:BAND:SPAN?
Couplings	Changing the Band/Interval Span necessarily changes the Band/Interval Left and Band/Interval Right values.
Preset	Depends on X axis range of selected Trace.
State Saved	Saved in instrument state.
Min	-9.9E+37
Max	9.9E+37
Initial S/W Revision	Prior to A.02.00

Band/Interval Left for Frequency Domain

Sets the left edge frequency or time value for the band of the selected marker.

Key Path	Marker Function
Mode	All except SA and BASIC
Remote Command	:CALCulate:MONitor:MARKer[1] 2 ... 12:FUNction:BAND:LEFT <freq> :CALCulate:MONitor:MARKer[1] 2 ... 12:FUNction:BAND:LEFT?
Example	CALC:MON:MARK12:FUNC:BAND:LEFT 20 GHz CALC:MON:MARK12:FUNC:BAND:LEFT?
Couplings	Changing the Band/Interval Left necessarily changes the Band/Interval Span value.
Preset	Depends on X axis range of selected Trace.
State Saved	Saved in instrument state.
Min	-9.9E+37
Max	9.9E+37
Initial S/W Revision	Prior to A.02.00

Band/Interval Right for Frequency Domain

Sets the right edge frequency or time value for the band of the selected marker.

Key Path	Marker Function
Mode	All except SA and BASIC
Remote Command	:CALCulate:MONitor:MARKer[1] 2 ... 12:FUNCtion:BAND:RIGHT <freq> :CALCulate:MONitor:MARKer[1] 2 ... 12:FUNCtion:BAND:RIGHT?
Example	CALC:MON:MARK12:FUNC:BAND:RIGH 20 GHz CALC:MON:MARK12:FUNC:BAND:RIGH?
Couplings	Changing the Band/Interval Right necessarily changes the Band/Interval Span value.
Preset	Depends on X axis range of selected Trace.
State Saved	Saved in instrument state.
Min	-9.9E+37
Max	9.9E+37
Initial S/W Revision	Prior to A.02.00

Marker To

There is no 'Marker To' functionality supported in Monitor Spectrum. The front-panel key displays a blank menu when pressed.

Key Path	Front-panel key
Initial S/W Revision	Prior to A.02.00

Meas

The information in this section is common to all measurements. For key and remote command information for a specific measurement, refer to the section that describes the measurement of interest.

Measurements available under the Meas key are specific to the current Mode.

When viewing Help for measurements, note the following:

NOTE

Operation for some keys differs between measurements. The information displayed in Help pertains to the current measurement. To see how a key operates in a different measurement, exit Help (press the Cancel Esc key), select the measurement, then reenter Help (press the Help key) and press that key.

Key Path	Front-panel key
Initial S/W Revision	Prior to A.02.00

Remote Measurement Functions

This section contains the following topics:

"Measurement Group of Commands" on page 1166

"Current Measurement Query (Remote Command Only)" on page 1168

"Limit Test Current Results (Remote Command Only)" on page 1168

"Data Query (Remote Command Only)" on page 1168

"Calculate/Compress Trace Data Query (Remote Command Only)" on page 1169

"Calculate Peaks of Trace Data (Remote Command Only)" on page 1174

Hardware-Accelerated Fast Power Measurement (Remote Command Only)

"Format Data: Numeric Data (Remote Command Only)" on page 1175

"Format Data: Byte Order (Remote Command Only)" on page 1176

Initial S/W Revision	Prior to A.02.00
----------------------	------------------

Measurement Group of Commands

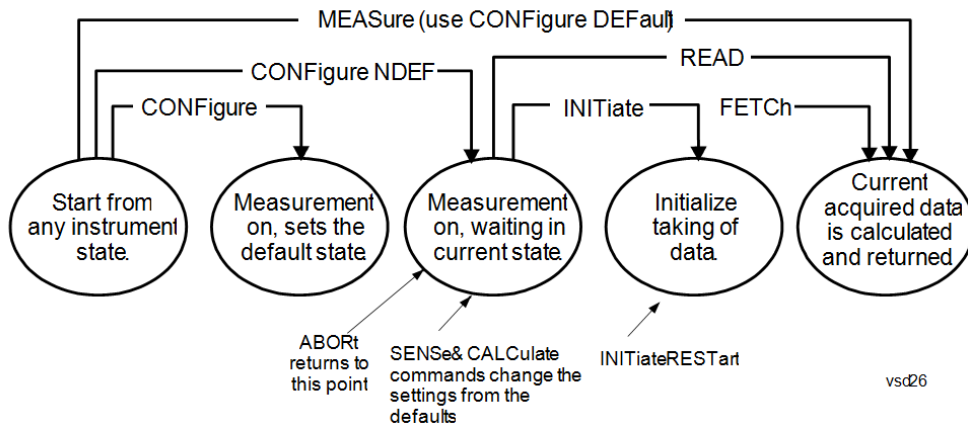

Measure Commands:

:MEASure:<measurement>[n]?

This is a fast single-command way to make a measurement using the factory default instrument settings. These are the settings and units that conform to the Mode Setup settings (e.g. radio standard) that you have currently selected.

- Stops the current measurement (if any) and sets up the instrument for the specified measurement using the factory defaults
- Initiates the data acquisition for the measurement
- Blocks other SCPI communication, waiting until the measurement is complete before returning results.
- If the function does averaging, it is turned on and the number of averages is set to 10.
- After the data is valid it returns the scalar results, or the trace data, for the specified measurement. The type of data returned may be defined by an [n] value that is sent with the command.
- The scalar measurement results will be returned if the optional [n] value is not included, or is set to 1. If the [n] value is set to a value other than 1, the selected trace data results will be returned. See each command for details of what types of scalar results or trace data results are available.
- ASCII is the default format for the data output. (Older versions of Spectrum Analysis and Phase Noise mode measurements only use ASCII.) The binary data formats should be used for handling large blocks of data since they are smaller and faster than the ASCII format. Refer to the FORMat:DATA command for more information.

If you need to change some of the measurement parameters from the factory default settings you can set up the measurement with the CONFigure command. Use the commands in the SENSe:<measurement> and CALCulate:<measurement> subsystems to change the settings. Then you can use the READ? command to initiate the measurement and query the results.

If you need to repeatedly make a given measurement with settings other than the factory defaults, you can use the commands in the SENSe:<measurement> and CALCulate:<measurement> subsystems to set up the measurement. Then use the READ? command to initiate the measurement and query results.

Measurement settings persist if you initiate a different measurement and then return to a previous one. Use READ:<measurement>? if you want to use those persistent settings. If you want to go back to the default settings, use MEASure:<measurement>?.

Configure Commands:

:CONFigure:<measurement>

This command stops the current measurement (if any) and sets up the instrument for the specified measurement using

the factory default instrument settings. It does not initiate the taking of measurement data unless INIT:CONTInuous is ON. If you change any measurement settings after using the CONFigure command, the READ command can be used to initiate a measurement without changing the settings back to their defaults.

In the Swept SA measurement in Spectrum Analyzer mode the CONFigure command also turns the averaging function on and sets the number of averages to 10 for all measurements.

:CONFigure: <measurement>: NDEFault stops the current measurement and changes to the specified measurement. It does not change the settings to the defaults. It does not initiate the taking of measurement data unless INIT:CONTInuous is ON.

The CONFigure? query returns the current measurement name.

The CONFigure:CATalog? query returns a quoted string of all licensed measurement names in the current mode. For example, "SAN, CHP, OBW, ACP, PST, TXP, SPUR, SEM, LIST".

Fetch Commands:

:FETCh:<measurement>[n]?

This command puts selected data from the most recent measurement into the output buffer. Use FETCh if you have already made a good measurement and you want to return several types of data (different [n] values, for example, both scalars and trace data) from a single measurement. FETCh saves you the time of re-making the measurement. You can only FETCh results from the measurement that is currently active, it will not change to a different measurement. An error message is reported if a measurement other than the current one is specified.

If you need to get new measurement data, use the READ command, which is equivalent to an INITiate followed by a FETCh.

The scalar measurement results will be returned if the optional [n] value is not included, or is set to 1. If the [n] value is set to a value other than 1, the selected trace data results will be returned. See each command for details of what types of scalar results or trace data results are available. The binary data formats should be used for handling large blocks of data since they are smaller and transfer faster than the ASCII format. (FORMat:DATA)

FETCh may be used to return results other than those specified with the original READ or MEASure command that you sent.

INITiate Commands:

:INITiate:<measurement>

This command is not available for measurements in all the instrument modes:

- Initiates a trigger cycle for the specified measurement, but does not output any data. You must then use the FETCh<meas> command to return data. If a measurement other than the current one is specified, the instrument will switch to that measurement and then initiate it.
- For example, suppose you have previously initiated the ACP measurement, but now you are running the channel power measurement. If you send INIT:ACP? it will change from channel power to ACP and will initiate an ACP measurement.
- Does not change any of the measurement settings. For example, if you have previously started the ACP measurement and you send INIT:ACP? it will initiate a new ACP measurement using the same instrument settings as the last time ACP was run.
- If your selected measurement is currently active (in the idle state) it triggers the measurement, assuming the trigger conditions are met. Then it completes one trigger cycle. Depending upon the measurement and the number of averages, there may be multiple data acquisitions, with multiple trigger events, for one full trigger cycle. It also holds off additional commands on GPIB until the acquisition is complete.

READ Commands:

:READ:<measurement>[n]?

- Does not preset the measurement to the factory default settings. For example, if you have previously initiated the ACP
-

measurement and you send READ:ACP? it will initiate a new measurement using the same instrument settings.

- Initiates the measurement and puts valid data into the output buffer. If a measurement other than the current one is specified, the instrument will switch to that measurement before it initiates the measurement and returns results.
 - For example, suppose you have previously initiated the ACP measurement, but now you are running the channel power measurement. Then you send READ:ACP? It will change from channel power back to ACP and, using the previous ACP settings, will initiate the measurement and return results.
 - Blocks other SCPI communication, waiting until the measurement is complete before returning the results
 - If the optional [n] value is not included, or is set to 1, the scalar measurement results will be returned. If the [n] value is set to a value other than 1, the selected trace data results will be returned. See each command for details of what types of scalar results or trace data results are available. The binary data formats should be used when handling large blocks of data since they are smaller and faster than the ASCII format. (FORMat:DATA)
-

Initial S/W Revision	Prior to A.02.00
----------------------	------------------

Current Measurement Query (Remote Command Only)

This command returns the name of the measurement that is currently running.

Remote Command	:CONFigure?
-----------------------	-------------

Example	CONF?
----------------	-------

Initial S/W Revision	Prior to A.02.00
----------------------	------------------

Limit Test Current Results (Remote Command Only)

Queries the status of the current measurement limit testing. It returns a 0 if the measured results pass when compared with the current limits. It returns a 1 if the measured results fail any limit tests.

Remote Command	:CALCulate:CLIMits:FAIL?
-----------------------	--------------------------

Example	CALC:CLIM:FAIL? queries the current measurement to see if it fails the defined limits. Returns a 0 or 1: 0 it passes, 1 it fails.
----------------	--

Initial S/W Revision	Prior to A.02.00
----------------------	------------------

Data Query (Remote Command Only)

Returns the designated measurement data for the currently selected measurement and subopcode.

n = any valid subopcode for the current measurement. See the measurement command results table for your current measurement, for information about what data is returned for the subopcodes.

This command uses the data setting specified by the FORMat:BORDER and FORMat:DATA commands and can return real or ASCII data. (See the format command descriptions under Input/Output in the Analyzer Setup section.)

Remote Command	:CALCulate:DATA[n]?
Notes	The return trace depends on the measurement. In CALCulate:<meas>:DATA[n], n is any valid subopcode for the current measurement. It returns the same data as the FETCH:<measurement>? query where <measurement> is the current measurement.
Initial S/W Revision	Prior to A.02.00

Calculate/Compress Trace Data Query (Remote Command Only)

Returns compressed data for the currently selected measurement and sub-opcode [n].

n = any valid sub-opcode for that measurement. See the MEASure:<measurement>? command description of your specific measurement for information on the data that can be returned.

The data is returned in the current Y Axis Unit of the analyzer. The command is used with a sub-opcode <n> (default=1) to specify the trace. With trace queries, it is best if the analyzer is not sweeping during the query. Therefore, it is generally advisable to be in Single Sweep, or Update=Off.

This command is used to compress or decimate a long trace to extract and return only the desired data. A typical example would be to acquire N frames of GSM data and return the mean power of the first burst in each frame. The command can also be used to identify the best curve fit for the data.

Remote Command	:CALCulate:DATA<n>:COMPRESS? BLOCK CFIT MAXimum MINimum MEAN DMEan RMS RMSCubed SAMPLE SDEVIation PPHase [,<soffset> [,<length>[,<roffset>[,<rlimit>]]]]
Example	To query the mean power of a set of GSM bursts: Supply a signal that is a set of GSM bursts. Select the IQ Waveform measurement (in IQ Analyzer Mode). Set the sweep time to acquire at least one burst. Set the triggers such that acquisition happens at a known position relative to a burst. Then query the mean burst levels using, CALC:DATA2:COMP? MEAN, 24e-6, 526e-6 (These parameter values correspond to GSM signals, where 526e-6 is the length of the burst in the slot and you just want 1 burst.)
Notes	The command supports 5 parameters. Note that the last 4 (<soffset>, <length>, <roffset>, <rlimit>) are optional. But these optional parameters must be entered in the specified order. For example, if you want to specify <length>, then you must also specify <soffset>. See details below for a definition of each of these parameters. This command uses the data in the format specified by FORMat:DATA, returning either binary or ASCII data.
Initial S/W Revision	Prior to A.02.00

- BLOCK or block data - returns all the data points from the region of the trace data that you specify. For example, it could be used to return the data points of an input signal over several timeslots, excluding the portions of the trace data that you do not want. (This is x,y pairs for trace data and I,Q pairs for complex data.)

- CFIT or curve fit - applies curve fitting routines to the data. <soffset> and <length> are required to define the data that you want. <roffset> is an optional parameter for the desired order of the curve equation. The query will return the following values: the x-offset (in seconds) and the curve coefficients ((order + 1) values).

MIN, MAX, MEAN, DME, RMS, RMSC, SAMP, SDEV and PPH return one data value for each specified region (or <length>) of trace data, for as many regions as possible until you run out of trace data (using <roffset> to specify regions). Or they return the number of regions you specify (using <rlimit>) ignoring any data beyond that.

- MINimum - returns the minimum data point (y value) for the specified region(s) of trace data. For I/Q trace data, the minimum magnitude of the I/Q pairs is returned.
- MAXimum - returns the maximum data point (y value) for the specified region(s) of trace data. For I/Q trace data, the maximum magnitude of the I/Q pairs is returned.
- MEAN - returns a single value that is the arithmetic mean of the data point values (in dB/ dBm) for the specified region(s) of trace data. For I/Q trace data, the mean of the magnitudes of the I/Q pairs is returned. See the following equations.

NOTE If the original trace data is in dB, this function returns the arithmetic mean of those log values, not log of the mean power which is a more useful value. The mean of the log is the better measurement technique when measuring CW signals in the presence of noise. The mean of the power, expressed in dB, is useful in power measurements such as Channel Power. To achieve the mean of the power, use the RMS option.

Equation 1

Mean Value of Data Points for Specified Region(s)

$$\text{MEAN} = \frac{1}{n} \sum_{X_i \in \text{region}(s)} X_i$$

where X_i is a data point value, and n is the number of data points in the specified region(s).

Equation 2

Mean Value of I/Q Data Pairs for Specified Region(s)

$$\text{MEAN} = \frac{1}{n} \sum_{X_i \in \text{region}(s)} |X_i|$$

where $|X_i|$ is the magnitude of an I/Q pair, and n is the number of I/Q pairs in the specified region(s).

- DMEan - returns a single value that is the mean power (in dB/ dBm) of the data point values for the specified region(s) of trace data. See the following equation:

Equation 3

DMEan Value of Data Points for Specified Region(s)

$$\text{DME} = 10 \times \log_{10} \left(\frac{1}{n} \sum_{X_i \in \text{region}(s)} 10^{\frac{X_i}{10}} \right)$$

- RMS - returns a single value that is the average power on a root-mean-squared voltage scale (arithmetic rms) of the data point values for the specified region(s) of trace data. See the following equation.

NOTE

For I/Q trace data, the rms of the magnitudes of the I/Q pairs is returned. See the following equation. This function is very useful for I/Q trace data. However, if the original trace data is in dB, this function returns the rms of the log values which is not usually needed.

Equation 4

RMS Value of Data Points for Specified Region(s)

$$\text{RMS} = \sqrt{\frac{1}{n} \sum_{X_i \in \text{region}(s)} X_i^2}$$

where X_i is a data point value, and n is the number of data points in the specified region(s).

Equation 5

RMS Value of I/Q Data Pairs for Specified Region(s)

$$\text{RMS} = \sqrt{\frac{1}{n} \sum_{X_i \in \text{region}(s)} X_i X_i^*}$$

where X_i is the complex value representation of an I/Q pair, X_i^* its conjugate complex number, and n is the number of I/Q pairs in the specified region(s).

Once you have the rms value for a region of trace data (linear or I/Q), you may want to calculate the mean power. You must convert this rms value (peak volts) to power in dBm:

$$10 \times \log[10 \times (\text{rms value})^2]$$

- SAMPLe - returns the first data value (x,y pair) for the specified region(s) of trace data. For I/Q trace data, the first I/Q pair is returned.
- SDEViation - returns a single value that is the arithmetic standard deviation for the data point values for the specified region(s) of trace data. See the following equation.
- For I/Q trace data, the standard deviation of the magnitudes of the I/Q pairs is returned. See the following equation.

Equation 6

Standard Deviation of Data Point Values for Specified Region(s)

$$\text{SDEV} = \sqrt{\frac{1}{n} \sum_{X_i \in \text{region}(s)} (X_i - \bar{X})^2}$$

where X_i is a data point value, \bar{X} is the arithmetic mean of the data point values for the specified region (s), and n is the number of data points in the specified region(s).

$$\text{SDEV} = \sqrt{\frac{1}{n} \sum_{X_i \in \text{region}(s)} (|X_i| - \bar{X})^2}$$

where $|X_i|$ is the magnitude of an I/Q pair, \bar{X} is the mean of the magnitudes for the specified region(s), and n is the number of data points in the specified region(s).

- PPHase - returns the x,y pairs of both rms power (dBm) and arithmetic mean phase (radian) for every specified region and frequency offset (Hz). The number of pairs is defined by the specified number of regions. This parameter can be used for I/Q vector ($n=0$) in Waveform (time domain) measurement and all parameters are specified by data point in PPHase.

The rms power of the specified region may be expressed as:

$$\text{Power} = 10 \times \log [10 \times (\text{RMS I/Q value})] + 10.$$

The RMS I/Q value (peak volts) is:

$$\sqrt{\frac{1}{n} \sum_{X_i \in \text{region}} X_i X_i^*}$$

where X_i is the complex value representation of an I/Q pair, X_i^* its conjugate complex number, and n is the number of I/Q pairs in the specified region.

The arithmetic mean phase of the specified region may be expressed as:

$$\frac{1}{n} \sum_{Y_i \in \text{region}} Y_i$$

where Y_i is the unwrapped phase of I/Q pair with applying frequency correction and n is the number of I/Q pairs in the specified region.

The frequency correction is made by the frequency offset calculated by the arithmetic mean of every specified region's frequency offset. Each frequency offset is calculated by the least square method against the unwrapped phase of I/Q pair.

Sample Trace Data - Constant Envelope

(See below for explanation of variables.)

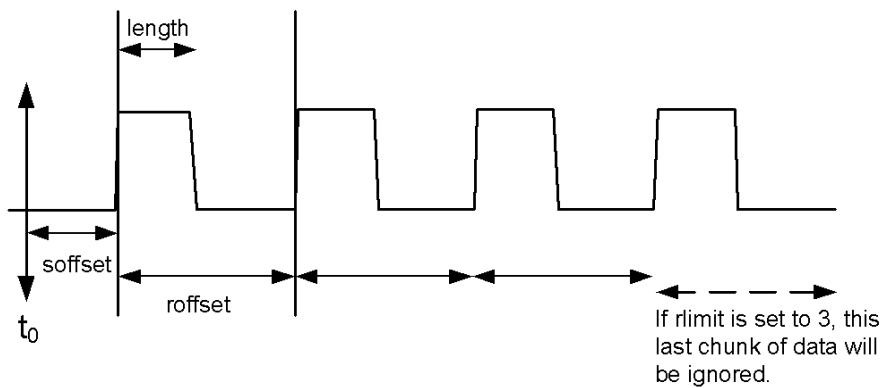

Sample Trace Data - Not Constant Envelope

(See below for explanation of variables.)

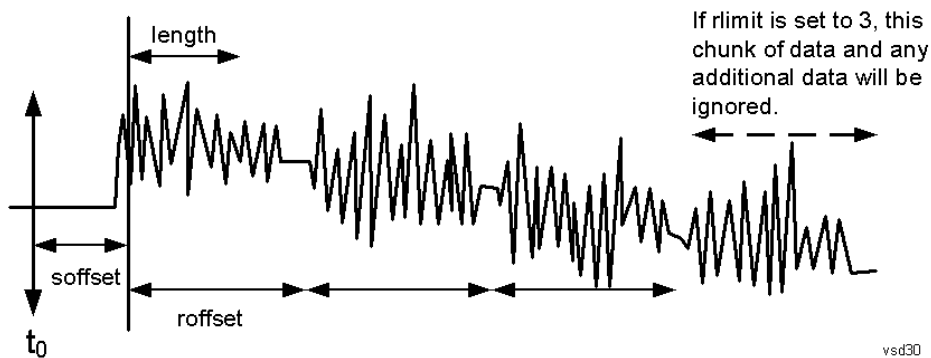

<soffset> - start offset is an optional real number. (It is in seconds for time-domain traces, and is a dimensionless index 0 to Npoints - 1, for frequency-domain traces). It specifies the amount of data at the beginning of the trace that will be ignored before the decimation process starts. It is the time or frequency change from the start of the trace to the point where you want to start using the data. The default value is zero.

<length> - is an optional real number. (It is in seconds for time-domain traces, and is a dimensionless index 0 to Npoints - 1, for frequency-domain traces). It defines how much data will be compressed into one value. This parameter has a default value equal to the current trace length.

<roffset> - repeat offset is an optional real number. (It is in seconds for time-domain traces, and is a dimensionless index 0 to Npoints - 1, for frequency-domain traces). It defines the beginning of the next field of trace elements to be compressed. This is relative to the beginning of the previous field. This parameter has a default value equal to the <length> variable. Note that this parameter is used for a completely different purpose when curve fitting (see CFIT above).

<rlimit> - repeat limit is an optional integer. It specifies the number of data items that you want returned. It will ignore any additional items beyond that number. You can use the Start offset and the Repeat limit to pick out exactly what part of the data you want to use. The default value is all the data.

Calculate Peaks of Trace Data (Remote Command Only)

Returns a list of all the peaks for the currently selected measurement and sub-opcode [n]. The peaks must meet the requirements of the peak threshold and excursion values.

n = any valid sub-opcode for the current measurement. See the MEASure:<measurement> command description of your specific measurement for information on the data that can be returned.

The command can only be used with specific sub-opcodes with measurement results that are trace data. Both real and complex traces can be searched, but complex traces are converted to magnitude in dBm. In many measurements the sub-opcode n=0, is the raw trace data which cannot be searched for peaks. And Sub-opcode n=1, is often calculated results values which also cannot be searched for peaks.

This command uses the data setting specified by the FORMat:BORDER and FORMat:DATA commands and can return real or ASCII data. If the format is set to INT,32, it returns REAL,32 data.

The command has four types of parameters:

- Threshold (in dBm)
- Excursion (in dB)
- Sorting order (amplitude, frequency, time)
- Optional in some measurements: Display line use (all, > display line, < display line)

Remote Command	<p>For Swept SA measurement:</p> <pre>:CALCulate:DATA[1] 2 ... 6:PEAKs? <threshold>,<excursion>[,AMPLitude FREQuency TIME[,ALL GTDLine LTDLine]]</pre> <p>For most other measurements:</p> <pre>:CALCulate:DATA[1] 2 ... 6:PEAKs? <threshold>,<excursion>[,AMPLitude FREQuency TIME]</pre>
-----------------------	--

Example	<p>Example for Swept SA measurement in Spectrum Analyzer Mode:</p> <p>CALC:DATA4:PEAK? -40, 10, FREQ, GTDL This will identify the peaks of trace 4 that are above -40 dBm, with excursions of at least 10 dB. The peaks are returned in order of increasing frequency, starting with the lowest frequency. Only the peaks that are above the display line are returned.</p> <p>Query Results 1:</p> <p>With FORMat:DATA REAL, 32 selected, it returns a list of floating-point numbers. The first value in the list is the number of peak points that are in the following list. A peak point consists of two values: a peak amplitude followed by its corresponding frequency (or time).</p> <p>If no peaks are found the peak list will consist of only the number of peaks, (0).</p>
----------------	---

Notes	<p><n> - is the trace that will be used</p> <p><threshold> - is the level below which trace data peaks are ignored. Note that the threshold value is required and is always used as a peak criterion. To effectively disable the threshold criterion for this command, provide a substantially low threshold value such as -200 dBm. Also note that the threshold value used in this command is independent of and has no effect on the threshold value stored under the Peak Criteria menu.</p> <p><excursion> - is the minimum amplitude variation (rise and fall) required for a signal to be identified as peak. Note that the excursion value is required and is always used as a peak criterion. To effectively disable the excursion criterion for this command, provide the minimum value of 0.0 dB. Also note that the excursion value used in this command is independent of and has no effect on the</p>
--------------	---

excursion value stored under the Peak Criteria menu.

Values must be provided for threshold and excursion. The sorting and display line parameters are optional (defaults are AMPLitude and ALL).

Note that there is always a Y-axis value for the display line, regardless of whether the display line state is on or off. It is the current Y-axis value of the display line which is used by this command to determine whether a peak should be reported

Sorting order:

AMPLitude - lists the peaks in order of descending amplitude, with the highest peak first (default if optional parameter not sent)

FREQUency - lists the peaks in order of occurrence, left to right across the x-axis.

TIME - lists the peaks in order of occurrence, left to right across the x-axis.

Peaks vs. Display Line:

ALL - lists all of the peaks found (default if optional parameter not sent).

GTDLine (greater than display line) - lists all of the peaks found above the display line.

LTDLine (less than display line) - lists all of the peaks found below the display line.

Initial S/W Revision Prior to A.02.00

Format Data: Numeric Data (Remote Command Only)

This command specifies the format of the trace data input and output. It specifies the formats used for trace data during data transfer across any remote port. It affects only the data format for setting and querying trace data for the :TRACe[:DATA], TRACe[:DATA]?, :CALCulate:DATA[n]? and FETCh:SANalyzer [n]? commands and queries.

Remote Command :FORMat[:TRACe][:DATA] ASCii|INTeger,32|REAL,32 |REAL,64
:FORMat[:TRACe][:DATA]?

Notes The query response is:
ASCii: ASC,8
REAL,32: REAL,32
REAL,64: REAL,64
INTeger,32: INT,32

When the numeric data format is REAL or ASCii, data is output in the current Y Axis unit. When the data format is INTeger, data is output in units of m dBm (.001 dBm).

The INT,32 format returns binary 32-bit integer values in internal units (m dBm), in a definite length block.

Dependencies Sending a data format spec with an invalid number (for example, INT,48) generates no error. The analyzer simply uses the default (8 for ASCii, 32 for INTeger, 32 for REAL).

Sending data to the analyzer which does not conform to the current FORMat specified, results in an error. Sending ASCII data when a definite block is expected generates message -161 "Invalid Block Data" and sending a definite block when ASCII data is expected generates message -121 "Invalid Character in Number".

Preset ASCii

Backwards Compatibility Notes Note that the INT,32 format is only applicable to the command, TRACe:DATA. This preserves backwards compatibility for the Swept SA measurement. For all other commands/queries which honor FORMat:DATA, if INT,32 is sent the analyzer will behave as though it were set to REAL,32.

Initial S/W Revision Prior to A.02.00

The specs for each output type follow:

ASCIi - Amplitude values are in ASCII, in the current Y Axis Unit, one ASCII character per digit, values separated by commas, each value in the form:

SX.YYYYYEsZZ

Where:

S = sign (+ or -)

X = one digit to left of decimal point

Y = 5 digits to right of decimal point

E = E, exponent header

s = sign of exponent (+ or -)

ZZ = two digit exponent

REAL,32 - Binary 32-bit real values in the current Y Axis Unit, in a definite length block.

REAL,64 - Binary 64-bit real values in the current Y Axis Unit, in a definite length block.

Format Data: Byte Order (Remote Command Only)

This command selects the binary data byte order for data transfer and other queries. It controls whether binary data is transferred in normal or swapped mode. This command affects only the byte order for setting and querying trace data for the :TRACe[:DATA], TRACe[:DATA]? , :CALCulate:DATA[n]? and FETCh:SANalyzer[n]? commands and queries.

By definition any command that says it uses FORMat:DATA uses any format supported by FORMat:DATA.

The NORMal order is a byte sequence that begins with the most significant byte (MSB) first, and ends with the least significant byte (LSB) last in the sequence: 1|2|3|4. SWAPped order is when the byte sequence begins with the LSB first, and ends with the MSB last in the sequence: 4|3|2|1.

Remote Command	:FORMat:BORDER NORMal SWAPped :FORMat:BORDER?
Preset	NORMal
Initial S/W Revision	Prior to A.02.00

Meas Setup

Displays the setup menu for the current measurement. The measurement setup parameters include the number of measurement averages used to calculate the measurement result and the averaging mode. The setup menu also includes the option to reset the measurement settings to their factory defaults.

Key Path	Front-panel key
Initial S/W Revision	Prior to A.02.00

Avg/Hold Num

Specifies the number of measurement averages used when calculating the measurement result. The average is displayed at the end of each sweep.

After the specified number of average counts, the averaging mode (terminal control) setting determines the averaging action.

Key Path	Meas Setup
Mode	All except SA and BASIC
Remote Command	[:SENSe]:MONitor:AVERage:COUNT <integer> [:SENSe]:MONitor:AVERage:COUNT? [:SENSe]:MONitor:AVERage[:STATe] OFF ON 0 1 [:SENSe]:MONitor:AVERage[:STATe]?
Example	MON:AVER:COUN 25 MON:AVER:COUN? MON:AVER ON MON:AVER?
Preset	10 OFF
State Saved	Saved in instrument state.
Min	1
Max	1000
Initial S/W Revision	Prior to A.02.00

Avg Mode

Toggles the average mode between exponential (Exp) and Repeat.

- **Exp**– continues measurement averaging, using the specified number of averages to compute each averaged value. The average is displayed at the end of each sweep.
- **Repeat**– causes the measurement to reset the average counter each time the specified number of averages is reached.

Key Path	Meas Setup
Mode	All except SA and BASIC
Remote Command	[:SENSe] :MONitor :AVERage :TCONtrol EXPonential REPEAT [:SENSe] :MONitor :AVERage :TCONtrol ?
Example	MON:AVER:TCON EXP MON:AVER:TCON?
Preset	EXPonential
State Saved	Saved in instrument state.
Range	ExpRepeat
Initial S/W Revision	Prior to A.02.00

Meas Preset

Restores all the measurement parameters to their default values.

Key Path	Meas Setup
Mode	All except SA and BASIC
Remote Command	:CONFigure:MONitor
Example	CONF:MON
Initial S/W Revision	Prior to A.02.00

Mode

See "Mode" on page 196

Mode Preset

Returns the active mode to a known state.

Mode Preset does the following for the currently active mode:

- Aborts the currently running measurement.
- Brings up the default menu for the mode, with no active function.
- Sets measurement Global settings to their preset values for the active mode only.
- Activates the default measurement.
- Brings up the default menu for the mode.
- Clears the input and output buffers.
- Sets Status Byte to 0.

Mode Preset does not:

- Cause a mode switch
- Affect mode persistent settings
- Affect system settings

See "[How-To Preset](#)" on page 589 for more information.

Key Path	Front-panel key
Remote Command	:SYSTem:PRESet
Example	:SYST:PRES
Notes	*RST is preferred over :SYST:PRES for remote operation. *RST does a Mode Preset, as done by the :SYST:PRES command, and it sets the measurement mode to Single measurement rather than Continuous for optimal remote control throughput. Clears all pending OPC bits. The Status Byte is set to 0.
Couplings	A Mode Preset aborts the currently running measurement, activates the default measurement, and gets the mode to a consistent state with all of the default couplings set.
Backwards Compatibility Notes	In the X-Series, the legacy "Factory Preset" has been replaced with Mode Preset, which only presets the currently active mode, not the entire instrument. In the X-Series, the way to preset the entire instrument is by using System, Restore System Defaults All, which behaves essentially the same way as restore System Defaults does on ESA and PSA. There is also no "Preset Type" as there is on the PSA. There is a green Mode Preset front-panel key that does a Mode Preset and a white-with-green-letters User Preset front-panel key that does a User Preset. The old PRESet:TYPE command is ignored (without generating an error), and SYST:PRES without a parameter does a Mode Preset, which should cover most backward code compatibility issues. The settings and correction data under the Input/Output front-panel key (examples: Input Z Corr, Ext Amp Gain, etc.) are no longer part of any Mode, so they will not be preset by a Mode Preset. They are preset using Restore Input/Output Defaults, Restore System Defaults All. Note that because User Preset does a Recall State, and all of these settings are saved in State, they ARE recalled when using

	User Preset.
Initial S/W Revision	Prior to A.02.00

How-To Preset

The table below shows all possible presets, their corresponding SCPI commands and front-panel access (key paths). Instrument settings depend on the current measurement context. Some settings are local to the current measurement, some are global (common) across all the measurements in the current mode, and some are global to all the available modes. In a similar way, restoring the settings to their preset state can be done within the different contexts.

Auto Couple - is a measurement local key. It sets all Auto/Man parameter couplings in the measurement to Auto. Any Auto/Man selection that is local to other measurements in the mode will not be affected.

Meas Preset - is a measurement local key. Meas Preset resets all the variables local to the current measurement except the persistent ones.

Mode Preset - resets all the current mode's measurement local and measurement global variables except the persistent ones.

Restore Mode Defaults - resets ALL the Mode variables (and all the Meas global and Meas local variables), including the persistent ones.

Type Of Preset	SCPI Command	Front Panel Access
Auto Couple	:COUPlE ALL	Auto Couple front-panel key
Meas Preset	:CONFIgure:<Measurement>	Meas Setup Menu
Mode Preset	:SYSTem:PRESet	Mode Preset (green key)
Restore Mode Defaults	:INSTrument:DEFault	Mode Setup Menu
Restore All Mode Defaults	:SYSTem:DEFault MODEs	System Menu; Restore System Default Menu
*RST	*RST	not possible (Mode Preset with Single)
Restore Input/Output Defaults	:SYSTem:DEFault INPut	System Menu; Restore System Default Menu
Restore Power On Defaults	:SYSTem:DEFault PON	System Menu; Restore System Default Menu
Restore Alignment Defaults	:SYSTem:DEFault ALIGn	System Menu; Restore System Default Menu
Restore Miscellaneous Defaults	:SYSTem:DEFault MISC	System Menu; Restore System Default Menu
Restore All System Defaults	:SYSTem:DEFault [ALL] :SYSTem:PRESet:PERSistent	System Menu; Restore System Default Menu
User Preset	:SYSTem:PRESet:USER	User Preset Menu
User Preset All Modes	:SYSTem:PRESet:USER:ALL	User Preset Menu

9 Monitor Spectrum Measurement
Mode Preset

Power On Mode Preset	:SYSTem:PON:TYPE MODE	System Menu
Power On User Preset	:SYSTem:PON:TYPE USER	System Menu
Power On Last State	:SYSTem:PON:TYPE LAST	System Menu

Mode Setup

See ["Mode Setup" on page 226](#)

Peak Search

Places the selected marker on the trace point with the maximum y-axis value for that marker's trace. Pressing Peak Search with the selected marker off causes the selected marker to be set to Normal, then a peak search is immediately performed.

Key Path	Front-panel key
Mode	All except SA and BASIC
Remote Command	:CALCulate:MONitor:MARKer[1] 2 ... 12:MAXimum
Example	CALC:MON:MARK2:MAX
Initial S/W Revision	Prior to A.02.00

Print

See "Print" on page 241

Quick Save

The Quick Save front-panel key repeats the most recent save that was performed from the Save menu, with the following exceptions:

- Register saves are not remembered as Saves for the purpose of the Quick Save function
- If the current measurement does not support the last non-register save that was performed, an informational message is generated, “File type not supported for this measurement”

Quick Save repeats the last type of qualified save (that is, a save qualified by the above criteria) in the last save directory by creating a unique filename using the Auto File Naming algorithm described below.

If Quick Save is pressed after startup and before any qualified Save has been performed, the Quick Save function performs a Screen Image save using the current settings for Screen Image saves (current theme, current directory), which then becomes the “last save” for the purpose of subsequent Quick Saves.

The Auto File Naming feature automatically generates a file name for use when saving a file. The filename consists of a prefix and suffix separated by a dot, as is standard for the Windows® file system. A default prefix exists for each of the available file types:

Type	Default Prefix	Menu
State	State_	(Save/Recall)
Trace + State	State_	(Save/Recall)
Screen	Screen_	(Save/Recall)
Amplitude Corrections	Ampcor_	(Import/Export)
Traces	Trace_	(Import/Export)
Limit Lines	LLine_	(Import/Export)
Measurement Result	MeasR_	(Import/Export)
Capture Buffer	CapBuf_	(Import/Export)

A four digit number is appended to the prefix to create a unique file name. The numbering sequence starts at 0000 within each Mode for each file type and updates incrementally to 9999, then wraps to 0000 again. It remembers where it was through a Mode Preset and when leaving and returning to the Mode. It is reset by Restore Misc Defaults and Restore System Defaults and subsequent running of the instrument application. So, for example, the first auto file name generated for State files is State_0000.state. The next is State_0001, and so forth.

One of the key features of Auto File Name is that we guarantee that the Auto File Name will never conflict with an existing file. The algorithm looks for the next available number. If it gets to 9999, then it looks for holes. If it find no holes, that is no more numbers are available, it gives an error.

For example, if when we get to State_0010.state there is already a State_0010.state file in the current directory, it advances the counter to State_0011.state to ensure that no conflict will exist (and then it verifies that State_0011.state also does not exist in the current directory and advances again if it does, and so forth).

If you enter a file name for a given file type, then the prefix becomes the filename you entered instead of the default prefix, followed by an underscore. The last four letters (the suffix) are the 4-digit number.

For example, if you save a measurement results file as “fred.csv”, then the next auto file name chosen for a measurement results save will be fred_0000.csv.

NOTE Although 0000 is used in the example above, the number that is used is actually the current number in the Meas Results sequence, that is, the number that would have been used if you had not entered your own file name.

NOTE If the filename you entered ends with _dddd, where d=any number, making it look just like an auto file name, then the next auto file name picks up where you left off with the suffix being dddd + 1.

Key Path	Front-panel key
Notes	No remote command for this key specifically.
Initial S/W Revision	Prior to A.02.00

Recall

The Recall menu lets you choose what you want to recall, and where you want to recall it from. Among the types of files you can recall are **States and Traces**. In addition, an Import (Data) option lets you recall a number of data types stored in CSV files (as used by Excel and other spreadsheet programs).

The default paths for Recall are data type dependent and are the same as for the Save key.

Key Path	Front-panel key
Notes	<p>No remote command for this key specifically, but the :MMEM:LOAD command is available for specific file types. An example is :MMEM:LOAD:STATe <filename>.</p> <p>If you try to recall a State file for a mode that is not licensed or not available in the instrument, an error message will occur and the state will not change.</p>
Backwards Compatibility Notes	<p>In legacy analyzers, it was possible to load a state without affecting the trace data, limit lines or correction data. Similarly (since User Preset is actually loading a state), it was possible to do a User Preset without affecting the trace data, limit lines or correction data.</p> <p>In the X-Series, “state” always includes all of this data; so whenever state is loaded, all of the traces, limit lines and corrections are affected. Although this differs from previous behavior, it is desirable behavior, and should not cause adverse issues for users.</p>
Backwards Compatibility Notes	<p>Recall for the X-Series supports backward compatibility in the sense that you can recall a state file from any X-Series model number and any version of X-Series software. This is only possible if part of the recalling process goes through a limiting step after recalling the mode settings, at least for settings that may vary with version number, model number, option and license differences. If you try to recall a state file onto an instrument with less capability than what was available on the instrument during the save, the recall will ignore the state it doesn't support and it will limit the recalled setting to what it allows.</p> <p>Example: if the saved state includes preamp ON, but the recalling instrument does not have a preamp; the preamp is limited to OFF. Conversely, if you save a state without a preamp, the preamp is OFF in the state file. When this saved file is recalled on an instrument with a licensed preamp, the preamp is changed to OFF. Another example is if the saved state has center frequency set to 20 GHz, but the instrument recalling the saved state is a different model and only supports 13.5 GHz. In this case, the center frequency is limited along with any other frequency based settings. Since the center frequency can't be preserved in this case, the recall limiting tries to at least preserve span to keep the measurement setup as intact as possible.</p> <p>It may be appropriate to issue a warning if the state is limited on the recall; warnings do not go out to SCPI so this would only affect the manual user.</p> <p>Note that there is no state file compatibility outside of the X-Series. For example, you cannot recall a state file from ESA or PSA.</p>
Initial S/W Revision	Prior to A.02.00

State

The Recall State menu lets you choose a register or file from which to recall the state.

The content of a state file includes all of the settings and data required to return the analyzer as closely as possible to the Mode it was in, with the exact settings that were in place, when the save occurred. The Mode settings in each state file include the settings that are affected by Mode Preset, as well as the

additional settings affected by Restore Mode Defaults; all of the Mode’s settings. In addition, all of the settings of the Input/Output system are included, even though they are outside of the Mode’s state, because they are needed to restore the complete setup. Persistent System settings (for example, GPIB address) are not affected by either a Mode Preset or Restore Mode Defaults, nor are they included in a saved State file.

Since each state file is only for one Mode, the settings for other Modes are unaffected when it is loaded. Recall State will cause a mode switch if the state being recalled is not from the current active mode.

After the recall completes, the message "File <filename> recalled" or “Recalled State Register <register number>” is displayed.

For rapid recalls, the State menu lists 16 registers that you can choose from to recall. Pressing a Register key initiates the recall. You can also select a file from which to recall.

The default path for all State Files is:

My Documents\<<mode name>\state

where <mode name> is the parameter used to select the mode with the INST:SEL command (for example, SA for the Spectrum Analyzer).

See "[More Information](#)" on page 598.

Key Path	Recall
Mode	All
Remote Command	:MMEMory:LOAD:STATe <filename>
Example	:MMEM:LOAD:STAT "myState.state" This recalls the file myState.state on the default path
Example	MMEM:LOAD:STAT "MyStateFile.state" This loads the state file data (on the default file directory path) into the instrument state.
Notes	<p>When you pick a file to recall, the analyzer first verifies that the file is recallable in the current instrument by checking the software version and model number of the instrument. If everything matches, a full recall proceeds by aborting the currently running measurement, clearing any pending operations, and then loading the State from the saved state file. You can open state files from any mode, so recalling a State file switches to the mode that was active when the save occurred. After switching to the mode of the saved state file, mode settings and data (if any for the mode) are loaded with values from the saved file. The saved measurement of the mode becomes the newly active measurement and the data relevant to the measurement (if there is any) is recalled.</p> <p>If there is a mismatch between file version or model number or instrument version or model number, the recall function tries to recall as much as possible and returns a warning message. It may limit settings that differ based on model number, licensing or version number.</p> <p>After recalling the state, the Recall State function does the following:</p> <ul style="list-style-type: none"> • Makes the saved measurement for the mode the active measurement. • Clears the input and output buffers. • Status Byte is set to 0. • Executes a *CLS <p>If the file specified is empty an error is generated. If the specified file does not exist, another error is generated. If there is a mismatch between the file and the proper file type, an error is generated. If</p>

	there is a mismatch between file version or model number or instrument version or model number, a warning is displayed. Then it returns to the State menu and File Open dialog goes away. After the Recall, the analyzer exits the Recall menu and returns to the previous menu.
Backwards Compatibility SCPI	:MMEMory:LOAD:STATe 1,<filename> For backwards compatibility, the above syntax is supported. The "1" is simply ignored.
Initial S/W Revision	Prior to A.02.00

More Information

In measurements that support saving Traces, for example, Swept SA, the Trace data is saved along with the State in the State file. When recalling the State, the Trace data is recalled as well. Traces are recalled exactly as they were stored, including the writing mode and update and display modes. If a Trace was updating and visible when the State was saved, it will come back updating and visible, and its data will be rewritten right away. When you use State to save and recall traces, any trace whose data must be preserved should be placed in View or Blank mode before saving.

The following table describes the Trace Save and Recall possibilities:

You want to recall state and one trace's data, leaving other traces unaffected.	Save Trace+State from 1 trace. Make sure that no other traces are updating (they should all be in View or Blank mode) when the save is performed.	On Recall, specify the trace you want to load the one trace's data into. This trace will load in View. All other traces' data will be unaffected, although their trace mode will be as it was when the state save was performed.
You want to recall all traces	Save Trace+State from ALL traces.	On Recall, all traces will come back in View (or Blank if they were in Blank or Background when saved)
You want all traces to load exactly as they were when saved.	Save State	On recall, all traces' mode and data will be exactly as they were when saved. Any traces that were updating will have their data immediately overwritten.

From File...

When you press "From File", the analyzer brings up a Windows dialog and a menu entitled "File Open." This menu allows you to navigate to the various fields in the Windows dialog without using a keyboard or mouse. The Tab and Arrow keys can also be used for dialog navigation.

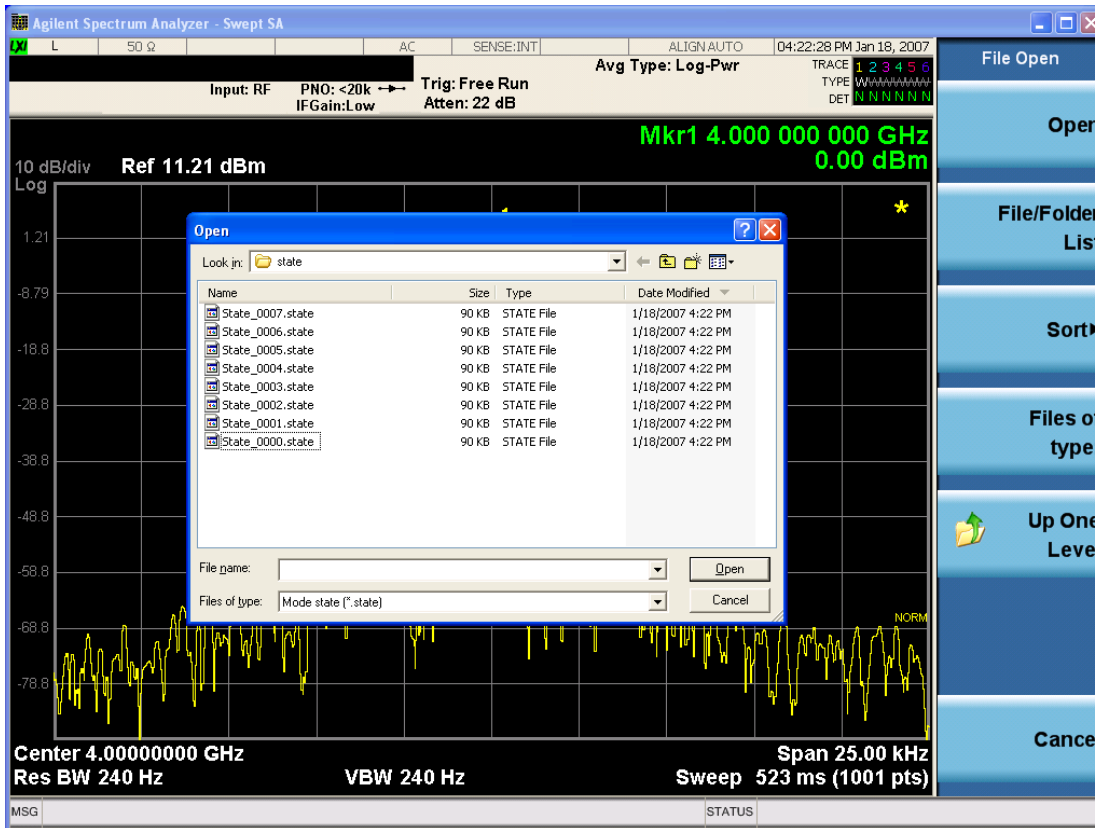

Listed below are the functions of the various fields in the dialog, and the corresponding softkeys:

Open

Performs the recall of the specified file. While the recall is being performed, the floppy icon appears briefly in the Meas bar.

File/Folder List

Enables you to navigate to the center of the dialog that contains the list of files and folders. Once here you can get information about the file and use the tab keys to navigate to the other fields in the dialog, such as Look In.

Look In

The Look In field shows the path from which the file will be recalled and allows you to change the path using the up and down arrow keys to navigate to other paths; the Enter key to open a directory; and the Backspace key to go back one directory. The **Look In field** first uses the last path from the Save As dialog **Save In:** path for that same file type. There is no softkey for directly navigating to the Look In field, but you can use the left tab to get here from the File/Folder List.

User specified paths are remembered when you leave and return to a Mode and are reset back to the default using Restore Mode Defaults.

Sort

Accesses a menu that enables you to sort the files within the File Open dialog. Only one sorting type can be selected at a time and the sorting happens immediately. The sorting types are By Date, By Name, By extension, and By Size.

Files of Type

This field shows the file suffix for the type of file you have selected to recall. For example, if you navigated here while recalling State, "Mode state (*.state)" is in the field. If you navigated here while recalling Trace, ""Mode state (*.trace)" is in the field. If you navigated here while importing a trace data file, "Trace Data (*.csv)" is in the field. For some file types, there is more than one choice in the dropdown menu, which you can select by using the up and down arrow keys and Enter.

Up One Level

This key corresponds to the icon of a folder with the up arrow that is in the tool bar of the dialog. When pressed, it causes the file and folder list to navigate up one level in the directory structure. The Backspace key does the same thing.

Cancel

This key corresponds to the Cancel selection in the dialog. It causes the current **Open** request to be cancelled. The ESC key does the same thing.

Key Path	Recall, State
Notes	Brings up the Open dialog for recalling a State Save Type
Initial S/W Revision	Prior to A.02.00

Edit Register Names

You may enter a custom name on any of the Register keys, to help you remember what you are using that state to save. To do this, press the Edit Register Names key, choose the register whose name you wish to edit, and then enter the desired label using the Alpha Editor or an external PC keyboard.

The maximum number of characters that can be added is 30. In most cases, 30 characters will fit on two lines of the key.

For more information and the SCPI command, see Edit Register Names under the Save, State function.

Key Path	Recall, State
Mode	All
Dependencies	N9060A-7FP or N9060B-2FP license required to edit the register names. When the feature is not licensed, sending the SCPI command generates an error, -221, "Settings conflict;Option not available"
Initial S/W Revision	A.11.00

Register 1 thru Register 16

Selecting any one of these register keys causes the State of the mode from the specified Register to be recalled. Each of the register keys annotates whether it is empty or at what date and time it was last

modified. In addition, you can use the Edit Register Names key under Save, State to enter custom names for each register.

Registers are shared by all modes, so recalling from any one of the registers will cause a mode switch to the mode that was active when the save to the Register occurred.

Although these 16 registers are the only registers available from the front panel, there are 128 state registers available in the instrument. Registers 17–128 are only available from the SCPI interface, using the *RCL command.

After the recall completes, the message "Register <register number> recalled" appears in the message bar. If you are in the Spectrum Analyzer Mode, and you are recalling a register that was saved in the Spectrum Analyzer Mode, then after the recall, you will still be in the Recall Register menu. If the Recall causes you to switch modes, then after the Recall, you will be in the Frequency menu.

If a requested register is empty an error is generated.

Key Path	Recall, State
Example	*RCL 1
Range	1–16 from front panel, 1–128 from SCPI
Readback	Date and time with seconds resolution are displayed on the key OR A custom name of up to 30 characters entered using the Save, State, Edit Register Names key OR “(empty)” if no prior save operation has been performed to this register.
Initial S/W Revision	Prior to A.02.00
Modified at S/W Revision	Prior to A.11.00

Register 1 thru Register 16

Selecting any one of these register keys causes the State of the mode from the specified Register to be recalled. Each of the register keys annotates whether it is empty or at what date and time it was last modified. In addition, you can use the Edit Register Names key under Save, State to enter custom names for each register.

Registers are shared by all modes, so recalling from any one of the registers will cause a mode switch to the mode that was active when the save to the Register occurred.

Although these 16 registers are the only registers available from the front panel, there are 128 state registers available in the instrument. Registers 17–128 are only available from the SCPI interface, using the *RCL command.

After the recall completes, the message "Register <register number> recalled" appears in the message bar. If you are in the Spectrum Analyzer Mode, and you are recalling a register that was saved in the Spectrum Analyzer Mode, then after the recall, you will still be in the Recall Register menu. If the Recall causes you to switch modes, then after the Recall, you will be in the Frequency menu.

If a requested register is empty an error is generated.

Key Path	Recall, State
Example	*RCL 1
Range	1-16 from front panel, 1-128 from SCPI
Readback	Date and time with seconds resolution are displayed on the key OR A custom name of up to 30 characters entered using the Save, State,Edit Register Names key OR “(empty)” if no prior save operation has been performed to this register.
Initial S/W Revision	Prior to A.02.00
Modified at S/W Revision	Prior to A.11.00

Trace

This key selects Trace as the data type to be imported. When pressed a second time, it brings up the Trace Menu, which lets you select the Trace into which the data will be imported.

The trace file contains “meta” data which describes the state of the analyzer when the trace was exported (see Trace File Contents). If the meta data in the file does not match the current SA state, the “invalid data indicator” (*) is displayed.

Key Path	Recall, Data
Remote Command	:MMEMory:LOAD:TRACe:DATA TRACE1 TRACE2 TRACE3 TRACE4 TRACE5 TRACE6,<filename>
Example	:MMEM:LOAD:TRAC DATA TRACE2, "myTrace2.csv" Imports the 2nd trace from the file myTrace2.csv in the current path. The default path is My Documents\SA\data\traces
Dependencies	For SA measurements, a trace cannot be recalled from a trace file that was exported with ALL traces selected. A trace cannot be imported if the number of trace points in the file do not match the number of sweep points currently set for the measurement. If this happens, an error message is generated. Errors are reported if the file is empty or missing, or if the file type does not match, or if there is a mismatch between the file type and the destination data type. If any error occurs while trying to load a file manually (as opposed to during remote operation), the analyzer returns to the Import Data menu and the File Open dialog goes away.
Couplings	When a trace is imported, Trace Update is always turned OFF for that trace and Trace Display is always turned ON.
Readback	Selected Trace
Status Bits/OPC dependencies	Sequential - aborts the current measurement.
Initial S/W Revision	Prior to A.02.00

Import Trace Data

Enables you to import previously saved trace data into a Data Register and optionally display it. Selecting this key displays a menu that enables you to select the destination data register, and also enables you to choose whether or not to display the recalled data in the currently selected trace. After making these selections, select Open... and use the file dialog to select the file you want to recall.

Recalling trace data into an already used Data Register overwrites the previous data. If the data register is displayed on any trace, the display is updated to reflect the new data.

The SCPI command

```
:MMEM:LOAD:TRAC:DATA D1|D2|D3|D4|D5|D6,<filename>
```

recalls data into a specified register, but does not display it in the selected trace. Use the command

```
:DISP:<meas>:TRAC<n>:FEED D1|D2|D3|D4|D5|D6
```

to display the register in the desired trace.

It is possible to recall trace data saved by other VXA measurements, or measurements made using the LTE, LTETDD, iDEN, or 89601 applications.

Key Path	Recall, Data (Import)
Mode	VSA, LTE, LTETDD, IDEN
Remote Command	:MMEMory:LOAD:TRACe:DATA D1 D2 D3 D4 D5 D6,<filename>[,CSV TXT SDF MAT4 MAT HDF5 BIN]
Example	:MMEM:LOAD:TRAC:DATA D1,"Trc1.txt",TXT
Notes	<p>The Open: dialog box has the following filter options when you are recalling trace data::</p> <ul style="list-style-type: none"> • CSV (Comma delimited) (*.csv) • SDF (Fast) (*.sdf;*.dat) • Text (Tab delimited) (*.txt) <p>The file must have the same format as that created by the Export Recorded Data command.</p> <p>The SCPI command has an optional file format parameter. If you do not include this parameter in the SCPI command, the file format is determined by the file name extension. If no file extension is recognized, the file is scanned to determine the format.</p> <p>If you are not licensed to recall a particular file type, then error -203.9010 is returned. If the file format cannot be determined or the file cannot be recalled successfully, then error -250.5290 is returned. If the recall is successful, then advisory 0.1600 is shown.</p>
State Saved	No
Readback	Data 1 Data 2 Data 3 Data 4 Data 5 Data 6

Data 1

Selects the Data 1 register as the destination for the imported data.

Key Path	Recall, Data (Import), Trace (to)
Mode	VSA, LTE, LTETDD, IDEN

Data 2

Selects the Data 2 register as the destination for the imported data.

Key Path	Recall, Data (Import), Trace (to)
Mode	VSA, LTE, LTETDD, IDEN

Data 3

Selects the Data 3 register as the destination for the imported data.

Key Path	Recall, Data (Import), Trace (to)
Mode	VSA, LTE, LTETDD, IDEN

Data 4

Selects the Data 4 register as the destination for the imported data.

Key Path	Recall, Data (Import), Trace (to)
Mode	VSA, LTE, LTETDD, IDEN

Data 5

Selects the Data 5 register as the destination for the imported data..

Key Path	Recall, Data (Import), Trace (to)
Mode	VSA, LTE, LTETDD, IDEN

Data 6

Selects the Data 6 register as the destination for the imported data.

Key Path	Recall, Data (Import), Trace (to)
Mode	VSA, LTE, LTETDD, IDEN

Display in Selected Trace

Enables you to select whether the recalled trace data is displayed in the current Trace.

Key Path	Recall, Data (Import), Trace (to)
----------	-----------------------------------

Mode	VSA, LTE, LTETDD, IDEN
State Saved	No

Open...

When you press “Open”, the analyzer brings up a Windows dialog and a menu entitled “**File Open.**” This menu allows you to navigate to the various fields in the Windows dialog without using a keyboard or mouse. The Tab and Arrow keys can also be used for dialog navigation.

See "[From File...](#)" on page 1200 in Recall, State, for a full description of this dialog and menu.

Key Path	Recall, Data
Notes	The key location is mode-dependent and will vary. Brings up Open dialog for recalling a <mode specific> Save Type
Initial S/W Revision	Prior to A.02.00

Restart

The Restart function restarts the current sweep, or measurement, or set of averaged/held sweeps or measurements. If you are Paused, pressing Restart does a Resume.

The Restart function is accessed in several ways:

- Pressing the Restart key
- Sending the remote command INIT:IMMEDIATE
- Sending the remote command INIT:RESTART

See "[More Information](#)" on page 606

Key Path	Front-panel key
Remote Command	:INITiate[:IMMEDIATE] :INITiate:RESTART
Example	:INIT:IMM :INIT:REST
Notes	:INITiate:RESTART and :INITiate:IMMEDIATE perform exactly the same function.
Couplings	Resets average/hold count k. For the first sweep overwrites all active (update=on) traces with new current data. For application modes, it resets other parameters as required by the measurement.
Status Bits/OPC dependencies	This is an Overlapped command. The STATus:OPERation register bits 0 through 8 are cleared. The STATus:QUESTionable register bit 9 (INTegrity sum) is cleared. The SWEEPING bit is set. The MEASURING bit is set.
Backwards Compatibility Notes	For Spectrum Analysis mode in ESA and PSA, the Restart hardkey and the INITiate:RESTART command restart trace averages (displayed average count reset to 1) for a trace in Clear Write, but did not restart Max Hold and Min Hold. In the X-Series, the Restart hardkey and the INITiate:RESTART command restart not only Trace Average, but MaxHold and MinHold traces as well. For wireless comms modes in ESA and PSA, the Restart hardkey and the INITiate:RESTART command restart every measurement, which includes all traces and numeric results. There is no change to this operation.
Initial S/W Revision	Prior to A.02.00

More Information

The **Restart** function first aborts the current sweep/measurement as quickly as possible. It then resets the sweep and trigger systems, sets up the measurement and initiates a new data measurement sequence with a new data acquisition (sweep) taken once the trigger condition is met.

If the analyzer is in the process of aligning when **Restart** is executed, the alignment finishes before the restart function is performed.

Even when set for Single operation, multiple sweeps may be taken when Restart is pressed (for example, when averaging/holding is on). Thus when we say that **Restart** "restarts a measurement," we may mean:

- It restarts the current sweep
- It restarts the current measurement
- It restarts the current set of sweeps if any trace is in Trace Average, Max Hold or Min Hold
- It restarts the current set of measurements if Averaging, or Max Hold, or Min Hold is on for the measurement
- depending on the current settings.

With **Average/Hold Number** (in **Meas Setup** menu) set to 1, or Averaging off, or no trace in Trace Average or Hold, a single sweep is equivalent to a single measurement. A single sweep is taken after the trigger condition is met; and the analyzer stops sweeping once that sweep has completed. However, with **Average/Hold Number** >1 and at least one trace set to **Trace Average, Max Hold, or Min Hold (SA Measurement)** or **Averaging on (most other measurements)**, multiple sweeps/data acquisitions are taken for a single measurement. The trigger condition must be met prior to each sweep. The sweep is stopped when the average count k equals the number N set for **Average/Hold Number**. A measurement average usually applies to all traces, marker results, and numeric results; but sometimes it only applies to the numeric results.

Once the full set of sweeps has been taken, the analyzer will go to idle state. To take one more sweep without resetting the average count, increment the average count by 1, by pressing the step up key while **Average/Hold Number** is the active function, or sending the remote command `CALC:AVER:TCON UP`.

Save

The Save menu lets you choose what you want to save and where you want to save it. Among the types of files you can save are **States**, **Traces**, and **Screen Images**. In addition, an Export (Data) option lets you save a number of data types as CSV files for easy import into Excel and other spreadsheet programs.

Key Path	Front-panel key
Mode	All
Notes	No remote command for this key specifically, but the :MMEM:STORe command is available for specific file types. An example is :MMEM:STOR:STATe <filename>.
Initial S/W Revision	Prior to A.02.00

State

The Save State menu lets you choose a register or file for saving the state.

The content of a state file includes all of the settings and data required to return the analyzer as closely as possible to the Mode it was in, with the exact settings which were in place, when the save occurred. The Mode settings in each state file include the settings that are affected by Mode Preset, as well as the additional settings affected by Restore Mode Defaults; all of the Mode's settings. In addition, all of the settings of the Input/Output system are included, even though they are outside of the Mode's state, because they are needed to restore the complete setup. Persistent System settings (for example, Verbose SCPI) are not affected by either Mode Preset or Restore Mode Defaults, nor are they included in a saved State file.

After the save completes, the message "File <filename> saved" or "State Register <register number> saved" is displayed.

For rapid saving, the State menu lists 16 registers to save to. Pressing a Register key initiates the save. You can also select a file to save to.

The default path for all State Files is:

My Documents\<<mode name>\state

where <mode name> is the parameter used to select the mode with the INST:SEL command (for example, SA for the Spectrum Analyzer).

Key Path	Save
Mode	All
Remote Command	:MMEMory:STORe:STATe <filename>
Example	MMEM:STOR:STATe "MyStateFile.state" This stores the current instrument state data in the file MyStateFile.state in the default directory.
Notes	Both single and double quotes are supported for any filename parameter over remote. After saving to a register, that register's menu key is updated with the date the time, unless a custom label has been entered for that key. After saving to a register, you remain in the Save State menu, so that you can see the Register key

update. After saving to a file, the analyzer automatically returns to the previous menu and any Save As dialog goes away.

Backwards Compatibility SCPI	:MMEMory:STORe:STATe 1,<filename>
Initial S/W Revision	Prior to A.02.00

To File . . .

When you press “To File”, the analyzer brings up a Windows dialog and a menu entitled “**Save As.**” This menu allows you to navigate to the various fields in the Windows dialog without using a keyboard or mouse. The Tab and Arrow keys can also be used for dialog navigation.

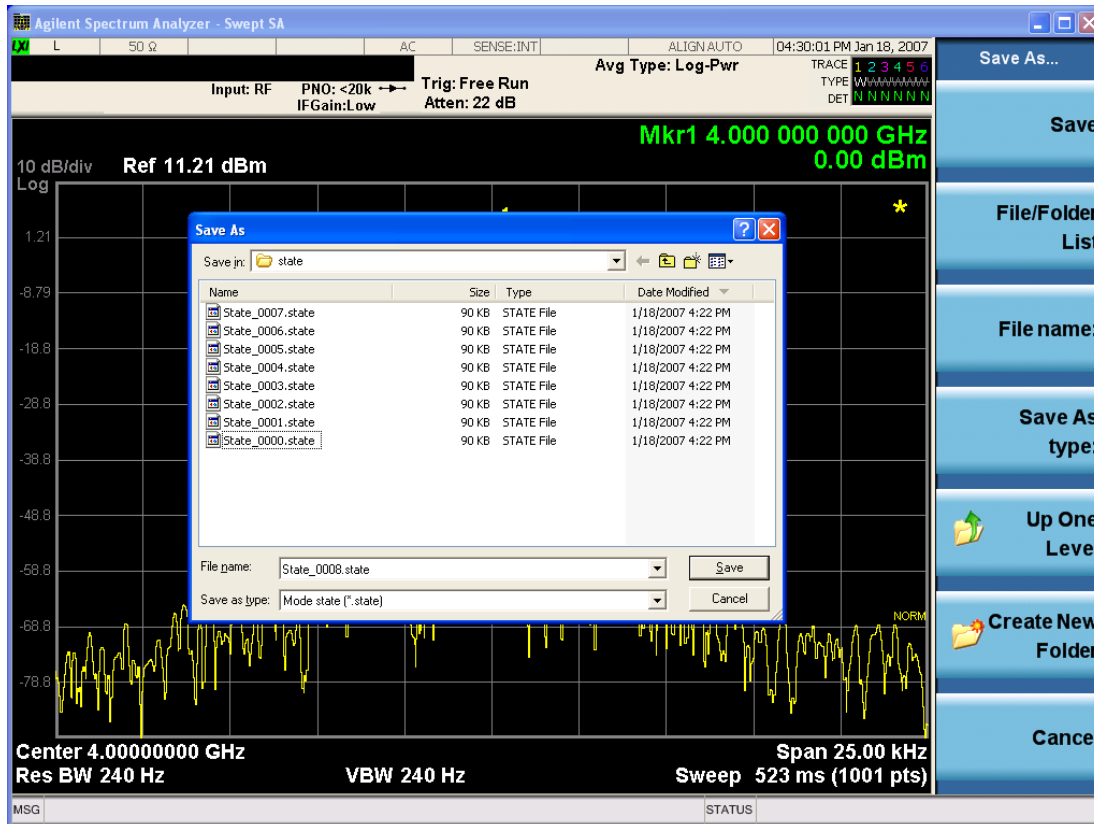

The Listed below

are the functions of the various fields in the dialog, and the corresponding softkeys:

Save

Performs the save to the specified file of the selected type. If the file already exists, a dialog will appear that allows you to replace the existing file by selecting OK, or you can Cancel the request. If you select OK, the file will be overwritten. Using the C: drive is strongly discouraged, since it runs the risk of being overwritten during an instrument software upgrade.

While the save is being performed, the floppy icon appears briefly in the Meas bar.

File/Folder List

Enables you to navigate to the center of the dialog that contains the list of files and folders. Once here you can get information about the file and use the tab keys to navigate to the other fields in the dialog, such as Save In.

Save In

The Save In field shows the path to which the file will be saved and allows you to change the path using the up and down arrow keys to navigate to other paths; the Enter key to open a directory; and the Backspace key to go back one directory. The **Save In field** defaults to the default path for this type of file and remembers the last path you used to save this type of file. There is no softkey for directly navigating to the Save In field but you can use left tab to get here from the File/Folder List.

User specified paths are remembered when you leave and return to a Mode and are reset back to the default using Restore Mode Defaults.

File Name

The File Name field is initially loaded with an automatically generated filename specific to the appropriate Save Type. The automatically generated filename is guaranteed not to conflict with any filename currently in the directory. You may replace or modify this filename using the File Name key. See the ["Quick Save " on page 1196](#) documentation for more on the automatic file naming algorithm.

When you press the File Name key the analyzer displays the Alpha Editor. Use the knob to choose the letter to add and the front-panel Enter key to add the letter to the file name. The BK character moves you back and the FW character moves you forward in the filename. The Select key on the front panel generates a space character. When you are done entering the filename press the Done softkey. This returns back to the **File Open** dialog and menu, but does not cause the save to occur.

Save As Type

This field shows the file suffix for the type of file you have selected to save. For example, if you navigated here while saving State, "Mode state (*.state)" is in the field. If you navigated here from saving Trace, ""Mode state (*.trace)" is in the field. If you navigated here while exporting a trace data file, "Trace Data (*.csv)" is in the field. For some file types, there is more than one choice in the dropdown, which you can select by using the up and down arrow keys and Enter.

Up One Level

This key corresponds to the icon of a folder with the up arrow that is in the tool bar of the dialog. When pressed, it causes the file and folder list to navigate up one level in the directory structure. The Backspace key does the same thing.

Create New Folder

This key corresponds to the icon of a folder with the "*" that is in the tool bar of the dialog. When pressed, a new folder is created in the current directory with the name **New Folder** and you can enter a new folder name using the Alpha Editor.

Cancel

This key corresponds to the Cancel selection in the dialog. It causes the current **Save As** request to be cancelled. The ESC key does the same thing.

Key Path	Save, State
Mode	All
Notes	Brings up Save As dialog for saving a State Save Type
Initial S/W Revision	Prior to A.02.00

Edit Register Names

You may enter a custom name on any of the Register keys, to help you remember what you are using that state to save. To do this, press the Edit Register Names key, choose the register whose name you wish to edit, and then enter the desired label using the Alpha Editor or an external PC keyboard.

The maximum number of characters that can be added is 30. In most cases, 30 characters will fit on two lines of the key.

See "[More Information](#)" on page 611

Key Path	Save, State
Mode	All
Remote Command	:MMEMory:REGister:STATe:LABel <reg number>,"label" :MMEMory:REGister:STATe:LABel? <reg number>
Example	:MMEM:REG:STAT:LAB 1,"my label"
Notes	<reg number> is an integer from 1 to 16. If the SCPI specifies an invalid register number an error message is generated, -222,"Data out of range;Invalid register label number" "label" is a string from 0 to 30 characters in length. If a label exceeds 30 characters, an error message is generated, -150,"String data error;Label clipped to 30 characters" "label" of length 0 erases the custom label and restores the default (time and date) label. E.g.: :MMEM:REG:STAT:LAB 1,""
Dependencies	N9060A-7FP or N9060B-2FP license required to edit the register names. When the feature is not licensed, sending this command generates an error, -221,"Settings conflict;Option not available"
Preset	The names are unaffected by Preset or power cycle but are set to the default label (time and date) on a "Restore System Defaults->Misc"
Initial S/W Revision	A.11.00

More Information

When you edit one of the register names, the time and date field will be replaced by the custom name.

If you delete all the characters in the custom name, it restores the default (time and date).

The register names are stored within the state files, but they are not part of the instrument state; that is, once you have edited a register name, loading a new state will not change that register name. Another consequence of this is that the names will be persistent through a power cycle. Also, if a named state file is transferred to another analyzer, it will bring its custom name along with it.

If you try to edit the name of an empty register, the analyzer will first save the state to have a file to put the name in. If you load a named state file into an analyzer with older firmware it will ignore the metadata.

The *SAV and *RCL commands will not be affected by the custom register names, nor will the MMEM commands.

Register 1 thru Register 16

Selecting any one of these register menu keys causes the State of the currently active mode to be saved to the specified Register. The registers are provided for rapid saving and recalling, since you do not need to specify a filename or navigate to a file. Each of the register menu keys annotates whether it is empty or at what date and time it was last modified. In addition, you can use the Edit Register Names key to enter custom names for each register.

Although these 16 registers are the only registers available from the front panel, there are 128 state registers available in the instrument. Registers 17–128 are only available from the SCPI interface, using the *SAV command.

There is one set of 128 state registers in the instrument, not one set for each Mode. When a state is saved, the Mode it was saved from is saved with it; then when it is recalled, the instrument switches to that Mode.

After the save completes, the corresponding register menu key annotation is updated with the date and time and the message "Register <register number> saved" is displayed.

Key Path	Save, State
Mode	All
Example	*SAV 1
Range	1–16 from front panel, 1–128 from SCPI
Readback	Date and time with seconds resolution are displayed on the key OR A custom name of up to 30 characters entered using the Edit Register Names key OR “(empty)” if no prior save operation has been performed to this register.
Initial S/W Revision	Prior to A.02.00
Modified at S/W Revision	A.11.00

Register 1 thru Register 16

Selecting any one of these register menu keys causes the State of the currently active mode to be saved to the specified Register. The registers are provided for rapid saving and recalling, since you do not need to specify a filename or navigate to a file. Each of the register menu keys annotates whether it is empty or at what date and time it was last modified. In addition, you can use the Edit Register Names key to enter custom names for each register.

Although these 16 registers are the only registers available from the front panel, there are 128 state registers available in the instrument. Registers 17–128 are only available from the SCPI interface, using the *SAV command.

There is one set of 128 state registers in the instrument, not one set for each Mode. When a state is saved, the Mode it was saved from is saved with it; then when it is recalled, the instrument switches to that Mode.

After the save completes, the corresponding register menu key annotation is updated with the date and time and the message "Register <register number> saved" is displayed.

Key Path	Save, State
Mode	All
Example	*SAV 1
Range	1–16 from front panel, 1–128 from SCPI
Readback	Date and time with seconds resolution are displayed on the key OR A custom name of up to 30 characters entered using the Edit Register Names key OR “(empty)” if no prior save operation has been performed to this register.
Initial S/W Revision	Prior to A.02.00
Modified at S/W Revision	A.11.00

Mass Storage Catalog (Remote Command Only)

Key path	SCPI Only
Remote Command	:MMEMory:CATalog? [<directory_name>]
Notes	The string must be a valid logical path. Queries disk usage information (drive capacity, free space available) and obtains a list of files and directories in a specified directory in the following format: <numeric_value>,<numeric_value>,{<file_entry>} It returns two numeric parameters and as many strings as there are files and directories. The first parameter indicates the total amount of storage currently used in bytes. The second parameter indicates the total amount of storage available, also in bytes. The <file_entry> is a string. Each <file_entry> indicates the name, type, and size of one file in the directory list: <file_name>,<file_type>,<file_size> As the windows file system has an extension that indicates file type, <file_type> is always empty. <file_size> provides the size of the file in bytes. For directories, <file_entry> is surrounded by square brackets and both <file_type> and <file_size> are empty
Initial S/W Revision	Prior to A.02.00

Mass Storage Change Directory (Remote Command Only)

Key path	SCPI Only
Remote Command	:MMEMory:CDIRectory [<directory_name>] :MMEMory:CDIRectory?

Notes	<p>The string must be a valid logical path.</p> <p>Changes the default directory for a mass memory file system. The <directory_name> parameter is a string. If no parameter is specified, the directory is set to the *RST value.</p> <p>At *RST, this value is set to the default user data storage area, that is defined as System.Environment.SpecialFolder.Personal.</p> <p>Query returns full path of the default directory.</p>
Initial S/W Revision	Prior to A.02.00

Mass Storage Copy (Remote Command Only)

Key path	SCPI Only
Remote Command	:MMEMory:COpy <string>,<string>[,<string>,<string>]
Notes	<p>The string must be a valid logical path.</p> <p>Copies an existing file to a new file or an existing directory to a new directory.</p> <p>Two forms of parameters are allowed. The first form has two parameters. In this form, the first parameter specifies the source, and the second parameter specifies the destination.</p> <p>The second form has four parameters. In this form, the first and third parameters specify the source. The second and fourth parameters specify the directories. The first pair of parameters specifies the source. The second pair specifies the destination. An error is generated if the source doesn't exist or the destination file already exists.</p> <p>This command will generate an "access denied" error if the destination is a restricted folder (e.g., C:\Windows) and the current user does not have Power User or Administrator privileges.</p>

Mass Storage Device Copy (Remote Command Only)

This command transfers data to/from a file and a peripheral device.

Key path	SCPI Only
Remote Command	:MMEMory:COpy:DEvice <source_string>,<dest_string>
Notes	<p>The strings must be a valid logical path or a valid device keyword. If the dest_string is a device keyword, the data is copied from the source file to the device. If the source_string is a device keyword, the data is copied to the source file from the device.</p> <p>Valid device keywords are:</p> <p>SNS (smart noise source)</p> <p>An error is generated if the file or device is not found.</p>

Mass Storage Delete (Remote Command Only)

Key path	SCPI Only
Remote Command	:MMEMory:DElete <file_name>[,<directory_name>]

Notes	The string must be a valid logical path. Removes a file from the specified directory. The <file_name> parameter specifies the file name to be removed. This command will generate an “access denied” error if the file is in a restricted folder (e.g., C:\Windows) and the current user does not have Power User or Administrator privileges.
Initial S/W Revision	Prior to A.02.00

Mass Storage Data (Remote Command Only)

Creates a file containing the specified data OR queries the data from an existing file.

Key path	SCPI Only
Remote Command	:MMEMory:DATA <file_name>, <data> :MMEMory:DATA? <file_name>
Notes	The string must be a valid logical path. The command form is MMEMory:DATA <file_name>,<data>. It loads <data> into the file <file_name>. <data> is in 488.2 block format. <file_name> is string data. The query form is MMEMory:DATA? <file_name> with the response being the associated <data> in block format.
Initial S/W Revision	Prior to A.02.00

Mass Storage Make Directory (Remote Command Only)

Key path	SCPI Only
Remote Command	:MMEMory:MDIRectory <directory_name>
Notes	The string must be a valid logical path. Creates a new directory. The <directory_name> parameter specifies the name to be created. This command will generate an “access denied” error if the new directory would be in a restricted folder (e.g., C:\Windows) and the current user does not have Power User or Administrator privileges.
Initial S/W Revision	Prior to A.02.00

Mass Storage Move (Remote Command Only)

Key path	SCPI Only
Remote Command	:MMEMory:MOVE <string>,<string>[,<string>,<string>]
Notes	The string must be a valid logical path. Moves an existing file to a new file or an existing directory to a new directory. Two forms of parameters are allowed. The first form has two parameters. In this form, the first parameter specifies the source, and the second parameter specifies the destination. The second form has four parameters. In this form, the first and third parameters specify the source.

	<p>The second and fourth parameters specify the directories. The first pair of parameters specifies the source. The second pair specifies the destination. An error is generated if the source doesn't exist or the destination file already exists.</p> <p>This command will generate an "access denied" error if the destination is a restricted folder (e.g., C:\Windows) and the current user does not have Power User or Administrator privileges.</p>
Initial S/W Revision	Prior to A.02.00

Mass Storage Remove Directory (Remote Command Only)

Key path	SCPI Only
Remote Command	<code>:MMEMory:RDIRECTory <directory_name></code>
Notes	<p>The string must be a valid logical path.</p> <p>Removes a directory. The <directory_name> parameter specifies the directory name to be removed. All files and directories under the specified directory shall also be removed.</p> <p>This command will generate an "access denied" error if the folder is a restricted folder (e.g., C:\Windows) or is in a restricted folder and the current user does not have Power User or Administrator privileges.</p>
Initial S/W Revision	Prior to A.02.00

Data (Export)

Exporting a data file stores data from the current measurement to mass storage files. The Export Menu only contains data types that are supported by the current measurement.

Since the commonly exported data files are in .csv format, the data can be edited by you prior to importing. This allows you to export a data file, manipulate the data in Excel (the most common PC Application for manipulating .csv files) and then import it.

Selecting an Export Data menu key will not actually cause the exporting to occur, since the analyzer still needs to know where you wish to save the data. Pressing the Save As key in this menu brings up the Save As dialog and Save As menu that allows you to specify the destination file and directory. Once a filename has been selected or entered in the Open menu, the export will occur as soon as the Save key is pressed.

Key Path	Save
Mode	All
Notes	<p>The menu is built from whatever data types are available for the mode. So the key locations in the sub menu will vary.</p> <p>No SCPI command directly controls the Data Type that this key controls. The Data Type is included in the MMEM:STORe commands.</p>
Dependencies	If a file type is not used by a certain measurement, that type is grayed out for that measurement. The key for a file type will not show at all if there are no measurements in the Mode that support it.
Preset	Is not affected by a Preset or shutdown, but is reset during Restore Mode Defaults
Readback	The data type that is currently selected
Initial S/W Revision	Prior to A.02.00

Export Trace Data

Enables you to export trace data with (optional) associated headers. Selecting this key displays a menu that enables you to choose which Trace to save (default is the selected Trace) and whether or not to save headers with the data. The header information is used by the VXA application when saved trace data is recalled, and enables it to be displayed with the same formatting and scaling that it had when saved. If headers are not saved, the scaling and format are set to default values when the trace is recalled. After making these selections, press Save As... and use the file dialog to choose a file name and format for the saved data.

Trace data can be exported in several different formats. Text and comma-separated variable (CSV) formats are useful for viewing the data or importing it to a spreadsheet program. The other formats are binary and thus more compact. Trace data files can be recalled for viewing into other VXA, LTE, LTETDD, iDEN, or 89601 measurements.

Key Path	Save, Data (Export)
Mode	VSA, LTE, LTETDD, IDEN
Remote Command	:MMEMory:STORe:TRACe:DATA TRACE1 TRACE2 TRACE3 TRACE4 TRACE5 TRACE6, "<filename>"[,CSV TXT SDF MAT4 MAT HDF5 BIN[,OFF ON 0 1]]
Example	:MMEM:STOR:TRAC:DATA TRACE1, "TRC1.TXT", TXT, ON
Notes	<p>The Save As... dialog box has the following format options when you are saving trace data:</p> <ul style="list-style-type: none"> • CSV (Comma delimited) (*.csv) • SDF (Fast) (*.sdf;*.dat) • Text (Tab delimited) (*.txt) <p>File format saved depends on selection. The appropriate file extension is appended to the filename if it is not supplied by the user.</p> <p>If the SCPI command includes just a file name, the file format is determined by the filename extension, which must be one of the choices above. *.sdf or an unrecognized extension chooses the SDF fast format. If the optional file format enumerator is included in the command, then this determines the file format and the file extension is ignored. The optional binary parameter determines if file headers are saved. The default is ON. If file headers are not wanted, use the optional "OFF" parameter.</p> <p>The optional Boolean parameter determines whether headers are saved in the file. By default the headers are saved.</p> <p>If you are not licensed to save a particular file type, then error -203.9010 is returned. If an invalid file format is specified or the file cannot be saved successfully, then error -25x is returned. If the save is successful, then advisory 0.1500 is shown.</p>
State Saved	No
Readback	(Trace 1 Trace 2 Trace 3 Trace 4 Trace 5 Trace 6)(with without) headers

Trace 1

Selects the Trace 1 register as the destination for the imported data.

Key Path	Save, Data (Export), Trace
Mode	VSA, LTE, LTETDD, IDEN

Trace 2

Selects the Trace 2 register as the destination for the imported data.

Key Path	Save, Data (Export), Trace
Mode	VSA, LTE, LTETDD, IDEN

Trace 3

Selects the Trace 3 register as the destination for the imported data.

Key Path	Save, Data (Export), Trace
Mode	VSA, LTE, LTETDD, IDEN

Trace 4

Selects the Trace 4 register as the destination for the imported data.

Key Path	Save, Data (Export), Trace
Mode	VSA, LTE, LTETDD, IDEN

Trace 5

Selects the Trace 5 register as the destination for the imported data.

Key Path	Save, Data (Export), Trace
Mode	VSA, LTE, LTETDD, IDEN

Trace 6

Selects the Trace 6 register as the destination for the imported data.

Key Path	Save, Data (Export), Trace
Mode	VSA, LTE, LTETDD, IDEN

Include Header

Enables you to select whether or not the saved trace data includes header information describing scaling, formatting, etc.

Key Path	Save, Data (Export), Trace
Mode	VSA, LTE, LTETDD, IDEN
State Saved	No

Save As . . .

When you press “Save As”, the analyzer brings up a Windows dialog and a menu entitled “**Save As.**” This menu allows you to navigate to the various fields in the Windows dialog without using a keyboard or mouse. The Tab and Arrow keys can also be used for dialog navigation.

See ["To File . . ." on page 1211](#) in Save, State for a full description of this dialog and menu.

The default path for saving files is:

For all of the Trace Data Files:

My Documents\<<mode name>\data\traces

For all of the Limit Data Files:

My Documents\<<mode name>\data\limits

For all of the Measurement Results Data Files:

My Documents\<<mode name>\data\<<measurement name>\results

For all of the Capture Buffer Data Files:

My Documents\<<mode name>\data\captureBuffer

Key Path	Save, Data
Mode	All
Notes	The key location is mode-dependent and will vary. Brings up the Save As dialog for saving a <mode specific> Save Type. The save is performed immediately and does not wait until the measurement is complete.
Initial S/W Revision	Prior to A.02.00

Screen Image

Pressing Screen Image accesses a menu of functions that enable you to specify a format and location for the saved screen image. It brings up a menu that allows you to specify the color scheme of the Screen Image (Themes) or navigate to the Save As dialog to perform the actual save.

Screen Image files contain an exact representation of the analyzer display. They cannot be loaded back onto the analyzer, but they can be loaded into your PC for use in many popular applications.

9 Monitor Spectrum Measurement Save

The image to be saved is actually captured when the Save front panel key is pressed, and kept in temporary storage to be used if you ask for a Screen Image save. When the Screen Image key is pressed, a "thumbnail" of the captured image is displayed, as shown below:

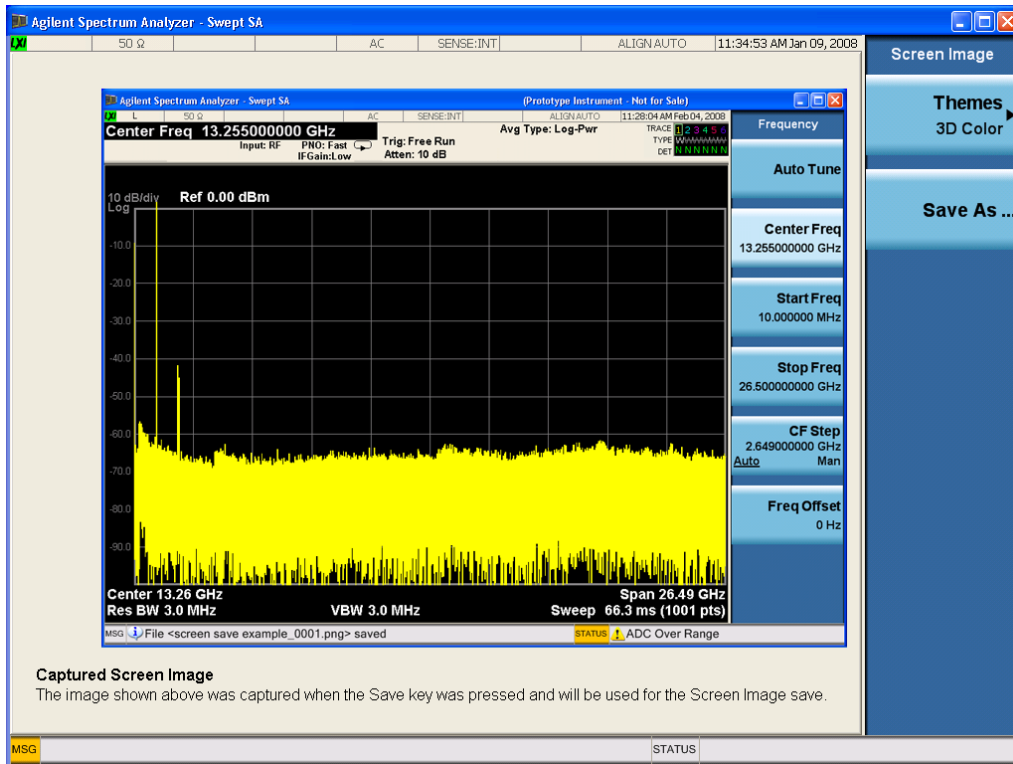

When you continue on into the Save As menu and complete the Screen Image save, the image depicted in the thumbnail is the one that gets saved, showing the menus that were on the screen before going into the Save menus. The save is performed immediately and does not wait until the measurement is complete.

After you have completed the save, the Quick Save front-panel key lets you quickly repeat the last save performed, using an auto-named file, with the current screen data.

NOTE

For versions previous to A.01.55, if you initiate a screen image save by navigating through the Save menus, the image that is saved will contain the Save menu softkeys, not the menus and the active function that were on the screen when you first pressed the Save front panel key.

Key Path	Save
Mode	All
Remote Command	:MMEMory:STORe:SCReen <filename>
Example	:MMEM:STOR:SCR "myScreen.png" This stores the current screen image in the file MyScreenFile.png in the default directory.
Initial S/W Revision	Prior to A.02.00

Themes

Accesses a menu of functions that enable you to choose the theme to be used when saving the screen image.

The **Themes** option is the same as the **Themes** option under the **Display** and **Page Setup** dialogs. It allows you to choose between themes to be used when saving the screen image.

Key Path	Save, Screen Image
Remote Command	:MMEMory:STORe:SCReen:THEMe TDColor TDMonochrome FCOlor FMONochrome :MMEMory:STORe:SCReen:THEMe?
Example	:MMEM:STOR:SCR:THEM TDM
Preset	3D Color; Is not part of Preset, but is reset by Restore Misc Defaults or Restore System Defaults All and survives subsequent running of the modes.
Readback	3D Color 3D Mono Flat Color Flat Mono
Backwards Compatibility Notes	In ESA and PSA we offer the choice of "Reverse Bitmap" or "Reverse Metafile" when saving screen images. This is much like the "Flat Color" theme available in X-Series. Also, if you selected Reverse Bitmap AND a black & white screen image, that would be much like "Flat Monochrome". In other words, each of the X-Series themes has a similar screen image type in ESA/PSA. But they are not identical.
Initial S/W Revision	Prior to A.02.00

3D Color

Selects a standard color theme with each object filled, shaded and colored as designed.

Key Path	Save, Screen Image, Themes
Example	MMEM:STOR:SCR:THEM TDC
Readback	3D Color
Initial S/W Revision	Prior to A.02.00

3D Monochrome

Selects a format that is like 3D color but shades of gray are used instead of colors.

Key Path	Save, Screen Image, Themes
Example	MMEM:STOR:SCR:THEM TDM
Readback	3D Mono
Initial S/W Revision	Prior to A.02.00

Flat Color

Selects a format that is best when the screen is to be printed on an ink printer.

Key Path	Save, Screen Image, Themes
Example	MMEM:STOR:SCR:THEM FCOL
Readback	Flat Color
Initial S/W Revision	Prior to A.02.00

Flat Monochrome

Selects a format that is like Flat Color. But only black is used (no colors, not even gray), and no fill.

Key Path	Save, Screen Image, Themes
Example	MMEM:STOR:SCR:THEM FMON
Readback	Flat Mono
Initial S/W Revision	Prior to A.02.00

Save As...

When you press "Save As", the analyzer brings up a Windows dialog and a menu entitled "**Save As.**" This menu allows you to navigate to the various fields in the Windows dialog without using a keyboard or mouse. The Tab and Arrow keys can also be used for dialog navigation.

See "[To File . . .](#)" on page 1211 in Save, State for a full description of this dialog and menu.

The default path for Screen Images is

My Documents\`<mode name>`\screen.

where `<mode name>` is the parameter used to select the mode with the INST:SEL command (for example, SA for the Spectrum Analyzer).

Key Path	Save, Screen Image
Notes	Brings up Save As dialog for saving a Screen Image Save Type
Initial S/W Revision	Prior to A.02.00

Single (Single Measurement/Sweep)

Sets the analyzer for Single measurement operation. The single/continuous state is Meas Global, so the setting will affect all the measurements. If you are Paused, pressing Single does a Resume.

See "[More Information](#)" on page 623

Key Path	Front-panel key
Example	:INIT:CONT OFF
Notes	See Cont key description.
Backwards Compatibility Notes	<p>For Spectrum Analysis mode in ESA and PSA, the Single hardkey and the INITiate:IMM switched from continuous measurement to single measurement and restarted sweeps and averages (displayed average count reset to 1), but did not restart Max Hold and Min Hold. In the X-Series, the Single hardkey and the INITiate:IMM command initiate a sweep/ measurement/ average sequence/hold sequence including MaxHold and MinHold.</p> <p>For Spectrum Analysis mode in ESA and PSA, the Single hardkey restarted the sweep regardless of whether or not you were in an active sweep or sweep sequence. In the X-Series, Restart does this but Single only restarts the sweep or sweep sequence if you are in the idle state.</p> <p>INIT[:IMM] in ESA & PSA Spectrum Analysis Mode does an implied ABORT. In some other PSA Modes, INIT[:IMM] is ignored if not in the idle state. . The X-Series follows the ESA/PSA SA Mode model, which may cause some Modes to have compatibility problems.</p>
Initial S/W Revision	Prior to A.02.00

More Information

See "[Restart](#)" on page 1208 for details on the INIT:IMMEDIATE (Restart) function.

If you are already in single sweep, the INIT:CONT OFF command has no effect.

If you are already in Single Sweep, then pressing the Single key in the middle of a sweep does not restart the sweep or sequence. Similarly, pressing the Single key does not restart the sweep or sequence if the sweep is not in the idle state (for example, if you are taking a very slow sweep, or the analyzer is waiting for a trigger). Instead, it results in a message. "Already in Single, press Restart to initiate a new sweep or sequence". Even though pressing the Single key in the middle of a sweep does not restart the sweep, sending INIT:IMMEDIATE does reset it.

To take one more sweep without resetting the average count, increment the average count by 1, by pressing the step up key while **Average/Hold Number** is the active function, or sending the remote command CALC:AVER:TCON UP.

Source

There is no Source control functionality for this measurement. When this key is pressed, the screen either displays a blank menu, or the previously-selected menu remains unchanged.

Key Path	Front-panel key
----------	-----------------

Span X Scale

Accesses a menu of functions that enable you to set the horizontal scale parameters.

Key Path	Front-panel key
Initial S/W Revision	Prior to A.02.00

Span

Changes the frequency range symmetrically about the center frequency.

For details of WiDEN preset values, see ["IDEN Mode Span Preset for Monitor Spectrum" on page 626](#).

Key Path	Span X Scale
Mode	All except SA, BASIC
Remote Command	[:SENSe] :MONitor:FREQuency:SPAN <freq> [:SENSe] :MONitor:FREQuency:SPAN?
Example	MON:FREQ:SPAN 1 MHz MON:FREQ:SPAN?
Couplings	Changing the span causes the resolution bandwidth to change automatically, and affects data acquisition time.
Preset	WCDMA: 10.0 MHz WIMAX OFDMA: 50.0 MHz C2K: 2.5MHz PN: 1.0 MHz GSM/EDGE: 1.0 MHz TD-SCDMA: 3.2 MHz 1xEVDO: 2.0MHz DVB-T/H: 10.0MHz DTMB (CTTB): 10.0MHz ISDB-T: 10.0MHz CMMB: 10.0MHz LTE: 50 MHz LTETDD: 50 MHz IDEN: See the table below Digital Cable TV: 10.0MHz WLAN: If Radio Std is 802.11a/b/g 802.11n(20MHz) 802.11ac(20MHz): 25 MHz If Radio Std is 802.11n(40MHz), 802.11 ac (40MHz): 50 MHz If Radio Std is 802.11ac(80MHz): 100MHz If Radio Std is 802.11ac(160MHz): 200MHz

	MSR: 20.0 MHz LTEAFDD, LTEATDD: 20.0MHz
State Saved	Saved in instrument state.
Min	10 Hz
Max	Hardware Dependent: Option 503 = 3.7 GHz Option 507 = 7.1GHz Option 508 = 8.5 GHz Option 513 = 13.8 GHz Option 526 = 27.0 GHz
Initial S/W Revision	Prior to A.02.00
Modified at S/W Revision	A.02.00
Modified at S/W Revision	A.03.00

IDEN Mode Span Preset for Monitor Spectrum

iDEN Slot Format	WiDEN Slot Format 25kHz	WiDEN Slot Format 50kHz	WiDEN Slot Format 75kHz	WiDEN Slot Format 100kHz	WiDEN Slot Format 50kHz Out
60kHz	60kHz	85kHz	110kHz	135kHz	135kHz

Full Span

Changes the Span to show the full frequency range of the analyzer.

Key Path	Span X Scale
Mode	All except SA and BASIC
Remote Command	[:SENSe] :MONitor:FREQuency:SPAN:FULL
Example	MON:FREQ:SPAN:FULL
Couplings	Sets the span to the full frequency range, and adjusts the center frequency accordingly.
Initial S/W Revision	Prior to A.02.00

Last Span

Changes the measurement span to the span setting of the previous measurement. If there is no existing previous span value, then the span remains unchanged.

Key Path	Span X Scale
----------	--------------

Mode	All except SA and BASIC
Remote Command	<code>[:SENSe] :MONitor :FREQuency :SPAN :PREVious</code>
Example	MON:FREQ:SPAN:PREV
Couplings	Selecting last span changes the measurement span value.
Initial S/W Revision	Prior to A.02.00

Sweep/Control

Access a menu of functions that enable you to set up and control the sweep time for the current measurement

Key Path	Front-panel key
Initial S/W Revision	Prior to A.02.00

Sweep Time

Selects the length of time in which the spectrum analyzer sweeps the displayed frequency span. Additional overhead time is required by the analyzer. It impacts the sweep rate, but is not calculated as part of the sweep time. Reducing the sweep time increases the rate of sweeps.

Key Path	Sweep/Control
Mode	All except SA and BASIC
Remote Command	[:SENSe]:MONitor:SWEep:TIME <time> [:SENSe]:MONitor:SWEep:TIME? [:SENSe]:MONitor:SWEep:TIME:AUTO OFF ON 0 1 [:SENSe]:MONitor:SWEep:TIME:AUTO?
Example	MON:SWE:TIME 100 ms MON:SWE:TIME? MON:SWE:TIME:AUTO ON MON:SWE:TIME:AUTO?
Preset	Automatically Calculated
State Saved	Saved in instrument state.
Min	1 ms
Max	4000 s
Initial S/W Revision	Prior to A.02.00
MIN/MAX/DEF Support	Yes

Pause

Pauses a measurement after the current data acquisition is complete.

When Paused, the label on the key changes to Resume. Pressing Resume continues the measurement at the point where it had been paused.

See Pause/Resume under Sweep/Control for more information.

Key Path	Sweep/Control
Initial S/W Revision	Prior to A.02.00

Gate

Accesses a menu that enables you to control the gating function. The Gate functionality is used to view signals best viewed by qualifying them with other events.

Gate setup parameters are the same for all measurements – they do not change as you change measurements. Settings like these are called “Meas Global” and are unaffected by Meas Preset.

Note that Sweep Time autocoupling rules and annotation are changed by Gate being on.

Key Path	Sweep/Control
Scope	Meas Global
Readback	The state and method of Gate, as [Off, LO] or [On, Video]. Note that for measurements that only support gated LO, the method is nonetheless read back, but always as LO.
Initial S/W Revision	Prior to A.02.00

Gate On/Off

Turns the gate function on and off.

When the Gate Function is on, the selected Gate Method is used along with the gate settings and the signal at the gate source to control the sweep and video system with the gate signal. Not all measurements allow every type of Gate Methods.

When Gate is on, the annunciation in the measurement bar reflects that it is on and what method is used, as seen in the following "Gate: LO" annunciator graphic.

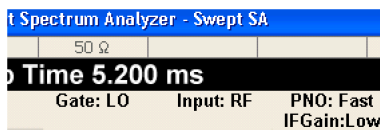

Key Path	Sweep/Control, Gate
Remote Command	[:SENSe] :SWEep:EGATe [:STATe] OFF ON 0 1 [:SENSe] :SWEep:EGATe [:STATe] ?
Example	SWE:EGAT ON SWE:EGAT?
Dependencies	The function is unavailable (grayed out) and Off when:

- Gate Method is LO or Video and FFT Sweep Type is manually selected.
- Gate Method is FFT and Swept Sweep Type is manually selected.
- Marker Count is ON.

The following are unavailable whenever Gate is on:

- FFT under Sweep Type when Method=LO or Video or Swept under Sweep Type when Method=FFT
- Marker Count

While Gate is on, the Auto Rules for Sweep Type are modified so that the choice agrees with the Gate Method: i.e., FFT for Method = FFT and Swept for Method = LO or Video.

The Gate softkey and all SCPI under the [:SENSe]:SWEep:EGATe SCPI node are grayed out when Source Mode is Tracking with an external source. This is because the Gate circuitry is used to sync the external source. If the Tracking Source is turned on, the Gate is turned off.

When in the ACP measurement:

- When Meas Method is RBW or FAST, this function is unavailable and the key is grayed out.
- Whenever Gate is on, Meas Method, RBW or FAST is unavailable and keys for those are grayed out.
- When Gate is on, Offset Res BW and Offset Video BW are ignored (if you set these values) and the measurement works as if all Offset Res BW and all Offset Video BW are coupled with the Res BW and the Video BW under the BW menu. When Gate is on, the Offset BW key in the Offset/Limit menu is grayed out.

Preset	Off LTETDD: On
State Saved	Saved in instrument state
Range	On Off
Backwards Compatibility SCPI	[:SENSe]:SWEep:TIME:GATE[:STATe] ESA compatibility
Backwards Compatibility Notes	In ESA, Trig Delay (On) and Gate (On) could not be active at the same time.. This dependency does not exist in PSA or in the X-Series.
Initial S/W Revision	Prior to A.02.00

Gate View On/Off

Turning on Gate View in the Swept SA measurement provides a single-window gate view display..

Turning on Gate View in other measurements shows the split-screen Gate View. In these measurements, when the Gate View is on, the regular view of the current measurement traces and results are reduced vertically to about 70% of the regular height. The Zero Span window, showing the positions of the Gate, is shown between the Measurement Bar and the reduced measurement window. By reducing the height of the measurement window, some of the annotation on the Data Display may not fit and is not shown.

Key Path	Sweep/Control, Gate
Remote Command	[:SENSe]:SWEep:EGATe:VIEW ON OFF 1 0 [:SENSe]:SWEep:EGATe:VIEW?

Example	SWE:EGAT:VIEW ON turns on the gate view.
Dependencies	<p>In the Swept SA measurement:</p> <p>In Gate View, the regular Sweep Time key is grayed out . When pressed, the grayed out key puts up the informational message "Use Gate View Sweep Time in the Gate menu."</p> <p>In the other measurements:</p> <p>When you turn Gate View on, the lower window takes on the current state of the instrument. Upon leaving Gate View, the instrument takes on the state of the lower window.</p> <p>When you turn Gate View on, the upper window Sweep Time is set to the gate view sweep time.</p>
Couplings	<p>These couplings apply to the Swept SA measurement:</p> <ul style="list-style-type: none"> • When Gate View is turned on, the instrument is set to Zero Span. • Gate View automatically turns off whenever a Span other than Zero is selected. • Gate View automatically turns off if you press the Last Span key while in Gate View, and the instrument returns to the Span it was in before entering Gate View (even if that is Zero Span). • When Gate View is turned on, the sweep time used is the gate view sweep time. This is set according to the rules in section "Gate View Setup" on page 633 • When Gate View is turned off, Sweep Time is set to the normal Swept SA measurement sweep time. • If Gate View is on and Gate is off, then turning on Gate turns off Gate View.
Preset	OFF
State Saved	Saved in instrument state
Range	On Off
Initial S/W Revision	Prior to A.02.00

A sample of the Gate View screen in the Swept SA measurement is shown in the following graphic :

9 Monitor Spectrum Measurement Sweep/Control

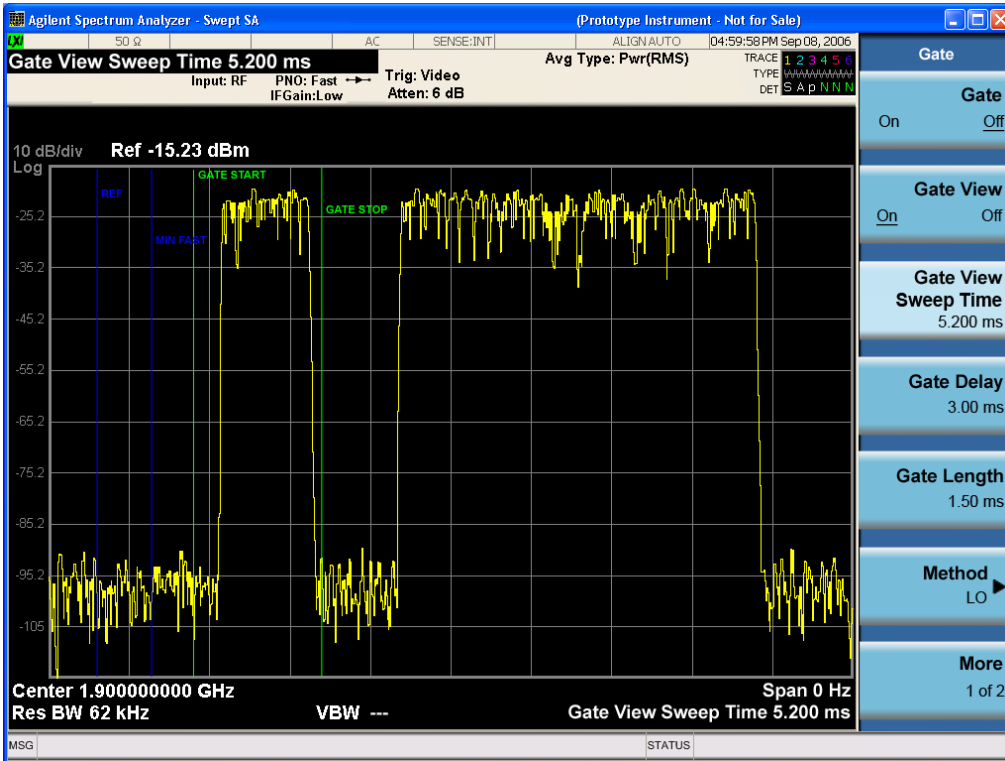

A sample of the Gate View screen in other measurements is shown in the following graphic. This example is for the ACP measurement:

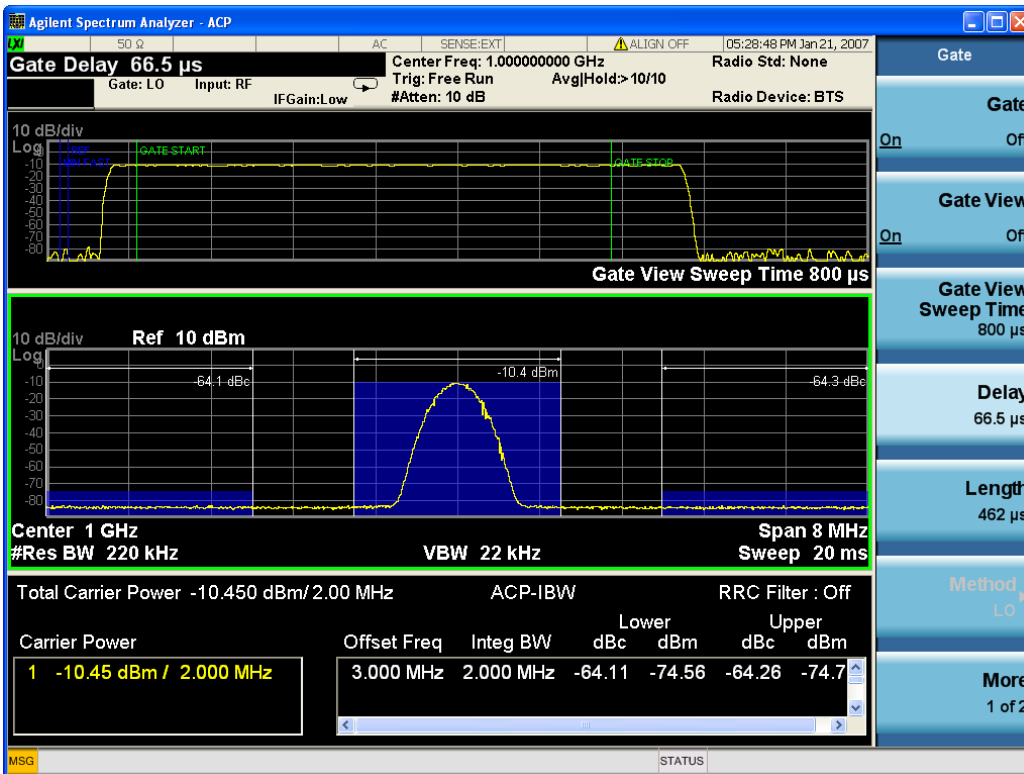

Turning Gate View off returns the analyzer to the Normal measurement view.

In the Swept SA, the normal measurement view is the single-window Swept SA view. When returning to this view, the Swept SA measurement returns to the Span it was in before entering **Gate View** (even if that is Zero Span).

The **Gate View** window is triggered from the Gate Source, with zero trigger delay. Also, when updating the **Gate View** window, the Gate itself must not operate. So it is internally shut off while the gate view window is being updated. For the Swept SA measurement, this means that the Gate is internally shut off whenever the gate view window is displayed. The measurement bar and softkeys continue to show the Trigger source for the main sweep window and give no indication that the Gate is shut off or that the Gate View window is triggered from the Gate Source.

When in **Gate View**, vertical lines are displayed in the Gate View window as follows:

- Green lines are displayed at the gate edges as follows: in Edge Gate, a line is shown for Delay and one for the end of the Gate period, defined by Length. In Level Gate a line is shown only for Delay. You can adjust the position of the green lines by adjusting the gate length and the gate delay. These lines update in the Gate View window as the active function changes, even if the window is not being updated. In Gated LO and Gated Video, these lines are positioned relative to the delay reference line (not relative to 0 time). In Gated FFT, their location is relative to the left edge of the screen.
- A blue line is displayed showing the delay reference, that is, the reference point for the Gate Delay within the Zero Span window. The blue line represents where (in time) the effective location of the gate start would be if the gate were programmed to zero delay.
-
- The second blue line is labeled "MIN FAST" as shown in the figure above because it represents the minimum Gate Delay for fast Gated LO operation. This line is only displayed in Gated LO. You cannot scroll (knob) or decrement (down key) the Gate Delay to less than that represented by the position of this line, it can only be set below this position manually, although once there it can be moved freely with the knob while below the line.
- A yellow line in the Gated Video case only, is displayed at Blength, where Blength is the display point (bucket) length for the swept trace, which is given by the sweep time for that trace divided by number of Points – 1. So it is referenced to 0 time, not to the delay reference. This line is labeled NEXT PT (it is not shown in the figure above because the figure above is for Gated LO).
- The yellow line represents the edge of a display point (bucket). Normally in Gated Video, the bucket length must be selected so that it exceeds the off time of the burst. There is another way to use the analyzer in Gated Video measurements, and that is to set the bucket width much shorter than the off time of the burst. Then use the Max Hold trace function to fill in "missing" buckets more slowly. This allows you to see some of the patterns of the Gated Video results earlier, though seeing a completely filled-in spectrum later.

Gate View Setup

Accesses a menu that enables you to setup parameters relevant to the Gate View

Key Path	Sweep/Control, Gate
Scope	Meas Global
Initial S/W Revision	A.10.00

Gate View Sweep Time

Controls the sweep time in the Gate View window. To provide an optimal view of the gate signal, the analyzer initializes Gate View Sweep Time based on the current settings of Gate Delay and Gate Length.

Key Path	Sweep/Control, Gate, Gate View Setup
Remote Command	[:SENSe] :SWEep:EGATe:TIME <time> [:SENSe] :SWEep:EGATe:TIME?
Example	SWE:EGAT:TIME 500 ms
Dependencies	Gate View Sweep Time is initialized: <ul style="list-style-type: none"> • On Preset (after initializing delay and length). • Every time the Gate Method is set/changed. <p>Additionally, in the Swept SA measurement, whenever you do a Preset, or leave Gate View, the analyzer remembers the Gate Delay and Gate Length settings. Then, when returning to Gate View, if the current Gate Delay and/or Gate Length do not match the remembered values Gate View Sweep Time is re-initialized.</p> <ol style="list-style-type: none"> 1. Compute the location of the "gate stop" line, which you know is at time $t = t_{min} + \text{GateDelay} + \text{GateLength}$.
Preset	519.3 μ s WiMAX OFDMA: 5 ms GSM/EDGE: 1 ms
State Saved	Saved in instrument state
Max	6000 s
Initial S/W Revision	Prior to A.02.00

Gate View Start Time

Controls the time at the left edge of the Gate View.

Key Path	Sweep/Control, Gate, Gate View Setup
Remote Command	[:SENSe] :SWEep:EGATe:VIEW:START <time> [:SENSe] :SWEep:EGATe:VIEW:START?
Example	SWE:EGAT:VIEW:STAR 10ms
Notes	Units of time are required or no units; otherwise an invalid suffix error message will be generated. See error -131.
Preset	0 ms
State Saved	Saved in instrument state
Min	0
Max	500 ms
Initial S/W Revision	A.10.00

Gate Delay

Controls the length of time from the time the gate condition goes True until the gate is turned on.

Key Path	Sweep/Control, Gate
Remote Command	[:SENSe] :SWEep:EGATe:DELay <time> [:SENSe] :SWEep:EGATe:DELay?
Example	SWE:EGAT:DELay 500ms SWE:EGAT:DELay?
Notes	Units of time are required or no units; otherwise an invalid suffix error message will be generated.
Preset	57.7 us WiMAX OFDMA: 71 us GSM/EDGE: 600 us WLAN: 500 us
State Saved	Saved in instrument state
Min	0.0 us
Max	100 s
Backwards Compatibility SCPI	[:SENSe] :SWEep:TIME:GATE:DELay ESA compatibility
Initial S/W Revision	Prior to A.02.00

Gate Length

Controls the length of time that the gate is on after it opens.

Key Path	Sweep/Control, Gate
Remote Command	[:SENSe] :SWEep:EGATe:LENGth <time> [:SENSe] :SWEep:EGATe:LENGth?
Example	SWE:EGAT:LENG 1 SWE:EGAT:LENG?
Notes	Units of time are required or no units; otherwise an invalid suffix error message will be generated.
Dependencies	<p>Grayed out when Gate Method is set to FFT in which case the label changes to that shown below.</p>  <p>The key is also grayed out if Gate Control = Level.</p>
Preset	461.6 us

	WiMAX OFDMA: 50 us GSM/EDGE: 200 us WLAN: 1.54 ms
State Saved	Saved in instrument state
Min	100 ns
Max	5 s
Backwards Compatibility SCPI	[:SENSe]:SWEep:TIME:GATE:LENGth ESA compatibility
Initial S/W Revision	Prior to A.02.00

Gate Source

The menus under the Gate Source key are the same as those under the Trigger key, with the exception that neither Free Run nor Video are available as Gate Source selections. However, a different SCPI command is used to select the Gate Source (see table below) because you may independently set the Gate Source and the Trigger Source.

Any changes to the settings in the setup menus under each Gate Source selection key (for example: Trigger Level, Trigger Delay, etc.) also affect the corresponding settings under the Trigger menu keys. The SCPI commands used for these are the same for Trigger and Gate, since there is only one setting which affects both Gate and Trigger. Example: to set the Trigger Level for External 1 you use the command :TRIG:EXT1:LEV regardless of whether you are using External 1 as a Trigger Source or a Gate Source.

Key Path	Sweep/Control, Gate
Remote Command	[:SENSe]:SWEep:EGATE:SOURce EXTernal1 EXTernal2 LINE FRAME RFBurst [:SENSe]:SWEep:EGATE:SOURce?
Dependencies	In some models, there is no second External input. In these models, the External 2 key is blanked and the EXTernal2 parameter will generate a "Hardware missing; Not available for this model number" error.
Preset	EXTernal 1 GSM/EDGE, MSR: FRAME LTETDD: EXTernal 1When Direction is Downlink, FRAME when Direction is Uplink.
Backwards Compatibility Notes	In ESA, there is a single Gate input port. In PSA, the Gate Source may be taken from one of two specified input ports. In the X-Series, any Trigger Source can be a Gate Source.
Initial S/W Revision	Prior to A.02.00
Modified at S/W Revision	A.03.00, A.14.00

External 1

Pressing this key, when it is not selected, selects an external input signal as the trigger. A new sweep/measurement will start when the external trigger condition is met using the external 1 input connector on the rear panel.

Pressing this key, when it is already selected, accesses the external 1 trigger setup menu.

Key Path	Trigger
Example	TRIG:SOUR EXT1 Swept SA measurement TRIG:<meas>:SOUR EXT1 Measurements other than Swept SA
Dependencies	Grayed out if in use by Point Trigger in the Source Setup menu. Forced to Free Run if already selected and Point Trigger is set to External 1.
State Saved	Saved in instrument state
Status Bits/OPC dependencies	The Status Operation Register bit 5 "Waiting for Trigger" is set at the same time as the Sweeping or Measuring bit is set. It is cleared when the trigger actually occurs (that is, after the trigger event occurs and all the applicable trigger criteria have been met). A corresponding pop-up message ("Waiting for trigger") is generated if no trigger signal appears after approximately 2 sec. This message goes away when a trigger signal appears.
Initial S/W Revision	Prior to A.02.00

Trigger Level

Sets the value where the external 1 trigger input will trigger a new sweep/measurement.

Key Path	Trigger, External 1
Remote Command	:TRIGger[:SEquence]:EXTernal1:LEVel <level> :TRIGger[:SEquence]:EXTernal1:LEVel?
Example	TRIG:EXT1:LEV 0.4 V
Couplings	This same level is used for the Ext1 trigger source in the Trigger menu, for the Ext1 selection in the Periodic Timer sync source (in the Trigger menu and in the Gate Source menu), and also for the Ext1 selection in the Gate Source menu.
Preset	1.2 V
State Saved	Saved in instrument state
Min	-5 V
Max	5 V
Default Unit	V
Backwards Compatibility SCPI	:TRIGger[:SEquence]:EXTernal:LEVel For backward compatibility, the parameter EXTernal is mapped to EXTernal1
Backwards Compatibility SCPI	:TRIGger[:SEquence]:FRAME:EXTernal1:LEVel
Initial S/W Revision	Prior to A.02.00

Trig Slope

Controls the trigger polarity. It is set positive to trigger on a rising edge and negative to trigger on a falling edge.

Key Path	Trigger, External 1
Remote Command	:TRIGger[:SEquence]:EXTernal1:SLOPe POSitive NEGative :TRIGger[:SEquence]:EXTernal1:SLOPe?
Example	TRIG:EXT1:SLOP NEG
Couplings	This same slope is used in the Ext1 selection for the trigger source in the Trigger menu and for the period timer sync source (in the Trigger menu and in the Gate Source menu).
Preset	POSitive
State Saved	Saved in instrument state
Backwards Compatibility SCPI	:TRIGger[:SEquence]:EXTernal:SLOPe For backward compatibility, the parameter EXTernal is mapped to EXTernal1
Backwards Compatibility SCPI	:TRIGger[:SEquence]:FRAME:EXTernal1:SLOPe
Backwards Compatibility Notes	The legacy :TRIGger[:SEquence]:SLOPe command affects the slopes for the VID, LINE, EXT1, EXT2, and RFB triggers.
Initial S/W Revision	Prior to A.02.00

External 2

Pressing this key, when it is not selected, selects an external input signal as the trigger. A new sweep/measurement will start when the external trigger condition is met using the external 2 input connector. The external trigger 2 input connector is on the rear panel.

Pressing this key, when it is already selected, accesses the external 2 trigger setup menu.

Key Path	Trigger
Example	TRIG:SOUR EXT2 Swept SA measurement TRIG:<meas>:SOUR EXT2 Measurements other than Swept SA
Dependencies	In some models, there is no second External input. In these models, the External 2 key is blanked and the EXTernal2 parameter will generate a "Hardware missing; Not available for this model number" message. Grayed out if in use by Point Trigger in the Source Setup menu. Forced to Free Run if already selected and Point Trigger is set to External 2.
State Saved	Saved in instrument state
Status Bits/OPC dependencies	The Status Operation Register bit 5 "Waiting for Trigger" is set at the same time as the Sweeping or Measuring bit is set. It is cleared when the trigger actually occurs (that is, after the trigger event occurs and all the applicable trigger criteria have been met). A corresponding pop-up message

	("Waiting for trigger") is generated if no trigger signal appears after approximately 2 sec. This message goes away when a trigger signal appears.
Initial S/W Revision	Prior to A.02.00
Modified at S/W Revision	A.03.00

Trigger Level

Sets the value where the external 2 trigger input will trigger a new sweep/measurement.

Key Path	Trigger, External 2
Remote Command	:TRIGger[:SEquence]:EXTernal2:LEVel :TRIGger[:SEquence]:EXTernal2:LEVel?
Example	TRIG:EXT2:LEV 1.1 V
Couplings	This same level is used for the Ext2 trigger source in the Trigger menu, for the Ext2 selection in the Periodic Timer sync source (in the Trigger menu and in the Gate Source menu), and also for the Ext2 selection in the Gate Source menu.
Preset	1.2 V
State Saved	Saved in instrument state
Min	-5 V
Max	5 V
Default Unit	V
Backwards Compatibility SCPI	:TRIGger[:SEquence]:FRAMe:EXTernal2:LEVel
Initial S/W Revision	Prior to A.02.00

Trig Slope

Controls the trigger polarity. It is set positive to trigger on a rising edge and negative to trigger on a falling edge.

Key Path	Trigger, External 2
Remote Command	:TRIGger[:SEquence]:EXTernal2:SLOPe POSitive NEGative :TRIGger[:SEquence]:EXTernal2:SLOPe?
Example	TRIG:EXT2:SLOP NEG
Couplings	This same slope is used in the Ext2 selection for the trigger source in the Trigger menu and for the period timer sync source (in the Trigger menu and in the Gate Source menu).
Preset	POSitive
State Saved	Saved in instrument state
Backwards Compatibility SCPI	:TRIGger[:SEquence]:FRAMe:EXTernal2:SLOPe

Backwards Compatibility Notes	The legacy :TRIGger[:SEQuence]:SLOPe command affects the slopes for the VID, LINE, EXT1, EXT2, and RFB triggers.
Initial S/W Revision	Prior to A.02.00

RF Burst

Pressing this key, when it is not selected, selects the RF Burst as the trigger. A new sweep/measurement will start when an RF burst envelope signal is identified from the signal at the RF Input connector. Pressing this key, when it is already selected, accesses the RF Burst trigger setup menu.

In some models, a variety of burst trigger circuitry is available, resulting in various available burst trigger bandwidths. The analyzer automatically chooses the appropriate trigger path based on the hardware configuration and other settings of the analyzer.

Key Path	Trigger
Example	TRIG:SOUR RFB Swept SA measurement TRIG:< meas>:SOUR RFB Measurements other than Swept SA
State Saved	Saved in instrument state
Status Bits/OPC dependencies	The Status Operation Register bit 5 "Waiting for Trigger" is set at the same time as the Sweeping or Measuring bit is set. It is cleared when the trigger actually occurs (that is, after the trigger event occurs and all the applicable trigger criteria have been met). A corresponding pop-up message ("Waiting for trigger") is generated if no trigger signal appears after approximately 2 sec. This message goes away when a trigger signal appears.
Backwards Compatibility Notes	The legacy command: :TRIGger[:SEQuence]:RFBurst:FSElectivity[:STATe] OFF ON 0 1 is not supported in the X-Series, as the hardware to do Frequency Selective burst triggers does not exist in X-Series.
Initial S/W Revision	Prior to A.02.00
Modified at S/W Revision	A.04.00

Absolute Trigger Level

Sets the absolute trigger level for the RF burst envelope.

When using the External Mixing path, the Absolute Trigger Level is uncalibrated because the factory default was set to accommodate the expected IF levels for the RF path.

Key Path	Trigger, RF Burst
Scope	Meas Global
Remote Command	:TRIGger[:SEQuence]:RFBurst:LEVel:ABSolute <ampl> :TRIGger[:SEQuence]:RFBurst:LEVel:ABSolute?
Example	TRIG:RFB:LEV:ABS 10 dBm

	sets the trigger level of the RF burst envelope signal to the absolute level of 10 dBm
Notes	<p>Sending this command does not switch the setting from relative to absolute; to switch it you need to send the :TRIGger[:SEquence]:RFBurst:LEVel:TYPE command, below.</p> <p>Amplitude Corrections are not taken into account by the Absolute Trigger Level. For example, if you have given yourself effective gain with an amplitude correction factor, the Absolute Trigger will not fire until you have set the trigger level that far below the displayed signal level, rather than simply to the displayed signal level. This is only true for Amplitude Corrections, not External Gain or Ref Level Offset functions.</p> <p>If mode is Bluetooth, the default value is -50 dBm.</p>
Couplings	This same level is used for the RF Burst trigger source in the Trigger menu, for the RF Burst selection in the Periodic Timer sync source (in the Trigger menu and in the Gate Source menu), and also for the RF Burst selection in the Gate Source menu
Preset	-20 dBm
State Saved	Saved in instrument state
Min	-200 dBm
Max	100 dBm
Default Unit	depends on the current selected Y-Axis unit
Backwards Compatibility SCPI	:TRIGger[:SEquence]:FRAMe:RFBurst:LEVel:ABSolute
Initial S/W Revision	Prior to A.02.00
Modified at S/W Revision	A.04.00

Key Path	Trigger, RF Burst
Remote Command	:TRIGger[:SEquence]:RFBurst:LEVel:TYPE ABSolute RELative :TRIGger[:SEquence]:RFBurst:LEVel:TYPE?
Example	TRIG:RFB:LEV:TYPE REL sets the trigger level type of the RF burst trigger to Relative.
Preset	ABSolute
State Saved	Saved in instrument state
Initial S/W Revision	Prior to A.02.00
Modified at S/W Revision	A.04.00

Relative Trigger Level

Sets the relative trigger level for the RF burst envelope.

In some models, the relative burst trigger function is implemented in hardware. In other models, without the advanced triggering hardware required, the relative burst trigger function is implemented in software in some measurements, and is unavailable in other measurements.

When implemented in software, the relative RF Burst trigger function is implemented as follows:

1. The measurement starts with the absolute RF Burst trigger setting. If it cannot get a trigger with that level, auto trigger fires and the acquisition starts anyway. After the acquisition, the measurement searches for the peak in the acquired waveform and saves it.
2. Now, in the next cycle of the measurement, the measurement determines a new absolute RF Burst level based on the peak value from the first measurement and the Relative RF Burst Trigger Level (always 0 or negative dB) set by the user. The following formula is used:
3. absolute RF Burst level = peak level of the previous acquisition + relative RF Burst level
4. If the new absolute RF Burst level differs from the previous by more than 0.5 dB, the new level is sent to the hardware; otherwise it is not updated (to avoid slowing down the acquisition)

Steps 2 and 3 repeat for subsequent measurements.

Key Path	Trigger, RF Burst
Scope	Meas Global
Remote Command	:TRIGger[:SEquence]:RFBurst:LEVel:RELative <rel_ampl> :TRIGger[:SEquence]:RFBurst:LEVel:RELative?
Example	TRIG:RFB:LEV:REL -10 dB sets the trigger level of the RF burst envelope signal to the relative level of -10 dB
Notes	Sending this command does not switch the setting from absolute to relative; to switch it you need to send the :TRIGger[:SEquence]:RFBurst:LEVel:TYPE command, above. The relative trigger level is not available in some measurements. In those measurements the RELative parameter, and the :TRIGger[:SEquence]:RFBurst:LEVel:TYPE command (above), will generate an error if sent.
Dependencies	This key is grayed out and Absolute Trigger Level selected if the required hardware is not present in your analyzer and the current measurement does not support Relative triggering.
Preset	-6 dB GSM: -25 dB
State Saved	Saved in instrument state
Min	-45 dB
Max	0 dB
Default Unit	dB or dBc
Backwards Compatibility SCPI	:TRIGger[:SEquence]:RFBurst:LEVel This legacy command is aliased to :TRIGger[:SEquence]:RFBurst:LEVel:RELative because the PSA had ONLY relative burst triggering
Initial S/W Revision	Prior to A.02.00
Modified at S/W Revision	A.04.00

Trigger Slope

It is set positive to trigger on a rising edge and negative to trigger on a falling edge.

Key Path	Trigger, RF Burst
Remote Command	:TRIGger[:SEquence]:RFBurst:SLOPe POSitive NEGative :TRIGger[:SEquence]:RFBurst:SLOPe?
Example	TRIG:RFB:SLOP NEG
Couplings	This same slope is used in the RF Burst selection for the trigger source in the Trigger menu and for the period timer sync source (in the Trigger menu and in the Gate Source menu).
Preset	POSitive
State Saved	Saved in instrument state
Backwards Compatibility SCPI	:TRIGger[:SEquence]:FRAME:RFBurst:SLOPe
Backwards Compatibility Notes	The legacy :TRIGger[:SEquence]:SLOPe command affects the slopes for the VID, LINE, EXT1, EXT2, and RFB triggers.
Initial S/W Revision	Prior to A.02.00

Control Edge/Level

Sets the method of controlling the gating function from the gating signal.

Edge

In Edge triggering, the gate opens (after the Delay) on the selected edge (for example, positive) of the gate signal and closes on the alternate edge (for example, negative).

Level

In Level triggering, the gate opens (after the Delay) when the gate signal has achieved a certain level and stays open as long as that level is maintained.

Key Path	Sweep/Control, Gate
Remote Command	[:SENSe]:SWEep:EGATe:CONTRol EDGE LEVel [:SENSe]:SWEep:EGATe:CONTRol?
Example	SWE:EGAT:CONT EDGE
Dependencies	If the Gate Method is FFT the Control key is grayed out and Edge is selected. If the Gate Source is TV, Frame or Line, the Control key is grayed out and Edge is selected.
Preset	EDGE
State Saved	Saved in instrument state
Backwards Compatibility SCPI	[:SENSe]:SWEep:TIME:GATE:TYPE ESA Compatibility
Initial S/W Revision	Prior to A.02.00

Gate Holdoff

Lets you increase or decrease the wait time after a gate event ends before the analyzer will respond to the next gate signal.

After any Gate event finishes, the analyzer must wait for the sweep system to settle before it can respond to another Gate signal. The analyzer calculates a "wait time," taking into account a number of factors, including RBW and Phase Noise Optimization settings. The goal is to achieve the same accuracy when gated as in ungated operation. The figure below illustrates this concept:

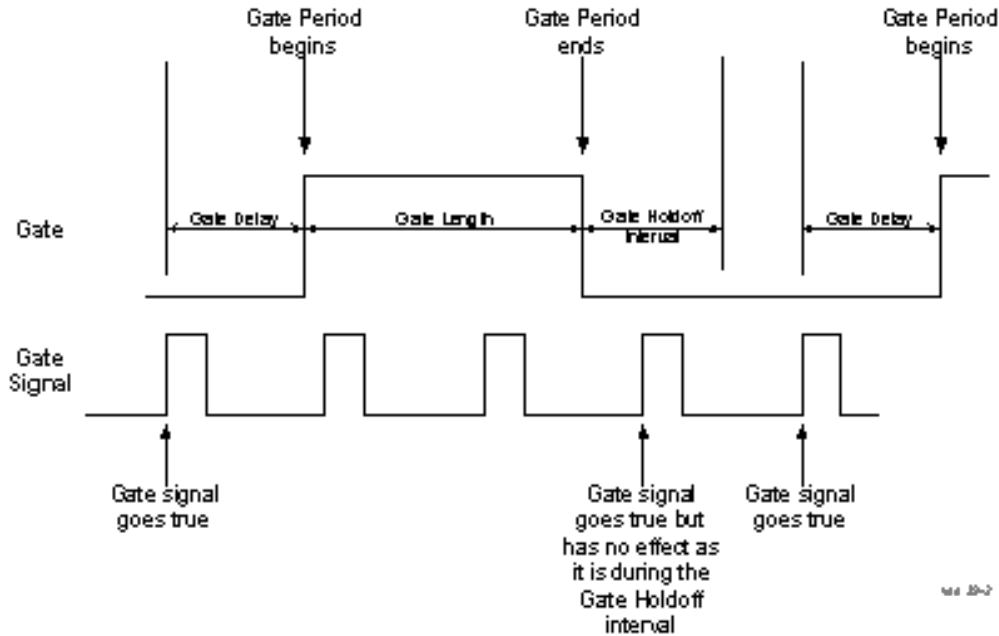

When Gate Holdoff is in Auto, the wait time calculated by the analyzer is used. When Gate Time is in Manual, the user may adjust the wait time, usually decreasing it in order to achieve greater speed, but at the risk of decreasing accuracy.

When the Method key is set to Video or FFT, the Gate Holdoff function has no effect.

In measurements that do not support Auto, the value shown when Auto is selected is “---” and the manually set holdoff is returned to a query.

Key Path	Sweep/Control, Gate
Remote Command	<pre>[:SENSe] :SWEep:EGATe:HOLDoff <time> [:SENSe] :SWEep:EGATe:HOLDoff? [:SENSe] :SWEep:EGATe:HOLDoff:AUTO OFF ON 0 1 [:SENSe] :SWEep:EGATe:HOLDoff:AUTO?</pre>
Example	<pre>SWE:EGAT:HOLD 0.0002 SWE:EGAT:HOLD? SWE:EGAT:HOLD:AUTO ON SWE:EGAT:HOLD:AUTO?</pre>
Couplings	<p>When Gate Holdoff is Auto, the Gate Holdoff key shows the value calculated by the analyzer for the wait time.</p> <p>Pressing the Gate Holdoff key while it is in Auto and not selected, causes the key to become selected and allows the user to adjust the value. If the value is adjusted, the setting changes to Man.</p> <p>Pressing the Gate Holdoff key, while it is in Auto and selected, does not change the value of Gate</p>

	<p>Holdoff, but causes the setting to change to Man. Now the user can adjust the value.</p> <p>Pressing the key while it is in Man and selected, cause the value to change back to Auto.</p> <p>Pressing the key while it is in Man and not selected, causes the key to become selected and allows the user to adjust the value.</p> <p>When Method is set to Video or FFT, the Gate Holdoff function has no effect.</p>
Preset	<p>Auto</p> <p>Auto/On</p>
State Saved	Saved in instrument state
Min	1 μ sec
Max	1 sec
Initial S/W Revision	Prior to A.02.00

Gate Delay Compensation

This function allows you to select an RBW-dependent value by which to adjust the gate delay, to compensate for changes in the delay caused by RBW effects.

You can select between uncompensated operation and two types of compensation, Delay Until RBW Settled and Compensate for RBW Group Delay.

See ["More Information" on page 646](#)

Key Path	Sweep/Control, Gate
Scope	Meas Global
Remote Command	<p>[:SENSe] :SWEep:EGATe:DELAy:COMPensation:TYPE OFF SETTled GDELAy</p> <p>[:SENSe] :SWEep:EGATe:DELAy:COMPensation:TYPE?</p>
Example	<p>SWE:EGAT:DEL:COMP:TYPE SETT</p> <p>SWE:EGAT:DEL:COMP:TYPE?</p>
Notes	<p>Although this function is Meas Global, there are some measurements that do not support this function. In those measurements the operation will be Uncompensated. Going into one of those measurements will not change the Meas Global selection; it will simply display the grayed-out menu key with "Uncompensated" showing as the selection. This is a non-forceful grayout, so the SCPI command is still accepted.</p> <p>If Gate Delay Compensation is not supported at all within a particular mode, the key is not displayed, and if the SCPI command is sent while in a measurement within that mode, an "Undefined Header" message is generated.</p> <p>Measurements that do not support this function include:</p> <p>Swept SA</p>
Preset	<p>TD-SCDMA mode: Compensate for RBW Group Delay</p> <p>All other modes: Delay Until RBW Settled</p>
State Saved	Saved in instrument state

Range	Uncompensated Delay Until RBW Settled Compensate for RBW Group Delay
Readback text	Uncompensated Settled Group Delay
Initial S/W Revision	Prior to A.02.00
Modified at S/W Revision	A.11.0

More Information

Selecting Uncompensated means that the actual gate delay is as you sets it.

Selecting Delay Until RBW Settled causes the gate delay to be increased above the user setting by an amount equal to $3.06/\text{RBW}$. This compensated delay causes the GATE START and GATE STOP lines on the display to move by the compensation amount, and the actual hardware gate delay to be increased by the same amount. All the other gate lines (for example, MIN FAST) are unaffected. If the RBW subsequently changes, the compensation is readjusted for the new RBW. The value shown on the Gate Delay key does NOT change.

Delay Until RBW Settled allows excellent measurements of gated signals, by allowing the IF to settle following any transient that affects the burst. Excellent measurements also require that the analysis region not extend into the region affected by the falling edge of the burst. Thus, excellent measurements can only be made over a width that declines with narrowing RBWs, which is achieved by decreasing the gate length below the user setting by an amount equal to $2.53/\text{RBW}$. Therefore, for general purpose compensation, you will still want to change the gate length with changes in RBW even if the gate delay is compensated. The compensated Gate Length is limited by the analyzer so that it will never go below 10% of the value shown on the Gate Length key, as otherwise the sweep times could get very long. Anytime the Gate Length and RBW values combine in such a way that this limiting takes place, a warning is displayed. For measurements which contain multiple sweeps with different RBW like SEM and SPUR, the smallest RBW is used for this limiting.

Selecting Compensate for RBW Group Delay causes the gate delay to be increased above the user setting by an amount equal to $1.81/\text{RBW}$. This compensated delay causes the GATE START, GATE STOP lines on the display to move by the compensation amount, and the actual hardware gate delay to be increased by the same amount. All the other gate lines (for example, MIN FAST) are unaffected. If the RBW subsequently changes, the compensation is readjusted for the new RBW. The value shown on the Gate Delay key does NOT change. Compensate for RBW Group Delay also includes gate length compensation; the gate length itself is adjusted as necessary to attempt to compensate for delay effects imposed by the RBW.

Compensate for RBW Group Delay is similar to Delay Until RBW Settled, but compensates for the group delay of the RBW filter, rather than the filter settling time. As the RBW gets narrow, this can allow the settling tail of the RBW to affect the beginning part of the gated measurement, and allow the beginning of the RBW settling transient to affect the end of the gated measurement. These two effects are symmetric because the RBW response is symmetric. Because the gate length is not automatically compensated, some users might find this compensation to be more intuitive than compensation for RBW settling.

Min Fast Position Query (Remote Command Only)

This command queries the position of the MIN FAST line, relative to the delay reference (REF) line. See section ["Gate View On/Off" on page 630](#). If this query is sent while not in gate view, the MinFast calculation

is performed based on the current values of the appropriate parameters and the result is returned. Knowing this value lets you set an optimal gate delay value for the current measurement setup.

Remote Command	<code>[:SENSe] :SWEep:EGATe:MINFast?</code>
Example	<code>SWE:EGAT:MIN?</code>
Initial S/W Revision	Prior to A.02.00

Gate Preset (Remote Command Only)

Presets the time-gated spectrum analysis capability.

This command sets gate parameter values to the ESA preset values, as follows:

Gate trigger type = edge

Gate polarity = positive

Gate delay = 1 us

Gate length = 1 us

Remote Command	<code>[:SENSe] :SWEep:TIME:GATE:PRESet</code> ESA Compatibility
Initial S/W Revision	Prior to A.02.00

Gate Level (Remote Command Only)

Sets the gate input transition point level for the external TRIGGER inputs on the front and rear panel. This is a legacy command for PSA compatibility. It is simply an alias to the equivalent trigger level command.

Remote Command	<code>[:SENSe] :SWEep:EGATe:EXTernal [1] 2 :LEVel <voltage></code> <code>[:SENSe] :SWEep:EGATe:EXTernal [1] 2 :LEVel?</code>
Notes	This command is simply an alias to <code>:TRIGger[:SEQUence]:EXTernal[1] 2 :LEVel</code> For details refer
Initial S/W Revision	Prior to A.02.00

Gate Polarity (Remote Command Only)

Sets the polarity for the gate signal. This setup is now done using the gate trigger's slope setting.

When Positive (Pos) is selected, a positive-going edge (Edge) or a high voltage (Level) will satisfy the gate condition, after the delay set with the Gate Delay key. When Negative (Neg) is selected, a negative-going edge (Edge) or a low voltage (Level) will satisfy the gate condition after the delay.

Remote Command	<code>[:SENSe] :SWEep:EGATe:POLarity</code> NEGative POSitive <code>[:SENSe] :SWEep:EGATe:POLarity?</code>
-----------------------	---

Example	SWE:EGAT:POL NEG SWE:EGAT:POL?
Preset	POSitive
State Saved	Saved in instrument state
Backwards Compatibility SCPI	[:SENSe] :SWEep:TIME:GATE:POLarity ESA compatibility
Initial S/W Revision	Prior to A.02.00

Remote Command	[:SENSe] :SWEep:TIME:GATE:LEVEl HIGH LOW [:SENSe] :SWEep:TIME:GATE:LEVEl? ESA compatibility
Preset	HIGH
Initial S/W Revision	Prior to A.02.00

Points

Sets the number of points per sweep. The resolution of setting the sweep time depends on the number of points selected. If Preset is selected, the number of points per sweep defaults to 1001. The current value of points is displayed parenthetically, next to the sweep time in the lower right corner of the display.

Key Path	Sweep/Control
Mode	All except SA and BASIC
Remote Command	[:SENSe] :MONitor:SWEep:POINts <integer> [:SENSe] :MONitor:SWEep:POINts?
Example	:MON:SWE:POIN 1000 :MON:SWE:POIN?
Couplings	Whenever the number of sweep points changes, the sweep time is re-quantized.
Preset	1001
State Saved	Saved in instrument state.
Range	1 to 20001
Min	1
Max	20001
Initial S/W Revision	Prior to A.02.00

System

See "System" on page 242

Trace/Detector

Accesses a menu that enables you to control the display, storage, detection and manipulation of trace data. Each trace is comprised of a series of data points in which X and Y axis information is stored. The analyzer updates the information for the active trace with each sweep of the current measurement.

Key Path	Front-panel key
Initial S/W Revision	Prior to A.02.00

Select Trace

Allows you to select which trace you want to use for the current measurement. You can select one of three traces. Monitor Spectrum supports 3 traces, numbered 1 through 3.

Key Path	Trace/Detector
Mode	All except SA and BASIC
Preset	Trace 1
State Saved	The number of the selected trace is saved in Instrument State
Initial S/W Revision	Prior to A.02.00

Trace Type

Allows you to select the type of trace you want to use for the current measurement. You can assign a trace type to one of the three available traces.

The first page of this menu contains a 1-of-N selection of the trace type for the selected trace:

WRITe	Clear Write
AVERAge	Average
MAXHold	Max Hold
MINHold	Min Hold

Key Path	Trace/Detector
Mode	All except SA and BASIC
Remote Command	:TRACe[1] 2 3:MONitor:TYPE WRITe AVERAge MAXHold MINHold :TRACe[1] 2 3:MONitor:TYPE?
Example	TRAC:MON:TYPE WRIT TRAC:MON:TYPE?
Preset	WRITe
State Saved	Saved in instrument state.

Range	WRITE AVERage MAXHold MINHold for traces 1 through 3
Backwards Compatibility SCPI	:DISPlay:MONitor:VIEW:WINDow:TRACe [1] 2 3 :TYPE
Initial S/W Revision	Prior to A.02.00

Update

Toggles a trace state between Update and Off. The Off selection makes the trace inactive (or a *stored trace*). This does not affect whether the trace is visible or not. To change the trace visibility, see "[Display](#)" on page 651.

Key Path	Trace/Detector
Mode	All except SA and BASIC
Remote Command	:TRACe [1] 2 3 :MONitor:UPDate[:STATe] ON OFF 0 1 :TRACe [1] 2 3 :MONitor:UPDate[:STATe]?
Example	TRAC3:MON:UPD OFF TRAC3:MON:UPD?
Preset	ON
State Saved	Saved in instrument state.
Range	On Off(View)
Initial S/W Revision	Prior to A.02.00

Display

Controls the visibility of a trace. When set to Blank, traces do not display nor appear on printouts but are otherwise unaffected. They may be queried and markers may be placed on them.

Key Path	Trace/Detector
Mode	All except SA and BASIC
Remote Command	:TRACe [1] 2 3 :MONitor:DISPlay[:STATe] ON OFF 0 1 :TRACe [1] 2 3 :MONitor:DISPlay[:STATe]?
Example	TRAC:MON:DISP ON TRAC:MON:DISP?
Preset	ON OFF OFF
State Saved	Saved in instrument state.
Range	Show Blank
Initial S/W Revision	Prior to A.02.00

Detector

Accesses a menu of functions that enable you to control the detectors for the current measurement. The following choices are available:

- **Auto** – the detector selected depends on marker functions, trace functions, average type, and the trace averaging function. See "[Auto](#)" on page 653.
- **Normal** – the detector determines the peak of the CW-like signals, and it yields alternating maximums and minimums of noise-like signals. This is also referred to as Rosenfell detection.
- **Average** – the detector determines the average of the signal within the sweep points. The averaging method depends upon the Average Type selection (voltage, power or log scales).
- **Peak** – the detector determines the maximum of the signal within the sweep points.
- **Sample** – the detector indicates the instantaneous level of the signal at the center of the sweep points represented by each display point.
- **Negative Peak** – the detector determines the minimum of the signal within the sweep points.

In swept analysis, the time interval of the data collection for the display sweep points also represents a frequency interval. In FFT analysis, the sweep points represent just a frequency interval. The detector determines the relationship between the spectrum computed by the FFT and the single data point displayed for the sweep points.

Key Path	Trace/Detector
Mode	All except SA and BASIC
Remote Command	<code>[:SENSe] :MONitor :DETector :TRACe AVERage NEGative NORMal POSitive SAMPle [:SENSe] :MONitor :DETector :TRACe?</code>
Example	MON:DET:TRAC NORM MON:DET:TRAC?
Notes	The query returns a name that corresponds to the detector type as shown below. String Returned - Definition <ul style="list-style-type: none"> • NORM - Normal • AVER - Average • POS - Peak • SAMP - Sample • NEG - Negative Peak
Couplings	When the Detector choice is Auto, the detector selected depends on average type.
Preset	NORMal
State Saved	Saved in instrument state.
Range	Normal Average(RMS) Peak Sample Negative Peak
Backwards Compatibility SCPI	<code>[:SENSe] :MONitor :DETector [:FUNction]</code>
Initial S/W Revision	Prior to A.02.00

Auto

Sets the detector for the currently selected trace to Auto. When the detector choice is Auto, the analyzer selects the detector. The selected detector depends on marker functions, trace functions, and trace averaging functions for the current measurement.

Key Path	Trace/DetectorTrace/Detector, Detector
Mode	All except SA and BASIC
Remote Command	<code>[:SENSe] :MONitor :DETECTOR :AUTO ON OFF 1 0</code> <code>[:SENSe] :MONitor :DETECTOR :AUTO ?</code>
Example	<code>MON:DET:AUTO OFF</code> <code>MON:DET:AUTO ?</code>
Couplings	When the Detector choice is Auto, the detector selected depends on average state and trace type.
Preset	ON
State Saved	Saved in instrument state.
Range	Auto Man
Initial S/W Revision	Prior to A.02.00

Clear Trace

Clears the selected trace from the display.

Key Path	Trace/Detector
Mode	All except SA and BASIC
Remote Command	<code>:TRACe :MONitor :CLEAr [TRACE1] TRACE2 TRACE3</code>
Example	<code>TRAC:MON:CLE</code>
Initial S/W Revision	Prior to A.02.00

Mode	All except SA and BASIC
Remote Command	<code>:DISPlay :MONitor :VIEW :WINDow :TRACe [1] 2 3 :CLEAr</code>
Example	<code>DISP:MON:VIEW:WIND:TRAC:CLE</code>
Initial S/W Revision	Prior to A.02.00

Clear All Traces

Clears all traces from the display.

Key Path	Trace/Detector
Mode	All except SA and BASIC

Remote Command	:TRACe:MONitor:CLEar:ALL
Example	TRAC:MON:CLE:ALL
Backwards Compatibility SCPI	:DISPlay:MONitor:VIEW:WINDow:TRACe:CLEar:ALL
Initial S/W Revision	Prior to A.02.00

Trigger

See ___ on page X

Free Run

See ___ on page X

External 1

See "External 1 " on page 637

Trigger Level

See "Trigger Level " on page 637

Trig Slope

See "Trig Slope " on page 638

Trig Delay

See ___ on page X

External 2

See "External 2 " on page 638

Trigger Level

See "Trigger Level " on page 639

Trig Slope

See "Trig Slope " on page 639

Trig Delay

See ___ on page X

RF Burst

See "RF Burst " on page 640

Absolute Trigger

See "Absolute Trigger Level" on page 640

Relative Trigger

See "Relative Trigger Level" on page 641

Trig Slope

See "Trigger Slope " on page 642

Trig Delay

See ___ on page X

Auto/Holdoff

See ___ on page X

Auto Trig

See ___ on page X

Trig Holdoff

See ___ on page X

User Preset

Accesses a menu that gives you the following three choices:

- User Preset – recalls a state previously saved using the Save User Preset function.
- User Preset All Modes – presets all of the modes in the analyzer
- Save User Preset– saves the current state for the current mode

Key Path	Front-panel key
Backwards Compatibility Notes	<p>User Preset is actually loading a state, and in legacy analyzers, it was possible to load a state without affecting the trace data, limit lines or correction data. Similarly it was possible to do a User Preset without affecting the trace data, limit lines or correction data.</p> <p>In the X-Series, “state” always includes all of this data; so whenever state is loaded, or User Preset is executed, all of the traces, limit lines and corrections are affected. Although this differs from previous behavior, it is desirable behavior, and should not cause adverse issues for users.</p> <p>On ESA and PSA, User Preset affected the entire instrument’s state. In the X-Series, User Preset only recalls the state for the active mode. There is a User Preset file for each mode. User Preset can never cause a mode switch as it can in legacy analyzers. If you want to recall all modes to their user preset file state, you will need to do a User Preset after mode switching into each mode.</p> <p>User Preset recalls mode state which can now include data like traces; whereas on ESA and PSA, User Preset did not affect data.</p>
Initial S/W Revision	Prior to A.02.00

User Preset

User Preset sets the state of the currently active mode back to the state that was previously saved for this mode using the Save User Preset menu key or the SCPI command, SYST:PRES:USER:SAV. It not only recalls the Mode Preset settings, but it also recalls all of the mode persistent settings, and the Input/Output system setting that existed at the time Save User Preset was executed.

If a Save User Preset has not been done at any time, User Preset recalls the default user preset file for the currently active mode. The default user preset files are created if, at power-on, a mode detects there is no user preset file. There will never be a scenario when there is no user preset file to restore. For each mode, the default user preset state is the same state that would be saved if a Save User Preset is performed in each mode right after doing a Restore Mode Default and after a Restore Input/Output Defaults.

The User Preset function does the following:

- Aborts the currently running measurement.
- Sets the mode State to the values defined by Save User Preset.
- Makes the saved measurement for the currently running mode the active measurement.
- Brings up the saved menu for the power-on mode.
- Clears the input and output buffers.
- Sets the Status Byte to 0.

Key Path	User Preset
Remote Command	:SYSTem:PRESet:USER
Example	:SYST:PRES:USER:SAVE:SYST:PRES:USER
Notes	:SYST:PRES:USER:SAVE is used to save the current state as the user preset state. Clears all pending OPC bits. The Status Byte is set to 0. Pressing the User Preset front-panel key while already in the User Preset menu will cause the User Preset to get executed
Couplings	A user preset will cause the currently running measurement to be aborted and cause the saved measurement to be active. Recalling a User Preset file has the same issues that recalling a Save State file has. Some settings may need to be limited and therefore re-coupled, since the capabilities of the mode may have changes when the User Preset file was last saved.
Initial S/W Revision	Prior to A.02.00

User Preset All Modes

Recalls all of the User Preset files for each mode, switches to the power-on mode, and activates the saved measurement from the power-on mode User Preset file.

NOTE

When the instrument is secured, all of the user preset files are converted back to their default user preset files.

The User Preset function does the following:

- Aborts the currently running measurement.
- Switches the Mode to the power-on mode.
- Restores the User Preset files for each mode.
- Makes the saved measurement for the power-on mode the active measurement.
- Brings up the saved menu for the power-on mode.
- Clears the input and output buffers.
- Sets the Status Byte to 0.

Key Path	User Preset
Remote Command	:SYSTem:PRESet:USER:ALL
Example	:SYST:PRES:USER:SAVE:SYST:PRES:USER:ALL
Notes	Clears all pending OPC bits. The Status Byte is set to 0. :SYST:PRES:USER:SAVE is used to save the current state as the user preset state.
Couplings	A user preset will cause the currently running measurement to be aborted, cause a mode switch to the power-on mode, and cause the saved measurement to be active in the power-on mode. Recalling a User Preset file has the same issues that recalling a Save State file has. Some settings may need to be limited and therefore re-coupled, since the capabilities of the mode may have changes when the User Preset file was last saved.
Initial S/W Revision	Prior to A.02.00

Save User Preset

Saves the currently active mode and its State. You can recall this User Preset file by pressing the User Preset menu key or sending the SYST:PRES:USER remote command. This same state is also saved by the Save State function.

Key Path	User Preset
Remote Command	:SYSTem:PRESet:USER:SAVE
Example	:SYST:PRES:USER:SAVE
Notes	:SYST:PRES:SAVE creates the same file as if the user requested a *SAV or a MMEM:STOR:STAT, except User Preset Save does not allow the user to specify the filename or the location of the file.
Initial S/W Revision	Prior to A.02.00

View/Display

The View/Display key opens the Display Menu (common to most measurements) and the View menu for the current measurement.

Some measurements have simple View menus, or even no View menu, others provide many different Views.

Views are different ways of looking at data, usually different ways of looking at the same data, often when the data represents a time record that is being digitally processed with an FFT and/or other digital signal processing algorithms.

Key Path	Front-panel key
Initial S/W Revision	Prior to A.02.00

Display

The Display menu is common to most measurements, and is used for configuring items on the display. Some Display menu settings apply to all the measurements in a mode, and some only to the current measurement. Those under the System Display Settings key apply to all measurements in all modes.

Key Path	Display
Key Path	View/Display
Initial S/W Revision	Prior to A.02.00

Annotation

Turns on and off various parts of the display annotation. The annotation is divided up into four categories:

1. Meas Bar: This is the measurement bar at the top of the screen. It does not include the settings panel or the Active Function. Turning off the Meas Bar turns off the settings panel and the Active Function. When the Meas Bar is off, the graticule area expands to fill the area formerly occupied by the Meas Bar.
2. Screen Annotation: this is the annotation and annunciation around the graticule, including any annotation on lines (such as the display line, the threshold line, etc.) This does NOT include the marker number or the N dB result. When off, the graticule expands to fill the entire graticule area.
3. Trace annotation: these are the labels on the traces, showing their detector (or their math mode).
4. Active Function annotation: this is the active function display in the meas bar, and all of the active function values displayed on softkeys.

See the figure below. Each type of annotation can be turned on and off individually.

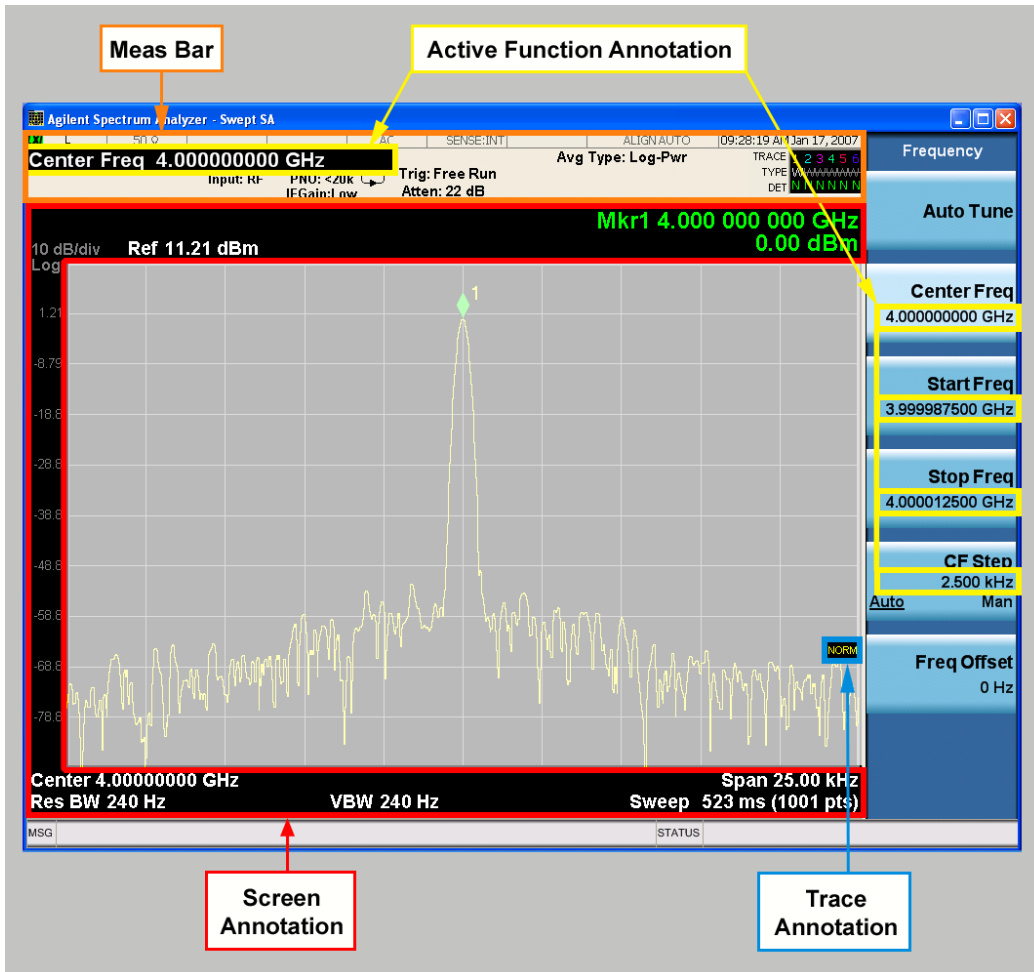

Key Path	View/Display, Display
Initial S/W Revision	Prior to A.02.00

Meas Bar On/Off

This function turns the Measurement Bar on and off, including the settings panel. When off, the graticule area expands to fill the area formerly occupied by the Measurement Bar.

Key Path	View/Display, Display, Annotation
Remote Command	:DISPlay:ANNotation:MBAR[:STATE] OFF ON 0 1 :DISPlay:ANNotation:MBAR[:STATE]?
Example	DISP:ANN:MBAR OFF
Dependencies	Grayed out and forced to OFF when System Display Settings, Annotation is set to Off.
Preset	On This should remain Off through a Preset when System DisplaySettings, Annotation is set to Off.
State Saved	Saved in instrument state.
Initial S/W Revision	Prior to A.02.00

Screen

This controls the display of the annunciation and annotation around the graticule, including any annotation on lines (such as the display line, the threshold line, etc.) and the y-axis annotation. This does NOT include marker annotation (or the N dB result). When off, the graticule expands to fill the entire graticule area, leaving only the 1.5% gap above the graticule as described in the Trace/Detector chapter.

Key Path	View/Display, Display, Annotation
Remote Command	:DISPlay:ANNotation:SCReen[:STATe] OFF ON 0 1 :DISPlay:ANNotation:SCReen[:STATe]?
Example	DISP:ANN:SCR OFF
Dependencies	Grayed-out and forced to OFF when System Display Settings, Annotation is set to Off.
Preset	On This should remain Off through a Preset when System DisplaySettings, Annotation is set to Off
State Saved	Saved in instrument state.
Initial S/W Revision	Prior to A.02.00

Active Function Values On/Off

Turns on and off the active function display in the Meas Bar, and all of the active function values displayed on the softkeys.

Note that all of the softkeys that have active functions have these numeric values blanked when this function is on. This is a security feature..

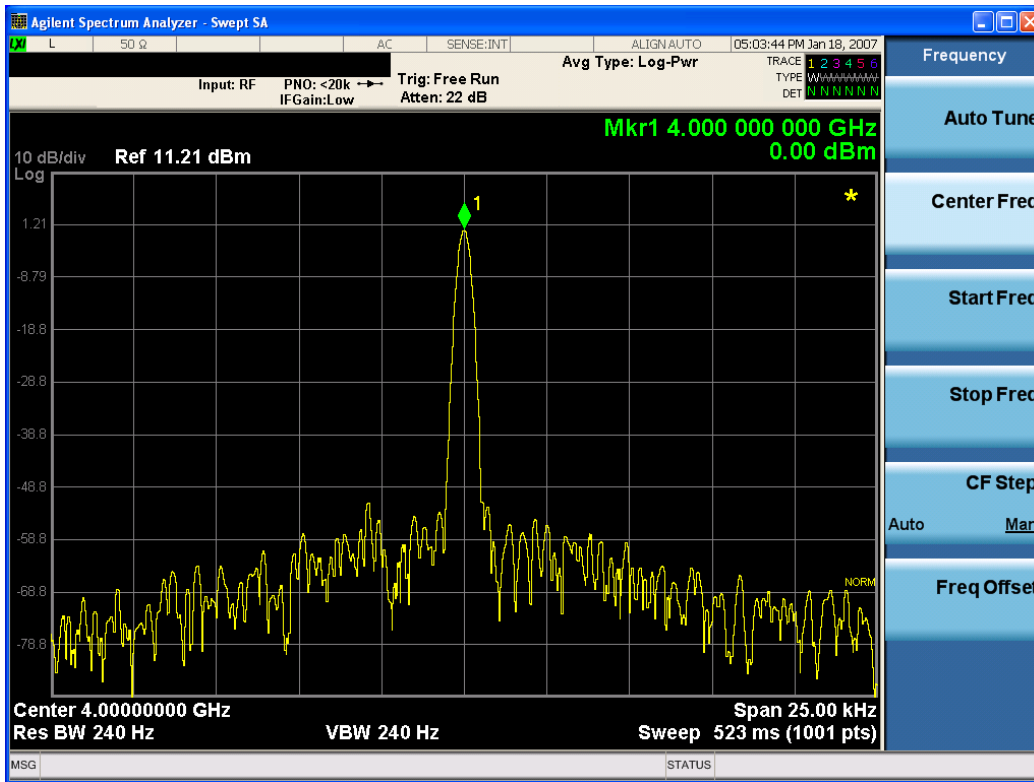

Key Path	View/Display, Display, Annotation
Remote Command	:DISPlay:ACTivefunc[:STATE] ON OFF 1 0 :DISPlay:ACTivefunc[:STATE]?
Example	DISP:ACT OFF
Dependencies	Grayed out and forced to OFF when System Display Settings, Annotation is set to Off.
Preset	On This should remain Off through a Preset when System DisplaySettings, Annotation is set to Off
State Saved	Saved in instrument state.
Initial S/W Revision	Prior to A.02.00

Title

Displays menu keys that enable you to change or clear a title on your display.

Key Path	View/Display, Display
Initial S/W Revision	Prior to A.02.00

Change Title

Writes a title into the "measurement name" field in the banner, for example, "Swept SA".

Press Change Title to enter a new title through the alpha editor. Press Enter or Return to complete the entry. Press ESC to cancel the entry and preserve your existing title.

The display title will replace the measurement name. It remains for this measurement until you press Change Title again, or you recall a state, or a Preset is performed. A title can also be cleared by pressing Title, Clear Title.

NOTE

Notice the inclusion of the <measurement> parameter in the command below. Because each measurement remembers the Display Title, the command must be qualified with the measurement name. For the Swept SA measurement this is not the case; no <measurement> parameter is used when changing the Display Title for the Swept SA measurement.

Key Path	View/Display, Display, Title
Mode	All
Remote Command	:DISPlay:<measurement>:ANNotation:TITLe:DATA <string> :DISPlay:<measurement>:ANNotation:TITLe:DATA?
Example	DISP:ANN:TITL:DATA "This Is My Title" This example is for the Swept SA measurement in the Spectrum Analyzer mode. The SANalyzer <measurement> name is not used. DISP:ACP:ANN:TITL:DATA "This Is My Title" This example is for Measurements other than Swept SA. Both set the title to: This Is My Title
Notes	Pressing this key cancels any active function. When a title is edited the previous title remains intact (it is not cleared) and the cursor goes at the end so that characters can be added or BKSP can be used to go back over previous characters.
Preset	No title (measurement name instead)
State Saved	Saved in instrument state.
Initial S/W Revision	Prior to A.02.00

Clear Title

Clears a title from the front-panel display. Once cleared, the title cannot be retrieved. After the title is cleared, the current Measurement Name replaces it in the title bar.

Key Path	View/Display, Display, Title
Example	The following commands clear the title and restore the measurement's original title: DISP:ANN:TITL:DATA "" This example is for the Swept SA measurement in the Spectrum Analyzer mode. The SANalyzer <measurement> name is not used. DISP:ACP:ANN:TITL:DATA "" This example is for ACP; in measurements other than Swept SA the measurement name is required.
Notes	Uses the :DISPlay:<measurement>:ANNotation:TITLe:DATA <string> command with an empty string (in the Swept SA, the <measurement> is omitted).
Preset	Performed on Preset.
Initial S/W Revision	Prior to A.02.00

Graticule

Pressing Graticule turns the display graticule On or Off. It also turns the graticule y-axis annotation on and off.

Key Path	View/Display, Display
Remote Command	:DISPlay:WINDow[1]:TRACe:GRATicule:GRID[:STATe] OFF ON 0 1 :DISPlay:WINDow[1]:TRACe:GRATicule:GRID[:STATe]?
Example	DISP:WIND:TRAC:GRAT:GRID OFF
Notes	The graticule is the set of horizontal and vertical lines that make up the grid/divisions for the x-axis and y-axis.
Preset	On
State Saved	Saved in instrument state
Initial S/W Revision	Prior to A.02.00

System Display Settings

These settings are "Mode Global" – they affect all modes and measurements and are reset only by Restore Misc Defaults or Restore System Defaults under System.

Key Path	View/Display, Display
Initial S/W Revision	Prior to A.02.00

Annotation Local Settings

This is a Mode Global override of the meas local annotation settings. When it is All Off, it forces ScreenAnnotation, Meas Bar, Trace, and Active Function Values settings to be OFF for all measurements in all modes. This provides the security based "annotation off" function of previous analyzers; hence it uses the legacy SCPI command.

When it is All Off, the Screen, Meas Bar, Trace, and Active Function Values keys under the Display, Annotation menu are grayed out and forced to Off. When Local Settings is selected, you are able to set the local annotation settings on a measurement by measurement basis.

Key Path	View/Display, Display, System Display Settings
Remote Command	:DISPlay:WINDow[1]:ANNOtation[:ALL] OFF ON 0 1 :DISPlay:WINDow[1]:ANNOtation[:ALL]?
Example	:DISP:WIND:ANN OFF
Preset	On (Set by Restore Misc Defaults)
State Saved	Not saved in instrument state.
Backwards Compatibility Notes	The WINDow parameter and optional subopcode is included for backwards compatibility but ignored – all windows are equally affected.
Initial S/W Revision	Prior to A.02.00

Themes

Accesses a menu of functions that enable you to choose the theme to be used when saving the screen image.

The **Themes** option is the same as the **Themes** option under the **Display** and **Page Setup** dialogs. It allows you to choose between themes to be used when saving the screen image.

Key Path	Save, Screen Image
Remote Command	:MMEMory:STORe:SCReen:THEMe TDColor TDMonochrome FCOLor FMONochrome :MMEMory:STORe:SCReen:THEMe?
Example	:MMEM:STOR:SCR:THEM TDM
Preset	3D Color; Is not part of Preset, but is reset by Restore Misc Defaults or Restore System Defaults All and survives subsequent running of the modes.
Readback	3D Color 3D Mono Flat Color Flat Mono
Backwards Compatibility Notes	In ESA and PSA we offer the choice of "Reverse Bitmap" or "Reverse Metafile" when saving screen images. This is much like the "Flat Color" theme available in X-Series. Also, if you selected Reverse Bitmap AND a black & white screen image, that would be much like "Flat Monochrome". In other words, each of the X-Series themes has a similar screen image type in ESA/PSA. But they are not identical.
Initial S/W Revision	Prior to A.02.00

3D Color

Selects a standard color theme with each object filled, shaded and colored as designed.

Key Path	Save, Screen Image, Themes
Example	MMEM:STOR:SCR:THEM TDC
Readback	3D Color
Initial S/W Revision	Prior to A.02.00

3D Monochrome

Selects a format that is like 3D color but shades of gray are used instead of colors.

Key Path	Save, Screen Image, Themes
Example	MMEM:STOR:SCR:THEM TDM
Readback	3D Mono
Initial S/W Revision	Prior to A.02.00

Flat Color

Selects a format that is best when the screen is to be printed on an ink printer.

Key Path	Save, Screen Image, Themes
Example	MMEM:STOR:SCR:THEM FCOL
Readback	Flat Color
Initial S/W Revision	Prior to A.02.00

Flat Monochrome

Selects a format that is like Flat Color. But only black is used (no colors, not even gray), and no fill.

Key Path	Save, Screen Image, Themes
Example	MMEM:STOR:SCR:THEM FMON
Readback	Flat Mono
Initial S/W Revision	Prior to A.02.00

Backlight

Accesses the display backlight on/off keys. This setting may interact with settings under the Windows "Power" menu.

When the backlight is off, pressing ESC, TAB, SPACE, ENTER, UP, DOWN, LEFT, RIGHT, DEL, BKSP, CTRL, or ALT turns the backlight on without affecting the application. Pressing any other key will turn backlight on and could potentially perform the action as well.

Key Path	View/Display, Display, System Display Settings
Remote Command	:DISPlay:BACKlight ON OFF :DISPlay:BACKlight?
Preset	ON (Set by Restore Misc Defaults)
Initial S/W Revision	Prior to A.02.00

Backlight Intensity

An active function used to set the backlight intensity. It goes from 0 to 100 where 100 is full on and 0 is off. This value is independent of the values set under the Backlight on/off key.

Key Path	View/Display, Display, System Display Settings
Remote Command	:DISPlay:BACKlight:INTensity <integer> :DISPlay:BACKlight:INTensity?
Example	DISP:BACK:INT 50

9 Monitor Spectrum Measurement
View/Display

Preset	100 (Set by Restore Misc Defaults)
Min	0
Max	100
Initial S/W Revision	Prior to A.02.00

Remote SCPI Commands and Data Queries

Remote SCPI Results described in this section include:

[":READ and :FETCh Commands" on page 1285](#)

[":CALCulate:DATA" on page 1288](#)

[":CALCulate:DATA:RAW" on page 1289](#)

[":CALCulate:DATA:RAW:COMPLex" on page 1290](#)

[":CALCulate:DATA:POINTs commands" on page 1290](#)

[":CALCulate:DATA:TABL commands" on page 1291](#)

[":CALCulate:DATA:HEADer commands" on page 1295](#)

[":CALC:CLIMits:FAIL?" on page 1297](#)

["IQ Data Transfers " on page 1297](#)

VSA based Measurements produce a rich variety of results that can be displayed in any of 4 traces. A result can consist of an array of X,Y trace data that is typically shown as a graph or scalar results that are displayed as a table. The Symbol/Error result that is part of many demodulation measurements actually displays both a trace table (the error statistics) and trace data (the symbol information, which is not graphed but listed). The CALC:<meas>:DATA<n> commands enable you to retrieve any trace data or trace table. This family of commands also enable you to get information about the names of data results available and the units associated with them, as well as names and results of meta-data associated with traces.

Selected results are available via the FETCh and READ SCPI interfaces. These commands refer to data results by arbitrary index number rather than by trace number.

Key Path	SCPI Only
Mode	LTE, LTETDD, IDEN, VSA

:READ and :FETCh Commands

The SCPI MEASure, READ, and FETCh are typically offered by applications with focus on manufacturing test, where a fixed set of desired results is known in advance and seldom changes. The VSA based measurements are many, due to a focus on development. Thus, for most VSA based measurements there is no standard configuration that yields a useful measurement 90% of the time. Thus, the MEASure function is not offered for most measurements in the VSA Application. However, READ and FETCh can be implemented for select results. Note that these results are also still available using the CALC:<meas>:DATA:TABLE family of commands.

ACP and OBW are available in all VSA based measurements. To retrieve the ACP or OBW data, the function must be enabled on a frequency-domain trace and the associated summary data table must be assigned to another trace. Note however, the index n in the following commands is not trace number but an index picked out of the tables shown below.

:FETCh:<meas> [n] ?

:READ:<meas>[n]?

The results available for various values of n are shown below:

Condition	N	Results Returned
Mode = VSA LTE IDEN	Not specified or n=1	Reserved for selected results of VSA measurements. If not used for a particular measurement, no result is returned and error -114 Header suffix out of range is generated.
Mode = VSA LTE IDEN	2 - 50	Reserved for selected results of VSA measurements. If not used for a particular measurement, no result is returned and error -114 Header suffix out of range is generated.
Mode = VSA LTE IDEN, ACP on trace 1	51	ACP Summary for trace 1 Returns 28 comma-separated scalar results, corresponding to the swept ACP results where possible; n/a elsewhere: Returns 28 comma-separated scalar results, in the following order. 1. 0.0 2. Total carrier power (dBm) (same as item 4, because only 1 carrier supported) 3. 0.0 4. Reference carrier power (dBm) 5. Lower offset A - relative power (dB) 6. Lower offset A - absolute power (dBm) 7. Upper offset A - relative power (dB) 8. Upper offset A - absolute power (dBm) 9. Lower offset B - relative power (dB) 10. Lower offset B - absolute power (dBm) 11. Upper offset B - relative power (dB) 12. Upper offset B - absolute power (dBm) ... 21. Lower offset E - relative power (dB) 22. Lower offset E - absolute power (dBm) 23. Upper offset E - relative power (dB) 24. Upper offset E - absolute power (dBm) 25. n/a 26. n/a 27. n/a 28. n/a 29. Overall ACP test result summary (0 indicates at least 1 failure, 1 indicates all passed) If any result is not available, NaN (9.91 E 37) is returned. This can happen if ACP is turned off (all results unavailable) or when an offset is entirely off-screen. In the case where it is partially off-screen, the measured result is returned even though its validity is questionable.
Mode = VSA LTE IDEN, ACP on trace 2	52	ACP Summary for trace 2 see list for trace 1 summary

Mode = VSA LTE IDEN, ACP on trace 3	53	ACP Summary for trace 3 see list for trace 1 summary
Mode = VSA LTE IDEN, ACP on trace 4	54	ACP Summary for trace 4 see list for trace 1 summary
Mode = VSA LTE IDEN, ACP on trace 5	55	ACP Summary for trace 5 see list for trace 1 summary
Mode = VSA LTE IDEN, ACP on trace 6	56	ACP Summary for trace 6 see list for trace 1 summary
	57-60	no result returned; error -114, Header suffix out of range generated
Mode = VSA LTE IDEN, OBW on trace 1	61	OBW Summary for trace 1 Returns 9 comma-separated scalar results corresponding exactly to the items in the OBW Summary trace: 1. OBW (Hz) 2. Pwr (dBm) 3. Total Pwr (dBm) 4. Pwr Ratio (no unit, E.g. 0.99) 5. OBW upper freq (Hz) 6. OBW lower freq (Hz) 7. Centroid freq (Hz) 8. Offset freq (Hz) 9. OBW Test Result (0 for fail, 1 for pass) If the results are not available, NaN (9.91 E 37) is returned.
Mode = VSA LTE IDEN, OBW on trace 2	62	OBW Summary for trace 2 see list for trace 1 summary
Mode = VSA LTE IDEN, OBW on trace 3	63	OBW Summary for trace 3 see list for trace 1 summary
Mode = VSA LTE IDEN, OBW on trace 4	64	OBW Summary for trace 4 see list for trace 1 summary
Mode = VSA LTE IDEN, OBW on trace 5	65	OBW Summary for trace 5 see list for trace 1 summary
Mode = VSA LTE IDEN, OBW on trace 6	66	OBW Summary for trace 6 see list for trace 1 summary

Key Path	SCPI Only
Mode	LTE, LTETDD, IDEN, VSA

:CALCulate:DATA

Once measurement data result is assigned to a trace, the data can be retrieved by using one of the following commands (where <n> is the trace number and <meas> is the current VSA based measurement).

:CALC:<meas>:DATA<n>?

:CALC:<meas>:DATA<n>:RAW?

The first form of the command retrieves the data as formatted on the display. For example, if (in a vector measurement) you have the Spectrum result in LogMag format on trace 1, then

:CALC:VECT:DATA1?

returns an array of spectrum amplitude (Y data) in units of dBm, and

:CALC:VECT:DATA1:RAW?

returns the Y data in its underlying units of Volts (peak) squared.

(To get data from displayed tables, see [":CALCulate:DATA:TABL commands" on page 1291.](#))

The CALC:<meas>:DATA commands get data from traces. There are many results available from a VSA based measurement and only 4 traces in which to view them. View Preset commands are one way of displaying frequently-used results in standard trace locations. Or you can assign any measurement result to any trace using the softkeys under Trace/Detector, Data. The SCPI command for doing this is:

:DISP:<meas>:TRAC<n>:FEED "<data_name>"

For example, if (in a vector measurement) you want to view the CCDF result in trace 4, you send:

:DISP:VECT:TRAC4:FEED "CCDF1"

(If the measurement has not run yet, use INIT:IMM to run it.) Then the CCDF data can be retrieved using

CALC:VECT:DATA4?

or

CALC:VECT:DATA4:RAW?

Key Path	SCPI Only
Mode	VSA, LTE, LTETDD, IDEN
Measurement	<meas>:=VECTor ADEMod DDEMod W11A W11B EVM IPOWER IDEMod MOTotalk
Remote Command	:CALCulate:<meas>:DATA[1] 2 ...4? [Y X XY[,OFF ON 0 1] LL UL]
Example	CALC:VECT:DATA1? CALC:VECT:DATA1? Y,ON

	<p>CALC:VECT:DATA1? X CALC:VECT:DATA1? XY</p>
Notes	<p>Query only. This retrieves the data in the designated trace as displayed.</p> <p>For example, if Trace 1 is assigned Spectrum data and formatted as LogMag, then :CALC:VECT:DATA1? returns the Y data in dBm. If the X axis is scaled to show only a portion of the trace data, only the data shown is returned.</p> <p>The numeric format of the returned data is controlled by FORMat[:TRACe][:DATA] command</p> <p>The optional parameters control what data is returned.</p> <p>:CALC:VECT:DATA1? Y is the same as :CALC:VECT:DATA1? with no parameter. It returns an array of Y values.</p> <p>:CALC:VECT:DATA1? X returns an array of X values that correspond to the Y values above.</p> <p>:CALC:VECT:DATA1? XY returns interleaved X and Y data. That is: <x1> <y1> <x2> <y2>...</p> <p>Normally, this command only returns the data between the current X scale limits. If the optional ",OFF" or ",0" switch is included at the end of the command, then all data is returned (regardless of X scaling or the state of All Frequency Points).</p> <p>:CALC:EVM:DATA1? LL UL returns an array of Lower/Upper Limit values when Limit Test is enabled and the trace includes limit values. When Limit Test is disabled or the trace does not include limit value, this query is the same as :CALC:EVM:DATA1? with no parameter.</p> <p>Note: LL and UL are available only for the EVM measurement in the LTE/LTE TDD modes.</p> <p>Note: the X and Y parameters in this command refer to the display's horizontal and vertical axes. Normally the X axis is the independent variable, but if the display format is Constellation or IQ, then CALC:<meas>:DATA<n>? [Y] returns the imaginary part of the data and CALC:<meas>:DATA<n>? X returns the real part of the data. If you want the values of the independent variable, change to a non-vector format (such as Log Mag) and use CALC:<meas>:DATA<n>? X</p>
Initial S/W Revision	Prior to A.02.00
Modified at S/W Revision	A.02.00, A.08.00

:CALCulate:DATA:RAW

Retrieves trace data in its underlying units, before the formatting calculation that converts it to displayed units. Underlying units are typically Volts peak (for signal results) or Volts peak squared (for power results). All data points are returned, whether or not they are displayed.

Key Path	SCPI Only
Mode	VSA, LTE, LTETDD, IDEN
Measurement	<meas>:=VECTor ADEMod DDEMod W11A W11B EVM IPOWER IDEMod MOTotalk
Remote Command	:CALCulate:<meas>:DATA[1] 2 ...4:RAW?
Example	CALC:VECT:DATA1:RAW?
Notes	Query only. This retrieves the unformatted Y data in the designated trace. If Y data is complex, it is returned as <y_real1> <y_imag1> <y_real2> <y_imag2> etc.
Initial S/W Revision	Prior to A.02.00
Modified at S/W Revision	A.02.00

:CALCulate:DATA:RAW:COMPLex

Determines if the data retrieved by CALC:<meas>:DATA:RAW<n>? is complex.

Key Path	SCPI Only
Mode	VSA, LTE, LTETDD, IDEN
Measurement	<meas>:=VECTor ADEMod DDEMod W11A W11B EVM IPOWER IDEMod MOTotalk
Remote Command	:CALCulate:<meas>:DATA[1] 2 ...4:RAW:COMPLex?
Example	CALC:VECT:DATA1:RAW:COMP?
Notes	Query only. Returns 1 if the trace data is complex, 0 if it is real.
Initial S/W Revision	Prior to A.02.00
Modified at S/W Revision	A.02.00

:CALCulate:DATA:POINTs commands

Returns the number of points that are returned by

CALCulate:<meas>:DATA<n>?

X axis scaling and whether All Frequency Points is on or off can affect this number.

NOTE

For the CALCulate:<meas>:DATA<n>? XY command there are 2 numbers returned per data point.

Key Path	SCPI Only
Mode	VSA, LTE, LTETDD, IDEN
Measurement	<meas>:=VECTor ADEMod DDEMod W11A W11B EVM IPOWER IDEMod MOTotalk
Remote Command	:CALCulate:<meas>:DATA[1] 2 ...4:POINTs? [OFF ON 0 1]
Example	CALC:VECT:DATA1:POINTs?
Notes	<p>Query only.</p> <p>Use the optional "OFF 0" parameter to determine the number of points that are returned by the optional command form:</p> <p>:CALCulate:<meas>:DATA<n>? Y X XY,OFF 0</p> <p>Note that this is points, not array size. If the XY parameter is included, there are 2 numbers returned per point.</p> <p>(ON or 0, which means use the X-scaled version, is the default and the result is the same as if the parameter is omitted).</p>
Initial S/W Revision	Prior to A.02.00
Modified at S/W Revision	A.02.00

This query returns the number of points that are returned by

CALCulate:<meas>:DATA:RAW<n>?

NOTE

For complex trace data, there are 2 numbers returned per data point.

Key Path	SCPI Only
Mode	VSA, LTE, LTETDD, IDEN
Measurement	<meas>:=VECTor ADEMod DDEMod W11A W11B EVM IPOWER IDEMod MOTotalk
Remote Command	:CALCulate:<meas>:DATA[1] 2 ...4:RAW:POINTs?
Example	CALC:VECT:DATA1:RAW:POINTs?
Notes	Query only.
Initial S/W Revision	Prior to A.02.00
Modified at S/W Revision	A.02.00

:CALCulate:DATA:TABL commands

Some traces have tabular data associated with them. In fact, there may be only a table and no trace data. Each entry in the table consists of a name, a measured value, and units. The units are sometimes not shown. You can programmatically retrieve arrays of all the names, all the values, and all the units of a table. These arrays are all ordered so that corresponding indices have associated values, for example, the 4th name in the names array corresponds to the 4th value in the results array. (Note that the array order cannot be the same as the displayed order.) You can also get a particular result from the table by name. Here is a summary of the remote table data commands.

Command	Returns	Example
CALCulate:<meas>:DATA<n>:TABLe?	All table data results (as an array)	CALC:DDEM:DATA4:TABL?
CALCulate:<meas>:DATA<n>:TABLe? "<name>"	The table data result referred to by name	CALC:DDEM:DATA4:TABL? "EvmPeak"
CALCulate:<meas>:DATA<n>:TABLe:NAMes?	Comma-separated list of all table data names	CALC:DDEM:DATA4:TABL:NAM?
CALCulate:<meas>:DATA<n>:TABLe:UNIT?	Comma-separated list of all table data units	CALC:DDEM:DATA4:TABL:UNIT?

For example, if within the Vector Analysis measurement, you have an OBW Summary Table displayed in trace 2, CALC:DDEM:DATA2:TABL:NAM? would return the table names as follows:

"Obw,Pwr,TotalPwr,PwrRatio,ObwUpper,ObwLower,Centroid,Offset"

and CALC:DDEM:DATA2:TABL:UNIT? would return the units. (A null string means the result is unitless.)

"Hz,Vrms^2,Vrms^2,,Hz,HZ,HZ,HZ"

You can then get all the table results by sending

CALC:DDEM:DATA2:TABL?

Result number 1 is Obw and has units of Hz, result number 2 is Pwr with units of Vrms^2, and so on.

You can also get individual table entries by asking for them by name. Any name returned from the CALC:DDEM:DATA2:TABL:NAM? query can be used. For example, to get TotalPwr you can send the following query:

CALC:DDEM:DATA2:TABL? "TotalPwr"

Query Table Data as Number

Gets data from a table shown in the designated trace. Tables shown on the display typically have the name of a parameter followed by its measured value

Key Path	SCPI Only
Mode	VSA, LTE, LTETDD, IDEN
Measurement	<meas>:=VECTor ADEMod DDEMod W11A W11B EVM IPOWER IDEMod MOTotalk
Remote Command	:CALCulate:<meas>:DATA[1] 2 ...4:TABLe[:NUMBer]? [<string>]
Example	CALC:DDEM:DATA2:TABL? "Obw"
Notes	Query only. If sent without a string specifier, this returns the entire table for the designated trace. If sent with a string specifier, returns a specific table entry in the designated trace. The string specifier must be delimited by single or double quotes. A list of valid strings can be obtained using CALC:<meas>:DATA:TABL:NAM? If an invalid string is sent, an error is generated. The returned results are in numeric format, under control of the FORMat[:TRACe][:DATA] command. For table data that is non-numeric, NaN is returned. To get the value of these data, use the CALC:<meas>:DATA2:TABL:STR? command.
Initial S/W Revision	Prior to A.02.00
Modified at S/W Revision	A.02.00

Query Table Data as String

Some tables have string data. The above Trace Table Data query cannot return it and sends NaN in its place. Here is a form of Trace Table Data query that can return string data from tables.

Key Path	SCPI Only
Mode	VSA, LTE, LTETDD, IDEN

Measurement	<meas>:=VECTor ADEMod DDEMod W11A W11B EVM IPOWER IDEMod MOTotalk
Remote Command	:CALCulate:<meas>:DATA[1] 2 ...4:TABLE:STR? [<string>]
Example	CALC:DDEM:DATA2:TABL:STR? "Obw"
Notes	Query only. If sent without a string specifier, this returns the entire table for the designated trace in comma-separated format. If sent with a string specifier, returns a specific table entry in the designated trace. The string specifier must be delimited by single or double quotes. A list of valid strings can be obtained using CALC:<meas>:DATA:TABL:NAM? If an invalid string is sent, an error is generated.
Initial S/W Revision	Prior to A.02.00
Modified at S/W Revision	A.02.00

Query Table Names

Returns a comma-separated list of names of the table data entries for the designated trace. Each of the names can be used (surrounded by quotes or double quotes) as a parameter in the Trace Table Data commands. The names appear in the same order as the corresponding data values returned by the CALC:<meas>:DATA<n>:TABL[:NUMB|STR]? query.

Key Path	SCPI Only
Mode	VSA, LTE, LTETDD, IDEN
Measurement	<meas>:=VECTor ADEMod DDEMod W11A W11B EVM IPOWER IDEMod MOTotalk
Remote Command	:CALCulate:<meas>:DATA[1] 2 ...4:TABLE:NAMes?
Example	CALC:VECT:DATA1:TABL:NAM?
Notes	Query only. This retrieves the names of the table entries for the designated trace. Each of these names can be used in the CALC:<meas>:DATA:TABL? '<name>' command to access a single table entry.
Initial S/W Revision	Prior to A.02.00
Modified at S/W Revision	A.02.00

Query Table Units

Returns a comma-separated list of all the units for the table data entries for the designated trace. If a data result is unitless, an empty string appears in the list for that result. The units appear in the same order as the corresponding data values returned by the CALC:<meas>:DATA<n>:TABL[:NUMB|STR]? query.

Key Path	SCPI Only
Mode	VSA, LTE, LTETDD, IDEN
Measurement	<meas>:=VECTor ADEMod DDEMod W11A W11B EVM IPOWER IDEMod MOTotalk
Remote Command	:CALCulate:<meas>:DATA[1] 2 ...4:TABLE:UNIT?

Example	CALC:VECT:DATA1:TABL:UNIT?
Notes	Query only. This retrieves a list of units for table entries for the designated trace. The units are given in the order that the entries are sent from the :CALC:<meas>:DATA:TABL? command.
Initial S/W Revision	Prior to A.02.00
Modified at S/W Revision	A.02.00

The following table data is available in all measurements when the ACP function is turned on and the associated summary table is shown in a trace:

Result name	Displayed Unit	Remote Name	Remote Unit
Reference Bandwidth	Hz	RefBw	Hz
Reference Alpha		RefAlpha	
Reference Power	dBm	RefPwr	Vrms ²
Offset	Hz	Offset1, Offset2, Offset3, Offset4, Offset5	Hz
BW	Hz	Bw1, Bw2, Bw3, Bw4, Bw5	Hz
Alpha		Alpha1, Alpha2, Alpha3, Alpha4, Alpha5	
Lower Pwr	dBm	LowPwr1, LowPwr2, LowPwr3, LowPwr4, LowPwr5	Vrms ²
Lower ACPR	dB	LowRatio1, LowRatio2, LowRatio3, LowRatio4, LowRatio5	
Upper Pwr	dBm	HiPwr1, HiPwr2, HiPwr3, HiPwr4, HiPwr5	Vrms ²
Upper ACPR	dB	HiRatio1, HiRatio2, HiRatio3, HiRatio4, HiRatio5	
Max ACPR	dB	MaxRatio1, MaxRatio2, MaxRatio3, MaxRatio4, MaxRatio5	

The following table data is available in all measurements when the OBW function is turned on and the associated summary table is shown in a trace:

Result name	Displayed Unit	Remote Name	Remote Unit
Occupied Bandwidth	Hz	Obw	Hz
Power	dBm	Pwr	Vrms ²

Total Power	dBm	TotalPwr	Vrms^2
Power Ratio	%	PwrRatio	
Upper Freq	Hz	ObwUpper	Hz
Lower Freq	Hz	ObwLower	Hz
Centroid Freq	Hz	Centroid	Hz
Offset Freq	Hz	Offset	Hz

:CALCulate:DATA:HEADer commands

Trace data also has meta-data associated with it, called headers, which is visible if you export trace data in text format. The headers have a name and a value that can be obtained from any trace by using the CALCulate:<meas>:DATA:HEADer commands described in this section.

The following Remote Commands are described in this section:

["Query Header Names" on page 1295](#)

["Query Header Type" on page 1295](#)

["Query Header as String" on page 1296](#)

["Query Numeric Header" on page 1296](#)

[":CALC:CLIMits:FAIL?" on page 1297](#)

Query Header Names

Returns a comma-separated list of all the header names associated with the designated trace. Each of the names can be used (surrounded by quotes or double quotes) as a parameter in the other CALC:<meas>:DATA<n>:HEAD queries.

Key Path	SCPI Only
Mode	VSA, LTE, LTETDD, IDEN
Measurement	<meas>:=VECTor ADEMod DDEMod W11A W11B EVM IPOWER IDEMod MOTotalk
Remote Command	:CALCulate:<meas>:DATA[1] 2 ...4:HEADer:NAMes?
Example	CALC:VECT:DATA1:HEAD:NAM?
Notes	Query only. Returns a comma-separated list of header names.
Initial S/W Revision	Prior to A.02.00
Modified at S/W Revision	A.02.00

Query Header Type

Returns whether the designated header on the designated trace can be queried as a number or by a string only.

Key Path	SCPI Only
Mode	VSA, LTE, LTETDD, IDEN
Measurement	<meas>:=VECTor ADEMod DDEMod W11A W11B EVM IPOWER IDEMod MOTotalk
Remote Command	:CALCulate:<meas>:DATA[1] 2 ...4:HEADer:TYPE? <string>
Example	CALC:VECT:DATA1:HEAD:TYPE? 'XDelta'
Notes	Query only. This retrieves the type of the named header for the designated trace. The name (delimited by single or double quotes) is one of the names returned by CALC:<meas>:DATA:HEAD:NAMES? If a valid header name is passed in, the return value from this query is either STR or NUMB. NONE is returned if there is no such header.
Initial S/W Revision	Prior to A.02.00
Modified at S/W Revision	A.02.00

Query Header as String

Gets a header by name from the designated trace and returns its value as a string.

Key Path	SCPI Only
Mode	VSA, LTE, LTETDD, IDEN
Measurement	<meas>:=VECTor ADEMod DDEMod W11A W11B EVM IPOWER IDEMod MOTotalk
Remote Command	:CALCulate:<meas>:DATA[1] 2 ...4:HEADer:STRing? <string>
Example	CALC:VECT:DATA1:HEAD:STR? 'WindowType'
Notes	Query only. This retrieves the named header for the designated trace. The name (delimited by single or double quotes) is one of the names returned by the CALC:<meas>:DATA:HEAD:NAMES? The return value is a string. If the requested header value is a numeric or if there is no such header, an empty string is returned.
Initial S/W Revision	Prior to A.02.00
Modified at S/W Revision	A.02.00

Query Numeric Header

Gets a numeric header by name from the designated trace and returns its value in a format determined by the last FORM command.

Key Path	SCPI Only
Mode	VSA, LTE, LTETDD, IDEN
Measurement	<meas>:=VECTor ADEMod DDEMod W11A W11B EVM IPOWER IDEMod MOTotalk
Remote Command	:CALCulate:<meas>:DATA[1] 2 ...4:HEADer[:NUMBer]? <string>
Example	CALC:VECT:DATA1:HEAD? 'XDelta'
Notes	Query only. This retrieves the named header for the designated trace. This form of the HEAD? query is for headers whose type is NUMB (as determined by :CALC:<meas>:DATA:HEAD:TYPE?).

	The name parameter (delimited by single or double quotes) is one of the names returned by CALC:<meas>:DATA:HEAD:NAMes? The format of the return data is determined by the FORMat [:TRACe][:DATA] command. If used to query a header whose type is STR or there is no such header, NaN (9.91e37) is returned
Initial S/W Revision	Prior to A.02.00
Modified at S/W Revision	A.02.00

:CALC:CLIMits:FAIL?

If one or more ACP or OBW limit tests are active, then the CALC:CLIMits:FAIL? command returns the aggregate pass or fail status.

IQ Data Transfers

Fast capture/transfer of a large amount of IQ data is supported over SCPI. To do this, first set up the desired measurement range, center frequency, span, triggering, and so on. Use a time length that is convenient for setting up the measurement. The time length for the captured data is set indirectly as shown below.

To perform the capture, a typical SCPI sequence is as follows:

```
FCAP:LENG <num_samples>
```

This command sets the length for the next capture in samples. The sample rate is proportional to the current span and can be determined by a SCPI query, for example, in the Vector measurement the query:

```
VECT:SWE:ISR?
```

returns the input sample rate. For the IQAnalyzer (Basic) mode, the sample rate SCPI query is defined as follows:

```
:SPEC:SRAT? (Complex spectrum measurement)
```

```
:WAV:SRAT? (Waveform measurement)
```

Multiply the time length desired for the captured data by this sample rate to get the number of samples needed.

```
INIT:FCAP
```

pauses the current measurement and starts capturing IQ data using the current setup and trigger conditions. (The instrument front panel display does not change nor show the captured data.)

To read the captured data via SCPI in blocks, set the read block size using the command:

```
FCAP:BLOC <num_points_per_read_block>
```

The maximum read block size is typically less than the total fast capture buffer size and can be determined by the query "FCAP:BLOC? MAX". Now you can repeatedly use the following query to read out successive blocks of data:

```
FETC:FCAP?
```

The returned data is formatted according to the most recent :FORMat[:DATA] and :FORMat:BORDER commands. A read pointer that indicates the next sample to be transferred is advanced automatically following each FETC:FCAP? query. This pointer position can be read or manually set via the SCPI commands:

FCAP:POIN?

FCAP:POIN <read_pointer_position>

The fast capture data can be read as long as you use only the commands to set read block size and pointer position, or queries that return the state of the current measurement. The capture data is cleared by any command that changes the measurement state or initiates a new measurement, or via SCPI device clear or :ABORT commands.

Fast capture data word size can be set to either 32 bit or 64 bit via the FCAP:WLEN command. This enables you to trade off precision for total capture length.

Note: when the word size is 32 bit, points can only be retrieved on even sample number boundaries, that is, the pointer and block length should be even numbers. Therefore, when the word size is set to auto, it is recommended that the pointer and block size be only set to even numbers.

Fast Capture Length

Sets the length of the SCPI Fast Capture in samples (points). This is constrained to be an even number.

Query returns the most recent length setting.

Key Path	SCPI Only
Mode	VSA, BASIC
Remote Command	[[:SENSe]]:FCAPture:LENGth <integer> [[:SENSe]]:FCAPture:LENGth?
Example	FCAP:LENG 1000 FCAP:LENG?
Notes	This is affected by the IF path currently used, which can in turn be affected by span. It is also affected by the internal Fast Capture Word Length. The current maximum fast capture length can be found by using the query: FCAP:LENG? MAX Changing the Capture Length after initiating a fast capture clears the capture memory in preparation for a new fast capture of a different length. No Front panel access; SCPI only
Preset	1048576 Samples
Min	2
Max	536 870 908 Samples for internal 40 MHz and 140 MHz options with FCAP:WLEN BIT32
Initial S/W Revision	A.04.00

Fast Capture Word Length

Enables choice of internal fast capture word length. Shorter word length enables twice the time length to be captured at the cost of quantization noise. Note that this does not affect the format of data returned by FETCh:FCAPture, only the internal representation.

Key Path	SCPI Only
Mode	VSA, BASIC
Remote Command	<code>[:SENSe] :FCAPture:WLENgth AUTO BIT32 BIT64</code> <code>[:SENSe] :FCAPture:WLENgth?</code>
Example	FCAP:WLEN AUTO FCAP:WLEN?
Notes	No Front panel access; SCPI only.
Preset	AUTO
Initial S/W Revision	A.04.00

Initiate Fast Capture

Waits for the sweep to trigger and then captures the fast capture data. Sweep is then set to pause. The amount of data captured is controlled by the Fast Capture Length command (FCAP:LENG).

Key Path	SCPI Only
Mode	VSA, BASIC
Remote Command	<code>:INITiate:FCAPture</code>
Example	INIT:FCAP
Notes	This is an overlapped command. It returns immediately, but the capture may not be complete. Use *OPC?, *WAI, or *OPC to determine when the capture is complete.
Notes	No Front panel access; SCPI only This command resets the Fast Capture Pointer to 0
Initial S/W Revision	A.04.00

Fast Capture Block

Sets the block size for the Fast Capture transfer in samples (points). This is the number of points that are returned from the Capture buffer by the FETC:FCAP? command. This is constrained to be an even number.

Query returns most recent block size setting.

Key Path	SCPI Only
Mode	VSA, BASIC
Remote Command	<code>[:SENSe] :FCAPture:BLOCK <integer></code>

	<code>[:SENSe] :FCAPture:BLOCK?</code>
Example	<code>FCAP:BLOC 100</code> <code>FCAP:BLOC?</code>
Notes	No Front panel access. SCPI only.
Preset	1024 Samples
Min	0
Max	131072 or Fast Capture Length, whichever is smaller
Initial S/W Revision	A.04.00

Fast Capture Pointer

Sets the pointer position for the Fast Capture transfer in samples (points). The pointer is incremented by the block size each time the fetch is performed. Preset value (0) is the first sample in the record. Thus repetitive fetches result in contiguous data without needing to increment the pointer over SCPI. This is constrained to be an even number. Query returns most recent pointer setting.

Key Path	SCPI Only
Mode	VSA, BASIC
Remote Command	<code>[:SENSe] :FCAPture:POINter <integer></code> <code>[:SENSe] :FCAPture:POINter?</code>
Example	<code>FCAP:POIN 100</code> <code>FCAP:POIN?</code>
Notes	INIT:FCAP or FCAP:ABOR resets the pointer to 0. No front panel access; SCPI only.
Preset	0 Samples
Min	0
Max	Must be less than the Fast Capture length
Initial S/W Revision	A.04.00

Fetch Fast Capture

Transfers the block of data starting at the pointer. The number of samples transferred is set with the block size. The pointer is incremented by the block size after the fetch.

Key Path	SCPI Only
Mode	VSA, BASIC
Remote Command	<code>:FETCh:FCAPture?</code>
Example	<code>FETC:FCAP?</code>
Notes	The returned data is formatted according to the most recent <code>:FORMat[:DATA]</code> and <code>:FORMat:BORDER</code>

commands.

If the read pointer position plus read block size exceeds the Fast Capture Length, only the data between the pointer and the end of the fast capture buffer are returned, and error -200 is reported.

If Fetch is attempted before an INIT:FCAP or if the captured data is cleared by some other operation (e.g., REC), error -230 is reported and no data is returned.

No front panel access; SCPI only.

Initial S/W Revision	A.04.00
----------------------	---------

Input Sample Rate Query

Returns the complex sample rate in Hz for the current VXA measurement setup conditions. The sample rate can be used to convert between time and number of sample points when using the Fast Capture feature.

Sample rate depends on the settings for `FREQ:SPAN` and `IFPath`. You need to set these before making this query. Though the measurement name is specified in the query, you can only query the currently configured measurement. That is, if you have sent `CONF:VECT`, the query `ADEM:SWE:ISR?` generates an error.

Key Path	SCPI Only
Mode	VSA
Measurement	<meas>:=VECTor ADEMod DDEMod W11A W11B
Remote Command	[:SENSe] :<meas>:SWEp:ISRate?
Example	VECT:SWE:ISR?
Notes	<p>Query returns the complex sample rate in Hz for the current VXA Vector measurement setup conditions.</p> <p>If the measurement in the query is not the active measurement, error -230 is reported and no data is returned.</p> <p>This query is SCPI only, no Front Panel softkey.</p>
Preset	Depends on the licensed IF path
Initial S/W Revision	A.04.00

Parameter Update Enable

Refers only to measurements that use the VSA measurement engine. These are all the measurements in the Vector Signal Analyzer (VXA) Application and the EVM measurement in the LTE Applications.

When a measurement parameter is changed, the new value is used to update any dependent parameters and measurement results. This update process is normally done after every parameter change. This enables visual feedback during interactive GUI operation. However, with SCPI controlled measurements, typically a lot of parameter changes are done at once with the measurement stopped and then the measurement is run once and data retrieved. Here, is not necessary, and the accumulated update time for

each parameter change can become significant. The Parameter Update Enable command enables you to postpone update while sending setup commands and then enable one update to occur just before the measurement.

For example, if you are programmatically setting up a complex LTE measurement, you could save some setup time by first sending EVM:PUPD:ENAB OFF, then sending the whole group of measurement setup commands. When you are done with the setup, send EVM:PUPD:ENAB:ON. This causes the measurement state to be updated with all dependencies resolved. After this, you can read back the parameters' actual values. As a convenience, starting or continuing a measurement (INITiate:REStart, INITiate:IMMEDIATE, INITiate:<meas> or INITiate:RESume) automatically sets <meas>:PUPD:ENAB to ON. So does CONFigure:<meas> or any of the reset and recall state commands.

This command should be used with caution.

It is only valid to turn <meas>:PUPD:ENAB OFF when <meas> is the currently active measurement and the measurement is paused (i.e., INIT:CONT is OFF).

If you try to set and then read back a parameter value while Parameter Update Enable is off, you are not guaranteed to get back the true value that is used in the measurement because no parameter limiting is being done nor are any dependencies between parameters being resolved.

If you try to set coupled parameters independently when Parameter Update Enable is off, then when it is turned on, at most one of the parameter settings remain the same and the others change due to dependency resolution.

Key Path	SCPI Only
Mode	VSA, LTE, LTETDD, IDEN
Measurement	<meas>:=VECTor ADEMod DDEMod W11A W11B EVM IPOWER IDEMod MOTotalk
Remote Command	[:SENSe] : <meas> : PUPDate : ENABle OFF ON 0 1 [:SENSe] : <meas> : PUPDate : ENABle ?
Example	EVM:PUPD:ENAB OFF
Notes	Commands that cause a measurement to run, that switch measurements, or that preset or recall measurement state, set Parameter Update state to ON. These include INIT:IMM, INIT:REST, INIT:RES, INIT:<meas>, and CONF:<meas>.
Preset	1
State Saved	No
Initial S/W Revision	A.03.00

10 Measurement Functions

10 iDEN Power Measurement

The iDEN Power measurement provides results for Occupied Bandwidth and Adjacent Channel Power measurements for iDEN/WiDEN signals.

This topic contains the following sections:

["Measurement Commands for iDEN Power Measurement" on page 688](#)

["Remote Command Results for iDEN Power Measurement" on page 689](#)

Measurement Commands for iDEN Power Measurement

The particular tests enabled does not affect the order, or subopcode, of the remote results. Each available remote result, indexed by subopcode, has a corresponding summary trace. The remote user can use this equivalence by either visually inspecting the corresponding summary trace on the display or by using CALC:DATA queries that programmatically describe the corresponding summary trace.

```
:CONF:IPower  
:FETCh:IPower [n]?  
:INITiate:IPower  
:MEASure:IPower [n]?  
:READ:IPower [n]?
```

For more measurement related commands, see the SENSE subsystem and the section ["Remote Measurement Functions" on page 1165](#).

Remote Command Results for iDEN Power Measurement

The following table denotes the returned results from the (FETCh|MEASure|READ):IPOWER commands and their corresponding CALC:DATA queries, indexed by subopcode:

Index n	Results Returned
Not specified or n=1	<p>In order to read this result, trace 3 should display the "Spectrum" trace and trace 4 should display the "Trc3 ACP Summary" trace. The power-on layout can satisfy this requirement. You can also press "Preset View:Test Standard" key at "View/Display" panel, or send SCPI ":DISPlay:IPOWER:VIEW:PRESet TSTD" to return to the power-on layout.</p> <p>Returns 29 comma-separated scalar results, corresponding exactly to the items in the ACP Summary trace:</p> <ol style="list-style-type: none"> 1. Unused, returns 0.0 2. TotalPwr (dBm)(Same value as RefPwr) 3. Unused, returns 0.0 4. Ref Pwr (dBm) 5. Lower Offset 1 Rel Power (dB) 6. Lower Offset 1 Abs Power (dBm) 7. Upper Offset 1 Rel Power (dB) 8. Upper Offset 1 Abs Power (dBm) 9. Lower Offset 2 Rel Power (dB) 10. Lower Offset 2 Abs Power (dBm) 11. Upper Offset 2 Rel Power (dB) 12. Upper Offset 2 Abs Power (dBm) 13. Lower Offset 3 Rel Power (dB) 14. Lower Offset 3 Abs Power (dBm) 15. Upper Offset 3 Rel Power (dB) 16. Upper Offset 3 Abs Power (dBm) 17. Lower Offset 4 Rel Power (dB) 18. Lower Offset 4 Abs Power (dBm) 19. Upper Offset 4 Rel Power (dB) 20. Upper Offset 4 Abs Power (dBm) 21. Lower Offset 5 Rel Power (dB) 22. Lower Offset 5 Abs Power (dBm) 23. Upper Offset 5 Rel Power (dB) 24. Upper Offset 5 Abs Power (dBm) 25. Unused, returns 0.0 26. Unused, returns 0.0 27. Unused, returns 0.0 28. Unused, returns 0.0 29. ACP Test Result (0 for fail, 1 for pass) <p>If the results are not available, NaN is returned. This includes the case of when the Adjacent Channel is entirely off-screen. In the case where it is partially off-screen, the</p>

measured result is returned, even though its validity is questionable.

n=2

In order to read this result, trace 1 should display the "Spectrum" trace and trace 2 should display the "Trc1 ACP Summary" trace. The power-on layout can satisfy this requirement. You can also press "Preset View:Test Standard" key at "View/Display" panel or send SCPI ":DISPlay:IPower:VIEW:PRESet TSTD" to return to the power-on layout.

Returns 9 comma-separated scalar results, corresponding exactly to the items in the OBW Summary trace:

1. OBW (Hz)
2. Pwr (dBm)
3. Total Pwr (dBm)
4. Pwr Ratio (no unit, for example 0.99)
5. OBW upper freq (Hz)
6. OBW lower freq (Hz)
7. Centroid freq (Hz)
8. Offset freq (Hz)
9. OBW Test Result (0 for fail, 1 for pass)

If the results are not available, -NaN is returned.

In addition to these results, other results are defined in [":CALCulate:DATA" on page 1288.](#)

Key Path	Meas
Mode	IDEN
Initial S/W Revision	A.02.00

AMPTD Y Scale (Amplitude)

Accesses a menu that enables you to control input signal conditioning as well as the Y-scaling of trace data. Input signal conditioning actually affects the input signal and the associated measurement quality, whereas Y-scaling is non-destructive of data. Even if the data is scaled so as to be clipped or completely off the display, the marker readouts are still correct and accurate data can still be retrieved via SCPI.

Key Path	Front Panel
Initial S/W Revision	Prior to A.02.00

Y Auto Scale

Changes the Y reference value and Scale per Division so the full trace is displayed without clipping.

Key Path	AMPTD Y Scale
Mode	VSA, LTE, LTETDD, IDEN, LTEAFDD, LTEATDD
Measurement	<meas>:=VECTor ADEMod DDEMod W11A W11B EVM IPOWER IDEMod MOTotalk
Remote Command	:DISPlay:<meas>:TRACe [1] 2 . . . 4 : Y [: SCALe] : AUTO : ONCE
Example	:DISP:VECT:TRAC1:Y:AUTO:ONCE
Initial S/W Revision	Prior to A.02.00
Modified at S/W Revision	A.02.00

Range

Represents the amplitude of the largest sinusoidal signal that could be present within the IF without being clipped by the ADC. For signals with high peak-to-rms ratios, the range may need to exceed the rms signal power by a fair amount to avoid clipping.

Key Path	AMPTD Y Scale
Mode	VSA, LTE, LTETDD, IDEN
Remote Command	[: SENSE] : POWer [: RF] : RANGE <real> [: SENSE] : POWer [: RF] : RANGE?
Example	POW:RANG 25 POW:RANG?
Notes	The parameter is interpreted as dBm
Preset	20
State Saved	Saved in instrument state.
Min	depends on model and preamp options
Max	depends on model and preamp options
Initial S/W Revision	Prior to A.02.00
Modified at S/W Revision	A.02.00

Range

This key is only available when I/Q is the selected input. It replaces the Attenuation key in that case.

Each input channel (I and Q) has four internal gain ranges. The maximum allowed voltage in each gain range is slightly more than the nominal value, so the break point between ranges is a couple of millivolts higher than the nominal (setting a peak voltage of 0.502 mV will still map to the 0.5 V Peak range).

Gain Setting	Volts RMS	Volts Peak	Volts Peak - Peak	dBm (50Ω)	Break Point
0 dB	0.7071	1.0	2.0	10	n/a
6 dB	0.3536	0.5	1.0	4	0.502 V Peak
12 dB	0.1768	0.25	0.5	-2	0.252 V Peak
18 dB	0.0884	0.125	0.25	-8	0.127 V Peak

Key Path	AMPTD Y Scale
Notes	Visible only when the selected input is I/Q.
State Saved	No
Readback Text	When Range is Auto, "[Auto]" When Range is Man and I & Q are the same, "[<range value>]" When Range is Man and I & Q are different: "[I: <I range value> Q: <Q range value>]" See I Range and Q Range for the <range value> enumeration definition.
Initial S/W Revision	Prior to A.02.00

Range Auto/Man

The Auto setting for Range causes the range to be set based on the Y Scale settings. When Range is "Auto", the I & Q Range are set based on the top of the Y Scale when the Y scale is in dB units (for example, power), or to the max(abs(top), abs(bottom)) when the Y scale reference is not at the top of the screen.

Not all measurements support Range Auto/Man. If Auto is not supported in the current measurement, this key is grayed out and shows "Man" and MAN is returned to a SCPI query, but this does NOT change the Auto/Man setting for Range. When you go to a measurement that supports Auto, it goes back to Auto if it was previously in Auto mode.

Key Path	AMPTD Y Scale, Range
Scope	Meas Global
Remote Command	[:SENSe] :VOLTage:IQ:RANGe:AUTO OFF ON 0 1 [:SENSe] :VOLTage:IQ:RANGe:AUTO?
Example	Put the I Range and Q Range in manual.

	VOLT:IQ:RANG:AUTO OFF
Dependencies	If Auto is not supported, sending the SCPI command will generate an error.
Couplings	When in Auto, both I Range and Q Range are set to the same value, computed as follows: Maximum absolute value is computed for the Y Scale. The top and bottom of the graph are computed based on Ref Value, Scale/Div, and Ref Position. Formula: YMax = max(abs(top), abs(bottom)). The I Range and Q Range are then set to YMax.
Preset	ON
State Saved	Saved in instrument state
Range	Auto Man
Initial S/W Revision	Prior to A.02.00

Remote Command	[:SENSe] :POWer: IQ:RANGe:AUTO OFF ON 0 1 [:SENSe] :POWer: IQ:RANGe:AUTO?
Example	Put the I Range and Q Range in manual. POW:IQ:RANG:AUTO OFF
Notes	The POW:IQ:RANG:AUTO is an alternate form of the VOLT:IQ:RANG:AUTO command. This is to maintain consistency with I Range and Q Range, which support both the POWER and VOLTage forms of the command.
Preset	ON
Range	Auto Man
Initial S/W Revision	Prior to A.02.00

I Range

This is the internal gain range for the I channel when Input Path is I Only or I and I/Q, and it is used for both the I and Q channels when the Input Path is I+jQ. See ["I/Q Gain Ranges" on page 1119](#).

Key Path	AMPTD Y Scale, Range
Remote Command	[:SENSe] :VOLTage: IQ[:I] :RANGe[:UPPer] <voltage> [:SENSe] :VOLTage: IQ[:I] :RANGe[:UPPer] ?
Example	Set the I Range to 0.5 V Peak VOLT:IQ:RANG 0.5 V
Notes	The numeric entries are mapped to the smallest gain range whose break point is greater than or equal to the value, or 1 V Peak if the value is greater than 1 V.
Couplings	When Q Same as I is On, the I Range value will be copied to the Q Range. Changing the value will also set Range = Man.
Preset	1 V Peak
State Saved	Saved in instrument state

Range	1 V Peak 0.5 V Peak 0.25 V Peak 0.125 V Peak
Min	0.125 V
Max	1 V
Initial S/W Revision	Prior to A.02.00

Remote Command	<code>[:SENSe] :POWer :IQ [:I] :RANGe [:UPPer] <ampl></code> <code>[:SENSe] :POWer :IQ [:I] :RANGe [:UPPer] ?</code>
-----------------------	---

Example	Set the I Range to 0.5 V Peak when Reference Z is 50Ω, and to 1.0 V Peak when Reference Z is 75Ω. <code>POW:IQ:RANG 4 dBm</code>
----------------	---

Notes	The POWER form of the command is provided for convenience. It maps to the same underlying gain range parameter as the VOLTage form of the command. The Reference Z (not the I channel Input Z) is used to convert the power to peak voltage, which is then used to set the I Range as with the VOLTage form of the command. The power values of the 4 range states (1V Peak, 0.5V Peak, 0.25V Peak, and 0.125V Peak) will vary with Reference Z. Here are some examples: 50Ω: 10, 4, -2, -8 75Ω: 8.2, 2.2, -3.8, -9.8 600Ω: -0.8, -6.8, -12.8, -18.9
--------------	--

Preset	10.0 dBm
Range	-20 dBm to 10 dBm
Min	-20 dBm
Max	10 dBm
Initial S/W Revision	Prior to A.02.00

Q Range Value

This is the internal gain range for the Q channel. See "[I/Q Gain Ranges](#)" on page 1119. The Q Range only applies to Input Path Q Only and Ind I/Q. For input I+jQ the I Range determines both I and Q channel range settings.

Key Path	AMPTD Y Scale, Range
Remote Command	<code>[:SENSe] :VOLTage :IQ :Q :RANGe [:UPPer] <voltage></code> <code>[:SENSe] :VOLTage :IQ :Q :RANGe [:UPPer] ?</code>

Example	Set the Q Range to 0.5 V Peak <code>VOLT:IQ:Q:RANG 0.5 V</code>
----------------	--

Notes	The numeric entries are mapped to the smallest gain range whose break point is greater than or equal to the value, or 1 V Peak if the value is greater than 1 V. The Q Range is only used for Input Path Q Only and Ind I/Q. For input I+jQ the I Range determines both I and Q channel range settings.
--------------	--

Couplings	When Q Same as I is On, the I Range value will be copied to the Q Range and the range value keys are disabled. Changing the value will also set Range = Man.
Preset	1 V Peak
State Saved	Saved in instrument state
Range	1 V Peak 0.5 V Peak 0.25 V Peak 0.125 V Peak
Min	0.125 V
Max	1 V
Initial S/W Revision	Prior to A.02.00

Remote Command	<code>[:SENSe] :POWer:IQ:Q:RANGe[:UPPer] <ampl></code> <code>[:SENSe] :POWer:IQ:Q:RANGe[:UPPer]?</code>
-----------------------	--

Example	Will set the Q Range to 0.5 V Peak when Reference Z is 50Ω, and to 1.0 V Peak when Reference Z is 75Ω. POW:IQ:Q:RANG 4 dBm
----------------	---

Notes	The POWER form of the command is provided for convenience. It maps to the same underlying gain range parameter as the VOLTage form of the command. The Reference Z (not the Q channel Input Z) is used to convert the power to peak voltage, which is then used to set the Q Range as with the VOLTage form of the command. The power values of the 4 range states (1V Peak, 0.5V Peak, 0.25V Peak, and 0.125V Peak) will vary with Reference Z. Here are some examples: 50Ω: 10, 4, -2, -8 75Ω: 8.2, 2.2, -3.8, -9.8 600Ω: -0.8, -6.8, -12.8, -18.9
-------	--

Preset	10.0 dBm
Range	-20 dBm to 10 dBm
Min	-20 dBm
Max	10 dBm
Initial S/W Revision	Prior to A.02.00

Q Same as I

Many, but not all, usages require the I and Q channels to have an identical setup. To simplify channel setup, the Q Same as I will cause the Q channel range to be mirrored from the I channel. That way you only need to set up one channel (the I channel). The I channel values are copied to the Q channel, so at the time Q Same as I is Off, the I and Q channel setups will be identical.

Key Path	AMPTD Y Scale, Range, Q Range
Remote Command	<code>[:SENSe] :VOLTage POWer:IQ:MIRROred OFF ON 0 1</code> <code>[:SENSe] :VOLTage POWer:IQ:MIRROred?</code>

Example	Turn off the mirroring of I Range to Q Range. VOLT:IQ:MIRR OFF POW:IQ:MIRR OFF
Couplings	When On, the I Range value is mirrored (copied) to the Q Range.
Preset	On
State Saved	Saved in instrument state.
Range	On Off
Readback Text	"Q Same as I" when On, otherwise none.
Initial S/W Revision	Prior to A.02.00

I/Q Gain Ranges

See the following sections:

["1 V Peak" on page 1119](#)

["0.5 V Peak" on page 1119](#)

["0.25 V Peak" on page 1119](#)

["0.125 V Peak" on page 1120](#)

1 V Peak

Set the channel gain state to 1 Volt Peak.

Key Path	AMPTD Y Scale, I Range Q Range
Initial S/W Revision	Prior to A.02.00

0.5 V Peak

Set the channel gain state to 0.5 Volt Peak.

Key Path	AMPTD Y Scale, I Range Q Range
Initial S/W Revision	Prior to A.02.00

0.25 V Peak

Set the channel gain state to 0.25 Volt Peak.

Key Path	AMPTD Y Scale, I Range Q Range
Initial S/W Revision	Prior to A.02.00

0.125 V Peak

Set the channel gain state to 0.125 Volt Peak.

Key Path	AMPTD Y Scale, I Range Q Range
Initial S/W Revision	Prior to A.02.00

Select Trace

Displays a menu that enables you to select the trace that is to receive the action of all successive trace-specific commands like scaling, assignment of trace data, and so on. The selected trace is outlined in green and is always visible. While the Select Trace menu is showing, each visible trace is annotated in the middle with its own trace number, as shown in the following figure. The trace number annotations disappear when any other menu is showing.

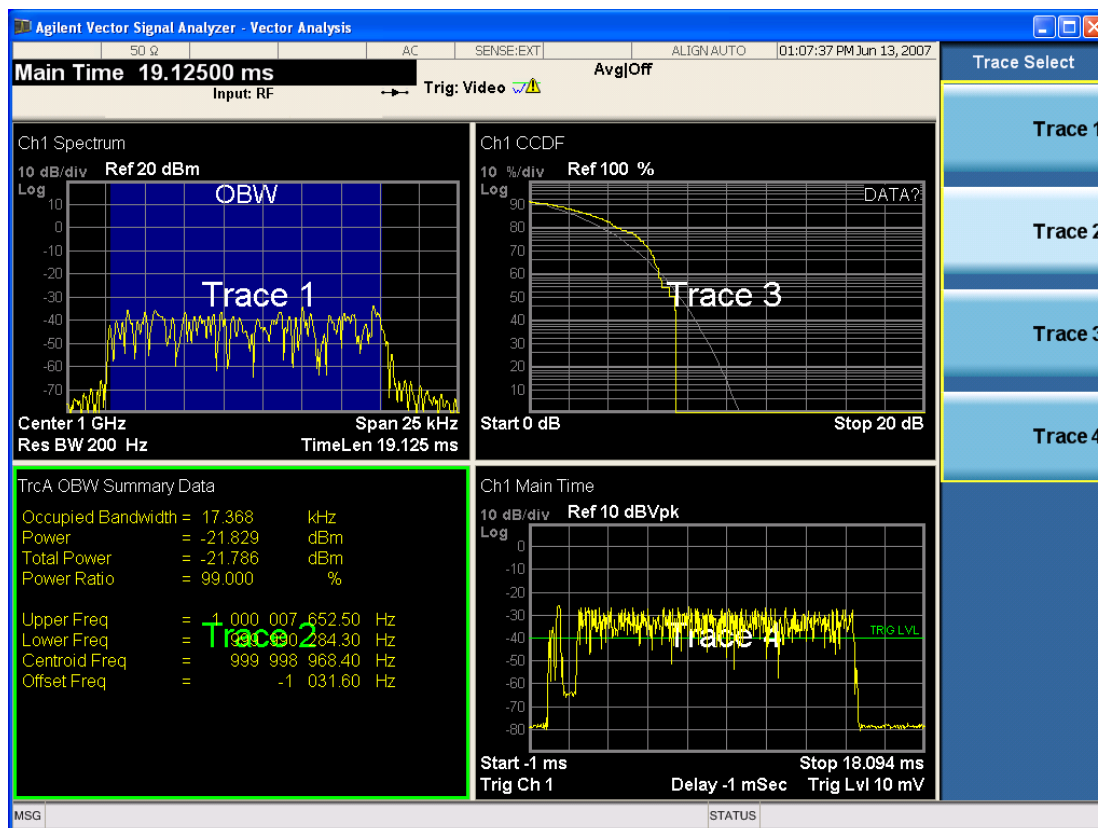

Grid 2x2 layout showing trace annotations when Trace Select dialog is active

This softkey also appears in the X and Y scaling menus. There is only one selected trace at any time. If you change which trace is selected, that change is reflected in this softkey/menu wherever it appears. Other ways to select a trace include use of the Next Window key, clicking within a trace window with a mouse cursor, and issuing a trace-specific SCPI command.

There is no SCPI command associated with this function. Instead, SCPI commands that are trace-specific have an index on the TRACe node that determines the selected trace. Using such a command has the side

effect that the trace addressed by the SCPI command becomes the selected trace for any front panel interaction.

Key Path	Trace/Detector or Span X Scale or AMPTD Y Scale
Mode	VSA, LTE, LTETDD, IDEN, LTEAFDD, LTEATDD
Notes	No SCPI. Front panel only.
Couplings	Affects any trace-specific commands
Range	Trace 1 Trace 2 Trace 3 Trace 4 Trace 5 Trace 6
Readback Text	Trace <n>
Initial S/W Revision	Prior to A.02.00
Modified at S/W Revision	A.02.00

Couple Ref to Range

When Couple Ref to Range is on, Y scaling is adjusted when the Range changes. For example, on traces with Y units of dBm, the reference value changes by the same amount in dB as the Range does. On a trace with Y units of Volts, the Per Division setting changes by a factor of approximately 1.25 when the Range changes by 2 dB. This function can be turned on or off for each individual trace.

Key Path	AMPTD Y Scale
Mode	VSA, LTE, LTETDD, IDEN, LTEAFDD, LTEATDD
Measurement	<meas>:=VECTor ADEMod DDEMod W11A W11B EVM IPOWER IDEMod MOTotalk
Remote Command	:DISPlay:<meas>:TRACe [1] 2 . . . 4 : Y [: SCALE] : RLEVEL : AUTO OFF ON 0 1 :DISPlay:<meas>:TRACe [1] 2 . . . 4 : Y [: SCALE] : RLEVEL : AUTO ?
Example	DISP:VECT:TRAC1:Y:RLEV:AUTO ON DISP:VECT:TRAC1:Y:RLEV:AUTO ?
Notes	Range coupling is not available for Phase and Group delay traces.
Preset	1
State Saved	Saved in instrument state.
Range	On Off
Initial S/W Revision	Prior to A.02.00
Modified at S/W Revision	A.02.00

Y Reference Value

Controls the Y value of the selected trace at the Reference Position. It has no effect on hardware input settings.

See "[Y Reference: Position](#)" on page 1122 for more details.

Key Path	AMPTD Y Scale
----------	---------------

Mode	VSA, LTE, LTETDD, IDEN, LTEAFDD, LTEATDD
Measurement	<meas>:=VECTor ADEMod DDEMod W11A W11B EVM IPOWER IDEMod MOTotalk
Remote Command	:DISPlay:<meas>:TRACe[1] 2 ...4:Y[:SCALe]:RLEVel <real> :DISPlay:<meas>:TRACe[1] 2 ...4:Y[:SCALe]:RLEVel?
Example	DISP:VECT:TRAC:Y:RLEV 20 DISP:VECT:TRAC:Y:RLEV?
Couplings	None. This does not affect any hardware input settings.
Preset	Depends on trace
State Saved	Saved in instrument state.
Min	-9.9E+37
Max	9.9E+37
Initial S/W Revision	Prior to A.02.00
Modified at S/W Revision	A.02.00

Y Scale Per Division

Controls the Y scale per division of the selected trace.

Key Path	AMPTD Y Scale
Mode	VSA, LTE, LTETDD, IDEN, LTEAFDD, LTEATDD
Measurement	<meas>:=VECTor ADEMod DDEMod W11A W11B EVM IPOWER IDEMod MOTotalk
Remote Command	:DISPlay:<meas>:TRACe[1] 2 ...4:Y[:SCALe]:PDIVision <real> :DISPlay:<meas>:TRACe[1] 2 ...4:Y[:SCALe]:PDIVision?
Example	DISP:VECT:TRAC:Y:PDIV 10 DISP:VECT:TRAC:Y:PDIV?
Couplings	None.
Preset	Depends on trace
State Saved	Saved in instrument state.
Min	-9.9E+37
Max	9.9E+37
Initial S/W Revision	Prior to A.02.00
Modified at S/W Revision	A.02.00

Y Reference: Position

Sets the position of the reference line for Y scaling for the selected trace. It can be set to the top, bottom, or center of the grid.

Key Path	AMPTD Y Scale
Mode	VSA, LTE, LTETDD, IDEN, LTEAFDD, LTEATDD
Measurement	<meas>:=VECTor ADEMod DDEMod W11A W11B EVM IPOWER IDEMod MOTotalk
Remote Command	:DISPlay:<meas>:TRACe[1] 2 ...4:Y[:SCALE]:RPOStion TOP CENTER BOTTOm :DISPlay:<meas>:TRACe[1] 2 ...4:Y[:SCALE]:RPOStion?
Example	DISP:VECT:TRAC1:Y:RPOS TOP DISP:VECT:TRAC1:Y:RPOS?
Couplings	Changing trace format or data can affect this. Each format "remembers" its reference position.
Preset	Depends on trace format and trace data. Top for LogMag or most LinearMag traces, middle for Real, Imaginary, Vector displays, Eye diagrams, Phase, Delay, Bottom for Linear Mag EVM.
State Saved	Saved in instrument state.
Range	Top Ctr Bottom
Initial S/W Revision	Prior to A.02.00
Modified at S/W Revision	A.02.00

Reference Line

Controls whether the Y reference line is visible or not.

Key Path	AMPTD Y Scale
Mode	VSA, LTE, LTETDD, IDEN, LTEAFDD, LTEATDD
Measurement	<meas>:=VECTor ADEMod DDEMod W11A W11B EVM IPOWER IDEMod MOTotalk
Remote Command	:DISPlay:<meas>:TRACe[1] 2 ...4:RLINe OFF ON 0 1 :DISPlay:<meas>:TRACe [1] 2 ...4:RLINe?
Example	DISP:VECT:TRAC1:RLIN ON DISP:VECT:TRAC1:RLIN?
Preset	OFF
State Saved	Saved in instrument state.
Initial S/W Revision	Prior to A.02.00
Modified at S/W Revision	A.02.00

Y Unit Preference

Displays a menu that enables you to set the preferred Y unit for the selected trace. You can select Peak, RMS, Power units, or an automatic selection. The automatic selection uses Power units for frequency domain data and Peak units for time domain data.

Key Path	AMPTD Y Scale
----------	---------------

Mode	VSA, LTE, LTETDD, IDEN, LTEAFDD, LTEATDD
Measurement	<meas>:=VECTor ADEMod DDEMod W11A W11B EVM IPOWER IDEMod MOTotalk
Remote Command	:DISPlay:<meas>:TRACe[1] 2 ...4:Y:UNIT:PREFERENCE AUTO PEAK RMS POWer MRMS :DISPlay:<meas>:TRACe[1] 2 ...4:Y:UNIT:PREFERENCE?
Example	DISP:VECT:TRAC1:Y:UNIT:PREF PEAK DISP:VECT:TRAC1:Y:UNIT:PREF?
Preset	AUTO
State Saved	Saved in instrument state.
Range	AUTO PEAK RMS POW MRMS
Readback Text	Auto Peak RMS Power mRMS
Initial S/W Revision	Prior to A.02.00
Modified at S/W Revision	A.02.00

The following SCPI only command can be used to determine exactly which Y unit was chosen based on the setting of the above:

Key Path	AMPTD Y Scale
Mode	VSA, LTE, LTETDD, IDEN
Measurement	<meas>:=VECTor ADEMod DDEMod W11A W11B EVM IPOWER IDEMod MOTotalk
Remote Command	:DISPlay:<meas>:TRACe[1] 2 ...4:Y:UNIT?
Example	DISP:VECT:TRAC1:Y:UNIT?
Initial S/W Revision	Prior to A.02.00
Modified at S/W Revision	A.02.00

Y Log Ratio

Enabled if the Trace Format is set to LogMag (Linear Unit). In this format type, you set the Y Log Ratio instead of Y Scale Per Division to determine Y scaling. It sets the ratio of the top of the Y axis to the bottom.

Key Path	AMPTD Y Scale
Mode	VSA, LTE, LTETDD, IDEN, LTEAFDD, LTEATDD
Measurement	<meas>:=VECTor ADEMod DDEMod W11A W11B EVM IPOWER IDEMod MOTotalk
Remote Command	:DISPlay:<meas>:TRACe[1] 2 ...4:Y:LRATio <real> :DISPlay:<meas>:TRACe[1] 2 ...4:Y:LRATIO?
Example	DISP:VECT:TRAC1:Y:LRAT 10000 DISP:VECT:TRAC1:Y:LRAT?
Notes	This is grayed out if the trace format is not Log Mag (linear unit).

Preset	100000
State Saved	Saved in instrument state.
Min	1.001
Max	100e6
Initial S/W Revision	Prior to A.02.00
Modified at S/W Revision	A.02.00

Vector Horiz Center

Sets the position of the origin for Vector trace formats such as I-Q and Constellation. When using one of these formats, you set the vertical (imaginary) axis scaling with the Y Reference Value, Y Reference Position, and Y Scale Per Division properties. The scaling of the horizontal axis is set to maintain an aspect ratio of 1:1.

Key Path	AMPTD Y Scale
Mode	VSA, LTE, LTETDD, IDEN, LTEAFDD, LTEATDD
Measurement	<meas>:=VECTor ADEMod DDEMod W11A W11B EVM IPOWER IDEMod MOTotalk
Remote Command	:DISPlay:<meas>:TRACe[1] 2 ...4:VHCenter <real> :DISPlay:<meas>:TRACe[1] 2 ...4:VHCenter?
Example	DISP:DDEM:TRAC1:VHC 0.2 DISP:DDEM:TRAC1:VHC?
Preset	0
State Saved	Saved in instrument state.
Min	-9.9e37
Max	9.9e37
Initial S/W Revision	Prior to A.02.00
Modified at S/W Revision	A.02.00

Copy Y Scale

Copies the following Y scaling information from the selected trace to another:

- Y reference Position
- Y Reference Value
- Y Unit Preference
- Vector Horiz Center
- Couple Ref to Range
- Y Log Ratio

- Y Reference Line

This is a front-panel only function.

Key Path	AMPTD Y Scale, Y Axis Scaling
Mode	VSA, LTE, LTETDD, IDEN, LTEAFDD, LTEATDD
Initial S/W Revision	Prior to A.02.00
Modified at S/W Revision	A.02.00

Auto Couple

The Auto Couple feature provides a quick and convenient way to automatically couple multiple instrument settings. This helps ensure accurate measurements and optimum dynamic range. When the Auto Couple feature is activated, either from the front panel or remotely, all parameters of the current measurement that have an Auto/Manual mode are set to Auto mode and all measurement settings dependent on (or coupled to) the Auto/Man parameters are automatically adjusted for optimal performance.

However, the Auto Couple key actions are confined to the current measurement only. It does not affect other measurements in the mode, and it does not affect markers, marker functions, or trace or display attributes.

See ["More Information" on page 704](#)

Key Path	Front-panel key
Remote Command	:COUPLe ALL NONE
Example	:COUP ALL
Notes	:COUPLe ALL puts all Auto/Man parameters in Auto mode (equivalent to pressing the Auto Couple key). :COUPLE NONE puts all Auto/Man parameters in manual mode. It decouples all the coupled instrument parameters and is not recommended for making measurements.
Initial S/W Revision	Prior to A.02.00

More Information

There are two types of functions that have Auto/Manual modes.

Auto/Man Active Function keys

An Auto/Man toggle key controls the binary state associated with an instrument parameter by toggling between Auto (where the parameter is automatically coupled to the other parameters it is dependent upon) and Man (where the parameter is controlled independent of the other parameters), as well as making the parameter the active function. The current mode is indicated on the softkey with either Auto or Man underlined as illustrated below.

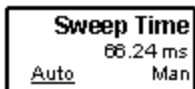

usd07

Auto/Man 1-of-N keys

An Auto/Man 1-of-N key allows you to manually pick from a list of parameter values, or place the function in Auto, in which case the value is automatically selected (and indicated) as shown below. If in Auto, Auto is underlined on the calling key. If in manual operation, manual is indicated on the calling key. But the calling key does not actually toggle the function, it simply opens the menu.

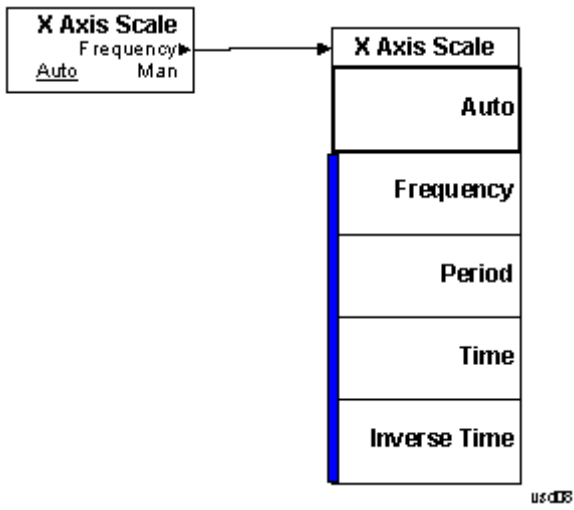

BW (Bandwidth)

Displays a menu that enables you to control the resolution bandwidth of the spectrum measurement result, as well as the shape of the resolution bandwidth filter (controlled by the FFT windowing function).

Key Path	Front Panel
Mode	VSA, LTE, LTETDD, IDEN
Initial S/W Revision	Prior to A.02.00
Modified at S/W Revision	A.02.00

Res BW

Enables you to select the resolution bandwidth of the measurement. Res BW is mathematically related to Time length and Window type, so changing one of these, directly or indirectly, must change at least one other.

Res BW and Time length are related by the following equation:

$$\text{Res BW} = \text{ENBW} / T$$

where:

ENBW is the normalized effective noise bandwidth of the Window. See ["FFT Window" on page 1129](#) for more details).

T is the time record length.

Therefore, **if you change Res BW, Main Time must also change**, and vice versa. (If the Gate function is on, then it is Gate Length, not Main Time, that is related to Res BW by the above equation.)

For convenience, Res BW is by default also coupled to Span (but not vice versa). This coupling can be turned off. See ["Res BW Coupling" on page 707](#) for more details.

Limits:

- The minimum Res Bw to Span ratio is related to the maximum Main Time length, and is given by:

$$\text{ENBW} / 409600 \text{ if Freq points state parameter is set to Auto}$$

$$\text{ENBW} / (\text{Freq Points} - 1) \text{ if Freq points parameter is manually set}$$

- The maximum Res BW to Span ratio is related to the minimum time record size (16 points for most windows, 17 points for Flat Top), and is given by:

$$\text{ENBW} / 12.5$$

$$(\text{ENBW} / 13.28125 \text{ for Flat Top window})$$

See ["Main Time" on page 818](#) for more on relationships between Res BW and time.

Key Path	BW
Mode	VSA

Measurement	<meas>:=VECTor ADEMod IPOWER IDEMod MOTotalk
Remote Command	[:SENSe] :<meas>:BANDwidth BWIDth[:RESolution] <bandwidth> [:SENSe] :<meas>:BANDwidth BWIDth[:RESolution] ?
Example	VECT:BWID 200 KHZ VECT:BWID?
Notes	Key blanked in any other measurement than Vector or Analog Demod
Couplings	Changing Main Time or Gate Length changes Res BW. See Res BW Coupling for other changes that can affect (or be affected by) Res BW
Preset	300 kHz
State Saved	Saved in instrument state.
Min	-9.9e37
Max	9.9e37
Initial S/W Revision	Prior to A.02.00
Modified at S/W Revision	A.02.00

Res BW Coupling

Enables you to control how Res BW is affected by other parameters. The three possible settings are:

Span: (default) This setting keeps the ratio of Res BW:Span constant whenever the Span is changed. However, you can change the Res BW at will, and doing so establishes a new Res BW:Span ratio.

Min: This setting is only available when the Freq Points property is manually set, and is disabled (forceful grey out) when Freq Points is Auto. It maintains the RBW at the minimum possible value given the settings for Freq Points, Span, and Window. Res BW coupling is changed from Min to Span if you manually set Res BW.

Fixed: This setting attempts to keep the Res BW setting fixed as Span, Freq Points, or FFT Window type change. Changing FFT Window causes Main Time (or Gate) length to change in order to keep the Res BW Fixed. Res BW coupling is forced to Fixed mode any time you turn the Gate function on or manually set Main Time length. See "[Main Time](#)" on page 818 for details.

If a requested change to Res BW or Time Length (Main or Gate) causes the Res BW to go outside the minimum or maximum Res BW: Span limits (see "[Res BW](#)" on page 706 for specifics), the Res BW is clipped at the appropriate limit. The Time length is then set according to the limited Res BW.

In Fixed coupling mode, if increasing the Span causes the new Res BW:Span to drop below the minimum, or if decreasing Span would cause the new Res BW:Span to exceed the maximum, the requested Span is accepted and then the Res BW is changed to the limiting value. The associated Time length is updated.

In Fixed or Span coupling, increasing Freq Points does not cause the Main (or Gate) Time Length to increase. It only adds zero padding to the array that is used in the FFT to calculate the Spectrum. Therefore, it does not affect Res BW. If decreasing Freq Points decreases the maximum time length below the current Main Time, then the Main Time length is clipped to the new limits. If Gating is on, the Gate Delay is first limited, then the Gate Length. The Res BW is then updated as a result of the Time changes.

In Fixed or Span coupling, changing the Window Type does not affect RBW unless it falls outside the limits calculated using the new window. Then the Res BW is clipped at the appropriate limit. The associated Time length is also updated.

Key Path	BW
Mode	VSA
Measurement	<meas>:=VECTor ADEMod IPOWER IDEMod MOTotalk
Remote Command	[:SENSe] : <meas> : BANDwidth BWIDth [:RESolution] : COUPle SPAN MIN FIXed [:SENSe] : <meas> : BANDwidth BWIDth [:RESolution] : COUPle?
Example	VECT:BWID:COUP FIX VECT:BWID:COUP?
Notes	Blanked when in any other measurement than Vector or Analog Demod MIN is not available if Freq Points is set to Auto and trying to set it generates error -221 Settings conflict
Couplings	See narrative above table and also "Res BW" on page 706
Preset	SPAN
State Saved	Saved in instrument state.
Range	Span Min Fixed
Initial S/W Revision	Prior to A.02.00
Modified at S/W Revision	A.02.00

FFT Window

Displays a menu that enables you to choose the Window function that is applied to the time data prior to the FFT calculation used for Spectrum and PSD displays. Four windows are available.

Window name	Common usage	Normalized ENBW (Hz-s)
Uniform	Transient or self-windowing signals, signals that are periodic within a time record length.	1.0
Hanning	Frequency resolution	1.5
Gaussian	High dynamic range	2.21536
Flat Top	High amplitude accuracy	3.8194

The normalized ENBW is the equivalent noise bandwidth, that is, the width of a rectangular filter that passes the same amount of white noise as the window. It is used to define the resolution bandwidth.

Key Path	BW
Mode	VSA, LTE, LTETDD, IDEN
Measurement	<meas>:=VECTor ADEMod DDEMod W11A W11B EVM IPOWER IDEMod MOTotalk
Remote Command	[:SENSe] : <meas> : FFT:WINDow [:TYPE] UNIFORM HANNing GAUSSian

	FLATtop
	[:SENSe] : <meas> : FFT : WINDow [:TYPE] ?
Example	VECT:FFT:WIND GAUS VECT:FFT:WIND?
Couplings	See Res BW and Res BW Coupling
Preset	FLAT
State Saved	Saved in instrument state.
Range	Uniform Hanning Gaussian (High Dyn Rng) Flat Top (High Amptd Accy)
Readback Text	Uniform Hanning Gaussian Flat Top
Initial S/W Revision	Prior to A.02.00
Modified at S/W Revision	A.02.00

Cont (Continuous Measurement/Sweep)

Sets the analyzer for Continuous measurement operation. The single/continuous state is Meas Global so the setting will affect all measurements. If you are Paused, pressing Cont does a Resume.

Key Path	Front-panel key
Remote Command	:INITiate:CONTinuous OFF ON 0 1 :INITiate:CONTinuous?
Example	:INIT:CONT 0 puts analyzer in Single measurement operation. :INIT:CONT 1 puts analyzer in Continuous measurement operation
Preset	ON (Note that SYST:PRESet sets INIT:CONT to ON but *RST sets INIT:CONT to OFF)
State Saved	Saved in instrument state
Backwards Compatibility Notes	For Spectrum Analysis mode in ESA and PSA, there is no Cont hardkey, instead there is a Sweep Single/Cont key. In these analyzers, switching the Sweep Single/Cont key from Single to Cont restarts averages (displayed average count reset to 1), but does not restart Max Hold and Min Hold. The X-Series has Single and Cont keys in place of the SweepSingleCont key. In the X-Series, if in single measurement, the Cont key (and INIT:CONT ON) switches to continuous measurement, but never restarts a measurement and never resets a sweep.
Initial S/W Revision	Prior to A.02.00

In Swept SA Measurement (Spectrum Analysis Mode):

The analyzer takes repetitive sweeps, averages, measurements, etc., when in Continuous mode. When the average count reaches the Average/Hold Number the count stops incrementing, but the analyzer keeps sweeping. See the Trace/Detector section for the averaging formula used both before and after the Average/Hold Number is reached. The trigger condition must be met prior to each sweep. The type of trace processing for multiple sweeps, is set under the Trace/Detector key, with choices of Trace Average, Max Hold, or Min Hold.

In Other Measurements/Modes:

With Avg/Hold Num (in the Meas Setup menu) set to Off or set to On with a value of 1, a sweep is taken after the trigger condition is met; and the analyzer continues to take new sweeps after the current sweep has completed and the trigger condition is again met. However, with Avg/Hold Num set to On with a value >1, multiple sweeps (data acquisitions) are taken for the measurement. The trigger condition must be met prior to each sweep. The sweep is not stopped when the average count k equals the number N set for Avg/Hold Num is reached, but the number k stops incrementing. A measurement average usually applies to all traces, marker results, and numeric results. But sometimes it only applies to the numeric results.

If the analyzer is in Single measurement, pressing the Cont key does not change k and does not cause the sweep to be reset; the only action is to put the analyzer into Continuous measurement operation.

If it is already in continuous sweep:

the INIT:CONT 1 command has no effect

the INIT:CONT 0 command will place the analyzer in Single Sweep but will have no effect on the current sequence until $k = N$, at which point the current sequence will stop and the instrument will go to the idle state.

10 iDEN Power Measurement
File

File

See "File" on page 236

FREQ Channel

Displays a menu that enables you to set center frequency, start frequency, stop frequency, and center frequency step. Pressing the Freq hardkey changes the active function to Center Frequency.

The frequency parameters for any vector measurement consist of two pairs of properties: Center Frequency and Span or Start Frequency and Stop Frequency. These behave much as they do in any other application, but there is the additional constraint that the span is limited to much less than the center frequency range.

If you change center frequency, the start and stop frequencies change by the same amount.

If you change span, start frequency and stop frequency are changed by 1/2 the span change.

If you change start frequency, stop frequency remains fixed and span and center frequency are refigured accordingly. Changing stop frequency has similar behavior.

Limits:

If you change the start frequency such that it equals or exceeds the stop frequency, the new start frequency is accepted if possible and the stop frequency is set to min span above the start. Similarly if you attempt to set the stop below the start, the start frequency moves to a min span below the new stop frequency.

If you reduce the start frequency beyond a max span below the stop, the stop frequency is "dragged along" such that it is a max span above the new start frequency, and similarly increasing the stop frequency drags the start frequency along if you attempt to increase the span beyond the maximum.

Stop frequency can be 1/2 span above the maximum center frequency, but frequency-domain traces are blanked above the maximum center frequency.

Start frequency can be 1/2 span below the minimum center frequency, but frequency-domain traces are blanked below the minimum center frequency.

Key Path	Front Panel
Mode	VSA, LTE, LTETDD, IDEN
Initial S/W Revision	Prior to A.02.00
Modified at S/W Revision	A.02.00

Center Freq

Sets the frequency of the display Center.

Key Path	FREQ Channel
Mode	VSA, LTE, LTETDD, IDEN
Remote Command	[:SENSe] :FREQuency:CENTer <freq> [:SENSe] :FREQuency:CENTer?
Example	FREQ:CENT 985 MHZ FREQ:CENT?

Couplings	Start Freq, Stop Freq, and Span. See "FREQ Channel" on page 1134 for more details.
Preset	1 GHz
State Saved	Saved in instrument state.
Min	0 Hz
Max	Depends on frequency range option.
Initial S/W Revision	Prior to A.02.00
Modified at S/W Revision	A.02.00

Start Freq

Sets the frequency of the display Start.

Key Path	FREQ Channel
Mode	VSA, IDEN
Remote Command	[:SENSe] :FREQuency:STARt <freq> [:SENSe] :FREQuency:STARt?
Example	FREQ:STAR 980 MHz FREQ:STAR?
Couplings	Stop Freq, Center Freq, and Span. See "FREQ Channel" on page 1134 for more details.
Preset	Depends on span option. It is 1/2 max span below 1 GHz.
State Saved	Saved in instrument state.
Min	-9.9e37
Max	9.9e37
Initial S/W Revision	Prior to A.02.00
Modified at S/W Revision	A.02.00

Stop Freq

Sets the frequency of the display Stop.

Key Path	FREQ Channel
Mode	VSA, IDEN
Remote Command	[:SENSe] :FREQuency:STOP <freq> [:SENSe] :FREQuency:STOP?
Example	FREQ:STOP 990 MHz FREQ:STOP?
Couplings	Start Freq, Center Freq, and Span. See "FREQ Channel" on page 1134 for more details.
Preset	Depends on span option. It is 1/2 max span above 1 GHz.

State Saved	Saved in instrument state.
Min	-9.9e37
Max	9.9e37
Initial S/W Revision	Prior to A.02.00
Modified at S/W Revision	A.02.00

CF Step

Sets the amount the center frequency changes if it is the active function when you press the Up or Down arrow key. Note: the start and stop frequency also changes by the amount of the CF Step if the Up/Down arrow keys are used to change them; but the key is mainly used in connection with stepping the center frequency, so the legacy key name has been retained. The step size in Auto mode is 1/10th the span. It can be set to any value in manual mode.

Key Path	FREQ Channel
Mode	VSA, LTE, LTETDD, IDEN
Remote Command	[:SENSe]:FREQuency:CENTer:STEP[:INCRement] <freq> [:SENSe]:FREQuency:CENTer:STEP[:INCRement]? [:SENSe]:FREQuency:CENTer:STEP:AUTO OFF ON 0 1 [:SENSe]:FREQuency:CENTer:STEP:AUTO?
Example	FREQ:CENT:STEP 1 MHZ FREQ:CENT:STEP? FREQ:CENT:STEP:AUTO ON FREQ:CENT:STEP:AUTO?
Couplings	1/10th Span when auto is turned on.
Preset	Depends on span option; 1/10th default span.
State Saved	Saved in instrument state.
Min	-9.9e37
Max	9.9e37
Initial S/W Revision	Prior to A.02.00
Modified at S/W Revision	A.02.00

10 iDEN Power Measurement
Input/Output

Input/Output

See "[Input/Output](#)" on page 146

Marker

Displays the Marker menu. A marker can be placed on a trace to precisely determine the value of the trace data at the marker position. Markers can also be used in pairs to read the difference (or delta) between two data points. They can also be used to make power calculations over a band of frequencies or a time interval. See "[Marker Function](#)" on page 1157 for more details.

The functions in this menu include a 1-of-N selection of the control mode **Normal**, **Delta**, **Fixed**, or **Off** for the selected marker. The control mode is described below.

Pressing **Marker** always makes the selected maker's X position the active function.

If the currently selected marker is **Off**, pressing **Marker** sets it to **Normal** mode and places it at the center of the screen on the currently selected trace.

As a convenience, if there are no markers displayed on the current trace, pressing the marker hardkey (whenever the marker menu is already showing) selects the lowest numbered marker that is currently off and turns it on in normal mode on the selected trace. In other words, pressing the Marker hardkey twice always turns on a marker on the selected trace if none was turned on before.

Key Path	Front Panel
Mode	VSA, LTE, LTETDD, IDEN,LTEAFDD,LTEATDD
Initial S/W Revision	Prior to A.02.00
Modified at S/W Revision	A.02.00

Control Mode

Pressing **Normal**, **Delta**, **Fixed**, or **Off** sets the control mode of the selected marker. The current control mode is shown by highlighting the appropriate key.

The SCPI command in the table below selects the marker and sets the marker control mode as described under "[Normal \(Position\)](#)" on page 1139, "[Delta](#)" on page 1140, "[Fixed](#)" on page 1140 and "[Off](#)" on page 1141. All interactions and dependencies detailed under the key description are enforced when the remote command is sent.

Key Path	Marker
Mode	VSA, LTE, LTETDD, IDEN,LTEAFDD,LTEATDD
Measurement	<meas>:=VECTor ADEMod DDEMod W11A W11B EVM IPOWER IDEMod MOTotalk
Remote Command	:CALCulate:<meas>:MARKer[1] 2 ...12:MODE POSition DELTa FIXed =OFF :CALCulate:<meas>:MARKer[1] 2 ...12:MODE?
Example	CALC:VECT:MARK1:MODE POS CALC:VECT:MARK1:MODE?
Couplings	When Delta mode is selected or when the mode is changed from Delta to Off, the marker relative to the selected marker can be affected as described in the text descriptions below.
Preset	=OFF

State Saved	Saved in instrument state.
Range	Normal Delta Fixed Off
Initial S/W Revision	Prior to A.02.00
Modified at S/W Revision	A.02.00

Normal (Position)

Reports the trace data value (Y value) at a particular point on a trace. The marker's absolute X (and Z) position is specified by you in displayed units. The marker symbol appears on the trace at the specified position and tracks the absolute Y value at that position as it changes from scan to scan. The absolute Y value is displayed in the marker readout area. In older instruments this was called Position mode, and the designation can still be used for backward compatibility.

For Control Mode SCPI command information see: ["Control Mode" on page 1139](#)

Key Path	Marker
Mode	VSA, LTE, LTETDD, IDEN,LTEAFDD,LTEATDD
Initial S/W Revision	Prior to A.02.00
Modified at S/W Revision	A.02.00

Delta

Reports the difference between Y values at two points. A delta marker is relative to an associated reference marker on the same trace. (The reference marker can be set on the Marker, Properties, Relative To menu). The reference marker is usually fixed, but can also be normal or delta. The X (and Z) position of a delta marker is specified as an offset from the reference marker position. The delta marker symbol tracks the absolute Y value just like a normal marker, but the marker readout displays the difference between the absolute Y values of the delta marker and its reference marker (absolute units are used even if the reference is itself a delta marker). Usually this is a straight difference in the current displayed units. For example, if the trace format is LogMag (dBm), the delta marker displays the difference in dB, thus showing a power ratio. But if the trace format is Real, then the delta marker shows a voltage difference, not a ratio. Exceptions for this are:

- When the trace format is **Linear Mag** or **Log Mag (linear unit)** the delta marker displays a voltage ratio or (if the Y Axis unit is Power) a power ratio, rather than a difference.
- When either the marker or its reference has a marker function turned on, the delta marker always displays a ratio or its decibel equivalent. See ["Marker Function" on page 1157](#) for more details on how delta markers work with marker functions. The type of ratio calculated (power or voltage) depends on the delta marker units; the reference marker value is converted as needed so it has compatible units.
- When the trace format is **Wrap Phase**, the delta marker readout is constrained to the wrapped phase display range, which is usually (-180, +180] degrees. For example, if the absolute phase at marker 1 is 170 deg and its reference has phase of -170 deg, the delta does not show 340 deg, but -20 deg. Note that the Wrap Phase display range can be changed (see ["Phase/Trellis Offset" on page 1253](#)).

There is no current support for calculating deltas across traces (and this cannot be done at all unless the traces have the same domain and ranges).

By default, the reference marker for marker 1 is marker 2; for marker 2 is 3 and so on, but the reference marker can be changed. See ["Relative To" on page 1142](#).

For coupling rules, see ["Coupling of Delta and Reference Markers" on page 1152](#).

For Control Mode SCPI command information see: ["Control Mode" on page 1139](#)

Key Path	Marker
Mode	VSA, LTE, LTETDD, IDEN,LTEAFDD,LTEATDD
Initial S/W Revision	Prior to A.02.00
Modified at S/W Revision	A.02.00

Fixed

Mainly used as reference markers for Delta markers. A fixed marker's X and Y Axis values can be directly or indirectly specified by you, and they remain fixed once specified, in other words, they do not follow the trace data value. These markers are represented on the display by an "X" rather than a diamond. If a marker is changed from off to fixed, the X and Y (and Z) values are chosen to put it in the center of the display. If the marker is changed from some other type to fixed, the current X and Z values of the marker remain unchanged. The Y value is taken from the current trace data value and must be changed manually thereafter.

For Control Mode SCPI command information see: ["Control Mode" on page 1139](#)

Key Path	Marker
Mode	VSA, LTE, LTETDD, IDEN,LTEAFDD,LTEATDD
Initial S/W Revision	Prior to A.02.00
Modified at S/W Revision	A.02.00

Off

Turning a marker off makes it invisible, and also its annotation.

Turning a marker on (i.e., changing its control mode from Off to any other control mode) assigns the marker to the currently selected trace.

For Control Mode SCPI command information see: ["Control Mode" on page 1139](#)

Key Path	Marker
Mode	VSA, LTE, LTETDD, IDEN,LTEAFDD,LTEATDD
Initial S/W Revision	Prior to A.02.00
Modified at S/W Revision	A.02.00

Coupling of Delta and Reference Markers

The following coupling rules apply from the front panel and also if the equivalent SCPI commands are sent.

Pressing the Delta key causes the selected marker to become a delta marker if it is not already. Also, the selected marker's reference is affected as follows:

- If the reference marker was off, it is turned on as a fixed marker.
- The reference marker is moved to the trace of the selected marker and set to the same position as the selected marker.
- If the delta marker has a marker function turned on, the reference marker takes on the same function (with the same band limits).

Exception: Pressing Delta when the selected marker's mode is not yet Delta does not move or change a reference marker that is already turned on (Normal, Delta, or Fixed) and on the same trace as the selected marker. It merely changes the selected marker's mode to Delta and shows the current offset between it and the reference. If you press Delta again (when the selected marker is already in Delta mode) then the reference is moved and modified as described above.

When a delta marker is changed to any other control mode, if its reference marker is fixed then the reference marker is also turned off.

If you move a delta marker to a different trace, it is forced to Normal mode and if its reference is fixed, the reference is turned off.

A delta marker is forced to Normal mode if you turn its reference off or if you move its reference to another trace. (In the latter case the reference is not turned off even if it is fixed.)

If you change the selected marker's reference (using the Marker, Properties, Relative To), the selected marker is forced to Delta mode. This change of the selected marker to Delta mode causes its new reference's control mode and position to change as described above.

Select Marker

Specifies the selected marker. The selected marker is the one that is affected by the marker position and properties settings, peak search, and other marker functions. Several menus have a Select Marker key for convenience. Marker selection using any one of these is reflected in all others, in other words, there is only one selected marker for the whole measurement. If all markers are off, then marker 1 becomes the selected marker.

As a convenience, if no markers are displayed on the selected trace, selecting a marker that is off automatically turns it on in normal mode on the selected trace.

There is no SCPI function for selecting a marker. Instead, SCPI functions can explicitly include the index of the marker for which they are to apply. (Most SCPI marker functions that affect the state of a marker also make it the selected marker for front panel commands.)

Key Path	Marker or Marker> or Marker Function or Peak Search
Mode	VSA, LTE, LTETDD, IDEN, LTEAFDD, LTEATDD
State Saved	No

Range	1 2 3 4 5 6 7 8 9 10 11 12
Initial S/W Revision	Prior to A.02.00
Modified at S/W Revision	A.02.00

Marker Properties

Accesses a menu of common marker properties.

Key Path	Marker
Mode	VSA, LTE, LTETDD, IDEN,LTEAFDD,LTEATDD
Initial S/W Revision	Prior to A.02.00

Select Marker

Specifies the selected marker. The selected marker is the one that is affected by the marker position and properties settings, peak search, and other marker functions. Several menus have a Select Marker key for convenience. Marker selection using any one of these is reflected in all others, in other words, there is only one selected marker for the whole measurement. If all markers are off, then marker 1 becomes the selected marker.

As a convenience, if no markers are displayed on the selected trace, selecting a marker that is off automatically turns it on in normal mode on the selected trace.

There is no SCPI function for selecting a marker. Instead, SCPI functions can explicitly include the index of the marker for which they are to apply. (Most SCPI marker functions that affect the state of a marker also make it the selected marker for front panel commands.)

Key Path	Marker or Marker> or Marker Function or Peak Search
Mode	VSA, LTE, LTETDD, IDEN,LTEAFDD,LTEATDD
State Saved	No
Range	1 2 3 4 5 6 7 8 9 10 11 12
Initial S/W Revision	Prior to A.02.00
Modified at S/W Revision	A.02.00

Relative To

Enables you to specify which marker is used as a reference for the selected marker when the selected marker's control mode is set to Delta. By default, the reference marker is numerically one higher than the selected marker, that is, marker 1 is relative to marker 2, marker 2 to marker 3, and so on. Marker 12 by default is relative to marker 1. This key enables you to change the reference marker from the default. Note that a marker cannot be made relative to itself.

Key Path	Marker, Properties
Mode	VSA, LTE, LTETDD, IDEN, LTEAFDD, LTEATDD
Measurement	<meas>:=VECTor ADEMod DDEMod W11A W11B EVM IPOWER IDEMod MOTotalk
Remote Command	:CALCulate:<meas>:MARKer [1] 2 ... 12:REFerence <integer> :CALCulate:<meas>:MARKer [1] 2 ... 12:REFerence?
Example	CALC:VECT:MARK2:REF 4 CALC:VECT:MARK2:REF?
Notes	The reference marker cannot be the same value as the selected marker, that is, a marker cannot be relative to itself. The currently selected marker is not an available choice in the relative to selection (i.e., the selected marker appears grayed out). When queried, a single value is returned (the specified marker numbers relative marker).
Couplings	See " Coupling of Delta and Reference Markers " on page 1152. The old reference remains as it was.
Preset	2 3 4 5 6 7 8 9 10 11 12 1
State Saved	Saved in instrument state.
Range	1 2 3 4 5 6 7 8 9 10 11 12
Initial S/W Revision	Prior to A.02.00
Modified at S/W Revision	A.02.00

Complex Format

Determines the format for the readout when a marker is placed on a complex display (vector or constellation). The choices are to read out in rectangular or polar coordinates. The readout format applies to the marker display and marker table only; there is no SCPI for reading out the marker value in polar form.

Key Path	Marker, Properties
Mode	VSA, LTE, LTETDD, IDEN, LTEAFDD, LTEATDD
Measurement	<meas>:=VECTor ADEMod DDEMod W11A W11B EVM IPOWER IDEMod MOTotalk
Remote Command	:CALCulate:<meas>:MARKer [1] 2 ... 12:CFORmat RECTangular POLar :CALCulate:<meas>:MARKer [1] 2 ... 12:CFORmat?
Example	CALC:VECT:MARK1:CFOR RECT CALC:VECT:MARK1:CFOR?
Preset	RECT
State Saved	Saved in instrument state.
Range	Rect Polar
Initial S/W Revision	Prior to A.02.00
Modified at S/W Revision	A.02.00

Marker Trace

Enables you to determine the trace to which a marker is assigned. By default, when a marker is turned on it is assigned to the currently selected trace. You can change that assignment using this control.

Key Path	Marker, Properties
Mode	VSA, LTE, LTETDD, IDEN, LTEAFDD, LTEATDD
Measurement	<meas>:=VECTor ADEMod DDEMod W11A W11B EVM IPOWER IDEMod MOTotalk
Remote Command	:CALCulate:<meas>:MARKer[1] 2 ...12:TRACe <integer> :CALCulate:<meas>:MARKer[1] 2 ...12:TRACe?
Example	CALC:VECT:MARK3:TRAC 2 CALC:VECT:MARK3:TRAC?
Couplings	See " Coupling of Delta and Reference Markers " on page 1152.
Preset	Marker is assigned to currently selected trace when turned on.
State Saved	Saved in instrument state.
Range	Trace 1 Trace2 Trace 3 Trace 4
Min	1
Max	4
Initial S/W Revision	Prior to A.02.00
Modified at S/W Revision	A.02.00

Marker Count

Enables the frequency counter algorithm on the selected marker. This algorithm can more precisely determine the frequency of a peak. The marker must be on a frequency domain trace, with data coming from hardware. Place the marker on a peak and enable the frequency counter. The marker readout then shows the calculated frequency rather than the marker X position. Only one marker can be counted at any time. Turning on marker count for any marker turns it off for all other markers.

Key Path	Marker, Properties
Mode	VSA, IDEN, LTEAFDD, LTEATDD
Measurement	<meas>:=VECTor ADEMod DDEMod W11A W11B EVM IPOWER IDEMod MOTotalk
Remote Command	:CALCulate:<meas>:MARKer[1] 2 ...12:FCOut[:STATE] OFF ON 0 1 :CALCulate:<meas>:MARKer[1] 2 ...12:FCOut[:STATE]?
Example	CALC:VECT:MARK:FCO ON CALC:VECT:MARK:FCO?
Notes	Marker must be on a frequency-domain trace and data must be live, not recorded or simulated.
Preset	OFF
State Saved	Saved in instrument state.
Range	Off On
Initial S/W Revision	Prior to A.02.00
Modified at S/W Revision	A.02.00

The frequency counter result must be read back with the following SCPI command. The Marker X query command only gets the marker's data point position, which is not as accurate as the frequency counter result.

Mode	VSA, IDEN, LTEAFDD, LTEATDD
Measurement	<meas>:=VECTor ADEMod DDEMod W11A W11B EVM IPOWER IDEMod MOTotalk
Remote Command	:CALCulate:<meas>:MARKer[1] 2 ...12:FCOUNT:X?
Example	CALC:VECT:MARK:FCO:X?
Notes	Query only. If the marker counter result is unavailable, NaN is returned.
Initial S/W Revision	Prior to A.02.00
Modified at S/W Revision	A.02.00

Marker Table

Displays the marker data display window below the measurement window. For each marker that is on, information is displayed in the data display window, which includes the marker number, control mode, trace number, X axis scale, X axis value, and the Y-axis result. Additional information is shown for markers that have marker functions turned on.

Key Path	Marker
Mode	VSA, LTE, LTETDD, IDEN, LTEAFDD, LTEATDD
Measurement	<meas>:=VECTor ADEMod DDEMod W11A W11B EVM IPOWER IDEMod MOTotalk
Remote Command	:CALCulate:<meas>:MARKer:TABLE[:STATE] OFF ON 0 1 :CALCulate:<meas>:MARKer:TABLE[:STATE]?
Example	CALC:VECT:MARK:TABL ON CALC:VECT:MARK:TABL?
Preset	OFF
State Saved	No
Range	Off On
Initial S/W Revision	Prior to A.02.00
Modified at S/W Revision	A.02.00

Marker Position

Selects which data point in a trace to read out with the marker (or where to locate a fixed marker). The marker position is primarily set in terms of the domain units, not trace points (although it can be set in terms of points via SCPI). The default active function when you press a marker hard key is the X position for the currently selected marker. The exception to this is when the selected marker is fixed. In that case there is no default active function (to prevent inadvertently changing a fixed marker's location).

Marker position is not defined when a marker's control mode is Off. When a marker is turned on in Normal or Delta mode, its X (and Z) values are set to the center of the trace data. If a marker is turned on in Fixed mode, its position is set so that it appears in the middle of the trace grid.

The Marker Position key branches to the Marker Position menu, which enables you to set any position variable relevant to the selected marker's control mode and trace format.

For Normal and Delta markers, usually only Marker X is available. Marker Z is available for trace data with 2-dimensional domain. For Fixed markers, Y can also be set. If the trace format is Vector or Constellation, **Marker Y** controls the real (horizontal axis) value and **Marker Y Imag** controls the imaginary (vertical axis) value. The key (or the keys below it) is grayed out if the selected marker is off.

Key Path	Marker
Mode	VSA, LTE, LTETDD, IDEN,LTEAFDD,LTEATDD
Initial S/W Revision	Prior to A.02.00
Modified at S/W Revision	A.02.00

Marker X

Sets the selected marker's X Axis value position in the current X Axis Scale unit. If the control mode is Off, the SCPI command has no affect other than to cause the marker to become selected. Note that the X value can change if the marker is moved to a trace with a different domain.

The Marker X position is absolute if the marker control mode is Normal or Fixed. If the control mode is Delta, then the X position is relative to the reference marker. The valid X positions are the actual data points in the trace; the marker cannot be located between points. If a SCPI command attempts to place the marker between two points, the X value snaps to the closest point.

Note that for Vector or Constellation format, the X axis is perpendicular to the screen (because the screen axes are used to show the real and imaginary parts of the Y value), so adjusting the X value in this case only causes the marker to move horizontally if the real Y value changes. For Fixed markers on a trace with one of these formats, adjusting the X value does not cause horizontal motion of the marker at all. Instead, use the Marker Y and Marker Y (imag) controls to move the marker horizontally and vertically.

Key Path	Marker, Marker Position
Mode	VSA, LTE, LTETDD, IDEN,LTEAFDD,LTEATDD
Measurement	<meas>:=VECTor ADEMod DDEMod W11A W11B EVM IPOWER IDEMod MOTotalk
Remote Command	:CALCulate:<meas>:MARKer[1] 2 ...12:X <real> :CALCulate:<meas>:MARKer[1] 2 ...12:X?
Example	CALC:VECT:MARK:X 0.325 CALC:VECT:MARK:X?
Notes	Marker X does not go outside the bounds of the data unless it is Fixed. If you attempt to set it to a value outside the bounds, it is clipped at the closest limit and error -222 Data Out of Range is generated. If suffix is sent, it must match the X units for the trace the marker is on. Otherwise, error -138, "Suffix not allowed" is generated.

	If you try to read or set the position of a Delta marker, remember that the position is in relative units.
Couplings	See "Coupling of Delta and Reference Markers" on page 1152 . See also: "Couple Markers" on page 1151
Preset	None until marker is turned on.
State Saved	Saved in instrument state.
Min	Depends on trace data
Max	Depends on trace data
Initial S/W Revision	Prior to A.02.00
Modified at S/W Revision	A.02.00

SCPI only X position commands

Via SCPI, the marker position can also be set or queried in trace points. In this case, the position setting or reading is absolute regardless of control mode.

NOTE

The entered value in Trace Points is immediately translated into the current domain units for setting the value of the marker. The marker's value in domain units, NOT trace points, is preserved if a change is made to the X Axis scale settings. Thus, if you use this command to place a marker on point 500, which happens at that time to correspond to 13 GHz, and then you change the Start Frequency so that point 500 is no longer 13 GHz, the marker stays at 13 GHz, NOT at point 500.

If the trace the marker is on has a 2-dimensional domain, then the points are numbered in the following way:

Starting at the minimum X and Z position, this point is numbered 0. Each time you increment the point number, increment the X value to the next available value. When X reaches the maximum X position, then reset X to the minimum and increment the Z value. Then continue incrementing the X position in the same manner as before.

Note that for symbol tables, which have no axes, incrementing the X position in points moves the marker consecutively through all table entries.

Mode	VSA, LTE, LTETDD, IDEN,LTEAFDD,LTEATDD
Measurement	<meas>:=VECTor ADEMod DDEMod W11A W11B EVM IPOWER IDEMod MOTotalk
Remote Command	:CALCulate:<meas>:MARKer[1] 2 ...12[:X]:POSition <real> :CALCulate:<meas>:MARKer[1] 2 ...12[:X]:POSition?
Example	CALC:VECT:MARK:POS 25 CALC:VECT:MARK:POS?
Notes	When a marker control mode is changed from off to any other mode, the X position is set to mid-screen.
Couplings	See "Coupling of Delta and Reference Markers" on page 1152 . See also: "Couple Markers" on page 1151
Preset	None until marker is turned on.

State Saved	Saved in instrument state.
Min	Depends on trace data
Max	Depends on trace data
Initial S/W Revision	Prior to A.02.00
Modified at S/W Revision	A.02.00

Marker X Unit can be queried via SCPI

Mode	VSA, LTE, LTETDD, IDEN,LTEAFDD,LTEATDD
Measurement	<meas>:=VECTor ADEMod DDEMod W11A W11B EVM IPOWER IDEMod MOTotalk
Remote Command	:CALCulate:<meas>:MARKer[1] 2 ...12:X:UNIT?
Example	CALC:VECT:MARK:X:UNIT?
Notes	Query Only
Initial S/W Revision	Prior to A.02.00
Modified at S/W Revision	A.02.00

Marker Z

Sets the selected markers Z Axis value in the current Z Axis Scale unit for markers on traces with a 2-dimensional domain. In each case the marker that is addressed becomes the selected marker. It has no affect (other than to cause the marker to become selected) if the control mode is **Off** or if the trace has no Z domain. Note that the Z value can change or become irrelevant if the marker is moved to a trace with a different Z domain or no Z domain.

Note that this Z value is affected if the SCPI command to set marker point position is used.

Key Path	Marker, Marker Position
Mode	VSA, LTE, LTETDD, IDEN,LTEAFDD,LTEATDD
Measurement	<meas>:=VECTor ADEMod DDEMod W11A W11B EVM IPOWER IDEMod MOTotalk
Remote Command	:CALCulate:<meas>:MARKer[1] 2 ...12:Z <real> :CALCulate:<meas>:MARKer[1] 2 ...12:Z?
Example	CALC:OFDM:MARK:Z 12 CALC:OFDM:MARK:Z?
Notes	Marker Z does not go outside the bounds of the data unless it is Fixed. If you attempt to set it to a value outside the bounds it is clipped at the closest limit, and error -222 Data Out of Range is generated. If suffix is sent, it must match the Z units for the trace the marker is on. Otherwise, error -138, "Suffix not allowed" is generated.
Couplings	See "Coupling of Delta and Reference Markers" on page 1152 . See also: "Couple Markers" on page 1151

Preset	None until marker is turned on.
State Saved	Saved in instrument state.
Min	Depends on trace data
Max	Depends on trace data
Initial S/W Revision	Prior to A.02.00
Modified at S/W Revision	A.02.00

Marker Z Unit can be queried via SCPI.

Mode	VSA, LTE, LTETDD, IDEN,LTEAFDD,LTEATDD
Measurement	<meas>:=VECTor ADEMod DDEMod W11A W11B EVM IPOWER IDEMod MOTotalk
Remote Command	:CALCulate:<meas>:MARKer [1] 2 ...12:Z:UNIT?
Example	CALC:OFDM:MARK:Z:UNIT?
Notes	Query Only
Initial S/W Revision	Prior to A.02.00
Modified at S/W Revision	A.02.00

Marker Y

Enables you to set or read back the selected marker's Y Axis value in the current Y Axis Scale unit. Setting the Y value has no affect (other than to cause the marker to become selected) if the control mode is other than fixed. The query form generates an error if the control mode is Off. Note that the Y value can change if the Y-axis units change, either from a change in format of the trace the marker is on or if the marker is moved to a different trace.

If the selected marker is on a trace that is displayed with Vector or Constellation format, this function controls only the real part of the Y value (i.e., the horizontal axis value). Use the **Marker Y (imag)** control to change the imaginary (vertical) value. Marker Y and Marker Y Imag always set or get the rectangular form of Y, regardless of whether the marker readout is polar or rectangular.

Key Path	Marker, Marker Position
Mode	VSA, LTE, LTETDD, IDEN,LTEAFDD,LTEATDD
Measurement	<meas>:=VECTor ADEMod DDEMod W11A W11B EVM IPOWER IDEMod MOTotalk
Remote Command	:CALCulate:<meas>:MARKer [1] 2 ...12:Y[:REAL] <real> :CALCulate:<meas>:MARKer [1] 2 ...12:Y[:REAL] ?
Example	CALC:VECT:MARK2:Y 0.325 CALC:VECT:MARK2:Y?
Notes	You cannot set Y unless the marker type is fixed. If the marker becomes fixed after a marker function is turned on, it is set to whatever the Y value was when the marker became fixed. If suffix is sent, it must match the Y units for the trace the marker is on. Otherwise, error -138, "Suffix not allowed" is generated.

Couplings	Changes if marker is relative to a Delta marker that is turned on or re-zeroed (see " Coupling of Delta and Reference Markers " on page 1152).
Preset	None until marker is turned on.
State Saved	Saved in instrument state.
Min	-9.9E+37
Max	9.9E+37
Initial S/W Revision	Prior to A.02.00
Modified at S/W Revision	A.02.00

Marker Y Unit can be queried via SCPI.

Mode	VSA, LTE, LTETDD, IDEN,LTEAFDD,LTEATDD
Measurement	<meas>:=VECTor ADEMod DDEMod W11A W11B EVM IPOWER IDEMod MOTotalk
Remote Command	:CALCulate:<meas>:MARKer[1] 2 ...12:Y:UNIT?
Example	CALC:VECT:MARK:Y:UNIT?
Notes	Query Only
Initial S/W Revision	Prior to A.02.00
Modified at S/W Revision	A.02.00

Marker Y Imag (Imaginary)

Enables you to set or read back the selected marker's quadrature (imaginary) Y value in the current Y Axis Scale unit. It has no affect (other than to cause the marker to become selected) if the control mode is other than fixed or if the current trace format is not complex (Vector or Constellation). The query form generates an error if it is used for a marker that is not on a complex trace. Marker Y Imag is not affected by whether the marker readout is polar or rectangular.

Key Path	Marker, Marker Position
Mode	VSA, LTE, LTETDD, IDEN,LTEAFDD,LTEATDD
Measurement	<meas>:=VECTor ADEMod DDEMod W11A W11B EVM IPOWER IDEMod MOTotalk
Remote Command	:CALCulate:<meas>:MARKer[1] 2 ...12:Y:IMAGinary <real> :CALCulate:<meas>:MARKer[1] 2 ...12:Y:IMAGinary?
Example	CALC:DDEM:MARK1:Y:IMAG 0.435 CALC:DDEM:MARK1:Y:IMAG?
Notes	Grayed out unless the marker is fixed and on a vector display. If suffix is sent, it must match the Y units for the trace the marker is on. Otherwise, an Invalid Suffix error is generated. Otherwise, error -138, "Suffix not allowed" is generated. If query is sent while the marker is on a trace whose format is not vector or constellation, NaN (9.91E+37) is returned.
Preset	None until marker is turned on.

State Saved	Saved in instrument state.
Min	Depends on trace format
Max	Depends on trace format
Initial S/W Revision	Prior to A.02.00
Modified at S/W Revision	A.02.00

Couple Markers

Affects all currently displayed markers. In general, when coupling is turned on then all Normal or Delta markers with the same (or equivalent) domain as the selected marker move in the same manner as the selected marker. Coupling is relative between markers on the same trace (so that their relative positions in the domain are maintained). Coupling can be absolute between markers on different traces that have equivalent domains. That is, they have the same position in the domain, if possible. (As an example of equivalent domains, demodulated symbol positions can be derived from time by using the current symbol rate). When you move the selected marker, then others on related traces track it. This enables you to correlate different measurement results. For example, you can place a marker at a particular symbol time on an error vector magnitude display, have tracking markers on the symbol table and pre-demod time trace showing you the symbol value, and the actual time-varying signal value at the same point in time.

Absolute coupling is performed only for the lowest numbered Normal or Delta marker on each trace. All other markers on a trace couple relatively. When you turn on marker coupling, the subset of markers that have the same domain as the selected marker track it and all other markers remain at their current location. The absolutely coupled markers within this subset is moved at this time to match the domain setting of the selected marker, with the relatively coupled markers following accordingly to maintain offsets within their respective traces. Those markers with different domains remain at their current location. When you select a marker with a different domain than the previously selected marker, then the subset of markers with that domain go through the same procedure.

Any marker that coupling would move outside its range of X values, remains at the closest limiting value until the selected marker moves in such a way as to bring the coupled X value back into range. If the coupled markers are on data that do not have the same domain resolution, then they are positioned as close to each other as possible.

If markers change mode or trace, or trace data is changed below them, the coupling rules are immediately applied to the new set.

Key Path	Marker
Mode	VSA, LTE, LTETDD, IDEN, LTEAFDD, LTEATDD
Measurement	<meas>:=VECTor ADEMod DDEMod W11A W11B EVM IPOWER IDEMod MOTotalk
Remote Command	:CALCulate:<meas>:MARKer:COUPlE[:STATe] OFF ON 0 1 :CALCulate:<meas>:MARKer:COUPlE[:STATe]?
Example	CALC:VECT:MARK:COUP ON CALC:VECT:MARK:COUP?
Preset	OFF

State Saved	Saved in instrument state.
Range	Off On
Initial S/W Revision	Prior to A.02.00
Modified at S/W Revision	A.02.00

All Markers Off

Turns all markers off and sets the selected marker to 1.

Key Path	Marker
Mode	VSA, LTE, LTETDD, IDEN,LTEAFDD,LTEATDD
Measurement	<meas>:=VECTor ADEMod DDEMod W11A W11B EVM IPOWER IDEMod MOTotalk
Remote Command	:CALCulate:<meas>:MARKer:AOFF
Example	CALC:VECT:MARK:AOFF:
Initial S/W Revision	Prior to A.02.00
Modified at S/W Revision	A.02.00

Coupling of Delta and Reference Markers

The following coupling rules apply from the front panel and also if the equivalent SCPI commands are sent.

Pressing the Delta key causes the selected marker to become a delta marker if it is not already. Also, the selected marker's reference is affected as follows:

- If the reference marker was off, it is turned on as a fixed marker.
- The reference marker is moved to the trace of the selected marker and set to the same position as the selected marker.
- If the delta marker has a marker function turned on, the reference marker takes on the same function (with the same band limits).

Exception: Pressing Delta when the selected marker's mode is not yet Delta does not move or change a reference marker that is already turned on (Normal, Delta, or Fixed) and on the same trace as the selected marker. It merely changes the selected marker's mode to Delta and shows the current offset between it and the reference. If you press Delta again (when the selected marker is already in Delta mode) then the reference is moved and modified as described above.

When a delta marker is changed to any other control mode, if its reference marker is fixed then the reference marker is also turned off.

If you move a delta marker to a different trace, it is forced to Normal mode and if its reference is fixed, the reference is turned off.

A delta marker is forced to Normal mode if you turn its reference off or if you move its reference to another trace. (In the latter case the reference is not turned off even if it is fixed.)

10 iDEN Power Measurement Marker

If you change the selected marker's reference (using the Marker, Properties, Relative To), the selected marker is forced to Delta mode. This change of the selected marker to Delta mode causes its new reference's control mode and position to change as described above.

Marker -> (Marker To)

Provides access to some convenient functions for copying the marker position to a number of frequency and Y-axis scaling parameters. These functions are available from the front panel only. No SCPI is provided, because you can already read the marker position via SCPI and then set any frequency or scaling parameter accordingly, with full accuracy.

Pressing the Marker -> hardkey always makes the selected marker's X position the active function.

If the selected marker is off, pressing the Marker -> hardkey turns on the selected marker in normal mode on the currently selected trace.

Key Path	Front Panel
Mode	VSA, LTE, LTETDD, IDEN,LTEAFDD,LTEATDD
Initial S/W Revision	Prior to A.02.00
Modified at S/W Revision	A.02.00

Mkr -> CF (Center Frequency)

Sets the center frequency equal to the selected marker's absolute frequency. The marker must be on a frequency-domain trace. The absolute marker frequency is used regardless of whether its control mode is Normal, Delta, or Fixed.

If the currently selected marker is not on when this key is pressed, it is turned on at the center of the screen as a normal type marker.

Key Path	Marker To
Mode	VSA, LTE, LTETDD, IDEN,LTEAFDD,LTEATDD
Initial S/W Revision	Prior to A.02.00
Modified at S/W Revision	A.02.00

Mkr -> CF Step

Sets the center frequency step size equal to the selected marker's frequency. The marker must be on a frequency-domain trace. The absolute marker frequency is used regardless of whether its control mode is Normal, Delta, or Fixed.

If the currently selected marker is not on when this key is pressed, it is turned on at the center of the screen as a normal type marker.

Key Path	Marker To
Mode	VSA, LTE, LTETDD, IDEN,LTEAFDD,LTEATDD
Initial S/W Revision	Prior to A.02.00
Modified at S/W Revision	A.02.00

Mkr -> Start

Sets the start frequency equal to the selected marker's frequency. The marker must be on a frequency-domain trace. The absolute marker frequency is used regardless of whether its control mode is Normal, Delta, or Fixed.

If the currently selected marker is not on when this key is pressed, it is turned on at the center of the screen as a normal type marker.

Key Path	Marker To
Mode	VSA, LTE, LTETDD, IDEN,LTEAFDD,LTEATDD
Initial S/W Revision	Prior to A.02.00
Modified at S/W Revision	A.02.00

Mkr -> Stop

Sets the stop frequency equal to the selected marker's frequency. The marker must be on a frequency-domain trace. The absolute marker frequency is used regardless of whether its control mode is Normal, Delta, or Fixed.

If the currently selected marker is not on when this key is pressed, it is turned on at the center of the screen as a normal type marker.

Key Path	Marker To
Mode	VSA, LTE, LTETDD, IDEN,LTEAFDD,LTEATDD
Initial S/W Revision	Prior to A.02.00
Modified at S/W Revision	A.02.00

Mkr Delta -> Span

Sets the start and stop frequencies equal to the selected marker's frequency and that of its reference. That is, the measurement span is "zoomed in" so that the selected marker and its associated reference appear on the extreme left and right of the display. The marker must be on a frequency-domain trace and its control mode must be Delta.

Key Path	Marker To
Mode	VSA, LTE, LTETDD, IDEN,LTEAFDD,LTEATDD
Initial S/W Revision	Prior to A.02.00
Modified at S/W Revision	A.02.00

Mkr -> Ref Lvl

Sets the Y axis reference value equal to the selected marker's Y value. For example, if the reference position is at the top of the screen, the whole trace is moved up so that the marker appears at the top of

the screen. Note that this is a display scaling function only. The input range remains the same.

Key Path	Marker To
Mode	VSA, LTE, LTETDD, IDEN,LTEAFDD,LTEATDD
Initial S/W Revision	Prior to A.02.00
Modified at S/W Revision	A.02.00

Counter -> CF (Center Frequency)

Sets the frequency of the marker counter to the center frequency. The marker counter function must be on.

Key Path	Marker To
Mode	VSA, IDEN,LTEAFDD,LTEATDD
Initial S/W Revision	Prior to A.02.00
Modified at S/W Revision	A.02.00

Mkr Delta -> CF (Center Frequency)

Sets the center frequency equal to the difference in frequency between the selected Delta marker and its reference. The marker must be on a frequency-domain trace and the selected marker's control mode must be Delta.

Key Path	Marker To
Mode	VSA, LTE, LTETDD, IDEN,LTEAFDD,LTEATDD
Initial S/W Revision	Prior to A.02.00
Modified at S/W Revision	A.02.00

Marker Function

Accesses a menu of selectable marker functions for VSA based measurements.

Marker Functions perform post-processing operations on marker data. Band Functions are Marker Functions that enable you to define a band of frequencies around the marker. The band defines the region of data used for the numerical calculations. These marker functions also enable you to perform mathematical calculations on trace and marker data and report the results of these calculations in place of the normal marker result.

Unlike regular markers, marker function markers are not placed directly on the trace. They are placed at a location that is relative to the result of the function calculation.

The Marker Function menu provides access to power calculations in bands of frequencies or time intervals centered on a marker. It also enables you to make calculations like carrier to noise by combining delta markers with marker functions. Marker functions are generally available for time and frequency domain traces, and not for others. If the marker function calculation is undefined for particular trace data, then "---" is shown in place of a number in the result display and marker table, and CALC:<meas>:MARK[n]:Y? returns 9.91E+37 (NaN).

Pressing Marker Function always makes the selected marker's X position the active function.

If the selected marker is off, pressing the Marker Function hardkey turns on the selected marker in normal mode on the currently selected trace.

Key Path	Front Panel
Mode	VSA, LTE, LTETDD, IDEN,LTEAFDD,LTEATDD
Measurement	<meas>:=VECTor ADEMod DDEMod W11A W11B EVM IPOWER IDEMod MOTotalk
Remote Command	:CALCulate:<meas>:MARKer[1] 2 ...12:FUNction BPOwer BDENsity =OFF :CALCulate:<meas>:MARKer[1] 2 ...12:FUNction?
Example	CALC:VECT:MARK1:FUNC BPOW CALC:VECT:MARK1:FUNC?
Notes	:CALC:<meas>:MARK1:FUNC? returns the current function type for marker 1. To return the result, use :CALC:<meas>:MARK1:Y?
Preset	=OFF
State Saved	Saved in instrument state.
Range	Band Power Band Density Off
Initial S/W Revision	Prior to A.02.00
Modified at S/W Revision	A.02.00

Select Marker

Specifies the selected marker. The selected marker is the one that is affected by the marker position and properties settings, peak search, and other marker functions. Several menus have a Select Marker key for convenience. Marker selection using any one of these is reflected in all others, in other words, there is only

one selected marker for the whole measurement. If all markers are off, then marker 1 becomes the selected marker.

As a convenience, if no markers are displayed on the selected trace, selecting a marker that is off automatically turns it on in normal mode on the selected trace.

There is no SCPI function for selecting a marker. Instead, SCPI functions can explicitly include the index of the marker for which they are to apply. (Most SCPI marker functions that affect the state of a marker also make it the selected marker for front panel commands.)

Key Path	Marker or Marker> or Marker Function or Peak Search
Mode	VSA, LTE, LTETDD, IDEN,LTEAFDD,LTEATDD
State Saved	No
Range	1 2 3 4 5 6 7 8 9 10 11 12
Initial S/W Revision	Prior to A.02.00
Modified at S/W Revision	A.02.00

Band/Interval Power

Turns on the Band/Interval Power function for the selected marker. This function calculates the power within the band centered on the marker. The function works generally with frequency spectra, PSD, and time traces. On traces where band power is undefined, the result display shows "---" and CALC:<meas>:MARK[n]:Y? returns 9.91E+37 (NaN), although the band interval can still be defined.

Frequency-domain data

If the marker is on a frequency-domain trace, the result is total power within the band. This is true whether the underlying trace data is a power spectrum or power spectral density.

Time-domain data

If the marker is on a time-domain trace, the result is average power within the time interval, that is, the power at each time sample in the time interval is calculated, the powers are summed and the total divided by the number of samples.

Key Path	Marker Function
Mode	VSA, LTE, LTETDD, IDEN,LTEAFDD,LTEATDD
Initial S/W Revision	Prior to A.02.00
Modified at S/W Revision	A.02.00

Band Power Calculation

Shows results in dBm, dBVrms, Watts, Volts RMS Squared or Volts RMS. The table below shows the choice of display units if **Band Power Calculation** is set to **Mean**, depending on the current format and Y units of the trace the marker is on.

Trace data type	Trace Format	Y Unit	Result format
Spectrum, PSD, Time record	LogMag (dB)	Auto, Power	dBm
		Peak, RMS	dBVrms
		mRMS	dBmVrms
	Linear Mag, Real, Imag, Log Mag (lin)	Auto, Peak, RMS, mRMS	Vrms^2
	Linear Mag, Real, Imag, Log Mag(lin)	Power	W
	Wrap Phase, Unwrap Phase, Delay	Any	Vrms^2
	Vector, Constellation, Eye, Trellis	Any	blanked
Dimensionless (e.g., Frequency response, Impulse response, various Demodulation error types)	LogMag (dB)	Any	dBrms
	Linear Mag, Real, Imag, Wrap Phase, Unwrap Phase, Delay, Log Mag (lin)	Any	rms^2
General dimensions(e.g., Hz, %)	LogMag (dB)	Any	dB<unit>rms
	Linear Mag, Real, Imag, Wrap Phase, Unwrap Phase, Delay, Log Mag (lin)	Any	<unit>rms^2

If the **Band Power Calculation** is set to **RMS**, then the readout unit does not depend on trace format or Y unit. For Spectrums, PS, and Time record traces, the displayed unit is "Vrms". For general units, the unit abbreviation is shown followed by "rms".

The Band Power Calculation only controls the readout format for Normal and Fixed markers. For Delta markers, see ["Band Power and Delta Markers" on page 1163](#).

Key Path	Marker Function, Band/Interval Power
Mode	VSA, LTE, LTETDD, IDEN, LTEAFDD, LTEATDD
Measurement	<meas>:=VECTor ADEMod DDEMod W11A W11B EVM IPOWER IDEMod MOTotalk
Remote Command	:CALCulate:<meas>:MARKer[1] 2 ...12:FUNCTION:BPOWER:CTYPe MEAN RMS :CALCulate:<meas>:MARKer[1] 2 ...12:FUNCTION:BPOWER:CTYPe?
Example	CALC:VECT:MARK1:FUNC:BPOW:CTYP MEAN CALC:VECT:MARK1:FUNC:BPOW:CTYP?
Preset	MEAN
State Saved	Saved in instrument state.
Range	Mean RMS
Initial S/W Revision	Prior to A.02.00
Modified at S/W Revision	A.02.00

Band/Interval Density

Calculates the average power density within the band centered on the marker. The function works generally with frequency spectra, PSD, and time traces. On traces where band power cannot reasonably be defined, the result display shows "---" and CALC:<meas>:MARK[n]:Y? returns NaN (9.91E+37), although the band interval can still be defined.

Frequency-domain data

If the marker is on a frequency-domain trace, the result is the band power (as computed above) divided by the bandwidth over which it is measured. This is true whether the underlying trace data is a power spectrum or power spectral density.

Time-domain data

If the marker is on a time-domain trace, the result is average power within the time interval (as computed above) divided by the equivalent noise bandwidth of the span.

Key Path	Marker Function
Mode	VSA, LTE, LTETDD, IDEN,LTEAFDD,LTEATDD
Initial S/W Revision	Prior to A.02.00
Modified at S/W Revision	A.02.00

Band Density Calculation

Turns on the Band/Interval Density function for the selected marker. If the selected marker is off, it is turned on in **Normal** marker mode and is located at the center of the screen.

If **Band/Interval Density** is selected while in the **Marker Function Off** state, the **Band Span** or **Interval Span** is initialized to 5% of the screen width.

If the detector mode for the detector on the marker's trace is set to Auto, the average detector is selected. If the Average type is set to Auto, Power Averaging is selected. Other choices for the detector or Average type usually cause measurement inaccuracy.

A band/interval density calculation result can be shown in dBm/Hz, Volts RMS Squared, or Volts RMS. The following table shows the choice of display units if **Band Density Calculation** is set to **Mean**, depending on the current format of the trace the marker is on.

Trace data type	Trace Format	Result format
Spectrum, PSD, Time record	LogMag (dB)	dBm/Hz
	Linear Mag, Real, Imag, Wrap Phase, Unwrap Phase, Delay, Log Mag (lin)	Vrms ² /Hz
Dimensionless (e.g., Frequency response, Impulse response, various Demodulation error types)	LogMag (dB)	dBrms/Hz
	Linear Mag, Real, Imag, Wrap Phase, Unwrap Phase, Delay, Log Mag (lin)	rms ² /Hz

General dimensions (e.g., Hz, %)	LogMag (dB)	dB<unit>rms/Hz
	Linear Mag, Real, Imag, Wrap Phase, Unwrap Phase, Delay, Log Mag (lin)	<unit>rms^2/Hz

If the **Band Density Calculation** is set to **RMS**, then the readout unit does not depend on trace format. For Spectrum, PSD, and Time record traces, the displayed unit is "Vrms/rtHz". For general units, the unit abbreviation is shown followed by "rms/rtHz".

The Band Density Calculation only controls the readout format for Normal and Fixed markers. For Delta markers, see ["Band Power and Delta Markers" on page 1163](#).

Key Path	Marker Function, Band/Interval Power
Mode	VSA, LTE, LTETDD, IDEN,LTEAFDD,LTEATDD
Measurement	<meas>:=VECTor ADEMod DDEMod W11A W11B EVM IPOWER IDEMod MOTotalk
Remote Command	:CALCulate:<meas>:MARKer[1] 2 ...12:FUNCTION:BDENsity:CTYPe MEAN RMS :CALCulate:<meas>:MARKer[1] 2 ...12:FUNCTION:BDENsity:CTYPe?
Example	CALC:VECT:MARK1:FUNC:BDEN:CTYP RMS CALC:VECT:MARK1:FUNC:BDEN:CTYP?
Preset	MEAN
State Saved	Saved in instrument state.
Range	Mean RMS
Initial S/W Revision	Prior to A.02.00
Modified at S/W Revision	A.02.00

Band Adjust

Enables you to define the bandwidth around the marker. The band is always centered on the marker position. Entering the menu always sets Band/Interval Span as the active function.

Key Path	Marker Function
Mode	VSA, LTE, LTETDD, IDEN,LTEAFDD,LTEATDD
Initial S/W Revision	Prior to A.02.00
Modified at S/W Revision	A.02.00

Band/Interval Center

Enables you to define the center of the band. That is, it enables you to adjust the marker position in absolute units (regardless of whether the marker mode is Normal or Delta).

Key Path	Marker Function, Band Adjust
----------	------------------------------

Mode	VSA, LTE, LTETDD, IDEN, LTEAFDD, LTEATDD
Measurement	<meas>:=VECTor ADEMod DDEMod W11A W11B EVM IPOWER IDEMod MOTotalk
Remote Command	:CALCulate:<meas>:MARKer[1] 2 ...12:FUNction:BAND:CENTer <real> :CALCulate:<meas>:MARKer[1] 2 ...12:FUNction:BAND:CENTer?
Example	CALC:VECT:MARK2:FUNC:BAND:CENT 1.23E+09 CALC:VECT:MARK2:FUNC:BAND:CENT?
Preset	Center of screen
State Saved	Saved in instrument state.
Min	-9.9E+37
Max	9.9E+37
Initial S/W Revision	Prior to A.02.00
Modified at S/W Revision	A.02.00

Band/Interval Span

Sets the width of the span for the selected marker. This function defines the span of frequencies or time. The marker position does not change when you adjust the span.

Key Path	Marker Function, Band Adjust
Mode	VSA, LTE, LTETDD, IDEN, LTEAFDD, LTEATDD
Measurement	<meas>:=VECTor ADEMod DDEMod W11A W11B EVM IPOWER IDEMod MOTotalk
Remote Command	:CALCulate:<meas>:MARKer[1] 2 ...12:FUNction:BAND:SPAN <real> :CALCulate:<meas>:MARKer[1] 2 ...12:FUNction:BAND:SPAN?
Example	CALC:VECT:MARK2:FUNC:BAND:SPAN 1.23E+06 CALC:VECT:MARK2:FUNC:BAND:SPAN?
Preset	When marker turned on, 1/20th of current span or displayed time length.
State Saved	Saved in instrument state.
Min	-9.9E+37
Max	9.9E+37
Initial S/W Revision	Prior to A.02.00
Modified at S/W Revision	A.02.00

Band/Interval Left

Enables you to adjust the left side of the band. In order to remain centered in the band, the marker position must also change as you change the left edge. The right edge is unaffected.

Key Path	Marker Function, Band Adjust
----------	------------------------------

Mode	VSA, LTE, LTETDD, IDEN, LTEAFDD, LTEATDD
Measurement	<meas>:=VECTor ADEMod DDEMod W11A W11B EVM IPOWER IDEMod MOTotalk
Remote Command	:CALCulate:<meas>:MARKer[1] 2 ...12:FUNction:BAND:LEFT <real> :CALCulate:<meas>:MARKer[1] 2 ...12:FUNction:BAND:LEFT?
Example	CALC:VECT:MARK2:FUNC:BAND:LEFT 1.23E+06 CALC:VECT:MARK2:FUNC:BAND:LEFT?
Couplings	Changes marker X to keep the marker centered in the band.
Preset	When marker turned on, 1/40th of current span or displayed time length left of the marker position.
State Saved	Saved in instrument state.
Min	-9.9E+37
Max	9.9E+37
Initial S/W Revision	Prior to A.02.00
Modified at S/W Revision	A.02.00

Band/Interval Right

Enables you to adjust the right side of the band. In order to remain centered in the band, the marker position must also change as you change the right edge. The left edge is unaffected.

Key Path	Marker Function, Band Adjust
Mode	VSA, LTE, LTETDD, IDEN, LTEAFDD, LTEATDD
Measurement	<meas>:=VECTor ADEMod DDEMod W11A W11B EVM IPOWER IDEMod MOTotalk
Remote Command	:CALCulate:<meas>:MARKer[1] 2 ...12:FUNction:BAND:RIGHT <real> :CALCulate:<meas>:MARKer[1] 2 ...12:FUNction:BAND:RIGHT?
Example	CALC:VECT:MARK2:FUNC:BAND:RIGHT 1.23E+06 CALC:VECT:MARK2:FUNC:BAND:RIGHT?
Couplings	Changes marker X to keep the marker centered in the band.
Preset	When marker turned on, 1/40th of current span or displayed time length right of the marker position.
State Saved	Saved in instrument state.
Min	-9.9E+37
Max	9.9E+37
Initial S/W Revision	Prior to A.02.00
Modified at S/W Revision	A.02.00

Band Power and Delta Markers

When either a Delta marker or its reference has a band power function turned on, the Delta marker readout always shows a ratio calculation. This enables you to perform common calculations like carrier to noise ratio or adjacent channel power ratio. The form of the ratio depends on the main marker function

calculation type (Mean or RMS). If the main marker function calculation type is Mean, then when you change the marker to Delta the result is a power ratio. If the main marker function calculation type is RMS, then the Delta marker result is a voltage ratio. (If the main marker band power function is off, then the form of the ratio depends on the reference marker calculation type: If it is Mean you get a power ratio and if it is RMS you get a voltage ratio.)

For example, if the main marker function is Band/Interval Power with a calculation type of Mean and the reference marker function is Band/Interval Power with a calculation type of RMS, then the Delta marker shows the ratio of the main marker "Band/Interval Power Mean" value to the reference marker "Band/Interval Power Mean" (not RMS) value.

A dimensionless ratio (for example, Volt/Volt or Watt/Watt) is shown with units of "x". The marker function calculation type indicates whether the ratio is voltage or power (see above). A dimensionless power ratio is shown with units of dB if the trace format is Log Mag (dB).

If the reference marker function is Band/Interval Density and the main marker is either Band/Interval Power or its function is turned off, then the ratio is not dimensionless, but has units of Hz (or dB-Hz) for power calculations or rHz for voltage calculations. When the main marker function is Band/Interval Density and the reference is either Band/interval Power or its function is off, the units are /Hz (or dB/Hz) for power calculations or /rHz for voltage calculations.

Key Path	Marker Function
Mode	VSA, LTE, LTETDD, IDEN,LTEAFDD,LTEATDD
Initial S/W Revision	Prior to A.02.00
Modified at S/W Revision	A.02.00

Meas

The information in this section is common to all measurements. For key and remote command information for a specific measurement, refer to the section that describes the measurement of interest.

Measurements available under the Meas key are specific to the current Mode.

When viewing Help for measurements, note the following:

NOTE

Operation for some keys differs between measurements. The information displayed in Help pertains to the current measurement. To see how a key operates in a different measurement, exit Help (press the Cancel Esc key), select the measurement, then reenter Help (press the Help key) and press that key.

Key Path	Front-panel key
Initial S/W Revision	Prior to A.02.00

Remote Measurement Functions

This section contains the following topics:

["Measurement Group of Commands" on page 1166](#)

["Current Measurement Query \(Remote Command Only\)" on page 1168](#)

["Limit Test Current Results \(Remote Command Only\)" on page 1168](#)

["Data Query \(Remote Command Only\)" on page 1168](#)

["Calculate/Compress Trace Data Query \(Remote Command Only\)" on page 1169](#)

["Calculate Peaks of Trace Data \(Remote Command Only\)" on page 1174](#)

[Hardware-Accelerated Fast Power Measurement \(Remote Command Only\)](#)

["Format Data: Numeric Data \(Remote Command Only\)" on page 1175](#)

["Format Data: Byte Order \(Remote Command Only\)" on page 1176](#)

Initial S/W Revision	Prior to A.02.00
----------------------	------------------

Measurement Group of Commands

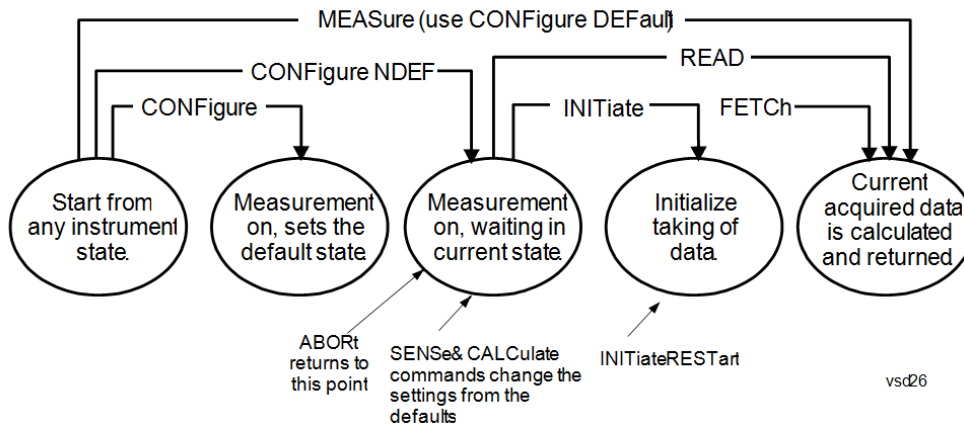

Measure Commands:

:MEASure:<measurement>[n]?

This is a fast single-command way to make a measurement using the factory default instrument settings. These are the settings and units that conform to the Mode Setup settings (e.g. radio standard) that you have currently selected.

- Stops the current measurement (if any) and sets up the instrument for the specified measurement using the factory defaults
- Initiates the data acquisition for the measurement
- Blocks other SCPI communication, waiting until the measurement is complete before returning results.
- If the function does averaging, it is turned on and the number of averages is set to 10.
- After the data is valid it returns the scalar results, or the trace data, for the specified measurement. The type of data returned may be defined by an [n] value that is sent with the command.
- The scalar measurement results will be returned if the optional [n] value is not included, or is set to 1. If the [n] value is set to a value other than 1, the selected trace data results will be returned. See each command for details of what types of scalar results or trace data results are available.
- ASCII is the default format for the data output. (Older versions of Spectrum Analysis and Phase Noise mode measurements only use ASCII.) The binary data formats should be used for handling large blocks of data since they are smaller and faster than the ASCII format. Refer to the FORMat:DATA command for more information.

If you need to change some of the measurement parameters from the factory default settings you can set up the measurement with the CONFigure command. Use the commands in the SENSe:<measurement> and CALCulate:<measurement> subsystems to change the settings. Then you can use the READ? command to initiate the measurement and query the results.

If you need to repeatedly make a given measurement with settings other than the factory defaults, you can use the commands in the SENSe:<measurement> and CALCulate:<measurement> subsystems to set up the measurement. Then use the READ? command to initiate the measurement and query results.

Measurement settings persist if you initiate a different measurement and then return to a previous one. Use READ:<measurement>? if you want to use those persistent settings. If you want to go back to the default settings, use MEASure:<measurement>?.

Configure Commands:

:CONFigure:<measurement>

This command stops the current measurement (if any) and sets up the instrument for the specified measurement using

the factory default instrument settings. It does not initiate the taking of measurement data unless INIT:CONTinuous is ON. If you change any measurement settings after using the CONFigure command, the READ command can be used to initiate a measurement without changing the settings back to their defaults.

In the Swept SA measurement in Spectrum Analyzer mode the CONFigure command also turns the averaging function on and sets the number of averages to 10 for all measurements.

:CONFigure: <measurement>: NDEFault stops the current measurement and changes to the specified measurement. It does not change the settings to the defaults. It does not initiate the taking of measurement data unless INIT:CONTinuous is ON.

The CONFigure? query returns the current measurement name.

The CONFigure:CATalog? query returns a quoted string of all licensed measurement names in the current mode. For example, "SAN, CHP, OBW, ACP, PST, TXP, SPUR, SEM, LIST".

Fetch Commands:

:FETCh:<measurement>[n]?

This command puts selected data from the most recent measurement into the output buffer. Use FETCh if you have already made a good measurement and you want to return several types of data (different [n] values, for example, both scalars and trace data) from a single measurement. FETCh saves you the time of re-making the measurement. You can only FETCh results from the measurement that is currently active, it will not change to a different measurement. An error message is reported if a measurement other than the current one is specified.

If you need to get new measurement data, use the READ command, which is equivalent to an INITiate followed by a FETCh.

The scalar measurement results will be returned if the optional [n] value is not included, or is set to 1. If the [n] value is set to a value other than 1, the selected trace data results will be returned. See each command for details of what types of scalar results or trace data results are available. The binary data formats should be used for handling large blocks of data since they are smaller and transfer faster than the ASCII format. (FORMat:DATA)

FETCh may be used to return results other than those specified with the original READ or MEASure command that you sent.

INITiate Commands:

:INITiate:<measurement>

This command is not available for measurements in all the instrument modes:

- Initiates a trigger cycle for the specified measurement, but does not output any data. You must then use the FETCh<meas> command to return data. If a measurement other than the current one is specified, the instrument will switch to that measurement and then initiate it.
 - For example, suppose you have previously initiated the ACP measurement, but now you are running the channel power measurement. If you send INIT:ACP? it will change from channel power to ACP and will initiate an ACP measurement.
 - Does not change any of the measurement settings. For example, if you have previously started the ACP measurement and you send INIT:ACP? it will initiate a new ACP measurement using the same instrument settings as the last time ACP was run.
 - If your selected measurement is currently active (in the idle state) it triggers the measurement, assuming the trigger conditions are met. Then it completes one trigger cycle. Depending upon the measurement and the number of averages, there may be multiple data acquisitions, with multiple trigger events, for one full trigger cycle. It also holds off additional commands on GPIB until the acquisition is complete.
-

READ Commands:

:READ:<measurement>[n]?

- Does not preset the measurement to the factory default settings. For example, if you have previously initiated the ACP
-

measurement and you send READ:ACP? it will initiate a new measurement using the same instrument settings.

- Initiates the measurement and puts valid data into the output buffer. If a measurement other than the current one is specified, the instrument will switch to that measurement before it initiates the measurement and returns results.
 - For example, suppose you have previously initiated the ACP measurement, but now you are running the channel power measurement. Then you send READ:ACP? It will change from channel power back to ACP and, using the previous ACP settings, will initiate the measurement and return results.
 - Blocks other SCPI communication, waiting until the measurement is complete before returning the results
 - If the optional [n] value is not included, or is set to 1, the scalar measurement results will be returned. If the [n] value is set to a value other than 1, the selected trace data results will be returned. See each command for details of what types of scalar results or trace data results are available. The binary data formats should be used when handling large blocks of data since they are smaller and faster than the ASCII format. (FORMat:DATA)
-

Initial S/W Revision	Prior to A.02.00
----------------------	------------------

Current Measurement Query (Remote Command Only)

This command returns the name of the measurement that is currently running.

Remote Command	:CONFigure?
-----------------------	-------------

Example	CONF?
----------------	-------

Initial S/W Revision	Prior to A.02.00
----------------------	------------------

Limit Test Current Results (Remote Command Only)

Queries the status of the current measurement limit testing. It returns a 0 if the measured results pass when compared with the current limits. It returns a 1 if the measured results fail any limit tests.

Remote Command	:CALCulate:CLIMits:FAIL?
-----------------------	--------------------------

Example	CALC:CLIM:FAIL? queries the current measurement to see if it fails the defined limits. Returns a 0 or 1: 0 it passes, 1 it fails.
----------------	--

Initial S/W Revision	Prior to A.02.00
----------------------	------------------

Data Query (Remote Command Only)

Returns the designated measurement data for the currently selected measurement and subopcode.

n = any valid subopcode for the current measurement. See the measurement command results table for your current measurement, for information about what data is returned for the subopcodes.

This command uses the data setting specified by the FORMat:BORDER and FORMat:DATA commands and can return real or ASCII data. (See the format command descriptions under Input/Output in the Analyzer Setup section.)

Remote Command	:CALCulate:DATA[n]?
Notes	The return trace depends on the measurement. In CALCulate:<meas>:DATA[n], n is any valid subopcode for the current measurement. It returns the same data as the FETCH:<measurement>? query where <measurement> is the current measurement.
Initial S/W Revision	Prior to A.02.00

Calculate/Compress Trace Data Query (Remote Command Only)

Returns compressed data for the currently selected measurement and sub-opcode [n].

n = any valid sub-opcode for that measurement. See the MEASure:<measurement>? command description of your specific measurement for information on the data that can be returned.

The data is returned in the current Y Axis Unit of the analyzer. The command is used with a sub-opcode <n> (default=1) to specify the trace. With trace queries, it is best if the analyzer is not sweeping during the query. Therefore, it is generally advisable to be in Single Sweep, or Update=Off.

This command is used to compress or decimate a long trace to extract and return only the desired data. A typical example would be to acquire N frames of GSM data and return the mean power of the first burst in each frame. The command can also be used to identify the best curve fit for the data.

Remote Command	:CALCulate:DATA<n>:COMPRESS? BLOCK CFIT MAXimum MINimum MEAN DMEan RMS RMSCubed SAMPLE SDEVIation PPHase [,<soffset> [,<length>[,<roffset>[,<rlimit>]]]]
Example	To query the mean power of a set of GSM bursts: Supply a signal that is a set of GSM bursts. Select the IQ Waveform measurement (in IQ Analyzer Mode). Set the sweep time to acquire at least one burst. Set the triggers such that acquisition happens at a known position relative to a burst. Then query the mean burst levels using, CALC:DATA2:COMP? MEAN, 24e-6, 526e-6 (These parameter values correspond to GSM signals, where 526e-6 is the length of the burst in the slot and you just want 1 burst.)
Notes	The command supports 5 parameters. Note that the last 4 (<soffset>, <length>, <roffset>, <rlimit>) are optional. But these optional parameters must be entered in the specified order. For example, if you want to specify <length>, then you must also specify <soffset>. See details below for a definition of each of these parameters. This command uses the data in the format specified by FORMat:DATA, returning either binary or ASCII data.
Initial S/W Revision	Prior to A.02.00

- BLOCK or block data - returns all the data points from the region of the trace data that you specify. For example, it could be used to return the data points of an input signal over several timeslots, excluding the portions of the trace data that you do not want. (This is x,y pairs for trace data and I,Q pairs for complex data.)

- CFIT or curve fit - applies curve fitting routines to the data. <soffset> and <length> are required to define the data that you want. <roffset> is an optional parameter for the desired order of the curve equation. The query will return the following values: the x-offset (in seconds) and the curve coefficients ((order + 1) values).

MIN, MAX, MEAN, DME, RMS, RMSC, SAMP, SDEV and PPH return one data value for each specified region (or <length>) of trace data, for as many regions as possible until you run out of trace data (using <roffset> to specify regions). Or they return the number of regions you specify (using <rlimit>) ignoring any data beyond that.

- MINimum - returns the minimum data point (y value) for the specified region(s) of trace data. For I/Q trace data, the minimum magnitude of the I/Q pairs is returned.
- MAXimum - returns the maximum data point (y value) for the specified region(s) of trace data. For I/Q trace data, the maximum magnitude of the I/Q pairs is returned.
- MEAN - returns a single value that is the arithmetic mean of the data point values (in dB/ dBm) for the specified region(s) of trace data. For I/Q trace data, the mean of the magnitudes of the I/Q pairs is returned. See the following equations.

-

NOTE

If the original trace data is in dB, this function returns the arithmetic mean of those log values, not log of the mean power which is a more useful value. The mean of the log is the better measurement technique when measuring CW signals in the presence of noise. The mean of the power, expressed in dB, is useful in power measurements such as Channel Power. To achieve the mean of the power, use the RMS option.

Equation 1

Mean Value of Data Points for Specified Region(s)

$$\text{MEAN} = \frac{1}{n} \sum_{X_i \in \text{region}(s)} X_i$$

where X_i is a data point value, and n is the number of data points in the specified region(s).

Equation 2

Mean Value of I/Q Data Pairs for Specified Region(s)

$$\text{MEAN} = \frac{1}{n} \sum_{X_i \in \text{region}(s)} |X_i|$$

where $|X_i|$ is the magnitude of an I/Q pair, and n is the number of I/Q pairs in the specified region(s).

- DMEan - returns a single value that is the mean power (in dB/ dBm) of the data point values for the specified region(s) of trace data. See the following equation:

Equation 3

DMEan Value of Data Points for Specified Region(s)

$$DME = 10 \times \log_{10} \left(\frac{1}{n} \sum_{X_i \in \text{region}(s)} 10^{\frac{X_i}{10}} \right)$$

- RMS - returns a single value that is the average power on a root-mean-squared voltage scale (arithmetic rms) of the data point values for the specified region(s) of trace data. See the following equation.

NOTE

For I/Q trace data, the rms of the magnitudes of the I/Q pairs is returned. See the following equation. This function is very useful for I/Q trace data. However, if the original trace data is in dB, this function returns the rms of the log values which is not usually needed.

Equation 4

RMS Value of Data Points for Specified Region(s)

$$RMS = \sqrt{\frac{1}{n} \sum_{X_i \in \text{region}(s)} X_i^2}$$

where X_i is a data point value, and n is the number of data points in the specified region(s).

Equation 5

RMS Value of I/Q Data Pairs for Specified Region(s)

$$RMS = \sqrt{\frac{1}{n} \sum_{X_i \in \text{region}(s)} X_i X_i^*}$$

where X_i is the complex value representation of an I/Q pair, X_i^* its conjugate complex number, and n is the number of I/Q pairs in the specified region(s).

Once you have the rms value for a region of trace data (linear or I/Q), you may want to calculate the mean power. You must convert this rms value (peak volts) to power in dBm:

$$10 \times \log[10 \times (\text{rms value})^2]$$

- SAMPLe - returns the first data value (x,y pair) for the specified region(s) of trace data. For I/Q trace data, the first I/Q pair is returned.
- SDEViation - returns a single value that is the arithmetic standard deviation for the data point values for the specified region(s) of trace data. See the following equation.
- For I/Q trace data, the standard deviation of the magnitudes of the I/Q pairs is returned. See the following equation.

Equation 6

Standard Deviation of Data Point Values for Specified Region(s)

$$\text{SDEV} = \sqrt{\frac{1}{n} \sum_{X_i \in \text{region}(s)} (X_i - \bar{X})^2}$$

where X_i is a data point value, \bar{X} is the arithmetic mean of the data point values for the specified region (s), and n is the number of data points in the specified region(s).

$$\text{SDEV} = \sqrt{\frac{1}{n} \sum_{X_i \in \text{region}(s)} (|X_i| - \bar{X})^2}$$

where $|X_i|$ is the magnitude of an I/Q pair, \bar{X} is the mean of the magnitudes for the specified region(s), and n is the number of data points in the specified region(s).

- PPHase - returns the x,y pairs of both rms power (dBm) and arithmetic mean phase (radian) for every specified region and frequency offset (Hz). The number of pairs is defined by the specified number of regions. This parameter can be used for I/Q vector ($n=0$) in Waveform (time domain) measurement and all parameters are specified by data point in PPHase.

The rms power of the specified region may be expressed as:

$$\text{Power} = 10 \times \log [10 \times (\text{RMS I/Q value})] + 10.$$

The RMS I/Q value (peak volts) is:

$$\sqrt{\frac{1}{n} \sum_{X_i \in \text{region}} X_i X_i^*}$$

where X_i is the complex value representation of an I/Q pair, X_i^* its conjugate complex number, and n is the number of I/Q pairs in the specified region.

The arithmetic mean phase of the specified region may be expressed as:

$$\frac{1}{n} \sum_{Y_i \in \text{region}} Y_i$$

where Y_i is the unwrapped phase of I/Q pair with applying frequency correction and n is the number of I/Q pairs in the specified region.

The frequency correction is made by the frequency offset calculated by the arithmetic mean of every specified region's frequency offset. Each frequency offset is calculated by the least square method against the unwrapped phase of I/Q pair.

Sample Trace Data - Constant Envelope

(See below for explanation of variables.)

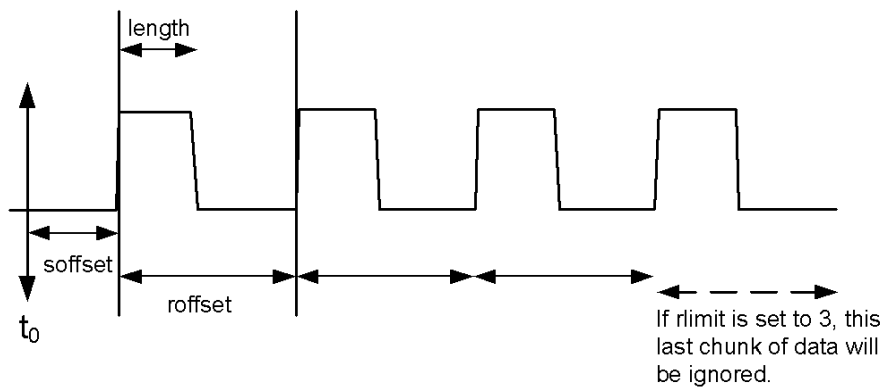

Sample Trace Data - Not Constant Envelope

(See below for explanation of variables.)

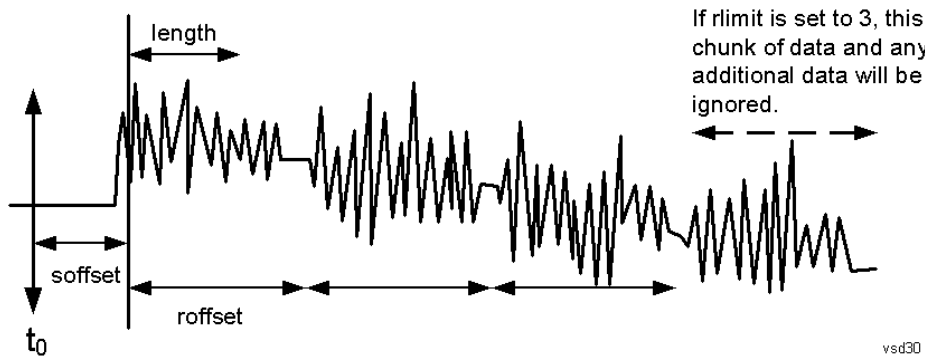

<soffset> - start offset is an optional real number. (It is in seconds for time-domain traces, and is a dimensionless index 0 to Npoints - 1, for frequency-domain traces). It specifies the amount of data at the beginning of the trace that will be ignored before the decimation process starts. It is the time or frequency change from the start of the trace to the point where you want to start using the data. The default value is zero.

<length> - is an optional real number. (It is in seconds for time-domain traces, and is a dimensionless index 0 to Npoints - 1, for frequency-domain traces). It defines how much data will be compressed into one value. This parameter has a default value equal to the current trace length.

<roffset> - repeat offset is an optional real number. (It is in seconds for time-domain traces, and is a dimensionless index 0 to Npoints - 1, for frequency-domain traces). It defines the beginning of the next field of trace elements to be compressed. This is relative to the beginning of the previous field. This parameter has a default value equal to the <length> variable. Note that this parameter is used for a completely different purpose when curve fitting (see CFIT above).

<rlimit> - repeat limit is an optional integer. It specifies the number of data items that you want returned. It will ignore any additional items beyond that number. You can use the Start offset and the Repeat limit to pick out exactly what part of the data you want to use. The default value is all the data.

Calculate Peaks of Trace Data (Remote Command Only)

Returns a list of all the peaks for the currently selected measurement and sub-opcode [n]. The peaks must meet the requirements of the peak threshold and excursion values.

n = any valid sub-opcode for the current measurement. See the MEASure:<measurement> command description of your specific measurement for information on the data that can be returned.

The command can only be used with specific sub-opcodes with measurement results that are trace data. Both real and complex traces can be searched, but complex traces are converted to magnitude in dBm. In many measurements the sub-opcode n=0, is the raw trace data which cannot be searched for peaks. And Sub-opcode n=1, is often calculated results values which also cannot be searched for peaks.

This command uses the data setting specified by the FORMat:BORDER and FORMat:DATA commands and can return real or ASCII data. If the format is set to INT,32, it returns REAL,32 data.

The command has four types of parameters:

- Threshold (in dBm)
- Excursion (in dB)
- Sorting order (amplitude, frequency, time)
- Optional in some measurements: Display line use (all, > display line, < display line)

Remote Command	<p>For Swept SA measurement:</p> <pre>:CALCulate:DATA[1] 2 ... 6:PEAKs? <threshold>,<excursion>[,AMPLitude FREQuency TIME[,ALL GTDLline LTDLine]]</pre> <p>For most other measurements:</p> <pre>:CALCulate:DATA[1] 2 ... 6:PEAKs? <threshold>,<excursion>[,AMPLitude FREQuency TIME]</pre>
-----------------------	---

Example	<p>Example for Swept SA measurement in Spectrum Analyzer Mode:</p> <p>CALC:DATA4:PEAK? -40, 10, FREQ, GTDL This will identify the peaks of trace 4 that are above -40 dBm, with excursions of at least 10 dB. The peaks are returned in order of increasing frequency, starting with the lowest frequency. Only the peaks that are above the display line are returned.</p> <p>Query Results 1:</p> <p>With FORMat:DATA REAL, 32 selected, it returns a list of floating-point numbers. The first value in the list is the number of peak points that are in the following list. A peak point consists of two values: a peak amplitude followed by its corresponding frequency (or time).</p> <p>If no peaks are found the peak list will consist of only the number of peaks, (0).</p>
----------------	---

Notes	<p><n> - is the trace that will be used</p> <p><threshold> - is the level below which trace data peaks are ignored. Note that the threshold value is required and is always used as a peak criterion. To effectively disable the threshold criterion for this command, provide a substantially low threshold value such as -200 dBm. Also note that the threshold value used in this command is independent of and has no effect on the threshold value stored under the Peak Criteria menu.</p> <p><excursion> - is the minimum amplitude variation (rise and fall) required for a signal to be identified as peak. Note that the excursion value is required and is always used as a peak criterion. To effectively disable the excursion criterion for this command, provide the minimum value of 0.0 dB. Also note that the excursion value used in this command is independent of and has no effect on the</p>
--------------	---

excursion value stored under the Peak Criteria menu.

Values must be provided for threshold and excursion. The sorting and display line parameters are optional (defaults are AMPLitude and ALL).

Note that there is always a Y-axis value for the display line, regardless of whether the display line state is on or off. It is the current Y-axis value of the display line which is used by this command to determine whether a peak should be reported

Sorting order:

AMPLitude - lists the peaks in order of descending amplitude, with the highest peak first (default if optional parameter not sent)

FREQuency - lists the peaks in order of occurrence, left to right across the x-axis.

TIME - lists the peaks in order of occurrence, left to right across the x-axis.

Peaks vs. Display Line:

ALL - lists all of the peaks found (default if optional parameter not sent).

GTDLine (greater than display line) - lists all of the peaks found above the display line.

LTDLine (less than display line) - lists all of the peaks found below the display line.

Initial S/W Revision Prior to A.02.00

Format Data: Numeric Data (Remote Command Only)

This command specifies the format of the trace data input and output. It specifies the formats used for trace data during data transfer across any remote port. It affects only the data format for setting and querying trace data for the :TRACe[:DATA], TRACe[:DATA]?, :CALCulate:DATA[n]? and FETCh:SANalyzer [n]? commands and queries.

Remote Command :FORMat [:TRACe] [:DATA] ASCii | INTeger, 32 | REAL, 32 | REAL, 64
:FORMat [:TRACe] [:DATA] ?

Notes The query response is:
ASCii: ASC,8
REAL,32: REAL,32
REAL,64: REAL,64
INTeger,32: INT,32

When the numeric data format is REAL or ASCii, data is output in the current Y Axis unit. When the data format is INTeger, data is output in units of m dBm (.001 dBm).

The INT,32 format returns binary 32-bit integer values in internal units (m dBm), in a definite length block.

Dependencies Sending a data format spec with an invalid number (for example, INT,48) generates no error. The analyzer simply uses the default (8 for ASCii, 32 for INTeger, 32 for REAL).

Sending data to the analyzer which does not conform to the current FORMat specified, results in an error. Sending ASCII data when a definite block is expected generates message -161 "Invalid Block Data" and sending a definite block when ASCII data is expected generates message -121 "Invalid Character in Number".

Preset ASCii

Backwards Compatibility Notes Note that the INT,32 format is only applicable to the command, TRACe:DATA. This preserves backwards compatibility for the Swept SA measurement. For all other commands/queries which honor FORMat:DATA, if INT,32 is sent the analyzer will behave as though it were set to REAL,32.

Initial S/W Revision Prior to A.02.00

The specs for each output type follow:

ASCIi - Amplitude values are in ASCII, in the current Y Axis Unit, one ASCII character per digit, values separated by commas, each value in the form:

SX.YYYYYEsZZ

Where:

S = sign (+ or -)

X = one digit to left of decimal point

Y = 5 digits to right of decimal point

E = E, exponent header

s = sign of exponent (+ or -)

ZZ = two digit exponent

REAL,32 - Binary 32-bit real values in the current Y Axis Unit, in a definite length block.

REAL,64 - Binary 64-bit real values in the current Y Axis Unit, in a definite length block.

Format Data: Byte Order (Remote Command Only)

This command selects the binary data byte order for data transfer and other queries. It controls whether binary data is transferred in normal or swapped mode. This command affects only the byte order for setting and querying trace data for the :TRACe[:DATA], TRACe[:DATA]? , :CALCulate:DATA[n]? and FETCh:SANalyzer[n]? commands and queries.

By definition any command that says it uses FORMat:DATA uses any format supported by FORMat:DATA.

The NORMal order is a byte sequence that begins with the most significant byte (MSB) first, and ends with the least significant byte (LSB) last in the sequence: 1|2|3|4. SWAPPed order is when the byte sequence begins with the LSB first, and ends with the MSB last in the sequence: 4|3|2|1.

Remote Command	:FORMat:BORDER NORMal SWAPPed :FORMat:BORDER?
Preset	NORMal
Initial S/W Revision	Prior to A.02.00

Meas Setup

Changing any of the parameters under the Radio menu, or changing the test enabled in the Test Selection menu, or pressing Test Preset will change measurement setup parameters as noted in the Coupling sections of the individual parameters.

See "[More Information about Meas Setup:](#)" on page 756.

Key Path	Front-panel key
Mode	IDEN
Initial S/W Revision	A.02.00

More Information about Meas Setup:

The first three menu softkeys are intended to be set and used in the order they appear in this menu, top to bottom: They are outlined in the following sections:

1. Set up the Radio parameters,
2. Make the Test Selection ("[Test Selection](#)" on page 756) or select the Tests that you want to run,
3. Perform a Test Preset ("[Test Preset](#)" on page 757), which uses what you have just selected to preset the remaining measurement parameters to a known state, which should be a good starting point for your test(s).

After performing these three steps, you may want to fine-tune the remaining parameters to optimize the measurement for your application.

Test Selection

Controls which measurement calculations are enabled with accompanying test comparisons. A change in Test Selection changes some measurement setup parameters as noted in their Coupling descriptions.

Key Path	Meas Setup
Mode	IDEN
Initial S/W Revision	A.02.00

OBW

Enables Occupied Bandwidth testing. The bandwidth of the signal is measured and compared to the OBW Test Limit.

Key Path	Meas Setup, Test Selection
Mode	IDEN
Remote Command	[:SENSe] : IPOWER : TSEL : OBWidth OFF ON 0 1 [:SENSe] : IPOWER : TSEL : OBWidth ?

Example	:IPOW:TSEL:OBW ON
Couplings	Changes in this parameter may have an immediate effect on other parameters, as well as affecting parameter values set by Test Preset (" Test Preset " on page 757), noted in the coupling row table entries for the affected parameters.
Preset	ON
State Saved	Saved in instrument state.
Range	ON OFF
Initial S/W Revision	A.02.00

ACP

Enables Adjacent Channel Power testing. The ACP test measures and reports power in the reference band and compares that to the power in up to five adjacent channel bands.

Key Path	Meas Setup, Test Selection
Mode	IDEN
Remote Command	[:SENSe] : IPOWer : TSEL : ACPower OFF ON 0 1 [:SENSe] : IPOWer : TSEL : ACPower ?
Example	:IPOW:TSEL:ACP ON
Couplings	Changes in this parameter may have an immediate effect on other parameters, as well as affecting parameter values set by Test Preset (" Test Preset " on page 757), both as noted in the coupling row table entries for the affected parameters.
Preset	ON
State Saved	Saved in instrument state.
Range	ON OFF
Initial S/W Revision	A.02.00

Test Preset

Initializes the setup for the selected tests based on the radio setup specified. Test Preset initializes all the coupled parameters for the selected tests. This key color is green, indicating that it is a preset key.

Key Path	Meas Setup
Mode	IDEN
Remote Command	CONF : IPOWer
Example	CONF:IPOW
Couplings	This affects parameter values as detailed below. It also performs a Preset View:Test Standard (" Preset View: Test Standard " on page 876).
Initial S/W Revision	A.02.00

NOTE

Test Preset does not change the Test selection (OBW Test and/or ACP Test) ("[Test Selection](#)" on page 756).

Parameters affected by Test Preset are noted in the Coupling line of the parameter tables for each affected parameter.

Power Calc Uses

Sets whether OBW and ACP measure over the whole burst or measure over the MQAM modulation part of the burst. This distinction is made by enabling or disabling time gating. Since only Full Signal is valid when an Outbound Slot Format is active, this key is grayed out when Outbound Slot Format is active.

Key Path	Meas Setup
Mode	IDEN
Remote Command	CALCulate:IPower:PCALculation MOD FULL CALCulate:IPower:PCALculation?
Example	CALC:IPOW:PCAL MOD
Couplings	This parameter affects FFT Window, Gate parameters. In particular, Gate (On/Off) is controlled directly by this parameter and visa versa. It is set to Full Signal when an Outbound Slot Format is selected. It is set to Modulation by Test Preset (" Test Preset " on page 757) if the Slot Format is an Inbound type and to Full Signal when Slot Format is an Outbound type.
Preset	MOD
State Saved	Saved in instrument state.
Range	MOD FULL
Readback Text	MOD FULL
Initial S/W Revision	A.02.00

Modulation

Selects Power Calc Uses Modulation. Only the modulated portion of the burst will be analyzed.

Key Path	Meas setup, Power Calc Uses
Mode	IDEN
Initial S/W Revision	A.02.00

Full Signal

Selects Power Calc Uses Full Signal. The entire slot will be analyzed, which includes the time that the burst is off.

Key Path	Meas setup, Power Calc Uses
Mode	IDEN
Initial S/W Revision	A.02.00

ACP Setup

ACP in the iDEN Power measurement is set up as in other VXA Measurements, with the following exceptions:

The ACP Setup softkey menu that appears under the Meas Setup key is for setting the standard ACP test parameters. These will appear on trace 3 when using the Test Standard Preset view. ACP Setup softkeys for this and all other traces are found under the Trace/Detector key. Corresponding keys under both menus perform the same setup functions.

See ["More Information about ACP Setup" on page 759](#).

Key Path	Meas Setup
Mode	IDEN
Initial S/W Revision	A.02.00

More Information about ACP Setup

SCPI access to ACP features under the Meas Setup key is the same as for the general case (refer to trace 3) and is documented in ["ACP Setup" on page 1255](#).

Other keys and SCPI in this menu follow VXA standard conventions for ACP setup.

Five sets of adjacent channel offsets and bandwidths are available, the default state is with one set enabled, and the other four sets configured. An exception to this is when the Outer 50 kHz Carrier Config is selected, the first two offsets are enabled and the other 3 configured.

Test Preset (["Test Preset" on page 757](#)) or changes to Carrier Config sets the ACP parameters as follows. Changing between iDEN and WiDEN Slot Format may also result in other couplings or changes.

ACP Enabled	iDEN formats,	iDEN formats, WiDEN 25 kHz	WiDEN 50 kHz	WiDEN 75 kHz	WiDEN 100 kHz	Outer 50 kHz
Reference BW	18 kHz	18 kHz	43 kHz	68 kHz	93 kHz	93 kHz
Channel A	Enable	Enable	Enable	Enable	Enable	Enable
Channel A offset	+/- 25 kHz	+/- 25 kHz	+/- 37.5 kHz	+/- 50 kHz	+/- 62.5 kHz	+/- 12.5 kHz
Channel A BW	18 kHz	18 kHz	18 kHz	18 kHz	18 kHz	18 kHz
Channel A Test Limit	-50 dBc, On	-50 dBc, On	-50 dBc, On	-50 dBc, On	-50 dBc, On	-50 dBc, On
Channel B	Disable	Disable	Disable	Disable	Disable	Enable
Channel B offset	+/- 50 kHz	+/- 50 kHz	+/- 62.5 kHz	+/- 75 kHz	+/- 87.5 kHz	+/- 37.5 kHz
Channel B BW	18 kHz	18 kHz	18 kHz	18 kHz	18 kHz	18 kHz
Channel B Test	Off	Off	Off	Off	Off	-50 dBc, On

Limit						
Channel C	Disable	Disable	Disable	Disable	Disable	Disable
Channel C offset	+/- 75 kHz	+/- 75 kHz	+/- 87.5 kHz	+/- 100 kHz	+/- 112.5 kHz	+/- 62.5 kHz
Channel C BW	18 kHz	18 kHz	18 kHz	18 kHz	18 kHz	18 kHz
Channel C Test Limit	Off	Off	Off	Off	Off	Off
Channel D	Disable	Disable	Disable	Disable	Disable	Disable
Channel D offset	+/- 100 kHz	+/- 100 kHz	+/- 112.5 kHz	+/- 125 kHz	+/- 137.5 kHz	+/- 87.5 kHz
Channel D BW	18 kHz	18 kHz	18 kHz	18 kHz	18 kHz	18 kHz
Channel D Test Limit	Off	Off	Off	Off	Off	Off
Channel E	Disable	Disable	Disable	Disable	Disable	Disable
Channel E offset	+/- 125 kHz	+/- 125 kHz	+/- 137.5 kHz	+/- 150 kHz	+/- 162.5 kHz	+/- 137.5 kHz
Channel E BW	18 kHz	18 kHz	18 kHz	18 kHz	18 kHz	18 kHz
Channel E Test Limit	Off	Off	Off	Off	Off	Off

Offsets

The ACP measurement compares power in frequency bands that are offset from the carrier to power in the reference channel (centered on the carrier). Up to 5 offsets may be defined. The offsets are designated by letters A through E. Each offset is defined by an offset frequency and bandwidth. Each offset defines two bands or sidebands, one above the reference frequency and one below. Each band is used individually in the ACP calculation.

The Offsets branch key accesses a menu that has a branch key for each offset. Each offset branch key shows a summary of its current parameters. Pressing any of the Offset A|B|C|D|E softkeys will access a menu for adjusting that offsets parameters.

Key Path	Trace/Detector, ACP, Offsets
Mode	IDEN
Initial S/W Revision	A.02.00

Offset Freq

Turns ACP analysis on or off for a selected offset and sets the offset frequency, which is relative to the carrier frequency.

Key Path	Trace/Detector, ACP, Offsets, Offset A B C D E
Mode	VSA, LTE, LTETDD, IDEN
Measurement	<meas>:=VECTor ADEMod DDEMod W11A W11B EVM IPOWER IDEMod MOTotalk
Remote Command	:CALCulate:<meas>:TRACe [1] 2 . . . 4:ACP:OFFSet:LIST:FREQuency <freq>, ... :CALCulate:<meas>:TRACe [1] 2 . . . 4:ACP:OFFSet:LIST:FREQuency? :CALCulate:<meas>:TRACe [1] 2 . . . 4:ACP:OFFSet:LIST:STATe OFF ON 0 1, ... :CALCulate:<meas>:TRACe [1] 2 . . . 4:ACP:OFFSet:LIST:STATe?
Example	CALC:VECT:TRAC1:ACP:OFFS:LIST:FREQ 1 MHZ, 1 MHZ, 500 KHZ, 500 KHZ, 1 MHZ CALC:VECT:TRAC1:ACP:OFFS:LIST:FREQ? :CALC:VECT:TRAC1:ACP:OFFS:LIST:STAT ON, OFF, OFF, ON, OFF
Notes	If you send fewer than 5 frequencies in the parameter list, then the remaining offsets frequencies are set to 0. You can send a single on/off parameter or a comma-separated list of up to 5 parameters. These enable/disable each of the Offsets in sequence. Any remaining Offsets are disabled
Preset	3000000,0,0,0,0 1,0,0,0,0
State Saved	Saved in instrument state.
Min	-9.9E+37
Max	9.9E+37
Initial S/W Revision	Prior to A.02.00
Modified at S/W Revision	A.02.00

Offset Meas Noise BW

Enables you to set the measurement noise bandwidth for the power measurement of a selected offset band.

Key Path	Trace/Detector, ACP, Offsets, Offset A B C D E
Mode	VSA, LTE, LTETDD, IDEN
Measurement	<meas>:=VECTor ADEMod DDEMod W11A W11B EVM IPOWER IDEMod MOTotalk
Remote Command	:CALCulate:<meas>:TRACe [1] 2 . . . 4:ACP:OFFSet:LIST:BANDwidth BWIDth:INTEgration <bandwidth>, ... :CALCulate:<meas>:TRACe [1] 2 . . . 4:ACP:OFFSet:LIST:BANDwidth BWIDth:INTEgration?
Example	CALC:VECT:TRAC1:ACP:OFFS:LIST:BAND:INT 1 MHZ, 2 MHZ, 3 MHZ, 4 MHZ, 5 MHZ CALC:VECT:TRAC1:ACP:OFFS:LIST:BAND:INT?
Notes	If you send fewer than 5 bandwidth parameters in the list, then Measurement Noise Bandwidths for the remaining Offsets are set to 0.

Preset	1000000,0,0,0,0
State Saved	Saved in instrument state.
Min	-9.9e37
Max	9.9e37
Initial S/W Revision	Prior to A.02.00
Modified at S/W Revision	A.02.00

Offset Relative Limit

Enables you to turn on/off a relative limit test and set the limit for the selected offset. The test shows a failure if the power in either the upper or lower band at the selected offset exceeds the reference power plus the relative test limit. For example, if the test limit is -60, the reference power is -4.5 dBm, a test failure would be shown if the power in the lower or upper band exceeds -64.5 dBm.

Key Path	Trace/Detector, ACP, Offsets
Mode	VSA, LTE, LTETDD, IDEN
Measurement	<meas>:=VECTor ADEMod DDEMod W11A W11B EVM IPOWER IDEMod MOTotalk
Remote Command	:CALCulate:<meas>:TRACe[1] 2 ...4:ACP:OFFSet:LIST:RCARrier <real>, ... :CALCulate:<meas>:TRACe[1] 2 ...4:ACP:OFFSet:LIST:RCARrier? :CALCulate:<meas>:TRACe[1] 2 ...4:ACP:OFFSet:LIST:RCARrier:TEST OFF ON 0 1, ... :CALCulate:<meas>:TRACe[1] 2 ...4:ACP:OFFSet:LIST:RCARrier:TEST?
Example	CALC:VECT:TRAC1:ACP:OFFS:LIST:RCAR -50, -55, -60, -65, -80 CALC:VECT:TRAC1:ACP:OFFS:LIST:RCAR? CALC:VECT:TRAC1:ACP:OFFS:LIST:RCAR:TEST 1, 1, 1, 1, 1 CALC:VECT:TRAC1:ACP:OFFS:LIST:RCAR:TEST?
Notes	You can send a single Limit for Offset A or a comma-separated list of up to 5 limit parameters. These are assigned in sequence to the Offset frequencies with the remaining limits being set to 0. You can send a single on/off parameter or a comma-separated list of up to 5 parameters. These turn the Limit Test on or off for each of the Offsets in sequence. For any remaining Offsets, the Limit test is turned off.
Preset	-120,-120,-120,-120,-120 0,0,0,0,0
State Saved	Saved in instrument state.
Min	50
Max	-200
Initial S/W Revision	Prior to A.02.00
Modified at S/W Revision	A.02.00

Carrier Meas Noise BW

Enables you to define the measurement noise bandwidth of the reference channel. For more information, see "[Carrier Meas Noise BW](#)" on page 1257 for Trace 3.

Key Path	Meas Setup, ACP Setup
Mode	IDEN
Couplings	Test Preset (" Test Preset " on page 757), Carrier Config, and Slot Format set this as defined in the table under ACP Setup (" ACP Setup " on page 759).
Initial S/W Revision	A.02.00

OBW Centroid -> CF

Copies the current measured Centroid frequency to the Center Frequency. For more information, see "[OBW Setup \(Occupied Bandwidth\)](#)" on page 1263.

Key Path	Meas Setup
Mode	IDEN
Initial S/W Revision	A.02.00

Avg Number

Enables you to turn averaging on or off, and set the number of scans (time records) whose measurement results are averaged. Averaging can be done over spectrum results (RMS) or over time records (Time). A third kind of pseudo averaging displays the maximum value seen at each spectral line over the specified number of scans. See "[Average Type](#)" on page 1180 for a more detailed description of how measurement results are averaged. For RMS or Time averaging, the process is similar. Each time an averaged result is displayed, it is the sum of the individual results taken since measurement restart, divided by the number of scans. (For Max averaging, there is no actual summation or division.) The Measurement Bar shows the number of scans and the Avg number setting. For example, if 4 scans have been taken and the Avg Number is 10, the Meas Bar shows "4/10". The measurement continues to take new scans until the number of scans is equal to the Avg Number setting, at which time the measurement stops if Sweep control is in Single Mode. Otherwise, the measurement continues, and the Average Mode setting determines how successive scans are added to the averaged result. See "[Average Mode](#)" on page 1179 for details.

Key Path	Meas Setup, More
Mode	VSA, LTE, LTETDD, IDEN, LTEAFDD, LTEATDD
Measurement	<meas>:=VECTor ADEMod DDEMod W11A W11B EVM IPOWER IDEMod MOTotalk
Remote Command	[:SENSe] :<meas>:AVERage:COUNT <integer> [:SENSe] :<meas>:AVERage:COUNT? [:SENSe] :<meas>:AVERage [:STATe] OFF ON 0 1 [:SENSe] :<meas>:AVERage [:STATe] ?
Example	VECT:AVER:COUN 20

	VECT: AVER: COUN? VECT: AVER ON VECT: AVER?
Notes	If an averaged measurement is idle because the scan count is equal to the Avg Number and the Avg Number is increased, the measurement resumes until the new number of averages is satisfied.
Preset	10 OFF IPOW: ON
State Saved	Saved in instrument state.
Min	1
Max	2147483647
Initial S/W Revision	Prior to A.02.00
Modified at S/W Revision	A.02.00

Average Mode

Determines what happens when the Sweep Mode is Continuous and the number of scans processed exceeds the Average Number (see "Avg Number" on page 1178). If the Sweep Control is in Single mode, this setting has no affect.

When averaging is on and the number of scans is less than or equal to the Avg Number setting, a linear average is calculated as explained in the Avg Number topic. After the scan count exceeds the Avg Number setting, the measurement continues to take new scans. The Measurement Bar average indicator shows ">N/N" where N is the Avg Number.

If Average Mode is Exp then new results are averaged in exponentially. In other words, each succeeding average is the weighted sum of the previous average, weighted by $(N-1)/N$, and the new measurement, weighted by $1/N$, where N is the Average Number setting. (For Max averaging, no weighting occurs; the result continues to be the max value seen at each spectral line for every previous scan since measurement restart.)

If Average Mode is Repeat, then the average buffer is cleared after the average counter reaches the Average Number setting, and the average counter is reset to 0. Then a new set of averages is taken. The measurement bar therefore continues to show "k/N" in the average indicator, where k is the number of scans since the last time the average buffer was cleared and N is the Avg Number. The averaged result is the sum of the last k results divided by k. (For Max averaging, no sum or division takes place, but the buffer is cleared as stated above. The averaged result is the max value seen over the last k scans.)

Key Path	Meas Setup
Mode	VSA, LTE, LTETDD, IDEN, LTEAFDD, LTEATDD
Measurement	<meas>:=VECTor ADEMod DDEMod W11A W11B EVM IPOWER IDEMod MOTotalk
Remote Command	[:SENSE] : <meas> : AVERage : TCONtrol EXPonential REPeat [:SENSE] : <meas> : AVERage : TCONtrol ?
Example	VECT: AVER: TCON EXP

	VECT:AVER:TCON?
Preset	EXP
State Saved	Saved in instrument state.
Range	Exp Repeat
Initial S/W Revision	Prior to A.02.00
Modified at S/W Revision	A.02.00

Average Setup

Accesses a menu enabling you to set Averaging parameters for all VSA based measurements.

Key Path	Meas Setup
Mode	VSA, LTE, LTETDD, IDEN, LTEAFDD, LTEATDD
Initial S/W Revision	Prior to A.02.00
Modified at S/W Revision	A.02.00

Average Type

Enables you to select the type of averaging. The following table shows what measurement results are averaged for each average type. This applies in the Vector Measurement.

Average Type	Measurement result averaged.
RMS	Spectrum, PSD: Power is averaged for each spectral line (i.e., this is a mean-square average of voltage). For the Spectrum result only, if the display transform is linear or real, the RMS result is displayed.
Time	Main Time: Individual time samples in the current time record are averaged vectorially (not RMS) with corresponding points in previous time records. See Main Time for more details.
Max	Spectrum, PSD: Not strictly an average. For each spectral line, power from the current measurement is compared to the average buffer value and the maximum is kept in the average buffer.

Some measurement results are inherently averaged, and are not affected by the Average controls. These are: CCDF, CDF, and PDF. They average continuously until the next measurement restart.

Key Path	Meas Setup, Average Setup
Mode	VSA, LTE, LTETDD, IDEN, LTEAFDD, LTEATDD
Measurement	<meas>:=VECTor ADEMod DDEMod W11A W11B EVM IPOWER IDEMod MOTotalk
Remote Command	[:SENSe] :<meas>:AVERage:TYPE RMS TIME MAXimum [:SENSe] :<meas>:AVERage:TYPE?
Example	VECT:AVER:TYPE RMS

	VECT:AVER:TYPE?
Preset	RMS
State Saved	Saved in instrument state.
Range	RMS Time Max
Initial S/W Revision	Prior to A.02.00
Modified at S/W Revision	A.02.00

Fast Average

Controls the display of average data. If fast averaging is off, then the display is updated after each time record is processed. If fast averaging is on, then the display is only updated after every M records, where M is the Update Rate (see ["Update Rate" on page 1181](#)). For example, if the fast average count is 10, then the running average is only displayed every 10th time record.

Key Path	Meas Setup, Average Setup
Mode	VSA, LTE, LTETDD, IDEN, LTEAFDD, LTEATDD
Measurement	<meas>:=VECTor ADEMod DDEMod W11A W11B EVM IPOWER IDEMod MOTotalk
Remote Command	[:SENSe] :<meas>:AVERage:FAST OFF ON 0 1 [:SENSe] :<meas>:AVERage:FAST?
Example	VECT:AVER:FAST ON VECT:AVER:FAST?
Preset	OFF
State Saved	Saved in instrument state.
Range	On Off
Initial S/W Revision	Prior to A.02.00
Modified at S/W Revision	A.02.00

Update Rate

Controls how often the display updates when fast averaging is turned on. If the Fast Averaging State is MAX then the display is updated only after the full Average Count is reached. Otherwise, the display is updated whenever the average count is a multiple of the Update Rate.

Key Path	Meas Setup, More, Average Setup
Mode	VSA, LTE, LTETDD, IDEN, LTEAFDD, LTEATDD
Measurement	<meas>:=VECTor ADEMod DDEMod W11A W11B EVM IPOWER IDEMod MOTotalk
Remote Command	[:SENSe] :<meas>:AVERage:FAST:URATe <integer> [:SENSe] :<meas>:AVERage:FAST:URATe? [:SENSe] :<meas>:AVERage:FAST:URATe:AUTO OFF ON 0 1

[:SENSe] :<meas> :AVERage :FAST :URATe :AUTO?

Example
 VECT:AVER:FAST:URAT 20
 VECT:AVER:FAST:URAT?
 VECT:AVER:FAST:URAT:AUTO ON
 VECT:AVER:FAST:URAT:AUTO?

Preset	10 ON
State Saved	Saved in instrument state.
Min	1
Max	2147483647
Initial S/W Revision	Prior to A.02.00
Modified at S/W Revision	A.02.00

OBW % Power

Specifies the percentage of power used to determine the occupied BW and to turn the OBW function on or off. For more information, see ["OBW Power" on page 1264](#).

Key Path	Meas Setup, More
Mode	IDEN
Couplings	Test Preset ("Test Preset" on page 757) sets to 99.0%
Preset	99.0 %
Initial S/W Revision	A.02.00

OBW Limit

Sets the OBW Limit as well as turns it off or on. For more information, see ["BW Limit" on page 1265](#).

Key Path	Meas Setup, More
Mode	IDEN
Couplings	Test Preset ("Test Preset" on page 757) sets as follows
Preset	20 kHz (On)
Initial S/W Revision	A.02.00

OBW Test Preset (["Test Preset" on page 757](#)) turns this On and sets these values:

	iDEN formats, WiDEN 25 kHz	WiDEN 50 kHz	WiDEN 75 kHz	WiDEN 100 kHz	WiDEN Outer 50 kHz
OBW Test Limit	20 kHz	45 kHz	70 kHz	95 kHz	95 kHz

Mode

See "Mode" on page 196

Mode Preset

Returns the active mode to a known state.

Mode Preset does the following for the currently active mode:

- Aborts the currently running measurement.
- Brings up the default menu for the mode, with no active function.
- Sets measurement Global settings to their preset values for the active mode only.
- Activates the default measurement.
- Brings up the default menu for the mode.
- Clears the input and output buffers.
- Sets Status Byte to 0.

Mode Preset does not:

- Cause a mode switch
- Affect mode persistent settings
- Affect system settings

See "[How-To Preset](#)" on page 771 for more information.

Key Path	Front-panel key
Remote Command	:SYSTem:PRESet
Example	:SYST:PRES
Notes	*RST is preferred over :SYST:PRES for remote operation. *RST does a Mode Preset, as done by the :SYST:PRES command, and it sets the measurement mode to Single measurement rather than Continuous for optimal remote control throughput. Clears all pending OPC bits. The Status Byte is set to 0.
Couplings	A Mode Preset aborts the currently running measurement, activates the default measurement, and gets the mode to a consistent state with all of the default couplings set.
Backwards Compatibility Notes	In the X-Series, the legacy "Factory Preset" has been replaced with Mode Preset, which only presets the currently active mode, not the entire instrument. In the X-Series, the way to preset the entire instrument is by using System, Restore System Defaults All, which behaves essentially the same way as restore System Defaults does on ESA and PSA. There is also no "Preset Type" as there is on the PSA. There is a green Mode Preset front-panel key that does a Mode Preset and a white-with-green-letters User Preset front-panel key that does a User Preset. The old PRESet:TYPE command is ignored (without generating an error), and SYST:PRES without a parameter does a Mode Preset, which should cover most backward code compatibility issues. The settings and correction data under the Input/Output front-panel key (examples: Input Z Corr, Ext Amp Gain, etc.) are no longer part of any Mode, so they will not be preset by a Mode Preset. They are preset using Restore Input/Output Defaults, Restore System Defaults All. Note that because User Preset does a Recall State, and all of these settings are saved in State, they ARE recalled when using

	User Preset.
Initial S/W Revision	Prior to A.02.00

How-To Preset

The table below shows all possible presets, their corresponding SCPI commands and front-panel access (key paths). Instrument settings depend on the current measurement context. Some settings are local to the current measurement, some are global (common) across all the measurements in the current mode, and some are global to all the available modes. In a similar way, restoring the settings to their preset state can be done within the different contexts.

Auto Couple - is a measurement local key. It sets all Auto/Man parameter couplings in the measurement to Auto. Any Auto/Man selection that is local to other measurements in the mode will not be affected.

Meas Preset - is a measurement local key. Meas Preset resets all the variables local to the current measurement except the persistent ones.

Mode Preset - resets all the current mode's measurement local and measurement global variables except the persistent ones.

Restore Mode Defaults - resets ALL the Mode variables (and all the Meas global and Meas local variables), including the persistent ones.

Type Of Preset	SCPI Command	Front Panel Access
Auto Couple	:COUPlE ALL	Auto Couple front-panel key
Meas Preset	:CONFIgure:<Measurement>	Meas Setup Menu
Mode Preset	:SYSTem:PRESet	Mode Preset (green key)
Restore Mode Defaults	:INSTrument:DEFault	Mode Setup Menu
Restore All Mode Defaults	:SYSTem:DEFault MODEs	System Menu; Restore System Default Menu
*RST	*RST	not possible (Mode Preset with Single)
Restore Input/Output Defaults	:SYSTem:DEFault INPut	System Menu; Restore System Default Menu
Restore Power On Defaults	:SYSTem:DEFault PON	System Menu; Restore System Default Menu
Restore Alignment Defaults	:SYSTem:DEFault ALIGn	System Menu; Restore System Default Menu
Restore Miscellaneous Defaults	:SYSTem:DEFault MISC	System Menu; Restore System Default Menu
Restore All System Defaults	:SYSTem:DEFault [ALL] :SYSTem:PRESet:PERSistent	System Menu; Restore System Default Menu
User Preset	:SYSTem:PRESet:USER	User Preset Menu
User Preset All Modes	:SYSTem:PRESet:USER:ALL	User Preset Menu

10 iDEN Power Measurement
Mode Preset

Power On Mode Preset	:SYSTem:PON:TYPE MODE	System Menu
Power On User Preset	:SYSTem:PON:TYPE USER	System Menu
Power On Last State	:SYSTem:PON:TYPE LAST	System Menu

Mode Setup

See ["Mode Setup" on page 226](#)

Peak Search

Displays a menu that enables markers to be easily moved among peaks on a trace and also performs the peak search function. Pressing Peak Search also makes the selected marker's X position the active function.

The peak search function causes the marker to move to the highest point in the trace. The highest point is the point with the largest y-axis value in the current trace format. If the format is complex (vector or constellation) then the point with the highest magnitude is chosen.

Pressing the Peak Search hard key always performs a Peak Search, with one exception: if the Peak Search menu is not showing but the selected marker is on (Normal, Delta, or Fixed), then pressing the Peak Search hardkey only displays the Peak Search menu. This enables you to select one of the other peak search functions without disturbing the selected marker's position. If you want to perform a peak search in this case, press the Peak Search hardkey again.

If the selected marker is Off, then pressing the Peak Search hardkey once not only shows the menu, but it turns on the selected marker in Normal mode, assigns it to the selected trace, and performs a peak search.

If any peak search SCPI command is invoked on a marker that is Off, the marker is first turned on in Normal mode and assigned to the selected trace. Then the peak search is performed.

Key Path	Front Panel
Mode	VSA, LTE, LTETDD, IDEN
Measurement	<meas>:=VECTor ADEMod DDEMod W11A W11B EVM IPOWER IDEMod MOTotalk
Remote Command	:CALCulate:<meas>:MARKer[1] 2 ...12:MAXimum
Example	CALC:VECT:MARK2:MAX
Notes	There is no softkey for this function. Instead, you press the Peak Search hardkey twice. (Pressing it once is sufficient if the Peak Search menu is showing, but twice guarantees that the function is invoked) If peak search function is not invoked (because the response to pressing the hardkey was only to show the menu) then the following message is shown: "Press Peak Search again to perform a Peak Search."
Initial S/W Revision	Prior to A.02.00
Modified at S/W Revision	A.02.00

Select Marker

Specifies the selected marker. The selected marker is the one that is affected by the marker position and properties settings, peak search, and other marker functions. Several menus have a Select Marker key for convenience. Marker selection using any one of these is reflected in all others, in other words, there is only one selected marker for the whole measurement. If all markers are off, then marker 1 becomes the selected marker.

As a convenience, if no markers are displayed on the selected trace, selecting a marker that is off automatically turns it on in normal mode on the selected trace.

There is no SCPI function for selecting a marker. Instead, SCPI functions can explicitly include the index of the marker for which they are to apply. (Most SCPI marker functions that affect the state of a marker also make it the selected marker for front panel commands.)

Key Path	Marker or Marker> or Marker Function or Peak Search
Mode	VSA, LTE, LTETDD, IDEN,LTEAFDD,LTEATDD
State Saved	No
Range	1 2 3 4 5 6 7 8 9 10 11 12
Initial S/W Revision	Prior to A.02.00
Modified at S/W Revision	A.02.00

Next Peak (Next Lower Amptd)

Moves the marker to the peak next lower in Y value than the peak it is currently on. If the format is complex (vector or constellation) then the marker moves to the closest point that has a lower magnitude than the marker's current position. If this function is invoked via SCPI on a marker that is off, the result is the same as if you sent a Peak Search command.

Key Path	Peak Search
Mode	VSA, LTE, LTETDD, IDEN
Measurement	<meas>:=VECTor ADEMod DDEMod W11A W11B EVM IPOWER IDEMod MOTotalk
Remote Command	:CALCulate:<meas>:MARKer[1] 2 ...12:MAXimum:NEXT
Example	CALC:VECT:MARK2:MAX:NEXT
Initial S/W Revision	Prior to A.02.00
Modified at S/W Revision	A.02.00

Next Higher Amptd

Moves the marker to the peak next higher in Y value than the peak it is currently on. If the format is complex (vector or constellation) then the marker moves to the closest point that has a higher magnitude than the marker's current position. If this function is invoked via SCPI on a marker that is off, the result is the same as if you sent a Peak Search command.

Key Path	Peak Search
Mode	VSA, LTE, LTETDD, IDEN
Measurement	<meas>:=VECTor ADEMod DDEMod W11A W11B EVM IPOWER IDEMod MOTotalk
Remote Command	:CALCulate:<meas>:MARKer[1] 2 ...12:MAXimum:PREVious
Example	CALC:VECT:MARK2:MAX:PREV
Initial S/W Revision	Prior to A.02.00
Modified at S/W Revision	A.02.00

Next Right

Moves the marker to the next peak to the right of its current position. If the format is complex (vector or constellation) then the marker moves forward in time to the next peak. If this function is invoked via SCPI on a marker that is off, the result is the same as if you sent a Peak Search command.

A valid peak is one for which the displayed Y-axis values drop monotonically on both sides of the local maximum at least 4% of the distance between the top and bottom of the display grid before the values begin to rise again.

Key Path	Peak Search
Mode	VSA, LTE, LTETDD, IDEN
Measurement	<meas>:=VECTor ADEMod DDEMod W11A W11B EVM IPOWER IDEMod MOTotalk
Remote Command	:CALCulate:<meas>:MARKer [1] 2 . . . 12:MAXimum:RIGHT
Example	CALC:VECT:MARK2:MAX:RIGH
Initial S/W Revision	Prior to A.02.00
Modified at S/W Revision	A.02.00

Next Left

Moves the marker to the next peak to the left of its current position. If the format is complex (vector or constellation) then the marker moves back in time to the next peak. If this function is invoked via SCPI on a marker that is off, the result is the same as if you sent a Peak Search command.

A valid peak is one for which the displayed Y-axis values drop monotonically on both sides of the local maximum at least 4% of the distance between the top and bottom of the display grid before the values begin to rise again.

Key Path	Peak Search
Mode	VSA, LTE, LTETDD, IDEN
Measurement	<meas>:=VECTor ADEMod DDEMod W11A W11B EVM IPOWER IDEMod MOTotalk
Remote Command	:CALCulate:<meas>:MARKer [1] 2 . . . 12:MAXimum:LEFT
Example	CALC:VECT:MARK2:MAX:LEFT
Initial S/W Revision	Prior to A.02.00
Modified at S/W Revision	A.02.00

Mkr -> CF (Center Frequency)

Sets the center frequency equal to the selected marker's absolute frequency. The marker must be on a frequency-domain trace. The absolute marker frequency is used regardless of whether its control mode is Normal, Delta, or Fixed.

If the currently selected marker is not on when this key is pressed, it is turned on at the center of the screen as a normal type marker.

Key Path	Marker To
Mode	VSA, LTE, LTETDD, IDEN,LTEAFDD,LTEATDD
Initial S/W Revision	Prior to A.02.00
Modified at S/W Revision	A.02.00

Continuous Peak Search

Turns on Continuous Peak Search for the selected marker. This function can be turned on for any marker independently of any other marker. This function moves the marker to the highest point on the trace each time the trace is updated. If the SCPI command refers to a marker that is off, it is turned on in Normal mode.

It is possible to have Couple Markers and Continuous Peak Search both on. If this is the case, it is recommended that Continuous Peak search be turned on for only one marker in any tracking set (that is, any set of markers with the same or equivalent domain). Otherwise, conflicts over marker position can arise that cause erratic marker movement.

Key Path	Peak Search
Mode	VSA, LTE, LTETDD, IDEN
Measurement	<meas>:=VECTor ADEMod DDEMod W11A W11B EVM IPOWER IDEMod MOTotalk
Remote Command	:CALCulate:<meas>:MARKer[1] 2 ...12:CPSearch[:STATe] ON OFF 1 0 :CALCulate:<meas>:MARKer[1] 2 ...12:CPSearch[:STATe]?
Example	CALC:VECT:MARK1:CPS ON
Couplings	The Continuous Peak Search key is grayed out when the selected marker is a Fixed marker. Also, if Continuous Peak Search is on and the selected marker becomes a fixed marker, then Continuous Peak Search is turned off and the key grayed out. Continuous Peak Search is turned off when the selected marker is turned off.
Preset	OFF
State Saved	Saved in instrument state.
Range	Off On
Initial S/W Revision	Prior to A.02.00
Modified at S/W Revision	A.02.00

Min Search

Moves the marker to the lowest Y value on the trace. If the format is complex (vector or constellation) then the marker moves to the lowest value in magnitude. If the SCPI command refers to a marker that is off, it is first turned on in Normal mode and then set on the minimum point.

Key Path	Peak Search
Mode	VSA, LTE, LTETDD, IDEN

Measurement	<meas>:=VECTor ADEMod DDEMod W11A W11B EVM IPOWER IDEMod MOTotalk
Remote Command	:CALCulate:<meas>:MARKer [1] 2 ... 12:MINimum
Example	CALC:VECT:MARK2:MIN
Initial S/W Revision	Prior to A.02.00
Modified at S/W Revision	A.02.00

Mkr -> Ref Lvl (Reference Level)

Sets the Y axis reference value equal to the selected marker's Y value. For example, if the reference position is at the top of the screen, the whole trace is moved up so that the marker appears at the top of the screen. Note that this is a display scaling function only. The input range remains the same.

Key Path	Peak Search
Mode	VSA, LTE, LTETDD, IDEN
Initial S/W Revision	Prior to A.02.00
Modified at S/W Revision	A.02.00

Print

See "Print" on page 241

Quick Save

The Quick Save front-panel key repeats the most recent save that was performed from the Save menu, with the following exceptions:

- Register saves are not remembered as Saves for the purpose of the Quick Save function
- If the current measurement does not support the last non-register save that was performed, an informational message is generated, “File type not supported for this measurement”

Quick Save repeats the last type of qualified save (that is, a save qualified by the above criteria) in the last save directory by creating a unique filename using the Auto File Naming algorithm described below.

If Quick Save is pressed after startup and before any qualified Save has been performed, the Quick Save function performs a Screen Image save using the current settings for Screen Image saves (current theme, current directory), which then becomes the “last save” for the purpose of subsequent Quick Saves.

The Auto File Naming feature automatically generates a file name for use when saving a file. The filename consists of a prefix and suffix separated by a dot, as is standard for the Windows® file system. A default prefix exists for each of the available file types:

Type	Default Prefix	Menu
State	State_	(Save/Recall)
Trace + State	State_	(Save/Recall)
Screen	Screen_	(Save/Recall)
Amplitude Corrections	Ampcor_	(Import/Export)
Traces	Trace_	(Import/Export)
Limit Lines	LLine_	(Import/Export)
Measurement Result	MeasR_	(Import/Export)
Capture Buffer	CapBuf_	(Import/Export)

A four digit number is appended to the prefix to create a unique file name. The numbering sequence starts at 0000 within each Mode for each file type and updates incrementally to 9999, then wraps to 0000 again. It remembers where it was through a Mode Preset and when leaving and returning to the Mode. It is reset by Restore Misc Defaults and Restore System Defaults and subsequent running of the instrument application. So, for example, the first auto file name generated for State files is State_0000.state. The next is State_0001, and so forth.

One of the key features of Auto File Name is that we guarantee that the Auto File Name will never conflict with an existing file. The algorithm looks for the next available number. If it gets to 9999, then it looks for holes. If it find no holes, that is no more numbers are available, it gives an error.

For example, if when we get to State_0010.state there is already a State_0010.state file in the current directory, it advances the counter to State_0011.state to ensure that no conflict will exist (and then it verifies that State_0011.state also does not exist in the current directory and advances again if it does, and so forth).

If you enter a file name for a given file type, then the prefix becomes the filename you entered instead of the default prefix, followed by an underscore. The last four letters (the suffix) are the 4-digit number.

For example, if you save a measurement results file as “fred.csv”, then the next auto file name chosen for a measurement results save will be fred_0000.csv.

NOTE

Although 0000 is used in the example above, the number that is used is actually the current number in the Meas Results sequence, that is, the number that would have been used if you had not entered your own file name.

NOTE

If the filename you entered ends with _dddd, where d=any number, making it look just like an auto file name, then the next auto file name picks up where you left off with the suffix being dddd + 1.

Key Path	Front-panel key
Notes	No remote command for this key specifically.
Initial S/W Revision	Prior to A.02.00

Recall

The Recall menu lets you choose what you want to recall, and where you want to recall it from. Among the types of files you can recall are **States and Traces**. In addition, an Import (Data) option lets you recall a number of data types stored in CSV files (as used by Excel and other spreadsheet programs).

The default paths for Recall are data type dependent and are the same as for the Save key.

Key Path	Front-panel key
Notes	<p>No remote command for this key specifically, but the :MMEM:LOAD command is available for specific file types. An example is :MMEM:LOAD:STATE <filename>.</p> <p>If you try to recall a State file for a mode that is not licensed or not available in the instrument, an error message will occur and the state will not change.</p>
Backwards Compatibility Notes	<p>In legacy analyzers, it was possible to load a state without affecting the trace data, limit lines or correction data. Similarly (since User Preset is actually loading a state), it was possible to do a User Preset without affecting the trace data, limit lines or correction data.</p> <p>In the X-Series, "state" always includes all of this data; so whenever state is loaded, all of the traces, limit lines and corrections are affected. Although this differs from previous behavior, it is desirable behavior, and should not cause adverse issues for users.</p>
Backwards Compatibility Notes	<p>Recall for the X-Series supports backward compatibility in the sense that you can recall a state file from any X-Series model number and any version of X-Series software. This is only possible if part of the recalling process goes through a limiting step after recalling the mode settings, at least for settings that may vary with version number, model number, option and license differences. If you try to recall a state file onto an instrument with less capability than what was available on the instrument during the save, the recall will ignore the state it doesn't support and it will limit the recalled setting to what it allows.</p> <p>Example: if the saved state includes preamp ON, but the recalling instrument does not have a preamp; the preamp is limited to OFF. Conversely, if you save a state without a preamp, the preamp is OFF in the state file. When this saved file is recalled on an instrument with a licensed preamp, the preamp is changed to OFF. Another example is if the saved state has center frequency set to 20 GHz, but the instrument recalling the saved state is a different model and only supports 13.5 GHz. In this case, the center frequency is limited along with any other frequency based settings. Since the center frequency can't be preserved in this case, the recall limiting tries to at least preserve span to keep the measurement setup as intact as possible.</p> <p>It may be appropriate to issue a warning if the state is limited on the recall; warnings do not go out to SCPI so this would only affect the manual user.</p> <p>Note that there is no state file compatibility outside of the X-Series. For example, you cannot recall a state file from ESA or PSA.</p>
Initial S/W Revision	Prior to A.02.00

State

The Recall State menu lets you choose a register or file from which to recall the state.

The content of a state file includes all of the settings and data required to return the analyzer as closely as possible to the Mode it was in, with the exact settings that were in place, when the save occurred. The Mode settings in each state file include the settings that are affected by Mode Preset, as well as the

additional settings affected by Restore Mode Defaults; all of the Mode's settings. In addition, all of the settings of the Input/Output system are included, even though they are outside of the Mode's state, because they are needed to restore the complete setup. Persistent System settings (for example, GPIB address) are not affected by either a Mode Preset or Restore Mode Defaults, nor are they included in a saved State file.

Since each state file is only for one Mode, the settings for other Modes are unaffected when it is loaded. Recall State will cause a mode switch if the state being recalled is not from the current active mode.

After the recall completes, the message "File <filename> recalled" or "Recalled State Register <register number>" is displayed.

For rapid recalls, the State menu lists 16 registers that you can choose from to recall. Pressing a Register key initiates the recall. You can also select a file from which to recall.

The default path for all State Files is:

My Documents\<<mode name>\state

where <mode name> is the parameter used to select the mode with the INST:SEL command (for example, SA for the Spectrum Analyzer).

See "[More Information](#)" on page 784.

Key Path	Recall
Mode	All
Remote Command	:MMEMory:LOAD:STATe <filename>
Example	:MMEM:LOAD:STAT "myState.state" This recalls the file myState.state on the default path
Example	MMEM:LOAD:STAT "MyStateFile.state" This loads the state file data (on the default file directory path) into the instrument state.
Notes	<p>When you pick a file to recall, the analyzer first verifies that the file is recallable in the current instrument by checking the software version and model number of the instrument. If everything matches, a full recall proceeds by aborting the currently running measurement, clearing any pending operations, and then loading the State from the saved state file. You can open state files from any mode, so recalling a State file switches to the mode that was active when the save occurred. After switching to the mode of the saved state file, mode settings and data (if any for the mode) are loaded with values from the saved file. The saved measurement of the mode becomes the newly active measurement and the data relevant to the measurement (if there is any) is recalled.</p> <p>If there is a mismatch between file version or model number or instrument version or model number, the recall function tries to recall as much as possible and returns a warning message. It may limit settings that differ based on model number, licensing or version number.</p> <p>After recalling the state, the Recall State function does the following:</p> <ul style="list-style-type: none"> • Makes the saved measurement for the mode the active measurement. • Clears the input and output buffers. • Status Byte is set to 0. • Executes a *CLS <p>If the file specified is empty an error is generated. If the specified file does not exist, another error is generated. If there is a mismatch between the file and the proper file type, an error is generated. If</p>

	there is a mismatch between file version or model number or instrument version or model number, a warning is displayed. Then it returns to the State menu and File Open dialog goes away. After the Recall, the analyzer exits the Recall menu and returns to the previous menu.
Backwards Compatibility SCPI	:MMEMory:LOAD:STATe 1,<filename> For backwards compatibility, the above syntax is supported. The "1" is simply ignored.
Initial S/W Revision	Prior to A.02.00

More Information

In measurements that support saving Traces, for example, Swept SA, the Trace data is saved along with the State in the State file. When recalling the State, the Trace data is recalled as well. Traces are recalled exactly as they were stored, including the writing mode and update and display modes. If a Trace was updating and visible when the State was saved, it will come back updating and visible, and its data will be rewritten right away. When you use State to save and recall traces, any trace whose data must be preserved should be placed in View or Blank mode before saving.

The following table describes the Trace Save and Recall possibilities:

You want to recall state and one trace's data, leaving other traces unaffected.	Save Trace+State from 1 trace. Make sure that no other traces are updating (they should all be in View or Blank mode) when the save is performed.	On Recall, specify the trace you want to load the one trace's data into. This trace will load in View. All other traces' data will be unaffected, although their trace mode will be as it was when the state save was performed.
You want to recall all traces	Save Trace+State from ALL traces.	On Recall, all traces will come back in View (or Blank if they were in Blank or Background when saved)
You want all traces to load exactly as they were when saved.	Save State	On recall, all traces' mode and data will be exactly as they were when saved. Any traces that were updating will have their data immediately overwritten.

From File...

When you press "From File", the analyzer brings up a Windows dialog and a menu entitled "File Open." This menu allows you to navigate to the various fields in the Windows dialog without using a keyboard or mouse. The Tab and Arrow keys can also be used for dialog navigation.

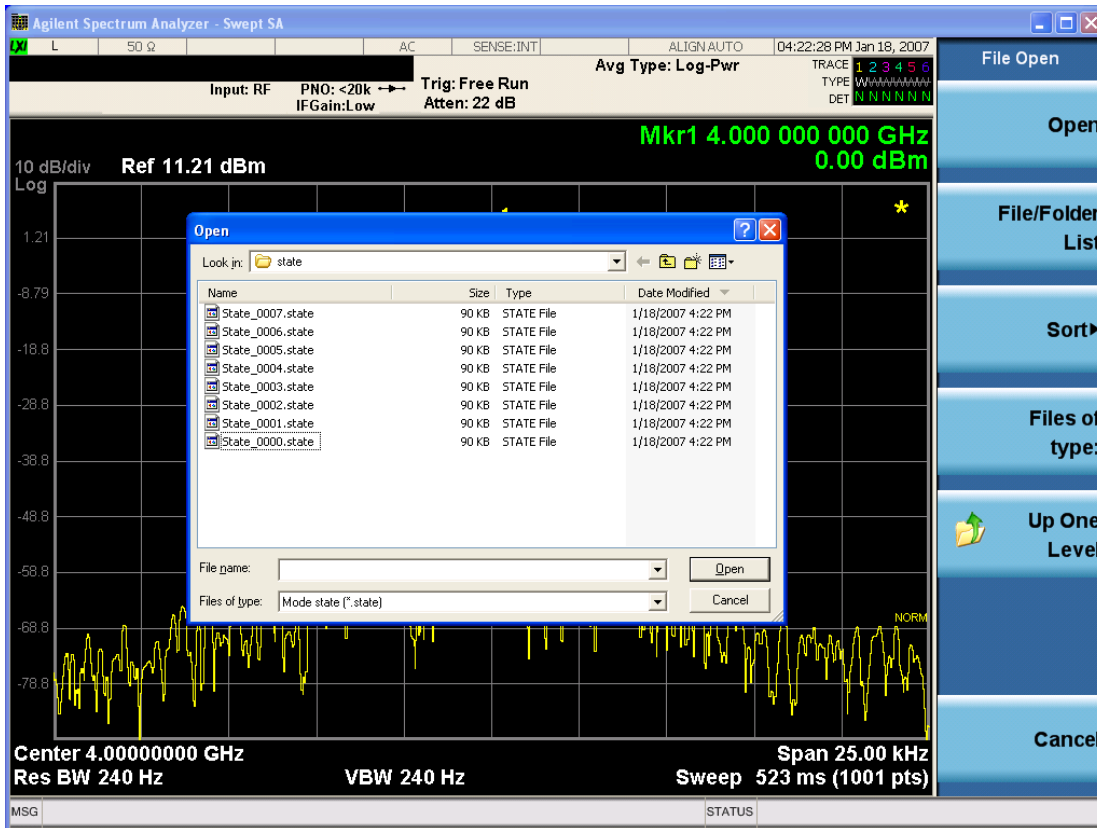

Listed below are the functions of the various fields in the dialog, and the corresponding softkeys:

Open

Performs the recall of the specified file. While the recall is being performed, the floppy icon appears briefly in the Meas bar.

File/Folder List

Enables you to navigate to the center of the dialog that contains the list of files and folders. Once here you can get information about the file and use the tab keys to navigate to the other fields in the dialog, such as Look In.

Look In

The Look In field shows the path from which the file will be recalled and allows you to change the path using the up and down arrow keys to navigate to other paths; the Enter key to open a directory; and the Backspace key to go back one directory. The **Look In field** first uses the last path from the Save As dialog **Save In:** path for that same file type. There is no softkey for directly navigating to the Look In field, but you can use the left tab to get here from the File/Folder List.

User specified paths are remembered when you leave and return to a Mode and are reset back to the default using Restore Mode Defaults.

Sort

Accesses a menu that enables you to sort the files within the File Open dialog. Only one sorting type can be selected at a time and the sorting happens immediately. The sorting types are By Date, By Name, By extension, and By Size.

Files of Type

This field shows the file suffix for the type of file you have selected to recall. For example, if you navigated here while recalling State, "Mode state (*.state)" is in the field. If you navigated here while recalling Trace, ""Mode state (*.trace)" is in the field. If you navigated here while importing a trace data file, "Trace Data (*.csv)" is in the field. For some file types, there is more than one choice in the dropdown menu, which you can select by using the up and down arrow keys and Enter.

Up One Level

This key corresponds to the icon of a folder with the up arrow that is in the tool bar of the dialog. When pressed, it causes the file and folder list to navigate up one level in the directory structure. The Backspace key does the same thing.

Cancel

This key corresponds to the Cancel selection in the dialog. It causes the current **Open** request to be cancelled. The ESC key does the same thing.

Key Path	Recall, State
Notes	Brings up the Open dialog for recalling a State Save Type
Initial S/W Revision	Prior to A.02.00

Edit Register Names

You may enter a custom name on any of the Register keys, to help you remember what you are using that state to save. To do this, press the Edit Register Names key, choose the register whose name you wish to edit, and then enter the desired label using the Alpha Editor or an external PC keyboard.

The maximum number of characters that can be added is 30. In most cases, 30 characters will fit on two lines of the key.

For more information and the SCPI command, see Edit Register Names under the Save, State function.

Key Path	Recall, State
Mode	All
Dependencies	N9060A-7FP or N9060B-2FP license required to edit the register names. When the feature is not licensed, sending the SCPI command generates an error, -221, "Settings conflict;Option not available"
Initial S/W Revision	A.11.00

Register 1 thru Register 16

Selecting any one of these register keys causes the State of the mode from the specified Register to be recalled. Each of the register keys annotates whether it is empty or at what date and time it was last

modified. In addition, you can use the Edit Register Names key under Save, State to enter custom names for each register.

Registers are shared by all modes, so recalling from any one of the registers will cause a mode switch to the mode that was active when the save to the Register occurred.

Although these 16 registers are the only registers available from the front panel, there are 128 state registers available in the instrument. Registers 17–128 are only available from the SCPI interface, using the *RCL command.

After the recall completes, the message "Register <register number> recalled" appears in the message bar. If you are in the Spectrum Analyzer Mode, and you are recalling a register that was saved in the Spectrum Analyzer Mode, then after the recall, you will still be in the Recall Register menu. If the Recall causes you to switch modes, then after the Recall, you will be in the Frequency menu.

If a requested register is empty an error is generated.

Key Path	Recall, State
Example	*RCL 1
Range	1–16 from front panel, 1–128 from SCPI
Readback	Date and time with seconds resolution are displayed on the key OR A custom name of up to 30 characters entered using the Save, State, Edit Register Names key OR “(empty)” if no prior save operation has been performed to this register.
Initial S/W Revision	Prior to A.02.00
Modified at S/W Revision	Prior to A.11.00

Register 1 thru Register 16

Selecting any one of these register keys causes the State of the mode from the specified Register to be recalled. Each of the register keys annotates whether it is empty or at what date and time it was last modified. In addition, you can use the Edit Register Names key under Save, State to enter custom names for each register.

Registers are shared by all modes, so recalling from any one of the registers will cause a mode switch to the mode that was active when the save to the Register occurred.

Although these 16 registers are the only registers available from the front panel, there are 128 state registers available in the instrument. Registers 17–128 are only available from the SCPI interface, using the *RCL command.

After the recall completes, the message "Register <register number> recalled" appears in the message bar. If you are in the Spectrum Analyzer Mode, and you are recalling a register that was saved in the Spectrum Analyzer Mode, then after the recall, you will still be in the Recall Register menu. If the Recall causes you to switch modes, then after the Recall, you will be in the Frequency menu.

If a requested register is empty an error is generated.

Key Path	Recall, State
Example	*RCL 1
Range	1-16 from front panel, 1-128 from SCPI
Readback	Date and time with seconds resolution are displayed on the key OR A custom name of up to 30 characters entered using the Save, State,Edit Register Names key OR “(empty)” if no prior save operation has been performed to this register.
Initial S/W Revision	Prior to A.02.00
Modified at S/W Revision	Prior to A.11.00

Trace

This key selects Trace as the data type to be imported. When pressed a second time, it brings up the Trace Menu, which lets you select the Trace into which the data will be imported.

The trace file contains “meta” data which describes the state of the analyzer when the trace was exported (see Trace File Contents). If the meta data in the file does not match the current SA state, the “invalid data indicator” (*) is displayed.

Key Path	Recall, Data
Remote Command	:MMEMory:LOAD:TRACe:DATA TRACE1 TRACE2 TRACE3 TRACE4 TRACE5 TRACE6,<filename>
Example	:MMEM:LOAD:TRAC DATA TRACE2, "myTrace2.csv" Imports the 2nd trace from the file myTrace2.csv in the current path. The default path is My Documents\SA\data\traces
Dependencies	For SA measurements, a trace cannot be recalled from a trace file that was exported with ALL traces selected. A trace cannot be imported if the number of trace points in the file do not match the number of sweep points currently set for the measurement. If this happens, an error message is generated. Errors are reported if the file is empty or missing, or if the file type does not match, or if there is a mismatch between the file type and the destination data type. If any error occurs while trying to load a file manually (as opposed to during remote operation), the analyzer returns to the Import Data menu and the File Open dialog goes away.
Couplings	When a trace is imported, Trace Update is always turned OFF for that trace and Trace Display is always turned ON.
Readback	Selected Trace
Status Bits/OPC dependencies	Sequential - aborts the current measurement.
Initial S/W Revision	Prior to A.02.00

Import Trace Data

Enables you to import previously saved trace data into a Data Register and optionally display it. Selecting this key displays a menu that enables you to select the destination data register, and also enables you to choose whether or not to display the recalled data in the currently selected trace. After making these selections, select Open... and use the file dialog to select the file you want to recall.

Recalling trace data into an already used Data Register overwrites the previous data. If the data register is displayed on any trace, the display is updated to reflect the new data.

The SCPI command

```
:MMEM:LOAD:TRAC:DATA D1|D2|D3|D4|D5|D6,<filename>
```

recalls data into a specified register, but does not display it in the selected trace. Use the command

```
:DISP:<meas>:TRAC<n>:FEED D1|D2|D3|D4|D5|D6
```

to display the register in the desired trace.

It is possible to recall trace data saved by other VXA measurements, or measurements made using the LTE, LTETDD, iDEN, or 89601 applications.

Key Path	Recall, Data (Import)
Mode	VSA, LTE, LTETDD, IDEN
Remote Command	:MMEMory:LOAD:TRACe:DATA D1 D2 D3 D4 D5 D6,<filename>[,CSV TXT SDF MAT4 MAT HDF5 BIN]
Example	:MMEM:LOAD:TRAC:DATA D1,"Trc1.txt",TXT
Notes	<p>The Open: dialog box has the following filter options when you are recalling trace data::</p> <ul style="list-style-type: none"> • CSV (Comma delimited) (*.csv) • SDF (Fast) (*.sdf;*.dat) • Text (Tab delimited) (*.txt) <p>The file must have the same format as that created by the Export Recorded Data command.</p> <p>The SCPI command has an optional file format parameter. If you do not include this parameter in the SCPI command, the file format is determined by the file name extension. If no file extension is recognized, the file is scanned to determine the format.</p> <p>If you are not licensed to recall a particular file type, then error -203.9010 is returned. If the file format cannot be determined or the file cannot be recalled successfully, then error -250.5290 is returned. If the recall is successful, then advisory 0.1600 is shown.</p>
State Saved	No
Readback	Data 1 Data 2 Data 3 Data 4 Data 5 Data 6

Data 1

Selects the Data 1 register as the destination for the imported data.

Key Path	Recall, Data (Import), Trace (to)
Mode	VSA, LTE, LTETDD, IDEN

Data 2

Selects the Data 2 register as the destination for the imported data.

Key Path	Recall, Data (Import), Trace (to)
Mode	VSA, LTE, LTETDD, IDEN

Data 3

Selects the Data 3 register as the destination for the imported data.

Key Path	Recall, Data (Import), Trace (to)
Mode	VSA, LTE, LTETDD, IDEN

Data 4

Selects the Data 4 register as the destination for the imported data.

Key Path	Recall, Data (Import), Trace (to)
Mode	VSA, LTE, LTETDD, IDEN

Data 5

Selects the Data 5 register as the destination for the imported data..

Key Path	Recall, Data (Import), Trace (to)
Mode	VSA, LTE, LTETDD, IDEN

Data 6

Selects the Data 6 register as the destination for the imported data.

Key Path	Recall, Data (Import), Trace (to)
Mode	VSA, LTE, LTETDD, IDEN

Display in Selected Trace

Enables you to select whether the recalled trace data is displayed in the current Trace.

Key Path	Recall, Data (Import), Trace (to)
----------	-----------------------------------

Mode	VSA, LTE, LTETDD, IDEN
State Saved	No

Open...

When you press “Open”, the analyzer brings up a Windows dialog and a menu entitled “**File Open.**” This menu allows you to navigate to the various fields in the Windows dialog without using a keyboard or mouse. The Tab and Arrow keys can also be used for dialog navigation.

See "[From File...](#)" on page 1200 in Recall, State, for a full description of this dialog and menu.

Key Path	Recall, Data
Notes	The key location is mode-dependent and will vary. Brings up Open dialog for recalling a <mode specific> Save Type
Initial S/W Revision	Prior to A.02.00

Restart

The Restart function restarts the current sweep, or measurement, or set of averaged/held sweeps or measurements. If you are Paused, pressing Restart does a Resume.

The Restart function is accessed in several ways:

- Pressing the Restart key
- Sending the remote command INIT:IMMediate
- Sending the remote command INIT:REStart

See "[More Information](#)" on page 792

Key Path	Front-panel key
Remote Command	:INITiate[:IMMediate] :INITiate:REStart
Example	:INIT:IMM :INIT:REST
Notes	:INITiate:REStart and :INITiate:IMMediate perform exactly the same function.
Couplings	Resets average/hold count k. For the first sweep overwrites all active (update=on) traces with new current data. For application modes, it resets other parameters as required by the measurement.
Status Bits/OPC dependencies	This is an Overlapped command. The STATus:OPERation register bits 0 through 8 are cleared. The STATus:QUESTionable register bit 9 (INTegrity sum) is cleared. The SWEEPING bit is set. The MEASURING bit is set.
Backwards Compatibility Notes	For Spectrum Analysis mode in ESA and PSA, the Restart hardkey and the INITiate:REStart command restart trace averages (displayed average count reset to 1) for a trace in Clear Write, but did not restart Max Hold and Min Hold. In the X-Series, the Restart hardkey and the INITiate:REStart command restart not only Trace Average, but MaxHold and MinHold traces as well. For wireless comms modes in ESA and PSA, the Restart hardkey and the INITiate:REStart command restart every measurement, which includes all traces and numeric results. There is no change to this operation.
Initial S/W Revision	Prior to A.02.00

More Information

The **Restart** function first aborts the current sweep/measurement as quickly as possible. It then resets the sweep and trigger systems, sets up the measurement and initiates a new data measurement sequence with a new data acquisition (sweep) taken once the trigger condition is met.

If the analyzer is in the process of aligning when **Restart** is executed, the alignment finishes before the restart function is performed.

Even when set for Single operation, multiple sweeps may be taken when Restart is pressed (for example, when averaging/holding is on). Thus when we say that **Restart** "restarts a measurement," we may mean:

- It restarts the current sweep
- It restarts the current measurement
- It restarts the current set of sweeps if any trace is in Trace Average, Max Hold or Min Hold
- It restarts the current set of measurements if Averaging, or Max Hold, or Min Hold is on for the measurement
- depending on the current settings.

With **Average/Hold Number** (in **Meas Setup** menu) set to 1, or Averaging off, or no trace in Trace Average or Hold, a single sweep is equivalent to a single measurement. A single sweep is taken after the trigger condition is met; and the analyzer stops sweeping once that sweep has completed. However, with **Average/Hold Number** >1 and at least one trace set to **Trace Average, Max Hold, or Min Hold (SA Measurement)** or **Averaging on (most other measurements)**, multiple sweeps/data acquisitions are taken for a single measurement. The trigger condition must be met prior to each sweep. The sweep is stopped when the average count k equals the number N set for **Average/Hold Number**. A measurement average usually applies to all traces, marker results, and numeric results; but sometimes it only applies to the numeric results.

Once the full set of sweeps has been taken, the analyzer will go to idle state. To take one more sweep without resetting the average count, increment the average count by 1, by pressing the step up key while **Average/Hold Number** is the active function, or sending the remote command `CALC:AVER:TCON UP`.

Save

The Save menu lets you choose what you want to save and where you want to save it. Among the types of files you can save are **States**, **Traces**, and **Screen Images**. In addition, an Export (Data) option lets you save a number of data types as CSV files for easy import into Excel and other spreadsheet programs.

Key Path	Front-panel key
Mode	All
Notes	No remote command for this key specifically, but the :MMEM:STORe command is available for specific file types. An example is :MMEM:STOR:STATe <filename>.
Initial S/W Revision	Prior to A.02.00

State

The Save State menu lets you choose a register or file for saving the state.

The content of a state file includes all of the settings and data required to return the analyzer as closely as possible to the Mode it was in, with the exact settings which were in place, when the save occurred. The Mode settings in each state file include the settings that are affected by Mode Preset, as well as the additional settings affected by Restore Mode Defaults; all of the Mode's settings. In addition, all of the settings of the Input/Output system are included, even though they are outside of the Mode's state, because they are needed to restore the complete setup. Persistent System settings (for example, Verbose SCPI) are not affected by either Mode Preset or Restore Mode Defaults, nor are they included in a saved State file.

After the save completes, the message "File <filename> saved" or "State Register <register number> saved" is displayed.

For rapid saving, the State menu lists 16 registers to save to. Pressing a Register key initiates the save. You can also select a file to save to.

The default path for all State Files is:

My Documents\<<mode name>\state

where <mode name> is the parameter used to select the mode with the INST:SEL command (for example, SA for the Spectrum Analyzer).

Key Path	Save
Mode	All
Remote Command	:MMEMory:STORe:STATe <filename>
Example	MMEM:STOR:STATe "MyStateFile.state" This stores the current instrument state data in the file MyStateFile.state in the default directory.
Notes	Both single and double quotes are supported for any filename parameter over remote. After saving to a register, that register's menu key is updated with the date the time, unless a custom label has been entered for that key. After saving to a register, you remain in the Save State menu, so that you can see the Register key

update. After saving to a file, the analyzer automatically returns to the previous menu and any Save As dialog goes away.

Backwards Compatibility SCPI	:MMEMory:STORe:STATe 1,<filename>
Initial S/W Revision	Prior to A.02.00

To File . . .

When you press “To File”, the analyzer brings up a Windows dialog and a menu entitled “**Save As.**” This menu allows you to navigate to the various fields in the Windows dialog without using a keyboard or mouse. The Tab and Arrow keys can also be used for dialog navigation.

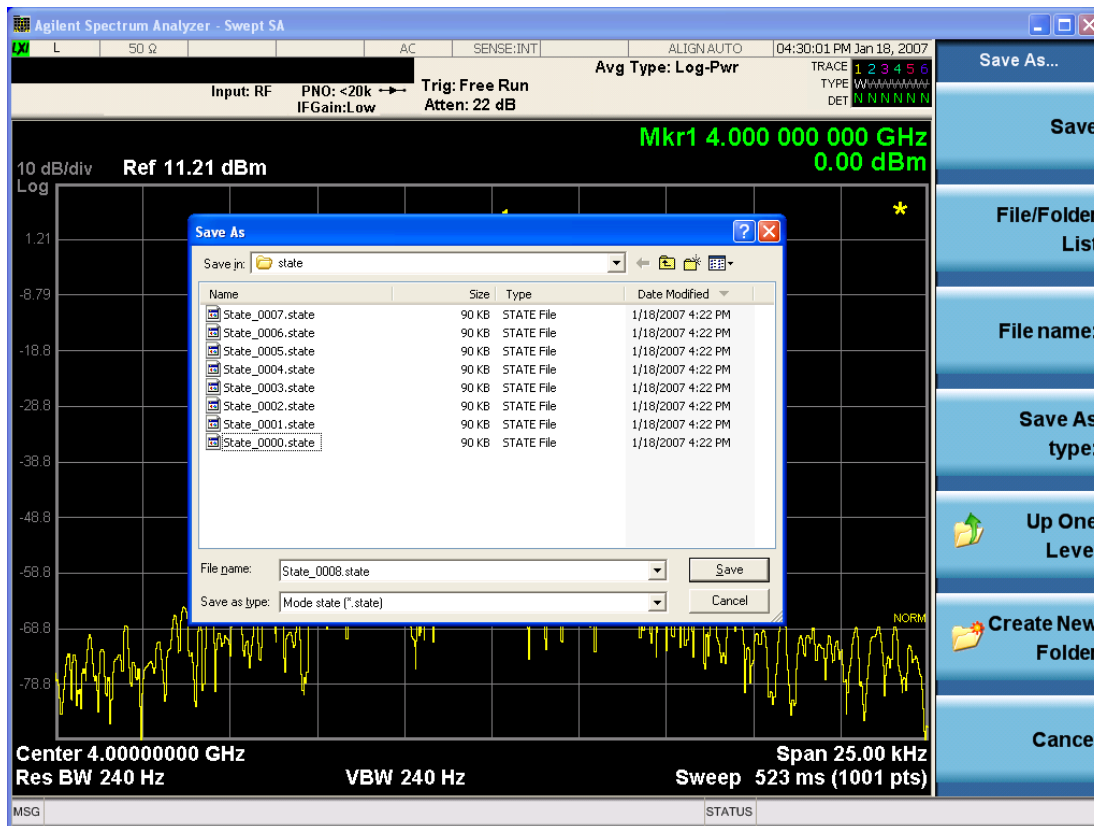

The Listed below

are the functions of the various fields in the dialog, and the corresponding softkeys:

Save

Performs the save to the specified file of the selected type. If the file already exists, a dialog will appear that allows you to replace the existing file by selecting OK, or you can Cancel the request. If you select OK, the file will be overwritten. Using the C: drive is strongly discouraged, since it runs the risk of being overwritten during an instrument software upgrade.

While the save is being performed, the floppy icon appears briefly in the Meas bar.

File/Folder List

Enables you to navigate to the center of the dialog that contains the list of files and folders. Once here you can get information about the file and use the tab keys to navigate to the other fields in the dialog, such as Save In.

Save In

The Save In field shows the path to which the file will be saved and allows you to change the path using the up and down arrow keys to navigate to other paths; the Enter key to open a directory; and the Backspace key to go back one directory. The **Save In field** defaults to the default path for this type of file and remembers the last path you used to save this type of file. There is no softkey for directly navigating to the Save In field but you can use left tab to get here from the File/Folder List.

User specified paths are remembered when you leave and return to a Mode and are reset back to the default using Restore Mode Defaults.

File Name

The File Name field is initially loaded with an automatically generated filename specific to the appropriate Save Type. The automatically generated filename is guaranteed not to conflict with any filename currently in the directory. You may replace or modify this filename using the File Name key. See the ["Quick Save " on page 1196](#) documentation for more on the automatic file naming algorithm.

When you press the File Name key the analyzer displays the Alpha Editor. Use the knob to choose the letter to add and the front-panel Enter key to add the letter to the file name. The BK character moves you back and the FW character moves you forward in the filename. The Select key on the front panel generates a space character. When you are done entering the filename press the Done softkey. This returns back to the **File Open** dialog and menu, but does not cause the save to occur.

Save As Type

This field shows the file suffix for the type of file you have selected to save. For example, if you navigated here while saving State, "Mode state (*.state)" is in the field. If you navigated here from saving Trace, ""Mode state (*.trace)" is in the field. If you navigated here while exporting a trace data file, "Trace Data (*.csv)" is in the field. For some file types, there is more than one choice in the dropdown, which you can select by using the up and down arrow keys and Enter.

Up One Level

This key corresponds to the icon of a folder with the up arrow that is in the tool bar of the dialog. When pressed, it causes the file and folder list to navigate up one level in the directory structure. The Backspace key does the same thing.

Create New Folder

This key corresponds to the icon of a folder with the "*" that is in the tool bar of the dialog. When pressed, a new folder is created in the current directory with the name **New Folder** and you can enter a new folder name using the Alpha Editor.

Cancel

This key corresponds to the Cancel selection in the dialog. It causes the current **Save As** request to be cancelled. The ESC key does the same thing.

Key Path	Save, State
Mode	All
Notes	Brings up Save As dialog for saving a State Save Type
Initial S/W Revision	Prior to A.02.00

Edit Register Names

You may enter a custom name on any of the Register keys, to help you remember what you are using that state to save. To do this, press the Edit Register Names key, choose the register whose name you wish to edit, and then enter the desired label using the Alpha Editor or an external PC keyboard.

The maximum number of characters that can be added is 30. In most cases, 30 characters will fit on two lines of the key.

See "[More Information](#)" on page 797

Key Path	Save, State
Mode	All
Remote Command	:MMEMory:REGister:STATe:LABel <reg number>,"label" :MMEMory:REGister:STATe:LABel? <reg number>
Example	:MMEM:REG:STAT:LAB 1,"my label"
Notes	<reg number> is an integer from 1 to 16. If the SCPI specifies an invalid register number an error message is generated, -222,"Data out of range;Invalid register label number" "label" is a string from 0 to 30 characters in length. If a label exceeds 30 characters, an error message is generated, -150,"String data error;Label clipped to 30 characters" "label" of length 0 erases the custom label and restores the default (time and date) label. E.g.: :MMEM:REG:STAT:LAB 1,""
Dependencies	N9060A-7FP or N9060B-2FP license required to edit the register names. When the feature is not licensed, sending this command generates an error, -221,"Settings conflict;Option not available"
Preset	The names are unaffected by Preset or power cycle but are set to the default label (time and date) on a "Restore System Defaults->Misc"
Initial S/W Revision	A.11.00

More Information

When you edit one of the register names, the time and date field will be replaced by the custom name.

If you delete all the characters in the custom name, it restores the default (time and date).

The register names are stored within the state files, but they are not part of the instrument state; that is, once you have edited a register name, loading a new state will not change that register name. Another consequence of this is that the names will be persistent through a power cycle. Also, if a named state file is transferred to another analyzer, it will bring its custom name along with it.

If you try to edit the name of an empty register, the analyzer will first save the state to have a file to put the name in. If you load a named state file into an analyzer with older firmware it will ignore the metadata.

The *SAV and *RCL commands will not be affected by the custom register names, nor will the MMEM commands.

Register 1 thru Register 16

Selecting any one of these register menu keys causes the State of the currently active mode to be saved to the specified Register. The registers are provided for rapid saving and recalling, since you do not need to specify a filename or navigate to a file. Each of the register menu keys annotates whether it is empty or at what date and time it was last modified. In addition, you can use the Edit Register Names key to enter custom names for each register.

Although these 16 registers are the only registers available from the front panel, there are 128 state registers available in the instrument. Registers 17–128 are only available from the SCPI interface, using the *SAV command.

There is one set of 128 state registers in the instrument, not one set for each Mode. When a state is saved, the Mode it was saved from is saved with it; then when it is recalled, the instrument switches to that Mode.

After the save completes, the corresponding register menu key annotation is updated with the date and time and the message "Register <register number> saved" is displayed.

Key Path	Save, State
Mode	All
Example	*SAV 1
Range	1–16 from front panel, 1–128 from SCPI
Readback	Date and time with seconds resolution are displayed on the key OR A custom name of up to 30 characters entered using the Edit Register Names key OR “(empty)” if no prior save operation has been performed to this register.
Initial S/W Revision	Prior to A.02.00
Modified at S/W Revision	A.11.00

Register 1 thru Register 16

Selecting any one of these register menu keys causes the State of the currently active mode to be saved to the specified Register. The registers are provided for rapid saving and recalling, since you do not need to specify a filename or navigate to a file. Each of the register menu keys annotates whether it is empty or at what date and time it was last modified. In addition, you can use the Edit Register Names key to enter custom names for each register.

Although these 16 registers are the only registers available from the front panel, there are 128 state registers available in the instrument. Registers 17–128 are only available from the SCPI interface, using the *SAV command.

There is one set of 128 state registers in the instrument, not one set for each Mode. When a state is saved, the Mode it was saved from is saved with it; then when it is recalled, the instrument switches to that Mode.

After the save completes, the corresponding register menu key annotation is updated with the date and time and the message "Register <register number> saved" is displayed.

Key Path	Save, State
Mode	All
Example	*SAV 1
Range	1–16 from front panel, 1–128 from SCPI
Readback	Date and time with seconds resolution are displayed on the key OR A custom name of up to 30 characters entered using the Edit Register Names key OR “(empty)” if no prior save operation has been performed to this register.
Initial S/W Revision	Prior to A.02.00
Modified at S/W Revision	A.11.00

Mass Storage Catalog (Remote Command Only)

Key path	SCPI Only
Remote Command	:MMEMory:CATalog? [<directory_name>]
Notes	The string must be a valid logical path. Queries disk usage information (drive capacity, free space available) and obtains a list of files and directories in a specified directory in the following format: <numeric_value>,<numeric_value>,{<file_entry>} It returns two numeric parameters and as many strings as there are files and directories. The first parameter indicates the total amount of storage currently used in bytes. The second parameter indicates the total amount of storage available, also in bytes. The <file_entry> is a string. Each <file_entry> indicates the name, type, and size of one file in the directory list: <file_name>,<file_type>,<file_size> As the windows file system has an extension that indicates file type, <file_type> is always empty. <file_size> provides the size of the file in bytes. For directories, <file_entry> is surrounded by square brackets and both <file_type> and <file_size> are empty
Initial S/W Revision	Prior to A.02.00

Mass Storage Change Directory (Remote Command Only)

Key path	SCPI Only
Remote Command	:MMEMory:CDIRectory [<directory_name>] :MMEMory:CDIRectory?

Notes	<p>The string must be a valid logical path.</p> <p>Changes the default directory for a mass memory file system. The <directory_name> parameter is a string. If no parameter is specified, the directory is set to the *RST value.</p> <p>At *RST, this value is set to the default user data storage area, that is defined as System.Environment.SpecialFolder.Personal.</p> <p>Query returns full path of the default directory.</p>
Initial S/W Revision	Prior to A.02.00

Mass Storage Copy (Remote Command Only)

Key path	SCPI Only
Remote Command	:MMEMory:COpy <string>,<string>[,<string>,<string>]
Notes	<p>The string must be a valid logical path.</p> <p>Copies an existing file to a new file or an existing directory to a new directory.</p> <p>Two forms of parameters are allowed. The first form has two parameters. In this form, the first parameter specifies the source, and the second parameter specifies the destination.</p> <p>The second form has four parameters. In this form, the first and third parameters specify the source. The second and fourth parameters specify the directories. The first pair of parameters specifies the source. The second pair specifies the destination. An error is generated if the source doesn't exist or the destination file already exists.</p> <p>This command will generate an "access denied" error if the destination is a restricted folder (e.g., C:\Windows) and the current user does not have Power User or Administrator privileges.</p>

Mass Storage Device Copy (Remote Command Only)

This command transfers data to/from a file and a peripheral device.

Key path	SCPI Only
Remote Command	:MMEMory:COpy:DEvice <source_string>,<dest_string>
Notes	<p>The strings must be a valid logical path or a valid device keyword. If the dest_string is a device keyword, the data is copied from the source file to the device. If the source_string is a device keyword, the data is copied to the source file from the device.</p> <p>Valid device keywords are:</p> <p>SNS (smart noise source)</p> <p>An error is generated if the file or device is not found.</p>

Mass Storage Delete (Remote Command Only)

Key path	SCPI Only
Remote Command	:MMEMory:DElete <file_name>[,<directory_name>]

Notes	The string must be a valid logical path. Removes a file from the specified directory. The <file_name> parameter specifies the file name to be removed. This command will generate an “access denied” error if the file is in a restricted folder (e.g., C:\Windows) and the current user does not have Power User or Administrator privileges.
Initial S/W Revision	Prior to A.02.00

Mass Storage Data (Remote Command Only)

Creates a file containing the specified data OR queries the data from an existing file.

Key path	SCPI Only
Remote Command	:MMEMory:DATA <file_name>, <data> :MMEMory:DATA? <file_name>
Notes	The string must be a valid logical path. The command form is MMEMory:DATA <file_name>,<data>. It loads <data> into the file <file_name>. <data> is in 488.2 block format. <file_name> is string data. The query form is MMEMory:DATA? <file_name> with the response being the associated <data> in block format.
Initial S/W Revision	Prior to A.02.00

Mass Storage Make Directory (Remote Command Only)

Key path	SCPI Only
Remote Command	:MMEMory:MDIRectory <directory_name>
Notes	The string must be a valid logical path. Creates a new directory. The <directory_name> parameter specifies the name to be created. This command will generate an “access denied” error if the new directory would be in a restricted folder (e.g., C:\Windows) and the current user does not have Power User or Administrator privileges.
Initial S/W Revision	Prior to A.02.00

Mass Storage Move (Remote Command Only)

Key path	SCPI Only
Remote Command	:MMEMory:MOVE <string>,<string>[,<string>,<string>]
Notes	The string must be a valid logical path. Moves an existing file to a new file or an existing directory to a new directory. Two forms of parameters are allowed. The first form has two parameters. In this form, the first parameter specifies the source, and the second parameter specifies the destination. The second form has four parameters. In this form, the first and third parameters specify the source.

	<p>The second and fourth parameters specify the directories. The first pair of parameters specifies the source. The second pair specifies the destination. An error is generated if the source doesn't exist or the destination file already exists.</p> <p>This command will generate an "access denied" error if the destination is a restricted folder (e.g., C:\Windows) and the current user does not have Power User or Administrator privileges.</p>
Initial S/W Revision	Prior to A.02.00

Mass Storage Remove Directory (Remote Command Only)

Key path	SCPI Only
Remote Command	:MMEMory:RDIRECTory <directory_name>
Notes	<p>The string must be a valid logical path.</p> <p>Removes a directory. The <directory_name> parameter specifies the directory name to be removed. All files and directories under the specified directory shall also be removed.</p> <p>This command will generate an "access denied" error if the folder is a restricted folder (e.g., C:\Windows) or is in a restricted folder and the current user does not have Power User or Administrator privileges.</p>
Initial S/W Revision	Prior to A.02.00

Data (Export)

Exporting a data file stores data from the current measurement to mass storage files. The Export Menu only contains data types that are supported by the current measurement.

Since the commonly exported data files are in .csv format, the data can be edited by you prior to importing. This allows you to export a data file, manipulate the data in Excel (the most common PC Application for manipulating .csv files) and then import it.

Selecting an Export Data menu key will not actually cause the exporting to occur, since the analyzer still needs to know where you wish to save the data. Pressing the Save As key in this menu brings up the Save As dialog and Save As menu that allows you to specify the destination file and directory. Once a filename has been selected or entered in the Open menu, the export will occur as soon as the Save key is pressed.

Key Path	Save
Mode	All
Notes	<p>The menu is built from whatever data types are available for the mode. So the key locations in the sub menu will vary.</p> <p>No SCPI command directly controls the Data Type that this key controls. The Data Type is included in the MMEM:STORe commands.</p>
Dependencies	If a file type is not used by a certain measurement, that type is grayed out for that measurement. The key for a file type will not show at all if there are no measurements in the Mode that support it.
Preset	Is not affected by a Preset or shutdown, but is reset during Restore Mode Defaults
Readback	The data type that is currently selected
Initial S/W Revision	Prior to A.02.00

Export Trace Data

Enables you to export trace data with (optional) associated headers. Selecting this key displays a menu that enables you to choose which Trace to save (default is the selected Trace) and whether or not to save headers with the data. The header information is used by the VXA application when saved trace data is recalled, and enables it to be displayed with the same formatting and scaling that it had when saved. If headers are not saved, the scaling and format are set to default values when the trace is recalled. After making these selections, press Save As... and use the file dialog to choose a file name and format for the saved data.

Trace data can be exported in several different formats. Text and comma-separated variable (CSV) formats are useful for viewing the data or importing it to a spreadsheet program. The other formats are binary and thus more compact. Trace data files can be recalled for viewing into other VXA, LTE, LTETDD, iDEN, or 89601 measurements.

Key Path	Save, Data (Export)
Mode	VSA, LTE, LTETDD, IDEN
Remote Command	:MMEMory:STORe:TRACe:DATA TRACE1 TRACE2 TRACE3 TRACE4 TRACE5 TRACE6, "<filename>"[,CSV TXT SDF MAT4 MAT HDF5 BIN[,OFF ON 0 1]]
Example	:MMEM:STOR:TRAC:DATA TRACE1, "TRC1.TXT", TXT, ON
Notes	<p>The Save As... dialog box has the following format options when you are saving trace data:</p> <ul style="list-style-type: none"> • CSV (Comma delimited) (*.csv) • SDF (Fast) (*.sdf;*.dat) • Text (Tab delimited) (*.txt) <p>File format saved depends on selection. The appropriate file extension is appended to the filename if it is not supplied by the user.</p> <p>If the SCPI command includes just a file name, the file format is determined by the filename extension, which must be one of the choices above. *.sdf or an unrecognized extension chooses the SDF fast format. If the optional file format enumerator is included in the command, then this determines the file format and the file extension is ignored. The optional binary parameter determines if file headers are saved. The default is ON. If file headers are not wanted, use the optional "OFF" parameter.</p> <p>The optional Boolean parameter determines whether headers are saved in the file. By default the headers are saved.</p> <p>If you are not licensed to save a particular file type, then error -203.9010 is returned. If an invalid file format is specified or the file cannot be saved successfully, then error -25x is returned. If the save is successful, then advisory 0.1500 is shown.</p>
State Saved	No
Readback	(Trace 1 Trace 2 Trace 3 Trace 4 Trace 5 Trace 6)(with without) headers

Trace 1

Selects the Trace 1 register as the destination for the imported data.

Key Path	Save, Data (Export), Trace
Mode	VSA, LTE, LTETDD, IDEN

Trace 2

Selects the Trace 2 register as the destination for the imported data.

Key Path	Save, Data (Export), Trace
Mode	VSA, LTE, LTETDD, IDEN

Trace 3

Selects the Trace 3 register as the destination for the imported data.

Key Path	Save, Data (Export), Trace
Mode	VSA, LTE, LTETDD, IDEN

Trace 4

Selects the Trace 4 register as the destination for the imported data.

Key Path	Save, Data (Export), Trace
Mode	VSA, LTE, LTETDD, IDEN

Trace 5

Selects the Trace 5 register as the destination for the imported data.

Key Path	Save, Data (Export), Trace
Mode	VSA, LTE, LTETDD, IDEN

Trace 6

Selects the Trace 6 register as the destination for the imported data.

Key Path	Save, Data (Export), Trace
Mode	VSA, LTE, LTETDD, IDEN

Include Header

Enables you to select whether or not the saved trace data includes header information describing scaling, formatting, etc.

Key Path	Save, Data (Export), Trace
Mode	VSA, LTE, LTETDD, IDEN
State Saved	No

Save As . . .

When you press “Save As”, the analyzer brings up a Windows dialog and a menu entitled “**Save As.**” This menu allows you to navigate to the various fields in the Windows dialog without using a keyboard or mouse. The Tab and Arrow keys can also be used for dialog navigation.

See ["To File . . ." on page 1211](#) in Save, State for a full description of this dialog and menu.

The default path for saving files is:

For all of the Trace Data Files:

My Documents\<<mode name>\data\traces

For all of the Limit Data Files:

My Documents\<<mode name>\data\limits

For all of the Measurement Results Data Files:

My Documents\<<mode name>\data\<<measurement name>\results

For all of the Capture Buffer Data Files:

My Documents\<<mode name>\data\captureBuffer

Key Path	Save, Data
Mode	All
Notes	The key location is mode-dependent and will vary. Brings up the Save As dialog for saving a <mode specific> Save Type. The save is performed immediately and does not wait until the measurement is complete.
Initial S/W Revision	Prior to A.02.00

Screen Image

Pressing Screen Image accesses a menu of functions that enable you to specify a format and location for the saved screen image. It brings up a menu that allows you to specify the color scheme of the Screen Image (Themes) or navigate to the Save As dialog to perform the actual save.

Screen Image files contain an exact representation of the analyzer display. They cannot be loaded back onto the analyzer, but they can be loaded into your PC for use in many popular applications.

10 iDEN Power Measurement
Save

The image to be saved is actually captured when the Save front panel key is pressed, and kept in temporary storage to be used if you ask for a Screen Image save. When the Screen Image key is pressed, a "thumbnail" of the captured image is displayed, as shown below:

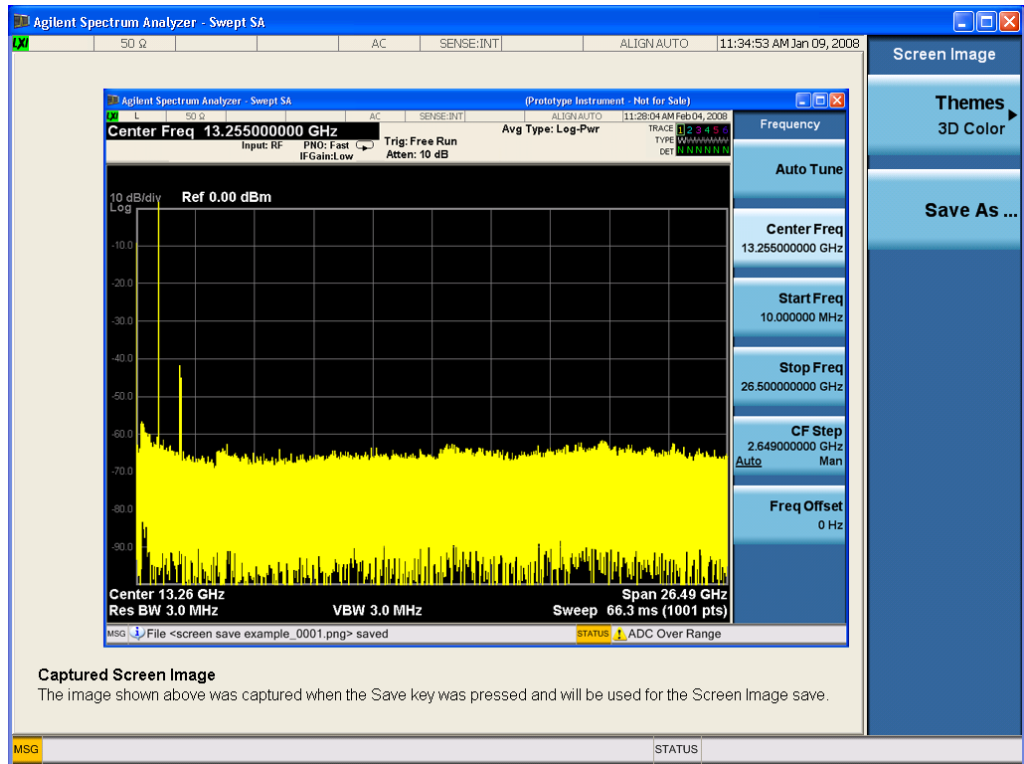

When you continue on into the Save As menu and complete the Screen Image save, the image depicted in the thumbnail is the one that gets saved, showing the menus that were on the screen before going into the Save menus. The save is performed immediately and does not wait until the measurement is complete.

After you have completed the save, the Quick Save front-panel key lets you quickly repeat the last save performed, using an auto-named file, with the current screen data.

NOTE For versions previous to A.01.55, if you initiate a screen image save by navigating through the Save menus, the image that is saved will contain the Save menu softkeys, not the menus and the active function that were on the screen when you first pressed the Save front panel key.

Key Path	Save
Mode	All
Remote Command	:MMEMory:STORe:SCReen <filename>
Example	:MMEM:STOR:SCR "myScreen.png" This stores the current screen image in the file MyScreenFile.png in the default directory.
Initial S/W Revision	Prior to A.02.00

Themes

Accesses a menu of functions that enable you to choose the theme to be used when saving the screen image.

The **Themes** option is the same as the **Themes** option under the **Display** and **Page Setup** dialogs. It allows you to choose between themes to be used when saving the screen image.

Key Path	Save, Screen Image
Remote Command	:MMEMory:STORe:SCReen:THEME TDColor TDMonochrome FCOlor FMONochrome :MMEMory:STORe:SCReen:THEMe?
Example	:MMEM:STOR:SCR:THEM TDM
Preset	3D Color; Is not part of Preset, but is reset by Restore Misc Defaults or Restore System Defaults All and survives subsequent running of the modes.
Readback	3D Color 3D Mono Flat Color Flat Mono
Backwards Compatibility Notes	In ESA and PSA we offer the choice of "Reverse Bitmap" or "Reverse Metafile" when saving screen images. This is much like the "Flat Color" theme available in X-Series. Also, if you selected Reverse Bitmap AND a black & white screen image, that would be much like "Flat Monochrome". In other words, each of the X-Series themes has a similar screen image type in ESA/PSA. But they are not identical.
Initial S/W Revision	Prior to A.02.00

3D Color

Selects a standard color theme with each object filled, shaded and colored as designed.

Key Path	Save, Screen Image, Themes
Example	MMEM:STOR:SCR:THEM TDC
Readback	3D Color
Initial S/W Revision	Prior to A.02.00

3D Monochrome

Selects a format that is like 3D color but shades of gray are used instead of colors.

Key Path	Save, Screen Image, Themes
Example	MMEM:STOR:SCR:THEM TDM
Readback	3D Mono
Initial S/W Revision	Prior to A.02.00

Flat Color

Selects a format that is best when the screen is to be printed on an ink printer.

Key Path	Save, Screen Image, Themes
Example	MMEM:STOR:SCR:THEM FCOL
Readback	Flat Color
Initial S/W Revision	Prior to A.02.00

Flat Monochrome

Selects a format that is like Flat Color. But only black is used (no colors, not even gray), and no fill.

Key Path	Save, Screen Image, Themes
Example	MMEM:STOR:SCR:THEM FMON
Readback	Flat Mono
Initial S/W Revision	Prior to A.02.00

Save As...

When you press "Save As", the analyzer brings up a Windows dialog and a menu entitled "**Save As.**" This menu allows you to navigate to the various fields in the Windows dialog without using a keyboard or mouse. The Tab and Arrow keys can also be used for dialog navigation.

See "[To File . . .](#)" on page 1211 in Save, State for a full description of this dialog and menu.

The default path for Screen Images is

My Documents\`<mode name>`\screen.

where `<mode name>` is the parameter used to select the mode with the INST:SEL command (for example, SA for the Spectrum Analyzer).

Key Path	Save, Screen Image
Notes	Brings up Save As dialog for saving a Screen Image Save Type
Initial S/W Revision	Prior to A.02.00

Single (Single Measurement/Sweep)

Sets the analyzer for Single measurement operation. The single/continuous state is Meas Global, so the setting will affect all the measurements. If you are Paused, pressing Single does a Resume.

See "[More Information](#)" on page 809

Key Path	Front-panel key
Example	:INIT:CONT OFF
Notes	See Cont key description.
Backwards Compatibility Notes	<p>For Spectrum Analysis mode in ESA and PSA, the Single hardkey and the INITiate:IMM switched from continuous measurement to single measurement and restarted sweeps and averages (displayed average count reset to 1), but did not restart Max Hold and Min Hold. In the X-Series, the Single hardkey and the INITiate:IMM command initiate a sweep/ measurement/ average sequence/hold sequence including MaxHold and MinHold.</p> <p>For Spectrum Analysis mode in ESA and PSA, the Single hardkey restarted the sweep regardless of whether or not you were in an active sweep or sweep sequence. In the X-Series, Restart does this but Single only restarts the sweep or sweep sequence if you are in the idle state.</p> <p>INIT[:IMM] in ESA & PSA Spectrum Analysis Mode does an implied ABORT. In some other PSA Modes, INIT[:IMM] is ignored if not in the idle state. . The X-Series follows the ESA/PSA SA Mode model, which may cause some Modes to have compatibility problems.</p>
Initial S/W Revision	Prior to A.02.00

More Information

See "[Restart](#)" on page 1208 for details on the INIT:IMMEDIATE (Restart) function.

If you are already in single sweep, the INIT:CONT OFF command has no effect.

If you are already in Single Sweep, then pressing the Single key in the middle of a sweep does not restart the sweep or sequence. Similarly, pressing the Single key does not restart the sweep or sequence if the sweep is not in the idle state (for example, if you are taking a very slow sweep, or the analyzer is waiting for a trigger). Instead, it results in a message. "Already in Single, press Restart to initiate a new sweep or sequence". Even though pressing the Single key in the middle of a sweep does not restart the sweep, sending INIT:IMMEDIATE does reset it.

To take one more sweep without resetting the average count, increment the average count by 1, by pressing the step up key while **Average/Hold Number** is the active function, or sending the remote command CALC:AVER:TCON UP.

Source

There is no Source control functionality for this measurement. When this key is pressed, the screen either displays a blank menu, or the previously-selected menu remains unchanged.

Key Path	Front-panel key
----------	-----------------

SPAN X Scale

Displays a menu for selecting measurement span and also for scaling of the X axis.

Key Path	Front Panel
Mode	VSA, LTE, LTETDD, IDEN, LTEAFDD,LTEATDD
Initial S/W Revision	Prior to A.02.00
Modified at S/W Revision	A.02.00

Span

Controls the frequency span of the measurement. This is the full span that is displayed on a spectrum display. The actual IF bandwidth that the time record detects is 1.28 times the span. See "[FREQ Channel](#)" on page 1134 for details on how this interacts with start, stop, and center frequencies.

Key Path	SPAN X Scale
Mode	VSA, IDEN
Remote Command	[:SENSe] :FREQuency:SPAN <freq> [:SENSe] :FREQuency:SPAN?
Example	FREQ:SPAN 10 MHZ FREQ:SPAN?
Couplings	Start Freq and Stop Freq. See " FREQ Channel " on page 1134 for details.
Preset	depends on span option
State Saved	Saved in instrument state.
Min	2 Hz
Max	depends on span option
Initial S/W Revision	Prior to A.02.00
Modified at S/W Revision	A.02.00

Full Span

Changes the span to the maximum available. The center frequency remains unchanged, regardless of whether the Frequency Annotation property is Start/Stop or Center/Span.

Key Path	SPAN X Scale
Mode	VSA, IDEN
Remote Command	[:SENSe] :FREQuency:SPAN:FULL
Example	FREQ:SPAN:FULL
Notes	The label on the softkey gives the full span available, which depends on span option.
Couplings	Changes span to maximum while keeping the center frequency constant. Start and Stop frequency

	are affected
Readback Text	[25 MHz] If playing back a recording, list the recorded bandwidth here
Initial S/W Revision	Prior to A.02.00
Modified at S/W Revision	A.02.00

Signal Track

Attempts to keep the largest magnitude signal in the center of the screen for a spectrum display. It is the equivalent of manually doing a single acquisition, doing a marker to peak search on a spectrum trace, then copying the marker position to the center frequency and repeating. (It is not necessary to be viewing a spectrum display for this function to work.)

Key Path	SPAN X Scale
Mode	VSA
Remote Command	[:SENSe] :VECTor ADEMod : FREQuency : CENTer : TRACk OFF ON 0 1 [:SENSe] :VECTor ADEMod : FREQuency : CENTer : TRACk ?
Example	VECT:FREQ:CEN:TRAC ON VECT:FREQ:CEN:TRAC?
Couplings	Unavailable if averaging is turned on.
Preset	0
State Saved	Saved in instrument state.
Range	On Off
Initial S/W Revision	Prior to A.02.00

Select Trace

Displays a menu that enables you to select the trace that is to receive the action of all successive trace-specific commands like scaling, assignment of trace data, and so on. The selected trace is outlined in green and is always visible. While the Select Trace menu is showing, each visible trace is annotated in the middle with its own trace number, as shown in the following figure. The trace number annotations disappear when any other menu is showing.

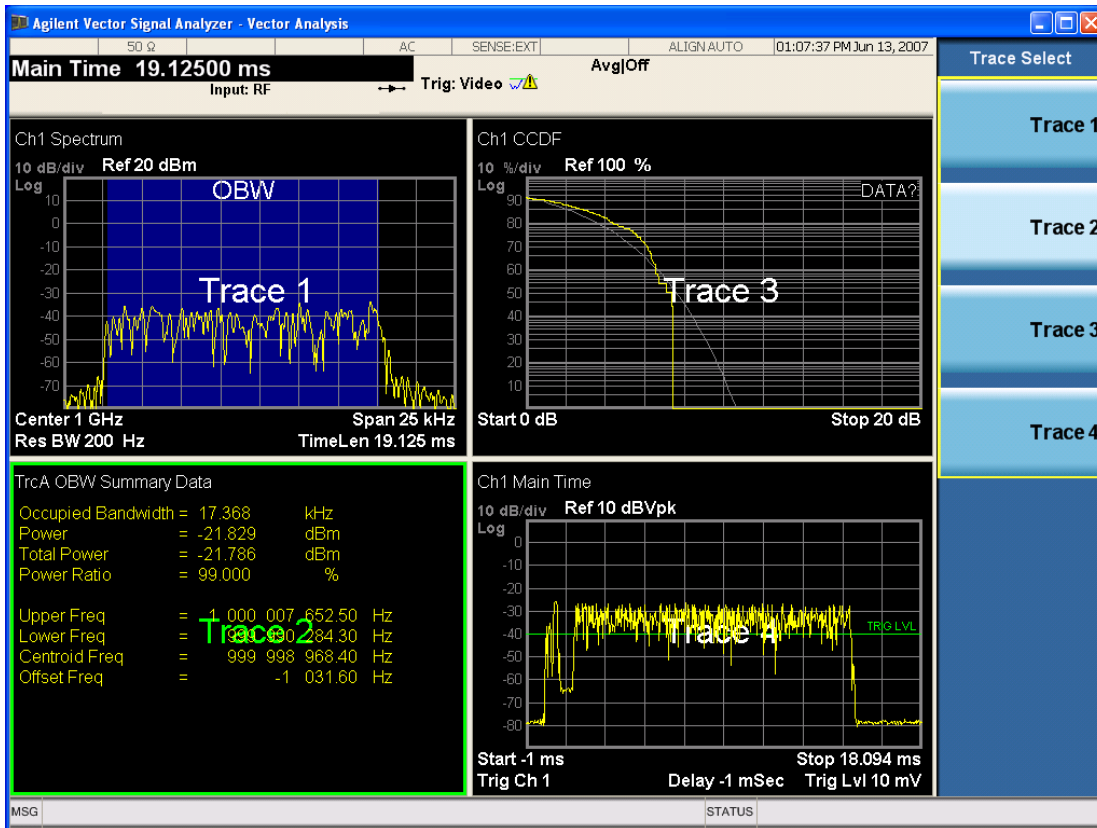

Grid 2x2 layout showing trace annotations when Trace Select dialog is active

This softkey also appears in the X and Y scaling menus. There is only one selected trace at any time. If you change which trace is selected, that change is reflected in this softkey/menu wherever it appears. Other ways to select a trace include use of the Next Window key, clicking within a trace window with a mouse cursor, and issuing a trace-specific SCPI command.

There is no SCPI command associated with this function. Instead, SCPI commands that are trace-specific have an index on the TRACe node that determines the selected trace. Using such a command has the side effect that the trace addressed by the SCPI command becomes the selected trace for any front panel interaction.

Key Path	Trace/Detector or Span X Scale or AMPTD Y Scale
Mode	VSA, LTE, LTETDD, IDEN, LTEAFDD, LTEATDD
Notes	No SCPI. Front panel only.
Couplings	Affects any trace-specific commands
Range	Trace 1 Trace 2 Trace 3 Trace 4 Trace 5 Trace 6
Readback Text	Trace <n>
Initial S/W Revision	Prior to A.02.00
Modified at S/W Revision	A.02.00

X Scale

Causes the trace to display all available trace data when set to Auto. (Exception: the display of the outer edges of a spectrum that can contain aliases is governed by the All Frequency Points function setting – see below.) The annotation is updated as needed, but the X Reference Value and X Width keys are grayed out and not updated. When this function is set to Man, the X Reference Value and X Width softkey readbacks are updated with the current values.

Key Path	SPAN X Scale
Mode	VSA, LTE, LTETDD, IDEN, LTEAFDD, LTEATDD
Measurement	<meas>:=VECTor ADEMod DDEMod W11A W11B EVM IPOWER IDEMod MOTotalk
Remote Command	:DISPlay:<meas>:TRACe [1] 2 ...4:X[:SCALE]:COUPle OFF ON 0 1 :DISPlay:<meas>:TRACe [1] 2 ...4:X[:SCALE]:COUPle?
Example	:DISP:VECT:TRAC1:X:COUP ON DISP:VECT:TRAC1:X:COUP?
Couplings	Forced to Man if X Reference Value or X Width is set by user.
Preset	1
State Saved	Saved in instrument state.
Range	Auto Man
Initial S/W Revision	Prior to A.02.00
Modified at S/W Revision	A.02.00

X Reference Value

Controls the X value of the selected trace at the chosen X Reference Position (see below). It has no effect on hardware input settings.

Key Path	SPAN X Scale
Mode	VSA, LTE, LTETDD, IDEN, LTEAFDD, LTEATDD
Measurement	<meas>:=VECTor ADEMod DDEMod W11A W11B EVM IPOWER IDEMod MOTotalk
Remote Command	:DISPlay:<meas>:TRACe [1] 2 ...4:X[:SCALE]:RLEVel <real> :DISPlay:<meas>:TRACe [1] 2 ...4:X[:SCALE]:RLEVel?
Example	DISP:VECT:TRAC:X:RLEV 1e9 DISP:VECT:TRAC:X:RLEV?
Couplings	If X Scale is set to Auto, the X Reference Value is determined by the trace data and this key is grayed out.
Preset	Depends on trace
State Saved	Saved in instrument state.
Min	-9.9E+37
Max	9.9E+37
Initial S/W Revision	Prior to A.02.00
Modified at S/W Revision	A.02.00

X Width

Sets the width of the X axis that is displayed for the selected trace. The X width can be set less than the Span for frequency-domain traces, enabling you to zoom in on just a portion of the measured values. Likewise, it can be less than time span covered by time-domain data. This plus the X Reference Value and X Reference Position control the range of X values that can be displayed on a trace. For example, if the X Reference position is Center, the X Reference value is 1 GHz and the X Width is 20 MHz.

Key Path	SPAN X Scale
Mode	VSA, LTE, LTETDD, IDEN, LTEAFDD,LTEATDD
Measurement	<meas>:=VECTor ADEMod DDEMod W11A W11B EVM IPOWER IDEMod MOTotalk
Remote Command	:DISPlay:<meas>:TRACe [1] 2 ...4:X[:SCALE]:SPAN <real> :DISPlay:<meas>:TRACe [1] 2 ...4:X[:SCALE]:SPAN?
Example	DISP:VECT:TRAC:X:SPAN 10e6 DISP:VECT:TRAC:X:SPAN?
Couplings	If X Scale is set to Auto, the X Width is determined by the trace data and this key is grayed out.
Preset	Depends on trace
State Saved	Saved in instrument state.
Min	-9.9E+37
Max	9.9E+37
Initial S/W Revision	Prior to A.02.00
Modified at S/W Revision	A.02.00

X Reference Position

Determines the position from which the X scaling is calculated for the selected trace. It can be set to the left side, center, or right side of the grid.

Key Path	SPAN X Scale
Mode	VSA, LTE, LTETDD, IDEN, LTEAFDD,LTEATDD
Measurement	<meas>:=VECTor ADEMod DDEMod W11A W11B EVM IPOWER IDEMod MOTotalk
Remote Command	:DISPlay:<meas>:TRACe [1] 2 ...4:X[:SCALE]:RPOSition LEFT CENTer RIGHT :DISPlay:<meas>:TRACe [1] 2 ...4:X[:SCALE]:RPOSition?
Example	DISP:VECT:TRAC1:X:RPOS LEFT DISP:VECT:TRAC1:X:RPOS?
Couplings	If X Scale is set to Auto, the X Reference Position is determined by the trace data and this key is grayed out.
Preset	CENT
State Saved	Saved in instrument state.

Range	Left Ctr Right
Initial S/W Revision	Prior to A.02.00
Modified at S/W Revision	A.02.00

Freq Annotation

Controls how Spectrum and PSD traces are annotated when their X Scale is set to Auto. If Freq Annotation is set to Center/Span, the X-axes on windows containing frequency domain traces are labeled with the center frequency on the left and the span on the right. If the Freq Annotation is set to Start/Stop, then the start and stop frequencies appear in place of center and span. If the X Scale is manual, then this annotation style does not apply.

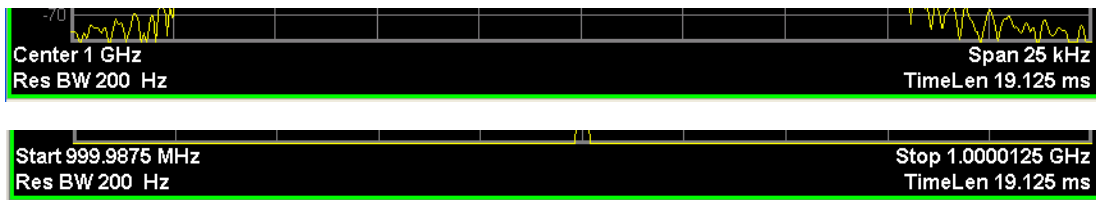

Key Path	SPAN X Scale
Mode	VSA, LTE, LTETDD, IDEN, LTEAFDD,LTEATDD
Measurement	<meas>:=VECTor ADEMod DDEMod W11A W11B EVM IPOWER IDEMod MOTotalk
Remote Command	:DISPlay:<meas>:FANNotation CSPan SSTop :DISPlay:<meas>:FANNotation?
Example	DISP:VECT:FANN CSP DISP:VECT:FANN?
Preset	CSP
State Saved	Saved in instrument state.
Range	Center/Span Start/Stop
Initial S/W Revision	Prior to A.02.00
Modified at S/W Revision	A.02.00

All Frequency Points

Spectrum trace data (and PSD) are based on the FFT algorithm. By default, the outer edges of the spectrum are not displayed because they can show spurious results that are aliases of real signals that are not completely filtered out by the IF filter. For example, in the case of a 1024 point FFT only 801 points are displayed. If you want to view the additional FFT points at the edges of spectral displays, turn this function on. It is global to all traces, not specific to a single trace.

Key Path	SPAN X Scale
----------	--------------

Mode	VSA, LTE, LTETDD, IDEN, LTEAFDD, LTEATDD
Measurement	<meas>:=VECTor ADEMod DDEMod W11A W11B EVM IPOWER IDEMod MOTotalk
Remote Command	:DISPlay:<meas>:AFPpoints OFF ON 0 1 :DISPlay:<meas>:AFPpoints?
Example	DISP:VECT:AFP ON DISP:VECT:AFP?
Notes	ac
Couplings	Only applies if trace is showing Spectrum or PSD results.
Preset	OFF
State Saved	Saved in instrument state.
Range	On Off
Initial S/W Revision	Prior to A.02.00
Modified at S/W Revision	A.02.00

Copy X Scale

Copies the following X scaling information from the selected trace to another:

- X reference Position
- X Reference Value
- X Width
- X Scale (Auto/Man)

This is a front-panel only function.

Key Path	SPAN X Scale, X Axis Scaling
Mode	VSA, LTE, LTETDD, IDEN, LTEAFDD, LTEATDD
Initial S/W Revision	Prior to A.02.00
Modified at S/W Revision	A.02.00

Sweep/Control

Displays a menu that enables you to control time-related measurement parameters and to pause or resume the measurement.

Key Path	Front Panel
Mode	VSA
Initial S/W Revision	A.01060 or later

Main Time

Enables you to control the length of the overall time record used in the measurement. Note that the Gate function (see "[Gate](#)" on page 819) enables you to analyze only a portion of the displayed Main Time. Time length and Res BW are related by the following equation:

$$\text{Res BW} = \text{ENBW} / T$$

where ENBW is the normalized effective noise bandwidth of the Window (see the FFT Window topic under BW for more details) and T is the time record length (in seconds).

Therefore, if you change Main Time, the Resolution bandwidth must also change, and vice versa.

Time record size (in sample points) can vary between 16 points and the full FFT size used for spectrum calculations. The FFT size is indirectly chosen by setting Freq Points (see "[Freq Points](#)" on page 821) and is equal to $(\text{Freq Points} - 1) * 1.28$.

Main Time length (in seconds) is the time record size times the sample period. The sample period for the Main Time result is $1 / (1.28 * \text{Span})$.

Limits:

The maximum Main Time length is:

$$\text{Max FFT size} / (1.28 * \text{Span}) = (409600) / \text{Span} \text{ if Freq points state parameter is set to Auto}$$

$$\text{FFT size} / (1.28 * \text{Span}) = (\text{Freq Points} - 1) / \text{Span} \text{ if Freq points parameter is manually set}$$

Note that the minimum Res BW is related to maximum Main Time length.

The minimum Main Time length is

$$16 \text{ points} / (1.28 * \text{Span}) = 12.5 / \text{Span}$$

See "[Res BW](#)" on page 706 and "[Res BW Coupling](#)" on page 707 for details on couplings that can change Main Time length due to Res BW changes.

Key Path	Sweep Control
Mode	VSA
Measurement	<meas>:=VECTOR ADEMod
Remote Command	[:SENSE] : <meas> : SWEep:TIME <time> [:SENSE] : <meas> : SWEep:TIME?

Example	VECT:SWE:TIME 3 MS VECT:SWE:TIME?
Notes	This key is not available in measurements other than Vector or Analog Demod. The annotation is shown, however. In other measurements the time length is determined by number of symbols.
Couplings	Affected by Res BW, Span, Freq Points, and Window. See " Res BW " on page 706 and " Res BW Coupling " on page 707 for details.
Preset	12.75e-6
State Saved	Saved in instrument state.
Min	-9.9e37
Max	9.9e37
Initial S/W Revision	A.01060 or later

Pause / Resume

Pauses or resumes acquisition at the end of the current time record acquisition.

Key Path	Sweep Control
Mode	VSA
Initial S/W Revision	A.01060 or later

Gate

Accesses a menu of time gating control functions. Time gating lets you isolate a portion of a Main Time record to be used for downstream spectrum and statistical analysis (instead of the whole time record). The gate position can be changed during a stopped measurement and the instantaneous gate time and spectrum traces update immediately. Averages are restarted when gate properties change. The windowing function used in gated measurements is the same as non-gated measurements.

Key Path	Sweep Control
Mode	VSA
Initial S/W Revision	A.01060 or later

Gate

Turns time gating on or off.

Key Path	Sweep/Control
Mode	VSA
Measurement	<meas>:=VECTor ADEMod
Remote Command	[:SENSe] :<meas>:SWEep:EGATe:STATe OFF ON 0 1

	<code>[:SENSe] : <meas> : SWEEp : EGATe : STATe ?</code>
Example	VECT:SWE:EGAT:STAT ON VECT:SWE:EGAT:STAT?
Preset	0
State Saved	Saved in instrument state.
Initial S/W Revision	A.01060 or later

Gate Length

Adjusts the time between the beginning and the end of the gate.

Key Path	Sweep/Control
Mode	VSA
Measurement	<code><meas> := VECTor ADEMod</code>
Remote Command	<code>[:SENSe] : <meas> : SWEEp : EGATe [:SPAN] <time></code> <code>[:SENSe] : <meas> : SWEEp : EGATe [:SPAN] ?</code>
Example	VECT:SWE:EGAT 2 MS VECT:SWE:EGAT?
Couplings	Gate length and delay are limited so that the gate always falls within the current time record. If the time record length decreases, the gate delay is limited first, then the gate length.
Preset	1.28125e-6
State Saved	Saved in instrument state.
Min	16 time samples
Max	Time record length
Initial S/W Revision	A.01060 or later

Gate Delay

Adjusts the time between the start of the time record and the beginning of the gate.

Key Path	Sweep/Control
Mode	VSA
Measurement	<code><meas> := VECTor ADEMod</code>
Remote Command	<code>[:SENSe] : <meas> : SWEEp : EGATe : DELay <time></code> <code>[:SENSe] : <meas> : SWEEp : EGATe : DELay ?</code>
Example	VECT:SWE:EGAT:DEL 500 US VECT:SWE:EGAT:DEL?
Couplings	Gate length and delay are limited so that the gate always falls within the current time record. If the time record length decreases, the gate delay is limited first, then the gate length.

Preset	0
State Saved	Saved in instrument state.
Min	0
Max	Time record length – gate length
Initial S/W Revision	A.01060 or later

Freq Points

Enables you to manually enter the number of displayed frequency points. By default, the analyzer chooses the number of Freq Points displayed in Spectrum or PSD displays, depending on the Res BW or Main Time length chosen. Auto mode is recommended. The number of Freq Points is related to the number of FFT points used in spectrum calculations (which is always a power of 2).

$$\text{Freq Points} = (\text{FFT points}) / 1.28 + 1$$

Note that if All Frequency Points is turned on for a selected trace, then all computed FFT points are shown. (See ["All Frequency Points" on page 1232.](#))

Key Path	Sweep Control
Mode	VSA
Measurement	<meas>:=VECTor ADEMod
Remote Command	[:SENSe]:<meas>:SWEep:POINts <integer> [:SENSe]:<meas>:SWEep:POINts? [:SENSe]:<meas>:SWEep:POINts:AUTO OFF ON 0 1 [:SENSe]:<meas>:SWEep:POINts:AUTO?
Example	VECT:SWE:POIN 801 VECT:SWE:POIN? VECT:SWE:POIN:AUTO ON VECT:SWE:POIN:AUTO?
Notes	Keyboard entry or setting this by SCPI forces state to manual. Any entry other than a valid value is rounded up to the next available value (or limited to the maximum). This key is not shown in measurements other than Vector or Analog Demod.
Couplings	See Res BW Coupling section
Preset	801 1
State Saved	Saved in instrument state.
Range	51 101 201 401 801 1601 3201 6401 12801 25601 51201 102401 204801 409601
Initial S/W Revision	A.01060 or later

10 iDEN Power Measurement
System

System

See ["System" on page 242](#)

Trace/Detector

Accesses a menu enabling you to select various trace parameters for all VSA based measurements.

Key Path	Front Panel
Mode	VSA, LTE, LTETDD, IDEN, LTEAFDD, LTEATDD
Initial S/W Revision	Prior to A.02.00
Modified at S/W Revision	A.02.00

Select Trace

Displays a menu that enables you to select the trace that is to receive the action of all successive trace-specific commands like scaling, assignment of trace data, and so on. The selected trace is outlined in green and is always visible. While the Select Trace menu is showing, each visible trace is annotated in the middle with its own trace number, as shown in the following figure. The trace number annotations disappear when any other menu is showing.

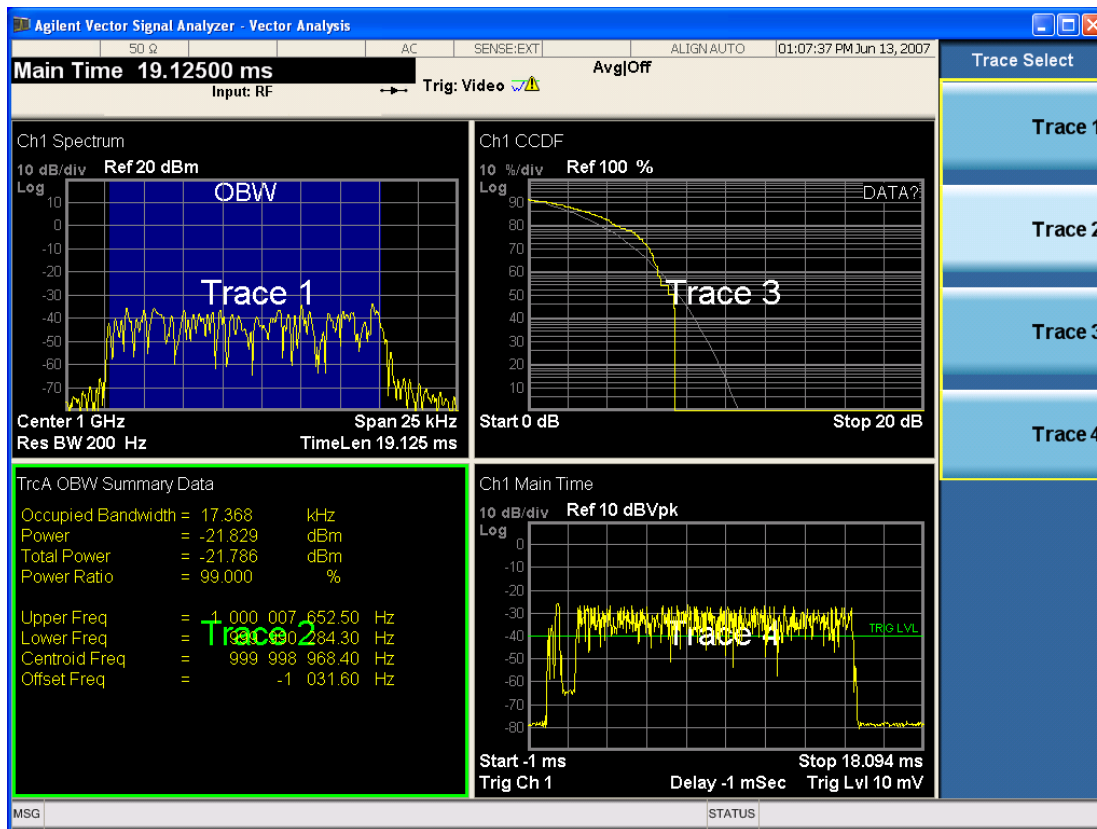

Grid 2x2 layout showing trace annotations when Trace Select dialog is active

This softkey also appears in the X and Y scaling menus. There is only one selected trace at any time. If you change which trace is selected, that change is reflected in this softkey/menu wherever it appears. Other

ways to select a trace include use of the Next Window key, clicking within a trace window with a mouse cursor, and issuing a trace-specific SCPI command.

There is no SCPI command associated with this function. Instead, SCPI commands that are trace-specific have an index on the TRACe node that determines the selected trace. Using such a command has the side effect that the trace addressed by the SCPI command becomes the selected trace for any front panel interaction.

Key Path	Trace/Detector or Span X Scale or AMPTD Y Scale
Mode	VSA, LTE, LTETDD, IDEN,LTEAFDD,LTEATDD
Notes	No SCPI. Front panel only.
Couplings	Affects any trace-specific commands
Range	Trace 1 Trace 2 Trace 3 Trace 4 Trace 5 Trace 6
Readback Text	Trace <n>
Initial S/W Revision	Prior to A.02.00
Modified at S/W Revision	A.02.00

Data

Accesses a menu of Trace data choices for the selected trace. A VSA Measurement can produce many different results from a single scan; either a graph or a table. In addition, the ACP and OBW functions can be enabled on any trace, showing a frequency-domain result, and produce Summary table results. Any of these results can be assigned to a trace and displayed.

The following Trace Data types are available in all measurements:

Soft Key Name	SCPI string form
No Data	"No Data"
Spectrum	"Spectrum1"
Inst Spectrum	"Inst Spectrum1"
Raw Main Time	"Raw Main Time1"
OBW Summary for Trace 1	"Obw Summary Trc1"
OBW Summary for Trace 2	"Obw Summary Trc2"
OBW Summary for Trace 3	"Obw Summary Trc3"
OBW Summary for Trace 4	"Obw Summary Trc4"
ACP Summary for Trace 1	"Acp Summary Trc1"
ACP Summary for Trace 2	" Acp Summary Trc2"
ACP Summary for Trace 3	" Acp Summary Trc3"
ACP Summary for Trace 4	" Acp Summary Trc4"

The following Data Registers are also available for display if there are traces stored in them (see ["Copy to Data Register" on page 1252](#) and ["Import Trace Data" on page 1205](#): "D1", "D2", "D3", "D4", "D5", and "D6")

Key Path	Trace/Detector, Data
Mode	VSA, LTE, LTETDD, IDEN
Measurement	<meas>:=VECTor ADEMod DDEMod W11A W11B EVM IPOWER IDEMod MOTotalk
Remote Command	:DISPlay:<meas>:TRACe[1] 2 ...4:FEED <string> :DISPlay:<meas>:TRACe[1] 2 ...4:FEED?
Example	DISP:VECT:TRAC1:FEED "Spectrum1" DISP:VECT:TRAC1:FEED?
Preset	Depends on trace number and measurement
State Saved	Saved in instrument state.
Initial S/W Revision	Prior to A.02.00
Modified at S/W Revision	A.02.00

The complete list of Trace Data names that can be assigned using the above SCPI can be obtained by using the following SCPI query:

Mode	VSA, LTE, LTETDD, IDEN
Measurement	<meas>:=VECTor ADEMod DDEMod W11A W11B EVM IPOWER IDEMod MOTotalk
Remote Command	:CALCulate:<meas>:DATA[1] 2 ...4:NAMes?
Example	CALC:VECT:DATA:NAM?
Notes	Query only. Returns a comma-separated list of trace data names that can be used in DISPlay:<meas>:TRACe[1]]2 3 4:FEED "<string>". The list is the same regardless of trace index.
Initial S/W Revision	Prior to A.02.00
Modified at S/W Revision	A.02.00

Channel 1

Accesses time domain and frequency domain measurement results and enables you to assign them to traces.

Key Path	Trace/Detector, Data,
Mode	VSA

Spectrum

Displays the Spectrum data result in the selected trace.

The Spectrum trace data displays the spectrum of the selected channel. The spectrum computation displays frequency on the x axis and amplitude on the y axis.

The following formulas show how the analyzer calculates spectrum information:

Key: F = Fast Fourier Transform (FFT)
 AF = Averaged spectra
 AT = Averaged time
 f = Instantaneous spectra
 t = Instantaneous time
 W = Windowing function
 n = Average number
 c = Correction trace (from calibration)
 $f[n]^2 = f[n] \times \text{conjugate}(f[n])$
 × = multiplication

No Average	$f = F(W \times t) \times c$
rms Average	$AF[n] = \frac{1}{n} \text{sum} (f [n]^2)$
rms Exponential AF[n]Average	$AF[n] = \frac{1}{n} (f [n]^2) + \frac{n-1}{n} AF[n-1]$ where $1 \leq n \leq \text{number of averages}$
Continuous Peak Hold Average	$AF[n] = \text{MAX} (AF[n-1], f [n]^2)$
Time Average	$AF[n] = F\{W \times AT[n]\} \times c$ where $AT[n] = \frac{1}{n} \text{sum} (t [n])$
Time Exponential Average	$AF[n] = F\{W \times AT[n]\} \times c$ where $AT[n] = \frac{1}{n} t [n] + \frac{n-1}{n} AT[n-1]$ and $1 \leq n \leq \text{number of averages}$

As shown in the previous formulas, the spectrum can be a linear spectrum or power spectrum as follows:

If the average is...	then the spectrum is...
Averaging OFF	Linear
rms Average	Power
Continuous peak	Power

Linear spectra contain magnitude and phase (real and imaginary) information. Power spectra contain only magnitude (real) information. This occurs with rms averages, for instance, because the results of the FFT are squared. Remember that the FFT yields both real and imaginary information. When the analyzer squares the results of the FFT, the imaginary part becomes zero.

See also: ["Data" on page 1237](#)

Key Path	Trace/Detector, Data
Mode	VSA, LTE, LTETDD, IDEN
Initial S/W Revision	Prior to A.02.00
Modified at S/W Revision	A.02.00

Inst Spectrum

Displays the Inst Spectrum data result in the selected trace.

Inst Spectrum trace data displays the instantaneous spectrum for the selected input channel. Instantaneous spectrum is computed before data is averaged, which enables you see spectrum data before the data is averaged with other spectrum data.

NOTE Inst Spectrum is not available when analog or digital demodulation is selected.

The following block diagram shows where spectrum and instantaneous spectrum are created.

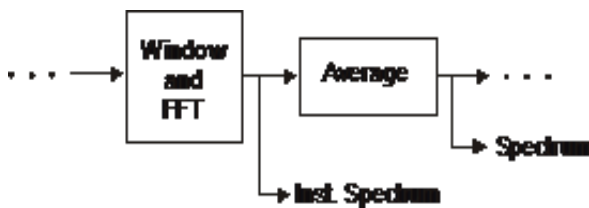

This measurement calculation is useful for these types of averaged measurements:

- rms
- rms exponential
- Continuous peak hold

If averaging is off, the spectrum and instantaneous spectrum display the same information.

See also: ["Data" on page 1237](#)

Key Path	Trace/Detector, Data
Mode	VSA, LTE, LTETDD, IDEN
Initial S/W Revision	Prior to A.02.00
Modified at S/W Revision	A.02.00

Main Time

Displays the Main Time data result in the selected trace.

Main Time versus Gate Time

The term is used to differentiate between the "main" time record and the "gate" time record when time gating is on.

A time record is the basic building block of the Fast Fourier Transform (FFT). The FFT takes the time-domain information in the time record and transforms it into the frequency domain.

When time gating is on, you can identify a portion of the main time-record to be used by the FFT. The term "main time-record" identifies the entire time record; the term "gate time-record" identifies the portion selected by the gate.

The following block diagram shows the blocks that create main time and gate time.

Note that the Analog Demodulation block is available only when analog demodulation is enabled.

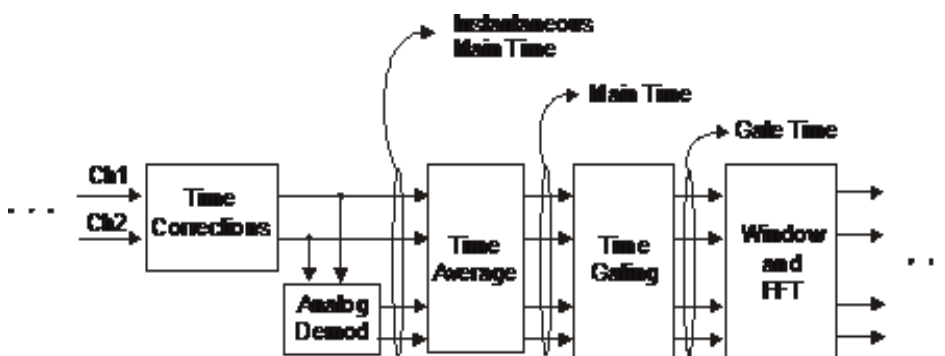

There are many reasons why you may want to view the main time record. Here are just a few:

- To verify that there is an input signal.
- To see the characteristics of the input signal.
- To help in manually setting the input range.

Time Records and Span

If you set the analyzer to full span, the time data you see is the actual input time-record. This is raw input data – the signal from which all subsequent measurements are based.

If you set the instrument to measure a specific bandwidth (something less than full span), the time data you see is the raw input data after it has been filtered (to provide alias protection) and decimated (to obtain the desired span).

Time Records and Averaging

If rms or continuous peak-hold averaging is on, the analyzer displays the most recent time record. The analyzer does not show an averaged time waveform, because all averaging is done after the time data has been transformed to the frequency domain.

If time averaging is on, the analyzer displays the averaged time-record. In other words, the time record has been averaged with previous time records.

How the Analyzer Displays the Time Record

It is important to remember that although the time record looks like an oscilloscope display, the analyzer is not a digital oscilloscope.

The time record represents samples of a waveform. The samples have enough information to accurately reconstruct the input signal – but the human eye may not properly perform the reconstruction. In fact, for frequencies that are higher than about ten percent of the frequency span, there is noticeable visible distortion.

The analyzer's anti-alias filters cause some ringing or distortion of square waves or transients when viewed in the time domain.

See also: ["Data" on page 1237](#)

Key Path	Trace/Detector, Data
Mode	VSA
Initial S/W Revision	Prior to A.02.00
Modified at S/W Revision	A.02.00

Gate Time

Displays the Gate Time data result in the selected trace.

Gate Time trace data displays the selected channel's gate time-record.

Note that Gate Time is not available when analog or digital demodulation is selected.

If time gating is on, Gate Time displays the portion of the main time-record marked by the gate – this portion is called the gate record (if time gating is off, Gate Time displays nothing).

As a reminder, if time gating is on, the Fast Fourier Transform (FFT) uses the gate time-record, which can be all or a portion of the main time-record, to compute frequency information such as spectrum, frequency response, coherence, and correlation.

See also: ["Data" on page 1237](#)

Key Path	Trace/Detector, Data
Mode	VSA, LTE, LTETDD, IDEN
Initial S/W Revision	Prior to A.02.00
Modified at S/W Revision	A.02.00

Inst Main Time

Displays the Inst Main Time data result in the selected trace.

Inst Main Time trace data displays the instantaneous time-domain data for the selected input channel.

Note that Inst Main Time is not available when analog or digital demodulation is selected.

The following block diagram shows how Instantaneous Main Time is derived.

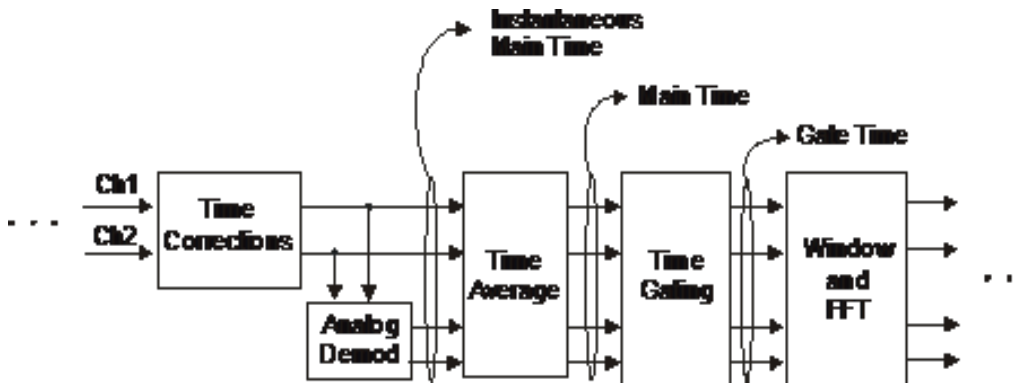

Notice that Instantaneous Main Time shows you time data before time averaging. If time averaging is off, Instantaneous Main Time is identical to Main Time.

See also: ["Data" on page 1237](#)

Key Path	Trace/Detector, Data
Mode	VSA, LTE, LTETDD, IDEN
Initial S/W Revision	Prior to A.02.00
Modified at S/W Revision	A.02.00

Raw Main Time

Displays the Raw Main Time data result in the selected trace.

Raw Main Time is the raw data read from the input hardware or playback file. It is similar to Main Time with the following exceptions:

- This data has not had time corrections applied, so it displays a “CAL?” trace indicator.
- The data has not gone through the analyzer's software resampling filters, so is generally not sampled at the specified sample rate.
- The data has a wider bandwidth than the measurement span would indicate.

Raw Main Time data is useful in the following situations:

- When you use Channel, IF Magnitude, or Magnitude trigger types, the input hardware detects the trigger, so Raw Main Time sometimes gives a better indication of what caused the trigger.
- When you play back a recording, the Raw Main Time measurement data enables you to see the samples that are saved in the recording, with no filtering applied or settling removed.

See also: ["Data" on page 1237](#)

Key Path	Trace/Detector, Data
Mode	VSA, LTE, LTETDD, IDEN
Initial S/W Revision	Prior to A.02.00
Modified at S/W Revision	A.02.00

PSD (Power Spectral Density)

Displays the Power Spectral Density (PSD) data result in the selected trace. PSD trace data displays the power spectral density (PSD) of the selected channel. The definition of PSD yields y-axis units of V_{pk}^2/Hz and x-axis units of frequency:

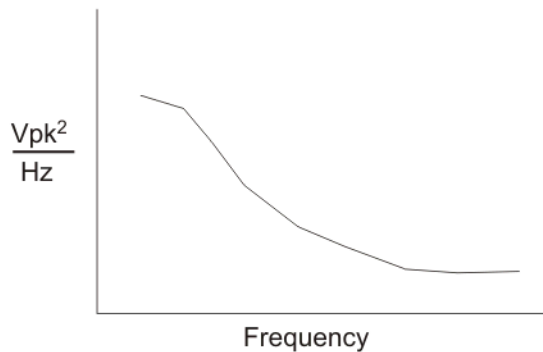

PSD is used for noise measurements. It shows the power density of a signal as a function of frequency. In general, noise can have any arbitrary frequency content, resulting in a variety of possible PSD shapes. Noise that has equal power density at all frequencies is called white noise:

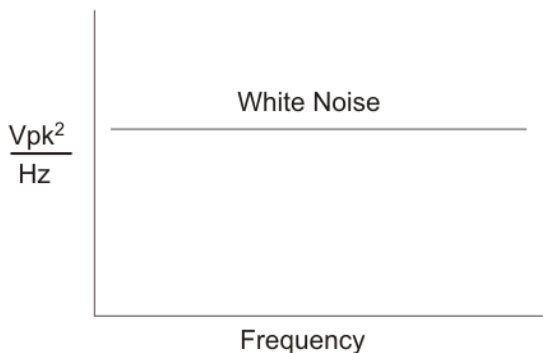

The definition of PSD is power per Hertz. In other words, power is divided by the measurement bandwidth, which in this analyzer is the resolution bandwidth (ResBW), as follows:

$$\frac{V_{pk}^2}{RBW} = \frac{V_{pk}^2}{Hz}$$

Units of V_{pk}^2/Hz assumes the signal is referenced to 1 ohm. That is, because no resistance is specified, the signal is interpreted as a voltage across a one ohm resistor with the power in the resistor equal to V_{pk}^2 .

You can select units of dBm/Hz to take into account the analyzer's input impedance. PSD defaults to these units. The analyzer calculates dBm/Hz as follows:

$$\frac{\text{dBm}}{\text{Hz}} = 10 \log \left[\frac{\frac{V_{\text{rms}}^2}{Z} \times 1000}{\text{RBW}} \right]$$

where:

RBW = resolution bandwidth (Hz)

Z = input impedance

See also: ["Data" on page 1237](#)

Key Path	Trace/Detector, Data
Mode	VSA, LTE, LTETDD, IDEN
Initial S/W Revision	Prior to A.02.00
Modified at S/W Revision	A.02.00

Auto Correlation

Displays the autocorrelation data result in the selected trace. Auto Correlation trace data displays the autocorrelation for the selected input channel. Autocorrelation is a form of correlation, a measure of the similarity between two signals.

Note that Auto Correlation is not available when digital demodulation is selected.

Tips

- Use ac coupling only. Correlation measurements are disturbed by dc offsets in the signal.
- Some types of averaging can be useful – rms averaging does not affect correlation measurements, but you can use time averaging to reduce noise, if you can provide a consistent trigger. However, averaging is usually unnecessary to make good correlation measurements.
- Use appropriate triggering and trigger delays. This is especially true for time averaging.
- Use a random noise source for delay measurements. Correlation measurements provide the ability to resolve time differences between waveforms that appear to be random.
- Waveforms on the correlation trace may not appear as they do in the time trace. This is particularly noticeable when you are using correlation to extract synchronous signals from noise. The different shape of some waveforms is a direct result of the mathematical definition of correlation. For example, a correlated square wave appears as a triangle wave. It's important to remember that the period of the waveform is preserved even if the correlation waveform looks different.
- To avoid wrap-around effects, correlation produces a time record one-half the length of the measurement time-record.

Theory of Operation

Autocorrelation is a form of correlation, a measure of the similarity between two signals. Correlation is performed by multiplying two signals together at each instant in time and summing all the products. If the signals are identical, every product is positive and the resulting sum is large.

If, however, the two signals are dissimilar, then some of the products are positive and some are negative. In this case, the final sum is smaller because the products tend to cancel.

Autocorrelation performs a time-shifted, "averaged" correlation on a single signal. The signal is correlated with time-shifted versions of itself. Furthermore, the products from each time-shift are averaged by dividing each final sum by the number of products contributing to it.

$$R_{xx}(\tau) = \lim_{T \rightarrow \infty} \frac{1}{T} \int_{-\infty}^{\infty} \text{conj}[x(t)] \times x(t + \tau) dt$$

where: R_{xx} = autocorrelation function

τ = amount of time shift

∞ = infinity

$x(\tau)$ = signal to be correlated

intgrl = integration

conj = conjugation

T = time

\times = multiplication

That is, the autocorrelation function is found by taking a signal, multiplying it by the same signal displaced (τ) units in time, and averaging the product over all time.

Duality With the Power Spectrum

For simplicity and speed, this analyzer performs the autocorrelation operation by taking advantage of its duality with the power spectrum:

$$R_{xx}(\tau) \leftrightarrow G_{xx}(f)$$

Thus,

$$\begin{aligned} R_{xx}(\tau) &= I_{\text{FFT}} [G_{xx}(f)] \\ &= I_{\text{FFT}} [\text{conj}(F[r \times t]) \times F(t)] \end{aligned}$$

where: I_{FFT} = Inverse FFT

conj = conjugation

\times = multiplication

r = half size of the rectangular window

(thus the result is $\frac{1}{2}$ the original time length)

When to use Auto Correlation

Auto correlation is useful for detecting echoes in a signal. For random noise, an echo appears as an impulse – if there is more than one echo, you can see multiple peaks on the auto correlation trace. Keep in mind that an echo appears as an impulse only if the delayed signal has not been filtered. The impulse broadens as the original random noise signal is filtered – in fact, the width of each peak is inversely proportional to the bandwidth of the signal.

To determine the time delay (in seconds) of an echo, you can move the marker to the peak of the echo. Note that there is always a correlated peak at zero lag – this peak marks the original excitation signal. Any other peaks let you know that the excitation signal also appeared at another time relative to the original signal. The amplitude value at the zero lag point is the total power in the time record.

This function is also useful for isolating low-level periodic signals from noise. A sine wave signal shows up as a sine wave in auto correlation. A square wave signal shows up as a triangular wave of the same frequency.

Auto correlation is a single-channel measurement. If you have the original signal on one channel and the delayed version on another, use cross correlation.

Auto Correlation and Averaging

The following formulas show how the analyzer calculates auto correlation for different averaging functions:

Key: F = Fast Fourier Transform (FFT)

AC = Averaged correlation

AT = Averaged time

t = Instantaneous time

c = Instantaneous correlation

r = 1/2 width rectangular window

× = multiplication

n = Average number

No Average $c = | \text{conj} (F(r \times t)) \times F [t] |$

rms Average $c = | \text{conj} (F(r \times t)) \times F [t] |$

rms Expon. $c = | \text{conj} (F(r \times t)) \times F [t] |$

Average

Continuous

Peak Hold $c = | \text{conj} (F(r \times t)) \times F [t] |$

Average

Time $AC [n] = | \text{conj} (F(r \times AT [n])) \times F (AT [n]) |$

Average

where: $AT [n] = \frac{1}{n} \text{sum} (t [n])$

Time

Expon. $AC[n] = | \text{conj} (F(r \times AT [n])) \times F (AT [n]) |$

Average

$$\text{where: } AT [n] = \frac{1}{n} t [n] + \frac{n-1}{n} AT [n-1]$$

and: $1 < n < \text{number of averages}$

See also: ["Data" on page 1237](#)

Key Path	Trace/Detector, Data
Mode	VSA
Initial S/W Revision	Prior to A.02.00

ACP (Adjacent Channel Power)

Provides access to ACP summary table data. These results are available when the ACP function is enabled for a particular trace, and it enables you to display the results in another trace.

Key Path	Trace/Detector, Data
Mode	VSA, LTE, LTETDD, IDEN
Initial S/W Revision	Prior to A.02.00
Modified at S/W Revision	A.02.00

ACP Summary for Trace 1

Displays results for the ACP function on Trace 1 in the selected trace.

See also: ["ACP Setup" on page 1255](#)

Key Path	Trace/Detector, Data, ACP
Mode	VSA, LTE, LTETDD, IDEN
Initial S/W Revision	Prior to A.02.00
Modified at S/W Revision	A.02.00

ACP Summary for Trace 2

Displays results for the ACP function on Trace 2 in the selected trace.

See also: ["ACP Setup" on page 1255](#)

Key Path	Trace/Detector, Data, ACP
Mode	VSA, LTE, LTETDD, IDEN
Initial S/W Revision	Prior to A.02.00
Modified at S/W Revision	A.02.00

ACP Summary for Trace 3

Displays results for the ACP function on Trace 3 in the selected trace.

See also: ["ACP Setup" on page 1255](#)

Key Path	Trace/Detector, Data, ACP
Mode	VSA, LTE, LTETDD, IDEN
Initial S/W Revision	Prior to A.02.00
Modified at S/W Revision	A.02.00

ACP Summary for Trace 4

Displays results for the ACP function on Trace 4 in the selected trace.

See also: ["ACP Setup" on page 1255](#)

Key Path	Trace/Detector, Data, ACP
Mode	VSA, LTE, LTETDD, IDEN
Initial S/W Revision	Prior to A.02.00
Modified at S/W Revision	A.02.00

ACP Summary for Trace 5

Displays results for the ACP function on Trace 5 in the selected trace.

See also: ["ACP Setup" on page 1255](#)

Key Path	Trace/Detector, Data, ACP
Mode	VSA

ACP Summary for Trace 6

Displays results for the ACP function on Trace 6 in the selected trace.

See also: ["ACP Setup" on page 1255](#)

Key Path	Trace/Detector, Data, ACP
Mode	VSA

OBW (Occupied Bandwidth)

Provides access to OBW summary table data. These results are available if the OBW function is enabled for a particular trace, and enable you to display the results in another trace.

Key Path	Trace/Detector, Data
Mode	VSA, LTE, LTETDD, IDEN
Initial S/W Revision	Prior to A.02.00
Modified at S/W Revision	A.02.00

OBW Summary for Trace 1

Displays results for the OBW function on Trace 1 in the selected trace.

See also: ["OBW Setup \(Occupied Bandwidth\)" on page 1263](#)

Key Path	Trace/Detector, Data, OBW
Mode	VSA, LTE, LTETDD, IDEN
Initial S/W Revision	Prior to A.02.00
Modified at S/W Revision	A.02.00

OBW Summary for Trace 2

Displays results for the OBW function on Trace 2 in the selected trace.

See also: ["OBW Setup \(Occupied Bandwidth\)" on page 1263](#)

Key Path	Trace/Detector, Data, OBW
Mode	VSA, LTE, LTETDD, IDEN
Initial S/W Revision	Prior to A.02.00
Modified at S/W Revision	A.02.00

OBW Summary for Trace 3

Displays results for the OBW function on Trace 3 in the selected trace.

See also: ["OBW Setup \(Occupied Bandwidth\)" on page 1263](#)

Key Path	Trace/Detector, Data, OBW
Mode	VSA, LTE, LTETDD, IDEN
Initial S/W Revision	Prior to A.02.00
Modified at S/W Revision	A.02.00

OBW Summary for Trace 4

Displays results for the OBW function on Trace 4 in the selected trace.

See also: ["OBW Setup \(Occupied Bandwidth\)" on page 1263](#)

Key Path	Trace/Detector, Data, OBW
Mode	VSA, LTE, LTETDD, IDEN
Initial S/W Revision	Prior to A.02.00
Modified at S/W Revision	A.02.00

OBW Summary for Trace 5

Displays results for the OBW function on Trace 5 in the selected trace.

See also: ["OBW Setup \(Occupied Bandwidth\)" on page 1263](#)

Key Path	Trace/Detector, Data, OBW
Mode	VSA

OBW Summary for Trace 6

Displays results for the OBW function on Trace 6 in the selected trace.

See also: ["OBW Setup \(Occupied Bandwidth\)" on page 1263](#)

Key Path	Trace/Detector, Data, OBW
Mode	VSA

Register

Accesses a menu that enables you to select registers for assignment of trace data.

Key Path	Trace/Detector, Data
Mode	VSA, LTE, LTETDD, IDEN
Initial S/W Revision	Prior to A.02.00
Modified at S/W Revision	A.02.00

Data 1

Select register 1 for assignment of trace data.

Key Path	Trace/Detector, Data, Register
Mode	VSA, LTE, LTETDD, IDEN
Initial S/W Revision	Prior to A.02.00
Modified at S/W Revision	A.02.00

Data 2

Selects register 2 for assignment of trace data.

Key Path	Trace/Detector, Data, Register
Mode	VSA, LTE, LTETDD, IDEN
Initial S/W Revision	Prior to A.02.00
Modified at S/W Revision	A.02.00

Data 3

Selects register 3 for assignment of trace data.

Key Path	Trace/Detector, Data, Register
Mode	VSA, LTE, LTETDD, IDEN
Initial S/W Revision	Prior to A.02.00
Modified at S/W Revision	A.02.00

Data 4

Selects register 4 for assignment of trace data.

Key Path	Trace/Detector, Data, Register
Mode	VSA, LTE, LTETDD, IDEN
Initial S/W Revision	Prior to A.02.00
Modified at S/W Revision	A.02.00

Data 5

Selects register 5 for assignment of trace data.

Key Path	Trace/Detector, Data, Register
Mode	VSA
Initial S/W Revision	Prior to A.02.00
Modified at S/W Revision	A.02.00

Data 6

Selects register 6 for assignment of trace data.

Key Path	Trace/Detector, Data, Register
Mode	VSA
Initial S/W Revision	Prior to A.02.00
Modified at S/W Revision	A.02.00

No Data

Enables you to turn off trace computations. Measurement results are not computed unless assigned to a trace. No Data lets you increase measurement speed by turning off post-processing calculations that are not needed.

Key Path	Trace/Detector, Data
Mode	VSA, LTE, LTETDD, IDEN
Initial S/W Revision	Prior to A.02.00
Modified at S/W Revision	A.02.00

Format

Accesses a menu that enables you to choose the format of the selected trace. Any format can be assigned to any trace. For symbol tables and tabular data the format choice is ignored. If the data doesn't have defined symbol times, Constellation format is the same as I-Q, Eye formats are the same as Real or Imaginary, and Trellis format is the same as Unwrapped Phase.

The formats are:

Format name	Description
Log Mag (dB)	Data is converted to decibel units and shown on a linear Y axis
Linear Mag (Abs Value)	Magnitude of the data is shown on a linear Y axis
Real (I)	Real part of data is shown on a linear Y axis
Imaginary (Q)	Imaginary part of data is shown on linear Y axis
I-Q	Real part of data is shown on horizontal axis, imaginary part is shown on vertical axis, Independent variable (X axis) is normal to display
Constellation	Same as I-Q, but for data with symbols defined, only the symbol points are shown as dots with no connecting lines.
Wrap Phase	Phase of complex data, limited to ± 180 deg, is shown on Y axis
Unwrap Phase	Phase of complex data is shown "unwrapped", that is, without discontinuities. Not limited to ± 180 degrees.
I-Eye	Real part of data is shown with X axis segmented (generally into 2 symbol segments) and each segment is overlaid to show signal crossings at symbol boundaries
Q-Eye	Same as I-eye but imaginary part of data is shown

Trellis	Same as I-eye but uses unwrapped phase of data
Group Delay	Useful for frequency response displays. Shows the derivative of phase response with respect to frequency.
Log Mag (Linear Unit)	Displays data with a logarithmic Y axis, but marker read outs are in linear magnitude units.

Key Path	Trace/Detector, Format
Mode	VSA, LTE, LTETDD, IDEN
Measurement	<meas>:=VECTor ADEMod DDEMod W11A W11B EVM IPOWER IDEMod MOTotalk
Remote Command	:DISPlay:<meas>:TRACe[1] 2 ...4:FORMat MLOG MLINear REAL IMAGinary VECTor CONS PHASE UPHase IEYE QEYE TRELLis GDElay MLGLinear :DISPlay:<meas>:TRACe[1] 2 ...4:FORMat?
Example	DISP:DDEM:TRAC2:FORM MLIN DISP:DDEM:TRAC2:FORM?
Preset	Depends on trace and measurement
State Saved	Saved in instrument state.
Range	Log Mag (dB) Linear Mag (Abs Value) Real (I) (Lin) Imaginary (Q) (Lin) I-Q Constellation Wrap Phase Unwrap Phase I-Eye Q-Eye Trellis-Eye Group Delay Log Mag (Linear Unit)
Readback Text	Log Mag (dB) Linear Mag Real (I) Imaginary (Q) I-Q Constellation Wrap Phase Unwrap Phase I-Eye Q-Eye Trellis-Eye Group Delay Log Mag
Initial S/W Revision	Prior to A.02.00
Modified at S/W Revision	A.02.00

Digital Demod Trace Setup

Accesses a menu of settings that control certain elements of displays of digitally demodulated trace data.

Key Path	Trace/Detector
Mode	VSA, LTE, LTETDD, IDEN
Initial S/W Revision	Prior to A.02.00
Modified at S/W Revision	A.02.00

Symbol Shape

Enables you to display dots, bars, or nothing (none) at symbol locations (if the trace contains demodulated time-domain data) for all time-domain displays except IQ diagrams. This key enables you to select the symbol shape for the selected trace.

If you select bars, vertical lines (bars) are drawn from the baseline to the symbol location on the trace. The baseline is 0 for all traces that have coordinates other than log (dB). The baseline is the bottom of the trace box for traces that have log (dB) coordinates.

With IQ diagrams, displaying vertical bars is meaningless. Therefore, selecting bars displays dots in IQ diagrams.

With constellation diagrams, selecting none is the same as selecting bars – you cannot turn off the dots in a constellation diagram.

Key Path	Trace/Detector, Digital Demod Trace Setup
Mode	VSA, LTE, LTETDD, IDEN
Measurement	<meas>:=VECTor ADEMod DDEMod W11A W11B EVM IPOWER IDEMod MOTotalk
Remote Command	:DISPlay:<meas>:TRACe [1] 2 . . . 4 :DDEMod:SYMBol BARS DOTS OFF :DISPlay:<meas>:TRACe [1] 2 . . . 4 :DDEMod:SYMBol ?
Example	DISP:DDEM:TRAC2:DDEM:SYMB DOTS DISP:DDEM:TRAC2:DDEM:SYMB ?
Preset	BARS
State Saved	Saved in instrument state.
Range	Bars Dots None
Initial S/W Revision	Prior to A.02.00
Modified at S/W Revision	A.02.00

Ideal State Shape

Enables you to choose between a cross, circle, or none to represent the ideal state on the selected trace. Digital Demodulation shows you the location of all ideal symbol states in an I-Q or constellation diagram.

Key Path	Trace/Detector, Digital Demod Trace Setup
Mode	VSA, LTE, LTETDD, IDEN
Measurement	<meas>:=VECTor ADEMod DDEMod W11A W11B EVM IPOWER IDEMod MOTotalk
Remote Command	:DISPlay:<meas>:TRACe [1] 2 . . . 4 :DDEMod:SYMBol:SHAPE CIRCle CROSS OFF :DISPlay:<meas>:TRACe [1] 2 . . . 4 :DDEMod:SYMBol:SHAPE ?
Example	DISP:DDEM:TRAC2:DDEM:SYMB:SHAP CIRC DISP:DDEM:TRAC2:DDEM:SYMB:SHAP ?
Preset	CIRC
State Saved	Saved in instrument state.
Range	Circle Cross None
Initial S/W Revision	Prior to A.02.00
Modified at S/W Revision	A.02.00

Ideal State Size

Determines the ideal state size, as a percentage of the maximum ideal state distance from the origin (the same way Error Vector Magnitude is defined). Ideal states are shown as circles or crosses in Vector and constellation diagrams, as determined by the Ideal State Shape setting.

The ideal state is where symbols occur if your signal is without error. Showing the ideal states gives a visual indication of the quality of your signal.

You can use this feature to determine if symbols have an EVM above a specified Value. For example, to see if any symbols have an EVM greater than 10%, set the state size to 10% and select Circle as the shape. Any symbols that fall outside of the circle (other than SYNC or PILOT symbols) have an EVM greater than 10%.

Key Path	Trace/Detector, Digital Demod Trace Setup
Mode	VSA, LTE, LTETDD, IDEN
Measurement	<meas>:=VECTor ADEMod DDEMod W11A W11B EVM IPOWER IDEMod MOTotalk
Remote Command	:DISPlay:<meas>:TRACe[1] 2 ...4:DDEMod:SYMBol:SIZE <real> :DISPlay:<meas>:TRACe[1] 2 ...4:DDEMod:SYMBol:SIZE?
Example	DISP:DDEM:TRAC2:DDEM:SYMB:SIZE 10 DISP:DDEM:TRAC2:DDEM:SYMB:SIZE?
Notes	Parameter is interpreted as a percent, e.g., if you want the ideal size to be 10% send 10, not 0.1
Preset	5
State Saved	Saved in instrument state.
Min	0.1
Max	50
Initial S/W Revision	Prior to A.02.00
Modified at S/W Revision	A.02.00

Symbol Table Format

Enables you to choose the format in which symbol table data is displayed, when the modulation format encodes 4 or more bits per symbol. You can choose binary or hexadecimal. Binary symbol data is padded with leading zeros to make a multiple of 4 bits before conversion to hexadecimal. For example, for 16 QAM format, each 4-bit symbol is displayed as 2 hex digits.

Binary Format: The symbol data bit format is binary and each character represents a binary digit. The number to the left of each row indicates the bit offset of the first bit in the row.

Hexadecimal Format: The symbol data bit format is hexadecimal and each character represents a hexadecimal digit. The number to the left of each row indicate the symbol offset of the first symbol in the row.

NOTE

There must be at least 4 bits/symbol to use the hexadecimal format, that is, symbols that have less than 4 bits/symbol are only displayed in binary format regardless of the Symbol Table Format setting.

This parameter is valid only when:

- The active trace is a symbol table, and
- The current demodulation format supports hexadecimal, the demodulation format's bits/symbol is equal to or greater than four.

Key Path	Trace/Detector, Digital Demod Trace Setup
Mode	VSA, LTE, LTETDD, IDEN
Measurement	<meas>:=VECTor ADEMod DDEMod W11A W11B EVM IPOWER IDEMod MOTotalk
Remote Command	:DISPlay:<meas>:TRACe [1] 2 . . . 4 :DDEMod:SYMBol:FORMat HEXadecimal BINary :DISPlay:<meas>:TRACe [1] 2 . . . 4 :DDEMod:SYMBol:FORMat?
Example	DISP:DDEM:TRAC2:DDEM:SYMB:FORM BIN DISP:DDEM:TRAC2:DDEM:SYMB:FORM?
Preset	HEX
Range	Hex Binary
Initial S/W Revision	Prior to A.02.00
Modified at S/W Revision	A.02.00

Time Unit

Enables you to select the time units that are applied to x-axis annotations and marker readouts for the selected trace, whenever it is assigned data with (demodulation) symbol information. The available measurement units are sym (symbols) or sec (seconds).

Key Path	Trace/Detector, Digital Demod Trace Setup
Mode	VSA, LTE, LTETDD, IDEN
Measurement	<meas>:=VECTor ADEMod DDEMod W11A W11B EVM IPOWER IDEMod MOTotalk
Remote Command	:DISPlay:<meas>:TRACe [1] 2 . . . 4 :DDEMod:UNIT:TIME SEC SYMBol :DISPlay:<meas>:TRACe [1] 2 . . . 4 :DDEMod:UNIT:TIME?
Example	DISP:VECT:TRAC2:DDEM:UNIT:TIME SYMB DISP:VECT:TRAC2:DDEM:UNIT:TIME?
Preset	SYMB
State Saved	Saved in instrument state.
Range	sym sec
Initial S/W Revision	Prior to A.02.00
Modified at S/W Revision	A.02.00

Freq Unit

Enables you to select the frequency units that are applied to x-axis annotations and marker readouts for the selected trace, whenever it is assigned data with (demodulation) carrier information. The available

measurement units are carrier or Hz.

Key Path	Trace/Detector, Digital Demod Trace Setup
Mode	VSA, LTE, LTETDD, IDEN
Measurement	<meas>:=VECTor ADEMod DDEMod W11A W11B EVM IPOWER IDEMod MOTotalk
Remote Command	:DISPlay:<meas>:TRACe [1] 2 . . . 4 :DDEMod:UNIT:FREQuency CARRier HZ :DISPlay:<meas>:TRACe [1] 2 . . . 4 :DDEMod:UNIT:FREQuency?
Example	DISP:VECT:TRAC2:DDEM:UNIT:FREQ CARR DISP:VECT:TRAC2:DDEM:UNIT:FREQ?
Preset	CARR
State Saved	Saved in instrument state.
Range	carrier Hz
Initial S/W Revision	Prior to A.02.00
Modified at S/W Revision	A.02.00

Eye Length

Controls how wide (in symbol periods) the eye and trellis diagrams are, for the selected trace.

Key Path	Trace/Detector, Digital Demod Trace Setup
Mode	VSA, LTE, LTETDD, IDEN
Measurement	<meas>:=VECTor ADEMod DDEMod W11A W11B EVM IPOWER IDEMod MOTotalk
Remote Command	:DISPlay:<meas>:TRACe [1] 2 . . . 4 :DDEMod:EYE:COUNT <real> :DISPlay:<meas>:TRACe [1] 2 . . . 4 :DDEMod:EYE:COUNT?
Example	DISP:DDEM:TRAC2:DDEM:EYE:COUN 3 DISP:DDEM:TRAC2:DDEM:EYE:COUN?
Preset	2
State Saved	Saved in instrument state.
Min	0.1
Max	40
Initial S/W Revision	Prior to A.02.00
Modified at S/W Revision	A.02.00

Avg Line

Controls whether or not the average line is visible on certain demodulation analysis traces such as Error Vector Time and Error Vector Spectrum in Digital Demod measurements. These traces have 2-dimensional domains; typically subcarriers (frequency) and symbol times. Since the result can only be shown with one of these dimensions on the x-axis, the other dimension is placed on the z-axis. Since all the z-axis values

are overlapped, an average is calculated for all z values at each x value and the average is normally displayed as a line in front of trace. The average line display can be turned on or off using this control.

Key Path	Trace/Detector, Digital Demod Trace Setup
Mode	VSA, LTE, LTETDD, IDEN
Measurement	<meas>:=VECTor ADEMod DDEMod W11A W11B EVM IPOWER IDEMod MOTotalk
Remote Command	:DISPlay:<meas>:TRACe [1] 2 ...4:DDEMod:ALINe OFF ON 0 1 :DISPlay:<meas>:TRACe [1] 2 ...4:DDEMod:ALIN?
Example	DISP:W11A:TRAC:DDEM:ALIN OFF
Preset	1
State Saved	Saved in instrument state.
Initial S/W Revision	A.03.00 or later

Copy to Data Register

Accesses a menu of immediate execute keys, each of which copies the selected trace to a particular data register. Data registers can be displayed in any trace. They are measurement global, so you can copy data to a register while in the Digital Demod measurement and view it later while in the Vector measurement. Data registers are cleared when the VSA Application is exited and reentered, but not when you change Modes and return.

Key Path	Trace/Detector
Mode	VSA, LTE, LTETDD, IDEN
Measurement	<meas>:=VECTor ADEMod DDEMod W11A W11B EVM IPOWER IDEMod MOTotalk
Remote Command	:DISPlay:<meas>:TRACe [1] 2 ...4:COpy D1 D2 D3 D4 D5 D6
Example	DISP:VECT:TRAC:COpy D1
Readback Text	Last: <date_time> Empty
Initial S/W Revision	Prior to A.02.00
Modified at S/W Revision	A.02.00

The following SCPI provides means to determine if a Data Register is empty, and to erase the data from any or all Data Registers.

Mode	VSA, LTE, LTETDD, IDEN
Remote Command	:CALCulate:DATA:REGister [1] 2 ...6:EMPTy?
Example	:CALC:DATA:REG2:EMPT?
Notes	Query only: returns 1 if a Data Register has no trace data assigned to it.
Initial S/W Revision	Prior to A.02.00
Modified at S/W Revision	A.02.00

Mode	VSA, LTE, LTETDD, IDEN
Remote Command	:CALCulate:DATA:REGister[1] 2 ...6:REMove
Example	:CALC:DATA:REG2:REM
Notes	Removes trace data assigned to specified Data Register.
Couplings	If Data Register is assigned to a trace, the trace data is changed to No Data
Initial S/W Revision	Prior to A.02.00
Modified at S/W Revision	A.02.00

Mode	VSA, LTE, LTETDD, IDEN
Remote Command	:CALCulate:DATA:REGister:ALL:REMove
Example	:CALC:DATA:REG:ALL:REM
Notes	Removes trace data assigned to all Data Registers.
Couplings	If Data Register is assigned to a trace, the trace data is changed to No Data
Initial S/W Revision	Prior to A.02.00
Modified at S/W Revision	A.02.00

Phase/Delay Properties

Accesses a menu of properties that affect the selected trace when displayed using phase or delay formats.

Key Path	Trace/Detector
Mode	VSA, LTE, LTETDD, IDEN
Initial S/W Revision	Prior to A.02.00
Modified at S/W Revision	A.02.00

Phase/Trellis Offset

Only used if the trace format is Wrap Phase, Unwrap Phase, or Trellis. For Unwrap Phase or Trellis traces, the phase offset value is added to the existing phase at each point. For example, if you are viewing an Unwrapped Phase trace, setting the Phase/Trellis Offset to 5 degrees moves the entire trace up 5 degrees (and changes the value displayed by a marker by the same amount). For Wrap Phase traces the phase offset only affects the phase wrap point, not the underlying data. The point at which the phase wraps is 180 degrees plus the phase offset. For example, suppose you have a marker on a Wrap Phase trace whose phase offset is 0 and the marker is showing -3 degrees. The trace data is all confined within (-180, 180] degrees. If you then change the phase offset to 180 degrees, then the Wrap Phase trace shows values within the interval (0, 360] degrees and the marker value is displayed as 357 degrees, which is the wrapped equivalent of -3 degrees.

Key Path	Trace/Detector, Phase Delay Properties
----------	--

Mode	VSA, LTE, LTETDD, IDEN
Measurement	<meas>:=VECTor ADEMod DDEMod W11A W11B EVM IPOWER IDEMod MOTotalk
Remote Command	:DISPlay:<meas>:TRACe [1] 2 . . . 4 :FORMat:PHASe:OFFSet <real> :DISPlay:<meas>:TRACe [1] 2 . . . 4 :FORMat:PHASe:OFFSet?
Example	DISP:DDEM:TRAC3:FORM:PHAS:OFFS 31 DISP:DDEM:TRAC3:FORM:PHAS:OFFS?
Preset	0
State Saved	Saved in instrument state.
Min	-1E+8
Max	1E+8
Initial S/W Revision	Prior to A.02.00
Modified at S/W Revision	A.02.00

Unwrap Phase Ref

Enables you to designate the point (x-axis) value about which phase values are to be unwrapped. That is, the phase at the designated reference is within -180 to 180 degrees, and phase varies smoothly without jumps around that point.

Key Path	Trace/Detector, Phase Delay Properties
Mode	VSA, LTE, LTETDD, IDEN
Measurement	<meas>:=VECTor ADEMod DDEMod W11A W11B EVM IPOWER IDEMod MOTotalk
Remote Command	:DISPlay:<meas>:TRACe [1] 2 . . . 4 :FORMat:PHASe:UNWRap:REFErence <real> :DISPlay:<meas>:TRACe [1] 2 . . . 4 :FORMat:PHASe:UNWRap:REFErence?
Example	DISP:DDEM:TRAC3:FORM:PHAS:UNWR:REF 24.5E6 DISP:DDEM:TRAC3:FORM:PHAS:UNWR:REF?
Preset	0
State Saved	Saved in instrument state.
Min	-9.9e37
Max	9.9e37
Initial S/W Revision	Prior to A.02.00
Modified at S/W Revision	A.02.00

Group Delay Aperture

Used when the trace format is Group Delay. The aperture is specified as a percentage of the current frequency span for frequency-domain data. It is specified as a percentage of the time-record length for time-domain data.

When group delay is calculated for a given point (which can be a time- or frequency-domain point), the aperture is centered at that point. Larger apertures decrease resolution, but they increase the smoothing of the group-delay trace.

The point plotted for group delay is located between the data points used to calculate it. For example, in the frequency domain, the group delay for 100 Hz can be calculated by measuring the change in phase between 90 and 110 Hz. If you had specified a start frequency of 90 Hz, 100 Hz would be the first point with group delay data. This results in a trace that does not extend to the edges of the screen (more noticeable as the delay aperture increases).

Note that the smallest aperture that you can select depends on the number of frequency points. If you select an invalid aperture, the analyzer automatically selects the smallest valid aperture.

Key Path	Trace/Detector, Phase Delay Properties
Mode	VSA, LTE, LTETDD, IDEN
Measurement	<meas>:=VECTor ADEMod DDEMod W11A W11B EVM IPOWER IDEMod MOTotalk
Remote Command	:DISPlay:<meas>:TRACe[1] 2 ...4:FORMat:DELaY:APERture <real> :DISPlay:<meas>:TRACe[1] 2 ...4:FORMat:DELaY:APERture?
Example	DISP:DDEM:TRAC3:FORM:DEL:APER 1 DISP:DDEM:TRAC3:FORM:DEL:APER?
Notes	Parameter is interpreted as a percent, e.g., if you want the group delay aperture to be 1% send 1, not 0.01
Preset	0.5
State Saved	Saved in instrument state.
Min	0.00390625
Max	16
Initial S/W Revision	Prior to A.02.00
Modified at S/W Revision	A.02.00

ACP Setup

Accesses a menu of functions that enable you to define and turn on the ACP function on the selected trace. One reference channel and up to 5 offset frequencies can be defined, and ACP is calculated for bands both above and below the reference frequency for each offset.

The adjacent channel power (ACP) function calculates the power in a reference band of frequencies as well as bands of frequencies offset from the reference, and calculates the ratio of each offset band to the reference band power.

An ACP measurement can be defined for each trace, although it is only active on frequency-domain trace data. The reference and offset frequency bands defined by the ACP measurement are shown as gold bars overlaying the trace display. To see tabular data showing power and power ratio results, you can assign the ACP Summary (Trace n) to a different trace. For example, you can assign Spectrum data to trace 1, turn on and define an ACP measurement on trace 1, assign the ACP Summary (Trace 1) to trace 2, and use a 2x2 display to view both at the same time, as shown below.

10 iDEN Power Measurement
Trace/Detector

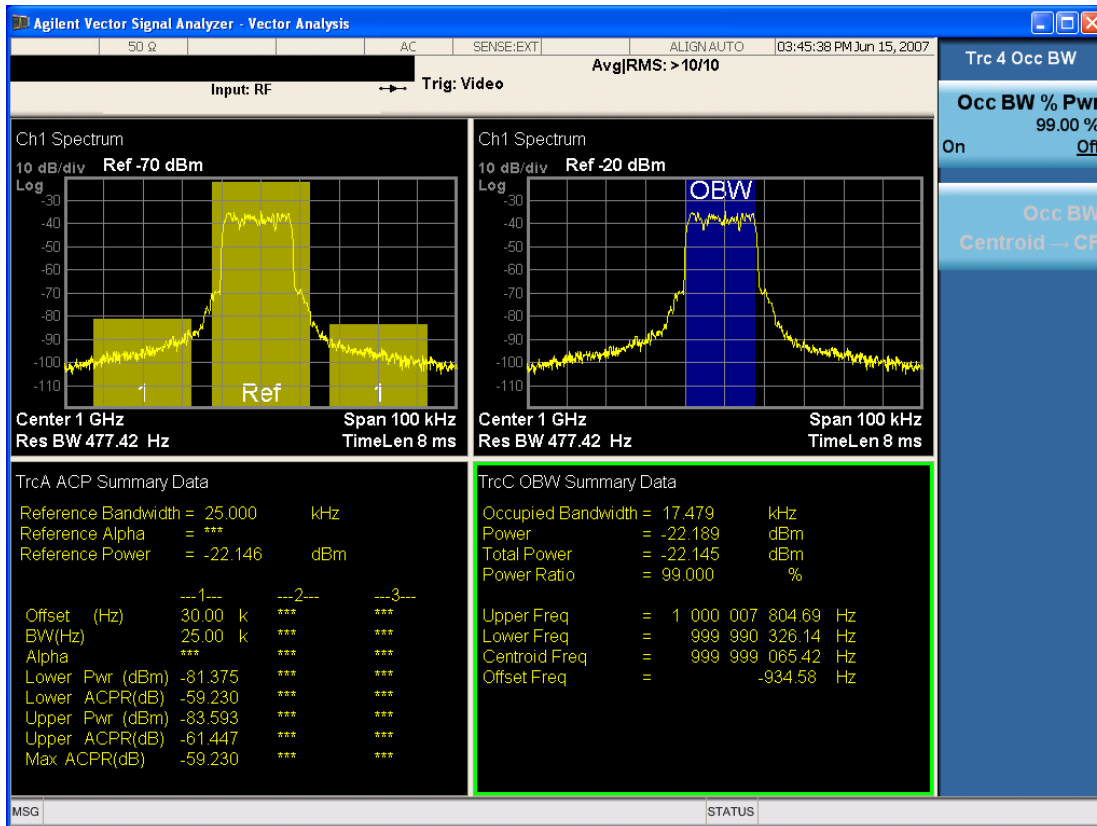

The summary data can be retrieved programmatically using FETCH? or the CALCulate:<meas>:DATA:TABLE commands. See "[CALCulate:DATA:TABLE commands](#)" on page 1291 for more details.

Key Path	Trace/Detector
Mode	VSA, LTE, LTETDD, IDEN
Readback Text	[On Off,]
Initial S/W Revision	Prior to A.02.00
Modified at S/W Revision	A.02.00

ACP On/Off

Turns the ACP function on or off for the selected trace.

Key Path	Trace/Detector, ACP
Mode	VSA, LTE, LTETDD, IDEN
Measurement	<meas>:=VECTor ADEMod DDEMod W11A W11B EVM IPOWER IDEMod MOTotalk
Remote Command	:CALCulate:<meas>:TRACE[1] 2 ...4:ACPpower:STATE OFF ON 0 1 :CALCulate:<meas>:TRACE[1] 2 ...4:ACPpower:STATE?
Example	CALC:VECT:TRAC1:ACP:STATE ON

	CALC:VECT:TRAC1:ACP:STATE?
Preset	0
State Saved	Saved in instrument state.
Initial S/W Revision	Prior to A.02.00
Modified at S/W Revision	A.02.00

Carrier Freq

Enables you to enter the carrier frequency of the reference channel for the ACP measurement. The carrier frequency is relative to the center frequency of the measurement. There is only one available reference carrier.

Key Path	Trace/Detector, ACP
Mode	VSA, LTE, LTETDD, IDEN
Measurement	<meas>:=VECTor ADEMod DDEMod W11A W11B EVM IPOWER IDEMod MOTotalk
Remote Command	:CALCulate:<meas>:TRACe[1] 2 ...4:ACPpower:CARRier:FREQuency <freq> :CALCulate:<meas>:TRACe[1] 2 ...4:ACPpower:CARRier:FREQuency?
Example	CALC:VECT:TRAC1:ACP:CARR:FREQ 100 KHZ CALC:VECT:TRAC1:ACP:CARR:FREQ?
Preset	0
State Saved	Saved in instrument state.
Min	-9.9e37
Max	9.9e37
Initial S/W Revision	Prior to A.02.00
Modified at S/W Revision	A.02.00

Carrier Meas Noise BW

Enables you to define the measurement noise bandwidth of the reference channel.

Key Path	Trace/Detector, ACP
Mode	VSA, LTE, LTETDD, IDEN
Measurement	<meas>:=VECTor ADEMod DDEMod W11A W11B EVM IPOWER IDEMod MOTotalk
Remote Command	:CALCulate:<meas>:TRACe[1] 2 ...4:ACPpower:CARRier:BANDwidth BWIDth:INTegration <bandwidth> :CALCulate:<meas>:TRACe[1] 2 ...4:ACPpower:CARRier:BANDwidth BWIDth:INTegration?
Example	CALC:VECT:TRAC1:ACP:CARR:BAND:INT 1 MHZ CALC:VECT:TRAC1:ACP:CARR:BAND:INT?

Preset	1000000
State Saved	Saved in instrument state.
Min	-9.9e37
Max	9.9e37
Initial S/W Revision	Prior to A.02.00
Modified at S/W Revision	A.02.00

Carrier RRC Weighting

Turns on or off RRC weighting for the reference (carrier) power measurement.

Key Path	Trace/Detector, ACP
Mode	VSA, LTE, LTETDD, IDEN
Measurement	<meas>:=VECTor ADEMod DDEMod W11A W11B EVM IPOWER IDEMod MOTotalk
Remote Command	:CALCulate:<meas>:TRACe[1] 2 ...4:ACP:Power:CARRier:FILTer:RRC:STATe OFF ON 0 1 :CALCulate:<meas>:TRACe[1] 2 ...4:ACP:Power:CARRier:FILTer:RRC:STATe?
Example	CALC:VECT:TRAC1:ACP:CARR:FILT:RRC:STAT ON CALC:VECT:TRAC1:ACP:CARR:FILT:RRC:STAT?
Preset	0
State Saved	Saved in instrument state.
Initial S/W Revision	Prior to A.02.00
Modified at S/W Revision	A.02.00

Carrier Filter Alpha

Enables you to adjust the alpha of the RRC filter for the reference (carrier) power measurement.

Key Path	Trace/Detector, ACP
Mode	VSA, LTE, LTETDD, IDEN
Measurement	<meas>:=VECTor ADEMod DDEMod W11A W11B EVM IPOWER IDEMod MOTotalk
Remote Command	:CALCulate:<meas>:TRACe[1] 2 ...4:ACP:Power:CARRier:FILTer:RRC:ALPHa <real> :CALCulate:<meas>:TRACe[1] 2 ...4:ACP:Power:CARRier:FILTer:RRC:ALPHa?
Example	CALC:VECT:TRAC1:ACP:CARR:FILT:RRC:ALPH 0.22 CALC:VECT:TRAC1:ACP:CARR:FILT:RRC:ALPH?
Preset	0.35
State Saved	Saved in instrument state.

Min	0
Max	1
Initial S/W Revision	Prior to A.02.00
Modified at S/W Revision	A.02.00

Offsets

Accesses a menu that has a key for each offset, and also an Offset RRC weighting on/off key. Each offset key shows a summary of its current parameters. Pressing one of the Offset A|B|C|D|E keys accesses a menu for adjusting its parameters.

The ACP measurement compares power in frequency bands offset from the carrier to power in the reference channel (centered on the carrier). Up to 5 offsets can be defined. The offsets are designated by letters A through E. Each offset is defined by an offset frequency, bandwidth, and optional RRC weighting. An offset actually defines two bands, one above the reference frequency and one below. Each band is used individually in the ACP calculation. RRC weighting can only be turned on or off for all offsets, but each offset can have its own RRC filter alpha. A filter alpha of 0 is the same as no RRC weighting.

Key Path	Trace/Detector,ACP,Offsets
Mode	VSA, LTE, LTETDD, IDEN
Initial S/W Revision	Prior to A.02.00
Modified at S/W Revision	A.02.00

Offsets

Accesses a menu that has a key for each offset, and also an Offset RRC weighting on/off key. Each offset key shows a summary of its current parameters. Pressing one of the Offset A|B|C|D|E keys accesses a menu for adjusting its parameters.

The ACP measurement compares power in frequency bands offset from the carrier to power in the reference channel (centered on the carrier). Up to 5 offsets can be defined. The offsets are designated by letters A through E. Each offset is defined by an offset frequency, bandwidth, and optional RRC weighting. An offset actually defines two bands, one above the reference frequency and one below. Each band is used individually in the ACP calculation. RRC weighting can only be turned on or off for all offsets, but each offset can have its own RRC filter alpha. A filter alpha of 0 is the same as no RRC weighting.

Key Path	Trace/Detector,ACP,Offsets
Mode	VSA, LTE, LTETDD, IDEN
Initial S/W Revision	Prior to A.02.00
Modified at S/W Revision	A.02.00

Offset Freq

Turns ACP analysis on or off for a selected offset and sets the offset frequency, which is relative to the carrier frequency.

Key Path	Trace/Detector, ACP, Offsets, Offset A B C D E
Mode	VSA, LTE, LTETDD, IDEN
Measurement	<meas>:=VECTor ADEMod DDEMod W11A W11B EVM IPOWER IDEMod MOTotalk
Remote Command	:CALCulate:<meas>:TRACe[1] 2 ...4:ACP:OFFSet:LIST:FREQuency <freq>, ... :CALCulate:<meas>:TRACe[1] 2 ...4:ACP:OFFSet:LIST:FREQuency? :CALCulate:<meas>:TRACe[1] 2 ...4:ACP:OFFSet:LIST:STATe OFF ON 0 1, ... :CALCulate:<meas>:TRACe[1] 2 ...4:ACP:OFFSet:LIST:STATe?
Example	CALC:VECT:TRAC1:ACP:OFFS:LIST:FREQ 1 MHZ, 1 MHZ, 500 KHZ, 500 KHZ, 1 MHZ CALC:VECT:TRAC1:ACP:OFFS:LIST:FREQ? :CALC:VECT:TRAC1:ACP:OFFS:LIST:STAT ON, OFF, OFF, ON, OFF
Notes	If you send fewer than 5 frequencies in the parameter list, then the remaining offsets frequencies are set to 0. You can send a single on/off parameter or a comma-separated list of up to 5 parameters. These enable/disable each of the Offsets in sequence. Any remaining Offsets are disabled
Preset	3000000,0,0,0,0 1,0,0,0,0
State Saved	Saved in instrument state.
Min	-9.9E+37
Max	9.9E+37
Initial S/W Revision	Prior to A.02.00
Modified at S/W Revision	A.02.00

Offset Meas Noise BW

Enables you to set the measurement noise bandwidth for the power measurement of a selected offset band.

Key Path	Trace/Detector, ACP, Offsets, Offset A B C D E
Mode	VSA, LTE, LTETDD, IDEN
Measurement	<meas>:=VECTor ADEMod DDEMod W11A W11B EVM IPOWER IDEMod MOTotalk
Remote Command	:CALCulate:<meas>:TRACe[1] 2 ...4:ACP:OFFSet:LIST:BANDwidth BWIDth:INTegration <bandwidth>, ... :CALCulate:<meas>:TRACe[1] 2 ...4:ACP:OFFSet:LIST:BANDwidth BWIDth:INTegration?
Example	CALC:VECT:TRAC1:ACP:OFFS:LIST:BAND:INT 1 MHZ, 2 MHZ, 3 MHZ, 4 MHZ, 5 MHZ CALC:VECT:TRAC1:ACP:OFFS:LIST:BAND:INT?

Notes	If you send fewer than 5 bandwidth parameters in the list, then Measurement Noise Bandwidths for the remaining Offsets are set to 0.
Preset	1000000,0,0,0,0
State Saved	Saved in instrument state.
Min	-9.9e37
Max	9.9e37
Initial S/W Revision	Prior to A.02.00
Modified at S/W Revision	A.02.00

Offset Filter Alpha

Enables you to adjust the alpha of the RRC filter for the power measurement of the selected offset band.

Key Path	Trace/Detector, ACP, Offsets, Offset A B C D E
Mode	VSA, LTE, LTETDD, IDEN
Measurement	<meas>:=VECTor ADEMod DDEMod W11A W11B EVM IPOWER IDEMod MOTotalk
Remote Command	:CALCulate:<meas>:TRACe[1] 2 ...4:ACPpower:OFFSet:LIST:FILTer:RRC:ALPHA <real>, ... :CALCulate:<meas>:TRACe[1] 2 ...4:ACPpower:OFFSet:LIST:FILTer:RRC:ALPHA?
Example	CALC:VECT:TRAC1:ACP:OFFS:LIST:FILT:RRC:ALPH 0.22, 0.22, 0.22, 0.22, 0.22 CALC:VECT:TRAC1:ACP:OFFS:LIST:FILT:RRC:ALPH?
Notes	You can send a single Filter Alpha for Offset A or a comma-separated list of up to 5 Filter Alpha parameters. These are assigned in sequence to the Offsets. Alpha for any remaining Offsets are set to 0.
Preset	0.35,0.35,0.35,0.35,0.35
State Saved	Saved in instrument state.
Min	0
Max	1.0
Initial S/W Revision	Prior to A.02.00
Modified at S/W Revision	A.02.00

Offset Relative Limit

Enables you to turn on/off a relative limit test and set the limit for the selected offset. The test shows a failure if the power in either the upper or lower band at the selected offset exceeds the reference power plus the relative test limit. For example, if the test limit is -60, the reference power is -4.5 dBm, a test failure would be shown if the power in the lower or upper band exceeds -64.5 dBm.

Key Path	Trace/Detector, ACP, Offsets
Mode	VSA, LTE, LTETDD, IDEN

Measurement	<meas>:=VECTor ADEMod DDEMod W11A W11B EVM IPOWER IDEMod MOTotalk
Remote Command	:CALCulate:<meas>:TRACe[1] 2 ...4:ACP:OFFSet:LIST:RCARrier <reall>,... :CALCulate:<meas>:TRACe[1] 2 ...4:ACP:OFFSet:LIST:RCARrier? :CALCulate:<meas>:TRACe[1] 2 ...4:ACP:OFFSet:LIST:RCARrier:TEST OFF ON 0 1,... :CALCulate:<meas>:TRACe[1] 2 ...4:ACP:OFFSet:LIST:RCARrier:TEST?
Example	CALC:VECT:TRAC1:ACP:OFFS:LIST:RCAR -50, -55, -60, -65, -80 CALC:VECT:TRAC1:ACP:OFFS:LIST:RCAR? CALC:VECT:TRAC1:ACP:OFFS:LIST:RCAR:TEST 1, 1, 1, 1, 1 CALC:VECT:TRAC1:ACP:OFFS:LIST:RCAR:TEST?
Notes	You can send a single Limit for Offset A or a comma-separated list of up to 5 limit parameters. These are assigned in sequence to the Offset frequencies with the remaining limits being set to 0. You can send a single on/off parameter or a comma-separated list of up to 5 parameters. These turn the Limit Test on or off for each of the Offsets in sequence. For any remaining Offsets, the Limit test is turned off.
Preset	-120,-120,-120,-120,-120 0,0,0,0,0
State Saved	Saved in instrument state.
Min	50
Max	-200
Initial S/W Revision	Prior to A.02.00
Modified at S/W Revision	A.02.00

RRC Weighting (All Offsets)

Turns on or off RRC weighting for the power measurement for all offsets. If RRC weighting is turned on, but you want to exclude RRC weighting for a particular offset, set its filter alpha to 0.

Key Path	Trace/Detector,ACP,Offsets
Mode	VSA, LTE, LTETDD, IDEN
Measurement	<meas>:=VECTor ADEMod DDEMod W11A W11B EVM IPOWER IDEMod MOTotalk
Remote Command	:CALCulate:<meas>:TRACe[1] 2 ...4:ACP:OFFSet:FILTer:RRC:STATe OFF ON 0 1 :CALCulate:<meas>:TRACe[1] 2 ...4:ACP:OFFSet:FILTer:RRC:STATe?
Example	CALC:VECT:TRAC1:ACP:OFFS:FILT:RRC:STAT ON CALC:VECT:TRAC1:ACP:OFFS:FILT:RRC:STAT?
Preset	0
State Saved	Saved in instrument state.
Initial S/W Revision	Prior to A.02.00
Modified at S/W Revision	A.02.00

OBW Setup (Occupied Bandwidth)

Accesses a menu of functions that enable you to define and turn on the OBW function on the selected trace.

The occupied bandwidth (OBW) function finds and displays the band of frequencies that contain a specified percentage of the total power within the measurement span.

An OBW measurement can be defined for each trace, although it is only active on frequency-domain trace data. The band defined by the OBW measurement is shown as a blue bar overlaying the trace display. To see tabular data showing the frequencies of the band limits, the total power, and so on, you can assign the OBW Summary (Trace n) to a different trace. For example, you can assign Spectrum data to trace 3, turn on OBW on trace 3, and assign the OBW Summary (Trace 3) to trace 4, as shown below.

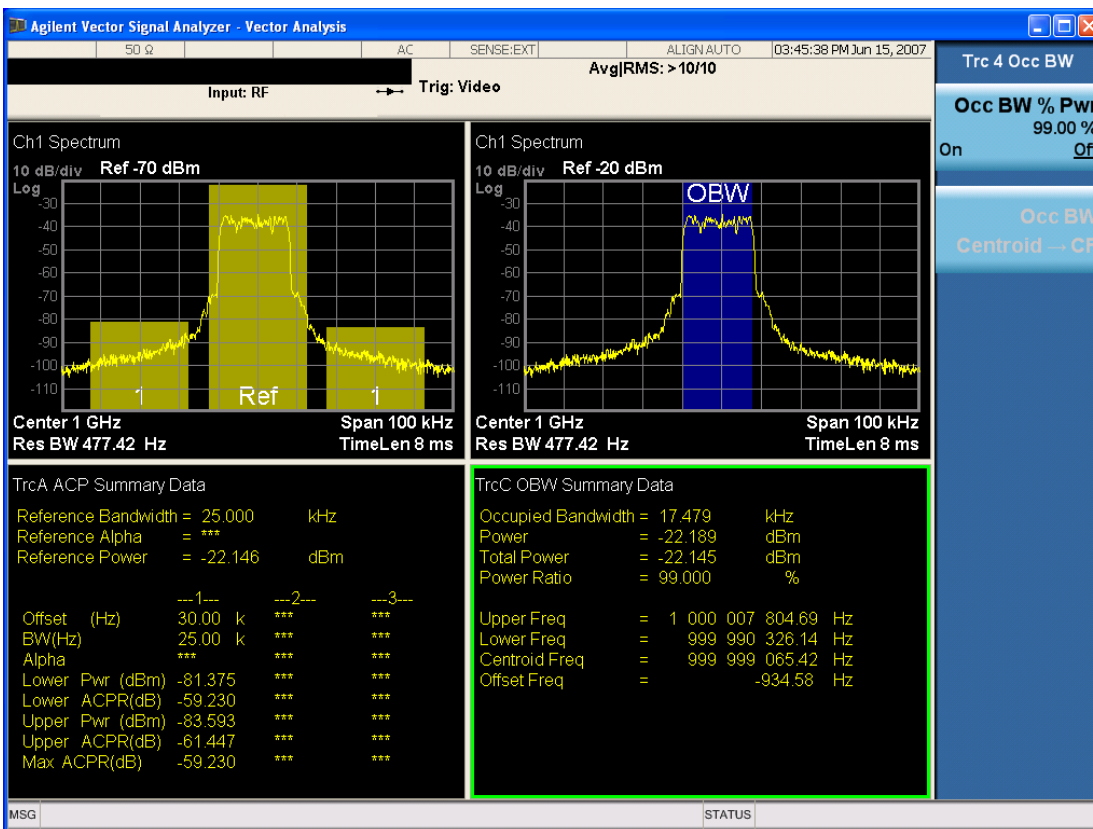

The summary data can be retrieved programmatically using FETCH? or the CALCulate:<meas>:DATA:TABLE commands. See [":CALCulate:DATA:TABL commands"](#) on page 1291 for more details.

Key Path	Trace/Detector
Mode	VSA, LTE, LTETDD, iDEN
Readback Text	[On Off, <num>%]
Initial S/W Revision	Prior to A.02.00
Modified at S/W Revision	A.02.00

OBW Power

Specifies the percentage of power for determining the occupied BW, and turns the OBW function on or off for the selected trace.

Key Path	Trace/Detector, OBW
Mode	VSA, LTE, LTETDD, IDEN
Measurement	<meas>:=VECTor ADEMod DDEMod W11A W11B EVM IPOWER IDEMod MOTotalk
Remote Command	:CALCulate:<meas>:TRACe[1] 2 ...4:OBWidth:PERCent <real> :CALCulate:<meas>:TRACe[1] 2 ...4:OBWidth:PERCent? :CALCulate:<meas>:TRACe[1] 2 ...4:OBWidth:STATE OFF ON 0 1 :CALCulate:<meas>:TRACe[1] 2 ...4:OBWidth:STATE?
Example	CALC:VECT:TRAC1:OBW:PERC 99 CALC:VECT:TRAC1:OBW:PERC? CALC:VECT:TRAC1:OBW:STAT ON CALC:VECT:TRAC1:OBW:STAT?
Notes	Parameter is interpreted as a percent, e.g., if you want the OBW to be 95% send 95, not 0.95
Preset	99.0 0
State Saved	Saved in instrument state.
Min	0
Max	100
Initial S/W Revision	Prior to A.02.00
Modified at S/W Revision	A.02.00

OBW Centroid > CF

Copies the centroid of the occupied bandwidth to the Center Frequency. It only works if the currently selected trace has data compatible with the OBW function and OBW is turned on.

This is a front-panel function only.

You can read the OBW centroid using the following SCPI-only query and use the result to set the center frequency.

Mode	VSA, LTE, LTETDD, IDEN
Measurement	<meas>:=VECTor ADEMod DDEMod W11A W11B EVM IPOWER IDEMod MOTotalk
Remote Command	:CALCulate:<meas>:TRACe[1] 2 ...4:OBWidth:CENTroid?
Example	CALC:VECT:TRAC1:OBW:CEN?
Notes	Query only. Returns NaN (9.91E+37) if the OBW function is not active for the selected trace or is not supported for the trace data assigned to the selected trace.

Initial S/W Revision	Prior to A.02.00
Modified at S/W Revision	A.02.00

BW Limit

Turns on or off limit testing for the Occupied BW test for the selected trace, and enables you to define the limit. Test pass or fail status appears in the OBW Summary table associated with the trace.

Key Path	Trace/Detector, OBW
Mode	VSA, LTE, LTETDD, IDEN
Measurement	<meas>:=VECTor ADEMod DDEMod W11A W11B EVM IPOWER IDEMod MOTotalk
Remote Command	:CALCulate:<meas>:TRACe[1] 2 ...4:OBWidth:LIMit:FBLimit <freq> :CALCulate:<meas>:TRACe[1] 2 ...4:OBWidth:LIMit:FBLimit? :CALCulate:<meas>:TRACe[1] 2 ...4:OBWidth:LIMit[:TEST] OFF ON 0 1 :CALCulate:<meas>:TRACe[1] 2 ...4:OBWidth:LIMit[:TEST]?
Example	CALC:VECT:TRAC1:OBW:LIMIT:FBL 10 MHZ CALC:VECT:TRAC1:OBW:LIMIT:FBL? CALC:VECT:TRAC1:OBW:LIMIT:TEST ON CALC:VECT:TRAC1:OBW:LIMIT:TEST?
Preset	1000000 0
State Saved	Saved in instrument state.
Min	1 Hz
Max	9.9e37 (Infinity) Hz
Initial S/W Revision	Prior to A.02.00
Modified at S/W Revision	A.02.00

Trace Indicator Info

Enables you to get more information about why a trace indicator is showing. A trace indicator appears in the upper right corner of a trace display to announce exceptional conditions. When such an indicator is showing on the selected trace, pressing this key causes more information about the condition to appear in the message area. This is a front-panel only function. The SCPI commands for querying the Trace Indicator and the Trace Indicator Info for a particular trace are:

CALC:<meas>:DATA[1]|2|3|4:HEAD:STR? "TrcLedStr"

CALC:<meas>:DATA[1]|2|3|4:HEAD:STR? "TrcLedReason"

Key Path	Trace/Detector
Mode	VSA, LTE, LTETDD, IDEN

10 iDEN Power Measurement
Trace/Detector

Initial S/W Revision	Prior to A.02.00
Modified at S/W Revision	A.02.00

Trigger

See ["Trigger"](#) on page 310

Free Run

See ["Free Run"](#) on page 310

Video

See ["Video \(IF Envelope\)"](#) on page 310

Trigger Level

See ["Trigger Level"](#) on page 311

Trig Slope

See ["Trig Slope"](#) on page 311

Trig Delay

See ["Trig Delay"](#) on page 312

Trig Holdoff

See ["Trig Holdoff"](#) on page 312

Holdoff Type

See ["Holdoff Type"](#) on page 313

External 1

See ["External 1"](#) on page 314

Trigger Level

See ["Trigger Level"](#) on page 314

Trig Slope

See ["Trig Slope"](#) on page 315

Trig Delay

See ["Trig Delay"](#) on page 315

Trig Holdoff

See ["Trig Holdoff"](#) on page 316

Holdoff Type

See ["Holdoff Type"](#) on page 316

10 iDEN Power Measurement
Trigger

Trig Reference Line

See "Trig Reference Line" on page 317

User Preset

Accesses a menu that gives you the following three choices:

- User Preset – recalls a state previously saved using the Save User Preset function.
- User Preset All Modes – presets all of the modes in the analyzer
- Save User Preset– saves the current state for the current mode

Key Path	Front-panel key
Backwards Compatibility Notes	<p>User Preset is actually loading a state, and in legacy analyzers, it was possible to load a state without affecting the trace data, limit lines or correction data. Similarly it was possible to do a User Preset without affecting the trace data, limit lines or correction data.</p> <p>In the X-Series, “state” always includes all of this data; so whenever state is loaded, or User Preset is executed, all of the traces, limit lines and corrections are affected. Although this differs from previous behavior, it is desirable behavior, and should not cause adverse issues for users.</p> <p>On ESA and PSA, User Preset affected the entire instrument’s state. In the X-Series, User Preset only recalls the state for the active mode. There is a User Preset file for each mode. User Preset can never cause a mode switch as it can in legacy analyzers. If you want to recall all modes to their user preset file state, you will need to do a User Preset after mode switching into each mode.</p> <p>User Preset recalls mode state which can now include data like traces; whereas on ESA and PSA, User Preset did not affect data.</p>
Initial S/W Revision	Prior to A.02.00

User Preset

User Preset sets the state of the currently active mode back to the state that was previously saved for this mode using the Save User Preset menu key or the SCPI command, SYST:PRES:USER:SAV. It not only recalls the Mode Preset settings, but it also recalls all of the mode persistent settings, and the Input/Output system setting that existed at the time Save User Preset was executed.

If a Save User Preset has not been done at any time, User Preset recalls the default user preset file for the currently active mode. The default user preset files are created if, at power-on, a mode detects there is no user preset file. There will never be a scenario when there is no user preset file to restore. For each mode, the default user preset state is the same state that would be saved if a Save User Preset is performed in each mode right after doing a Restore Mode Default and after a Restore Input/Output Defaults.

The User Preset function does the following:

- Aborts the currently running measurement.
- Sets the mode State to the values defined by Save User Preset.
- Makes the saved measurement for the currently running mode the active measurement.
- Brings up the saved menu for the power-on mode.
- Clears the input and output buffers.
- Sets the Status Byte to 0.

Key Path	User Preset
Remote Command	:SYSTem:PRESet:USER
Example	:SYST:PRES:USER:SAVE:SYST:PRES:USER
Notes	:SYST:PRES:USER:SAVE is used to save the current state as the user preset state. Clears all pending OPC bits. The Status Byte is set to 0. Pressing the User Preset front-panel key while already in the User Preset menu will cause the User Preset to get executed
Couplings	A user preset will cause the currently running measurement to be aborted and cause the saved measurement to be active. Recalling a User Preset file has the same issues that recalling a Save State file has. Some settings may need to be limited and therefore re-coupled, since the capabilities of the mode may have changes when the User Preset file was last saved.
Initial S/W Revision	Prior to A.02.00

User Preset All Modes

Recalls all of the User Preset files for each mode, switches to the power-on mode, and activates the saved measurement from the power-on mode User Preset file.

NOTE

When the instrument is secured, all of the user preset files are converted back to their default user preset files.

The User Preset function does the following:

- Aborts the currently running measurement.
- Switches the Mode to the power-on mode.
- Restores the User Preset files for each mode.
- Makes the saved measurement for the power-on mode the active measurement.
- Brings up the saved menu for the power-on mode.
- Clears the input and output buffers.
- Sets the Status Byte to 0.

Key Path	User Preset
Remote Command	:SYSTem:PRESet:USER:ALL
Example	:SYST:PRES:USER:SAVE:SYST:PRES:USER:ALL
Notes	Clears all pending OPC bits. The Status Byte is set to 0. :SYST:PRES:USER:SAVE is used to save the current state as the user preset state.
Couplings	A user preset will cause the currently running measurement to be aborted, cause a mode switch to the power-on mode, and cause the saved measurement to be active in the power-on mode. Recalling a User Preset file has the same issues that recalling a Save State file has. Some settings may need to be limited and therefore re-coupled, since the capabilities of the mode may have changes when the User Preset file was last saved.
Initial S/W Revision	Prior to A.02.00

Save User Preset

Saves the currently active mode and its State. You can recall this User Preset file by pressing the User Preset menu key or sending the SYST:PRES:USER remote command. This same state is also saved by the Save State function.

Key Path	User Preset
Remote Command	:SYSTem:PRESet:USER:SAVE
Example	:SYST:PRES:USER:SAVE
Notes	:SYST:PRES:SAVE creates the same file as if the user requested a *SAV or a MMEM:STOR:STAT, except User Preset Save does not allow the user to specify the filename or the location of the file.
Initial S/W Revision	Prior to A.02.00

View/Display

The traces configured for any window can be changed at any time using the standard UI. The Test Preset key and the Preset View: Test Standard keys configure a default window layout and trace setup for the selected tests.

The default layout includes two windows for each test enabled, for example, either 2 or 4 windows.

When the OBW test is enabled, the default layout has the Spectrum trace with the occupied bandwidth highlight displayed in trace 1 and the OBW Summary trace in trace 2.

When the ACP test is enabled, the default layout has the Spectrum trace with ACP color bars displayed in trace 3 and the ACP Summary trace in trace 4.

If no test state is enabled (generally a transitory event), the two traces from the last test enabled will continue to be displayed.

The view setup can be changed by selections from the View/Display menu, or by pressing Test Preset after enabling the desired tests, or by individually selecting traces and layout. You may change the number of windows in the layout or the contents of those windows at will.

The Preset View softkeys do an immediate action of changing the layout and view for various Preset Views unique to this measurement. These Preset Views are actions, not states.

Key Path	Front-panel key
Mode	IDEN
Initial S/W Revision	A.02.00

Display

The Display menu is common to most measurements, and is used for configuring items on the display. Some Display menu settings apply to all the measurements in a mode, and some only to the current measurement. Those under the System Display Settings key apply to all measurements in all modes.

Key Path	Display
Key Path	View/Display
Initial S/W Revision	Prior to A.02.00

Annotation

Turns on and off various parts of the display annotation. The annotation is divided up into four categories:

1. Meas Bar: This is the measurement bar at the top of the screen. It does not include the settings panel or the Active Function. Turning off the Meas Bar turns off the settings panel and the Active Function. When the Meas Bar is off, the graticule area expands to fill the area formerly occupied by the Meas Bar.

2. Screen Annotation: this is the annotation and annunciation around the graticule, including any annotation on lines (such as the display line, the threshold line, etc.) This does NOT include the marker number or the N dB result. When off, the graticule expands to fill the entire graticule area.
 3. Trace annotation: these are the labels on the traces, showing their detector (or their math mode).
 4. Active Function annotation: this is the active function display in the meas bar, and all of the active function values displayed on softkeys.
- See the figure below. Each type of annotation can be turned on and off individually.

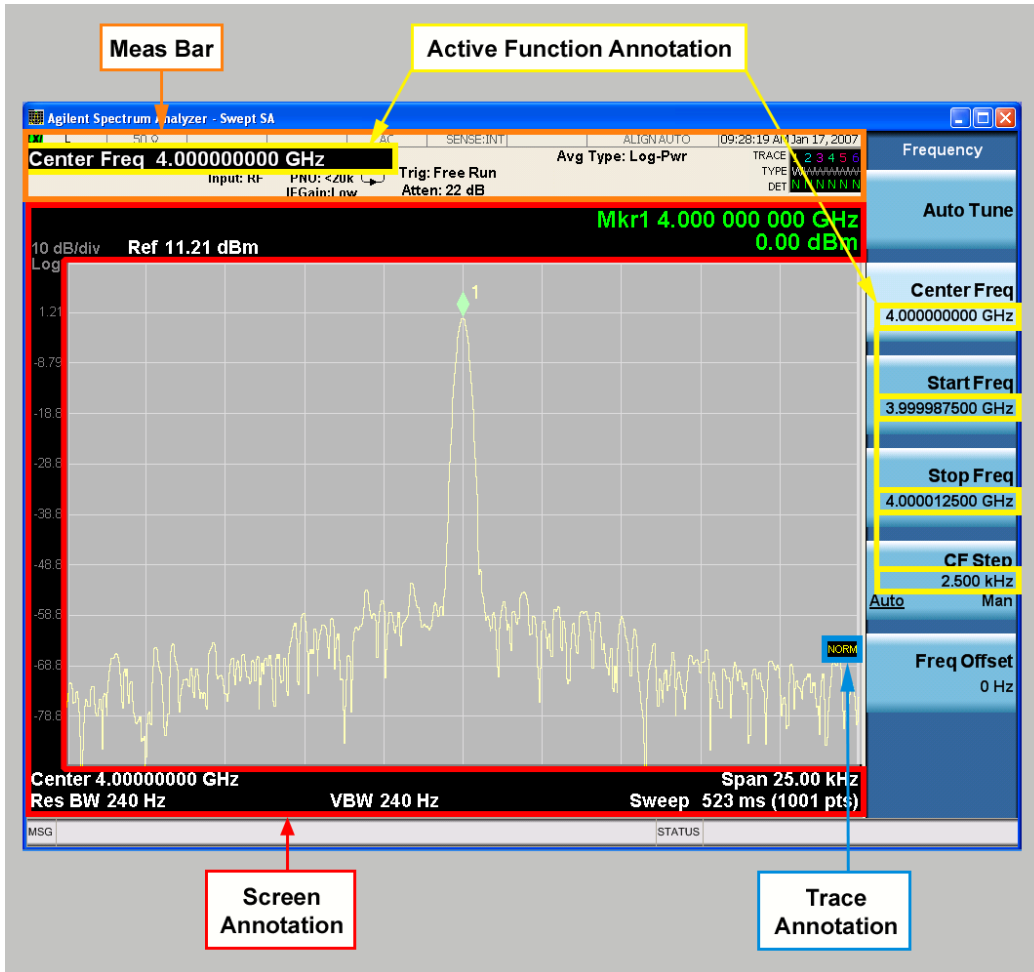

Key Path	View/Display, Display
Initial S/W Revision	Prior to A.02.00

Meas Bar On/Off

This function turns the Measurement Bar on and off, including the settings panel. When off, the graticule area expands to fill the area formerly occupied by the Measurement Bar.

Key Path	View/Display, Display, Annotation
Remote Command	:DISPlay:ANNotation:MBAR[:STATe] OFF ON 0 1 :DISPlay:ANNotation:MBAR[:STATe]?
Example	DISP:ANN:MBAR OFF
Dependencies	Grayed out and forced to OFF when System Display Settings, Annotation is set to Off.
Preset	On This should remain Off through a Preset when System DisplaySettings, Annotation is set to Off.
State Saved	Saved in instrument state.
Initial S/W Revision	Prior to A.02.00

Screen

This controls the display of the annunciation and annotation around the graticule, including any annotation on lines (such as the display line, the threshold line, etc.) and the y-axis annotation. This does NOT include marker annotation (or the N dB result). When off, the graticule expands to fill the entire graticule area, leaving only the 1.5% gap above the graticule as described in the Trace/Detector chapter.

Key Path	View/Display, Display, Annotation
Remote Command	:DISPlay:ANNotation:SCReen[:STATe] OFF ON 0 1 :DISPlay:ANNotation:SCReen[:STATe]?
Example	DISP:ANN:SCR OFF
Dependencies	Grayed-out and forced to OFF when System Display Settings, Annotation is set to Off.
Preset	On This should remain Off through a Preset when System DisplaySettings, Annotation is set to Off
State Saved	Saved in instrument state.
Initial S/W Revision	Prior to A.02.00

Active Function Values On/Off

Turns on and off the active function display in the Meas Bar, and all of the active function values displayed on the softkeys.

Note that all of the softkeys that have active functions have these numeric values blanked when this function is on. This is a security feature..

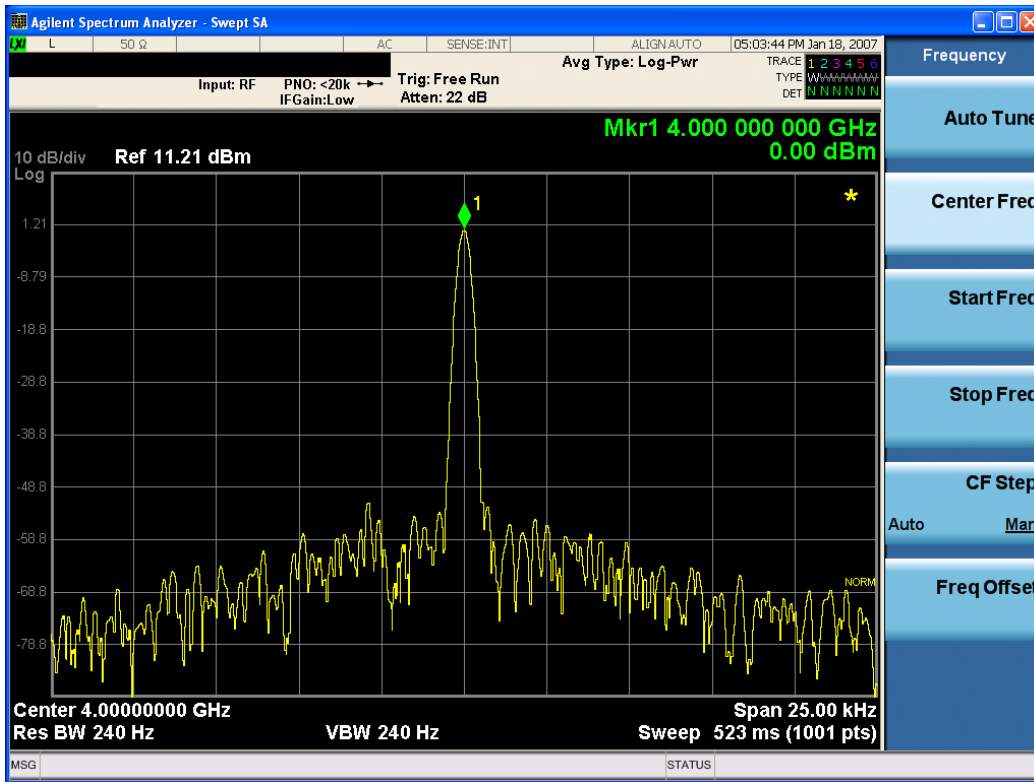

Key Path	View/Display, Display, Annotation
Remote Command	:DISPlay:ACTivefunc[:STATE] ON OFF 1 0 :DISPlay:ACTivefunc[:STATE]?
Example	DISP:ACT OFF
Dependencies	Grayed out and forced to OFF when System Display Settings, Annotation is set to Off.
Preset	On This should remain Off through a Preset when System DisplaySettings, Annotation is set to Off
State Saved	Saved in instrument state.
Initial S/W Revision	Prior to A.02.00

Title

Displays menu keys that enable you to change or clear a title on your display.

Key Path	View/Display, Display
Initial S/W Revision	Prior to A.02.00

Change Title

Writes a title into the "measurement name" field in the banner, for example, "Swept SA".

Press Change Title to enter a new title through the alpha editor. Press Enter or Return to complete the entry. Press ESC to cancel the entry and preserve your existing title.

The display title will replace the measurement name. It remains for this measurement until you press Change Title again, or you recall a state, or a Preset is performed. A title can also be cleared by pressing Title, Clear Title.

NOTE

Notice the inclusion of the <measurement> parameter in the command below. Because each measurement remembers the Display Title, the command must be qualified with the measurement name. For the Swept SA measurement this is not the case; no <measurement> parameter is used when changing the Display Title for the Swept SA measurement.

Key Path	View/Display, Display, Title
Mode	All
Remote Command	:DISPlay:<measurement>:ANNotation:TITLe:DATA <string> :DISPlay:<measurement>:ANNotation:TITLe:DATA?
Example	DISP:ANN:TITL:DATA "This Is My Title" This example is for the Swept SA measurement in the Spectrum Analyzer mode. The SANalyzer <measurement> name is not used. DISP:ACP:ANN:TITL:DATA "This Is My Title" This example is for Measurements other than Swept SA. Both set the title to: This Is My Title
Notes	Pressing this key cancels any active function. When a title is edited the previous title remains intact (it is not cleared) and the cursor goes at the end so that characters can be added or BKSP can be used to go back over previous characters.
Preset	No title (measurement name instead)
State Saved	Saved in instrument state.
Initial S/W Revision	Prior to A.02.00

Clear Title

Clears a title from the front-panel display. Once cleared, the title cannot be retrieved. After the title is cleared, the current Measurement Name replaces it in the title bar.

Key Path	View/Display, Display, Title
Example	The following commands clear the title and restore the measurement's original title: DISP:ANN:TITL:DATA "" This example is for the Swept SA measurement in the Spectrum Analyzer mode. The SANalyzer <measurement> name is not used. DISP:ACP:ANN:TITL:DATA "" This example is for ACP; in measurements other than Swept SA the measurement name is required.
Notes	Uses the :DISPlay:<measurement>:ANNotation:TITLe:DATA <string> command with an empty string (in the Swept SA, the <measurement> is omitted).
Preset	Performed on Preset.
Initial S/W Revision	Prior to A.02.00

Graticule

Pressing Graticule turns the display graticule On or Off. It also turns the graticule y-axis annotation on and off.

Key Path	View/Display, Display
Remote Command	:DISPlay:WINDow[1]:TRACe:GRATicule:GRID[:STATe] OFF ON 0 1 :DISPlay:WINDow[1]:TRACe:GRATicule:GRID[:STATe]?
Example	DISP:WIND:TRAC:GRAT:GRID OFF
Notes	The graticule is the set of horizontal and vertical lines that make up the grid/divisions for the x-axis and y-axis.
Preset	On
State Saved	Saved in instrument state
Initial S/W Revision	Prior to A.02.00

System Display Settings

These settings are "Mode Global" – they affect all modes and measurements and are reset only by Restore Misc Defaults or Restore System Defaults under System.

Key Path	View/Display, Display
Initial S/W Revision	Prior to A.02.00

Annotation Local Settings

This is a Mode Global override of the meas local annotation settings. When it is All Off, it forces ScreenAnnotation, Meas Bar, Trace, and Active Function Values settings to be OFF for all measurements in all modes. This provides the security based "annotation off" function of previous analyzers; hence it uses the legacy SCPI command.

When it is All Off, the Screen, Meas Bar, Trace, and Active Function Values keys under the Display, Annotation menu are grayed out and forced to Off. When Local Settings is selected, you are able to set the local annotation settings on a measurement by measurement basis.

Key Path	View/Display, Display, System Display Settings
Remote Command	:DISPlay:WINDow[1]:ANNotation[:ALL] OFF ON 0 1 :DISPlay:WINDow[1]:ANNotation[:ALL]?
Example	:DISP:WIND:ANN OFF
Preset	On (Set by Restore Misc Defaults)
State Saved	Not saved in instrument state.
Backwards Compatibility Notes	The WINDow parameter and optional subopcode is included for backwards compatibility but ignored – all windows are equally affected.
Initial S/W Revision	Prior to A.02.00

Themes

Accesses a menu of functions that enable you to choose the theme to be used when saving the screen image.

The **Themes** option is the same as the **Themes** option under the **Display** and **Page Setup** dialogs. It allows you to choose between themes to be used when saving the screen image.

Key Path	Save, Screen Image
Remote Command	:MMEMory:STORe:SCReem:THEMe TDColor TDMonochrome FCOLor FMONochrome :MMEMory:STORe:SCReem:THEMe?
Example	:MMEM:STOR:SCR:THEM TDM
Preset	3D Color; Is not part of Preset, but is reset by Restore Misc Defaults or Restore System Defaults All and survives subsequent running of the modes.
Readback	3D Color 3D Mono Flat Color Flat Mono
Backwards Compatibility Notes	In ESA and PSA we offer the choice of "Reverse Bitmap" or "Reverse Metafile" when saving screen images. This is much like the "Flat Color" theme available in X-Series. Also, if you selected Reverse Bitmap AND a black & white screen image, that would be much like "Flat Monochrome". In other words, each of the X-Series themes has a similar screen image type in ESA/PSA. But they are not identical.
Initial S/W Revision	Prior to A.02.00

3D Color

Selects a standard color theme with each object filled, shaded and colored as designed.

Key Path	Save, Screen Image, Themes
Example	MMEM:STOR:SCR:THEM TDC
Readback	3D Color
Initial S/W Revision	Prior to A.02.00

3D Monochrome

Selects a format that is like 3D color but shades of gray are used instead of colors.

Key Path	Save, Screen Image, Themes
Example	MMEM:STOR:SCR:THEM TDM
Readback	3D Mono
Initial S/W Revision	Prior to A.02.00

Flat Color

Selects a format that is best when the screen is to be printed on an ink printer.

Key Path	Save, Screen Image, Themes
Example	MMEM:STOR:SCR:THEM FCOL
Readback	Flat Color
Initial S/W Revision	Prior to A.02.00

Flat Monochrome

Selects a format that is like Flat Color. But only black is used (no colors, not even gray), and no fill.

Key Path	Save, Screen Image, Themes
Example	MMEM:STOR:SCR:THEM FMON
Readback	Flat Mono
Initial S/W Revision	Prior to A.02.00

Backlight

Accesses the display backlight on/off keys. This setting may interact with settings under the Windows "Power" menu.

When the backlight is off, pressing ESC, TAB, SPACE, ENTER, UP, DOWN, LEFT, RIGHT, DEL, BKSP, CTRL, or ALT turns the backlight on without affecting the application. Pressing any other key will turn backlight on and could potentially perform the action as well.

Key Path	View/Display, Display, System Display Settings
Remote Command	:DISPlay:BACKlight ON OFF :DISPlay:BACKlight?
Preset	ON (Set by Restore Misc Defaults)
Initial S/W Revision	Prior to A.02.00

Backlight Intensity

An active function used to set the backlight intensity. It goes from 0 to 100 where 100 is full on and 0 is off. This value is independent of the values set under the Backlight on/off key.

Key Path	View/Display, Display, System Display Settings
Remote Command	:DISPlay:BACKlight:INTensity <integer> :DISPlay:BACKlight:INTensity?
Example	DISP:BACK:INT 50

Preset	100 (Set by Restore Misc Defaults)
Min	0
Max	100
Initial S/W Revision	Prior to A.02.00

Layout

Enables you to choose the number and position of windows on the screen. Each window contains one trace. The selected trace is always visible and its window outlined in green. The Window zoom key toggles between multiple windows and a single window mode without changing the setting for Layout.

Single layout has one window.

Stack 2 layout has two windows, one on top of the other, that display either traces 1 (top) and 2 (bottom) or traces 3 and 4. The pair that is showing always includes the selected trace.

Stack 3 layout has three windows that display, top to bottom, traces 1, 2, 3 or traces 2, 3, 4.

Grid 2x2 layout has 4 windows, arranged 2x2. They display (in order top to bottom, left to right) traces 1, 2, 3, and 4.

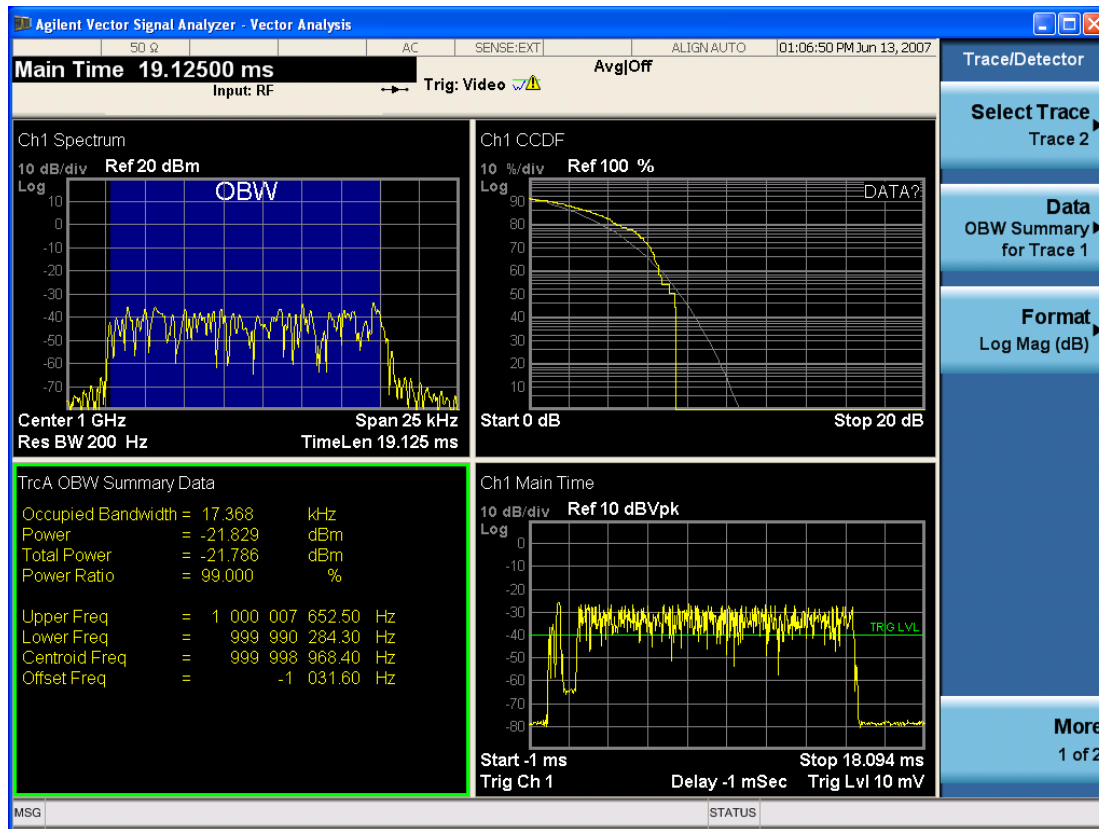

Grid 2x2 layout with Trace 2 selected

There are two other layouts that are available for iDEN Power, iDEN Demod, and MOTOTalk measurements since these enable 6 traces.

Grid 2x3 layout has 2 rows of 3 windows that display all 6 traces in order, top to bottom, then left to right.

Grid 3x2 layout has 3 rows of 2 windows that display all 6 traces in order, top to bottom, then left to right.

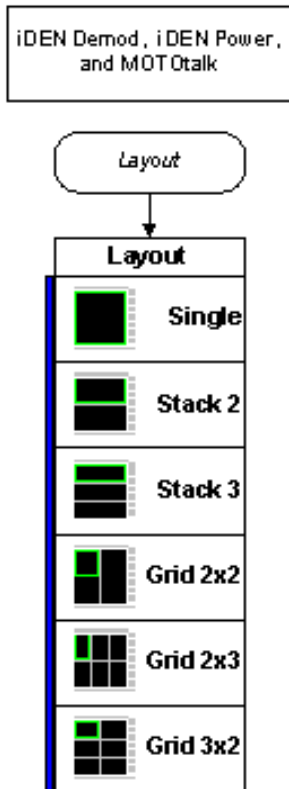

Key Path	View/Display
Mode	VSA, LTE, LTETDD, IDEN,LTEAFDD,LTEATDD
Measurement	<meas>:=VECTor ADEMod DDEMod W11A W11B EVM IPOWER IDEMod MOTotalk
Remote Command	:DISPlay:<meas>:WINDow:FORMat SINGLE TWO TRI QUAD :DISPlay:<meas>:WINDow:FORMat? For iDEN Power, iDEN Demod and MotoTalk measurements: :DISPlay:<meas>:WINDow:FORMat SINGLE TWO TRI QUAD GR2X3 GR3X2 :DISPlay:<meas>:WINDow:FORMat?
Example	DISP:VECT:WIND:FORM TWO DISP:IPOW:WIND:FORM GR2X3 DISP:VECT:WIND:FORM?
Couplings	If the window is currently zoomed, selecting a layout (even the current one) switches it to tiled mode.
Preset	TWO QUAD QUAD QUAD QUAD QUAD QUAD QUAD GR2X3 TRI

State Saved	Saved in instrument state.
Range	Single Stack 2 Stack 3 Grid 2x2 Grid 2x2 Grid 2x3 Stack 3
Initial S/W Revision	Prior to A.02.00
Modified at S/W Revision	A.02.00

Preset View: Test Standard

Preset the layout to pre-defined patterns.

Key Path	View/Display
Remote Command	:DISPlay:IPower:VIEW:PRESet TSTD ACP ACPOBW ACPBURST
Example	:DISP:IPOW:VIEW:PRES TSTD
Notes	Command Only. TSTD: Test Standard ACP: ACP ACPOBW: ACP & OBW ACPBURST: ACP Burst
Couplings	Action dependent on the state of the test selections
Initial S/W Revision	A.02.00

Preset View: ACP

Preset the layout to pre-defined patterns.

Key Path	View/Display
Example	:DISP:IPOW:VIEW:PRES ACP
Notes	Command Only. TSTD: Test Standard ACP: ACP ACPOBW: ACP & OBW ACPBURST: ACP Burst
Initial S/W Revision	A.02.00

Preset View: ACP & OBW

Preset the layout to pre-defined patterns.

Key Path	View/Display
Example	:DISP:IPOW:VIEW:PRES ACPOBW

Notes	Command Only. TSTD: Test Standard ACP: ACP ACPOBW: ACP & OBW ACPBURST: ACP Burst
Initial S/W Revision	A.02.00

Preset View: OBW & Burst

Preset the layout to pre-defined patterns.

Key Path	View/Display
Example	:DISP:IPOW:VIEW:PRES ACPBURST
Notes	Command Only. TSTD: Test Standard ACP: ACP ACPOBW: ACP & OBW ACPBURST: ACP Burst
Initial S/W Revision	A.02.00

Measurement Views

This measurement has four views as follows:

- ["Preset View: Test Standard" on page 877](#)
- ["Preset View: ACP" on page 878](#)
- ["Preset View: OWB & ACP" on page 879](#)
- ["Preset View: ACP & Burst" on page 880](#)

Preset View: Test Standard

The Test Standard view provides the preset view for the set of selected tests. The exact action is dependent on the test selections.

The following illustration is the display after pressing the Preset View:Test Standard softkey.

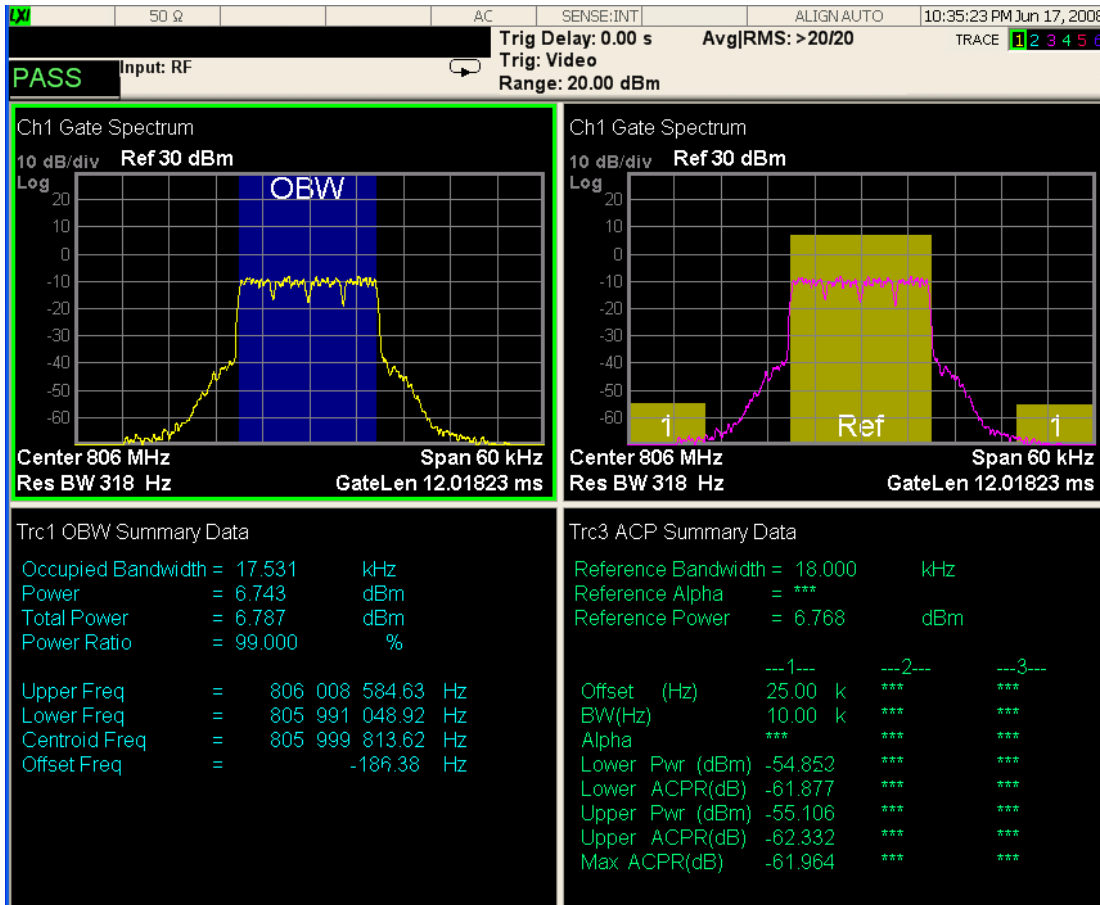

The action performed is:

1. ACP Test only selected: Preset View: ACP ("Preset View: ACP" on page 876) OBW Test only selected: 2 window display. Trace 1 displays the Spectrum with OBW measurement and trace 2 displays the OBW Summary.
2. Both ACP and OBW Tests selected: Preset View OBW & ACP ("Preset View: ACP & OBW" on page 876)

Preset View: ACP

The ACP view is a 2 window display, with the Spectrum and the ACP color bars in trace 3, and the ACP Summary in trace 4. This is the default view when only the ACP test is enabled. If the ACP Test is not enabled ("ACP" on page 757), these traces will still be shown but the ACP Summary trace will contain no data.

Below is the display after pressing this key.

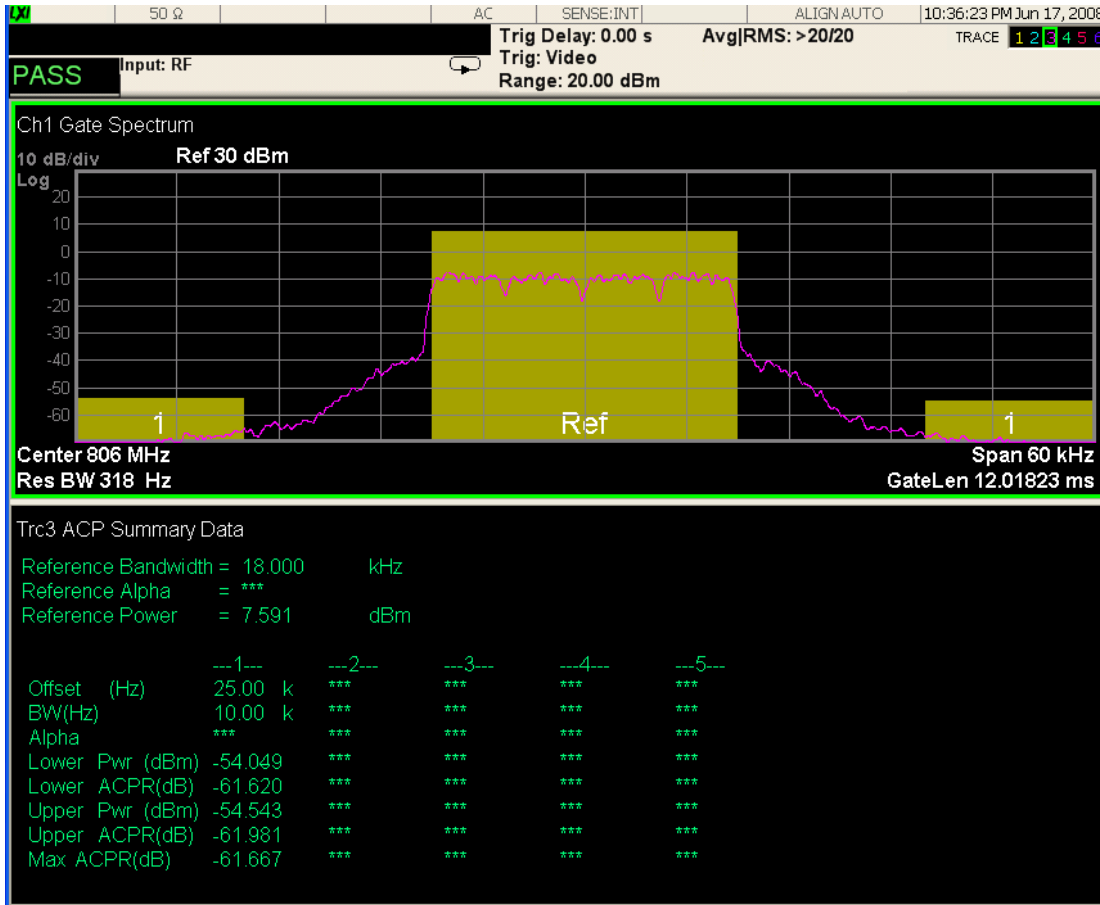

Preset View: OWB & ACP

The OWB & ACP view is a 4 window layout. Trace 1 displays the Spectrum with OWB measurement and trace 2 displays the OWB Summary. Trace 3 displays the Spectrum with ACP measurement and trace 4 displays the ACP Summary. This is the default view when OWB and ACP tests are enabled. If the OWB Test is not enabled ("["OBW" on page 756](#)"), these traces will still be shown but the OWB Summary trace will contain no data and the ACP measurement will not be visible on the Spectrum. If the ACP Test is not enabled ("["ACP" on page 757](#)"), these traces will still be shown but the ACP Summary trace will contain no data and the ACP measurement will not be visible on the Spectrum.

Below is the display after pressing this key.

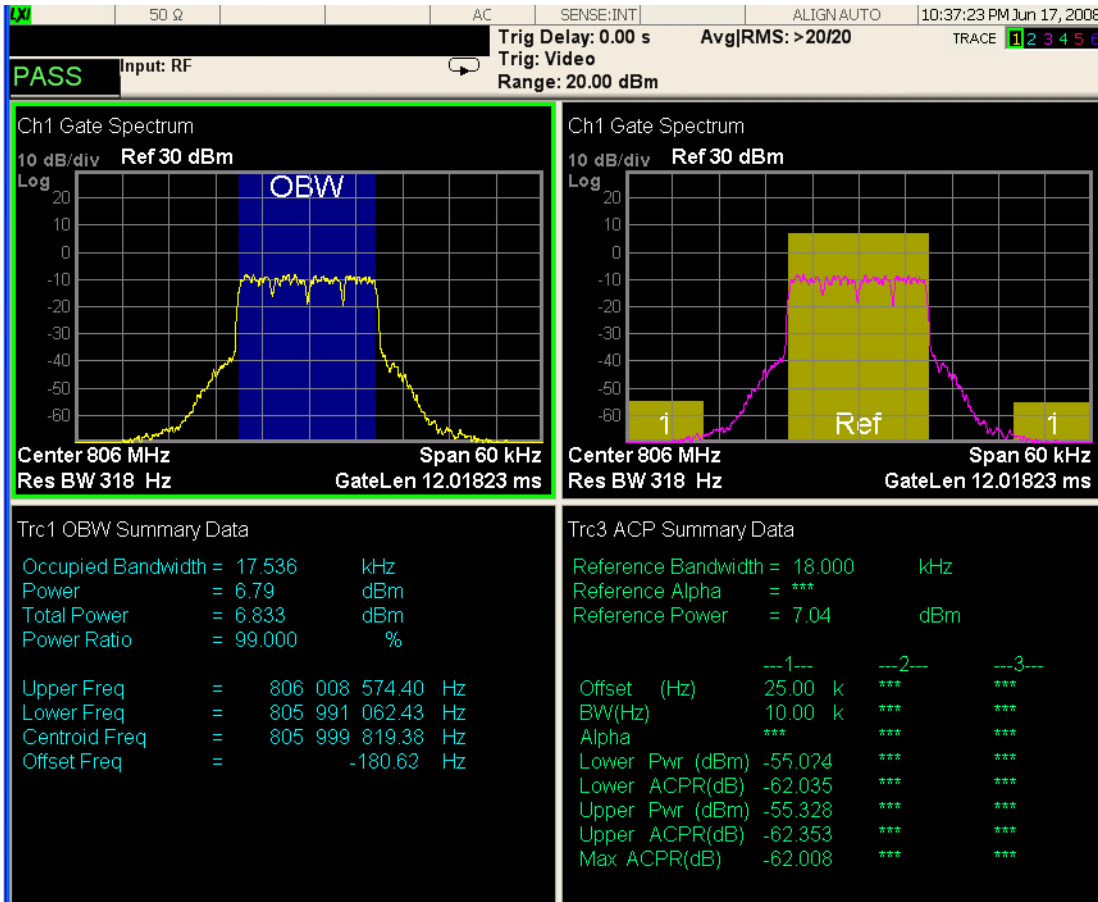

Preset View: ACP & Burst

The ACP & Burst view is a 2 window layout. Trace 5 displays the Spectrum with ACP measurement and trace 6 displays Main Time. If the ACP Test is not enabled ("[ACP](#)" on page 757), the ACP measurement will not be visible on the Spectrum trace.

Below is the display after pressing this key.

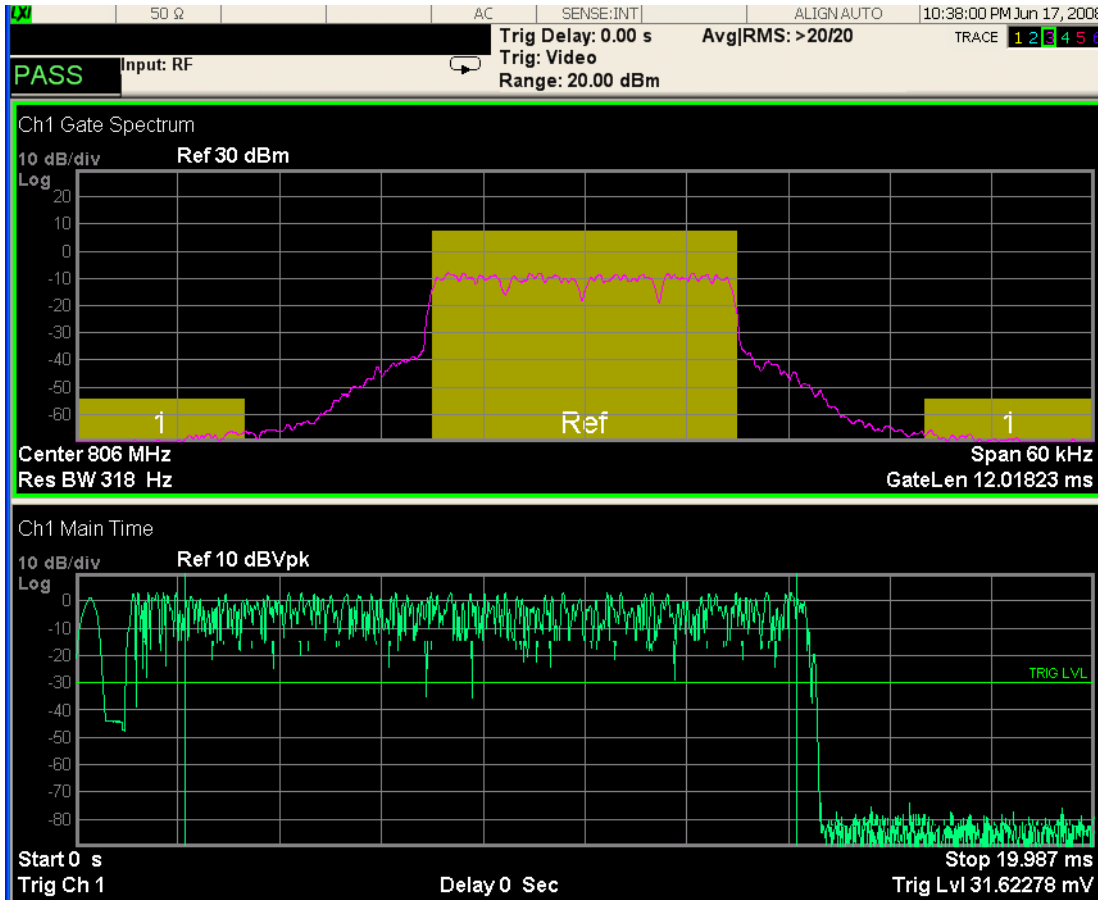

Front Panel Results

There are two sets of test results combined into this measurement.

- "Occupied Bandwidth Results" on page 882
- "Adjacent Channel Power Results" on page 882

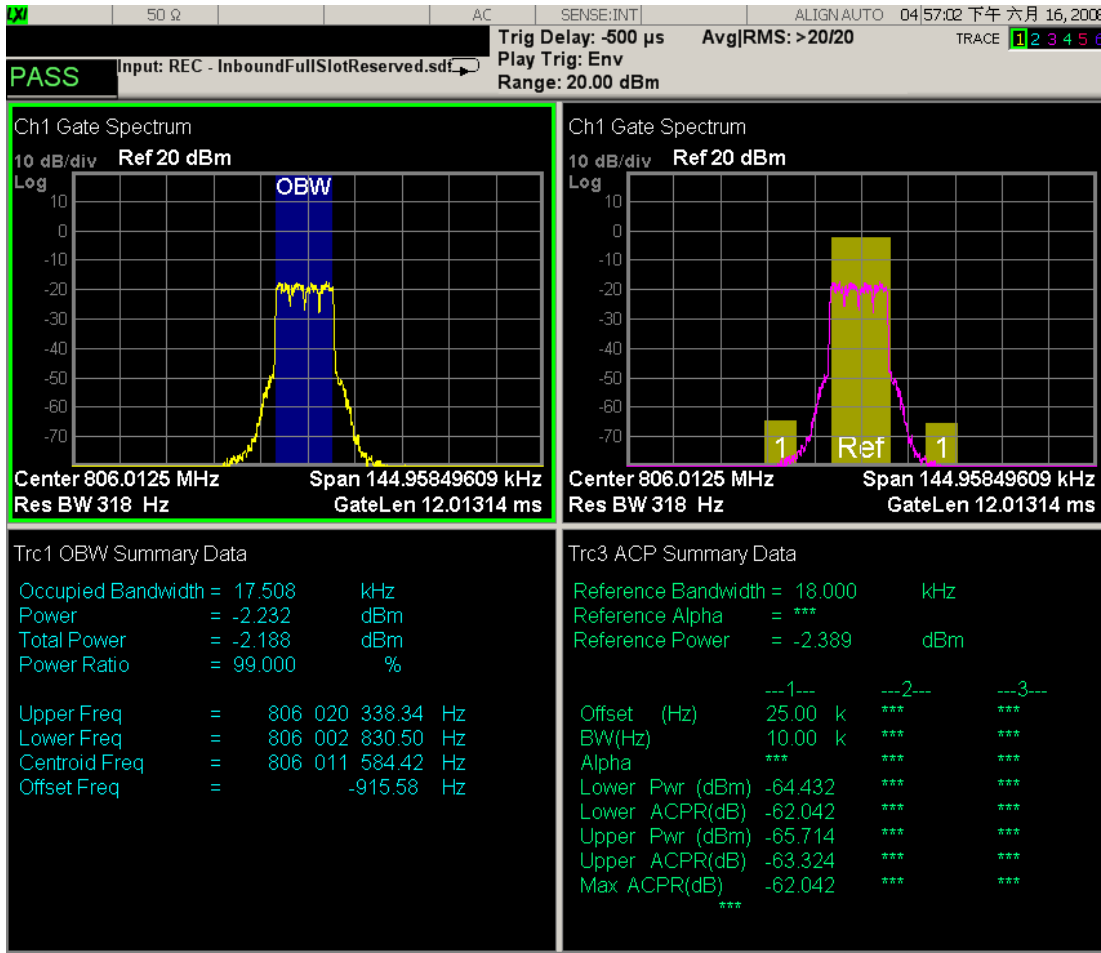

Occupied Bandwidth Results

OBW results are available, including a color bar highlighting the occupied bandwidth, and an OBW summary trace.

Adjacent Channel Power Results

ACP results are available, including color bars on a spectrum trace highlighting the reference channel and the adjacent channels, and an overall ACP summary.

Remote SCPI Commands and Data Queries

Remote SCPI Results described in this section include:

[":READ and :FETCh Commands" on page 1285](#)

[":CALCulate:DATA" on page 1288](#)

[":CALCulate:DATA:RAW" on page 1289](#)

[":CALCulate:DATA:RAW:COMPLex" on page 1290](#)

[":CALCulate:DATA:POINTs commands" on page 1290](#)

[":CALCulate:DATA:TABL commands" on page 1291](#)

[":CALCulate:DATA:HEADer commands" on page 1295](#)

[":CALC:CLIMits:FAIL?" on page 1297](#)

["IQ Data Transfers " on page 1297](#)

VSA based Measurements produce a rich variety of results that can be displayed in any of 4 traces. A result can consist of an array of X,Y trace data that is typically shown as a graph or scalar results that are displayed as a table. The Symbol/Error result that is part of many demodulation measurements actually displays both a trace table (the error statistics) and trace data (the symbol information, which is not graphed but listed). The CALC:<meas>:DATA<n> commands enable you to retrieve any trace data or trace table. This family of commands also enable you to get information about the names of data results available and the units associated with them, as well as names and results of meta-data associated with traces.

Selected results are available via the FETCh and READ SCPI interfaces. These commands refer to data results by arbitrary index number rather than by trace number.

Key Path	SCPI Only
Mode	LTE, LTETDD, IDEN, VSA

:READ and :FETCh Commands

The SCPI MEASure, READ, and FETCh are typically offered by applications with focus on manufacturing test, where a fixed set of desired results is known in advance and seldom changes. The VSA based measurements are many, due to a focus on development. Thus, for most VSA based measurements there is no standard configuration that yields a useful measurement 90% of the time. Thus, the MEASure function is not offered for most measurements in the VSA Application. However, READ and FETCh can be implemented for select results. Note that these results are also still available using the CALC:<meas>:DATA:TABLE family of commands.

ACP and OBW are available in all VSA based measurements. To retrieve the ACP or OBW data, the function must be enabled on a frequency-domain trace and the associated summary data table must be assigned to another trace. Note however, the index n in the following commands is not trace number but an index picked out of the tables shown below.

:FETCh:<meas> [n] ?

:READ:<meas>[n]?

The results available for various values of n are shown below:

Condition	N	Results Returned
Mode = VSA LTE IDEN	Not specified or n=1	Reserved for selected results of VSA measurements. If not used for a particular measurement, no result is returned and error -114 Header suffix out of range is generated.
Mode = VSA LTE IDEN	2 - 50	Reserved for selected results of VSA measurements. If not used for a particular measurement, no result is returned and error -114 Header suffix out of range is generated.
Mode = VSA LTE IDEN, ACP on trace 1	51	ACP Summary for trace 1 Returns 28 comma-separated scalar results, corresponding to the swept ACP results where possible; n/a elsewhere: Returns 28 comma-separated scalar results, in the following order. 1. 0.0 2. Total carrier power (dBm) (same as item 4, because only 1 carrier supported) 3. 0.0 4. Reference carrier power (dBm) 5. Lower offset A - relative power (dB) 6. Lower offset A - absolute power (dBm) 7. Upper offset A - relative power (dB) 8. Upper offset A - absolute power (dBm) 9. Lower offset B - relative power (dB) 10. Lower offset B - absolute power (dBm) 11. Upper offset B - relative power (dB) 12. Upper offset B - absolute power (dBm) ... 21. Lower offset E - relative power (dB) 22. Lower offset E - absolute power (dBm) 23. Upper offset E - relative power (dB) 24. Upper offset E - absolute power (dBm) 25. n/a 26. n/a 27. n/a 28. n/a 29. Overall ACP test result summary (0 indicates at least 1 failure, 1 indicates all passed) If any result is not available, NaN (9.91 E 37) is returned. This can happen if ACP is turned off (all results unavailable) or when an offset is entirely off-screen. In the case where it is partially off-screen, the measured result is returned even though its validity is questionable.
Mode = VSA LTE IDEN, ACP on trace 2	52	ACP Summary for trace 2 see list for trace 1 summary

Mode = VSA LTE IDEN, ACP on trace 3	53	ACP Summary for trace 3 see list for trace 1 summary
Mode = VSA LTE IDEN, ACP on trace 4	54	ACP Summary for trace 4 see list for trace 1 summary
Mode = VSA LTE IDEN, ACP on trace 5	55	ACP Summary for trace 5 see list for trace 1 summary
Mode = VSA LTE IDEN, ACP on trace 6	56	ACP Summary for trace 6 see list for trace 1 summary
	57-60	no result returned; error -114, Header suffix out of range generated
Mode = VSA LTE IDEN, OBW on trace 1	61	OBW Summary for trace 1 Returns 9 comma-separated scalar results corresponding exactly to the items in the OBW Summary trace: 1. OBW (Hz) 2. Pwr (dBm) 3. Total Pwr (dBm) 4. Pwr Ratio (no unit, E.g. 0.99) 5. OBW upper freq (Hz) 6. OBW lower freq (Hz) 7. Centroid freq (Hz) 8. Offset freq (Hz) 9. OBW Test Result (0 for fail, 1 for pass) If the results are not available, NaN (9.91 E 37) is returned.
Mode = VSA LTE IDEN, OBW on trace 2	62	OBW Summary for trace 2 see list for trace 1 summary
Mode = VSA LTE IDEN, OBW on trace 3	63	OBW Summary for trace 3 see list for trace 1 summary
Mode = VSA LTE IDEN, OBW on trace 4	64	OBW Summary for trace 4 see list for trace 1 summary
Mode = VSA LTE IDEN, OBW on trace 5	65	OBW Summary for trace 5 see list for trace 1 summary
Mode = VSA LTE IDEN, OBW on trace 6	66	OBW Summary for trace 6 see list for trace 1 summary

Key Path	SCPI Only
Mode	LTE, LTETDD, IDEN, VSA

:CALCulate:DATA

Once measurement data result is assigned to a trace, the data can be retrieved by using one of the following commands (where <n> is the trace number and <meas> is the current VSA based measurement).

```
:CALC:<meas>:DATA<n>?
```

```
:CALC:<meas>:DATA<n>:RAW?
```

The first form of the command retrieves the data as formatted on the display. For example, if (in a vector measurement) you have the Spectrum result in LogMag format on trace 1, then

```
:CALC:VECT:DATA1?
```

returns an array of spectrum amplitude (Y data) in units of dBm, and

```
:CALC:VECT:DATA1:RAW?
```

returns the Y data in its underlying units of Volts (peak) squared.

(To get data from displayed tables, see [":CALCulate:DATA:TABL commands" on page 1291.](#))

The CALC:<meas>:DATA commands get data from traces. There are many results available from a VSA based measurement and only 4 traces in which to view them. View Preset commands are one way of displaying frequently-used results in standard trace locations. Or you can assign any measurement result to any trace using the softkeys under Trace/Detector, Data. The SCPI command for doing this is:

```
:DISP:<meas>:TRAC<n>:FEED "<data_name>"
```

For example, if (in a vector measurement) you want to view the CCDF result in trace 4, you send:

```
:DISP:VECT:TRAC4:FEED "CCDF1"
```

(If the measurement has not run yet, use INIT:IMM to run it.) Then the CCDF data can be retrieved using

```
CALC:VECT:DATA4?
```

or

```
CALC:VECT:DATA4:RAW?
```

Key Path	SCPI Only
Mode	VSA, LTE, LTETDD, IDEN
Measurement	<meas>:=VECTor ADEMod DDEMod W11A W11B EVM IPOWER IDEMod MOTotalk
Remote Command	:CALCulate:<meas>:DATA[1] 2 ...4? [Y X XY[,OFF ON 0 1] LL UL]
Example	CALC:VECT:DATA1? CALC:VECT:DATA1? Y,ON

	<p>CALC:VECT:DATA1? X CALC:VECT:DATA1? XY</p>
Notes	<p>Query only. This retrieves the data in the designated trace as displayed.</p> <p>For example, if Trace 1 is assigned Spectrum data and formatted as LogMag, then :CALC:VECT:DATA1? returns the Y data in dBm. If the X axis is scaled to show only a portion of the trace data, only the data shown is returned.</p> <p>The numeric format of the returned data is controlled by FORMat[:TRACe][:DATA] command</p> <p>The optional parameters control what data is returned.</p> <p>:CALC:VECT:DATA1? Y is the same as :CALC:VECT:DATA1? with no parameter. It returns an array of Y values.</p> <p>:CALC:VECT:DATA1? X returns an array of X values that correspond to the Y values above.</p> <p>:CALC:VECT:DATA1? XY returns interleaved X and Y data. That is: <x1> <y1> <x2> <y2>...</p> <p>Normally, this command only returns the data between the current X scale limits. If the optional ",OFF" or ",0" switch is included at the end of the command, then all data is returned (regardless of X scaling or the state of All Frequency Points).</p> <p>:CALC:EVM:DATA1? LL UL returns an array of Lower/Upper Limit values when Limit Test is enabled and the trace includes limit values. When Limit Test is disabled or the trace does not include limit value, this query is the same as :CALC:EVM:DATA1? with no parameter.</p> <p>Note: LL and UL are available only for the EVM measurement in the LTE/LTE TDD modes.</p> <p>Note: the X and Y parameters in this command refer to the display's horizontal and vertical axes. Normally the X axis is the independent variable, but if the display format is Constellation or IQ, then CALC:<meas>:DATA<n>? [Y] returns the imaginary part of the data and CALC:<meas>:DATA<n>? X returns the real part of the data. If you want the values of the independent variable, change to a non-vector format (such as Log Mag) and use CALC:<meas>:DATA<n>? X</p>
Initial S/W Revision	Prior to A.02.00
Modified at S/W Revision	A.02.00, A.08.00

:CALCulate:DATA:RAW

Retrieves trace data in its underlying units, before the formatting calculation that converts it to displayed units. Underlying units are typically Volts peak (for signal results) or Volts peak squared (for power results). All data points are returned, whether or not they are displayed.

Key Path	SCPI Only
Mode	VSA, LTE, LTETDD, IDEN
Measurement	<meas>:=VECTor ADEMod DDEMod W11A W11B EVM IPOWER IDEMod MOTotalk
Remote Command	:CALCulate:<meas>:DATA[1] 2 ...4:RAW?
Example	CALC:VECT:DATA1:RAW?
Notes	Query only. This retrieves the unformatted Y data in the designated trace. If Y data is complex, it is returned as <y_real1> <y_imag1> <y_real2> <y_imag2> etc.
Initial S/W Revision	Prior to A.02.00
Modified at S/W Revision	A.02.00

:CALCulate:DATA:RAW:COMPLex

Determines if the data retrieved by CALC:<meas>:DATA:RAW<n>? is complex.

Key Path	SCPI Only
Mode	VSA, LTE, LTETDD, IDEN
Measurement	<meas>:=VECTor ADEMod DDEMod W11A W11B EVM IPOWER IDEMod MOTotalk
Remote Command	:CALCulate:<meas>:DATA[1] 2 ...4:RAW:COMPLex?
Example	CALC:VECT:DATA1:RAW:COMP?
Notes	Query only. Returns 1 if the trace data is complex, 0 if it is real.
Initial S/W Revision	Prior to A.02.00
Modified at S/W Revision	A.02.00

:CALCulate:DATA:POINts commands

Returns the number of points that are returned by

CALCulate:<meas>:DATA<n>?

X axis scaling and whether All Frequency Points is on or off can affect this number.

NOTE For the CALCulate:<meas>:DATA<n>? XY command there are 2 numbers returned per data point.

Key Path	SCPI Only
Mode	VSA, LTE, LTETDD, IDEN
Measurement	<meas>:=VECTor ADEMod DDEMod W11A W11B EVM IPOWER IDEMod MOTotalk
Remote Command	:CALCulate:<meas>:DATA[1] 2 ...4:POINts? [OFF ON 0 1]
Example	CALC:VECT:DATA1:POINts?
Notes	<p>Query only.</p> <p>Use the optional "OFF 0" parameter to determine the number of points that are returned by the optional command form:</p> <p>:CALCulate:<meas>:DATA<n>? Y X XY,OFF 0</p> <p>Note that this is points, not array size. If the XY parameter is included, there are 2 numbers returned per point.</p> <p>(ON or 0, which means use the X-scaled version, is the default and the result is the same as if the parameter is omitted).</p>
Initial S/W Revision	Prior to A.02.00
Modified at S/W Revision	A.02.00

This query returns the number of points that are returned by

CALCulate:<meas>:DATA:RAW<n>?

NOTE

For complex trace data, there are 2 numbers returned per data point.

Key Path	SCPI Only
Mode	VSA, LTE, LTETDD, IDEN
Measurement	<meas>:=VECTor ADEMod DDEMod W11A W11B EVM IPOWER IDEMod MOTotalk
Remote Command	:CALCulate:<meas>:DATA[1] 2 ...4:RAW:POINTs?
Example	CALC:VECT:DATA1:RAW:POINTs?
Notes	Query only.
Initial S/W Revision	Prior to A.02.00
Modified at S/W Revision	A.02.00

:CALCulate:DATA:TABL commands

Some traces have tabular data associated with them. In fact, there may be only a table and no trace data. Each entry in the table consists of a name, a measured value, and units. The units are sometimes not shown. You can programmatically retrieve arrays of all the names, all the values, and all the units of a table. These arrays are all ordered so that corresponding indices have associated values, for example, the 4th name in the names array corresponds to the 4th value in the results array. (Note that the array order cannot be the same as the displayed order.) You can also get a particular result from the table by name. Here is a summary of the remote table data commands.

Command	Returns	Example
CALCulate:<meas>:DATA<n>:TABLe?	All table data results (as an array)	CALC:DDEM:DATA4:TABL?
CALCulate:<meas>:DATA<n>:TABLe? "<name>"	The table data result referred to by name	CALC:DDEM:DATA4:TABL? "EvmPeak"
CALCulate:<meas>:DATA<n>:TABLe:NAMes?	Comma-separated list of all table data names	CALC:DDEM:DATA4:TABL:NAM?
CALCulate:<meas>:DATA<n>:TABLe:UNIT?	Comma-separated list of all table data units	CALC:DDEM:DATA4:TABL:UNIT?

For example, if within the Vector Analysis measurement, you have an OBW Summary Table displayed in trace 2, CALC:DDEM:DATA2:TABL:NAM? would return the table names as follows:

"Obw,Pwr,TotalPwr,PwrRatio,ObwUpper,ObwLower,Centroid,Offset"

and CALC:DDEM:DATA2:TABL:UNIT? would return the units. (A null string means the result is unitless.)

"Hz,Vrms^2,Vrms^2,,Hz,HZ,HZ,HZ"

You can then get all the table results by sending

CALC:DDEM:DATA2:TABL?

Result number 1 is Obw and has units of Hz, result number 2 is Pwr with units of Vrms^2, and so on.

You can also get individual table entries by asking for them by name. Any name returned from the CALC:DDEM:DATA2:TABL:NAM? query can be used. For example, to get TotalPwr you can send the following query:

CALC:DDEM:DATA2:TABL? "TotalPwr"

Query Table Data as Number

Gets data from a table shown in the designated trace. Tables shown on the display typically have the name of a parameter followed by its measured value

Key Path	SCPI Only
Mode	VSA, LTE, LTETDD, IDEN
Measurement	<meas>:=VECTor ADEMod DDEMod W11A W11B EVM IPOWER IDEMod MOTotalk
Remote Command	:CALCulate:<meas>:DATA[1] 2 ...4:TABL[:NUMBer]? [<string>]
Example	CALC:DDEM:DATA2:TABL? "Obw"
Notes	Query only. If sent without a string specifier, this returns the entire table for the designated trace. If sent with a string specifier, returns a specific table entry in the designated trace. The string specifier must be delimited by single or double quotes. A list of valid strings can be obtained using CALC:<meas>:DATA:TABL:NAM? If an invalid string is sent, an error is generated. The returned results are in numeric format, under control of the FORMat[:TRACe][:DATA] command. For table data that is non-numeric, NaN is returned. To get the value of these data, use the CALC:<meas>:DATA2:TABL:STR? command.
Initial S/W Revision	Prior to A.02.00
Modified at S/W Revision	A.02.00

Query Table Data as String

Some tables have string data. The above Trace Table Data query cannot return it and sends NaN in its place. Here is a form of Trace Table Data query that can return string data from tables.

Key Path	SCPI Only
Mode	VSA, LTE, LTETDD, IDEN

Measurement	<meas>:=VECTor ADEMod DDEMod W11A W11B EVM IPOWER IDEMod MOTotalk
Remote Command	:CALCulate:<meas>:DATA[1] 2 ...4:TABLE:STR? [<string>]
Example	CALC:DDEM:DATA2:TABL:STR? "Obw"
Notes	Query only. If sent without a string specifier, this returns the entire table for the designated trace in comma-separated format. If sent with a string specifier, returns a specific table entry in the designated trace. The string specifier must be delimited by single or double quotes. A list of valid strings can be obtained using CALC:<meas>:DATA:TABL:NAM? If an invalid string is sent, an error is generated.
Initial S/W Revision	Prior to A.02.00
Modified at S/W Revision	A.02.00

Query Table Names

Returns a comma-separated list of names of the table data entries for the designated trace. Each of the names can be used (surrounded by quotes or double quotes) as a parameter in the Trace Table Data commands. The names appear in the same order as the corresponding data values returned by the CALC:<meas>:DATA<n>:TABL[:NUMB|STR]? query.

Key Path	SCPI Only
Mode	VSA, LTE, LTETDD, IDEN
Measurement	<meas>:=VECTor ADEMod DDEMod W11A W11B EVM IPOWER IDEMod MOTotalk
Remote Command	:CALCulate:<meas>:DATA[1] 2 ...4:TABLE:NAMes?
Example	CALC:VECT:DATA1:TABL:NAM?
Notes	Query only. This retrieves the names of the table entries for the designated trace. Each of these names can be used in the CALC:<meas>:DATA:TABL? '<name>' command to access a single table entry.
Initial S/W Revision	Prior to A.02.00
Modified at S/W Revision	A.02.00

Query Table Units

Returns a comma-separated list of all the units for the table data entries for the designated trace. If a data result is unitless, an empty string appears in the list for that result. The units appear in the same order as the corresponding data values returned by the CALC:<meas>:DATA<n>:TABL[:NUMB|STR]? query.

Key Path	SCPI Only
Mode	VSA, LTE, LTETDD, IDEN
Measurement	<meas>:=VECTor ADEMod DDEMod W11A W11B EVM IPOWER IDEMod MOTotalk
Remote Command	:CALCulate:<meas>:DATA[1] 2 ...4:TABLE:UNIT?

Example	CALC:VECT:DATA1:TABL:UNIT?
Notes	Query only. This retrieves a list of units for table entries for the designated trace. The units are given in the order that the entries are sent from the :CALC:<meas>:DATA:TABL? command.
Initial S/W Revision	Prior to A.02.00
Modified at S/W Revision	A.02.00

The following table data is available in all measurements when the ACP function is turned on and the associated summary table is shown in a trace:

Result name	Displayed Unit	Remote Name	Remote Unit
Reference Bandwidth	Hz	RefBw	Hz
Reference Alpha		RefAlpha	
Reference Power	dBm	RefPwr	Vrms ²
Offset	Hz	Offset1, Offset2, Offset3, Offset4, Offset5	Hz
BW	Hz	Bw1, Bw2, Bw3, Bw4, Bw5	Hz
Alpha		Alpha1, Alpha2, Alpha3, Alpha4, Alpha5	
Lower Pwr	dBm	LowPwr1, LowPwr2, LowPwr3, LowPwr4, LowPwr5	Vrms ²
Lower ACPR	dB	LowRatio1, LowRatio2, LowRatio3, LowRatio4, LowRatio5	
Upper Pwr	dBm	HiPwr1, HiPwr2, HiPwr3, HiPwr4, HiPwr5	Vrms ²
Upper ACPR	dB	HiRatio1, HiRatio2, HiRatio3, HiRatio4, HiRatio5	
Max ACPR	dB	MaxRatio1, MaxRatio2, MaxRatio3, MaxRatio4, MaxRatio5	

The following table data is available in all measurements when the OBW function is turned on and the associated summary table is shown in a trace:

Result name	Displayed Unit	Remote Name	Remote Unit
Occupied Bandwidth	Hz	Obw	Hz
Power	dBm	Pwr	Vrms ²

Total Power	dBm	TotalPwr	Vrms^2
Power Ratio	%	PwrRatio	
Upper Freq	Hz	ObwUpper	Hz
Lower Freq	Hz	ObwLower	Hz
Centroid Freq	Hz	Centroid	Hz
Offset Freq	Hz	Offset	Hz

:CALCulate:DATA:HEADer commands

Trace data also has meta-data associated with it, called headers, which is visible if you export trace data in text format. The headers have a name and a value that can be obtained from any trace by using the CALCulate:<meas>:DATA:HEADer commands described in this section.

The following Remote Commands are described in this section:

["Query Header Names" on page 1295](#)

["Query Header Type" on page 1295](#)

["Query Header as String" on page 1296](#)

["Query Numeric Header" on page 1296](#)

[":CALC:CLIMits:FAIL?" on page 1297](#)

Query Header Names

Returns a comma-separated list of all the header names associated with the designated trace. Each of the names can be used (surrounded by quotes or double quotes) as a parameter in the other CALC:<meas>:DATA<n>:HEAD queries.

Key Path	SCPI Only
Mode	VSA, LTE, LTETDD, IDEN
Measurement	<meas>:=VECTor ADEMod DDEMod W11A W11B EVM IPOWER IDEMod MOTotalk
Remote Command	:CALCulate:<meas>:DATA[1] 2 ...4:HEADer:NAMes?
Example	CALC:VECT:DATA1:HEAD:NAM?
Notes	Query only. Returns a comma-separated list of header names.
Initial S/W Revision	Prior to A.02.00
Modified at S/W Revision	A.02.00

Query Header Type

Returns whether the designated header on the designated trace can be queried as a number or by a string only.

Key Path	SCPI Only
Mode	VSA, LTE, LTETDD, IDEN
Measurement	<meas>:=VECTor ADEMod DDEMod W11A W11B EVM IPOWER IDEMod MOTotalk
Remote Command	:CALCulate:<meas>:DATA[1] 2 ...4:HEADer:TYPE? <string>
Example	CALC:VECT:DATA1:HEAD:TYPE? 'XDelta'
Notes	Query only. This retrieves the type of the named header for the designated trace. The name (delimited by single or double quotes) is one of the names returned by CALC:<meas>:DATA:HEAD:NAMES? If a valid header name is passed in, the return value from this query is either STR or NUMB. NONE is returned if there is no such header.
Initial S/W Revision	Prior to A.02.00
Modified at S/W Revision	A.02.00

Query Header as String

Gets a header by name from the designated trace and returns its value as a string.

Key Path	SCPI Only
Mode	VSA, LTE, LTETDD, IDEN
Measurement	<meas>:=VECTor ADEMod DDEMod W11A W11B EVM IPOWER IDEMod MOTotalk
Remote Command	:CALCulate:<meas>:DATA[1] 2 ...4:HEADer:STRing? <string>
Example	CALC:VECT:DATA1:HEAD:STR? 'WindowType'
Notes	Query only. This retrieves the named header for the designated trace. The name (delimited by single or double quotes) is one of the names returned by the CALC:<meas>:DATA:HEAD:NAMES? The return value is a string. If the requested header value is a numeric or if there is no such header, an empty string is returned.
Initial S/W Revision	Prior to A.02.00
Modified at S/W Revision	A.02.00

Query Numeric Header

Gets a numeric header by name from the designated trace and returns its value in a format determined by the last FORM command.

Key Path	SCPI Only
Mode	VSA, LTE, LTETDD, IDEN
Measurement	<meas>:=VECTor ADEMod DDEMod W11A W11B EVM IPOWER IDEMod MOTotalk
Remote Command	:CALCulate:<meas>:DATA[1] 2 ...4:HEADer[:NUMBer]? <string>
Example	CALC:VECT:DATA1:HEAD? 'XDelta'
Notes	Query only. This retrieves the named header for the designated trace. This form of the HEAD? query is for headers whose type is NUMB (as determined by :CALC:<meas>:DATA:HEAD:TYPE?).

	The name parameter (delimited by single or double quotes) is one of the names returned by CALC:<meas>:DATA:HEAD:NAMes? The format of the return data is determined by the FORMat [:TRACe][:DATA] command. If used to query a header whose type is STR or there is no such header, NaN (9.91e37) is returned
Initial S/W Revision	Prior to A.02.00
Modified at S/W Revision	A.02.00

:CALC:CLIMits:FAIL?

If one or more ACP or OBW limit tests are active, then the CALC:CLIMits:FAIL? command returns the aggregate pass or fail status.

IQ Data Transfers

Fast capture/transfer of a large amount of IQ data is supported over SCPI. To do this, first set up the desired measurement range, center frequency, span, triggering, and so on. Use a time length that is convenient for setting up the measurement. The time length for the captured data is set indirectly as shown below.

To perform the capture, a typical SCPI sequence is as follows:

```
FCAP:LENG <num_samples>
```

This command sets the length for the next capture in samples. The sample rate is proportional to the current span and can be determined by a SCPI query, for example, in the Vector measurement the query:

```
VECT:SWE:ISR?
```

returns the input sample rate. For the IQAnalyzer (Basic) mode, the sample rate SCPI query is defined as follows:

```
:SPEC:SRAT? (Complex spectrum measurement)
```

```
:WAV:SRAT? (Waveform measurement)
```

Multiply the time length desired for the captured data by this sample rate to get the number of samples needed.

```
INIT:FCAP
```

pauses the current measurement and starts capturing IQ data using the current setup and trigger conditions. (The instrument front panel display does not change nor show the captured data.)

To read the captured data via SCPI in blocks, set the read block size using the command:

```
FCAP:BLOC <num_points_per_read_block>
```

The maximum read block size is typically less than the total fast capture buffer size and can be determined by the query "FCAP:BLOC? MAX". Now you can repeatedly use the following query to read out successive blocks of data:

```
FETC:FCAP?
```

The returned data is formatted according to the most recent :FORMat[:DATA] and :FORMat:BORDER commands. A read pointer that indicates the next sample to be transferred is advanced automatically following each FETC:FCAP? query. This pointer position can be read or manually set via the SCPI commands:

FCAP:POIN?

FCAP:POIN <read_pointer_position>

The fast capture data can be read as long as you use only the commands to set read block size and pointer position, or queries that return the state of the current measurement. The capture data is cleared by any command that changes the measurement state or initiates a new measurement, or via SCPI device clear or :ABORT commands.

Fast capture data word size can be set to either 32 bit or 64 bit via the FCAP:WLEN command. This enables you to trade off precision for total capture length.

Note: when the word size is 32 bit, points can only be retrieved on even sample number boundaries, that is, the pointer and block length should be even numbers. Therefore, when the word size is set to auto, it is recommended that the pointer and block size be only set to even numbers.

Fast Capture Length

Sets the length of the SCPI Fast Capture in samples (points). This is constrained to be an even number.

Query returns the most recent length setting.

Key Path	SCPI Only
Mode	VSA, BASIC
Remote Command	[[:SENSe]:FCAPture:LENGth <integer> [:SENSe]:FCAPture:LENGth?
Example	FCAP:LENG 1000 FCAP:LENG?
Notes	This is affected by the IF path currently used, which can in turn be affected by span. It is also affected by the internal Fast Capture Word Length. The current maximum fast capture length can be found by using the query: FCAP:LENG? MAX Changing the Capture Length after initiating a fast capture clears the capture memory in preparation for a new fast capture of a different length. No Front panel access; SCPI only
Preset	1048576 Samples
Min	2
Max	536 870 908 Samples for internal 40 MHz and 140 MHz options with FCAP:WLEN BIT32
Initial S/W Revision	A.04.00

Fast Capture Word Length

Enables choice of internal fast capture word length. Shorter word length enables twice the time length to be captured at the cost of quantization noise. Note that this does not affect the format of data returned by FETCh:FCAPture, only the internal representation.

Key Path	SCPI Only
Mode	VSA, BASIC
Remote Command	<code>[:SENSe] :FCAPture:WLENgth AUTO BIT32 BIT64</code> <code>[:SENSe] :FCAPture:WLENgth?</code>
Example	FCAP:WLEN AUTO FCAP:WLEN?
Notes	No Front panel access; SCPI only.
Preset	AUTO
Initial S/W Revision	A.04.00

Initiate Fast Capture

Waits for the sweep to trigger and then captures the fast capture data. Sweep is then set to pause. The amount of data captured is controlled by the Fast Capture Length command (FCAP:LENG).

Key Path	SCPI Only
Mode	VSA, BASIC
Remote Command	<code>:INITiate:FCAPture</code>
Example	INIT:FCAP
Notes	This is an overlapped command. It returns immediately, but the capture may not be complete. Use *OPC?, *WAI, or *OPC to determine when the capture is complete.
Notes	No Front panel access; SCPI only This command resets the Fast Capture Pointer to 0
Initial S/W Revision	A.04.00

Fast Capture Block

Sets the block size for the Fast Capture transfer in samples (points). This is the number of points that are returned from the Capture buffer by the FETC:FCAP? command. This is constrained to be an even number.

Query returns most recent block size setting.

Key Path	SCPI Only
Mode	VSA, BASIC
Remote Command	<code>[:SENSe] :FCAPture:BLOCK <integer></code>

	<code>[:SENSe] :FCAPture:BLOCK?</code>
Example	<code>FCAP:BLOC 100</code> <code>FCAP:BLOC?</code>
Notes	No Front panel access. SCPI only.
Preset	1024 Samples
Min	0
Max	131072 or Fast Capture Length, whichever is smaller
Initial S/W Revision	A.04.00

Fast Capture Pointer

Sets the pointer position for the Fast Capture transfer in samples (points). The pointer is incremented by the block size each time the fetch is performed. Preset value (0) is the first sample in the record. Thus repetitive fetches result in contiguous data without needing to increment the pointer over SCPI. This is constrained to be an even number. Query returns most recent pointer setting.

Key Path	SCPI Only
Mode	VSA, BASIC
Remote Command	<code>[:SENSe] :FCAPture:POINter <integer></code> <code>[:SENSe] :FCAPture:POINter?</code>
Example	<code>FCAP:POIN 100</code> <code>FCAP:POIN?</code>
Notes	INIT:FCAP or FCAP:ABOR resets the pointer to 0. No front panel access; SCPI only.
Preset	0 Samples
Min	0
Max	Must be less than the Fast Capture length
Initial S/W Revision	A.04.00

Fetch Fast Capture

Transfers the block of data starting at the pointer. The number of samples transferred is set with the block size. The pointer is incremented by the block size after the fetch.

Key Path	SCPI Only
Mode	VSA, BASIC
Remote Command	<code>:FETCh:FCAPture?</code>
Example	<code>FETC:FCAP?</code>
Notes	The returned data is formatted according to the most recent <code>:FORMat[:DATA]</code> and <code>:FORMat:BORDER</code>

commands.

If the read pointer position plus read block size exceeds the Fast Capture Length, only the data between the pointer and the end of the fast capture buffer are returned, and error -200 is reported.

If Fetch is attempted before an INIT:FCAP or if the captured data is cleared by some other operation (e.g., REC), error -230 is reported and no data is returned.

No front panel access; SCPI only.

Initial S/W Revision	A.04.00
----------------------	---------

Input Sample Rate Query

Returns the complex sample rate in Hz for the current VXA measurement setup conditions. The sample rate can be used to convert between time and number of sample points when using the Fast Capture feature.

Sample rate depends on the settings for `FREQ:SPAN` and `IFPath`. You need to set these before making this query. Though the measurement name is specified in the query, you can only query the currently configured measurement. That is, if you have sent `CONF:VECT`, the query `ADEM:SWE:ISR?` generates an error.

Key Path	SCPI Only
Mode	VSA
Measurement	<meas>:=VECTor ADEMod DDEMod W11A W11B
Remote Command	[:SENSe] :<meas>:SWEp:ISRate?
Example	VECT:SWE:ISR?
Notes	<p>Query returns the complex sample rate in Hz for the current VXA Vector measurement setup conditions.</p> <p>If the measurement in the query is not the active measurement, error -230 is reported and no data is returned.</p> <p>This query is SCPI only, no Front Panel softkey.</p>
Preset	Depends on the licensed IF path
Initial S/W Revision	A.04.00

Parameter Update Enable

Refers only to measurements that use the VSA measurement engine. These are all the measurements in the Vector Signal Analyzer (VXA) Application and the EVM measurement in the LTE Applications.

When a measurement parameter is changed, the new value is used to update any dependent parameters and measurement results. This update process is normally done after every parameter change. This enables visual feedback during interactive GUI operation. However, with SCPI controlled measurements, typically a lot of parameter changes are done at once with the measurement stopped and then the measurement is run once and data retrieved. Here, is not necessary, and the accumulated update time for

each parameter change can become significant. The Parameter Update Enable command enables you to postpone update while sending setup commands and then enable one update to occur just before the measurement.

For example, if you are programmatically setting up a complex LTE measurement, you could save some setup time by first sending EVM:PUPD:ENAB OFF, then sending the whole group of measurement setup commands. When you are done with the setup, send EVM:PUPD:ENAB:ON. This causes the measurement state to be updated with all dependencies resolved. After this, you can read back the parameters' actual values. As a convenience, starting or continuing a measurement (INITiate:REStart, INITiate:IMMEDIATE, INITiate:<meas> or INITiate:RESume) automatically sets <meas>:PUPD:ENAB to ON. So does CONFigure:<meas> or any of the reset and recall state commands.

This command should be used with caution.

It is only valid to turn <meas>:PUPD:ENAB OFF when <meas> is the currently active measurement and the measurement is paused (i.e., INIT:CONT is OFF).

If you try to set and then read back a parameter value while Parameter Update Enable is off, you are not guaranteed to get back the true value that is used in the measurement because no parameter limiting is being done nor are any dependencies between parameters being resolved.

If you try to set coupled parameters independently when Parameter Update Enable is off, then when it is turned on, at most one of the parameter settings remain the same and the others change due to dependency resolution.

Key Path	SCPI Only
Mode	VSA, LTE, LTETDD, IDEN
Measurement	<meas>:=VECTor ADEMod DDEMod W11A W11B EVM IPOWER IDEMod MOTotalk
Remote Command	[:SENSe] : <meas> : PUPDate : ENABle OFF ON 0 1 [:SENSe] : <meas> : PUPDate : ENABle ?
Example	EVM:PUPD:ENAB OFF
Notes	Commands that cause a measurement to run, that switch measurements, or that preset or recall measurement state, set Parameter Update state to ON. These include INIT:IMM, INIT:REST, INIT:RES, INIT:<meas>, and CONF:<meas>.
Preset	1
State Saved	No
Initial S/W Revision	A.03.00

11 Measurement Functions

11 iDEN Demod Measurement

This measurement consists of Test setups for modulation quality (EVM), power vs. time (PvT) and bit error rate (BER). There are three sets of demodulation-based test results combined into this measurement. Each set of results has limit testing to provide a Pass or Fail indication. Additional results can be obtained for each Test.

This topic contains the following sections:

["Measurement Commands for iDEN Demod Measurement "](#) on page 902

["Remote Command Results for iDEN Demod Measurement"](#) on page 903

Measurement Commands for iDEN Demod Measurement

The set of tests enabled do not affect the order, or subopcode, of the remote results. Each available remote result, indexed by subopcode, has a corresponding summary trace. The remote user can use this equivalence by either visually inspecting the corresponding summary trace on the display, or by using CALC:DATA queries which programmatically describe the corresponding summary trace.

```
:CONF:IDEMod  
:FETCh:IDEMod [n]?  
:INITiate:IDEMod  
:MEASure:IDEMod [n]?  
:READ:IDEMod [n]
```

For more measurement related commands, see the SENSE subsystem, and the section "[Remote Measurement Functions](#)" on page 1165.

Remote Command Results for iDEN Demod Measurement

The following table denotes the returned results from the (FETCh|MEASure|READ):IDEMod commands, indexed by subopcode:

Index n	Results Returned
Not specified, or n=1	<p>Returns 23 comma-separated scalar results, corresponding exactly to the items returned in the MQAM Summary trace:</p> <ol style="list-style-type: none"> 1. Total BER (ratio) 2. Peak BER (ratio) 3. Slot location with peak BER, counting from 0 4. Residual BER (ratio) 5. Bits Failed 6. Bits Tested 7. Words Failed (same as Slots for iDEN, 25 kHz WiDEN) 8. Words Tested (same as Slots for iDEN, 25 kHz WiDEN) 9. BER Test Status (0 for invalid, 1 for valid) 10. EVM (ratio) 11. EVM Max (ratio) 12. Slot location with peak EVM, counting from 0 13. Frequency Error (Hz) 14. IQ Offset (dB) 15. IQ Offset Max (dB) 16. Subchannel with peak IQ Offset, counting from 0 17. EVM Test Status (0 for fail, 1 for pass) 18. Slot Power (Vrms): If slot type is WiDEN, this gives composite power 19. Data Power (Vrms) : If slot type is WiDEN, this gives composite power 20. Relative AGC Power (dB) : If slot type is WiDEN, this gives composite power 21. Off Power (Vrms) : If slot type is WiDEN, this gives composite power 22. Relative Off Power (dB) : If slot type is WiDEN, this gives composite power 23. PvT Test Status(0 for fail, 1 for pass) <p>If the results are not available, NaN is returned.</p>
n=2	<p>Returns 19 comma-separated scalar results, corresponding exactly to the items in the BER Overall Summary trace:</p> <ol style="list-style-type: none"> 1. Total BER (ratio) 2. Peak BER (ratio) 3. Slot location with peak BER, counting from 0 4. Residual BER (ratio) 5. Bits Tested 6. Bits Failed 7. Words Tested (same as Slots for iDEN, 25 kHz WiDEN) 8. Words Failed (same as Slots for iDEN, 25 kHz WiDEN)

-
9. Words Erasure Ratio (ratio)
 10. EVM (rms e.g. .03)
 11. EVM Max (rms e.g. .03)
 12. Slot location with Max EVM, counting from 0
 13. Data Power (Vrms): If slot type is WiDEN, this gives composite power
 14. Relative AGC Power Max (dB): If slot type is WiDEN, this gives composite power
 15. Slot location with max Relative AGC Power, counting from 0
 16. Relative AGC Power Min (dB): If slot type is WiDEN, this gives composite power
 17. Slot location with min Relative AGC Power, counting from 0
 18. Relative Off Power Max (dB): If slot type is WiDEN, this gives composite power
 19. Slot location with Off Power Max, counting from 0
 20. BER Test Status (0 for invalid, 1 for valid)
- If the results are not available, NAN is returned.
-

n=3

Returns 34 comma-separated scalar results, corresponding exactly to the items in the Composite Error Summary trace:

1. EVM ratio)
 2. EVM Max (rms e.g. .03)
 3. Slot location with max EVM, counting from 0
 4. Sub-carrier with max EVM, counting from 0
 5. EVM Peak (rms e.g. .03)
 6. Symbol with peak EVM, counting from 0
 7. Subchannel with peak EVM, counting from 0
 8. Sub-carrier with peak EVM, counting from 0
 9. Mag Err (rms e.g. .03)
 10. Mag Err Peak (rms e.g. .03)
 11. Subchannel with max Mag Err, counting from 0
 12. Sub-carrier with max Mag Err, counting from 0
 13. Mag Err Peak (% rms)
 14. Symbol with peak Mag Err, counting from 0
 15. Subchannel with peak Mag Err, counting from 0
 16. Sub-carrier with peak Mag Err, counting from 0
 17. Phase Err (degrees)
 18. Phase Err Peak (degrees)
 19. Subchannel with max Phase Err, counting from 0
 20. Sub-carrier with max Phase Err, counting from 0
 21. Phase Err Peak (degrees)
 22. Symbol with peak Phase Err, counting from 0
 23. Subchannel with peak Phase Err, counting from 0
 24. Sub-carrier with peak Phase Err, counting from 0
 25. Frequency Err (Hz)
 26. Frequency Err Max (Hz)
-

-
- 27. Subchannel with Max Frequency Err, counting from 0
 - 28. Sub-carrier with Max Frequency Err, counting from 0
 - 29. IQ Offset (dB)
 - 30. IQ Offset Max (dB)
 - 31. Subchannel with max IQ Offset, counting from 0
 - 32. Sub-carrier with max IQ Offset, counting from 0
 - 33. Droop Rate (dB/sym)
- EVM Test Result
-

n=4

Returns 59 comma-separated scalar results, corresponding exactly to the items in the PVT Summary trace:

- 1. Slot Power (Vrms) : If slot type is WiDEN, this gives composite power
 - 2. Data Power (Vrms) : If slot type is WiDEN, this gives composite power
 - 3. Relative Slot Power (dB) : If slot type is WiDEN, this gives composite power
 - 4. AGC Power (Vrms) : If slot type is WiDEN, this gives composite power
 - 5. Relative AGC Power (dB) : If slot type is WiDEN, this gives composite power
 - 6. Off Power (Vrms) : If slot type is WiDEN, this gives composite power
 - 7. Relative Off Power (dB) : If slot type is WiDEN, this gives composite power
 - 8. Symbol 0 Time (sec)
 - 9. PVT Test Result (0 for fail, 1 for pass)
 - 10. Unused
 - 11. Unused
 - 12. Unused
 - 13. Unused
 - 14. Unused
 - 15. Carrier Number 0, returns 0. Unused for non-WiDEN Slot Type
 - 16. Slot Power of Carrier 0 (Vrms). Unused for non-WiDEN Slot Type
 - 17. Data Power of Carrier 0 (Vrms), Unused for non-WiDEN Slot Type
 - 18. Relative Slot Power of Carrier 0 (dB), Unused for non-WiDEN Slot Type
 - 19. AGC Power of Carrier 0 (Vrms), Unused for non-WiDEN Slot Type
 - 20. Carrier Number 1, returns 1. Unused for non-WiDEN Slot Type
 - 21. Slot Power of Carrier 1 (Vrms). Unused for non-WiDEN Slot Type
 - 22. Data Power of Carrier 1 (Vrms), Unused for non-WiDEN Slot Type
 - 23. Relative Slot Power of Carrier 1 (dB), Unused for non-WiDEN Slot Type
 - 24. AGC Power of Carrier 1 (Vrms), Unused for non-WiDEN Slot Type
 - 25. Carrier Number 2, returns 2. Unused for non-WiDEN Slot Type
 - 26. Slot Power of Carrier 2 (Vrms). Unused for non-WiDEN Slot Type
 - 27. Data Power of Carrier 2 (Vrms), Unused for non-WiDEN Slot Type
 - 28. Relative Slot Power of Carrier 2 (dB), Unused for non-WiDEN Slot Type
 - 29. AGC Power of Carrier 2 (Vrms), Unused for non-WiDEN Slot Type
 - 30. Carrier Number 3, returns 3. Unused for non-WiDEN Slot Type
 - 31. Slot Power of Carrier 3 (Vrms). Unused for non-WiDEN Slot Type
-

	<p>32. Data Power of Carrier 3 (Vrms), Unused for non-WiDEN Slot Type</p> <p>33. Relative Slot Power of Carrier 3 (dB), Unused for non-WiDEN Slot Type</p> <p>34. AGC Power of Carrier 3 (Vrms), Unused for non-WiDEN Slot Type</p> <p>35. Unused</p> <p>36. Unused</p> <p>37. Unused</p> <p>38. Unused</p> <p>39. Unused</p> <p>40. Carrier Number 0, returns 0. Unused for non-WiDEN Slot Type</p> <p>41. Relative AGC Power of Carrier 0 (dB). Unused for non-WiDEN Slot Type</p> <p>42. Off Power of Carrier 0 (Vrms), Unused for non-WiDEN Slot Type</p> <p>43. Relative Off Power of Carrier 0 (dB), Unused for non-WiDEN Slot Type</p> <p>44. PvT Test Result of Carrier 0. (0 for fail, 1 for pass). Unused for non-WiDEN Slot Type</p> <p>45. Carrier Number 1, returns 1. Unused for non-WiDEN Slot Type</p> <p>46. Relative AGC Power of Carrier 1 (dB). Unused for non-WiDEN Slot Type</p> <p>47. Off Power of Carrier 1 (Vrms), Unused for non-WiDEN Slot Type</p> <p>48. Relative Off Power of Carrier 1 (dB), Unused for non-WiDEN Slot Type</p> <p>49. PvT Test Result of Carrier 1. (0 for fail, 1 for pass). Unused for non-WiDEN Slot Type</p> <p>50. Carrier Number 2, returns 2. Unused for non-WiDEN Slot Type</p> <p>51. Relative AGC Power of Carrier 2 (dB). Unused for non-WiDEN Slot Type</p> <p>52. Off Power of Carrier 2 (Vrms), Unused for non-WiDEN Slot Type</p> <p>53. Relative Off Power of Carrier 2 (dB), Unused for non-WiDEN Slot Type</p> <p>54. PvT Test Result of Carrier 2. (0 for fail, 1 for pass). Unused for non-WiDEN Slot Type</p> <p>55. Carrier Number 3, returns 3. Unused for non-WiDEN Slot Type</p> <p>56. Relative AGC Power of Carrier 3 (dB). Unused for non-WiDEN Slot Type</p> <p>57. Off Power of Carrier 3 (Vrms), Unused for non-WiDEN Slot Type</p> <p>58. Relative Off Power of Carrier 3 (dB), Unused for non-WiDEN Slot Type</p> <p>59. PvT Test Result of Carrier 3. (0 for fail, 1 for pass). Unused for non-WiDEN Slot Type</p> <p>If the results are not available, -999.0 is returned.</p>
n=5	<p>Returns 5 comma-separated scalar results, corresponding exactly to the items in the BER Slot Summary trace:</p> <ol style="list-style-type: none"> 1. Slot BER (dBm) 2. Bits Tested 3. Bits Failed 4. BER Word 5. BER Test Status (0 for invalid, 1 for valid) <p>If the results are not available, NAN is returned.</p>
n=6	<p>Returns 11 comma-separated scalar results, corresponding exactly to the items in the EVM Subchannel Error Summary trace:</p> <ol style="list-style-type: none"> 1. EVM (rms e.g. .03) 2. EVM Peak (rms e.g. .03)

-
3. Symbol with peak EVM, counting from 0
 4. Mag Err (rms e.g. .03)
 5. Mag Err Peak (rms e.g. .03)
 6. Symbol with Peak Mag Err, counting from 0
 7. Phase Err (degrees)
 8. Phase Err Peak (degrees)
 9. Symbol with Peak Phase Err, counting from 0
 10. Frequency Err (Hz)
 11. IQ Offset (dB)
- If no results are available, NAN is returned.
-

NOTE

Note that the PvT Test Status is not included in any tables but is visible on the Instrument front panel and is also accessible using the `CALCulate:CLIMits:FAIL?` query command.

Note that when calculate peak EVM, the pilot and sync symbol's EVM is not calculated.

In addition to these results, other results are defined in Common Functions, Data Queries, MEASure, READ, FETCh in [":CALCulate:DATA" on page 1288](#).

Key Path	Meas
Mode	IDEN
Initial S/W Revision	A.02.00

AMPTD Y Scale (Amplitude)

Accesses a menu that enables you to control input signal conditioning as well as the Y-scaling of trace data. Input signal conditioning actually affects the input signal and the associated measurement quality, whereas Y-scaling is non-destructive of data. Even if the data is scaled so as to be clipped or completely off the display, the marker readouts are still correct and accurate data can still be retrieved via SCPI.

Key Path	Front Panel
Initial S/W Revision	Prior to A.02.00

Y Auto Scale

Changes the Y reference value and Scale per Division so the full trace is displayed without clipping.

Key Path	AMPTD Y Scale
Mode	VSA, LTE, LTETDD, IDEN, LTEAFDD, LTEATDD
Measurement	<meas>:=VECTor ADEMod DDEMod W11A W11B EVM IPOWER IDEMod MOTotalk
Remote Command	:DISPlay:<meas>:TRACe[1] 2 ...4:Y[:SCALE]:AUTO:ONCE
Example	:DISP:VECT:TRAC1:Y:AUTO:ONCE
Initial S/W Revision	Prior to A.02.00
Modified at S/W Revision	A.02.00

Range

Represents the amplitude of the largest sinusoidal signal that could be present within the IF without being clipped by the ADC. For signals with high peak-to-rms ratios, the range may need to exceed the rms signal power by a fair amount to avoid clipping.

Key Path	AMPTD Y Scale
Mode	VSA, LTE, LTETDD, IDEN
Remote Command	[:SENSe] :POWeR [:RF] :RANGe <real> [:SENSe] :POWeR [:RF] :RANGe?
Example	POW:RANG 25 POW:RANG?
Notes	The parameter is interpreted as dBm
Preset	20
State Saved	Saved in instrument state.
Min	depends on model and preamp options
Max	depends on model and preamp options
Initial S/W Revision	Prior to A.02.00
Modified at S/W Revision	A.02.00

Range

This key is only available when I/Q is the selected input. It replaces the Attenuation key in that case.

Each input channel (I and Q) has four internal gain ranges. The maximum allowed voltage in each gain range is slightly more than the nominal value, so the break point between ranges is a couple of millivolts higher than the nominal (setting a peak voltage of 0.502 mV will still map to the 0.5 V Peak range).

Gain Setting	Volts RMS	Volts Peak	Volts Peak - Peak	dBm (50Ω)	Break Point
0 dB	0.7071	1.0	2.0	10	n/a
6 dB	0.3536	0.5	1.0	4	0.502 V Peak
12 dB	0.1768	0.25	0.5	-2	0.252 V Peak
18 dB	0.0884	0.125	0.25	-8	0.127 V Peak

Key Path	AMPTD Y Scale
Notes	Visible only when the selected input is I/Q.
State Saved	No
Readback Text	When Range is Auto, "[Auto]" When Range is Man and I & Q are the same, "[<range value>]" When Range is Man and I & Q are different: "[I: <I range value> Q: <Q range value>]" See I Range and Q Range for the <range value> enumeration definition.
Initial S/W Revision	Prior to A.02.00

Range Auto/Man

The Auto setting for Range causes the range to be set based on the Y Scale settings. When Range is "Auto", the I & Q Range are set based on the top of the Y Scale when the Y scale is in dB units (for example, power), or to the max(abs(top), abs(bottom)) when the Y scale reference is not at the top of the screen.

Not all measurements support Range Auto/Man. If Auto is not supported in the current measurement, this key is grayed out and shows "Man" and MAN is returned to a SCPI query, but this does NOT change the Auto/Man setting for Range. When you go to a measurement that supports Auto, it goes back to Auto if it was previously in Auto mode.

Key Path	AMPTD Y Scale, Range
Scope	Meas Global
Remote Command	[:SENSe] :VOLTagE :IQ :RANGe :AUTO OFF ON 0 1 [:SENSe] :VOLTagE :IQ :RANGe :AUTO ?
Example	Put the I Range and Q Range in manual.

	VOLT:IQ:RANG:AUTO OFF
Dependencies	If Auto is not supported, sending the SCPI command will generate an error.
Couplings	When in Auto, both I Range and Q Range are set to the same value, computed as follows: Maximum absolute value is computed for the Y Scale. The top and bottom of the graph are computed based on Ref Value, Scale/Div, and Ref Position. Formula: YMax = max(abs(top), abs(bottom)). The I Range and Q Range are then set to YMax.
Preset	ON
State Saved	Saved in instrument state
Range	Auto Man
Initial S/W Revision	Prior to A.02.00

Remote Command	[:SENSe] : POWer : IQ : RANGe : AUTO OFF ON 0 1 [:SENSe] : POWer : IQ : RANGe : AUTO ?
Example	Put the I Range and Q Range in manual. POW:IQ:RANG:AUTO OFF
Notes	The POW:IQ:RANG:AUTO is an alternate form of the VOLT:IQ:RANG:AUTO command. This is to maintain consistency with I Range and Q Range, which support both the POWer and VOLTage forms of the command.
Preset	ON
Range	Auto Man
Initial S/W Revision	Prior to A.02.00

I Range

This is the internal gain range for the I channel when Input Path is I Only or I and I/Q, and it is used for both the I and Q channels when the Input Path is I+jQ. See "[I/Q Gain Ranges](#)" on page 1119.

Key Path	AMPTD Y Scale, Range
Remote Command	[:SENSe] : VOLTage : IQ [: I] : RANGe [: UPPer] <voltage> [:SENSe] : VOLTage : IQ [: I] : RANGe [: UPPer] ?
Example	Set the I Range to 0.5 V Peak VOLT:IQ:RANG 0.5 V
Notes	The numeric entries are mapped to the smallest gain range whose break point is greater than or equal to the value, or 1 V Peak if the value is greater than 1 V.
Couplings	When Q Same as I is On, the I Range value will be copied to the Q Range. Changing the value will also set Range = Man.
Preset	1 V Peak
State Saved	Saved in instrument state

Range	1 V Peak 0.5 V Peak 0.25 V Peak 0.125 V Peak
Min	0.125 V
Max	1 V
Initial S/W Revision	Prior to A.02.00

Remote Command	<code>[:SENSe] :POWer :IQ [:I] :RANGe [:UPPer] <amp;l></code> <code>[:SENSe] :POWer :IQ [:I] :RANGe [:UPPer] ?</code>
Example	Set the I Range to 0.5 V Peak when Reference Z is 50Ω, and to 1.0 V Peak when Reference Z is 75Ω. POW:IQ:RANG 4 dBm
Notes	The POWER form of the command is provided for convenience. It maps to the same underlying gain range parameter as the VOLTage form of the command. The Reference Z (not the I channel Input Z) is used to convert the power to peak voltage, which is then used to set the I Range as with the VOLTage form of the command. The power values of the 4 range states (1V Peak, 0.5V Peak, 0.25V Peak, and 0.125V Peak) will vary with Reference Z. Here are some examples: 50Ω: 10, 4, -2, -8 75Ω: 8.2, 2.2, -3.8, -9.8 600Ω: -0.8, -6.8, -12.8, -18.9
Preset	10.0 dBm
Range	-20 dBm to 10 dBm
Min	-20 dBm
Max	10 dBm
Initial S/W Revision	Prior to A.02.00

Q Range Value

This is the internal gain range for the Q channel. See "[I/Q Gain Ranges](#)" on page 1119. The Q Range only applies to Input Path Q Only and Ind I/Q. For input I+jQ the I Range determines both I and Q channel range settings.

Key Path	AMPTD Y Scale, Range
Remote Command	<code>[:SENSe] :VOLTage :IQ :Q :RANGe [:UPPer] <voltage></code> <code>[:SENSe] :VOLTage :IQ :Q :RANGe [:UPPer] ?</code>
Example	Set the Q Range to 0.5 V Peak VOLT:IQ:Q:RANG 0.5 V
Notes	The numeric entries are mapped to the smallest gain range whose break point is greater than or equal to the value, or 1 V Peak if the value is greater than 1 V. The Q Range is only used for Input Path Q Only and Ind I/Q. For input I+jQ the I Range determines both I and Q channel range settings.

Couplings	When Q Same as I is On, the I Range value will be copied to the Q Range and the range value keys are disabled. Changing the value will also set Range = Man.
Preset	1 V Peak
State Saved	Saved in instrument state
Range	1 V Peak 0.5 V Peak 0.25 V Peak 0.125 V Peak
Min	0.125 V
Max	1 V
Initial S/W Revision	Prior to A.02.00

Remote Command	<code>[:SENSe] :POWer:IQ:Q:RANGe[:UPPer] <ampl></code> <code>[:SENSe] :POWer:IQ:Q:RANGe[:UPPer]?</code>
-----------------------	--

Example	Will set the Q Range to 0.5 V Peak when Reference Z is 50Ω, and to 1.0 V Peak when Reference Z is 75Ω. POW:IQ:Q:RANG 4 dBm
----------------	---

Notes	The POWER form of the command is provided for convenience. It maps to the same underlying gain range parameter as the VOLTage form of the command. The Reference Z (not the Q channel Input Z) is used to convert the power to peak voltage, which is then used to set the Q Range as with the VOLTage form of the command. The power values of the 4 range states (1V Peak, 0.5V Peak, 0.25V Peak, and 0.125V Peak) will vary with Reference Z. Here are some examples: 50Ω: 10, 4, -2, -8 75Ω: 8.2, 2.2, -3.8, -9.8 600Ω: -0.8, -6.8, -12.8, -18.9
-------	--

Preset	10.0 dBm
Range	-20 dBm to 10 dBm
Min	-20 dBm
Max	10 dBm
Initial S/W Revision	Prior to A.02.00

Q Same as I

Many, but not all, usages require the I and Q channels to have an identical setup. To simplify channel setup, the Q Same as I will cause the Q channel range to be mirrored from the I channel. That way you only need to set up one channel (the I channel). The I channel values are copied to the Q channel, so at the time Q Same as I is Off, the I and Q channel setups will be identical.

Key Path	AMPTD Y Scale, Range, Q Range
Remote Command	<code>[:SENSe] :VOLTage POWer:IQ:MIRRored OFF ON 0 1</code> <code>[:SENSe] :VOLTage POWer:IQ:MIRRored?</code>

Example	Turn off the mirroring of I Range to Q Range. VOLT:IQ:MIRR OFF POW:IQ:MIRR OFF
Couplings	When On, the I Range value is mirrored (copied) to the Q Range.
Preset	On
State Saved	Saved in instrument state.
Range	On Off
Readback Text	"Q Same as I" when On, otherwise none.
Initial S/W Revision	Prior to A.02.00

I/Q Gain Ranges

See the following sections:

["1 V Peak" on page 1119](#)

["0.5 V Peak" on page 1119](#)

["0.25 V Peak" on page 1119](#)

["0.125 V Peak" on page 1120](#)

1 V Peak

Set the channel gain state to 1 Volt Peak.

Key Path	AMPTD Y Scale, I Range Q Range
Initial S/W Revision	Prior to A.02.00

0.5 V Peak

Set the channel gain state to 0.5 Volt Peak.

Key Path	AMPTD Y Scale, I Range Q Range
Initial S/W Revision	Prior to A.02.00

0.25 V Peak

Set the channel gain state to 0.25 Volt Peak.

Key Path	AMPTD Y Scale, I Range Q Range
Initial S/W Revision	Prior to A.02.00

0.125 V Peak

Set the channel gain state to 0.125 Volt Peak.

Key Path	AMPTD Y Scale, I Range Q Range
Initial S/W Revision	Prior to A.02.00

Select Trace

Displays a menu that enables you to select the trace that is to receive the action of all successive trace-specific commands like scaling, assignment of trace data, and so on. The selected trace is outlined in green and is always visible. While the Select Trace menu is showing, each visible trace is annotated in the middle with its own trace number, as shown in the following figure. The trace number annotations disappear when any other menu is showing.

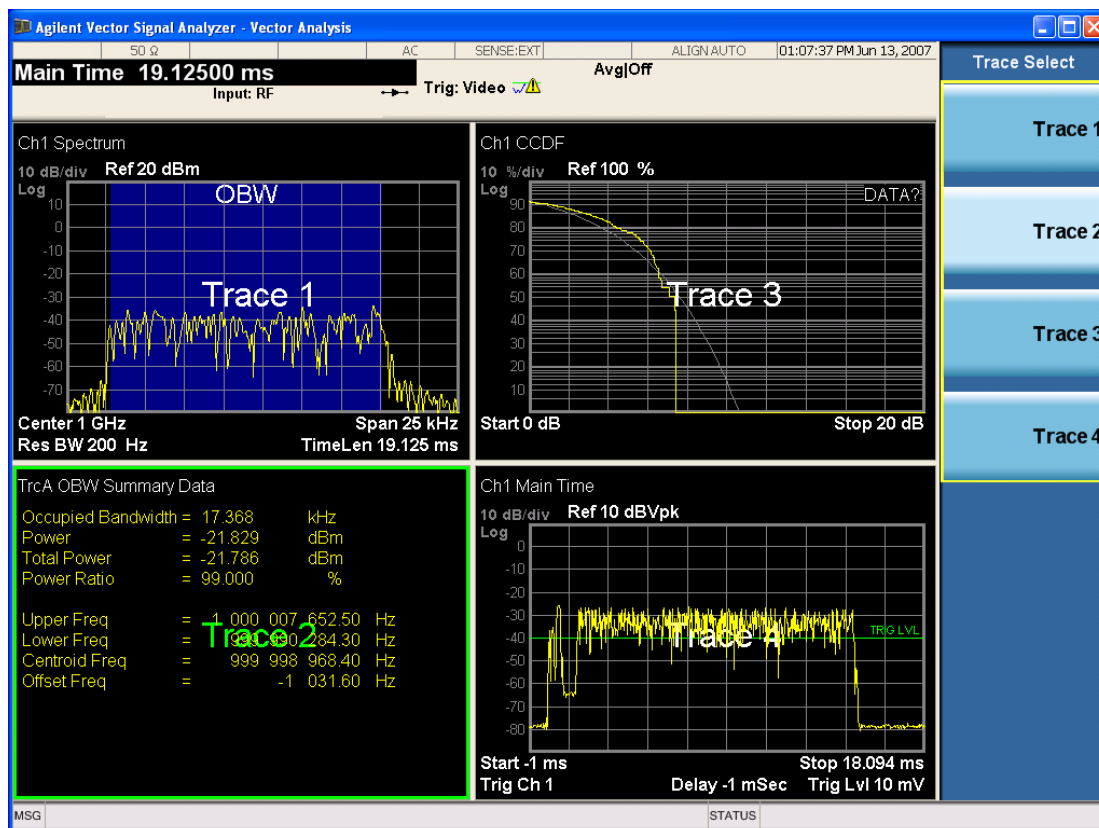

Grid 2x2 layout showing trace annotations when Trace Select dialog is active

This softkey also appears in the X and Y scaling menus. There is only one selected trace at any time. If you change which trace is selected, that change is reflected in this softkey/menu wherever it appears. Other ways to select a trace include use of the Next Window key, clicking within a trace window with a mouse cursor, and issuing a trace-specific SCPI command.

There is no SCPI command associated with this function. Instead, SCPI commands that are trace-specific have an index on the TRACe node that determines the selected trace. Using such a command has the side

effect that the trace addressed by the SCPI command becomes the selected trace for any front panel interaction.

Key Path	Trace/Detector or Span X Scale or AMPTD Y Scale
Mode	VSA, LTE, LTETDD, IDEN, LTEAFDD, LTEATDD
Notes	No SCPI. Front panel only.
Couplings	Affects any trace-specific commands
Range	Trace 1 Trace 2 Trace 3 Trace 4 Trace 5 Trace 6
Readback Text	Trace <n>
Initial S/W Revision	Prior to A.02.00
Modified at S/W Revision	A.02.00

Couple Ref to Range

When Couple Ref to Range is on, Y scaling is adjusted when the Range changes. For example, on traces with Y units of dBm, the reference value changes by the same amount in dB as the Range does. On a trace with Y units of Volts, the Per Division setting changes by a factor of approximately 1.25 when the Range changes by 2 dB. This function can be turned on or off for each individual trace.

Key Path	AMPTD Y Scale
Mode	VSA, LTE, LTETDD, IDEN, LTEAFDD, LTEATDD
Measurement	<meas>:=VECTor ADEMod DDEMod W11A W11B EVM IPOWER IDEMod MOTotalk
Remote Command	:DISPlay:<meas>:TRACe [1] 2 . . . 4 : Y [: SCALE] : RLEVEL : AUTO OFF ON 0 1 :DISPlay:<meas>:TRACe [1] 2 . . . 4 : Y [: SCALE] : RLEVEL : AUTO ?
Example	DISP:VECT:TRAC1:Y:RLEV:AUTO ON DISP:VECT:TRAC1:Y:RLEV:AUTO?
Notes	Range coupling is not available for Phase and Group delay traces.
Preset	1
State Saved	Saved in instrument state.
Range	On Off
Initial S/W Revision	Prior to A.02.00
Modified at S/W Revision	A.02.00

Y Reference Value

Controls the Y value of the selected trace at the Reference Position. It has no effect on hardware input settings.

See "[Y Reference: Position](#)" on page 1122 for more details.

Key Path	AMPTD Y Scale
----------	---------------

Mode	VSA, LTE, LTETDD, IDEN, LTEAFDD, LTEATDD
Measurement	<meas>:=VECTor ADEMod DDEMod W11A W11B EVM IPOWER IDEMod MOTotalk
Remote Command	:DISPlay:<meas>:TRACe[1] 2 ...4:Y[:SCALE]:RLEVel <real> :DISPlay:<meas>:TRACe[1] 2 ...4:Y[:SCALE]:RLEVel?
Example	DISP:VECT:TRAC:Y:RLEV 20 DISP:VECT:TRAC:Y:RLEV?
Couplings	None. This does not affect any hardware input settings.
Preset	Depends on trace
State Saved	Saved in instrument state.
Min	-9.9E+37
Max	9.9E+37
Initial S/W Revision	Prior to A.02.00
Modified at S/W Revision	A.02.00

Y Scale Per Division

Controls the Y scale per division of the selected trace.

Key Path	AMPTD Y Scale
Mode	VSA, LTE, LTETDD, IDEN, LTEAFDD, LTEATDD
Measurement	<meas>:=VECTor ADEMod DDEMod W11A W11B EVM IPOWER IDEMod MOTotalk
Remote Command	:DISPlay:<meas>:TRACe[1] 2 ...4:Y[:SCALE]:PDIVision <real> :DISPlay:<meas>:TRACe[1] 2 ...4:Y[:SCALE]:PDIVision?
Example	DISP:VECT:TRAC:Y:PDIV 10 DISP:VECT:TRAC:Y:PDIV?
Couplings	None.
Preset	Depends on trace
State Saved	Saved in instrument state.
Min	-9.9E+37
Max	9.9E+37
Initial S/W Revision	Prior to A.02.00
Modified at S/W Revision	A.02.00

Y Reference: Position

Sets the position of the reference line for Y scaling for the selected trace. It can be set to the top, bottom, or center of the grid.

Key Path	AMPTD Y Scale
Mode	VSA, LTE, LTETDD, IDEN, LTEAFDD, LTEATDD
Measurement	<meas>:=VECTor ADEMod DDEMod W11A W11B EVM IPOWER IDEMod MOTotalk
Remote Command	:DISPlay:<meas>:TRACe[1] 2 ...4:Y[:SCALe]:RPOSition TOP CENTer BOTTom :DISPlay:<meas>:TRACe[1] 2 ...4:Y[:SCALe]:RPOSition?
Example	DISP:VECT:TRAC1:Y:RPOS TOP DISP:VECT:TRAC1:Y:RPOS?
Couplings	Changing trace format or data can affect this. Each format "remembers" its reference position.
Preset	Depends on trace format and trace data. Top for LogMag or most LinearMag traces, middle for Real, Imaginary, Vector displays, Eye diagrams, Phase, Delay, Bottom for Linear Mag EVM.
State Saved	Saved in instrument state.
Range	Top Ctr Bottom
Initial S/W Revision	Prior to A.02.00
Modified at S/W Revision	A.02.00

Reference Line

Controls whether the Y reference line is visible or not.

Key Path	AMPTD Y Scale
Mode	VSA, LTE, LTETDD, IDEN, LTEAFDD, LTEATDD
Measurement	<meas>:=VECTor ADEMod DDEMod W11A W11B EVM IPOWER IDEMod MOTotalk
Remote Command	:DISPlay:<meas>:TRACe[1] 2 ...4:RLINE OFF ON 0 1 :DISPlay:<meas>:TRACe [1] 2 ...4:RLINe?
Example	DISP:VECT:TRAC1:RLIN ON DISP:VECT:TRAC1:RLIN?
Preset	OFF
State Saved	Saved in instrument state.
Initial S/W Revision	Prior to A.02.00
Modified at S/W Revision	A.02.00

Y Unit Preference

Displays a menu that enables you to set the preferred Y unit for the selected trace. You can select Peak, RMS, Power units, or an automatic selection. The automatic selection uses Power units for frequency domain data and Peak units for time domain data.

Key Path	AMPTD Y Scale
----------	---------------

Mode	VSA, LTE, LTETDD, IDEN, LTEAFDD, LTEATDD
Measurement	<meas>:=VECTor ADEMod DDEMod W11A W11B EVM IPOWER IDEMod MOTotalk
Remote Command	:DISPlay:<meas>:TRACe [1] 2 ...4:Y:UNIT:PREFerence AUTO PEAK RMS POWer MRMS :DISPlay:<meas>:TRACe [1] 2 ...4:Y:UNIT:PREFerence?
Example	DISP:VECT:TRAC1:Y:UNIT:PREF PEAK DISP:VECT:TRAC1:Y:UNIT:PREF?
Preset	AUTO
State Saved	Saved in instrument state.
Range	AUTO PEAK RMS POW MRMS
Readback Text	Auto Peak RMS Power mRMS
Initial S/W Revision	Prior to A.02.00
Modified at S/W Revision	A.02.00

The following SCPI only command can be used to determine exactly which Y unit was chosen based on the setting of the above:

Key Path	AMPTD Y Scale
Mode	VSA, LTE, LTETDD, IDEN
Measurement	<meas>:=VECTor ADEMod DDEMod W11A W11B EVM IPOWER IDEMod MOTotalk
Remote Command	:DISPlay:<meas>:TRACe [1] 2 ...4:Y:UNIT?
Example	DISP:VECT:TRAC1:Y:UNIT?
Initial S/W Revision	Prior to A.02.00
Modified at S/W Revision	A.02.00

Y Log Ratio

Enabled if the Trace Format is set to LogMag (Linear Unit). In this format type, you set the Y Log Ratio instead of Y Scale Per Division to determine Y scaling. It sets the ratio of the top of the Y axis to the bottom.

Key Path	AMPTD Y Scale
Mode	VSA, LTE, LTETDD, IDEN, LTEAFDD, LTEATDD
Measurement	<meas>:=VECTor ADEMod DDEMod W11A W11B EVM IPOWER IDEMod MOTotalk
Remote Command	:DISPlay:<meas>:TRACe [1] 2 ...4:Y:LRATio <real> :DISPlay:<meas>:TRACe [1] 2 ...4:Y:LRATio?
Example	DISP:VECT:TRAC1:Y:LRAT 10000 DISP:VECT:TRAC1:Y:LRAT?
Notes	This is grayed out if the trace format is not Log Mag (linear unit).

Preset	100000
State Saved	Saved in instrument state.
Min	1.001
Max	100e6
Initial S/W Revision	Prior to A.02.00
Modified at S/W Revision	A.02.00

Vector Horiz Center

Sets the position of the origin for Vector trace formats such as I-Q and Constellation. When using one of these formats, you set the vertical (imaginary) axis scaling with the Y Reference Value, Y Reference Position, and Y Scale Per Division properties. The scaling of the horizontal axis is set to maintain an aspect ratio of 1:1.

Key Path	AMPTD Y Scale
Mode	VSA, LTE, LTETDD, IDEN, LTEAFDD, LTEATDD
Measurement	<meas>:=VECTor ADEMod DDEMod W11A W11B EVM IPOWER IDEMod MOTotalk
Remote Command	:DISPlay:<meas>:TRACe[1] 2 ...4:VHCenter <real> :DISPlay:<meas>:TRACe[1] 2 ...4:VHCenter?
Example	DISP:DDEM:TRAC1:VHC 0.2 DISP:DDEM:TRAC1:VHC?
Preset	0
State Saved	Saved in instrument state.
Min	-9.9e37
Max	9.9e37
Initial S/W Revision	Prior to A.02.00
Modified at S/W Revision	A.02.00

Copy Y Scale

Copies the following Y scaling information from the selected trace to another:

- Y reference Position
- Y Reference Value
- Y Unit Preference
- Vector Horiz Center
- Couple Ref to Range
- Y Log Ratio

11 iDEN Demod Measurement
AMPTD Y Scale (Amplitude)

- Y Reference Line

This is a front-panel only function.

Key Path	AMPTD Y Scale, Y Axis Scaling
Mode	VSA, LTE, LTETDD, IDEN, LTEAFDD, LTEATDD
Initial S/W Revision	Prior to A.02.00
Modified at S/W Revision	A.02.00

Auto Couple

The Auto Couple feature provides a quick and convenient way to automatically couple multiple instrument settings. This helps ensure accurate measurements and optimum dynamic range. When the Auto Couple feature is activated, either from the front panel or remotely, all parameters of the current measurement that have an Auto/Manual mode are set to Auto mode and all measurement settings dependent on (or coupled to) the Auto/Man parameters are automatically adjusted for optimal performance.

However, the Auto Couple key actions are confined to the current measurement only. It does not affect other measurements in the mode, and it does not affect markers, marker functions, or trace or display attributes.

See "[More Information](#)" on page 921

Key Path	Front-panel key
Remote Command	:COUPle ALL NONE
Example	:COUP ALL
Notes	:COUPle ALL puts all Auto/Man parameters in Auto mode (equivalent to pressing the Auto Couple key). :COUPLE NONE puts all Auto/Man parameters in manual mode. It decouples all the coupled instrument parameters and is not recommended for making measurements.
Initial S/W Revision	Prior to A.02.00

More Information

There are two types of functions that have Auto/Manual modes.

Auto/Man Active Function keys

An Auto/Man toggle key controls the binary state associated with an instrument parameter by toggling between Auto (where the parameter is automatically coupled to the other parameters it is dependent upon) and Man (where the parameter is controlled independent of the other parameters), as well as making the parameter the active function. The current mode is indicated on the softkey with either Auto or Man underlined as illustrated below.



Auto/Man 1-of-N keys

An Auto/Man 1-of-N key allows you to manually pick from a list of parameter values, or place the function in Auto, in which case the value is automatically selected (and indicated) as shown below. If in Auto, Auto is underlined on the calling key. If in manual operation, manual is indicated on the calling key. But the calling key does not actually toggle the function, it simply opens the menu.

11 iDEN Demod Measurement
Auto Couple

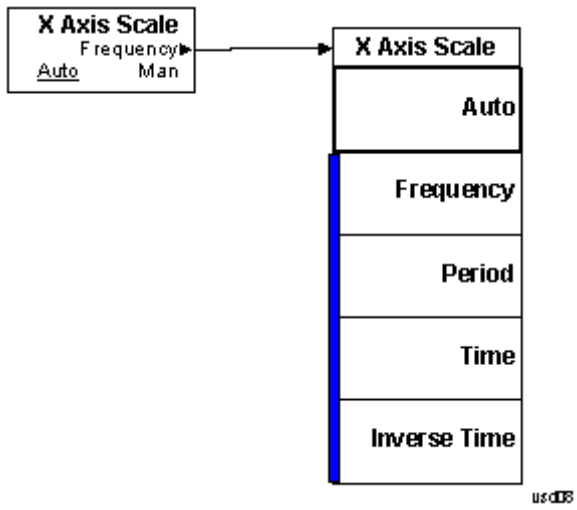

BW (Bandwidth)

Displays a menu that enables you to control the resolution bandwidth of the spectrum measurement result, as well as the shape of the resolution bandwidth filter (controlled by the FFT windowing function).

Key Path	Front Panel
Mode	VSA, LTE, LTETDD, IDEN
Initial S/W Revision	Prior to A.02.00
Modified at S/W Revision	A.02.00

FFT Window

Displays a menu that enables you to choose the Window function that is applied to the time data prior to the FFT calculation used for Spectrum and PSD displays. Four windows are available.

Window name	Common usage	Normalized ENBW (Hz-s)
Uniform	Transient or self-windowing signals, signals that are periodic within a time record length.	1.0
Hanning	Frequency resolution	1.5
Gaussian	High dynamic range	2.21536
Flat Top	High amplitude accuracy	3.8194

The normalized ENBW is the equivalent noise bandwidth, that is, the width of a rectangular filter that passes the same amount of white noise as the window. It is used to define the resolution bandwidth.

Key Path	BW
Mode	VSA, LTE, LTETDD, IDEN
Measurement	<meas>:=VECTor ADEMod DDEMod W11A W11B EVM IPOWER IDEMod MOTotalk
Remote Command	[:SENSe] :<meas>:FFT:WINDow[:TYPE] UNIFORM HANNing GAUSSian FLATtop [:SENSe] :<meas>:FFT:WINDow[:TYPE] ?
Example	VECT:FFT:WIND GAUS VECT:FFT:WIND?
Couplings	See Res BW and Res BW Coupling
Preset	FLAT
State Saved	Saved in instrument state.
Range	Uniform Hanning Gaussian (High Dyn Rng) Flat Top (High Amptd Accy)
Readback Text	Uniform Hanning Gaussian Flat Top
Initial S/W Revision	Prior to A.02.00
Modified at S/W Revision	A.02.00

11 iDEN Demod Measurement
BW (Bandwidth)

Cont (Continuous Measurement/Sweep)

Sets the analyzer for Continuous measurement operation. The single/continuous state is Meas Global so the setting will affect all measurements. If you are Paused, pressing Cont does a Resume.

Key Path	Front-panel key
Remote Command	:INITiate:CONTinuous OFF ON 0 1 :INITiate:CONTinuous?
Example	:INIT:CONT 0 puts analyzer in Single measurement operation. :INIT:CONT 1 puts analyzer in Continuous measurement operation
Preset	ON (Note that SYST:PRESet sets INIT:CONT to ON but *RST sets INIT:CONT to OFF)
State Saved	Saved in instrument state
Backwards Compatibility Notes	For Spectrum Analysis mode in ESA and PSA, there is no Cont hardkey, instead there is a Sweep Single/Cont key. In these analyzers, switching the Sweep Single/Cont key from Single to Cont restarts averages (displayed average count reset to 1), but does not restart Max Hold and Min Hold. The X-Series has Single and Cont keys in place of the SweepSingleCont key. In the X-Series, if in single measurement, the Cont key (and INIT:CONT ON) switches to continuous measurement, but never restarts a measurement and never resets a sweep.
Initial S/W Revision	Prior to A.02.00

In Swept SA Measurement (Spectrum Analysis Mode):

The analyzer takes repetitive sweeps, averages, measurements, etc., when in Continuous mode. When the average count reaches the Average/Hold Number the count stops incrementing, but the analyzer keeps sweeping. See the Trace/Detector section for the averaging formula used both before and after the Average/Hold Number is reached. The trigger condition must be met prior to each sweep. The type of trace processing for multiple sweeps, is set under the Trace/Detector key, with choices of Trace Average, Max Hold, or Min Hold.

In Other Measurements/Modes:

With Avg/Hold Num (in the Meas Setup menu) set to Off or set to On with a value of 1, a sweep is taken after the trigger condition is met; and the analyzer continues to take new sweeps after the current sweep has completed and the trigger condition is again met. However, with Avg/Hold Num set to On with a value >1, multiple sweeps (data acquisitions) are taken for the measurement. The trigger condition must be met prior to each sweep. The sweep is not stopped when the average count k equals the number N set for Avg/Hold Num is reached, but the number k stops incrementing. A measurement average usually applies to all traces, marker results, and numeric results. But sometimes it only applies to the numeric results.

If the analyzer is in Single measurement, pressing the Cont key does not change k and does not cause the sweep to be reset; the only action is to put the analyzer into Continuous measurement operation.

If it is already in continuous sweep:

the INIT:CONT 1 command has no effect

11 iDEN Demod Measurement
Cont (Continuous Measurement/Sweep)

the INIT:CONT 0 command will place the analyzer in Single Sweep but will have no effect on the current sequence until $k = N$, at which point the current sequence will stop and the instrument will go to the idle state.

File

See "File" on page 236

FREQ Channel

Displays a menu that enables you to set center frequency, start frequency, stop frequency, and center frequency step. Pressing the Freq hardkey changes the active function to Center Frequency.

The frequency parameters for any vector measurement consist of two pairs of properties: Center Frequency and Span or Start Frequency and Stop Frequency. These behave much as they do in any other application, but there is the additional constraint that the span is limited to much less than the center frequency range.

If you change center frequency, the start and stop frequencies change by the same amount.

If you change span, start frequency and stop frequency are changed by 1/2 the span change.

If you change start frequency, stop frequency remains fixed and span and center frequency are refigured accordingly. Changing stop frequency has similar behavior.

Limits:

If you change the start frequency such that it equals or exceeds the stop frequency, the new start frequency is accepted if possible and the stop frequency is set to min span above the start. Similarly if you attempt to set the stop below the start, the start frequency moves to a min span below the new stop frequency.

If you reduce the start frequency beyond a max span below the stop, the stop frequency is "dragged along" such that it is a max span above the new start frequency, and similarly increasing the stop frequency drags the start frequency along if you attempt to increase the span beyond the maximum.

Stop frequency can be 1/2 span above the maximum center frequency, but frequency-domain traces are blanked above the maximum center frequency.

Start frequency can be 1/2 span below the minimum center frequency, but frequency-domain traces are blanked below the minimum center frequency.

Key Path	Front Panel
Mode	VSA, LTE, LTETDD, IDEN
Initial S/W Revision	Prior to A.02.00
Modified at S/W Revision	A.02.00

Center Freq

Sets the frequency of the display Center.

Key Path	FREQ Channel
Mode	VSA, LTE, LTETDD, IDEN
Remote Command	[:SENSe] :FREQuency:CENTer <freq> [:SENSe] :FREQuency:CENTer?
Example	FREQ:CENT 985 MHZ FREQ:CENT?

Couplings	Start Freq, Stop Freq, and Span. See " FREQ Channel " on page 1134 for more details.
Preset	1 GHz
State Saved	Saved in instrument state.
Min	0 Hz
Max	Depends on frequency range option.
Initial S/W Revision	Prior to A.02.00
Modified at S/W Revision	A.02.00

Start Freq

Sets the frequency of the display Start.

Key Path	FREQ Channel
Mode	VSA, IDEN
Remote Command	<code>[:SENSe] :FREQuency:STARt <freq></code> <code>[:SENSe] :FREQuency:STARt?</code>
Example	FREQ:STAR 980 MHz FREQ:STAR?
Couplings	Stop Freq, Center Freq, and Span. See " FREQ Channel " on page 1134 for more details.
Preset	Depends on span option. It is 1/2 max span below 1 GHz.
State Saved	Saved in instrument state.
Min	-9.9e37
Max	9.9e37
Initial S/W Revision	Prior to A.02.00
Modified at S/W Revision	A.02.00

Stop Freq

Sets the frequency of the display Stop.

Key Path	FREQ Channel
Mode	VSA, IDEN
Remote Command	<code>[:SENSe] :FREQuency:STOP <freq></code> <code>[:SENSe] :FREQuency:STOP?</code>
Example	FREQ:STOP 990 MHz FREQ:STOP?
Couplings	Start Freq, Center Freq, and Span. See " FREQ Channel " on page 1134 for more details.
Preset	Depends on span option. It is 1/2 max span above 1 GHz.

State Saved	Saved in instrument state.
Min	-9.9e37
Max	9.9e37
Initial S/W Revision	Prior to A.02.00
Modified at S/W Revision	A.02.00

CF Step

Sets the amount the center frequency changes if it is the active function when you press the Up or Down arrow key. Note: the start and stop frequency also changes by the amount of the CF Step if the Up/Down arrow keys are used to change them; but the key is mainly used in connection with stepping the center frequency, so the legacy key name has been retained. The step size in Auto mode is 1/10th the span. It can be set to any value in manual mode.

Key Path	FREQ Channel
Mode	VSA, LTE, LTETDD, IDEN
Remote Command	[:SENSe]:FREQuency:CENTer:STEP[:INCRement] <freq> [:SENSe]:FREQuency:CENTer:STEP[:INCRement]? [:SENSe]:FREQuency:CENTer:STEP:AUTO OFF ON 0 1 [:SENSe]:FREQuency:CENTer:STEP:AUTO?
Example	FREQ:CENT:STEP 1 MHZ FREQ:CENT:STEP? FREQ:CENT:STEP:AUTO ON FREQ:CENT:STEP:AUTO?
Couplings	1/10th Span when auto is turned on.
Preset	Depends on span option; 1/10th default span.
State Saved	Saved in instrument state.
Min	-9.9e37
Max	9.9e37
Initial S/W Revision	Prior to A.02.00
Modified at S/W Revision	A.02.00

Input/Output

See "Input/Output" on page 146

Marker

Displays the Marker menu. A marker can be placed on a trace to precisely determine the value of the trace data at the marker position. Markers can also be used in pairs to read the difference (or delta) between two data points. They can also be used to make power calculations over a band of frequencies or a time interval. See "[Marker Function](#)" on page 1157 for more details.

The functions in this menu include a 1-of-N selection of the control mode **Normal**, **Delta**, **Fixed**, or **Off** for the selected marker. The control mode is described below.

Pressing **Marker** always makes the selected maker's X position the active function.

If the currently selected marker is **Off**, pressing **Marker** sets it to **Normal** mode and places it at the center of the screen on the currently selected trace.

As a convenience, if there are no markers displayed on the current trace, pressing the marker hardkey (whenever the marker menu is already showing) selects the lowest numbered marker that is currently off and turns it on in normal mode on the selected trace. In other words, pressing the Marker hardkey twice always turns on a marker on the selected trace if none was turned on before.

Key Path	Front Panel
Mode	VSA, LTE, LTETDD, IDEN,LTEAFDD,LTEATDD
Initial S/W Revision	Prior to A.02.00
Modified at S/W Revision	A.02.00

Select Marker

Specifies the selected marker. The selected marker is the one that is affected by the marker position and properties settings, peak search, and other marker functions. Several menus have a Select Marker key for convenience. Marker selection using any one of these is reflected in all others, in other words, there is only one selected marker for the whole measurement. If all markers are off, then marker 1 becomes the selected marker.

As a convenience, if no markers are displayed on the selected trace, selecting a marker that is off automatically turns it on in normal mode on the selected trace.

There is no SCPI function for selecting a marker. Instead, SCPI functions can explicitly include the index of the marker for which they are to apply. (Most SCPI marker functions that affect the state of a marker also make it the selected marker for front panel commands.)

Key Path	Marker or Marker> or Marker Function or Peak Search
Mode	VSA, LTE, LTETDD, IDEN,LTEAFDD,LTEATDD
State Saved	No
Range	1 2 3 4 5 6 7 8 9 10 11 12
Initial S/W Revision	Prior to A.02.00
Modified at S/W Revision	A.02.00

Control Mode

Pressing **Normal**, **Delta**, **Fixed**, or **Off** sets the control mode of the selected marker. The current control mode is shown by highlighting the appropriate key.

The SCPI command in the table below selects the marker and sets the marker control mode as described under "[Normal \(Position\)](#)" on page 1139, "[Delta](#)" on page 1140, "[Fixed](#)" on page 1140 and "[Off](#)" on page 1141. All interactions and dependencies detailed under the key description are enforced when the remote command is sent.

Key Path	Marker
Mode	VSA, LTE, LTETDD, IDEN,LTEAFDD,LTEATDD
Measurement	<meas>:=VECTor ADEMod DDEMod W11A W11B EVM IPOWER IDEMod MOTotalk
Remote Command	:CALCulate:<meas>:MARKer[1] 2 ...12:MODE POSition DELTA FIXEd =OFF :CALCulate:<meas>:MARKer[1] 2 ...12:MODE?
Example	CALC:VECT:MARK1:MODE POS CALC:VECT:MARK1:MODE?
Couplings	When Delta mode is selected or when the mode is changed from Delta to Off, the marker relative to the selected marker can be affected as described in the text descriptions below.
Preset	=OFF
State Saved	Saved in instrument state.
Range	Normal Delta Fixed Off
Initial S/W Revision	Prior to A.02.00
Modified at S/W Revision	A.02.00

Normal (Position)

Reports the trace data value (Y value) at a particular point on a trace. The marker's absolute X (and Z) position is specified by you in displayed units. The marker symbol appears on the trace at the specified position and tracks the absolute Y value at that position as it changes from scan to scan. The absolute Y value is displayed in the marker readout area. In older instruments this was called Position mode, and the designation can still be used for backward compatibility.

For Control Mode SCPI command information see: "[Control Mode](#)" on page 1139

Key Path	Marker
Mode	VSA, LTE, LTETDD, IDEN,LTEAFDD,LTEATDD
Initial S/W Revision	Prior to A.02.00
Modified at S/W Revision	A.02.00

Delta

Reports the difference between Y values at two points. A delta marker is relative to an associated reference marker on the same trace. (The reference marker can be set on the Marker, Properties, Relative To menu). The reference marker is usually fixed, but can also be normal or delta. The X (and Z) position of a delta marker is specified as an offset from the reference marker position. The delta marker symbol tracks the absolute Y value just like a normal marker, but the marker readout displays the difference between the absolute Y values of the delta marker and its reference marker (absolute units are used even if the reference is itself a delta marker). Usually this is a straight difference in the current displayed units. For example, if the trace format is LogMag (dBm), the delta marker displays the difference in dB, thus showing a power ratio. But if the trace format is Real, then the delta marker shows a voltage difference, not a ratio. Exceptions for this are:

- When the trace format is **Linear Mag** or **Log Mag (linear unit)** the delta marker displays a voltage ratio or (if the Y Axis unit is Power) a power ratio, rather than a difference.
- When either the marker or its reference has a marker function turned on, the delta marker always displays a ratio or its decibel equivalent. See ["Marker Function" on page 1157](#) for more details on how delta markers work with marker functions. The type of ratio calculated (power or voltage) depends on the delta marker units; the reference marker value is converted as needed so it has compatible units.
- When the trace format is **Wrap Phase**, the delta marker readout is constrained to the wrapped phase display range, which is usually $(-180, +180]$ degrees. For example, if the absolute phase at marker 1 is 170 deg and its reference has phase of -170 deg, the delta does not show 340 deg, but -20 deg. Note that the Wrap Phase display range can be changed (see ["Phase/Trellis Offset" on page 1253](#)).

There is no current support for calculating deltas across traces (and this cannot be done at all unless the traces have the same domain and ranges).

By default, the reference marker for marker 1 is marker 2; for marker 2 is 3 and so on, but the reference marker can be changed. See ["Relative To" on page 1142](#).

For coupling rules, see ["Coupling of Delta and Reference Markers" on page 1152](#).

For Control Mode SCPI command information see: ["Control Mode" on page 1139](#)

Key Path	Marker
Mode	VSA, LTE, LTETDD, IDEN,LTEAFDD,LTEATDD
Initial S/W Revision	Prior to A.02.00
Modified at S/W Revision	A.02.00

Fixed

Mainly used as reference markers for Delta markers. A fixed marker's X and Y Axis values can be directly or indirectly specified by you, and they remain fixed once specified, in other words, they do not follow the trace data value. These markers are represented on the display by an "X" rather than a diamond. If a marker is changed from off to fixed, the X and Y (and Z) values are chosen to put it in the center of the display. If the marker is changed from some other type to fixed, the current X and Z values of the marker remain unchanged. The Y value is taken from the current trace data value and must be changed manually thereafter.

For Control Mode SCPI command information see: ["Control Mode" on page 1139](#)

Key Path	Marker
Mode	VSA, LTE, LTETDD, IDEN,LTEAFDD,LTEATDD
Initial S/W Revision	Prior to A.02.00
Modified at S/W Revision	A.02.00

Off

Turning a marker off makes it invisible, and also its annotation.

Turning a marker on (i.e., changing its control mode from Off to any other control mode) assigns the marker to the currently selected trace.

For Control Mode SCPI command information see: ["Control Mode" on page 1139](#)

Key Path	Marker
Mode	VSA, LTE, LTETDD, IDEN,LTEAFDD,LTEATDD
Initial S/W Revision	Prior to A.02.00
Modified at S/W Revision	A.02.00

Coupling of Delta and Reference Markers

The following coupling rules apply from the front panel and also if the equivalent SCPI commands are sent.

Pressing the Delta key causes the selected marker to become a delta marker if it is not already. Also, the selected marker's reference is affected as follows:

- If the reference marker was off, it is turned on as a fixed marker.
- The reference marker is moved to the trace of the selected marker and set to the same position as the selected marker.
- If the delta marker has a marker function turned on, the reference marker takes on the same function (with the same band limits).

Exception: Pressing Delta when the selected marker's mode is not yet Delta does not move or change a reference marker that is already turned on (Normal, Delta, or Fixed) and on the same trace as the selected marker. It merely changes the selected marker's mode to Delta and shows the current offset between it and the reference. If you press Delta again (when the selected marker is already in Delta mode) then the reference is moved and modified as described above.

When a delta marker is changed to any other control mode, if its reference marker is fixed then the reference marker is also turned off.

If you move a delta marker to a different trace, it is forced to Normal mode and if its reference is fixed, the reference is turned off.

A delta marker is forced to Normal mode if you turn its reference off or if you move its reference to another trace. (In the latter case the reference is not turned off even if it is fixed.)

If you change the selected marker's reference (using the Marker, Properties, Relative To), the selected marker is forced to Delta mode. This change of the selected marker to Delta mode causes its new reference's control mode and position to change as described above.

Marker Properties

Accesses a menu of common marker properties.

Key Path	Marker
Mode	VSA, LTE, LTETDD, IDEN,LTEAFDD,LTEATDD
Initial S/W Revision	Prior to A.02.00

Select Marker

Specifies the selected marker. The selected marker is the one that is affected by the marker position and properties settings, peak search, and other marker functions. Several menus have a Select Marker key for convenience. Marker selection using any one of these is reflected in all others, in other words, there is only one selected marker for the whole measurement. If all markers are off, then marker 1 becomes the selected marker.

As a convenience, if no markers are displayed on the selected trace, selecting a marker that is off automatically turns it on in normal mode on the selected trace.

There is no SCPI function for selecting a marker. Instead, SCPI functions can explicitly include the index of the marker for which they are to apply. (Most SCPI marker functions that affect the state of a marker also make it the selected marker for front panel commands.)

Key Path	Marker or Marker> or Marker Function or Peak Search
Mode	VSA, LTE, LTETDD, IDEN,LTEAFDD,LTEATDD
State Saved	No
Range	1 2 3 4 5 6 7 8 9 10 11 12
Initial S/W Revision	Prior to A.02.00
Modified at S/W Revision	A.02.00

Relative To

Enables you to specify which marker is used as a reference for the selected marker when the selected marker's control mode is set to Delta. By default, the reference marker is numerically one higher than the selected marker, that is, marker 1 is relative to marker 2, marker 2 to marker 3, and so on. Marker 12 by default is relative to marker 1. This key enables you to change the reference marker from the default. Note that a marker cannot be made relative to itself.

Key Path	Marker, Properties
Mode	VSA, LTE, LTETDD, IDEN, LTEAFDD, LTEATDD
Measurement	<meas>:=VECTor ADEMod DDEMod W11A W11B EVM IPOWER IDEMod MOTotalk
Remote Command	:CALCulate:<meas>:MARKer[1] 2 ...12:REFerence <integer> :CALCulate:<meas>:MARKer[1] 2 ...12:REFerence?
Example	CALC:VECT:MARK2:REF 4 CALC:VECT:MARK2:REF?
Notes	The reference marker cannot be the same value as the selected marker, that is, a marker cannot be relative to itself. The currently selected marker is not an available choice in the relative to selection (i.e., the selected marker appears grayed out). When queried, a single value is returned (the specified marker numbers relative marker).
Couplings	See " Coupling of Delta and Reference Markers " on page 1152. The old reference remains as it was.
Preset	2 3 4 5 6 7 8 9 10 11 12 1
State Saved	Saved in instrument state.
Range	1 2 3 4 5 6 7 8 9 10 11 12
Initial S/W Revision	Prior to A.02.00
Modified at S/W Revision	A.02.00

Complex Format

Determines the format for the readout when a marker is placed on a complex display (vector or constellation). The choices are to read out in rectangular or polar coordinates. The readout format applies to the marker display and marker table only; there is no SCPI for reading out the marker value in polar form.

Key Path	Marker, Properties
Mode	VSA, LTE, LTETDD, IDEN, LTEAFDD, LTEATDD
Measurement	<meas>:=VECTor ADEMod DDEMod W11A W11B EVM IPOWER IDEMod MOTotalk
Remote Command	:CALCulate:<meas>:MARKer[1] 2 ...12:CFORmat RECTangular POLar :CALCulate:<meas>:MARKer[1] 2 ...12:CFORmat?
Example	CALC:VECT:MARK1:CFOR RECT CALC:VECT:MARK1:CFOR?
Preset	RECT
State Saved	Saved in instrument state.
Range	Rect Polar
Initial S/W Revision	Prior to A.02.00
Modified at S/W Revision	A.02.00

Marker Trace

Enables you to determine the trace to which a marker is assigned. By default, when a marker is turned on it is assigned to the currently selected trace. You can change that assignment using this control.

Key Path	Marker, Properties
Mode	VSA, LTE, LTE-TDD, iDEN, LTE-AFDD, LTE-TDD
Measurement	<meas>:=VECTor ADEMod DDEMod W11A W11B EVM IPOWER IDEMod MOTotalk
Remote Command	:CALCulate:<meas>:MARKer[1] 2 ...12:TRACe <integer> :CALCulate:<meas>:MARKer[1] 2 ...12:TRACe?
Example	CALC:VECT:MARK3:TRAC 2 CALC:VECT:MARK3:TRAC?
Couplings	See " Coupling of Delta and Reference Markers " on page 1152.
Preset	Marker is assigned to currently selected trace when turned on.
State Saved	Saved in instrument state.
Range	Trace 1 Trace 2 Trace 3 Trace 4
Min	1
Max	4
Initial S/W Revision	Prior to A.02.00
Modified at S/W Revision	A.02.00

Marker Count

Enables the frequency counter algorithm on the selected marker. This algorithm can more precisely determine the frequency of a peak. The marker must be on a frequency domain trace, with data coming from hardware. Place the marker on a peak and enable the frequency counter. The marker readout then shows the calculated frequency rather than the marker X position. Only one marker can be counted at any time. Turning on marker count for any marker turns it off for all other markers.

Key Path	Marker, Properties
Mode	VSA, iDEN, LTE-AFDD, LTE-TDD
Measurement	<meas>:=VECTor ADEMod DDEMod W11A W11B EVM IPOWER IDEMod MOTotalk
Remote Command	:CALCulate:<meas>:MARKer[1] 2 ...12:FCOunt[:STATe] OFF ON 0 1 :CALCulate:<meas>:MARKer[1] 2 ...12:FCOunt[:STATe]?
Example	CALC:VECT:MARK:FCO ON CALC:VECT:MARK:FCO?
Notes	Marker must be on a frequency-domain trace and data must be live, not recorded or simulated.
Preset	OFF
State Saved	Saved in instrument state.
Range	Off On
Initial S/W Revision	Prior to A.02.00
Modified at S/W Revision	A.02.00

The frequency counter result must be read back with the following SCPI command. The Marker X query command only gets the marker's data point position, which is not as accurate as the frequency counter result.

Mode	VSA, IDEN,LTEAFDD,LTEATDD
Measurement	<meas>:=VECTor ADEMod DDEMod W11A W11B EVM IPOWER IDEMod MOTotalk
Remote Command	:CALCulate:<meas>:MARKer[1] 2 ...12:FCOut:X?
Example	CALC:VECT:MARK:FCO:X?
Notes	Query only. If the marker counter result is unavailable, NaN is returned.
Initial S/W Revision	Prior to A.02.00
Modified at S/W Revision	A.02.00

Marker Table

Displays the marker data display window below the measurement window. For each marker that is on, information is displayed in the data display window, which includes the marker number, control mode, trace number, X axis scale, X axis value, and the Y-axis result. Additional information is shown for markers that have marker functions turned on.

Key Path	Marker
Mode	VSA, LTE, LTETDD, IDEN,LTEAFDD,LTEATDD
Measurement	<meas>:=VECTor ADEMod DDEMod W11A W11B EVM IPOWER IDEMod MOTotalk
Remote Command	:CALCulate:<meas>:MARKer:TABLE[:STATe] OFF ON 0 1 :CALCulate:<meas>:MARKer:TABLE[:STATe]?
Example	CALC:VECT:MARK:TABL ON CALC:VECT:MARK:TABL?
Preset	OFF
State Saved	No
Range	Off On
Initial S/W Revision	Prior to A.02.00
Modified at S/W Revision	A.02.00

Marker Position

Selects which data point in a trace to read out with the marker (or where to locate a fixed marker). The marker position is primarily set in terms of the domain units, not trace points (although it can be set in terms of points via SCPI). The default active function when you press a marker hard key is the X position for the currently selected marker. The exception to this is when the selected marker is fixed. In that case there is no default active function (to prevent inadvertently changing a fixed marker's location).

Marker position is not defined when a marker's control mode is Off. When a marker is turned on in Normal or Delta mode, its X (and Z) values are set to the center of the trace data. If a marker is turned on in Fixed mode, its position is set so that it appears in the middle of the trace grid.

The Marker Position key branches to the Marker Position menu, which enables you to set any position variable relevant to the selected marker's control mode and trace format.

For Normal and Delta markers, usually only Marker X is available. Marker Z is available for trace data with 2-dimensional domain. For Fixed markers, Y can also be set. If the trace format is Vector or Constellation, **Marker Y** controls the real (horizontal axis) value and **Marker Y Imag** controls the imaginary (vertical axis) value. The key (or the keys below it) is grayed out if the selected marker is off.

Key Path	Marker
Mode	VSA, LTE, LTETDD, IDEN, LTEAFDD, LTEATDD
Initial S/W Revision	Prior to A.02.00
Modified at S/W Revision	A.02.00

Marker X

Sets the selected marker's X Axis value position in the current X Axis Scale unit. If the control mode is Off, the SCPI command has no affect other than to cause the marker to become selected. Note that the X value can change if the marker is moved to a trace with a different domain.

The Marker X position is absolute if the marker control mode is Normal or Fixed. If the control mode is Delta, then the X position is relative to the reference marker. The valid X positions are the actual data points in the trace; the marker cannot be located between points. If a SCPI command attempts to place the marker between two points, the X value snaps to the closest point.

Note that for Vector or Constellation format, the X axis is perpendicular to the screen (because the screen axes are used to show the real and imaginary parts of the Y value), so adjusting the X value in this case only causes the marker to move horizontally if the real Y value changes. For Fixed markers on a trace with one of these formats, adjusting the X value does not cause horizontal motion of the marker at all. Instead, use the Marker Y and Marker Y (imag) controls to move the marker horizontally and vertically.

Key Path	Marker, Marker Position
Mode	VSA, LTE, LTETDD, IDEN, LTEAFDD, LTEATDD
Measurement	<meas>:=VECTor ADEMod DDEMod W11A W11B EVM IPOWER IDEMod MOTotalk
Remote Command	:CALCulate:<meas>:MARKer[1] 2 ...12:X <real> :CALCulate:<meas>:MARKer[1] 2 ...12:X?
Example	CALC:VECT:MARK:X 0.325 CALC:VECT:MARK:X?
Notes	Marker X does not go outside the bounds of the data unless it is Fixed. If you attempt to set it to a value outside the bounds, it is clipped at the closest limit and error -222 Data Out of Range is generated. If suffix is sent, it must match the X units for the trace the marker is on. Otherwise, error -138, "Suffix not allowed" is generated.

	If you try to read or set the position of a Delta marker, remember that the position is in relative units.
Couplings	See "Coupling of Delta and Reference Markers" on page 1152 . See also: "Couple Markers" on page 1151
Preset	None until marker is turned on.
State Saved	Saved in instrument state.
Min	Depends on trace data
Max	Depends on trace data
Initial S/W Revision	Prior to A.02.00
Modified at S/W Revision	A.02.00

SCPI only X position commands

Via SCPI, the marker position can also be set or queried in trace points. In this case, the position setting or reading is absolute regardless of control mode.

NOTE

The entered value in Trace Points is immediately translated into the current domain units for setting the value of the marker. The marker's value in domain units, NOT trace points, is preserved if a change is made to the X Axis scale settings. Thus, if you use this command to place a marker on point 500, which happens at that time to correspond to 13 GHz, and then you change the Start Frequency so that point 500 is no longer 13 GHz, the marker stays at 13 GHz, NOT at point 500.

If the trace the marker is on has a 2-dimensional domain, then the points are numbered in the following way:

Starting at the minimum X and Z position, this point is numbered 0. Each time you increment the point number, increment the X value to the next available value. When X reaches the maximum X position, then reset X to the minimum and increment the Z value. Then continue incrementing the X position in the same manner as before.

Note that for symbol tables, which have no axes, incrementing the X position in points moves the marker consecutively through all table entries.

Mode	VSA, LTE, LTETDD, IDEN, LTEAFDD, LTEATDD
Measurement	<meas>:=VECTor ADEMod DDEMod W11A W11B EVM IPOWER IDEMod MOTotalk
Remote Command	:CALCulate:<meas>:MARKer[1] 2 ...12[:X]:POSition <real> :CALCulate:<meas>:MARKer[1] 2 ...12[:X]:POSition?
Example	CALC:VECT:MARK:POS 25 CALC:VECT:MARK:POS?
Notes	When a marker control mode is changed from off to any other mode, the X position is set to mid-screen.
Couplings	See "Coupling of Delta and Reference Markers" on page 1152 . See also: "Couple Markers" on page 1151
Preset	None until marker is turned on.

State Saved	Saved in instrument state.
Min	Depends on trace data
Max	Depends on trace data
Initial S/W Revision	Prior to A.02.00
Modified at S/W Revision	A.02.00

Marker X Unit can be queried via SCPI

Mode	VSA, LTE, LTETDD, IDEN, LTEAFDD, LTEATDD
Measurement	<meas>:=VECTor ADEMod DDEMod W11A W11B EVM IPOWER IDEMod MOTotalk
Remote Command	:CALCulate:<meas>:MARKer[1] 2 ...12:X:UNIT?
Example	CALC:VECT:MARK:X:UNIT?
Notes	Query Only
Initial S/W Revision	Prior to A.02.00
Modified at S/W Revision	A.02.00

Marker Z

Sets the selected markers Z Axis value in the current Z Axis Scale unit for markers on traces with a 2-dimensional domain. In each case the marker that is addressed becomes the selected marker. It has no affect (other than to cause the marker to become selected) if the control mode is **Off** or if the trace has no Z domain. Note that the Z value can change or become irrelevant if the marker is moved to a trace with a different Z domain or no Z domain.

Note that this Z value is affected if the SCPI command to set marker point position is used.

Key Path	Marker, Marker Position
Mode	VSA, LTE, LTETDD, IDEN, LTEAFDD, LTEATDD
Measurement	<meas>:=VECTor ADEMod DDEMod W11A W11B EVM IPOWER IDEMod MOTotalk
Remote Command	:CALCulate:<meas>:MARKer[1] 2 ...12:Z <real> :CALCulate:<meas>:MARKer[1] 2 ...12:Z?
Example	CALC:OFDM:MARK:Z 12 CALC:OFDM:MARK:Z?
Notes	Marker Z does not go outside the bounds of the data unless it is Fixed. If you attempt to set it to a value outside the bounds it is clipped at the closest limit, and error -222 Data Out of Range is generated. If suffix is sent, it must match the Z units for the trace the marker is on. Otherwise, error -138, "Suffix not allowed" is generated.
Couplings	See "Coupling of Delta and Reference Markers" on page 1152 . See also: "Couple Markers" on page 1151

Preset	None until marker is turned on.
State Saved	Saved in instrument state.
Min	Depends on trace data
Max	Depends on trace data
Initial S/W Revision	Prior to A.02.00
Modified at S/W Revision	A.02.00

Marker Z Unit can be queried via SCPI.

Mode	VSA, LTE, LTETDD, IDEN, LTEAFDD, LTEATDD
Measurement	<meas>:=VECTor ADEMod DDEMod W11A W11B EVM IPOWER IDEMod MOTotalk
Remote Command	:CALCulate:<meas>:MARKer[1] 2 ...12:Z:UNIT?
Example	CALC:OFDM:MARK:Z:UNIT?
Notes	Query Only
Initial S/W Revision	Prior to A.02.00
Modified at S/W Revision	A.02.00

Marker Y

Enables you to set or read back the selected marker's Y Axis value in the current Y Axis Scale unit. Setting the Y value has no affect (other than to cause the marker to become selected) if the control mode is other than fixed. The query form generates an error if the control mode is Off. Note that the Y value can change if the Y-axis units change, either from a change in format of the trace the marker is on or if the marker is moved to a different trace.

If the selected marker is on a trace that is displayed with Vector or Constellation format, this function controls only the real part of the Y value (i.e., the horizontal axis value). Use the **Marker Y (imag)** control to change the imaginary (vertical) value. Marker Y and Marker Y Imag always set or get the rectangular form of Y, regardless of whether the marker readout is polar or rectangular.

Key Path	Marker, Marker Position
Mode	VSA, LTE, LTETDD, IDEN, LTEAFDD, LTEATDD
Measurement	<meas>:=VECTor ADEMod DDEMod W11A W11B EVM IPOWER IDEMod MOTotalk
Remote Command	:CALCulate:<meas>:MARKer[1] 2 ...12:Y[:REAL] <real> :CALCulate:<meas>:MARKer[1] 2 ...12:Y[:REAL]?
Example	CALC:VECT:MARK2:Y 0.325 CALC:VECT:MARK2:Y?
Notes	You cannot set Y unless the marker type is fixed. If the marker becomes fixed after a marker function is turned on, it is set to whatever the Y value was when the marker became fixed. If suffix is sent, it must match the Y units for the trace the marker is on. Otherwise, error -138, "Suffix not allowed" is generated.

Couplings	Changes if marker is relative to a Delta marker that is turned on or re-zeroed (see " Coupling of Delta and Reference Markers " on page 1152).
Preset	None until marker is turned on.
State Saved	Saved in instrument state.
Min	-9.9E+37
Max	9.9E+37
Initial S/W Revision	Prior to A.02.00
Modified at S/W Revision	A.02.00

Marker Y Unit can be queried via SCPI.

Mode	VSA, LTE, LTETDD, IDEN, LTEAFDD, LTEATDD
Measurement	<meas>:=VECTor ADEMod DDEMod W11A W11B EVM IPOWER IDEMod MOTotalk
Remote Command	:CALCulate:<meas>:MARKer[1] 2 ...12:Y:UNIT?
Example	CALC:VECT:MARK:Y:UNIT?
Notes	Query Only
Initial S/W Revision	Prior to A.02.00
Modified at S/W Revision	A.02.00

Marker Y Imag (Imaginary)

Enables you to set or read back the selected marker's quadrature (imaginary) Y value in the current Y Axis Scale unit. It has no affect (other than to cause the marker to become selected) if the control mode is other than fixed or if the current trace format is not complex (Vector or Constellation). The query form generates an error if it is used for a marker that is not on a complex trace. Marker Y Imag is not affected by whether the marker readout is polar or rectangular.

Key Path	Marker, Marker Position
Mode	VSA, LTE, LTETDD, IDEN, LTEAFDD, LTEATDD
Measurement	<meas>:=VECTor ADEMod DDEMod W11A W11B EVM IPOWER IDEMod MOTotalk
Remote Command	:CALCulate:<meas>:MARKer[1] 2 ...12:Y:IMAGinary <real> :CALCulate:<meas>:MARKer[1] 2 ...12:Y:IMAGinary?
Example	CALC:DDEM:MARK1:Y:IMAG 0.435 CALC:DDEM:MARK1:Y:IMAG?
Notes	Grayed out unless the marker is fixed and on a vector display. If suffix is sent, it must match the Y units for the trace the marker is on. Otherwise, an Invalid Suffix error is generated. Otherwise, error -138, "Suffix not allowed" is generated. If query is sent while the marker is on a trace whose format is not vector or constellation, NaN (9.91E+37) is returned.
Preset	None until marker is turned on.

State Saved	Saved in instrument state.
Min	Depends on trace format
Max	Depends on trace format
Initial S/W Revision	Prior to A.02.00
Modified at S/W Revision	A.02.00

Couple Markers

Affects all currently displayed markers. In general, when coupling is turned on then all Normal or Delta markers with the same (or equivalent) domain as the selected marker move in the same manner as the selected marker. Coupling is relative between markers on the same trace (so that their relative positions in the domain are maintained). Coupling can be absolute between markers on different traces that have equivalent domains. That is, they have the same position in the domain, if possible. (As an example of equivalent domains, demodulated symbol positions can be derived from time by using the current symbol rate). When you move the selected marker, then others on related traces track it. This enables you to correlate different measurement results. For example, you can place a marker at a particular symbol time on an error vector magnitude display, have tracking markers on the symbol table and pre-demod time trace showing you the symbol value, and the actual time-varying signal value at the same point in time.

Absolute coupling is performed only for the lowest numbered Normal or Delta marker on each trace. All other markers on a trace couple relatively. When you turn on marker coupling, the subset of markers that have the same domain as the selected marker track it and all other markers remain at their current location. The absolutely coupled markers within this subset is moved at this time to match the domain setting of the selected marker, with the relatively coupled markers following accordingly to maintain offsets within their respective traces. Those markers with different domains remain at their current location. When you select a marker with a different domain than the previously selected marker, then the subset of markers with that domain go through the same procedure.

Any marker that coupling would move outside its range of X values, remains at the closest limiting value until the selected marker moves in such a way as to bring the coupled X value back into range. If the coupled markers are on data that do not have the same domain resolution, then they are positioned as close to each other as possible.

If markers change mode or trace, or trace data is changed below them, the coupling rules are immediately applied to the new set.

Key Path	Marker
Mode	VSA, LTE, LTETDD, IDEN, LTEAFDD, LTEATDD
Measurement	<meas>:=VECTor ADEMod DDEMod W11A W11B EVM IPOWER IDEMod MOTotalk
Remote Command	:CALCulate:<meas>:MARKer:COUPle[:STATe] OFF ON 0 1 :CALCulate:<meas>:MARKer:COUPle[:STATe]?
Example	CALC:VECT:MARK:COUP ON CALC:VECT:MARK:COUP?
Preset	OFF

State Saved	Saved in instrument state.
Range	Off On
Initial S/W Revision	Prior to A.02.00
Modified at S/W Revision	A.02.00

All Markers Off

Turns all markers off and sets the selected marker to 1.

Key Path	Marker
Mode	VSA, LTE, LTETDD, IDEN, LTEAFDD, LTEATDD
Measurement	<meas>:=VECTor ADEMod DDEMod W11A W11B EVM IPOWER IDEMod MOTotalk
Remote Command	:CALCulate:<meas>:MARKer:AOff
Example	CALC:VECT:MARK:AOff:
Initial S/W Revision	Prior to A.02.00
Modified at S/W Revision	A.02.00

Coupling of Delta and Reference Markers

The following coupling rules apply from the front panel and also if the equivalent SCPI commands are sent.

Pressing the Delta key causes the selected marker to become a delta marker if it is not already. Also, the selected marker's reference is affected as follows:

- If the reference marker was off, it is turned on as a fixed marker.
- The reference marker is moved to the trace of the selected marker and set to the same position as the selected marker.
- If the delta marker has a marker function turned on, the reference marker takes on the same function (with the same band limits).

Exception: Pressing Delta when the selected marker's mode is not yet Delta does not move or change a reference marker that is already turned on (Normal, Delta, or Fixed) and on the same trace as the selected marker. It merely changes the selected marker's mode to Delta and shows the current offset between it and the reference. If you press Delta again (when the selected marker is already in Delta mode) then the reference is moved and modified as described above.

When a delta marker is changed to any other control mode, if its reference marker is fixed then the reference marker is also turned off.

If you move a delta marker to a different trace, it is forced to Normal mode and if its reference is fixed, the reference is turned off.

A delta marker is forced to Normal mode if you turn its reference off or if you move its reference to another trace. (In the latter case the reference is not turned off even if it is fixed.)

If you change the selected marker's reference (using the Marker, Properties, Relative To), the selected marker is forced to Delta mode. This change of the selected marker to Delta mode causes its new reference's control mode and position to change as described above.

Marker -> (Marker To)

Provides access to some convenient functions for copying the marker position to a number of frequency and Y-axis scaling parameters. These functions are available from the front panel only. No SCPI is provided, because you can already read the marker position via SCPI and then set any frequency or scaling parameter accordingly, with full accuracy.

Pressing the Marker -> hardkey always makes the selected marker's X position the active function.

If the selected marker is off, pressing the Marker -> hardkey turns on the selected marker in normal mode on the currently selected trace.

Key Path	Front Panel
Mode	VSA, LTE, LTETDD, IDEN,LTEAFDD,LTEATDD
Initial S/W Revision	Prior to A.02.00
Modified at S/W Revision	A.02.00

Mkr -> CF (Center Frequency)

Sets the center frequency equal to the selected marker's absolute frequency. The marker must be on a frequency-domain trace. The absolute marker frequency is used regardless of whether its control mode is Normal, Delta, or Fixed.

If the currently selected marker is not on when this key is pressed, it is turned on at the center of the screen as a normal type marker.

Key Path	Marker To
Mode	VSA, LTE, LTETDD, IDEN,LTEAFDD,LTEATDD
Initial S/W Revision	Prior to A.02.00
Modified at S/W Revision	A.02.00

Mkr -> CF Step

Sets the center frequency step size equal to the selected marker's frequency. The marker must be on a frequency-domain trace. The absolute marker frequency is used regardless of whether its control mode is Normal, Delta, or Fixed.

If the currently selected marker is not on when this key is pressed, it is turned on at the center of the screen as a normal type marker.

Key Path	Marker To
Mode	VSA, LTE, LTETDD, IDEN,LTEAFDD,LTEATDD
Initial S/W Revision	Prior to A.02.00
Modified at S/W Revision	A.02.00

Mkr -> Start

Sets the start frequency equal to the selected marker's frequency. The marker must be on a frequency-domain trace. The absolute marker frequency is used regardless of whether its control mode is Normal, Delta, or Fixed.

If the currently selected marker is not on when this key is pressed, it is turned on at the center of the screen as a normal type marker.

Key Path	Marker To
Mode	VSA, LTE, LTETDD, IDEN,LTEAFDD,LTEATDD
Initial S/W Revision	Prior to A.02.00
Modified at S/W Revision	A.02.00

Mkr -> Stop

Sets the stop frequency equal to the selected marker's frequency. The marker must be on a frequency-domain trace. The absolute marker frequency is used regardless of whether its control mode is Normal, Delta, or Fixed.

If the currently selected marker is not on when this key is pressed, it is turned on at the center of the screen as a normal type marker.

Key Path	Marker To
Mode	VSA, LTE, LTETDD, IDEN,LTEAFDD,LTEATDD
Initial S/W Revision	Prior to A.02.00
Modified at S/W Revision	A.02.00

Mkr Delta -> Span

Sets the start and stop frequencies equal to the selected marker's frequency and that of its reference. That is, the measurement span is "zoomed in" so that the selected marker and its associated reference appear on the extreme left and right of the display. The marker must be on a frequency-domain trace and its control mode must be Delta.

Key Path	Marker To
Mode	VSA, LTE, LTETDD, IDEN,LTEAFDD,LTEATDD
Initial S/W Revision	Prior to A.02.00
Modified at S/W Revision	A.02.00

Mkr -> Ref Lvl

Sets the Y axis reference value equal to the selected marker's Y value. For example, if the reference position is at the top of the screen, the whole trace is moved up so that the marker appears at the top of

the screen. Note that this is a display scaling function only. The input range remains the same.

Key Path	Marker To
Mode	VSA, LTE, LTETDD, IDEN,LTEAFDD,LTEATDD
Initial S/W Revision	Prior to A.02.00
Modified at S/W Revision	A.02.00

Counter -> CF (Center Frequency)

Sets the frequency of the marker counter to the center frequency. The marker counter function must be on.

Key Path	Marker To
Mode	VSA, IDEN,LTEAFDD,LTEATDD
Initial S/W Revision	Prior to A.02.00
Modified at S/W Revision	A.02.00

Mkr Delta -> CF (Center Frequency)

Sets the center frequency equal to the difference in frequency between the selected Delta marker and its reference. The marker must be on a frequency-domain trace and the selected marker's control mode must be Delta.

Key Path	Marker To
Mode	VSA, LTE, LTETDD, IDEN,LTEAFDD,LTEATDD
Initial S/W Revision	Prior to A.02.00
Modified at S/W Revision	A.02.00

Marker Function

Accesses a menu of selectable marker functions for VSA based measurements.

Marker Functions perform post-processing operations on marker data. Band Functions are Marker Functions that enable you to define a band of frequencies around the marker. The band defines the region of data used for the numerical calculations. These marker functions also enable you to perform mathematical calculations on trace and marker data and report the results of these calculations in place of the normal marker result.

Unlike regular markers, marker function markers are not placed directly on the trace. They are placed at a location that is relative to the result of the function calculation.

The Marker Function menu provides access to power calculations in bands of frequencies or time intervals centered on a marker. It also enables you to make calculations like carrier to noise by combining delta markers with marker functions. Marker functions are generally available for time and frequency domain traces, and not for others. If the marker function calculation is undefined for particular trace data, then "---" is shown in place of a number in the result display and marker table, and CALC:<meas>:MARK[n]:Y? returns 9.91E+37 (NaN).

Pressing Marker Function always makes the selected marker's X position the active function.

If the selected marker is off, pressing the Marker Function hardkey turns on the selected marker in normal mode on the currently selected trace.

Key Path	Front Panel
Mode	VSA, LTE, LTETDD, IDEN, LTEAFDD, LTEATDD
Measurement	<meas>:=VECTor ADEMod DDEMod W11A W11B EVM IPOWER IDEMod MOTotalk
Remote Command	:CALCulate:<meas>:MARKer[1] 2 ...12:FUNction BPOwer BDENsity =OFF :CALCulate:<meas>:MARKer[1] 2 ...12:FUNction?
Example	CALC:VECT:MARK1:FUNC BPOW CALC:VECT:MARK1:FUNC?
Notes	:CALC:<meas>:MARK1:FUNC? returns the current function type for marker 1. To return the result, use :CALC:<meas>:MARK1:Y?
Preset	=OFF
State Saved	Saved in instrument state.
Range	Band Power Band Density Off
Initial S/W Revision	Prior to A.02.00
Modified at S/W Revision	A.02.00

Select Marker

Specifies the selected marker. The selected marker is the one that is affected by the marker position and properties settings, peak search, and other marker functions. Several menus have a Select Marker key for convenience. Marker selection using any one of these is reflected in all others, in other words, there is only

one selected marker for the whole measurement. If all markers are off, then marker 1 becomes the selected marker.

As a convenience, if no markers are displayed on the selected trace, selecting a marker that is off automatically turns it on in normal mode on the selected trace.

There is no SCPI function for selecting a marker. Instead, SCPI functions can explicitly include the index of the marker for which they are to apply. (Most SCPI marker functions that affect the state of a marker also make it the selected marker for front panel commands.)

Key Path	Marker or Marker> or Marker Function or Peak Search
Mode	VSA, LTE, LTETDD, IDEN,LTEAFDD,LTEATDD
State Saved	No
Range	1 2 3 4 5 6 7 8 9 10 11 12
Initial S/W Revision	Prior to A.02.00
Modified at S/W Revision	A.02.00

Band/Interval Power

Turns on the Band/Interval Power function for the selected marker. This function calculates the power within the band centered on the marker. The function works generally with frequency spectra, PSD, and time traces. On traces where band power is undefined, the result display shows "---" and CALC:<meas>:MARK[n]:Y? returns 9.91E+37 (NaN), although the band interval can still be defined.

Frequency-domain data

If the marker is on a frequency-domain trace, the result is total power within the band. This is true whether the underlying trace data is a power spectrum or power spectral density.

Time-domain data

If the marker is on a time-domain trace, the result is average power within the time interval, that is, the power at each time sample in the time interval is calculated, the powers are summed and the total divided by the number of samples.

Key Path	Marker Function
Mode	VSA, LTE, LTETDD, IDEN,LTEAFDD,LTEATDD
Initial S/W Revision	Prior to A.02.00
Modified at S/W Revision	A.02.00

Band Power Calculation

Shows results in dBm, dBVrms, Watts, Volts RMS Squared or Volts RMS. The table below shows the choice of display units if **Band Power Calculation** is set to **Mean**, depending on the current format and Y units of the trace the marker is on.

Trace data type	Trace Format	Y Unit	Result format
Spectrum, PSD, Time record	LogMag (dB)	Auto, Power	dBm
		Peak, RMS	dBVrms
		mRMS	dBmVrms
	Linear Mag, Real, Imag, Log Mag (lin)	Auto, Peak, RMS, mRMS	Vrms^2
	Linear Mag, Real, Imag, Log Mag(lin)	Power	W
	Wrap Phase, Unwrap Phase, Delay	Any	Vrms^2
Dimensionless (e.g., Frequency response, Impulse response, various Demodulation error types)	LogMag (dB)	Any	dBrms
	Linear Mag, Real, Imag, Wrap Phase, Unwrap Phase, Delay, Log Mag (lin)	Any	rms^2
	Vector, Constellation, Eye, Trellis	Any	blanked
General dimensions(e.g., Hz, %)	LogMag (dB)	Any	dB<unit>rms
	Linear Mag, Real, Imag, Wrap Phase, Unwrap Phase, Delay, Log Mag (lin)	Any	<unit>rms^2

If the **Band Power Calculation** is set to **RMS**, then the readout unit does not depend on trace format or Y unit. For Spectrums, PS, and Time record traces, the displayed unit is "Vrms". For general units, the unit abbreviation is shown followed by "rms".

The Band Power Calculation only controls the readout format for Normal and Fixed markers. For Delta markers, see "[Band Power and Delta Markers](#)" on page 1163.

Key Path	Marker Function, Band/Interval Power
Mode	VSA, LTE, LTETDD, IDEN,LTEAFDD,LTEATDD
Measurement	<meas>:=VECTor ADEMod DDEMod W11A W11B EVM POWER IDEMod MOTotalk
Remote Command	:CALCulate:<meas>:MARKer[1] 2 ...12:FUNction:BPOwer:CTYPe MEAN RMS :CALCulate:<meas>:MARKer[1] 2 ...12:FUNction:BPOwer:CTYPe?
Example	CALC:VECT:MARK1:FUNC:BPOW:CTYP MEAN CALC:VECT:MARK1:FUNC:BPOW:CTYP?
Preset	MEAN
State Saved	Saved in instrument state.
Range	Mean RMS
Initial S/W Revision	Prior to A.02.00
Modified at S/W Revision	A.02.00

Band/Interval Density

Calculates the average power density within the band centered on the marker. The function works generally with frequency spectra, PSD, and time traces. On traces where band power cannot reasonably be defined, the result display shows "---" and CALC:<meas>:MARK[n]:Y? returns NaN (9.91E+37), although the band interval can still be defined.

Frequency-domain data

If the marker is on a frequency-domain trace, the result is the band power (as computed above) divided by the bandwidth over which it is measured. This is true whether the underlying trace data is a power spectrum or power spectral density.

Time-domain data

If the marker is on a time-domain trace, the result is average power within the time interval (as computed above) divided by the equivalent noise bandwidth of the span.

Key Path	Marker Function
Mode	VSA, LTE, LTETDD, IDEN,LTEAFDD,LTEATDD
Initial S/W Revision	Prior to A.02.00
Modified at S/W Revision	A.02.00

Band Density Calculation

Turns on the Band/Interval Density function for the selected marker. If the selected marker is off, it is turned on in **Normal** marker mode and is located at the center of the screen.

If **Band/Interval Density** is selected while in the **Marker Function Off** state, the **Band Span** or **Interval Span** is initialized to 5% of the screen width.

If the detector mode for the detector on the marker's trace is set to Auto, the average detector is selected. If the Average type is set to Auto, Power Averaging is selected. Other choices for the detector or Average type usually cause measurement inaccuracy.

A band/interval density calculation result can be shown in dBm/Hz, Volts RMS Squared, or Volts RMS. The following table shows the choice of display units if **Band Density Calculation** is set to **Mean**, depending on the current format of the trace the marker is on.

Trace data type	Trace Format	Result format
Spectrum, PSD, Time record	LogMag (dB)	dBm/Hz
	Linear Mag, Real, Imag, Wrap Phase, Unwrap Phase, Delay, Log Mag (lin)	Vrms ² /Hz
Dimensionless (e.g., Frequency response, Impulse response, various Demodulation error types)	LogMag (dB)	dBrms/Hz
	Linear Mag, Real, Imag, Wrap Phase, Unwrap Phase, Delay, Log Mag (lin)	rms ² /Hz

General dimensions (e.g., Hz, %)	LogMag (dB)	dB<unit>rms/Hz
	Linear Mag, Real, Imag, Wrap Phase, Unwrap Phase, Delay, Log Mag (lin)	<unit>rms^2/Hz

If the **Band Density Calculation** is set to **RMS**, then the readout unit does not depend on trace format. For Spectrum, PSD, and Time record traces, the displayed unit is "Vrms/rtHz". For general units, the unit abbreviation is shown followed by "rms/rtHz".

The Band Density Calculation only controls the readout format for Normal and Fixed markers. For Delta markers, see ["Band Power and Delta Markers" on page 1163](#).

Key Path	Marker Function, Band/Interval Power
Mode	VSA, LTE, LTETDD, IDEN,LTEAFDD,LTEATDD
Measurement	<meas>:=VECTor ADEMod DDEMod W11A W11B EVM IPOWER IDEMod MOTotalk
Remote Command	:CALCulate:<meas>:MARKer[1] 2 ...12:FUNction:BDensity:CTYPe MEAN RMS :CALCulate:<meas>:MARKer[1] 2 ...12:FUNction:BDensity:CTYPe?
Example	CALC:VECT:MARK1:FUNC:BDEN:CTYP RMS CALC:VECT:MARK1:FUNC:BDEN:CTYP?
Preset	MEAN
State Saved	Saved in instrument state.
Range	Mean RMS
Initial S/W Revision	Prior to A.02.00
Modified at S/W Revision	A.02.00

Band Adjust

Enables you to define the bandwidth around the marker. The band is always centered on the marker position. Entering the menu always sets Band/Interval Span as the active function.

Key Path	Marker Function
Mode	VSA, LTE, LTETDD, IDEN,LTEAFDD,LTEATDD
Initial S/W Revision	Prior to A.02.00
Modified at S/W Revision	A.02.00

Band/Interval Center

Enables you to define the center of the band. That is, it enables you to adjust the marker position in absolute units (regardless of whether the marker mode is Normal or Delta).

Key Path	Marker Function, Band Adjust
----------	------------------------------

Mode	VSA, LTE, LTETDD, IDEN, LTEAFDD, LTEATDD
Measurement	<meas>:=VECTor ADEMod DDEMod W11A W11B EVM IPOWER IDEMod MOTotalk
Remote Command	:CALCulate:<meas>:MARKer[1] 2 ...12:FUNCTION:BAND:CENTer <real> :CALCulate:<meas>:MARKer[1] 2 ...12:FUNCTION:BAND:CENTer?
Example	CALC:VECT:MARK2:FUNC:BAND:CENT 1.23E+09 CALC:VECT:MARK2:FUNC:BAND:CENT?
Preset	Center of screen
State Saved	Saved in instrument state.
Min	-9.9E+37
Max	9.9E+37
Initial S/W Revision	Prior to A.02.00
Modified at S/W Revision	A.02.00

Band/Interval Span

Sets the width of the span for the selected marker. This function defines the span of frequencies or time. The marker position does not change when you adjust the span.

Key Path	Marker Function, Band Adjust
Mode	VSA, LTE, LTETDD, IDEN, LTEAFDD, LTEATDD
Measurement	<meas>:=VECTor ADEMod DDEMod W11A W11B EVM IPOWER IDEMod MOTotalk
Remote Command	:CALCulate:<meas>:MARKer[1] 2 ...12:FUNCTION:BAND:SPAN <real> :CALCulate:<meas>:MARKer[1] 2 ...12:FUNCTION:BAND:SPAN?
Example	CALC:VECT:MARK2:FUNC:BAND:SPAN 1.23E+06 CALC:VECT:MARK2:FUNC:BAND:SPAN?
Preset	When marker turned on, 1/20th of current span or displayed time length.
State Saved	Saved in instrument state.
Min	-9.9E+37
Max	9.9E+37
Initial S/W Revision	Prior to A.02.00
Modified at S/W Revision	A.02.00

Band/Interval Left

Enables you to adjust the left side of the band. In order to remain centered in the band, the marker position must also change as you change the left edge. The right edge is unaffected.

Key Path	Marker Function, Band Adjust
----------	------------------------------

Mode	VSA, LTE, LTETDD, IDEN, LTEAFDD, LTEATDD
Measurement	<meas>:=VECTor ADEMod DDEMod W11A W11B EVM IPOWER IDEMod MOTotalk
Remote Command	:CALCulate:<meas>:MARKer[1] 2 ...12:FUNction:BAND:LEFT <real> :CALCulate:<meas>:MARKer[1] 2 ...12:FUNction:BAND:LEFT?
Example	CALC:VECT:MARK2:FUNC:BAND:LEFT 1.23E+06 CALC:VECT:MARK2:FUNC:BAND:LEFT?
Couplings	Changes marker X to keep the marker centered in the band.
Preset	When marker turned on, 1/40th of current span or displayed time length left of the marker position.
State Saved	Saved in instrument state.
Min	-9.9E+37
Max	9.9E+37
Initial S/W Revision	Prior to A.02.00
Modified at S/W Revision	A.02.00

Band/Interval Right

Enables you to adjust the right side of the band. In order to remain centered in the band, the marker position must also change as you change the right edge. The left edge is unaffected.

Key Path	Marker Function, Band Adjust
Mode	VSA, LTE, LTETDD, IDEN, LTEAFDD, LTEATDD
Measurement	<meas>:=VECTor ADEMod DDEMod W11A W11B EVM IPOWER IDEMod MOTotalk
Remote Command	:CALCulate:<meas>:MARKer[1] 2 ...12:FUNction:BAND:RIGHT <real> :CALCulate:<meas>:MARKer[1] 2 ...12:FUNction:BAND:RIGHT?
Example	CALC:VECT:MARK2:FUNC:BAND:RIGHT 1.23E+06 CALC:VECT:MARK2:FUNC:BAND:RIGHT?
Couplings	Changes marker X to keep the marker centered in the band.
Preset	When marker turned on, 1/40th of current span or displayed time length right of the marker position.
State Saved	Saved in instrument state.
Min	-9.9E+37
Max	9.9E+37
Initial S/W Revision	Prior to A.02.00
Modified at S/W Revision	A.02.00

Band Power and Delta Markers

When either a Delta marker or its reference has a band power function turned on, the Delta marker readout always shows a ratio calculation. This enables you to perform common calculations like carrier to noise ratio or adjacent channel power ratio. The form of the ratio depends on the main marker function

calculation type (Mean or RMS). If the main marker function calculation type is Mean, then when you change the marker to Delta the result is a power ratio. If the main marker function calculation type is RMS, then the Delta marker result is a voltage ratio. (If the main marker band power function is off, then the form of the ratio depends on the reference marker calculation type: If it is Mean you get a power ratio and if it is RMS you get a voltage ratio.)

For example, if the main marker function is Band/Interval Power with a calculation type of Mean and the reference marker function is Band/Interval Power with a calculation type of RMS, then the Delta marker shows the ratio of the main marker "Band/Interval Power Mean" value to the reference marker "Band/Interval Power Mean" (not RMS) value.

A dimensionless ratio (for example, Volt/Volt or Watt/Watt) is shown with units of "x". The marker function calculation type indicates whether the ratio is voltage or power (see above). A dimensionless power ratio is shown with units of dB if the trace format is Log Mag (dB).

If the reference marker function is Band/Interval Density and the main marker is either Band/Interval Power or its function is turned off, then the ratio is not dimensionless, but has units of Hz (or dB-Hz) for power calculations or rHz for voltage calculations. When the main marker function is Band/Interval Density and the reference is either Band/interval Power or its function is off, the units are /Hz (or dB/Hz) for power calculations or /rHz for voltage calculations.

Key Path	Marker Function
Mode	VSA, LTE, LTETDD, IDEN,LTEAFDD,LTEATDD
Initial S/W Revision	Prior to A.02.00
Modified at S/W Revision	A.02.00

Meas

The information in this section is common to all measurements. For key and remote command information for a specific measurement, refer to the section that describes the measurement of interest.

Measurements available under the Meas key are specific to the current Mode.

When viewing Help for measurements, note the following:

NOTE

Operation for some keys differs between measurements. The information displayed in Help pertains to the current measurement. To see how a key operates in a different measurement, exit Help (press the Cancel Esc key), select the measurement, then reenter Help (press the Help key) and press that key.

Key Path	Front-panel key
Initial S/W Revision	Prior to A.02.00

Remote Measurement Functions

This section contains the following topics:

"Measurement Group of Commands" on page 1166

"Current Measurement Query (Remote Command Only)" on page 1168

"Limit Test Current Results (Remote Command Only)" on page 1168

"Data Query (Remote Command Only)" on page 1168

"Calculate/Compress Trace Data Query (Remote Command Only)" on page 1169

"Calculate Peaks of Trace Data (Remote Command Only)" on page 1174

Hardware-Accelerated Fast Power Measurement (Remote Command Only)

"Format Data: Numeric Data (Remote Command Only)" on page 1175

"Format Data: Byte Order (Remote Command Only)" on page 1176

Initial S/W Revision	Prior to A.02.00
----------------------	------------------

Measurement Group of Commands

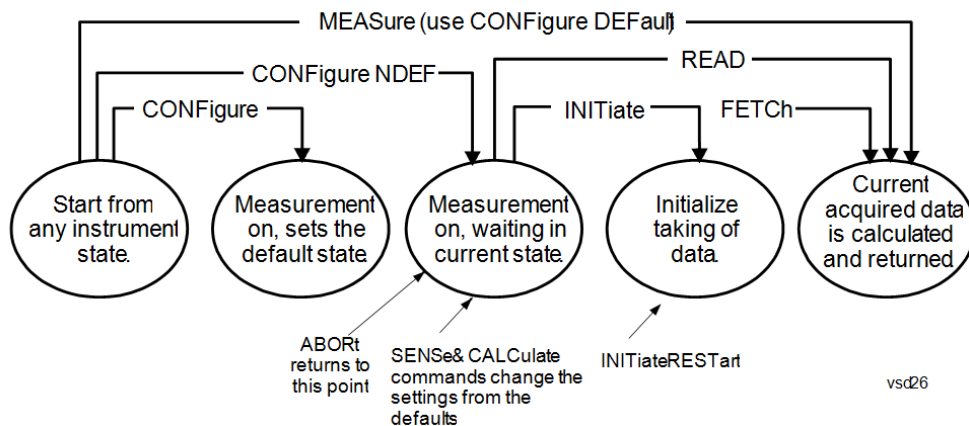

Measure Commands:

:MEASure:<measurement>[n]?

This is a fast single-command way to make a measurement using the factory default instrument settings. These are the settings and units that conform to the Mode Setup settings (e.g. radio standard) that you have currently selected.

- Stops the current measurement (if any) and sets up the instrument for the specified measurement using the factory defaults
- Initiates the data acquisition for the measurement
- Blocks other SCPI communication, waiting until the measurement is complete before returning results.
- If the function does averaging, it is turned on and the number of averages is set to 10.
- After the data is valid it returns the scalar results, or the trace data, for the specified measurement. The type of data returned may be defined by an [n] value that is sent with the command.
- The scalar measurement results will be returned if the optional [n] value is not included, or is set to 1. If the [n] value is set to a value other than 1, the selected trace data results will be returned. See each command for details of what types of scalar results or trace data results are available.
- ASCII is the default format for the data output. (Older versions of Spectrum Analysis and Phase Noise mode measurements only use ASCII.) The binary data formats should be used for handling large blocks of data since they are smaller and faster than the ASCII format. Refer to the FORMat:DATA command for more information.

If you need to change some of the measurement parameters from the factory default settings you can set up the measurement with the CONFigure command. Use the commands in the SENSE:<measurement> and CALCulate:<measurement> subsystems to change the settings. Then you can use the READ? command to initiate the measurement and query the results.

If you need to repeatedly make a given measurement with settings other than the factory defaults, you can use the commands in the SENSE:<measurement> and CALCulate:<measurement> subsystems to set up the measurement. Then use the READ? command to initiate the measurement and query results.

Measurement settings persist if you initiate a different measurement and then return to a previous one. Use READ:<measurement>? if you want to use those persistent settings. If you want to go back to the default settings, use MEASure:<measurement>?.

Configure Commands:

:CONFigure:<measurement>

This command stops the current measurement (if any) and sets up the instrument for the specified measurement using

the factory default instrument settings. It does not initiate the taking of measurement data unless INIT:CONTInuous is ON. If you change any measurement settings after using the CONFigure command, the READ command can be used to initiate a measurement without changing the settings back to their defaults.

In the Swept SA measurement in Spectrum Analyzer mode the CONFigure command also turns the averaging function on and sets the number of averages to 10 for all measurements.

:CONFigure: <measurement>: NDEFault stops the current measurement and changes to the specified measurement. It does not change the settings to the defaults. It does not initiate the taking of measurement data unless INIT:CONTInuous is ON.

The CONFigure? query returns the current measurement name.

The CONFigure:CATalog? query returns a quoted string of all licensed measurement names in the current mode. For example, "SAN, CHP, OBW, ACP, PST, TXP, SPUR, SEM, LIST".

Fetch Commands:

:FETCh:<measurement>[n]?

This command puts selected data from the most recent measurement into the output buffer. Use FETCh if you have already made a good measurement and you want to return several types of data (different [n] values, for example, both scalars and trace data) from a single measurement. FETCh saves you the time of re-making the measurement. You can only FETCh results from the measurement that is currently active, it will not change to a different measurement. An error message is reported if a measurement other than the current one is specified.

If you need to get new measurement data, use the READ command, which is equivalent to an INITiate followed by a FETCh.

The scalar measurement results will be returned if the optional [n] value is not included, or is set to 1. If the [n] value is set to a value other than 1, the selected trace data results will be returned. See each command for details of what types of scalar results or trace data results are available. The binary data formats should be used for handling large blocks of data since they are smaller and transfer faster than the ASCII format. (FORMat:DATA)

FETCh may be used to return results other than those specified with the original READ or MEASure command that you sent.

INITiate Commands:

:INITiate:<measurement>

This command is not available for measurements in all the instrument modes:

- Initiates a trigger cycle for the specified measurement, but does not output any data. You must then use the FETCh<meas> command to return data. If a measurement other than the current one is specified, the instrument will switch to that measurement and then initiate it.
- For example, suppose you have previously initiated the ACP measurement, but now you are running the channel power measurement. If you send INIT:ACP? it will change from channel power to ACP and will initiate an ACP measurement.
- Does not change any of the measurement settings. For example, if you have previously started the ACP measurement and you send INIT:ACP? it will initiate a new ACP measurement using the same instrument settings as the last time ACP was run.
- If your selected measurement is currently active (in the idle state) it triggers the measurement, assuming the trigger conditions are met. Then it completes one trigger cycle. Depending upon the measurement and the number of averages, there may be multiple data acquisitions, with multiple trigger events, for one full trigger cycle. It also holds off additional commands on GPIB until the acquisition is complete.

READ Commands:

:READ:<measurement>[n]?

- Does not preset the measurement to the factory default settings. For example, if you have previously initiated the ACP
-

measurement and you send READ:ACP? it will initiate a new measurement using the same instrument settings.

- Initiates the measurement and puts valid data into the output buffer. If a measurement other than the current one is specified, the instrument will switch to that measurement before it initiates the measurement and returns results.
 - For example, suppose you have previously initiated the ACP measurement, but now you are running the channel power measurement. Then you send READ:ACP? It will change from channel power back to ACP and, using the previous ACP settings, will initiate the measurement and return results.
 - Blocks other SCPI communication, waiting until the measurement is complete before returning the results
 - If the optional [n] value is not included, or is set to 1, the scalar measurement results will be returned. If the [n] value is set to a value other than 1, the selected trace data results will be returned. See each command for details of what types of scalar results or trace data results are available. The binary data formats should be used when handling large blocks of data since they are smaller and faster than the ASCII format. (FORMat:DATA)
-

Initial S/W Revision	Prior to A.02.00
----------------------	------------------

Current Measurement Query (Remote Command Only)

This command returns the name of the measurement that is currently running.

Remote Command	:CONFigure?
-----------------------	-------------

Example	CONF?
----------------	-------

Initial S/W Revision	Prior to A.02.00
----------------------	------------------

Limit Test Current Results (Remote Command Only)

Queries the status of the current measurement limit testing. It returns a 0 if the measured results pass when compared with the current limits. It returns a 1 if the measured results fail any limit tests.

Remote Command	:CALCulate:CLIMits:FAIL?
-----------------------	--------------------------

Example	CALC:CLIM:FAIL? queries the current measurement to see if it fails the defined limits. Returns a 0 or 1: 0 it passes, 1 it fails.
----------------	--

Initial S/W Revision	Prior to A.02.00
----------------------	------------------

Data Query (Remote Command Only)

Returns the designated measurement data for the currently selected measurement and subopcode.

n = any valid subopcode for the current measurement. See the measurement command results table for your current measurement, for information about what data is returned for the subopcodes.

This command uses the data setting specified by the FORMat:BORDER and FORMat:DATA commands and can return real or ASCII data. (See the format command descriptions under Input/Output in the Analyzer Setup section.)

Remote Command	:CALCulate:DATA[n]?
Notes	The return trace depends on the measurement. In CALCulate:<meas>:DATA[n], n is any valid subopcode for the current measurement. It returns the same data as the FETCH:<measurement>? query where <measurement> is the current measurement.
Initial S/W Revision	Prior to A.02.00

Calculate/Compress Trace Data Query (Remote Command Only)

Returns compressed data for the currently selected measurement and sub-opcode [n].

n = any valid sub-opcode for that measurement. See the MEASure:<measurement>? command description of your specific measurement for information on the data that can be returned.

The data is returned in the current Y Axis Unit of the analyzer. The command is used with a sub-opcode <n> (default=1) to specify the trace. With trace queries, it is best if the analyzer is not sweeping during the query. Therefore, it is generally advisable to be in Single Sweep, or Update=Off.

This command is used to compress or decimate a long trace to extract and return only the desired data. A typical example would be to acquire N frames of GSM data and return the mean power of the first burst in each frame. The command can also be used to identify the best curve fit for the data.

Remote Command	:CALCulate:DATA<n>:COMPRESS? BLOCK CFIT MAXimum MINimum MEAN DMEan RMS RMSCubed SAMPLE SDEVIation PPHase [,<soffset> [,<length>[,<roffset>[,<rlimit>]]]]
Example	To query the mean power of a set of GSM bursts: Supply a signal that is a set of GSM bursts. Select the IQ Waveform measurement (in IQ Analyzer Mode). Set the sweep time to acquire at least one burst. Set the triggers such that acquisition happens at a known position relative to a burst. Then query the mean burst levels using, CALC:DATA2:COMP? MEAN, 24e-6, 526e-6 (These parameter values correspond to GSM signals, where 526e-6 is the length of the burst in the slot and you just want 1 burst.)
Notes	The command supports 5 parameters. Note that the last 4 (<soffset>, <length>, <roffset>, <rlimit>) are optional. But these optional parameters must be entered in the specified order. For example, if you want to specify <length>, then you must also specify <soffset>. See details below for a definition of each of these parameters. This command uses the data in the format specified by FORMat:DATA, returning either binary or ASCII data.
Initial S/W Revision	Prior to A.02.00

- BLOCK or block data - returns all the data points from the region of the trace data that you specify. For example, it could be used to return the data points of an input signal over several timeslots, excluding the portions of the trace data that you do not want. (This is x,y pairs for trace data and I,Q pairs for complex data.)

- CFIT or curve fit - applies curve fitting routines to the data. <soffset> and <length> are required to define the data that you want. <roffset> is an optional parameter for the desired order of the curve equation. The query will return the following values: the x-offset (in seconds) and the curve coefficients ((order + 1) values).

MIN, MAX, MEAN, DME, RMS, RMSC, SAMP, SDEV and PPH return one data value for each specified region (or <length>) of trace data, for as many regions as possible until you run out of trace data (using <roffset> to specify regions). Or they return the number of regions you specify (using <rlimit>) ignoring any data beyond that.

- MINimum - returns the minimum data point (y value) for the specified region(s) of trace data. For I/Q trace data, the minimum magnitude of the I/Q pairs is returned.
- MAXimum - returns the maximum data point (y value) for the specified region(s) of trace data. For I/Q trace data, the maximum magnitude of the I/Q pairs is returned.
- MEAN - returns a single value that is the arithmetic mean of the data point values (in dB/ dBm) for the specified region(s) of trace data. For I/Q trace data, the mean of the magnitudes of the I/Q pairs is returned. See the following equations.

•

NOTE

If the original trace data is in dB, this function returns the arithmetic mean of those log values, not log of the mean power which is a more useful value. The mean of the log is the better measurement technique when measuring CW signals in the presence of noise. The mean of the power, expressed in dB, is useful in power measurements such as Channel Power. To achieve the mean of the power, use the RMS option.

Equation 1

Mean Value of Data Points for Specified Region(s)

$$MEAN = \frac{1}{n} \sum_{X_i \in \text{region}(s)} X_i$$

where X_i is a data point value, and n is the number of data points in the specified region(s).

Equation 2

Mean Value of I/Q Data Pairs for Specified Region(s)

$$MEAN = \frac{1}{n} \sum_{X_i \in \text{region}(s)} |X_i|$$

where $|X_i|$ is the magnitude of an I/Q pair, and n is the number of I/Q pairs in the specified region(s).

- DMEan - returns a single value that is the mean power (in dB/ dBm) of the data point values for the specified region(s) of trace data. See the following equation:

Equation 3

DMEan Value of Data Points for Specified Region(s)

$$\text{DME} = 10 \times \log_{10} \left(\frac{1}{n} \sum_{X_i \in \text{region}(s)} 10^{\frac{X_i}{10}} \right)$$

- RMS - returns a single value that is the average power on a root-mean-squared voltage scale (arithmetic rms) of the data point values for the specified region(s) of trace data. See the following equation.

NOTE

For I/Q trace data, the rms of the magnitudes of the I/Q pairs is returned. See the following equation. This function is very useful for I/Q trace data. However, if the original trace data is in dB, this function returns the rms of the log values which is not usually needed.

Equation 4

RMS Value of Data Points for Specified Region(s)

$$\text{RMS} = \sqrt{\frac{1}{n} \sum_{X_i \in \text{region}(s)} X_i^2}$$

where X_i is a data point value, and n is the number of data points in the specified region(s).

Equation 5

RMS Value of I/Q Data Pairs for Specified Region(s)

$$\text{RMS} = \sqrt{\frac{1}{n} \sum_{X_i \in \text{region}(s)} X_i X_i^*}$$

where X_i is the complex value representation of an I/Q pair, X_i^* its conjugate complex number, and n is the number of I/Q pairs in the specified region(s).

Once you have the rms value for a region of trace data (linear or I/Q), you may want to calculate the mean power. You must convert this rms value (peak volts) to power in dBm:

$$10 \times \log[10 \times (\text{rms value})^2]$$

- SAMPlE - returns the first data value (x,y pair) for the specified region(s) of trace data. For I/Q trace data, the first I/Q pair is returned.
- SDEVIation - returns a single value that is the arithmetic standard deviation for the data point values for the specified region(s) of trace data. See the following equation.
- For I/Q trace data, the standard deviation of the magnitudes of the I/Q pairs is returned. See the following equation.

Equation 6

Standard Deviation of Data Point Values for Specified Region(s)

$$\text{SDEV} = \sqrt{\frac{1}{n} \sum_{X_i \in \text{region}(s)} (X_i - \bar{X})^2}$$

where X_i is a data point value, \bar{X} is the arithmetic mean of the data point values for the specified region (s), and n is the number of data points in the specified region(s).

$$\text{SDEV} = \sqrt{\frac{1}{n} \sum_{X_i \in \text{region}(s)} (|X_i| - \bar{X})^2}$$

where $|X_i|$ is the magnitude of an I/Q pair, \bar{X} is the mean of the magnitudes for the specified region(s), and n is the number of data points in the specified region(s).

- PPHase - returns the x,y pairs of both rms power (dBm) and arithmetic mean phase (radian) for every specified region and frequency offset (Hz). The number of pairs is defined by the specified number of regions. This parameter can be used for I/Q vector ($n=0$) in Waveform (time domain) measurement and all parameters are specified by data point in PPHase.

The rms power of the specified region may be expressed as:

$$\text{Power} = 10 \times \log [10 \times (\text{RMS I/Q value})] + 10.$$

The RMS I/Q value (peak volts) is:

$$\sqrt{\frac{1}{n} \sum_{X_i \in \text{region}} X_i X_i^*}$$

where X_i is the complex value representation of an I/Q pair, X_i^* its conjugate complex number, and n is the number of I/Q pairs in the specified region.

The arithmetic mean phase of the specified region may be expressed as:

$$\frac{1}{n} \sum_{Y_i \in \text{region}} Y_i$$

where Y_i is the unwrapped phase of I/Q pair with applying frequency correction and n is the number of I/Q pairs in the specified region.

The frequency correction is made by the frequency offset calculated by the arithmetic mean of every specified region's frequency offset. Each frequency offset is calculated by the least square method against the unwrapped phase of I/Q pair.

Sample Trace Data - Constant Envelope

(See below for explanation of variables.)

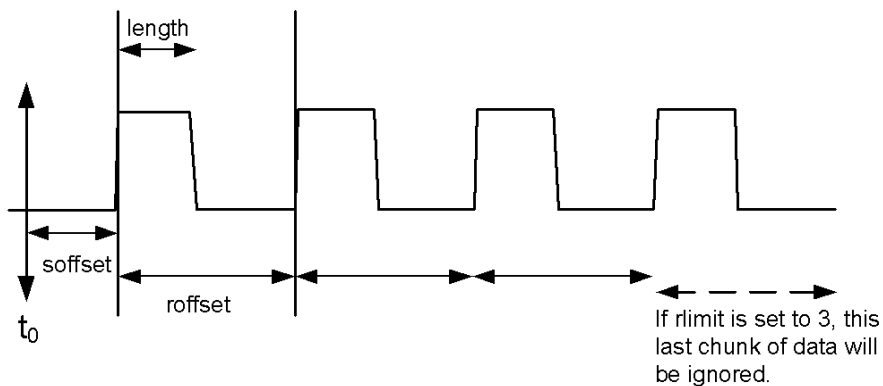

Sample Trace Data - Not Constant Envelope

(See below for explanation of variables.)

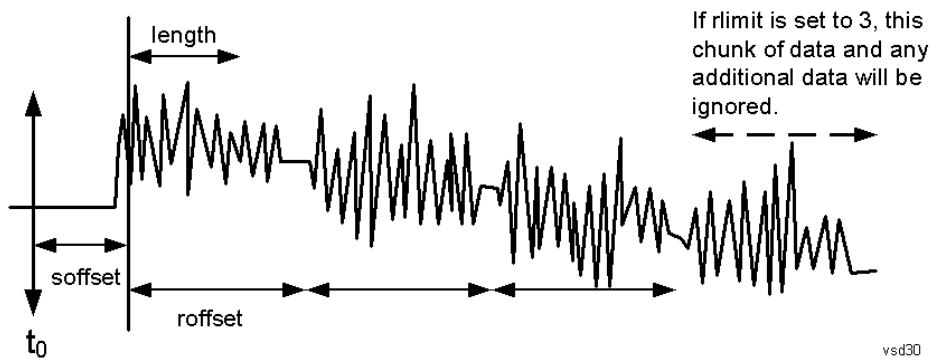

<soffset> - start offset is an optional real number. (It is in seconds for time-domain traces, and is a dimensionless index 0 to Npoints - 1, for frequency-domain traces). It specifies the amount of data at the beginning of the trace that will be ignored before the decimation process starts. It is the time or frequency change from the start of the trace to the point where you want to start using the data. The default value is zero.

<length> - is an optional real number. (It is in seconds for time-domain traces, and is a dimensionless index 0 to Npoints - 1, for frequency-domain traces). It defines how much data will be compressed into one value. This parameter has a default value equal to the current trace length.

<roffset> - repeat offset is an optional real number. (It is in seconds for time-domain traces, and is a dimensionless index 0 to Npoints - 1, for frequency-domain traces). It defines the beginning of the next field of trace elements to be compressed. This is relative to the beginning of the previous field. This parameter has a default value equal to the <length> variable. Note that this parameter is used for a completely different purpose when curve fitting (see CFIT above).

<rlimit> - repeat limit is an optional integer. It specifies the number of data items that you want returned. It will ignore any additional items beyond that number. You can use the Start offset and the Repeat limit to pick out exactly what part of the data you want to use. The default value is all the data.

Calculate Peaks of Trace Data (Remote Command Only)

Returns a list of all the peaks for the currently selected measurement and sub-opcode [n]. The peaks must meet the requirements of the peak threshold and excursion values.

n = any valid sub-opcode for the current measurement. See the MEASure:<measurement> command description of your specific measurement for information on the data that can be returned.

The command can only be used with specific sub-opcodes with measurement results that are trace data. Both real and complex traces can be searched, but complex traces are converted to magnitude in dBm. In many measurements the sub-opcode n=0, is the raw trace data which cannot be searched for peaks. And Sub-opcode n=1, is often calculated results values which also cannot be searched for peaks.

This command uses the data setting specified by the FORMat:BORDER and FORMat:DATA commands and can return real or ASCII data. If the format is set to INT,32, it returns REAL,32 data.

The command has four types of parameters:

- Threshold (in dBm)
- Excursion (in dB)
- Sorting order (amplitude, frequency, time)
- Optional in some measurements: Display line use (all, > display line, < display line)

Remote Command	<p>For Swept SA measurement:</p> <pre>:CALCulate:DATA[1] 2 ... 6:PEAKs? <threshold>,<excursion>[,AMPLitude FREQuency TIME[,ALL GTDLLine LTDLine]]</pre> <p>For most other measurements:</p> <pre>:CALCulate:DATA[1] 2 ... 6:PEAKs? <threshold>,<excursion>[,AMPLitude FREQuency TIME]</pre>
-----------------------	---

Example	<p>Example for Swept SA measurement in Spectrum Analyzer Mode:</p> <p>CALC:DATA4:PEAK? -40, 10, FREQ, GTDL This will identify the peaks of trace 4 that are above -40 dBm, with excursions of at least 10 dB. The peaks are returned in order of increasing frequency, starting with the lowest frequency. Only the peaks that are above the display line are returned.</p> <p>Query Results 1:</p> <p>With FORMat:DATA REAL, 32 selected, it returns a list of floating-point numbers. The first value in the list is the number of peak points that are in the following list. A peak point consists of two values: a peak amplitude followed by its corresponding frequency (or time).</p> <p>If no peaks are found the peak list will consist of only the number of peaks, (0).</p>
----------------	---

Notes	<p><n> - is the trace that will be used</p> <p><threshold> - is the level below which trace data peaks are ignored. Note that the threshold value is required and is always used as a peak criterion. To effectively disable the threshold criterion for this command, provide a substantially low threshold value such as -200 dBm. Also note that the threshold value used in this command is independent of and has no effect on the threshold value stored under the Peak Criteria menu.</p> <p><excursion> - is the minimum amplitude variation (rise and fall) required for a signal to be identified as peak. Note that the excursion value is required and is always used as a peak criterion. To effectively disable the excursion criterion for this command, provide the minimum value of 0.0 dB. Also note that the excursion value used in this command is independent of and has no effect on the</p>
--------------	---

excursion value stored under the Peak Criteria menu.

Values must be provided for threshold and excursion. The sorting and display line parameters are optional (defaults are AMPLitude and ALL).

Note that there is always a Y-axis value for the display line, regardless of whether the display line state is on or off. It is the current Y-axis value of the display line which is used by this command to determine whether a peak should be reported

Sorting order:

AMPLitude - lists the peaks in order of descending amplitude, with the highest peak first (default if optional parameter not sent)

FREQUency - lists the peaks in order of occurrence, left to right across the x-axis.

TIME - lists the peaks in order of occurrence, left to right across the x-axis.

Peaks vs. Display Line:

ALL - lists all of the peaks found (default if optional parameter not sent).

GTDLine (greater than display line) - lists all of the peaks found above the display line.

LTDLine (less than display line) - lists all of the peaks found below the display line.

Initial S/W Revision Prior to A.02.00

Format Data: Numeric Data (Remote Command Only)

This command specifies the format of the trace data input and output. It specifies the formats used for trace data during data transfer across any remote port. It affects only the data format for setting and querying trace data for the :TRACe[:DATA], TRACe[:DATA]?, :CALCulate:DATA[n]? and FETCh:SANalyzer [n]? commands and queries.

Remote Command	:FORMat[:TRACe] [:DATA] ASCii INTeger, 32 REAL, 32 REAL, 64 :FORMat[:TRACe] [:DATA] ?
Notes	The query response is: ASCii: ASC,8 REAL,32: REAL,32 REAL,64: REAL,64 INTeger,32: INT,32 When the numeric data format is REAL or ASCii, data is output in the current Y Axis unit. When the data format is INTeger, data is output in units of m dBm (.001 dBm). The INT,32 format returns binary 32-bit integer values in internal units (m dBm), in a definite length block.
Dependencies	Sending a data format spec with an invalid number (for example, INT,48) generates no error. The analyzer simply uses the default (8 for ASCii, 32 for INTeger, 32 for REAL). Sending data to the analyzer which does not conform to the current FORMat specified, results in an error. Sending ASCII data when a definite block is expected generates message -161 "Invalid Block Data" and sending a definite block when ASCII data is expected generates message -121 "Invalid Character in Number".
Preset	ASCii
Backwards Compatibility Notes	Note that the INT,32 format is only applicable to the command, TRACe:DATA. This preserves backwards compatibility for the Swept SA measurement. For all other commands/queries which honor FORMat:DATA, if INT,32 is sent the analyzer will behave as though it were set to REAL,32.
Initial S/W Revision	Prior to A.02.00

The specs for each output type follow:

AScii - Amplitude values are in ASCII, in the current Y Axis Unit, one ASCII character per digit, values separated by commas, each value in the form:

SX.YYYYYEsZZ

Where:

S = sign (+ or -)

X = one digit to left of decimal point

Y = 5 digits to right of decimal point

E = E, exponent header

s = sign of exponent (+ or -)

ZZ = two digit exponent

REAL,32 - Binary 32-bit real values in the current Y Axis Unit, in a definite length block.

REAL,64 - Binary 64-bit real values in the current Y Axis Unit, in a definite length block.

Format Data: Byte Order (Remote Command Only)

This command selects the binary data byte order for data transfer and other queries. It controls whether binary data is transferred in normal or swapped mode. This command affects only the byte order for setting and querying trace data for the :TRACe[:DATA], TRACe[:DATA]? , :CALCulate:DATA[n]? and FETCh:SANalyzer[n]? commands and queries.

By definition any command that says it uses FORMat:DATA uses any format supported by FORMat:DATA.

The NORMal order is a byte sequence that begins with the most significant byte (MSB) first, and ends with the least significant byte (LSB) last in the sequence: 1|2|3|4. SWAPped order is when the byte sequence begins with the LSB first, and ends with the MSB last in the sequence: 4|3|2|1.

Remote Command	:FORMat:BORDER NORMal SWAPped :FORMat:BORDER?
Preset	NORMal
Initial S/W Revision	Prior to A.02.00

Meas Setup

Changing any of the parameters under the Radio menu, changing test enables in the Test Selection menu, or by pressing Test Preset, will change measurement setup parameters as noted in the Coupling sections of the individual parameters.

See "[More Information about Meas Setup:](#)" on page 971.

Key Path	Front-panel key
Mode	IDEN
Initial S/W Revision	A.02.00

More Information about Meas Setup:

The first three menu softkeys are intended to be set and used in the order they appear on this menu, top to bottom. They are outlined in the following sections.

You should first set up the Radio parameters, then make the Test Selection ("[Test Selection](#)" on page 971) or selections of the Tests that you want to run, and finally perform a Test Preset ("[Test Preset](#)" on page 973), which uses what you have just selected to preset the remaining measurement parameters to a known state which should be a good starting point for your test(s).

After performing these three steps, you may want to adjust the remaining parameters for your test application.

Test Selection

Controls which measurement calculations and accompanying test comparisons are enabled. Test Selection changes affect some measurement setup parameters, as noted in their Coupling descriptions.

Key Path	Meas Setup
Mode	IDEN
Initial S/W Revision	A.02.00

EVM

Enables EVM testing. The composite EVM of a signal burst is measured and compared to the EVM Test Limit.

Key Path	Meas Setup, Test Selection
Mode	IDEN
Remote Command	<code>[:SENSe] :IDEMod:TSEL:EVMagnitude OFF ON 0 1</code> <code>[:SENSe] :IDEMod:TSEL:EVMagnitude?</code>
Example	<code>:IDEM:TSEL:EVM ON</code>
Couplings	This affects parameter values as set by Test Preset (" Test Preset " on page 973), noted in the coupling

	row table entries for the affected parameters.
Preset	ON
State Saved	Saved in instrument state.
Range	ON OFF
Initial S/W Revision	A.02.00

PvT

Enables PvT testing. The envelope of a slot is measured and compared to the mask for the specified slot format.

Key Path	Meas Setup, Test Selection
Mode	IDEN
Remote Command	[:SENSe] :IDEMod:TSEL:PVTime OFF ON 0 1 [:SENSe] :IDEMod:TSEL:PVTime?
Example	:IDEM:TSEL:PVT ON
Couplings	This affects parameter values set by Test Preset (" Test Preset " on page 973), noted in the coupling row table entries for the affected parameters.
Preset	ON
State Saved	Saved in instrument state.
Range	ON OFF
Initial S/W Revision	A.02.00

BER

Enables BER testing. The overall BER of a number of slots is measured and compared to the BER Test Limit.

Key Path	Meas Setup, Test Selection
Mode	IDEN
Remote Command	[:SENSe] :IDEMod:TSEL:BERate OFF ON 0 1 [:SENSe] :IDEMod:TSEL:BERate?
Example	:IDEM:TSEL:BER ON
Couplings	This affects parameter values set by Test Preset (" Test Preset " on page 973), as noted in the coupling row table entries for the affected parameters. When the BER test is selected, the BER Slots parameter is active. This will change the minimum allowed Search Length (" Search Length " on page 977), as well as BER Slots (" BER Slots " on page 976).
Preset	ON

State Saved	Saved in instrument state.
Range	ON OFF
Initial S/W Revision	A.02.00

Test Preset

Initializes the setup to perform the tests selected, and based on the radio setup specified. Test Preset initializes all the coupled parameters for the selected tests. This key color is green, indicating it is a preset key.

See "[More Information about Test Preset:](#)" on page 973.

Key Path	Meas Setup
Mode	IDEN
Remote Command	CONF:IDEMod
Example	CONF:IDEM
Couplings	This affects parameter values as detailed below. It also performs a Preset View:Test Standard (" Preset View: Test Standard " on page 1088).
Initial S/W Revision	A.02.00

More Information about Test Preset:

Test Preset does not change the following parameters:

- Test selection (EVM Test, PvT Test, and/or BER Test) ("[Test Selection](#)" on page 971)
- MQAM Format
- Slot Format
- Color Code
- Carrier Config

In many cases, Test Preset uses the parameters noted above to determine by their settings what other parameters will be preset to.

Parameters that will be affected by Test Preset are noted in the Couplings row in the parameter tables.

EVM Setup

The parameters in the following sections primarily affect the functionality of the EVM measurements and EVM Test.

Key Path	Meas Setup
Mode	IDEN
Initial S/W Revision	A.02.00

Analysis Subchannel

Selects the subchannel to be analyzed. It affects the Subchannel demodulation results ("[Subchannel Demod](#)" on page 1044), and the Subchannel Error Summary table ("[Subchannel Error Summary](#)" on page 1046).

Viewing the analysis of only one subchannel may identify specific signal impairments. Selecting a different analysis subchannel of the current signal acquisition, causes the analysis to be performed on that specified subchannel.

For WiDEN slot formats, the Subchannel data results are of the Analysis Subchannel chosen, of the selected WiDEN Carrier ("[WiDEN Carrier](#)" on page 975).

Key Path	Meas Setup, EVM Setup
Mode	IDEN
Remote Command	[:SENSe] :IDEMod:ASCHannel LO LI RI RO [:SENSe] :IDEMod:ASCHannel?
Example	:IDEM:ASCH LO
Preset	LO
State Saved	Saved in instrument state.
Range	0 (LO) 1 (LI) 2 (RI) 3 (RO)
Initial S/W Revision	A.02.00

0 (LO)

Selects the first, Left Outer (LO) subchannel.

Key Path	Meas setup, EVM Setup, Analysis Subchannel
Mode	IDEN
Initial S/W Revision	A.02.00

1 (LI)

Selects the second, Left Inner (LI) subchannel.

Key Path	Meas setup, EVM Setup, Analysis Subchannel
Mode	IDEN
Initial S/W Revision	A.02.00

2 (RI)

Selects the third, Right Inner (RI) subchannel.

Key Path	Meas setup, EVM Setup, Analysis Subchannel
Mode	IDEN
Initial S/W Revision	A.02.00

3 (RO)

Selects the fourth, Right Outer (RO) subchannel.

Key Path	Meas setup, EVM Setup, Analysis Subchannel
Mode	IDEN
Initial S/W Revision	A.02.00

WiDEN Carrier

Only used when WiDEN Slot Formats are active. It is ignored (grayed out) for other slot formats. It affects the Subchannel demodulation results ("[Subchannel Demod](#)" on page 1044), and the Subchannel Error Summary table ("[Subchannel Error Summary](#)" on page 1046). See also Analysis Subchannel ("[Analysis Subchannel](#)" on page 974).

Key Path	Meas Setup, EVM Setup
Mode	IDEN
Remote Command	<code>[:SENSe] :IDEMod:WCARrier <integer></code> <code>[:SENSe] :IDEMod:WCARrier?</code>
Example	<code>:IDEM:WCAR 0</code>
Preset	0
State Saved	Saved in instrument state.
Min	0
Max	3
Initial S/W Revision	A.02.00

EVM Test Limit

Test limit for the EVM test, in % EVM.

Key Path	Meas Setup, EVM Setup
Mode	IDEN
Remote Command	<code>:CALCulate:IDEMod:EVMagnitude:LIMit:EVMLimit <real></code> <code>:CALCulate:IDEMod:EVMagnitude:LIMit:EVMLimit?</code>
Example	<code>:CALC:IDEM:EVM:LIM:EVML 10</code>

Preset	10
State Saved	Saved in instrument state.
Min	.01
Max	100
Initial S/W Revision	A.02.00

BER Setup

Affect functionality of BER measurements and the BER Test. In addition, the Analysis Slot defines which detected slot is analyzed by the EVM and PVT Tests.

Key Path	Meas Setup
Mode	IDEN
Initial S/W Revision	A.02.00

BER Slots

Active when BER test is selected ("[BER](#)" on page 972). This parameter sets the number of slots to demodulate and measure BER. Slots with no detected burst signal will be ignored. The number of BER Slots defines the minimum allowed Search Length. See "[Search Length](#)" on page 977 for details.

BER Slots also set the upper bound of the Analysis Slot. See "[Analysis Slot](#)" on page 978 for details.

When the BER Test is not enabled, BER Slots is clamped to 1.

Key Path	Meas Setup, BER Setup
Mode	IDEN
Remote Command	<code>[:SENSe] :IDEMod :SLOTs <integer></code> <code>[:SENSe] :IDEMod :SLOTs ?</code>
Example	:IDEM:SLOT 1
Couplings	BER Slots defines the minimum allowed Search Length (" Search Length " on page 977), and the maximum allowed Analysis Slot (" Analysis Slot " on page 978). Test Preset (" Test Preset " on page 973) sets this to 1 or 16, depending on whether the BER Test (" BER " on page 972) is enabled or disabled; see below.
Preset	16
State Saved	Saved in instrument state.
Range	See table below
Min	1
Max	32
Initial S/W Revision	A.02.00

Preset, Test Preset value:

BER Test enabled	16
BER Test disabled	1

BER Test Limit

Test limit for the BER test, given in % BER.

Key Path	Meas Setup, BER Setup
Mode	IDEN
Remote Command	:CALCulate:IDEMod:BERate:LIMit:ERATe <real> :CALCulate:IDEMod:BERate:LIMit:ERATe
Example	:CALC:IDEM:BER:LIM:ERAT 5
Couplings	No
Preset	5
State Saved	Saved in instrument state.
Min	0
Max	50
Initial S/W Revision	A.02.00

Search Length

Sets the time record for acquiring the signal in making a measurement. It must be long enough to include the number of slots to be analyzed. When the Trigger is set to Free Run, it must also include the maximum expected latency time.

Search Length is preset to a length appropriate for all slots active in inbound slot formats, as detailed below. Search Length is set to a default value when the BER Test is enabled, or when the BER Slots are changed. A longer search length is necessary when the subscriber radio under test is not transmitting in every slot in each frame. If a sparse frame is transmitted, increasing the Search Length will ensure enough slots are captured to satisfy the BER Slots requirement for inbound slot formats.

Key Path	Meas Setup
Mode	IDEN
Remote Command	[:SENSe] :IDEMod:SYNC:SLEngth <time> [:SENSe] :IDEMod:SYNC:SLEngth?
Example	:IDEM:SYNC:SLEN .260
Couplings	When user change the BER Slots parameter, the search length will be adjusted according to it.
Preset	260 ms
Min	35 ms
Max	2 s
Initial S/W Revision	A.02.00

Default Search Length - assumes that the slots are as densely packed as possible, as in the case of outbound slot formats.

	BER Test enabled	BER Test disabled
BER Slots default	16	1
Search Length	15 * (BER Slots +1) + 5 ms	15 * (BER Slots +1) + 5 ms
Search Length at default number of BER Slots	260 ms	35 ms

Analysis Slot

Selects the slot analyzed in the BER Slot Summary data result. It also specifies the slot analyzed for all other single slot data results, such as the EVM results and PvT results. Changing the analysis slot causes the analysis to be performed on that newly specified slot of the current signal acquisition.

Analysis Slot range is from 0 to BER Slots-1, where each value is a different slot in the BER acquisition. When the BER Test is not enabled, the Analysis Slot is clamped to slot 0.

Key Path	Meas Setup
Mode	IDEN
Remote Command	[:SENSe] :IDEMod:ASLot <integer> [:SENSe] :IDEMod:ASLot?
Example	:IDEM:ASL 0
Couplings	Maximum is limited to BER Slots - 1 (" BER Slots " on page 976)
Preset	0
State Saved	Saved in instrument state.
Min	0
Max	31
Initial S/W Revision	A.02.00

Avg Number

Enables you to turn averaging on or off, and set the number of scans (time records) whose measurement results are averaged. Averaging can be done over spectrum results (RMS) or over time records (Time). A third kind of pseudo averaging displays the maximum value seen at each spectral line over the specified number of scans. See "**Average Type**" on page 1180 for a more detailed description of how measurement results are averaged. For RMS or Time averaging, the process is similar. Each time an averaged result is displayed, it is the sum of the individual results taken since measurement restart, divided by the number of scans. (For Max averaging, there is no actual summation or division.) The Measurement Bar shows the number of scans and the Avg number setting. For example, if 4 scans have been taken and the Avg Number is 10, the Meas Bar shows "4/10". The measurement continues to take new scans until the number of scans is equal to the Avg Number setting, at which time the measurement stops if Sweep control is in

Single Mode. Otherwise, the measurement continues, and the Average Mode setting determines how successive scans are added to the averaged result. See ["Average Mode" on page 1179](#) for details.

Key Path	Meas Setup, More
Mode	VSA, LTE, LTETDD, IDEN, LTEAFDD, LTEATDD
Measurement	<meas>:=VECTor ADEMod DDEMod W11A W11B EVM IPOWER IDEMod MOTotalk
Remote Command	[:SENSe] :<meas>:AVERage:COUNT <integer> [:SENSe] :<meas>:AVERage:COUNT? [:SENSe] :<meas>:AVERage [:STATe] OFF ON 0 1 [:SENSe] :<meas>:AVERage [:STATe] ?
Example	VECT:AVER:COUN 20 VECT:AVER:COUN? VECT:AVER ON VECT:AVER?
Notes	If an averaged measurement is idle because the scan count is equal to the Avg Number and the Avg Number is increased, the measurement resumes until the new number of averages is satisfied.
Preset	10 OFF IPOW: ON
State Saved	Saved in instrument state.
Min	1
Max	2147483647
Initial S/W Revision	Prior to A.02.00
Modified at S/W Revision	A.02.00

Average Mode

Determines what happens when the Sweep Mode is Continuous and the number of scans processed exceeds the Average Number (see ["Avg Number" on page 1178](#)). If the Sweep Control is in Single mode, this setting has no affect.

When averaging is on and the number of scans is less than or equal to the Avg Number setting, a linear average is calculated as explained in the Avg Number topic. After the scan count exceeds the Avg Number setting, the measurement continues to take new scans. The Measurement Bar average indicator shows ">N/N" where N is the Avg Number.

If Average Mode is Exp then new results are averaged in exponentially. In other words, each succeeding average is the weighted sum of the previous average, weighted by $(N-1)/N$, and the new measurement, weighted by $1/N$, where N is the Average Number setting. (For Max averaging, no weighting occurs; the result continues to be the max value seen at each spectral line for every previous scan since measurement restart.)

If Average Mode is Repeat, then the average buffer is cleared after the average counter reaches the Average Number setting, and the average counter is reset to 0. Then a new set of averages is taken. The

measurement bar therefore continues to show "k/N" in the average indicator, where k is the number of scans since the last time the average buffer was cleared and N is the Avg Number. The averaged result is the sum of the last k results divided by k. (For Max averaging, no sum or division takes place, but the buffer is cleared as stated above. The averaged result is the max value seen over the last k scans.)

Key Path	Meas Setup
Mode	VSA, LTE, LTETDD, IDEN, LTEAFDD, LTEATDD
Measurement	<meas>:=VECTor ADEMod DDEMod W11A W11B EVM IPOWER IDEMod MOTotalk
Remote Command	[:SENSe] : <meas> : AVERage : TCONtrol EXPonential REPeat [:SENSe] : <meas> : AVERage : TCONtrol ?
Example	VECT: AVER: TCON EXP VECT: AVER: TCON ?
Preset	EXP
State Saved	Saved in instrument state.
Range	Exp Repeat
Initial S/W Revision	Prior to A.02.00
Modified at S/W Revision	A.02.00

Average Setup

Accesses a menu enabling you to set Averaging parameters for all VSA based measurements.

Key Path	Meas Setup
Mode	VSA, LTE, LTETDD, IDEN, LTEAFDD, LTEATDD
Initial S/W Revision	Prior to A.02.00
Modified at S/W Revision	A.02.00

Average Type

Enables you to select the type of averaging. The following table shows what measurement results are averaged for each average type. This applies in the Vector Measurement.

Average Type	Measurement result averaged.
RMS	Spectrum, PSD: Power is averaged for each spectral line (i.e., this is a mean-square average of voltage). For the Spectrum result only, if the display transform is linear or real, the RMS result is displayed.
Time	Main Time: Individual time samples in the current time record are averaged vectorially (not RMS) with corresponding points in previous time records. See Main Time for more details.
Max	Spectrum, PSD: Not strictly an average. For each spectral line, power from the current measurement is compared to the average buffer value and the maximum is kept in the average buffer.

Some measurement results are inherently averaged, and are not affected by the Average controls. These are: CCDF, CDF, and PDF. They average continuously until the next measurement restart.

Key Path	Meas Setup, Average Setup
Mode	VSA, LTE, LTETDD, IDEN, LTEAFDD, LTEATDD
Measurement	<meas>:=VECTor ADEMod DDEMod W11A W11B EVM IPOWER IDEMod MOTotalk
Remote Command	[:SENSe] :<meas>:AVERage:TYPE RMS TIME MAXimum [:SENSe] :<meas>:AVERage:TYPE?
Example	VECT:AVER:TYPE RMS VECT:AVER:TYPE?
Preset	RMS
State Saved	Saved in instrument state.
Range	RMS Time Max
Initial S/W Revision	Prior to A.02.00
Modified at S/W Revision	A.02.00

Fast Average

Controls the display of average data. If fast averaging is off, then the display is updated after each time record is processed. If fast averaging is on, then the display is only updated after every M records, where M is the Update Rate (see ["Update Rate" on page 1181](#)). For example, if the fast average count is 10, then the running average is only displayed every 10th time record.

Key Path	Meas Setup, Average Setup
Mode	VSA, LTE, LTETDD, IDEN, LTEAFDD, LTEATDD
Measurement	<meas>:=VECTor ADEMod DDEMod W11A W11B EVM IPOWER IDEMod MOTotalk
Remote Command	[:SENSe] :<meas>:AVERage:FAST OFF ON 0 1 [:SENSe] :<meas>:AVERage:FAST?
Example	VECT:AVER:FAST ON VECT:AVER:FAST?
Preset	OFF
State Saved	Saved in instrument state.
Range	On Off
Initial S/W Revision	Prior to A.02.00
Modified at S/W Revision	A.02.00

Update Rate

Controls how often the display updates when fast averaging is turned on. If the Fast Averaging State is MAX then the display is updated only after the full Average Count is reached. Otherwise, the display is

updated whenever the average count is a multiple of the Update Rate.

Key Path	Meas Setup, More, Average Setup
Mode	VSA, LTE, LTE-TDD, iDEN, LTE-AFDD, LTE-TDD
Measurement	<meas>:=VECTor ADEMod DDEMod W11A W11B EVM IPOWER iDEMod MOTotalk
Remote Command	[:SENSe] : <meas> : AVERage : FAST : URATe <integer> [:SENSe] : <meas> : AVERage : FAST : URATe ? [:SENSe] : <meas> : AVERage : FAST : URATe : AUTO OFF ON 0 1 [:SENSe] : <meas> : AVERage : FAST : URATe : AUTO ?
Example	VECT: AVER: FAST: URAT 20 VECT: AVER: FAST: URAT ? VECT: AVER: FAST: URAT: AUTO ON VECT: AVER: FAST: URAT: AUTO ?
Preset	10 ON
State Saved	Saved in instrument state.
Min	1
Max	2147483647
Initial S/W Revision	Prior to A.02.00
Modified at S/W Revision	A.02.00

Extend Freq Lock Range

Setting this parameter to ON enables the modulation to NOT be closely centered on the Center Frequency. Turn this parameter OFF only in special cases where specific data patterns cause display instabilities.

Key Path	Meas Setup, More
Mode	iDEN
Remote Command	[:SENSe] : iDEMod : EFLock OFF ON 0 1 [:SENSe] : iDEMod : EFLock ?
Example	:iDEMod: EFL ON
Couplings	Set to ON by Test Preset (" Test Preset " on page 973)
Preset	ON
State Saved	Saved in instrument state.
Range	OFF ON
Initial S/W Revision	A.02.00

Normalize

Setting this parameter to ON results in the constellation diagram and other absolute demodulation results being normalized to a nominal 1.0 value. When set to OFF, results are presented in absolute units. This parameter will also affect the PvT trace. When normalize is ON, the PvT trace will be the normalized by the data power. If it's OFF, the PvT trace contains the absolute value.

Key Path	Meas Setup, More
Mode	IDEN
Remote Command	[:SENSe] :IDEMod:NORMAlize:STATe OFF ON 0 1 [:SENSe] :IDEMod:NORMAlize:STATe?
Example	:IDEM:NORM:STAT ON
Couplings	Set to ON by Test Preset (" Test Preset " on page 973)
Preset	ON
State Saved	Saved in instrument state.
Range	OFF ON
Initial S/W Revision	A.02.00

Advanced

Accesses advanced demodulation controls that are not commonly used. These menu selections are defined in the following sections.

Key Path	Meas Setup, More
Mode	IDEN
Initial S/W Revision	A.02.00

Filter Alpha

Sets the Root Raised Cosine (RRC) demodulation receive filter alpha parameter. It is preset per the test standards.

Key Path	Meas Setup, More, Advanced
Mode	IDEN
Remote Command	[:SENSe] :IDEMod:ALPHa <real> [:SENSe] :IDEMod:ALPHa?
Example	:IDEM:ALPH .2
Couplings	Set to .2 by Test Preset
Preset	.2
State Saved	Saved in instrument state.

Min	.05
Max	1.0
Initial S/W Revision	A.02.00

Time Scale Factor

Enables you to scale the timebase of a signal, or a debug environment where the symbol rate and DAC (Digital to Analog Converter) clocking is scaled at a faster or slower rate. For example, you can scale a test signal with a symbol rate of 4Hz instead of 4000Hz by entering: Time Scale Factor = 0.001, which results in a closer analysis.

Key Path	Meas Setup, More, Advanced
Mode	IDEN
Remote Command	<code>[:SENSe] :IDEMod:TSCale <real></code> <code>[:SENSe] :IDEMod:TSCale?</code>
Example	<code>:IDEM:TSC 1.0</code>
Couplings	Test Preset is 1.0. Will change Span
Preset	1.0
State Saved	Saved in instrument state.
Min	.1
Max	1000
Initial S/W Revision	A.02.00

Sync/Pilot Symbols

When this softkey selection is On, the EVM calculations include the Sync and Pilot Symbols. When Off, these symbols are not included in the EVM calculations.

Key Path	Meas Setup, More, Advanced
Mode	IDEN
Remote Command	<code>[:SENSe] :IDEMod:SPSYmbols:INCLude OFF ON 0 1</code> <code>[:SENSe] :IDEMod:SPSYmbols:INCLude?</code>
Example	<code>:IDEM:SPSY:INCL OFF</code>
Couplings	Test Preset set this to Off.
Preset	OFF
State Saved	Saved in instrument state.
Range	OFF ON
Initial S/W Revision	A.02.00

Droop

When this softkey selection is On, droop corrections are applied to the EVM calculations. When Off, droop corrections are not applied and droop errors are included in EVM results.

Key Path	Meas Setup, More, Advanced
Mode	IDEN
Remote Command	[:SENSe] : IDEMod : ADRoop : COMPensation OFF ON 0 1 [:SENSe] : IDEMod : ADRoop : COMPensation ?
Example	:IDEM:ADR:COMP ON
Couplings	Test Preset sets this to ON
Preset	ON
State Saved	Saved in instrument state.
Range	OFF ON
Initial S/W Revision	A.02.00

Pilot Tracking

Sets whether or not to include Pilot Tracking in Error Vector Magnitude (EVM) calculations and adjust constellation diagrams.

When Pilot Tracking is set to On, the analyzer uses the predicted locations of the pilot symbols compared to the actual pilot symbol locations. It then adds phase/amplitude corrections to better position the actual pilot symbols at the predicted locations. This generally results in improved EVM measurement accuracy.

Key Path	Meas Setup, More, Advanced
Mode	IDEN
Remote Command	[:SENSe] : IDEMod : PILot : TRACK OFF ON 0 1 [:SENSe] : IDEMod : PILot : TRACK ?
Example	:IDEM:PIL:TRAC OFF
Couplings	Test Preset set this to ON.
Preset	ON
State Saved	Saved in instrument state.
Range	OFF ON
Initial S/W Revision	A.02.00

11 iDEN Demod Measurement
Mode

Mode

See "[Mode](#)" on page 196

Mode Preset

Returns the active mode to a known state.

Mode Preset does the following for the currently active mode:

- Aborts the currently running measurement.
- Brings up the default menu for the mode, with no active function.
- Sets measurement Global settings to their preset values for the active mode only.
- Activates the default measurement.
- Brings up the default menu for the mode.
- Clears the input and output buffers.
- Sets Status Byte to 0.

Mode Preset does not:

- Cause a mode switch
- Affect mode persistent settings
- Affect system settings

See "[How-To Preset](#)" on page 988 for more information.

Key Path	Front-panel key
Remote Command	:SYSTem:PRESet
Example	:SYST:PRES
Notes	*RST is preferred over :SYST:PRES for remote operation. *RST does a Mode Preset, as done by the :SYST:PRES command, and it sets the measurement mode to Single measurement rather than Continuous for optimal remote control throughput. Clears all pending OPC bits. The Status Byte is set to 0.
Couplings	A Mode Preset aborts the currently running measurement, activates the default measurement, and gets the mode to a consistent state with all of the default couplings set.
Backwards Compatibility Notes	In the X-Series, the legacy "Factory Preset" has been replaced with Mode Preset, which only presets the currently active mode, not the entire instrument. In the X-Series, the way to preset the entire instrument is by using System, Restore System Defaults All, which behaves essentially the same way as restore System Defaults does on ESA and PSA. There is also no "Preset Type" as there is on the PSA. There is a green Mode Preset front-panel key that does a Mode Preset and a white-with-green-letters User Preset front-panel key that does a User Preset. The old PRESet:TYPE command is ignored (without generating an error), and SYST:PRES without a parameter does a Mode Preset, which should cover most backward code compatibility issues. The settings and correction data under the Input/Output front-panel key (examples: Input Z Corr, Ext Amp Gain, etc.) are no longer part of any Mode, so they will not be preset by a Mode Preset. They are preset using Restore Input/Output Defaults, Restore System Defaults All. Note that because User Preset does a Recall State, and all of these settings are saved in State, they ARE recalled when using

	User Preset.
Initial S/W Revision	Prior to A.02.00

How-To Preset

The table below shows all possible presets, their corresponding SCPI commands and front-panel access (key paths). Instrument settings depend on the current measurement context. Some settings are local to the current measurement, some are global (common) across all the measurements in the current mode, and some are global to all the available modes. In a similar way, restoring the settings to their preset state can be done within the different contexts.

Auto Couple - is a measurement local key. It sets all Auto/Man parameter couplings in the measurement to Auto. Any Auto/Man selection that is local to other measurements in the mode will not be affected.

Meas Preset - is a measurement local key. Meas Preset resets all the variables local to the current measurement except the persistent ones.

Mode Preset - resets all the current mode's measurement local and measurement global variables except the persistent ones.

Restore Mode Defaults - resets ALL the Mode variables (and all the Meas global and Meas local variables), including the persistent ones.

Type Of Preset	SCPI Command	Front Panel Access
Auto Couple	:COUPle ALL	Auto Couple front-panel key
Meas Preset	:CONFigure:<Measurement>	Meas Setup Menu
Mode Preset	:SYSTem:PRESet	Mode Preset (green key)
Restore Mode Defaults	:INSTrument:DEFault	Mode Setup Menu
Restore All Mode Defaults	:SYSTem:DEFault MODes	System Menu; Restore System Default Menu
*RST	*RST	not possible (Mode Preset with Single)
Restore Input/Output Defaults	:SYSTem:DEFault INPUt	System Menu; Restore System Default Menu
Restore Power On Defaults	:SYSTem:DEFault PON	System Menu; Restore System Default Menu
Restore Alignment Defaults	:SYSTem:DEFault ALIGN	System Menu; Restore System Default Menu
Restore Miscellaneous Defaults	:SYSTem:DEFault MISC	System Menu; Restore System Default Menu
Restore All System Defaults	:SYSTem:DEFault [ALL] :SYSTem:PRESet:PERsistent	System Menu; Restore System Default Menu
User Preset	:SYSTem:PRESet:USER	User Preset Menu
User Preset All Modes	:SYSTem:PRESet:USER:ALL	User Preset Menu

Power On Mode Preset	:SYSTem:PON:TYPE MODE	System Menu
Power On User Preset	:SYSTem:PON:TYPE USER	System Menu
Power On Last State	:SYSTem:PON:TYPE LAST	System Menu

Mode Setup

See "[Mode Setup](#)" on page 226

Peak Search

Displays a menu that enables markers to be easily moved among peaks on a trace and also performs the peak search function. Pressing Peak Search also makes the selected marker's X position the active function.

The peak search function causes the marker to move to the highest point in the trace. The highest point is the point with the largest y-axis value in the current trace format. If the format is complex (vector or constellation) then the point with the highest magnitude is chosen.

Pressing the Peak Search hard key always performs a Peak Search, with one exception: if the Peak Search menu is not showing but the selected marker is on (Normal, Delta, or Fixed), then pressing the Peak Search hardkey only displays the Peak Search menu. This enables you to select one of the other peak search functions without disturbing the selected marker's position. If you want to perform a peak search in this case, press the Peak Search hardkey again.

If the selected marker is Off, then pressing the Peak Search hardkey once not only shows the menu, but it turns on the selected marker in Normal mode, assigns it to the selected trace, and performs a peak search.

If any peak search SCPI command is invoked on a marker that is Off, the marker is first turned on in Normal mode and assigned to the selected trace. Then the peak search is performed.

Key Path	Front Panel
Mode	VSA, LTE, LTETDD, IDEN
Measurement	<meas>:=VECTor ADEMod DDEMod W11A W11B EVM IPOWER IDEMod MOTotalk
Remote Command	:CALCulate:<meas>:MARKer[1] 2 ...12:MAXimum
Example	CALC:VECT:MARK2:MAX
Notes	There is no softkey for this function. Instead, you press the Peak Search hardkey twice. (Pressing it once is sufficient if the Peak Search menu is showing, but twice guarantees that the function is invoked) If peak search function is not invoked (because the response to pressing the hardkey was only to show the menu) then the following message is shown: "Press Peak Search again to perform a Peak Search."
Initial S/W Revision	Prior to A.02.00
Modified at S/W Revision	A.02.00

Select Marker

Specifies the selected marker. The selected marker is the one that is affected by the marker position and properties settings, peak search, and other marker functions. Several menus have a Select Marker key for convenience. Marker selection using any one of these is reflected in all others, in other words, there is only one selected marker for the whole measurement. If all markers are off, then marker 1 becomes the selected marker.

As a convenience, if no markers are displayed on the selected trace, selecting a marker that is off automatically turns it on in normal mode on the selected trace.

There is no SCPI function for selecting a marker. Instead, SCPI functions can explicitly include the index of the marker for which they are to apply. (Most SCPI marker functions that affect the state of a marker also make it the selected marker for front panel commands.)

Key Path	Marker or Marker> or Marker Function or Peak Search
Mode	VSA, LTE, LTETDD, IDEN, LTEAFDD, LTEATDD
State Saved	No
Range	1 2 3 4 5 6 7 8 9 10 11 12
Initial S/W Revision	Prior to A.02.00
Modified at S/W Revision	A.02.00

Next Peak (Next Lower Amptd)

Moves the marker to the peak next lower in Y value than the peak it is currently on. If the format is complex (vector or constellation) then the marker moves to the closest point that has a lower magnitude than the marker's current position. If this function is invoked via SCPI on a marker that is off, the result is the same as if you sent a Peak Search command.

Key Path	Peak Search
Mode	VSA, LTE, LTETDD, IDEN
Measurement	<meas>:=VECTor ADEMod DDEMod W11A W11B EVM IPOWER IDEMod MOTotalk
Remote Command	:CALCulate:<meas>:MARKer [1] 2 . . . 12 :MAXimum:NEXT
Example	CALC:VECT:MARK2:MAX:NEXT
Initial S/W Revision	Prior to A.02.00
Modified at S/W Revision	A.02.00

Next Higher Amptd

Moves the marker to the peak next higher in Y value than the peak it is currently on. If the format is complex (vector or constellation) then the marker moves to the closest point that has a higher magnitude than the marker's current position. If this function is invoked via SCPI on a marker that is off, the result is the same as if you sent a Peak Search command.

Key Path	Peak Search
Mode	VSA, LTE, LTETDD, IDEN
Measurement	<meas>:=VECTor ADEMod DDEMod W11A W11B EVM IPOWER IDEMod MOTotalk
Remote Command	:CALCulate:<meas>:MARKer [1] 2 . . . 12 :MAXimum:PREVIOUS
Example	CALC:VECT:MARK2:MAX:PREV
Initial S/W Revision	Prior to A.02.00
Modified at S/W Revision	A.02.00

Next Right

Moves the marker to the next peak to the right of its current position. If the format is complex (vector or constellation) then the marker moves forward in time to the next peak. If this function is invoked via SCPI on a marker that is off, the result is the same as if you sent a Peak Search command.

A valid peak is one for which the displayed Y-axis values drop monotonically on both sides of the local maximum at least 4% of the distance between the top and bottom of the display grid before the values begin to rise again.

Key Path	Peak Search
Mode	VSA, LTE, LTETDD, IDEN
Measurement	<meas>:=VECTor ADEMod DDEMod W11A W11B EVM IPOWER IDEMod MOTotalk
Remote Command	:CALCulate:<meas>:MARKer[1] 2 ...12:MAXimum:RIGHT
Example	CALC:VECT:MARK2:MAX:RIGH
Initial S/W Revision	Prior to A.02.00
Modified at S/W Revision	A.02.00

Next Left

Moves the marker to the next peak to the left of its current position. If the format is complex (vector or constellation) then the marker moves back in time to the next peak. If this function is invoked via SCPI on a marker that is off, the result is the same as if you sent a Peak Search command.

A valid peak is one for which the displayed Y-axis values drop monotonically on both sides of the local maximum at least 4% of the distance between the top and bottom of the display grid before the values begin to rise again.

Key Path	Peak Search
Mode	VSA, LTE, LTETDD, IDEN
Measurement	<meas>:=VECTor ADEMod DDEMod W11A W11B EVM IPOWER IDEMod MOTotalk
Remote Command	:CALCulate:<meas>:MARKer[1] 2 ...12:MAXimum:LEFT
Example	CALC:VECT:MARK2:MAX:LEFT
Initial S/W Revision	Prior to A.02.00
Modified at S/W Revision	A.02.00

Mkr -> CF (Center Frequency)

Sets the center frequency equal to the selected marker's absolute frequency. The marker must be on a frequency-domain trace. The absolute marker frequency is used regardless of whether its control mode is Normal, Delta, or Fixed.

If the currently selected marker is not on when this key is pressed, it is turned on at the center of the screen as a normal type marker.

Key Path	Marker To
Mode	VSA, LTE, LTETDD, IDEN, LTEAFDD, LTEATDD
Initial S/W Revision	Prior to A.02.00
Modified at S/W Revision	A.02.00

Continuous Peak Search

Turns on Continuous Peak Search for the selected marker. This function can be turned on for any marker independently of any other marker. This function moves the marker to the highest point on the trace each time the trace is updated. If the SCPI command refers to a marker that is off, it is turned on in Normal mode.

It is possible to have Couple Markers and Continuous Peak Search both on. If this is the case, it is recommended that Continuous Peak search be turned on for only one marker in any tracking set (that is, any set of markers with the same or equivalent domain). Otherwise, conflicts over marker position can arise that cause erratic marker movement.

Key Path	Peak Search
Mode	VSA, LTE, LTETDD, IDEN
Measurement	<meas>:=VECTor ADEMod DDEMod W11A W11B EVM IPOWER IDEMod MOTotalk
Remote Command	:CALCulate:<meas>:MARKer[1] 2 ...12:CPSearch[:STATe] ON OFF 1 0 :CALCulate:<meas>:MARKer[1] 2 ...12:CPSearch[:STATe]?
Example	CALC:VECT:MARK1:CPS ON
Couplings	The Continuous Peak Search key is grayed out when the selected marker is a Fixed marker. Also, if Continuous Peak Search is on and the selected marker becomes a fixed marker, then Continuous Peak Search is turned off and the key grayed out. Continuous Peak Search is turned off when the selected marker is turned off.
Preset	OFF
State Saved	Saved in instrument state.
Range	Off On
Initial S/W Revision	Prior to A.02.00
Modified at S/W Revision	A.02.00

Min Search

Moves the marker to the lowest Y value on the trace. If the format is complex (vector or constellation) then the marker moves to the lowest value in magnitude. If the SCPI command refers to a marker that is off, it is first turned on in Normal mode and then set on the minimum point.

Key Path	Peak Search
Mode	VSA, LTE, LTETDD, IDEN

Measurement	<meas>:=VECTor ADEMod DDEMod W11A W11B EVM IPOWER IDEMod MOTotalk
Remote Command	:CALCulate:<meas>:MARKer [1] 2 . . . 12 :MINimum
Example	CALC:VECT:MARK2:MIN
Initial S/W Revision	Prior to A.02.00
Modified at S/W Revision	A.02.00

Mkr -> Ref Lvl (Reference Level)

Sets the Y axis reference value equal to the selected marker's Y value. For example, if the reference position is at the top of the screen, the whole trace is moved up so that the marker appears at the top of the screen. Note that this is a display scaling function only. The input range remains the same.

Key Path	Peak Search
Mode	VSA, LTE, LTETDD, IDEN
Initial S/W Revision	Prior to A.02.00
Modified at S/W Revision	A.02.00

11 iDEN Demod Measurement
Print

Print

See "Print" on page 241

Quick Save

The Quick Save front-panel key repeats the most recent save that was performed from the Save menu, with the following exceptions:

- Register saves are not remembered as Saves for the purpose of the Quick Save function
- If the current measurement does not support the last non-register save that was performed, an informational message is generated, “File type not supported for this measurement”

Quick Save repeats the last type of qualified save (that is, a save qualified by the above criteria) in the last save directory by creating a unique filename using the Auto File Naming algorithm described below.

If Quick Save is pressed after startup and before any qualified Save has been performed, the Quick Save function performs a Screen Image save using the current settings for Screen Image saves (current theme, current directory), which then becomes the “last save” for the purpose of subsequent Quick Saves.

The Auto File Naming feature automatically generates a file name for use when saving a file. The filename consists of a prefix and suffix separated by a dot, as is standard for the Windows® file system. A default prefix exists for each of the available file types:

Type	Default Prefix	Menu
State	State_	(Save/Recall)
Trace + State	State_	(Save/Recall)
Screen	Screen_	(Save/Recall)
Amplitude Corrections	Ampcor_	(Import/Export)
Traces	Trace_	(Import/Export)
Limit Lines	LLine_	(Import/Export)
Measurement Result	MeasR_	(Import/Export)
Capture Buffer	CapBuf_	(Import/Export)

A four digit number is appended to the prefix to create a unique file name. The numbering sequence starts at 0000 within each Mode for each file type and updates incrementally to 9999, then wraps to 0000 again. It remembers where it was through a Mode Preset and when leaving and returning to the Mode. It is reset by Restore Misc Defaults and Restore System Defaults and subsequent running of the instrument application. So, for example, the first auto file name generated for State files is State_0000.state. The next is State_0001, and so forth.

One of the key features of Auto File Name is that we guarantee that the Auto File Name will never conflict with an existing file. The algorithm looks for the next available number. If it gets to 9999, then it looks for holes. If it find no holes, that is no more numbers are available, it gives an error.

For example, if when we get to State_0010.state there is already a State_0010.state file in the current directory, it advances the counter to State_0011.state to ensure that no conflict will exist (and then it verifies that State_0011.state also does not exist in the current directory and advances again if it does, and so forth).

If you enter a file name for a given file type, then the prefix becomes the filename you entered instead of the default prefix, followed by an underscore. The last four letters (the suffix) are the 4-digit number.

For example, if you save a measurement results file as “fred.csv”, then the next auto file name chosen for a measurement results save will be fred_0000.csv.

NOTE

Although 0000 is used in the example above, the number that is used is actually the current number in the Meas Results sequence, that is, the number that would have been used if you had not entered your own file name.

NOTE

If the filename you entered ends with _dddd, where d=any number, making it look just like an auto file name, then the next auto file name picks up where you left off with the suffix being dddd + 1.

Key Path	Front-panel key
Notes	No remote command for this key specifically.
Initial S/W Revision	Prior to A.02.00

Recall

The Recall menu lets you choose what you want to recall, and where you want to recall it from. Among the types of files you can recall are **States and Traces**. In addition, an Import (Data) option lets you recall a number of data types stored in CSV files (as used by Excel and other spreadsheet programs).

The default paths for Recall are data type dependent and are the same as for the Save key.

Key Path	Front-panel key
Notes	<p>No remote command for this key specifically, but the :MMEM:LOAD command is available for specific file types. An example is :MMEM:LOAD:STATe <filename>.</p> <p>If you try to recall a State file for a mode that is not licensed or not available in the instrument, an error message will occur and the state will not change.</p>
Backwards Compatibility Notes	<p>In legacy analyzers, it was possible to load a state without affecting the trace data, limit lines or correction data. Similarly (since User Preset is actually loading a state), it was possible to do a User Preset without affecting the trace data, limit lines or correction data.</p> <p>In the X-Series, "state" always includes all of this data; so whenever state is loaded, all of the traces, limit lines and corrections are affected. Although this differs from previous behavior, it is desirable behavior, and should not cause adverse issues for users.</p>
Backwards Compatibility Notes	<p>Recall for the X-Series supports backward compatibility in the sense that you can recall a state file from any X-Series model number and any version of X-Series software. This is only possible if part of the recalling process goes through a limiting step after recalling the mode settings, at least for settings that may vary with version number, model number, option and license differences. If you try to recall a state file onto an instrument with less capability than what was available on the instrument during the save, the recall will ignore the state it doesn't support and it will limit the recalled setting to what it allows.</p> <p>Example: if the saved state includes preamp ON, but the recalling instrument does not have a preamp; the preamp is limited to OFF. Conversely, if you save a state without a preamp, the preamp is OFF in the state file. When this saved file is recalled on an instrument with a licensed preamp, the preamp is changed to OFF. Another example is if the saved state has center frequency set to 20 GHz, but the instrument recalling the saved state is a different model and only supports 13.5 GHz. In this case, the center frequency is limited along with any other frequency based settings. Since the center frequency can't be preserved in this case, the recall limiting tries to at least preserve span to keep the measurement setup as intact as possible.</p> <p>It may be appropriate to issue a warning if the state is limited on the recall; warnings do not go out to SCPI so this would only affect the manual user.</p> <p>Note that there is no state file compatibility outside of the X-Series. For example, you cannot recall a state file from ESA or PSA.</p>
Initial S/W Revision	Prior to A.02.00

State

The Recall State menu lets you choose a register or file from which to recall the state.

The content of a state file includes all of the settings and data required to return the analyzer as closely as possible to the Mode it was in, with the exact settings that were in place, when the save occurred. The Mode settings in each state file include the settings that are affected by Mode Preset, as well as the

additional settings affected by Restore Mode Defaults; all of the Mode's settings. In addition, all of the settings of the Input/Output system are included, even though they are outside of the Mode's state, because they are needed to restore the complete setup. Persistent System settings (for example, GPIB address) are not affected by either a Mode Preset or Restore Mode Defaults, nor are they included in a saved State file.

Since each state file is only for one Mode, the settings for other Modes are unaffected when it is loaded. Recall State will cause a mode switch if the state being recalled is not from the current active mode.

After the recall completes, the message "File <filename> recalled" or "Recalled State Register <register number>" is displayed.

For rapid recalls, the State menu lists 16 registers that you can choose from to recall. Pressing a Register key initiates the recall. You can also select a file from which to recall.

The default path for all State Files is:

My Documents\<<mode name>\state

where <mode name> is the parameter used to select the mode with the INST:SEL command (for example, SA for the Spectrum Analyzer).

See "[More Information](#)" on page 1001.

Key Path	Recall
Mode	All
Remote Command	:MMEMory:LOAD:STATe <filename>
Example	:MMEM:LOAD:STAT "myState.state" This recalls the file myState.state on the default path
Example	MMEM:LOAD:STAT "MyStateFile.state" This loads the state file data (on the default file directory path) into the instrument state.
Notes	<p>When you pick a file to recall, the analyzer first verifies that the file is recallable in the current instrument by checking the software version and model number of the instrument. If everything matches, a full recall proceeds by aborting the currently running measurement, clearing any pending operations, and then loading the State from the saved state file. You can open state files from any mode, so recalling a State file switches to the mode that was active when the save occurred. After switching to the mode of the saved state file, mode settings and data (if any for the mode) are loaded with values from the saved file. The saved measurement of the mode becomes the newly active measurement and the data relevant to the measurement (if there is any) is recalled.</p> <p>If there is a mismatch between file version or model number or instrument version or model number, the recall function tries to recall as much as possible and returns a warning message. It may limit settings that differ based on model number, licensing or version number.</p> <p>After recalling the state, the Recall State function does the following:</p> <ul style="list-style-type: none"> • Makes the saved measurement for the mode the active measurement. • Clears the input and output buffers. • Status Byte is set to 0. • Executes a *CLS <p>If the file specified is empty an error is generated. If the specified file does not exist, another error is generated. If there is a mismatch between the file and the proper file type, an error is generated. If</p>

	there is a mismatch between file version or model number or instrument version or model number, a warning is displayed. Then it returns to the State menu and File Open dialog goes away. After the Recall, the analyzer exits the Recall menu and returns to the previous menu.
Backwards Compatibility SCPI	:MMEMory:LOAD:STATe 1,<filename> For backwards compatibility, the above syntax is supported. The "1" is simply ignored.
Initial S/W Revision	Prior to A.02.00

More Information

In measurements that support saving Traces, for example, Swept SA, the Trace data is saved along with the State in the State file. When recalling the State, the Trace data is recalled as well. Traces are recalled exactly as they were stored, including the writing mode and update and display modes. If a Trace was updating and visible when the State was saved, it will come back updating and visible, and its data will be rewritten right away. When you use State to save and recall traces, any trace whose data must be preserved should be placed in View or Blank mode before saving.

The following table describes the Trace Save and Recall possibilities:

You want to recall state and one trace's data, leaving other traces unaffected.	Save Trace+State from 1 trace. Make sure that no other traces are updating (they should all be in View or Blank mode) when the save is performed.	On Recall, specify the trace you want to load the one trace's data into. This trace will load in View. All other traces' data will be unaffected, although their trace mode will be as it was when the state save was performed.
You want to recall all traces	Save Trace+State from ALL traces.	On Recall, all traces will come back in View (or Blank if they were in Blank or Background when saved)
You want all traces to load exactly as they were when saved.	Save State	On recall, all traces' mode and data will be exactly as they were when saved. Any traces that were updating will have their data immediately overwritten.

From File...

When you press "From File", the analyzer brings up a Windows dialog and a menu entitled "File Open." This menu allows you to navigate to the various fields in the Windows dialog without using a keyboard or mouse. The Tab and Arrow keys can also be used for dialog navigation.

11 iDEN Demod Measurement Recall

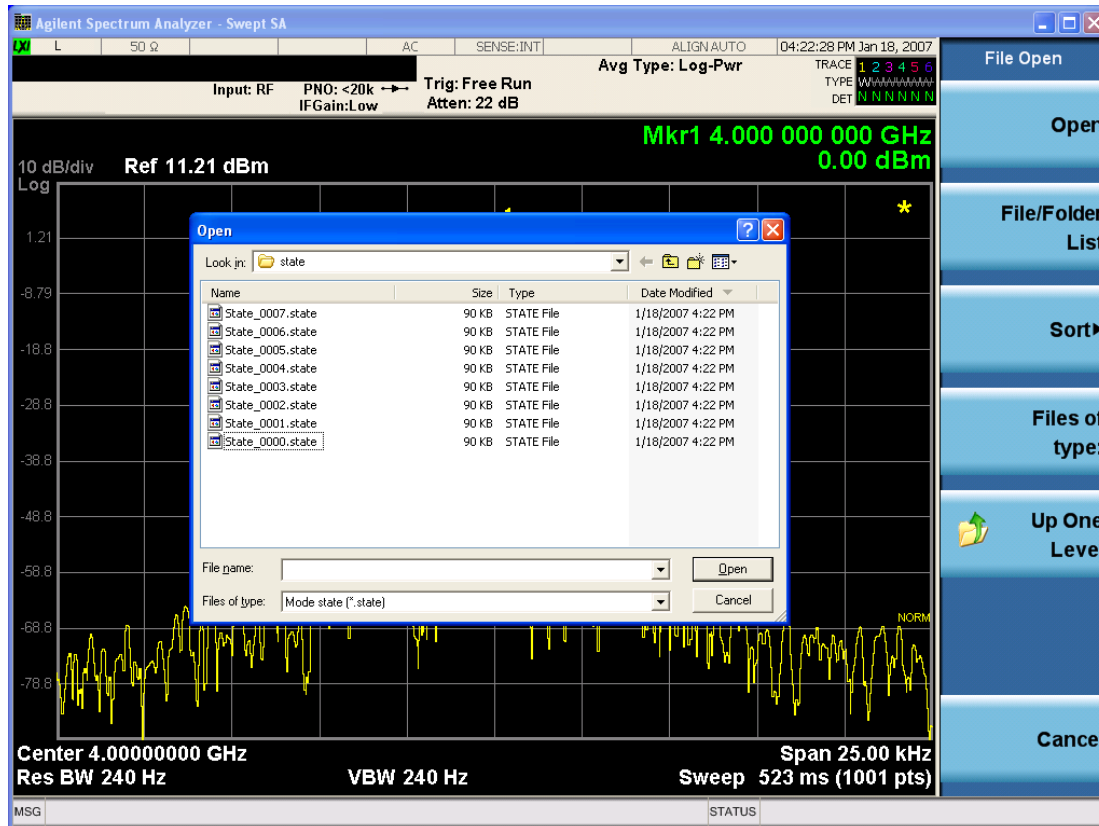

Listed below are the functions of the various fields in the dialog, and the corresponding softkeys:

Open

Performs the recall of the specified file. While the recall is being performed, the floppy icon appears briefly in the Meas bar.

File/Folder List

Enables you to navigate to the center of the dialog that contains the list of files and folders. Once here you can get information about the file and use the tab keys to navigate to the other fields in the dialog, such as Look In.

Look In

The Look In field shows the path from which the file will be recalled and allows you to change the path using the up and down arrow keys to navigate to other paths; the Enter key to open a directory; and the Backspace key to go back one directory. The **Look In field** first uses the last path from the Save As dialog **Save In:** path for that same file type. There is no softkey for directly navigating to the Look In field, but you can use the left tab to get here from the File/Folder List.

User specified paths are remembered when you leave and return to a Mode and are reset back to the default using Restore Mode Defaults.

Sort

Accesses a menu that enables you to sort the files within the File Open dialog. Only one sorting type can be selected at a time and the sorting happens immediately. The sorting types are By Date, By Name, By extension, and By Size.

Files of Type

This field shows the file suffix for the type of file you have selected to recall. For example, if you navigated here while recalling State, "Mode state (*.state)" is in the field. If you navigated here while recalling Trace, ""Mode state (*.trace)" is in the field. If you navigated here while importing a trace data file, "Trace Data (*.csv)" is in the field. For some file types, there is more than one choice in the dropdown menu, which you can select by using the up and down arrow keys and Enter.

Up One Level

This key corresponds to the icon of a folder with the up arrow that is in the tool bar of the dialog. When pressed, it causes the file and folder list to navigate up one level in the directory structure. The Backspace key does the same thing.

Cancel

This key corresponds to the Cancel selection in the dialog. It causes the current **Open** request to be cancelled. The ESC key does the same thing.

Key Path	Recall, State
Notes	Brings up the Open dialog for recalling a State Save Type
Initial S/W Revision	Prior to A.02.00

Edit Register Names

You may enter a custom name on any of the Register keys, to help you remember what you are using that state to save. To do this, press the Edit Register Names key, choose the register whose name you wish to edit, and then enter the desired label using the Alpha Editor or an external PC keyboard.

The maximum number of characters that can be added is 30. In most cases, 30 characters will fit on two lines of the key.

For more information and the SCPI command, see Edit Register Names under the Save, State function.

Key Path	Recall, State
Mode	All
Dependencies	N9060A-7FP or N9060B-2FP license required to edit the register names. When the feature is not licensed, sending the SCPI command generates an error, -221, "Settings conflict;Option not available"
Initial S/W Revision	A.11.00

Register 1 thru Register 16

Selecting any one of these register keys causes the State of the mode from the specified Register to be recalled. Each of the register keys annotates whether it is empty or at what date and time it was last

modified. In addition, you can use the Edit Register Names key under Save, State to enter custom names for each register.

Registers are shared by all modes, so recalling from any one of the registers will cause a mode switch to the mode that was active when the save to the Register occurred.

Although these 16 registers are the only registers available from the front panel, there are 128 state registers available in the instrument. Registers 17–128 are only available from the SCPI interface, using the *RCL command.

After the recall completes, the message "Register <register number> recalled" appears in the message bar. If you are in the Spectrum Analyzer Mode, and you are recalling a register that was saved in the Spectrum Analyzer Mode, then after the recall, you will still be in the Recall Register menu. If the Recall causes you to switch modes, then after the Recall, you will be in the Frequency menu.

If a requested register is empty an error is generated.

Key Path	Recall, State
Example	*RCL 1
Range	1–16 from front panel, 1–128 from SCPI
Readback	Date and time with seconds resolution are displayed on the key OR A custom name of up to 30 characters entered using the Save, State, Edit Register Names key OR “(empty)” if no prior save operation has been performed to this register.
Initial S/W Revision	Prior to A.02.00
Modified at S/W Revision	Prior to A.11.00

Register 1 thru Register 16

Selecting any one of these register keys causes the State of the mode from the specified Register to be recalled. Each of the register keys annotates whether it is empty or at what date and time it was last modified. In addition, you can use the Edit Register Names key under Save, State to enter custom names for each register.

Registers are shared by all modes, so recalling from any one of the registers will cause a mode switch to the mode that was active when the save to the Register occurred.

Although these 16 registers are the only registers available from the front panel, there are 128 state registers available in the instrument. Registers 17–128 are only available from the SCPI interface, using the *RCL command.

After the recall completes, the message "Register <register number> recalled" appears in the message bar. If you are in the Spectrum Analyzer Mode, and you are recalling a register that was saved in the Spectrum Analyzer Mode, then after the recall, you will still be in the Recall Register menu. If the Recall causes you to switch modes, then after the Recall, you will be in the Frequency menu.

If a requested register is empty an error is generated.

Key Path	Recall, State
Example	*RCL 1
Range	1-16 from front panel, 1-128 from SCPI
Readback	Date and time with seconds resolution are displayed on the key OR A custom name of up to 30 characters entered using the Save, State,Edit Register Names key OR “(empty)” if no prior save operation has been performed to this register.
Initial S/W Revision	Prior to A.02.00
Modified at S/W Revision	Prior to A.11.00

Trace

This key selects Trace as the data type to be imported. When pressed a second time, it brings up the Trace Menu, which lets you select the Trace into which the data will be imported.

The trace file contains “meta” data which describes the state of the analyzer when the trace was exported (see Trace File Contents). If the meta data in the file does not match the current SA state, the “invalid data indicator” (*) is displayed.

Key Path	Recall, Data
Remote Command	:MMEMory:LOAD:TRACe:DATA TRACE1 TRACE2 TRACE3 TRACE4 TRACE5 TRACE6,<filename>
Example	:MMEM:LOAD:TRAC DATA TRACE2, "myTrace2.csv" Imports the 2nd trace from the file myTrace2.csv in the current path. The default path is My Documents\SA\data\traces
Dependencies	For SA measurements, a trace cannot be recalled from a trace file that was exported with ALL traces selected. A trace cannot be imported if the number of trace points in the file do not match the number of sweep points currently set for the measurement. If this happens, an error message is generated. Errors are reported if the file is empty or missing, or if the file type does not match, or if there is a mismatch between the file type and the destination data type. If any error occurs while trying to load a file manually (as opposed to during remote operation), the analyzer returns to the Import Data menu and the File Open dialog goes away.
Couplings	When a trace is imported, Trace Update is always turned OFF for that trace and Trace Display is always turned ON.
Readback	Selected Trace
Status Bits/OPC dependencies	Sequential - aborts the current measurement.
Initial S/W Revision	Prior to A.02.00

Import Trace Data

Enables you to import previously saved trace data into a Data Register and optionally display it. Selecting this key displays a menu that enables you to select the destination data register, and also enables you to choose whether or not to display the recalled data in the currently selected trace. After making these selections, select Open... and use the file dialog to select the file you want to recall.

Recalling trace data into an already used Data Register overwrites the previous data. If the data register is displayed on any trace, the display is updated to reflect the new data.

The SCPI command

```
:MMEM:LOAD:TRAC:DATA D1|D2|D3|D4|D5|D6,<filename>
```

recalls data into a specified register, but does not display it in the selected trace. Use the command

```
:DISP:<meas>:TRAC<n>:FEED D1|D2|D3|D4|D5|D6
```

to display the register in the desired trace.

It is possible to recall trace data saved by other VXA measurements, or measurements made using the LTE, LTETDD, iDEN, or 89601 applications.

Key Path	Recall, Data (Import)
Mode	VSA, LTE, LTETDD, IDEN
Remote Command	:MMEMory:LOAD:TRACe:DATA D1 D2 D3 D4 D5 D6,<filename>[,CSV TXT SDF MAT4 MAT HDF5 BIN]
Example	:MMEM:LOAD:TRAC:DATA D1,"Trc1.txt",TXT
Notes	<p>The Open: dialog box has the following filter options when you are recalling trace data::</p> <ul style="list-style-type: none"> • CSV (Comma delimited) (*.csv) • SDF (Fast) (*.sdf;*.dat) • Text (Tab delimited) (*.txt) <p>The file must have the same format as that created by the Export Recorded Data command.</p> <p>The SCPI command has an optional file format parameter. If you do not include this parameter in the SCPI command, the file format is determined by the file name extension. If no file extension is recognized, the file is scanned to determine the format.</p> <p>If you are not licensed to recall a particular file type, then error -203.9010 is returned. If the file format cannot be determined or the file cannot be recalled successfully, then error -250.5290 is returned. If the recall is successful, then advisory 0.1600 is shown.</p>
State Saved	No
Readback	Data 1 Data 2 Data 3 Data 4 Data 5 Data 6

Data 1

Selects the Data 1 register as the destination for the imported data.

Key Path	Recall, Data (Import), Trace (to)
Mode	VSA, LTE, LTETDD, IDEN

Data 2

Selects the Data 2 register as the destination for the imported data.

Key Path	Recall, Data (Import), Trace (to)
Mode	VSA, LTE, LTETDD, IDEN

Data 3

Selects the Data 3 register as the destination for the imported data.

Key Path	Recall, Data (Import), Trace (to)
Mode	VSA, LTE, LTETDD, IDEN

Data 4

Selects the Data 4 register as the destination for the imported data.

Key Path	Recall, Data (Import), Trace (to)
Mode	VSA, LTE, LTETDD, IDEN

Data 5

Selects the Data 5 register as the destination for the imported data..

Key Path	Recall, Data (Import), Trace (to)
Mode	VSA, LTE, LTETDD, IDEN

Data 6

Selects the Data 6 register as the destination for the imported data.

Key Path	Recall, Data (Import), Trace (to)
Mode	VSA, LTE, LTETDD, IDEN

Display in Selected Trace

Enables you to select whether the recalled trace data is displayed in the current Trace.

Key Path	Recall, Data (Import), Trace (to)
----------	-----------------------------------

Mode	VSA, LTE, LTETDD, IDEN
State Saved	No

Open...

When you press “Open”, the analyzer brings up a Windows dialog and a menu entitled “**File Open.**” This menu allows you to navigate to the various fields in the Windows dialog without using a keyboard or mouse. The Tab and Arrow keys can also be used for dialog navigation.

See "[From File...](#)" on page 1200 in Recall, State, for a full description of this dialog and menu.

Key Path	Recall, Data
Notes	The key location is mode-dependent and will vary. Brings up Open dialog for recalling a <mode specific> Save Type
Initial S/W Revision	Prior to A.02.00

Restart

The Restart function restarts the current sweep, or measurement, or set of averaged/held sweeps or measurements. If you are Paused, pressing Restart does a Resume.

The Restart function is accessed in several ways:

- Pressing the Restart key
- Sending the remote command INIT:IMMEDIATE
- Sending the remote command INIT:RESTART

See "[More Information](#)" on page 1009

Key Path	Front-panel key
Remote Command	:INITiate[:IMMEDIATE] :INITiate:RESTART
Example	:INIT:IMM :INIT:REST
Notes	:INITiate:RESTART and :INITiate:IMMEDIATE perform exactly the same function.
Couplings	Resets average/hold count k. For the first sweep overwrites all active (update=on) traces with new current data. For application modes, it resets other parameters as required by the measurement.
Status Bits/OPC dependencies	This is an Overlapped command. The STATUS:OPERation register bits 0 through 8 are cleared. The STATUS:QUESTIONable register bit 9 (INTEgrity sum) is cleared. The SWEEPING bit is set. The MEASURING bit is set.
Backwards Compatibility Notes	For Spectrum Analysis mode in ESA and PSA, the Restart hardkey and the INITiate:RESTART command restart trace averages (displayed average count reset to 1) for a trace in Clear Write, but did not restart Max Hold and Min Hold. In the X-Series, the Restart hardkey and the INITiate:RESTART command restart not only Trace Average, but MaxHold and MinHold traces as well. For wireless comms modes in ESA and PSA, the Restart hardkey and the INITiate:RESTART command restart every measurement, which includes all traces and numeric results. There is no change to this operation.
Initial S/W Revision	Prior to A.02.00

More Information

The **Restart** function first aborts the current sweep/measurement as quickly as possible. It then resets the sweep and trigger systems, sets up the measurement and initiates a new data measurement sequence with a new data acquisition (sweep) taken once the trigger condition is met.

If the analyzer is in the process of aligning when **Restart** is executed, the alignment finishes before the restart function is performed.

Even when set for Single operation, multiple sweeps may be taken when Restart is pressed (for example, when averaging/holding is on). Thus when we say that **Restart** "restarts a measurement," we may mean:

- It restarts the current sweep
- It restarts the current measurement
- It restarts the current set of sweeps if any trace is in Trace Average, Max Hold or Min Hold
- It restarts the current set of measurements if Averaging, or Max Hold, or Min Hold is on for the measurement
- depending on the current settings.

With **Average/Hold Number** (in **Meas Setup** menu) set to 1, or Averaging off, or no trace in Trace Average or Hold, a single sweep is equivalent to a single measurement. A single sweep is taken after the trigger condition is met; and the analyzer stops sweeping once that sweep has completed. However, with **Average/Hold Number** >1 and at least one trace set to **Trace Average, Max Hold, or Min Hold (SA Measurement)** or **Averaging on (most other measurements)**, multiple sweeps/data acquisitions are taken for a single measurement. The trigger condition must be met prior to each sweep. The sweep is stopped when the average count k equals the number N set for **Average/Hold Number**. A measurement average usually applies to all traces, marker results, and numeric results; but sometimes it only applies to the numeric results.

Once the full set of sweeps has been taken, the analyzer will go to idle state. To take one more sweep without resetting the average count, increment the average count by 1, by pressing the step up key while **Average/Hold Number** is the active function, or sending the remote command CALC:AVER:TCON UP.

Save

The Save menu lets you choose what you want to save and where you want to save it. Among the types of files you can save are **States**, **Traces**, and **Screen Images**. In addition, an Export (Data) option lets you save a number of data types as CSV files for easy import into Excel and other spreadsheet programs.

Key Path	Front-panel key
Mode	All
Notes	No remote command for this key specifically, but the :MMEM:STORe command is available for specific file types. An example is :MMEM:STOR:STATe <filename>.
Initial S/W Revision	Prior to A.02.00

State

The Save State menu lets you choose a register or file for saving the state.

The content of a state file includes all of the settings and data required to return the analyzer as closely as possible to the Mode it was in, with the exact settings which were in place, when the save occurred. The Mode settings in each state file include the settings that are affected by Mode Preset, as well as the additional settings affected by Restore Mode Defaults; all of the Mode's settings. In addition, all of the settings of the Input/Output system are included, even though they are outside of the Mode's state, because they are needed to restore the complete setup. Persistent System settings (for example, Verbose SCPI) are not affected by either Mode Preset or Restore Mode Defaults, nor are they included in a saved State file.

After the save completes, the message "File <filename> saved" or "State Register <register number> saved" is displayed.

For rapid saving, the State menu lists 16 registers to save to. Pressing a Register key initiates the save. You can also select a file to save to.

The default path for all State Files is:

My Documents\<<mode name>\state

where <mode name> is the parameter used to select the mode with the INST:SEL command (for example, SA for the Spectrum Analyzer).

Key Path	Save
Mode	All
Remote Command	:MMEMory:STORe:STATe <filename>
Example	MMEM:STOR:STATe "MyStateFile.state" This stores the current instrument state data in the file MyStateFile.state in the default directory.
Notes	Both single and double quotes are supported for any filename parameter over remote. After saving to a register, that register's menu key is updated with the date the time, unless a custom label has been entered for that key. After saving to a register, you remain in the Save State menu, so that you can see the Register key

update. After saving to a file, the analyzer automatically returns to the previous menu and any Save As dialog goes away.

Backwards Compatibility SCPI :MMEMory:STORe:STATe 1,<filename>

For backwards compatibility, the above syntax is supported. The "1" is simply ignored. The command is sequential.

Initial S/W Revision Prior to A.02.00

To File . . .

When you press “To File”, the analyzer brings up a Windows dialog and a menu entitled “Save As.” This menu allows you to navigate to the various fields in the Windows dialog without using a keyboard or mouse. The Tab and Arrow keys can also be used for dialog navigation.

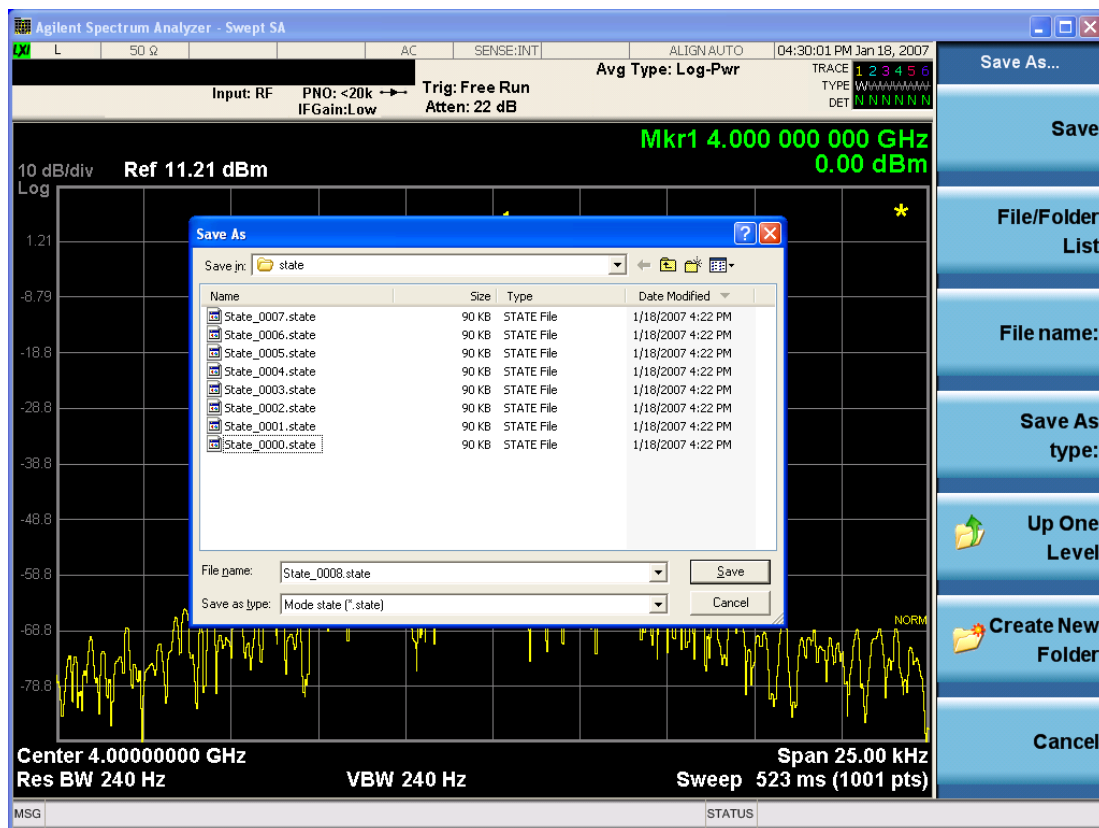

The Listed below

are the functions of the various fields in the dialog, and the corresponding softkeys:

Save

Performs the save to the specified file of the selected type. If the file already exists, a dialog will appear that allows you to replace the existing file by selecting OK, or you can Cancel the request. If you select OK, the file will be overwritten. Using the C: drive is strongly discouraged, since it runs the risk of being overwritten during an instrument software upgrade.

While the save is being performed, the floppy icon appears briefly in the Meas bar.

File/Folder List

Enables you to navigate to the center of the dialog that contains the list of files and folders. Once here you can get information about the file and use the tab keys to navigate to the other fields in the dialog, such as Save In.

Save In

The Save In field shows the path to which the file will be saved and allows you to change the path using the up and down arrow keys to navigate to other paths; the Enter key to open a directory; and the Backspace key to go back one directory. The **Save In field** defaults to the default path for this type of file and remembers the last path you used to save this type of file. There is no softkey for directly navigating to the Save In field but you can use left tab to get here from the File/Folder List.

User specified paths are remembered when you leave and return to a Mode and are reset back to the default using Restore Mode Defaults.

File Name

The File Name field is initially loaded with an automatically generated filename specific to the appropriate Save Type. The automatically generated filename is guaranteed not to conflict with any filename currently in the directory. You may replace or modify this filename using the File Name key. See the ["Quick Save " on page 1196](#) documentation for more on the automatic file naming algorithm.

When you press the File Name key the analyzer displays the Alpha Editor. Use the knob to choose the letter to add and the front-panel Enter key to add the letter to the file name. The BK character moves you back and the FW character moves you forward in the filename. The Select key on the front panel generates a space character. When you are done entering the filename press the Done softkey. This returns back to the **File Open** dialog and menu, but does not cause the save to occur.

Save As Type

This field shows the file suffix for the type of file you have selected to save. For example, if you navigated here while saving State, "Mode state (*.state)" is in the field. If you navigated here from saving Trace, ""Mode state (*.trace)" is in the field. If you navigated here while exporting a trace data file, "Trace Data (*.csv)" is in the field. For some file types, there is more than one choice in the dropdown, which you can select by using the up and down arrow keys and Enter.

Up One Level

This key corresponds to the icon of a folder with the up arrow that is in the tool bar of the dialog. When pressed, it causes the file and folder list to navigate up one level in the directory structure. The Backspace key does the same thing.

Create New Folder

This key corresponds to the icon of a folder with the "*" that is in the tool bar of the dialog. When pressed, a new folder is created in the current directory with the name **New Folder** and you can enter a new folder name using the Alpha Editor.

Cancel

This key corresponds to the Cancel selection in the dialog. It causes the current **Save As** request to be cancelled. The ESC key does the same thing.

Key Path	Save, State
Mode	All
Notes	Brings up Save As dialog for saving a State Save Type
Initial S/W Revision	Prior to A.02.00

Edit Register Names

You may enter a custom name on any of the Register keys, to help you remember what you are using that state to save. To do this, press the Edit Register Names key, choose the register whose name you wish to edit, and then enter the desired label using the Alpha Editor or an external PC keyboard.

The maximum number of characters that can be added is 30. In most cases, 30 characters will fit on two lines of the key.

See ["More Information" on page 1014](#)

Key Path	Save, State
Mode	All
Remote Command	:MMEMory:REGister:STATe:LABel <reg number>,"label" :MMEMory:REGister:STATe:LABel? <reg number>
Example	:MMEM:REG:STAT:LAB 1,"my label"
Notes	<reg number> is an integer from 1 to 16. If the SCPI specifies an invalid register number an error message is generated, -222,"Data out of range;Invalid register label number" "label" is a string from 0 to 30 characters in length. If a label exceeds 30 characters, an error message is generated, -150,"String data error;Label clipped to 30 characters" "label" of length 0 erases the custom label and restores the default (time and date) label. E.g.: :MMEM:REG:STAT:LAB 1,""
Dependencies	N9060A-7FP or N9060B-2FP license required to edit the register names. When the feature is not licensed, sending this command generates an error, -221,"Settings conflict;Option not available"
Preset	The names are unaffected by Preset or power cycle but are set to the default label (time and date) on a "Restore System Defaults->Misc"
Initial S/W Revision	A.11.00

More Information

When you edit one of the register names, the time and date field will be replaced by the custom name.

If you delete all the characters in the custom name, it restores the default (time and date).

The register names are stored within the state files, but they are not part of the instrument state; that is, once you have edited a register name, loading a new state will not change that register name. Another consequence of this is that the names will be persistent through a power cycle. Also, if a named state file is transferred to another analyzer, it will bring its custom name along with it.

If you try to edit the name of an empty register, the analyzer will first save the state to have a file to put the name in. If you load a named state file into an analyzer with older firmware it will ignore the metadata.

The *SAV and *RCL commands will not be affected by the custom register names, nor will the MMEM commands.

Register 1 thru Register 16

Selecting any one of these register menu keys causes the State of the currently active mode to be saved to the specified Register. The registers are provided for rapid saving and recalling, since you do not need to specify a filename or navigate to a file. Each of the register menu keys annotates whether it is empty or at what date and time it was last modified. In addition, you can use the Edit Register Names key to enter custom names for each register.

Although these 16 registers are the only registers available from the front panel, there are 128 state registers available in the instrument. Registers 17–128 are only available from the SCPI interface, using the *SAV command.

There is one set of 128 state registers in the instrument, not one set for each Mode. When a state is saved, the Mode it was saved from is saved with it; then when it is recalled, the instrument switches to that Mode.

After the save completes, the corresponding register menu key annotation is updated with the date and time and the message "Register <register number> saved" is displayed.

Key Path	Save, State
Mode	All
Example	*SAV 1
Range	1–16 from front panel, 1–128 from SCPI
Readback	Date and time with seconds resolution are displayed on the key OR A custom name of up to 30 characters entered using the Edit Register Names key OR “(empty)” if no prior save operation has been performed to this register.
Initial S/W Revision	Prior to A.02.00
Modified at S/W Revision	A.11.00

Register 1 thru Register 16

Selecting any one of these register menu keys causes the State of the currently active mode to be saved to the specified Register. The registers are provided for rapid saving and recalling, since you do not need to specify a filename or navigate to a file. Each of the register menu keys annotates whether it is empty or at what date and time it was last modified. In addition, you can use the Edit Register Names key to enter custom names for each register.

Although these 16 registers are the only registers available from the front panel, there are 128 state registers available in the instrument. Registers 17–128 are only available from the SCPI interface, using the *SAV command.

There is one set of 128 state registers in the instrument, not one set for each Mode. When a state is saved, the Mode it was saved from is saved with it; then when it is recalled, the instrument switches to that Mode.

After the save completes, the corresponding register menu key annotation is updated with the date and time and the message "Register <register number> saved" is displayed.

Key Path	Save, State
Mode	All
Example	*SAV 1
Range	1-16 from front panel, 1-128 from SCPI
Readback	Date and time with seconds resolution are displayed on the key OR A custom name of up to 30 characters entered using the Edit Register Names key OR “(empty)” if no prior save operation has been performed to this register.
Initial S/W Revision	Prior to A.02.00
Modified at S/W Revision	A.11.00

Mass Storage Catalog (Remote Command Only)

Key path	SCPI Only
Remote Command	:MMEMory:CATalog? [<directory_name>]
Notes	The string must be a valid logical path. Queries disk usage information (drive capacity, free space available) and obtains a list of files and directories in a specified directory in the following format: <numeric_value>,<numeric_value>,{<file_entry>} It returns two numeric parameters and as many strings as there are files and directories. The first parameter indicates the total amount of storage currently used in bytes. The second parameter indicates the total amount of storage available, also in bytes. The <file_entry> is a string. Each <file_entry> indicates the name, type, and size of one file in the directory list: <file_name>,<file_type>,<file_size> As the windows file system has an extension that indicates file type, <file_type> is always empty. <file_size> provides the size of the file in bytes. For directories, <file_entry> is surrounded by square brackets and both <file_type> and <file_size> are empty
Initial S/W Revision	Prior to A.02.00

Mass Storage Change Directory (Remote Command Only)

Key path	SCPI Only
Remote Command	:MMEMory:CDIRectory [<directory_name>] :MMEMory:CDIRectory?

Notes	<p>The string must be a valid logical path.</p> <p>Changes the default directory for a mass memory file system. The <directory_name> parameter is a string. If no parameter is specified, the directory is set to the *RST value.</p> <p>At *RST, this value is set to the default user data storage area, that is defined as System.Environment.SpecialFolder.Personal.</p> <p>Query returns full path of the default directory.</p>
Initial S/W Revision	Prior to A.02.00

Mass Storage Copy (Remote Command Only)

Key path	SCPI Only
Remote Command	:MMEMory:COpy <string>,<string>[,<string>,<string>]
Notes	<p>The string must be a valid logical path.</p> <p>Copies an existing file to a new file or an existing directory to a new directory.</p> <p>Two forms of parameters are allowed. The first form has two parameters. In this form, the first parameter specifies the source, and the second parameter specifies the destination.</p> <p>The second form has four parameters. In this form, the first and third parameters specify the source. The second and fourth parameters specify the directories. The first pair of parameters specifies the source. The second pair specifies the destination. An error is generated if the source doesn't exist or the destination file already exists.</p> <p>This command will generate an "access denied" error if the destination is a restricted folder (e.g., C:\Windows) and the current user does not have Power User or Administrator privileges.</p>

Mass Storage Device Copy (Remote Command Only)

This command transfers data to/from a file and a peripheral device.

Key path	SCPI Only
Remote Command	:MMEMory:COpy:DEvice <source_string>,<dest_string>
Notes	<p>The strings must be a valid logical path or a valid device keyword. If the dest_string is a device keyword, the data is copied from the source file to the device. If the source_string is a device keyword, the data is copied to the source file from the device.</p> <p>Valid device keywords are:</p> <p>SNS (smart noise source)</p> <p>An error is generated if the file or device is not found.</p>

Mass Storage Delete (Remote Command Only)

Key path	SCPI Only
Remote Command	:MMEMory:DElete <file_name>[,<directory_name>]

Notes	The string must be a valid logical path. Removes a file from the specified directory. The <file_name> parameter specifies the file name to be removed. This command will generate an “access denied” error if the file is in a restricted folder (e.g., C:\Windows) and the current user does not have Power User or Administrator privileges.
Initial S/W Revision	Prior to A.02.00

Mass Storage Data (Remote Command Only)

Creates a file containing the specified data OR queries the data from an existing file.

Key path	SCPI Only
Remote Command	:MMEMory:DATA <file_name>, <data> :MMEMory:DATA? <file_name>
Notes	The string must be a valid logical path. The command form is MMEMory:DATA <file_name>,<data>. It loads <data> into the file <file_name>. <data> is in 488.2 block format. <file_name> is string data. The query form is MMEMory:DATA? <file_name> with the response being the associated <data> in block format.
Initial S/W Revision	Prior to A.02.00

Mass Storage Make Directory (Remote Command Only)

Key path	SCPI Only
Remote Command	:MMEMory:MDIRectory <directory_name>
Notes	The string must be a valid logical path. Creates a new directory. The <directory_name> parameter specifies the name to be created. This command will generate an “access denied” error if the new directory would be in a restricted folder (e.g., C:\Windows) and the current user does not have Power User or Administrator privileges.
Initial S/W Revision	Prior to A.02.00

Mass Storage Move (Remote Command Only)

Key path	SCPI Only
Remote Command	:MMEMory:MOVE <string>,<string>[,<string>,<string>]
Notes	The string must be a valid logical path. Moves an existing file to a new file or an existing directory to a new directory. Two forms of parameters are allowed. The first form has two parameters. In this form, the first parameter specifies the source, and the second parameter specifies the destination. The second form has four parameters. In this form, the first and third parameters specify the source.

	<p>The second and fourth parameters specify the directories. The first pair of parameters specifies the source. The second pair specifies the destination. An error is generated if the source doesn't exist or the destination file already exists.</p> <p>This command will generate an "access denied" error if the destination is a restricted folder (e.g., C:\Windows) and the current user does not have Power User or Administrator privileges.</p>
Initial S/W Revision	Prior to A.02.00

Mass Storage Remove Directory (Remote Command Only)

Key path	SCPI Only
Remote Command	:MMEMory:RDIRectory <directory_name>
Notes	<p>The string must be a valid logical path.</p> <p>Removes a directory. The <directory_name> parameter specifies the directory name to be removed. All files and directories under the specified directory shall also be removed.</p> <p>This command will generate an "access denied" error if the folder is a restricted folder (e.g., C:\Windows) or is in a restricted folder and the current user does not have Power User or Administrator privileges.</p>
Initial S/W Revision	Prior to A.02.00

Data (Export)

Exporting a data file stores data from the current measurement to mass storage files. The Export Menu only contains data types that are supported by the current measurement.

Since the commonly exported data files are in .csv format, the data can be edited by you prior to importing. This allows you to export a data file, manipulate the data in Excel (the most common PC Application for manipulating .csv files) and then import it.

Selecting an Export Data menu key will not actually cause the exporting to occur, since the analyzer still needs to know where you wish to save the data. Pressing the Save As key in this menu brings up the Save As dialog and Save As menu that allows you to specify the destination file and directory. Once a filename has been selected or entered in the Open menu, the export will occur as soon as the Save key is pressed.

Key Path	Save
Mode	All
Notes	<p>The menu is built from whatever data types are available for the mode. So the key locations in the sub menu will vary.</p> <p>No SCPI command directly controls the Data Type that this key controls. The Data Type is included in the MMEM:STORe commands.</p>
Dependencies	If a file type is not used by a certain measurement, that type is grayed out for that measurement. The key for a file type will not show at all if there are no measurements in the Mode that support it.
Preset	Is not affected by a Preset or shutdown, but is reset during Restore Mode Defaults
Readback	The data type that is currently selected
Initial S/W Revision	Prior to A.02.00

Export Trace Data

Enables you to export trace data with (optional) associated headers. Selecting this key displays a menu that enables you to choose which Trace to save (default is the selected Trace) and whether or not to save headers with the data. The header information is used by the VXA application when saved trace data is recalled, and enables it to be displayed with the same formatting and scaling that it had when saved. If headers are not saved, the scaling and format are set to default values when the trace is recalled. After making these selections, press Save As... and use the file dialog to choose a file name and format for the saved data.

Trace data can be exported in several different formats. Text and comma-separated variable (CSV) formats are useful for viewing the data or importing it to a spreadsheet program. The other formats are binary and thus more compact. Trace data files can be recalled for viewing into other VXA, LTE, LTETDD, iDEN, or 89601 measurements.

Key Path	Save, Data (Export)
Mode	VSA, LTE, LTETDD, IDEN
Remote Command	:MMEMory:StORe:TRACe:DATA TRACE1 TRACE2 TRACE3 TRACE4 TRACE5 TRACE6, "<filename>" [,CSV TXT SDF MAT4 MAT HDF5 BIN[,OFF ON 0 1]]
Example	:MMEM:StOR:TRAC:DATA TRACE1, "TRC1.TXT", TXT, ON
Notes	<p>The Save As... dialog box has the following format options when you are saving trace data:</p> <ul style="list-style-type: none"> • CSV (Comma delimited) (*.csv) • SDF (Fast) (*.sdf;*.dat) • Text (Tab delimited) (*.txt) <p>File format saved depends on selection. The appropriate file extension is appended to the filename if it is not supplied by the user.</p> <p>If the SCPI command includes just a file name, the file format is determined by the filename extension, which must be one of the choices above. *.sdf or an unrecognized extension chooses the SDF fast format. If the optional file format enumerator is included in the command, then this determines the file format and the file extension is ignored. The optional binary parameter determines if file headers are saved. The default is ON. If file headers are not wanted, use the optional "OFF" parameter.</p> <p>The optional Boolean parameter determines whether headers are saved in the file. By default the headers are saved.</p> <p>If you are not licensed to save a particular file type, then error -203.9010 is returned. If an invalid file format is specified or the file cannot be saved successfully, then error -25x is returned. If the save is successful, then advisory 0.1500 is shown.</p>
State Saved	No
Readback	(Trace 1 Trace 2 Trace 3 Trace 4 Trace 5 Trace 6)(with without) headers

Trace 1

Selects the Trace 1 register as the destination for the imported data.

Key Path	Save, Data (Export), Trace
Mode	VSA, LTE, LTETDD, IDEN

Trace 2

Selects the Trace 2 register as the destination for the imported data.

Key Path	Save, Data (Export), Trace
Mode	VSA, LTE, LTETDD, IDEN

Trace 3

Selects the Trace 3 register as the destination for the imported data.

Key Path	Save, Data (Export), Trace
Mode	VSA, LTE, LTETDD, IDEN

Trace 4

Selects the Trace 4 register as the destination for the imported data.

Key Path	Save, Data (Export), Trace
Mode	VSA, LTE, LTETDD, IDEN

Trace 5

Selects the Trace 5 register as the destination for the imported data.

Key Path	Save, Data (Export), Trace
Mode	VSA, LTE, LTETDD, IDEN

Trace 6

Selects the Trace 6 register as the destination for the imported data.

Key Path	Save, Data (Export), Trace
Mode	VSA, LTE, LTETDD, IDEN

Include Header

Enables you to select whether or not the saved trace data includes header information describing scaling, formatting, etc.

Key Path	Save, Data (Export), Trace
Mode	VSA, LTE, LTETDD, IDEN
State Saved	No

Save As . . .

When you press “Save As”, the analyzer brings up a Windows dialog and a menu entitled “**Save As.**” This menu allows you to navigate to the various fields in the Windows dialog without using a keyboard or mouse. The Tab and Arrow keys can also be used for dialog navigation.

See "[To File . . .](#)" on page 1211 in Save, State for a full description of this dialog and menu.

The default path for saving files is:

For all of the Trace Data Files:

My Documents\<<mode name>\data\traces

For all of the Limit Data Files:

My Documents\<<mode name>\data\limits

For all of the Measurement Results Data Files:

My Documents\<<mode name>\data\<<measurement name>\results

For all of the Capture Buffer Data Files:

My Documents\<<mode name>\data\captureBuffer

Key Path	Save, Data
Mode	All
Notes	The key location is mode-dependent and will vary. Brings up the Save As dialog for saving a <mode specific> Save Type. The save is performed immediately and does not wait until the measurement is complete.
Initial S/W Revision	Prior to A.02.00

Screen Image

Pressing Screen Image accesses a menu of functions that enable you to specify a format and location for the saved screen image. It brings up a menu that allows you to specify the color scheme of the Screen Image (Themes) or navigate to the Save As dialog to perform the actual save.

Screen Image files contain an exact representation of the analyzer display. They cannot be loaded back onto the analyzer, but they can be loaded into your PC for use in many popular applications.

The image to be saved is actually captured when the Save front panel key is pressed, and kept in temporary storage to be used if you ask for a Screen Image save. When the Screen Image key is pressed, a "thumbnail" of the captured image is displayed, as shown below:

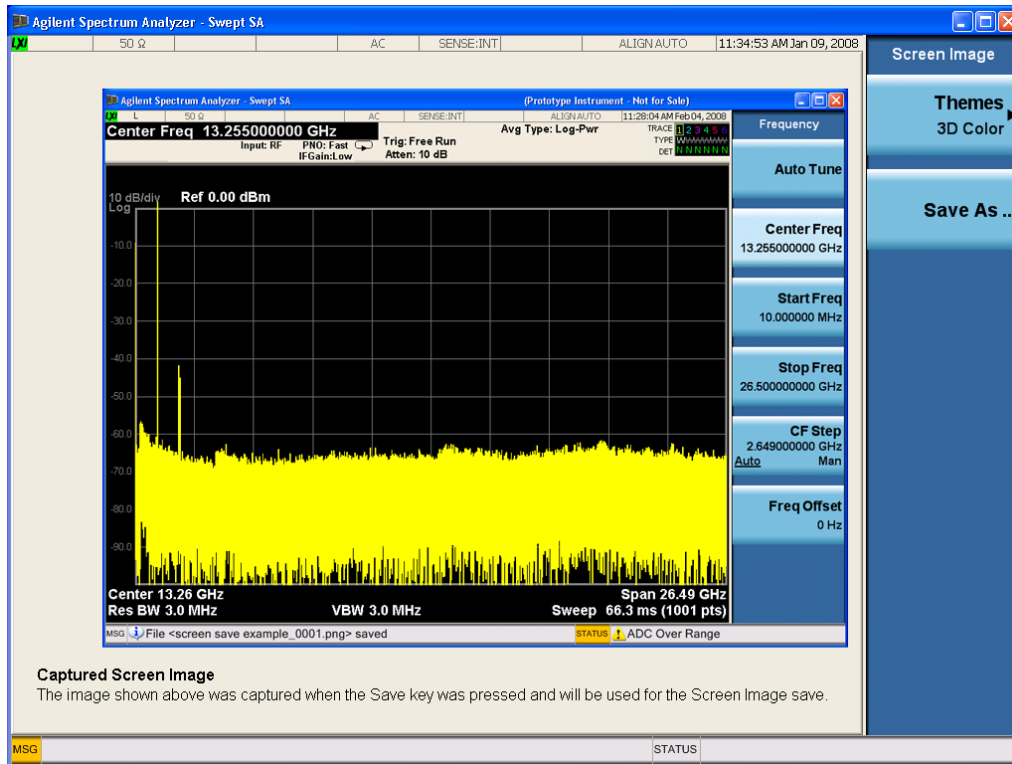

When you continue on into the Save As menu and complete the Screen Image save, the image depicted in the thumbnail is the one that gets saved, showing the menus that were on the screen before going into the Save menu. The save is performed immediately and does not wait until the measurement is complete.

After you have completed the save, the Quick Save front-panel key lets you quickly repeat the last save performed, using an auto-named file, with the current screen data.

NOTE

For versions previous to A.01.55, if you initiate a screen image save by navigating through the Save menus, the image that is saved will contain the Save menu softkeys, not the menus and the active function that were on the screen when you first pressed the Save front panel key.

Key Path	Save
Mode	All
Remote Command	:MMEMory:STORe:SCReen <filename>
Example	:MMEM:STOR:SCR "myScreen.png" This stores the current screen image in the file MyScreenFile.png in the default directory.
Initial S/W Revision	Prior to A.02.00

Themes

Accesses a menu of functions that enable you to choose the theme to be used when saving the screen image.

The **Themes** option is the same as the **Themes** option under the **Display** and **Page Setup** dialogs. It allows you to choose between themes to be used when saving the screen image.

Key Path	Save, Screen Image
Remote Command	:MMEMory:STORe:SCReen:THEMe TDColor TDMonochrome FCOLor FMONochrome :MMEMory:STORe:SCReen:THEMe?
Example	:MMEM:STOR:SCR:THEM TDM
Preset	3D Color; Is not part of Preset, but is reset by Restore Misc Defaults or Restore System Defaults All and survives subsequent running of the modes.
Readback	3D Color 3D Mono Flat Color Flat Mono
Backwards Compatibility Notes	In ESA and PSA we offer the choice of "Reverse Bitmap" or "Reverse Metafile" when saving screen images. This is much like the "Flat Color" theme available in X-Series. Also, if you selected Reverse Bitmap AND a black & white screen image, that would be much like "Flat Monochrome". In other words, each of the X-Series themes has a similar screen image type in ESA/PSA. But they are not identical.
Initial S/W Revision	Prior to A.02.00

3D Color

Selects a standard color theme with each object filled, shaded and colored as designed.

Key Path	Save, Screen Image, Themes
Example	MMEM:STOR:SCR:THEM TDC
Readback	3D Color
Initial S/W Revision	Prior to A.02.00

3D Monochrome

Selects a format that is like 3D color but shades of gray are used instead of colors.

Key Path	Save, Screen Image, Themes
Example	MMEM:STOR:SCR:THEM TDM
Readback	3D Mono
Initial S/W Revision	Prior to A.02.00

Flat Color

Selects a format that is best when the screen is to be printed on an ink printer.

Key Path	Save, Screen Image, Themes
Example	MMEM:STOR:SCR:THEM FCOL
Readback	Flat Color
Initial S/W Revision	Prior to A.02.00

Flat Monochrome

Selects a format that is like Flat Color. But only black is used (no colors, not even gray), and no fill.

Key Path	Save, Screen Image, Themes
Example	MMEM:STOR:SCR:THEM FMON
Readback	Flat Mono
Initial S/W Revision	Prior to A.02.00

Save As...

When you press "Save As", the analyzer brings up a Windows dialog and a menu entitled "**Save As.**" This menu allows you to navigate to the various fields in the Windows dialog without using a keyboard or mouse. The Tab and Arrow keys can also be used for dialog navigation.

See "[To File . . .](#)" on page 1211 in Save, State for a full description of this dialog and menu.

The default path for Screen Images is

My Documents\`<mode name>`\screen.

where `<mode name>` is the parameter used to select the mode with the INST:SEL command (for example, SA for the Spectrum Analyzer).

Key Path	Save, Screen Image
Notes	Brings up Save As dialog for saving a Screen Image Save Type
Initial S/W Revision	Prior to A.02.00

Single (Single Measurement/Sweep)

Sets the analyzer for Single measurement operation. The single/continuous state is Meas Global, so the setting will affect all the measurements. If you are Paused, pressing Single does a Resume.

See "[More Information](#)" on page 1026

Key Path	Front-panel key
Example	:INIT:CONT OFF
Notes	See Cont key description.
Backwards Compatibility Notes	<p>For Spectrum Analysis mode in ESA and PSA, the Single hardkey and the INITiate:IMM switched from continuous measurement to single measurement and restarted sweeps and averages (displayed average count reset to 1), but did not restart Max Hold and Min Hold. In the X-Series, the Single hardkey and the INITiate:IMM command initiate a sweep/ measurement/ average sequence/hold sequence including MaxHold and MinHold.</p> <p>For Spectrum Analysis mode in ESA and PSA, the Single hardkey restarted the sweep regardless of whether or not you were in an active sweep or sweep sequence. In the X-Series, Restart does this but Single only restarts the sweep or sweep sequence if you are in the idle state.</p> <p>INIT[:IMM] in ESA & PSA Spectrum Analysis Mode does an implied ABORT. In some other PSA Modes, INIT[:IMM] is ignored if not in the idle state. . The X-Series follows the ESA/PSA SA Mode model, which may cause some Modes to have compatibility problems.</p>
Initial S/W Revision	Prior to A.02.00

More Information

See "[Restart](#)" on page 1208 for details on the INIT:IMMEDIATE (Restart) function.

If you are already in single sweep, the INIT:CONT OFF command has no effect.

If you are already in Single Sweep, then pressing the Single key in the middle of a sweep does not restart the sweep or sequence. Similarly, pressing the Single key does not restart the sweep or sequence if the sweep is not in the idle state (for example, if you are taking a very slow sweep, or the analyzer is waiting for a trigger). Instead, it results in a message. "Already in Single, press Restart to initiate a new sweep or sequence". Even though pressing the Single key in the middle of a sweep does not restart the sweep, sending INIT:IMMEDIATE does reset it.

To take one more sweep without resetting the average count, increment the average count by 1, by pressing the step up key while **Average/Hold Number** is the active function, or sending the remote command CALC:AVER:TCON UP.

Source

There is no Source control functionality for this measurement. When this key is pressed, the screen either displays a blank menu, or the previously-selected menu remains unchanged.

Key Path	Front-panel key
----------	-----------------

SPAN X Scale

Displays a menu for selecting measurement span and also for scaling of the X axis.

Key Path	Front Panel
Mode	VSA, LTE, LTETDD, IDEN, LTEAFDD,LTEATDD
Initial S/W Revision	Prior to A.02.00
Modified at S/W Revision	A.02.00

Span

Controls the frequency span of the measurement. This is the full span that is displayed on a spectrum display. The actual IF bandwidth that the time record detects is 1.28 times the span. See ["FREQ Channel" on page 1134](#) for details on how this interacts with start, stop, and center frequencies.

Key Path	SPAN X Scale
Mode	VSA, IDEN
Remote Command	[:SENSe] :FREQuency:SPAN <freq> [:SENSe] :FREQuency:SPAN?
Example	FREQ:SPAN 10 MHZ FREQ:SPAN?
Couplings	Start Freq and Stop Freq. See "FREQ Channel" on page 1134 for details.
Preset	depends on span option
State Saved	Saved in instrument state.
Min	2 Hz
Max	depends on span option
Initial S/W Revision	Prior to A.02.00
Modified at S/W Revision	A.02.00

Full Span

Changes the span to the maximum available. The center frequency remains unchanged, regardless of whether the Frequency Annotation property is Start/Stop or Center/Span.

Key Path	SPAN X Scale
Mode	VSA, IDEN
Remote Command	[:SENSe] :FREQuency:SPAN:FULL
Example	FREQ:SPAN:FULL
Notes	The label on the softkey gives the full span available, which depends on span option.
Couplings	Changes span to maximum while keeping the center frequency constant. Start and Stop frequency

	are affected
Readback Text	[25 MHz] If playing back a recording, list the recorded bandwidth here
Initial S/W Revision	Prior to A.02.00
Modified at S/W Revision	A.02.00

Select Trace

Displays a menu that enables you to select the trace that is to receive the action of all successive trace-specific commands like scaling, assignment of trace data, and so on. The selected trace is outlined in green and is always visible. While the Select Trace menu is showing, each visible trace is annotated in the middle with its own trace number, as shown in the following figure. The trace number annotations disappear when any other menu is showing.

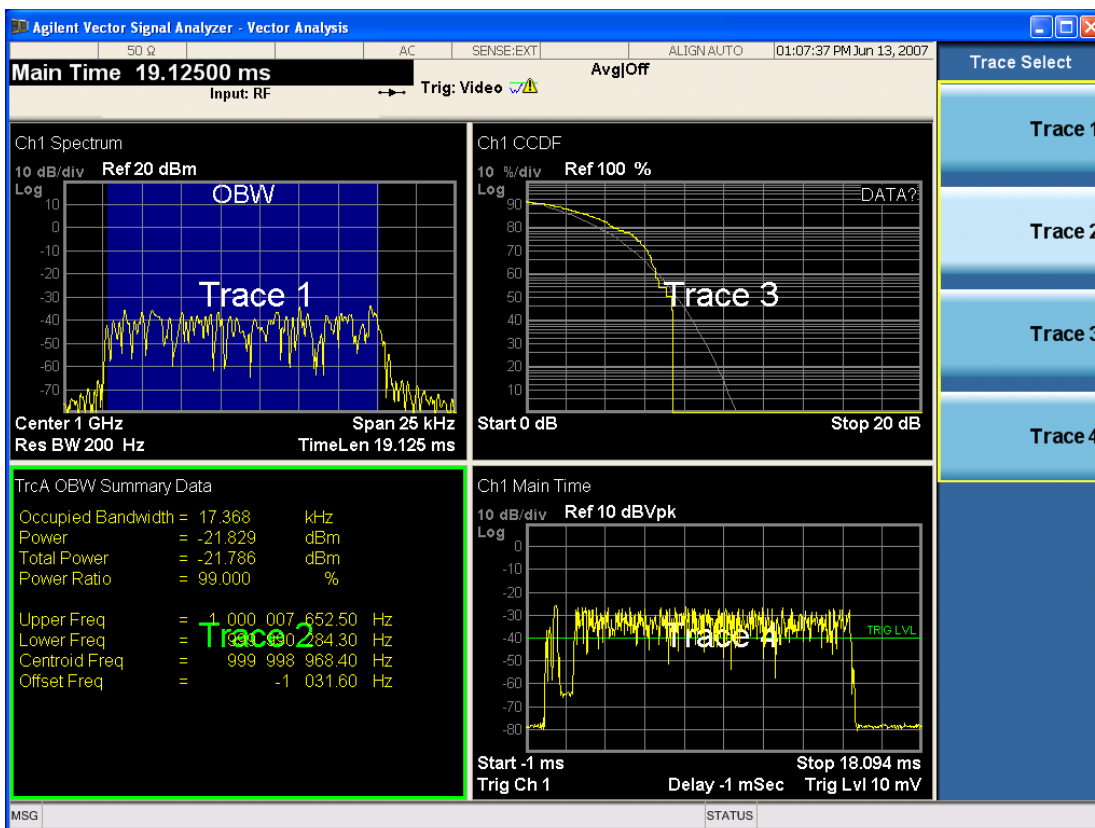

Grid 2x2 layout showing trace annotations when Trace Select dialog is active

This softkey also appears in the X and Y scaling menus. There is only one selected trace at any time. If you change which trace is selected, that change is reflected in this softkey/menu wherever it appears. Other ways to select a trace include use of the Next Window key, clicking within a trace window with a mouse cursor, and issuing a trace-specific SCPI command.

There is no SCPI command associated with this function. Instead, SCPI commands that are trace-specific have an index on the TRACE node that determines the selected trace. Using such a command has the side

effect that the trace addressed by the SCPI command becomes the selected trace for any front panel interaction.

Key Path	Trace/Detector or Span X Scale or AMPTD Y Scale
Mode	VSA, LTE, LTETDD, IDEN, LTEAFDD, LTEATDD
Notes	No SCPI. Front panel only.
Couplings	Affects any trace-specific commands
Range	Trace 1 Trace 2 Trace 3 Trace 4 Trace 5 Trace 6
Readback Text	Trace <n>
Initial S/W Revision	Prior to A.02.00
Modified at S/W Revision	A.02.00

X Scale

Causes the trace to display all available trace data when set to Auto. (Exception: the display of the outer edges of a spectrum that can contain aliases is governed by the All Frequency Points function setting – see below.) The annotation is updated as needed, but the X Reference Value and X Width keys are grayed out and not updated. When this function is set to Man, the X Reference Value and X Width softkey readbacks are updated with the current values.

Key Path	SPAN X Scale
Mode	VSA, LTE, LTETDD, IDEN, LTEAFDD, LTEATDD
Measurement	<meas>:=VECTor ADEMod DDEMod W11A W11B EVM IPOWER IDEMod MOTotalk
Remote Command	:DISPlay:<meas>:TRACe [1] 2 ...4:X[:SCALe]:COUPle OFF ON 0 1 :DISPlay:<meas>:TRACe [1] 2 ...4:X[:SCALe]:COUPle?
Example	:DISP:VECT:TRAC1:X:COUP ON DISP:VECT:TRAC1:X:COUP?
Couplings	Forced to Man if X Reference Value or X Width is set by user.
Preset	1
State Saved	Saved in instrument state.
Range	Auto Man
Initial S/W Revision	Prior to A.02.00
Modified at S/W Revision	A.02.00

X Reference Value

Controls the X value of the selected trace at the chosen X Reference Position (see below). It has no effect on hardware input settings.

Key Path	SPAN X Scale
----------	--------------

Mode	VSA, LTE, LTETDD, IDEN, LTEAFDD, LTEATDD
Measurement	<meas>:=VECTor ADEMod DDEMod W11A W11B EVM IPOWER IDEMod MOTotalk
Remote Command	:DISPlay:<meas>:TRACe[1] 2 ...4:X[:SCALE]:RLEVel <real> :DISPlay:<meas>:TRACe[1] 2 ...4:X[:SCALE]:RLEVel?
Example	DISP:VECT:TRAC:X:RLEV 1e9 DISP:VECT:TRAC:X:RLEV?
Couplings	If X Scale is set to Auto, the X Reference Value is determined by the trace data and this key is grayed out.
Preset	Depends on trace
State Saved	Saved in instrument state.
Min	-9.9E+37
Max	9.9E+37
Initial S/W Revision	Prior to A.02.00
Modified at S/W Revision	A.02.00

X Width

Sets the width of the X axis that is displayed for the selected trace. The X width can be set less than the Span for frequency-domain traces, enabling you to zoom in on just a portion of the measured values. Likewise, it can be less than time span covered by time-domain data. This plus the X Reference Value and X Reference Position control the range of X values that can be displayed on a trace. For example, if the X Reference position is Center, the X Reference value is 1 GHz and the X Width is 20 MHz.

Key Path	SPAN X Scale
Mode	VSA, LTE, LTETDD, IDEN, LTEAFDD, LTEATDD
Measurement	<meas>:=VECTor ADEMod DDEMod W11A W11B EVM IPOWER IDEMod MOTotalk
Remote Command	:DISPlay:<meas>:TRACe[1] 2 ...4:X[:SCALE]:SPAN <real> :DISPlay:<meas>:TRACe[1] 2 ...4:X[:SCALE]:SPAN?
Example	DISP:VECT:TRAC:X:SPAN 10e6 DISP:VECT:TRAC:X:SPAN?
Couplings	If X Scale is set to Auto, the X Width is determined by the trace data and this key is grayed out.
Preset	Depends on trace
State Saved	Saved in instrument state.
Min	-9.9E+37
Max	9.9E+37
Initial S/W Revision	Prior to A.02.00
Modified at S/W Revision	A.02.00

X Reference Position

Determines the position from which the X scaling is calculated for the selected trace. It can be set to the left side, center, or right side of the grid.

Key Path	SPAN X Scale
Mode	VSA, LTE, LTETDD, IDEN, LTEAFDD,LTEATDD
Measurement	<meas>:=VECTor ADEMod DDEMod W11A W11B EVM IPOWER IDEMod MOTotalk
Remote Command	:DISPlay:<meas>:TRACe[1] 2 ...4:X[:SCALE]:RPOStion LEFT CENTER RIGHT :DISPlay:<meas>:TRACe[1] 2 ...4:X[:SCALE]:RPOStion?
Example	DISP:VECT:TRAC1:X:RPOS LEFT DISP:VECT:TRAC1:X:RPOS?
Couplings	If X Scale is set to Auto, the X Reference Position is determined by the trace data and this key is grayed out.
Preset	CENT
State Saved	Saved in instrument state.
Range	Left Ctr Right
Initial S/W Revision	Prior to A.02.00
Modified at S/W Revision	A.02.00

Freq Annotation

Controls how Spectrum and PSD traces are annotated when their X Scale is set to Auto. If Freq Annotation is set to Center/Span, the X-axes on windows containing frequency domain traces are labeled with the center frequency on the left and the span on the right. If the Freq Annotation is set to Start/Stop, then the start and stop frequencies appear in place of center and span. If the X Scale is manual, then this annotation style does not apply.



Key Path	SPAN X Scale
Mode	VSA, LTE, LTETDD, IDEN, LTEAFDD,LTEATDD
Measurement	<meas>:=VECTor ADEMod DDEMod W11A W11B EVM IPOWER IDEMod MOTotalk
Remote Command	:DISPlay:<meas>:FANNotation CSPan SSTop :DISPlay:<meas>:FANNotation?
Example	DISP:VECT:FANN CSP DISP:VECT:FANN?

Preset	CSP
State Saved	Saved in instrument state.
Range	Center/Span Start/Stop
Initial S/W Revision	Prior to A.02.00
Modified at S/W Revision	A.02.00

All Frequency Points

Spectrum trace data (and PSD) are based on the FFT algorithm. By default, the outer edges of the spectrum are not displayed because they can show spurious results that are aliases of real signals that are not completely filtered out by the IF filter. For example, in the case of a 1024 point FFT only 801 points are displayed. If you want to view the additional FFT points at the edges of spectral displays, turn this function on. It is global to all traces, not specific to a single trace.

Key Path	SPAN X Scale
Mode	VSA, LTE, LTETDD, IDEN, LTEAFDD, LTEATDD
Measurement	<meas>:=VECTor ADEMod DDEMod W11A W11B EVM IPOWER IDEMod MOTotalk
Remote Command	:DISPlay:<meas>:AFPpoints OFF ON 0 1 :DISPlay:<meas>:AFPpoints?
Example	DISP:VECT:AFP ON DISP:VECT:AFP?
Notes	ac
Couplings	Only applies if trace is showing Spectrum or PSD results.
Preset	OFF
State Saved	Saved in instrument state.
Range	On Off
Initial S/W Revision	Prior to A.02.00
Modified at S/W Revision	A.02.00

Copy X Scale

Copies the following X scaling information from the selected trace to another:

- X reference Position
- X Reference Value
- X Width
- X Scale (Auto/Man)

This is a front-panel only function.

11 iDEN Demod Measurement
SPAN X Scale

Key Path	SPAN X Scale, X Axis Scaling
Mode	VSA, LTE, LTETDD, IDEN, LTEAFDD,LTEATDD
Initial S/W Revision	Prior to A.02.00
Modified at S/W Revision	A.02.00

Sweep/Control

Displays a menu that enables you to control time-related measurement parameters and to pause or resume the measurement.

Key Path	Front Panel
Mode	VSA
Initial S/W Revision	A.01060 or later

Pause / Resume

Pauses or resumes acquisition at the end of the current time record acquisition.

Key Path	Sweep Control
Mode	VSA
Initial S/W Revision	A.01060 or later

11 iDEN Demod Measurement
System

System

See ["System" on page 242](#)

Trace/Detector

Accesses a menu enabling you to select various trace parameters for all VSA based measurements.

Key Path	Front Panel
Mode	VSA, LTE, LTETDD, IDEN, LTEAFDD, LTEATDD
Initial S/W Revision	Prior to A.02.00
Modified at S/W Revision	A.02.00

Select Trace

Displays a menu that enables you to select the trace that is to receive the action of all successive trace-specific commands like scaling, assignment of trace data, and so on. The selected trace is outlined in green and is always visible. While the Select Trace menu is showing, each visible trace is annotated in the middle with its own trace number, as shown in the following figure. The trace number annotations disappear when any other menu is showing.

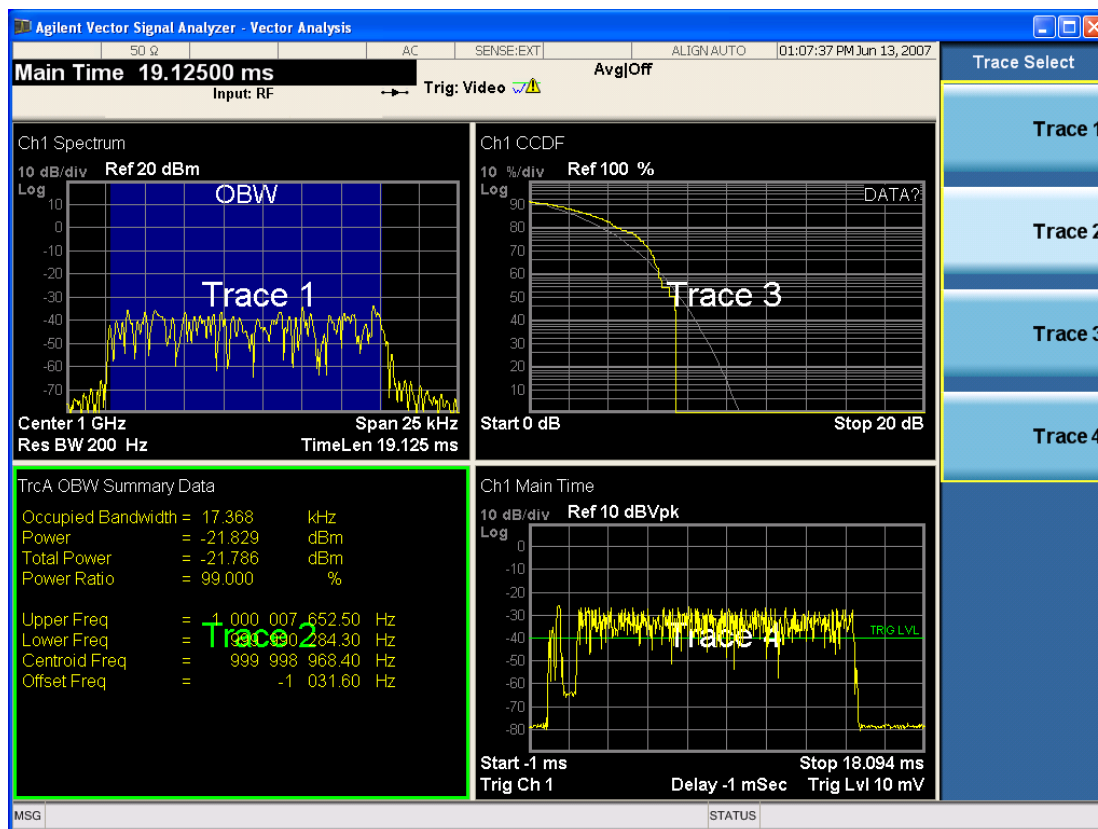

Grid 2x2 layout showing trace annotations when Trace Select dialog is active

This softkey also appears in the X and Y scaling menus. There is only one selected trace at any time. If you change which trace is selected, that change is reflected in this softkey/menu wherever it appears. Other

ways to select a trace include use of the Next Window key, clicking within a trace window with a mouse cursor, and issuing a trace-specific SCPI command.

There is no SCPI command associated with this function. Instead, SCPI commands that are trace-specific have an index on the TRACe node that determines the selected trace. Using such a command has the side effect that the trace addressed by the SCPI command becomes the selected trace for any front panel interaction.

Key Path	Trace/Detector or Span X Scale or AMPTD Y Scale
Mode	VSA, LTE, LTETDD, IDEN,LTEAFDD,LTEATDD
Notes	No SCPI. Front panel only.
Couplings	Affects any trace-specific commands
Range	Trace 1 Trace 2 Trace 3 Trace 4 Trace 5 Trace 6
Readback Text	Trace <n>
Initial S/W Revision	Prior to A.02.00
Modified at S/W Revision	A.02.00

Data

Accesses a menu of Trace data choices for the selected trace. A VSA Measurement can produce many different results from a single scan; either a graph or a table. In addition, the ACP and OBW functions can be enabled on any trace, showing a frequency-domain result, and produce Summary table results. Any of these results can be assigned to a trace and displayed.

The following Trace Data types are available in all measurements:

Soft Key Name	SCPI string form
No Data	"No Data"
Spectrum	"Spectrum1"
Inst Spectrum	"Inst Spectrum1"
Raw Main Time	"Raw Main Time1"
OBW Summary for Trace 1	"Obw Summary Trc1"
OBW Summary for Trace 2	"Obw Summary Trc2"
OBW Summary for Trace 3	"Obw Summary Trc3"
OBW Summary for Trace 4	"Obw Summary Trc4"
ACP Summary for Trace 1	"Acp Summary Trc1"
ACP Summary for Trace 2	" Acp Summary Trc2"
ACP Summary for Trace 3	" Acp Summary Trc3"
ACP Summary for Trace 4	" Acp Summary Trc4"

The following Data Registers are also available for display if there are traces stored in them (see ["Copy to Data Register" on page 1252](#) and ["Import Trace Data" on page 1205](#): "D1", "D2", "D3", "D4", "D5", and "D6")

Key Path	Trace/Detector, Data
Mode	VSA, LTE, LTETDD, IDEN
Measurement	<meas>:=VECTor ADEMod DDEMod W11A W11B EVM IPOWER IDEMod MOTotalk
Remote Command	:DISPlay:<meas>:TRACe[1] 2 ...4:FEED <string> :DISPlay:<meas>:TRACe[1] 2 ...4:FEED?
Example	DISP:VECT:TRAC1:FEED "Spectrum1" DISP:VECT:TRAC1:FEED?
Preset	Depends on trace number and measurement
State Saved	Saved in instrument state.
Initial S/W Revision	Prior to A.02.00
Modified at S/W Revision	A.02.00

The complete list of Trace Data names that can be assigned using the above SCPI can be obtained by using the following SCPI query:

Mode	VSA, LTE, LTETDD, IDEN
Measurement	<meas>:=VECTor ADEMod DDEMod W11A W11B EVM IPOWER IDEMod MOTotalk
Remote Command	:CALCulate:<meas>:DATA[1] 2 ...4:NAMes?
Example	CALC:VECT:DATA:NAM?
Notes	Query only. Returns a comma-separated list of trace data names that can be used in DISPlay:<meas>:TRACe[1]]2 3 4:FEED "<string>". The list is the same regardless of trace index.
Initial S/W Revision	Prior to A.02.00
Modified at S/W Revision	A.02.00

Pre Demod

Accesses several Trace Data types which show results prior to demodulation.

Key Path	Trace/Detector, Data
Mode	IDEN
Initial S/W Revision	A.02.00

Spectrum

Shows the frequency spectrum of the signal, scaled to the display and averaged if averaging is on.

Key Path	Trace/Detector, Data, Pre Demod
Mode	IDEN
Initial S/W Revision	A.02.00

Inst Spectrum

Displays the most recent spectrum measurement of your signal, scaled to the display.

Key Path	Trace/Detector, Data, Pre Demod
Mode	IDEN
Initial S/W Revision	A.02.00

Search Time

Shows the time-data before pulse search and demodulation, that is, shows the acquired time data used to search for the pulse (or burst).

Key Path	Trace/Detector, Data, Pre Demod
Mode	IDEN
Initial S/W Revision	A.02.00

Time

Shows the block of time-record samples of the signal waveform, from which time, frequency, and modulation domain data is derived.

Key Path	Trace/Detector, Data, Pre Demod
Mode	IDEN
Initial S/W Revision	A.02.00

Raw Main Time

Shows the raw data acquired from the input hardware. This data is unprocessed and includes additional points acquired for settling of the filters involved in subsequent processing, such as the demodulation filtering.

Key Path	Trace/Detector, Data, Pre Demod
Mode	IDEN
Initial S/W Revision	A.02.00

PvT

Shows a menu for a number of Trace Data types which show PvT specific results.

Key Path	Trace/Detector, Data
Mode	IDEN
Initial S/W Revision	A.02.00

PvT Time

Shows a non-complex time display of the full slot with time = 0 referenced to the first data symbol.

Key Path	Trace/Detector, PvT
Mode	IDEN
Initial S/W Revision	A.02.00

PvT Summary

Shows a summary of the composite signal (all subchannels) for elements of the slot format, overall slot power, data, AGC, and power off levels. Note that the PvT Test Status is not included in this table but is visible on the front panel and is accessible via the CALCulate:CLIMits:FAIL? query.

Key Path	Trace/Detector, PvT
Mode	IDEN
Initial S/W Revision	A.02.00

WiDEN Carr0 PvT Time

Shows a non-complex time display of the full slot with time = 0 referenced to the first data symbol.

Key Path	Trace/Detector, PvT
Mode	IDEN
Initial S/W Revision	A.02.00

WiDEN Carr1 PvT Time

Shows a non-complex time display of the full slot with time = 0 referenced to the first data symbol.

Key Path	Trace/Detector, PvT
Mode	IDEN
Initial S/W Revision	A.02.00

WiDEN Carr2 PvT Time

Shows a non-complex time display of the full slot with time = 0 referenced to the first data symbol.

Key Path	Trace/Detector, PvT
Mode	IDEN
Initial S/W Revision	A.02.00

WiDEN Carr3 PvT Time

Shows a non-complex time display of the full slot with time = 0 referenced to the first data symbol.

Key Path	Trace/Detector, PvT
Mode	IDEN
Initial S/W Revision	A.02.00

BER

Accesses a number of Trace Data types which are BER specific tables.

Key Path	Trace/Detector, Data
Mode	IDEN
Initial S/W Revision	A.02.00

BER Overall Summary

Shows a trace of an overall Bit Error Rate (BER).

Key Path	Trace/Detector, BER
Mode	IDEN
Initial S/W Revision	A.02.00

BER Slot Summary

Shows a trace for a visual representation of Bit Error Rate (BER) symbol errors within an overall slot.

Key Path	Trace/Detector, BER
Mode	IDEN
Initial S/W Revision	A.02.00

Overlaid Demod

Shows a number of Trace Data types which show demodulation results for all subchannels on a single display.

Key Path	Trace/Detector, Data
Mode	IDEN
Initial S/W Revision	A.02.00

Overlaid IQ Meas Time

Displays all sub-carrier symbols. In a constellation diagram, the symbols are overlaid on an ideal state pattern with circles for data symbols and cross-marks for sync and pilot symbols.

Key Path	Trace/Detector, Overlaid Demod
Mode	IDEN
Initial S/W Revision	A.02.00

Overlaid IQ Ref Time

Shows the sequence of ideal I and Q states as a composite of all sub-carriers.

Key Path	Trace/Detector, Overlaid Demod
Mode	IDEN
Initial S/W Revision	A.02.00

Overlaid Error Vector Time

Displays error vector time for every subchannel symbol on a symbol by symbol basis (vertical green line), overlaid with a white trace that shows the average error vector time per symbol (LinMag or LogMag scale only).

Key Path	Trace/Detector, Overlaid Demod
Mode	IDEN
Initial S/W Revision	A.02.00

Overlaid Error Vector Spectrum

Displays all of the iDEN/WiDEN subchannels as green vertical lines, with each green vertical line containing all the symbols for a subchannel, and the entire display overlaid with a white trace (LinMag or LogMag scale only) showing the average vector error of each subchannel.

Key Path	Trace/Detector, Overlaid Demod
Mode	IDEN
Initial S/W Revision	A.02.00

Overlaid IQ Mag Error

Displays the IQ magnitude error for every subchannel symbol on a symbol by symbol basis, overlaid with a white trace (LinMag or LogMag scale only) that shows the average IQ magnitude error per symbol.

Key Path	Trace/Detector, Overlaid Demod
Mode	IDEN
Initial S/W Revision	A.02.00

Overlaid IQ Phase Error

Displays the IQ phase error for every sub-carrier symbol, on a symbol-by-symbol basis. The display is overlaid with a white trace identifying the average IQ phase error per symbol.

Key Path	Trace/Detector, Overlaid Demod
Mode	IDEN
Initial S/W Revision	A.02.00

Subchannel Demod

Accesses a number of Trace Data types which show demodulation results for the single subchannel selected by Analysis Subchannel ("[Analysis Subchannel](#)" on page 974) and WiDEN Carrier ("[WiDEN Carrier](#)" on page 975).

Key Path	Trace/Detector, Data
Mode	IDEN
Initial S/W Revision	A.02.00

Subchannel IQ Meas Time

Displays all symbols for the selected subchannel, overlaid using an ideal state pattern. Circles are used to identify data symbols and cross-marks for sync and pilot symbols.

Key Path	Trace/Detector, Subchannel Demod
Mode	IDEN
Initial S/W Revision	A.02.00

Subchannel IQ Ref Time

Shows a sequence of ideal I and Q states for the specified subchannel.

Key Path	Trace/Detector, Subchannel Demod
Mode	IDEN
Initial S/W Revision	A.02.00

Subchannel Error Vector Time

Displays error vector time for the specified subchannel on a symbol-by-symbol basis.

Key Path	Trace/Detector, Subchannel Demod
Mode	IDEN
Initial S/W Revision	A.02.00

Subchannel IQ Mag Error

Displays the IQ magnitude time error for the selected subchannel on a symbol-by-symbol basis.

Key Path	Trace/Detector, Subchannel Demod
Mode	IDEN
Initial S/W Revision	A.02.00

Subchannel IQ Phase Error

Displays the IQ phase error for the selected subchannel on a symbol-by-symbol basis.

Key Path	Trace/Detector, Subchannel Demod
Mode	IDEN
Initial S/W Revision	A.02.00

Tables

Accesses a menu selection for a number of tabular Trace Data types: Composite Error Summary, Composite Symbols, Subchannel Error Summary, and MQAM Summary.

Key Path	Trace/Detector, Data
Mode	IDEN
Initial S/W Revision	A.02.00

Composite Error Summary

Displays an error summary for the composite iDEN/WiDEN signal, which includes all valid subchannels.

Key Path	Trace/Detector, Tables
Mode	IDEN
Initial S/W Revision	A.02.00

Composite Symbols

Displays all the demodulated symbols for the selected slot format.

Key Path	Trace/Detector, Tables
Mode	IDEN
Initial S/W Revision	A.02.00

Subchannel Error Summary

Shows an error summary for the subchannel selected by Analysis Subchannel and WiDEN Carrier.

Key Path	Trace/Detector, Tables
Mode	IDEN
Initial S/W Revision	A.02.00

MQAM Summary

Shows a summary of EVM, PvT, and BER Test results.

Key Path	Trace/Detector, Tables
Mode	IDEN
Initial S/W Revision	A.02.00

ACP (Adjacent Channel Power)

Provides access to ACP summary table data. These results are available when the ACP function is enabled for a particular trace, and it enables you to display the results in another trace.

Key Path	Trace/Detector, Data
Mode	VSA, LTE, LTETDD, IDEN
Initial S/W Revision	Prior to A.02.00
Modified at S/W Revision	A.02.00

ACP Summary for Trace 1

Displays results for the ACP function on Trace 1 in the selected trace.

See also: ["ACP Setup" on page 1255](#)

Key Path	Trace/Detector, Data, ACP
Mode	VSA, LTE, LTETDD, IDEN
Initial S/W Revision	Prior to A.02.00
Modified at S/W Revision	A.02.00

ACP Summary for Trace 2

Displays results for the ACP function on Trace 2 in the selected trace.

See also: ["ACP Setup" on page 1255](#)

Key Path	Trace/Detector, Data, ACP
Mode	VSA, LTE, LTETDD, IDEN
Initial S/W Revision	Prior to A.02.00
Modified at S/W Revision	A.02.00

ACP Summary for Trace 3

Displays results for the ACP function on Trace 3 in the selected trace.

See also: ["ACP Setup" on page 1255](#)

Key Path	Trace/Detector, Data, ACP
Mode	VSA, LTE, LTETDD, IDEN
Initial S/W Revision	Prior to A.02.00
Modified at S/W Revision	A.02.00

ACP Summary for Trace 4

Displays results for the ACP function on Trace 4 in the selected trace.

See also: ["ACP Setup" on page 1255](#)

Key Path	Trace/Detector, Data, ACP
Mode	VSA, LTE, LTETDD, IDEN
Initial S/W Revision	Prior to A.02.00
Modified at S/W Revision	A.02.00

ACP Summary for Trace 5

Displays results for the ACP function on Trace 5 in the selected trace.

See also: ["ACP Setup" on page 1255](#)

Key Path	Trace/Detector, Data, ACP
Mode	VSA

ACP Summary for Trace 6

Displays results for the ACP function on Trace 6 in the selected trace.

See also: ["ACP Setup" on page 1255](#)

Key Path	Trace/Detector, Data, ACP
Mode	VSA

OBW (Occupied Bandwidth)

Provides access to OBW summary table data. These results are available if the OBW function is enabled for a particular trace, and enable you to display the results in another trace.

Key Path	Trace/Detector, Data
Mode	VSA, LTE, LTETDD, IDEN
Initial S/W Revision	Prior to A.02.00
Modified at S/W Revision	A.02.00

OBW Summary for Trace 1

Displays results for the OBW function on Trace 1 in the selected trace.

See also: ["OBW Setup \(Occupied Bandwidth\)" on page 1263](#)

Key Path	Trace/Detector, Data, OBW
Mode	VSA, LTE, LTETDD, IDEN
Initial S/W Revision	Prior to A.02.00
Modified at S/W Revision	A.02.00

OBW Summary for Trace 2

Displays results for the OBW function on Trace 2 in the selected trace.

See also: ["OBW Setup \(Occupied Bandwidth\)" on page 1263](#)

Key Path	Trace/Detector, Data, OBW
Mode	VSA, LTE, LTETDD, IDEN
Initial S/W Revision	Prior to A.02.00
Modified at S/W Revision	A.02.00

OBW Summary for Trace 3

Displays results for the OBW function on Trace 3 in the selected trace.

See also: ["OBW Setup \(Occupied Bandwidth\)" on page 1263](#)

Key Path	Trace/Detector, Data, OBW
Mode	VSA, LTE, LTETDD, IDEN
Initial S/W Revision	Prior to A.02.00
Modified at S/W Revision	A.02.00

OBW Summary for Trace 4

Displays results for the OBW function on Trace 4 in the selected trace.

See also: ["OBW Setup \(Occupied Bandwidth\)" on page 1263](#)

Key Path	Trace/Detector, Data, OBW
Mode	VSA, LTE, LTETDD, IDEN
Initial S/W Revision	Prior to A.02.00
Modified at S/W Revision	A.02.00

OBW Summary for Trace 5

Displays results for the OBW function on Trace 5 in the selected trace.

See also: ["OBW Setup \(Occupied Bandwidth\)" on page 1263](#)

Key Path	Trace/Detector, Data, OBW
Mode	VSA

OBW Summary for Trace 6

Displays results for the OBW function on Trace 6 in the selected trace.

See also: ["OBW Setup \(Occupied Bandwidth\)" on page 1263](#)

Key Path	Trace/Detector, Data, OBW
Mode	VSA

Register

Accesses a menu that enables you to select registers for assignment of trace data.

Key Path	Trace/Detector, Data
Mode	VSA, LTE, LTETDD, IDEN
Initial S/W Revision	Prior to A.02.00
Modified at S/W Revision	A.02.00

Data 1

Select register 1 for assignment of trace data.

Key Path	Trace/Detector, Data, Register
Mode	VSA, LTE, LTETDD, IDEN
Initial S/W Revision	Prior to A.02.00
Modified at S/W Revision	A.02.00

Data 2

Selects register 2 for assignment of trace data.

Key Path	Trace/Detector, Data, Register
Mode	VSA, LTE, LTETDD, IDEN
Initial S/W Revision	Prior to A.02.00
Modified at S/W Revision	A.02.00

Data 3

Selects register 3 for assignment of trace data.

Key Path	Trace/Detector, Data, Register
Mode	VSA, LTE, LTETDD, IDEN
Initial S/W Revision	Prior to A.02.00
Modified at S/W Revision	A.02.00

Data 4

Selects register 4 for assignment of trace data.

Key Path	Trace/Detector, Data, Register
Mode	VSA, LTE, LTETDD, IDEN
Initial S/W Revision	Prior to A.02.00
Modified at S/W Revision	A.02.00

Data 5

Selects register 5 for assignment of trace data.

Key Path	Trace/Detector, Data, Register
Mode	VSA
Initial S/W Revision	Prior to A.02.00
Modified at S/W Revision	A.02.00

Data 6

Selects register 6 for assignment of trace data.

Key Path	Trace/Detector, Data, Register
Mode	VSA
Initial S/W Revision	Prior to A.02.00
Modified at S/W Revision	A.02.00

No Data

Enables you to turn off trace computations. Measurement results are not computed unless assigned to a trace. No Data lets you increase measurement speed by turning off post-processing calculations that are not needed.

Key Path	Trace/Detector, Data
Mode	VSA, LTE, LTETDD, IDEN
Initial S/W Revision	Prior to A.02.00
Modified at S/W Revision	A.02.00

Format

Accesses a menu that enables you to choose the format of the selected trace. Any format can be assigned to any trace. For symbol tables and tabular data the format choice is ignored. If the data doesn't have defined symbol times, Constellation format is the same as I-Q, Eye formats are the same as Real or Imaginary, and Trellis format is the same as Unwrapped Phase.

The formats are:

Format name	Description
Log Mag (dB)	Data is converted to decibel units and shown on a linear Y axis
Linear Mag (Abs Value)	Magnitude of the data is shown on a linear Y axis
Real (I)	Real part of data is shown on a linear Y axis
Imaginary (Q)	Imaginary part of data is shown on linear Y axis
I-Q	Real part of data is shown on horizontal axis, imaginary part is shown on vertical axis, Independent variable (X axis) is normal to display
Constellation	Same as I-Q, but for data with symbols defined, only the symbol points are shown as dots with no connecting lines.
Wrap Phase	Phase of complex data, limited to ± 180 deg, is shown on Y axis
Unwrap Phase	Phase of complex data is shown "unwrapped", that is, without discontinuities. Not limited to ± 180 degrees.
I-Eye	Real part of data is shown with X axis segmented (generally into 2 symbol segments) and each segment is overlaid to show signal crossings at symbol boundaries
Q-Eye	Same as I-eye but imaginary part of data is shown
Trellis	Same as I-eye but uses unwrapped phase of data
Group Delay	Useful for frequency response displays. Shows the derivative of phase response with respect to frequency.
Log Mag (Linear Unit)	Displays data with a logarithmic Y axis, but marker read outs are in linear magnitude units.

Key Path	Trace/Detector, Format
Mode	VSA, LTE, LTETDD, IDEN
Measurement	<meas>:=VECTOR ADEMod DDEMod W11A W11B EVM IPOWER IDEMod MOTotalk
Remote Command	:DISPlay:<meas>:TRACe[1] 2 ...4:FORMat MLOG MLINear REAL IMAGinary VECTor CONS PHASe UPHase IEYE QEYE TRELLis GDELay MLGLinear :DISPlay:<meas>:TRACe[1] 2 ...4:FORMat?
Example	DISP:DDEM:TRAC2:FORM MLIN DISP:DDEM:TRAC2:FORM?
Preset	Depends on trace and measurement
State Saved	Saved in instrument state.

Range	Log Mag (dB) Linear Mag (Abs Value) Real (I) (Lin) Imaginary (Q) (Lin) I-Q Constellation Wrap Phase Unwrap Phase I-Eye Q-Eye Trellis-Eye Group Delay Log Mag (Linear Unit)
Readback Text	Log Mag (dB) Linear Mag Real (I) Imaginary (Q) I-Q Constellation Wrap Phase Unwrap Phase I-Eye Q-Eye Trellis-Eye Group Delay Log Mag
Initial S/W Revision	Prior to A.02.00
Modified at S/W Revision	A.02.00

Digital Demod Trace Setup

Accesses a menu of settings that control certain elements of displays of digitally demodulated trace data.

Key Path	Trace/Detector
Mode	VSA, LTE, LTETDD, IDEN
Initial S/W Revision	Prior to A.02.00
Modified at S/W Revision	A.02.00

Symbol Shape

Enables you to display dots, bars, or nothing (none) at symbol locations (if the trace contains demodulated time-domain data) for all time-domain displays except IQ diagrams. This key enables you to select the symbol shape for the selected trace.

If you select bars, vertical lines (bars) are drawn from the baseline to the symbol location on the trace. The baseline is 0 for all traces that have coordinates other than log (dB). The baseline is the bottom of the trace box for traces that have log (dB) coordinates.

With IQ diagrams, displaying vertical bars is meaningless. Therefore, selecting bars displays dots in IQ diagrams.

With constellation diagrams, selecting none is the same as selecting bars – you cannot turn off the dots in a constellation diagram.

Key Path	Trace/Detector, Digital Demod Trace Setup
Mode	VSA, LTE, LTETDD, IDEN
Measurement	<meas>:=VECTor ADEMod DDEMod W11A W11B EVM IPOWER IDEMod MOTotalk
Remote Command	:DISPlay:<meas>:TRACe [1] 2 . . . 4 :DDEMod:SYMBol BARS DOTS OFF :DISPlay:<meas>:TRACe [1] 2 . . . 4 :DDEMod:SYMBol?
Example	DISP:DDEM:TRAC2:DDEM:SYMB DOTS DISP:DDEM:TRAC2:DDEM:SYMB?
Preset	BARS
State Saved	Saved in instrument state.
Range	Bars Dots None

Initial S/W Revision	Prior to A.02.00
Modified at S/W Revision	A.02.00

Ideal State Shape

Enables you to choose between a cross, circle, or none to represent the ideal state on the selected trace. Digital Demodulation shows you the location of all ideal symbol states in an I-Q or constellation diagram.

Key Path	Trace/Detector, Digital Demod Trace Setup
Mode	VSA, LTE, LTETDD, IDEN
Measurement	<meas>:=VECTor ADEMod DDEMod W11A W11B EVM IPOWER IDEMod MOTotalk
Remote Command	:DISPlay:<meas>:TRACe [1] 2 . . . 4 :DDEMod:SYMBol:SHAPE CIRCle CROSS OFF :DISPlay:<meas>:TRACe [1] 2 . . . 4 :DDEMod:SYMBol:SHAPE?
Example	DISP:DDEM:TRAC2:DDEM:SYMB:SHAP CIRC DISP:DDEM:TRAC2:DDEM:SYMB:SHAP?
Preset	CIRC
State Saved	Saved in instrument state.
Range	Circle Cross None
Initial S/W Revision	Prior to A.02.00
Modified at S/W Revision	A.02.00

Ideal State Size

Determines the ideal state size, as a percentage of the maximum ideal state distance from the origin (the same way Error Vector Magnitude is defined). Ideal states are shown as circles or crosses in Vector and constellation diagrams, as determined by the Ideal State Shape setting.

The ideal state is where symbols occur if your signal is without error. Showing the ideal states gives a visual indication of the quality of your signal.

You can use this feature to determine if symbols have an EVM above a specified Value. For example, to see if any symbols have an EVM greater than 10%, set the state size to 10% and select Circle as the shape. Any symbols that fall outside of the circle (other than SYNC or PILOT symbols) have an EVM greater than 10%.

Key Path	Trace/Detector, Digital Demod Trace Setup
Mode	VSA, LTE, LTETDD, IDEN
Measurement	<meas>:=VECTor ADEMod DDEMod W11A W11B EVM IPOWER IDEMod MOTotalk
Remote Command	:DISPlay:<meas>:TRACe [1] 2 . . . 4 :DDEMod:SYMBol:SIZE <real> :DISPlay:<meas>:TRACe [1] 2 . . . 4 :DDEMod:SYMBol:SIZE?
Example	DISP:DDEM:TRAC2:DDEM:SYMB:SIZE 10

	DISP:DDEM:TRAC2:DDEM:SYMB:SIZE?
Notes	Parameter is interpreted as a percent, e.g., if you want the ideal size to be 10% send 10, not 0.1
Preset	5
State Saved	Saved in instrument state.
Min	0.1
Max	50
Initial S/W Revision	Prior to A.02.00
Modified at S/W Revision	A.02.00

Symbol Table Format

Enables you to choose the format in which symbol table data is displayed, when the modulation format encodes 4 or more bits per symbol. You can choose binary or hexadecimal. Binary symbol data is padded with leading zeros to make a multiple of 4 bits before conversion to hexadecimal. For example, for 16 QAM format, each 4-bit symbol is displayed as 2 hex digits.

Binary Format: The symbol data bit format is binary and each character represents a binary digit. The number to the left of each row indicates the bit offset of the first bit in the row.

Hexadecimal Format: The symbol data bit format is hexadecimal and each character represents a hexadecimal digit. The number to the left of each row indicate the symbol offset of the first symbol in the row.

NOTE

There must be at least 4 bits/symbol to use the hexadecimal format, that is, symbols that have less than 4 bits/symbol are only displayed in binary format regardless of the Symbol Table Format setting.

This parameter is valid only when:

- The active trace is a symbol table, and
- The current demodulation format supports hexadecimal, the demodulation format's bits/symbol is equal to or greater than four.

Key Path	Trace/Detector, Digital Demod Trace Setup
Mode	VSA, LTE, LTETDD, IDEN
Measurement	<meas>:=VECTor ADEMod DDEMod W11A W11B EVM IPOWER IDEMod MOTotalk
Remote Command	:DISPlay:<meas>:TRACe[1] 2 ...4:DDEMod:SYMBol:FORMat HEXadecimal BINary :DISPlay:<meas>:TRACe[1] 2 ...4:DDEMod:SYMBol:FORMat?
Example	DISP:DDEM:TRAC2:DDEM:SYMB:FORM BIN DISP:DDEM:TRAC2:DDEM:SYMB:FORM?
Preset	HEX
Range	Hex Binary
Initial S/W Revision	Prior to A.02.00
Modified at S/W Revision	A.02.00

Time Unit

Enables you to select the time units that are applied to x-axis annotations and marker readouts for the selected trace, whenever it is assigned data with (demodulation) symbol information. The available measurement units are sym (symbols) or sec (seconds).

Key Path	Trace/Detector, Digital Demod Trace Setup
Mode	VSA, LTE, LTETDD, IDEN
Measurement	<meas>:=VECTor ADEMod DDEMod W11A W11B EVM IPOWER IDEMod MOTotalk
Remote Command	:DISPlay:<meas>:TRACe [1] 2 ...4:DDEMod:UNIT:TIME SEC SYMBOL :DISPlay:<meas>:TRACe [1] 2 ...4:DDEMod:UNIT:TIME?
Example	DISP:VECT:TRAC2:DDEM:UNIT:TIME SYMB DISP:VECT:TRAC2:DDEM:UNIT:TIME?
Preset	SYMB
State Saved	Saved in instrument state.
Range	sym sec
Initial S/W Revision	Prior to A.02.00
Modified at S/W Revision	A.02.00

Freq Unit

Enables you to select the frequency units that are applied to x-axis annotations and marker readouts for the selected trace, whenever it is assigned data with (demodulation) carrier information. The available measurement units are carrier or Hz.

Key Path	Trace/Detector, Digital Demod Trace Setup
Mode	VSA, LTE, LTETDD, IDEN
Measurement	<meas>:=VECTor ADEMod DDEMod W11A W11B EVM IPOWER IDEMod MOTotalk
Remote Command	:DISPlay:<meas>:TRACe [1] 2 ...4:DDEMod:UNIT:FREQuency CARRier HZ :DISPlay:<meas>:TRACe [1] 2 ...4:DDEMod:UNIT:FREQuency?
Example	DISP:VECT:TRAC2:DDEM:UNIT:FREQ CARR DISP:VECT:TRAC2:DDEM:UNIT:FREQ?
Preset	CARR
State Saved	Saved in instrument state.
Range	carrier Hz
Initial S/W Revision	Prior to A.02.00
Modified at S/W Revision	A.02.00

Eye Length

Controls how wide (in symbol periods) the eye and trellis diagrams are, for the selected trace.

Key Path	Trace/Detector, Digital Demod Trace Setup
Mode	VSA, LTE, LTETDD, IDEN
Measurement	<meas>:=VECTor ADEMod DDEMod W11A W11B EVM IPOWER IDEMod MOTotalk
Remote Command	:DISPlay:<meas>:TRACe[1] 2 ...4:DDEMod:EYE:COUNT <real> :DISPlay:<meas>:TRACe[1] 2 ...4:DDEMod:EYE:COUNT?
Example	DISP:DDEM:TRAC2:DDEM:EYE:COUN 3 DISP:DDEM:TRAC2:DDEM:EYE:COUN?
Preset	2
State Saved	Saved in instrument state.
Min	0.1
Max	40
Initial S/W Revision	Prior to A.02.00
Modified at S/W Revision	A.02.00

Avg Line

Controls whether or not the average line is visible on certain demodulation analysis traces such as Error Vector Time and Error Vector Spectrum in Digital Demod measurements. These traces have 2-dimensional domains; typically subcarriers (frequency) and symbol times. Since the result can only be shown with one of these dimensions on the x-axis, the other dimension is placed on the z-axis. Since all the z-axis values are overlapped, an average is calculated for all z values at each x value and the average is normally displayed as a line in front of trace. The average line display can be turned on or off using this control.

Key Path	Trace/Detector, Digital Demod Trace Setup
Mode	VSA, LTE, LTETDD, IDEN
Measurement	<meas>:=VECTor ADEMod DDEMod W11A W11B EVM IPOWER IDEMod MOTotalk
Remote Command	:DISPlay:<meas>:TRACe[1] 2 ...4:DDEMod:ALINE OFF ON 0 1 :DISPlay:<meas>:TRACe[1] 2 ...4:DDEMod:ALIN?
Example	DISP:W11A:TRAC:DDEM:ALIN OFF
Preset	1
State Saved	Saved in instrument state.
Initial S/W Revision	A.03.00 or later

Copy to Data Register

Accesses a menu of immediate execute keys, each of which copies the selected trace to a particular data register. Data registers can be displayed in any trace. They are measurement global, so you can copy data

to a register while in the Digital Demod measurement and view it later while in the Vector measurement. Data registers are cleared when the VSA Application is exited and reentered, but not when you change Modes and return.

Key Path	Trace/Detector
Mode	VSA, LTE, LTETDD, IDEN
Measurement	<meas>:=VECTor ADEMod DDEMod W11A W11B EVM IPOWER IDEMod MOTotalk
Remote Command	:DISPlay:<meas>:TRACe [1] 2 . . . 4 : COPY D1 D2 D3 D4 D5 D6
Example	DISP:VECT:TRAC:COPY D1
Readback Text	Last: <date_time> Empty
Initial S/W Revision	Prior to A.02.00
Modified at S/W Revision	A.02.00

The following SCPI provides means to determine if a Data Register is empty, and to erase the data from any or all Data Registers.

Mode	VSA, LTE, LTETDD, IDEN
Remote Command	:CALCulate:DATA:REGister [1] 2 . . . 6 : EMPTy?
Example	:CALC:DATA:REG2:EMPT?
Notes	Query only: returns 1 if a Data Register has no trace data assigned to it.
Initial S/W Revision	Prior to A.02.00
Modified at S/W Revision	A.02.00

Mode	VSA, LTE, LTETDD, IDEN
Remote Command	:CALCulate:DATA:REGister [1] 2 . . . 6 : REMove
Example	:CALC:DATA:REG2:REM
Notes	Removes trace data assigned to specified Data Register.
Couplings	If Data Register is assigned to a trace, the trace data is changed to No Data
Initial S/W Revision	Prior to A.02.00
Modified at S/W Revision	A.02.00

Mode	VSA, LTE, LTETDD, IDEN
Remote Command	:CALCulate:DATA:REGister:ALL:REMOve
Example	:CALC:DATA:REG:ALL:REM
Notes	Removes trace data assigned to all Data Registers.
Couplings	If Data Register is assigned to a trace, the trace data is changed to No Data
Initial S/W Revision	Prior to A.02.00
Modified at S/W Revision	A.02.00

Phase/Delay Properties

Accesses a menu of properties that affect the selected trace when displayed using phase or delay formats.

Key Path	Trace/Detector
Mode	VSA, LTE, LTETDD, IDEN
Initial S/W Revision	Prior to A.02.00
Modified at S/W Revision	A.02.00

Phase/Trellis Offset

Only used if the trace format is Wrap Phase, Unwrap Phase, or Trellis. For Unwrap Phase or Trellis traces, the phase offset value is added to the existing phase at each point. For example, if you are viewing an Unwrapped Phase trace, setting the Phase/Trellis Offset to 5 degrees moves the entire trace up 5 degrees (and changes the value displayed by a marker by the same amount). For Wrap Phase traces the phase offset only affects the phase wrap point, not the underlying data. The point at which the phase wraps is 180 degrees plus the phase offset. For example, suppose you have a marker on a Wrap Phase trace whose phase offset is 0 and the marker is showing -3 degrees. The trace data is all confined within (-180, 180] degrees. If you then change the phase offset to 180 degrees, then the Wrap Phase trace shows values within the interval (0, 360] degrees and the marker value is displayed as 357 degrees, which is the wrapped equivalent of -3 degrees.

Key Path	Trace/Detector, Phase Delay Properties
Mode	VSA, LTE, LTETDD, IDEN
Measurement	<meas>:=VECTor ADEMod DDEMod W11A W11B EVM IPOWER IDEMod MOTotalk
Remote Command	:DISPlay:<meas>:TRACe [1] 2 . . . 4 :FORMat:PHASe:OFFSet <real> :DISPlay:<meas>:TRACe [1] 2 . . . 4 :FORMat:PHASe:OFFSet?
Example	DISP:DDEM:TRAC3:FORM:PHAS:OFFS 31 DISP:DDEM:TRAC3:FORM:PHAS:OFFS?
Preset	0
State Saved	Saved in instrument state.
Min	-1E+8
Max	1E+8
Initial S/W Revision	Prior to A.02.00
Modified at S/W Revision	A.02.00

Unwrap Phase Ref

Enables you to designate the point (x-axis) value about which phase values are to be unwrapped. That is, the phase at the designated reference is within -180 to 180 degrees, and phase varies smoothly without jumps around that point.

Key Path	Trace/Detector, Phase Delay Properties
Mode	VSA, LTE, LTETDD, IDEN
Measurement	<meas>:=VECTor ADEMod DDEMod W11A W11B EVM IPOWER IDEMod MOTotalk
Remote Command	:DISPlay:<meas>:TRACe[1] 2 ...4:FORMat:PHASe:UNWRap:REFerence <real> :DISPlay:<meas>:TRACe[1] 2 ...4:FORMat:PHASe:UNWRap:REFerence?
Example	DISP:DDEM:TRAC3:FORM:PHAS:UNWR:REF 24.5E6 DISP:DDEM:TRAC3:FORM:PHAS:UNWR:REF?
Preset	0
State Saved	Saved in instrument state.
Min	-9.9e37
Max	9.9e37
Initial S/W Revision	Prior to A.02.00
Modified at S/W Revision	A.02.00

Group Delay Aperture

Used when the trace format is Group Delay. The aperture is specified as a percentage of the current frequency span for frequency-domain data. It is specified as a percentage of the time-record length for time-domain data.

When group delay is calculated for a given point (which can be a time- or frequency-domain point), the aperture is centered at that point. Larger apertures decrease resolution, but they increase the smoothing of the group-delay trace.

The point plotted for group delay is located between the data points used to calculate it. For example, in the frequency domain, the group delay for 100 Hz can be calculated by measuring the change in phase between 90 and 110 Hz. If you had specified a start frequency of 90 Hz, 100 Hz would be the first point with group delay data. This results in a trace that does not extend to the edges of the screen (more noticeable as the delay aperture increases).

Note that the smallest aperture that you can select depends on the number of frequency points. If you select an invalid aperture, the analyzer automatically selects the smallest valid aperture.

Key Path	Trace/Detector, Phase Delay Properties
Mode	VSA, LTE, LTETDD, IDEN
Measurement	<meas>:=VECTor ADEMod DDEMod W11A W11B EVM IPOWER IDEMod MOTotalk
Remote Command	:DISPlay:<meas>:TRACe[1] 2 ...4:FORMat:DELAy:APERture <real> :DISPlay:<meas>:TRACe[1] 2 ...4:FORMat:DELAy:APERture?
Example	DISP:DDEM:TRAC3:FORM:DEL:APER 1 DISP:DDEM:TRAC3:FORM:DEL:APER?
Notes	Parameter is interpreted as a percent, e.g., if you want the group delay aperture to be 1% send 1, not 0.01

Preset	0.5
State Saved	Saved in instrument state.
Min	0.00390625
Max	16
Initial S/W Revision	Prior to A.02.00
Modified at S/W Revision	A.02.00

ACP Setup

Accesses a menu of functions that enable you to define and turn on the ACP function on the selected trace. One reference channel and up to 5 offset frequencies can be defined, and ACP is calculated for bands both above and below the reference frequency for each offset.

The adjacent channel power (ACP) function calculates the power in a reference band of frequencies as well as bands of frequencies offset from the reference, and calculates the ratio of each offset band to the reference band power.

An ACP measurement can be defined for each trace, although it is only active on frequency-domain trace data. The reference and offset frequency bands defined by the ACP measurement are shown as gold bars overlaying the trace display. To see tabular data showing power and power ratio results, you can assign the ACP Summary (Trace n) to a different trace. For example, you can assign Spectrum data to trace 1, turn on and define an ACP measurement on trace 1, assign the ACP Summary (Trace 1) to trace 2, and use a 2x2 display to view both at the same time, as shown below.

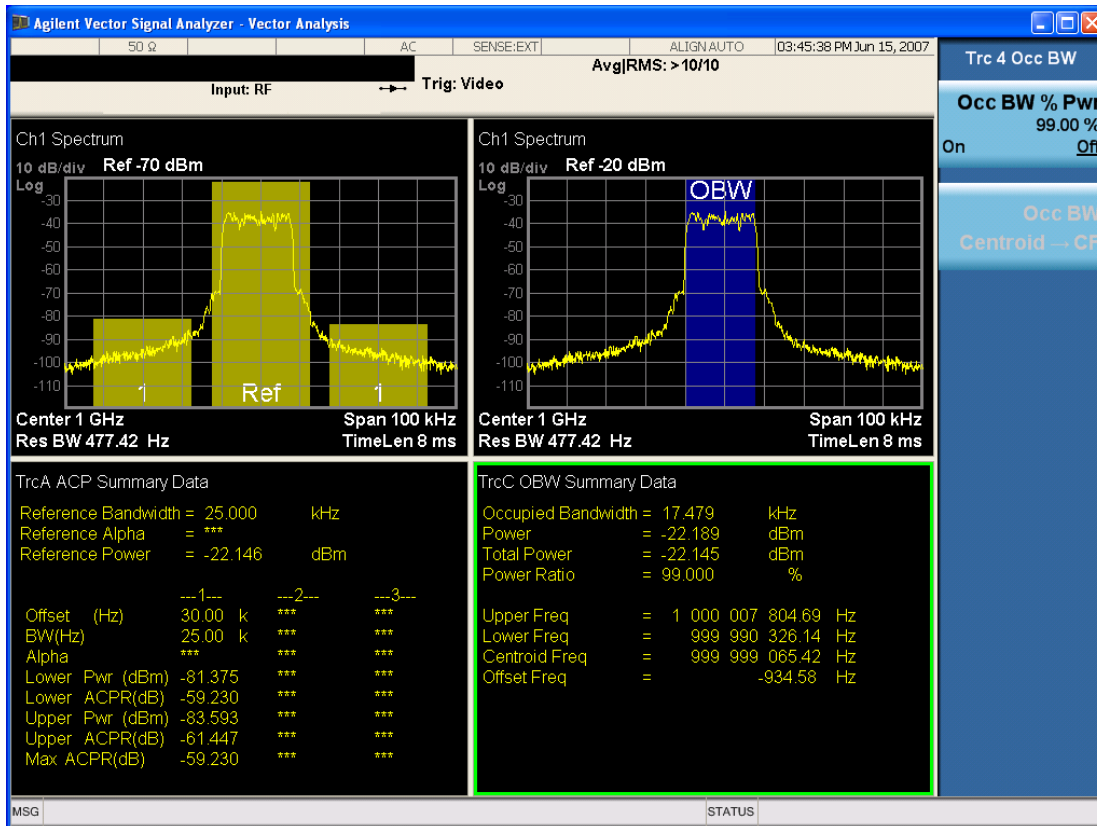

The summary data can be retrieved programmatically using FETCH? or the CALCulate:<meas>:DATA:TABLE commands. See "[CALCulate:DATA:TABLE commands](#)" on page 1291 for more details.

Key Path	Trace/Detector
Mode	VSA, LTE, LTETDD, IDEN
Readback Text	[On Off,]
Initial S/W Revision	Prior to A.02.00
Modified at S/W Revision	A.02.00

ACP On/Off

Turns the ACP function on or off for the selected trace.

Key Path	Trace/Detector, ACP
Mode	VSA, LTE, LTETDD, IDEN
Measurement	<meas>:=VECTor ADEMod DDEMod W11A W11B EVM IPOWER IDEMod MOTotalk
Remote Command	:CALCulate:<meas>:TRACE[1] 2 ...4:ACPpower:STATE OFF ON 0 1 :CALCulate:<meas>:TRACE[1] 2 ...4:ACPpower:STATE?
Example	CALC:VECT:TRAC1:ACP:STATE ON

	CALC:VECT:TRAC1:ACP:STATE?
Preset	0
State Saved	Saved in instrument state.
Initial S/W Revision	Prior to A.02.00
Modified at S/W Revision	A.02.00

Carrier Freq

Enables you to enter the carrier frequency of the reference channel for the ACP measurement. The carrier frequency is relative to the center frequency of the measurement. There is only one available reference carrier.

Key Path	Trace/Detector, ACP
Mode	VSA, LTE, LTETDD, IDEN
Measurement	<meas>:=VECTor ADEMod DDEMod W11A W11B EVM IPOWER IDEMod MOTotalk
Remote Command	:CALCulate:<meas>:TRACe[1] 2 ...4:ACPpower:CARRier:FREQuency <freq> :CALCulate:<meas>:TRACe[1] 2 ...4:ACPpower:CARRier:FREQuency?
Example	CALC:VECT:TRAC1:ACP:CARR:FREQ 100 KHZ CALC:VECT:TRAC1:ACP:CARR:FREQ?
Preset	0
State Saved	Saved in instrument state.
Min	-9.9e37
Max	9.9e37
Initial S/W Revision	Prior to A.02.00
Modified at S/W Revision	A.02.00

Carrier Meas Noise BW

Enables you to define the measurement noise bandwidth of the reference channel.

Key Path	Trace/Detector, ACP
Mode	VSA, LTE, LTETDD, IDEN
Measurement	<meas>:=VECTor ADEMod DDEMod W11A W11B EVM IPOWER IDEMod MOTotalk
Remote Command	:CALCulate:<meas>:TRACe[1] 2 ...4:ACPpower:CARRier:BANDwidth BWIDth:INTegration <bandwidth> :CALCulate:<meas>:TRACe[1] 2 ...4:ACPpower:CARRier:BANDwidth BWIDth:INTegration?
Example	CALC:VECT:TRAC1:ACP:CARR:BAND:INT 1 MHZ CALC:VECT:TRAC1:ACP:CARR:BAND:INT?

Preset	1000000
State Saved	Saved in instrument state.
Min	-9.9e37
Max	9.9e37
Initial S/W Revision	Prior to A.02.00
Modified at S/W Revision	A.02.00

Carrier RRC Weighting

Turns on or off RRC weighting for the reference (carrier) power measurement.

Key Path	Trace/Detector, ACP
Mode	VSA, LTE, LTETDD, IDEN
Measurement	<meas>:=VECTor ADEMod DDEMod W11A W11B EVM IPOWER IDEMod MOTotalk
Remote Command	:CALCulate:<meas>:TRACe[1] 2 ...4:ACPowEr:CARRier:FILTer:RRC:STATe OFF ON 0 1 :CALCulate:<meas>:TRACe[1] 2 ...4:ACPowEr:CARRier:FILTer:RRC:STATe?
Example	CALC:VECT:TRAC1:ACP:CARR:FILT:RRC:STAT ON CALC:VECT:TRAC1:ACP:CARR:FILT:RRC:STAT?
Preset	0
State Saved	Saved in instrument state.
Initial S/W Revision	Prior to A.02.00
Modified at S/W Revision	A.02.00

Carrier Filter Alpha

Enables you to adjust the alpha of the RRC filter for the reference (carrier) power measurement.

Key Path	Trace/Detector, ACP
Mode	VSA, LTE, LTETDD, IDEN
Measurement	<meas>:=VECTor ADEMod DDEMod W11A W11B EVM IPOWER IDEMod MOTotalk
Remote Command	:CALCulate:<meas>:TRACe[1] 2 ...4:ACPowEr:CARRier:FILTer:RRC:ALPHa <real> :CALCulate:<meas>:TRACe[1] 2 ...4:ACPowEr:CARRier:FILTer:RRC:ALPHa?
Example	CALC:VECT:TRAC1:ACP:CARR:FILT:RRC:ALPH 0.22 CALC:VECT:TRAC1:ACP:CARR:FILT:RRC:ALPH?
Preset	0.35
State Saved	Saved in instrument state.

Min	0
Max	1
Initial S/W Revision	Prior to A.02.00
Modified at S/W Revision	A.02.00

Offsets

Accesses a menu that has a key for each offset, and also an Offset RRC weighting on/off key. Each offset key shows a summary of its current parameters. Pressing one of the Offset A|B|C|D|E keys accesses a menu for adjusting its parameters.

The ACP measurement compares power in frequency bands offset from the carrier to power in the reference channel (centered on the carrier). Up to 5 offsets can be defined. The offsets are designated by letters A through E. Each offset is defined by an offset frequency, bandwidth, and optional RRC weighting. An offset actually defines two bands, one above the reference frequency and one below. Each band is used individually in the ACP calculation. RRC weighting can only be turned on or off for all offsets, but each offset can have its own RRC filter alpha. A filter alpha of 0 is the same as no RRC weighting.

Key Path	Trace/Detector,ACP,Offsets
Mode	VSA, LTE, LTETDD, IDEN
Initial S/W Revision	Prior to A.02.00
Modified at S/W Revision	A.02.00

Offsets

Accesses a menu that has a key for each offset, and also an Offset RRC weighting on/off key. Each offset key shows a summary of its current parameters. Pressing one of the Offset A|B|C|D|E keys accesses a menu for adjusting its parameters.

The ACP measurement compares power in frequency bands offset from the carrier to power in the reference channel (centered on the carrier). Up to 5 offsets can be defined. The offsets are designated by letters A through E. Each offset is defined by an offset frequency, bandwidth, and optional RRC weighting. An offset actually defines two bands, one above the reference frequency and one below. Each band is used individually in the ACP calculation. RRC weighting can only be turned on or off for all offsets, but each offset can have its own RRC filter alpha. A filter alpha of 0 is the same as no RRC weighting.

Key Path	Trace/Detector,ACP,Offsets
Mode	VSA, LTE, LTETDD, IDEN
Initial S/W Revision	Prior to A.02.00
Modified at S/W Revision	A.02.00

Offset Freq

Turns ACP analysis on or off for a selected offset and sets the offset frequency, which is relative to the carrier frequency.

Key Path	Trace/Detector, ACP, Offsets, Offset A B C D E
Mode	VSA, LTE, LTETDD, IDEN
Measurement	<meas>:=VECTor ADEMod DDEMod W11A W11B EVM IPOWER IDEMod MOTotalk
Remote Command	:CALCulate:<meas>:TRACe[1] 2 ...4:ACPpower:OFFSet:LIST:FREQuency <freq>, ... :CALCulate:<meas>:TRACe[1] 2 ...4:ACPpower:OFFSet:LIST:FREQuency? :CALCulate:<meas>:TRACe[1] 2 ...4:ACPpower:OFFSet:LIST:STATe OFF ON 0 1, ... :CALCulate:<meas>:TRACe[1] 2 ...4:ACPpower:OFFSet:LIST:STATe?
Example	CALC:VECT:TRAC1:ACP:OFFS:LIST:FREQ 1 MHZ, 1 MHZ, 500 KHZ, 500 KHZ, 1 MHZ CALC:VECT:TRAC1:ACP:OFFS:LIST:FREQ? :CALC:VECT:TRAC1:ACP:OFFS:LIST:STAT ON, OFF, OFF, ON, OFF
Notes	If you send fewer than 5 frequencies in the parameter list, then the remaining offsets frequencies are set to 0. You can send a single on/off parameter or a comma-separated list of up to 5 parameters. These enable/disable each of the Offsets in sequence. Any remaining Offsets are disabled
Preset	3000000,0,0,0,0 1,0,0,0,0
State Saved	Saved in instrument state.
Min	-9.9E+37
Max	9.9E+37
Initial S/W Revision	Prior to A.02.00
Modified at S/W Revision	A.02.00

Offset Meas Noise BW

Enables you to set the measurement noise bandwidth for the power measurement of a selected offset band.

Key Path	Trace/Detector, ACP, Offsets, Offset A B C D E
Mode	VSA, LTE, LTETDD, IDEN
Measurement	<meas>:=VECTor ADEMod DDEMod W11A W11B EVM IPOWER IDEMod MOTotalk
Remote Command	:CALCulate:<meas>:TRACe[1] 2 ...4:ACPpower:OFFSet:LIST:BANDwidth BWIDth:INTegration <bandwidth>, ... :CALCulate:<meas>:TRACe[1] 2 ...4:ACPpower:OFFSet:LIST:BANDwidth BWIDth:INTegration?
Example	CALC:VECT:TRAC1:ACP:OFFS:LIST:BAND:INT 1 MHZ, 2 MHZ, 3 MHZ, 4 MHZ, 5 MHZ CALC:VECT:TRAC1:ACP:OFFS:LIST:BAND:INT?

Notes	If you send fewer than 5 bandwidth parameters in the list, then Measurement Noise Bandwidths for the remaining Offsets are set to 0.
Preset	1000000,0,0,0,0
State Saved	Saved in instrument state.
Min	-9.9e37
Max	9.9e37
Initial S/W Revision	Prior to A.02.00
Modified at S/W Revision	A.02.00

Offset Filter Alpha

Enables you to adjust the alpha of the RRC filter for the power measurement of the selected offset band.

Key Path	Trace/Detector, ACP, Offsets, Offset A B C D E
Mode	VSA, LTE, LTETDD, IDEN
Measurement	<meas>:=VECTor ADEMod DDEMod W11A W11B EVM IPOWER IDEMod MOTotalk
Remote Command	:CALCulate:<meas>:TRACe[1] 2 ...4:ACPpower:OFFSet:LIST:FILTer:RRC:ALPHA <real>, ... :CALCulate:<meas>:TRACe[1] 2 ...4:ACPpower:OFFSet:LIST:FILTer:RRC:ALPHA?
Example	CALC:VECT:TRAC1:ACP:OFFS:LIST:FILT:RRC:ALPH 0.22, 0.22, 0.22, 0.22, 0.22 CALC:VECT:TRAC1:ACP:OFFS:LIST:FILT:RRC:ALPH?
Notes	You can send a single Filter Alpha for Offset A or a comma-separated list of up to 5 Filter Alpha parameters. These are assigned in sequence to the Offsets. Alpha for any remaining Offsets are set to 0.
Preset	0.35,0.35,0.35,0.35,0.35
State Saved	Saved in instrument state.
Min	0
Max	1.0
Initial S/W Revision	Prior to A.02.00
Modified at S/W Revision	A.02.00

Offset Relative Limit

Enables you to turn on/off a relative limit test and set the limit for the selected offset. The test shows a failure if the power in either the upper or lower band at the selected offset exceeds the reference power plus the relative test limit. For example, if the test limit is -60, the reference power is -4.5 dBm, a test failure would be shown if the power in the lower or upper band exceeds -64.5 dBm.

Key Path	Trace/Detector, ACP, Offsets
Mode	VSA, LTE, LTETDD, IDEN

Measurement	<meas>:=VECTor ADEMod DDEMod W11A W11B EVM IPOWER IDEMod MOTotalk
Remote Command	:CALCulate:<meas>:TRACe[1] 2 ...4:ACP:OFFSet:LIST:RCARrier <reall>,... :CALCulate:<meas>:TRACe[1] 2 ...4:ACP:OFFSet:LIST:RCARrier? :CALCulate:<meas>:TRACe[1] 2 ...4:ACP:OFFSet:LIST:RCARrier:TEST OFF ON 0 1,... :CALCulate:<meas>:TRACe[1] 2 ...4:ACP:OFFSet:LIST:RCARrier:TEST?
Example	CALC:VECT:TRAC1:ACP:OFFS:LIST:RCAR -50, -55, -60, -65, -80 CALC:VECT:TRAC1:ACP:OFFS:LIST:RCAR? CALC:VECT:TRAC1:ACP:OFFS:LIST:RCAR:TEST 1, 1, 1, 1, 1 CALC:VECT:TRAC1:ACP:OFFS:LIST:RCAR:TEST?
Notes	You can send a single Limit for Offset A or a comma-separated list of up to 5 limit parameters. These are assigned in sequence to the Offset frequencies with the remaining limits being set to 0. You can send a single on/off parameter or a comma-separated list of up to 5 parameters. These turn the Limit Test on or off for each of the Offsets in sequence. For any remaining Offsets, the Limit test is turned off.
Preset	-120,-120,-120,-120,-120 0,0,0,0,0
State Saved	Saved in instrument state.
Min	50
Max	-200
Initial S/W Revision	Prior to A.02.00
Modified at S/W Revision	A.02.00

RRC Weighting (All Offsets)

Turns on or off RRC weighting for the power measurement for all offsets. If RRC weighting is turned on, but you want to exclude RRC weighting for a particular offset, set its filter alpha to 0.

Key Path	Trace/Detector,ACP,Offsets
Mode	VSA, LTE, LTETDD, IDEN
Measurement	<meas>:=VECTor ADEMod DDEMod W11A W11B EVM IPOWER IDEMod MOTotalk
Remote Command	:CALCulate:<meas>:TRACe[1] 2 ...4:ACP:OFFSet:FILTer:RRC:STATe OFF ON 0 1 :CALCulate:<meas>:TRACe[1] 2 ...4:ACP:OFFSet:FILTer:RRC:STATe?
Example	CALC:VECT:TRAC1:ACP:OFFS:FILT:RRC:STAT ON CALC:VECT:TRAC1:ACP:OFFS:FILT:RRC:STAT?
Preset	0
State Saved	Saved in instrument state.
Initial S/W Revision	Prior to A.02.00
Modified at S/W Revision	A.02.00

OBW Setup (Occupied Bandwidth)

Accesses a menu of functions that enable you to define and turn on the OBW function on the selected trace.

The occupied bandwidth (OBW) function finds and displays the band of frequencies that contain a specified percentage of the total power within the measurement span.

An OBW measurement can be defined for each trace, although it is only active on frequency-domain trace data. The band defined by the OBW measurement is shown as a blue bar overlaying the trace display. To see tabular data showing the frequencies of the band limits, the total power, and so on, you can assign the OBW Summary (Trace n) to a different trace. For example, you can assign Spectrum data to trace 3, turn on OBW on trace 3, and assign the OBW Summary (Trace 3) to trace 4, as shown below.

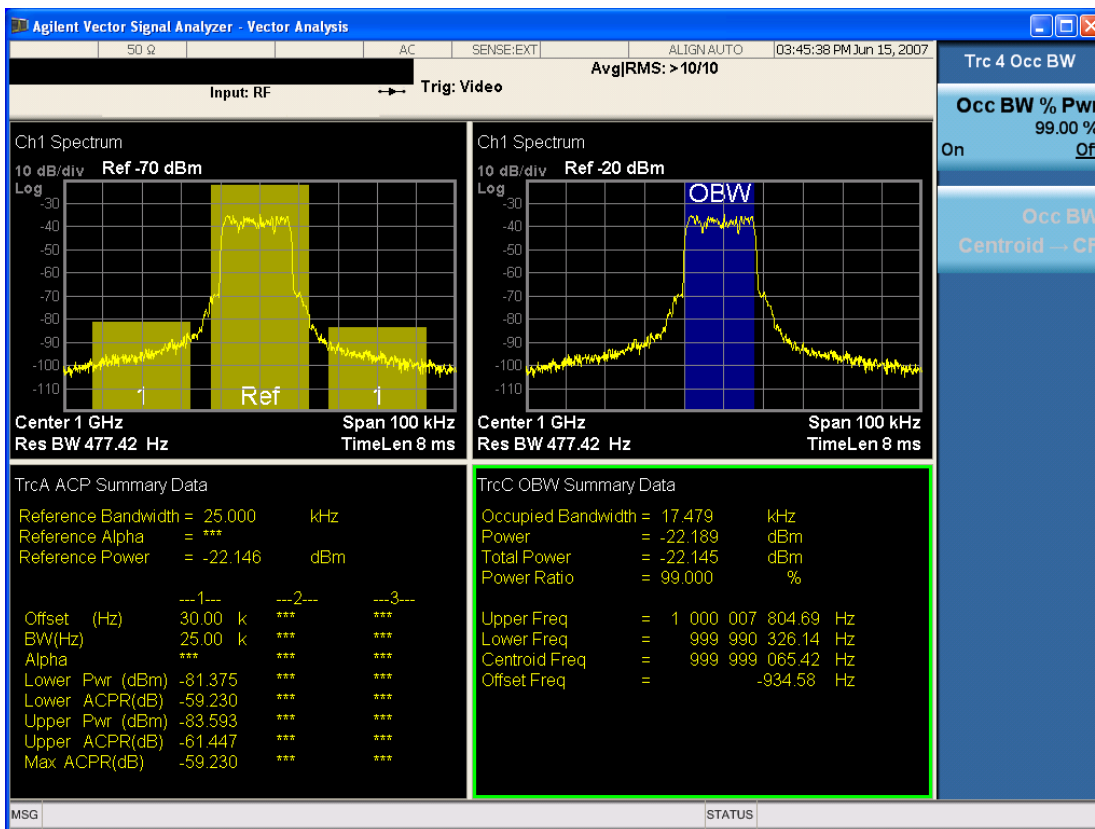

The summary data can be retrieved programmatically using FETCH? or the CALCulate:<meas>:DATA:TABLE commands. See [":CALCulate:DATA:TABL commands"](#) on page 1291 for more details.

Key Path	Trace/Detector
Mode	VSA, LTE, LTETDD, iDEN
Readback Text	[On Off, <num>%]
Initial S/W Revision	Prior to A.02.00
Modified at S/W Revision	A.02.00

OBW Power

Specifies the percentage of power for determining the occupied BW, and turns the OBW function on or off for the selected trace.

Key Path	Trace/Detector, OBW
Mode	VSA, LTE, LTETDD, IDEN
Measurement	<meas>:=VECTor ADEMod DDEMod W11A W11B EVM IPOWER IDEMod MOTotalk
Remote Command	:CALCulate:<meas>:TRACe[1] 2 ...4:OBWidth:PERCent <real> :CALCulate:<meas>:TRACe[1] 2 ...4:OBWidth:PERCent? :CALCulate:<meas>:TRACe[1] 2 ...4:OBWidth:STATE OFF ON 0 1 :CALCulate:<meas>:TRACe[1] 2 ...4:OBWidth:STATE?
Example	CALC:VECT:TRAC1:OBW:PERC 99 CALC:VECT:TRAC1:OBW:PERC? CALC:VECT:TRAC1:OBW:STAT ON CALC:VECT:TRAC1:OBW:STAT?
Notes	Parameter is interpreted as a percent, e.g., if you want the OBW to be 95% send 95, not 0.95
Preset	99.0 0
State Saved	Saved in instrument state.
Min	0
Max	100
Initial S/W Revision	Prior to A.02.00
Modified at S/W Revision	A.02.00

OBW Centroid > CF

Copies the centroid of the occupied bandwidth to the Center Frequency. It only works if the currently selected trace has data compatible with the OBW function and OBW is turned on.

This is a front-panel function only.

You can read the OBW centroid using the following SCPI-only query and use the result to set the center frequency.

Mode	VSA, LTE, LTETDD, IDEN
Measurement	<meas>:=VECTor ADEMod DDEMod W11A W11B EVM IPOWER IDEMod MOTotalk
Remote Command	:CALCulate:<meas>:TRACe[1] 2 ...4:OBWidth:CENTroid?
Example	CALC:VECT:TRAC1:OBW:CENT?
Notes	Query only. Returns NaN (9.91E+37) if the OBW function is not active for the selected trace or is not supported for the trace data assigned to the selected trace.

Initial S/W Revision	Prior to A.02.00
Modified at S/W Revision	A.02.00

BW Limit

Turns on or off limit testing for the Occupied BW test for the selected trace, and enables you to define the limit. Test pass or fail status appears in the OBW Summary table associated with the trace.

Key Path	Trace/Detector, OBW
Mode	VSA, LTE, LTETDD, IDEN
Measurement	<meas>:=VECTor ADEMod DDEMod W11A W11B EVM IPOWER IDEMod MOTotalk
Remote Command	:CALCulate:<meas>:TRACe[1] 2 ...4:OBWidth:LIMit:FBLimit <freq> :CALCulate:<meas>:TRACe[1] 2 ...4:OBWidth:LIMit:FBLimit? :CALCulate:<meas>:TRACe[1] 2 ...4:OBWidth:LIMit[:TEST] OFF ON 0 1 :CALCulate:<meas>:TRACe[1] 2 ...4:OBWidth:LIMit[:TEST]?
Example	CALC:VECT:TRAC1:OBW:LIMIT:FBL 10 MHZ CALC:VECT:TRAC1:OBW:LIMIT:FBL? CALC:VECT:TRAC1:OBW:LIMIT:TEST ON CALC:VECT:TRAC1:OBW:LIMIT:TEST?
Preset	1000000 0
State Saved	Saved in instrument state.
Min	1 Hz
Max	9.9e37 (Infinity) Hz
Initial S/W Revision	Prior to A.02.00
Modified at S/W Revision	A.02.00

Trace Indicator Info

Enables you to get more information about why a trace indicator is showing. A trace indicator appears in the upper right corner of a trace display to announce exceptional conditions. When such an indicator is showing on the selected trace, pressing this key causes more information about the condition to appear in the message area. This is a front-panel only function. The SCPI commands for querying the Trace Indicator and the Trace Indicator Info for a particular trace are:

CALC:<meas>:DATA[1]|2|3|4:HEAD:STR? "TrcLedStr"

CALC:<meas>:DATA[1]|2|3|4:HEAD:STR? "TrcLedReason"

Key Path	Trace/Detector
Mode	VSA, LTE, LTETDD, IDEN

11 iDEN Demod Measurement
Trace/Detector

Initial S/W Revision	Prior to A.02.00
Modified at S/W Revision	A.02.00

Trigger

See ["Trigger"](#) on page 310

Free Run

See ["Free Run"](#) on page 310

Video

See ["Video \(IF Envelope\)"](#) on page 310

Trigger Level

See ["Trigger Level"](#) on page 311

Trig Slope

See ["Trig Slope"](#) on page 311

Trig Delay

See ["Trig Delay"](#) on page 312

Trig Holdoff

See ["Trig Holdoff"](#) on page 312

Holdoff Type

See ["Holdoff Type"](#) on page 313

External 1

See ["External 1"](#) on page 314

Trigger Level

See ["Trigger Level"](#) on page 314

Trig Slope

See ["Trig Slope"](#) on page 315

Trig Delay

See ["Trig Delay"](#) on page 315

Trig Holdoff

See ["Trig Holdoff"](#) on page 316

Holdoff Type

See ["Holdoff Type"](#) on page 316

11 iDEN Demod Measurement
Trigger

Trig Reference Line

See "Trig Reference Line" on page 317

User Preset

Accesses a menu that gives you the following three choices:

- User Preset – recalls a state previously saved using the Save User Preset function.
- User Preset All Modes – presets all of the modes in the analyzer
- Save User Preset– saves the current state for the current mode

Key Path	Front-panel key
Backwards Compatibility Notes	<p>User Preset is actually loading a state, and in legacy analyzers, it was possible to load a state without affecting the trace data, limit lines or correction data. Similarly it was possible to do a User Preset without affecting the trace data, limit lines or correction data.</p> <p>In the X-Series, “state” always includes all of this data; so whenever state is loaded, or User Preset is executed, all of the traces, limit lines and corrections are affected. Although this differs from previous behavior, it is desirable behavior, and should not cause adverse issues for users.</p> <p>On ESA and PSA, User Preset affected the entire instrument’s state. In the X-Series, User Preset only recalls the state for the active mode. There is a User Preset file for each mode. User Preset can never cause a mode switch as it can in legacy analyzers. If you want to recall all modes to their user preset file state, you will need to do a User Preset after mode switching into each mode.</p> <p>User Preset recalls mode state which can now include data like traces; whereas on ESA and PSA, User Preset did not affect data.</p>
Initial S/W Revision	Prior to A.02.00

User Preset

User Preset sets the state of the currently active mode back to the state that was previously saved for this mode using the Save User Preset menu key or the SCPI command, SYST:PRES:USER:SAV. It not only recalls the Mode Preset settings, but it also recalls all of the mode persistent settings, and the Input/Output system setting that existed at the time Save User Preset was executed.

If a Save User Preset has not been done at any time, User Preset recalls the default user preset file for the currently active mode. The default user preset files are created if, at power-on, a mode detects there is no user preset file. There will never be a scenario when there is no user preset file to restore. For each mode, the default user preset state is the same state that would be saved if a Save User Preset is performed in each mode right after doing a Restore Mode Default and after a Restore Input/Output Defaults.

The User Preset function does the following:

- Aborts the currently running measurement.
- Sets the mode State to the values defined by Save User Preset.
- Makes the saved measurement for the currently running mode the active measurement.
- Brings up the saved menu for the power-on mode.
- Clears the input and output buffers.
- Sets the Status Byte to 0.

Key Path	User Preset
Remote Command	:SYSTem:PRESet:USER
Example	:SYST:PRES:USER:SAVE:SYST:PRES:USER
Notes	:SYST:PRES:USER:SAVE is used to save the current state as the user preset state. Clears all pending OPC bits. The Status Byte is set to 0. Pressing the User Preset front-panel key while already in the User Preset menu will cause the User Preset to get executed
Couplings	A user preset will cause the currently running measurement to be aborted and cause the saved measurement to be active. Recalling a User Preset file has the same issues that recalling a Save State file has. Some settings may need to be limited and therefore re-coupled, since the capabilities of the mode may have changes when the User Preset file was last saved.
Initial S/W Revision	Prior to A.02.00

User Preset All Modes

Recalls all of the User Preset files for each mode, switches to the power-on mode, and activates the saved measurement from the power-on mode User Preset file.

NOTE

When the instrument is secured, all of the user preset files are converted back to their default user preset files.

The User Preset function does the following:

- Aborts the currently running measurement.
- Switches the Mode to the power-on mode.
- Restores the User Preset files for each mode.
- Makes the saved measurement for the power-on mode the active measurement.
- Brings up the saved menu for the power-on mode.
- Clears the input and output buffers.
- Sets the Status Byte to 0.

Key Path	User Preset
Remote Command	:SYSTem:PRESet:USER:ALL
Example	:SYST:PRES:USER:SAVE:SYST:PRES:USER:ALL
Notes	Clears all pending OPC bits. The Status Byte is set to 0. :SYST:PRES:USER:SAVE is used to save the current state as the user preset state.
Couplings	A user preset will cause the currently running measurement to be aborted, cause a mode switch to the power-on mode, and cause the saved measurement to be active in the power-on mode. Recalling a User Preset file has the same issues that recalling a Save State file has. Some settings may need to be limited and therefore re-coupled, since the capabilities of the mode may have changes when the User Preset file was last saved.
Initial S/W Revision	Prior to A.02.00

Save User Preset

Saves the currently active mode and its State. You can recall this User Preset file by pressing the User Preset menu key or sending the SYST:PRES:USER remote command. This same state is also saved by the Save State function.

Key Path	User Preset
Remote Command	:SYSTem:PRESet:USER:SAVE
Example	:SYST:PRES:USER:SAVE
Notes	:SYST:PRES:SAVE creates the same file as if the user requested a *SAV or a MMEM:STOR:STAT, except User Preset Save does not allow the user to specify the filename or the location of the file.
Initial S/W Revision	Prior to A.02.00

View / Display

After Test Preset, the layout will include two windows for each test enabled. The view layout will be 2, 4 or 6 windows. If no tests are enabled, the view layout will be two windows with the IQ Meas Time constellation in trace 1, and the MQAM Summary Trace in trace 2.

When the EVM test is enabled, and Test Preset is pressed, the IQ Meas Time constellation in trace 1, and the EVM Composite Summary trace will be displayed in trace 2.

When the PvT test is enabled, and Test Preset is pressed, the PvT Time trace will be displayed in trace 3, and the PvT Summary trace will be displayed in trace 4.

When the BER test is enabled, and Test Preset is pressed, the BER Slot Summary trace will be displayed in trace 5, and the BER Overall Summary trace will be displayed in trace 6.

The view setup can be changed by selections from the View/Display menu, or by pressing Test Preset after enabling the desired tests, or by individually selecting traces and layout. The user may change the number of windows in the layout, or the contents of those windows.

The Preset View softkeys perform an immediate action of changing the layout and view for various Preset Views unique to this measurement. These Preset Views are actions, not states.

Key Path	Front-panel key
Mode	IDEN
Initial S/W Revision	A.02.00

Display

The Display menu is common to most measurements, and is used for configuring items on the display. Some Display menu settings apply to all the measurements in a mode, and some only to the current measurement. Those under the System Display Settings key apply to all measurements in all modes.

Key Path	Display
Key Path	View/Display
Initial S/W Revision	Prior to A.02.00

Annotation

Turns on and off various parts of the display annotation. The annotation is divided up into four categories:

1. Meas Bar: This is the measurement bar at the top of the screen. It does not include the settings panel or the Active Function. Turning off the Meas Bar turns off the settings panel and the Active Function. When the Meas Bar is off, the graticule area expands to fill the area formerly occupied by the Meas Bar.
2. Screen Annotation: this is the annotation and annunciation around the graticule, including any annotation on lines (such as the display line, the threshold line, etc.) This does NOT include the marker number or the N dB result. When off, the graticule expands to fill the entire graticule area.

- Trace annotation: these are the labels on the traces, showing their detector (or their math mode).
- Active Function annotation: this is the active function display in the meas bar, and all of the active function values displayed on softkeys.

See the figure below. Each type of annotation can be turned on and off individually.

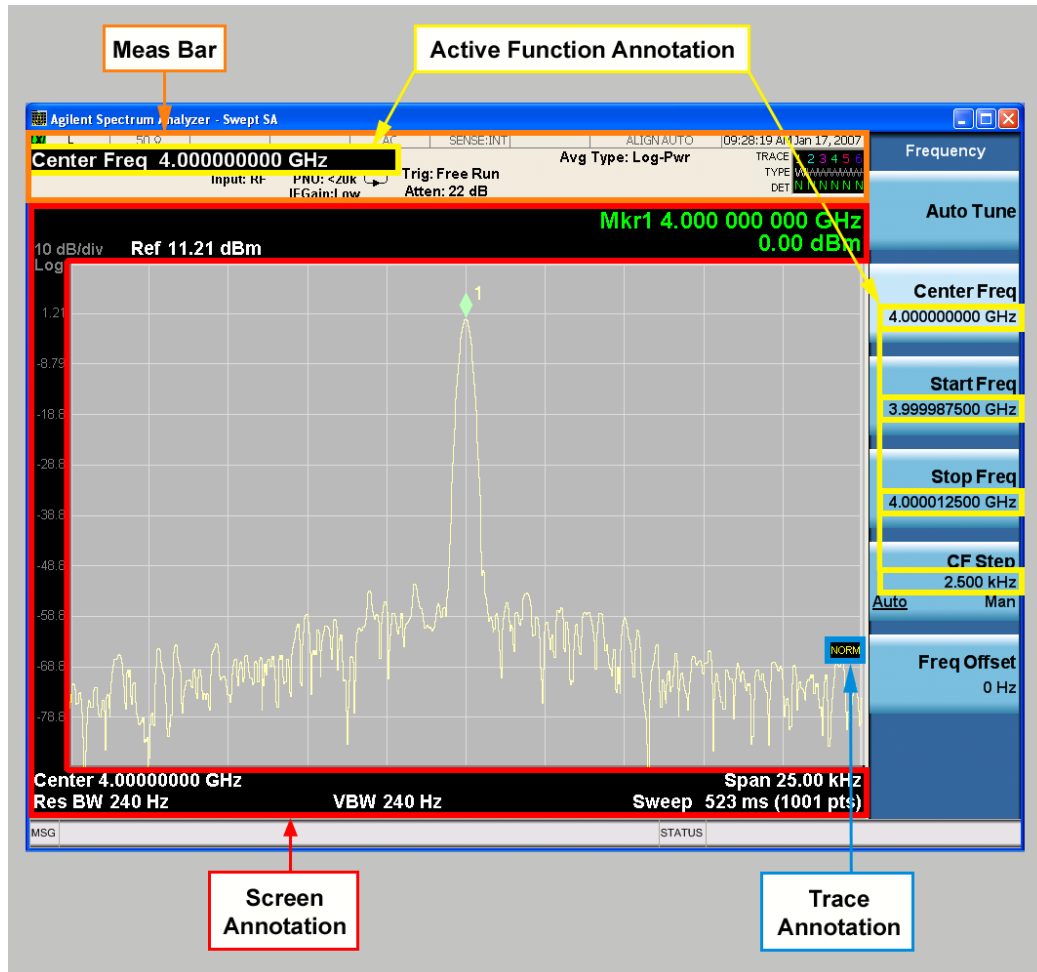

Key Path	View/Display, Display
Initial S/W Revision	Prior to A.02.00

Meas Bar On/Off

This function turns the Measurement Bar on and off, including the settings panel. When off, the graticule area expands to fill the area formerly occupied by the Measurement Bar.

Key Path	View/Display, Display, Annotation
Remote Command	:DISPlay:ANNotation:MBAR[:STATE] OFF ON 0 1 :DISPlay:ANNotation:MBAR[:STATE]?

Example	DISP:ANN:MBAR OFF
Dependencies	Grayed out and forced to OFF when System Display Settings, Annotation is set to Off.
Preset	On This should remain Off through a Preset when System DisplaySettings, Annotation is set to Off.
State Saved	Saved in instrument state.
Initial S/W Revision	Prior to A.02.00

Screen

This controls the display of the annunciation and annotation around the graticule, including any annotation on lines (such as the display line, the threshold line, etc.) and the y-axis annotation. This does NOT include marker annotation (or the N dB result). When off, the graticule expands to fill the entire graticule area, leaving only the 1.5% gap above the graticule as described in the Trace/Detector chapter.

Key Path	View/Display, Display, Annotation
Remote Command	:DISPlay:ANNotation:SCReen[:STATe] OFF ON 0 1 :DISPlay:ANNotation:SCReen[:STATe]?
Example	DISP:ANN:SCR OFF
Dependencies	Grayed-out and forced to OFF when System Display Settings, Annotation is set to Off.
Preset	On This should remain Off through a Preset when System DisplaySettings, Annotation is set to Off
State Saved	Saved in instrument state.
Initial S/W Revision	Prior to A.02.00

Active Function Values On/Off

Turns on and off the active function display in the Meas Bar, and all of the active function values displayed on the softkeys.

Note that all of the softkeys that have active functions have these numeric values blanked when this function is on. This is a security feature..

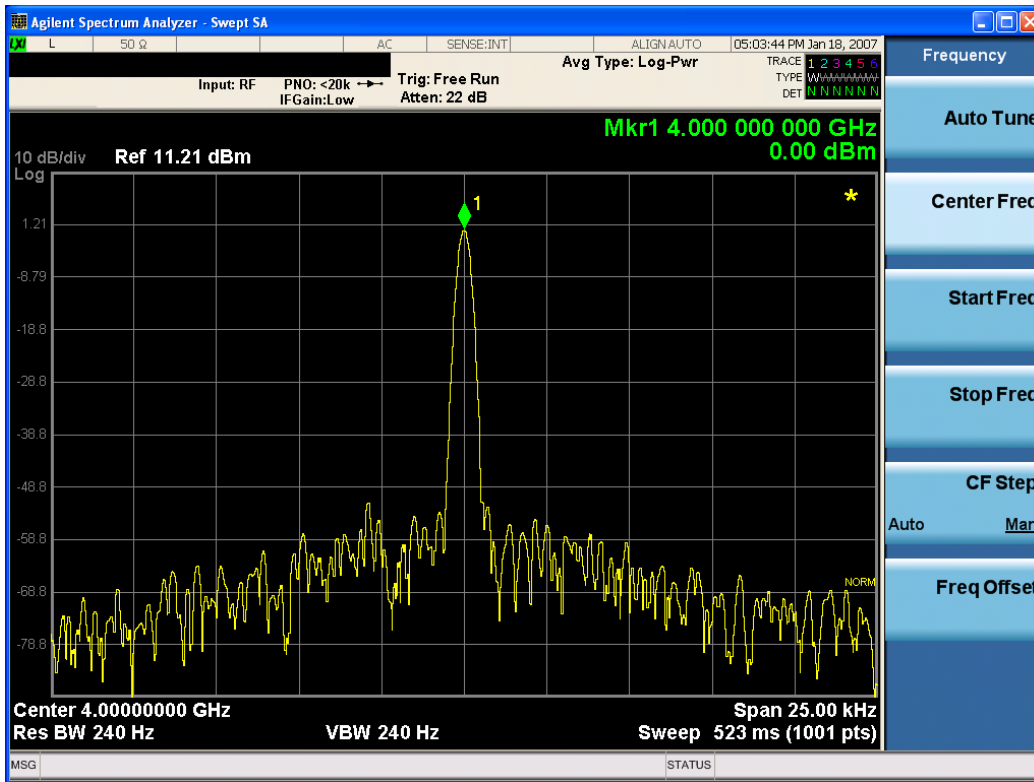

Key Path	View/Display, Display, Annotation
Remote Command	:DISPlay:ACTivefunc[:STATE] ON OFF 1 0 :DISPlay:ACTivefunc[:STATE]?
Example	DISP:ACT OFF
Dependencies	Grayed out and forced to OFF when System Display Settings, Annotation is set to Off.
Preset	On This should remain Off through a Preset when System DisplaySettings, Annotation is set to Off
State Saved	Saved in instrument state.
Initial S/W Revision	Prior to A.02.00

Title

Displays menu keys that enable you to change or clear a title on your display.

Key Path	View/Display, Display
Initial S/W Revision	Prior to A.02.00

Change Title

Writes a title into the "measurement name" field in the banner, for example, "Swept SA".

Press Change Title to enter a new title through the alpha editor. Press Enter or Return to complete the entry. Press ESC to cancel the entry and preserve your existing title.

The display title will replace the measurement name. It remains for this measurement until you press Change Title again, or you recall a state, or a Preset is performed. A title can also be cleared by pressing Title, Clear Title.

NOTE

Notice the inclusion of the <measurement> parameter in the command below. Because each measurement remembers the Display Title, the command must be qualified with the measurement name. For the Swept SA measurement this is not the case; no <measurement> parameter is used when changing the Display Title for the Swept SA measurement.

Key Path	View/Display, Display, Title
Mode	All
Remote Command	:DISPlay:<measurement>:ANNotation:TITLe:DATA <string> :DISPlay:<measurement>:ANNotation:TITLe:DATA?
Example	DISP:ANN:TITL:DATA "This Is My Title" This example is for the Swept SA measurement in the Spectrum Analyzer mode. The SANalyzer <measurement> name is not used. DISP:ACP:ANN:TITL:DATA "This Is My Title" This example is for Measurements other than Swept SA. Both set the title to: This Is My Title
Notes	Pressing this key cancels any active function. When a title is edited the previous title remains intact (it is not cleared) and the cursor goes at the end so that characters can be added or BKSP can be used to go back over previous characters.
Preset	No title (measurement name instead)
State Saved	Saved in instrument state.
Initial S/W Revision	Prior to A.02.00

Clear Title

Clears a title from the front-panel display. Once cleared, the title cannot be retrieved. After the title is cleared, the current Measurement Name replaces it in the title bar.

Key Path	View/Display, Display, Title
Example	The following commands clear the title and restore the measurement's original title: DISP:ANN:TITL:DATA "" This example is for the Swept SA measurement in the Spectrum Analyzer mode. The SANalyzer <measurement> name is not used. DISP:ACP:ANN:TITL:DATA "" This example is for ACP; in measurements other than Swept SA the measurement name is required.
Notes	Uses the :DISPlay:<measurement>:ANNotation:TITLe:DATA <string> command with an empty string (in the Swept SA, the <measurement> is omitted).
Preset	Performed on Preset.
Initial S/W Revision	Prior to A.02.00

Graticule

Pressing Graticule turns the display graticule On or Off. It also turns the graticule y-axis annotation on and off.

Key Path	View/Display, Display
Remote Command	:DISPlay:WINDow[1]:TRACe:GRATicule:GRID[:STATe] OFF ON 0 1 :DISPlay:WINDow[1]:TRACe:GRATicule:GRID[:STATe]?
Example	DISP:WIND:TRAC:GRAT:GRID OFF
Notes	The graticule is the set of horizontal and vertical lines that make up the grid/divisions for the x-axis and y-axis.
Preset	On
State Saved	Saved in instrument state
Initial S/W Revision	Prior to A.02.00

System Display Settings

These settings are "Mode Global" – they affect all modes and measurements and are reset only by Restore Misc Defaults or Restore System Defaults under System.

Key Path	View/Display, Display
Initial S/W Revision	Prior to A.02.00

Annotation Local Settings

This is a Mode Global override of the meas local annotation settings. When it is All Off, it forces ScreenAnnotation, Meas Bar, Trace, and Active Function Values settings to be OFF for all measurements in all modes. This provides the security based "annotation off" function of previous analyzers; hence it uses the legacy SCPI command.

When it is All Off, the Screen, Meas Bar, Trace, and Active Function Values keys under the Display, Annotation menu are grayed out and forced to Off. When Local Settings is selected, you are able to set the local annotation settings on a measurement by measurement basis.

Key Path	View/Display, Display, System Display Settings
Remote Command	:DISPlay:WINDow[1]:ANNotation[:ALL] OFF ON 0 1 :DISPlay:WINDow[1]:ANNotation[:ALL]?
Example	:DISP:WIND:ANN OFF
Preset	On (Set by Restore Misc Defaults)
State Saved	Not saved in instrument state.
Backwards Compatibility Notes	The WINDow parameter and optional subopcode is included for backwards compatibility but ignored – all windows are equally affected.
Initial S/W Revision	Prior to A.02.00

Themes

Accesses a menu of functions that enable you to choose the theme to be used when saving the screen image.

The **Themes** option is the same as the **Themes** option under the **Display** and **Page Setup** dialogs. It allows you to choose between themes to be used when saving the screen image.

Key Path	Save, Screen Image
Remote Command	:MMEMory:STORe:SCReem:THEMe TDColor TDMonochrome FCOLor FMONochrome :MMEMory:STORe:SCReem:THEMe?
Example	:MMEM:STOR:SCR:THEM TDM
Preset	3D Color; Is not part of Preset, but is reset by Restore Misc Defaults or Restore System Defaults All and survives subsequent running of the modes.
Readback	3D Color 3D Mono Flat Color Flat Mono
Backwards Compatibility Notes	In ESA and PSA we offer the choice of "Reverse Bitmap" or "Reverse Metafile" when saving screen images. This is much like the "Flat Color" theme available in X-Series. Also, if you selected Reverse Bitmap AND a black & white screen image, that would be much like "Flat Monochrome". In other words, each of the X-Series themes has a similar screen image type in ESA/PSA. But they are not identical.
Initial S/W Revision	Prior to A.02.00

3D Color

Selects a standard color theme with each object filled, shaded and colored as designed.

Key Path	Save, Screen Image, Themes
Example	MMEM:STOR:SCR:THEM TDC
Readback	3D Color
Initial S/W Revision	Prior to A.02.00

3D Monochrome

Selects a format that is like 3D color but shades of gray are used instead of colors.

Key Path	Save, Screen Image, Themes
Example	MMEM:STOR:SCR:THEM TDM
Readback	3D Mono
Initial S/W Revision	Prior to A.02.00

Flat Color

Selects a format that is best when the screen is to be printed on an ink printer.

Key Path	Save, Screen Image, Themes
Example	MMEM:STOR:SCR:THEM FCOL
Readback	Flat Color
Initial S/W Revision	Prior to A.02.00

Flat Monochrome

Selects a format that is like Flat Color. But only black is used (no colors, not even gray), and no fill.

Key Path	Save, Screen Image, Themes
Example	MMEM:STOR:SCR:THEM FMON
Readback	Flat Mono
Initial S/W Revision	Prior to A.02.00

Backlight

Accesses the display backlight on/off keys. This setting may interact with settings under the Windows "Power" menu.

When the backlight is off, pressing ESC, TAB, SPACE, ENTER, UP, DOWN, LEFT, RIGHT, DEL, BKSP, CTRL, or ALT turns the backlight on without affecting the application. Pressing any other key will turn backlight on and could potentially perform the action as well.

Key Path	View/Display, Display, System Display Settings
Remote Command	:DISPlay:BACKlight ON OFF :DISPlay:BACKlight?
Preset	ON (Set by Restore Misc Defaults)
Initial S/W Revision	Prior to A.02.00

Backlight Intensity

An active function used to set the backlight intensity. It goes from 0 to 100 where 100 is full on and 0 is off. This value is independent of the values set under the Backlight on/off key.

Key Path	View/Display, Display, System Display Settings
Remote Command	:DISPlay:BACKlight:INTensity <integer> :DISPlay:BACKlight:INTensity?
Example	DISP:BACK:INT 50

Preset	100 (Set by Restore Misc Defaults)
Min	0
Max	100
Initial S/W Revision	Prior to A.02.00

Layout

Enables you to choose the number and position of windows on the screen. Each window contains one trace. The selected trace is always visible and its window outlined in green. The Window zoom key toggles between multiple windows and a single window mode without changing the setting for Layout.

Single layout has one window.

Stack 2 layout has two windows, one on top of the other, that display either traces 1 (top) and 2 (bottom) or traces 3 and 4. The pair that is showing always includes the selected trace.

Stack 3 layout has three windows that display, top to bottom, traces 1, 2, 3 or traces 2, 3, 4.

Grid 2x2 layout has 4 windows, arranged 2x2. They display (in order top to bottom, left to right) traces 1, 2, 3, and 4.

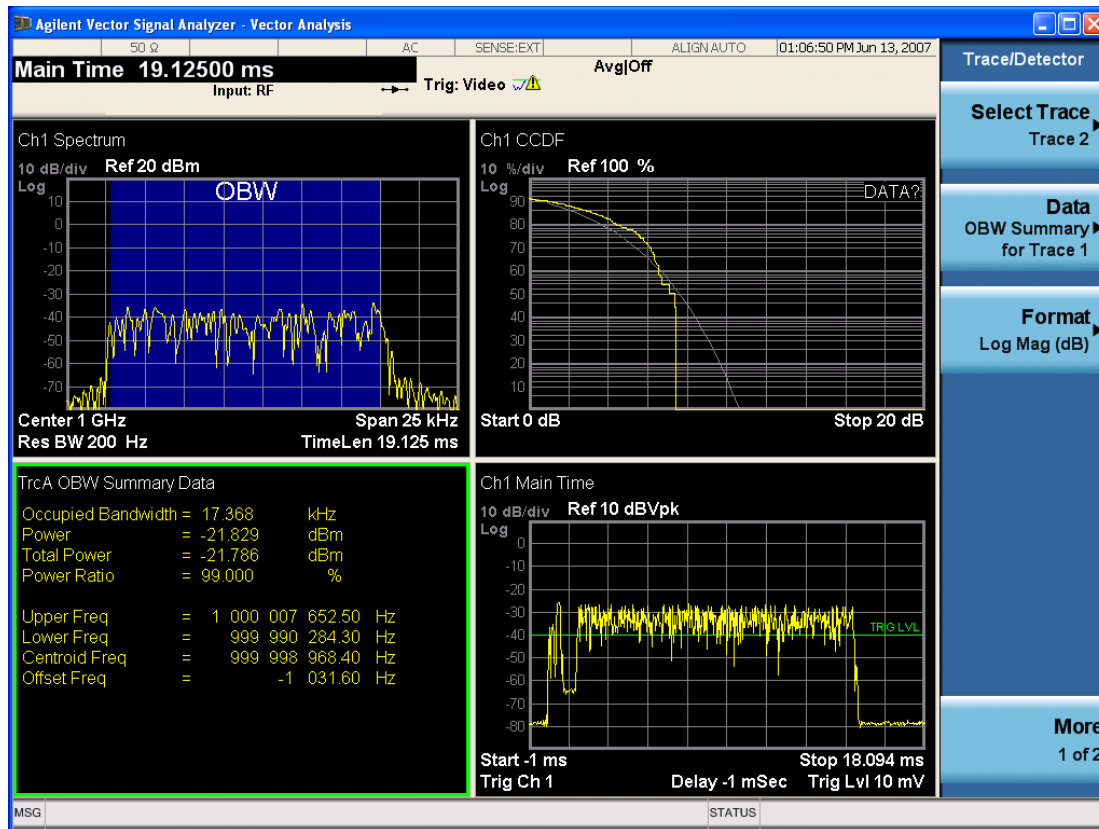

Grid 2x2 layout with Trace 2 selected

There are two other layouts that are available for iDEN Power, iDEN Demod, and MOTOTalk measurements since these enable 6 traces.

Grid 2x3 layout has 2 rows of 3 windows that display all 6 traces in order, top to bottom, then left to right.

Grid 3x2 layout has 3 rows of 2 windows that display all 6 traces in order, top to bottom, then left to right.

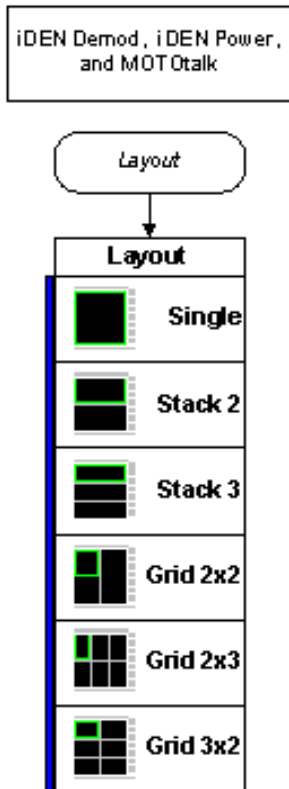

Key Path	View/Display
Mode	VSA, LTE, LTETDD, IDEN,LTEAFDD,LTEATDD
Measurement	<meas>:=VECTor ADEMod DDEMod W11A W11B EVM IPOWER IDEMod MOTotalk
Remote Command	:DISPlay:<meas>:WINDow:FORMat SINGLE TWO TRI QUAD :DISPlay:<meas>:WINDow:FORMat? For iDEN Power, iDEN Demod and MotoTalk measurements: :DISPlay:<meas>:WINDow:FORMat SINGLE TWO TRI QUAD GR2X3 GR3X2 :DISPlay:<meas>:WINDow:FORMat?
Example	DISP:VECT:WIND:FORM TWO DISP:IPOW:WIND:FORM GR2X3 DISP:VECT:WIND:FORM?
Couplings	If the window is currently zoomed, selecting a layout (even the current one) switches it to tiled mode.
Preset	TWO QUAD QUAD QUAD QUAD QUAD QUAD QUAD GR2X3 TRI

State Saved	Saved in instrument state.
Range	Single Stack 2 Stack 3 Grid 2x2 Grid 2x2 Grid 2x3 Stack 3
Initial S/W Revision	Prior to A.02.00
Modified at S/W Revision	A.02.00

Preset View: Test Standard

Preset the display layout to pre-defined patterns.

Key Path	View/Display
Remote Command	:DISPlay:IDEMod:VIEW:PRESet TSTD PVTBOTH EVMQUAD EVMSYMS WPVT
Example	:DISP:IDEM:VIEW:PRES TSTD
Notes	Command Only. TSTD: Test Standard PVTBOTH: PVT Rise & Fall EVMQUAD: EVM(Quad) EVMSYMS: EVM & Symbols WPVT: WiDEN PVT
Couplings	Action dependent on the state of the several test enables
Initial S/W Revision	A.02.00

Preset View: PVT Rise & Fall

Preset the display layout to pre-defined patterns.

Key Path	View/Display
Example	:DISP:IDEM:VIEW:PRES PVTBOTH
Notes	Command Only. TSTD: Test Standard PVTBOTH: PVT Rise & Fall EVMQUAD: EVM(Quad) EVMSYMS: EVM & Symbols WPVT: WiDEN PVT
Couplings	Action dependent on the state of the several test enables
Initial S/W Revision	A.02.00

Preset View: EVM (Quad)

Preset the display layout to pre-defined patterns.

Key Path	View/Display
Example	:DISP:IDEM:VIEW:PRES EVMQUAD
Notes	Command Only. TSTD: Test Standard PVTBOTH: PvT Rise & Fall EVMQUAD: EVM(Quad) EVMSYMS: EVM & Symbols WPVT: WiDEN PvT
Couplings	Action dependent on the state of the several test enables
Initial S/W Revision	A.02.00

Preset View: EVM & Symbols

Preset the display layout to pre-defined patterns.

Key Path	View/Display
Example	:DISP:IDEM:VIEW:PRES EVMSYMS
Notes	Command Only. TSTD: Test Standard PVTBOTH: PvT Rise & Fall EVMQUAD: EVM(Quad) EVMSYMS: EVM & Symbols WPVT: WiDEN PvT
Couplings	Action dependent on the state of the several test enables
Initial S/W Revision	A.02.00

Preset View: WiDEN PvT

Preset the display layout to pre-defined patterns.

Key Path	View/Display
Example	:DISP:IDEM:VIEW:PRES WPVT
Notes	Command Only. TSTD: Test Standard PVTBOTH: PvT Rise & Fall EVMQUAD: EVM(Quad) EVMSYMS: EVM & Symbols WPVT: WiDEN PvT
Couplings	Action dependent on the state of the several test enables
Initial S/W Revision	A.02.00

Remote SCPI Commands and Data Queries

Remote SCPI Results described in this section include:

[":READ and :FETCh Commands" on page 1285](#)

[":CALCulate:DATA" on page 1288](#)

[":CALCulate:DATA:RAW" on page 1289](#)

[":CALCulate:DATA:RAW:COMPLex" on page 1290](#)

[":CALCulate:DATA:POINTs commands" on page 1290](#)

[":CALCulate:DATA:TABL commands" on page 1291](#)

[":CALCulate:DATA:HEADer commands" on page 1295](#)

[":CALC:CLIMits:FAIL?" on page 1297](#)

["IQ Data Transfers " on page 1297](#)

VSA based Measurements produce a rich variety of results that can be displayed in any of 4 traces. A result can consist of an array of X,Y trace data that is typically shown as a graph or scalar results that are displayed as a table. The Symbol/Error result that is part of many demodulation measurements actually displays both a trace table (the error statistics) and trace data (the symbol information, which is not graphed but listed). The CALC:<meas>:DATA<n> commands enable you to retrieve any trace data or trace table. This family of commands also enable you to get information about the names of data results available and the units associated with them, as well as names and results of meta-data associated with traces.

Selected results are available via the FETCh and READ SCPI interfaces. These commands refer to data results by arbitrary index number rather than by trace number.

Key Path	SCPI Only
Mode	LTE, LTETDD, IDEN, VSA

:READ and :FETCh Commands

The SCPI MEASure, READ, and FETCh are typically offered by applications with focus on manufacturing test, where a fixed set of desired results is known in advance and seldom changes. The VSA based measurements are many, due to a focus on development. Thus, for most VSA based measurements there is no standard configuration that yields a useful measurement 90% of the time. Thus, the MEASure function is not offered for most measurements in the VSA Application. However, READ and FETCh can be implemented for select results. Note that these results are also still available using the CALC:<meas>:DATA:TABLE family of commands.

ACP and OBW are available in all VSA based measurements. To retrieve the ACP or OBW data, the function must be enabled on a frequency-domain trace and the associated summary data table must be assigned to another trace. Note however, the index n in the following commands is not trace number but an index picked out of the tables shown below.

:FETCh:<meas> [n] ?

:READ:<meas>[n]?

The results available for various values of n are shown below:

Condition	N	Results Returned
Mode = VSA LTE IDEN	Not specified or n=1	Reserved for selected results of VSA measurements. If not used for a particular measurement, no result is returned and error -114 Header suffix out of range is generated.
Mode = VSA LTE IDEN	2 - 50	Reserved for selected results of VSA measurements. If not used for a particular measurement, no result is returned and error -114 Header suffix out of range is generated.
Mode = VSA LTE IDEN, ACP on trace 1	51	ACP Summary for trace 1 Returns 28 comma-separated scalar results, corresponding to the swept ACP results where possible; n/a elsewhere: Returns 28 comma-separated scalar results, in the following order. 1. 0.0 2. Total carrier power (dBm) (same as item 4, because only 1 carrier supported) 3. 0.0 4. Reference carrier power (dBm) 5. Lower offset A - relative power (dB) 6. Lower offset A - absolute power (dBm) 7. Upper offset A - relative power (dB) 8. Upper offset A - absolute power (dBm) 9. Lower offset B - relative power (dB) 10. Lower offset B - absolute power (dBm) 11. Upper offset B - relative power (dB) 12. Upper offset B - absolute power (dBm) ... 21. Lower offset E - relative power (dB) 22. Lower offset E - absolute power (dBm) 23. Upper offset E - relative power (dB) 24. Upper offset E - absolute power (dBm) 25. n/a 26. n/a 27. n/a 28. n/a 29. Overall ACP test result summary (0 indicates at least 1 failure, 1 indicates all passed) If any result is not available, NaN (9.91 E 37) is returned. This can happen if ACP is turned off (all results unavailable) or when an offset is entirely off-screen. In the case where it is partially off-screen, the measured result is returned even though its validity is questionable.
Mode = VSA LTE IDEN, ACP on trace 2	52	ACP Summary for trace 2 see list for trace 1 summary

Mode = VSA LTE IDEN, ACP on trace 3	53	ACP Summary for trace 3 see list for trace 1 summary
Mode = VSA LTE IDEN, ACP on trace 4	54	ACP Summary for trace 4 see list for trace 1 summary
Mode = VSA LTE IDEN, ACP on trace 5	55	ACP Summary for trace 5 see list for trace 1 summary
Mode = VSA LTE IDEN, ACP on trace 6	56	ACP Summary for trace 6 see list for trace 1 summary
	57-60	no result returned; error -114, Header suffix out of range generated
Mode = VSA LTE IDEN, OBW on trace 1	61	OBW Summary for trace 1 Returns 9 comma-separated scalar results corresponding exactly to the items in the OBW Summary trace: 1. OBW (Hz) 2. Pwr (dBm) 3. Total Pwr (dBm) 4. Pwr Ratio (no unit, E.g. 0.99) 5. OBW upper freq (Hz) 6. OBW lower freq (Hz) 7. Centroid freq (Hz) 8. Offset freq (Hz) 9. OBW Test Result (0 for fail, 1 for pass) If the results are not available, NaN (9.91 E 37) is returned.
Mode = VSA LTE IDEN, OBW on trace 2	62	OBW Summary for trace 2 see list for trace 1 summary
Mode = VSA LTE IDEN, OBW on trace 3	63	OBW Summary for trace 3 see list for trace 1 summary
Mode = VSA LTE IDEN, OBW on trace 4	64	OBW Summary for trace 4 see list for trace 1 summary
Mode = VSA LTE IDEN, OBW on trace 5	65	OBW Summary for trace 5 see list for trace 1 summary
Mode = VSA LTE IDEN, OBW on trace 6	66	OBW Summary for trace 6 see list for trace 1 summary

Key Path	SCPI Only
Mode	LTE, LTETDD, IDEN, VSA

:CALCulate:DATA

Once measurement data result is assigned to a trace, the data can be retrieved by using one of the following commands (where <n> is the trace number and <meas> is the current VSA based measurement).

:CALC:<meas>:DATA<n>?

:CALC:<meas>:DATA<n>:RAW?

The first form of the command retrieves the data as formatted on the display. For example, if (in a vector measurement) you have the Spectrum result in LogMag format on trace 1, then

:CALC:VECT:DATA1?

returns an array of spectrum amplitude (Y data) in units of dBm, and

:CALC:VECT:DATA1:RAW?

returns the Y data in its underlying units of Volts (peak) squared.

(To get data from displayed tables, see [":CALCulate:DATA:TABL commands" on page 1291.](#))

The CALC:<meas>:DATA commands get data from traces. There are many results available from a VSA based measurement and only 4 traces in which to view them. View Preset commands are one way of displaying frequently-used results in standard trace locations. Or you can assign any measurement result to any trace using the softkeys under Trace/Detector, Data. The SCPI command for doing this is:

:DISP:<meas>:TRAC<n>:FEED "<data_name>"

For example, if (in a vector measurement) you want to view the CCDF result in trace 4, you send:

:DISP:VECT:TRAC4:FEED "CCDF1"

(If the measurement has not run yet, use INIT:IMM to run it.) Then the CCDF data can be retrieved using

CALC:VECT:DATA4?

or

CALC:VECT:DATA4:RAW?

Key Path	SCPI Only
Mode	VSA, LTE, LTETDD, IDEN
Measurement	<meas>:=VECTor ADEMod DDEMod W11A W11B EVM IPOWER IDEMod MOTotalk
Remote Command	:CALCulate:<meas>:DATA[1] 2 ...4? [Y X XY[,OFF ON 0 1] LL UL]
Example	CALC:VECT:DATA1? CALC:VECT:DATA1? Y,ON

	CALC:VECT:DATA1? X CALC:VECT:DATA1? XY
Notes	<p>Query only. This retrieves the data in the designated trace as displayed.</p> <p>For example, if Trace 1 is assigned Spectrum data and formatted as LogMag, then :CALC:VECT:DATA1? returns the Y data in dBm. If the X axis is scaled to show only a portion of the trace data, only the data shown is returned.</p> <p>The numeric format of the returned data is controlled by FORMat[:TRACe][:DATA] command</p> <p>The optional parameters control what data is returned.</p> <p>:CALC:VECT:DATA1? Y is the same as :CALC:VECT:DATA1? with no parameter. It returns an array of Y values.</p> <p>:CALC:VECT:DATA1? X returns an array of X values that correspond to the Y values above.</p> <p>:CALC:VECT:DATA1? XY returns interleaved X and Y data. That is: <x1> <y1> <x2> <y2>...</p> <p>Normally, this command only returns the data between the current X scale limits. If the optional ",OFF" or ",0" switch is included at the end of the command, then all data is returned (regardless of X scaling or the state of All Frequency Points).</p> <p>:CALC:EVM:DATA1? LL UL returns an array of Lower/Upper Limit values when Limit Test is enabled and the trace includes limit values. When Limit Test is disabled or the trace does not include limit value, this query is the same as :CALC:EVM:DATA1? with no parameter.</p> <p>Note: LL and UL are available only for the EVM measurement in the LTE/LTE TDD modes.</p> <p>Note: the X and Y parameters in this command refer to the display's horizontal and vertical axes. Normally the X axis is the independent variable, but if the display format is Constellation or IQ, then CALC:<meas>:DATA<n>? [Y] returns the imaginary part of the data and CALC:<meas>:DATA<n>? X returns the real part of the data. If you want the values of the independent variable, change to a non-vector format (such as Log Mag) and use CALC:<meas>:DATA<n>? X</p>
Initial S/W Revision	Prior to A.02.00
Modified at S/W Revision	A.02.00, A.08.00

:CALCulate:DATA:RAW

Retrieves trace data in its underlying units, before the formatting calculation that converts it to displayed units. Underlying units are typically Volts peak (for signal results) or Volts peak squared (for power results). All data points are returned, whether or not they are displayed.

Key Path	SCPI Only
Mode	VSA, LTE, LTETDD, IDEN
Measurement	<meas>:=VECTor ADEMod DDEMod W11A W11B EVM IPOWER IDEMod MOTotalk
Remote Command	:CALCulate:<meas>:DATA[1] 2 ...4:RAW?
Example	CALC:VECT:DATA1:RAW?
Notes	Query only. This retrieves the unformatted Y data in the designated trace. If Y data is complex, it is returned as <y_real1> <y_imag1> <y_real2> <y_imag2> etc.
Initial S/W Revision	Prior to A.02.00
Modified at S/W Revision	A.02.00

:CALCulate:DATA:RAW:COMPLex

Determines if the data retrieved by CALC:<meas>:DATA:RAW<n>? is complex.

Key Path	SCPI Only
Mode	VSA, LTE, LTETDD, IDEN
Measurement	<meas>:=VECTor ADEMod DDEMod W11A W11B EVM IPOWER IDEMod MOTotalk
Remote Command	:CALCulate:<meas>:DATA[1] 2 ...4:RAW:COMPLex?
Example	CALC:VECT:DATA1:RAW:COMP?
Notes	Query only. Returns 1 if the trace data is complex, 0 if it is real.
Initial S/W Revision	Prior to A.02.00
Modified at S/W Revision	A.02.00

:CALCulate:DATA:POINTs commands

Returns the number of points that are returned by

CALCulate:<meas>:DATA<n>?

X axis scaling and whether All Frequency Points is on or off can affect this number.

NOTE For the CALCulate:<meas>:DATA<n>? XY command there are 2 numbers returned per data point.

Key Path	SCPI Only
Mode	VSA, LTE, LTETDD, IDEN
Measurement	<meas>:=VECTor ADEMod DDEMod W11A W11B EVM IPOWER IDEMod MOTotalk
Remote Command	:CALCulate:<meas>:DATA[1] 2 ...4:POINTs? [OFF ON 0 1]
Example	CALC:VECT:DATA1:POINTs?
Notes	<p>Query only.</p> <p>Use the optional "OFF 0" parameter to determine the number of points that are returned by the optional command form:</p> <p>:CALCulate:<meas>:DATA<n>? Y X XY,OFF 0</p> <p>Note that this is points, not array size. If the XY parameter is included, there are 2 numbers returned per point.</p> <p>(ON or 0, which means use the X-scaled version, is the default and the result is the same as if the parameter is omitted).</p>
Initial S/W Revision	Prior to A.02.00
Modified at S/W Revision	A.02.00

This query returns the number of points that are returned by

CALCulate:<meas>:DATA:RAW<n>?

NOTE

For complex trace data, there are 2 numbers returned per data point.

Key Path	SCPI Only
Mode	VSA, LTE, LTETDD, IDEN
Measurement	<meas>:=VECTor ADEMod DDEMod W11A W11B EVM IPOWER IDEMod MOTotalk
Remote Command	:CALCulate:<meas>:DATA[1] 2 ...4:RAW:POINTs?
Example	CALC:VECT:DATA1:RAW:POINTs?
Notes	Query only.
Initial S/W Revision	Prior to A.02.00
Modified at S/W Revision	A.02.00

:CALCulate:DATA:TABL commands

Some traces have tabular data associated with them. In fact, there may be only a table and no trace data. Each entry in the table consists of a name, a measured value, and units. The units are sometimes not shown. You can programmatically retrieve arrays of all the names, all the values, and all the units of a table. These arrays are all ordered so that corresponding indices have associated values, for example, the 4th name in the names array corresponds to the 4th value in the results array. (Note that the array order cannot be the same as the displayed order.) You can also get a particular result from the table by name. Here is a summary of the remote table data commands.

Command	Returns	Example
CALCulate:<meas>:DATA<n>:TABLe?	All table data results (as an array)	CALC:DDEM:DATA4:TABL?
CALCulate:<meas>:DATA<n>:TABLe? "<name>"	The table data result referred to by name	CALC:DDEM:DATA4:TABL? "EvmPeak"
CALCulate:<meas>:DATA<n>:TABLe:NAMes?	Comma-separated list of all table data names	CALC:DDEM:DATA4:TABL:NAM?
CALCulate:<meas>:DATA<n>:TABLe:UNIT?	Comma-separated list of all table data units	CALC:DDEM:DATA4:TABL:UNIT?

For example, if within the Vector Analysis measurement, you have an OBW Summary Table displayed in trace 2, CALC:DDEM:DATA2:TABL:NAM? would return the table names as follows:

"Obw,Pwr,TotalPwr,PwrRatio,ObwUpper,ObwLower,Centroid,Offset"

and CALC:DDEM:DATA2:TABL:UNIT? would return the units. (A null string means the result is unitless.)

"Hz,Vrms^2,Vrms^2,,Hz,HZ,HZ,HZ"

You can then get all the table results by sending

CALC:DDEM:DATA2:TABL?

Result number 1 is Obw and has units of Hz, result number 2 is Pwr with units of Vrms^2, and so on.

You can also get individual table entries by asking for them by name. Any name returned from the CALC:DDEM:DATA2:TABL:NAM? query can be used. For example, to get TotalPwr you can send the following query:

CALC:DDEM:DATA2:TABL? "TotalPwr"

Query Table Data as Number

Gets data from a table shown in the designated trace. Tables shown on the display typically have the name of a parameter followed by its measured value

Key Path	SCPI Only
Mode	VSA, LTE, LTETDD, IDEN
Measurement	<meas>:=VECTor ADEMod DDEMod W11A W11B EVM IPOWER IDEMod MOTotalk
Remote Command	:CALCulate:<meas>:DATA[1] 2 ...4:TABLe[:NUMBer]? [<string>]
Example	CALC:DDEM:DATA2:TABL? "Obw"
Notes	Query only. If sent without a string specifier, this returns the entire table for the designated trace. If sent with a string specifier, returns a specific table entry in the designated trace. The string specifier must be delimited by single or double quotes. A list of valid strings can be obtained using CALC:<meas>:DATA:TABL:NAM? If an invalid string is sent, an error is generated. The returned results are in numeric format, under control of the FORMat[:TRACe][:DATA] command. For table data that is non-numeric, NaN is returned. To get the value of these data, use the CALC:<meas>:DATA2:TABL:STR? command.
Initial S/W Revision	Prior to A.02.00
Modified at S/W Revision	A.02.00

Query Table Data as String

Some tables have string data. The above Trace Table Data query cannot return it and sends NaN in its place. Here is a form of Trace Table Data query that can return string data from tables.

Key Path	SCPI Only
Mode	VSA, LTE, LTETDD, IDEN

Measurement	<meas>:=VECTor ADEMod DDEMod W11A W11B EVM IPOWER IDEMod MOTotalk
Remote Command	:CALCulate:<meas>:DATA[1] 2 ...4:TABLE:STR? [<string>]
Example	CALC:DDEM:DATA2:TABL:STR? "Obw"
Notes	Query only. If sent without a string specifier, this returns the entire table for the designated trace in comma-separated format. If sent with a string specifier, returns a specific table entry in the designated trace. The string specifier must be delimited by single or double quotes. A list of valid strings can be obtained using CALC:<meas>:DATA:TABL:NAM? If an invalid string is sent, an error is generated.
Initial S/W Revision	Prior to A.02.00
Modified at S/W Revision	A.02.00

Query Table Names

Returns a comma-separated list of names of the table data entries for the designated trace. Each of the names can be used (surrounded by quotes or double quotes) as a parameter in the Trace Table Data commands. The names appear in the same order as the corresponding data values returned by the CALC:<meas>:DATA<n>:TABL[:NUMB|STR]? query.

Key Path	SCPI Only
Mode	VSA, LTE, LTETDD, IDEN
Measurement	<meas>:=VECTor ADEMod DDEMod W11A W11B EVM IPOWER IDEMod MOTotalk
Remote Command	:CALCulate:<meas>:DATA[1] 2 ...4:TABLE:NAMes?
Example	CALC:VECT:DATA1:TABL:NAM?
Notes	Query only. This retrieves the names of the table entries for the designated trace. Each of these names can be used in the CALC:<meas>:DATA:TABL? '<name>' command to access a single table entry.
Initial S/W Revision	Prior to A.02.00
Modified at S/W Revision	A.02.00

Query Table Units

Returns a comma-separated list of all the units for the table data entries for the designated trace. If a data result is unitless, an empty string appears in the list for that result. The units appear in the same order as the corresponding data values returned by the CALC:<meas>:DATA<n>:TABL[:NUMB|STR]? query.

Key Path	SCPI Only
Mode	VSA, LTE, LTETDD, IDEN
Measurement	<meas>:=VECTor ADEMod DDEMod W11A W11B EVM IPOWER IDEMod MOTotalk
Remote Command	:CALCulate:<meas>:DATA[1] 2 ...4:TABLE:UNIT?

Example	CALC:VECT:DATA1:TABL:UNIT?
Notes	Query only. This retrieves a list of units for table entries for the designated trace. The units are given in the order that the entries are sent from the :CALC:<meas>:DATA:TABL? command.
Initial S/W Revision	Prior to A.02.00
Modified at S/W Revision	A.02.00

The following table data is available in all measurements when the ACP function is turned on and the associated summary table is shown in a trace:

Result name	Displayed Unit	Remote Name	Remote Unit
Reference Bandwidth	Hz	RefBw	Hz
Reference Alpha		RefAlpha	
Reference Power	dBm	RefPwr	Vrms ²
Offset	Hz	Offset1, Offset2, Offset3, Offset4, Offset5	Hz
BW	Hz	Bw1, Bw2, Bw3, Bw4, Bw5	Hz
Alpha		Alpha1, Alpha2, Alpha3, Alpha4, Alpha5	
Lower Pwr	dBm	LowPwr1, LowPwr2, LowPwr3, LowPwr4, LowPwr5	Vrms ²
Lower ACPR	dB	LowRatio1, LowRatio2, LowRatio3, LowRatio4, LowRatio5	
Upper Pwr	dBm	HiPwr1, HiPwr2, HiPwr3, HiPwr4, HiPwr5	Vrms ²
Upper ACPR	dB	HiRatio1, HiRatio2, HiRatio3, HiRatio4, HiRatio5	
Max ACPR	dB	MaxRatio1, MaxRatio2, MaxRatio3, MaxRatio4, MaxRatio5	

The following table data is available in all measurements when the OBW function is turned on and the associated summary table is shown in a trace:

Result name	Displayed Unit	Remote Name	Remote Unit
Occupied Bandwidth	Hz	Obw	Hz
Power	dBm	Pwr	Vrms ²

Total Power	dBm	TotalPwr	Vrms^2
Power Ratio	%	PwrRatio	
Upper Freq	Hz	ObwUpper	Hz
Lower Freq	Hz	ObwLower	Hz
Centroid Freq	Hz	Centroid	Hz
Offset Freq	Hz	Offset	Hz

:CALCulate:DATA:HEADer commands

Trace data also has meta-data associated with it, called headers, which is visible if you export trace data in text format. The headers have a name and a value that can be obtained from any trace by using the CALCulate:<meas>:DATA:HEADer commands described in this section.

The following Remote Commands are described in this section:

["Query Header Names" on page 1295](#)

["Query Header Type" on page 1295](#)

["Query Header as String" on page 1296](#)

["Query Numeric Header" on page 1296](#)

[":CALC:CLIMits:FAIL?" on page 1297](#)

Query Header Names

Returns a comma-separated list of all the header names associated with the designated trace. Each of the names can be used (surrounded by quotes or double quotes) as a parameter in the other CALC:<meas>:DATA<n>:HEAD queries.

Key Path	SCPI Only
Mode	VSA, LTE, LTETDD, IDEN
Measurement	<meas>:=VECTor ADEMod DDEMod W11A W11B EVM IPOWER IDEMod MOTotalk
Remote Command	:CALCulate:<meas>:DATA[1] 2 ...4:HEADer:NAMes?
Example	CALC:VECT:DATA1:HEAD:NAM?
Notes	Query only. Returns a comma-separated list of header names.
Initial S/W Revision	Prior to A.02.00
Modified at S/W Revision	A.02.00

Query Header Type

Returns whether the designated header on the designated trace can be queried as a number or by a string only.

Key Path	SCPI Only
Mode	VSA, LTE, LTETDD, IDEN
Measurement	<meas>:=VECTor ADEMod DDEMod W11A W11B EVM IPOWER IDEMod MOTotalk
Remote Command	:CALCulate:<meas>:DATA[1] 2 ...4:HEADer:TYPE? <string>
Example	CALC:VECT:DATA1:HEAD:TYPE? 'XDelta'
Notes	Query only. This retrieves the type of the named header for the designated trace. The name (delimited by single or double quotes) is one of the names returned by CALC:<meas>:DATA:HEAD:NAMES? If a valid header name is passed in, the return value from this query is either STR or NUMB. NONE is returned if there is no such header.
Initial S/W Revision	Prior to A.02.00
Modified at S/W Revision	A.02.00

Query Header as String

Gets a header by name from the designated trace and returns its value as a string.

Key Path	SCPI Only
Mode	VSA, LTE, LTETDD, IDEN
Measurement	<meas>:=VECTor ADEMod DDEMod W11A W11B EVM IPOWER IDEMod MOTotalk
Remote Command	:CALCulate:<meas>:DATA[1] 2 ...4:HEADer:STRing? <string>
Example	CALC:VECT:DATA1:HEAD:STR? 'WindowType'
Notes	Query only. This retrieves the named header for the designated trace. The name (delimited by single or double quotes) is one of the names returned by the CALC:<meas>:DATA:HEAD:NAMES? The return value is a string. If the requested header value is a numeric or if there is no such header, an empty string is returned.
Initial S/W Revision	Prior to A.02.00
Modified at S/W Revision	A.02.00

Query Numeric Header

Gets a numeric header by name from the designated trace and returns its value in a format determined by the last FORM command.

Key Path	SCPI Only
Mode	VSA, LTE, LTETDD, IDEN
Measurement	<meas>:=VECTor ADEMod DDEMod W11A W11B EVM IPOWER IDEMod MOTotalk
Remote Command	:CALCulate:<meas>:DATA[1] 2 ...4:HEADer[:NUMBer]? <string>
Example	CALC:VECT:DATA1:HEAD? 'XDelta'
Notes	Query only. This retrieves the named header for the designated trace. This form of the HEAD? query is for headers whose type is NUMB (as determined by :CALC:<meas>:DATA:HEAD:TYPE?).

	The name parameter (delimited by single or double quotes) is one of the names returned by CALC:<meas>:DATA:HEAD:NAMes? The format of the return data is determined by the FORMat [:TRACe][:DATA] command. If used to query a header whose type is STR or there is no such header, NaN (9.91e37) is returned
Initial S/W Revision	Prior to A.02.00
Modified at S/W Revision	A.02.00

:CALC:CLIMits:FAIL?

If one or more ACP or OBW limit tests are active, then the CALC:CLIMits:FAIL? command returns the aggregate pass or fail status.

IQ Data Transfers

Fast capture/transfer of a large amount of IQ data is supported over SCPI. To do this, first set up the desired measurement range, center frequency, span, triggering, and so on. Use a time length that is convenient for setting up the measurement. The time length for the captured data is set indirectly as shown below.

To perform the capture, a typical SCPI sequence is as follows:

```
FCAP:LENG <num_samples>
```

This command sets the length for the next capture in samples. The sample rate is proportional to the current span and can be determined by a SCPI query, for example, in the Vector measurement the query:

```
VECT:SWE:ISR?
```

returns the input sample rate. For the IQAnalyzer (Basic) mode, the sample rate SCPI query is defined as follows:

```
:SPEC:SRAT? (Complex spectrum measurement)
```

```
:WAV:SRAT? (Waveform measurement)
```

Multiply the time length desired for the captured data by this sample rate to get the number of samples needed.

```
INIT:FCAP
```

pauses the current measurement and starts capturing IQ data using the current setup and trigger conditions. (The instrument front panel display does not change nor show the captured data.)

To read the captured data via SCPI in blocks, set the read block size using the command:

```
FCAP:BLOC <num_points_per_read_block>
```

The maximum read block size is typically less than the total fast capture buffer size and can be determined by the query "FCAP:BLOC? MAX". Now you can repeatedly use the following query to read out successive blocks of data:

```
FETC:FCAP?
```

The returned data is formatted according to the most recent :FORMat[:DATA] and :FORMat:BORDER commands. A read pointer that indicates the next sample to be transferred is advanced automatically following each FETC:FCAP? query. This pointer position can be read or manually set via the SCPI commands:

FCAP:POIN?

FCAP:POIN <read_pointer_position>

The fast capture data can be read as long as you use only the commands to set read block size and pointer position, or queries that return the state of the current measurement. The capture data is cleared by any command that changes the measurement state or initiates a new measurement, or via SCPI device clear or :ABORT commands.

Fast capture data word size can be set to either 32 bit or 64 bit via the FCAP:WLEN command. This enables you to trade off precision for total capture length.

Note: when the word size is 32 bit, points can only be retrieved on even sample number boundaries, that is, the pointer and block length should be even numbers. Therefore, when the word size is set to auto, it is recommended that the pointer and block size be only set to even numbers.

Fast Capture Length

Sets the length of the SCPI Fast Capture in samples (points). This is constrained to be an even number.

Query returns the most recent length setting.

Key Path	SCPI Only
Mode	VSA, BASIC
Remote Command	[[:SENSe]:FCAPture:LENGth <integer> [:SENSe]:FCAPture:LENGth?
Example	FCAP:LENG 1000 FCAP:LENG?
Notes	This is affected by the IF path currently used, which can in turn be affected by span. It is also affected by the internal Fast Capture Word Length. The current maximum fast capture length can be found by using the query: FCAP:LENG? MAX Changing the Capture Length after initiating a fast capture clears the capture memory in preparation for a new fast capture of a different length. No Front panel access; SCPI only
Preset	1048576 Samples
Min	2
Max	536 870 908 Samples for internal 40 MHz and 140 MHz options with FCAP:WLEN BIT32
Initial S/W Revision	A.04.00

Fast Capture Word Length

Enables choice of internal fast capture word length. Shorter word length enables twice the time length to be captured at the cost of quantization noise. Note that this does not affect the format of data returned by FETCh:FCAPture, only the internal representation.

Key Path	SCPI Only
Mode	VSA, BASIC
Remote Command	[:SENSe] :FCAPture:WLENgth AUTO BIT32 BIT64 [:SENSe] :FCAPture:WLENgth?
Example	FCAP:WLEN AUTO FCAP:WLEN?
Notes	No Front panel access; SCPI only.
Preset	AUTO
Initial S/W Revision	A.04.00

Initiate Fast Capture

Waits for the sweep to trigger and then captures the fast capture data. Sweep is then set to pause. The amount of data captured is controlled by the Fast Capture Length command (FCAP:LENG).

Key Path	SCPI Only
Mode	VSA, BASIC
Remote Command	:INITiate:FCAPture
Example	INIT:FCAP
Notes	This is an overlapped command. It returns immediately, but the capture may not be complete. Use *OPC?, *WAI, or *OPC to determine when the capture is complete.
Notes	No Front panel access; SCPI only This command resets the Fast Capture Pointer to 0
Initial S/W Revision	A.04.00

Fast Capture Block

Sets the block size for the Fast Capture transfer in samples (points). This is the number of points that are returned from the Capture buffer by the FETC:FCAP? command. This is constrained to be an even number.

Query returns most recent block size setting.

Key Path	SCPI Only
Mode	VSA, BASIC
Remote Command	[:SENSe] :FCAPture:BLOCK <integer>

	<code>[:SENSe] :FCAPture:BLOCK?</code>
Example	<code>FCAP:BLOC 100</code> <code>FCAP:BLOC?</code>
Notes	No Front panel access. SCPI only.
Preset	1024 Samples
Min	0
Max	131072 or Fast Capture Length, whichever is smaller
Initial S/W Revision	A.04.00

Fast Capture Pointer

Sets the pointer position for the Fast Capture transfer in samples (points). The pointer is incremented by the block size each time the fetch is performed. Preset value (0) is the first sample in the record. Thus repetitive fetches result in contiguous data without needing to increment the pointer over SCPI. This is constrained to be an even number. Query returns most recent pointer setting.

Key Path	SCPI Only
Mode	VSA, BASIC
Remote Command	<code>[:SENSe] :FCAPture:POINter <integer></code> <code>[:SENSe] :FCAPture:POINter?</code>
Example	<code>FCAP:POIN 100</code> <code>FCAP:POIN?</code>
Notes	INIT:FCAP or FCAP:ABOR resets the pointer to 0. No front panel access; SCPI only.
Preset	0 Samples
Min	0
Max	Must be less than the Fast Capture length
Initial S/W Revision	A.04.00

Fetch Fast Capture

Transfers the block of data starting at the pointer. The number of samples transferred is set with the block size. The pointer is incremented by the block size after the fetch.

Key Path	SCPI Only
Mode	VSA, BASIC
Remote Command	<code>:FETCh:FCAPture?</code>
Example	<code>FETC:FCAP?</code>
Notes	The returned data is formatted according to the most recent <code>:FORMat[:DATA]</code> and <code>:FORMat:BORDER</code>

commands.

If the read pointer position plus read block size exceeds the Fast Capture Length, only the data between the pointer and the end of the fast capture buffer are returned, and error -200 is reported.

If Fetch is attempted before an INIT:FCAP or if the captured data is cleared by some other operation (e.g., REC), error -230 is reported and no data is returned.

No front panel access; SCPI only.

Initial S/W Revision	A.04.00
----------------------	---------

Input Sample Rate Query

Returns the complex sample rate in Hz for the current VXA measurement setup conditions. The sample rate can be used to convert between time and number of sample points when using the Fast Capture feature.

Sample rate depends on the settings for `FREQ:SPAN` and `IFPath`. You need to set these before making this query. Though the measurement name is specified in the query, you can only query the currently configured measurement. That is, if you have sent `CONF:VECT`, the query `ADEM:SWE:ISR?` generates an error.

Key Path	SCPI Only
Mode	VSA
Measurement	<meas>:=VECTor ADEMod DDEMod W11A W11B
Remote Command	[:SENSe] :<meas>:SWEp:ISRate?
Example	VECT:SWE:ISR?
Notes	<p>Query returns the complex sample rate in Hz for the current VXA Vector measurement setup conditions.</p> <p>If the measurement in the query is not the active measurement, error -230 is reported and no data is returned.</p> <p>This query is SCPI only, no Front Panel softkey.</p>
Preset	Depends on the licensed IF path
Initial S/W Revision	A.04.00

Parameter Update Enable

Refers only to measurements that use the VSA measurement engine. These are all the measurements in the Vector Signal Analyzer (VXA) Application and the EVM measurement in the LTE Applications.

When a measurement parameter is changed, the new value is used to update any dependent parameters and measurement results. This update process is normally done after every parameter change. This enables visual feedback during interactive GUI operation. However, with SCPI controlled measurements, typically a lot of parameter changes are done at once with the measurement stopped and then the measurement is run once and data retrieved. Here, is not necessary, and the accumulated update time for

each parameter change can become significant. The Parameter Update Enable command enables you to postpone update while sending setup commands and then enable one update to occur just before the measurement.

For example, if you are programmatically setting up a complex LTE measurement, you could save some setup time by first sending EVM:PUPD:ENAB OFF, then sending the whole group of measurement setup commands. When you are done with the setup, send EVM:PUPD:ENAB:ON. This causes the measurement state to be updated with all dependencies resolved. After this, you can read back the parameters' actual values. As a convenience, starting or continuing a measurement (INITiate:REStart, INITiate:IMMEDIATE, INITiate:<meas> or INITiate:RESume) automatically sets <meas>:PUPD:ENAB to ON. So does CONFigure:<meas> or any of the reset and recall state commands.

This command should be used with caution.

It is only valid to turn <meas>:PUPD:ENAB OFF when <meas> is the currently active measurement and the measurement is paused (i.e., INIT:CONT is OFF).

If you try to set and then read back a parameter value while Parameter Update Enable is off, you are not guaranteed to get back the true value that is used in the measurement because no parameter limiting is being done nor are any dependencies between parameters being resolved.

If you try to set coupled parameters independently when Parameter Update Enable is off, then when it is turned on, at most one of the parameter settings remain the same and the others change due to dependency resolution.

Key Path	SCPI Only
Mode	VSA, LTE, LTETDD, IDEN
Measurement	<meas>:=VECTor ADEMod DDEMod W11A W11B EVM IPOWER IDEMod MOTotalk
Remote Command	[:SENSe] : <meas> : PUPDate : ENABle OFF ON 0 1 [:SENSe] : <meas> : PUPDate : ENABle ?
Example	EVM:PUPD:ENAB OFF
Notes	Commands that cause a measurement to run, that switch measurements, or that preset or recall measurement state, set Parameter Update state to ON. These include INIT:IMM, INIT:REST, INIT:RES, INIT:<meas>, and CONF:<meas>.
Preset	1
State Saved	No
Initial S/W Revision	A.03.00

12 Measurement Functions

12 MotoTalk Measurement

This topic contains the following sections:

["Measurement Commands for MotoTalk Measurement "](#) on page 1110

["Remote Command Results for MotoTalk Measurement"](#) on page 1111

Measurement Commands for MotoTalk Measurement

All scalar results for this measurement are contained in one table and there is one equivalent subopcode for the remote results. The remote user can use this equivalence by visually inspecting the corresponding summary trace on the display, or by using CALC:DATA queries, which programmatically describes the corresponding summary trace.

```
CONFigure:MOtTotalk
```

```
CONFigure:MOtTotalk:NDEFault
```

```
FETCh:MOtTotalk[n]?
```

```
INITiate:MOtTotalk
```

```
MEASure:MOtTotalk[n]?
```

```
READ:MOtTotalk[n]?
```

For more measurement related commands, see the SENSE subsystem, and the section "[Remote Measurement Functions](#)" on page 1165.

Remote Command Results for MotoTalk Measurement

The following table displays the returned results from the (FETCh|MEASure|READ):IDEMod commands, indexed by subopcode:

Index n	Results Returned
Not specified or n=1	<p>Returns 36 comma-separated overall scalar results, corresponding exactly to the items returned in the Error Summary:</p> <ol style="list-style-type: none"> 1. Total bursts found 2. Unused 3. Unused 4. Unused 5. Unused 6. Unused 7. EVM (% rms) mean: RMS average for RMS EVM. Unused if average is turned off. 8. EVM (% rms) max: Max for RMS EVM Unused if average is turned off. 9. EVM (% rms) min: Min for RMS EVM Unused if average is turned off. 10. EVM (% rms) StdDev: StdDev for RMS EVM Unused if average is turned off. 11. EVM (% rms) Current: Current value for RMS EVM 12. EVM Peak (% peak) mean : RMS average for Peak EVM. Unused if average is turned off. 13. EVM Peak (% peak) max: Max for Peak EVM. Unused if average is turned off. 14. EVM Peak (% peak) min: Min for Peak EVM. Unused if average is turned off. 15. EVM Peak (% peak) StdDev : StdDev for Peak EVM. Unused if average is turned off. 16. EVM Peak (% peak) Current : Current value for Peak EVM. 17. Carrier Frequency Offset (Hz) mean : RMS average. Unused if average is turned off. 18. Carrier Frequency Offset (Hz) max : Max value. Unused if average is turned off. 19. Carrier Frequency Offset (Hz) min : Min value. Unused if average is turned off. 20. Carrier Frequency Offset (Hz) StdDev: StdDev value. Unused if average is turned off. 21. Carrier Frequency Offset (Hz) Current : Current Value. 22. Freq Dev (Hz) mean : RMS average. Unused if average is turned off. 23. Freq Dev (Hz) max : Max value. Unused if average is turned off. 24. Freq Dev (Hz) min : Min value. Unused if average is turned off. 25. Freq Dev (Hz) StdDev: StdDev value. Unused if average is turned off. 26. Freq Dev (Hz) Current : Current Value. 27. Burst Power (dBm) mean: RMS average. Unused if average is turned off. 28. Burst Power (dBm) max: Max value. Unused if average is turned off. 29. Burst Power (dBm) min: Min value. Unused if average is turned off. 30. Burst Power (dBm) StdDev: StdDev value. Unused if average is turned off. 31. Burst Power (dBm) current: Current value. 32. Slot Power (dBm) mean: RMS average. Unused if average is turned off. 33. Slot Power (dBm) max: Max value. Unused if average is turned off. 34. Slot Power (dBm) min: Min value. Unused if average is turned off.

	35. Slot Power (dBm) StdDev: StdDev value. Unused if average is turned off.
	36. Slot Power (dBm) current: Current value.
n=2	Returns 37 comma-separated slot scalar results, corresponding exactly to the items returned in the Error Summary:
	1. Analysis slot: The user's setting in Meas Setup
	2. Peak EVM symbol location
	3. Unused
	4. Unused
	5. Unused
	6. Unused
	7. Unused
	8. EVM (% rms) mean: RMS average for RMS EVM. Unused if average is turned off.
	9. EVM (% rms) max: Max for RMS EVM Unused if average is turned off.
	10. EVM (% rms) min: Min for RMS EVM Unused if average is turned off.
	11. EVM (% rms) StdDev: StdDev for RMS EVM Unused if average is turned off.
	12. EVM (% rms) Current: Current value for RMS EVM
	13. EVM Peak (% peak) mean : RMS average for Peak EVM. Unused if average is turned off.
	14. EVM Peak (% peak) max: Max for Peak EVM. Unused if average is turned off.
	15. EVM Peak (% peak) min: Min for Peak EVM. Unused if average is turned off.
	16. EVM Peak (% peak) StdDev : StdDev for Peak EVM. Unused if average is turned off.
	17. EVM Peak (% peak) Current : Current value for Peak EVM.
	18. Carrier Frequency Offset (Hz) mean : RMS average. Unused if average is turned off.
	19. Carrier Frequency Offset (Hz) max : Max value. Unused if average is turned off.
	20. Carrier Frequency Offset (Hz) min : Min value. Unused if average is turned off.
	21. Carrier Frequency Offset (Hz) StdDev: StdDev value. Unused if average is turned off.
	22. Carrier Frequency Offset (Hz) Current : Current Value.
	23. Freq Dev (Hz) mean : RMS average. Unused if average is turned off.
	24. Freq Dev (Hz) max : Max value. Unused if average is turned off.
	25. Freq Dev (Hz) min : Min value. Unused if average is turned off.
	26. Freq Dev (Hz) StdDev: StdDev value. Unused if average is turned off.
	27. Freq Dev (Hz) Current : Current Value.
	28. Burst Power (dBm) mean: RMS average. Unused if average is turned off.
	29. Burst Power (dBm) max: Max value. Unused if average is turned off.
	30. Burst Power (dBm) min: Min value. Unused if average is turned off.
	31. Burst Power (dBm) StdDev: StdDev value. Unused if average is turned off.
	32. Burst Power (dBm) current: Current value.
	33. Slot Power (dBm) mean: RMS average. Unused if average is turned off.
	34. Slot Power (dBm) max: Max value. Unused if average is turned off.
	35. Slot Power (dBm) min: Min value. Unused if average is turned off.
	36. Slot Power (dBm) StdDev: StdDev value. Unused if average is turned off.
	37. Slot Power (dBm) current: Current value.

In addition to these results, other results are defined in Common Functions, Data Queries, MEASure, READ, FETCh in [":CALCulate:DATA" on page 1288](#)

This key selects the MotoTalk EVM and Power measurement.

Key Path	Meas
Mode	IDEN
Initial S/W Revision	A.02.00

AMPTD Y Scale (Amplitude)

Accesses a menu that enables you to control input signal conditioning as well as the Y-scaling of trace data. Input signal conditioning actually affects the input signal and the associated measurement quality, whereas Y-scaling is non-destructive of data. Even if the data is scaled so as to be clipped or completely off the display, the marker readouts are still correct and accurate data can still be retrieved via SCPI.

Key Path	Front Panel
Initial S/W Revision	Prior to A.02.00

Y Auto Scale

Changes the Y reference value and Scale per Division so the full trace is displayed without clipping.

Key Path	AMPTD Y Scale
Mode	VSA, LTE, LTETDD, IDEN, LTEAFDD, LTEATDD
Measurement	<meas>:=VECTor ADEMod DDEMod W11A W11B EVM IPOWER IDEMod MOTotalk
Remote Command	:DISPlay:<meas>:TRACe [1] 2 . . . 4 : Y [: SCALE] : AUTO : ONCE
Example	:DISP:VECT:TRAC1:Y:AUTO:ONCE
Initial S/W Revision	Prior to A.02.00
Modified at S/W Revision	A.02.00

Range

Represents the amplitude of the largest sinusoidal signal that could be present within the IF without being clipped by the ADC. For signals with high peak-to-rms ratios, the range may need to exceed the rms signal power by a fair amount to avoid clipping.

Key Path	AMPTD Y Scale
Mode	VSA, LTE, LTETDD, IDEN
Remote Command	[: SENSE] : POWer [: RF] : RANGe <real> [: SENSE] : POWer [: RF] : RANGe?
Example	POW:RANG 25 POW:RANG?
Notes	The parameter is interpreted as dBm
Preset	20
State Saved	Saved in instrument state.
Min	depends on model and preamp options
Max	depends on model and preamp options
Initial S/W Revision	Prior to A.02.00
Modified at S/W Revision	A.02.00

Range

This key is only available when I/Q is the selected input. It replaces the Attenuation key in that case.

Each input channel (I and Q) has four internal gain ranges. The maximum allowed voltage in each gain range is slightly more than the nominal value, so the break point between ranges is a couple of millivolts higher than the nominal (setting a peak voltage of 0.502 mV will still map to the 0.5 V Peak range).

Gain Setting	Volts RMS	Volts Peak	Volts Peak - Peak	dBm (50Ω)	Break Point
0 dB	0.7071	1.0	2.0	10	n/a
6 dB	0.3536	0.5	1.0	4	0.502 V Peak
12 dB	0.1768	0.25	0.5	-2	0.252 V Peak
18 dB	0.0884	0.125	0.25	-8	0.127 V Peak

Key Path	AMPTD Y Scale
Notes	Visible only when the selected input is I/Q.
State Saved	No
Readback Text	When Range is Auto, "[Auto]" When Range is Man and I & Q are the same, "[<range value>]" When Range is Man and I & Q are different: "[I: <I range value> Q: <Q range value>]" See I Range and Q Range for the <range value> enumeration definition.
Initial S/W Revision	Prior to A.02.00

Range Auto/Man

The Auto setting for Range causes the range to be set based on the Y Scale settings. When Range is "Auto", the I & Q Range are set based on the top of the Y Scale when the Y scale is in dB units (for example, power), or to the max(abs(top), abs(bottom)) when the Y scale reference is not at the top of the screen.

Not all measurements support Range Auto/Man. If Auto is not supported in the current measurement, this key is grayed out and shows "Man" and MAN is returned to a SCPI query, but this does NOT change the Auto/Man setting for Range. When you go to a measurement that supports Auto, it goes back to Auto if it was previously in Auto mode.

Key Path	AMPTD Y Scale, Range
Scope	Meas Global
Remote Command	[:SENSe] :VOLTagE:IQ:RANGe:AUTO OFF ON 0 1 [:SENSe] :VOLTagE:IQ:RANGe:AUTO?
Example	Put the I Range and Q Range in manual.

	VOLT:IQ:RANG:AUTO OFF
Dependencies	If Auto is not supported, sending the SCPI command will generate an error.
Couplings	When in Auto, both I Range and Q Range are set to the same value, computed as follows: Maximum absolute value is computed for the Y Scale. The top and bottom of the graph are computed based on Ref Value, Scale/Div, and Ref Position. Formula: YMax = max(abs(top), abs(bottom)). The I Range and Q Range are then set to YMax.
Preset	ON
State Saved	Saved in instrument state
Range	Auto Man
Initial S/W Revision	Prior to A.02.00

Remote Command	[:SENSe] : POWer : IQ : RANGe : AUTO OFF ON 0 1 [:SENSe] : POWer : IQ : RANGe : AUTO ?
Example	Put the I Range and Q Range in manual. POW:IQ:RANG:AUTO OFF
Notes	The POW:IQ:RANG:AUTO is an alternate form of the VOLT:IQ:RANG:AUTO command. This is to maintain consistency with I Range and Q Range, which support both the POWer and VOLTage forms of the command.
Preset	ON
Range	Auto Man
Initial S/W Revision	Prior to A.02.00

I Range

This is the internal gain range for the I channel when Input Path is I Only or I and I/Q, and it is used for both the I and Q channels when the Input Path is I+jQ. See "[I/Q Gain Ranges](#)" on page 1119.

Key Path	AMPTD Y Scale, Range
Remote Command	[:SENSe] : VOLTage : IQ [: I] : RANGe [: UPPer] <voltage> [:SENSe] : VOLTage : IQ [: I] : RANGe [: UPPer] ?
Example	Set the I Range to 0.5 V Peak VOLT:IQ:RANG 0.5 V
Notes	The numeric entries are mapped to the smallest gain range whose break point is greater than or equal to the value, or 1 V Peak if the value is greater than 1 V.
Couplings	When Q Same as I is On, the I Range value will be copied to the Q Range. Changing the value will also set Range = Man.
Preset	1 V Peak
State Saved	Saved in instrument state

Range	1 V Peak 0.5 V Peak 0.25 V Peak 0.125 V Peak
Min	0.125 V
Max	1 V
Initial S/W Revision	Prior to A.02.00

Remote Command	<code>[:SENSe] :POWer :IQ [:I] :RANGe [:UPPer] <ampl></code> <code>[:SENSe] :POWer :IQ [:I] :RANGe [:UPPer] ?</code>
-----------------------	---

Example	Set the I Range to 0.5 V Peak when Reference Z is 50Ω, and to 1.0 V Peak when Reference Z is 75Ω. POW:IQ:RANG 4 dBm
----------------	--

Notes	The POWER form of the command is provided for convenience. It maps to the same underlying gain range parameter as the VOLTage form of the command. The Reference Z (not the I channel Input Z) is used to convert the power to peak voltage, which is then used to set the I Range as with the VOLTage form of the command. The power values of the 4 range states (1V Peak, 0.5V Peak, 0.25V Peak, and 0.125V Peak) will vary with Reference Z. Here are some examples: 50Ω: 10, 4, -2, -8 75Ω: 8.2, 2.2, -3.8, -9.8 600Ω: -0.8, -6.8, -12.8, -18.9
-------	--

Preset	10.0 dBm
Range	-20 dBm to 10 dBm
Min	-20 dBm
Max	10 dBm
Initial S/W Revision	Prior to A.02.00

Q Range Value

This is the internal gain range for the Q channel. See "[I/Q Gain Ranges](#)" on page 1119. The Q Range only applies to Input Path Q Only and Ind I/Q. For input I+jQ the I Range determines both I and Q channel range settings.

Key Path	AMPTD Y Scale, Range
----------	----------------------

Remote Command	<code>[:SENSe] :VOLTage :IQ :Q :RANGe [:UPPer] <voltage></code> <code>[:SENSe] :VOLTage :IQ :Q :RANGe [:UPPer] ?</code>
-----------------------	--

Example	Set the Q Range to 0.5 V Peak VOLT:IQ:Q:RANG 0.5 V
----------------	---

Notes	The numeric entries are mapped to the smallest gain range whose break point is greater than or equal to the value, or 1 V Peak if the value is greater than 1 V. The Q Range is only used for Input Path Q Only and Ind I/Q. For input I+jQ the I Range determines both I and Q channel range settings.
-------	--

Couplings	When Q Same as I is On, the I Range value will be copied to the Q Range and the range value keys are disabled. Changing the value will also set Range = Man.
Preset	1 V Peak
State Saved	Saved in instrument state
Range	1 V Peak 0.5 V Peak 0.25 V Peak 0.125 V Peak
Min	0.125 V
Max	1 V
Initial S/W Revision	Prior to A.02.00

Remote Command	<code>[:SENSe] :POWer:IQ:Q:RANGe[:UPPer] <ampl></code> <code>[:SENSe] :POWer:IQ:Q:RANGe[:UPPer]?</code>
-----------------------	--

Example	Will set the Q Range to 0.5 V Peak when Reference Z is 50Ω, and to 1.0 V Peak when Reference Z is 75Ω. POW:IQ:Q:RANG 4 dBm
----------------	---

Notes	The POWER form of the command is provided for convenience. It maps to the same underlying gain range parameter as the VOLTage form of the command. The Reference Z (not the Q channel Input Z) is used to convert the power to peak voltage, which is then used to set the Q Range as with the VOLTage form of the command. The power values of the 4 range states (1V Peak, 0.5V Peak, 0.25V Peak, and 0.125V Peak) will vary with Reference Z. Here are some examples: 50Ω: 10, 4, -2, -8 75Ω: 8.2, 2.2, -3.8, -9.8 600Ω: -0.8, -6.8, -12.8, -18.9
-------	--

Preset	10.0 dBm
Range	-20 dBm to 10 dBm
Min	-20 dBm
Max	10 dBm
Initial S/W Revision	Prior to A.02.00

Q Same as I

Many, but not all, usages require the I and Q channels to have an identical setup. To simplify channel setup, the Q Same as I will cause the Q channel range to be mirrored from the I channel. That way you only need to set up one channel (the I channel). The I channel values are copied to the Q channel, so at the time Q Same as I is Off, the I and Q channel setups will be identical.

Key Path	AMPTD Y Scale, Range, Q Range
Remote Command	<code>[:SENSe] :VOLTage POWer:IQ:MIRRored OFF ON 0 1</code> <code>[:SENSe] :VOLTage POWer:IQ:MIRRored?</code>

Example	Turn off the mirroring of I Range to Q Range. VOLT:IQ:MIRR OFF POW:IQ:MIRR OFF
Couplings	When On, the I Range value is mirrored (copied) to the Q Range.
Preset	On
State Saved	Saved in instrument state.
Range	On Off
Readback Text	"Q Same as I" when On, otherwise none.
Initial S/W Revision	Prior to A.02.00

I/Q Gain Ranges

See the following sections:

["1 V Peak" on page 1119](#)

["0.5 V Peak" on page 1119](#)

["0.25 V Peak" on page 1119](#)

["0.125 V Peak" on page 1120](#)

1 V Peak

Set the channel gain state to 1 Volt Peak.

Key Path	AMPTD Y Scale, I Range Q Range
Initial S/W Revision	Prior to A.02.00

0.5 V Peak

Set the channel gain state to 0.5 Volt Peak.

Key Path	AMPTD Y Scale, I Range Q Range
Initial S/W Revision	Prior to A.02.00

0.25 V Peak

Set the channel gain state to 0.25 Volt Peak.

Key Path	AMPTD Y Scale, I Range Q Range
Initial S/W Revision	Prior to A.02.00

0.125 V Peak

Set the channel gain state to 0.125 Volt Peak.

Key Path	AMPTD Y Scale, I Range Q Range
Initial S/W Revision	Prior to A.02.00

Select Trace

Displays a menu that enables you to select the trace that is to receive the action of all successive trace-specific commands like scaling, assignment of trace data, and so on. The selected trace is outlined in green and is always visible. While the Select Trace menu is showing, each visible trace is annotated in the middle with its own trace number, as shown in the following figure. The trace number annotations disappear when any other menu is showing.

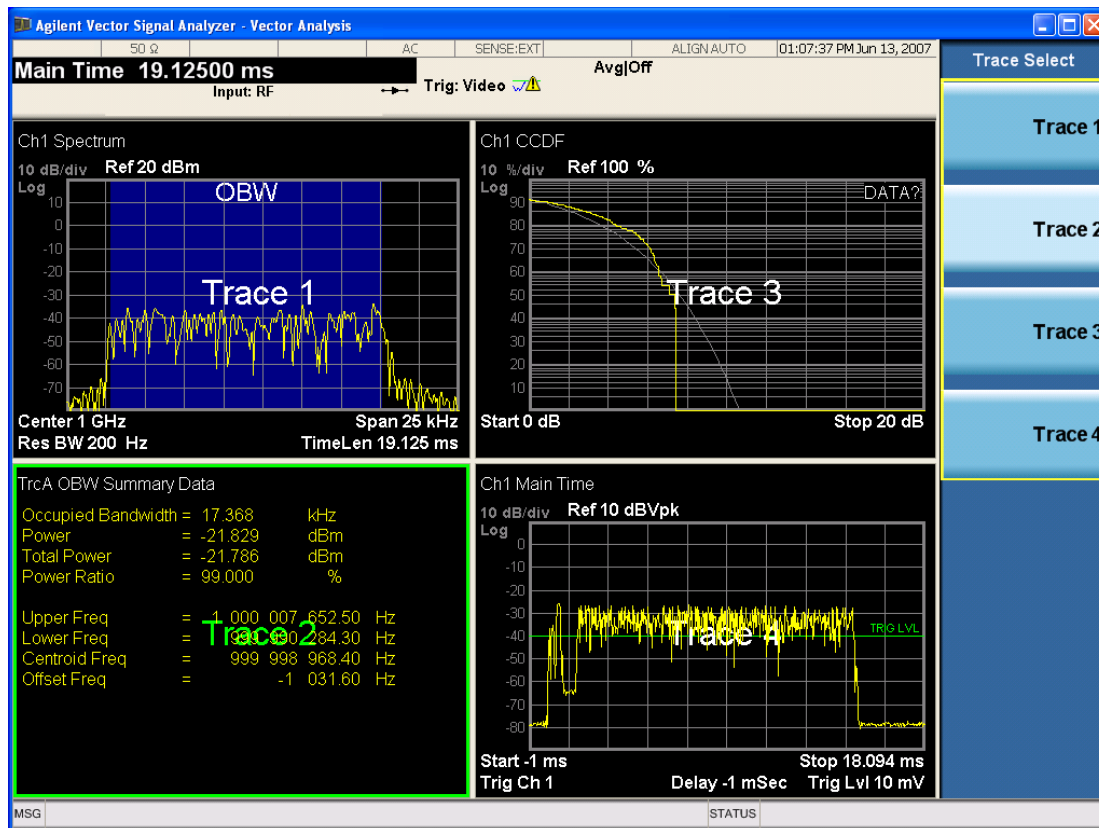

Grid 2x2 layout showing trace annotations when Trace Select dialog is active

This softkey also appears in the X and Y scaling menus. There is only one selected trace at any time. If you change which trace is selected, that change is reflected in this softkey/menu wherever it appears. Other ways to select a trace include use of the Next Window key, clicking within a trace window with a mouse cursor, and issuing a trace-specific SCPI command.

There is no SCPI command associated with this function. Instead, SCPI commands that are trace-specific have an index on the TRACe node that determines the selected trace. Using such a command has the side

effect that the trace addressed by the SCPI command becomes the selected trace for any front panel interaction.

Key Path	Trace/Detector or Span X Scale or AMPTD Y Scale
Mode	VSA, LTE, LTETDD, IDEN, LTEAFDD, LTEATDD
Notes	No SCPI. Front panel only.
Couplings	Affects any trace-specific commands
Range	Trace 1 Trace 2 Trace 3 Trace 4 Trace 5 Trace 6
Readback Text	Trace <n>
Initial S/W Revision	Prior to A.02.00
Modified at S/W Revision	A.02.00

Couple Ref to Range

When Couple Ref to Range is on, Y scaling is adjusted when the Range changes. For example, on traces with Y units of dBm, the reference value changes by the same amount in dB as the Range does. On a trace with Y units of Volts, the Per Division setting changes by a factor of approximately 1.25 when the Range changes by 2 dB. This function can be turned on or off for each individual trace.

Key Path	AMPTD Y Scale
Mode	VSA, LTE, LTETDD, IDEN, LTEAFDD, LTEATDD
Measurement	<meas>:=VECTor ADEMod DDEMod W11A W11B EVM IPOWER IDEMod MOTotalk
Remote Command	:DISPlay:<meas>:TRACe [1] 2 . . . 4 : Y [: SCALE] : RLEVEL : AUTO OFF ON 0 1 :DISPlay:<meas>:TRACe [1] 2 . . . 4 : Y [: SCALE] : RLEVEL : AUTO ?
Example	DISP:VECT:TRAC1:Y:RLEV:AUTO ON DISP:VECT:TRAC1:Y:RLEV:AUTO?
Notes	Range coupling is not available for Phase and Group delay traces.
Preset	1
State Saved	Saved in instrument state.
Range	On Off
Initial S/W Revision	Prior to A.02.00
Modified at S/W Revision	A.02.00

Y Reference Value

Controls the Y value of the selected trace at the Reference Position. It has no effect on hardware input settings.

See "[Y Reference: Position](#)" on page 1122 for more details.

Key Path	AMPTD Y Scale
----------	---------------

Mode	VSA, LTE, LTETDD, IDEN, LTEAFDD, LTEATDD
Measurement	<meas>:=VECTor ADEMod DDEMod W11A W11B EVM IPOWER IDEMod MOTotalk
Remote Command	:DISPlay:<meas>:TRACe[1] 2 ...4:Y[:SCALE]:RLEVel <real> :DISPlay:<meas>:TRACe[1] 2 ...4:Y[:SCALE]:RLEVel?
Example	DISP:VECT:TRAC:Y:RLEV 20 DISP:VECT:TRAC:Y:RLEV?
Couplings	None. This does not affect any hardware input settings.
Preset	Depends on trace
State Saved	Saved in instrument state.
Min	-9.9E+37
Max	9.9E+37
Initial S/W Revision	Prior to A.02.00
Modified at S/W Revision	A.02.00

Y Scale Per Division

Controls the Y scale per division of the selected trace.

Key Path	AMPTD Y Scale
Mode	VSA, LTE, LTETDD, IDEN, LTEAFDD, LTEATDD
Measurement	<meas>:=VECTor ADEMod DDEMod W11A W11B EVM IPOWER IDEMod MOTotalk
Remote Command	:DISPlay:<meas>:TRACe[1] 2 ...4:Y[:SCALE]:PDIVision <real> :DISPlay:<meas>:TRACe[1] 2 ...4:Y[:SCALE]:PDIVision?
Example	DISP:VECT:TRAC:Y:PDIV 10 DISP:VECT:TRAC:Y:PDIV?
Couplings	None.
Preset	Depends on trace
State Saved	Saved in instrument state.
Min	-9.9E+37
Max	9.9E+37
Initial S/W Revision	Prior to A.02.00
Modified at S/W Revision	A.02.00

Y Reference: Position

Sets the position of the reference line for Y scaling for the selected trace. It can be set to the top, bottom, or center of the grid.

Key Path	AMPTD Y Scale
Mode	VSA, LTE, LTETDD, IDEN, LTEAFDD, LTEATDD
Measurement	<meas>:=VECTor ADEMod DDEMod W11A W11B EVM IPOWER IDEMod MOTotalk
Remote Command	:DISPlay:<meas>:TRACe[1] 2 ...4:Y[:SCALE]:RPOSition TOP CENTER BOTTom :DISPlay:<meas>:TRACe[1] 2 ...4:Y[:SCALE]:RPOSition?
Example	DISP:VECT:TRAC1:Y:RPOS TOP DISP:VECT:TRAC1:Y:RPOS?
Couplings	Changing trace format or data can affect this. Each format "remembers" its reference position.
Preset	Depends on trace format and trace data. Top for LogMag or most LinearMag traces, middle for Real, Imaginary, Vector displays, Eye diagrams, Phase, Delay, Bottom for Linear Mag EVM.
State Saved	Saved in instrument state.
Range	Top Ctr Bottom
Initial S/W Revision	Prior to A.02.00
Modified at S/W Revision	A.02.00

Reference Line

Controls whether the Y reference line is visible or not.

Key Path	AMPTD Y Scale
Mode	VSA, LTE, LTETDD, IDEN, LTEAFDD, LTEATDD
Measurement	<meas>:=VECTor ADEMod DDEMod W11A W11B EVM IPOWER IDEMod MOTotalk
Remote Command	:DISPlay:<meas>:TRACe[1] 2 ...4:RLINE OFF ON 0 1 :DISPlay:<meas>:TRACe [1] 2 ...4:RLINe?
Example	DISP:VECT:TRAC1:RLIN ON DISP:VECT:TRAC1:RLIN?
Preset	OFF
State Saved	Saved in instrument state.
Initial S/W Revision	Prior to A.02.00
Modified at S/W Revision	A.02.00

Y Unit Preference

Displays a menu that enables you to set the preferred Y unit for the selected trace. You can select Peak, RMS, Power units, or an automatic selection. The automatic selection uses Power units for frequency domain data and Peak units for time domain data.

Key Path	AMPTD Y Scale
----------	---------------

Mode	VSA, LTE, LTETDD, IDEN, LTEAFDD, LTEATDD
Measurement	<meas>:=VECTor ADEMod DDEMod W11A W11B EVM IPOWER IDEMod MOTotalk
Remote Command	:DISPlay:<meas>:TRACe [1] 2 ...4:Y:UNIT:PREFerence AUTO PEAK RMS POWER MRMS :DISPlay:<meas>:TRACe [1] 2 ...4:Y:UNIT:PREFerence?
Example	DISP:VECT:TRAC1:Y:UNIT:PREF PEAK DISP:VECT:TRAC1:Y:UNIT:PREF?
Preset	AUTO
State Saved	Saved in instrument state.
Range	AUTO PEAK RMS POW MRMS
Readback Text	Auto Peak RMS Power mRMS
Initial S/W Revision	Prior to A.02.00
Modified at S/W Revision	A.02.00

The following SCPI only command can be used to determine exactly which Y unit was chosen based on the setting of the above:

Key Path	AMPTD Y Scale
Mode	VSA, LTE, LTETDD, IDEN
Measurement	<meas>:=VECTor ADEMod DDEMod W11A W11B EVM IPOWER IDEMod MOTotalk
Remote Command	:DISPlay:<meas>:TRACe [1] 2 ...4:Y:UNIT?
Example	DISP:VECT:TRAC1:Y:UNIT?
Initial S/W Revision	Prior to A.02.00
Modified at S/W Revision	A.02.00

Y Log Ratio

Enabled if the Trace Format is set to LogMag (Linear Unit). In this format type, you set the Y Log Ratio instead of Y Scale Per Division to determine Y scaling. It sets the ratio of the top of the Y axis to the bottom.

Key Path	AMPTD Y Scale
Mode	VSA, LTE, LTETDD, IDEN, LTEAFDD, LTEATDD
Measurement	<meas>:=VECTor ADEMod DDEMod W11A W11B EVM IPOWER IDEMod MOTotalk
Remote Command	:DISPlay:<meas>:TRACe [1] 2 ...4:Y:LRATio <real> :DISPlay:<meas>:TRACe [1] 2 ...4:Y:LRATio?
Example	DISP:VECT:TRAC1:Y:LRAT 10000 DISP:VECT:TRAC1:Y:LRAT?
Notes	This is grayed out if the trace format is not Log Mag (linear unit).

Preset	100000
State Saved	Saved in instrument state.
Min	1.001
Max	100e6
Initial S/W Revision	Prior to A.02.00
Modified at S/W Revision	A.02.00

Vector Horiz Center

Sets the position of the origin for Vector trace formats such as I-Q and Constellation. When using one of these formats, you set the vertical (imaginary) axis scaling with the Y Reference Value, Y Reference Position, and Y Scale Per Division properties. The scaling of the horizontal axis is set to maintain an aspect ratio of 1:1.

Key Path	AMPTD Y Scale
Mode	VSA, LTE, LTETDD, IDEN, LTEAFDD, LTEATDD
Measurement	<meas>:=VECTor ADEMod DDEMod W11A W11B EVM IPOWER IDEMod MOTotalk
Remote Command	:DISPlay:<meas>:TRACe[1] 2 ...4:VHCenter <real> :DISPlay:<meas>:TRACe[1] 2 ...4:VHCenter?
Example	DISP:DDEM:TRAC1:VHC 0.2 DISP:DDEM:TRAC1:VHC?
Preset	0
State Saved	Saved in instrument state.
Min	-9.9e37
Max	9.9e37
Initial S/W Revision	Prior to A.02.00
Modified at S/W Revision	A.02.00

Copy Y Scale

Copies the following Y scaling information from the selected trace to another:

- Y reference Position
- Y Reference Value
- Y Unit Preference
- Vector Horiz Center
- Couple Ref to Range
- Y Log Ratio

12 MotoTalk Measurement
AMPTD Y Scale (Amplitude)

- Y Reference Line

This is a front-panel only function.

Key Path	AMPTD Y Scale, Y Axis Scaling
Mode	VSA, LTE, LTETDD, IDEN, LTEAFDD, LTEATDD
Initial S/W Revision	Prior to A.02.00
Modified at S/W Revision	A.02.00

Auto Couple

The Auto Couple feature provides a quick and convenient way to automatically couple multiple instrument settings. This helps ensure accurate measurements and optimum dynamic range. When the Auto Couple feature is activated, either from the front panel or remotely, all parameters of the current measurement that have an Auto/Manual mode are set to Auto mode and all measurement settings dependent on (or coupled to) the Auto/Man parameters are automatically adjusted for optimal performance.

However, the Auto Couple key actions are confined to the current measurement only. It does not affect other measurements in the mode, and it does not affect markers, marker functions, or trace or display attributes.

See ["More Information" on page 1127](#)

Key Path	Front-panel key
Remote Command	:COUPle ALL NONE
Example	:COUP ALL
Notes	:COUPle ALL puts all Auto/Man parameters in Auto mode (equivalent to pressing the Auto Couple key). :COUPLE NONE puts all Auto/Man parameters in manual mode. It decouples all the coupled instrument parameters and is not recommended for making measurements.
Initial S/W Revision	Prior to A.02.00

More Information

There are two types of functions that have Auto/Manual modes.

Auto/Man Active Function keys

An Auto/Man toggle key controls the binary state associated with an instrument parameter by toggling between Auto (where the parameter is automatically coupled to the other parameters it is dependent upon) and Man (where the parameter is controlled independent of the other parameters), as well as making the parameter the active function. The current mode is indicated on the softkey with either Auto or Man underlined as illustrated below.



Auto/Man 1-of-N keys

An Auto/Man 1-of-N key allows you to manually pick from a list of parameter values, or place the function in Auto, in which case the value is automatically selected (and indicated) as shown below. If in Auto, Auto is underlined on the calling key. If in manual operation, manual is indicated on the calling key. But the calling key does not actually toggle the function, it simply opens the menu.

12 MotoTalk Measurement
Auto Couple

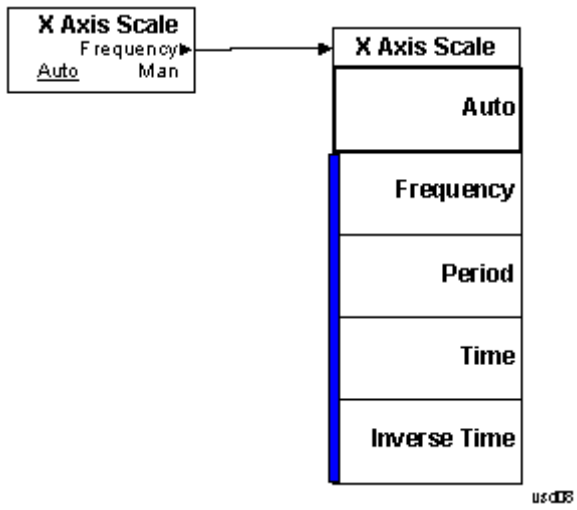

BW (Bandwidth)

Displays a menu that enables you to control the resolution bandwidth of the spectrum measurement result, as well as the shape of the resolution bandwidth filter (controlled by the FFT windowing function).

Key Path	Front Panel
Mode	VSA, LTE, LTETDD, IDEN
Initial S/W Revision	Prior to A.02.00
Modified at S/W Revision	A.02.00

FFT Window

Displays a menu that enables you to choose the Window function that is applied to the time data prior to the FFT calculation used for Spectrum and PSD displays. Four windows are available.

Window name	Common usage	Normalized ENBW (Hz-s)
Uniform	Transient or self-windowing signals, signals that are periodic within a time record length.	1.0
Hanning	Frequency resolution	1.5
Gaussian	High dynamic range	2.21536
Flat Top	High amplitude accuracy	3.8194

The normalized ENBW is the equivalent noise bandwidth, that is, the width of a rectangular filter that passes the same amount of white noise as the window. It is used to define the resolution bandwidth.

Key Path	BW
Mode	VSA, LTE, LTETDD, IDEN
Measurement	<meas>:=VECTor ADEMod DDEMod W11A W11B EVM IPOWER IDEMod MOTotalk
Remote Command	[:SENSe] :<meas>:FFT:WINDow[:TYPE] UNIFORM HANNing GAUSSian FLATtop [:SENSe] :<meas>:FFT:WINDow[:TYPE] ?
Example	VECT:FFT:WIND GAUS VECT:FFT:WIND?
Couplings	See Res BW and Res BW Coupling
Preset	FLAT
State Saved	Saved in instrument state.
Range	Uniform Hanning Gaussian (High Dyn Rng) Flat Top (High Amptd Accy)
Readback Text	Uniform Hanning Gaussian Flat Top
Initial S/W Revision	Prior to A.02.00
Modified at S/W Revision	A.02.00

Cont (Continuous Measurement/Sweep)

Sets the analyzer for Continuous measurement operation. The single/continuous state is Meas Global so the setting will affect all measurements. If you are Paused, pressing Cont does a Resume.

Key Path	Front-panel key
Remote Command	:INITiate:CONTinuous OFF ON 0 1 :INITiate:CONTinuous?
Example	:INIT:CONT 0 puts analyzer in Single measurement operation. :INIT:CONT 1 puts analyzer in Continuous measurement operation
Preset	ON (Note that SYST:PRESet sets INIT:CONT to ON but *RST sets INIT:CONT to OFF)
State Saved	Saved in instrument state
Backwards Compatibility Notes	For Spectrum Analysis mode in ESA and PSA, there is no Cont hardkey, instead there is a Sweep Single/Cont key. In these analyzers, switching the Sweep Single/Cont key from Single to Cont restarts averages (displayed average count reset to 1), but does not restart Max Hold and Min Hold. The X-Series has Single and Cont keys in place of the SweepSingleCont key. In the X-Series, if in single measurement, the Cont key (and INIT:CONT ON) switches to continuous measurement, but never restarts a measurement and never resets a sweep.
Initial S/W Revision	Prior to A.02.00

In Swept SA Measurement (Spectrum Analysis Mode):

The analyzer takes repetitive sweeps, averages, measurements, etc., when in Continuous mode. When the average count reaches the Average/Hold Number the count stops incrementing, but the analyzer keeps sweeping. See the Trace/Detector section for the averaging formula used both before and after the Average/Hold Number is reached. The trigger condition must be met prior to each sweep. The type of trace processing for multiple sweeps, is set under the Trace/Detector key, with choices of Trace Average, Max Hold, or Min Hold.

In Other Measurements/Modes:

With Avg/Hold Num (in the Meas Setup menu) set to Off or set to On with a value of 1, a sweep is taken after the trigger condition is met; and the analyzer continues to take new sweeps after the current sweep has completed and the trigger condition is again met. However, with Avg/Hold Num set to On with a value >1, multiple sweeps (data acquisitions) are taken for the measurement. The trigger condition must be met prior to each sweep. The sweep is not stopped when the average count k equals the number N set for Avg/Hold Num is reached, but the number k stops incrementing. A measurement average usually applies to all traces, marker results, and numeric results. But sometimes it only applies to the numeric results.

If the analyzer is in Single measurement, pressing the Cont key does not change k and does not cause the sweep to be reset; the only action is to put the analyzer into Continuous measurement operation.

If it is already in continuous sweep:

the INIT:CONT 1 command has no effect

12 MotoTalk Measurement
Cont (Continuous Measurement/Sweep)

the INIT:CONT 0 command will place the analyzer in Single Sweep but will have no effect on the current sequence until $k = N$, at which point the current sequence will stop and the instrument will go to the idle state.

File

See "File" on page 236

FREQ Channel

Displays a menu that enables you to set center frequency, start frequency, stop frequency, and center frequency step. Pressing the Freq hardkey changes the active function to Center Frequency.

The frequency parameters for any vector measurement consist of two pairs of properties: Center Frequency and Span or Start Frequency and Stop Frequency. These behave much as they do in any other application, but there is the additional constraint that the span is limited to much less than the center frequency range.

If you change center frequency, the start and stop frequencies change by the same amount.

If you change span, start frequency and stop frequency are changed by 1/2 the span change.

If you change start frequency, stop frequency remains fixed and span and center frequency are refigured accordingly. Changing stop frequency has similar behavior.

Limits:

If you change the start frequency such that it equals or exceeds the stop frequency, the new start frequency is accepted if possible and the stop frequency is set to min span above the start. Similarly if you attempt to set the stop below the start, the start frequency moves to a min span below the new stop frequency.

If you reduce the start frequency beyond a max span below the stop, the stop frequency is "dragged along" such that it is a max span above the new start frequency, and similarly increasing the stop frequency drags the start frequency along if you attempt to increase the span beyond the maximum.

Stop frequency can be 1/2 span above the maximum center frequency, but frequency-domain traces are blanked above the maximum center frequency.

Start frequency can be 1/2 span below the minimum center frequency, but frequency-domain traces are blanked below the minimum center frequency.

Key Path	Front Panel
Mode	VSA, LTE, LTETDD, IDEN
Initial S/W Revision	Prior to A.02.00
Modified at S/W Revision	A.02.00

Center Freq

Sets the frequency of the display Center.

Key Path	FREQ Channel
Mode	VSA, LTE, LTETDD, IDEN
Remote Command	[:SENSe] :FREQuency:CENTer <freq> [:SENSe] :FREQuency:CENTer?
Example	FREQ:CENT 985 MHZ FREQ:CENT?

Couplings	Start Freq, Stop Freq, and Span. See " FREQ Channel " on page 1134 for more details.
Preset	1 GHz
State Saved	Saved in instrument state.
Min	0 Hz
Max	Depends on frequency range option.
Initial S/W Revision	Prior to A.02.00
Modified at S/W Revision	A.02.00

Start Freq

Sets the frequency of the display Start.

Key Path	FREQ Channel
Mode	VSA, IDEN
Remote Command	<code>[:SENSe] :FREQuency:STARt <freq></code> <code>[:SENSe] :FREQuency:STARt?</code>
Example	FREQ:STAR 980 MHz FREQ:STAR?
Couplings	Stop Freq, Center Freq, and Span. See " FREQ Channel " on page 1134 for more details.
Preset	Depends on span option. It is 1/2 max span below 1 GHz.
State Saved	Saved in instrument state.
Min	-9.9e37
Max	9.9e37
Initial S/W Revision	Prior to A.02.00
Modified at S/W Revision	A.02.00

Stop Freq

Sets the frequency of the display Stop.

Key Path	FREQ Channel
Mode	VSA, IDEN
Remote Command	<code>[:SENSe] :FREQuency:STOP <freq></code> <code>[:SENSe] :FREQuency:STOP?</code>
Example	FREQ:STOP 990 MHz FREQ:STOP?
Couplings	Start Freq, Center Freq, and Span. See " FREQ Channel " on page 1134 for more details.
Preset	Depends on span option. It is 1/2 max span above 1 GHz.

State Saved	Saved in instrument state.
Min	-9.9e37
Max	9.9e37
Initial S/W Revision	Prior to A.02.00
Modified at S/W Revision	A.02.00

CF Step

Sets the amount the center frequency changes if it is the active function when you press the Up or Down arrow key. Note: the start and stop frequency also changes by the amount of the CF Step if the Up/Down arrow keys are used to change them; but the key is mainly used in connection with stepping the center frequency, so the legacy key name has been retained. The step size in Auto mode is 1/10th the span. It can be set to any value in manual mode.

Key Path	FREQ Channel
Mode	VSA, LTE, LTETDD, IDEN
Remote Command	[:SENSe]:FREQuency:CENTer:STEP[:INCRement] <freq> [:SENSe]:FREQuency:CENTer:STEP[:INCRement]? [:SENSe]:FREQuency:CENTer:STEP:AUTO OFF ON 0 1 [:SENSe]:FREQuency:CENTer:STEP:AUTO?
Example	FREQ:CENT:STEP 1 MHZ FREQ:CENT:STEP? FREQ:CENT:STEP:AUTO ON FREQ:CENT:STEP:AUTO?
Couplings	1/10th Span when auto is turned on.
Preset	Depends on span option; 1/10th default span.
State Saved	Saved in instrument state.
Min	-9.9e37
Max	9.9e37
Initial S/W Revision	Prior to A.02.00
Modified at S/W Revision	A.02.00

Input/Output

See ["Input/Output" on page 146](#)

Marker

Displays the Marker menu. A marker can be placed on a trace to precisely determine the value of the trace data at the marker position. Markers can also be used in pairs to read the difference (or delta) between two data points. They can also be used to make power calculations over a band of frequencies or a time interval. See "[Marker Function](#)" on page 1157 for more details.

The functions in this menu include a 1-of-N selection of the control mode **Normal**, **Delta**, **Fixed**, or **Off** for the selected marker. The control mode is described below.

Pressing **Marker** always makes the selected maker's X position the active function.

If the currently selected marker is **Off**, pressing **Marker** sets it to **Normal** mode and places it at the center of the screen on the currently selected trace.

As a convenience, if there are no markers displayed on the current trace, pressing the marker hardkey (whenever the marker menu is already showing) selects the lowest numbered marker that is currently off and turns it on in normal mode on the selected trace. In other words, pressing the Marker hardkey twice always turns on a marker on the selected trace if none was turned on before.

Key Path	Front Panel
Mode	VSA, LTE, LTETDD, IDEN,LTEAFDD,LTEATDD
Initial S/W Revision	Prior to A.02.00
Modified at S/W Revision	A.02.00

Select Marker

Specifies the selected marker. The selected marker is the one that is affected by the marker position and properties settings, peak search, and other marker functions. Several menus have a Select Marker key for convenience. Marker selection using any one of these is reflected in all others, in other words, there is only one selected marker for the whole measurement. If all markers are off, then marker 1 becomes the selected marker.

As a convenience, if no markers are displayed on the selected trace, selecting a marker that is off automatically turns it on in normal mode on the selected trace.

There is no SCPI function for selecting a marker. Instead, SCPI functions can explicitly include the index of the marker for which they are to apply. (Most SCPI marker functions that affect the state of a marker also make it the selected marker for front panel commands.)

Key Path	Marker or Marker> or Marker Function or Peak Search
Mode	VSA, LTE, LTETDD, IDEN,LTEAFDD,LTEATDD
State Saved	No
Range	1 2 3 4 5 6 7 8 9 10 11 12
Initial S/W Revision	Prior to A.02.00
Modified at S/W Revision	A.02.00

Control Mode

Pressing **Normal**, **Delta**, **Fixed**, or **Off** sets the control mode of the selected marker. The current control mode is shown by highlighting the appropriate key.

The SCPI command in the table below selects the marker and sets the marker control mode as described under "[Normal \(Position\)](#)" on page 1139, "[Delta](#)" on page 1140, "[Fixed](#)" on page 1140 and "[Off](#)" on page 1141. All interactions and dependencies detailed under the key description are enforced when the remote command is sent.

Key Path	Marker
Mode	VSA, LTE, LTETDD, IDEN,LTEAFDD,LTEATDD
Measurement	<meas>:=VECTor ADEMod DDEMod W11A W11B EVM IPOWER IDEMod MOTotalk
Remote Command	:CALCulate:<meas>:MARKer[1] 2 ...12:MODE POSition DELTA FIXEd =OFF :CALCulate:<meas>:MARKer[1] 2 ...12:MODE?
Example	CALC:VECT:MARK1:MODE POS CALC:VECT:MARK1:MODE?
Couplings	When Delta mode is selected or when the mode is changed from Delta to Off, the marker relative to the selected marker can be affected as described in the text descriptions below.
Preset	=OFF
State Saved	Saved in instrument state.
Range	Normal Delta Fixed Off
Initial S/W Revision	Prior to A.02.00
Modified at S/W Revision	A.02.00

Normal (Position)

Reports the trace data value (Y value) at a particular point on a trace. The marker's absolute X (and Z) position is specified by you in displayed units. The marker symbol appears on the trace at the specified position and tracks the absolute Y value at that position as it changes from scan to scan. The absolute Y value is displayed in the marker readout area. In older instruments this was called Position mode, and the designation can still be used for backward compatibility.

For Control Mode SCPI command information see: "[Control Mode](#)" on page 1139

Key Path	Marker
Mode	VSA, LTE, LTETDD, IDEN,LTEAFDD,LTEATDD
Initial S/W Revision	Prior to A.02.00
Modified at S/W Revision	A.02.00

Delta

Reports the difference between Y values at two points. A delta marker is relative to an associated reference marker on the same trace. (The reference marker can be set on the Marker, Properties, Relative To menu). The reference marker is usually fixed, but can also be normal or delta. The X (and Z) position of a delta marker is specified as an offset from the reference marker position. The delta marker symbol tracks the absolute Y value just like a normal marker, but the marker readout displays the difference between the absolute Y values of the delta marker and its reference marker (absolute units are used even if the reference is itself a delta marker). Usually this is a straight difference in the current displayed units. For example, if the trace format is LogMag (dBm), the delta marker displays the difference in dB, thus showing a power ratio. But if the trace format is Real, then the delta marker shows a voltage difference, not a ratio. Exceptions for this are:

- When the trace format is **Linear Mag** or **Log Mag (linear unit)** the delta marker displays a voltage ratio or (if the Y Axis unit is Power) a power ratio, rather than a difference.
- When either the marker or its reference has a marker function turned on, the delta marker always displays a ratio or its decibel equivalent. See "[Marker Function](#)" on page 1157 for more details on how delta markers work with marker functions. The type of ratio calculated (power or voltage) depends on the delta marker units; the reference marker value is converted as needed so it has compatible units.
- When the trace format is **Wrap Phase**, the delta marker readout is constrained to the wrapped phase display range, which is usually $(-180, +180]$ degrees. For example, if the absolute phase at marker 1 is 170 deg and its reference has phase of -170 deg, the delta does not show 340 deg, but -20 deg. Note that the Wrap Phase display range can be changed (see "[Phase/Trellis Offset](#)" on page 1253).

There is no current support for calculating deltas across traces (and this cannot be done at all unless the traces have the same domain and ranges).

By default, the reference marker for marker 1 is marker 2; for marker 2 is 3 and so on, but the reference marker can be changed. See "[Relative To](#)" on page 1142.

For coupling rules, see "[Coupling of Delta and Reference Markers](#)" on page 1152.

For Control Mode SCPI command information see: "[Control Mode](#)" on page 1139

Key Path	Marker
Mode	VSA, LTE, LTETDD, IDEN, LTEAFDD, LTEATDD
Initial S/W Revision	Prior to A.02.00
Modified at S/W Revision	A.02.00

Fixed

Mainly used as reference markers for Delta markers. A fixed marker's X and Y Axis values can be directly or indirectly specified by you, and they remain fixed once specified, in other words, they do not follow the trace data value. These markers are represented on the display by an "X" rather than a diamond. If a marker is changed from off to fixed, the X and Y (and Z) values are chosen to put it in the center of the display. If the marker is changed from some other type to fixed, the current X and Z values of the marker remain unchanged. The Y value is taken from the current trace data value and must be changed manually thereafter.

For Control Mode SCPI command information see: ["Control Mode" on page 1139](#)

Key Path	Marker
Mode	VSA, LTE, LTETDD, IDEN,LTEAFDD,LTEATDD
Initial S/W Revision	Prior to A.02.00
Modified at S/W Revision	A.02.00

Off

Turning a marker off makes it invisible, and also its annotation.

Turning a marker on (i.e., changing its control mode from Off to any other control mode) assigns the marker to the currently selected trace.

For Control Mode SCPI command information see: ["Control Mode" on page 1139](#)

Key Path	Marker
Mode	VSA, LTE, LTETDD, IDEN,LTEAFDD,LTEATDD
Initial S/W Revision	Prior to A.02.00
Modified at S/W Revision	A.02.00

Coupling of Delta and Reference Markers

The following coupling rules apply from the front panel and also if the equivalent SCPI commands are sent.

Pressing the Delta key causes the selected marker to become a delta marker if it is not already. Also, the selected marker's reference is affected as follows:

- If the reference marker was off, it is turned on as a fixed marker.
- The reference marker is moved to the trace of the selected marker and set to the same position as the selected marker.
- If the delta marker has a marker function turned on, the reference marker takes on the same function (with the same band limits).

Exception: Pressing Delta when the selected marker's mode is not yet Delta does not move or change a reference marker that is already turned on (Normal, Delta, or Fixed) and on the same trace as the selected marker. It merely changes the selected marker's mode to Delta and shows the current offset between it and the reference. If you press Delta again (when the selected marker is already in Delta mode) then the reference is moved and modified as described above.

When a delta marker is changed to any other control mode, if its reference marker is fixed then the reference marker is also turned off.

If you move a delta marker to a different trace, it is forced to Normal mode and if its reference is fixed, the reference is turned off.

A delta marker is forced to Normal mode if you turn its reference off or if you move its reference to another trace. (In the latter case the reference is not turned off even if it is fixed.)

If you change the selected marker's reference (using the Marker, Properties, Relative To), the selected marker is forced to Delta mode. This change of the selected marker to Delta mode causes its new reference's control mode and position to change as described above.

Marker Properties

Accesses a menu of common marker properties.

Key Path	Marker
Mode	VSA, LTE, LTETDD, IDEN,LTEAFDD,LTEATDD
Initial S/W Revision	Prior to A.02.00

Select Marker

Specifies the selected marker. The selected marker is the one that is affected by the marker position and properties settings, peak search, and other marker functions. Several menus have a Select Marker key for convenience. Marker selection using any one of these is reflected in all others, in other words, there is only one selected marker for the whole measurement. If all markers are off, then marker 1 becomes the selected marker.

As a convenience, if no markers are displayed on the selected trace, selecting a marker that is off automatically turns it on in normal mode on the selected trace.

There is no SCPI function for selecting a marker. Instead, SCPI functions can explicitly include the index of the marker for which they are to apply. (Most SCPI marker functions that affect the state of a marker also make it the selected marker for front panel commands.)

Key Path	Marker or Marker> or Marker Function or Peak Search
Mode	VSA, LTE, LTETDD, IDEN,LTEAFDD,LTEATDD
State Saved	No
Range	1 2 3 4 5 6 7 8 9 10 11 12
Initial S/W Revision	Prior to A.02.00
Modified at S/W Revision	A.02.00

Relative To

Enables you to specify which marker is used as a reference for the selected marker when the selected marker's control mode is set to Delta. By default, the reference marker is numerically one higher than the selected marker, that is, marker 1 is relative to marker 2, marker 2 to marker 3, and so on. Marker 12 by default is relative to marker 1. This key enables you to change the reference marker from the default. Note that a marker cannot be made relative to itself.

Key Path	Marker, Properties
Mode	VSA, LTE, LTETDD, IDEN, LTEAFDD, LTEATDD
Measurement	<meas>:=VECTor ADEMod DDEMod W11A W11B EVM IPOWER IDEMod MOTotalk
Remote Command	:CALCulate:<meas>:MARKer [1] 2 . . . 12:REFerence <integer> :CALCulate:<meas>:MARKer [1] 2 . . . 12:REFerence?
Example	CALC:VECT:MARK2:REF 4 CALC:VECT:MARK2:REF?
Notes	The reference marker cannot be the same value as the selected marker, that is, a marker cannot be relative to itself. The currently selected marker is not an available choice in the relative to selection (i.e., the selected marker appears grayed out). When queried, a single value is returned (the specified marker numbers relative marker).
Couplings	See " Coupling of Delta and Reference Markers " on page 1152. The old reference remains as it was.
Preset	2 3 4 5 6 7 8 9 10 11 12 1
State Saved	Saved in instrument state.
Range	1 2 3 4 5 6 7 8 9 10 11 12
Initial S/W Revision	Prior to A.02.00
Modified at S/W Revision	A.02.00

Complex Format

Determines the format for the readout when a marker is placed on a complex display (vector or constellation). The choices are to read out in rectangular or polar coordinates. The readout format applies to the marker display and marker table only; there is no SCPI for reading out the marker value in polar form.

Key Path	Marker, Properties
Mode	VSA, LTE, LTETDD, IDEN, LTEAFDD, LTEATDD
Measurement	<meas>:=VECTor ADEMod DDEMod W11A W11B EVM IPOWER IDEMod MOTotalk
Remote Command	:CALCulate:<meas>:MARKer [1] 2 . . . 12:CFORmat RECTangular POLar :CALCulate:<meas>:MARKer [1] 2 . . . 12:CFORmat?
Example	CALC:VECT:MARK1:CFOR RECT CALC:VECT:MARK1:CFOR?
Preset	RECT
State Saved	Saved in instrument state.
Range	Rect Polar
Initial S/W Revision	Prior to A.02.00
Modified at S/W Revision	A.02.00

Marker Trace

Enables you to determine the trace to which a marker is assigned. By default, when a marker is turned on it is assigned to the currently selected trace. You can change that assignment using this control.

Key Path	Marker, Properties
Mode	VSA, LTE, LTE-TDD, IDEN, LTE-AFDD, LTE-ATDD
Measurement	<meas>:=VECTor ADEMod DDEMod W11A W11B EVM IPOWER IDEMod MOTotalk
Remote Command	:CALCulate:<meas>:MARKer[1] 2 ...12:TRACe <integer> :CALCulate:<meas>:MARKer[1] 2 ...12:TRACe?
Example	CALC:VECT:MARK3:TRAC 2 CALC:VECT:MARK3:TRAC?
Couplings	See " Coupling of Delta and Reference Markers " on page 1152.
Preset	Marker is assigned to currently selected trace when turned on.
State Saved	Saved in instrument state.
Range	Trace 1 Trace 2 Trace 3 Trace 4
Min	1
Max	4
Initial S/W Revision	Prior to A.02.00
Modified at S/W Revision	A.02.00

Marker Count

Enables the frequency counter algorithm on the selected marker. This algorithm can more precisely determine the frequency of a peak. The marker must be on a frequency domain trace, with data coming from hardware. Place the marker on a peak and enable the frequency counter. The marker readout then shows the calculated frequency rather than the marker X position. Only one marker can be counted at any time. Turning on marker count for any marker turns it off for all other markers.

Key Path	Marker, Properties
Mode	VSA, IDEN, LTE-AFDD, LTE-ATDD
Measurement	<meas>:=VECTor ADEMod DDEMod W11A W11B EVM IPOWER IDEMod MOTotalk
Remote Command	:CALCulate:<meas>:MARKer[1] 2 ...12:FCOunt[:STATe] OFF ON 0 1 :CALCulate:<meas>:MARKer[1] 2 ...12:FCOunt[:STATe]?
Example	CALC:VECT:MARK:FCO ON CALC:VECT:MARK:FCO?
Notes	Marker must be on a frequency-domain trace and data must be live, not recorded or simulated.
Preset	OFF
State Saved	Saved in instrument state.
Range	Off On
Initial S/W Revision	Prior to A.02.00
Modified at S/W Revision	A.02.00

The frequency counter result must be read back with the following SCPI command. The Marker X query command only gets the marker's data point position, which is not as accurate as the frequency counter result.

Mode	VSA, IDEN,LTEAFDD,LTEATDD
Measurement	<meas>:=VECTor ADEMod DDEMod W11A W11B EVM IPOWER IDEMod MOTotalk
Remote Command	:CALCulate:<meas>:MARKer[1] 2 ...12:FCOut:X?
Example	CALC:VECT:MARK:FCO:X?
Notes	Query only. If the marker counter result is unavailable, NaN is returned.
Initial S/W Revision	Prior to A.02.00
Modified at S/W Revision	A.02.00

Marker Table

Displays the marker data display window below the measurement window. For each marker that is on, information is displayed in the data display window, which includes the marker number, control mode, trace number, X axis scale, X axis value, and the Y-axis result. Additional information is shown for markers that have marker functions turned on.

Key Path	Marker
Mode	VSA, LTE, LTETDD, IDEN,LTEAFDD,LTEATDD
Measurement	<meas>:=VECTor ADEMod DDEMod W11A W11B EVM IPOWER IDEMod MOTotalk
Remote Command	:CALCulate:<meas>:MARKer:TABLE[:STATe] OFF ON 0 1 :CALCulate:<meas>:MARKer:TABLE[:STATe]?
Example	CALC:VECT:MARK:TABL ON CALC:VECT:MARK:TABL?
Preset	OFF
State Saved	No
Range	Off On
Initial S/W Revision	Prior to A.02.00
Modified at S/W Revision	A.02.00

Marker Position

Selects which data point in a trace to read out with the marker (or where to locate a fixed marker). The marker position is primarily set in terms of the domain units, not trace points (although it can be set in terms of points via SCPI). The default active function when you press a marker hard key is the X position for the currently selected marker. The exception to this is when the selected marker is fixed. In that case there is no default active function (to prevent inadvertently changing a fixed marker's location).

Marker position is not defined when a marker's control mode is Off. When a marker is turned on in Normal or Delta mode, its X (and Z) values are set to the center of the trace data. If a marker is turned on in Fixed mode, its position is set so that it appears in the middle of the trace grid.

The Marker Position key branches to the Marker Position menu, which enables you to set any position variable relevant to the selected marker's control mode and trace format.

For Normal and Delta markers, usually only Marker X is available. Marker Z is available for trace data with 2-dimensional domain. For Fixed markers, Y can also be set. If the trace format is Vector or Constellation, **Marker Y** controls the real (horizontal axis) value and **Marker Y Imag** controls the imaginary (vertical axis) value. The key (or the keys below it) is grayed out if the selected marker is off.

Key Path	Marker
Mode	VSA, LTE, LTETDD, IDEN, LTEAFDD, LTEATDD
Initial S/W Revision	Prior to A.02.00
Modified at S/W Revision	A.02.00

Marker X

Sets the selected marker's X Axis value position in the current X Axis Scale unit. If the control mode is Off, the SCPI command has no affect other than to cause the marker to become selected. Note that the X value can change if the marker is moved to a trace with a different domain.

The Marker X position is absolute if the marker control mode is Normal or Fixed. If the control mode is Delta, then the X position is relative to the reference marker. The valid X positions are the actual data points in the trace; the marker cannot be located between points. If a SCPI command attempts to place the marker between two points, the X value snaps to the closest point.

Note that for Vector or Constellation format, the X axis is perpendicular to the screen (because the screen axes are used to show the real and imaginary parts of the Y value), so adjusting the X value in this case only causes the marker to move horizontally if the real Y value changes. For Fixed markers on a trace with one of these formats, adjusting the X value does not cause horizontal motion of the marker at all. Instead, use the Marker Y and Marker Y (imag) controls to move the marker horizontally and vertically.

Key Path	Marker, Marker Position
Mode	VSA, LTE, LTETDD, IDEN, LTEAFDD, LTEATDD
Measurement	<meas>:=VECTor ADEMod DDEMod W11A W11B EVM IPOWER IDEMod MOTotalk
Remote Command	:CALCulate:<meas>:MARKer[1] 2 ...12:X <real> :CALCulate:<meas>:MARKer[1] 2 ...12:X?
Example	CALC:VECT:MARK:X 0.325 CALC:VECT:MARK:X?
Notes	Marker X does not go outside the bounds of the data unless it is Fixed. If you attempt to set it to a value outside the bounds, it is clipped at the closest limit and error -222 Data Out of Range is generated. If suffix is sent, it must match the X units for the trace the marker is on. Otherwise, error -138, "Suffix not allowed" is generated.

	If you try to read or set the position of a Delta marker, remember that the position is in relative units.
Couplings	See "Coupling of Delta and Reference Markers" on page 1152 . See also: "Couple Markers" on page 1151
Preset	None until marker is turned on.
State Saved	Saved in instrument state.
Min	Depends on trace data
Max	Depends on trace data
Initial S/W Revision	Prior to A.02.00
Modified at S/W Revision	A.02.00

SCPI only X position commands

Via SCPI, the marker position can also be set or queried in trace points. In this case, the position setting or reading is absolute regardless of control mode.

NOTE

The entered value in Trace Points is immediately translated into the current domain units for setting the value of the marker. The marker's value in domain units, NOT trace points, is preserved if a change is made to the X Axis scale settings. Thus, if you use this command to place a marker on point 500, which happens at that time to correspond to 13 GHz, and then you change the Start Frequency so that point 500 is no longer 13 GHz, the marker stays at 13 GHz, NOT at point 500.

If the trace the marker is on has a 2-dimensional domain, then the points are numbered in the following way:

Starting at the minimum X and Z position, this point is numbered 0. Each time you increment the point number, increment the X value to the next available value. When X reaches the maximum X position, then reset X to the minimum and increment the Z value. Then continue incrementing the X position in the same manner as before.

Note that for symbol tables, which have no axes, incrementing the X position in points moves the marker consecutively through all table entries.

Mode	VSA, LTE, LTETDD, IDEN, LTEAFDD, LTEATDD
Measurement	<meas>:=VECTor ADEMod DDEMod W11A W11B EVM IPOWER IDEMod MOTotalk
Remote Command	:CALCulate:<meas>:MARKer[1] 2 ...12[:X]:POSition <real> :CALCulate:<meas>:MARKer[1] 2 ...12[:X]:POSition?
Example	CALC:VECT:MARK:POS 25 CALC:VECT:MARK:POS?
Notes	When a marker control mode is changed from off to any other mode, the X position is set to mid-screen.
Couplings	See "Coupling of Delta and Reference Markers" on page 1152 . See also: "Couple Markers" on page 1151
Preset	None until marker is turned on.

State Saved	Saved in instrument state.
Min	Depends on trace data
Max	Depends on trace data
Initial S/W Revision	Prior to A.02.00
Modified at S/W Revision	A.02.00

Marker X Unit can be queried via SCPI

Mode	VSA, LTE, LTETDD, IDEN, LTEAFDD, LTEATDD
Measurement	<meas>:=VECTor ADEMod DDEMod W11A W11B EVM IPOWER IDEMod MOTotalk
Remote Command	:CALCulate:<meas>:MARKer[1] 2 ...12:X:UNIT?
Example	CALC:VECT:MARK:X:UNIT?
Notes	Query Only
Initial S/W Revision	Prior to A.02.00
Modified at S/W Revision	A.02.00

Marker Z

Sets the selected markers Z Axis value in the current Z Axis Scale unit for markers on traces with a 2-dimensional domain. In each case the marker that is addressed becomes the selected marker. It has no affect (other than to cause the marker to become selected) if the control mode is **Off** or if the trace has no Z domain. Note that the Z value can change or become irrelevant if the marker is moved to a trace with a different Z domain or no Z domain.

Note that this Z value is affected if the SCPI command to set marker point position is used.

Key Path	Marker, Marker Position
Mode	VSA, LTE, LTETDD, IDEN, LTEAFDD, LTEATDD
Measurement	<meas>:=VECTor ADEMod DDEMod W11A W11B EVM IPOWER IDEMod MOTotalk
Remote Command	:CALCulate:<meas>:MARKer[1] 2 ...12:Z <real> :CALCulate:<meas>:MARKer[1] 2 ...12:Z?
Example	CALC:OFDM:MARK:Z 12 CALC:OFDM:MARK:Z?
Notes	Marker Z does not go outside the bounds of the data unless it is Fixed. If you attempt to set it to a value outside the bounds it is clipped at the closest limit, and error -222 Data Out of Range is generated. If suffix is sent, it must match the Z units for the trace the marker is on. Otherwise, error -138, "Suffix not allowed" is generated.
Couplings	See "Coupling of Delta and Reference Markers" on page 1152 . See also: "Couple Markers" on page 1151

Preset	None until marker is turned on.
State Saved	Saved in instrument state.
Min	Depends on trace data
Max	Depends on trace data
Initial S/W Revision	Prior to A.02.00
Modified at S/W Revision	A.02.00

Marker Z Unit can be queried via SCPI.

Mode	VSA, LTE, LTETDD, IDEN,LTEAFDD,LTEATDD
Measurement	<meas>:=VECTor ADEMod DDEMod W11A W11B EVM IPOWER IDEMod MOTotalk
Remote Command	:CALCulate:<meas>:MARKer[1] 2 ...12:Z:UNIT?
Example	CALC:OFDM:MARK:Z:UNIT?
Notes	Query Only
Initial S/W Revision	Prior to A.02.00
Modified at S/W Revision	A.02.00

Marker Y

Enables you to set or read back the selected marker's Y Axis value in the current Y Axis Scale unit. Setting the Y value has no affect (other than to cause the marker to become selected) if the control mode is other than fixed. The query form generates an error if the control mode is Off. Note that the Y value can change if the Y-axis units change, either from a change in format of the trace the marker is on or if the marker is moved to a different trace.

If the selected marker is on a trace that is displayed with Vector or Constellation format, this function controls only the real part of the Y value (i.e., the horizontal axis value). Use the **Marker Y (imag)** control to change the imaginary (vertical) value. Marker Y and Marker Y Imag always set or get the rectangular form of Y, regardless of whether the marker readout is polar or rectangular.

Key Path	Marker, Marker Position
Mode	VSA, LTE, LTETDD, IDEN,LTEAFDD,LTEATDD
Measurement	<meas>:=VECTor ADEMod DDEMod W11A W11B EVM IPOWER IDEMod MOTotalk
Remote Command	:CALCulate:<meas>:MARKer[1] 2 ...12:Y[:REAL] <real> :CALCulate:<meas>:MARKer[1] 2 ...12:Y[:REAL]?
Example	CALC:VECT:MARK2:Y 0.325 CALC:VECT:MARK2:Y?
Notes	You cannot set Y unless the marker type is fixed. If the marker becomes fixed after a marker function is turned on, it is set to whatever the Y value was when the marker became fixed. If suffix is sent, it must match the Y units for the trace the marker is on. Otherwise, error -138, "Suffix not allowed" is generated.

Couplings	Changes if marker is relative to a Delta marker that is turned on or re-zeroed (see " Coupling of Delta and Reference Markers " on page 1152).
Preset	None until marker is turned on.
State Saved	Saved in instrument state.
Min	-9.9E+37
Max	9.9E+37
Initial S/W Revision	Prior to A.02.00
Modified at S/W Revision	A.02.00

Marker Y Unit can be queried via SCPI.

Mode	VSA, LTE, LTETDD, IDEN, LTEAFDD, LTEATDD
Measurement	<meas>:=VECTor ADEMod DDEMod W11A W11B EVM IPOWER IDEMod MOTotalk
Remote Command	:CALCulate:<meas>:MARKer[1] 2 ...12:Y:UNIT?
Example	CALC:VECT:MARK:Y:UNIT?
Notes	Query Only
Initial S/W Revision	Prior to A.02.00
Modified at S/W Revision	A.02.00

Marker Y Imag (Imaginary)

Enables you to set or read back the selected marker's quadrature (imaginary) Y value in the current Y Axis Scale unit. It has no affect (other than to cause the marker to become selected) if the control mode is other than fixed or if the current trace format is not complex (Vector or Constellation). The query form generates an error if it is used for a marker that is not on a complex trace. Marker Y Imag is not affected by whether the marker readout is polar or rectangular.

Key Path	Marker, Marker Position
Mode	VSA, LTE, LTETDD, IDEN, LTEAFDD, LTEATDD
Measurement	<meas>:=VECTor ADEMod DDEMod W11A W11B EVM IPOWER IDEMod MOTotalk
Remote Command	:CALCulate:<meas>:MARKer[1] 2 ...12:Y:IMAGinary <real> :CALCulate:<meas>:MARKer[1] 2 ...12:Y:IMAGinary?
Example	CALC:DDEM:MARK1:Y:IMAG 0.435 CALC:DDEM:MARK1:Y:IMAG?
Notes	Grayed out unless the marker is fixed and on a vector display. If suffix is sent, it must match the Y units for the trace the marker is on. Otherwise, an Invalid Suffix error is generated. Otherwise, error -138, "Suffix not allowed" is generated. If query is sent while the marker is on a trace whose format is not vector or constellation, NaN (9.91E+37) is returned.
Preset	None until marker is turned on.

State Saved	Saved in instrument state.
Min	Depends on trace format
Max	Depends on trace format
Initial S/W Revision	Prior to A.02.00
Modified at S/W Revision	A.02.00

Couple Markers

Affects all currently displayed markers. In general, when coupling is turned on then all Normal or Delta markers with the same (or equivalent) domain as the selected marker move in the same manner as the selected marker. Coupling is relative between markers on the same trace (so that their relative positions in the domain are maintained). Coupling can be absolute between markers on different traces that have equivalent domains. That is, they have the same position in the domain, if possible. (As an example of equivalent domains, demodulated symbol positions can be derived from time by using the current symbol rate). When you move the selected marker, then others on related traces track it. This enables you to correlate different measurement results. For example, you can place a marker at a particular symbol time on an error vector magnitude display, have tracking markers on the symbol table and pre-demod time trace showing you the symbol value, and the actual time-varying signal value at the same point in time.

Absolute coupling is performed only for the lowest numbered Normal or Delta marker on each trace. All other markers on a trace couple relatively. When you turn on marker coupling, the subset of markers that have the same domain as the selected marker track it and all other markers remain at their current location. The absolutely coupled markers within this subset is moved at this time to match the domain setting of the selected marker, with the relatively coupled markers following accordingly to maintain offsets within their respective traces. Those markers with different domains remain at their current location. When you select a marker with a different domain than the previously selected marker, then the subset of markers with that domain go through the same procedure.

Any marker that coupling would move outside its range of X values, remains at the closest limiting value until the selected marker moves in such a way as to bring the coupled X value back into range. If the coupled markers are on data that do not have the same domain resolution, then they are positioned as close to each other as possible.

If markers change mode or trace, or trace data is changed below them, the coupling rules are immediately applied to the new set.

Key Path	Marker
Mode	VSA, LTE, LTETDD, IDEN, LTEAFDD, LTEATDD
Measurement	<meas>:=VECTor ADEMod DDEMod W11A W11B EVM IPOWER IDEMod MOTotalk
Remote Command	:CALCulate:<meas>:MARKer:COUPle[:STATe] OFF ON 0 1 :CALCulate:<meas>:MARKer:COUPle[:STATe]?
Example	CALC:VECT:MARK:COUP ON CALC:VECT:MARK:COUP?
Preset	OFF

State Saved	Saved in instrument state.
Range	Off On
Initial S/W Revision	Prior to A.02.00
Modified at S/W Revision	A.02.00

All Markers Off

Turns all markers off and sets the selected marker to 1.

Key Path	Marker
Mode	VSA, LTE, LTETDD, IDEN, LTEAFDD, LTEATDD
Measurement	<meas>:=VECTor ADEMod DDEMod W11A W11B EVM IPOWER IDEMod MOTotalk
Remote Command	:CALCulate:<meas>:MARKer:AOff
Example	CALC:VECT:MARK:AOff:
Initial S/W Revision	Prior to A.02.00
Modified at S/W Revision	A.02.00

Coupling of Delta and Reference Markers

The following coupling rules apply from the front panel and also if the equivalent SCPI commands are sent.

Pressing the Delta key causes the selected marker to become a delta marker if it is not already. Also, the selected marker's reference is affected as follows:

- If the reference marker was off, it is turned on as a fixed marker.
- The reference marker is moved to the trace of the selected marker and set to the same position as the selected marker.
- If the delta marker has a marker function turned on, the reference marker takes on the same function (with the same band limits).

Exception: Pressing Delta when the selected marker's mode is not yet Delta does not move or change a reference marker that is already turned on (Normal, Delta, or Fixed) and on the same trace as the selected marker. It merely changes the selected marker's mode to Delta and shows the current offset between it and the reference. If you press Delta again (when the selected marker is already in Delta mode) then the reference is moved and modified as described above.

When a delta marker is changed to any other control mode, if its reference marker is fixed then the reference marker is also turned off.

If you move a delta marker to a different trace, it is forced to Normal mode and if its reference is fixed, the reference is turned off.

A delta marker is forced to Normal mode if you turn its reference off or if you move its reference to another trace. (In the latter case the reference is not turned off even if it is fixed.)

If you change the selected marker's reference (using the Marker, Properties, Relative To), the selected marker is forced to Delta mode. This change of the selected marker to Delta mode causes its new reference's control mode and position to change as described above.

Marker -> (Marker To)

Provides access to some convenient functions for copying the marker position to a number of frequency and Y-axis scaling parameters. These functions are available from the front panel only. No SCPI is provided, because you can already read the marker position via SCPI and then set any frequency or scaling parameter accordingly, with full accuracy.

Pressing the Marker -> hardkey always makes the selected marker's X position the active function.

If the selected marker is off, pressing the Marker -> hardkey turns on the selected marker in normal mode on the currently selected trace.

Key Path	Front Panel
Mode	VSA, LTE, LTETDD, IDEN,LTEAFDD,LTEATDD
Initial S/W Revision	Prior to A.02.00
Modified at S/W Revision	A.02.00

Mkr -> CF (Center Frequency)

Sets the center frequency equal to the selected marker's absolute frequency. The marker must be on a frequency-domain trace. The absolute marker frequency is used regardless of whether its control mode is Normal, Delta, or Fixed.

If the currently selected marker is not on when this key is pressed, it is turned on at the center of the screen as a normal type marker.

Key Path	Marker To
Mode	VSA, LTE, LTETDD, IDEN,LTEAFDD,LTEATDD
Initial S/W Revision	Prior to A.02.00
Modified at S/W Revision	A.02.00

Mkr -> CF Step

Sets the center frequency step size equal to the selected marker's frequency. The marker must be on a frequency-domain trace. The absolute marker frequency is used regardless of whether its control mode is Normal, Delta, or Fixed.

If the currently selected marker is not on when this key is pressed, it is turned on at the center of the screen as a normal type marker.

Key Path	Marker To
Mode	VSA, LTE, LTETDD, IDEN,LTEAFDD,LTEATDD
Initial S/W Revision	Prior to A.02.00
Modified at S/W Revision	A.02.00

Mkr -> Start

Sets the start frequency equal to the selected marker's frequency. The marker must be on a frequency-domain trace. The absolute marker frequency is used regardless of whether its control mode is Normal, Delta, or Fixed.

If the currently selected marker is not on when this key is pressed, it is turned on at the center of the screen as a normal type marker.

Key Path	Marker To
Mode	VSA, LTE, LTETDD, IDEN,LTEAFDD,LTEATDD
Initial S/W Revision	Prior to A.02.00
Modified at S/W Revision	A.02.00

Mkr -> Stop

Sets the stop frequency equal to the selected marker's frequency. The marker must be on a frequency-domain trace. The absolute marker frequency is used regardless of whether its control mode is Normal, Delta, or Fixed.

If the currently selected marker is not on when this key is pressed, it is turned on at the center of the screen as a normal type marker.

Key Path	Marker To
Mode	VSA, LTE, LTETDD, IDEN,LTEAFDD,LTEATDD
Initial S/W Revision	Prior to A.02.00
Modified at S/W Revision	A.02.00

Mkr Delta -> Span

Sets the start and stop frequencies equal to the selected marker's frequency and that of its reference. That is, the measurement span is "zoomed in" so that the selected marker and its associated reference appear on the extreme left and right of the display. The marker must be on a frequency-domain trace and its control mode must be Delta.

Key Path	Marker To
Mode	VSA, LTE, LTETDD, IDEN,LTEAFDD,LTEATDD
Initial S/W Revision	Prior to A.02.00
Modified at S/W Revision	A.02.00

Mkr -> Ref Lvl

Sets the Y axis reference value equal to the selected marker's Y value. For example, if the reference position is at the top of the screen, the whole trace is moved up so that the marker appears at the top of

the screen. Note that this is a display scaling function only. The input range remains the same.

Key Path	Marker To
Mode	VSA, LTE, LTETDD, IDEN,LTEAFDD,LTEATDD
Initial S/W Revision	Prior to A.02.00
Modified at S/W Revision	A.02.00

Counter -> CF (Center Frequency)

Sets the frequency of the marker counter to the center frequency. The marker counter function must be on.

Key Path	Marker To
Mode	VSA, IDEN,LTEAFDD,LTEATDD
Initial S/W Revision	Prior to A.02.00
Modified at S/W Revision	A.02.00

Mkr Delta -> CF (Center Frequency)

Sets the center frequency equal to the difference in frequency between the selected Delta marker and its reference. The marker must be on a frequency-domain trace and the selected marker's control mode must be Delta.

Key Path	Marker To
Mode	VSA, LTE, LTETDD, IDEN,LTEAFDD,LTEATDD
Initial S/W Revision	Prior to A.02.00
Modified at S/W Revision	A.02.00

Marker Function

Accesses a menu of selectable marker functions for VSA based measurements.

Marker Functions perform post-processing operations on marker data. Band Functions are Marker Functions that enable you to define a band of frequencies around the marker. The band defines the region of data used for the numerical calculations. These marker functions also enable you to perform mathematical calculations on trace and marker data and report the results of these calculations in place of the normal marker result.

Unlike regular markers, marker function markers are not placed directly on the trace. They are placed at a location that is relative to the result of the function calculation.

The Marker Function menu provides access to power calculations in bands of frequencies or time intervals centered on a marker. It also enables you to make calculations like carrier to noise by combining delta markers with marker functions. Marker functions are generally available for time and frequency domain traces, and not for others. If the marker function calculation is undefined for particular trace data, then "---" is shown in place of a number in the result display and marker table, and CALC:<meas>:MARK[n]:Y? returns 9.91E+37 (NaN).

Pressing Marker Function always makes the selected marker's X position the active function.

If the selected marker is off, pressing the Marker Function hardkey turns on the selected marker in normal mode on the currently selected trace.

Key Path	Front Panel
Mode	VSA, LTE, LTETDD, IDEN, LTEAFDD, LTEATDD
Measurement	<meas>:=VECTor ADEMod DDEMod W11A W11B EVM IPOWER IDEMod MOTotalk
Remote Command	:CALCulate:<meas>:MARKer[1] 2 ...12:FUNction BPOwer BDENsity =OFF :CALCulate:<meas>:MARKer[1] 2 ...12:FUNction?
Example	CALC:VECT:MARK1:FUNC BPOW CALC:VECT:MARK1:FUNC?
Notes	:CALC:<meas>:MARK1:FUNC? returns the current function type for marker 1. To return the result, use :CALC:<meas>:MARK1:Y?
Preset	=OFF
State Saved	Saved in instrument state.
Range	Band Power Band Density Off
Initial S/W Revision	Prior to A.02.00
Modified at S/W Revision	A.02.00

Select Marker

Specifies the selected marker. The selected marker is the one that is affected by the marker position and properties settings, peak search, and other marker functions. Several menus have a Select Marker key for convenience. Marker selection using any one of these is reflected in all others, in other words, there is only

one selected marker for the whole measurement. If all markers are off, then marker 1 becomes the selected marker.

As a convenience, if no markers are displayed on the selected trace, selecting a marker that is off automatically turns it on in normal mode on the selected trace.

There is no SCPI function for selecting a marker. Instead, SCPI functions can explicitly include the index of the marker for which they are to apply. (Most SCPI marker functions that affect the state of a marker also make it the selected marker for front panel commands.)

Key Path	Marker or Marker> or Marker Function or Peak Search
Mode	VSA, LTE, LTETDD, IDEN,LTEAFDD,LTEATDD
State Saved	No
Range	1 2 3 4 5 6 7 8 9 10 11 12
Initial S/W Revision	Prior to A.02.00
Modified at S/W Revision	A.02.00

Band/Interval Power

Turns on the Band/Interval Power function for the selected marker. This function calculates the power within the band centered on the marker. The function works generally with frequency spectra, PSD, and time traces. On traces where band power is undefined, the result display shows "---" and CALC:<meas>:MARK[n]:Y? returns 9.91E+37 (NaN), although the band interval can still be defined.

Frequency-domain data

If the marker is on a frequency-domain trace, the result is total power within the band. This is true whether the underlying trace data is a power spectrum or power spectral density.

Time-domain data

If the marker is on a time-domain trace, the result is average power within the time interval, that is, the power at each time sample in the time interval is calculated, the powers are summed and the total divided by the number of samples.

Key Path	Marker Function
Mode	VSA, LTE, LTETDD, IDEN,LTEAFDD,LTEATDD
Initial S/W Revision	Prior to A.02.00
Modified at S/W Revision	A.02.00

Band Power Calculation

Shows results in dBm, dBVrms, Watts, Volts RMS Squared or Volts RMS. The table below shows the choice of display units if **Band Power Calculation** is set to **Mean**, depending on the current format and Y units of the trace the marker is on.

Trace data type	Trace Format	Y Unit	Result format
Spectrum, PSD, Time record	LogMag (dB)	Auto, Power	dBm
		Peak, RMS	dBVrms
		mRMS	dBmVrms
	Linear Mag, Real, Imag, Log Mag (lin)	Auto, Peak, RMS, mRMS	Vrms^2
	Linear Mag, Real, Imag, Log Mag(lin)	Power	W
	Wrap Phase, Unwrap Phase, Delay	Any	Vrms^2
Dimensionless (e.g., Frequency response, Impulse response, various Demodulation error types)	LogMag (dB)	Any	dBrms
	Linear Mag, Real, Imag, Wrap Phase, Unwrap Phase, Delay, Log Mag (lin)	Any	rms^2
General dimensions(e.g., Hz, %)	LogMag (dB)	Any	dB<unit>rms
	Linear Mag, Real, Imag, Wrap Phase, Unwrap Phase, Delay, Log Mag (lin)	Any	<unit>rms^2

If the **Band Power Calculation** is set to **RMS**, then the readout unit does not depend on trace format or Y unit. For Spectrums, PS, and Time record traces, the displayed unit is "Vrms". For general units, the unit abbreviation is shown followed by "rms".

The Band Power Calculation only controls the readout format for Normal and Fixed markers. For Delta markers, see "[Band Power and Delta Markers](#)" on page 1163.

Key Path	Marker Function, Band/Interval Power
Mode	VSA, LTE, LTETDD, IDEN,LTEAFDD,LTEATDD
Measurement	<meas>:=VECTor ADEMod DDEMod W11A W11B EVM POWER IDEMod MOTotalk
Remote Command	:CALCulate:<meas>:MARKer[1] 2 ...12:FUNctIon:BPOwer:CTYPe MEAN RMS :CALCulate:<meas>:MARKer[1] 2 ...12:FUNctIon:BPOwer:CTYPe?
Example	CALC:VECT:MARK1:FUNC:BPOW:CTYP MEAN CALC:VECT:MARK1:FUNC:BPOW:CTYP?
Preset	MEAN
State Saved	Saved in instrument state.
Range	Mean RMS
Initial S/W Revision	Prior to A.02.00
Modified at S/W Revision	A.02.00

Band/Interval Density

Calculates the average power density within the band centered on the marker. The function works generally with frequency spectra, PSD, and time traces. On traces where band power cannot reasonably be defined, the result display shows "---" and CALC:<meas>:MARK[n]:Y? returns NaN (9.91E+37), although the band interval can still be defined.

Frequency-domain data

If the marker is on a frequency-domain trace, the result is the band power (as computed above) divided by the bandwidth over which it is measured. This is true whether the underlying trace data is a power spectrum or power spectral density.

Time-domain data

If the marker is on a time-domain trace, the result is average power within the time interval (as computed above) divided by the equivalent noise bandwidth of the span.

Key Path	Marker Function
Mode	VSA, LTE, LTETDD, IDEN,LTEAFDD,LTEATDD
Initial S/W Revision	Prior to A.02.00
Modified at S/W Revision	A.02.00

Band Density Calculation

Turns on the Band/Interval Density function for the selected marker. If the selected marker is off, it is turned on in **Normal** marker mode and is located at the center of the screen.

If **Band/Interval Density** is selected while in the **Marker Function Off** state, the **Band Span** or **Interval Span** is initialized to 5% of the screen width.

If the detector mode for the detector on the marker's trace is set to Auto, the average detector is selected. If the Average type is set to Auto, Power Averaging is selected. Other choices for the detector or Average type usually cause measurement inaccuracy.

A band/interval density calculation result can be shown in dBm/Hz, Volts RMS Squared, or Volts RMS. The following table shows the choice of display units if **Band Density Calculation** is set to **Mean**, depending on the current format of the trace the marker is on.

Trace data type	Trace Format	Result format
Spectrum, PSD, Time record	LogMag (dB)	dBm/Hz
	Linear Mag, Real, Imag, Wrap Phase, Unwrap Phase, Delay, Log Mag (lin)	Vrms ² /Hz
Dimensionless (e.g., Frequency response, Impulse response, various Demodulation error types)	LogMag (dB)	dBrms/Hz
	Linear Mag, Real, Imag, Wrap Phase, Unwrap Phase, Delay, Log Mag (lin)	rms ² /Hz

General dimensions (e.g., Hz, %)	LogMag (dB)	dB<unit>rms/Hz
	Linear Mag, Real, Imag, Wrap Phase, Unwrap Phase, Delay, Log Mag (lin)	<unit>rms^2/Hz

If the **Band Density Calculation** is set to **RMS**, then the readout unit does not depend on trace format. For Spectrum, PSD, and Time record traces, the displayed unit is "Vrms/rtHz". For general units, the unit abbreviation is shown followed by "rms/rtHz".

The Band Density Calculation only controls the readout format for Normal and Fixed markers. For Delta markers, see ["Band Power and Delta Markers" on page 1163](#).

Key Path	Marker Function, Band/Interval Power
Mode	VSA, LTE, LTETDD, IDEN,LTEAFDD,LTEATDD
Measurement	<meas>:=VECTor ADEMod DDEMod W11A W11B EVM IPOWER IDEMod MOTotalk
Remote Command	:CALCulate:<meas>:MARKer[1] 2 ...12:FUNction:BDENsity:CTYPe MEAN RMS :CALCulate:<meas>:MARKer[1] 2 ...12:FUNction:BDENsity:CTYPe?
Example	CALC:VECT:MARK1:FUNC:BDEN:CTYP RMS CALC:VECT:MARK1:FUNC:BDEN:CTYP?
Preset	MEAN
State Saved	Saved in instrument state.
Range	Mean RMS
Initial S/W Revision	Prior to A.02.00
Modified at S/W Revision	A.02.00

Band Adjust

Enables you to define the bandwidth around the marker. The band is always centered on the marker position. Entering the menu always sets Band/Interval Span as the active function.

Key Path	Marker Function
Mode	VSA, LTE, LTETDD, IDEN,LTEAFDD,LTEATDD
Initial S/W Revision	Prior to A.02.00
Modified at S/W Revision	A.02.00

Band/Interval Center

Enables you to define the center of the band. That is, it enables you to adjust the marker position in absolute units (regardless of whether the marker mode is Normal or Delta).

Key Path	Marker Function, Band Adjust
----------	------------------------------

Mode	VSA, LTE, LTETDD, IDEN, LTEAFDD, LTEATDD
Measurement	<meas>:=VECTor ADEMod DDEMod W11A W11B EVM IPOWER IDEMod MOTotalk
Remote Command	:CALCulate:<meas>:MARKer[1] 2 ...12:FUNCTION:BAND:CENTer <real> :CALCulate:<meas>:MARKer[1] 2 ...12:FUNCTION:BAND:CENTer?
Example	CALC:VECT:MARK2:FUNC:BAND:CENT 1.23E+09 CALC:VECT:MARK2:FUNC:BAND:CENT?
Preset	Center of screen
State Saved	Saved in instrument state.
Min	-9.9E+37
Max	9.9E+37
Initial S/W Revision	Prior to A.02.00
Modified at S/W Revision	A.02.00

Band/Interval Span

Sets the width of the span for the selected marker. This function defines the span of frequencies or time. The marker position does not change when you adjust the span.

Key Path	Marker Function, Band Adjust
Mode	VSA, LTE, LTETDD, IDEN, LTEAFDD, LTEATDD
Measurement	<meas>:=VECTor ADEMod DDEMod W11A W11B EVM IPOWER IDEMod MOTotalk
Remote Command	:CALCulate:<meas>:MARKer[1] 2 ...12:FUNCTION:BAND:SPAN <real> :CALCulate:<meas>:MARKer[1] 2 ...12:FUNCTION:BAND:SPAN?
Example	CALC:VECT:MARK2:FUNC:BAND:SPAN 1.23E+06 CALC:VECT:MARK2:FUNC:BAND:SPAN?
Preset	When marker turned on, 1/20th of current span or displayed time length.
State Saved	Saved in instrument state.
Min	-9.9E+37
Max	9.9E+37
Initial S/W Revision	Prior to A.02.00
Modified at S/W Revision	A.02.00

Band/Interval Left

Enables you to adjust the left side of the band. In order to remain centered in the band, the marker position must also change as you change the left edge. The right edge is unaffected.

Key Path	Marker Function, Band Adjust
----------	------------------------------

Mode	VSA, LTE, LTETDD, IDEN, LTEAFDD, LTEATDD
Measurement	<meas>:=VECTor ADEMod DDEMod W11A W11B EVM IPOWER IDEMod MOTotalk
Remote Command	:CALCulate:<meas>:MARKer[1] 2 ...12:FUNction:BAND:LEFT <real> :CALCulate:<meas>:MARKer[1] 2 ...12:FUNction:BAND:LEFT?
Example	CALC:VECT:MARK2:FUNC:BAND:LEFT 1.23E+06 CALC:VECT:MARK2:FUNC:BAND:LEFT?
Couplings	Changes marker X to keep the marker centered in the band.
Preset	When marker turned on, 1/40th of current span or displayed time length left of the marker position.
State Saved	Saved in instrument state.
Min	-9.9E+37
Max	9.9E+37
Initial S/W Revision	Prior to A.02.00
Modified at S/W Revision	A.02.00

Band/Interval Right

Enables you to adjust the right side of the band. In order to remain centered in the band, the marker position must also change as you change the right edge. The left edge is unaffected.

Key Path	Marker Function, Band Adjust
Mode	VSA, LTE, LTETDD, IDEN, LTEAFDD, LTEATDD
Measurement	<meas>:=VECTor ADEMod DDEMod W11A W11B EVM IPOWER IDEMod MOTotalk
Remote Command	:CALCulate:<meas>:MARKer[1] 2 ...12:FUNction:BAND:RIGHT <real> :CALCulate:<meas>:MARKer[1] 2 ...12:FUNction:BAND:RIGHT?
Example	CALC:VECT:MARK2:FUNC:BAND:RIGHT 1.23E+06 CALC:VECT:MARK2:FUNC:BAND:RIGHT?
Couplings	Changes marker X to keep the marker centered in the band.
Preset	When marker turned on, 1/40th of current span or displayed time length right of the marker position.
State Saved	Saved in instrument state.
Min	-9.9E+37
Max	9.9E+37
Initial S/W Revision	Prior to A.02.00
Modified at S/W Revision	A.02.00

Band Power and Delta Markers

When either a Delta marker or its reference has a band power function turned on, the Delta marker readout always shows a ratio calculation. This enables you to perform common calculations like carrier to noise ratio or adjacent channel power ratio. The form of the ratio depends on the main marker function

calculation type (Mean or RMS). If the main marker function calculation type is Mean, then when you change the marker to Delta the result is a power ratio. If the main marker function calculation type is RMS, then the Delta marker result is a voltage ratio. (If the main marker band power function is off, then the form of the ratio depends on the reference marker calculation type: If it is Mean you get a power ratio and if it is RMS you get a voltage ratio.)

For example, if the main marker function is Band/Interval Power with a calculation type of Mean and the reference marker function is Band/Interval Power with a calculation type of RMS, then the Delta marker shows the ratio of the main marker "Band/Interval Power Mean" value to the reference marker "Band/Interval Power Mean" (not RMS) value.

A dimensionless ratio (for example, Volt/Volt or Watt/Watt) is shown with units of "x". The marker function calculation type indicates whether the ratio is voltage or power (see above). A dimensionless power ratio is shown with units of dB if the trace format is Log Mag (dB).

If the reference marker function is Band/Interval Density and the main marker is either Band/Interval Power or its function is turned off, then the ratio is not dimensionless, but has units of Hz (or dB-Hz) for power calculations or rHz for voltage calculations. When the main marker function is Band/Interval Density and the reference is either Band/interval Power or its function is off, the units are /Hz (or dB/Hz) for power calculations or /rHz for voltage calculations.

Key Path	Marker Function
Mode	VSA, LTE, LTETDD, IDEN,LTEAFDD,LTEATDD
Initial S/W Revision	Prior to A.02.00
Modified at S/W Revision	A.02.00

Meas

The information in this section is common to all measurements. For key and remote command information for a specific measurement, refer to the section that describes the measurement of interest.

Measurements available under the Meas key are specific to the current Mode.

When viewing Help for measurements, note the following:

NOTE

Operation for some keys differs between measurements. The information displayed in Help pertains to the current measurement. To see how a key operates in a different measurement, exit Help (press the Cancel Esc key), select the measurement, then reenter Help (press the Help key) and press that key.

Key Path	Front-panel key
Initial S/W Revision	Prior to A.02.00

Remote Measurement Functions

This section contains the following topics:

"Measurement Group of Commands" on page 1166

"Current Measurement Query (Remote Command Only)" on page 1168

"Limit Test Current Results (Remote Command Only)" on page 1168

"Data Query (Remote Command Only)" on page 1168

"Calculate/Compress Trace Data Query (Remote Command Only)" on page 1169

"Calculate Peaks of Trace Data (Remote Command Only)" on page 1174

Hardware-Accelerated Fast Power Measurement (Remote Command Only)

"Format Data: Numeric Data (Remote Command Only)" on page 1175

"Format Data: Byte Order (Remote Command Only)" on page 1176

Initial S/W Revision	Prior to A.02.00
----------------------	------------------

Measurement Group of Commands

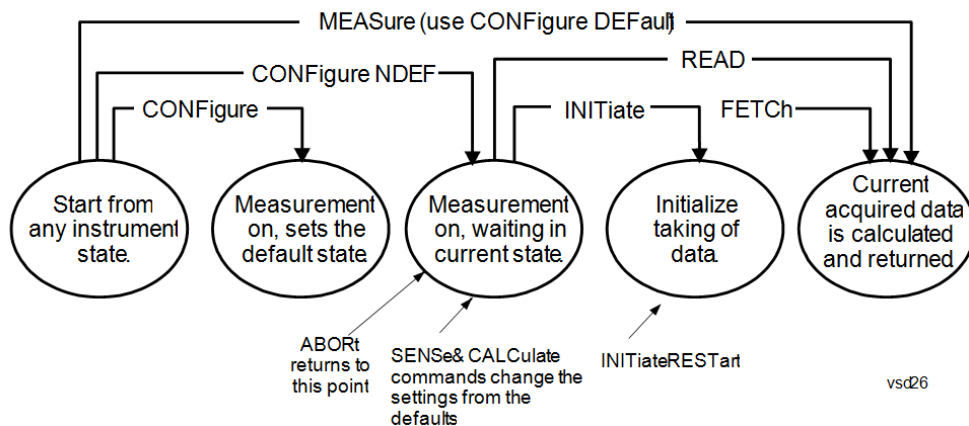

Measure Commands:

:MEASure:<measurement>[n]?

This is a fast single-command way to make a measurement using the factory default instrument settings. These are the settings and units that conform to the Mode Setup settings (e.g. radio standard) that you have currently selected.

- Stops the current measurement (if any) and sets up the instrument for the specified measurement using the factory defaults
- Initiates the data acquisition for the measurement
- Blocks other SCPI communication, waiting until the measurement is complete before returning results.
- If the function does averaging, it is turned on and the number of averages is set to 10.
- After the data is valid it returns the scalar results, or the trace data, for the specified measurement. The type of data returned may be defined by an [n] value that is sent with the command.
- The scalar measurement results will be returned if the optional [n] value is not included, or is set to 1. If the [n] value is set to a value other than 1, the selected trace data results will be returned. See each command for details of what types of scalar results or trace data results are available.
- ASCII is the default format for the data output. (Older versions of Spectrum Analysis and Phase Noise mode measurements only use ASCII.) The binary data formats should be used for handling large blocks of data since they are smaller and faster than the ASCII format. Refer to the FORMat:DATA command for more information.

If you need to change some of the measurement parameters from the factory default settings you can set up the measurement with the CONFIgure command. Use the commands in the SENSe:<measurement> and CALCulate:<measurement> subsystems to change the settings. Then you can use the READ? command to initiate the measurement and query the results.

If you need to repeatedly make a given measurement with settings other than the factory defaults, you can use the commands in the SENSe:<measurement> and CALCulate:<measurement> subsystems to set up the measurement. Then use the READ? command to initiate the measurement and query results.

Measurement settings persist if you initiate a different measurement and then return to a previous one. Use READ:<measurement>? if you want to use those persistent settings. If you want to go back to the default settings, use MEASure:<measurement>?.

Configure Commands:

:CONFIgure:<measurement>

This command stops the current measurement (if any) and sets up the instrument for the specified measurement using

the factory default instrument settings. It does not initiate the taking of measurement data unless INIT:CONTInuous is ON. If you change any measurement settings after using the CONFigure command, the READ command can be used to initiate a measurement without changing the settings back to their defaults.

In the Swept SA measurement in Spectrum Analyzer mode the CONFigure command also turns the averaging function on and sets the number of averages to 10 for all measurements.

:CONFigure: <measurement>: NDEFault stops the current measurement and changes to the specified measurement. It does not change the settings to the defaults. It does not initiate the taking of measurement data unless INIT:CONTInuous is ON.

The CONFigure? query returns the current measurement name.

The CONFigure:CATalog? query returns a quoted string of all licensed measurement names in the current mode. For example, "SAN, CHP, OBW, ACP, PST, TXP, SPUR, SEM, LIST".

Fetch Commands:

:FETCh:<measurement>[n]?

This command puts selected data from the most recent measurement into the output buffer. Use FETCh if you have already made a good measurement and you want to return several types of data (different [n] values, for example, both scalars and trace data) from a single measurement. FETCh saves you the time of re-making the measurement. You can only FETCh results from the measurement that is currently active, it will not change to a different measurement. An error message is reported if a measurement other than the current one is specified.

If you need to get new measurement data, use the READ command, which is equivalent to an INITiate followed by a FETCh.

The scalar measurement results will be returned if the optional [n] value is not included, or is set to 1. If the [n] value is set to a value other than 1, the selected trace data results will be returned. See each command for details of what types of scalar results or trace data results are available. The binary data formats should be used for handling large blocks of data since they are smaller and transfer faster than the ASCII format. (FORMat:DATA)

FETCh may be used to return results other than those specified with the original READ or MEASure command that you sent.

INITiate Commands:

:INITiate:<measurement>

This command is not available for measurements in all the instrument modes:

- Initiates a trigger cycle for the specified measurement, but does not output any data. You must then use the FETCh<meas> command to return data. If a measurement other than the current one is specified, the instrument will switch to that measurement and then initiate it.
- For example, suppose you have previously initiated the ACP measurement, but now you are running the channel power measurement. If you send INIT:ACP? it will change from channel power to ACP and will initiate an ACP measurement.
- Does not change any of the measurement settings. For example, if you have previously started the ACP measurement and you send INIT:ACP? it will initiate a new ACP measurement using the same instrument settings as the last time ACP was run.
- If your selected measurement is currently active (in the idle state) it triggers the measurement, assuming the trigger conditions are met. Then it completes one trigger cycle. Depending upon the measurement and the number of averages, there may be multiple data acquisitions, with multiple trigger events, for one full trigger cycle. It also holds off additional commands on GPIB until the acquisition is complete.

READ Commands:

:READ:<measurement>[n]?

- Does not preset the measurement to the factory default settings. For example, if you have previously initiated the ACP
-

measurement and you send READ:ACP? it will initiate a new measurement using the same instrument settings.

- Initiates the measurement and puts valid data into the output buffer. If a measurement other than the current one is specified, the instrument will switch to that measurement before it initiates the measurement and returns results.
 - For example, suppose you have previously initiated the ACP measurement, but now you are running the channel power measurement. Then you send READ:ACP? It will change from channel power back to ACP and, using the previous ACP settings, will initiate the measurement and return results.
 - Blocks other SCPI communication, waiting until the measurement is complete before returning the results
 - If the optional [n] value is not included, or is set to 1, the scalar measurement results will be returned. If the [n] value is set to a value other than 1, the selected trace data results will be returned. See each command for details of what types of scalar results or trace data results are available. The binary data formats should be used when handling large blocks of data since they are smaller and faster than the ASCII format. (FORMat:DATA)
-

Initial S/W Revision	Prior to A.02.00
----------------------	------------------

Current Measurement Query (Remote Command Only)

This command returns the name of the measurement that is currently running.

Remote Command	:CONFigure?
-----------------------	-------------

Example	CONF?
----------------	-------

Initial S/W Revision	Prior to A.02.00
----------------------	------------------

Limit Test Current Results (Remote Command Only)

Queries the status of the current measurement limit testing. It returns a 0 if the measured results pass when compared with the current limits. It returns a 1 if the measured results fail any limit tests.

Remote Command	:CALCulate:CLIMits:FAIL?
-----------------------	--------------------------

Example	CALC:CLIM:FAIL? queries the current measurement to see if it fails the defined limits. Returns a 0 or 1: 0 it passes, 1 it fails.
----------------	--

Initial S/W Revision	Prior to A.02.00
----------------------	------------------

Data Query (Remote Command Only)

Returns the designated measurement data for the currently selected measurement and subopcode.

n = any valid subopcode for the current measurement. See the measurement command results table for your current measurement, for information about what data is returned for the subopcodes.

This command uses the data setting specified by the FORMat:BORDER and FORMat:DATA commands and can return real or ASCII data. (See the format command descriptions under Input/Output in the Analyzer Setup section.)

Remote Command	:CALCulate:DATA[n]?
Notes	The return trace depends on the measurement. In CALCulate:<meas>:DATA[n], n is any valid subopcode for the current measurement. It returns the same data as the FETCH:<measurement>? query where <measurement> is the current measurement.
Initial S/W Revision	Prior to A.02.00

Calculate/Compress Trace Data Query (Remote Command Only)

Returns compressed data for the currently selected measurement and sub-opcode [n].

n = any valid sub-opcode for that measurement. See the MEASure:<measurement>? command description of your specific measurement for information on the data that can be returned.

The data is returned in the current Y Axis Unit of the analyzer. The command is used with a sub-opcode <n> (default=1) to specify the trace. With trace queries, it is best if the analyzer is not sweeping during the query. Therefore, it is generally advisable to be in Single Sweep, or Update=Off.

This command is used to compress or decimate a long trace to extract and return only the desired data. A typical example would be to acquire N frames of GSM data and return the mean power of the first burst in each frame. The command can also be used to identify the best curve fit for the data.

Remote Command	:CALCulate:DATA<n>:COMPRESS? BLOCK CFIT MAXimum MINimum MEAN DMEan RMS RMSCubed SAMPLE SDEVIation PPHase [,<soffset> [,<length>[,<roffset>[,<rlimit>]]]]
Example	To query the mean power of a set of GSM bursts: Supply a signal that is a set of GSM bursts. Select the IQ Waveform measurement (in IQ Analyzer Mode). Set the sweep time to acquire at least one burst. Set the triggers such that acquisition happens at a known position relative to a burst. Then query the mean burst levels using, CALC:DATA2:COMP? MEAN, 24e-6, 526e-6 (These parameter values correspond to GSM signals, where 526e-6 is the length of the burst in the slot and you just want 1 burst.)
Notes	The command supports 5 parameters. Note that the last 4 (<soffset>, <length>, <roffset>, <rlimit>) are optional. But these optional parameters must be entered in the specified order. For example, if you want to specify <length>, then you must also specify <soffset>. See details below for a definition of each of these parameters. This command uses the data in the format specified by FORMat:DATA, returning either binary or ASCII data.
Initial S/W Revision	Prior to A.02.00

- BLOCK or block data - returns all the data points from the region of the trace data that you specify. For example, it could be used to return the data points of an input signal over several timeslots, excluding the portions of the trace data that you do not want. (This is x,y pairs for trace data and I,Q pairs for complex data.)

- CFIT or curve fit - applies curve fitting routines to the data. <soffset> and <length> are required to define the data that you want. <roffset> is an optional parameter for the desired order of the curve equation. The query will return the following values: the x-offset (in seconds) and the curve coefficients ((order + 1) values).

MIN, MAX, MEAN, DME, RMS, RMSC, SAMP, SDEV and PPH return one data value for each specified region (or <length>) of trace data, for as many regions as possible until you run out of trace data (using <roffset> to specify regions). Or they return the number of regions you specify (using <rlimit>) ignoring any data beyond that.

- MINimum - returns the minimum data point (y value) for the specified region(s) of trace data. For I/Q trace data, the minimum magnitude of the I/Q pairs is returned.
- MAXimum - returns the maximum data point (y value) for the specified region(s) of trace data. For I/Q trace data, the maximum magnitude of the I/Q pairs is returned.
- MEAN - returns a single value that is the arithmetic mean of the data point values (in dB/ dBm) for the specified region(s) of trace data. For I/Q trace data, the mean of the magnitudes of the I/Q pairs is returned. See the following equations.

•

NOTE If the original trace data is in dB, this function returns the arithmetic mean of those log values, not log of the mean power which is a more useful value. The mean of the log is the better measurement technique when measuring CW signals in the presence of noise. The mean of the power, expressed in dB, is useful in power measurements such as Channel Power. To achieve the mean of the power, use the RMS option.

Equation 1

Mean Value of Data Points for Specified Region(s)

$$\text{MEAN} = \frac{1}{n} \sum_{X_i \in \text{region}(s)} X_i$$

where X_i is a data point value, and n is the number of data points in the specified region(s).

Equation 2

Mean Value of I/Q Data Pairs for Specified Region(s)

$$\text{MEAN} = \frac{1}{n} \sum_{X_i \in \text{region}(s)} |X_i|$$

where $|X_i|$ is the magnitude of an I/Q pair, and n is the number of I/Q pairs in the specified region(s).

- DMEan - returns a single value that is the mean power (in dB/ dBm) of the data point values for the specified region(s) of trace data. See the following equation:

Equation 3

DMEan Value of Data Points for Specified Region(s)

$$\text{DME} = 10 \times \log_{10} \left(\frac{1}{n} \sum_{X_i \in \text{region}(s)} 10^{\frac{X_i}{10}} \right)$$

- RMS - returns a single value that is the average power on a root-mean-squared voltage scale (arithmetic rms) of the data point values for the specified region(s) of trace data. See the following equation.

NOTE

For I/Q trace data, the rms of the magnitudes of the I/Q pairs is returned. See the following equation. This function is very useful for I/Q trace data. However, if the original trace data is in dB, this function returns the rms of the log values which is not usually needed.

Equation 4

RMS Value of Data Points for Specified Region(s)

$$\text{RMS} = \sqrt{\frac{1}{n} \sum_{X_i \in \text{region}(s)} X_i^2}$$

where X_i is a data point value, and n is the number of data points in the specified region(s).

Equation 5

RMS Value of I/Q Data Pairs for Specified Region(s)

$$\text{RMS} = \sqrt{\frac{1}{n} \sum_{X_i \in \text{region}(s)} X_i X_i^*}$$

where X_i is the complex value representation of an I/Q pair, X_i^* its conjugate complex number, and n is the number of I/Q pairs in the specified region(s).

Once you have the rms value for a region of trace data (linear or I/Q), you may want to calculate the mean power. You must convert this rms value (peak volts) to power in dBm:

$$10 \times \log[10 \times (\text{rms value})^2]$$

- SAMPLe - returns the first data value (x,y pair) for the specified region(s) of trace data. For I/Q trace data, the first I/Q pair is returned.
- SDEViation - returns a single value that is the arithmetic standard deviation for the data point values for the specified region(s) of trace data. See the following equation.
- For I/Q trace data, the standard deviation of the magnitudes of the I/Q pairs is returned. See the following equation.

Equation 6

Standard Deviation of Data Point Values for Specified Region(s)

$$\text{SDEV} = \sqrt{\frac{1}{n} \sum_{X_i \in \text{region}(s)} (X_i - \bar{X})^2}$$

where X_i is a data point value, \bar{X} is the arithmetic mean of the data point values for the specified region (s), and n is the number of data points in the specified region(s).

$$\text{SDEV} = \sqrt{\frac{1}{n} \sum_{X_i \in \text{region}(s)} (|X_i| - \bar{X})^2}$$

where $|X_i|$ is the magnitude of an I/Q pair, \bar{X} is the mean of the magnitudes for the specified region(s), and n is the number of data points in the specified region(s).

- PPHase - returns the x,y pairs of both rms power (dBm) and arithmetic mean phase (radian) for every specified region and frequency offset (Hz). The number of pairs is defined by the specified number of regions. This parameter can be used for I/Q vector ($n=0$) in Waveform (time domain) measurement and all parameters are specified by data point in PPHase.

The rms power of the specified region may be expressed as:

$$\text{Power} = 10 \times \log [10 \times (\text{RMS I/Q value})] + 10.$$

The RMS I/Q value (peak volts) is:

$$\sqrt{\frac{1}{n} \sum_{X_i \in \text{region}} X_i X_i^*}$$

where X_i is the complex value representation of an I/Q pair, X_i^* its conjugate complex number, and n is the number of I/Q pairs in the specified region.

The arithmetic mean phase of the specified region may be expressed as:

$$\frac{1}{n} \sum_{Y_i \in \text{region}} Y_i$$

where Y_i is the unwrapped phase of I/Q pair with applying frequency correction and n is the number of I/Q pairs in the specified region.

The frequency correction is made by the frequency offset calculated by the arithmetic mean of every specified region's frequency offset. Each frequency offset is calculated by the least square method against the unwrapped phase of I/Q pair.

Sample Trace Data - Constant Envelope

(See below for explanation of variables.)

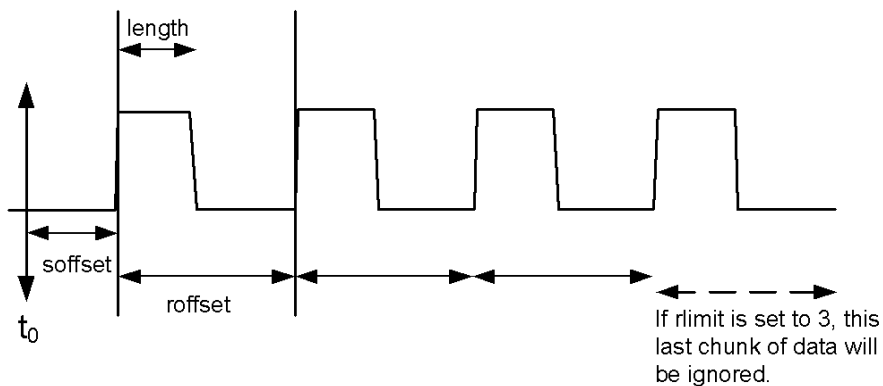

Sample Trace Data - Not Constant Envelope

(See below for explanation of variables.)

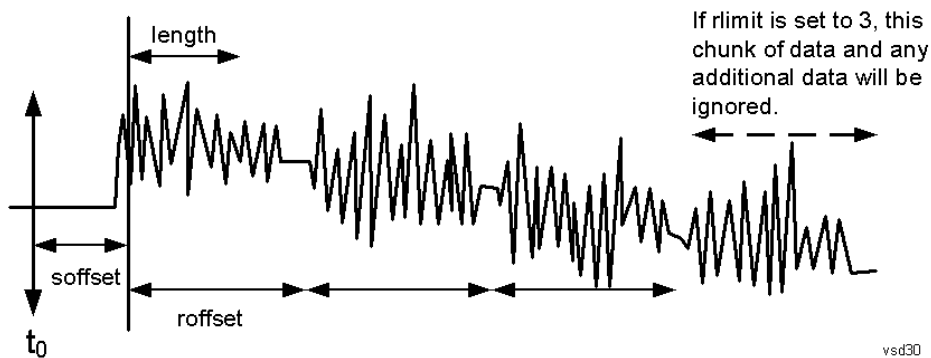

<soffset> - start offset is an optional real number. (It is in seconds for time-domain traces, and is a dimensionless index 0 to Npoints - 1, for frequency-domain traces). It specifies the amount of data at the beginning of the trace that will be ignored before the decimation process starts. It is the time or frequency change from the start of the trace to the point where you want to start using the data. The default value is zero.

<length> - is an optional real number. (It is in seconds for time-domain traces, and is a dimensionless index 0 to Npoints - 1, for frequency-domain traces). It defines how much data will be compressed into one value. This parameter has a default value equal to the current trace length.

<roffset> - repeat offset is an optional real number. (It is in seconds for time-domain traces, and is a dimensionless index 0 to Npoints - 1, for frequency-domain traces). It defines the beginning of the next field of trace elements to be compressed. This is relative to the beginning of the previous field. This parameter has a default value equal to the <length> variable. Note that this parameter is used for a completely different purpose when curve fitting (see CFIT above).

<rlimit> - repeat limit is an optional integer. It specifies the number of data items that you want returned. It will ignore any additional items beyond that number. You can use the Start offset and the Repeat limit to pick out exactly what part of the data you want to use. The default value is all the data.

Calculate Peaks of Trace Data (Remote Command Only)

Returns a list of all the peaks for the currently selected measurement and sub-opcode [n]. The peaks must meet the requirements of the peak threshold and excursion values.

n = any valid sub-opcode for the current measurement. See the MEASure:<measurement> command description of your specific measurement for information on the data that can be returned.

The command can only be used with specific sub-opcodes with measurement results that are trace data. Both real and complex traces can be searched, but complex traces are converted to magnitude in dBm. In many measurements the sub-opcode n=0, is the raw trace data which cannot be searched for peaks. And Sub-opcode n=1, is often calculated results values which also cannot be searched for peaks.

This command uses the data setting specified by the FORMat:BORDER and FORMat:DATA commands and can return real or ASCII data. If the format is set to INT,32, it returns REAL,32 data.

The command has four types of parameters:

- Threshold (in dBm)
- Excursion (in dB)
- Sorting order (amplitude, frequency, time)
- Optional in some measurements: Display line use (all, > display line, < display line)

Remote Command	<p>For Swept SA measurement:</p> <pre>:CALCulate:DATA[1] 2 ... 6:PEAKs? <threshold>,<excursion>[,AMPLitude FREQuency TIME[,ALL GTDLine LTDLine]]</pre> <p>For most other measurements:</p> <pre>:CALCulate:DATA[1] 2 ... 6:PEAKs? <threshold>,<excursion>[,AMPLitude FREQuency TIME]</pre>
-----------------------	--

Example	<p>Example for Swept SA measurement in Spectrum Analyzer Mode:</p> <p>CALC:DATA4:PEAK? -40, 10, FREQ, GTDL This will identify the peaks of trace 4 that are above -40 dBm, with excursions of at least 10 dB. The peaks are returned in order of increasing frequency, starting with the lowest frequency. Only the peaks that are above the display line are returned.</p> <p>Query Results 1:</p> <p>With FORMat:DATA REAL, 32 selected, it returns a list of floating-point numbers. The first value in the list is the number of peak points that are in the following list. A peak point consists of two values: a peak amplitude followed by its corresponding frequency (or time).</p> <p>If no peaks are found the peak list will consist of only the number of peaks, (0).</p>
----------------	---

Notes	<p><n> - is the trace that will be used</p> <p><threshold> - is the level below which trace data peaks are ignored. Note that the threshold value is required and is always used as a peak criterion. To effectively disable the threshold criterion for this command, provide a substantially low threshold value such as -200 dBm. Also note that the threshold value used in this command is independent of and has no effect on the threshold value stored under the Peak Criteria menu.</p> <p><excursion> - is the minimum amplitude variation (rise and fall) required for a signal to be identified as peak. Note that the excursion value is required and is always used as a peak criterion. To effectively disable the excursion criterion for this command, provide the minimum value of 0.0 dB. Also note that the excursion value used in this command is independent of and has no effect on the</p>
--------------	---

excursion value stored under the Peak Criteria menu.

Values must be provided for threshold and excursion. The sorting and display line parameters are optional (defaults are AMPLitude and ALL).

Note that there is always a Y-axis value for the display line, regardless of whether the display line state is on or off. It is the current Y-axis value of the display line which is used by this command to determine whether a peak should be reported

Sorting order:

AMPLitude - lists the peaks in order of descending amplitude, with the highest peak first (default if optional parameter not sent)

FREQUency - lists the peaks in order of occurrence, left to right across the x-axis.

TIME - lists the peaks in order of occurrence, left to right across the x-axis.

Peaks vs. Display Line:

ALL - lists all of the peaks found (default if optional parameter not sent).

GTDLine (greater than display line) - lists all of the peaks found above the display line.

LTDLine (less than display line) - lists all of the peaks found below the display line.

Initial S/W Revision Prior to A.02.00

Format Data: Numeric Data (Remote Command Only)

This command specifies the format of the trace data input and output. It specifies the formats used for trace data during data transfer across any remote port. It affects only the data format for setting and querying trace data for the :TRACe[:DATA], TRACe[:DATA]?, :CALCulate:DATA[n]? and FETCh:SANalyzer [n]? commands and queries.

Remote Command :FORMat[:TRACe] [:DATA] ASCii|INTeger, 32|REAL, 32 |REAL, 64
:FORMat[:TRACe] [:DATA] ?

Notes The query response is:
ASCii: ASC,8
REAL,32: REAL,32
REAL,64: REAL,64
INTeger,32: INT,32

When the numeric data format is REAL or ASCii, data is output in the current Y Axis unit. When the data format is INTeger, data is output in units of m dBm (.001 dBm).

The INT,32 format returns binary 32-bit integer values in internal units (m dBm), in a definite length block.

Dependencies Sending a data format spec with an invalid number (for example, INT,48) generates no error. The analyzer simply uses the default (8 for ASCii, 32 for INTeger, 32 for REAL).

Sending data to the analyzer which does not conform to the current FORMat specified, results in an error. Sending ASCII data when a definite block is expected generates message -161 "Invalid Block Data" and sending a definite block when ASCII data is expected generates message -121 "Invalid Character in Number".

Preset ASCii

Backwards Compatibility Notes Note that the INT,32 format is only applicable to the command, TRACe:DATA. This preserves backwards compatibility for the Swept SA measurement. For all other commands/queries which honor FORMat:DATA, if INT,32 is sent the analyzer will behave as though it were set to REAL,32.

Initial S/W Revision Prior to A.02.00

The specs for each output type follow:

AScii - Amplitude values are in ASCII, in the current Y Axis Unit, one ASCII character per digit, values separated by commas, each value in the form:

SX.YYYYYEsZZ

Where:

S = sign (+ or -)

X = one digit to left of decimal point

Y = 5 digits to right of decimal point

E = E, exponent header

s = sign of exponent (+ or -)

ZZ = two digit exponent

REAL,32 - Binary 32-bit real values in the current Y Axis Unit, in a definite length block.

REAL,64 - Binary 64-bit real values in the current Y Axis Unit, in a definite length block.

Format Data: Byte Order (Remote Command Only)

This command selects the binary data byte order for data transfer and other queries. It controls whether binary data is transferred in normal or swapped mode. This command affects only the byte order for setting and querying trace data for the :TRACe[:DATA], TRACe[:DATA]? , :CALCulate:DATA[n]? and FETCh:SANalyzer[n]? commands and queries.

By definition any command that says it uses FORMat:DATA uses any format supported by FORMat:DATA.

The NORMal order is a byte sequence that begins with the most significant byte (MSB) first, and ends with the least significant byte (LSB) last in the sequence: 1|2|3|4. SWAPped order is when the byte sequence begins with the LSB first, and ends with the MSB last in the sequence: 4|3|2|1.

Remote Command	:FORMat:BORDER NORMal SWAPped :FORMat:BORDER?
Preset	NORMal
Initial S/W Revision	Prior to A.02.00

Meas Setup

Displays the setup menu for the currently selected measurement.

Key Path	Front-panel key
Mode	IDEN
Initial S/W Revision	A.02.00

Test Preset

Test Preset key initializes the measurement to a known state for starting MotoTalk testing. The various Parameters are preset as noted in the Coupling row of each parameter table. This softkey color is green, indicating its status as a preset key.

Key Path	Meas Setup
Mode	IDEN
Remote Command	CONF:MOTotalk
Example	CONF:MOT
Couplings	This affects other parameters as documented in the Coupling row for each affected parameter. It also performs a Preset View:Test Standard.
Initial S/W Revision	A.02.00

Search Length

The Search Length is the length of the time record acquired to make the measurement. The time must be long enough to include the slot to be analyzed.

If the Trigger is set to Free Run, it must be increased to include the maximum expected latency time.

Search Length is preset to a length appropriate for all slots active. A longer Search Length is needed when the subscriber radio under test is not transmitting in every slot in each frame.

Key Path	Meas Setup
Mode	IDEN
Remote Command	[:SENSe] :MOTotalk [:SYNC] :SLENgth <time> [:SENSe] :MOTotalk [:SYNC] :SLENgth?
Example	:MOT:SYNC:SLEN .11
Couplings	Set to 110 ms by Test Preset.
Preset	110 ms
Min	110 ms
Max	2 s
Initial S/W Revision	A.02.00

Analysis Slot

Specifies the timeslot for analysis.

Key Path	Meas Setup
Mode	IDEN
Remote Command	[:SENSe] :MOTotalk:ANALysis:SLOT <integer> [:SENSe] :MOTotalk: ANALysis:SLOT?
Example	:MOT:ANAL:SLOT 0
Preset	0
Min	0
Max	24
Initial S/W Revision	A.02.00

Avg Number

Enables you to turn averaging on or off, and set the number of scans (time records) whose measurement results are averaged. Averaging can be done over spectrum results (RMS) or over time records (Time). A third kind of pseudo averaging displays the maximum value seen at each spectral line over the specified number of scans. See ["Average Type" on page 1180](#) for a more detailed description of how measurement results are averaged. For RMS or Time averaging, the process is similar. Each time an averaged result is displayed, it is the sum of the individual results taken since measurement restart, divided by the number of scans. (For Max averaging, there is no actual summation or division.) The Measurement Bar shows the number of scans and the Avg number setting. For example, if 4 scans have been taken and the Avg Number is 10, the Meas Bar shows "4/10". The measurement continues to take new scans until the number of scans is equal to the Avg Number setting, at which time the measurement stops if Sweep control is in Single Mode. Otherwise, the measurement continues, and the Average Mode setting determines how successive scans are added to the averaged result. See ["Average Mode" on page 1179](#) for details.

Key Path	Meas Setup, More
Mode	VSA, LTE, LTETDD, IDEN, LTEAFDD, LTEATDD
Measurement	<meas>:=VECTor ADEMod DDEMod W11A W11B EVM IPOWER IDEMod MOTotalk
Remote Command	[:SENSe] :<meas>:AVERage:COUNT <integer> [:SENSe] :<meas>:AVERage:COUNT? [:SENSe] :<meas>:AVERage [:STATe] OFF ON 0 1 [:SENSe] :<meas>:AVERage [:STATe] ?
Example	VECT:AVER:COUN 20 VECT:AVER:COUN? VECT:AVER ON VECT:AVER?
Notes	If an averaged measurement is idle because the scan count is equal to the Avg Number and the Avg

	Number is increased, the measurement resumes until the new number of averages is satisfied.
Preset	10 OFF IPOW: ON
State Saved	Saved in instrument state.
Min	1
Max	2147483647
Initial S/W Revision	Prior to A.02.00
Modified at S/W Revision	A.02.00

Average Mode

Determines what happens when the Sweep Mode is Continuous and the number of scans processed exceeds the Average Number (see "[Avg Number](#)" on page 1178). If the Sweep Control is in Single mode, this setting has no affect.

When averaging is on and the number of scans is less than or equal to the Avg Number setting, a linear average is calculated as explained in the Avg Number topic. After the scan count exceeds the Avg Number setting, the measurement continues to take new scans. The Measurement Bar average indicator shows ">N/N" where N is the Avg Number.

If Average Mode is Exp then new results are averaged in exponentially. In other words, each succeeding average is the weighted sum of the previous average, weighted by $(N-1)/N$, and the new measurement, weighted by $1/N$, where N is the Average Number setting. (For Max averaging, no weighting occurs; the result continues to be the max value seen at each spectral line for every previous scan since measurement restart.)

If Average Mode is Repeat, then the average buffer is cleared after the average counter reaches the Average Number setting, and the average counter is reset to 0. Then a new set of averages is taken. The measurement bar therefore continues to show "k/N" in the average indicator, where k is the number of scans since the last time the average buffer was cleared and N is the Avg Number. The averaged result is the sum of the last k results divided by k. (For Max averaging, no sum or division takes place, but the buffer is cleared as stated above. The averaged result is the max value seen over the last k scans.)

Key Path	Meas Setup
Mode	VSA, LTE, LTETDD, IDEN, LTEAFDD, LTEATDD
Measurement	<meas>:=VECTor ADEMod DDEMod W11A W11B EVM IPOWER IDEMod MOTotalk
Remote Command	[:SENSe] :<meas>:AVERage:TCONtrol EXPonential REPeat [:SENSe] :<meas>:AVERage:TCONtrol?
Example	VECT:AVER:TCON EXP VECT:AVER:TCON?
Preset	EXP
State Saved	Saved in instrument state.

Range	Exp Repeat
Initial S/W Revision	Prior to A.02.00
Modified at S/W Revision	A.02.00

Average Setup

Accesses a menu enabling you to set Averaging parameters for all VSA based measurements.

Key Path	Meas Setup
Mode	VSA, LTE, LTETDD, IDEN, LTEAFDD, LTEATDD
Initial S/W Revision	Prior to A.02.00
Modified at S/W Revision	A.02.00

Average Type

Enables you to select the type of averaging. The following table shows what measurement results are averaged for each average type. This applies in the Vector Measurement.

Average Type	Measurement result averaged.
RMS	Spectrum, PSD: Power is averaged for each spectral line (i.e., this is a mean-square average of voltage). For the Spectrum result only, if the display transform is linear or real, the RMS result is displayed.
Time	Main Time: Individual time samples in the current time record are averaged vectorially (not RMS) with corresponding points in previous time records. See Main Time for more details.
Max	Spectrum, PSD: Not strictly an average. For each spectral line, power from the current measurement is compared to the average buffer value and the maximum is kept in the average buffer.

Some measurement results are inherently averaged, and are not affected by the Average controls. These are: CCDF, CDF, and PDF. They average continuously until the next measurement restart.

Key Path	Meas Setup, Average Setup
Mode	VSA, LTE, LTETDD, IDEN, LTEAFDD, LTEATDD
Measurement	<meas>:=VECTor ADEMod DDEMod W11A W11B EVM IPOWER IDEMod MOTotalk
Remote Command	[:SENSE] : <meas> : AVERage : TYPE RMS TIME MAXimum [:SENSE] : <meas> : AVERage : TYPE ?
Example	VECT: AVER: TYPE RMS VECT: AVER: TYPE ?
Preset	RMS
State Saved	Saved in instrument state.

Range	RMS Time Max
Initial S/W Revision	Prior to A.02.00
Modified at S/W Revision	A.02.00

Fast Average

Controls the display of average data. If fast averaging is off, then the display is updated after each time record is processed. If fast averaging is on, then the display is only updated after every M records, where M is the Update Rate (see "Update Rate" on page 1181). For example, if the fast average count is 10, then the running average is only displayed every 10th time record.

Key Path	Meas Setup, Average Setup
Mode	VSA, LTE, LTETDD, IDEN, LTEAFDD, LTEATDD
Measurement	<meas>:=VECTor ADEMod DDEMod W11A W11B EVM IPOWER IDEMod MOTotalk
Remote Command	[:SENSe] :<meas>:AVERage:FAST OFF ON 0 1 [:SENSe] :<meas>:AVERage:FAST?
Example	VECT:AVER:FAST ON VECT:AVER:FAST?
Preset	OFF
State Saved	Saved in instrument state.
Range	On Off
Initial S/W Revision	Prior to A.02.00
Modified at S/W Revision	A.02.00

Update Rate

Controls how often the display updates when fast averaging is turned on. If the Fast Averaging State is MAX then the display is updated only after the full Average Count is reached. Otherwise, the display is updated whenever the average count is a multiple of the Update Rate.

Key Path	Meas Setup, More, Average Setup
Mode	VSA, LTE, LTETDD, IDEN, LTEAFDD, LTEATDD
Measurement	<meas>:=VECTor ADEMod DDEMod W11A W11B EVM IPOWER IDEMod MOTotalk
Remote Command	[:SENSe] :<meas>:AVERage:FAST:URATe <integer> [:SENSe] :<meas>:AVERage:FAST:URATe? [:SENSe] :<meas>:AVERage:FAST:URATe:AUTO OFF ON 0 1 [:SENSe] :<meas>:AVERage:FAST:URATe:AUTO?
Example	VECT:AVER:FAST:URAT 20 VECT:AVER:FAST:URAT?

	VECT:AVER:FAST:URAT:AUTO ON VECT:AVER:FAST:URAT:AUTO?
Preset	10 ON
State Saved	Saved in instrument state.
Min	1
Max	2147483647
Initial S/W Revision	Prior to A.02.00
Modified at S/W Revision	A.02.00

Normalize

Setting this parameter to On will result in the error vector time window to be normalized by the frequency deviation.

Key Path	Meas Setup, More
Mode	IDEN
Remote Command	[:SENSe] :MOTotalk :NORMAlize :STATe OFF ON 0 1 [:SENSe] :MOTotalk :NORMAlize :STATe ?
Example	:MOT:NORM:STAT ON
Couplings	Set to On by Test Preset
Preset	On
State Saved	Saved in instrument state.
Range	Off On
Initial S/W Revision	A.02.00

Advanced

These parameters are advanced demodulation controls that are not normally used.

Key Path	Meas Setup, More
Mode	IDEN
Initial S/W Revision	A.02.00

Gaussian BT

This softkey sets the demodulation Gaussian receive filter BT (Bandwidth Time product) parameter and is preset per the filter standards. The Gaussian receive filter bandwidth 3 dB bandwidth in Hz is the Symbol Rate ("[Symbol Rate](#)" on page 1183) divided by the Gaussian BT.

Key Path	Meas Setup, More, Advanced
Mode	IDEN
Remote Command	<code>[:SENSe] :MOTotalk:BT <real></code> <code>[:SENSe] :MOTotalk:BT?</code>
Example	<code>:MOT:BT 2.5</code>
Couplings	Set to .4 by Test Preset
Preset	2.5
State Saved	Saved in instrument state.
Min	.05
Max	100.0
Initial S/W Revision	A.02.00

Symbol Rate

This softkey sets the Symbol Rate expected by the demodulator and is preset per the standards. This can be used to "tune out" Symbol Rate errors or to accommodate an implementation that runs at less than the standard Symbol Rate.

Key Path	Meas Setup, More, Advanced
Mode	IDEN
Remote Command	<code>[:SENSe] :MOTotalk:SRATe <real></code> <code>[:SENSe] :MOTotalk:SRATe?</code>
Example	<code>:MOT:SRAT 3200</code>
Couplings	Set to 3200 by Test Preset. Span will be increased, if necessary, to accommodate the signal bandwidth.
Preset	3200
State Saved	Saved in instrument state.
Min	320
Max	32000
Initial S/W Revision	A.02.00

Burst Search

This softkey turns the Burst Search functionality On/Off. The burst search performs a coarse location of the beginning of the burst being analyzed. This is followed by a sync pattern search in the burst over a narrow portion of the detected burst. If Burst Search is turned Off, the sync pattern search will be expanded to include the full range of possible locations within the Search Length. Turning Burst Search off can potentially take much longer than a burst search followed by a limited sync search. Turn Burst Search off only if it appears that signal or interference problems are causing the burst search to fail. Test Preset turns Burst Search On.

Key Path	Meas Setup, More, Advanced
Mode	IDEN
Remote Command	<code>[:SENSe] :MOTotalk :SYNC :BURSt :STATe OFF ON 0 1</code> <code>[:SENSe] :MOTotalk :SYNC :BURSt :STATe ?</code>
Example	<code>:MOT:SYNC:BURS:STAT ON</code>
Couplings	Set to On by Test Preset
Preset	On
State Saved	Saved in instrument state.
Range	Off On
Initial S/W Revision	A.02.00

Mode

See "Mode" on page 196

Mode Preset

Returns the active mode to a known state.

Mode Preset does the following for the currently active mode:

- Aborts the currently running measurement.
- Brings up the default menu for the mode, with no active function.
- Sets measurement Global settings to their preset values for the active mode only.
- Activates the default measurement.
- Brings up the default menu for the mode.
- Clears the input and output buffers.
- Sets Status Byte to 0.

Mode Preset does not:

- Cause a mode switch
- Affect mode persistent settings
- Affect system settings

See "[How-To Preset](#)" on page 1187 for more information.

Key Path	Front-panel key
Remote Command	:SYSTem:PRESet
Example	:SYST:PRES
Notes	*RST is preferred over :SYST:PRES for remote operation. *RST does a Mode Preset, as done by the :SYST:PRES command, and it sets the measurement mode to Single measurement rather than Continuous for optimal remote control throughput. Clears all pending OPC bits. The Status Byte is set to 0.
Couplings	A Mode Preset aborts the currently running measurement, activates the default measurement, and gets the mode to a consistent state with all of the default couplings set.
Backwards Compatibility Notes	In the X-Series, the legacy "Factory Preset" has been replaced with Mode Preset, which only presets the currently active mode, not the entire instrument. In the X-Series, the way to preset the entire instrument is by using System, Restore System Defaults All, which behaves essentially the same way as restore System Defaults does on ESA and PSA. There is also no "Preset Type" as there is on the PSA. There is a green Mode Preset front-panel key that does a Mode Preset and a white-with-green-letters User Preset front-panel key that does a User Preset. The old PRESet:TYPE command is ignored (without generating an error), and SYST:PRES without a parameter does a Mode Preset, which should cover most backward code compatibility issues. The settings and correction data under the Input/Output front-panel key (examples: Input Z Corr, Ext Amp Gain, etc.) are no longer part of any Mode, so they will not be preset by a Mode Preset. They are preset using Restore Input/Output Defaults, Restore System Defaults All. Note that because User Preset does a Recall State, and all of these settings are saved in State, they ARE recalled when using

	User Preset.
Initial S/W Revision	Prior to A.02.00

How-To Preset

The table below shows all possible presets, their corresponding SCPI commands and front-panel access (key paths). Instrument settings depend on the current measurement context. Some settings are local to the current measurement, some are global (common) across all the measurements in the current mode, and some are global to all the available modes. In a similar way, restoring the settings to their preset state can be done within the different contexts.

Auto Couple - is a measurement local key. It sets all Auto/Man parameter couplings in the measurement to Auto. Any Auto/Man selection that is local to other measurements in the mode will not be affected.

Meas Preset - is a measurement local key. Meas Preset resets all the variables local to the current measurement except the persistent ones.

Mode Preset - resets all the current mode's measurement local and measurement global variables except the persistent ones.

Restore Mode Defaults - resets ALL the Mode variables (and all the Meas global and Meas local variables), including the persistent ones.

Type Of Preset	SCPI Command	Front Panel Access
Auto Couple	:COUPlE ALL	Auto Couple front-panel key
Meas Preset	:CONFIgure:<Measurement>	Meas Setup Menu
Mode Preset	:SYSTem:PRESet	Mode Preset (green key)
Restore Mode Defaults	:INSTrument:DEFault	Mode Setup Menu
Restore All Mode Defaults	:SYSTem:DEFault MODEs	System Menu; Restore System Default Menu
*RST	*RST	not possible (Mode Preset with Single)
Restore Input/Output Defaults	:SYSTem:DEFault INPut	System Menu; Restore System Default Menu
Restore Power On Defaults	:SYSTem:DEFault PON	System Menu; Restore System Default Menu
Restore Alignment Defaults	:SYSTem:DEFault ALIGn	System Menu; Restore System Default Menu
Restore Miscellaneous Defaults	:SYSTem:DEFault MISC	System Menu; Restore System Default Menu
Restore All System Defaults	:SYSTem:DEFault [ALL] :SYSTem:PRESet:PERSistent	System Menu; Restore System Default Menu
User Preset	:SYSTem:PRESet:USER	User Preset Menu
User Preset All Modes	:SYSTem:PRESet:USER:ALL	User Preset Menu

12 MotoTalk Measurement
Mode Preset

Power On Mode Preset	:SYSTem:PON:TYPE MODE	System Menu
Power On User Preset	:SYSTem:PON:TYPE USER	System Menu
Power On Last State	:SYSTem:PON:TYPE LAST	System Menu

Mode Setup

See "[Mode Setup](#)" on page 226

Peak Search

Displays a menu that enables markers to be easily moved among peaks on a trace and also performs the peak search function. Pressing Peak Search also makes the selected marker's X position the active function.

The peak search function causes the marker to move to the highest point in the trace. The highest point is the point with the largest y-axis value in the current trace format. If the format is complex (vector or constellation) then the point with the highest magnitude is chosen.

Pressing the Peak Search hard key always performs a Peak Search, with one exception: if the Peak Search menu is not showing but the selected marker is on (Normal, Delta, or Fixed), then pressing the Peak Search hardkey only displays the Peak Search menu. This enables you to select one of the other peak search functions without disturbing the selected marker's position. If you want to perform a peak search in this case, press the Peak Search hardkey again.

If the selected marker is Off, then pressing the Peak Search hardkey once not only shows the menu, but it turns on the selected marker in Normal mode, assigns it to the selected trace, and performs a peak search.

If any peak search SCPI command is invoked on a marker that is Off, the marker is first turned on in Normal mode and assigned to the selected trace. Then the peak search is performed.

Key Path	Front Panel
Mode	VSA, LTE, LTETDD, IDEN
Measurement	<meas>:=VECTor ADEMod DDEMod W11A W11B EVM IPOWER IDEMod MOTotalk
Remote Command	:CALCulate:<meas>:MARKer[1] 2 ...12:MAXimum
Example	CALC:VECT:MARK2:MAX
Notes	There is no softkey for this function. Instead, you press the Peak Search hardkey twice. (Pressing it once is sufficient if the Peak Search menu is showing, but twice guarantees that the function is invoked) If peak search function is not invoked (because the response to pressing the hardkey was only to show the menu) then the following message is shown: "Press Peak Search again to perform a Peak Search."
Initial S/W Revision	Prior to A.02.00
Modified at S/W Revision	A.02.00

Select Marker

Specifies the selected marker. The selected marker is the one that is affected by the marker position and properties settings, peak search, and other marker functions. Several menus have a Select Marker key for convenience. Marker selection using any one of these is reflected in all others, in other words, there is only one selected marker for the whole measurement. If all markers are off, then marker 1 becomes the selected marker.

As a convenience, if no markers are displayed on the selected trace, selecting a marker that is off automatically turns it on in normal mode on the selected trace.

There is no SCPI function for selecting a marker. Instead, SCPI functions can explicitly include the index of the marker for which they are to apply. (Most SCPI marker functions that affect the state of a marker also make it the selected marker for front panel commands.)

Key Path	Marker or Marker> or Marker Function or Peak Search
Mode	VSA, LTE, LTETDD, IDEN, LTEAFDD, LTEATDD
State Saved	No
Range	1 2 3 4 5 6 7 8 9 10 11 12
Initial S/W Revision	Prior to A.02.00
Modified at S/W Revision	A.02.00

Next Peak (Next Lower Amptd)

Moves the marker to the peak next lower in Y value than the peak it is currently on. If the format is complex (vector or constellation) then the marker moves to the closest point that has a lower magnitude than the marker's current position. If this function is invoked via SCPI on a marker that is off, the result is the same as if you sent a Peak Search command.

Key Path	Peak Search
Mode	VSA, LTE, LTETDD, IDEN
Measurement	<meas>:=VECTor ADEMod DDEMod W11A W11B EVM IPOWER IDEMod MOTotalk
Remote Command	:CALCulate:<meas>:MARKer[1] 2 ...12:MAXimum:NEXT
Example	CALC:VECT:MARK2:MAX:NEXT
Initial S/W Revision	Prior to A.02.00
Modified at S/W Revision	A.02.00

Next Higher Amptd

Moves the marker to the peak next higher in Y value than the peak it is currently on. If the format is complex (vector or constellation) then the marker moves to the closest point that has a higher magnitude than the marker's current position. If this function is invoked via SCPI on a marker that is off, the result is the same as if you sent a Peak Search command.

Key Path	Peak Search
Mode	VSA, LTE, LTETDD, IDEN
Measurement	<meas>:=VECTor ADEMod DDEMod W11A W11B EVM IPOWER IDEMod MOTotalk
Remote Command	:CALCulate:<meas>:MARKer[1] 2 ...12:MAXimum:PREVious
Example	CALC:VECT:MARK2:MAX:PREV
Initial S/W Revision	Prior to A.02.00
Modified at S/W Revision	A.02.00

Next Right

Moves the marker to the next peak to the right of its current position. If the format is complex (vector or constellation) then the marker moves forward in time to the next peak. If this function is invoked via SCPI on a marker that is off, the result is the same as if you sent a Peak Search command.

A valid peak is one for which the displayed Y-axis values drop monotonically on both sides of the local maximum at least 4% of the distance between the top and bottom of the display grid before the values begin to rise again.

Key Path	Peak Search
Mode	VSA, LTE, LTETDD, IDEN
Measurement	<meas>:=VECTor ADEMod DDEMod W11A W11B EVM IPOWER IDEMod MOTotalk
Remote Command	:CALCulate:<meas>:MARKer [1] 2 . . . 12:MAXimum:RIGHT
Example	CALC:VECT:MARK2:MAX:RIGH
Initial S/W Revision	Prior to A.02.00
Modified at S/W Revision	A.02.00

Next Left

Moves the marker to the next peak to the left of its current position. If the format is complex (vector or constellation) then the marker moves back in time to the next peak. If this function is invoked via SCPI on a marker that is off, the result is the same as if you sent a Peak Search command.

A valid peak is one for which the displayed Y-axis values drop monotonically on both sides of the local maximum at least 4% of the distance between the top and bottom of the display grid before the values begin to rise again.

Key Path	Peak Search
Mode	VSA, LTE, LTETDD, IDEN
Measurement	<meas>:=VECTor ADEMod DDEMod W11A W11B EVM IPOWER IDEMod MOTotalk
Remote Command	:CALCulate:<meas>:MARKer [1] 2 . . . 12:MAXimum:LEFT
Example	CALC:VECT:MARK2:MAX:LEFT
Initial S/W Revision	Prior to A.02.00
Modified at S/W Revision	A.02.00

Mkr -> CF (Center Frequency)

Sets the center frequency equal to the selected marker's absolute frequency. The marker must be on a frequency-domain trace. The absolute marker frequency is used regardless of whether its control mode is Normal, Delta, or Fixed.

If the currently selected marker is not on when this key is pressed, it is turned on at the center of the screen as a normal type marker.

Key Path	Marker To
Mode	VSA, LTE, LTETDD, IDEN, LTEAFDD, LTEATDD
Initial S/W Revision	Prior to A.02.00
Modified at S/W Revision	A.02.00

Continuous Peak Search

Turns on Continuous Peak Search for the selected marker. This function can be turned on for any marker independently of any other marker. This function moves the marker to the highest point on the trace each time the trace is updated. If the SCPI command refers to a marker that is off, it is turned on in Normal mode.

It is possible to have Couple Markers and Continuous Peak Search both on. If this is the case, it is recommended that Continuous Peak search be turned on for only one marker in any tracking set (that is, any set of markers with the same or equivalent domain). Otherwise, conflicts over marker position can arise that cause erratic marker movement.

Key Path	Peak Search
Mode	VSA, LTE, LTETDD, IDEN
Measurement	<meas>:=VECTor ADEMod DDEMod W11A W11B EVM IPOWER IDEMod MOTotalk
Remote Command	:CALCulate:<meas>:MARKer[1] 2 ...12:CPSearch[:STATe] ON OFF 1 0 :CALCulate:<meas>:MARKer[1] 2 ...12:CPSearch[:STATe]?
Example	CALC:VECT:MARK1:CPS ON
Couplings	The Continuous Peak Search key is grayed out when the selected marker is a Fixed marker. Also, if Continuous Peak Search is on and the selected marker becomes a fixed marker, then Continuous Peak Search is turned off and the key grayed out. Continuous Peak Search is turned off when the selected marker is turned off.
Preset	OFF
State Saved	Saved in instrument state.
Range	Off On
Initial S/W Revision	Prior to A.02.00
Modified at S/W Revision	A.02.00

Min Search

Moves the marker to the lowest Y value on the trace. If the format is complex (vector or constellation) then the marker moves to the lowest value in magnitude. If the SCPI command refers to a marker that is off, it is first turned on in Normal mode and then set on the minimum point.

Key Path	Peak Search
Mode	VSA, LTE, LTETDD, IDEN

Measurement	<meas>:=VECTor ADEMod DDEMod W11A W11B EVM IPOWER IDEMod MOTotalk
Remote Command	:CALCulate:<meas>:MARKer [1] 2 ... 12:MINimum
Example	CALC:VECT:MARK2:MIN
Initial S/W Revision	Prior to A.02.00
Modified at S/W Revision	A.02.00

Mkr -> Ref Lvl (Reference Level)

Sets the Y axis reference value equal to the selected marker's Y value. For example, if the reference position is at the top of the screen, the whole trace is moved up so that the marker appears at the top of the screen. Note that this is a display scaling function only. The input range remains the same.

Key Path	Peak Search
Mode	VSA, LTE, LTETDD, IDEN
Initial S/W Revision	Prior to A.02.00
Modified at S/W Revision	A.02.00

Print

See "Print" on page 241

Quick Save

The Quick Save front-panel key repeats the most recent save that was performed from the Save menu, with the following exceptions:

- Register saves are not remembered as Saves for the purpose of the Quick Save function
- If the current measurement does not support the last non-register save that was performed, an informational message is generated, “File type not supported for this measurement”

Quick Save repeats the last type of qualified save (that is, a save qualified by the above criteria) in the last save directory by creating a unique filename using the Auto File Naming algorithm described below.

If Quick Save is pressed after startup and before any qualified Save has been performed, the Quick Save function performs a Screen Image save using the current settings for Screen Image saves (current theme, current directory), which then becomes the “last save” for the purpose of subsequent Quick Saves.

The Auto File Naming feature automatically generates a file name for use when saving a file. The filename consists of a prefix and suffix separated by a dot, as is standard for the Windows® file system. A default prefix exists for each of the available file types:

Type	Default Prefix	Menu
State	State_	(Save/Recall)
Trace + State	State_	(Save/Recall)
Screen	Screen_	(Save/Recall)
Amplitude Corrections	Ampcor_	(Import/Export)
Traces	Trace_	(Import/Export)
Limit Lines	LLine_	(Import/Export)
Measurement Result	MeasR_	(Import/Export)
Capture Buffer	CapBuf_	(Import/Export)

A four digit number is appended to the prefix to create a unique file name. The numbering sequence starts at 0000 within each Mode for each file type and updates incrementally to 9999, then wraps to 0000 again. It remembers where it was through a Mode Preset and when leaving and returning to the Mode. It is reset by Restore Misc Defaults and Restore System Defaults and subsequent running of the instrument application. So, for example, the first auto file name generated for State files is State_0000.state. The next is State_0001, and so forth.

One of the key features of Auto File Name is that we guarantee that the Auto File Name will never conflict with an existing file. The algorithm looks for the next available number. If it gets to 9999, then it looks for holes. If it find no holes, that is no more numbers are available, it gives an error.

For example, if when we get to State_0010.state there is already a State_0010.state file in the current directory, it advances the counter to State_0011.state to ensure that no conflict will exist (and then it verifies that State_0011.state also does not exist in the current directory and advances again if it does, and so forth).

If you enter a file name for a given file type, then the prefix becomes the filename you entered instead of the default prefix, followed by an underscore. The last four letters (the suffix) are the 4-digit number.

For example, if you save a measurement results file as “fred.csv”, then the next auto file name chosen for a measurement results save will be fred_0000.csv.

NOTE

Although 0000 is used in the example above, the number that is used is actually the current number in the Meas Results sequence, that is, the number that would have been used if you had not entered your own file name.

NOTE

If the filename you entered ends with _dddd, where d=any number, making it look just like an auto file name, then the next auto file name picks up where you left off with the suffix being dddd + 1.

Key Path	Front-panel key
Notes	No remote command for this key specifically.
Initial S/W Revision	Prior to A.02.00

Recall

The Recall menu lets you choose what you want to recall, and where you want to recall it from. Among the types of files you can recall are **States and Traces**. In addition, an Import (Data) option lets you recall a number of data types stored in CSV files (as used by Excel and other spreadsheet programs).

The default paths for Recall are data type dependent and are the same as for the Save key.

Key Path	Front-panel key
Notes	<p>No remote command for this key specifically, but the :MMEM:LOAD command is available for specific file types. An example is :MMEM:LOAD:STATe <filename>.</p> <p>If you try to recall a State file for a mode that is not licensed or not available in the instrument, an error message will occur and the state will not change.</p>
Backwards Compatibility Notes	<p>In legacy analyzers, it was possible to load a state without affecting the trace data, limit lines or correction data. Similarly (since User Preset is actually loading a state), it was possible to do a User Preset without affecting the trace data, limit lines or correction data.</p> <p>In the X-Series, “state” always includes all of this data; so whenever state is loaded, all of the traces, limit lines and corrections are affected. Although this differs from previous behavior, it is desirable behavior, and should not cause adverse issues for users.</p>
Backwards Compatibility Notes	<p>Recall for the X-Series supports backward compatibility in the sense that you can recall a state file from any X-Series model number and any version of X-Series software. This is only possible if part of the recalling process goes through a limiting step after recalling the mode settings, at least for settings that may vary with version number, model number, option and license differences. If you try to recall a state file onto an instrument with less capability than what was available on the instrument during the save, the recall will ignore the state it doesn't support and it will limit the recalled setting to what it allows.</p> <p>Example: if the saved state includes preamp ON, but the recalling instrument does not have a preamp; the preamp is limited to OFF. Conversely, if you save a state without a preamp, the preamp is OFF in the state file. When this saved file is recalled on an instrument with a licensed preamp, the preamp is changed to OFF. Another example is if the saved state has center frequency set to 20 GHz, but the instrument recalling the saved state is a different model and only supports 13.5 GHz. In this case, the center frequency is limited along with any other frequency based settings. Since the center frequency can't be preserved in this case, the recall limiting tries to at least preserve span to keep the measurement setup as intact as possible.</p> <p>It may be appropriate to issue a warning if the state is limited on the recall; warnings do not go out to SCPI so this would only affect the manual user.</p> <p>Note that there is no state file compatibility outside of the X-Series. For example, you cannot recall a state file from ESA or PSA.</p>
Initial S/W Revision	Prior to A.02.00

State

The Recall State menu lets you choose a register or file from which to recall the state.

The content of a state file includes all of the settings and data required to return the analyzer as closely as possible to the Mode it was in, with the exact settings that were in place, when the save occurred. The Mode settings in each state file include the settings that are affected by Mode Preset, as well as the

additional settings affected by Restore Mode Defaults; all of the Mode’s settings. In addition, all of the settings of the Input/Output system are included, even though they are outside of the Mode’s state, because they are needed to restore the complete setup. Persistent System settings (for example, GPIB address) are not affected by either a Mode Preset or Restore Mode Defaults, nor are they included in a saved State file.

Since each state file is only for one Mode, the settings for other Modes are unaffected when it is loaded. Recall State will cause a mode switch if the state being recalled is not from the current active mode.

After the recall completes, the message "File <filename> recalled" or “Recalled State Register <register number>” is displayed.

For rapid recalls, the State menu lists 16 registers that you can choose from to recall. Pressing a Register key initiates the recall. You can also select a file from which to recall.

The default path for all State Files is:

My Documents\<<mode name>\state

where <mode name> is the parameter used to select the mode with the INST:SEL command (for example, SA for the Spectrum Analyzer).

See "[More Information](#)" on page 1200.

Key Path	Recall
Mode	All
Remote Command	:MMEMory:LOAD:STATe <filename>
Example	:MMEM:LOAD:STAT "myState.state" This recalls the file myState.state on the default path
Example	MMEM:LOAD:STAT "MyStateFile.state" This loads the state file data (on the default file directory path) into the instrument state.
Notes	<p>When you pick a file to recall, the analyzer first verifies that the file is recallable in the current instrument by checking the software version and model number of the instrument. If everything matches, a full recall proceeds by aborting the currently running measurement, clearing any pending operations, and then loading the State from the saved state file. You can open state files from any mode, so recalling a State file switches to the mode that was active when the save occurred. After switching to the mode of the saved state file, mode settings and data (if any for the mode) are loaded with values from the saved file. The saved measurement of the mode becomes the newly active measurement and the data relevant to the measurement (if there is any) is recalled.</p> <p>If there is a mismatch between file version or model number or instrument version or model number, the recall function tries to recall as much as possible and returns a warning message. It may limit settings that differ based on model number, licensing or version number.</p> <p>After recalling the state, the Recall State function does the following:</p> <ul style="list-style-type: none"> • Makes the saved measurement for the mode the active measurement. • Clears the input and output buffers. • Status Byte is set to 0. • Executes a *CLS <p>If the file specified is empty an error is generated. If the specified file does not exist, another error is generated. If there is a mismatch between the file and the proper file type, an error is generated. If</p>

	there is a mismatch between file version or model number or instrument version or model number, a warning is displayed. Then it returns to the State menu and File Open dialog goes away. After the Recall, the analyzer exits the Recall menu and returns to the previous menu.
Backwards Compatibility SCPI	:MMEMory:LOAD:STATe 1,<filename> For backwards compatibility, the above syntax is supported. The "1" is simply ignored.
Initial S/W Revision	Prior to A.02.00

More Information

In measurements that support saving Traces, for example, Swept SA, the Trace data is saved along with the State in the State file. When recalling the State, the Trace data is recalled as well. Traces are recalled exactly as they were stored, including the writing mode and update and display modes. If a Trace was updating and visible when the State was saved, it will come back updating and visible, and its data will be rewritten right away. When you use State to save and recall traces, any trace whose data must be preserved should be placed in View or Blank mode before saving.

The following table describes the Trace Save and Recall possibilities:

You want to recall state and one trace's data, leaving other traces unaffected.	Save Trace+State from 1 trace. Make sure that no other traces are updating (they should all be in View or Blank mode) when the save is performed.	On Recall, specify the trace you want to load the one trace's data into. This trace will load in View. All other traces' data will be unaffected, although their trace mode will be as it was when the state save was performed.
You want to recall all traces	Save Trace+State from ALL traces.	On Recall, all traces will come back in View (or Blank if they were in Blank or Background when saved)
You want all traces to load exactly as they were when saved.	Save State	On recall, all traces' mode and data will be exactly as they were when saved. Any traces that were updating will have their data immediately overwritten.

From File...

When you press "From File", the analyzer brings up a Windows dialog and a menu entitled "File Open." This menu allows you to navigate to the various fields in the Windows dialog without using a keyboard or mouse. The Tab and Arrow keys can also be used for dialog navigation.

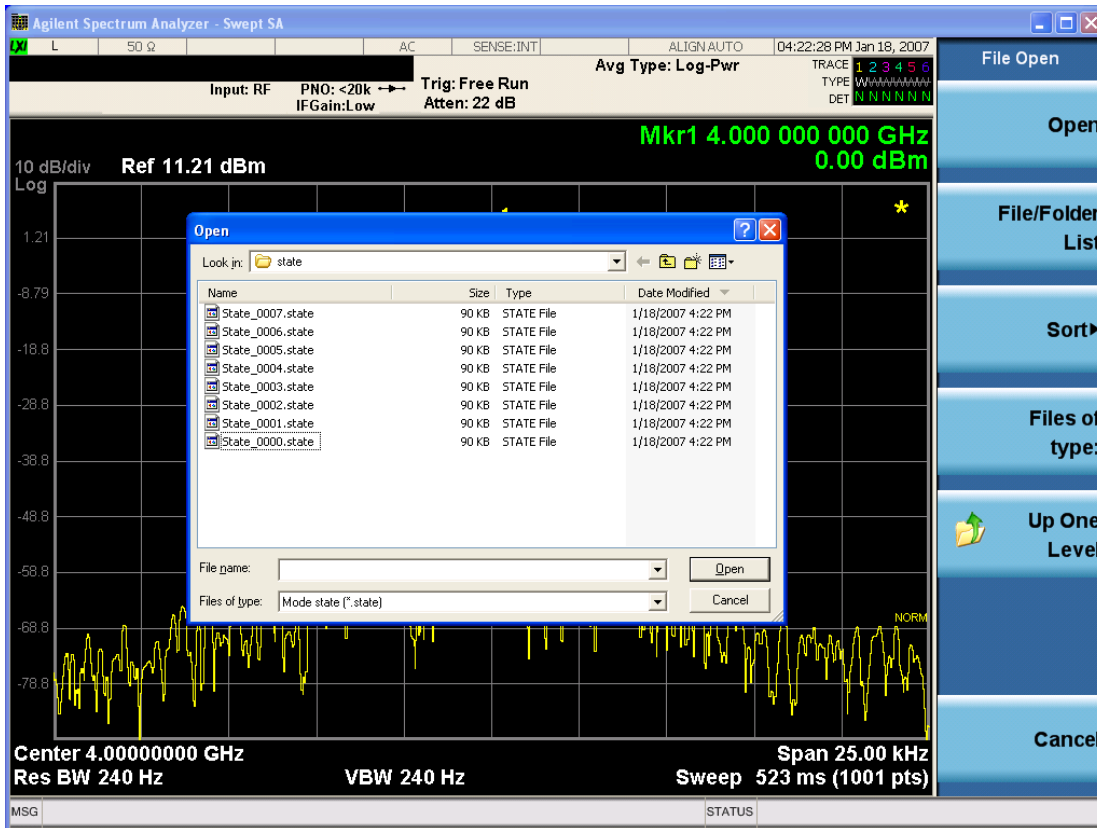

Listed below are the functions of the various fields in the dialog, and the corresponding softkeys:

Open

Performs the recall of the specified file. While the recall is being performed, the floppy icon appears briefly in the Meas bar.

File/Folder List

Enables you to navigate to the center of the dialog that contains the list of files and folders. Once here you can get information about the file and use the tab keys to navigate to the other fields in the dialog, such as Look In.

Look In

The Look In field shows the path from which the file will be recalled and allows you to change the path using the up and down arrow keys to navigate to other paths; the Enter key to open a directory; and the Backspace key to go back one directory. The **Look In field** first uses the last path from the Save As dialog **Save In:** path for that same file type. There is no softkey for directly navigating to the Look In field, but you can use the left tab to get here from the File/Folder List.

User specified paths are remembered when you leave and return to a Mode and are reset back to the default using Restore Mode Defaults.

Sort

Accesses a menu that enables you to sort the files within the File Open dialog. Only one sorting type can be selected at a time and the sorting happens immediately. The sorting types are By Date, By Name, By extension, and By Size.

Files of Type

This field shows the file suffix for the type of file you have selected to recall. For example, if you navigated here while recalling State, "Mode state (*.state)" is in the field. If you navigated here while recalling Trace, ""Mode state (*.trace)" is in the field. If you navigated here while importing a trace data file, "Trace Data (*.csv)" is in the field. For some file types, there is more than one choice in the dropdown menu, which you can select by using the up and down arrow keys and Enter.

Up One Level

This key corresponds to the icon of a folder with the up arrow that is in the tool bar of the dialog. When pressed, it causes the file and folder list to navigate up one level in the directory structure. The Backspace key does the same thing.

Cancel

This key corresponds to the Cancel selection in the dialog. It causes the current **Open** request to be cancelled. The ESC key does the same thing.

Key Path	Recall, State
Notes	Brings up the Open dialog for recalling a State Save Type
Initial S/W Revision	Prior to A.02.00

Edit Register Names

You may enter a custom name on any of the Register keys, to help you remember what you are using that state to save. To do this, press the Edit Register Names key, choose the register whose name you wish to edit, and then enter the desired label using the Alpha Editor or an external PC keyboard.

The maximum number of characters that can be added is 30. In most cases, 30 characters will fit on two lines of the key.

For more information and the SCPI command, see Edit Register Names under the Save, State function.

Key Path	Recall, State
Mode	All
Dependencies	N9060A-7FP or N9060B-2FP license required to edit the register names. When the feature is not licensed, sending the SCPI command generates an error, -221, "Settings conflict;Option not available"
Initial S/W Revision	A.11.00

Register 1 thru Register 16

Selecting any one of these register keys causes the State of the mode from the specified Register to be recalled. Each of the register keys annotates whether it is empty or at what date and time it was last

modified. In addition, you can use the Edit Register Names key under Save, State to enter custom names for each register.

Registers are shared by all modes, so recalling from any one of the registers will cause a mode switch to the mode that was active when the save to the Register occurred.

Although these 16 registers are the only registers available from the front panel, there are 128 state registers available in the instrument. Registers 17–128 are only available from the SCPI interface, using the *RCL command.

After the recall completes, the message "Register <register number> recalled" appears in the message bar. If you are in the Spectrum Analyzer Mode, and you are recalling a register that was saved in the Spectrum Analyzer Mode, then after the recall, you will still be in the Recall Register menu. If the Recall causes you to switch modes, then after the Recall, you will be in the Frequency menu.

If a requested register is empty an error is generated.

Key Path	Recall, State
Example	*RCL 1
Range	1–16 from front panel, 1–128 from SCPI
Readback	Date and time with seconds resolution are displayed on the key OR A custom name of up to 30 characters entered using the Save, State, Edit Register Names key OR “(empty)” if no prior save operation has been performed to this register.
Initial S/W Revision	Prior to A.02.00
Modified at S/W Revision	Prior to A.11.00

Register 1 thru Register 16

Selecting any one of these register keys causes the State of the mode from the specified Register to be recalled. Each of the register keys annotates whether it is empty or at what date and time it was last modified. In addition, you can use the Edit Register Names key under Save, State to enter custom names for each register.

Registers are shared by all modes, so recalling from any one of the registers will cause a mode switch to the mode that was active when the save to the Register occurred.

Although these 16 registers are the only registers available from the front panel, there are 128 state registers available in the instrument. Registers 17–128 are only available from the SCPI interface, using the *RCL command.

After the recall completes, the message "Register <register number> recalled" appears in the message bar. If you are in the Spectrum Analyzer Mode, and you are recalling a register that was saved in the Spectrum Analyzer Mode, then after the recall, you will still be in the Recall Register menu. If the Recall causes you to switch modes, then after the Recall, you will be in the Frequency menu.

If a requested register is empty an error is generated.

Key Path	Recall, State
Example	*RCL 1
Range	1-16 from front panel, 1-128 from SCPI
Readback	Date and time with seconds resolution are displayed on the key OR A custom name of up to 30 characters entered using the Save, State,Edit Register Names key OR “(empty)” if no prior save operation has been performed to this register.
Initial S/W Revision	Prior to A.02.00
Modified at S/W Revision	Prior to A.11.00

Trace

This key selects Trace as the data type to be imported. When pressed a second time, it brings up the Trace Menu, which lets you select the Trace into which the data will be imported.

The trace file contains “meta” data which describes the state of the analyzer when the trace was exported (see Trace File Contents). If the meta data in the file does not match the current SA state, the “invalid data indicator” (*) is displayed.

Key Path	Recall, Data
Remote Command	:MMEMory:LOAD:TRACe:DATA TRACE1 TRACE2 TRACE3 TRACE4 TRACE5 TRACE6,<filename>
Example	:MMEM:LOAD:TRAC DATA TRACE2, "myTrace2.csv" Imports the 2nd trace from the file myTrace2.csv in the current path. The default path is My Documents\SA\data\traces
Dependencies	For SA measurements, a trace cannot be recalled from a trace file that was exported with ALL traces selected. A trace cannot be imported if the number of trace points in the file do not match the number of sweep points currently set for the measurement. If this happens, an error message is generated. Errors are reported if the file is empty or missing, or if the file type does not match, or if there is a mismatch between the file type and the destination data type. If any error occurs while trying to load a file manually (as opposed to during remote operation), the analyzer returns to the Import Data menu and the File Open dialog goes away.
Couplings	When a trace is imported, Trace Update is always turned OFF for that trace and Trace Display is always turned ON.
Readback	Selected Trace
Status Bits/OPC dependencies	Sequential - aborts the current measurement.
Initial S/W Revision	Prior to A.02.00

Import Trace Data

Enables you to import previously saved trace data into a Data Register and optionally display it. Selecting this key displays a menu that enables you to select the destination data register, and also enables you to choose whether or not to display the recalled data in the currently selected trace. After making these selections, select Open... and use the file dialog to select the file you want to recall.

Recalling trace data into an already used Data Register overwrites the previous data. If the data register is displayed on any trace, the display is updated to reflect the new data.

The SCPI command

```
:MMEM:LOAD:TRAC:DATA D1|D2|D3|D4|D5|D6,<filename>
```

recalls data into a specified register, but does not display it in the selected trace. Use the command

```
:DISP:<meas>:TRAC<n>:FEED D1|D2|D3|D4|D5|D6
```

to display the register in the desired trace.

It is possible to recall trace data saved by other VXA measurements, or measurements made using the LTE, LTETDD, iDEN, or 89601 applications.

Key Path	Recall, Data (Import)
Mode	VSA, LTE, LTETDD, IDEN
Remote Command	:MMEMory:LOAD:TRACe:DATA D1 D2 D3 D4 D5 D6,<filename>[,CSV TXT SDF MAT4 MAT HDF5 BIN]
Example	:MMEM:LOAD:TRAC:DATA D1,"Trc1.txt",TXT
Notes	<p>The Open: dialog box has the following filter options when you are recalling trace data::</p> <ul style="list-style-type: none"> • CSV (Comma delimited) (*.csv) • SDF (Fast) (*.sdf;*.dat) • Text (Tab delimited) (*.txt) <p>The file must have the same format as that created by the Export Recorded Data command.</p> <p>The SCPI command has an optional file format parameter. If you do not include this parameter in the SCPI command, the file format is determined by the file name extension. If no file extension is recognized, the file is scanned to determine the format.</p> <p>If you are not licensed to recall a particular file type, then error -203.9010 is returned. If the file format cannot be determined or the file cannot be recalled successfully, then error -250.5290 is returned. If the recall is successful, then advisory 0.1600 is shown.</p>
State Saved	No
Readback	Data 1 Data 2 Data 3 Data 4 Data 5 Data 6

Data 1

Selects the Data 1 register as the destination for the imported data.

Key Path	Recall, Data (Import), Trace (to)
Mode	VSA, LTE, LTETDD, IDEN

Data 2

Selects the Data 2 register as the destination for the imported data.

Key Path	Recall, Data (Import), Trace (to)
Mode	VSA, LTE, LTETDD, IDEN

Data 3

Selects the Data 3 register as the destination for the imported data.

Key Path	Recall, Data (Import), Trace (to)
Mode	VSA, LTE, LTETDD, IDEN

Data 4

Selects the Data 4 register as the destination for the imported data.

Key Path	Recall, Data (Import), Trace (to)
Mode	VSA, LTE, LTETDD, IDEN

Data 5

Selects the Data 5 register as the destination for the imported data..

Key Path	Recall, Data (Import), Trace (to)
Mode	VSA, LTE, LTETDD, IDEN

Data 6

Selects the Data 6 register as the destination for the imported data.

Key Path	Recall, Data (Import), Trace (to)
Mode	VSA, LTE, LTETDD, IDEN

Display in Selected Trace

Enables you to select whether the recalled trace data is displayed in the current Trace.

Key Path	Recall, Data (Import), Trace (to)
----------	-----------------------------------

Mode	VSA, LTE, LTETDD, IDEN
State Saved	No

Open...

When you press “Open”, the analyzer brings up a Windows dialog and a menu entitled “**File Open.**” This menu allows you to navigate to the various fields in the Windows dialog without using a keyboard or mouse. The Tab and Arrow keys can also be used for dialog navigation.

See "[From File...](#)" on page 1200 in Recall, State, for a full description of this dialog and menu.

Key Path	Recall, Data
Notes	The key location is mode-dependent and will vary. Brings up Open dialog for recalling a <mode specific> Save Type
Initial S/W Revision	Prior to A.02.00

Restart

The Restart function restarts the current sweep, or measurement, or set of averaged/held sweeps or measurements. If you are Paused, pressing Restart does a Resume.

The Restart function is accessed in several ways:

- Pressing the Restart key
- Sending the remote command INIT:IMMEDIATE
- Sending the remote command INIT:RESTART

See "[More Information](#)" on page 1208

Key Path	Front-panel key
Remote Command	:INITiate[:IMMEDIATE] :INITiate:RESTART
Example	:INIT:IMM :INIT:REST
Notes	:INITiate:RESTART and :INITiate:IMMEDIATE perform exactly the same function.
Couplings	Resets average/hold count k. For the first sweep overwrites all active (update=on) traces with new current data. For application modes, it resets other parameters as required by the measurement.
Status Bits/OPC dependencies	This is an Overlapped command. The STATUS:OPERation register bits 0 through 8 are cleared. The STATUS:QUESTionable register bit 9 (INTEGRITY sum) is cleared. The SWEEPING bit is set. The MEASURING bit is set.
Backwards Compatibility Notes	For Spectrum Analysis mode in ESA and PSA, the Restart hardkey and the INITiate:RESTART command restart trace averages (displayed average count reset to 1) for a trace in Clear Write, but did not restart Max Hold and Min Hold. In the X-Series, the Restart hardkey and the INITiate:RESTART command restart not only Trace Average, but MaxHold and MinHold traces as well. For wireless comms modes in ESA and PSA, the Restart hardkey and the INITiate:RESTART command restart every measurement, which includes all traces and numeric results. There is no change to this operation.
Initial S/W Revision	Prior to A.02.00

More Information

The **Restart** function first aborts the current sweep/measurement as quickly as possible. It then resets the sweep and trigger systems, sets up the measurement and initiates a new data measurement sequence with a new data acquisition (sweep) taken once the trigger condition is met.

If the analyzer is in the process of aligning when **Restart** is executed, the alignment finishes before the restart function is performed.

Even when set for Single operation, multiple sweeps may be taken when Restart is pressed (for example, when averaging/holding is on). Thus when we say that **Restart** "restarts a measurement," we may mean:

- It restarts the current sweep
- It restarts the current measurement
- It restarts the current set of sweeps if any trace is in Trace Average, Max Hold or Min Hold
- It restarts the current set of measurements if Averaging, or Max Hold, or Min Hold is on for the measurement
- depending on the current settings.

With **Average/Hold Number** (in **Meas Setup** menu) set to 1, or Averaging off, or no trace in Trace Average or Hold, a single sweep is equivalent to a single measurement. A single sweep is taken after the trigger condition is met; and the analyzer stops sweeping once that sweep has completed. However, with **Average/Hold Number** >1 and at least one trace set to **Trace Average, Max Hold, or Min Hold (SA Measurement)** or **Averaging on (most other measurements)**, multiple sweeps/data acquisitions are taken for a single measurement. The trigger condition must be met prior to each sweep. The sweep is stopped when the average count k equals the number N set for **Average/Hold Number**. A measurement average usually applies to all traces, marker results, and numeric results; but sometimes it only applies to the numeric results.

Once the full set of sweeps has been taken, the analyzer will go to idle state. To take one more sweep without resetting the average count, increment the average count by 1, by pressing the step up key while **Average/Hold Number** is the active function, or sending the remote command `CALC:AVER:TCON UP`.

Save

The Save menu lets you choose what you want to save and where you want to save it. Among the types of files you can save are **States**, **Traces**, and **Screen Images**. In addition, an Export (Data) option lets you save a number of data types as CSV files for easy import into Excel and other spreadsheet programs.

Key Path	Front-panel key
Mode	All
Notes	No remote command for this key specifically, but the :MMEM:STORe command is available for specific file types. An example is :MMEM:STOR:STATe <filename>.
Initial S/W Revision	Prior to A.02.00

State

The Save State menu lets you choose a register or file for saving the state.

The content of a state file includes all of the settings and data required to return the analyzer as closely as possible to the Mode it was in, with the exact settings which were in place, when the save occurred. The Mode settings in each state file include the settings that are affected by Mode Preset, as well as the additional settings affected by Restore Mode Defaults; all of the Mode's settings. In addition, all of the settings of the Input/Output system are included, even though they are outside of the Mode's state, because they are needed to restore the complete setup. Persistent System settings (for example, Verbose SCPI) are not affected by either Mode Preset or Restore Mode Defaults, nor are they included in a saved State file.

After the save completes, the message "File <filename> saved" or "State Register <register number> saved" is displayed.

For rapid saving, the State menu lists 16 registers to save to. Pressing a Register key initiates the save. You can also select a file to save to.

The default path for all State Files is:

My Documents\<<mode name>\state

where <mode name> is the parameter used to select the mode with the INST:SEL command (for example, SA for the Spectrum Analyzer).

Key Path	Save
Mode	All
Remote Command	:MMEMory:STORe:STATe <filename>
Example	MMEM:STOR:STATe "MyStateFile.state" This stores the current instrument state data in the file MyStateFile.state in the default directory.
Notes	Both single and double quotes are supported for any filename parameter over remote. After saving to a register, that register's menu key is updated with the date the time, unless a custom label has been entered for that key. After saving to a register, you remain in the Save State menu, so that you can see the Register key

update. After saving to a file, the analyzer automatically returns to the previous menu and any Save As dialog goes away.

Backwards Compatibility SCPI	:MMEMoRY:STORe:STATe 1,<filename>
Initial S/W Revision	Prior to A.02.00

To File . . .

When you press “To File”, the analyzer brings up a Windows dialog and a menu entitled “**Save As.**” This menu allows you to navigate to the various fields in the Windows dialog without using a keyboard or mouse. The Tab and Arrow keys can also be used for dialog navigation.

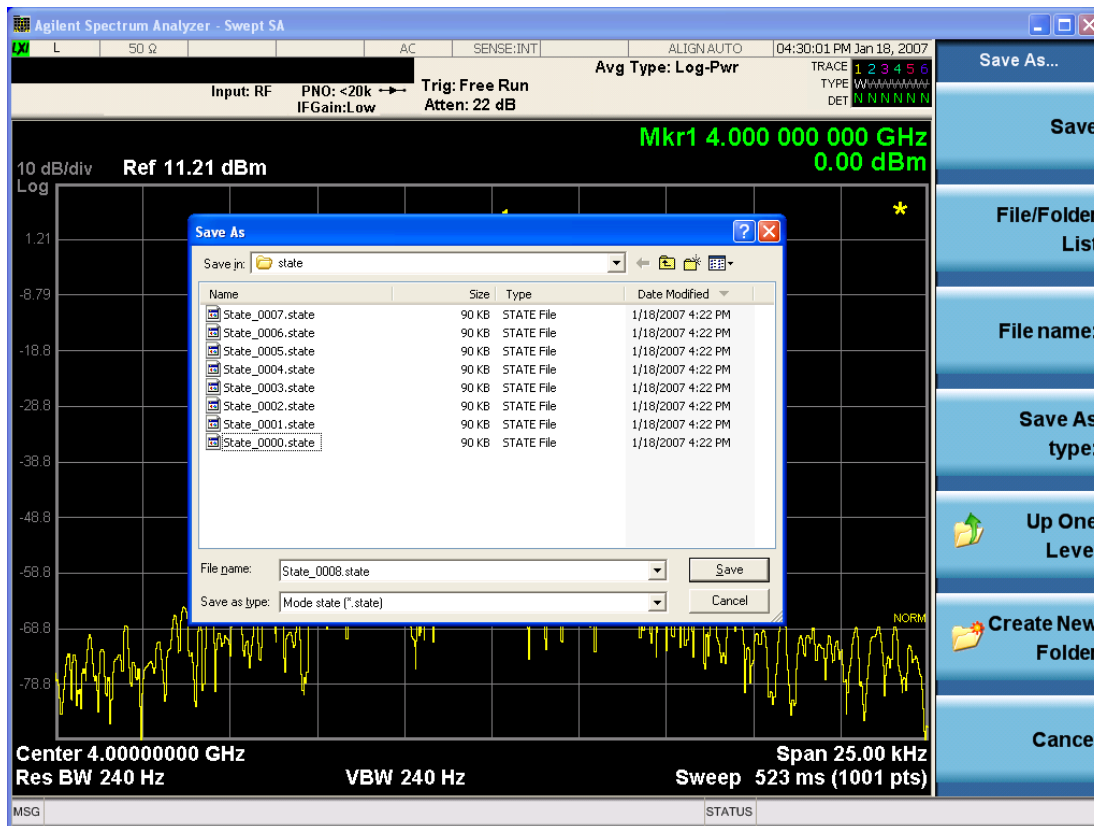

The Listed below

are the functions of the various fields in the dialog, and the corresponding softkeys:

Save

Performs the save to the specified file of the selected type. If the file already exists, a dialog will appear that allows you to replace the existing file by selecting OK, or you can Cancel the request. If you select OK, the file will be overwritten. Using the C: drive is strongly discouraged, since it runs the risk of being overwritten during an instrument software upgrade.

While the save is being performed, the floppy icon appears briefly in the Meas bar.

File/Folder List

Enables you to navigate to the center of the dialog that contains the list of files and folders. Once here you can get information about the file and use the tab keys to navigate to the other fields in the dialog, such as Save In.

Save In

The Save In field shows the path to which the file will be saved and allows you to change the path using the up and down arrow keys to navigate to other paths; the Enter key to open a directory; and the Backspace key to go back one directory. The **Save In field** defaults to the default path for this type of file and remembers the last path you used to save this type of file. There is no softkey for directly navigating to the Save In field but you can use left tab to get here from the File/Folder List.

User specified paths are remembered when you leave and return to a Mode and are reset back to the default using Restore Mode Defaults.

File Name

The File Name field is initially loaded with an automatically generated filename specific to the appropriate Save Type. The automatically generated filename is guaranteed not to conflict with any filename currently in the directory. You may replace or modify this filename using the File Name key. See the ["Quick Save " on page 1196](#) documentation for more on the automatic file naming algorithm.

When you press the File Name key the analyzer displays the Alpha Editor. Use the knob to choose the letter to add and the front-panel Enter key to add the letter to the file name. The BK character moves you back and the FW character moves you forward in the filename. The Select key on the front panel generates a space character. When you are done entering the filename press the Done softkey. This returns back to the **File Open** dialog and menu, but does not cause the save to occur.

Save As Type

This field shows the file suffix for the type of file you have selected to save. For example, if you navigated here while saving State, "Mode state (*.state)" is in the field. If you navigated here from saving Trace, ""Mode state (*.trace)" is in the field. If you navigated here while exporting a trace data file, "Trace Data (*.csv)" is in the field. For some file types, there is more than one choice in the dropdown, which you can select by using the up and down arrow keys and Enter.

Up One Level

This key corresponds to the icon of a folder with the up arrow that is in the tool bar of the dialog. When pressed, it causes the file and folder list to navigate up one level in the directory structure. The Backspace key does the same thing.

Create New Folder

This key corresponds to the icon of a folder with the "*" that is in the tool bar of the dialog. When pressed, a new folder is created in the current directory with the name **New Folder** and you can enter a new folder name using the Alpha Editor.

Cancel

This key corresponds to the Cancel selection in the dialog. It causes the current **Save As** request to be cancelled. The ESC key does the same thing.

Key Path	Save, State
Mode	All
Notes	Brings up Save As dialog for saving a State Save Type
Initial S/W Revision	Prior to A.02.00

Edit Register Names

You may enter a custom name on any of the Register keys, to help you remember what you are using that state to save. To do this, press the Edit Register Names key, choose the register whose name you wish to edit, and then enter the desired label using the Alpha Editor or an external PC keyboard.

The maximum number of characters that can be added is 30. In most cases, 30 characters will fit on two lines of the key.

See ["More Information" on page 1213](#)

Key Path	Save, State
Mode	All
Remote Command	:MMEMory:REGister:STATe:LABel <reg number>,"label" :MMEMory:REGister:STATe:LABel? <reg number>
Example	:MMEM:REG:STAT:LAB 1,"my label"
Notes	<reg number> is an integer from 1 to 16. If the SCPI specifies an invalid register number an error message is generated, -222,"Data out of range;Invalid register label number" "label" is a string from 0 to 30 characters in length. If a label exceeds 30 characters, an error message is generated, -150,"String data error;Label clipped to 30 characters" "label" of length 0 erases the custom label and restores the default (time and date) label. E.g.: :MMEM:REG:STAT:LAB 1,""
Dependencies	N9060A-7FP or N9060B-2FP license required to edit the register names. When the feature is not licensed, sending this command generates an error, -221,"Settings conflict;Option not available"
Preset	The names are unaffected by Preset or power cycle but are set to the default label (time and date) on a "Restore System Defaults->Misc"
Initial S/W Revision	A.11.00

More Information

When you edit one of the register names, the time and date field will be replaced by the custom name.

If you delete all the characters in the custom name, it restores the default (time and date).

The register names are stored within the state files, but they are not part of the instrument state; that is, once you have edited a register name, loading a new state will not change that register name. Another consequence of this is that the names will be persistent through a power cycle. Also, if a named state file is transferred to another analyzer, it will bring its custom name along with it.

If you try to edit the name of an empty register, the analyzer will first save the state to have a file to put the name in. If you load a named state file into an analyzer with older firmware it will ignore the metadata.

The *SAV and *RCL commands will not be affected by the custom register names, nor will the MMEM commands.

Register 1 thru Register 16

Selecting any one of these register menu keys causes the State of the currently active mode to be saved to the specified Register. The registers are provided for rapid saving and recalling, since you do not need to specify a filename or navigate to a file. Each of the register menu keys annotates whether it is empty or at what date and time it was last modified. In addition, you can use the Edit Register Names key to enter custom names for each register.

Although these 16 registers are the only registers available from the front panel, there are 128 state registers available in the instrument. Registers 17–128 are only available from the SCPI interface, using the *SAV command.

There is one set of 128 state registers in the instrument, not one set for each Mode. When a state is saved, the Mode it was saved from is saved with it; then when it is recalled, the instrument switches to that Mode.

After the save completes, the corresponding register menu key annotation is updated with the date and time and the message "Register <register number> saved" is displayed.

Key Path	Save, State
Mode	All
Example	*SAV 1
Range	1–16 from front panel, 1–128 from SCPI
Readback	Date and time with seconds resolution are displayed on the key OR A custom name of up to 30 characters entered using the Edit Register Names key OR “(empty)” if no prior save operation has been performed to this register.
Initial S/W Revision	Prior to A.02.00
Modified at S/W Revision	A.11.00

Register 1 thru Register 16

Selecting any one of these register menu keys causes the State of the currently active mode to be saved to the specified Register. The registers are provided for rapid saving and recalling, since you do not need to specify a filename or navigate to a file. Each of the register menu keys annotates whether it is empty or at what date and time it was last modified. In addition, you can use the Edit Register Names key to enter custom names for each register.

Although these 16 registers are the only registers available from the front panel, there are 128 state registers available in the instrument. Registers 17–128 are only available from the SCPI interface, using the *SAV command.

There is one set of 128 state registers in the instrument, not one set for each Mode. When a state is saved, the Mode it was saved from is saved with it; then when it is recalled, the instrument switches to that Mode.

After the save completes, the corresponding register menu key annotation is updated with the date and time and the message "Register <register number> saved" is displayed.

Key Path	Save, State
Mode	All
Example	*SAV 1
Range	1–16 from front panel, 1–128 from SCPI
Readback	Date and time with seconds resolution are displayed on the key OR A custom name of up to 30 characters entered using the Edit Register Names key OR “(empty)” if no prior save operation has been performed to this register.
Initial S/W Revision	Prior to A.02.00
Modified at S/W Revision	A.11.00

Mass Storage Catalog (Remote Command Only)

Key path	SCPI Only
Remote Command	:MMEMory:CATalog? [<directory_name>]
Notes	The string must be a valid logical path. Queries disk usage information (drive capacity, free space available) and obtains a list of files and directories in a specified directory in the following format: <numeric_value>,<numeric_value>,{<file_entry>} It returns two numeric parameters and as many strings as there are files and directories. The first parameter indicates the total amount of storage currently used in bytes. The second parameter indicates the total amount of storage available, also in bytes. The <file_entry> is a string. Each <file_entry> indicates the name, type, and size of one file in the directory list: <file_name>,<file_type>,<file_size> As the windows file system has an extension that indicates file type, <file_type> is always empty. <file_size> provides the size of the file in bytes. For directories, <file_entry> is surrounded by square brackets and both <file_type> and <file_size> are empty
Initial S/W Revision	Prior to A.02.00

Mass Storage Change Directory (Remote Command Only)

Key path	SCPI Only
Remote Command	:MMEMory:CDIRectory [<directory_name>] :MMEMory:CDIRectory?

Notes	<p>The string must be a valid logical path.</p> <p>Changes the default directory for a mass memory file system. The <directory_name> parameter is a string. If no parameter is specified, the directory is set to the *RST value.</p> <p>At *RST, this value is set to the default user data storage area, that is defined as System.Environment.SpecialFolder.Personal.</p> <p>Query returns full path of the default directory.</p>
Initial S/W Revision	Prior to A.02.00

Mass Storage Copy (Remote Command Only)

Key path	SCPI Only
Remote Command	:MMEMory:COpy <string>,<string>[,<string>,<string>]
Notes	<p>The string must be a valid logical path.</p> <p>Copies an existing file to a new file or an existing directory to a new directory.</p> <p>Two forms of parameters are allowed. The first form has two parameters. In this form, the first parameter specifies the source, and the second parameter specifies the destination.</p> <p>The second form has four parameters. In this form, the first and third parameters specify the source. The second and fourth parameters specify the directories. The first pair of parameters specifies the source. The second pair specifies the destination. An error is generated if the source doesn't exist or the destination file already exists.</p> <p>This command will generate an "access denied" error if the destination is a restricted folder (e.g., C:\Windows) and the current user does not have Power User or Administrator privileges.</p>

Mass Storage Device Copy (Remote Command Only)

This command transfers data to/from a file and a peripheral device.

Key path	SCPI Only
Remote Command	:MMEMory:COpy:DEvice <source_string>,<dest_string>
Notes	<p>The strings must be a valid logical path or a valid device keyword. If the dest_string is a device keyword, the data is copied from the source file to the device. If the source_string is a device keyword, the data is copied to the source file from the device.</p> <p>Valid device keywords are:</p> <p>SNS (smart noise source)</p> <p>An error is generated if the file or device is not found.</p>

Mass Storage Delete (Remote Command Only)

Key path	SCPI Only
Remote Command	:MMEMory:DElete <file_name>[,<directory_name>]

Notes	The string must be a valid logical path. Removes a file from the specified directory. The <file_name> parameter specifies the file name to be removed. This command will generate an “access denied” error if the file is in a restricted folder (e.g., C:\Windows) and the current user does not have Power User or Administrator privileges.
Initial S/W Revision	Prior to A.02.00

Mass Storage Data (Remote Command Only)

Creates a file containing the specified data OR queries the data from an existing file.

Key path	SCPI Only
Remote Command	:MMEMory:DATA <file_name>, <data> :MMEMory:DATA? <file_name>
Notes	The string must be a valid logical path. The command form is MMEMory:DATA <file_name>,<data>. It loads <data> into the file <file_name>. <data> is in 488.2 block format. <file_name> is string data. The query form is MMEMory:DATA? <file_name> with the response being the associated <data> in block format.
Initial S/W Revision	Prior to A.02.00

Mass Storage Make Directory (Remote Command Only)

Key path	SCPI Only
Remote Command	:MMEMory:MDIRectory <directory_name>
Notes	The string must be a valid logical path. Creates a new directory. The <directory_name> parameter specifies the name to be created. This command will generate an “access denied” error if the new directory would be in a restricted folder (e.g., C:\Windows) and the current user does not have Power User or Administrator privileges.
Initial S/W Revision	Prior to A.02.00

Mass Storage Move (Remote Command Only)

Key path	SCPI Only
Remote Command	:MMEMory:MOVE <string>,<string>[,<string>,<string>]
Notes	The string must be a valid logical path. Moves an existing file to a new file or an existing directory to a new directory. Two forms of parameters are allowed. The first form has two parameters. In this form, the first parameter specifies the source, and the second parameter specifies the destination. The second form has four parameters. In this form, the first and third parameters specify the source.

	<p>The second and fourth parameters specify the directories. The first pair of parameters specifies the source. The second pair specifies the destination. An error is generated if the source doesn't exist or the destination file already exists.</p> <p>This command will generate an "access denied" error if the destination is a restricted folder (e.g., C:\Windows) and the current user does not have Power User or Administrator privileges.</p>
Initial S/W Revision	Prior to A.02.00

Mass Storage Remove Directory (Remote Command Only)

Key path	SCPI Only
Remote Command	:MMEMory:RDIRECTory <directory_name>
Notes	<p>The string must be a valid logical path.</p> <p>Removes a directory. The <directory_name> parameter specifies the directory name to be removed. All files and directories under the specified directory shall also be removed.</p> <p>This command will generate an "access denied" error if the folder is a restricted folder (e.g., C:\Windows) or is in a restricted folder and the current user does not have Power User or Administrator privileges.</p>
Initial S/W Revision	Prior to A.02.00

Data (Export)

Exporting a data file stores data from the current measurement to mass storage files. The Export Menu only contains data types that are supported by the current measurement.

Since the commonly exported data files are in .csv format, the data can be edited by you prior to importing. This allows you to export a data file, manipulate the data in Excel (the most common PC Application for manipulating .csv files) and then import it.

Selecting an Export Data menu key will not actually cause the exporting to occur, since the analyzer still needs to know where you wish to save the data. Pressing the Save As key in this menu brings up the Save As dialog and Save As menu that allows you to specify the destination file and directory. Once a filename has been selected or entered in the Open menu, the export will occur as soon as the Save key is pressed.

Key Path	Save
Mode	All
Notes	<p>The menu is built from whatever data types are available for the mode. So the key locations in the sub menu will vary.</p> <p>No SCPI command directly controls the Data Type that this key controls. The Data Type is included in the MMEM:STORe commands.</p>
Dependencies	If a file type is not used by a certain measurement, that type is grayed out for that measurement. The key for a file type will not show at all if there are no measurements in the Mode that support it.
Preset	Is not affected by a Preset or shutdown, but is reset during Restore Mode Defaults
Readback	The data type that is currently selected
Initial S/W Revision	Prior to A.02.00

Export Trace Data

Enables you to export trace data with (optional) associated headers. Selecting this key displays a menu that enables you to choose which Trace to save (default is the selected Trace) and whether or not to save headers with the data. The header information is used by the VXA application when saved trace data is recalled, and enables it to be displayed with the same formatting and scaling that it had when saved. If headers are not saved, the scaling and format are set to default values when the trace is recalled. After making these selections, press Save As... and use the file dialog to choose a file name and format for the saved data.

Trace data can be exported in several different formats. Text and comma-separated variable (CSV) formats are useful for viewing the data or importing it to a spreadsheet program. The other formats are binary and thus more compact. Trace data files can be recalled for viewing into other VXA, LTE, LTETDD, iDEN, or 89601 measurements.

Key Path	Save, Data (Export)
Mode	VSA, LTE, LTETDD, IDEN
Remote Command	:MMEMory:STORe:TRACe:DATA TRACE1 TRACE2 TRACE3 TRACE4 TRACE5 TRACE6, "<filename>"[,CSV TXT SDF MAT4 MAT HDF5 BIN[,OFF ON 0 1]]
Example	:MMEM:STOR:TRAC:DATA TRACE1, "TRC1.TXT", TXT, ON
Notes	<p>The Save As... dialog box has the following format options when you are saving trace data:</p> <ul style="list-style-type: none"> • CSV (Comma delimited) (*.csv) • SDF (Fast) (*.sdf;*.dat) • Text (Tab delimited) (*.txt) <p>File format saved depends on selection. The appropriate file extension is appended to the filename if it is not supplied by the user.</p> <p>If the SCPI command includes just a file name, the file format is determined by the filename extension, which must be one of the choices above. *.sdf or an unrecognized extension chooses the SDF fast format. If the optional file format enumerator is included in the command, then this determines the file format and the file extension is ignored. The optional binary parameter determines if file headers are saved. The default is ON. If file headers are not wanted, use the optional "OFF" parameter.</p> <p>The optional Boolean parameter determines whether headers are saved in the file. By default the headers are saved.</p> <p>If you are not licensed to save a particular file type, then error -203.9010 is returned. If an invalid file format is specified or the file cannot be saved successfully, then error -25x is returned. If the save is successful, then advisory 0.1500 is shown.</p>
State Saved	No
Readback	(Trace 1 Trace 2 Trace 3 Trace 4 Trace 5 Trace 6)(with without) headers

Trace 1

Selects the Trace 1 register as the destination for the imported data.

Key Path	Save, Data (Export), Trace
Mode	VSA, LTE, LTETDD, IDEN

Trace 2

Selects the Trace 2 register as the destination for the imported data.

Key Path	Save, Data (Export), Trace
Mode	VSA, LTE, LTETDD, IDEN

Trace 3

Selects the Trace 3 register as the destination for the imported data.

Key Path	Save, Data (Export), Trace
Mode	VSA, LTE, LTETDD, IDEN

Trace 4

Selects the Trace 4 register as the destination for the imported data.

Key Path	Save, Data (Export), Trace
Mode	VSA, LTE, LTETDD, IDEN

Trace 5

Selects the Trace 5 register as the destination for the imported data.

Key Path	Save, Data (Export), Trace
Mode	VSA, LTE, LTETDD, IDEN

Trace 6

Selects the Trace 6 register as the destination for the imported data.

Key Path	Save, Data (Export), Trace
Mode	VSA, LTE, LTETDD, IDEN

Include Header

Enables you to select whether or not the saved trace data includes header information describing scaling, formatting, etc.

Key Path	Save, Data (Export), Trace
Mode	VSA, LTE, LTETDD, IDEN
State Saved	No

Save As . . .

When you press “Save As”, the analyzer brings up a Windows dialog and a menu entitled “**Save As.**” This menu allows you to navigate to the various fields in the Windows dialog without using a keyboard or mouse. The Tab and Arrow keys can also be used for dialog navigation.

See ["To File . . ." on page 1211](#) in Save, State for a full description of this dialog and menu.

The default path for saving files is:

For all of the Trace Data Files:

My Documents\`<mode name>`\data\traces

For all of the Limit Data Files:

My Documents\`<mode name>`\data\limits

For all of the Measurement Results Data Files:

My Documents\`<mode name>`\data\`<measurement name>`\results

For all of the Capture Buffer Data Files:

My Documents\`<mode name>`\data\captureBuffer

Key Path	Save, Data
Mode	All
Notes	The key location is mode-dependent and will vary. Brings up the Save As dialog for saving a <code><mode specific></code> Save Type. The save is performed immediately and does not wait until the measurement is complete.
Initial S/W Revision	Prior to A.02.00

Screen Image

Pressing Screen Image accesses a menu of functions that enable you to specify a format and location for the saved screen image. It brings up a menu that allows you to specify the color scheme of the Screen Image (Themes) or navigate to the Save As dialog to perform the actual save.

Screen Image files contain an exact representation of the analyzer display. They cannot be loaded back onto the analyzer, but they can be loaded into your PC for use in many popular applications.

The image to be saved is actually captured when the Save front panel key is pressed, and kept in temporary storage to be used if you ask for a Screen Image save. When the Screen Image key is pressed, a "thumbnail" of the captured image is displayed, as shown below:

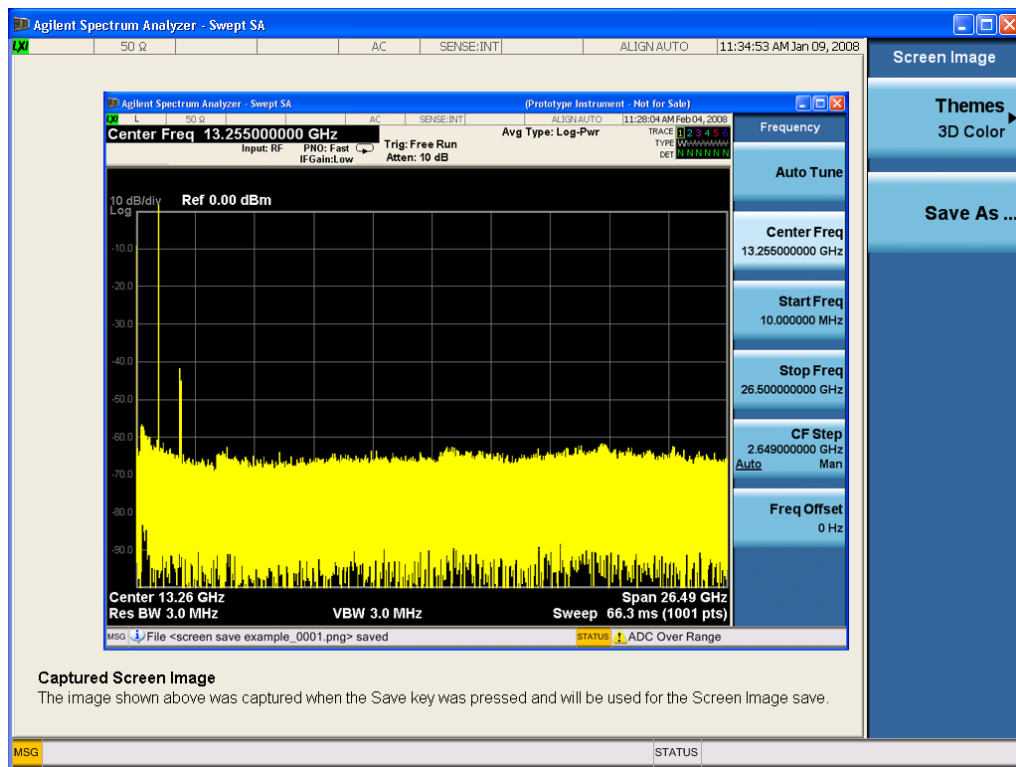

When you continue on into the Save As menu and complete the Screen Image save, the image depicted in the thumbnail is the one that gets saved, showing the menus that were on the screen before going into the Save menus. The save is performed immediately and does not wait until the measurement is complete.

After you have completed the save, the Quick Save front-panel key lets you quickly repeat the last save performed, using an auto-named file, with the current screen data.

NOTE

For versions previous to A.01.55, if you initiate a screen image save by navigating through the Save menus, the image that is saved will contain the Save menu softkeys, not the menus and the active function that were on the screen when you first pressed the Save front panel key.

Key Path	Save
Mode	All
Remote Command	:MMEMory:STORe:SCReen <filename>
Example	:MMEM:STOR:SCR "myScreen.png" This stores the current screen image in the file MyScreenFile.png in the default directory.
Initial S/W Revision	Prior to A.02.00

Themes

Accesses a menu of functions that enable you to choose the theme to be used when saving the screen image.

The **Themes** option is the same as the **Themes** option under the **Display** and **Page Setup** dialogs. It allows you to choose between themes to be used when saving the screen image.

Key Path	Save, Screen Image
Remote Command	:MMEMory:STORe:SCReen:THEMe TDColor TDMonochrome FCOlor FMONochrome :MMEMory:STORe:SCReen:THEMe?
Example	:MMEM:STOR:SCR:THEM TDM
Preset	3D Color; Is not part of Preset, but is reset by Restore Misc Defaults or Restore System Defaults All and survives subsequent running of the modes.
Readback	3D Color 3D Mono Flat Color Flat Mono
Backwards Compatibility Notes	In ESA and PSA we offer the choice of "Reverse Bitmap" or "Reverse Metafile" when saving screen images. This is much like the "Flat Color" theme available in X-Series. Also, if you selected Reverse Bitmap AND a black & white screen image, that would be much like "Flat Monochrome". In other words, each of the X-Series themes has a similar screen image type in ESA/PSA. But they are not identical.
Initial S/W Revision	Prior to A.02.00

3D Color

Selects a standard color theme with each object filled, shaded and colored as designed.

Key Path	Save, Screen Image, Themes
Example	MMEM:STOR:SCR:THEM TDC
Readback	3D Color
Initial S/W Revision	Prior to A.02.00

3D Monochrome

Selects a format that is like 3D color but shades of gray are used instead of colors.

Key Path	Save, Screen Image, Themes
Example	MMEM:STOR:SCR:THEM TDM
Readback	3D Mono
Initial S/W Revision	Prior to A.02.00

Flat Color

Selects a format that is best when the screen is to be printed on an ink printer.

Key Path	Save, Screen Image, Themes
Example	MMEM:STOR:SCR:THEM FCOL
Readback	Flat Color
Initial S/W Revision	Prior to A.02.00

Flat Monochrome

Selects a format that is like Flat Color. But only black is used (no colors, not even gray), and no fill.

Key Path	Save, Screen Image, Themes
Example	MMEM:STOR:SCR:THEM FMON
Readback	Flat Mono
Initial S/W Revision	Prior to A.02.00

Save As...

When you press "Save As", the analyzer brings up a Windows dialog and a menu entitled "**Save As.**" This menu allows you to navigate to the various fields in the Windows dialog without using a keyboard or mouse. The Tab and Arrow keys can also be used for dialog navigation.

See "[To File . . .](#)" on page 1211 in Save, State for a full description of this dialog and menu.

The default path for Screen Images is

My Documents\`<mode name>`\screen.

where `<mode name>` is the parameter used to select the mode with the INST:SEL command (for example, SA for the Spectrum Analyzer).

Key Path	Save, Screen Image
Notes	Brings up Save As dialog for saving a Screen Image Save Type
Initial S/W Revision	Prior to A.02.00

Single (Single Measurement/Sweep)

Sets the analyzer for Single measurement operation. The single/continuous state is Meas Global, so the setting will affect all the measurements. If you are Paused, pressing Single does a Resume.

See ["More Information" on page 1225](#)

Key Path	Front-panel key
Example	:INIT:CONT OFF
Notes	See Cont key description.
Backwards Compatibility Notes	<p>For Spectrum Analysis mode in ESA and PSA, the Single hardkey and the INITiate:IMM switched from continuous measurement to single measurement and restarted sweeps and averages (displayed average count reset to 1), but did not restart Max Hold and Min Hold. In the X-Series, the Single hardkey and the INITiate:IMM command initiate a sweep/ measurement/ average sequence/hold sequence including MaxHold and MinHold.</p> <p>For Spectrum Analysis mode in ESA and PSA, the Single hardkey restarted the sweep regardless of whether or not you were in an active sweep or sweep sequence. In the X-Series, Restart does this but Single only restarts the sweep or sweep sequence if you are in the idle state.</p> <p>INIT[:IMM] in ESA & PSA Spectrum Analysis Mode does an implied ABORT. In some other PSA Modes, INIT[:IMM] is ignored if not in the idle state. . The X-Series follows the ESA/PSA SA Mode model, which may cause some Modes to have compatibility problems.</p>
Initial S/W Revision	Prior to A.02.00

More Information

See ["Restart" on page 1208](#) for details on the INIT:IMMEDIATE (Restart) function.

If you are already in single sweep, the INIT:CONT OFF command has no effect.

If you are already in Single Sweep, then pressing the Single key in the middle of a sweep does not restart the sweep or sequence. Similarly, pressing the Single key does not restart the sweep or sequence if the sweep is not in the idle state (for example, if you are taking a very slow sweep, or the analyzer is waiting for a trigger). Instead, it results in a message. "Already in Single, press Restart to initiate a new sweep or sequence". Even though pressing the Single key in the middle of a sweep does not restart the sweep, sending INIT:IMMEDIATE does reset it.

To take one more sweep without resetting the average count, increment the average count by 1, by pressing the step up key while **Average/Hold Number** is the active function, or sending the remote command CALC:AVER:TCON UP.

Source

There is no Source control functionality for this measurement. When this key is pressed, the screen either displays a blank menu, or the previously-selected menu remains unchanged.

Key Path	Front-panel key
----------	-----------------

SPAN X Scale

Displays a menu for selecting measurement span and also for scaling of the X axis.

Key Path	Front Panel
Mode	VSA, LTE, LTETDD, IDEN, LTEAFDD,LTEATDD
Initial S/W Revision	Prior to A.02.00
Modified at S/W Revision	A.02.00

Span

Controls the frequency span of the measurement. This is the full span that is displayed on a spectrum display. The actual IF bandwidth that the time record detects is 1.28 times the span. See "[FREQ Channel](#)" on page 1134 for details on how this interacts with start, stop, and center frequencies.

Key Path	SPAN X Scale
Mode	VSA, IDEN
Remote Command	[:SENSe] :FREQuency:SPAN <freq> [:SENSe] :FREQuency:SPAN?
Example	FREQ:SPAN 10 MHZ FREQ:SPAN?
Couplings	Start Freq and Stop Freq. See " FREQ Channel " on page 1134 for details.
Preset	depends on span option
State Saved	Saved in instrument state.
Min	2 Hz
Max	depends on span option
Initial S/W Revision	Prior to A.02.00
Modified at S/W Revision	A.02.00

Full Span

Changes the span to the maximum available. The center frequency remains unchanged, regardless of whether the Frequency Annotation property is Start/Stop or Center/Span.

Key Path	SPAN X Scale
Mode	VSA, IDEN
Remote Command	[:SENSe] :FREQuency:SPAN:FULL
Example	FREQ:SPAN:FULL
Notes	The label on the softkey gives the full span available, which depends on span option.
Couplings	Changes span to maximum while keeping the center frequency constant. Start and Stop frequency

	are affected
Readback Text	[25 MHz] If playing back a recording, list the recorded bandwidth here
Initial S/W Revision	Prior to A.02.00
Modified at S/W Revision	A.02.00

Select Trace

Displays a menu that enables you to select the trace that is to receive the action of all successive trace-specific commands like scaling, assignment of trace data, and so on. The selected trace is outlined in green and is always visible. While the Select Trace menu is showing, each visible trace is annotated in the middle with its own trace number, as shown in the following figure. The trace number annotations disappear when any other menu is showing.

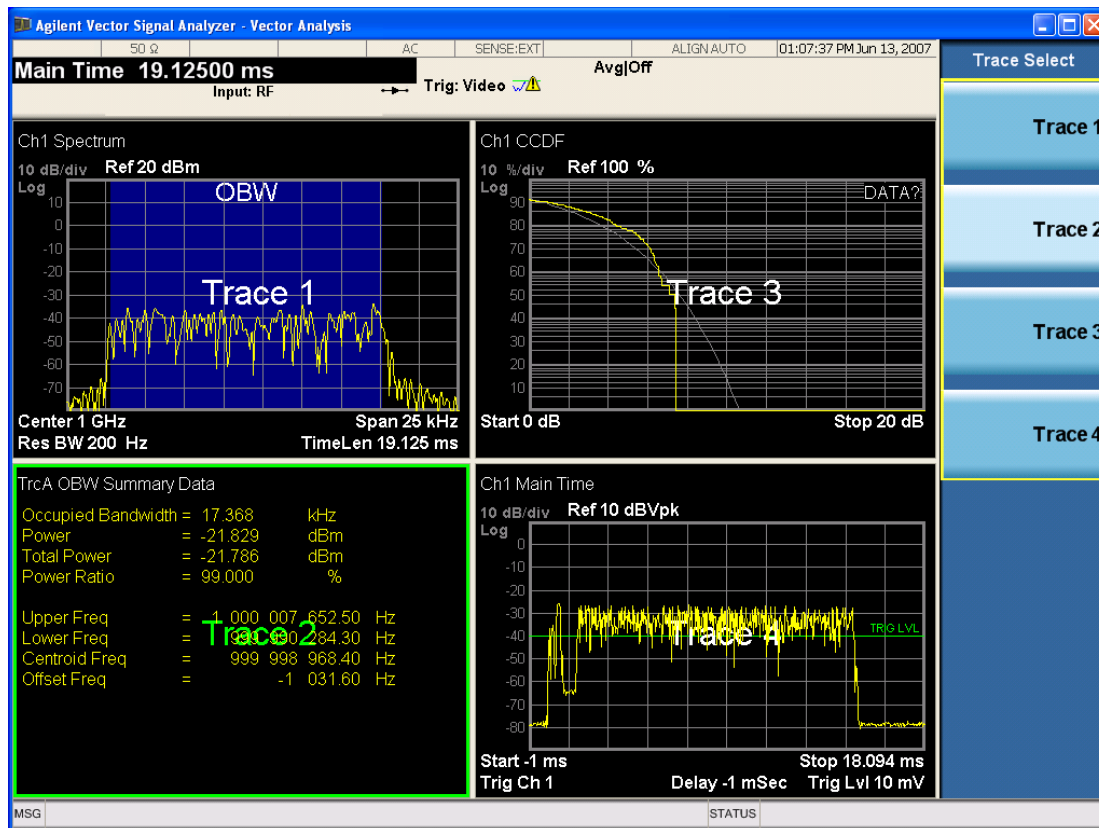

Grid 2x2 layout showing trace annotations when Trace Select dialog is active

This softkey also appears in the X and Y scaling menus. There is only one selected trace at any time. If you change which trace is selected, that change is reflected in this softkey/menu wherever it appears. Other ways to select a trace include use of the Next Window key, clicking within a trace window with a mouse cursor, and issuing a trace-specific SCPI command.

There is no SCPI command associated with this function. Instead, SCPI commands that are trace-specific have an index on the TRACe node that determines the selected trace. Using such a command has the side

effect that the trace addressed by the SCPI command becomes the selected trace for any front panel interaction.

Key Path	Trace/Detector or Span X Scale or AMPTD Y Scale
Mode	VSA, LTE, LTETDD, IDEN, LTEAFDD, LTEATDD
Notes	No SCPI. Front panel only.
Couplings	Affects any trace-specific commands
Range	Trace 1 Trace 2 Trace 3 Trace 4 Trace 5 Trace 6
Readback Text	Trace <n>
Initial S/W Revision	Prior to A.02.00
Modified at S/W Revision	A.02.00

X Scale

Causes the trace to display all available trace data when set to Auto. (Exception: the display of the outer edges of a spectrum that can contain aliases is governed by the All Frequency Points function setting – see below.) The annotation is updated as needed, but the X Reference Value and X Width keys are grayed out and not updated. When this function is set to Man, the X Reference Value and X Width softkey readbacks are updated with the current values.

Key Path	SPAN X Scale
Mode	VSA, LTE, LTETDD, IDEN, LTEAFDD, LTEATDD
Measurement	<meas>:=VECTor ADEMod DDEMod W11A W11B EVM IPOWER IDEMod MOTotalk
Remote Command	:DISPlay:<meas>:TRACe[1] 2 ...4:X[:SCALE]:COUPle OFF ON 0 1 :DISPlay:<meas>:TRACe[1] 2 ...4:X[:SCALE]:COUPle?
Example	:DISP:VECT:TRAC1:X:COUP ON DISP:VECT:TRAC1:X:COUP?
Couplings	Forced to Man if X Reference Value or X Width is set by user.
Preset	1
State Saved	Saved in instrument state.
Range	Auto Man
Initial S/W Revision	Prior to A.02.00
Modified at S/W Revision	A.02.00

X Reference Value

Controls the X value of the selected trace at the chosen X Reference Position (see below). It has no effect on hardware input settings.

Key Path	SPAN X Scale
----------	--------------

Mode	VSA, LTE, LTETDD, IDEN, LTEAFDD,LTEATDD
Measurement	<meas>:=VECTor ADEMod DDEMod W11A W11B EVM IPOWER IDEMod MOTotalk
Remote Command	:DISPlay:<meas>:TRACe [1] 2 ...4:X[:SCALE]:RLEVel <real> :DISPlay:<meas>:TRACe [1] 2 ...4:X[:SCALE]:RLEVel?
Example	DISP:VECT:TRAC:X:RLEV 1e9 DISP:VECT:TRAC:X:RLEV?
Couplings	If X Scale is set to Auto, the X Reference Value is determined by the trace data and this key is grayed out.
Preset	Depends on trace
State Saved	Saved in instrument state.
Min	-9.9E+37
Max	9.9E+37
Initial S/W Revision	Prior to A.02.00
Modified at S/W Revision	A.02.00

X Width

Sets the width of the X axis that is displayed for the selected trace. The X width can be set less than the Span for frequency-domain traces, enabling you to zoom in on just a portion of the measured values. Likewise, it can be less than time span covered by time-domain data. This plus the X Reference Value and X Reference Position control the range of X values that can be displayed on a trace. For example, if the X Reference position is Center, the X Reference value is 1 GHz and the X Width is 20 MHz.

Key Path	SPAN X Scale
Mode	VSA, LTE, LTETDD, IDEN, LTEAFDD,LTEATDD
Measurement	<meas>:=VECTor ADEMod DDEMod W11A W11B EVM IPOWER IDEMod MOTotalk
Remote Command	:DISPlay:<meas>:TRACe [1] 2 ...4:X[:SCALE]:SPAN <real> :DISPlay:<meas>:TRACe [1] 2 ...4:X[:SCALE]:SPAN?
Example	DISP:VECT:TRAC:X:SPAN 10e6 DISP:VECT:TRAC:X:SPAN?
Couplings	If X Scale is set to Auto, the X Width is determined by the trace data and this key is grayed out.
Preset	Depends on trace
State Saved	Saved in instrument state.
Min	-9.9E+37
Max	9.9E+37
Initial S/W Revision	Prior to A.02.00
Modified at S/W Revision	A.02.00

X Reference Position

Determines the position from which the X scaling is calculated for the selected trace. It can be set to the left side, center, or right side of the grid.

Key Path	SPAN X Scale
Mode	VSA, LTE, LTETDD, IDEN, LTEAFDD, LTEATDD
Measurement	<meas>:=VECTor ADEMod DDEMod W11A W11B EVM IPOWER IDEMod MOTotalk
Remote Command	:DISPlay:<meas>:TRACe[1] 2 ...4:X[:SCALE]:RPOSition LEFT CENTer RIGHT :DISPlay:<meas>:TRACe[1] 2 ...4:X[:SCALE]:RPOSition?
Example	DISP:VECT:TRAC1:X:RPOS LEFT DISP:VECT:TRAC1:X:RPOS?
Couplings	If X Scale is set to Auto, the X Reference Position is determined by the trace data and this key is grayed out.
Preset	CENT
State Saved	Saved in instrument state.
Range	Left Ctr Right
Initial S/W Revision	Prior to A.02.00
Modified at S/W Revision	A.02.00

Freq Annotation

Controls how Spectrum and PSD traces are annotated when their X Scale is set to Auto. If Freq Annotation is set to Center/Span, the X-axes on windows containing frequency domain traces are labeled with the center frequency on the left and the span on the right. If the Freq Annotation is set to Start/Stop, then the start and stop frequencies appear in place of center and span. If the X Scale is manual, then this annotation style does not apply.

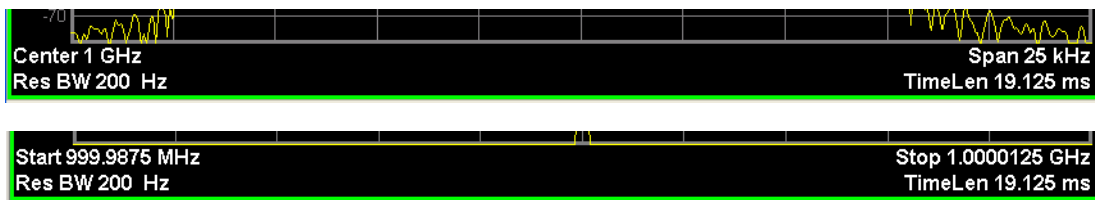

Key Path	SPAN X Scale
Mode	VSA, LTE, LTETDD, IDEN, LTEAFDD, LTEATDD
Measurement	<meas>:=VECTor ADEMod DDEMod W11A W11B EVM IPOWER IDEMod MOTotalk
Remote Command	:DISPlay:<meas>:FANNotation CSPan SSTop :DISPlay:<meas>:FANNotation?
Example	DISP:VECT:FANN CSP DISP:VECT:FANN?

Preset	CSP
State Saved	Saved in instrument state.
Range	Center/Span Start/Stop
Initial S/W Revision	Prior to A.02.00
Modified at S/W Revision	A.02.00

All Frequency Points

Spectrum trace data (and PSD) are based on the FFT algorithm. By default, the outer edges of the spectrum are not displayed because they can show spurious results that are aliases of real signals that are not completely filtered out by the IF filter. For example, in the case of a 1024 point FFT only 801 points are displayed. If you want to view the additional FFT points at the edges of spectral displays, turn this function on. It is global to all traces, not specific to a single trace.

Key Path	SPAN X Scale
Mode	VSA, LTE, LTETDD, IDEN, LTEAFDD, LTEATDD
Measurement	<meas>:=VECTor ADEMod DDEMod W11A W11B EVM IPOWER IDEMod MOTotalk
Remote Command	:DISPlay:<meas>:AFPpoints OFF ON 0 1 :DISPlay:<meas>:AFPpoints?
Example	DISP:VECT:AFP ON DISP:VECT:AFP?
Notes	ac
Couplings	Only applies if trace is showing Spectrum or PSD results.
Preset	OFF
State Saved	Saved in instrument state.
Range	On Off
Initial S/W Revision	Prior to A.02.00
Modified at S/W Revision	A.02.00

Copy X Scale

Copies the following X scaling information from the selected trace to another:

- X reference Position
- X Reference Value
- X Width
- X Scale (Auto/Man)

This is a front-panel only function.

Key Path	SPAN X Scale, X Axis Scaling
Mode	VSA, LTE, LTETDD, IDEN, LTEAFDD,LTEATDD
Initial S/W Revision	Prior to A.02.00
Modified at S/W Revision	A.02.00

Sweep/Control

Displays a menu that enables you to control time-related measurement parameters and to pause or resume the measurement.

Key Path	Front Panel
Mode	VSA
Initial S/W Revision	A.01060 or later

Pause / Resume

Pauses or resumes acquisition at the end of the current time record acquisition.

Key Path	Sweep Control
Mode	VSA
Initial S/W Revision	A.01060 or later

System

See "System" on page 242

Trace/Detector

Accesses a menu enabling you to select various trace parameters for all VSA based measurements.

Key Path	Front Panel
Mode	VSA, LTE, LTETDD, IDEN, LTEAFDD, LTEATDD
Initial S/W Revision	Prior to A.02.00
Modified at S/W Revision	A.02.00

Select Trace

Displays a menu that enables you to select the trace that is to receive the action of all successive trace-specific commands like scaling, assignment of trace data, and so on. The selected trace is outlined in green and is always visible. While the Select Trace menu is showing, each visible trace is annotated in the middle with its own trace number, as shown in the following figure. The trace number annotations disappear when any other menu is showing.

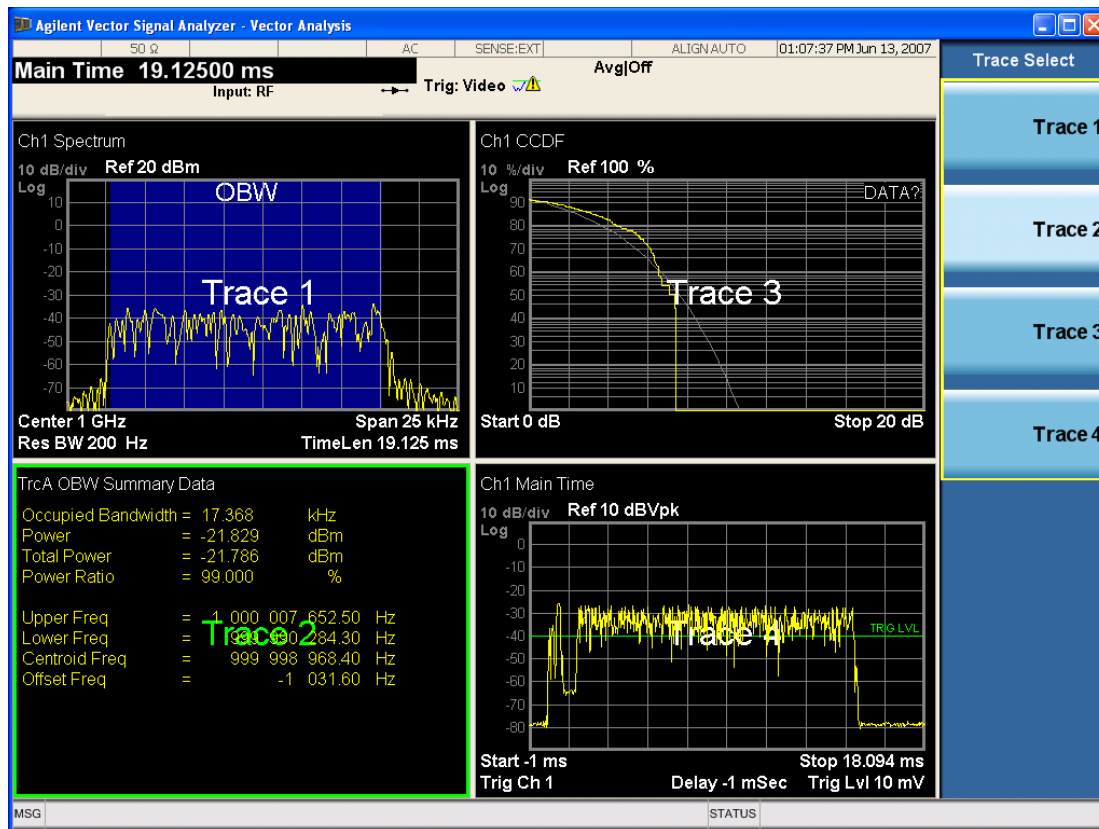

Grid 2x2 layout showing trace annotations when Trace Select dialog is active

This softkey also appears in the X and Y scaling menus. There is only one selected trace at any time. If you change which trace is selected, that change is reflected in this softkey/menu wherever it appears. Other

ways to select a trace include use of the Next Window key, clicking within a trace window with a mouse cursor, and issuing a trace-specific SCPI command.

There is no SCPI command associated with this function. Instead, SCPI commands that are trace-specific have an index on the TRACe node that determines the selected trace. Using such a command has the side effect that the trace addressed by the SCPI command becomes the selected trace for any front panel interaction.

Key Path	Trace/Detector or Span X Scale or AMPTD Y Scale
Mode	VSA, LTE, LTETDD, IDEN, LTEAFDD, LTEATDD
Notes	No SCPI. Front panel only.
Couplings	Affects any trace-specific commands
Range	Trace 1 Trace 2 Trace 3 Trace 4 Trace 5 Trace 6
Readback Text	Trace <n>
Initial S/W Revision	Prior to A.02.00
Modified at S/W Revision	A.02.00

Data

Accesses a menu of Trace data choices for the selected trace. A VSA Measurement can produce many different results from a single scan; either a graph or a table. In addition, the ACP and OBW functions can be enabled on any trace, showing a frequency-domain result, and produce Summary table results. Any of these results can be assigned to a trace and displayed.

The following Trace Data types are available in all measurements:

Soft Key Name	SCPI string form
No Data	"No Data"
Spectrum	"Spectrum1"
Inst Spectrum	"Inst Spectrum1"
Raw Main Time	"Raw Main Time1"
OBW Summary for Trace 1	"Obw Summary Trc1"
OBW Summary for Trace 2	"Obw Summary Trc2"
OBW Summary for Trace 3	"Obw Summary Trc3"
OBW Summary for Trace 4	"Obw Summary Trc4"
ACP Summary for Trace 1	"Acp Summary Trc1"
ACP Summary for Trace 2	" Acp Summary Trc2"
ACP Summary for Trace 3	" Acp Summary Trc3"
ACP Summary for Trace 4	" Acp Summary Trc4"

The following Data Registers are also available for display if there are traces stored in them (see ["Copy to Data Register" on page 1252](#) and ["Import Trace Data" on page 1205](#): "D1", "D2", "D3", "D4", "D5", and "D6")

Key Path	Trace/Detector, Data
Mode	VSA, LTE, LTETDD, IDEN
Measurement	<meas>:=VECTor ADEMod DDEMod W11A W11B EVM IPOWER IDEMod MOTotalk
Remote Command	:DISPlay:<meas>:TRACe[1] 2 ...4:FEED <string> :DISPlay:<meas>:TRACe[1] 2 ...4:FEED?
Example	DISP:VECT:TRAC1:FEED "Spectrum1" DISP:VECT:TRAC1:FEED?
Preset	Depends on trace number and measurement
State Saved	Saved in instrument state.
Initial S/W Revision	Prior to A.02.00
Modified at S/W Revision	A.02.00

The complete list of Trace Data names that can be assigned using the above SCPI can be obtained by using the following SCPI query:

Mode	VSA, LTE, LTETDD, IDEN
Measurement	<meas>:=VECTor ADEMod DDEMod W11A W11B EVM IPOWER IDEMod MOTotalk
Remote Command	:CALCulate:<meas>:DATA[1] 2 ...4:NAMes?
Example	CALC:VECT:DATA:NAM?
Notes	Query only. Returns a comma-separated list of trace data names that can be used in DISPlay:<meas>:TRACe[1] 2 3 4:FEED "<string>". The list is the same regardless of trace index.
Initial S/W Revision	Prior to A.02.00
Modified at S/W Revision	A.02.00

Pre Demod

This key accesses the Trace Data choices which show pre-demodulation results.

Key Path	Trace/Detector, Data
Mode	IDEN
Initial S/W Revision	A.02.00

Spectrum

Averaged FFT of the Time waveform.

Key Path	Trace/Detector, Data, Pre Demod
Mode	IDEN
Initial S/W Revision	A.02.00

Inst Spectrum

FFT display of the time waveform for the current measurement.

Key Path	Trace/Detector, Data, Pre Demod
Mode	IDEN
Initial S/W Revision	A.02.00

Search Time

The Search Length long time record acquired for the current measurement.

Key Path	Trace/Detector, Data, Pre Demod
Mode	IDEN
Initial S/W Revision	A.02.00

Time

The input waveform for the current measurement vs. time, over one slot time period.

Key Path	Trace/Detector, Data, Pre-Demod
Mode	IDEN
Initial S/W Revision	A.02.00

Raw Main Time

The raw time record acquired for the current measurement. This data is unprocessed and includes additional points acquired for settling of the filters involved in subsequent processing, such as the demodulation filtering.

Key Path	Trace/Detector, Data, Pre-Demod
Mode	IDEN
Initial S/W Revision	A.02.00

Error Vector Time

The overall error vector vs. time, for the measured trace.

Key Path	Trace/Detector, Data
Mode	IDEN
Initial S/W Revision	A.02.00

Slot Error Vector Time

The error vector vs. time of the specific slot defined by "Analysis Slot".

Key Path	Trace/Detector, Data
Mode	IDEN
Initial S/W Revision	A.02.00

Error Summary

It displays the overall scalar results for all burst found. The following results are shown on the Error Summary table (When average is turned off, the mean, max, min and StdDev values are not available):

- Total Bursts
- EVM (% RMS): Mean, Max, Min, StdDev, Current
- Peak EVM (%): Mean, Max, Min, StdDev, Current
- Carrier Frequency Offset: Mean, Max, Min, StdDev, Current
- Freq Dev: Mean, Max, Min, StdDev, Current
- Burst Power: Mean, Max, Min, StdDev, Current
- Slot Power: Mean, Max, Min, StdDev, Current

Key Path	Trace/Detector, Data
Mode	IDEN
Initial S/W Revision	A.02.00

Slot Error Summary

It displays the scalar results of the specific slot specified by "Analysis Slot". The following results are shown on the Slot Error Summary table (When average is turned off, the mean, max, min and StdDev values are not available):

- Analysis Slot
- Peak EVM symbol location
- EVM (% RMS): Mean, Max, Min, StdDev, Current
- Peak EVM (%): Mean, Max, Min, StdDev, Current
- Carrier Frequency Offset: Mean, Max, Min, StdDev, Current
- Freq Dev: Mean, Max, Min, StdDev, Current
- Burst Power: Mean, Max, Min, StdDev, Current

- Slot Power: Mean, Max, Min, StdDev, Current

Key Path	Trace/Detector, Data
Mode	IDEN
Initial S/W Revision	A.02.00

ACP (Adjacent Channel Power)

Provides access to ACP summary table data. These results are available when the ACP function is enabled for a particular trace, and it enables you to display the results in another trace.

Key Path	Trace/Detector, Data
Mode	VSA, LTE, LTETDD, IDEN
Initial S/W Revision	Prior to A.02.00
Modified at S/W Revision	A.02.00

ACP Summary for Trace 1

Displays results for the ACP function on Trace 1 in the selected trace.

See also: ["ACP Setup" on page 1255](#)

Key Path	Trace/Detector, Data, ACP
Mode	VSA, LTE, LTETDD, IDEN
Initial S/W Revision	Prior to A.02.00
Modified at S/W Revision	A.02.00

ACP Summary for Trace 2

Displays results for the ACP function on Trace 2 in the selected trace.

See also: ["ACP Setup" on page 1255](#)

Key Path	Trace/Detector, Data, ACP
Mode	VSA, LTE, LTETDD, IDEN
Initial S/W Revision	Prior to A.02.00
Modified at S/W Revision	A.02.00

ACP Summary for Trace 3

Displays results for the ACP function on Trace 3 in the selected trace.

See also: ["ACP Setup" on page 1255](#)

Key Path	Trace/Detector, Data, ACP
Mode	VSA, LTE, LTETDD, IDEN
Initial S/W Revision	Prior to A.02.00
Modified at S/W Revision	A.02.00

ACP Summary for Trace 4

Displays results for the ACP function on Trace 4 in the selected trace.

See also: ["ACP Setup" on page 1255](#)

Key Path	Trace/Detector, Data, ACP
Mode	VSA, LTE, LTETDD, IDEN
Initial S/W Revision	Prior to A.02.00
Modified at S/W Revision	A.02.00

ACP Summary for Trace 5

Displays results for the ACP function on Trace 5 in the selected trace.

See also: ["ACP Setup" on page 1255](#)

Key Path	Trace/Detector, Data, ACP
Mode	VSA

ACP Summary for Trace 6

Displays results for the ACP function on Trace 6 in the selected trace.

See also: ["ACP Setup" on page 1255](#)

Key Path	Trace/Detector, Data, ACP
Mode	VSA

OBW (Occupied Bandwidth)

Provides access to OBW summary table data. These results are available if the OBW function is enabled for a particular trace, and enable you to display the results in another trace.

Key Path	Trace/Detector, Data
Mode	VSA, LTE, LTETDD, IDEN

Initial S/W Revision	Prior to A.02.00
Modified at S/W Revision	A.02.00

OBW Summary for Trace 1

Displays results for the OBW function on Trace 1 in the selected trace.

See also: "[OBW Setup \(Occupied Bandwidth\)](#)" on page 1263

Key Path	Trace/Detector, Data, OBW
Mode	VSA, LTE, LTETDD, IDEN
Initial S/W Revision	Prior to A.02.00
Modified at S/W Revision	A.02.00

OBW Summary for Trace 2

Displays results for the OBW function on Trace 2 in the selected trace.

See also: "[OBW Setup \(Occupied Bandwidth\)](#)" on page 1263

Key Path	Trace/Detector, Data, OBW
Mode	VSA, LTE, LTETDD, IDEN
Initial S/W Revision	Prior to A.02.00
Modified at S/W Revision	A.02.00

OBW Summary for Trace 3

Displays results for the OBW function on Trace 3 in the selected trace.

See also: "[OBW Setup \(Occupied Bandwidth\)](#)" on page 1263

Key Path	Trace/Detector, Data, OBW
Mode	VSA, LTE, LTETDD, IDEN
Initial S/W Revision	Prior to A.02.00
Modified at S/W Revision	A.02.00

OBW Summary for Trace 4

Displays results for the OBW function on Trace 4 in the selected trace.

See also: "[OBW Setup \(Occupied Bandwidth\)](#)" on page 1263

Key Path	Trace/Detector, Data, OBW
Mode	VSA, LTE, LTETDD, IDEN
Initial S/W Revision	Prior to A.02.00
Modified at S/W Revision	A.02.00

OBW Summary for Trace 5

Displays results for the OBW function on Trace 5 in the selected trace.

See also: ["OBW Setup \(Occupied Bandwidth\)" on page 1263](#)

Key Path	Trace/Detector, Data, OBW
Mode	VSA

OBW Summary for Trace 6

Displays results for the OBW function on Trace 6 in the selected trace.

See also: ["OBW Setup \(Occupied Bandwidth\)" on page 1263](#)

Key Path	Trace/Detector, Data, OBW
Mode	VSA

Register

Accesses a menu that enables you to select registers for assignment of trace data.

Key Path	Trace/Detector, Data
Mode	VSA, LTE, LTETDD, IDEN
Initial S/W Revision	Prior to A.02.00
Modified at S/W Revision	A.02.00

Data 1

Select register 1 for assignment of trace data.

Key Path	Trace/Detector, Data, Register
Mode	VSA, LTE, LTETDD, IDEN
Initial S/W Revision	Prior to A.02.00
Modified at S/W Revision	A.02.00

Data 2

Selects register 2 for assignment of trace data.

Key Path	Trace/Detector, Data, Register
Mode	VSA, LTE, LTETDD, IDEN
Initial S/W Revision	Prior to A.02.00
Modified at S/W Revision	A.02.00

Data 3

Selects register 3 for assignment of trace data.

Key Path	Trace/Detector, Data, Register
Mode	VSA, LTE, LTETDD, IDEN
Initial S/W Revision	Prior to A.02.00
Modified at S/W Revision	A.02.00

Data 4

Selects register 4 for assignment of trace data.

Key Path	Trace/Detector, Data, Register
Mode	VSA, LTE, LTETDD, IDEN
Initial S/W Revision	Prior to A.02.00
Modified at S/W Revision	A.02.00

Data 5

Selects register 5 for assignment of trace data.

Key Path	Trace/Detector, Data, Register
Mode	VSA
Initial S/W Revision	Prior to A.02.00
Modified at S/W Revision	A.02.00

Data 6

Selects register 6 for assignment of trace data.

Key Path	Trace/Detector, Data, Register
Mode	VSA
Initial S/W Revision	Prior to A.02.00
Modified at S/W Revision	A.02.00

No Data

Enables you to turn off trace computations. Measurement results are not computed unless assigned to a trace. No Data lets you increase measurement speed by turning off post-processing calculations that are not needed.

Key Path	Trace/Detector, Data
Mode	VSA, LTE, LTETDD, IDEN
Initial S/W Revision	Prior to A.02.00
Modified at S/W Revision	A.02.00

Format

Accesses a menu that enables you to choose the format of the selected trace. Any format can be assigned to any trace. For symbol tables and tabular data the format choice is ignored. If the data doesn't have defined symbol times, Constellation format is the same as I-Q, Eye formats are the same as Real or Imaginary, and Trellis format is the same as Unwrapped Phase.

The formats are:

Format name	Description
Log Mag (dB)	Data is converted to decibel units and shown on a linear Y axis
Linear Mag (Abs Value)	Magnitude of the data is shown on a linear Y axis
Real (I)	Real part of data is shown on a linear Y axis
Imaginary (Q)	Imaginary part of data is shown on linear Y axis
I-Q	Real part of data is shown on horizontal axis, imaginary part is shown on vertical axis, Independent variable (X axis) is normal to display
Constellation	Same as I-Q, but for data with symbols defined, only the symbol points are shown as dots with no connecting lines.
Wrap Phase	Phase of complex data, limited to ± 180 deg, is shown on Y axis
Unwrap Phase	Phase of complex data is shown "unwrapped", that is, without discontinuities. Not limited to ± 180 degrees.
I-Eye	Real part of data is shown with X axis segmented (generally into 2 symbol segments) and each segment is overlaid to show signal crossings at symbol boundaries
Q-Eye	Same as I-eye but imaginary part of data is shown

Trellis	Same as I-eye but uses unwrapped phase of data
Group Delay	Useful for frequency response displays. Shows the derivative of phase response with respect to frequency.
Log Mag (Linear Unit)	Displays data with a logarithmic Y axis, but marker read outs are in linear magnitude units.

Key Path	Trace/Detector, Format
Mode	VSA, LTE, LTETDD, IDEN
Measurement	<meas>:=VECTor ADEMod DDEMod W11A W11B EVM IPOWER IDEMod MOTotalk
Remote Command	:DISPlay:<meas>:TRACe[1] 2 ...4:FORMat MLOG MLINear REAL IMAGinary VECTor CONS PHASE UPHase IEYE QEYE TRELLis GDELay MLGLinear :DISPlay:<meas>:TRACe[1] 2 ...4:FORMat?
Example	DISP:DDEM:TRAC2:FORM MLIN DISP:DDEM:TRAC2:FORM?
Preset	Depends on trace and measurement
State Saved	Saved in instrument state.
Range	Log Mag (dB) Linear Mag (Abs Value) Real (I) (Lin) Imaginary (Q) (Lin) I-Q Constellation Wrap Phase Unwrap Phase I-Eye Q-Eye Trellis-Eye Group Delay Log Mag (Linear Unit)
Readback Text	Log Mag (dB) Linear Mag Real (I) Imaginary (Q) I-Q Constellation Wrap Phase Unwrap Phase I-Eye Q-Eye Trellis-Eye Group Delay Log Mag
Initial S/W Revision	Prior to A.02.00
Modified at S/W Revision	A.02.00

Digital Demod Trace Setup

Accesses a menu of settings that control certain elements of displays of digitally demodulated trace data.

Key Path	Trace/Detector
Mode	VSA, LTE, LTETDD, IDEN
Initial S/W Revision	Prior to A.02.00
Modified at S/W Revision	A.02.00

Symbol Shape

Enables you to display dots, bars, or nothing (none) at symbol locations (if the trace contains demodulated time-domain data) for all time-domain displays except IQ diagrams. This key enables you to select the symbol shape for the selected trace.

If you select bars, vertical lines (bars) are drawn from the baseline to the symbol location on the trace. The baseline is 0 for all traces that have coordinates other than log (dB). The baseline is the bottom of the trace box for traces that have log (dB) coordinates.

With IQ diagrams, displaying vertical bars is meaningless. Therefore, selecting bars displays dots in IQ diagrams.

With constellation diagrams, selecting none is the same as selecting bars – you cannot turn off the dots in a constellation diagram.

Key Path	Trace/Detector, Digital Demod Trace Setup
Mode	VSA, LTE, LTETDD, IDEN
Measurement	<meas>:=VECTor ADEMod DDEMod W11A W11B EVM IPOWER IDEMod MOTotalk
Remote Command	:DISPlay:<meas>:TRACe [1] 2 . . . 4 :DDEMod:SYMBol BARS DOTS OFF :DISPlay:<meas>:TRACe [1] 2 . . . 4 :DDEMod:SYMBol ?
Example	DISP:DDEM:TRAC2:DDEM:SYMB DOTS DISP:DDEM:TRAC2:DDEM:SYMB?
Preset	BARS
State Saved	Saved in instrument state.
Range	Bars Dots None
Initial S/W Revision	Prior to A.02.00
Modified at S/W Revision	A.02.00

Ideal State Shape

Enables you to choose between a cross, circle, or none to represent the ideal state on the selected trace. Digital Demodulation shows you the location of all ideal symbol states in an I-Q or constellation diagram.

Key Path	Trace/Detector, Digital Demod Trace Setup
Mode	VSA, LTE, LTETDD, IDEN
Measurement	<meas>:=VECTor ADEMod DDEMod W11A W11B EVM IPOWER IDEMod MOTotalk
Remote Command	:DISPlay:<meas>:TRACe [1] 2 . . . 4 :DDEMod:SYMBol:SHAPE CIRCle CROSS OFF :DISPlay:<meas>:TRACe [1] 2 . . . 4 :DDEMod:SYMBol:SHAPE?
Example	DISP:DDEM:TRAC2:DDEM:SYMB:SHAP CIRC DISP:DDEM:TRAC2:DDEM:SYMB:SHAP?
Preset	CIRC
State Saved	Saved in instrument state.
Range	Circle Cross None
Initial S/W Revision	Prior to A.02.00
Modified at S/W Revision	A.02.00

Ideal State Size

Determines the ideal state size, as a percentage of the maximum ideal state distance from the origin (the same way Error Vector Magnitude is defined). Ideal states are shown as circles or crosses in Vector and constellation diagrams, as determined by the Ideal State Shape setting.

The ideal state is where symbols occur if your signal is without error. Showing the ideal states gives a visual indication of the quality of your signal.

You can use this feature to determine if symbols have an EVM above a specified Value. For example, to see if any symbols have an EVM greater than 10%, set the state size to 10% and select Circle as the shape. Any symbols that fall outside of the circle (other than SYNC or PILOT symbols) have an EVM greater than 10%.

Key Path	Trace/Detector, Digital Demod Trace Setup
Mode	VSA, LTE, LTETDD, IDEN
Measurement	<meas>:=VECTor ADEMod DDEMod W11A W11B EVM IPOWER IDEMod MOTotalk
Remote Command	:DISPlay:<meas>:TRACe[1] 2 ...4:DDEMod:SYMBol:SIZE <real> :DISPlay:<meas>:TRACe[1] 2 ...4:DDEMod:SYMBol:SIZE?
Example	DISP:DDEM:TRAC2:DDEM:SYMB:SIZE 10 DISP:DDEM:TRAC2:DDEM:SYMB:SIZE?
Notes	Parameter is interpreted as a percent, e.g., if you want the ideal size to be 10% send 10, not 0.1
Preset	5
State Saved	Saved in instrument state.
Min	0.1
Max	50
Initial S/W Revision	Prior to A.02.00
Modified at S/W Revision	A.02.00

Symbol Table Format

Enables you to choose the format in which symbol table data is displayed, when the modulation format encodes 4 or more bits per symbol. You can choose binary or hexadecimal. Binary symbol data is padded with leading zeros to make a multiple of 4 bits before conversion to hexadecimal. For example, for 16 QAM format, each 4-bit symbol is displayed as 2 hex digits.

Binary Format: The symbol data bit format is binary and each character represents a binary digit. The number to the left of each row indicates the bit offset of the first bit in the row.

Hexadecimal Format: The symbol data bit format is hexadecimal and each character represents a hexadecimal digit. The number to the left of each row indicate the symbol offset of the first symbol in the row.

NOTE

There must be at least 4 bits/symbol to use the hexadecimal format, that is, symbols that have less than 4 bits/symbol are only displayed in binary format regardless of the Symbol Table Format setting.

This parameter is valid only when:

- The active trace is a symbol table, and
- The current demodulation format supports hexadecimal, the demodulation format's bits/symbol is equal to or greater than four.

Key Path	Trace/Detector, Digital Demod Trace Setup
Mode	VSA, LTE, LTETDD, IDEN
Measurement	<meas>:=VECTor ADEMod DDEMod W11A W11B EVM IPOWER IDEMod MOTotalk
Remote Command	:DISPlay:<meas>:TRACe [1] 2 . . . 4 :DDEMod:SYMBol:FORMat HEXadecimal BINary :DISPlay:<meas>:TRACe [1] 2 . . . 4 :DDEMod:SYMBol:FORMat?
Example	DISP:DDEM:TRAC2:DDEM:SYMB:FORM BIN DISP:DDEM:TRAC2:DDEM:SYMB:FORM?
Preset	HEX
Range	Hex Binary
Initial S/W Revision	Prior to A.02.00
Modified at S/W Revision	A.02.00

Time Unit

Enables you to select the time units that are applied to x-axis annotations and marker readouts for the selected trace, whenever it is assigned data with (demodulation) symbol information. The available measurement units are sym (symbols) or sec (seconds).

Key Path	Trace/Detector, Digital Demod Trace Setup
Mode	VSA, LTE, LTETDD, IDEN
Measurement	<meas>:=VECTor ADEMod DDEMod W11A W11B EVM IPOWER IDEMod MOTotalk
Remote Command	:DISPlay:<meas>:TRACe [1] 2 . . . 4 :DDEMod:UNIT:TIME SEC SYMBol :DISPlay:<meas>:TRACe [1] 2 . . . 4 :DDEMod:UNIT:TIME?
Example	DISP:VECT:TRAC2:DDEM:UNIT:TIME SYMB DISP:VECT:TRAC2:DDEM:UNIT:TIME?
Preset	SYMB
State Saved	Saved in instrument state.
Range	sym sec
Initial S/W Revision	Prior to A.02.00
Modified at S/W Revision	A.02.00

Freq Unit

Enables you to select the frequency units that are applied to x-axis annotations and marker readouts for the selected trace, whenever it is assigned data with (demodulation) carrier information. The available

measurement units are carrier or Hz.

Key Path	Trace/Detector, Digital Demod Trace Setup
Mode	VSA, LTE, LTETDD, IDEN
Measurement	<meas>:=VECTor ADEMod DDEMod W11A W11B EVM IPOWER IDEMod MOTotalk
Remote Command	:DISPlay:<meas>:TRACe [1] 2 . . . 4 :DDEMod:UNIT:FREQuency CARRier HZ :DISPlay:<meas>:TRACe [1] 2 . . . 4 :DDEMod:UNIT:FREQuency?
Example	DISP:VECT:TRAC2:DDEM:UNIT:FREQ CARR DISP:VECT:TRAC2:DDEM:UNIT:FREQ?
Preset	CARR
State Saved	Saved in instrument state.
Range	carrier Hz
Initial S/W Revision	Prior to A.02.00
Modified at S/W Revision	A.02.00

Eye Length

Controls how wide (in symbol periods) the eye and trellis diagrams are, for the selected trace.

Key Path	Trace/Detector, Digital Demod Trace Setup
Mode	VSA, LTE, LTETDD, IDEN
Measurement	<meas>:=VECTor ADEMod DDEMod W11A W11B EVM IPOWER IDEMod MOTotalk
Remote Command	:DISPlay:<meas>:TRACe [1] 2 . . . 4 :DDEMod:EYE:COUNT <real> :DISPlay:<meas>:TRACe [1] 2 . . . 4 :DDEMod:EYE:COUNT?
Example	DISP:DDEM:TRAC2:DDEM:EYE:COUN 3 DISP:DDEM:TRAC2:DDEM:EYE:COUN?
Preset	2
State Saved	Saved in instrument state.
Min	0.1
Max	40
Initial S/W Revision	Prior to A.02.00
Modified at S/W Revision	A.02.00

Avg Line

Controls whether or not the average line is visible on certain demodulation analysis traces such as Error Vector Time and Error Vector Spectrum in Digital Demod measurements. These traces have 2-dimensional domains; typically subcarriers (frequency) and symbol times. Since the result can only be shown with one of these dimensions on the x-axis, the other dimension is placed on the z-axis. Since all the z-axis values

are overlapped, an average is calculated for all z values at each x value and the average is normally displayed as a line in front of trace. The average line display can be turned on or off using this control.

Key Path	Trace/Detector, Digital Demod Trace Setup
Mode	VSA, LTE, LTETDD, IDEN
Measurement	<meas>:=VECTor ADEMod DDEMod W11A W11B EVM IPOWER IDEMod MOTotalk
Remote Command	:DISPlay:<meas>:TRACe [1] 2 ...4:DDEMod:ALINe OFF ON 0 1 :DISPlay:<meas>:TRACe [1] 2 ...4:DDEMod:ALIN?
Example	DISP:W11A:TRAC:DDEM:ALIN OFF
Preset	1
State Saved	Saved in instrument state.
Initial S/W Revision	A.03.00 or later

Copy to Data Register

Accesses a menu of immediate execute keys, each of which copies the selected trace to a particular data register. Data registers can be displayed in any trace. They are measurement global, so you can copy data to a register while in the Digital Demod measurement and view it later while in the Vector measurement. Data registers are cleared when the VSA Application is exited and reentered, but not when you change Modes and return.

Key Path	Trace/Detector
Mode	VSA, LTE, LTETDD, IDEN
Measurement	<meas>:=VECTor ADEMod DDEMod W11A W11B EVM IPOWER IDEMod MOTotalk
Remote Command	:DISPlay:<meas>:TRACe [1] 2 ...4:COPI D1 D2 D3 D4 D5 D6
Example	DISP:VECT:TRAC:COPI D1
Readback Text	Last: <date_time> Empty
Initial S/W Revision	Prior to A.02.00
Modified at S/W Revision	A.02.00

The following SCPI provides means to determine if a Data Register is empty, and to erase the data from any or all Data Registers.

Mode	VSA, LTE, LTETDD, IDEN
Remote Command	:CALCulate:DATA:REGister [1] 2 ...6:EMPTy?
Example	:CALC:DATA:REG2:EMPT?
Notes	Query only: returns 1 if a Data Register has no trace data assigned to it.
Initial S/W Revision	Prior to A.02.00
Modified at S/W Revision	A.02.00

Mode	VSA, LTE, LTETDD, IDEN
Remote Command	:CALCulate:DATA:REGister[1] 2 ...6:REMove
Example	:CALC:DATA:REG2:REM
Notes	Removes trace data assigned to specified Data Register.
Couplings	If Data Register is assigned to a trace, the trace data is changed to No Data
Initial S/W Revision	Prior to A.02.00
Modified at S/W Revision	A.02.00

Mode	VSA, LTE, LTETDD, IDEN
Remote Command	:CALCulate:DATA:REGister:ALL:REMove
Example	:CALC:DATA:REG:ALL:REM
Notes	Removes trace data assigned to all Data Registers.
Couplings	If Data Register is assigned to a trace, the trace data is changed to No Data
Initial S/W Revision	Prior to A.02.00
Modified at S/W Revision	A.02.00

Phase/Delay Properties

Accesses a menu of properties that affect the selected trace when displayed using phase or delay formats.

Key Path	Trace/Detector
Mode	VSA, LTE, LTETDD, IDEN
Initial S/W Revision	Prior to A.02.00
Modified at S/W Revision	A.02.00

Phase/Trellis Offset

Only used if the trace format is Wrap Phase, Unwrap Phase, or Trellis. For Unwrap Phase or Trellis traces, the phase offset value is added to the existing phase at each point. For example, if you are viewing an Unwrapped Phase trace, setting the Phase/Trellis Offset to 5 degrees moves the entire trace up 5 degrees (and changes the value displayed by a marker by the same amount). For Wrap Phase traces the phase offset only affects the phase wrap point, not the underlying data. The point at which the phase wraps is 180 degrees plus the phase offset. For example, suppose you have a marker on a Wrap Phase trace whose phase offset is 0 and the marker is showing -3 degrees. The trace data is all confined within (-180, 180] degrees. If you then change the phase offset to 180 degrees, then the Wrap Phase trace shows values within the interval (0, 360] degrees and the marker value is displayed as 357 degrees, which is the wrapped equivalent of -3 degrees.

Key Path	Trace/Detector, Phase Delay Properties
----------	--

Mode	VSA, LTE, LTETDD, IDEN
Measurement	<meas>:=VECTor ADEMod DDEMod W11A W11B EVM IPOWER IDEMod MOTotalk
Remote Command	:DISPlay:<meas>:TRACe [1] 2 . . . 4 :FORMat:PHASe:OFFSet <real> :DISPlay:<meas>:TRACe [1] 2 . . . 4 :FORMat:PHASe:OFFSet?
Example	DISP:DDEM:TRAC3:FORM:PHAS:OFFS 31 DISP:DDEM:TRAC3:FORM:PHAS:OFFS?
Preset	0
State Saved	Saved in instrument state.
Min	-1E+8
Max	1E+8
Initial S/W Revision	Prior to A.02.00
Modified at S/W Revision	A.02.00

Unwrap Phase Ref

Enables you to designate the point (x-axis) value about which phase values are to be unwrapped. That is, the phase at the designated reference is within -180 to 180 degrees, and phase varies smoothly without jumps around that point.

Key Path	Trace/Detector, Phase Delay Properties
Mode	VSA, LTE, LTETDD, IDEN
Measurement	<meas>:=VECTor ADEMod DDEMod W11A W11B EVM IPOWER IDEMod MOTotalk
Remote Command	:DISPlay:<meas>:TRACe [1] 2 . . . 4 :FORMat:PHASe:UNWRap:REFErence <real> :DISPlay:<meas>:TRACe [1] 2 . . . 4 :FORMat:PHASe:UNWRap:REFErence?
Example	DISP:DDEM:TRAC3:FORM:PHAS:UNWR:REF 24.5E6 DISP:DDEM:TRAC3:FORM:PHAS:UNWR:REF?
Preset	0
State Saved	Saved in instrument state.
Min	-9.9e37
Max	9.9e37
Initial S/W Revision	Prior to A.02.00
Modified at S/W Revision	A.02.00

Group Delay Aperture

Used when the trace format is Group Delay. The aperture is specified as a percentage of the current frequency span for frequency-domain data. It is specified as a percentage of the time-record length for time-domain data.

When group delay is calculated for a given point (which can be a time- or frequency-domain point), the aperture is centered at that point. Larger apertures decrease resolution, but they increase the smoothing of the group-delay trace.

The point plotted for group delay is located between the data points used to calculate it. For example, in the frequency domain, the group delay for 100 Hz can be calculated by measuring the change in phase between 90 and 110 Hz. If you had specified a start frequency of 90 Hz, 100 Hz would be the first point with group delay data. This results in a trace that does not extend to the edges of the screen (more noticeable as the delay aperture increases).

Note that the smallest aperture that you can select depends on the number of frequency points. If you select an invalid aperture, the analyzer automatically selects the smallest valid aperture.

Key Path	Trace/Detector, Phase Delay Properties
Mode	VSA, LTE, LTETDD, IDEN
Measurement	<meas>:=VECTor ADEMod DDEMod W11A W11B EVM IPOWER IDEMod MOTotalk
Remote Command	:DISPlay:<meas>:TRACe[1] 2 ...4:FORMat:DELaY:APERture <real> :DISPlay:<meas>:TRACe[1] 2 ...4:FORMat:DELaY:APERture?
Example	DISP:DDEM:TRAC3:FORM:DEL:APER 1 DISP:DDEM:TRAC3:FORM:DEL:APER?
Notes	Parameter is interpreted as a percent, e.g., if you want the group delay aperture to be 1% send 1, not 0.01
Preset	0.5
State Saved	Saved in instrument state.
Min	0.00390625
Max	16
Initial S/W Revision	Prior to A.02.00
Modified at S/W Revision	A.02.00

ACP Setup

Accesses a menu of functions that enable you to define and turn on the ACP function on the selected trace. One reference channel and up to 5 offset frequencies can be defined, and ACP is calculated for bands both above and below the reference frequency for each offset.

The adjacent channel power (ACP) function calculates the power in a reference band of frequencies as well as bands of frequencies offset from the reference, and calculates the ratio of each offset band to the reference band power.

An ACP measurement can be defined for each trace, although it is only active on frequency-domain trace data. The reference and offset frequency bands defined by the ACP measurement are shown as gold bars overlaying the trace display. To see tabular data showing power and power ratio results, you can assign the ACP Summary (Trace n) to a different trace. For example, you can assign Spectrum data to trace 1, turn on and define an ACP measurement on trace 1, assign the ACP Summary (Trace 1) to trace 2, and use a 2x2 display to view both at the same time, as shown below.

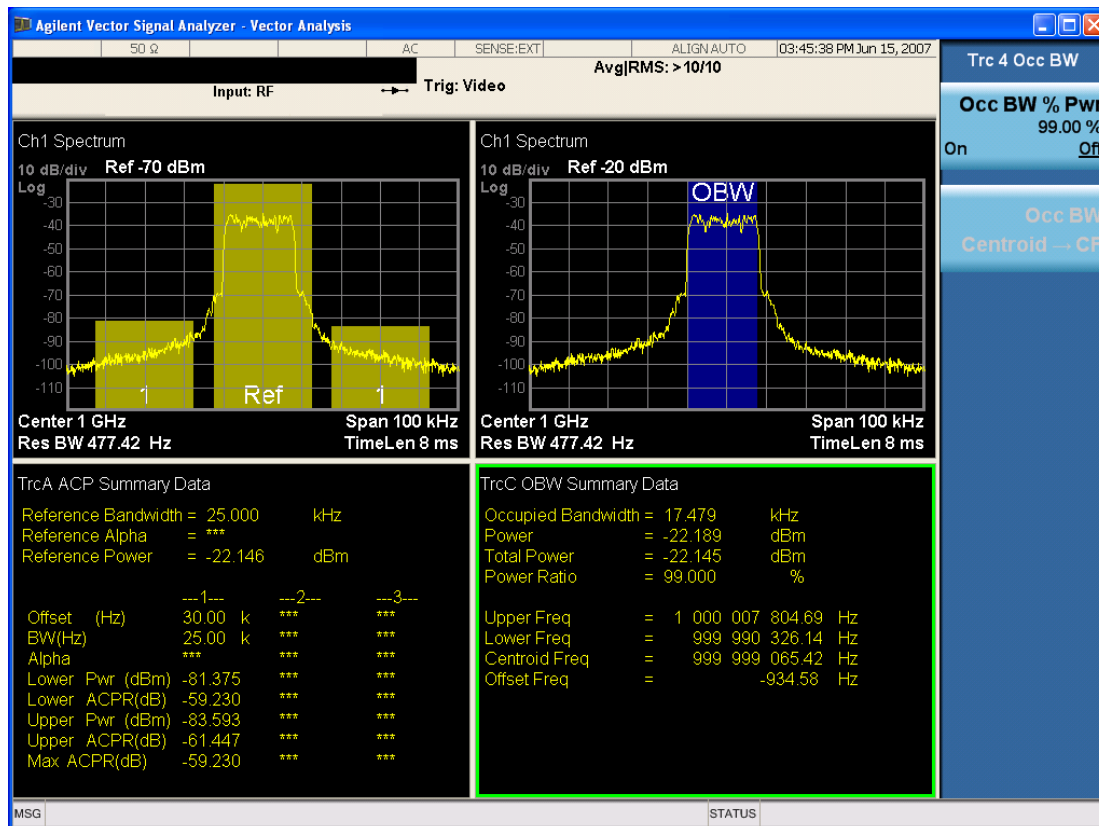

The summary data can be retrieved programmatically using FETCH? or the CALCulate:<meas>:DATA:TABLE commands. See "[CALCulate:DATA:TABLE commands](#)" on page 1291 for more details.

Key Path	Trace/Detector
Mode	VSA, LTE, LTETDD, IDEN
Readback Text	[On Off,]
Initial S/W Revision	Prior to A.02.00
Modified at S/W Revision	A.02.00

ACP On/Off

Turns the ACP function on or off for the selected trace.

Key Path	Trace/Detector, ACP
Mode	VSA, LTE, LTETDD, IDEN
Measurement	<meas>:=VECTor ADEMod DDEMod W11A W11B EVM IPOWER IDEMod MOTotalk
Remote Command	:CALCulate:<meas>:TRACE[1] 2 ...4:ACPpower:STATE OFF ON 0 1 :CALCulate:<meas>:TRACE[1] 2 ...4:ACPpower:STATE?
Example	CALC:VECT:TRAC1:ACP:STATE ON

	CALC:VECT:TRAC1:ACP:STATE?
Preset	0
State Saved	Saved in instrument state.
Initial S/W Revision	Prior to A.02.00
Modified at S/W Revision	A.02.00

Carrier Freq

Enables you to enter the carrier frequency of the reference channel for the ACP measurement. The carrier frequency is relative to the center frequency of the measurement. There is only one available reference carrier.

Key Path	Trace/Detector, ACP
Mode	VSA, LTE, LTETDD, IDEN
Measurement	<meas>:=VECTor ADEMod DDEMod W11A W11B EVM IPOWER IDEMod MOTotalk
Remote Command	:CALCulate:<meas>:TRACe[1] 2 ...4:ACPpower:CARRier:FREQuency <freq> :CALCulate:<meas>:TRACe[1] 2 ...4:ACPpower:CARRier:FREQuency?
Example	CALC:VECT:TRAC1:ACP:CARR:FREQ 100 KHZ CALC:VECT:TRAC1:ACP:CARR:FREQ?
Preset	0
State Saved	Saved in instrument state.
Min	-9.9e37
Max	9.9e37
Initial S/W Revision	Prior to A.02.00
Modified at S/W Revision	A.02.00

Carrier Meas Noise BW

Enables you to define the measurement noise bandwidth of the reference channel.

Key Path	Trace/Detector, ACP
Mode	VSA, LTE, LTETDD, IDEN
Measurement	<meas>:=VECTor ADEMod DDEMod W11A W11B EVM IPOWER IDEMod MOTotalk
Remote Command	:CALCulate:<meas>:TRACe[1] 2 ...4:ACPpower:CARRier:BANDwidth BWIDth:INTegration <bandwidth> :CALCulate:<meas>:TRACe[1] 2 ...4:ACPpower:CARRier:BANDwidth BWIDth:INTegration?
Example	CALC:VECT:TRAC1:ACP:CARR:BAND:INT 1 MHZ CALC:VECT:TRAC1:ACP:CARR:BAND:INT?

Preset	1000000
State Saved	Saved in instrument state.
Min	-9.9e37
Max	9.9e37
Initial S/W Revision	Prior to A.02.00
Modified at S/W Revision	A.02.00

Carrier RRC Weighting

Turns on or off RRC weighting for the reference (carrier) power measurement.

Key Path	Trace/Detector, ACP
Mode	VSA, LTE, LTETDD, IDEN
Measurement	<meas>:=VECTor ADEMod DDEMod W11A W11B EVM IPOWER IDEMod MOTotalk
Remote Command	:CALCulate:<meas>:TRACe[1] 2 ...4:ACP:Power:CARRier:FILTer:RRC:STATe OFF ON 0 1 :CALCulate:<meas>:TRACe[1] 2 ...4:ACP:Power:CARRier:FILTer:RRC:STATe?
Example	CALC:VECT:TRAC1:ACP:CARR:FILT:RRC:STAT ON CALC:VECT:TRAC1:ACP:CARR:FILT:RRC:STAT?
Preset	0
State Saved	Saved in instrument state.
Initial S/W Revision	Prior to A.02.00
Modified at S/W Revision	A.02.00

Carrier Filter Alpha

Enables you to adjust the alpha of the RRC filter for the reference (carrier) power measurement.

Key Path	Trace/Detector, ACP
Mode	VSA, LTE, LTETDD, IDEN
Measurement	<meas>:=VECTor ADEMod DDEMod W11A W11B EVM IPOWER IDEMod MOTotalk
Remote Command	:CALCulate:<meas>:TRACe[1] 2 ...4:ACP:Power:CARRier:FILTer:RRC:ALPHa <real> :CALCulate:<meas>:TRACe[1] 2 ...4:ACP:Power:CARRier:FILTer:RRC:ALPHa?
Example	CALC:VECT:TRAC1:ACP:CARR:FILT:RRC:ALPH 0.22 CALC:VECT:TRAC1:ACP:CARR:FILT:RRC:ALPH?
Preset	0.35
State Saved	Saved in instrument state.

Min	0
Max	1
Initial S/W Revision	Prior to A.02.00
Modified at S/W Revision	A.02.00

Offsets

Accesses a menu that has a key for each offset, and also an Offset RRC weighting on/off key. Each offset key shows a summary of its current parameters. Pressing one of the Offset A|B|C|D|E keys accesses a menu for adjusting its parameters.

The ACP measurement compares power in frequency bands offset from the carrier to power in the reference channel (centered on the carrier). Up to 5 offsets can be defined. The offsets are designated by letters A through E. Each offset is defined by an offset frequency, bandwidth, and optional RRC weighting. An offset actually defines two bands, one above the reference frequency and one below. Each band is used individually in the ACP calculation. RRC weighting can only be turned on or off for all offsets, but each offset can have its own RRC filter alpha. A filter alpha of 0 is the same as no RRC weighting.

Key Path	Trace/Detector,ACP,Offsets
Mode	VSA, LTE, LTETDD, IDEN
Initial S/W Revision	Prior to A.02.00
Modified at S/W Revision	A.02.00

Offsets

Accesses a menu that has a key for each offset, and also an Offset RRC weighting on/off key. Each offset key shows a summary of its current parameters. Pressing one of the Offset A|B|C|D|E keys accesses a menu for adjusting its parameters.

The ACP measurement compares power in frequency bands offset from the carrier to power in the reference channel (centered on the carrier). Up to 5 offsets can be defined. The offsets are designated by letters A through E. Each offset is defined by an offset frequency, bandwidth, and optional RRC weighting. An offset actually defines two bands, one above the reference frequency and one below. Each band is used individually in the ACP calculation. RRC weighting can only be turned on or off for all offsets, but each offset can have its own RRC filter alpha. A filter alpha of 0 is the same as no RRC weighting.

Key Path	Trace/Detector,ACP,Offsets
Mode	VSA, LTE, LTETDD, IDEN
Initial S/W Revision	Prior to A.02.00
Modified at S/W Revision	A.02.00

Offset Freq

Turns ACP analysis on or off for a selected offset and sets the offset frequency, which is relative to the carrier frequency.

Key Path	Trace/Detector, ACP, Offsets, Offset A B C D E
Mode	VSA, LTE, LTETDD, IDEN
Measurement	<meas>:=VECTor ADEMod DDEMod W11A W11B EVM IPOWER IDEMod MOTotalk
Remote Command	:CALCulate:<meas>:TRACe[1] 2 ...4:ACP:OFFSet:LIST:FREQuency <freq>, ... :CALCulate:<meas>:TRACe[1] 2 ...4:ACP:OFFSet:LIST:FREQuency? :CALCulate:<meas>:TRACe[1] 2 ...4:ACP:OFFSet:LIST:STATe OFF ON 0 1, ... :CALCulate:<meas>:TRACe[1] 2 ...4:ACP:OFFSet:LIST:STATe?
Example	CALC:VECT:TRAC1:ACP:OFFS:LIST:FREQ 1 MHZ, 1 MHZ, 500 KHZ, 500 KHZ, 1 MHZ CALC:VECT:TRAC1:ACP:OFFS:LIST:FREQ? :CALC:VECT:TRAC1:ACP:OFFS:LIST:STAT ON, OFF, OFF, ON, OFF
Notes	If you send fewer than 5 frequencies in the parameter list, then the remaining offsets frequencies are set to 0. You can send a single on/off parameter or a comma-separated list of up to 5 parameters. These enable/disable each of the Offsets in sequence. Any remaining Offsets are disabled
Preset	3000000,0,0,0,0 1,0,0,0,0
State Saved	Saved in instrument state.
Min	-9.9E+37
Max	9.9E+37
Initial S/W Revision	Prior to A.02.00
Modified at S/W Revision	A.02.00

Offset Meas Noise BW

Enables you to set the measurement noise bandwidth for the power measurement of a selected offset band.

Key Path	Trace/Detector, ACP, Offsets, Offset A B C D E
Mode	VSA, LTE, LTETDD, IDEN
Measurement	<meas>:=VECTor ADEMod DDEMod W11A W11B EVM IPOWER IDEMod MOTotalk
Remote Command	:CALCulate:<meas>:TRACe[1] 2 ...4:ACP:OFFSet:LIST:BANDwidth BWIDth:INTegration <bandwidth>, ... :CALCulate:<meas>:TRACe[1] 2 ...4:ACP:OFFSet:LIST:BANDwidth BWIDth:INTegration?
Example	CALC:VECT:TRAC1:ACP:OFFS:LIST:BAND:INT 1 MHZ, 2 MHZ, 3 MHZ, 4 MHZ, 5 MHZ CALC:VECT:TRAC1:ACP:OFFS:LIST:BAND:INT?

Notes	If you send fewer than 5 bandwidth parameters in the list, then Measurement Noise Bandwidths for the remaining Offsets are set to 0.
Preset	1000000,0,0,0,0
State Saved	Saved in instrument state.
Min	-9.9e37
Max	9.9e37
Initial S/W Revision	Prior to A.02.00
Modified at S/W Revision	A.02.00

Offset Filter Alpha

Enables you to adjust the alpha of the RRC filter for the power measurement of the selected offset band.

Key Path	Trace/Detector, ACP, Offsets, Offset A B C D E
Mode	VSA, LTE, LTETDD, IDEN
Measurement	<meas>:=VECTor ADEMod DDEMod W11A W11B EVM IPOWER IDEMod MOTotalk
Remote Command	:CALCulate:<meas>:TRACe[1] 2 ...4:ACPpower:OFFSet:LIST:FILTer:RRC:ALPHA <real>, ... :CALCulate:<meas>:TRACe[1] 2 ...4:ACPpower:OFFSet:LIST:FILTer:RRC:ALPHA?
Example	CALC:VECT:TRAC1:ACP:OFFS:LIST:FILT:RRC:ALPH 0.22, 0.22, 0.22, 0.22, 0.22 CALC:VECT:TRAC1:ACP:OFFS:LIST:FILT:RRC:ALPH?
Notes	You can send a single Filter Alpha for Offset A or a comma-separated list of up to 5 Filter Alpha parameters. These are assigned in sequence to the Offsets. Alpha for any remaining Offsets are set to 0.
Preset	0.35,0.35,0.35,0.35,0.35
State Saved	Saved in instrument state.
Min	0
Max	1.0
Initial S/W Revision	Prior to A.02.00
Modified at S/W Revision	A.02.00

Offset Relative Limit

Enables you to turn on/off a relative limit test and set the limit for the selected offset. The test shows a failure if the power in either the upper or lower band at the selected offset exceeds the reference power plus the relative test limit. For example, if the test limit is -60, the reference power is -4.5 dBm, a test failure would be shown if the power in the lower or upper band exceeds -64.5 dBm.

Key Path	Trace/Detector, ACP, Offsets
Mode	VSA, LTE, LTETDD, IDEN

Measurement	<meas>:=VECTor ADEMod DDEMod W11A W11B EVM IPOWER IDEMod MOTotalk
Remote Command	:CALCulate:<meas>:TRACe[1] 2 ...4:ACP:OFFSet:LIST:RCARrier <reall>,... :CALCulate:<meas>:TRACe[1] 2 ...4:ACP:OFFSet:LIST:RCARrier? :CALCulate:<meas>:TRACe[1] 2 ...4:ACP:OFFSet:LIST:RCARrier:TEST OFF ON 0 1,... :CALCulate:<meas>:TRACe[1] 2 ...4:ACP:OFFSet:LIST:RCARrier:TEST?
Example	CALC:VECT:TRAC1:ACP:OFFS:LIST:RCAR -50, -55, -60, -65, -80 CALC:VECT:TRAC1:ACP:OFFS:LIST:RCAR? CALC:VECT:TRAC1:ACP:OFFS:LIST:RCAR:TEST 1, 1, 1, 1, 1 CALC:VECT:TRAC1:ACP:OFFS:LIST:RCAR:TEST?
Notes	You can send a single Limit for Offset A or a comma-separated list of up to 5 limit parameters. These are assigned in sequence to the Offset frequencies with the remaining limits being set to 0. You can send a single on/off parameter or a comma-separated list of up to 5 parameters. These turn the Limit Test on or off for each of the Offsets in sequence. For any remaining Offsets, the Limit test is turned off.
Preset	-120,-120,-120,-120,-120 0,0,0,0,0
State Saved	Saved in instrument state.
Min	50
Max	-200
Initial S/W Revision	Prior to A.02.00
Modified at S/W Revision	A.02.00

RRC Weighting (All Offsets)

Turns on or off RRC weighting for the power measurement for all offsets. If RRC weighting is turned on, but you want to exclude RRC weighting for a particular offset, set its filter alpha to 0.

Key Path	Trace/Detector,ACP,Offsets
Mode	VSA, LTE, LTETDD, IDEN
Measurement	<meas>:=VECTor ADEMod DDEMod W11A W11B EVM IPOWER IDEMod MOTotalk
Remote Command	:CALCulate:<meas>:TRACe[1] 2 ...4:ACP:OFFSet:FILTer:RRC:STATe OFF ON 0 1 :CALCulate:<meas>:TRACe[1] 2 ...4:ACP:OFFSet:FILTer:RRC:STATe?
Example	CALC:VECT:TRAC1:ACP:OFFS:FILT:RRC:STAT ON CALC:VECT:TRAC1:ACP:OFFS:FILT:RRC:STAT?
Preset	0
State Saved	Saved in instrument state.
Initial S/W Revision	Prior to A.02.00
Modified at S/W Revision	A.02.00

OBW Setup (Occupied Bandwidth)

Accesses a menu of functions that enable you to define and turn on the OBW function on the selected trace.

The occupied bandwidth (OBW) function finds and displays the band of frequencies that contain a specified percentage of the total power within the measurement span.

An OBW measurement can be defined for each trace, although it is only active on frequency-domain trace data. The band defined by the OBW measurement is shown as a blue bar overlaying the trace display. To see tabular data showing the frequencies of the band limits, the total power, and so on, you can assign the OBW Summary (Trace n) to a different trace. For example, you can assign Spectrum data to trace 3, turn on OBW on trace 3, and assign the OBW Summary (Trace 3) to trace 4, as shown below.

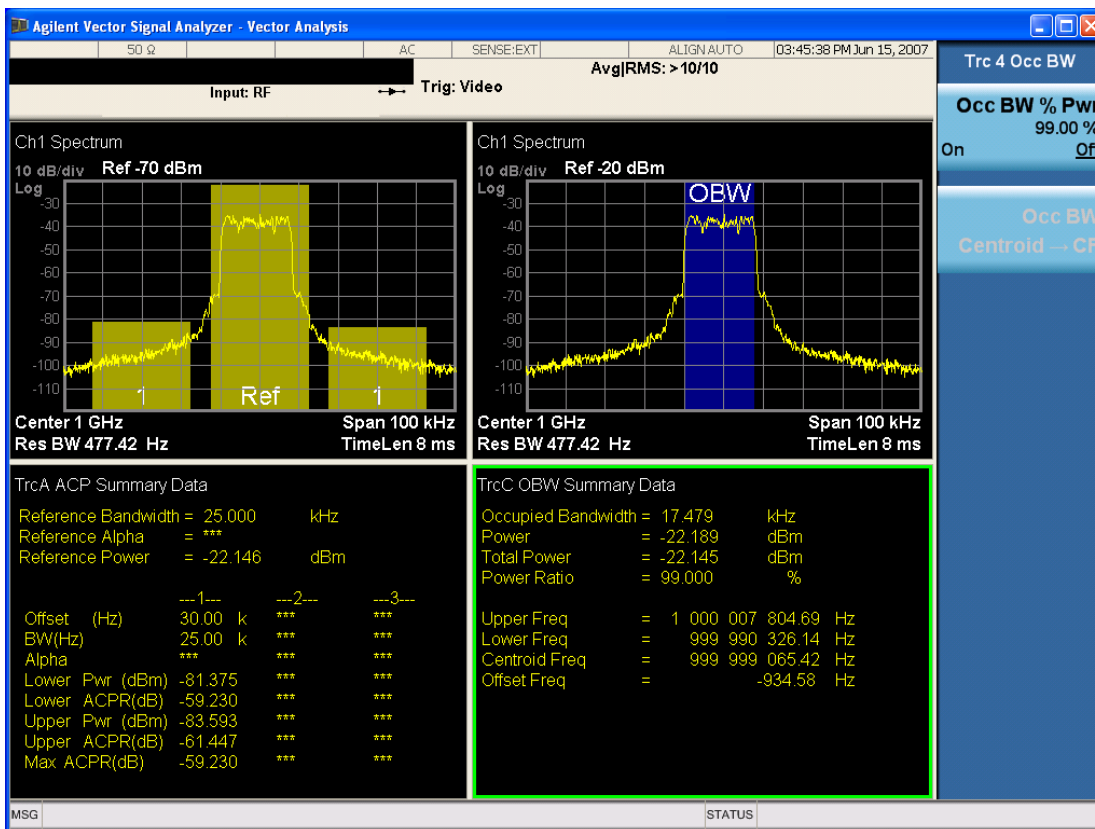

The summary data can be retrieved programmatically using FETCH? or the CALCulate:<meas>:DATA:TABLE commands. See "[CALCulate:DATA:TABLE commands](#)" on page 1291 for more details.

Key Path	Trace/Detector
Mode	VSA, LTE, LTETDD, IDEN
Readback Text	[On Off, <num>%]
Initial S/W Revision	Prior to A.02.00
Modified at S/W Revision	A.02.00

OBW Power

Specifies the percentage of power for determining the occupied BW, and turns the OBW function on or off for the selected trace.

Key Path	Trace/Detector, OBW
Mode	VSA, LTE, LTETDD, IDEN
Measurement	<meas>:=VECTor ADEMod DDEMod W11A W11B EVM IPOWER IDEMod MOTotalk
Remote Command	:CALCulate:<meas>:TRACe[1] 2 ...4:OBWidth:PERCent <real> :CALCulate:<meas>:TRACe[1] 2 ...4:OBWidth:PERCent? :CALCulate:<meas>:TRACe[1] 2 ...4:OBWidth:STATE OFF ON 0 1 :CALCulate:<meas>:TRACe[1] 2 ...4:OBWidth:STATE?
Example	CALC:VECT:TRAC1:OBW:PERC 99 CALC:VECT:TRAC1:OBW:PERC? CALC:VECT:TRAC1:OBW:STAT ON CALC:VECT:TRAC1:OBW:STAT?
Notes	Parameter is interpreted as a percent, e.g., if you want the OBW to be 95% send 95, not 0.95
Preset	99.0 0
State Saved	Saved in instrument state.
Min	0
Max	100
Initial S/W Revision	Prior to A.02.00
Modified at S/W Revision	A.02.00

OBW Centroid > CF

Copies the centroid of the occupied bandwidth to the Center Frequency. It only works if the currently selected trace has data compatible with the OBW function and OBW is turned on.

This is a front-panel function only.

You can read the OBW centroid using the following SCPI-only query and use the result to set the center frequency.

Mode	VSA, LTE, LTETDD, IDEN
Measurement	<meas>:=VECTor ADEMod DDEMod W11A W11B EVM IPOWER IDEMod MOTotalk
Remote Command	:CALCulate:<meas>:TRACe[1] 2 ...4:OBWidth:CENTroid?
Example	CALC:VECT:TRAC1:OBW:CENT?
Notes	Query only. Returns NaN (9.91E+37) if the OBW function is not active for the selected trace or is not supported for the trace data assigned to the selected trace.

Initial S/W Revision	Prior to A.02.00
Modified at S/W Revision	A.02.00

BW Limit

Turns on or off limit testing for the Occupied BW test for the selected trace, and enables you to define the limit. Test pass or fail status appears in the OBW Summary table associated with the trace.

Key Path	Trace/Detector, OBW
Mode	VSA, LTE, LTETDD, IDEN
Measurement	<meas>:=VECTor ADEMod DDEMod W11A W11B EVM IPOWER IDEMod MOTotalk
Remote Command	:CALCulate:<meas>:TRACe[1] 2 ...4:OBWidth:LIMit:FBLimit <freq> :CALCulate:<meas>:TRACe[1] 2 ...4:OBWidth:LIMit:FBLimit? :CALCulate:<meas>:TRACe[1] 2 ...4:OBWidth:LIMit[:TEST] OFF ON 0 1 :CALCulate:<meas>:TRACe[1] 2 ...4:OBWidth:LIMit[:TEST]?
Example	CALC:VECT:TRAC1:OBW:LIMIT:FBL 10 MHZ CALC:VECT:TRAC1:OBW:LIMIT:FBL? CALC:VECT:TRAC1:OBW:LIMIT:TEST ON CALC:VECT:TRAC1:OBW:LIMIT:TEST?
Preset	1000000 0
State Saved	Saved in instrument state.
Min	1 Hz
Max	9.9e37 (Infinity) Hz
Initial S/W Revision	Prior to A.02.00
Modified at S/W Revision	A.02.00

Trace Indicator Info

Enables you to get more information about why a trace indicator is showing. A trace indicator appears in the upper right corner of a trace display to announce exceptional conditions. When such an indicator is showing on the selected trace, pressing this key causes more information about the condition to appear in the message area. This is a front-panel only function. The SCPI commands for querying the Trace Indicator and the Trace Indicator Info for a particular trace are:

CALC:<meas>:DATA[1]]2|3|4:HEAD:STR? "TrcLedStr"

CALC:<meas>:DATA[1]]2|3|4:HEAD:STR? "TrcLedReason"

Key Path	Trace/Detector
Mode	VSA, LTE, LTETDD, IDEN

12 MotoTalk Measurement
Trace/Detector

Initial S/W Revision	Prior to A.02.00
Modified at S/W Revision	A.02.00

Trigger

See ["Trigger"](#) on page 310

Free Run

See ["Free Run"](#) on page 310

Video

See ["Video \(IF Envelope\)"](#) on page 310

Trigger Level

See ["Trigger Level"](#) on page 311

Trig Slope

See ["Trig Slope"](#) on page 311

Trig Delay

See ["Trig Delay"](#) on page 312

Trig Holdoff

See ["Trig Holdoff"](#) on page 312

Holdoff Type

See ["Holdoff Type"](#) on page 313

External 1

See ["External 1"](#) on page 314

Trigger Level

See ["Trigger Level"](#) on page 314

Trig Slope

See ["Trig Slope"](#) on page 315

Trig Delay

See ["Trig Delay"](#) on page 315

Trig Holdoff

See ["Trig Holdoff"](#) on page 316

Holdoff Type

See ["Holdoff Type"](#) on page 316

12 MotoTalk Measurement
Trigger

Trig Reference Line

See "Trig Reference Line" on page 317

User Preset

Accesses a menu that gives you the following three choices:

- User Preset – recalls a state previously saved using the Save User Preset function.
- User Preset All Modes – presets all of the modes in the analyzer
- Save User Preset– saves the current state for the current mode

Key Path	Front-panel key
Backwards Compatibility Notes	<p>User Preset is actually loading a state, and in legacy analyzers, it was possible to load a state without affecting the trace data, limit lines or correction data. Similarly it was possible to do a User Preset without affecting the trace data, limit lines or correction data.</p> <p>In the X-Series, “state” always includes all of this data; so whenever state is loaded, or User Preset is executed, all of the traces, limit lines and corrections are affected. Although this differs from previous behavior, it is desirable behavior, and should not cause adverse issues for users.</p> <p>On ESA and PSA, User Preset affected the entire instrument’s state. In the X-Series, User Preset only recalls the state for the active mode. There is a User Preset file for each mode. User Preset can never cause a mode switch as it can in legacy analyzers. If you want to recall all modes to their user preset file state, you will need to do a User Preset after mode switching into each mode.</p> <p>User Preset recalls mode state which can now include data like traces; whereas on ESA and PSA, User Preset did not affect data.</p>
Initial S/W Revision	Prior to A.02.00

User Preset

User Preset sets the state of the currently active mode back to the state that was previously saved for this mode using the Save User Preset menu key or the SCPI command, SYST:PRES:USER:SAV. It not only recalls the Mode Preset settings, but it also recalls all of the mode persistent settings, and the Input/Output system setting that existed at the time Save User Preset was executed.

If a Save User Preset has not been done at any time, User Preset recalls the default user preset file for the currently active mode. The default user preset files are created if, at power-on, a mode detects there is no user preset file. There will never be a scenario when there is no user preset file to restore. For each mode, the default user preset state is the same state that would be saved if a Save User Preset is performed in each mode right after doing a Restore Mode Default and after a Restore Input/Output Defaults.

The User Preset function does the following:

- Aborts the currently running measurement.
- Sets the mode State to the values defined by Save User Preset.
- Makes the saved measurement for the currently running mode the active measurement.
- Brings up the saved menu for the power-on mode.
- Clears the input and output buffers.
- Sets the Status Byte to 0.

Key Path	User Preset
Remote Command	:SYSTem:PRESet:USER
Example	:SYST:PRES:USER:SAVE:SYST:PRES:USER
Notes	:SYST:PRES:USER:SAVE is used to save the current state as the user preset state. Clears all pending OPC bits. The Status Byte is set to 0. Pressing the User Preset front-panel key while already in the User Preset menu will cause the User Preset to get executed
Couplings	A user preset will cause the currently running measurement to be aborted and cause the saved measurement to be active. Recalling a User Preset file has the same issues that recalling a Save State file has. Some settings may need to be limited and therefore re-coupled, since the capabilities of the mode may have changes when the User Preset file was last saved.
Initial S/W Revision	Prior to A.02.00

User Preset All Modes

Recalls all of the User Preset files for each mode, switches to the power-on mode, and activates the saved measurement from the power-on mode User Preset file.

NOTE

When the instrument is secured, all of the user preset files are converted back to their default user preset files.

The User Preset function does the following:

- Aborts the currently running measurement.
- Switches the Mode to the power-on mode.
- Restores the User Preset files for each mode.
- Makes the saved measurement for the power-on mode the active measurement.
- Brings up the saved menu for the power-on mode.
- Clears the input and output buffers.
- Sets the Status Byte to 0.

Key Path	User Preset
Remote Command	:SYSTem:PRESet:USER:ALL
Example	:SYST:PRES:USER:SAVE:SYST:PRES:USER:ALL
Notes	Clears all pending OPC bits. The Status Byte is set to 0. :SYST:PRES:USER:SAVE is used to save the current state as the user preset state.
Couplings	A user preset will cause the currently running measurement to be aborted, cause a mode switch to the power-on mode, and cause the saved measurement to be active in the power-on mode. Recalling a User Preset file has the same issues that recalling a Save State file has. Some settings may need to be limited and therefore re-coupled, since the capabilities of the mode may have changes when the User Preset file was last saved.
Initial S/W Revision	Prior to A.02.00

Save User Preset

Saves the currently active mode and its State. You can recall this User Preset file by pressing the User Preset menu key or sending the SYST:PRES:USER remote command. This same state is also saved by the Save State function.

Key Path	User Preset
Remote Command	:SYSTem:PRESet:USER:SAVE
Example	:SYST:PRES:USER:SAVE
Notes	:SYST:PRES:SAVE creates the same file as if the user requested a *SAV or a MMEM:STOR:STAT, except User Preset Save does not allow the user to specify the filename or the location of the file.
Initial S/W Revision	Prior to A.02.00

View/Display

The view setup can be changed by selections from the View/Display menu, or by pressing Test Preset, or by individually selecting traces and layout. The user may change the number of windows in the layout, or the contents of those windows.

Pressing the Preset View softkey will change the layout and view to the Preset View parameters unique to this measurement. This Preset View is an action, not a state.

Key Path	Front-panel key
Mode	IDEN
Initial S/W Revision	A.02.00

Display

The Display menu is common to most measurements, and is used for configuring items on the display. Some Display menu settings apply to all the measurements in a mode, and some only to the current measurement. Those under the System Display Settings key apply to all measurements in all modes.

Key Path	Display
Key Path	View/Display
Initial S/W Revision	Prior to A.02.00

Annotation

Turns on and off various parts of the display annotation. The annotation is divided up into four categories:

1. Meas Bar: This is the measurement bar at the top of the screen. It does not include the settings panel or the Active Function. Turning off the Meas Bar turns off the settings panel and the Active Function. When the Meas Bar is off, the graticule area expands to fill the area formerly occupied by the Meas Bar.
2. Screen Annotation: this is the annotation and annunciation around the graticule, including any annotation on lines (such as the display line, the threshold line, etc.) This does NOT include the marker number or the N dB result. When off, the graticule expands to fill the entire graticule area.
3. Trace annotation: these are the labels on the traces, showing their detector (or their math mode).
4. Active Function annotation: this is the active function display in the meas bar, and all of the active function values displayed on softkeys.

See the figure below. Each type of annotation can be turned on and off individually.

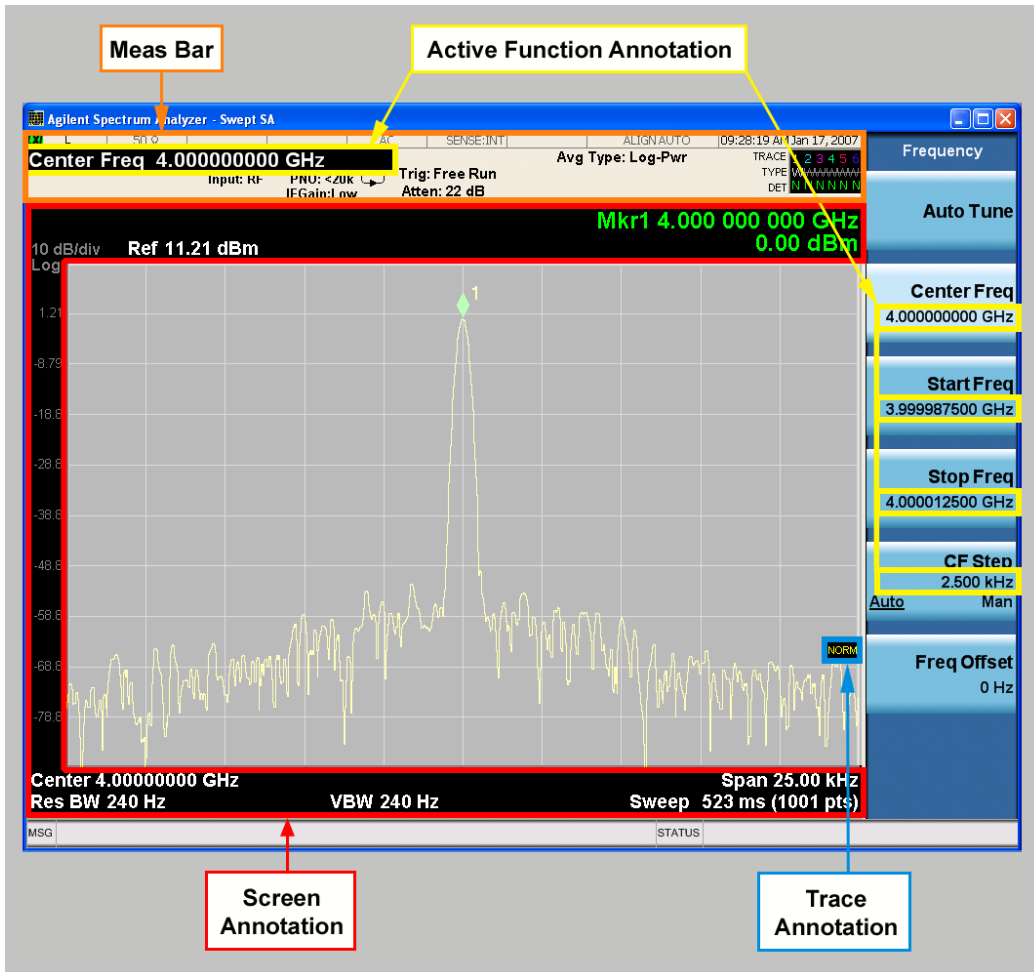

Key Path	View/Display, Display
Initial S/W Revision	Prior to A.02.00

Meas Bar On/Off

This function turns the Measurement Bar on and off, including the settings panel. When off, the graticule area expands to fill the area formerly occupied by the Measurement Bar.

Key Path	View/Display, Display, Annotation
Remote Command	:DISPlay:ANNotation:MBAR[:STATE] OFF ON 0 1 :DISPlay:ANNotation:MBAR[:STATE]?
Example	DISP:ANN:MBAR OFF
Dependencies	Grayed out and forced to OFF when System Display Settings, Annotation is set to Off.
Preset	On This should remain Off through a Preset when System DisplaySettings, Annotation is set to Off.
State Saved	Saved in instrument state.
Initial S/W Revision	Prior to A.02.00

Screen

This controls the display of the annunciation and annotation around the graticule, including any annotation on lines (such as the display line, the threshold line, etc.) and the y-axis annotation. This does NOT include marker annotation (or the N dB result). When off, the graticule expands to fill the entire graticule area, leaving only the 1.5% gap above the graticule as described in the Trace/Detector chapter.

Key Path	View/Display, Display, Annotation
Remote Command	:DISPlay:ANNotation:SCReen[:STATe] OFF ON 0 1 :DISPlay:ANNotation:SCReen[:STATe]?
Example	DISP:ANN:SCR OFF
Dependencies	Grayed-out and forced to OFF when System Display Settings, Annotation is set to Off.
Preset	On This should remain Off through a Preset when System DisplaySettings, Annotation is set to Off
State Saved	Saved in instrument state.
Initial S/W Revision	Prior to A.02.00

Active Function Values On/Off

Turns on and off the active function display in the Meas Bar, and all of the active function values displayed on the softkeys.

Note that all of the softkeys that have active functions have these numeric values blanked when this function is on. This is a security feature..

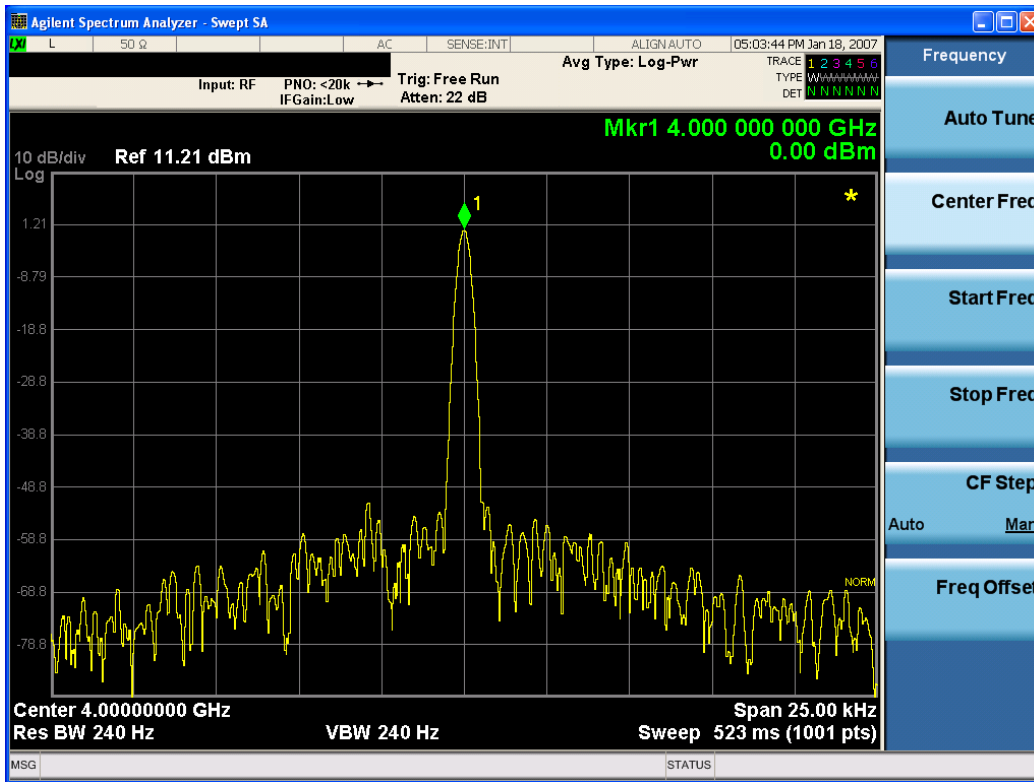

Key Path	View/Display, Display, Annotation
Remote Command	:DISPlay:ACTivefunc[:STATE] ON OFF 1 0 :DISPlay:ACTivefunc[:STATE]?
Example	DISP:ACT OFF
Dependencies	Grayed out and forced to OFF when System Display Settings, Annotation is set to Off.
Preset	On This should remain Off through a Preset when System DisplaySettings, Annotation is set to Off
State Saved	Saved in instrument state.
Initial S/W Revision	Prior to A.02.00

Title

Displays menu keys that enable you to change or clear a title on your display.

Key Path	View/Display, Display
Initial S/W Revision	Prior to A.02.00

Change Title

Writes a title into the "measurement name" field in the banner, for example, "Swept SA".

Press Change Title to enter a new title through the alpha editor. Press Enter or Return to complete the entry. Press ESC to cancel the entry and preserve your existing title.

The display title will replace the measurement name. It remains for this measurement until you press Change Title again, or you recall a state, or a Preset is performed. A title can also be cleared by pressing Title, Clear Title.

NOTE

Notice the inclusion of the <measurement> parameter in the command below. Because each measurement remembers the Display Title, the command must be qualified with the measurement name. For the Swept SA measurement this is not the case; no <measurement> parameter is used when changing the Display Title for the Swept SA measurement.

Key Path	View/Display, Display, Title
Mode	All
Remote Command	:DISPlay:<measurement>:ANNotation:TITLe:DATA <string> :DISPlay:<measurement>:ANNotation:TITLe:DATA?
Example	DISP:ANN:TITL:DATA "This Is My Title" This example is for the Swept SA measurement in the Spectrum Analyzer mode. The SANalyzer <measurement> name is not used. DISP:ACP:ANN:TITL:DATA "This Is My Title" This example is for Measurements other than Swept SA. Both set the title to: This Is My Title
Notes	Pressing this key cancels any active function. When a title is edited the previous title remains intact (it is not cleared) and the cursor goes at the end so that characters can be added or BKSP can be used to go back over previous characters.
Preset	No title (measurement name instead)
State Saved	Saved in instrument state.
Initial S/W Revision	Prior to A.02.00

Clear Title

Clears a title from the front-panel display. Once cleared, the title cannot be retrieved. After the title is cleared, the current Measurement Name replaces it in the title bar.

Key Path	View/Display, Display, Title
Example	The following commands clear the title and restore the measurement's original title: DISP:ANN:TITL:DATA "" This example is for the Swept SA measurement in the Spectrum Analyzer mode. The SANalyzer <measurement> name is not used. DISP:ACP:ANN:TITL:DATA "" This example is for ACP; in measurements other than Swept SA the measurement name is required.
Notes	Uses the :DISPlay:<measurement>:ANNotation:TITLe:DATA <string> command with an empty string (in the Swept SA, the <measurement> is omitted).
Preset	Performed on Preset.
Initial S/W Revision	Prior to A.02.00

Graticule

Pressing Graticule turns the display graticule On or Off. It also turns the graticule y-axis annotation on and off.

Key Path	View/Display, Display
Remote Command	:DISPlay:WINDow[1]:TRACe:GRATicule:GRID[:STATe] OFF ON 0 1 :DISPlay:WINDow[1]:TRACe:GRATicule:GRID[:STATe]?
Example	DISP:WIND:TRAC:GRAT:GRID OFF
Notes	The graticule is the set of horizontal and vertical lines that make up the grid/divisions for the x-axis and y-axis.
Preset	On
State Saved	Saved in instrument state
Initial S/W Revision	Prior to A.02.00

System Display Settings

These settings are "Mode Global" – they affect all modes and measurements and are reset only by Restore Misc Defaults or Restore System Defaults under System.

Key Path	View/Display, Display
Initial S/W Revision	Prior to A.02.00

Annotation Local Settings

This is a Mode Global override of the meas local annotation settings. When it is All Off, it forces ScreenAnnotation, Meas Bar, Trace, and Active Function Values settings to be OFF for all measurements in all modes. This provides the security based "annotation off" function of previous analyzers; hence it uses the legacy SCPI command.

When it is All Off, the Screen, Meas Bar, Trace, and Active Function Values keys under the Display, Annotation menu are grayed out and forced to Off. When Local Settings is selected, you are able to set the local annotation settings on a measurement by measurement basis.

Key Path	View/Display, Display, System Display Settings
Remote Command	:DISPlay:WINDow[1]:ANNotation[:ALL] OFF ON 0 1 :DISPlay:WINDow[1]:ANNotation[:ALL]?
Example	:DISP:WIND:ANN OFF
Preset	On (Set by Restore Misc Defaults)
State Saved	Not saved in instrument state.
Backwards Compatibility Notes	The WINDow parameter and optional subopcode is included for backwards compatibility but ignored – all windows are equally affected.
Initial S/W Revision	Prior to A.02.00

Themes

Accesses a menu of functions that enable you to choose the theme to be used when saving the screen image.

The **Themes** option is the same as the **Themes** option under the **Display** and **Page Setup** dialogs. It allows you to choose between themes to be used when saving the screen image.

Key Path	Save, Screen Image
Remote Command	:MMEMory:STORe:SCReem:THEMe TDColor TDMonochrome FCOLor FMONochrome :MMEMory:STORe:SCReem:THEMe?
Example	:MMEM:STOR:SCR:THEM TDM
Preset	3D Color; Is not part of Preset, but is reset by Restore Misc Defaults or Restore System Defaults All and survives subsequent running of the modes.
Readback	3D Color 3D Mono Flat Color Flat Mono
Backwards Compatibility Notes	In ESA and PSA we offer the choice of "Reverse Bitmap" or "Reverse Metafile" when saving screen images. This is much like the "Flat Color" theme available in X-Series. Also, if you selected Reverse Bitmap AND a black & white screen image, that would be much like "Flat Monochrome". In other words, each of the X-Series themes has a similar screen image type in ESA/PSA. But they are not identical.
Initial S/W Revision	Prior to A.02.00

3D Color

Selects a standard color theme with each object filled, shaded and colored as designed.

Key Path	Save, Screen Image, Themes
Example	MMEM:STOR:SCR:THEM TDC
Readback	3D Color
Initial S/W Revision	Prior to A.02.00

3D Monochrome

Selects a format that is like 3D color but shades of gray are used instead of colors.

Key Path	Save, Screen Image, Themes
Example	MMEM:STOR:SCR:THEM TDM
Readback	3D Mono
Initial S/W Revision	Prior to A.02.00

Flat Color

Selects a format that is best when the screen is to be printed on an ink printer.

Key Path	Save, Screen Image, Themes
Example	MMEM:STOR:SCR:THEM FCOL
Readback	Flat Color
Initial S/W Revision	Prior to A.02.00

Flat Monochrome

Selects a format that is like Flat Color. But only black is used (no colors, not even gray), and no fill.

Key Path	Save, Screen Image, Themes
Example	MMEM:STOR:SCR:THEM FMON
Readback	Flat Mono
Initial S/W Revision	Prior to A.02.00

Backlight

Accesses the display backlight on/off keys. This setting may interact with settings under the Windows "Power" menu.

When the backlight is off, pressing ESC, TAB, SPACE, ENTER, UP, DOWN, LEFT, RIGHT, DEL, BKSP, CTRL, or ALT turns the backlight on without affecting the application. Pressing any other key will turn backlight on and could potentially perform the action as well.

Key Path	View/Display, Display, System Display Settings
Remote Command	:DISPlay:BACKlight ON OFF :DISPlay:BACKlight?
Preset	ON (Set by Restore Misc Defaults)
Initial S/W Revision	Prior to A.02.00

Backlight Intensity

An active function used to set the backlight intensity. It goes from 0 to 100 where 100 is full on and 0 is off. This value is independent of the values set under the Backlight on/off key.

Key Path	View/Display, Display, System Display Settings
Remote Command	:DISPlay:BACKlight:INTensity <integer> :DISPlay:BACKlight:INTensity?
Example	DISP:BACK:INT 50

Preset	100 (Set by Restore Misc Defaults)
Min	0
Max	100
Initial S/W Revision	Prior to A.02.00

Layout

Enables you to choose the number and position of windows on the screen. Each window contains one trace. The selected trace is always visible and its window outlined in green. The Window zoom key toggles between multiple windows and a single window mode without changing the setting for Layout.

Single layout has one window.

Stack 2 layout has two windows, one on top of the other, that display either traces 1 (top) and 2 (bottom) or traces 3 and 4. The pair that is showing always includes the selected trace.

Stack 3 layout has three windows that display, top to bottom, traces 1, 2, 3 or traces 2, 3, 4.

Grid 2x2 layout has 4 windows, arranged 2x2. They display (in order top to bottom, left to right) traces 1, 2, 3, and 4.

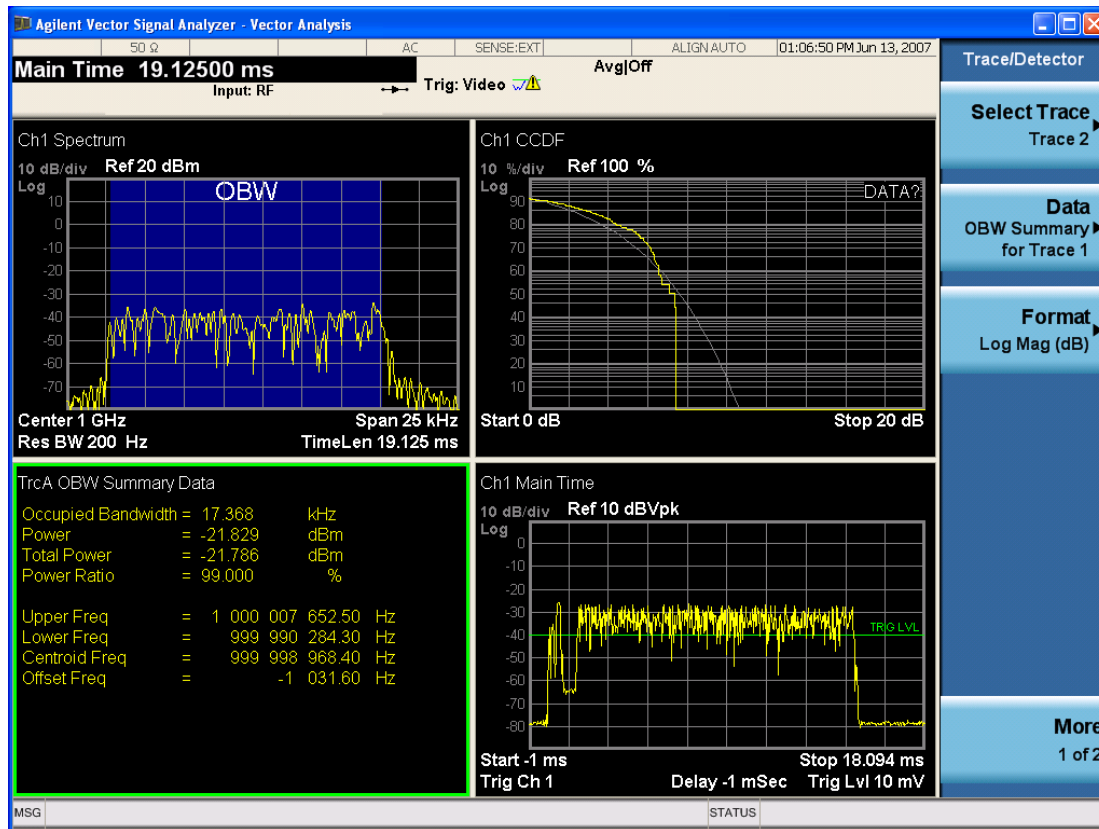

Grid 2x2 layout with Trace 2 selected

There are two other layouts that are available for iDEN Power, iDEN Demod, and MOTOTalk measurements since these enable 6 traces.

Grid 2x3 layout has 2 rows of 3 windows that display all 6 traces in order, top to bottom, then left to right.

Grid 3x2 layout has 3 rows of 2 windows that display all 6 traces in order, top to bottom, then left to right.

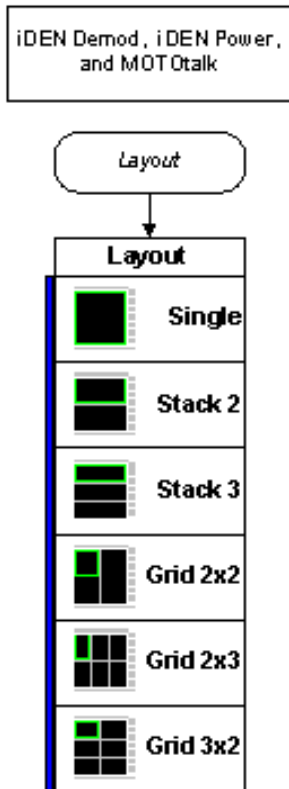

Key Path	View/Display
Mode	VSA, LTE, LTETDD, IDEN, LTEAFDD, LTEATDD
Measurement	<meas>:=VECTor ADEMod DDEMod W11A W11B EVM IPOWER IDEMod MOTotalk
Remote Command	:DISPlay:<meas>:WINDow:FORMat SINGLE TWO TRI QUAD :DISPlay:<meas>:WINDow:FORMat? For iDEN Power, iDEN Demod and MotoTalk measurements: :DISPlay:<meas>:WINDow:FORMat SINGLE TWO TRI QUAD GR2X3 GR3X2 :DISPlay:<meas>:WINDow:FORMat?
Example	DISP:VECT:WIND:FORM TWO DISP:IPOW:WIND:FORM GR2X3 DISP:VECT:WIND:FORM?
Couplings	If the window is currently zoomed, selecting a layout (even the current one) switches it to tiled mode.
Preset	TWO QUAD QUAD QUAD QUAD QUAD QUAD QUAD GR2X3 TRI

State Saved	Saved in instrument state.
Range	Single Stack 2 Stack 3 Grid 2x2 Grid 2x2 Grid 2x3 Stack 3
Initial S/W Revision	Prior to A.02.00
Modified at S/W Revision	A.02.00

Preset View: Test Standard

Preset the display layout to pre-defined patterns.

Key Path	View/Display
Mode	IDEN
Remote Command	:DISPlay:MOTotalk:VIEW:PRESet TSTD SLOT
Example	:DISP:MOT:VIEW:PRES TSTD
Notes	Command Only. TSTD: Test Standard SLOT: Slot
Couplings	This action is performed as part of Test Preset
Initial S/W Revision	A.02.00

Preset View: Slot

Preset the display layout to pre-defined patterns.

Key Path	View/Display
Mode	IDEN
Example	:DISP:MOT:VIEW:PRES SLOT
Initial S/W Revision	A.02.00

Measurement Views

- Preset View: Test Standard

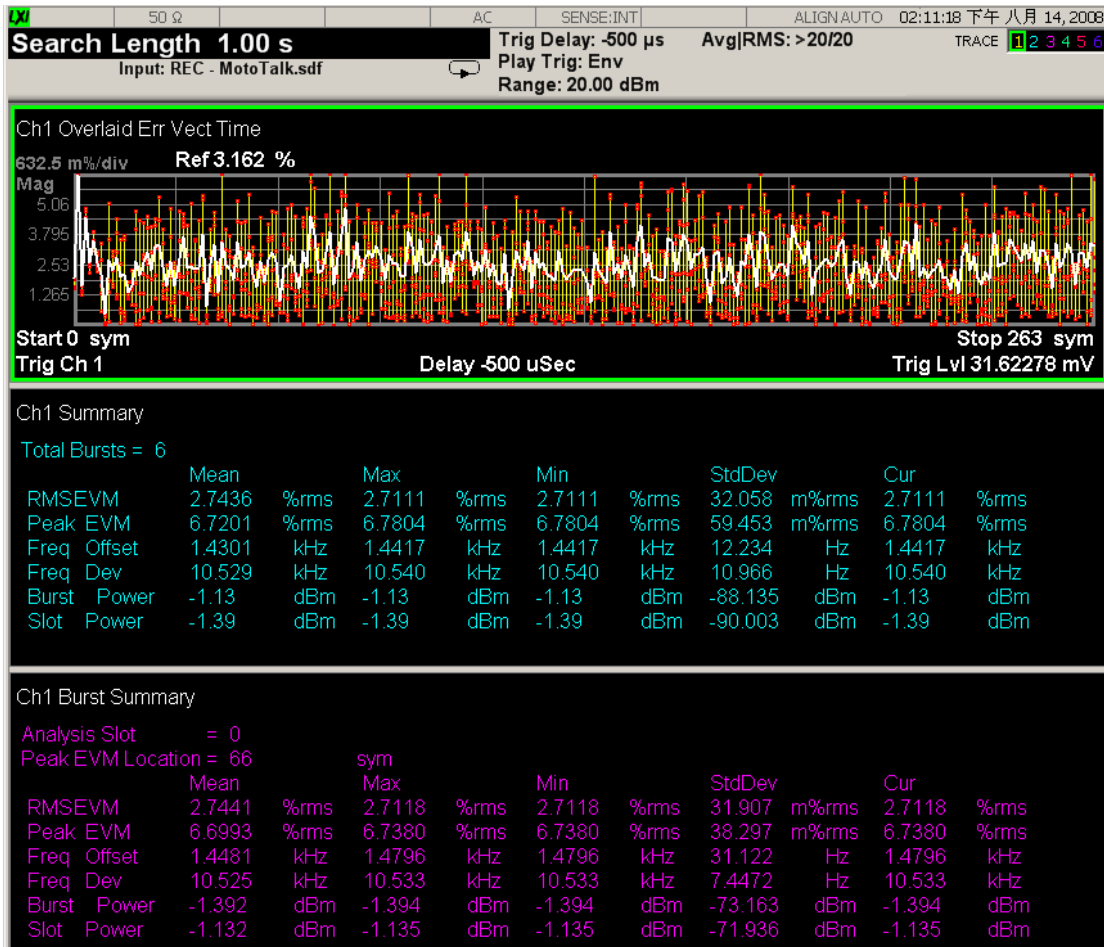

The Test Standard key changes the Layout to "Stack 3" with the following trace assignments and Formats:

1. Error Vector Time: Averaged trace for all of the bursts found
2. Error Summary: Averaged summary results for all of the bursts found
3. Slot Error Summary: Summary result for the burst specified by "Analysis Slot"

- Preset View: Slot

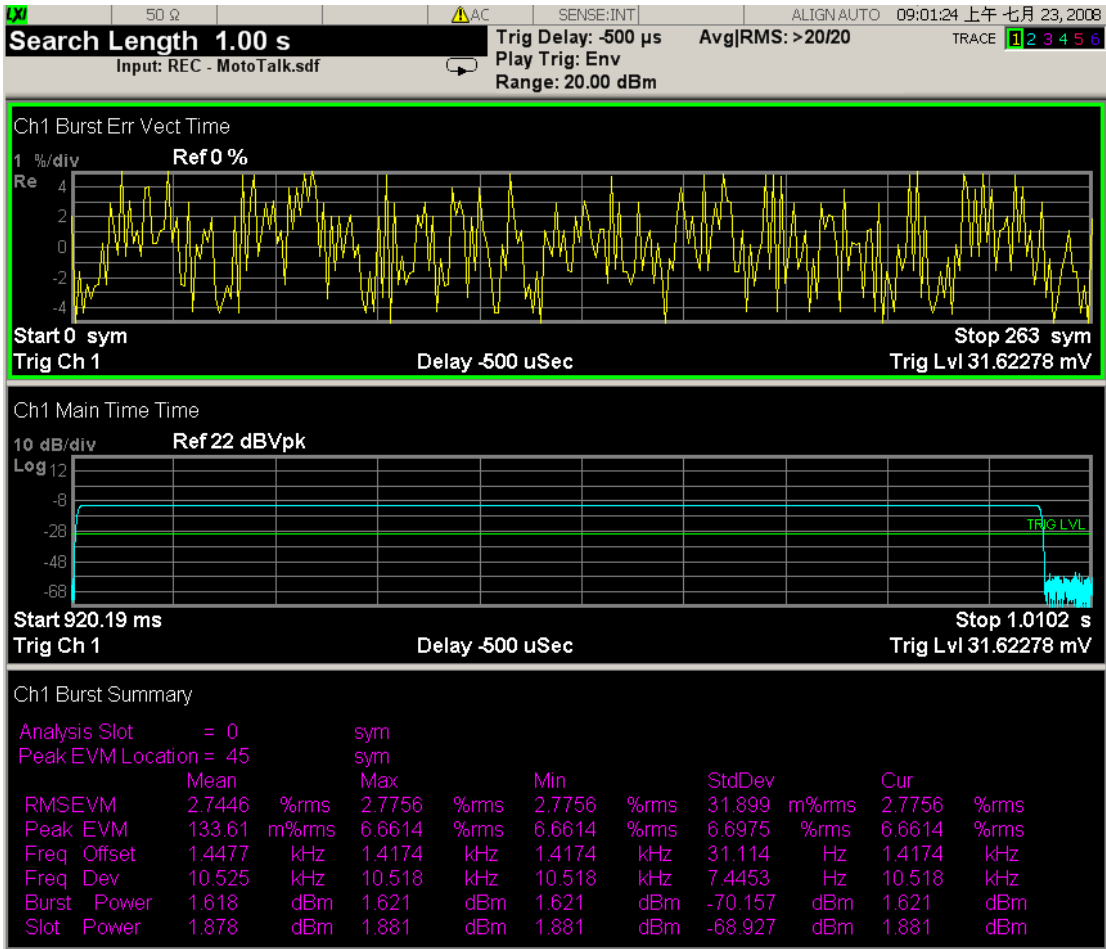

The Test Standard key changes the Layout to "Stack 3" with the following trace assignments and Formats:

1. Slot Error Vector Time: Error Vector trace for the specific burst specified by "Analysis Slot"
2. Time: The time trace of the slot specified by "Analysis Slot"
3. Slot Error Summary result for the burst specified by "Analysis Slot"

Front Panel Results

A number of results are available, that include the default displays: the Error Vector vs. Time display, the main Time display, and the scalar results shown in the Error Summary table. Other, more detailed displays are also available.

Remote SCPI Commands and Data Queries

Remote SCPI Results described in this section include:

[":READ and :FETCh Commands" on page 1285](#)

[":CALCulate:DATA" on page 1288](#)

[":CALCulate:DATA:RAW" on page 1289](#)

[":CALCulate:DATA:RAW:COMPLex" on page 1290](#)

[":CALCulate:DATA:POINTs commands" on page 1290](#)

[":CALCulate:DATA:TABL commands" on page 1291](#)

[":CALCulate:DATA:HEADer commands" on page 1295](#)

[":CALC:CLIMits:FAIL?" on page 1297](#)

["IQ Data Transfers " on page 1297](#)

VSA based Measurements produce a rich variety of results that can be displayed in any of 4 traces. A result can consist of an array of X,Y trace data that is typically shown as a graph or scalar results that are displayed as a table. The Symbol/Error result that is part of many demodulation measurements actually displays both a trace table (the error statistics) and trace data (the symbol information, which is not graphed but listed). The CALC:<meas>:DATA<n> commands enable you to retrieve any trace data or trace table. This family of commands also enable you to get information about the names of data results available and the units associated with them, as well as names and results of meta-data associated with traces.

Selected results are available via the FETCh and READ SCPI interfaces. These commands refer to data results by arbitrary index number rather than by trace number.

Key Path	SCPI Only
Mode	LTE, LTETDD, IDEN, VSA

:READ and :FETCh Commands

The SCPI MEASure, READ, and FETCh are typically offered by applications with focus on manufacturing test, where a fixed set of desired results is known in advance and seldom changes. The VSA based measurements are many, due to a focus on development. Thus, for most VSA based measurements there is no standard configuration that yields a useful measurement 90% of the time. Thus, the MEASure function is not offered for most measurements in the VSA Application. However, READ and FETCh can be implemented for select results. Note that these results are also still available using the CALC:<meas>:DATA:TABLE family of commands.

ACP and OBW are available in all VSA based measurements. To retrieve the ACP or OBW data, the function must be enabled on a frequency-domain trace and the associated summary data table must be assigned to another trace. Note however, the index n in the following commands is not trace number but an index picked out of the tables shown below.

:FETCh:<meas> [n] ?

:READ:<meas>[n]?

The results available for various values of n are shown below:

Condition	N	Results Returned
Mode = VSA LTE IDEN	Not specified or n=1	Reserved for selected results of VSA measurements. If not used for a particular measurement, no result is returned and error -114 Header suffix out of range is generated.
Mode = VSA LTE IDEN	2 - 50	Reserved for selected results of VSA measurements. If not used for a particular measurement, no result is returned and error -114 Header suffix out of range is generated.
Mode = VSA LTE IDEN, ACP on trace 1	51	ACP Summary for trace 1 Returns 28 comma-separated scalar results, corresponding to the swept ACP results where possible; n/a elsewhere: Returns 28 comma-separated scalar results, in the following order. 1. 0.0 2. Total carrier power (dBm) (same as item 4, because only 1 carrier supported) 3. 0.0 4. Reference carrier power (dBm) 5. Lower offset A - relative power (dB) 6. Lower offset A - absolute power (dBm) 7. Upper offset A - relative power (dB) 8. Upper offset A - absolute power (dBm) 9. Lower offset B - relative power (dB) 10. Lower offset B - absolute power (dBm) 11. Upper offset B - relative power (dB) 12. Upper offset B - absolute power (dBm) ... 21. Lower offset E - relative power (dB) 22. Lower offset E - absolute power (dBm) 23. Upper offset E - relative power (dB) 24. Upper offset E - absolute power (dBm) 25. n/a 26. n/a 27. n/a 28. n/a 29. Overall ACP test result summary (0 indicates at least 1 failure, 1 indicates all passed) If any result is not available, NaN (9.91 E 37) is returned. This can happen if ACP is turned off (all results unavailable) or when an offset is entirely off-screen. In the case where it is partially off-screen, the measured result is returned even though its validity is questionable.
Mode = VSA LTE IDEN, ACP on trace 2	52	ACP Summary for trace 2 see list for trace 1 summary

Mode = VSA LTE IDEN, ACP on trace 3	53	ACP Summary for trace 3 see list for trace 1 summary
Mode = VSA LTE IDEN, ACP on trace 4	54	ACP Summary for trace 4 see list for trace 1 summary
Mode = VSA LTE IDEN, ACP on trace 5	55	ACP Summary for trace 5 see list for trace 1 summary
Mode = VSA LTE IDEN, ACP on trace 6	56	ACP Summary for trace 6 see list for trace 1 summary
	57-60	no result returned; error -114, Header suffix out of range generated
Mode = VSA LTE IDEN, OBW on trace 1	61	OBW Summary for trace 1 Returns 9 comma-separated scalar results corresponding exactly to the items in the OBW Summary trace: 1. OBW (Hz) 2. Pwr (dBm) 3. Total Pwr (dBm) 4. Pwr Ratio (no unit, E.g. 0.99) 5. OBW upper freq (Hz) 6. OBW lower freq (Hz) 7. Centroid freq (Hz) 8. Offset freq (Hz) 9. OBW Test Result (0 for fail, 1 for pass) If the results are not available, NaN (9.91 E 37) is returned.
Mode = VSA LTE IDEN, OBW on trace 2	62	OBW Summary for trace 2 see list for trace 1 summary
Mode = VSA LTE IDEN, OBW on trace 3	63	OBW Summary for trace 3 see list for trace 1 summary
Mode = VSA LTE IDEN, OBW on trace 4	64	OBW Summary for trace 4 see list for trace 1 summary
Mode = VSA LTE IDEN, OBW on trace 5	65	OBW Summary for trace 5 see list for trace 1 summary
Mode = VSA LTE IDEN, OBW on trace 6	66	OBW Summary for trace 6 see list for trace 1 summary

Key Path	SCPI Only
Mode	LTE, LTETDD, IDEN, VSA

:CALCulate:DATA

Once measurement data result is assigned to a trace, the data can be retrieved by using one of the following commands (where <n> is the trace number and <meas> is the current VSA based measurement).

:CALC:<meas>:DATA<n>?

:CALC:<meas>:DATA<n>:RAW?

The first form of the command retrieves the data as formatted on the display. For example, if (in a vector measurement) you have the Spectrum result in LogMag format on trace 1, then

:CALC:VECT:DATA1?

returns an array of spectrum amplitude (Y data) in units of dBm, and

:CALC:VECT:DATA1:RAW?

returns the Y data in its underlying units of Volts (peak) squared.

(To get data from displayed tables, see "[:CALCulate:DATA:TABL commands](#)" on page 1291.)

The CALC:<meas>:DATA commands get data from traces. There are many results available from a VSA based measurement and only 4 traces in which to view them. View Preset commands are one way of displaying frequently-used results in standard trace locations. Or you can assign any measurement result to any trace using the softkeys under Trace/Detector, Data. The SCPI command for doing this is:

:DISP:<meas>:TRAC<n>:FEED "<data_name>"

For example, if (in a vector measurement) you want to view the CCDF result in trace 4, you send:

:DISP:VECT:TRAC4:FEED "CCDF1"

(If the measurement has not run yet, use INIT:IMM to run it.) Then the CCDF data can be retrieved using

CALC:VECT:DATA4?

or

CALC:VECT:DATA4:RAW?

Key Path	SCPI Only
Mode	VSA, LTE, LTETDD, IDEN
Measurement	<meas>:=VECTor ADEMod DDEMod W11A W11B EVM IPOWER IDEMod MOTotalk
Remote Command	:CALCulate:<meas>:DATA[1] 2 ...4? [Y X XY[,OFF ON 0 1] LL UL]
Example	CALC:VECT:DATA1? CALC:VECT:DATA1? Y,ON

	CALC:VECT:DATA1? X CALC:VECT:DATA1? XY
Notes	<p>Query only. This retrieves the data in the designated trace as displayed.</p> <p>For example, if Trace 1 is assigned Spectrum data and formatted as LogMag, then :CALC:VECT:DATA1? returns the Y data in dBm. If the X axis is scaled to show only a portion of the trace data, only the data shown is returned.</p> <p>The numeric format of the returned data is controlled by FORMat[:TRACe][:DATA] command</p> <p>The optional parameters control what data is returned.</p> <p>:CALC:VECT:DATA1? Y is the same as :CALC:VECT:DATA1? with no parameter. It returns an array of Y values.</p> <p>:CALC:VECT:DATA1? X returns an array of X values that correspond to the Y values above.</p> <p>:CALC:VECT:DATA1? XY returns interleaved X and Y data. That is: <x1> <y1> <x2> <y2>...</p> <p>Normally, this command only returns the data between the current X scale limits. If the optional ",OFF" or ",0" switch is included at the end of the command, then all data is returned (regardless of X scaling or the state of All Frequency Points).</p> <p>:CALC:EVM:DATA1? LL UL returns an array of Lower/Upper Limit values when Limit Test is enabled and the trace includes limit values. When Limit Test is disabled or the trace does not include limit value, this query is the same as :CALC:EVM:DATA1? with no parameter.</p> <p>Note: LL and UL are available only for the EVM measurement in the LTE/LTE TDD modes.</p> <p>Note: the X and Y parameters in this command refer to the display's horizontal and vertical axes. Normally the X axis is the independent variable, but if the display format is Constellation or IQ, then CALC:<meas>:DATA<n>? [Y] returns the imaginary part of the data and CALC:<meas>:DATA<n>? X returns the real part of the data. If you want the values of the independent variable, change to a non-vector format (such as Log Mag) and use CALC:<meas>:DATA<n>? X</p>
Initial S/W Revision	Prior to A.02.00
Modified at S/W Revision	A.02.00, A.08.00

:CALCulate:DATA:RAW

Retrieves trace data in its underlying units, before the formatting calculation that converts it to displayed units. Underlying units are typically Volts peak (for signal results) or Volts peak squared (for power results). All data points are returned, whether or not they are displayed.

Key Path	SCPI Only
Mode	VSA, LTE, LTETDD, IDEN
Measurement	<meas>:=VECTor ADEMod DDEMod W11A W11B EVM IPOWER IDEMod MOTotalk
Remote Command	:CALCulate:<meas>:DATA[1] 2 ...4:RAW?
Example	CALC:VECT:DATA1:RAW?
Notes	Query only. This retrieves the unformatted Y data in the designated trace. If Y data is complex, it is returned as <y_real1> <y_imag1> <y_real2> <y_imag2> etc.
Initial S/W Revision	Prior to A.02.00
Modified at S/W Revision	A.02.00

:CALCulate:DATA:RAW:COMPLex

Determines if the data retrieved by CALC:<meas>:DATA:RAW<n>? is complex.

Key Path	SCPI Only
Mode	VSA, LTE, LTETDD, IDEN
Measurement	<meas>:=VECTor ADEMod DDEMod W11A W11B EVM IPOWER IDEMod MOTotalk
Remote Command	:CALCulate:<meas>:DATA[1] 2 ...4:RAW:COMPLex?
Example	CALC:VECT:DATA1:RAW:COMP?
Notes	Query only. Returns 1 if the trace data is complex, 0 if it is real.
Initial S/W Revision	Prior to A.02.00
Modified at S/W Revision	A.02.00

:CALCulate:DATA:POINts commands

Returns the number of points that are returned by

CALCulate:<meas>:DATA<n>?

X axis scaling and whether All Frequency Points is on or off can affect this number.

NOTE For the CALCulate:<meas>:DATA<n>? XY command there are 2 numbers returned per data point.

Key Path	SCPI Only
Mode	VSA, LTE, LTETDD, IDEN
Measurement	<meas>:=VECTor ADEMod DDEMod W11A W11B EVM IPOWER IDEMod MOTotalk
Remote Command	:CALCulate:<meas>:DATA[1] 2 ...4:POINts? [OFF ON 0 1]
Example	CALC:VECT:DATA1:POINts?
Notes	<p>Query only.</p> <p>Use the optional "OFF 0" parameter to determine the number of points that are returned by the optional command form:</p> <p>:CALCulate:<meas>:DATA<n>? Y X XY,OFF 0</p> <p>Note that this is points, not array size. If the XY parameter is included, there are 2 numbers returned per point.</p> <p>(ON or 0, which means use the X-scaled version, is the default and the result is the same as if the parameter is omitted).</p>
Initial S/W Revision	Prior to A.02.00
Modified at S/W Revision	A.02.00

This query returns the number of points that are returned by

CALCulate:<meas>:DATA:RAW<n>?

NOTE

For complex trace data, there are 2 numbers returned per data point.

Key Path	SCPI Only
Mode	VSA, LTE, LTETDD, IDEN
Measurement	<meas>:=VECTor ADEMod DDEMod W11A W11B EVM IPOWER IDEMod MOTotalk
Remote Command	:CALCulate:<meas>:DATA[1] 2 ...4:RAW:POINTs?
Example	CALC:VECT:DATA1:RAW:POINTs?
Notes	Query only.
Initial S/W Revision	Prior to A.02.00
Modified at S/W Revision	A.02.00

:CALCulate:DATA:TABL commands

Some traces have tabular data associated with them. In fact, there may be only a table and no trace data. Each entry in the table consists of a name, a measured value, and units. The units are sometimes not shown. You can programmatically retrieve arrays of all the names, all the values, and all the units of a table. These arrays are all ordered so that corresponding indices have associated values, for example, the 4th name in the names array corresponds to the 4th value in the results array. (Note that the array order cannot be the same as the displayed order.) You can also get a particular result from the table by name. Here is a summary of the remote table data commands.

Command	Returns	Example
CALCulate:<meas>:DATA<n>:TABLe?	All table data results (as an array)	CALC:DDEM:DATA4:TABL?
CALCulate:<meas>:DATA<n>:TABLe? "<name>"	The table data result referred to by name	CALC:DDEM:DATA4:TABL? "EvmPeak"
CALCulate:<meas>:DATA<n>:TABLe:NAMes?	Comma-separated list of all table data names	CALC:DDEM:DATA4:TABL:NAM?
CALCulate:<meas>:DATA<n>:TABLe:UNIT?	Comma-separated list of all table data units	CALC:DDEM:DATA4:TABL:UNIT?

For example, if within the Vector Analysis measurement, you have an OBW Summary Table displayed in trace 2, CALC:DDEM:DATA2:TABL:NAM? would return the table names as follows:

"Obw,Pwr,TotalPwr,PwrRatio,ObwUpper,ObwLower,Centroid,Offset"

and CALC:DDEM:DATA2:TABL:UNIT? would return the units. (A null string means the result is unitless.)

"Hz,Vrms^2,Vrms^2,,Hz,HZ,HZ,HZ"

You can then get all the table results by sending

CALC:DDEM:DATA2:TABL?

Result number 1 is Obw and has units of Hz, result number 2 is Pwr with units of Vrms^2, and so on.

You can also get individual table entries by asking for them by name. Any name returned from the CALC:DDEM:DATA2:TABL:NAM? query can be used. For example, to get TotalPwr you can send the following query:

CALC:DDEM:DATA2:TABL? "TotalPwr"

Query Table Data as Number

Gets data from a table shown in the designated trace. Tables shown on the display typically have the name of a parameter followed by its measured value

Key Path	SCPI Only
Mode	VSA, LTE, LTETDD, IDEN
Measurement	<meas>:=VECTor ADEMod DDEMod W11A W11B EVM IPOWER IDEMod MOTotalk
Remote Command	:CALCulate:<meas>:DATA[1] 2 ...4:TABLe[:NUMBer]? [<string>]
Example	CALC:DDEM:DATA2:TABL? "Obw"
Notes	Query only. If sent without a string specifier, this returns the entire table for the designated trace. If sent with a string specifier, returns a specific table entry in the designated trace. The string specifier must be delimited by single or double quotes. A list of valid strings can be obtained using CALC:<meas>:DATA:TABL:NAM? If an invalid string is sent, an error is generated. The returned results are in numeric format, under control of the FORMat[:TRACe][:DATA] command. For table data that is non-numeric, NaN is returned. To get the value of these data, use the CALC:<meas>:DATA2:TABL:STR? command.
Initial S/W Revision	Prior to A.02.00
Modified at S/W Revision	A.02.00

Query Table Data as String

Some tables have string data. The above Trace Table Data query cannot return it and sends NaN in its place. Here is a form of Trace Table Data query that can return string data from tables.

Key Path	SCPI Only
Mode	VSA, LTE, LTETDD, IDEN

Measurement	<meas>:=VECTor ADEMod DDEMod W11A W11B EVM IPOWER IDEMod MOTotalk
Remote Command	:CALCulate:<meas>:DATA[1] 2 ...4:TABLE:STR? [<string>]
Example	CALC:DDEM:DATA2:TABL:STR? "Obw"
Notes	Query only. If sent without a string specifier, this returns the entire table for the designated trace in comma-separated format. If sent with a string specifier, returns a specific table entry in the designated trace. The string specifier must be delimited by single or double quotes. A list of valid strings can be obtained using CALC:<meas>:DATA:TABL:NAM? If an invalid string is sent, an error is generated.
Initial S/W Revision	Prior to A.02.00
Modified at S/W Revision	A.02.00

Query Table Names

Returns a comma-separated list of names of the table data entries for the designated trace. Each of the names can be used (surrounded by quotes or double quotes) as a parameter in the Trace Table Data commands. The names appear in the same order as the corresponding data values returned by the CALC:<meas>:DATA<n>:TABL[:NUMB|STR]? query.

Key Path	SCPI Only
Mode	VSA, LTE, LTETDD, IDEN
Measurement	<meas>:=VECTor ADEMod DDEMod W11A W11B EVM IPOWER IDEMod MOTotalk
Remote Command	:CALCulate:<meas>:DATA[1] 2 ...4:TABLE:NAMes?
Example	CALC:VECT:DATA1:TABL:NAM?
Notes	Query only. This retrieves the names of the table entries for the designated trace. Each of these names can be used in the CALC:<meas>:DATA:TABL? '<name>' command to access a single table entry.
Initial S/W Revision	Prior to A.02.00
Modified at S/W Revision	A.02.00

Query Table Units

Returns a comma-separated list of all the units for the table data entries for the designated trace. If a data result is unitless, an empty string appears in the list for that result. The units appear in the same order as the corresponding data values returned by the CALC:<meas>:DATA<n>:TABL[:NUMB|STR]? query.

Key Path	SCPI Only
Mode	VSA, LTE, LTETDD, IDEN
Measurement	<meas>:=VECTor ADEMod DDEMod W11A W11B EVM IPOWER IDEMod MOTotalk
Remote Command	:CALCulate:<meas>:DATA[1] 2 ...4:TABLE:UNIT?

Example	CALC:VECT:DATA1:TABL:UNIT?
Notes	Query only. This retrieves a list of units for table entries for the designated trace. The units are given in the order that the entries are sent from the :CALC:<meas>:DATA:TABL? command.
Initial S/W Revision	Prior to A.02.00
Modified at S/W Revision	A.02.00

The following table data is available in all measurements when the ACP function is turned on and the associated summary table is shown in a trace:

Result name	Displayed Unit	Remote Name	Remote Unit
Reference Bandwidth	Hz	RefBw	Hz
Reference Alpha		RefAlpha	
Reference Power	dBm	RefPwr	Vrms ²
Offset	Hz	Offset1, Offset2, Offset3, Offset4, Offset5	Hz
BW	Hz	Bw1, Bw2, Bw3, Bw4, Bw5	Hz
Alpha		Alpha1, Alpha2, Alpha3, Alpha4, Alpha5	
Lower Pwr	dBm	LowPwr1, LowPwr2, LowPwr3, LowPwr4, LowPwr5	Vrms ²
Lower ACPR	dB	LowRatio1, LowRatio2, LowRatio3, LowRatio4, LowRatio5	
Upper Pwr	dBm	HiPwr1, HiPwr2, HiPwr3, HiPwr4, HiPwr5	Vrms ²
Upper ACPR	dB	HiRatio1, HiRatio2, HiRatio3, HiRatio4, HiRatio5	
Max ACPR	dB	MaxRatio1, MaxRatio2, MaxRatio3, MaxRatio4, MaxRatio5	

The following table data is available in all measurements when the OBW function is turned on and the associated summary table is shown in a trace:

Result name	Displayed Unit	Remote Name	Remote Unit
Occupied Bandwidth	Hz	Obw	Hz
Power	dBm	Pwr	Vrms ²

Total Power	dBm	TotalPwr	Vrms^2
Power Ratio	%	PwrRatio	
Upper Freq	Hz	ObwUpper	Hz
Lower Freq	Hz	ObwLower	Hz
Centroid Freq	Hz	Centroid	Hz
Offset Freq	Hz	Offset	Hz

:CALCulate:DATA:HEADer commands

Trace data also has meta-data associated with it, called headers, which is visible if you export trace data in text format. The headers have a name and a value that can be obtained from any trace by using the CALCulate:<meas>:DATA:HEADer commands described in this section.

The following Remote Commands are described in this section:

["Query Header Names" on page 1295](#)

["Query Header Type" on page 1295](#)

["Query Header as String" on page 1296](#)

["Query Numeric Header" on page 1296](#)

[":CALC:CLIMits:FAIL?" on page 1297](#)

Query Header Names

Returns a comma-separated list of all the header names associated with the designated trace. Each of the names can be used (surrounded by quotes or double quotes) as a parameter in the other CALC:<meas>:DATA<n>:HEAD queries.

Key Path	SCPI Only
Mode	VSA, LTE, LTETDD, IDEN
Measurement	<meas>:=VECTor ADEMod DDEMod W11A W11B EVM IPOWER IDEMod MOTotalk
Remote Command	:CALCulate:<meas>:DATA[1] 2 ...4:HEADer:NAMes?
Example	CALC:VECT:DATA1:HEAD:NAM?
Notes	Query only. Returns a comma-separated list of header names.
Initial S/W Revision	Prior to A.02.00
Modified at S/W Revision	A.02.00

Query Header Type

Returns whether the designated header on the designated trace can be queried as a number or by a string only.

Key Path	SCPI Only
Mode	VSA, LTE, LTETDD, IDEN
Measurement	<meas>:=VECTor ADEMod DDEMod W11A W11B EVM IPOWER IDEMod MOTotalk
Remote Command	:CALCulate:<meas>:DATA[1] 2 ...4:HEADer:TYPE? <string>
Example	CALC:VECT:DATA1:HEAD:TYPE? 'XDelta'
Notes	Query only. This retrieves the type of the named header for the designated trace. The name (delimited by single or double quotes) is one of the names returned by CALC:<meas>:DATA:HEAD:NAMES? If a valid header name is passed in, the return value from this query is either STR or NUMB. NONE is returned if there is no such header.
Initial S/W Revision	Prior to A.02.00
Modified at S/W Revision	A.02.00

Query Header as String

Gets a header by name from the designated trace and returns its value as a string.

Key Path	SCPI Only
Mode	VSA, LTE, LTETDD, IDEN
Measurement	<meas>:=VECTor ADEMod DDEMod W11A W11B EVM IPOWER IDEMod MOTotalk
Remote Command	:CALCulate:<meas>:DATA[1] 2 ...4:HEADer:STRing? <string>
Example	CALC:VECT:DATA1:HEAD:STR? 'WindowType'
Notes	Query only. This retrieves the named header for the designated trace. The name (delimited by single or double quotes) is one of the names returned by the CALC:<meas>:DATA:HEAD:NAMES? The return value is a string. If the requested header value is a numeric or if there is no such header, an empty string is returned.
Initial S/W Revision	Prior to A.02.00
Modified at S/W Revision	A.02.00

Query Numeric Header

Gets a numeric header by name from the designated trace and returns its value in a format determined by the last FORM command.

Key Path	SCPI Only
Mode	VSA, LTE, LTETDD, IDEN
Measurement	<meas>:=VECTor ADEMod DDEMod W11A W11B EVM IPOWER IDEMod MOTotalk
Remote Command	:CALCulate:<meas>:DATA[1] 2 ...4:HEADer[:NUMBer]? <string>
Example	CALC:VECT:DATA1:HEAD? 'XDelta'
Notes	Query only. This retrieves the named header for the designated trace. This form of the HEAD? query is for headers whose type is NUMB (as determined by :CALC:<meas>:DATA:HEAD:TYPE?).

	The name parameter (delimited by single or double quotes) is one of the names returned by CALC:<meas>:DATA:HEAD:NAMes? The format of the return data is determined by the FORMat [:TRACe][:DATA] command. If used to query a header whose type is STR or there is no such header, NaN (9.91e37) is returned
Initial S/W Revision	Prior to A.02.00
Modified at S/W Revision	A.02.00

:CALC:CLIMits:FAIL?

If one or more ACP or OBW limit tests are active, then the CALC:CLIMits:FAIL? command returns the aggregate pass or fail status.

IQ Data Transfers

Fast capture/transfer of a large amount of IQ data is supported over SCPI. To do this, first set up the desired measurement range, center frequency, span, triggering, and so on. Use a time length that is convenient for setting up the measurement. The time length for the captured data is set indirectly as shown below.

To perform the capture, a typical SCPI sequence is as follows:

```
FCAP:LENG <num_samples>
```

This command sets the length for the next capture in samples. The sample rate is proportional to the current span and can be determined by a SCPI query, for example, in the Vector measurement the query:

```
VECT:SWE:ISR?
```

returns the input sample rate. For the IQAnalyzer (Basic) mode, the sample rate SCPI query is defined as follows:

```
:SPEC:SRAT? (Complex spectrum measurement)
```

```
:WAV:SRAT? (Waveform measurement)
```

Multiply the time length desired for the captured data by this sample rate to get the number of samples needed.

```
INIT:FCAP
```

pauses the current measurement and starts capturing IQ data using the current setup and trigger conditions. (The instrument front panel display does not change nor show the captured data.)

To read the captured data via SCPI in blocks, set the read block size using the command:

```
FCAP:BLOC <num_points_per_read_block>
```

The maximum read block size is typically less than the total fast capture buffer size and can be determined by the query "FCAP:BLOC? MAX". Now you can repeatedly use the following query to read out successive blocks of data:

```
FETC:FCAP?
```

The returned data is formatted according to the most recent :FORMat[:DATA] and :FORMat:BORDER commands. A read pointer that indicates the next sample to be transferred is advanced automatically following each FETC:FCAP? query. This pointer position can be read or manually set via the SCPI commands:

FCAP:POIN?

FCAP:POIN <read_pointer_position>

The fast capture data can be read as long as you use only the commands to set read block size and pointer position, or queries that return the state of the current measurement. The capture data is cleared by any command that changes the measurement state or initiates a new measurement, or via SCPI device clear or :ABORT commands.

Fast capture data word size can be set to either 32 bit or 64 bit via the FCAP:WLEN command. This enables you to trade off precision for total capture length.

Note: when the word size is 32 bit, points can only be retrieved on even sample number boundaries, that is, the pointer and block length should be even numbers. Therefore, when the word size is set to auto, it is recommended that the pointer and block size be only set to even numbers.

Fast Capture Length

Sets the length of the SCPI Fast Capture in samples (points). This is constrained to be an even number.

Query returns the most recent length setting.

Key Path	SCPI Only
Mode	VSA, BASIC
Remote Command	[[:SENSe]]:FCAPture:LENGth <integer> [[:SENSe]]:FCAPture:LENGth?
Example	FCAP:LENG 1000 FCAP:LENG?
Notes	This is affected by the IF path currently used, which can in turn be affected by span. It is also affected by the internal Fast Capture Word Length. The current maximum fast capture length can be found by using the query: FCAP:LENG? MAX Changing the Capture Length after initiating a fast capture clears the capture memory in preparation for a new fast capture of a different length. No Front panel access; SCPI only
Preset	1048576 Samples
Min	2
Max	536 870 908 Samples for internal 40 MHz and 140 MHz options with FCAP:WLEN BIT32
Initial S/W Revision	A.04.00

Fast Capture Word Length

Enables choice of internal fast capture word length. Shorter word length enables twice the time length to be captured at the cost of quantization noise. Note that this does not affect the format of data returned by FETCh:FCAPture, only the internal representation.

Key Path	SCPI Only
Mode	VSA, BASIC
Remote Command	<code>[:SENSe] :FCAPture:WLENgth AUTO BIT32 BIT64</code> <code>[:SENSe] :FCAPture:WLENgth?</code>
Example	FCAP:WLEN AUTO FCAP:WLEN?
Notes	No Front panel access; SCPI only.
Preset	AUTO
Initial S/W Revision	A.04.00

Initiate Fast Capture

Waits for the sweep to trigger and then captures the fast capture data. Sweep is then set to pause. The amount of data captured is controlled by the Fast Capture Length command (FCAP:LENG).

Key Path	SCPI Only
Mode	VSA, BASIC
Remote Command	<code>:INITiate:FCAPture</code>
Example	INIT:FCAP
Notes	This is an overlapped command. It returns immediately, but the capture may not be complete. Use *OPC?, *WAI, or *OPC to determine when the capture is complete.
Notes	No Front panel access; SCPI only This command resets the Fast Capture Pointer to 0
Initial S/W Revision	A.04.00

Fast Capture Block

Sets the block size for the Fast Capture transfer in samples (points). This is the number of points that are returned from the Capture buffer by the FETC:FCAP? command. This is constrained to be an even number.

Query returns most recent block size setting.

Key Path	SCPI Only
Mode	VSA, BASIC
Remote Command	<code>[:SENSe] :FCAPture:BLOCK <integer></code>

	<code>[:SENSe] :FCAPture:BLOCK?</code>
Example	<code>FCAP:BLOC 100</code> <code>FCAP:BLOC?</code>
Notes	No Front panel access. SCPI only.
Preset	1024 Samples
Min	0
Max	131072 or Fast Capture Length, whichever is smaller
Initial S/W Revision	A.04.00

Fast Capture Pointer

Sets the pointer position for the Fast Capture transfer in samples (points). The pointer is incremented by the block size each time the fetch is performed. Preset value (0) is the first sample in the record. Thus repetitive fetches result in contiguous data without needing to increment the pointer over SCPI. This is constrained to be an even number. Query returns most recent pointer setting.

Key Path	SCPI Only
Mode	VSA, BASIC
Remote Command	<code>[:SENSe] :FCAPture:POINter <integer></code> <code>[:SENSe] :FCAPture:POINter?</code>
Example	<code>FCAP:POIN 100</code> <code>FCAP:POIN?</code>
Notes	INIT:FCAP or FCAP:ABOR resets the pointer to 0. No front panel access; SCPI only.
Preset	0 Samples
Min	0
Max	Must be less than the Fast Capture length
Initial S/W Revision	A.04.00

Fetch Fast Capture

Transfers the block of data starting at the pointer. The number of samples transferred is set with the block size. The pointer is incremented by the block size after the fetch.

Key Path	SCPI Only
Mode	VSA, BASIC
Remote Command	<code>:FETCh:FCAPture?</code>
Example	<code>FETC:FCAP?</code>
Notes	The returned data is formatted according to the most recent <code>:FORMat[:DATA]</code> and <code>:FORMat:BORDER</code>

commands.

If the read pointer position plus read block size exceeds the Fast Capture Length, only the data between the pointer and the end of the fast capture buffer are returned, and error -200 is reported.

If Fetch is attempted before an INIT:FCAP or if the captured data is cleared by some other operation (e.g., REC), error -230 is reported and no data is returned.

No front panel access; SCPI only.

Initial S/W Revision	A.04.00
----------------------	---------

Input Sample Rate Query

Returns the complex sample rate in Hz for the current VXA measurement setup conditions. The sample rate can be used to convert between time and number of sample points when using the Fast Capture feature.

Sample rate depends on the settings for `FREQ:SPAN` and `IFPath`. You need to set these before making this query. Though the measurement name is specified in the query, you can only query the currently configured measurement. That is, if you have sent `CONF:VECT`, the query `ADEM:SWE:ISR?` generates an error.

Key Path	SCPI Only
Mode	VSA
Measurement	<meas>:=VECTor ADEMod DDEMod W11A W11B
Remote Command	[:SENSe] :<meas>:SWEp:ISRate?
Example	VECT:SWE:ISR?
Notes	<p>Query returns the complex sample rate in Hz for the current VXA Vector measurement setup conditions.</p> <p>If the measurement in the query is not the active measurement, error -230 is reported and no data is returned.</p> <p>This query is SCPI only, no Front Panel softkey.</p>
Preset	Depends on the licensed IF path
Initial S/W Revision	A.04.00

Parameter Update Enable

Refers only to measurements that use the VSA measurement engine. These are all the measurements in the Vector Signal Analyzer (VXA) Application and the EVM measurement in the LTE Applications.

When a measurement parameter is changed, the new value is used to update any dependent parameters and measurement results. This update process is normally done after every parameter change. This enables visual feedback during interactive GUI operation. However, with SCPI controlled measurements, typically a lot of parameter changes are done at once with the measurement stopped and then the measurement is run once and data retrieved. Here, is not necessary, and the accumulated update time for

each parameter change can become significant. The Parameter Update Enable command enables you to postpone update while sending setup commands and then enable one update to occur just before the measurement.

For example, if you are programmatically setting up a complex LTE measurement, you could save some setup time by first sending EVM:PUPD:ENAB OFF, then sending the whole group of measurement setup commands. When you are done with the setup, send EVM:PUPD:ENAB:ON. This causes the measurement state to be updated with all dependencies resolved. After this, you can read back the parameters' actual values. As a convenience, starting or continuing a measurement (INITiate:REStart, INITiate:IMMEDIATE, INITiate:<meas> or INITiate:RESume) automatically sets <meas>:PUPD:ENAB to ON. So does CONFigure:<meas> or any of the reset and recall state commands.

This command should be used with caution.

It is only valid to turn <meas>:PUPD:ENAB OFF when <meas> is the currently active measurement and the measurement is paused (i.e., INIT:CONT is OFF).

If you try to set and then read back a parameter value while Parameter Update Enable is off, you are not guaranteed to get back the true value that is used in the measurement because no parameter limiting is being done nor are any dependencies between parameters being resolved.

If you try to set coupled parameters independently when Parameter Update Enable is off, then when it is turned on, at most one of the parameter settings remain the same and the others change due to dependency resolution.

Key Path	SCPI Only
Mode	VSA, LTE, LTETDD, IDEN
Measurement	<meas>:=VECTor ADEMod DDEMod W11A W11B EVM IPOWER IDEMod MOTotalk
Remote Command	[:SENSe] : <meas> : PUPDate : ENABle OFF ON 0 1 [:SENSe] : <meas> : PUPDate : ENABle ?
Example	EVM:PUPD:ENAB OFF
Notes	Commands that cause a measurement to run, that switch measurements, or that preset or recall measurement state, set Parameter Update state to ON. These include INIT:IMM, INIT:REST, INIT:RES, INIT:<meas>, and CONF:<meas>.
Preset	1
State Saved	No
Initial S/W Revision	A.03.00