

# Keysight X-Series Signal Analyzer

This help file provides documentation for the following

X-Series Analyzers:

PXA Signal Analyzer N9030A

MXA Signal Analyzer N9020A

EXA Signal Analyzer N9010A

CXA Signal Analyzer N9000A

DVB-T/H with T2  
Mode User's &  
Programmer's  
Reference

## Notices

© Keysight Technologies, Inc.  
2006-2014

No part of this manual may be reproduced in any form or by any means (including electronic storage and retrieval or translation into a foreign language) without prior agreement and written consent from Keysight Technologies, Inc. as governed by United States and international copyright laws.

## Acknowledgments

Adobe Acrobat® and Reader® are U.S. registered trademarks of Adobe Systems Incorporated.

## Manual Part Number

N6153-90003

## Edition

August 2014

Printed in USA

Keysight Technologies, Inc.  
1400 Fountaingrove Parkway  
Santa Rosa, CA 95403

## Warranty

The material contained in this document is provided “as is,” and is subject to being changed, without notice, in future editions. Further, to the maximum extent permitted by applicable law, Keysight disclaims all warranties, either express or implied, with regard to this manual and any information contained herein, including but not limited to the implied warranties of merchantability and fitness for a particular purpose. Keysight shall not be liable for errors or for incidental or consequential

damages in connection with the furnishing, use, or performance of this document or of any information contained herein. Should Keysight and the user have a separate written agreement with warranty terms covering the material in this document that conflict with these terms, the warranty terms in the separate agreement shall control.

## Technology Licenses

The hardware and/or software described in this document are furnished under a license and may be used or copied only in accordance with the terms of such license.

## Restricted Rights

### Legend

If software is for use in the performance of a U.S. Government prime contract or subcontract, Software is delivered and licensed as “Commercial computer software” as defined in DFAR 252.227-7014 (June 1995), or as a “commercial item” as defined in FAR 2.101(a) or as “Restricted computer software” as defined in FAR 52.227-19 (June 1987) or any equivalent agency regulation or contract clause. Use, duplication or disclosure of Software is subject to Keysight Technologies’ standard commercial license terms, and non-DOD Departments and Agencies of the U.S. Government will receive no greater than Restricted Rights as defined in FAR 52.227-19(c)(1-2) (June 1987). U.S. Government users will

receive no greater than Limited Rights as defined in FAR 52.227-14 (June 1987) or DFAR 252.227-7015 (b)(2) (November 1995), as applicable in any technical data.

## Safety Notices

### CAUTION

A CAUTION notice denotes a hazard. It calls attention to an operating procedure, practice, or the like that, if not correctly performed or adhered to, could result in damage to the product or loss of important data. Do not proceed beyond a CAUTION notice until the indicated conditions are fully understood and met.

### WARNING

A WARNING notice denotes a hazard. It calls attention to an operating procedure, practice, or the like that, if not correctly performed or adhered to, could result in personal injury or death. Do not proceed beyond a WARNING notice until the indicated conditions are fully understood and met.

# Table of Contents

DVB-T/H with T2 Mode User's & Programmer's Reference	i
Table of Contents	iii
<b>1 About the Analyzer</b>	<b>85</b>
Installing Application Software	86
Viewing a License Key	86
Obtaining and Installing a License Key	86
Updating Measurement Application Software	86
X-Series Options and Accessories	88
Front-Panel Features	89
Display Annotations	90
Rear-Panel Features	91
Window Control Keys	92
Multi-Window	92
Zoom	92
Next Window	93
Full Screen	94
Display Enable (Remote Command Only)	94
Mouse and Keyboard Control	96
Right-Click	96
PC Keyboard	98
Instrument Security & Memory Volatility	101
<b>2 About the DVB-T/H Measurement Application</b>	<b>103</b>
What Does the DVB-T/H Application Do?	104
<b>3 Programming the Analyzer</b>	<b>107</b>
What Programming Information is Available?	108
List of SCPI Commands	109
STATus Subsystem	151
Detailed Description	153
What Are Status Registers	154
What Are Status Register SCPI Commands	154
How to Use the Status Registers	155
Using a Status Register	156
Using the Service Request (SRQ) Method	157
Generating a Service Request	157
Status Register System	158
The Status Byte Register	159
Standard Event Status Register	161
Operation and Questionable Status Registers	163
Operation Status Register	163
Questionable Status Register	163

STATus Subsystem Command Descriptions	164
Operation Register	164
Operation Condition Query	164
Operation Enable	165
Operation Event Query	165
Operation Negative Transition	165
Operation Positive Transition	166
Preset the Status Byte	166
Questionable Register	167
Questionable Condition	167
Questionable Enable	167
Questionable Event Query	168
Questionable Negative Transition	168
Questionable Positive Transition	168
Questionable Calibration Register	169
Questionable Calibration Condition	169
Questionable Calibration Enable	169
Questionable Calibration Event Query	170
Questionable Calibration Negative Transition	170
Questionable Calibration Positive Transition	171
Questionable Calibration Skipped Register	171
Questionable Calibration Skipped Condition	171
Questionable Calibration Skipped Enable	172
Questionable Calibration Skipped Event Query	172
Questionable Calibration Skipped Negative Transition	173
Questionable Calibration Skipped Positive Transition	173
Questionable Calibration Extended Failure Register	173
Questionable Calibration Extended Failure Condition	174
Questionable Calibration Extended Failure Enable	174
Questionable Calibration Extended Failure Event Query	174
Questionable Calibration Extended Failure Negative Transition	175
Questionable Calibration Extended Failure Positive Transition	175
Questionable Calibration Extended Needed Register	176
Questionable Calibration Extended Needed Condition	176
Questionable Calibration Extended Needed Enable	176
Questionable Calibration Extended Needed Event Query	177
Questionable Calibration Extended Needed Negative Transition	177
Questionable Calibration Extended Needed Positive Transition	178
Questionable Frequency Register	178
Questionable Frequency Condition	178
Questionable Frequency Enable	179
Questionable Frequency Event Query	179
Questionable Frequency Negative Transition	179

Questionable Frequency Positive Transition	180
Questionable Integrity Register	180
Questionable Integrity Condition	180
Questionable Integrity Enable	181
Questionable Integrity Event Query	181
Questionable Integrity Negative Transition	182
Questionable Integrity Positive Transition	182
Questionable Integrity Signal Register	182
Questionable Integrity Signal Condition	183
Questionable Integrity Signal Enable	183
Questionable Integrity Signal Event Query	184
Questionable Integrity Signal Negative Transition	184
Questionable Integrity Signal Positive Transition	184
Questionable Integrity Uncalibrated Register	185
Questionable Integrity Uncalibrated Condition	185
Questionable Integrity Uncalibrated Enable	185
Questionable Integrity Uncalibrated Event Query	186
Questionable Integrity Uncalibrated Negative Transition	186
Questionable Integrity Uncalibrated Positive Transition	187
Questionable Power Register	187
Questionable Power Condition	187
Questionable Power Enable	188
Questionable Power Event Query	188
Questionable Power Negative Transition	189
Questionable Power Positive Transition	189
Questionable Temperature Register	189
Questionable Temperature Condition	190
Questionable Temperature Enable	190
Questionable Temperature Event Query	190
Questionable Temperature Negative Transition	191
Questionable Temperature Positive Transition	191
IEEE 488.2 Common Commands	193
All	193
Clear Status	195
Standard Event Status Enable	195
Standard Event Status Register Query	196
Identification Query	196
Operation Complete	197
Query Instrument Options	198
Recall Instrument State	198
*RST (Remote Command Only)	199
Save Instrument State	199
Service Request Enable	199

Status Byte Query	200
Trigger	200
Self Test Query	200
Wait-to-Continue	201
<b>4 Input/Output Functions</b>	<b>203</b>
Input/Output	204
Input/Output variables - Preset behavior	205
RF Input	206
Input Z Correction	206
RF Coupling	207
External Mixer	208
More Information	209
Ext Mix Setup	211
Mixer Presets	216
Mixer Bias	221
Signal ID On/Off	221
Signal ID Mode	222
Image Suppress	222
Image Shift	223
Cable IF Loss	223
I/Q	224
Baseband I/Q (Option BBA)	224
Baseband I/Q Remote Language Compatibility	226
I/Q Path	227
I+jQ	228
I Only	228
Q Only	229
I Setup	229
I Differential Input	229
I Input Z	230
I Skew	231
I Probe	231
Combined Differential/Input Z (Remote Command Only)	233
Q Setup	234
Q Same as I	234
Q Differential Input	235
Q Input Z	236
Q Skew	236
Q Probe	237
Reference Z	239
I/Q Cable Calibrate...	239
I/Q Probe Setup	240
Attenuation	240

Offset	241
Coupling	242
Calibrate	243
Clear Calibration	243
RF Calibrator	244
50 MHz	245
4.8 GHz	245
Off	245
External Gain	246
Ext Preamp	246
More Information	247
MS	248
BTS	249
I Ext Gain	250
Q Ext Gain	250
Restore Input/Output Defaults	251
Data Source	251
Inputs	252
Capture Buffer	252
Current Meas -> Capture Buffer	252
Corrections	253
Select Correction	254
Correction On/Off	254
Properties	255
Select Correction	255
Antenna Unit	255
Frequency Interpolation	258
Description	260
Comment	260
Edit	260
Navigate	261
Frequency	262
Amplitude	262
Insert Point Below	262
Delete Point	262
Delete Correction	262
Apply Corrections	263
Delete All Corrections	263
Remote Correction Data Set Commands	264
Set (Replace) Data (Remote Command Only)	264
Merge Correction Data (Remote Command Only)	264
Freq Ref In	265
Sense	267

Internal	267
External	267
Ext Ref Freq	267
External Reference Lock BW	269
External Ref Coupling	269
Output Config	271
Trig Out	271
Polarity	272
Off	272
Sweeping (HSWP)	272
Measuring	273
Main Trigger	273
Gate Trigger	273
Gate	273
Source Point Trigger	274
Odd/Even Trace Point	274
Analog Out	274
More Information	275
Auto	275
Off	275
Screen Video	276
Log Video (RF Envelope, Ref=Mixer Level)	277
Linear Video (RF Envelope, Ref=Ref Level)	277
Demod Audio	278
Digital Bus	279
Bus Out On/Off	279
I/Q Cal Out	280
1 kHz Square Wave	280
250 kHz Square Wave	280
Off	280
Aux IF Out	281
Off	281
Second IF	281
Arbitrary IF	282
Fast Log Video	283
I/Q Guided Calibration	283
I/Q Isolation Calibration	284
Next	284
Exit	284
I/Q Isolation Calibration Time (Remote Command Only)	284
I/Q Cable Calibrate...	285
I Port	285
I-bar Port	286



Q Port	287
Q-bar Port	288
I/Q Cable Calibration Time (Remote Command Only)	289
I/Q Probe Calibration	289
I Port	290
I-bar Port	291
Q Port	293
Q-bar Port	294
Show Adapter Screen	295
I/Q Probe Calibration Time (Remote Command Only)	295
Exit Confirmation	295
<b>5 Mode Functions</b>	<b>297</b>
Mode	298
More Information	299
Spectrum Analyzer	300
DVB-T/H with T2	301
cdma2000	301
Vector Signal Analyzer (VXA)	301
Analog Demod	302
Phase Noise	302
CMMB	302
Combined WLAN	303
TD-SCDMA with HSPA/8PSK	303
IQ Analyzer (Basic)	303
W-CDMA with HSPA+	304
GSM/EDGE/EDGE Evo	304
Noise Figure	304
WLAN	304
EMI Receiver	305
802.16 OFDM (Fixed WiMAX)	305
DTMB (CTTB)	305
1xEV-DO	306
802.16 OFDMA (WiMAX/WiBro)	306
89601 VSA	306
MSR	307
Bluetooth	308
LTE	308
SCPI Language Compatibility	308
Combined Fixed WiMAX	309
ISDB-T	309
Digital Cable TV	309
LTE TDD	309
Remote Language Compatibility	310

iDEN/WiDEN/MOTOTalk	310
Application Mode Number Selection (Remote Command Only)	310
Application Mode Catalog Query (Remote Command Only)	312
Application Identification (Remote Commands Only)	312
Current Application Model	313
Current Application Revision	313
Current Application Options	313
Application Identification Catalog (Remote Commands Only)	314
Application Catalog Number of Entries	314
Application Catalog Model Numbers	314
Application Catalog Revision	314
Application Catalog Options	315
Detailed List of Modes	315
1xEV-DO	315
802.16 OFDMA (WiMAX/WiBro)	316
802.16 OFDM (Fixed WiMAX)	316
89601 VSA	316
Analog Demod	317
Bluetooth	317
cdma2000	318
CMMB	318
Combined WLAN	318
Combined Fixed WiMAX	319
Digital Cable TV	319
DTMB (CTTB)	319
DVB-T/H with T2	320
EMI Receiver	320
GSM/EDGE/EDGE Evo	320
iDEN/WiDEN/MOTOTalk	321
IQ Analyzer (Basic)	321
ISDB-T	321
LTE	321
LTE TDD	322
MSR	322
Noise Figure	322
Phase Noise	323
Remote Language Compatibility	323
SCPI Language Compatibility	323
Spectrum Analyzer	324
TD-SCDMA with HSPA/8PSK	324
Vector Signal Analyzer (VXA)	324
W-CDMA with HSPA+	325
WLAN	325

Global Settings	326
Global Center Freq	326
Restore Defaults	327
Mode Setup	328
Radio Std	328
DVB-T	329
DVB-H	329
DVB-T2	329
Version	329
Transmission Mode	330
Channel BW	331
Noise Reduction	331
Noise Floor Extension	331
More Information	332
Restore Mode Defaults	333
<b>6 System Functions</b>	<b>335</b>
File	336
File Explorer	336
Page Setup	337
Print	338
Restore Down	338
Minimize	338
Exit	339
Print	339
Maximize/Restore Down	339
Maximize	339
Restore Down	340
Print	341
System	342
Show	342
Errors	342
Previous Page	343
Next Page	344
History	344
Verbose SCPI On/Off	345
Refresh	345
Clear Error Queue	346
System	346
Show System contents (Remote Command Only)	347
Computer System description (Remote Command Only)	347
Hardware	347
LXI	348
Power On	348

Mode and Input/Output Defaults	349
User Preset	349
Last State	350
Power On Application	350
Configure Applications	351
Preloading Applications	352
Access to Configure Applications utility	352
Virtual memory usage	352
Select All	353
Deselect All	353
Move Up	353
Move Down	353
Select/Deselect	353
Save Changes and Exit	354
Exit Without Saving	354
Restore Power On Defaults	354
Configure Applications - Instrument boot-up	355
Configure Applications - Windows desktop	355
Configure Applications - Remote Commands	355
Configuration list (Remote Command Only)	356
Configuration Memory Available (Remote Command Only)	356
Configuration Memory Total (Remote Command Only)	356
Configuration Memory Used (Remote Command Only)	356
Configuration Application Memory (Remote Command Only)	357
Alignments	357
Auto Align	357
Normal	358
Partial	359
Off	359
All but RF	360
Alert	360
Execute Expired Alignments (Remote Command Only)	363
Align Now	364
All	364
All but RF	366
RF	367
External Mixer	368
Show Alignment Statistics	369
Restore Align Defaults	374
Backup or Restore Align Data...	374
Alignment Data Wizard	375
Perform Backup (Remote Command Only)	380
Perform Restore (Remote Command Only)	381

Advanced	381
Characterize Preselector	381
Characterize Reference Clock	382
Timebase DAC	385
Calibrated	386
User	386
I/O Config	387
GPIB	387
GPIB Address	387
GPIB Controller	388
SCPI LAN	389
SCPI Telnet	389
SCPI Socket	389
SICL Server	390
HiSLIP Server	391
SCPI Socket Control Port (Remote Command Only)	391
Reset Web Password	392
LXI	392
LAN Reset	392
Device Identification (Remote Command Only)	393
System IDN Response	393
Factory	393
User	394
Query USB Connection (Remote Command Only)	394
USB Connection Status (Remote Command Only)	394
USB Packet Count (Remote Command Only)	395
Restore Defaults	395
Restore Input/Output Defaults	396
Restore Power On Defaults	396
Restore Align Defaults	397
Restore Misc Defaults	397
Restore Mode Defaults (All Modes)	398
All	399
Control Panel...	400
Licensing...	401
Security	403
USB	403
Read-Write	403
Read only	404
Diagnostics	404
Show Hardware Statistics	404
SCPI for Show Hardware Statistics ( Remote Commands Only)	405
Internet Explorer...	407

System Remote Commands (Remote Commands Only)	407
System Powerdown (Remote Command Only)	407
List installed Options (Remote Command Only)	408
Lock the Front-panel keys (Remote Command Only)	408
List SCPI Commands (Remote Command Only)	408
SCPI Version Query (Remote Command Only)	409
Date (Remote Command Only)	409
Time (Remote Command Only)	409
<b>7 Trigger Functions</b>	<b>411</b>
Trigger	412
Trigger Source Presets	413
RF Trigger Source	416
I/Q Trigger Source	417
More Information	418
Free Run	419
Video (IF Envelope)	420
Trigger Level	420
Trig Slope	421
Trig Delay	422
Line	423
Trig Slope	424
Trig Delay	424
External 1	425
Trigger Level	425
Trig Slope	426
Trig Delay	427
External 2	427
Trigger Level	428
Trig Slope	428
Trig Delay	429
RF Burst	430
Absolute Trigger Level	430
Relative Trigger Level	431
Trigger Slope	432
Trig Delay	433
Periodic Timer (Frame Trigger)	434
Period	435
Offset	436
Reset Offset Display	437
Sync Source	437
Off	438
External 1	438
External 2	439

RF Burst	441
Trig Delay	443
Auto/Holdoff	444
Auto Trig	444
Trig Holdoff	445
<b>8 Channel Power Measurement</b>	<b>447</b>
AMPTD Y Scale	456
Ref Value	456
Attenuation	456
Dual Attenuator Configurations:	457
Single Attenuator Configuration:	458
(Mech) Atten	458
Attenuator Configurations and Auto/Man	460
Enable Elec Atten	460
More Information	461
Mechanical Attenuator Transition Rules	461
When the Electronic Attenuation is enabled from a disabled state:	461
Examples in the dual attenuator configuration:	461
When the Electronic Attenuation is disabled from an enabled state:	462
Using the Electronic Attenuator: Pros and Cons	462
Elec Atten	462
Adjust Atten for Min Clip	463
Pre-Adjust for Min Clip	463
Off	464
Elec Atten Only	464
Mech + Elec Atten	465
(Mech) Atten Step	465
Scale/Div	466
Presel Center	466
Proper Preselector Operation	467
Preselector Adjust	467
Y Axis Unit	469
dBm	470
dBmV	470
dBmA	470
W	471
V	471
A	471
dB $\mu$ V	472
dB $\mu$ A	472
dBpW	472
Antenna Unit	473
dB $\mu$ V/m	473

## Table of Contents

dB $\mu$ A/m	473
dB $\mu$ A	473
dBpT	474
dBG	474
None	474
$\mu$ W Path Control	475
Standard Path	476
Low Noise Path Enable	476
More Information	477
$\mu$ W Preselector Bypass	478
Internal Preamp	479
Off	480
Low Band	481
Full Range	481
Ref Position	481
Auto Scaling	482
Auto Couple	483
More Information	483
Auto/Man Active Function keys	483
Auto/Man 1-of-N keys	483
BW	485
Res BW	485
Video BW	486
Filter Type	488
Cont (Continuous Measurement/Sweep)	489
File	491
FREQ Channel	492
Channel	492
Center Freq	492
Maximum Frequency in X - Series Signal Analyzers	493
RF Center Freq	494
IQ Center Freq	494
Chan Step	495
CF Step	495
Chan Table	496
NTSC-M	496
NTSC-J	497
NTSC-Brazil	497
PAL-M	498
PAL-I	498
PAL-B/G	499
PAL-D/K	499
Input/Output	500



Marker	501
Select Marker	501
Marker Type	501
Properties	502
Select Marker	502
Relative To	502
Marker Trace (DVB-T/H, DTMB (CTTB), ISDB-T and CMMB only)	503
The table below is for ISDB-T and CMMB mode.	503
All Markers Off	503
Marker X Axis Value (Remote Command Only)	504
Marker X Axis Position (Remote Command Only)	504
Marker Y Axis Value (Remote Command only)	505
Backward Compatibility SCPI Commands	505
Marker Function	506
Marker To	507
Meas	508
Remote Measurement Functions	508
Measurement Group of Commands	509
Current Measurement Query (Remote Command Only)	511
Limit Test Current Results (Remote Command Only)	511
Data Query (Remote Command Only)	511
Calculate/Compress Trace Data Query (Remote Command Only)	512
Calculate Peaks of Trace Data (Remote Command Only)	517
Format Data: Numeric Data (Remote Command Only)	518
Format Data: Byte Order (Remote Command Only)	519
Meas Setup	520
Avg/Hold Num	520
Avg Mode	521
Integ BW	522
Shoulder Offset Start (Only for DVB-T/H and ISDB-T mode)	523
Shoulder Offset Stop (Only for DVB-T/H and ISDB-T mode)	523
PhNoise Opt	524
PhNoise Opt Auto	524
PhNoise Opt State	525
IF Gain	526
IF Gain Auto	526
IF Gain State	526
Method	527
Method	528
Filter Alpha	528
Filter BW	529
Meas Preset	530
PSD Unit	530

Mode	532
Mode Preset	533
How-To Preset	534
Preset Type (Remote Command Only)	535
Mode Setup	536
Peak Search	537
Print	538
Quick Save	539
Recall	541
State	541
More Information	543
From File...	543
Edit Register Names	545
Register 1 thru Register 16	545
Register 1 thru Register 16	546
Data (Import)	547
Amplitude Correction	548
Amplitude Correction	549
Chan Table	549
Capture Buffer	550
DVB-T2 Config	550
Open...	551
Restart	552
More Information	552
Save	554
State	554
To File . . .	555
Edit Register Names	557
More Information	557
Register 1 thru Register 16	558
Register 1 thru Register 16	558
Data (Export)	559
Amplitude Correction	560
Correction Data File	560
Amplitude Correction	563
Chan Table	563
Measurement Results	563
Capture Buffer	566
DVB-T2 Config	567
Save As . . .	567
Screen Image	568
Themes	569
3D Color	569

3D Monochrome	570
Flat Color	570
Flat Monochrome	570
Save As...	570
Mass Storage Catalog (Remote Command Only)	571
Mass Storage Change Directory (Remote Command Only)	571
Mass Storage Copy (Remote Command Only)	572
Mass Storage Device Copy (Remote Command Only)	572
Mass Storage Delete (Remote Command Only)	572
Mass Storage Data (Remote Command Only)	572
Mass Storage Make Directory (Remote Command Only)	573
Mass Storage Move (Remote Command Only)	573
Mass Storage Remove Directory (Remote Command Only)	574
Single (Single Measurement/Sweep)	575
More Information	575
Source	576
Span X Scale	577
Span	577
Full Span	578
Last Span	579
Sweep/Control	580
Sweep Time	580
Sweep Setup	581
Auto Sweep Time Rules	581
Pause	582
Gate	582
Gate On/Off	582
Gate View On/Off	583
Gate View Setup	586
Gate View Sweep Time	587
Gate View Start Time	587
Gate Delay	588
Gate Length	588
Gate Source	589
Line	590
External 1	590
External 2	592
RF Burst	594
Periodic Timer (Frame Trigger)	597
Control Edge/Level	608
Gate Holdoff	608
Gate Delay Compensation	610
More Information	611

Min Fast Position Query (Remote Command Only)	611
Gate Preset (Remote Command Only)	612
Gate Level (Remote Command Only)	612
Gate Polarity (Remote Command Only)	612
Points	613
System	615
Trace/Detector	616
Trace Type	616
Detector	616
Auto	617
Detector Selection	617
Trigger	619
Free Run	619
Video	619
Trigger Level	619
Trig Slope	619
Trig Delay	619
Line	619
Trig Slope	619
Trig Delay	619
External 1	619
Trigger Level	619
Trig Slope	619
Trig Delay	619
External 2	619
Trigger Level	620
Trig Slope	620
Trig Delay	620
RF Burst	620
Absolute Trigger	620
Relative Trigger	620
Trig Slope	620
Trig Delay	620
Periodic Timer	620
Period	620
Offset	620
Reset Offset Display	620
Sync Source	620
Off	620
External 1	621
External 2	621
RF Burst	621
Trig Delay	621

Auto/Holdoff	621
Auto Trig	621
Trig Holdoff	621
User Preset	622
User Preset	622
User Preset All Modes	623
Save User Preset	624
View/Display	625
View selection by name (MSR and LTE-Advanced FDD/TDD only)	627
Selects the results view. The following SCPI command allows you to select the desired measurement view by enumeration.	627
Selects the results view. The following SCPI command allows you to select the desired measurement view by enumeration.	628
View selection by name (DTMB (CTTB), DVB-T/H only)	628
View selection by name (ISDB-T, CMMB only)	629
Display	629
Annotation	629
Meas Bar On/Off	630
Screen	631
Active Function Values On/Off	631
Title	632
Change Title	632
Clear Title	633
Graticule	634
System Display Settings	634
Annotation Local Settings	634
Themes	635
Backlight	636
Backlight Intensity	636
RF Spectrum (Only for DVB-T/H, DTMB (CTTB), ISDB-T and CMMB)	637
Traces Window	638
Results Window	638
Bar Graph	638
Shoulder Attenuation (Only for DVB-T/H, DTMB (CTTB), ISDB-T and CMMB)	639
Shoulder Attenuation view for DVB-T/H and ISDB-T mode	639
Shoulder Attenuation view for DTMB (CTTB) and CMMB mode	640
Lower Shoulder Trace Window	640
Upper Shoulder Trace Window	640
Results Window	641
Spectrum Mask(DTMB (CTTB), DVB-T/H only)	642
Trace Window	643
Results Window	643
Mask - selection by Enum (Only for DVB-T/H mode)	643

Limit Mask (DTMB (CTTB), DVB-T/H only)	644
Scroll	644
Prev Page	644
Next Page	645
Scroll Up	645
Scroll Down	645
First Page	645
Last Page	645
<b>9 ACP Measurement</b>	<b>647</b>
AMPTD Y Scale	659
Ref Value	659
Attenuation	659
Dual Attenuator Configurations:	660
Single Attenuator Configuration:	661
(Mech) Atten	661
Attenuator Configurations and Auto/Man	663
Enable Elec Atten	663
More Information	664
Mechanical Attenuator Transition Rules	664
When the Electronic Attenuation is enabled from a disabled state:	664
Examples in the dual attenuator configuration:	664
When the Electronic Attenuation is disabled from an enabled state:	665
Using the Electronic Attenuator: Pros and Cons	665
Elec Atten	665
Adjust Atten for Min Clip	666
Pre-Adjust for Min Clip	666
Off	667
Elec Atten Only	667
Mech + Elec Atten	668
(Mech) Atten Step	668
Scale/Div	669
Presel Center	669
Proper Preselector Operation	670
Preselector Adjust	670
Y Axis Unit	672
dBm	673
dBmV	673
dBmA	673
W	674
V	674
A	674
dB $\mu$ V	675
dB $\mu$ A	675

dBpW	675
Antenna Unit	676
dB $\mu$ V/m	676
dB $\mu$ A/m	676
dB $\mu$ A	676
dBpT	677
dBG	677
None	677
$\mu$ W Path Control	678
Standard Path	679
Low Noise Path Enable	679
More Information	680
$\mu$ W Preselector Bypass	681
Internal Preamp	682
Off	683
Low Band	684
Full Range	684
Ref Position	684
Auto Scaling	685
Auto Couple	686
More Information	686
Auto/Man Active Function keys	686
Auto/Man 1-of-N keys	686
BW	688
Res BW	688
Video BW	689
RBW Control	691
Filter Type	691
Filter BW	692
Cont (Continuous Measurement/Sweep)	693
File	695
FREQ Channel	696
Channel	696
Center Freq	696
Maximum Frequency in X - Series Signal Analyzers	697
RF Center Freq	698
IQ Center Freq	698
Chan Step	699
CF Step	699
Chan Table	700
NTSC-M	700
NTSC-J	701
NTSC-Brazil	701

## Table of Contents

PAL-M	702
PAL-I	702
PAL-B/G	703
PAL-D/K	703
Input/Output	704
Marker	705
Select Marker	705
Marker Type	705
Properties	706
Select Marker	706
Relative To	706
Marker Trace	707
Couple Markers	708
Marker All Off	708
Marker X Axis Value (Remote Command only)	708
Marker X Axis Position (Remote Command only)	709
Marker Y Axis Value (Remote Command only)	710
Backward Compatibility Remote Commands	710
Marker Function	711
Marker To	712
Meas	713
Remote Measurement Functions	713
Measurement Group of Commands	714
Current Measurement Query (Remote Command Only)	716
Limit Test Current Results (Remote Command Only)	716
Data Query (Remote Command Only)	716
Calculate/Compress Trace Data Query (Remote Command Only)	717
Calculate Peaks of Trace Data (Remote Command Only)	722
Format Data: Numeric Data (Remote Command Only)	723
Format Data: Byte Order (Remote Command Only)	724
Meas Setup	725
Average/Hold Number	725
Avg Mode	726
Carrier Setup (This menu is unavailable in MSR and LTE-Advanced FDD/TDD)	726
Carriers	726
Ref Carrier	727
Ref Car Freq	728
Power Ref	729
Total Power	729
PSD	730
Configure Carriers	731
Carrier	731
Carrier Pwr Present	732



Carrier Spacing	733
Measurement Noise Bandwidth	734
Method for Carrier	735
Offset/Limits	737
Select Offset	737
Offset Freq	737
Integ BW	739
Offset BW	741
Res BW	741
Video BW	742
RBW Control	744
Limits	745
Select Offset	745
Abs Limit	746
Rel Lim (Car)	747
Rel Limit (PSD)	750
Fail Mask	751
Offset Side	752
Method for Offset	753
Method for Offset	754
Offset Frequency Define	756
Carrier Result	757
Meas Method	757
Meas Type	759
PSD Ref	759
Limit Test	760
Noise Correction	761
Meas Preset	761
Offset RRC Weighting (Backward Compatibility SCPI)	762
Offset Filter Alpha (Backward Compatibility SCPI)	763
Method for Carrier (Backward Compatibility SCPI)	764
Mode	765
Mode Preset	766
How-To Preset	767
Preset Type (Remote Command Only)	768
Mode Setup	769
Peak Search	770
Next Peak	770
Next Pk Right	770
Next Pk Left	771
Marker Delta	771
Pk-Pk Search	771
Min Search	771

## Table of Contents

Print	773
Quick Save	774
Recall	776
State	776
More Information	778
From File...	778
Edit Register Names	780
Register 1 thru Register 16	780
Register 1 thru Register 16	781
Data (Import)	782
Amplitude Correction	783
Amplitude Correction	784
Chan Table	784
Capture Buffer	785
DVB-T2 Config	785
Open...	786
Restart	787
More Information	787
Save	789
State	789
To File . . .	790
Edit Register Names	792
More Information	792
Register 1 thru Register 16	793
Register 1 thru Register 16	793
Data (Export)	794
Amplitude Correction	795
Correction Data File	795
Amplitude Correction	798
Chan Table	798
Measurement Results	798
Capture Buffer	807
DVB-T2 Config	807
Save As . . .	807
Screen Image	808
Themes	809
3D Color	810
3D Monochrome	810
Flat Color	810
Flat Monochrome	811
Save As...	811
Mass Storage Catalog (Remote Command Only)	811
Mass Storage Change Directory (Remote Command Only)	812

Mass Storage Copy (Remote Command Only)	812
Mass Storage Device Copy (Remote Command Only)	812
Mass Storage Delete (Remote Command Only)	813
Mass Storage Data (Remote Command Only)	813
Mass Storage Make Directory (Remote Command Only)	813
Mass Storage Move (Remote Command Only)	814
Mass Storage Remove Directory (Remote Command Only)	814
Single (Single Measurement/Sweep)	815
More Information	815
Source	816
SPAN X Scale	817
Span	817
Full Span	818
Last Span	818
Sweep/Control	820
Sweep Time	820
Sweep Setup	821
Auto Sweep Time Rules	822
Pause	822
Gate	822
Gate On/Off	823
Gate View On/Off	824
Gate View Setup	827
Gate View Sweep Time	827
Gate View Start Time	828
Gate Delay	828
Gate Length	829
Gate Source	829
Line	830
External 1	831
External 2	833
RF Burst	834
Periodic Timer (Frame Trigger)	837
Control Edge/Level	848
Gate Holdoff	849
Gate Delay Compensation	850
More Information	851
Min Fast Position Query (Remote Command Only)	852
Gate Preset (Remote Command Only)	852
Gate Level (Remote Command Only)	852
Gate Polarity (Remote Command Only)	852
Points	853
System	855

Trace/Detector	856
Select Trace (Front-panel Only)	856
Trace Type	856
View/Blank	857
Detector	858
Auto	859
Detector Selection	859
Trigger	861
Free Run	861
Video	861
Trigger Level	861
Trig Slope	861
Trig Delay	861
Line	861
Trig Slope	861
Trig Delay	861
External 1	861
Trigger Level	861
Trig Slope	861
Trig Delay	861
External 2	861
Trigger Level	862
Trig Slope	862
Trig Delay	862
RF Burst	862
Absolute Trigger	862
Relative Trigger	862
Trig Slope	862
Trig Delay	862
Periodic Timer	862
Period	862
Offset	862
Reset Offset Display	862
Sync Source	862
Off	862
External 1	863
External 2	863
RF Burst	863
Trig Delay	863
Auto/Holdoff	863
Auto Trig	863
Trig Holdoff	863
User Preset	864

User Preset	864
User Preset All Modes	865
Save User Preset	866
View/Display	867
Spectrum Window	869
Results Window	869
Display	872
Annotation	872
Meas Bar On/Off	873
Screen	874
Active Function Values On/Off	874
Title	875
Change Title	875
Clear Title	876
Graticule	877
System Display Settings	877
Annotation Local Settings	877
Themes	878
Backlight	879
Backlight Intensity	879
Bar Graph	880
<b>10 Power Stat CCDF Measurement</b>	<b>881</b>
AMPTD Y Scale	886
Attenuation	886
Dual Attenuator Configurations:	886
Single Attenuator Configuration:	887
(Mech) Atten	888
Attenuator Configurations and Auto/Man	889
Enable Elec Atten	889
More Information	890
Mechanical Attenuator Transition Rules	890
When the Electronic Attenuation is enabled from a disabled state:	891
Examples in the dual attenuator configuration:	891
When the Electronic Attenuation is disabled from an enabled state:	891
Using the Electronic Attenuator: Pros and Cons	891
Elec Atten	892
Adjust Atten for Min Clip	892
Pre-Adjust for Min Clip	893
Off	894
Elec Atten Only	894
Mech + Elec Atten	894
(Mech) Atten Step	894
Presel Center	895

Proper Preselector Operation	896
Preselector Adjust	896
$\mu$ W Path Control	898
Standard Path	899
Low Noise Path Enable	899
More Information	900
$\mu$ W Preselector Bypass	901
Internal Preamp	902
Off	903
Low Band	904
Full Range	904
Range	904
Range Auto/Man	905
I Range	906
1 V Peak	907
0.5 V Peak	907
0.25 V Peak	907
0.125 V Peak	907
Q Range Value	908
Q Same as I	909
1 V Peak	909
0.5 V Peak	909
0.25 V Peak	910
0.125 V Peak	910
I/Q Gain Ranges	910
1 V Peak	910
0.5 V Peak	910
0.25 V Peak	910
0.125 V Peak	911
Presel Center	911
Auto Couple	912
More Information	912
Auto/Man Active Function keys	912
Auto/Man 1-of-N keys	912
BW	914
Info BW	914
Cont (Continuous Measurement/Sweep)	916
File	918
FREQ Channel	919
Channel	919
Center Freq	919
Maximum Frequency in X - Series Signal Analyzers	920
RF Center Freq	921

IQ Center Freq	921
Chan Step	922
CF Step	922
Chan Table	923
NTSC-M	923
NTSC-J	924
NTSC-Brazil	924
PAL-M	925
PAL-I	925
PAL-B/G	926
PAL-D/K	926
Input/Output	927
Marker	928
Select Marker	928
Marker Type	928
Properties	929
Select Marker	929
Relative To	929
Marker Trace	930
Couple Markers	930
All Markers Off	930
Marker X Axis Value (Remote Command Only)	931
Marker Y Axis Value (Remote Command Only)	931
Marker Function	933
Marker To	934
Meas	935
Remote Measurement Functions	935
Measurement Group of Commands	936
Current Measurement Query (Remote Command Only)	938
Limit Test Current Results (Remote Command Only)	938
Data Query (Remote Command Only)	938
Calculate/Compress Trace Data Query (Remote Command Only)	939
Calculate Peaks of Trace Data (Remote Command Only)	944
Format Data: Numeric Data (Remote Command Only)	945
Format Data: Byte Order (Remote Command Only)	946
Meas Setup	947
Counts	947
Meas Cycles	947
Meas Interval (Not 1xEVDO)	948
IF Gain	949
IF Gain Auto	949
IF Gain State	950
Meas Preset	950

Mode	952
Mode Preset	953
How-To Preset	954
Preset Type (Remote Command Only)	955
Mode Setup	956
Peak Search	957
Print	958
Quick Save	959
Recall	961
State	961
More Information	963
From File...	963
Edit Register Names	965
Register 1 thru Register 16	965
Register 1 thru Register 16	966
Data (Import)	967
Amplitude Correction	968
Amplitude Correction	969
Chan Table	969
Capture Buffer	970
DVB-T2 Config	970
Open...	971
Restart	972
More Information	972
Save	974
State	974
To File . . .	975
Edit Register Names	977
More Information	977
Register 1 thru Register 16	978
Register 1 thru Register 16	978
Data (Export)	979
Amplitude Correction	980
Correction Data File	980
Amplitude Correction	983
Chan Table	983
Measurement Results	983
Meas Results File Definition	984
Meas Results File Example	986
Capture Buffer	987
DVB-T2 Config	988
Save As . . .	988
Screen Image	989



Themes	990
3D Color	991
3D Monochrome	991
Flat Color	991
Flat Monochrome	992
Save As...	992
Mass Storage Catalog (Remote Command Only)	992
Mass Storage Change Directory (Remote Command Only)	993
Mass Storage Copy (Remote Command Only)	993
Mass Storage Device Copy (Remote Command Only)	993
Mass Storage Delete (Remote Command Only)	994
Mass Storage Data (Remote Command Only)	994
Mass Storage Make Directory (Remote Command Only)	994
Mass Storage Move (Remote Command Only)	995
Mass Storage Remove Directory (Remote Command Only)	995
Single (Single Measurement/Sweep)	996
More Information	996
Source	997
Span X Scale	998
Scale/Div	998
Sweep/Control	999
Pause/Resume	999
System	1000
Trace/Detector	1001
Store Ref Trace	1001
Ref Trace	1001
Gaussian Line	1002
Trigger	1003
Free Run	1003
External 1	1003
Trigger Level	1003
Trig Slope	1003
Trig Delay	1003
External 2	1003
Trigger Level	1003
Trig Slope	1003
Trig Delay	1003
RF Burst	1003
Absolute Trigger	1003
Relative Trigger	1003
Trig Slope	1003
Trig Delay	1004
Auto/Holdoff	1004

## Table of Contents

Auto Trig	1004
Trig Holdoff	1004
Baseband I/Q	1004
I/Q Mag	1004
Trigger Level	1004
Trig Slope	1004
Trig Delay	1004
I	1004
Trigger Level	1004
Trig Slope	1004
Trig Delay	1004
Q	1004
Trigger Level	1005
Trig Slope	1005
Trig Delay	1005
Input I	1005
Trigger Level	1005
Trig Slope	1005
Trig Delay	1005
Input Q	1005
Trigger Level	1005
Trig Slope	1005
Trig Delay	1005
Aux Channel Center Freq	1005
Trigger Level	1005
Trig Slope	1005
Trig Delay	1005
Trigger Center Freq	1006
Trigger BW	1006
User Preset	1007
User Preset	1007
User Preset All Modes	1008
Save User Preset	1009
View/Display	1010
Metrics window	1012
Graph window	1013
Wave window (TD-SCDMA and LTE TDD only)	1013
Display	1014
Annotation	1014
Meas Bar On/Off	1015
Screen	1016
Active Function Values On/Off	1016
Title	1017

Change Title	1017
Clear Title	1018
Graticule	1019
System Display Settings	1019
Annotation Local Settings	1019
Themes	1020
Backlight	1021
Backlight Intensity	1021
<b>11 Spectrum Emission Mask Measurement</b>	<b>1023</b>
AMPTD Y Scale	1046
Ref Value	1046
Attenuation	1046
Dual Attenuator Configurations:	1047
Single Attenuator Configuration:	1048
(Mech) Atten	1048
Attenuator Configurations and Auto/Man	1050
Enable Elec Atten	1050
More Information	1051
Mechanical Attenuator Transition Rules	1051
When the Electronic Attenuation is enabled from a disabled state:	1051
Examples in the dual attenuator configuration:	1051
When the Electronic Attenuation is disabled from an enabled state:	1052
Using the Electronic Attenuator: Pros and Cons	1052
Elec Atten	1052
Adjust Atten for Min Clip	1053
Pre-Adjust for Min Clip	1053
Off	1054
Elec Atten Only	1054
Mech + Elec Atten	1055
(Mech) Atten Step	1055
Scale/Div	1056
Presel Center	1056
Proper Preselector Operation	1057
Preselector Adjust	1057
Y Axis Unit	1059
dBm	1060
dBmV	1060
dBmA	1060
W	1061
V	1061
A	1061
dB $\mu$ V	1062
dB $\mu$ A	1062

## Table of Contents

dBpW	1062
Antenna Unit	1063
dB $\mu$ V/m	1063
dB $\mu$ A/m	1063
dB $\mu$ A	1063
dBpT	1064
dBG	1064
None	1064
$\mu$ W Path Control	1065
Standard Path	1066
Low Noise Path Enable	1066
More Information	1067
$\mu$ W Preselector Bypass	1068
Internal Preamp	1069
Off	1070
Low Band	1071
Full Range	1071
Ref Position	1071
Auto Scaling	1072
Auto Couple	1073
More Information	1073
Auto/Man Active Function keys	1073
Auto/Man 1-of-N keys	1073
BW	1075
Filter Type	1075
Cont (Continuous Measurement/Sweep)	1076
File	1078
FREQ Channel	1079
Channel	1079
Center Freq	1079
Maximum Frequency in X - Series Signal Analyzers	1080
RF Center Freq	1081
IQ Center Freq	1081
Chan Step	1082
CF Step	1082
Chan Table	1083
NTSC-M	1083
NTSC-J	1084
NTSC-Brazil	1084
PAL-M	1085
PAL-I	1085
PAL-B/G	1086
PAL-D/K	1086

Input/Output	1087
Marker	1088
Select Marker	1088
Marker Type	1088
Couple Markers	1089
All Markers Off	1089
Marker X Axis Value (Remote Command Only)	1089
Marker X Axis Position (Remote Command Only)	1090
Marker Y Axis Value (Remote Command Only)	1091
Marker Function	1092
Marker To	1093
Meas	1094
Remote Measurement Functions	1094
Measurement Group of Commands	1095
Current Measurement Query (Remote Command Only)	1097
Limit Test Current Results (Remote Command Only)	1097
Data Query (Remote Command Only)	1097
Calculate/Compress Trace Data Query (Remote Command Only)	1098
Calculate Peaks of Trace Data (Remote Command Only)	1103
Format Data: Numeric Data (Remote Command Only)	1104
Format Data: Byte Order (Remote Command Only)	1105
Meas Setup	1106
Avg/Hold Num	1106
Meas Type	1106
Ref Channel	1107
Integ BW	1107
Span	1108
Sweep Time	1110
Res BW	1110
Video BW	1112
VBW/RBW	1113
Power Ref (for the modes except MSR and LTE-Advanced FDD/TDD)	1114
Total Power	1114
PSD	1115
Spectrum Peak	1116
Offset/Limits	1117
Select Offset	1117
Start Freq	1117
Stop Freq	1120
Sweep Time	1122
Offset Side	1123
Res BW	1124
Meas BW	1126

## Table of Contents

Video BW	1127
VBW/RBW	1128
Limits	1130
Select Offset	1130
Abs Start	1130
Abs Stop	1132
Rel Start	1135
Rel Stop	1137
Fail Mask	1139
Offset Freq Define	1141
Limit Type (Only for DVB-T/H)	1143
Method	1144
Filter Alpha	1145
Meas Preset	1145
Mode	1147
Mode Preset	1148
How-To Preset	1149
Preset Type (Remote Command Only)	1150
Mode Setup	1151
Peak Search	1152
Print	1153
Quick Save	1154
Recall	1156
State	1156
More Information	1158
From File...	1158
Edit Register Names	1160
Register 1 thru Register 16	1160
Register 1 thru Register 16	1161
Data (Import)	1162
Amplitude Correction	1163
Amplitude Correction	1164
Chan Table	1164
Capture Buffer	1165
DVB-T2 Config	1165
Open...	1166
Restart	1167
More Information	1167
Save	1169
State	1169
To File . . .	1170
Edit Register Names	1172
More Information	1172

Register 1 thru Register 16	1173
Register 1 thru Register 16	1173
Data (Export)	1174
Amplitude Correction	1175
Correction Data File	1175
Amplitude Correction	1178
Chan Table	1178
Measurement Results	1178
Meas Results File Contents	1179
Capture Buffer	1188
DVB-T2 Config	1189
Save As . . .	1189
Screen Image	1190
Themes	1191
3D Color	1191
3D Monochrome	1192
Flat Color	1192
Flat Monochrome	1192
Save As...	1192
Mass Storage Catalog (Remote Command Only)	1193
Mass Storage Change Directory (Remote Command Only)	1193
Mass Storage Copy (Remote Command Only)	1194
Mass Storage Device Copy (Remote Command Only)	1194
Mass Storage Delete (Remote Command Only)	1194
Mass Storage Data (Remote Command Only)	1194
Mass Storage Make Directory (Remote Command Only)	1195
Mass Storage Move (Remote Command Only)	1195
Mass Storage Remove Directory (Remote Command Only)	1196
Single (Single Measurement/Sweep)	1197
More Information	1197
Source	1198
Span X Scale	1199
Ref Value	1199
Scale/Div	1199
Ref Position	1200
Auto Scaling	1200
Sweep/Control	1202
Pause	1202
Gate	1202
Gate On/Off	1202
Gate View On/Off	1203
Gate View Setup	1206
Gate View Sweep Time	1207

Gate View Start Time	1207
Gate Delay	1208
Gate Length	1208
Gate Source	1209
Line	1210
External 1	1210
External 2	1212
RF Burst	1214
Periodic Timer (Frame Trigger)	1217
Control Edge/Level	1228
Gate Holdoff	1228
Gate Delay Compensation	1230
More Information	1231
Min Fast Position Query (Remote Command Only)	1231
Gate Preset (Remote Command Only)	1232
Gate Level (Remote Command Only)	1232
Gate Polarity (Remote Command Only)	1232
System	1234
Trace/Detector	1235
Trace Type	1235
Chan Detector	1235
Chan Detector Auto	1236
Chan Detector Selection	1236
Offset Detector	1237
Offset Detector Auto	1237
Offset Detector Selection	1238
Trigger	1239
Free Run	1239
Video	1239
Trigger Level	1239
Trig Slope	1239
Trig Delay	1239
Line	1239
Trig Slope	1239
Trig Delay	1239
External 1	1239
Trigger Level	1239
Trig Slope	1239
Trig Delay	1239
External 2	1239
Trigger Level	1240
Trig Slope	1240
Trig Delay	1240



RF Burst	1240
Absolute Trigger	1240
Relative Trigger	1240
Trig Slope	1240
Trig Delay	1240
Periodic Timer	1240
Period	1240
Offset	1240
Reset Offset Display	1240
Sync Source	1240
Off	1240
External 1	1241
External 2	1241
RF Burst	1241
Trig Delay	1241
Auto/Holdoff	1241
Auto Trig	1241
Trig Holdoff	1241
User Preset	1242
User Preset	1242
User Preset All Modes	1243
Save User Preset	1244
View/Display	1245
View Selection by Name (Remote Command Only)	1245
Views Selection by Number (Remote Command only)	1246
Display	1246
Annotation	1247
Meas Bar On/Off	1248
Screen	1249
Active Function Values On/Off	1249
Title	1250
Change Title	1250
Clear Title	1251
Graticule	1252
System Display Settings	1252
Annotation Local Settings	1252
Themes	1253
Backlight	1254
Backlight Intensity	1254
Abs Pwr Freq	1255
Abs Peak Pwr & Freq (Total Pwr Ref)	1255
Trace Window	1257
Results Window	1257

Abs Peak Pwr & Freq (PSD Ref)	1257
Trace Window	1259
Results Window	1259
Abs Peak Pwr & Freq (Spectrum Pk Ref)	1259
Trace Window	1261
Results Window	1261
Rel Pwr Freq	1261
Rel Peak Pwr & Freq (Total Pwr Ref)	1261
Trace Window	1262
Results Window	1262
Rel Peak Pwr & Freq (PSD Ref)	1263
Trace Window	1263
Results Window	1264
Rel Peak Pwr & Freq (Spectrum Pk Ref)	1264
Trace Window	1265
Results Window	1265
Integrated Power	1266
Integrated Power (Total Pwr Ref)	1266
Trace Window	1268
Results Window	1268
Integrated Power (PSD Ref)	1269
Trace Window	1271
Results Window	1271
Integrated Power (Spectrum Pk Ref)	1272
Trace Window	1273
Results Window	1273
Limit Lines	1274
<b>12 Mod Accuracy Measurement</b>	<b>1275</b>
Amplitude (AMPTD) Y Scale	1282
Ref Value	1282
Y Ref Value (I/Q Error View – MER/EVM vs. Sub-carrier/ Frequency Window)	1282
Y Ref Value (Scale Type is MER)	1282
Y Ref Value (Scale Type is EVM)	1283
Y Ref Value (I/Q Error View – Spectrum Window)	1283
Y Ref Value (Channel Frequency Response View – Amptd vs. Sub-carrier Window)	1284
Y Ref Value (Channel Frequency Response View – Phase vs. Sub-carrier Window)	1284
Y Ref Value (Channel Frequency Response View – Group Delay vs. Sub-carrier Window)	1285
Y Ref Value (Channel Impulse Response View – Amptd vs. Time Window)	1285
Y Ref Value (MER Monitor View – MER vs. Time Window)	1286
Attenuation	1287

Dual Attenuator Configurations:	1287
Single Attenuator Configuration:	1288
(Mech) Atten	1288
Attenuator Configurations and Auto/Man	1290
Enable Elec Atten	1290
More Information	1291
Mechanical Attenuator Transition Rules	1291
When the Electronic Attenuation is enabled from a disabled state:	1291
Examples in the dual attenuator configuration:	1292
When the Electronic Attenuation is disabled from an enabled state:	1292
Using the Electronic Attenuator: Pros and Cons	1292
Elec Atten	1292
Adjust Atten for Min Clip	1293
Pre-Adjust for Min Clip	1293
Off	1294
Elec Atten Only	1295
Mech + Elec Atten	1295
(Mech) Atten Step	1295
Scale/Div	1296
Y Scale/Div (I/Q Error View – MER/EVM vs. Sub-carrier/ Frequency Window)	1296
Y Scale/Div (Scale Type is MER)	1296
Y Scale/Div (Scale Type is EVM)	1297
Y Scale/Div (I/Q Error View – Spectrum Window)	1297
Y Scale/Div (Channel Frequency Response View – Amptd vs. Sub-carrier Window)	1298
Y Scale/Div (Channel Frequency Response View – Phase vs. Sub-carrier Window)	1298
Y Scale/Div (Channel Frequency Response View – Group Delay vs. Sub-carrier Window)	1299
Y Scale/Div (Channel Impulse Response View – Amptd vs. Time Window)	1300
Y Scale/Div (MER Monitor View – MER vs. Time Window)	1300
Presel Center	1301
Proper Preselector Operation	1302
Preselector Adjust	1302
$\mu$ W Path Control	1303
Standard Path	1304
Low Noise Path Enable	1305
More Information	1305
$\mu$ W Preselector Bypass	1307
Scale Type	1308
Internal Preamp	1308
Off	1309
Low Band	1309

Full Range	1310
Range	1310
Range Auto/Man	1311
I Range	1312
1 V Peak	1313
0.5 V Peak	1313
0.25 V Peak	1313
0.125 V Peak	1313
Q Range Value	1313
Q Same as I	1314
1 V Peak	1315
0.5 V Peak	1315
0.25 V Peak	1315
0.125 V Peak	1315
I/Q Gain Ranges	1316
1 V Peak	1316
0.5 V Peak	1316
0.25 V Peak	1316
0.125 V Peak	1316
Ref Position	1316
Y Ref Position (I/Q Error View – MER/EVM vs. Sub-carrier/Frequency Window)	1317
Y Ref Position (I/Q Error View – Spectrum Window)	1317
Y Ref Position (Channel Frequency Response View – Amptd vs. Sub-carrier Window)	1318
Y Ref Position (Channel Frequency Response View – Phase vs. Sub-carrier Window)	1318
Y Ref Position (Channel Frequency Response View –Group Delay vs. Sub-carrier Window)	1319
Y Ref Position (Channel Impulse Response View – Amptd vs. Time Window)	1319
Y Ref Position (MER Monitor View – MER vs. Time Window)	1320
Auto Scaling	1320
Y Auto Scaling (I/Q Error View – MER/EVM vs. Sub-carrier/Frequency Window)	1320
Y Auto Scaling (I/Q Error View – Spectrum Window)	1321
Y Auto Scaling (Channel Frequency Response View – Amptd vs. Sub-carrier Window)	1321
Y Auto Scaling (Channel Frequency Response View – Phase vs. Sub-carrier Window)	1322
Y Auto Scaling (Channel Frequency Response View –Group Delay vs. Sub-carrier Window)	1323
Y Auto Scaling (Channel Impulse Response View – Amptd vs. Time Window)	1323
Y Auto Scaling (MER Monitor View – MER vs. Time Window)	1324
Auto Couple	1325
More Information	1325

Auto/Man Active Function keys	1325
Auto/Man 1-of-N keys	1325
BW	1327
Cont (Continuous Measurement/Sweep)	1328
File	1330
FREQ Channel	1331
Channel	1331
Center Freq	1331
Maximum Frequency in X - Series Signal Analyzers	1332
RF Center Freq	1333
IQ Center Freq	1333
Chan Step	1334
CF Step	1334
Chan Table	1335
NTSC-M	1335
NTSC-J	1336
NTSC-Brazil	1336
PAL-M	1337
PAL-I	1337
PAL-B/G	1338
PAL-D/K	1338
Input/Output	1339
Marker	1340
Select Marker	1340
Marker Type	1340
Properties	1341
Select Marker	1341
Relative To	1341
Marker Trace	1342
Couple Markers	1342
All Markers Off	1343
Marker X-axis Value (Remote Command only)	1343
Marker X-axis Position (Remote Command only)	1344
Marker Y-axis Value (Remote Command only)	1344
Marker Function	1345
Marker To	1346
Meas	1347
Remote Measurement Functions	1347
Measurement Group of Commands	1348
Current Measurement Query (Remote Command Only)	1350
Limit Test Current Results (Remote Command Only)	1350
Data Query (Remote Command Only)	1350
Calculate/Compress Trace Data Query (Remote Command Only)	1351

Calculate Peaks of Trace Data (Remote Command Only)	1356
Format Data: Numeric Data (Remote Command Only)	1357
Format Data: Byte Order (Remote Command Only)	1358
Meas Setup	1359
Avg/Hold Num	1359
Avg Mode	1359
Auto Detect	1360
Demod	1360
Guard Interval	1361
FFT Size	1361
Hierarchical	1362
Modulation Format	1362
Alpha	1363
Decode	1364
Decoding	1364
Inner Interleaver	1364
HP (High Priority) Code Rate	1365
LP (Low Priority) Code Rate	1366
BER Count Type	1366
HP Before Viterbi	1367
HP Before RS	1367
LP Before Viterbi	1368
LP Before RS	1368
BER Bit Count	1368
Payload	1369
Advanced	1369
EVM Ref Calc Mode	1369
I/Q Mismatch	1371
Spectrum	1371
Equalization	1372
Clock Rate	1372
Demodulation Symbols	1373
Out of Band Filtering	1373
IF Gain	1374
IF Gain Auto	1374
IF Gain State	1375
FFT Start Position	1375
PhNoise Opt	1376
MER Monitor	1377
Monitor	1378
Display Points	1379
Limit Line	1379
Max Raw Data Files Saved	1380

Delete All MER Log and Data Files	1380
Meas Preset	1381
Mode	1382
Mode Preset	1383
How-To Preset	1384
Preset Type (Remote Command Only)	1385
Mode Setup	1386
Peak Search	1387
Next Peak	1387
Next Pk Right	1387
Next Pk Left	1387
Marker Delta	1388
Peak Criteria	1388
Pk Excursion	1388
Pk Threshold	1389
Pk Threshold Line	1390
More Information	1390
Peak Table	1391
Peak Table	1392
Peak Sort	1393
Peak Limit	1393
Pk-Pk Search	1394
Min Search	1394
Print	1395
Quick Save	1396
Recall	1398
State	1398
More Information	1400
From File...	1400
Edit Register Names	1402
Register 1 thru Register 16	1402
Register 1 thru Register 16	1403
Data (Import)	1404
Amplitude Correction	1405
Amplitude Correction	1406
Chan Table	1406
Capture Buffer	1407
DVB-T2 Config	1407
Open...	1408
Restart	1409
More Information	1409
Save	1411
State	1411

To File . . .	1412
Edit Register Names	1414
More Information	1414
Register 1 thru Register 16	1415
Register 1 thru Register 16	1415
Data (Export)	1416
Amplitude Correction	1417
Correction Data File	1417
Amplitude Correction	1420
Chan Table	1420
Measurement Results	1421
Capture Buffer	1421
DVB-T2 Config	1421
Save As . . .	1422
Screen Image	1422
Themes	1424
3D Color	1424
3D Monochrome	1424
Flat Color	1424
Flat Monochrome	1425
Save As...	1425
Mass Storage Catalog (Remote Command Only)	1425
Mass Storage Change Directory (Remote Command Only)	1426
Mass Storage Copy (Remote Command Only)	1426
Mass Storage Device Copy (Remote Command Only)	1426
Mass Storage Delete (Remote Command Only)	1427
Mass Storage Data (Remote Command Only)	1427
Mass Storage Make Directory (Remote Command Only)	1427
Mass Storage Move (Remote Command Only)	1428
Mass Storage Remove Directory (Remote Command Only)	1428
Single (Single Measurement/Sweep)	1429
More Information	1429
Source	1430
SPAN X Scale	1431
Ref Value	1431
X Ref Value (I/Q Error View – MER/EVM vs. Sub-carrier/Frequency Window)	1431
X Ref Value (Scale Type is Carrier)	1431
X Ref Value (Scale Type is Freq)	1432
X Ref Value (I/Q Error View – Spectrum Window)	1432
X Ref Value (Channel Frequency Response View – Amptd vs. Sub-carrier Window)	1433
X Ref Value (Channel Frequency Response View – Phase vs. Sub-carrier Window)	1433



X Ref Value (Channel Frequency Response View –Group Delay vs. Sub-carrier Window)	1434
X Ref Value (Channel Impulse Response View – Amptd vs. Time Window)	1434
X Ref Value (Scale Type is Time)	1435
X Ref Value (Scale Type is Distance)	1435
X Ref Value (MER Monitor View – MER vs. Time Window)	1436
Scale/Div	1436
X Scale/Div (I/Q Error View – MER/EVM vs. Sub-carrier/ Frequency Window)	1436
X Scale/Div (Scale Type is Carrier)	1437
X Scale/Div (Scale Type is Freq)	1437
X Scale/Div (I/Q Error View – Spectrum Window)	1438
X Scale/Div (Channel Frequency Response View – Amptd vs. Sub-carrier Window)	1438
X Scale/Div (Channel Frequency Response View – Phase vs. Sub-carrier Window)	1439
X Scale/Div (Channel Frequency Response View –Group Delay vs. Sub-carrier Window)	1439
X Scale/Div (Channel Impulse Response View – Amptd vs. Time Window)	1440
X Scale/Div (Scale Type is Time)	1440
X Scale/Div (Scale Type is Distance)	1441
X Scale/Div (MER Monitor View – MER vs. Time Window)	1441
Ref Position	1442
X Ref Position (I/Q Error View – MER/EVM vs. Sub-carrier/Frequency Window)	1442
X Ref Position (I/Q Error View – Spectrum Window)	1442
X Ref Position (Channel Frequency Response View – Amptd vs. Sub-carrier Window)	1443
X Ref Position (Channel Frequency Response View – Phase vs. Sub-carrier Window)	1443
X Ref Position (Channel Frequency Response View –Group Delay vs. Sub-carrier Window)	1444
X Ref Position (Channel Impulse Response View – Amptd vs. Time Window)	1444
X Ref Position (MER Monitor View – MER vs. Time Window)	1445
Auto Scaling	1445
X Auto Scaling (I/Q Error View – MER/EVM vs. Sub-carrier/Frequency Window)	1445
X Auto Scaling (I/Q Error View – Spectrum Window)	1446
X Auto Scaling (Channel Frequency Response View – Amptd vs. Sub-carrier Window)	1447
X Auto Scaling (Channel Frequency Response View – Phase vs. Sub-carrier Window)	1447
X Auto Scaling (Channel Frequency Response View –Group Delay vs. Sub-carrier Window)	1448
X Auto Scaling (Channel Impulse Response View – Amptd vs. Time Window)	1448
X Auto Scaling (MER Monitor MER vs. Time Window)	1449

## Table of Contents

Scale Type	1449
Scale Type (MER/EVM vs. Sub-carrier/ Frequency window)	1450
Scale Type (Amptd vs. Time window)	1450
Sweep/Control	1451
Pause/Resume	1451
Abort (Remote Command Only)	1451
System	1453
Trace/Detector	1454
Normalize	1454
Normalize On/Off	1454
Store Ref	1454
Show Ref Trace	1455
Norm Ref Lvl	1455
Norm Ref Posn	1455
Trigger	1457
Free Run	1457
External 1	1457
Trigger Level	1457
Trig Slope	1457
Trig Delay	1457
External 2	1457
Trigger Level	1457
Trig Slope	1457
Trig Delay	1457
RF Burst	1457
Absolute Trigger	1457
Relative Trigger	1457
Trig Slope	1457
Trig Delay	1458
Auto/Holdoff	1458
Auto Trig	1458
Trig Holdoff	1458
Baseband I/Q	1458
I/Q Mag	1458
Trigger Level	1458
Trig Slope	1458
Trig Delay	1458
I	1458
Trigger Level	1458
Trig Slope	1458
Trig Delay	1458
Q	1458
Trigger Level	1459

Trig Slope	1459
Trig Delay	1459
Input I	1459
Trigger Level	1459
Trig Slope	1459
Trig Delay	1459
Input Q	1459
Trigger Level	1459
Trig Slope	1459
Trig Delay	1459
Aux Channel Center Freq	1459
Trigger Level	1459
Trig Slope	1459
Trig Delay	1459
Trigger Center Freq	1460
Trigger BW	1460
User Preset	1461
User Preset	1461
User Preset All Modes	1462
Save User Preset	1463
View/Display	1464
View Selection	1464
Display	1465
Annotation	1465
Meas Bar On/Off	1466
Screen	1467
Active Function Values On/Off	1467
Title	1468
Change Title	1468
Clear Title	1469
Graticule	1470
System Display Settings	1470
Annotation Local Settings	1470
Themes	1471
Backlight	1472
Backlight Intensity	1472
I/Q Measured Polar Graph	1473
Result Metrics Window	1473
I/Q Measured Polar Graph Window	1474
Start Carrier	1475
Stop Carrier	1475
I/Q Error	1476
MER/EVM vs. Sub-carrier/Frequency Window	1477

Spectrum Window	1479
I/Q Mismatch Polar Graph Window	1480
Result Metrics Window	1480
Channel Frequency Response	1481
Amplitude vs. Sub-carrier Window	1481
Phase vs. Sub-carrier Window	1482
Group delay vs. Sub-carrier Window	1482
Group Delay Aperture	1482
Channel Impulse Response	1483
Amplitude vs. time window	1483
GI Range Bar	1484
TPS Decoding	1485
BER Results	1486
BER Results Window	1487
MER Monitor	1489
MER vs. time window	1490
Result Metrics	1491
Result Metrics Summary Window	1492
View Selection by number (Remote Command SCPI only)	1494
<b>13 DVB-T2 Mod Accuracy Measurement</b>	<b>1495</b>
Amplitude (AMPTD) Y Scale	1504
Ref Value	1504
Y Ref Value (I/Q Error View – MER/EVM vs. Sub-carrier/ Frequency Window)	1504
Y Ref Value (Scale Type is MER)	1504
Y Ref Value (Scale Type is EVM)	1505
Y Ref Value (Channel Frequency Response View – Amptd vs. Sub-carrier Window)	1505
Y Ref Value (Channel Frequency Response View – Phase vs. Sub-carrier Window)	1506
Y Ref Value (Channel Frequency Response View – Group Delay vs. Sub-carrier Window)	1506
Y Ref Value (Channel Impulse Response View – Amptd vs. Time Window)	1507
Y Ref Value (MER Monitor View – MER vs. Time Window)	1508
Attenuation	1508
Dual Attenuator Configurations:	1509
Single Attenuator Configuration:	1509
(Mech) Atten	1510
Attenuator Configurations and Auto/Man	1511
Enable Elec Atten	1512
More Information	1513
Mechanical Attenuator Transition Rules	1513
When the Electronic Attenuation is enabled from a disabled state:	1513
Examples in the dual attenuator configuration:	1513

When the Electronic Attenuation is disabled from an enabled state:	1513
Using the Electronic Attenuator: Pros and Cons	1514
Elec Atten	1514
Adjust Atten for Min Clip	1515
Pre-Adjust for Min Clip	1515
Off	1516
Elec Atten Only	1516
Mech + Elec Atten	1516
(Mech) Atten Step	1517
Scale/Div	1517
Y Scale/Div (I/Q Error View – MER/EVM vs. Sub-carrier/ Frequency Window)	1518
Y Scale/Div (Scale Type is MER)	1518
Y Scale/Div (Scale Type is EVM)	1518
Y Scale/Div (Channel Frequency Response View – Amptd vs. Sub-carrier Window)	1519
Y Scale/Div (Channel Frequency Response View – Phase vs. Sub-carrier Window)	1519
Y Scale/Div (Channel Frequency Response View – Group Delay vs. Sub-carrier Window)	1520
Y Scale/Div (Channel Impulse Response View – Amptd vs. Time Window)	1520
Y Scale/Div (MER Monitor View – MER vs. Time Window)	1521
Presel Center	1522
Proper Preselector Operation	1523
Preselector Adjust	1523
$\mu$ W Path Control	1524
Standard Path	1525
Low Noise Path Enable	1526
More Information	1526
$\mu$ W Preselector Bypass	1528
Scale Type	1529
Internal Preamp	1529
Off	1530
Low Band	1530
Full Range	1531
Range	1531
Range Auto/Man	1532
I Range	1533
1 V Peak	1534
0.5 V Peak	1534
0.25 V Peak	1534
0.125 V Peak	1534
Q Range Value	1534
Q Same as I	1535

## Table of Contents

1 V Peak	1536
0.5 V Peak	1536
0.25 V Peak	1536
0.125 V Peak	1536
I/Q Gain Ranges	1537
1 V Peak	1537
0.5 V Peak	1537
0.25 V Peak	1537
0.125 V Peak	1537
Ref Position	1537
Y Ref Position (I/Q Error View – MER/EVM vs. Sub-carrier/Frequency Window)	1538
Y Ref Position (Channel Frequency Response View – Amptd vs. Sub-carrier Window)	1538
Y Ref Position (Channel Frequency Response View – Phase vs. Sub-carrier Window)	1539
Y Ref Position (Channel Frequency Response View –Group Delay vs. Sub-carrier Window)	1539
Y Ref Position (Channel Impulse Response View – Amptd vs. Time Window)	1540
Y Ref Position (MER Monitor View – MER vs. Time Window)	1540
Auto Scaling	1541
Y Auto Scaling (I/Q Error View – MER/EVM vs. Sub-carrier/Frequency Window)	1541
Y Auto Scaling (Channel Frequency Response View – Amptd vs. Sub-carrier Window)	1541
Y Auto Scaling (Channel Frequency Response View – Phase vs. Sub-carrier Window)	1542
Y Auto Scaling (Channel Frequency Response View –Group Delay vs. Sub-carrier Window)	1542
Y Auto Scaling (Channel Impulse Response View – Amptd vs. Time Window)	1543
Y Auto Scaling (MER Monitor View – MER vs. Time Window)	1544
Auto Couple	1545
More Information	1545
Auto/Man Active Function keys	1545
Auto/Man 1-of-N keys	1545
BW	1547
Cont (Continuous Measurement/Sweep)	1548
File	1550
FREQ Channel	1551
Channel	1551
Center Freq	1551
Maximum Frequency in X – Series Signal Analyzers	1552
RF Center Freq	1553
IQ Center Freq	1553
Chan Step	1554

CF Step	1554
Chan Table	1555
NTSC-M	1555
NTSC-J	1556
NTSC-Brazil	1556
PAL-M	1557
PAL-I	1557
PAL-B/G	1558
PAL-D/K	1558
Input/Output	1559
Marker	1560
Select Marker	1560
Marker Type	1560
Properties	1561
Select Marker	1561
Relative To	1561
Marker Trace	1562
Couple Markers	1562
All Markers Off	1563
Marker X-axis Value (Remote Command only)	1563
Marker X-axis Position (Remote Command only)	1564
Marker Y-axis Value (Remote Command only)	1564
Marker Function	1565
Marker To	1566
Meas	1567
Remote Measurement Functions	1567
Measurement Group of Commands	1568
Current Measurement Query (Remote Command Only)	1570
Limit Test Current Results (Remote Command Only)	1570
Data Query (Remote Command Only)	1570
Calculate/Compress Trace Data Query (Remote Command Only)	1571
Calculate Peaks of Trace Data (Remote Command Only)	1576
Format Data: Numeric Data (Remote Command Only)	1577
Format Data: Byte Order (Remote Command Only)	1578
Meas Setup	1579
Avg/Hold Num	1579
Avg Mode	1579
Auto Detect	1580
Demod	1581
Guard Interval	1581
FFT Size	1582
Carrier Mode	1582
Pilot Pattern	1583

## Table of Contents

L1 Modulation Format	1584
Data Symbols	1585
PAPR Type	1585
PLP	1586
PLP Number	1586
Modulation Format	1586
Constellation Rotation	1587
FEC Type	1587
Time IL Length	1588
FEC Block Num	1588
Sync Frame Now	1589
Advanced	1589
Spectrum	1589
Equalization	1590
Clock Rate	1590
Out of Band Filtering	1591
FFT Start Position	1592
MISO Test Setup	1593
Frame Tracking	1593
IF Gain	1593
IF Gain Auto	1594
IF Gain State	1594
PhNoise Opt	1595
MER Monitor	1596
Monitor	1597
Monitor Time	1597
Display Points	1598
Limit Line	1598
Max Raw Data Files Saved	1599
Delete All MER Log and Data Files	1599
Decode	1600
Decoding	1600
PLP ID	1601
Code Rate	1601
BER Count Type	1601
Before LDPC	1602
Before BCH	1602
BER Bit Count	1602
Meas Preset	1603
Mode	1604
Mode Preset	1605
How-To Preset	1606
Preset Type (Remote Command Only)	1607



Mode Setup	1608
Peak Search	1609
Next Peak	1609
Next Pk Right	1609
Next Pk Left	1609
Marker Delta	1610
Peak Criteria	1610
Pk Excursion	1610
Pk Threshold	1611
Pk Threshold Line	1612
More Information	1612
Peak Table	1613
Peak Table	1614
Peak Sort	1615
Peak Limit	1615
Pk-Pk Search	1616
Min Search	1616
Print	1617
Quick Save	1618
Recall	1620
State	1620
More Information	1622
From File...	1622
Edit Register Names	1624
Register 1 thru Register 16	1624
Register 1 thru Register 16	1625
Data (Import)	1626
Amplitude Correction	1627
Amplitude Correction	1628
Chan Table	1628
Capture Buffer	1629
DVB-T2 Config	1629
Open...	1630
Restart	1631
More Information	1631
Save	1633
State	1633
To File . . .	1634
Edit Register Names	1636
More Information	1636
Register 1 thru Register 16	1637
Register 1 thru Register 16	1637
Data (Export)	1638

Amplitude Correction	1639
Correction Data File	1639
Amplitude Correction	1642
Chan Table	1642
Measurement Results	1643
Capture Buffer	1643
DVB-T2 Config	1643
Save As . . .	1644
Screen Image	1644
Themes	1646
3D Color	1646
3D Monochrome	1646
Flat Color	1646
Flat Monochrome	1647
Save As...	1647
Mass Storage Catalog (Remote Command Only)	1647
Mass Storage Change Directory (Remote Command Only)	1648
Mass Storage Copy (Remote Command Only)	1648
Mass Storage Device Copy (Remote Command Only)	1648
Mass Storage Delete (Remote Command Only)	1649
Mass Storage Data (Remote Command Only)	1649
Mass Storage Make Directory (Remote Command Only)	1649
Mass Storage Move (Remote Command Only)	1650
Mass Storage Remove Directory (Remote Command Only)	1650
Single (Single Measurement/Sweep)	1651
More Information	1651
Source	1652
SPAN X Scale	1653
Ref Value	1653
X Ref Value (I/Q Error View – MER/EVM vs. Sub-carrier/Frequency Window)	1653
X Ref Value (Scale Type is Carrier)	1653
X Ref Value (Scale Type is Freq)	1654
X Ref Value (Channel Frequency Response View – Amptd vs. Sub-carrier Window)	1654
X Ref Value (Channel Frequency Response View – Phase vs. Sub-carrier Window)	1655
X Ref Value (Channel Frequency Response View –Group Delay vs. Sub-carrier Window)	1655
X Ref Value (Channel Impulse Response View – Amptd vs. Time Window)	1656
X Ref Value (Scale Type is Time)	1656
X Ref Value (Scale Type is Distance)	1657
X Ref Value (MER Monitor View – MER vs. Time Window)	1657
Scale/Div	1658

X Scale/Div (I/Q Error View – MER/EVM vs. Sub-carrier/ Frequency Window)	1658
X Scale/Div (Scale Type is Carrier)	1658
X Scale/Div (Scale Type is Freq)	1659
X Scale/Div (Channel Frequency Response View – Amptd vs. Sub-carrier Window)	1659
X Scale/Div (Channel Frequency Response View – Phase vs. Sub-carrier Window)	1660
X Scale/Div (Channel Frequency Response View –Group Delay vs. Sub-carrier Window)	1660
X Scale/Div (Channel Impulse Response View – Amptd vs. Time Window)	1661
"X Scale/Div (Scale Type is Time)" on page 1	1661
"X Scale/Div (Scale Type is Distance)" on page 1	1661
X Scale/Div (Scale Type is Time)	1661
X Scale/Div (Scale Type is Distance)	1662
X Scale/Div (MER Monitor View – MER vs. Time Window)	1662
Ref Position	1663
X Ref Position (I/Q Error View – MER/EVM vs. Sub-carrier/Frequency Window)	1663
X Ref Position (Channel Frequency Response View – Amptd vs. Sub-carrier Window)	1664
X Ref Position (Channel Frequency Response View – Phase vs. Sub-carrier Window)	1664
X Ref Position (Channel Frequency Response View –Group Delay vs. Sub-carrier Window)	1665
X Ref Position (Channel Impulse Response View – Amptd vs. Time Window)	1665
X Ref Position (MER Monitor View – MER vs. Time Window)	1665
Auto Scaling	1666
X Auto Scaling (I/Q Error View – MER/EVM vs. Sub-carrier/Frequency Window)	1666
X Auto Scaling (Channel Frequency Response View – Amptd vs. Sub-carrier Window)	1667
X Auto Scaling (Channel Frequency Response View – Phase vs. Sub-carrier Window)	1667
X Auto Scaling (Channel Frequency Response View –Group Delay vs. Sub-carrier Window)	1668
X Auto Scaling (Channel Impulse Response View – Amptd vs. Time Window)	1668
X Auto Scaling (MER Monitor MER vs. Time Window)	1669
Scale Type	1670
Scale Type (MER/EVM vs. Sub-carrier/Frequency window)	1670
Scale Type (Amptd vs. Time window)	1670
Sweep/Control	1672
Pause/Resume	1672
Abort (Remote Command Only)	1672
System	1674
Trace/Detector	1675

## Table of Contents

Normalize	1675
Normalize On/Off	1675
Store Ref	1675
Show Ref Trace	1676
Norm Ref Lvl	1676
Norm Ref Posn	1676
Trigger	1678
Free Run	1678
External 1	1678
Trigger Level	1678
Trig Slope	1678
Trig Delay	1678
External 2	1678
Trigger Level	1678
Trig Slope	1678
Trig Delay	1678
RF Burst	1678
Absolute Trigger	1678
Relative Trigger	1678
Trig Slope	1678
Trig Delay	1679
Periodic Timer	1679
Period	1679
Offset	1679
Offset Adjust (Remote Command Only)	1679
Reset Offset Display	1679
Sync Source	1679
Off	1679
External 1	1679
External 2	1679
RF Burst	1679
Trig Delay	1680
Auto/Holdoff	1680
Auto Trig	1680
Trig Holdoff	1680
Baseband I/Q	1680
I/Q Mag	1680
Trigger Level	1680
Trig Slope	1680
Trig Delay	1680
I	1680
Trigger Level	1680
Trig Slope	1680

Trig Delay	1681
Q	1681
Trigger Level	1681
Trig Slope	1681
Trig Delay	1681
Input I	1681
Trigger Level	1681
Trig Slope	1681
Trig Delay	1681
Input Q	1681
Trigger Level	1681
Trig Slope	1681
Trig Delay	1681
Aux Channel Center Freq	1681
Trigger Level	1682
Trig Slope	1682
Trig Delay	1682
Trigger Center Freq	1682
Trigger BW	1682
User Preset	1683
User Preset	1683
User Preset All Modes	1684
Save User Preset	1685
View/Display	1686
View Selection	1686
Display	1687
Annotation	1688
Meas Bar On/Off	1689
Screen	1689
Active Function Values On/Off	1689
Title	1690
Change Title	1690
Clear Title	1691
Graticule	1692
System Display Settings	1692
Annotation Local Settings	1692
Themes	1693
Backlight	1694
Backlight Intensity	1694
I/Q Measured Polar Graph	1695
Result Metrics Window	1697
I/Q Measured Polar Graph Window	1698
Start Carrier	1698

Stop Carrier	1699
PLP ID	1700
Display Type	1700
Data	1700
Pilot	1701
L1-pre	1701
L1-post	1702
I/Q Error	1702
MER/EVM vs. Sub-carrier/Frequency Window	1703
L1 Signalling Window	1707
I/Q Measured Polar Graph Window	1708
Result Metrics Window	1708
PLP ID	1709
Scroll	1709
Prev Page	1709
Next Page	1710
Scroll Up	1710
Scroll Down	1710
First Page	1710
Last Page	1711
Channel Frequency Response	1711
Amplitude vs. Sub-carrier Window	1712
Phase vs. Sub-carrier Window	1712
Group delay vs. Sub-carrier Window	1712
MISO Display	1713
Group Delay Aperture	1713
Channel Impulse Response	1714
Amplitude vs. time window	1714
MISO Display	1716
GI Range Bar	1717
L1 Signalling	1717
Prev Page	1718
Next Page	1718
Scroll Up	1719
Scroll Down	1719
First Page	1719
Last Page	1719
MER Monitor	1720
MER vs. Time window	1721
MER vs. PLP	1721
Prev Page	1723
Next Page	1723
Scroll Up	1723

Scroll Down	1723
First Page	1724
Last Page	1724
Result Metrics	1724
Result Metrics Summary Window	1725
BER Results	1727
BER Results Window	1728
View Selection by number (Remote Command SCPI only)	1729
<b>14 Spurious Emissions Measurement</b>	<b>1731</b>
AMPTD Y Scale	1734
Ref Value	1734
Attenuation	1734
Dual Attenuator Configurations:	1735
Single Attenuator Configuration:	1736
(Mech) Atten	1736
Attenuator Configurations and Auto/Man	1738
Enable Elec Atten	1738
More Information	1739
Mechanical Attenuator Transition Rules	1739
When the Electronic Attenuation is enabled from a disabled state:	1739
Examples in the dual attenuator configuration:	1739
When the Electronic Attenuation is disabled from an enabled state:	1740
Using the Electronic Attenuator: Pros and Cons	1740
Elec Atten	1740
Adjust Atten for Min Clip	1741
Pre-Adjust for Min Clip	1741
Off	1742
Elec Atten Only	1742
Mech + Elec Atten	1743
(Mech) Atten Step	1743
Scale/Div	1744
Presel Center	1744
Proper Preselector Operation	1745
Preselector Adjust	1746
Y Axis Unit	1747
dBm	1748
dBmV	1748
dBmA	1749
W	1749
V	1749
A	1749
dB $\mu$ V	1750
dB $\mu$ A	1750

## Table of Contents

dBpW	1751
Antenna Unit	1751
dB $\mu$ V/m	1751
dB $\mu$ A/m	1751
dB $\mu$ A	1752
dBpT	1752
dBG	1752
None	1753
$\mu$ W Path Control	1753
Standard Path	1754
Low Noise Path Enable	1754
More Information	1755
$\mu$ W Preselector Bypass	1756
Internal Preamp	1757
Off	1758
Low Band	1759
Full Range	1759
Auto Scaling	1759
Auto Couple	1761
More Information	1761
Auto/Man Active Function keys	1761
Auto/Man 1-of-N keys	1761
BW	1763
Cont (Continuous Measurement/Sweep)	1764
File	1766
FREQ Channel	1767
Channel	1767
Center Freq	1767
Maximum Frequency in X - Series Signal Analyzers	1768
RF Center Freq	1769
IQ Center Freq	1769
Chan Step	1770
CF Step	1770
Chan Table	1771
NTSC-M	1771
NTSC-J	1772
NTSC-Brazil	1772
PAL-M	1773
PAL-I	1773
PAL-B/G	1774
PAL-D/K	1774
Input/Output	1775
Marker	1776



Select Marker	1776
Marker Type	1776
Properties	1777
Select Marker	1777
Relative To	1777
Couple Markers	1778
All Markers Off	1778
Marker X Axis Value (Remote Command only)	1779
Marker X Axis Position (Remote Command only)	1779
Marker Y Axis Value (Remote Command only)	1780
Marker Function	1781
Marker To	1782
Meas	1783
Remote Measurement Functions	1783
Measurement Group of Commands	1784
Current Measurement Query (Remote Command Only)	1786
Limit Test Current Results (Remote Command Only)	1786
Data Query (Remote Command Only)	1786
Calculate/Compress Trace Data Query (Remote Command Only)	1787
Calculate Peaks of Trace Data (Remote Command Only)	1792
Format Data: Numeric Data (Remote Command Only)	1793
Format Data: Byte Order (Remote Command Only)	1794
Meas Setup	1795
Avg/Hold Num	1795
Avg Mode	1795
CH Mean Power (DVB-T/H only)	1796
Range Table	1797
Range	1798
Start Freq	1799
Stop Freq	1800
Res BW	1801
Video BW	1803
Filter Type	1804
Abs Start Limit	1805
Abs Stop Limit	1806
Peak Excursion	1808
Pk Threshold	1809
Attenuation	1809
Detector 1	1810
Detector 2	1811
Sweep Time	1812
Points	1813
IF Gain	1814

## Table of Contents

IF Gain Auto	1814
IF Gain State	1815
Meas Type	1816
Spur	1817
Spurious Report Mode	1817
Meas Preset	1818
Fast Spurious Meas (Remote Command only)	1818
Mode	1820
Mode Preset	1821
How-To Preset	1822
Preset Type (Remote Command Only)	1823
Mode Setup	1824
Peak Search	1825
Next Peak	1825
Next Pk Right	1825
Next Pk Left	1826
Marker Delta	1826
Pk-Pk Search	1826
Min Search	1826
Print	1828
Quick Save	1829
Recall	1831
State	1831
More Information	1833
From File...	1833
Edit Register Names	1835
Register 1 thru Register 16	1835
Register 1 thru Register 16	1836
Data (Import)	1837
Amplitude Correction	1838
Amplitude Correction	1839
Chan Table	1839
Capture Buffer	1840
DVB-T2 Config	1840
Open...	1841
Restart	1842
More Information	1842
Save	1844
State	1844
To File . . .	1845
Edit Register Names	1847
More Information	1847
Register 1 thru Register 16	1848

Register 1 thru Register 16	1848
Data (Export)	1849
Amplitude Correction	1850
Correction Data File	1850
Amplitude Correction	1853
Chan Table	1853
Measurement Results	1853
Meas Results File Definition	1854
Meas Results File Example	1856
Capture Buffer	1859
DVB-T2 Config	1860
Save As . . .	1860
Screen Image	1861
Themes	1862
3D Color	1862
3D Monochrome	1863
Flat Color	1863
Flat Monochrome	1863
Save As...	1863
Mass Storage Catalog (Remote Command Only)	1864
Mass Storage Change Directory (Remote Command Only)	1864
Mass Storage Copy (Remote Command Only)	1865
Mass Storage Device Copy (Remote Command Only)	1865
Mass Storage Delete (Remote Command Only)	1865
Mass Storage Data (Remote Command Only)	1865
Mass Storage Make Directory (Remote Command Only)	1866
Mass Storage Move (Remote Command Only)	1866
Mass Storage Remove Directory (Remote Command Only)	1867
Single (Single Measurement/Sweep)	1868
More Information	1868
Source	1869
Span X Scale	1870
Sweep/Control	1871
Sweep Setup	1871
Auto Sweep Time Rules	1871
Sweep Type	1872
Pause	1872
Gate	1872
Gate On/Off	1873
Gate View On/Off	1874
Gate View Setup	1877
Gate View Sweep Time	1877
Gate View Start Time	1878

Gate Delay	1878
Gate Length	1879
Gate Source	1879
Line	1880
External 1	1881
External 2	1883
RF Burst	1884
Periodic Timer (Frame Trigger)	1887
Control Edge/Level	1898
Gate Holdoff	1899
Gate Delay Compensation	1900
More Information	1901
Min Fast Position Query (Remote Command Only)	1902
Gate Preset (Remote Command Only)	1902
Gate Level (Remote Command Only)	1902
Gate Polarity (Remote Command Only)	1902
Gate	1903
System	1904
Trace/Detector	1905
Trigger	1906
Free Run	1906
Video	1906
Trigger Level	1906
Trig Slope	1906
Trig Delay	1906
Line	1906
Trig Slope	1906
Trig Delay	1906
External 1	1906
Trigger Level	1906
Trig Slope	1906
Trig Delay	1906
External 2	1906
Trigger Level	1907
Trig Slope	1907
Trig Delay	1907
RF Burst	1907
Absolute Trigger	1907
Relative Trigger	1907
Trig Slope	1907
Trig Delay	1907
Periodic Timer	1907
Period	1907

Offset	1907
Reset Offset Display	1907
Sync Source	1907
Off	1907
External 1	1908
External 2	1908
RF Burst	1908
Trig Delay	1908
Auto/Holdoff	1908
Auto Trig	1908
Trig Holdoff	1908
User Preset	1909
User Preset	1909
User Preset All Modes	1910
Save User Preset	1911
View/Display	1912
Display	1912
Annotation	1912
Meas Bar On/Off	1913
Screen	1914
Active Function Values On/Off	1914
Title	1915
Change Title	1915
Clear Title	1916
Graticule	1917
System Display Settings	1917
Annotation Local Settings	1917
Themes	1918
Backlight	1919
Backlight Intensity	1919
View Selection	1920
Graph + Metrics	1920
Range Table	1921
All Ranges	1924
Range Table Selection (SCPI only command)	1925
<b>15 Monitor Spectrum Measurement</b>	<b>1927</b>
AMPTD Y Scale	1930
Ref Value	1930
Attenuation	1930
Dual Attenuator Configurations:	1931
Single Attenuator Configuration:	1931
(Mech) Atten	1932
Attenuator Configurations and Auto/Man	1933

Enable Elec Atten	1934
More Information	1935
Mechanical Attenuator Transition Rules	1935
When the Electronic Attenuation is enabled from a disabled state:	1935
Examples in the dual attenuator configuration:	1935
When the Electronic Attenuation is disabled from an enabled state:	1935
Using the Electronic Attenuator: Pros and Cons	1936
Elec Atten	1936
Adjust Atten for Min Clip	1937
Pre-Adjust for Min Clip	1937
Off	1938
Elec Atten Only	1938
Mech + Elec Atten	1939
(Mech) Atten Step	1939
Scale/Div	1939
Presel Center	1940
Proper Preselector Operation	1941
Preselector Adjust	1941
$\mu$ W Path Control	1942
Standard Path	1944
Low Noise Path Enable	1944
More Information	1945
$\mu$ W Preselector Bypass	1946
Internal Preamp	1947
Off	1948
Low Band	1949
Full Range	1949
Ref Position	1949
Auto Scaling	1950
Auto Couple	1951
More Information	1951
Auto/Man Active Function keys	1951
Auto/Man 1-of-N keys	1951
BW	1953
Res BW	1953
Video BW	1954
VBW:3dB RBW	1956
Span:3dB RBW	1956
Cont (Continuous Measurement/Sweep)	1958
File	1960
FREQ Channel	1961
Channel	1961
Center Freq	1961

Maximum Frequency in X - Series Signal Analyzers	1962
RF Center Freq	1963
IQ Center Freq	1963
Chan Step	1964
CF Step	1964
Chan Table	1965
NTSC-M	1965
NTSC-J	1966
NTSC-Brazil	1966
PAL-M	1967
PAL-I	1967
PAL-B/G	1968
PAL-D/K	1968
Input/Output	1969
Marker	1970
Select Marker	1970
Marker Type	1970
Properties	1971
Select Marker	1971
Relative To	1971
Marker Trace	1971
Couple Markers	1972
All Markers Off	1972
Marker X Axis Value (Remote Command only)	1973
Marker X Axis Position (Remote Command only)	1973
Marker Y Axis Value (Remote Command only)	1974
Marker Function	1975
Select Marker	1975
Marker Function Type	1975
Band Adjust	1975
Band/Interval Span for Frequency Domain	1976
Band/Interval Left for Frequency Domain	1976
Band/Interval Right for Frequency Domain	1977
Marker To	1978
Meas	1979
Remote Measurement Functions	1979
Measurement Group of Commands	1980
Current Measurement Query (Remote Command Only)	1982
Limit Test Current Results (Remote Command Only)	1982
Data Query (Remote Command Only)	1982
Calculate/Compress Trace Data Query (Remote Command Only)	1983
Calculate Peaks of Trace Data (Remote Command Only)	1988
Format Data: Numeric Data (Remote Command Only)	1989

## Table of Contents

Format Data: Byte Order (Remote Command Only)	1990
Meas Setup	1991
Avg/Hold Num	1991
Avg Mode	1991
Meas Preset	1992
Mode	1993
Mode Preset	1994
How-To Preset	1995
Preset Type (Remote Command Only)	1996
Mode Setup	1997
Peak Search	1998
Print	1999
Quick Save	2000
Recall	2002
State	2002
More Information	2004
From File...	2004
Edit Register Names	2006
Register 1 thru Register 16	2006
Register 1 thru Register 16	2007
Data (Import)	2008
Amplitude Correction	2009
Amplitude Correction	2010
Chan Table	2010
Capture Buffer	2011
DVB-T2 Config	2011
Open...	2012
Restart	2013
More Information	2013
Save	2015
State	2015
To File . . .	2016
Edit Register Names	2018
More Information	2018
Register 1 thru Register 16	2019
Register 1 thru Register 16	2019
Data (Export)	2020
Amplitude Correction	2021
Correction Data File	2021
Amplitude Correction	2024
Chan Table	2024
Measurement Results	2025
Capture Buffer	2025



DVB-T2 Config	2025
Save As . . .	2026
Screen Image	2026
Themes	2028
3D Color	2028
3D Monochrome	2028
Flat Color	2028
Flat Monochrome	2029
Save As...	2029
Mass Storage Catalog (Remote Command Only)	2029
Mass Storage Change Directory (Remote Command Only)	2030
Mass Storage Copy (Remote Command Only)	2030
Mass Storage Device Copy (Remote Command Only)	2030
Mass Storage Delete (Remote Command Only)	2031
Mass Storage Data (Remote Command Only)	2031
Mass Storage Make Directory (Remote Command Only)	2031
Mass Storage Move (Remote Command Only)	2032
Mass Storage Remove Directory (Remote Command Only)	2032
Single (Single Measurement/Sweep)	2033
More Information	2033
Source	2034
Span X Scale	2035
Span	2035
IDEN Mode Span Preset for Monitor Spectrum	2036
Full Span	2036
Last Span	2036
Sweep/Control	2038
Sweep Time	2038
Pause	2038
Gate	2039
Gate On/Off	2039
Gate View On/Off	2040
Gate View Setup	2043
Gate View Sweep Time	2044
Gate View Start Time	2044
Gate Delay	2045
Gate Length	2045
Gate Source	2046
Line	2047
External 1	2047
External 2	2049
RF Burst	2051
Periodic Timer (Frame Trigger)	2054

Control Edge/Level	2065
Gate Holdoff	2065
Gate Delay Compensation	2067
More Information	2068
Min Fast Position Query (Remote Command Only)	2068
Gate Preset (Remote Command Only)	2069
Gate Level (Remote Command Only)	2069
Gate Polarity (Remote Command Only)	2069
Points	2070
System	2071
Trace/Detector	2072
Select Trace	2072
Trace Type	2072
Update	2073
Display	2073
Detector	2074
Auto	2075
Clear Trace	2075
Clear All Traces	2075
Trigger	2077
Free Run	2077
Video	2077
Trigger Level	2077
Trig Slope	2077
Trig Delay	2077
Line	2077
Trig Slope	2077
Trig Delay	2077
External 1	2077
Trigger Level	2077
Trig Slope	2077
Trig Delay	2077
External 2	2077
Trigger Level	2078
Trig Slope	2078
Trig Delay	2078
RF Burst	2078
Absolute Trigger	2078
Relative Trigger	2078
Trig Slope	2078
Trig Delay	2078
Periodic Timer	2078
Period	2078

Offset	2078
Reset Offset Display	2078
Sync Source	2078
Off	2078
External 1	2079
External 2	2079
RF Burst	2079
Trig Delay	2079
Auto/Holdoff	2079
Auto Trig	2079
Trig Holdoff	2079
User Preset	2080
User Preset	2080
User Preset All Modes	2081
Save User Preset	2082
View/Display	2083
View for all modes except MSR, 1xEV-DO, LTE-Advanced FDD/TDD	2083
1xEV-DO Mode View	2084
MSR and LTE-Advanced FDD/TDD Mode Views	2084
View Selection by Name (MSR and LTE-Advanced FDD/TDD mode only)	2085
View Selection by Number (MSR and LTE-Advanced FDD/TDD mode only)	2085
Display	2085
Annotation	2086
Meas Bar On/Off	2087
Screen	2087
Active Function Values On/Off	2087
Title	2088
Change Title	2088
Clear Title	2089
Graticule	2090
System Display Settings	2090
Annotation Local Settings	2090
Themes	2091
Backlight	2092
Backlight Intensity	2092
<b>16 Waveform Measurement</b>	<b>2095</b>
AMPTD Y Scale	2099
Ref Value	2099
Ref Value (RF Envelope View)	2099
Ref Value (I/Q Waveform View)	2100
Attenuation	2100
Dual Attenuator Configurations:	2101
Single Attenuator Configuration:	2101

(Mech) Atten	2102
Attenuator Configurations and Auto/Man	2103
Enable Elec Atten	2104
More Information	2105
Mechanical Attenuator Transition Rules	2105
When the Electronic Attenuation is enabled from a disabled state:	2105
Examples in the dual attenuator configuration:	2105
When the Electronic Attenuation is disabled from an enabled state:	2105
Using the Electronic Attenuator: Pros and Cons	2106
Elec Atten	2106
Adjust Atten for Min Clip	2107
Pre-Adjust for Min Clip	2107
Off	2108
Elec Atten Only	2108
Mech + Elec Atten	2108
(Mech) Atten Step	2109
Scale/Div	2109
Scale/Div (RF Envelope View)	2110
Scale/Div (I/Q Waveform View)	2110
Presel Center	2111
Proper Preselector Operation	2112
Preselector Adjust	2112
$\mu$ W Path Control	2113
Standard Path	2114
Low Noise Path Enable	2115
More Information	2116
$\mu$ W Preselector Bypass	2117
Internal Preamp	2118
Off	2119
Low Band	2119
Full Range	2119
Ref Position	2120
Ref Position (RF Envelope View)	2120
Ref Position (I/Q Waveform View)	2121
Auto Scaling	2121
Range	2122
Range Auto/Man	2122
I Range	2123
1 V Peak	2124
0.5 V Peak	2124
0.25 V Peak	2125
0.125 V Peak	2125
Q Range Value	2125

Q Same as I	2126
1 V Peak	2127
0.5 V Peak	2127
0.25 V Peak	2127
0.125 V Peak	2127
I/Q Gain Ranges	2127
1 V Peak	2127
0.5 V Peak	2128
0.25 V Peak	2128
0.125 V Peak	2128
Auto Couple	2129
More Information	2129
Auto/Man Active Function keys	2129
Auto/Man 1-of-N keys	2129
BW	2131
Digital IF BW	2131
Filter Type	2132
Filter BW	2133
Filter Alpha	2134
Filter Type Bwcc	2134
Gaussian	2135
Gaussian filters	2135
Flattop	2139
Flattop Filters	2140
Channel Filter Bandwidth Bwcc (Remote Command Only)	2141
Cont (Continuous Measurement/Sweep)	2142
File	2144
FREQ Channel	2145
Channel	2145
Center Freq	2145
Maximum Frequency in X - Series Signal Analyzers	2146
RF Center Freq	2147
IQ Center Freq	2147
Chan Step	2148
CF Step	2148
Chan Table	2149
NTSC-M	2149
NTSC-J	2150
NTSC-Brazil	2150
PAL-M	2151
PAL-I	2151
PAL-B/G	2152
PAL-D/K	2152

Input/Output	2153
Marker	2154
Select Marker	2154
Marker Type	2154
Properties	2155
Select Marker	2155
Relative To	2155
Marker Trace	2156
Couple Markers	2156
All Markers Off	2157
Marker X Axis Value (Remote Command Only)	2157
Marker X Axis Position (Remote Command Only)	2158
Marker Y Axis Value (Remote Command Only)	2158
Backward Compatibility SCPI Commands	2159
Marker ->	2160
Marker Function	2161
Select Marker	2161
Marker Function Type	2161
Band Adjust	2162
Band/Interval Span for Time Domain	2162
Band/Interval Left for Time Domain	2163
Band/Interval Right for Time Domain	2163
Meas	2165
Remote Measurement Functions	2165
Measurement Group of Commands	2166
Current Measurement Query (Remote Command Only)	2168
Limit Test Current Results (Remote Command Only)	2168
Data Query (Remote Command Only)	2168
Calculate/Compress Trace Data Query (Remote Command Only)	2169
Calculate Peaks of Trace Data (Remote Command Only)	2174
Format Data: Numeric Data (Remote Command Only)	2175
Format Data: Byte Order (Remote Command Only)	2176
Meas Setup	2177
Average/Hold Num	2177
Avg Mode	2177
Avg Type	2178
Avg Type Auto	2179
Time Avg Num	2179
Meas Time	2179
Sample Rate	2180
PhNoise Opt	2181
Auto	2181
Best Close-in P Noise	2182

Best Wide-offset P Noise	2183
Fast Tuning	2183
Advanced	2183
ADC Dither	2184
ADC Dither Auto	2184
ADC Dither	2184
IF Gain	2185
IF Gain Auto	2185
IF Gain State	2186
IF Gain Offset	2187
Meas Preset	2187
HW Averaging	2188
Sample Period (Aperture) Setting (Remote Command Only)	2188
Mode	2189
Mode Preset	2190
How-To Preset	2191
Preset Type (Remote Command Only)	2192
Mode Setup	2193
Peak Search	2194
Next Peak	2194
Min Search	2194
Print	2196
Quick Save	2197
Recall	2199
State	2199
More Information	2201
From File...	2201
Edit Register Names	2203
Register 1 thru Register 16	2203
Register 1 thru Register 16	2204
Data (Import)	2205
Amplitude Correction	2206
Amplitude Correction	2207
Chan Table	2207
Capture Buffer	2208
DVB-T2 Config	2208
Open...	2209
Restart	2210
More Information	2210
Save	2212
State	2212
To File . . .	2213
Edit Register Names	2215

More Information	2215
Register 1 thru Register 16	2216
Register 1 thru Register 16	2216
Data (Export)	2217
Amplitude Correction	2218
Correction Data File	2218
Amplitude Correction	2221
Chan Table	2221
Measurement Results	2222
Capture Buffer	2222
DVB-T2 Config	2222
Save As . . .	2223
Screen Image	2223
Themes	2225
3D Color	2225
3D Monochrome	2225
Flat Color	2225
Flat Monochrome	2226
Save As...	2226
Mass Storage Catalog (Remote Command Only)	2226
Mass Storage Change Directory (Remote Command Only)	2227
Mass Storage Copy (Remote Command Only)	2227
Mass Storage Device Copy (Remote Command Only)	2227
Mass Storage Delete (Remote Command Only)	2228
Mass Storage Data (Remote Command Only)	2228
Mass Storage Make Directory (Remote Command Only)	2228
Mass Storage Move (Remote Command Only)	2229
Mass Storage Remove Directory (Remote Command Only)	2229
Single (Single Measurement/Sweep)	2230
More Information	2230
Source	2231
Span X Scale	2232
Ref Value	2232
Scale/Div	2232
Ref Position	2233
Auto Scaling	2233
Sweep/Control	2235
Pause/Resume	2235
Abort (Remote Command Only)	2235
System	2237
Trace/Detector	2238
Trigger	2239
Free Run	2239



Video	2239
Trigger Level	2239
Trig Slope	2239
Trig Delay	2239
Line	2239
Trig Slope	2239
Trig Delay	2239
External 1	2239
Trigger Level	2239
Trig Slope	2239
Trig Delay	2239
External 2	2239
Trigger Level	2240
Trig Slope	2240
Trig Delay	2240
RF Burst	2240
Absolute Trigger	2240
Relative Trigger	2240
Trig Slope	2240
Trig Delay	2240
Periodic Timer	2240
Period	2240
Offset	2240
Offset Adjust (Remote Command Only)	2240
Reset Offset Display	2240
Sync Source	2240
Off	2241
External 1	2241
External 2	2241
RF Burst	2241
Trig Delay	2241
Auto/Holdoff	2241
Auto Trig	2241
Trig Holdoff	2241
Baseband I/Q	2241
I/Q Mag	2242
Trigger Level	2242
Trig Slope	2242
Trig Delay	2242
I	2242
Trigger Level	2242
Trig Slope	2242
Trig Delay	2242

Q	2242
Trigger Level	2242
Trig Slope	2242
Trig Delay	2242
Input I	2242
Trigger Level	2242
Trig Slope	2243
Trig Delay	2243
Input Q	2243
Trigger Level	2243
Trig Slope	2243
Trig Delay	2243
Aux Channel Center Freq	2243
Trigger Level	2243
Trig Slope	2243
Trig Delay	2243
Trigger Center Freq	2243
Trigger BW	2243
User Preset	2244
User Preset	2244
User Preset All Modes	2245
Save User Preset	2246
View/Display	2247
View Selection by name (Remote Command Only)	2247
View Selection by number (Remote Command Only)	2247
Display	2248
Annotation	2248
Meas Bar On/Off	2249
Screen	2250
Active Function Values On/Off	2250
Title	2251
Change Title	2251
Clear Title	2252
Graticule	2253
System Display Settings	2253
Annotation Local Settings	2253
Themes	2254
Backlight	2255
Backlight Intensity	2255
RF Envelope	2256
I/Q Waveform	2257
<b>17 Appendix A: Channel Identification Plans</b>	<b>17-1</b>
NTSC channels	17-2

NTSC-M	17-2
NTSC-M AIR and PAL-M AIR	17-2
NTSC-M STD/HRC/IRC and PAL-M STD/HRC/IRC	17-4
NTSC-J	17-9
NTSC-J Cable	17-9
NTSC-J AIR	17-15
NTSC-J Digital Cable	17-18
NTSC-Brazil	17-19
NTSC-Brazil VHF	17-19
NTSC-Brazil UHF	17-20
PAL Channels	17-22
PAL-M	17-22
PAL-I	17-22
PAL-I VHF	17-22
PAL-I UHF	17-22
PAL-I HRC	17-22
PAL-B/G	17-22
PAL-B/G VHF	17-23
PAL-B/G UHF and PAL-I UHF	17-23
PAL B/G HRC and PAL-I HRC	17-25
PAL-B/G S	17-30
PAL-B/G Cable	17-32
PAL-B/G CENELEC	17-33
PAL-D/K (8 MHz)	17-34



## 1 About the Analyzer

The X-Series signal analyzer measures and monitors complex RF and microwave signals. Analog baseband analysis is available on MXA. The analyzer integrates traditional spectrum measurements with advanced vector signal analysis to optimize speed, accuracy, and dynamic range. The analyzer has Windows 7<sup>®</sup> built in as an operating system, which expands its usability.

With a broad set of applications and demodulation capabilities, an intuitive user interface, outstanding connectivity and powerful one-button measurements, the analyzer is ideal for both R&D and manufacturing engineers working on cellular, emerging wireless communications, general purpose, aerospace and defense applications.

## Installing Application Software

If you want to install a measurement application after your initial hardware purchase, you need only to license it. All of the available applications are loaded in your analyzer at the time of purchase.

Thus, when you purchase a new application, you will receive an entitlement certificate that you can use to obtain a license key for that application. To activate the new measurement application, enter the license key that you obtain into the Signal Analyzer.

For the latest information on Keysight Signal Analyzer measurement applications and upgrade kits, visit the following internet URL.

[http://www.agilent.com/find/sa\\_upgrades](http://www.agilent.com/find/sa_upgrades)

### Viewing a License Key

Measurement applications that you purchased with your instrument have been installed and activated at the factory before shipment. The instrument requires a unique License Key for every measurement application purchased. The license key is a hexadecimal string that is specific to your measurement application, instrument model number and serial number. It enables you to install, or reactivate, that particular application.

Press **System, Show, System** to display the measurement applications that are currently licensed in your analyzer.

Go to the following location to view the license keys for the installed measurement applications:

C:\Program Files\Agilent\Licensing

You may want to keep a copy of your license key in a secure location. To do this, you can print out a copy of the display showing the license numbers. If you should lose your license key, call your nearest Keysight Technologies service or sales office for assistance.

### Obtaining and Installing a License Key

If you purchase an additional application that requires installation, you will receive an "Entitlement Certificate", which may be redeemed for a license key for one instrument. To obtain your license key, follow the instructions that accompany the certificate.

Installing a license key for the selected application can be done automatically using a USB memory device. To do this, you copy the license file to the USB memory device, at the root level. Follow the instructions that come with your software installation kit.

Installing a license key can also be done manually using the built-in license management application, which may be found via the instrument front panel keys at **System, Licensing. . .**, or on-disk at:

C:\Programming Files\Agilent\Licensing

You can also use these procedures to reinstall a license key that has been accidentally deleted, or lost due to a memory failure.

### Updating Measurement Application Software

All the software applications were loaded at the time of original instrument manufacture. It is a good idea to regularly update your software with the latest available version. This helps to ensure that you receive

any improvements and expanded functionality.

Because the software was loaded at the initial purchase, further additional measurement applications may now be available. If the application you are interested in licensing is not available, you will need to do a software update. (To display a list of installed applications, press **System, Show, System.**)

Check the appropriate page of the Keysight web site for the latest available software versions, according to the name of your instrument, as follows:

[http://www.agilent.com/find/pxa\\_software](http://www.agilent.com/find/pxa_software)

[http://www.agilent.com/find/mxa\\_software](http://www.agilent.com/find/mxa_software)

[http://www.agilent.com/find/exa\\_software](http://www.agilent.com/find/exa_software)

[http://www.agilent.com/find/cxa\\_software](http://www.agilent.com/find/cxa_software)

You can load the updated software package into the analyzer from a USB drive, or directly from the internet. An automatic loading program is included with the files.

## X-Series Options and Accessories

You can view an online list of available Options and Accessories for your instrument as follows:

1. Browse to one of the following URLs, according to the product name of your analyzer:

[www.agilent.com/find/cxa](http://www.agilent.com/find/cxa)

[www.agilent.com/find/exa](http://www.agilent.com/find/exa)

[www.agilent.com/find/mxa](http://www.agilent.com/find/mxa)

[www.agilent.com/find/pxa](http://www.agilent.com/find/pxa)

2. The home page for your instrument appears (in some cases, you may see an initial splash screen containing a button named View the Webpage, which you should click to display the home page).
3. Locate the Options tab, as highlighted in the example below, which shows the home page for the MXA.



4. Click the Options tab, to display a list of available options and accessories for your instrument.



## Front-Panel Features

The instrument's Front-panel features are fully detailed in the section "Front-Panel Features" (under the chapter "Front and Rear Panel Features") of the document:

### [Getting Started Guide](#)

If you are viewing this information as a Help file in the instrument, then you can click on the link above to open the PDF document.

## Display Annotations

Display Annotations are fully detailed under the chapter "Front and Rear Panel Features" of the document:

[Getting Started Guide](#)

If you are viewing this information as a Help file in the instrument, then you can click on the link above to open the PDF document.

## Rear-Panel Features

The instrument's Rear-panel features are fully detailed in the section "Rear-Panel Features" (under the chapter "Front and Rear Panel Features") of the document:

### [Getting Started Guide](#)

If you are viewing this information as a Help file in the instrument, then you can click on the link above to open the PDF document.

## Window Control Keys

The instrument provides three front-panel keys for controlling windows. They are Multi Window, Zoom, and Next Window. These are all “immediate action” keys.

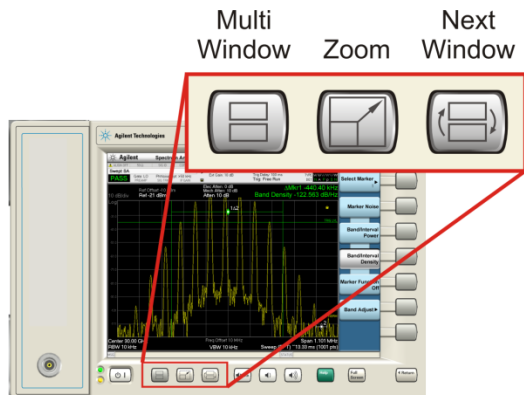

### Multi-Window



The Multi Window front-panel key will toggle you back and forth between the Normal View and the last Multi Window View (Zone Span, Trace Zoom or Spectrogram) that you were in, when using the Swept SA measurement of the Spectrum Analyzer Mode. It remembers which View you were in through a Preset. This “previous view” is set to Zone Span on a Restore Mode Defaults.

Key Path	Front-panel key
Initial S/W Revision	Prior to A.02.00

### Zoom

Zoom is a toggle function. Pressing this key once increases the size of the selected window. Pressing the key again returns the window to the original size.

When Zoom is on for a window, that window will get the entire primary display area. The zoomed window, since it is the selected window, is outlined in green.

Zoom is local to each Measurement. Each Measurement remembers its Zoom state. The Zoom state of each Measurement is part of the Mode’s state.

**NOTE**

Data acquisition and processing for the other windows continues while a window is zoomed, as does all SCPI communication with the other windows.

<b>Remote Command</b>	<code>:DISPlay:WINDow:FORMat:ZOOM</code>
-----------------------	--

<b>Remote Command</b>	:DISPlay:WINDow:FORMat:TILE
<b>Example</b>	:DISP:WIND:FORM:ZOOM sets zoomed :DISP:WIND:FORM:TILE sets un-zoomed
Preset	TILE
Initial S/W Revision	Prior to A.02.00

## Next Window

Selects the next window of the current view. When the Next Window key is pressed, the next window in the order of precedence becomes selected. If the selected window was zoomed, the next window will also be zoomed.

The window numbers are as follows. Note that these numbers also determine the order of precedence (that is, Next Window goes from 1 to 2, then 2 to 3, etc.):

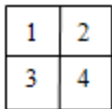

**Four window display**

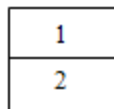

**Two window display**

## RTSA measurements:

Only two windows are available in the Spectrogram view under the Spectrum measurement and up to three windows are available in the Power vs. Time measurement, depending on the view set up.

<b>Remote Command</b>	:DISPlay:WINDow[:SElect] <number> :DISPlay:WINDow[:SElect]?
<b>Example</b>	:DISP:WIND 1
Preset	1
Min	1
Max	If <number> is greater than the number of windows, limit to <number of windows>
Initial S/W Revision	Prior to A.02.00

One and only one window is always selected. The selected window has the focus; this means that all window-specific key presses apply only to that window. You can tell which window is selected by the thick green border around it. If a window is not selected, its boundary is gray.

If a window in a multi-window display is zoomed it is still outlined in green. If there is only one window, the green outline is not used. This allows the user to distinguish between a zoomed window and a display with only one window.

The selected window is local to each Measurement. Each Measurement remembers which window is selected. The selected window for each Measurement is remembered in Mode state.

**NOTE**

When this key is pressed in Help Mode, it toggles focus between the table of contents window and the topic pane window.

## Full Screen

When Full Screen is pressed the measurement window expands horizontally over the entire instrument display. The screen graticule area expands to fill the available display area.

It turns off the display of the softkey labels, however the menus and active functions still work. (Though it would obviously be very hard to navigate without the key labels displayed.) Pressing Full Screen again while Full Screen is in effect cancels Full Screen.

Note that the banner and status lines are unaffected. You can get even more screen area for your data display by turning off the Meas Bar (in the Display menu) which also turns off the settings panel.

Full Screen is a Meas Global function. Therefore it is cancelled by the Preset key.

Key Path	Display
<b>Remote Command</b>	:DISPlay:FSCReen[:STATe] OFF ON 0 1 :DISPlay:FSCReen[:STATe]?
Preset	Unaffected by Preset but set to Off by Restore Misc Defaults or shutdown and restart
State Saved	Not saved in instrument state.
<b>Backwards Compatibility SCPI</b>	:DISPlay:MENU[:STATe] OFF ON 0 1 This emulates ESA full screen functionality, which is the same as the FSCReen command in PSA except that the sense of on/off is reversed (that is, OFF means the menus are OFF, so Fullscreen is ON) and the default is ON (meaning Fullscreen is OFF).
Backwards Compatibility Notes	In ESA/PSA, Full Screen was turned on with a softkey, so pressing any other key turned Full Screen off. In the X-Series, because a hardkey is provided to turn this function on and off, pressing any other key no longer turns off Full Screen
Initial S/W Revision	Prior to A.02.00

## Display Enable (Remote Command Only)

Turns the display on/off, including the display drive circuitry. The backlight stays lit so you can tell that the instrument is on. The display enable setting is mode global. The reasons for turning the display off are three:

- To increase speed as much as possible by freeing the instrument from having to update the display
- To reduce emissions from the display, drive circuitry
- For security purposes

If you have turned off the display:

- and you are in local operation, the display can be turned back on by pressing any key or by sending the SYSTem:DEFaults MISC command or the DISPlay:ENABle ON (neither \*RST nor SYSTem:PRESet enable the display.)
- and you are in remote operation, the display can be turned back on by pressing the Local or Esc keys or by sending the SYSTem:DEFaults MISC command or the DISPlay:ENABle ON (neither \*RST nor SYSTem:PRESet enable the display.)

and you are using either the SYSTem:KLOCK command or GPIB local lockout, then no front-panel key press will turn the display back on. You must turn it back on remotely.

<b>Remote Command</b>	:DISPlay:ENABle OFF ON 0 1 :DISPlay:ENABle?
<b>Example</b>	DISP:ENAB OFF
<b>Couplings</b>	DISP:ENAB OFF turns Backlight OFF and DISP:ENAB ON turns Backlight ON. However, settings of Backlight do not change the state of DISP:ENAB
<b>Preset</b>	On Set by SYST:DEF MISC, but Not affected by *RST or SYSTem:PRESet.
<b>State Saved</b>	Not saved in instrument state.
<b>Backwards Compatibility Notes</b>	SYST:PRES no longer turns on DISPlay:ENABle as it did in legacy analyzers
<b>Initial S/W Revision</b>	Prior to A.02.00

## Mouse and Keyboard Control

If you do not have access to the instrument front-panel, there are several ways that a mouse and PC Keyboard can give you access to functions normally accessed using the front-panel keys.

### Right-Click

If you plug in a mouse and right-click on the analyzer screen, a menu will appear as below:

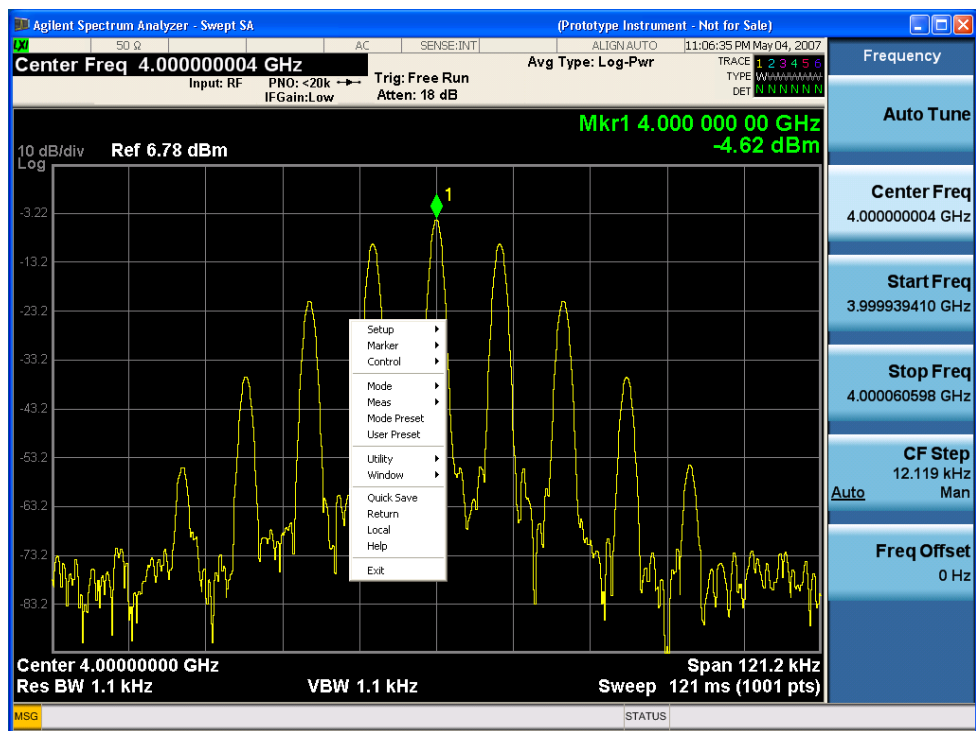

Placing the mouse on one of the rows marked with a right arrow symbol will cause that row to expand, as for example below where the mouse is hovered over the “Utility” row:



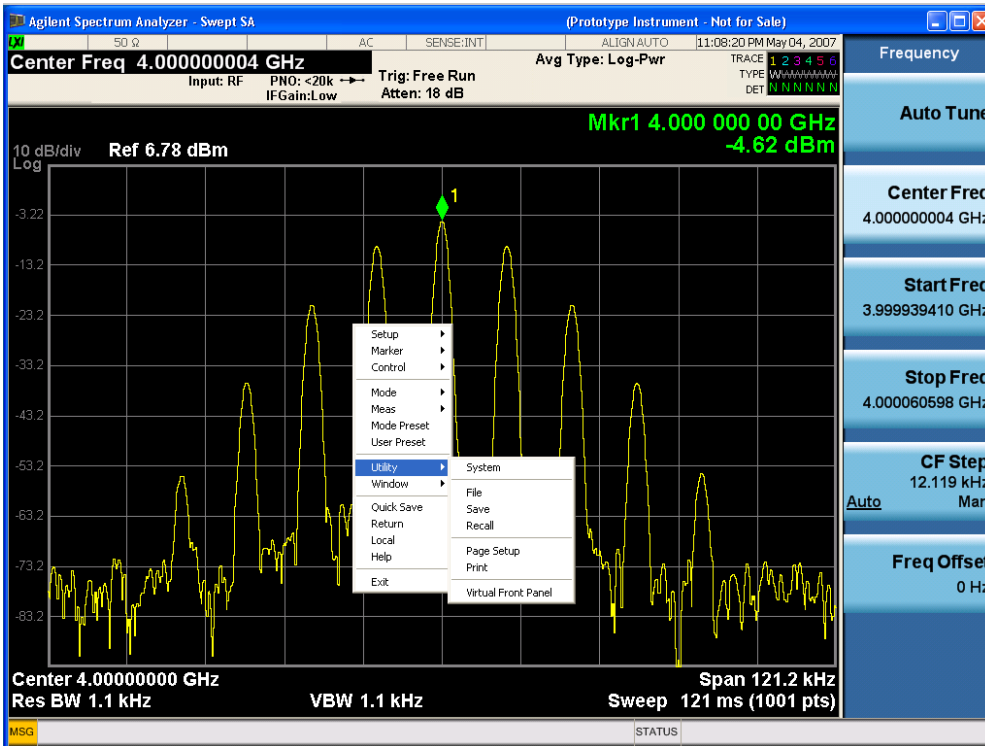

This method can be used to access any of the front-panel keys by using a mouse; as for example if you are accessing the instrument through Remote Desktop.

The array of keys thus available is shown below:

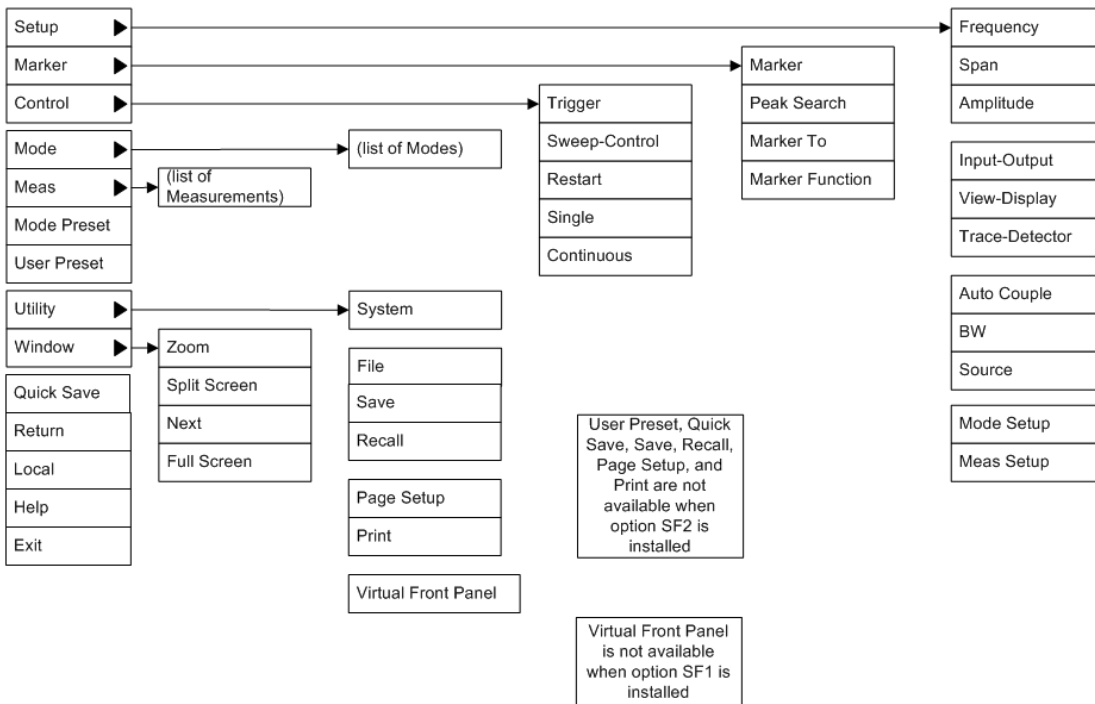

## PC Keyboard

If you have a PC keyboard plugged in (or via Remote Desktop), certain key codes on the PC keyboard map to front-panel keys on the GPSA front panel. These key codes are shown below:

Front-panel key	Key code
Frequency	CTRL+SHIFT+F
Span	CTRL+SHIFT+S
Amplitude	CTRL+SHIFT+A
Input/Output	CTRL+SHIFT+O
View/Display	CTRL+SHIFT+V
Trace/Detector	CTRL+ALT+T
Auto Couple	CTRL+SHIFT+C
Bandwidth	CTRL+ALT+B
Source	CTRL+ALT-U
Marker	CTRL+ALT+K
Peak Search	CTRL+ALT+P
Marker To	CTRL+ALT+N
Marker Function	CTRL+ALT+F
System	CTRL+SHIFT+Y
Quick Save	CTRL+Q
Save	CTRL+S
Recall	CTRL+R
Mode Preset	CTRL+M
User Preset	CTRL+U
Print	CTRL+P
File	CTRL+SHIFT+L
Mode	CTRL+SHIFT+M
Measure	CTRL+ALT+M
Mode Setup	CTRL+SHIFT+E
Meas Setup	CTRL+ALT+E
Trigger	CTRL+SHIFT+T
Sweep/Control	CTRL+SHIFT+W
Restart	CTRL+ALT+R
Single	CTRL+ALT+S
Cont	CTRL+ALT+C
Zoom	CTRL+SHIFT+Z
Next Window	CTRL+SHIFT+N
Split Screen	CTRL+L

Front-panel key	Key code
Full Screen	CTRL+SHIFT+B
Return	CTRL+SHIFT+R
Mute	Mute
Inc Audio	Volume Up
Dec Audio	Volume Down
Help	F1
Control	CTRL
Alt	ALT
Enter	Return
Cancel	Esc
Del	Delete
Backspace	Backspace
Select	Space
Up Arrow	Up
Down Arrow	Down
Left Arrow	Left
Right Arrow	Right
Menu key 1	CTRL+SHIFT+F1
Menu key 2	CTRL+SHIFT+F2
Menu key 3	CTRL+SHIFT+F3
Menu key 4	CTRL+SHIFT+F4
Menu key 5	CTRL+SHIFT+F5
Menu key 6	CTRL+SHIFT+F6
Menu key 7	CTRL+SHIFT+F7
Backspace	BACKSPACE
Enter	ENTER
Tab	Tab
1	1
2	2
3	3
4	4
5	5
6	6
7	7
8	8
9	9
0	0

1 About the Analyzer  
 Mouse and Keyboard Control

This is a pictorial view of the table:

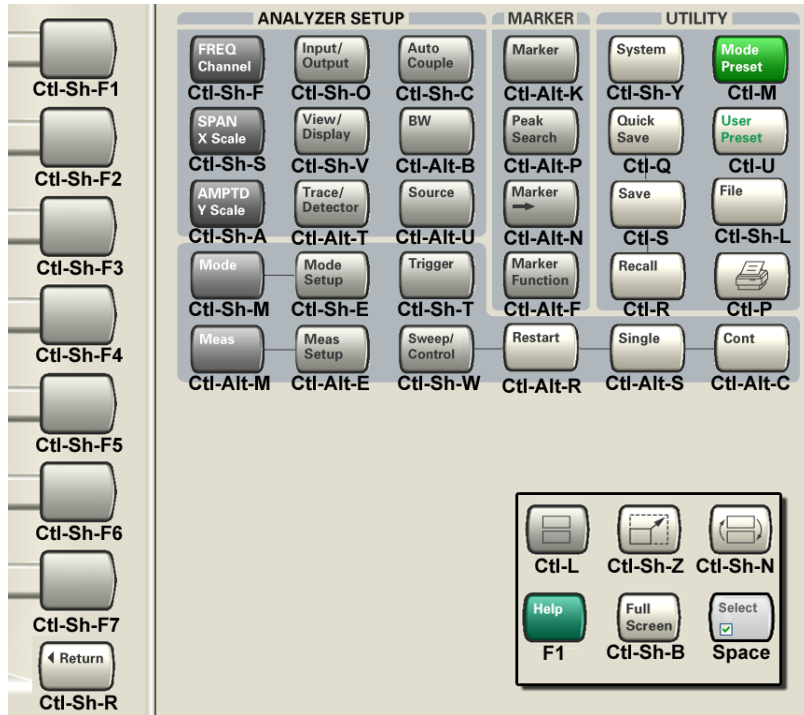

## Instrument Security & Memory Volatility

If you are using the instrument in a secure environment, you may need details of how to clear or sanitize its memory, in compliance with published security standards of the United States Department of Defense, or other similar authorities.

For X-Series analyzers, this information is contained in the document "Security Features and Document of Volatility". This document is not included in the Documentation CD, or the instrument's on-disk library, but it may be downloaded from Keysight's web site.

To obtain a copy of the document, click on or browse to the following URL:

<http://www.agilent.com/find/security>

To locate and download the document, select Model Number "N9020A", then click "Submit". Then, follow the on-screen instructions to download the file.



## 2 About the DVB-T/H Measurement Application

The N6153A (for PXA, MXA, EXA) & W6153A (for CXA) DVB-T/H with T2 measurement application offers two options:

- a. N6153A-2FP/W6153A-2FP DVB-T/H measurement application  
With this option, the mode name is DVB-T/H and measurements on DVB-T/H signals can be supported.
- b. N6153A-3FP/W6153A-3FP DVB-T2 measurement application  
With this option, the mode name is DVB-T/H with T2 and measurements on DVB-T2 signals, which are compliant with ETSI EN 302 755 V1.1.1 or V1.2.1, are supported. Note that the 3FP option must be used together with the 2FP option.

### NOTE

The "FP" in the option name is short for fixed perpetual, which means you can only install the license key on the specific instruments for which it was created. For PXA, MXA, and EXA, there is another license type called "TP", short for transportable perpetual, which means you can transport this license key between instruments.

The transportable licenses for the two N6153A options are N6153A-2TP and N6153A-3TP. In this document, all the features and functions for N6153A-2FP, N6153A-3FP also apply to N6153A-2TP, N6153A-3TP.

---

This chapter provides the overall information on the N6153A & W6153A DVB-T/H with T2 measurement application, and describes DVB-T/H and DVB-T2 measurements made by the analyzer.

DVB-T/H (Digital Video Broadcasting– Terrestrial/Handheld) is the European-based consortium standard for broadcast transmission of digital terrestrial/handheld television.

DVB-T2 (Digital Video Broadcasting – Second Generation Terrestrial), is an evolution of DVB-T, which incorporates the latest advanced technologies.

## What Does the DVB-T/H Application Do?

The DVB-T/H with T2 application allows the analyzer to be used for testing a DVB-T/H/T2 transmitter or exciter and for DVB-T field test in SFN (single frequency network) scenarios. This application is manufactured according to the following standard documents:

- ETSI EN 300 744 Digital Video Broadcasting (DVB); Framing structure, channel coding and modulation for digital terrestrial television
- ETSI EN 302 304 Digital Video Broadcasting (DVB); Transmission System for Handheld Terminals (DVB-H)
- ETSI EN 302 755 V1.1.1 Digital Video Broadcasting (DVB); Frame structure channel coding and modulation for a second generation digital terrestrial television broadcasting system (DVB-T2)
- ETSI EN 302 755 V1.2.1 Digital Video Broadcasting (DVB); Frame structure channel coding and modulation for a second generation digital terrestrial television broadcasting system (DVB-T2)
- DVB Document A133 Implementation guidelines for a second generation digital terrestrial television broadcasting system (DVB-T2)
- ETSI EN 302 296 Electromagnetic compatibility and Radio spectrum Matters (ERM); Transmitting equipment for the digital television broadcast service, Terrestrial (DVB-T); Harmonized EN under article 3.2 of the R&TTE Directive
- ETSI TR 101 290 Digital Video Broadcasting (DVB); Measurement guidelines for DVB systems

These documents define complex, multi-part measurements used to create and maintain an interference-free environment. For example, the documents include standardized test methods for the measurement of power, spectrum emission mask, and other critical measurements.

The instrument automatically makes these measurements using the measurement methods and limits defined in the documents. The detailed results displayed by the measurements enable you to analyze DVB-T/H and DVB-T2 transmitter's performance. You may alter the measurement parameters for specialized analysis. For infrastructure test, the analyzer will test transmitters in a non-interfering manner using a coupler or power splitter.

This analyzer makes the following measurements of DVB-T/H and DVB-T2 signals:

- Channel Power
- Adjacent Channel Power (ACP)
- Power Stat CCDF
- Spurious Emissions
- Spectrum Emission Mask
- DVB-T/H Modulation Accuracy
- DVB-T2 Modulation Accuracy



- Monitor Spectrum
- IQ Waveform (Time Domain)

If the option BBA is installed, the ability to analyzer baseband I/Q signal characteristics of mobile and base station transmitters is provided. The Baseband I/Q Input is available in the following measurements:

- DVB-T/H Modulation Accuracy
- DVB-T2 Modulation Accuracy
- Power Stat CCDF
- IQ Waveform (Time Domain)

## 2 About the DVB-T/H Measurement Application

### What Does the DVB-T/H Application Do?

### 3 Programming the Analyzer

This section provides introductory information about the programming documentation included with your product.

- ["What Programming Information is Available?" on page 108](#)
- ["STATus Subsystem " on page 151](#)
- ["IEEE 488.2 Common Commands" on page 193](#)

## What Programming Information is Available?

The X-Series Documentation can be accessed through the Additional Documentation page in the instrument Help system and is included on the Documentation DVD shipped with the instrument. It can also be found online at: [http://www.agilent.com/find/mxa\\_manuals](http://www.agilent.com/find/mxa_manuals).

The following resources are available to help you create programs for automating your X-Series measurements:

Resource	Description
X-Series Programmer's Guide	<p>Provides general SCPI programming information on the following topics:</p> <ul style="list-style-type: none"><li>• Programming the X-Series Applications</li><li>• Programming fundamentals</li><li>• Programming examples</li></ul> <p>Note that SCPI command descriptions for measurement applications are not in this book, but are in the User's and Programmer's Reference.</p>
User's and Programmer's Reference manuals	<p>Describes all front-panel keys and softkeys, including SCPI commands for a measurement application. Note that:</p> <ul style="list-style-type: none"><li>• Each measurement application has its own User's and Programmer's Reference.</li><li>• The content in this manual is duplicated in the instrument's Help (the Help that you see for a key is identical to what you see in this manual).</li></ul>
Embedded Help in your instrument	<p>Describes all front-panel keys and softkeys, including SCPI commands, for a measurement application. Note that the content that you see in Help when you press a key is identical to what you see in the User's and Programmer's Reference.</p>
X-Series Getting Started Guide	<p>Provides valuable sections related to programming including:</p> <ul style="list-style-type: none"><li>• Licensing New Measurement Application Software - After Initial Purchase</li><li>• Configuring instrument LAN Hostname, IP Address, and Gateway Address</li><li>• Using the Windows Remote Desktop to connect to the instrument remotely</li><li>• Using the Embedded Web Server Telnet connection to communicate SCPI</li></ul> <p>This printed document is shipped with the instrument.</p>
Keysight Application Notes	<p>Printable PDF versions of pertinent application notes.</p>
Keysight VISA User's Guide	<p>Describes the Keysight Virtual Instrument Software Architecture (VISA) library and shows how to use it to develop I/O applications and instrument drivers on Windows PCs.</p>

## List of SCPI Commands

```

*CAL?
*CLS
*ESE <integer>
*ESE?
*ESR?
*IDN?
*OPC
*OPC?
*OPT?
*RCL <register#>
*RST
*SAV <register#>
*SRE <integer>
*SRE?
*STB?
*TRG
*TST?
*WAI
ABORT
CALCulate:ACPower:LIMit:STATe OFF | ON | 0 | 1
CALCulate:ACPower:LIMit:STATe?
CALCulate:ACPower:MARKer:AOff
CALCulate:ACPower:MARKer:COUple[:STATe] ON | OFF | 1 | 0
CALCulate:ACPower:MARKer:COUple[:STATe]?
CALCulate:ACPower:MARKer[1]|2|...|12:FUNction:RESult?
CALCulate:ACPower:MARKer[1]|2|...|12:MAXimum
CALCulate:ACPower:MARKer[1]|2|...|12:MAXimum:LEfT
CALCulate:ACPower:MARKer[1]|2|...|12:MAXimum:NEXt
CALCulate:ACPower:MARKer[1]|2|...|12:MAXimum:RIGHT
CALCulate:ACPower:MARKer[1]|2|...|12:MINimum
CALCulate:ACPower:MARKer[1]|2|...|12:MODE POSition | DELTA | OFF
CALCulate:ACPower:MARKer[1]|2|...|12:MODE?
CALCulate:ACPower:MARKer[1]|2|...|12:PTPeak
CALCulate:ACPower:MARKer[1]|2|...|12:REFerence <integer>
CALCulate:ACPower:MARKer[1]|2|...|12:REFerence?
CALCulate:ACPower:MARKer[1]|2|...|12:STATe OFF | ON | 0 | 1
CALCulate:ACPower:MARKer[1]|2|...|12:STATe?
CALCulate:ACPower:MARKer[1]|2|...|12:TRACe 1 | 2 | 3
CALCulate:ACPower:MARKer[1]|2|...|12:TRACe?
CALCulate:ACPower:MARKer[1]|2|...|12:X <freq>
CALCulate:ACPower:MARKer[1]|2|...|12:X?
CALCulate:ACPower:MARKer[1]|2|...|12:X:POSition <real>
CALCulate:ACPower:MARKer[1]|2|...|12:X:POSition?
CALCulate:ACPower:MARKer[1]|2|...|12:Y?
CALCulate:ACPower:OFFSet[:OUTer]:LIST:LIMit:NEGative[:UPPer]:DATA <real>,
...
CALCulate:ACPower:OFFSet[:OUTer]:LIST:LIMit:NEGative[:UPPer]:DATA?
CALCulate:ACPower:OFFSet[:OUTer]:LIST:LIMit:POSitive[:UPPer]:DATA <real>,
...
CALCulate:ACPower:OFFSet[:OUTer]:LIST:LIMit:POSitive[:UPPer]:DATA?

```

```

CALCulate:CHPower:MARKer:AOff
CALCulate:CHPower:MARKer[1]|2|...|12:MAXimum
CALCulate:CHPower:MARKer[1]|2|...|12:MODE POSition | DELTa | OFF
CALCulate:CHPower:MARKer[1]|2|...|12:MODE?
CALCulate:CHPower:MARKer[1]|2|...|12:REFerence <integer>
CALCulate:CHPower:MARKer[1]|2|...|12:REFerence?
CALCulate:CHPower:MARKer[1]|2|...|12:STATE OFF | ON | 0 | 1
CALCulate:CHPower:MARKer[1]|2|...|12:STATE?
CALCulate:CHPower:MARKer[1]|2|...|12:TRACE RFSpectrum | LSHoulder |
RSHoulder
CALCulate:CHPower:MARKer[1]|2|...|12:TRACE RFSpectrum | LSHoulder |
RSHoulder | MASK
CALCulate:CHPower:MARKer[1]|2|...|12:TRACE?
CALCulate:CHPower:MARKer[1]|2|...|12:TRACE?
CALCulate:CHPower:MARKer[1]|2|...|12:X <real>
CALCulate:CHPower:MARKer[1]|2|...|12:X?
CALCulate:CHPower:MARKer[1]|2|...|12:X:POSition <real>
CALCulate:CHPower:MARKer[1]|2|...|12:X:POSition?
CALCulate:CHPower:MARKer[1]|2|...|12:Y?
CALCulate:CHPower:MASK:STATE ON | OFF | 1 | 0
CALCulate:CHPower:MASK:STATE?
CALCulate:CLIMits:FAIL?
CALCulate:DATA<n>:COMPRESS? BLOCK | CFIT | MAXimum | MINimum | MEAN |
DMEan | RMS | RMSCubed | SAMPLE | SDEVIation | PPHase[, <soffset>[,
<length>[, <roffset>[, <rlimit>]]]]
CALCulate:DATA[n]?
CALCulate:DATA[1]|2|...|6:PEAKs? <threshold>, <excursion>[, AMPLitude |
FREQuency | TIME]
CALCulate:DATA[1]|2|...|6:PEAKs? <threshold>, <excursion>[, AMPLitude |
FREQuency | TIME[, ALL | GTDLine | LTDLine]]
CALCulate:EVM:MARKer:AOff
CALCulate:EVM:MARKer:COUple[:STATE] OFF | ON | 0 | 1
CALCulate:EVM:MARKer:COUple[:STATE]?
CALCulate:EVM:MARKer[1]|2|...|12:MAXimum
CALCulate:EVM:MARKer[1]|2|...|12:MAXimum:LEFT
CALCulate:EVM:MARKer[1]|2|...|12:MAXimum:NEXT
CALCulate:EVM:MARKer[1]|2|...|12:MAXimum:RIGHT
CALCulate:EVM:MARKer[1]|2|...|12:MINimum
CALCulate:EVM:MARKer[1]|2|...|12:MODE POSition | DELTa | OFF
CALCulate:EVM:MARKer[1]|2|...|12:MODE?
CALCulate:EVM:MARKer:PEAK:EXCursion <rel_ampl>
CALCulate:EVM:MARKer:PEAK:EXCursion?
CALCulate:EVM:MARKer:PEAK:EXCursion:STATE OFF | ON | 0 | 1
CALCulate:EVM:MARKer:PEAK:EXCursion:STATE?
CALCulate:EVM:MARKer:PEAK:LIMit <real>
CALCulate:EVM:MARKer:PEAK:LIMit?
CALCulate:EVM:MARKer:PEAK:LIMit:STATE OFF | ON | 0 | 1
CALCulate:EVM:MARKer:PEAK:LIMit:STATE?
CALCulate:EVM:MARKer:PEAK:SORT TIME | AMPLitude
CALCulate:EVM:MARKer:PEAK:SORT?
CALCulate:EVM:MARKer:PEAK:TABLE:STATE OFF | ON | 0 | 1
CALCulate:EVM:MARKer:PEAK:TABLE:STATE?

```

```

CALCulate:EVM:MARKer:PEAK:THReshold <real>
CALCulate:EVM:MARKer:PEAK:THReshold?
CALCulate:EVM:MARKer:PEAK:THReshold:STATE OFF | ON | 0 | 1
CALCulate:EVM:MARKer:PEAK:THReshold:STATE?
CALCulate:EVM:MARKer[1]|2|...12:PTPeak
CALCulate:EVM:MARKer[1]|2|...12:REFErence <integer>
CALCulate:EVM:MARKer[1]|2|...12:REFErence?
CALCulate:EVM:MARKer[1]|2|...12:TRACe POLar | MVCarrier | SPECtrum |
AVCarrier | PVCCarrier | GDVCarrier | AVTime | MVTime
CALCulate:EVM:MARKer[1]|2|...12:TRACe?
CALCulate:EVM:MARKer[1]|2|...12:X <real>
CALCulate:EVM:MARKer[1]|2|...12:X?
CALCulate:EVM:MARKer[1]|2|...12:X:POSition <real>
CALCulate:EVM:MARKer[1]|2|...12:X:POSition?
CALCulate:EVM:MARKer[1]|2|...12:Y?
CALCulate:EVM:NTData[:STATE] OFF | ON | 0 | 1
CALCulate:EVM:NTData[:STATE]?
CALCulate:EVMTwo:MARKer:AOff
CALCulate:EVMTwo:MARKer:COUple[:STATE] OFF | ON | 0 | 1
CALCulate:EVMTwo:MARKer:COUple[:STATE]?
CALCulate:EVMTwo:MARKer[1]|2|...12:MAXimum
CALCulate:EVMTwo:MARKer[1]|2|...12:MAXimum:LEfT
CALCulate:EVMTwo:MARKer[1]|2|...12:MAXimum:NEXt
CALCulate:EVMTwo:MARKer[1]|2|...12:MAXimum:RIgHt
CALCulate:EVMTwo:MARKer[1]|2|...12:MINimum
CALCulate:EVMTwo:MARKer[1]|2|...12:MODE POSition | DELTA | OFF
CALCulate:EVMTwo:MARKer[1]|2|...12:MODE?
CALCulate:EVMTwo:MARKer:PEAK:EXCursion <rel_ampl>
CALCulate:EVMTwo:MARKer:PEAK:EXCursion?
CALCulate:EVMTwo:MARKer:PEAK:EXCursion:STATE OFF | ON | 0 | 1
CALCulate:EVMTwo:MARKer:PEAK:EXCursion:STATE?
CALCulate:EVMTwo:MARKer:PEAK:LIMit <real>
CALCulate:EVMTwo:MARKer:PEAK:LIMit?
CALCulate:EVMTwo:MARKer:PEAK:LIMit:STATE OFF | ON | 0 | 1
CALCulate:EVMTwo:MARKer:PEAK:LIMit:STATE?
CALCulate:EVMTwo:MARKer:PEAK:SORT TIME | AMPLitude
CALCulate:EVMTwo:MARKer:PEAK:SORT?
CALCulate:EVMTwo:MARKer:PEAK:TABLE:STATE OFF | ON | 0 | 1
CALCulate:EVMTwo:MARKer:PEAK:TABLE:STATE?
CALCulate:EVMTwo:MARKer:PEAK:THReshold <real>
CALCulate:EVMTwo:MARKer:PEAK:THReshold?
CALCulate:EVMTwo:MARKer:PEAK:THReshold:STATE OFF | ON | 0 | 1
CALCulate:EVMTwo:MARKer:PEAK:THReshold:STATE?
CALCulate:EVMTwo:MARKer[1]|2|...12:PTPeak
CALCulate:EVMTwo:MARKer[1]|2|...12:REFErence <integer>
CALCulate:EVMTwo:MARKer[1]|2|...12:REFErence?
CALCulate:EVMTwo:MARKer[1]|2|...12:TRACe POLar | MVCarrier | AVCarrier |
A2VCarrier | PVCCarrier | P2VCarrier | GDVCarrier | GD2VCarrier | AVTime |
A2VTime | MVTime
CALCulate:EVMTwo:MARKer[1]|2|...12:TRACe?
CALCulate:EVMTwo:MARKer[1]|2|...12:X <real>
CALCulate:EVMTwo:MARKer[1]|2|...12:X?

```

### 3 Programming the Analyzer

#### List of SCPI Commands

```
CALCulate:EVMTtwo:MARKer[1]|2|...|12:X:POSition <real>
CALCulate:EVMTtwo:MARKer[1]|2|...|12:X:POSition?
CALCulate:EVMTtwo:MARKer[1]|2|...|12:Y?
CALCulate:EVMTtwo:NTData[:STATE] OFF | ON | 0 | 1
CALCulate:EVMTtwo:NTData[:STATE]?
CALCulate:MCPower:OFFSet:LIST:LIMit:NEGative[:UPPer]:DATA (PSAPowerSuite)
CALCulate:MCPower:OFFSet:LIST:LIMit:POSitive[:UPPer]:DATA (PSAPowerSuite)
CALCulate:MONitor:MARKer:AOFF
CALCulate:MONitor:MARKer:COUPle[:STATE] ON | OFF | 1 | 0
CALCulate:MONitor:MARKer:COUPle[:STATE]?
CALCulate:MONitor:MARKer[1]|2|...|12:FUNCTION NOISE | BPOWER | BDENSITY |
OFF
CALCulate:MONitor:MARKer[1]|2|...|12:FUNCTION?
CALCulate:MONitor:MARKer[1]|2|...|12:FUNCTION:BAND:LEFT <freq>
CALCulate:MONitor:MARKer[1]|2|...|12:FUNCTION:BAND:LEFT?
CALCulate:MONitor:MARKer[1]|2|...|12:FUNCTION:BAND:RIGHT <freq>
CALCulate:MONitor:MARKer[1]|2|...|12:FUNCTION:BAND:RIGHT?
CALCulate:MONitor:MARKer[1]|2|...|12:FUNCTION:BAND:SPAN <freq>
CALCulate:MONitor:MARKer[1]|2|...|12:FUNCTION:BAND:SPAN?
CALCulate:MONitor:MARKer[1]|2|...|12:FUNCTION:RESULT?
CALCulate:MONitor:MARKer[1]|2|...|12:MAXimum
CALCulate:MONitor:MARKer[1]|2|...|12:MODE POSition | DELTA | OFF
CALCulate:MONitor:MARKer[1]|2|...|12:MODE?
CALCulate:MONitor:MARKer[1]|2|...|12:REFERENCE <integer>
CALCulate:MONitor:MARKer[1]|2|...|12:REFERENCE?
CALCulate:MONitor:MARKer[1]|2|...|12:TRACE <integer>
CALCulate:MONitor:MARKer[1]|2|...|12:TRACE?
CALCulate:MONitor:MARKer[1]|2|...|12:X <freq>
CALCulate:MONitor:MARKer[1]|2|...|12:X?
CALCulate:MONitor:MARKer[1]|2|...|12:X:POSition <real>
CALCulate:MONitor:MARKer[1]|2|...|12:X:POSition?
CALCulate:MONitor:MARKer[1]|2|...|12:Y?
CALCulate:PStatistic:MARKer:AOFF
CALCulate:PStatistic:MARKer[1]|2|...|12:FUNCTION:RESULT?
CALCulate:PStatistic:MARKer[1]|2|...|12:MODE POSition | DELTA | OFF
CALCulate:PStatistic:MARKer[1]|2|...|12:MODE?
CALCulate:PStatistic:MARKer[1]|2|...|12:REFERENCE <integer>
CALCulate:PStatistic:MARKer[1]|2|...|12:REFERENCE?
CALCulate:PStatistic:MARKer[1]|2|...|12:TRACE MEASURED | GAUSSIAN |
REFERENCE
CALCulate:PStatistic:MARKer[1]|2|...|12:TRACE?
CALCulate:PStatistic:MARKer[1]|2|...|12:X <rel_ampl>
CALCulate:PStatistic:MARKer[1]|2|...|12:X?
CALCulate:PStatistic:MARKer[1]|2|...|12:Y?
CALCulate:PStatistic:STORE:REFERENCE
CALCulate:SEMask:LLINE:STATE ON | OFF | 1 | 0
CALCulate:SEMask:LLINE:STATE?
CALCulate:SEMask:MARKer:AOFF
CALCulate:SEMask:MARKer:COUPle[:STATE] ON | OFF | 1 | 0
CALCulate:SEMask:MARKer:COUPle[:STATE]?
CALCulate:SEMask:MARKer[1]|2|...|12:FUNCTION:RESULT?
CALCulate:SEMask:MARKer[1]|2|...|12:MODE POSition | OFF
CALCulate:SEMask:MARKer[1]|2|...|12:MODE?
```



```

CALCulate:SEMask:MARKer[1]|2|...|12:X <freq>
CALCulate:SEMask:MARKer[1]|2|...|12:X?
CALCulate:SEMask:MARKer[1]|2|...|12:X:POSition <real>
CALCulate:SEMask:MARKer[1]|2|...|12:X:POSition?
CALCulate:SEMask:MARKer[1]|2|...|12:Y?
CALCulate:SPURious:MARKer:AOff
CALCulate:SPURious:MARKer:COUple[:STATe] ON | OFF | 1 | 0
CALCulate:SPURious:MARKer:COUple[:STATe]?
CALCulate:SPURious:MARKer[1]|2|...|12:MAXimum
CALCulate:SPURious:MARKer[1]|2|...|12:MAXimum:LEFT
CALCulate:SPURious:MARKer[1]|2|...|12:MAXimum:NEXT
CALCulate:SPURious:MARKer[1]|2|...|12:MAXimum:RIGHt
CALCulate:SPURious:MARKer[1]|2|...|12:MINimum
CALCulate:SPURious:MARKer[1]|2|...|12:MODE POSition | DELTA | OFF
CALCulate:SPURious:MARKer[1]|2|...|12:MODE?
CALCulate:SPURious:MARKer[1]|2|...|12:PTPeak
CALCulate:SPURious:MARKer[1]|2|...|12:REFerence <integer>
CALCulate:SPURious:MARKer[1]|2|...|12:REFerence?
CALCulate:SPURious:MARKer[1]|2|...|12:X <freq>
CALCulate:SPURious:MARKer[1]|2|...|12:X?
CALCulate:SPURious:MARKer[1]|2|...|12:X:POSition <integer>
CALCulate:SPURious:MARKer[1]|2|...|12:X:POSition?
CALCulate:SPURious:MARKer[1]|2|...|12:Y?
CALCulate:SPURious[:RANGE][:LIST]:LIMit:ABSolute[:UPPer]:DATA[:START]
<ampl>, ...
CALCulate:SPURious[:RANGE][:LIST]:LIMit:ABSolute[:UPPer]:DATA[:START]?
CALCulate:SPURious[:RANGE][:LIST]:LIMit:ABSolute[:UPPer]:DATA:STOP <ampl>,
...
CALCulate:SPURious[:RANGE][:LIST]:LIMit:ABSolute[:UPPer]:DATA:STOP?
CALCulate:SPURious[:RANGE][:LIST]:LIMit:ABSolute[:UPPer]:DATA:STOP:AUTO
OFF|ON|0|1, ...
CALCulate:SPURious[:RANGE][:LIST]:LIMit:ABSolute[:UPPer]:DATA:STOP:AUTO?
CALCulate:WAVEform:MARKer:AOff
CALCulate:WAVEform:MARKer:COUple[:STATe] ON | OFF | 1 | 0
CALCulate:WAVEform:MARKer:COUple[:STATe]?
CALCulate:WAVEform:MARKer[1]|2|...|12:FUNCTion BPOwer | BDENsity | OFF
CALCulate:WAVEform:MARKer[1]|2|...|12:FUNCTion?
CALCulate:WAVEform:MARKer[1]|2|...|12:FUNCTion:BAND:LEFT <time>
CALCulate:WAVEform:MARKer[1]|2|...|12:FUNCTion:BAND:LEFT?
CALCulate:WAVEform:MARKer[1]|2|...|12:FUNCTion:BAND:RIGHt <time>
CALCulate:WAVEform:MARKer[1]|2|...|12:FUNCTion:BAND:RIGHt?
CALCulate:WAVEform:MARKer[1]|2|...|12:FUNCTion:BAND:SPAN <time>
CALCulate:WAVEform:MARKer[1]|2|...|12:FUNCTion:BAND:SPAN?
CALCulate:WAVEform:MARKer[1]|2|...|12:FUNCTion:RESUlt?
CALCulate:WAVEform:MARKer[1]|2|...|12:MAXimum
CALCulate:WAVEform:MARKer[1]|2|...|12:MAXimum:NEXT
CALCulate:WAVEform:MARKer[1]|2|...|12:MINimum
CALCulate:WAVEform:MARKer[1]|2|...|12:MODE POSition | DELTA | OFF
CALCulate:WAVEform:MARKer[1]|2|...|12:MODE?
CALCulate:WAVEform:MARKer[1]|2|...|12:REFerence <integer>
CALCulate:WAVEform:MARKer[1]|2|...|12:REFerence?
CALCulate:WAVEform:MARKer[1]|2|...|12:STATe OFF | ON | 0 | 1

```

### 3 Programming the Analyzer

#### List of SCPI Commands

```
CALCulate:WAVEform:MARKer[1]|2|...|12:STATE?
CALCulate:WAVEform:MARKer[1]|2|...|12:TRACE RFENvelope | I | Q | IQ
CALCulate:WAVEform:MARKer[1]|2|...|12:TRACE?
CALCulate:WAVEform:MARKer[1]|2|...|12:X <time>
CALCulate:WAVEform:MARKer[1]|2|...|12:X?
CALCulate:WAVEform:MARKer[1]|2|...|12:X:POSition <real>
CALCulate:WAVEform:MARKer[1]|2|...|12:X:POSition?
CALCulate:WAVEform:MARKer[1]|2|...|4:X:SPAN
CALCulate:WAVEform:MARKer[1]|2|...|12:Y?
CALibration[:ALL]
CALibration[:ALL]?
CALibration:AUTO ALERT
CALibration:AUTO ON | PARTial | OFF
CALibration:AUTO?
CALibration:AUTO:ALERT TEMperature | DAY | WEEK | NONE
CALibration:AUTO:ALERT?
CALibration:AUTO:MODE ALL | NRF
CALibration:AUTO:MODE?
CALibration:AUTO:TIME:OFF?
CALibration:DATA:BACKup <filename>
CALibration:DATA:DEFault
CALibration:DATA:REStore <filename>
CALibration:EMIXer
CALibration:EMIXer?
CALibration:EXPIred?
CALibration:FREQuency:REFerence:COARse <integer>
CALibration:FREQuency:REFerence:COARse
CALibration:FREQuency:REFerence:COARse?
CALibration:FREQuency:REFerence:FINE <integer>
CALibration:FREQuency:REFerence:FINE?
CALibration:FREQuency:REFerence:MODE CALibrated | USER
CALibration:FREQuency:REFerence:MODE?
CALibration:IQ:FLATness:I
CALibration:IQ:FLATness:IBAR
CALibration:IQ:FLATness:I|IBAR|Q|QBAR:TIME?
CALibration:IQ:FLATness:Q
CALibration:IQ:FLATness:QBAR
CALibration:IQ:ISOLation
CALibration:IQ:ISOLation:TIME?
CALibration:IQ:PROBE:I
CALibration:IQ:PROBE:IBar
CALibration:IQ:PROBE:I|IBAR|Q|QBAR:TIME?
CALibration:IQ:PROBE:I|Q:CLEar
CALibration:IQ:PROBE:Q
CALibration:IQ:PROBE:QBar
CALibration:NRF
CALibration:NRF?
CALibration:REFerence:CLOCK?
CALibration:REFerence:CLOCK:END?
CALibration:REFerence:CLOCK:INITialize?
CALibration:RF
CALibration:RF?
CALibration:RFPSelector:SCHeduler:TIME:NEXT?
```

```

CALibration:SOURce:STATe OFF | ON | 0 | 1
CALibration:SOURce:STATe?
CALibration:TEMPerature:CURRent?
CALibration:TEMPerature:LALL?
CALibration:TEMPerature:LPReselector?
CALibration:TEMPerature:LRF?
CALibration:TEMPerature:RFPSelector:LCONducted?
CALibration:TEMPerature:RFPSelector:LRADiated?
CALibration:TIME:LALL?
CALibration:TIME:LPReselector?
CALibration:TIME:LRF?
CALibration:TIME:REFerence:CLOCK?
CALibration:TIME:RFPSelector:LCONducted?
CALibration:TIME:RFPSelector:LRADiated?
CALibration:YTF
CALibration:YTF?
CONF FSC
CONFigure?
CONFigure:ACP
CONFigure:ACP:NDEFault
CONFigure:ACPower
CONFigure:CHPower
CONFigure:CHPower
CONFigure:CHPower:NDEFault
CONFigure:EVM
CONFigure:EVM
CONFigure:EVM:NDEFault
CONFigure:EVMTtwo
CONFigure:EVMTtwo
CONFigure:EVMTtwo:NDEFault
CONFigure:MONitor
CONFigure:MONitor
CONFigure:MONitor:NDEFault
CONFigure:PStatistic
CONFigure:PStatistic
CONFigure:PStatistic:NDEFault
CONFigure:SEMask
CONFigure:SEMask
CONFigure:SEMask:NDEFault
CONFigure:SPURious
CONFigure:SPURious
CONFigure:SPURious:NDEFault
CONFigure:WAVEform
CONFigure:WAVEform
CONFigure:WAVEform:NDEFault
COUple ALL | NONE
DISPlay:<measurement>:ANNOtation:TITLe:DATA <string>
DISPlay:<measurement>:ANNOtation:TITLe:DATA?
DISPlay:ACPower:VIEW:NSElect <integer>
DISPlay:ACPower:VIEW:NSElect?
DISPlay:ACPower:VIEW[:SElect] PRESult | CINformation
DISPlay:ACPower:VIEW[:SElect]?
DISPlay:ACPower:VIEW[1]:WINDow[1]:BGRaph OFF | ON | 0 | 1

```

```
DISPlay:ACPower:VIEW[1]:WINDow[1]:BGRaph?
DISPlay:ACPower:VIEW[1]:WINDow[1]:TRACe:Y[:SCALe]:COUPlE 0 | 1 | OFF | ON
DISPlay:ACPower:VIEW[1]:WINDow[1]:TRACe:Y[:SCALe]:COUPlE?
DISPlay:ACPower:VIEW[1]:WINDow[1]:TRACe:Y[:SCALe]:PDIVision <rel_ampl>
DISPlay:ACPower:VIEW[1]:WINDow[1]:TRACe:Y[:SCALe]:PDIVision?
DISPlay:ACPower:VIEW[1]:WINDow[1]:TRACe:Y[:SCALe]:RLEVel <real>
DISPlay:ACPower:VIEW[1]:WINDow[1]:TRACe:Y[:SCALe]:RLEVel?
DISPlay:ACPower:VIEW[1]:WINDow[1]:TRACe:Y[:SCALe]:RPOSition TOP | CENTer |
BOTTom
DISPlay:ACPower:VIEW[1]:WINDow[1]:TRACe:Y[:SCALe]:RPOSition?
DISPlay:ACTivefunc[:STATe] ON | OFF | 1 | 0
DISPlay:ACTivefunc[:STATe]?
DISPlay:ANNotation:MBAR[:STATe] OFF | ON | 0 | 1
DISPlay:ANNotation:MBAR[:STATe]?
DISPlay:ANNotation:SCReen[:STATe] OFF | ON | 0 | 1
DISPlay:ANNotation:SCReen[:STATe]?
DISPlay:BACKlight ON | OFF
DISPlay:BACKlight?
DISPlay:BACKlight:INTensity <integer>
DISPlay:BACKlight:INTensity?
DISPlay:CHPower:VIEW:MASK[:SELEct] LSNI | GPNI | IPNI | GPA2 | KSKP
DISPlay:CHPower:VIEW:MASK[:SELEct]?
DISPlay:CHPower:VIEW:NSELEct <integer>
DISPlay:CHPower:VIEW:NSELEct?
DISPlay:CHPower:VIEW[:SELEct] PRESult | CINFormation
DISPlay:CHPower:VIEW[:SELEct] RFSpectrum | SHOULder
DISPlay:CHPower:VIEW[:SELEct] RFSpectrum | SHOULder | MASK
DISPlay:CHPower:VIEW[:SELEct]?
DISPlay:CHPower:VIEW[:SELEct]?
DISPlay:CHPower:VIEW[:SELEct]?
DISPlay:CHPower:VIEW[1]:WINDow[1]:BGRaph ON | OFF | 1 | 0
DISPlay:CHPower:VIEW[1]:WINDow[1]:BGRaph?
DISPlay:CHPower:VIEW[1]:WINDow[1]:TRACe:Y[:SCALe]:COUPlE 0 | 1 | OFF | ON
DISPlay:CHPower:VIEW[1]:WINDow[1]:TRACe:Y[:SCALe]:COUPlE?
DISPlay:CHPower:VIEW[1]:WINDow[1]:TRACe:Y[:SCALe]:PDIVision <rel_ampl>
DISPlay:CHPower:VIEW[1]:WINDow[1]:TRACe:Y[:SCALe]:PDIVision?
DISPlay:CHPower:VIEW[1]:WINDow[1]:TRACe:Y[:SCALe]:RLEVel <real>
DISPlay:CHPower:VIEW[1]:WINDow[1]:TRACe:Y[:SCALe]:RLEVel?
DISPlay:CHPower:VIEW[1]:WINDow[1]:TRACe:Y[:SCALe]:RPOSition TOP | CENTer |
BOTTom
DISPlay:CHPower:VIEW[1]:WINDow[1]:TRACe:Y[:SCALe]:RPOSition?
DISPlay:ENABle OFF | ON | 0 | 1
DISPlay:ENABle?
DISPlay:EVM:CARRier:START <integer>
DISPlay:EVM:CARRier:START?
DISPlay:EVM:CARRier:STOP <integer>
DISPlay:EVM:CARRier:STOP?
DISPlay:EVM:GD:APERTure <real>
DISPlay:EVM:GD:APERTure?
DISPlay:EVM:GDELay:APERTure <real>
DISPlay:EVM:GDELay:APERTure?
DISPlay:EVM:GIRBar[:STATe] OFF | ON | 0 | 1
DISPlay:EVM:GIRBar[:STATe]?
```

```

DISPlay:EVMTtwo:CARRier:START <integer>
DISPlay:EVMTtwo:CARRier:START?
DISPlay:EVMTtwo:CARRier:STOP <integer>
DISPlay:EVMTtwo:CARRier:STOP?
DISPlay:EVMTtwo:DTYPE:DATA[:STATE] OFF | ON | 0 | 1
DISPlay:EVMTtwo:DTYPE:DATA[:STATE]?
DISPlay:EVMTtwo:DTYPE:L1Signalling:POST[:STATE] OFF | ON | 0 | 1
DISPlay:EVMTtwo:DTYPE:L1Signalling:POST[:STATE]?
DISPlay:EVMTtwo:DTYPE:L1Signalling:PRE[:STATE] OFF | ON | 0 | 1
DISPlay:EVMTtwo:DTYPE:L1Signalling:PRE[:STATE]?
DISPlay:EVMTtwo:DTYPE:PILot[:STATE] OFF | ON | 0 | 1
DISPlay:EVMTtwo:DTYPE:PILot[:STATE]?
DISPlay:EVMTtwo:GD:APERture <real>
DISPlay:EVMTtwo:GD:APERture?
DISPlay:EVMTtwo:GDElay:APERture <real>
DISPlay:EVMTtwo:GDElay:APERture?
DISPlay:EVMTtwo:GIRBar[:STATE] OFF | ON | 0 | 1
DISPlay:EVMTtwo:GIRBar[:STATE]?
DISPlay:EVMTtwo:IDPLp <integer>
DISPlay:EVMTtwo:IDPLp <integer>
DISPlay:EVMTtwo:IDPLp?
DISPlay:EVMTtwo:IDPLp?
DISPlay:EVMTtwo:MISO:TYPE TX1 | TX2 | TX1TX2
DISPlay:EVMTtwo:MISO:TYPE TX1 | TX2 | TX1TX2
DISPlay:EVMTtwo:MISO:TYPE?
DISPlay:EVMTtwo:MISO:TYPE?
DISPlay:EVMTtwo:VIEW:NSElect <integer>
DISPlay:EVMTtwo:VIEW:NSElect?
DISPlay:EVMTtwo:VIEW[:SElect] POLar | IQERror | FREQuency | IMPulse |
SIGNalling | MERMonitor | NRESults | MERPlp | BER
DISPlay:EVMTtwo:VIEW[:SElect]?
DISPlay:EVMTtwo:VIEW2:WINDow[1]:TRACe:X[:SCALE][:CARRier]:PDIVision <real>
DISPlay:EVMTtwo:VIEW2:WINDow[1]:TRACe:X[:SCALE][:CARRier]:PDIVision?
DISPlay:EVMTtwo:VIEW2:WINDow[1]:TRACe:X[:SCALE][:CARRier]:RLEVel <real>
DISPlay:EVMTtwo:VIEW2:WINDow[1]:TRACe:X[:SCALE][:CARRier]:RLEVel?
DISPlay:EVMTtwo:VIEW3:WINDow2:TRACe:X[:SCALE]:COUPle OFF | ON | 0 | 1
DISPlay:EVMTtwo:VIEW5:WINDow[1]:TRACe:X[:SCALE]:COUPle OFF | ON | 0 | 1
DISPlay:EVMTtwo:VIEW4:WINDow[1]:TRACe:X[:SCALE]:COUPle OFF | ON | 0 | 1
DISPlay:EVMTtwo:VIEW2:WINDow[1]:TRACe:X[:SCALE]:COUPle OFF | ON | 0 | 1
DISPlay:EVMTtwo:VIEW3:WINDow[1]:TRACe:X[:SCALE]:COUPle OFF | ON | 0 | 1
DISPlay:EVMTtwo:VIEW3:WINDow3:TRACe:X[:SCALE]:COUPle OFF | ON | 0 | 1
DISPlay:EVMTtwo:VIEW5:WINDow[1]:TRACe:X[:SCALE]:COUPle?
DISPlay:EVMTtwo:VIEW4:WINDow[1]:TRACe:X[:SCALE]:COUPle?
DISPlay:EVMTtwo:VIEW3:WINDow2:TRACe:X[:SCALE]:COUPle?
DISPlay:EVMTtwo:VIEW3:WINDow[1]:TRACe:X[:SCALE]:COUPle?
DISPlay:EVMTtwo:VIEW3:WINDow3:TRACe:X[:SCALE]:COUPle?
DISPlay:EVMTtwo:VIEW2:WINDow[1]:TRACe:X[:SCALE]:COUPle?
DISPlay:EVMTtwo:VIEW4:WINDow[1]:TRACe:X[:SCALE]:DISTance:PDIVision <real>
DISPlay:EVMTtwo:VIEW4:WINDow[1]:TRACe:X[:SCALE]:DISTance:PDIVision?
DISPlay:EVMTtwo:VIEW4:WINDow[1]:TRACe:X[:SCALE]:DISTance:RLEVel <real>
DISPlay:EVMTtwo:VIEW4:WINDow[1]:TRACe:X[:SCALE]:DISTance:RLEVel?
DISPlay:EVMTtwo:VIEW2:WINDow[1]:TRACe:X[:SCALE]:FREQuency:PDIVision <real>
DISPlay:EVMTtwo:VIEW2:WINDow[1]:TRACe:X[:SCALE]:FREQuency:PDIVision?

```

```
DISPlay:EVMTtwo:VIEW2:WINDow[1]:TRACe:X[:SCALe]:FREQuency:RLEVel <real>
DISPlay:EVMTtwo:VIEW2:WINDow[1]:TRACe:X[:SCALe]:FREQuency:RLEVel?
DISPlay:EVMTtwo:VIEW3:WINDow2:TRACe:X[:SCALe]:PDIVision <real>
DISPlay:EVMTtwo:VIEW3:WINDow3:TRACe:X[:SCALe]:PDIVision <real>
DISPlay:EVMTtwo:VIEW5:WINDow[1]:TRACe:X[:SCALe]:PDIVision <real>
DISPlay:EVMTtwo:VIEW3:WINDow[1]:TRACe:X[:SCALe]:PDIVision <real>
DISPlay:EVMTtwo:VIEW5:WINDow[1]:TRACe:X[:SCALe]:PDIVision?
DISPlay:EVMTtwo:VIEW3:WINDow2:TRACe:X[:SCALe]:PDIVision?
DISPlay:EVMTtwo:VIEW3:WINDow3:TRACe:X[:SCALe]:PDIVision?
DISPlay:EVMTtwo:VIEW3:WINDow[1]:TRACe:X[:SCALe]:PDIVision?
DISPlay:EVMTtwo:VIEW3:WINDow2:TRACe:X[:SCALe]:RLEVel <real>
DISPlay:EVMTtwo:VIEW3:WINDow[1]:TRACe:X[:SCALe]:RLEVel <real>
DISPlay:EVMTtwo:VIEW3:WINDow3:TRACe:X[:SCALe]:RLEVel <real>
DISPlay:EVMTtwo:VIEW5:WINDow[1]:TRACe:X[:SCALe]:RLEVel <real>
DISPlay:EVMTtwo:VIEW3:WINDow[1]:TRACe:X[:SCALe]:RLEVel?
DISPlay:EVMTtwo:VIEW3:WINDow2:TRACe:X[:SCALe]:RLEVel?
DISPlay:EVMTtwo:VIEW5:WINDow[1]:TRACe:X[:SCALe]:RLEVel?
DISPlay:EVMTtwo:VIEW3:WINDow3:TRACe:X[:SCALe]:RLEVel?
DISPlay:EVMTtwo:VIEW2:WINDow[1]:TRACe:X[:SCALe]:RPOSition LEFT | CENTER |
RIGHT
DISPlay:EVMTtwo:VIEW3:WINDow[1]:TRACe:X[:SCALe]:RPOSition LEFT | CENTER |
RIGHT
DISPlay:EVMTtwo:VIEW5:WINDow[1]:TRACe:X[:SCALe]:RPOSition LEFT | CENTER |
RIGHT
DISPlay:EVMTtwo:VIEW4:WINDow[1]:TRACe:X[:SCALe]:RPOSition LEFT | CENTER |
RIGHT
DISPlay:EVMTtwo:VIEW3:WINDow2:TRACe:X[:SCALe]:RPOSition LEFT | CENTER |
RIGHT
DISPlay:EVMTtwo:VIEW3:WINDow3:TRACe:X[:SCALe]:RPOSition LEFT | CENTER |
RIGHT
DISPlay:EVMTtwo:VIEW3:WINDow3:TRACe:X[:SCALe]:RPOSition?
DISPlay:EVMTtwo:VIEW4:WINDow[1]:TRACe:X[:SCALe]:RPOSition?
DISPlay:EVMTtwo:VIEW5:WINDow[1]:TRACe:X[:SCALe]:RPOSition?
DISPlay:EVMTtwo:VIEW3:WINDow[1]:TRACe:X[:SCALe]:RPOSition?
DISPlay:EVMTtwo:VIEW2:WINDow[1]:TRACe:X[:SCALe]:RPOSition?
DISPlay:EVMTtwo:VIEW3:WINDow2:TRACe:X[:SCALe]:RPOSition?
DISPlay:EVMTtwo:VIEW4:WINDow[1]:TRACe:X[:SCALe][:TIME]:PDIVision <real>
DISPlay:EVMTtwo:VIEW4:WINDow[1]:TRACe:X[:SCALe][:TIME]:PDIVision?
DISPlay:EVMTtwo:VIEW4:WINDow[1]:TRACe:X[:SCALe][:TIME]:RLEVel <real>
DISPlay:EVMTtwo:VIEW4:WINDow[1]:TRACe:X[:SCALe][:TIME]:RLEVel?
DISPlay:EVMTtwo:VIEW2:WINDow[1]:TRACe:X[:SCALe]:TYPE CARRier | FREQuency
DISPlay:EVMTtwo:VIEW4:WINDow[1]:TRACe:X[:SCALe]:TYPE TIME | DISTance
DISPlay:EVMTtwo:VIEW4:WINDow[1]:TRACe:X[:SCALe]:TYPE?
DISPlay:EVMTtwo:VIEW2:WINDow[1]:TRACe:X[:SCALe]:TYPE?
DISPlay:EVMTtwo:VIEW2:WINDow[1]:TRACe:Y[:SCALe]:COUPle OFF | ON | 0 | 1
DISPlay:EVMTtwo:VIEW3:WINDow[1]:TRACe:Y[:SCALe]:COUPle OFF | ON | 0 | 1
DISPlay:EVMTtwo:VIEW4:WINDow[1]:TRACe:Y[:SCALe]:COUPle OFF | ON | 0 | 1
DISPlay:EVMTtwo:VIEW3:WINDow3:TRACe:Y[:SCALe]:COUPle OFF | ON | 0 | 1
DISPlay:EVMTtwo:VIEW5:WINDow[1]:TRACe:Y[:SCALe]:COUPle OFF | ON | 0 | 1
DISPlay:EVMTtwo:VIEW3:WINDow2:TRACe:Y[:SCALe]:COUPle OFF | ON | 0 | 1
DISPlay:EVMTtwo:VIEW3:WINDow[1]:TRACe:Y[:SCALe]:COUPle?
DISPlay:EVMTtwo:VIEW3:WINDow2:TRACe:Y[:SCALe]:COUPle?
```

```

DISPlay:EVMTtwo:VIEW2:WINDow[1]:TRACe:Y[:SCALe]:COUPLe?
DISPlay:EVMTtwo:VIEW5:WINDow[1]:TRACe:Y[:SCALe]:COUPLe?
DISPlay:EVMTtwo:VIEW4:WINDow[1]:TRACe:Y[:SCALe]:COUPLe?
DISPlay:EVMTtwo:VIEW3:WINDow3:TRACe:Y[:SCALe]:COUPLe?
DISPlay:EVMTtwo:VIEW2:WINDow[1]:TRACe:Y[:SCALe]:EVM:PDIVision <real>
DISPlay:EVMTtwo:VIEW2:WINDow[1]:TRACe:Y[:SCALe]:EVM:PDIVision?
DISPlay:EVMTtwo:VIEW2:WINDow[1]:TRACe:Y[:SCALe]:EVM:RLEVel <real>
DISPlay:EVMTtwo:VIEW2:WINDow[1]:TRACe:Y[:SCALe]:EVM:RLEVel?
DISPlay:EVMTtwo:VIEW2:WINDow[1]:TRACe:Y[:SCALe][:MER]:PDIVision <real>
DISPlay:EVMTtwo:VIEW2:WINDow[1]:TRACe:Y[:SCALe][:MER]:PDIVision?
DISPlay:EVMTtwo:VIEW2:WINDow[1]:TRACe:Y[:SCALe][:MER]:RLEVel <real>
DISPlay:EVMTtwo:VIEW2:WINDow[1]:TRACe:Y[:SCALe][:MER]:RLEVel?
DISPlay:EVMTtwo:VIEW3:WINDow[1]:TRACe:Y[:SCALe]:NRLevel <real>
DISPlay:EVMTtwo:VIEW3:WINDow[1]:TRACe:Y[:SCALe]:NRLevel?
DISPlay:EVMTtwo:VIEW3:WINDow[1]:TRACe:Y[:SCALe]:NRPosition <integer>
DISPlay:EVMTtwo:VIEW3:WINDow[1]:TRACe:Y[:SCALe]:NRPosition?
DISPlay:EVMTtwo:VIEW3:WINDow3:TRACe:Y[:SCALe]:PDIVision <real>
DISPlay:EVMTtwo:VIEW3:WINDow2:TRACe:Y[:SCALe]:PDIVision <real>
DISPlay:EVMTtwo:VIEW3:WINDow[1]:TRACe:Y[:SCALe]:PDIVision <real>
DISPlay:EVMTtwo:VIEW4:WINDow[1]:TRACe:Y[:SCALe]:PDIVision <real>
DISPlay:EVMTtwo:VIEW5:WINDow[1]:TRACe:Y[:SCALe]:PDIVision <real>
DISPlay:EVMTtwo:VIEW3:WINDow[1]:TRACe:Y[:SCALe]:PDIVision?
DISPlay:EVMTtwo:VIEW3:WINDow3:TRACe:Y[:SCALe]:PDIVision?
DISPlay:EVMTtwo:VIEW3:WINDow2:TRACe:Y[:SCALe]:PDIVision?
DISPlay:EVMTtwo:VIEW4:WINDow[1]:TRACe:Y[:SCALe]:PDIVision?
DISPlay:EVMTtwo:VIEW5:WINDow[1]:TRACe:Y[:SCALe]:PDIVision?
DISPlay:EVMTtwo:VIEW3:WINDow3:TRACe:Y[:SCALe]:RLEVel <real>
DISPlay:EVMTtwo:VIEW5:WINDow[1]:TRACe:Y[:SCALe]:RLEVel <real>
DISPlay:EVMTtwo:VIEW3:WINDow[1]:TRACe:Y[:SCALe]:RLEVel <real>
DISPlay:EVMTtwo:VIEW3:WINDow2:TRACe:Y[:SCALe]:RLEVel <real>
DISPlay:EVMTtwo:VIEW4:WINDow[1]:TRACe:Y[:SCALe]:RLEVel <real>
DISPlay:EVMTtwo:VIEW5:WINDow[1]:TRACe:Y[:SCALe]:RLEVel?
DISPlay:EVMTtwo:VIEW3:WINDow3:TRACe:Y[:SCALe]:RLEVel?
DISPlay:EVMTtwo:VIEW3:WINDow[1]:TRACe:Y[:SCALe]:RLEVel?
DISPlay:EVMTtwo:VIEW4:WINDow[1]:TRACe:Y[:SCALe]:RLEVel?
DISPlay:EVMTtwo:VIEW3:WINDow2:TRACe:Y[:SCALe]:RLEVel?
DISPlay:EVMTtwo:VIEW3:WINDow3:TRACe:Y[:SCALe]:RPOSition TOP | CENTer |
BOTTom
DISPlay:EVMTtwo:VIEW3:WINDow2:TRACe:Y[:SCALe]:RPOSition TOP | CENTer |
BOTTom
DISPlay:EVMTtwo:VIEW4:WINDow[1]:TRACe:Y[:SCALe]:RPOSition TOP | CENTer |
BOTTom
DISPlay:EVMTtwo:VIEW3:WINDow[1]:TRACe:Y[:SCALe]:RPOSition TOP | CENTer |
BOTTom
DISPlay:EVMTtwo:VIEW2:WINDow[1]:TRACe:Y[:SCALe]:RPOSition TOP | CENTer |
BOTTom
DISPlay:EVMTtwo:VIEW5:WINDow[1]:TRACe:Y[:SCALe]:RPOSition TOP | CENTer |
BOTTom
DISPlay:EVMTtwo:VIEW3:WINDow2:TRACe:Y[:SCALe]:RPOSition?
DISPlay:EVMTtwo:VIEW4:WINDow[1]:TRACe:Y[:SCALe]:RPOSition?
DISPlay:EVMTtwo:VIEW3:WINDow[1]:TRACe:Y[:SCALe]:RPOSition?
DISPlay:EVMTtwo:VIEW3:WINDow3:TRACe:Y[:SCALe]:RPOSition?

```

```
DISPlay:EVMtwo:VIEW2:WINDow[1]:TRACe:Y[:SCALe]:RPOSition?
DISPlay:EVMtwo:VIEW5:WINDow[1]:TRACe:Y[:SCALe]:RPOSition?
DISPlay:EVMtwo:VIEW2:WINDow[1]:TRACe:Y[:SCALe]:TYPE MER | EVM
DISPlay:EVMtwo:VIEW2:WINDow[1]:TRACe:Y[:SCALe]:TYPE?
DISPlay:EVM:VIEW:NSElect <integer>
DISPlay:EVM:VIEW:NSElect?
DISPlay:EVM:VIEW[:SElect] POLar | IQERror | FREQuency | IMPulse | TPS |
BER | MERMonitor | NRESults
DISPlay:EVM:VIEW[:SElect]?
DISPlay:EVM:VIEW2:WINDow[1]:TRACe:X[:SCALe][:CARRier]:PDIVision <real>
DISPlay:EVM:VIEW2:WINDow[1]:TRACe:X[:SCALe][:CARRier]:PDIVision?
DISPlay:EVM:VIEW2:WINDow[1]:TRACe:X[:SCALe][:CARRier]:RLEVel <real>
DISPlay:EVM:VIEW2:WINDow[1]:TRACe:X[:SCALe][:CARRier]:RLEVel?
DISPlay:EVM:VIEW3:WINDow2:TRACe:X[:SCALe]:COUPle OFF | ON | 0 | 1
DISPlay:EVM:VIEW3:WINDow[1]:TRACe:X[:SCALe]:COUPle OFF | ON | 0 | 1
DISPlay:EVM:VIEW3:WINDow3:TRACe:X[:SCALe]:COUPle OFF | ON | 0 | 1
DISPlay:EVM:VIEW5:WINDow[1]:TRACe:X[:SCALe]:COUPle OFF | ON | 0 | 1
DISPlay:EVM:VIEW4:WINDow[1]:TRACe:X[:SCALe]:COUPle OFF | ON | 0 | 1
DISPlay:EVM:VIEW2:WINDow2:TRACe:X[:SCALe]:COUPle OFF | ON | 0 | 1
DISPlay:EVM:VIEW2:WINDow[1]:TRACe:X[:SCALe]:COUPle OFF | ON | 0 | 1
DISPlay:EVM:VIEW3:WINDow3:TRACe:X[:SCALe]:COUPle?
DISPlay:EVM:VIEW3:WINDow2:TRACe:X[:SCALe]:COUPle?
DISPlay:EVM:VIEW5:WINDow[1]:TRACe:X[:SCALe]:COUPle?
DISPlay:EVM:VIEW4:WINDow[1]:TRACe:X[:SCALe]:COUPle?
DISPlay:EVM:VIEW3:WINDow[1]:TRACe:X[:SCALe]:COUPle?
DISPlay:EVM:VIEW2:WINDow2:TRACe:X[:SCALe]:COUPle?
DISPlay:EVM:VIEW2:WINDow[1]:TRACe:X[:SCALe]:COUPle?
DISPlay:EVM:VIEW4:WINDow[1]:TRACe:X[:SCALe]:DISTance:PDIVision <real>
DISPlay:EVM:VIEW4:WINDow[1]:TRACe:X[:SCALe]:DISTance:PDIVision?
DISPlay:EVM:VIEW4:WINDow[1]:TRACe:X[:SCALe]:DISTance:RLEVel <real>
DISPlay:EVM:VIEW4:WINDow[1]:TRACe:X[:SCALe]:DISTance:RLEVel?
DISPlay:EVM:VIEW2:WINDow[1]:TRACe:X[:SCALe]:FREQuency:PDIVision <real>
DISPlay:EVM:VIEW2:WINDow[1]:TRACe:X[:SCALe]:FREQuency:PDIVision?
DISPlay:EVM:VIEW2:WINDow[1]:TRACe:X[:SCALe]:FREQuency:RLEVel <real>
DISPlay:EVM:VIEW2:WINDow[1]:TRACe:X[:SCALe]:FREQuency:RLEVel?
DISPlay:EVM:VIEW5:WINDow[1]:TRACe:X[:SCALe]:PDIVision <real>
DISPlay:EVM:VIEW3:WINDow3:TRACe:X[:SCALe]:PDIVision <real>
DISPlay:EVM:VIEW2:WINDow2:TRACe:X[:SCALe]:PDIVision <real>
DISPlay:EVM:VIEW3:WINDow2:TRACe:X[:SCALe]:PDIVision <real>
DISPlay:EVM:VIEW3:WINDow[1]:TRACe:X[:SCALe]:PDIVision <real>
DISPlay:EVM:VIEW2:WINDow2:TRACe:X[:SCALe]:PDIVision?
DISPlay:EVM:VIEW3:WINDow2:TRACe:X[:SCALe]:PDIVision?
DISPlay:EVM:VIEW3:WINDow[1]:TRACe:X[:SCALe]:PDIVision?
DISPlay:EVM:VIEW5:WINDow[1]:TRACe:X[:SCALe]:PDIVision?
DISPlay:EVM:VIEW3:WINDow3:TRACe:X[:SCALe]:PDIVision?
DISPlay:EVM:VIEW2:WINDow2:TRACe:X[:SCALe]:RLEVel <real>
DISPlay:EVM:VIEW3:WINDow3:TRACe:X[:SCALe]:RLEVel <real>
DISPlay:EVM:VIEW3:WINDow[1]:TRACe:X[:SCALe]:RLEVel <real>
DISPlay:EVM:VIEW3:WINDow2:TRACe:X[:SCALe]:RLEVel <real>
DISPlay:EVM:VIEW5:WINDow[1]:TRACe:X[:SCALe]:RLEVel <real>
DISPlay:EVM:VIEW2:WINDow2:TRACe:X[:SCALe]:RLEVel?
DISPlay:EVM:VIEW3:WINDow2:TRACe:X[:SCALe]:RLEVel?
DISPlay:EVM:VIEW3:WINDow[1]:TRACe:X[:SCALe]:RLEVel?
```



```

DISPlay:EVM:VIEW5:WINDow[1]:TRACe:X[:SCALE]:RLEVel?
DISPlay:EVM:VIEW3:WINDow3:TRACe:X[:SCALE]:RLEVel?
DISPlay:EVM:VIEW2:WINDow2:TRACe:X[:SCALE]:RPOStion LEFT | CENTER | RIGHT
DISPlay:EVM:VIEW4:WINDow[1]:TRACe:X[:SCALE]:RPOStion LEFT | CENTER |
RIGHT
DISPlay:EVM:VIEW3:WINDow3:TRACe:X[:SCALE]:RPOStion LEFT | CENTER | RIGHT
DISPlay:EVM:VIEW3:WINDow[1]:TRACe:X[:SCALE]:RPOStion LEFT | CENTER |
RIGHT
DISPlay:EVM:VIEW5:WINDow[1]:TRACe:X[:SCALE]:RPOStion LEFT | CENTER |
RIGHT
DISPlay:EVM:VIEW3:WINDow2:TRACe:X[:SCALE]:RPOStion LEFT | CENTER | RIGHT
DISPlay:EVM:VIEW2:WINDow[1]:TRACe:X[:SCALE]:RPOStion LEFT | CENTER |
RIGHT
DISPlay:EVM:VIEW4:WINDow[1]:TRACe:X[:SCALE]:RPOStion?
DISPlay:EVM:VIEW5:WINDow[1]:TRACe:X[:SCALE]:RPOStion?
DISPlay:EVM:VIEW3:WINDow3:TRACe:X[:SCALE]:RPOStion?
DISPlay:EVM:VIEW3:WINDow2:TRACe:X[:SCALE]:RPOStion?
DISPlay:EVM:VIEW2:WINDow[1]:TRACe:X[:SCALE]:RPOStion?
DISPlay:EVM:VIEW2:WINDow2:TRACe:X[:SCALE]:RPOStion?
DISPlay:EVM:VIEW3:WINDow[1]:TRACe:X[:SCALE]:RPOStion?
DISPlay:EVM:VIEW4:WINDow[1]:TRACe:X[:SCALE][:TIME]:PDIVision <real>
DISPlay:EVM:VIEW4:WINDow[1]:TRACe:X[:SCALE][:TIME]:PDIVision?
DISPlay:EVM:VIEW4:WINDow[1]:TRACe:X[:SCALE][:TIME]:RLEVel <real>
DISPlay:EVM:VIEW4:WINDow[1]:TRACe:X[:SCALE][:TIME]:RLEVel?
DISPlay:EVM:VIEW4:WINDow[1]:TRACe:X[:SCALE]:TYPE TIME | DISTance
DISPlay:EVM:VIEW2:WINDow[1]:TRACe:X[:SCALE]:TYPE CARRier | FREQuency
DISPlay:EVM:VIEW4:WINDow[1]:TRACe:X[:SCALE]:TYPE?
DISPlay:EVM:VIEW2:WINDow[1]:TRACe:X[:SCALE]:TYPE?
DISPlay:EVM:VIEW2:WINDow2:TRACe:Y[:SCALE]:COUPle OFF | ON | 0 | 1
DISPlay:EVM:VIEW3:WINDow3:TRACe:Y[:SCALE]:COUPle OFF | ON | 0 | 1
DISPlay:EVM:VIEW3:WINDow2:TRACe:Y[:SCALE]:COUPle OFF | ON | 0 | 1
DISPlay:EVM:VIEW2:WINDow[1]:TRACe:Y[:SCALE]:COUPle OFF | ON | 0 | 1
DISPlay:EVM:VIEW5:WINDow[1]:TRACe:Y[:SCALE]:COUPle OFF | ON | 0 | 1
DISPlay:EVM:VIEW3:WINDow[1]:TRACe:Y[:SCALE]:COUPle OFF | ON | 0 | 1
DISPlay:EVM:VIEW4:WINDow[1]:TRACe:Y[:SCALE]:COUPle OFF | ON | 0 | 1
DISPlay:EVM:VIEW5:WINDow[1]:TRACe:Y[:SCALE]:COUPle?
DISPlay:EVM:VIEW3:WINDow2:TRACe:Y[:SCALE]:COUPle?
DISPlay:EVM:VIEW2:WINDow[1]:TRACe:Y[:SCALE]:COUPle?
DISPlay:EVM:VIEW2:WINDow2:TRACe:Y[:SCALE]:COUPle?
DISPlay:EVM:VIEW3:WINDow3:TRACe:Y[:SCALE]:COUPle?
DISPlay:EVM:VIEW3:WINDow[1]:TRACe:Y[:SCALE]:COUPle?
DISPlay:EVM:VIEW4:WINDow[1]:TRACe:Y[:SCALE]:COUPle?
DISPlay:EVM:VIEW2:WINDow[1]:TRACe:Y[:SCALE]:EVM:PDIVision <real>
DISPlay:EVM:VIEW2:WINDow[1]:TRACe:Y[:SCALE]:EVM:PDIVision?
DISPlay:EVM:VIEW2:WINDow[1]:TRACe:Y[:SCALE]:EVM:RLEVel <real>
DISPlay:EVM:VIEW2:WINDow[1]:TRACe:Y[:SCALE]:EVM:RLEVel?
DISPlay:EVM:VIEW2:WINDow[1]:TRACe:Y[:SCALE][:MER]:PDIVision <real>
DISPlay:EVM:VIEW2:WINDow[1]:TRACe:Y[:SCALE][:MER]:PDIVision?
DISPlay:EVM:VIEW2:WINDow[1]:TRACe:Y[:SCALE][:MER]:RLEVel <real>
DISPlay:EVM:VIEW2:WINDow[1]:TRACe:Y[:SCALE][:MER]:RLEVel?
DISPlay:EVM:VIEW3:WINDow[1]:TRACe:Y[:SCALE]:NRLevel <real>
DISPlay:EVM:VIEW3:WINDow[1]:TRACe:Y[:SCALE]:NRLevel?

```

### 3 Programming the Analyzer

#### List of SCPI Commands

```
DISPlay:EVM:VIEW3:WINDow[1]:TRACe:Y[:SCALe]:NRPosition <integer>
DISPlay:EVM:VIEW3:WINDow[1]:TRACe:Y[:SCALe]:NRPosition?
DISPlay:EVM:VIEW2:WINDow2:TRACe:Y[:SCALe]:PDIVision <real>
DISPlay:EVM:VIEW3:WINDow2:TRACe:Y[:SCALe]:PDIVision <real>
DISPlay:EVM:VIEW3:WINDow3:TRACe:Y[:SCALe]:PDIVision <real>
DISPlay:EVM:VIEW5:WINDow[1]:TRACe:Y[:SCALe]:PDIVision <real>
DISPlay:EVM:VIEW4:WINDow[1]:TRACe:Y[:SCALe]:PDIVision <real>
DISPlay:EVM:VIEW3:WINDow[1]:TRACe:Y[:SCALe]:PDIVision <real>
DISPlay:EVM:VIEW5:WINDow[1]:TRACe:Y[:SCALe]:PDIVision?
DISPlay:EVM:VIEW4:WINDow[1]:TRACe:Y[:SCALe]:PDIVision?
DISPlay:EVM:VIEW3:WINDow[1]:TRACe:Y[:SCALe]:PDIVision?
DISPlay:EVM:VIEW2:WINDow2:TRACe:Y[:SCALe]:PDIVision?
DISPlay:EVM:VIEW3:WINDow3:TRACe:Y[:SCALe]:PDIVision?
DISPlay:EVM:VIEW3:WINDow2:TRACe:Y[:SCALe]:PDIVision?
DISPlay:EVM:VIEW2:WINDow2:TRACe:Y[:SCALe]:RLEVel <real>
DISPlay:EVM:VIEW3:WINDow2:TRACe:Y[:SCALe]:RLEVel <real>
DISPlay:EVM:VIEW3:WINDow[1]:TRACe:Y[:SCALe]:RLEVel <real>
DISPlay:EVM:VIEW3:WINDow3:TRACe:Y[:SCALe]:RLEVel <real>
DISPlay:EVM:VIEW5:WINDow[1]:TRACe:Y[:SCALe]:RLEVel <real>
DISPlay:EVM:VIEW4:WINDow[1]:TRACe:Y[:SCALe]:RLEVel <real>
DISPlay:EVM:VIEW3:WINDow3:TRACe:Y[:SCALe]:RLEVel?
DISPlay:EVM:VIEW4:WINDow[1]:TRACe:Y[:SCALe]:RLEVel?
DISPlay:EVM:VIEW2:WINDow2:TRACe:Y[:SCALe]:RLEVel?
DISPlay:EVM:VIEW3:WINDow2:TRACe:Y[:SCALe]:RLEVel?
DISPlay:EVM:VIEW5:WINDow[1]:TRACe:Y[:SCALe]:RLEVel?
DISPlay:EVM:VIEW3:WINDow[1]:TRACe:Y[:SCALe]:RLEVel?
DISPlay:EVM:VIEW3:WINDow[1]:TRACe:Y[:SCALe]:RPOStion TOP | CENTER |
BOTTOm
DISPlay:EVM:VIEW2:WINDow2:TRACe:Y[:SCALe]:RPOStion TOP | CENTER | BOTTOm
DISPlay:EVM:VIEW2:WINDow[1]:TRACe:Y[:SCALe]:RPOStion TOP | CENTER |
BOTTOm
DISPlay:EVM:VIEW3:WINDow2:TRACe:Y[:SCALe]:RPOStion TOP | CENTER | BOTTOm
DISPlay:EVM:VIEW5:WINDow[1]:TRACe:Y[:SCALe]:RPOStion TOP | CENTER |
BOTTOm
DISPlay:EVM:VIEW4:WINDow[1]:TRACe:Y[:SCALe]:RPOStion TOP | CENTER |
BOTTOm
DISPlay:EVM:VIEW3:WINDow3:TRACe:Y[:SCALe]:RPOStion TOP | CENTER | BOTTOm
DISPlay:EVM:VIEW2:WINDow[1]:TRACe:Y[:SCALe]:RPOStion?
DISPlay:EVM:VIEW3:WINDow2:TRACe:Y[:SCALe]:RPOStion?
DISPlay:EVM:VIEW2:WINDow2:TRACe:Y[:SCALe]:RPOStion?
DISPlay:EVM:VIEW3:WINDow[1]:TRACe:Y[:SCALe]:RPOStion?
DISPlay:EVM:VIEW4:WINDow[1]:TRACe:Y[:SCALe]:RPOStion?
DISPlay:EVM:VIEW3:WINDow3:TRACe:Y[:SCALe]:RPOStion?
DISPlay:EVM:VIEW5:WINDow[1]:TRACe:Y[:SCALe]:RPOStion?
DISPlay:EVM:VIEW2:WINDow[1]:TRACe:Y[:SCALe]:TYPE MER | EVM
DISPlay:EVM:VIEW2:WINDow[1]:TRACe:Y[:SCALe]:TYPE?
DISPlay:FSCREEN[:STATE] OFF | ON | 0 | 1
DISPlay:FSCREEN[:STATE]?
DISPlay:MENU[:STATE] OFF | ON | 0 | 1
DISPlay:MONitor:VIEW:NSElect <integer>
DISPlay:MONitor:VIEW:NSElect?
DISPlay:MONitor:VIEW[:SElect] RTRace | CINformation
```

```

DISPlay:MONitor:VIEW[:SElect]?
DISPlay:MONitor:VIEW:WINDow:TRACe[1]|2|3:CLEar
DISPlay:MONitor:VIEW:WINDow:TRACe:CLEar:ALL
DISPlay:MONitor:VIEW:WINDow:TRACe[1]|2|3:TYPE
DISPlay:MONitor:VIEW[1]:WINDow[1]:TRACe:Y[:SCALe]:COUPlE 0 | 1 | OFF | ON
DISPlay:MONitor:VIEW[1]:WINDow[1]:TRACe:Y[:SCALe]:COUPlE?
DISPlay:MONitor:VIEW[1]:WINDow[1]:TRACe:Y[:SCALe]:PDIVision <rel_ampl>
DISPlay:MONitor:VIEW[1]:WINDow[1]:TRACe:Y[:SCALe]:PDIVision?
DISPlay:MONitor:VIEW[1]:WINDow[1]:TRACe:Y[:SCALe]:RLEVel <real>
DISPlay:MONitor:VIEW[1]:WINDow[1]:TRACe:Y[:SCALe]:RLEVel?
DISPlay:MONitor:VIEW[1]:WINDow[1]:TRACe:Y[:SCALe]:RPOSition TOP | CENTER |
BOTTOm
DISPlay:MONitor:VIEW[1]:WINDow[1]:TRACe:Y[:SCALe]:RPOSition?
DISPlay:PStatistic:GAUSSian[:STATE] OFF | ON | 0 | 1
DISPlay:PStatistic:GAUSSian[:STATE]?
DISPlay:PStatistic:RTRace[:STATE] OFF | ON | 0 | 1
DISPlay:PStatistic:RTRace[:STATE]?
DISPlay:PStatistic:VIEW[1]:WINDow2:TRACe:X[:SCALe]:PDIVision <rel_ampl>
DISPlay:PStatistic:VIEW[1]:WINDow2:TRACe:X[:SCALe]:PDIVision?
DISPlay:PStatistic:XSCale
DISPlay:SEMAsk:VIEW:NSElect <integer>
DISPlay:SEMAsk:VIEW:NSElect?
DISPlay:SEMAsk:VIEW[:SElect] APFReq | RPFReq | IPOWer | CINformation
DISPlay:SEMAsk:VIEW[:SElect]?
DISPlay:SEMAsk:VIEW[1]:WINDow[1]:TRACe:X[:SCALe]:COUPlE 0 | 1 | OFF | ON
DISPlay:SEMAsk:VIEW[1]:WINDow[1]:TRACe:X[:SCALe]:COUPlE?
DISPlay:SEMAsk:VIEW[1]:WINDow[1]:TRACe:X[:SCALe]:PDIVision <freq>
DISPlay:SEMAsk:VIEW[1]:WINDow[1]:TRACe:X[:SCALe]:PDIVision ?
DISPlay:SEMAsk:VIEW[1]:WINDow[1]:TRACe:X[:SCALe]:RLEVel <freq>
DISPlay:SEMAsk:VIEW[1]:WINDow[1]:TRACe:X[:SCALe]:RLEVel?
DISPlay:SEMAsk:VIEW[1]:WINDow[1]:TRACe:X[:SCALe]:RPOSition LEFT | CENTER |
RIGHT
DISPlay:SEMAsk:VIEW[1]:WINDow[1]:TRACe:X[:SCALe]:RPOSition?
DISPlay:SEMAsk:VIEW[1]:WINDow[1]:TRACe:Y[:SCALe]:COUPlE 0 | 1 | ON | OFF
DISPlay:SEMAsk:VIEW[1]:WINDow[1]:TRACe:Y[:SCALe]:COUPlE?
DISPlay:SEMAsk:VIEW[1]:WINDow[1]:TRACe:Y[:SCALe]:PDIVision <rel_ampl>
DISPlay:SEMAsk:VIEW[1]:WINDow[1]:TRACe:Y[:SCALe]:PDIVision?
DISPlay:SEMAsk:VIEW[1]:WINDow[1]:TRACe:Y[:SCALe]:RLEVel <real>
DISPlay:SEMAsk:VIEW[1]:WINDow[1]:TRACe:Y[:SCALe]:RLEVel?
DISPlay:SEMAsk:VIEW[1]:WINDow[1]:TRACe:Y[:SCALe]:RPOSition TOP | CENTER |
BOTTOm
DISPlay:SEMAsk:VIEW[1]:WINDow[1]:TRACe:Y[:SCALe]:RPOSition?
DISPlay:SPURious:VIEW:RANGe[:SElect] <integer>
DISPlay:SPURious:VIEW:RANGe[:SElect]?
DISPlay:SPURious:VIEW:RANGe:TABLE <integer>
DISPlay:SPURious:VIEW:RANGe:TABLE?
DISPlay:SPURious:VIEW[:SElect] RESult | RANGe | ALL
DISPlay:SPURious:VIEW[:SElect]?
DISPlay:SPURious:VIEW[1]:WINDow[1]:TRACe:Y[:SCALe]:COUPlE 0 | 1 | OFF | ON
DISPlay:SPURious:VIEW[1]:WINDow[1]:TRACe:Y[:SCALe]:COUPlE?
DISPlay:SPURious:VIEW[1]:WINDow[1]:TRACe:Y[:SCALe]:PDIVision <rel_ampl>
DISPlay:SPURious:VIEW[1]:WINDow[1]:TRACe:Y[:SCALe]:PDIVision?

```

```
DISPlay:SPURious:VIEW[1]:WINDow[1]:TRACe:Y[:SCALe]:RLEVel <real>
DISPlay:SPURious:VIEW[1]:WINDow[1]:TRACe:Y[:SCALe]:RLEVel?
DISPlay:WAVEform:VIEW:NSElect <integer>
DISPlay:WAVEform:VIEW:NSElect?
DISPlay:WAVEform:VIEW[:SElect] RFENvelope | IQ
DISPlay:WAVEform:VIEW[:SElect]?
DISPlay:WAVEform:VIEW[1]|2:WINDow[1]:TRACe:X[:SCALe]:COUPlE 0 | 1 | OFF |
ON
DISPlay:WAVEform:VIEW[1]|2:WINDow[1]:TRACe:X[:SCALe]:COUPlE?
DISPlay:WAVEform:VIEW[1]|2:WINDow[1]:TRACe:X[:SCALe]:PDIVision <time>
DISPlay:WAVEform:VIEW[1]|2:WINDow[1]:TRACe:X[:SCALe]:PDIVision?
DISPlay:WAVEform:VIEW[1]|2:WINDow[1]:TRACe:X[:SCALe]:RLEVel <time>
DISPlay:WAVEform:VIEW[1]|2:WINDow[1]:TRACe:X[:SCALe]:RLEVel?
DISPlay:WAVEform:VIEW[1]|2:WINDow[1]:TRACe:X[:SCALe]:RPOSition LEFT |
CENTer | RIGHT
DISPlay:WAVEform:VIEW[1]|2:WINDow[1]:TRACe:X[:SCALe]:RPOSition?
DISPlay:WAVEform:VIEW[1]|2:WINDow[1]:TRACe:Y[:SCALe]:COUPlE 0 | 1 | OFF |
ON
DISPlay:WAVEform:VIEW[1]|2:WINDow[1]:TRACe:Y[:SCALe]:COUPlE?
DISPlay:WAVEform:VIEW2:WINDow[1]:TRACe:Y[:SCALe]:PDIVision <voltage>
DISPlay:WAVEform:VIEW[1]:WINDow[1]:TRACe:Y[:SCALe]:PDIVision <rel_ampl>
DISPlay:WAVEform:VIEW2:WINDow[1]:TRACe:Y[:SCALe]:PDIVision?
DISPlay:WAVEform:VIEW[1]:WINDow[1]:TRACe:Y[:SCALe]:PDIVision?
DISPlay:WAVEform:VIEW[1]:WINDow[1]:TRACe:Y[:SCALe]:RLEVel <ampl>
DISPlay:WAVEform:VIEW2:WINDow[1]:TRACe:Y[:SCALe]:RLEVel <voltage>
DISPlay:WAVEform:VIEW[1]:WINDow[1]:TRACe:Y[:SCALe]:RLEVel?
DISPlay:WAVEform:VIEW2:WINDow[1]:TRACe:Y[:SCALe]:RLEVel?
DISPlay:WAVEform:VIEW2:WINDow[1]:TRACe:Y[:SCALe]:RPOSition TOP | CENTer |
BOTTom
DISPlay:WAVEform:VIEW[1]:WINDow[1]:TRACe:Y[:SCALe]:RPOSition TOP | CENTer
| BOTTom
DISPlay:WAVEform:VIEW2:WINDow[1]:TRACe:Y[:SCALe]:RPOSition?
DISPlay:WAVEform:VIEW[1]:WINDow[1]:TRACe:Y[:SCALe]:RPOSition?
DISPlay:WINDow[1]:ANNOtation[:ALL] OFF | ON | 0 | 1
DISPlay:WINDow[1]:ANNOtation[:ALL]?
DISPlay:WINDow:FORMat:TILE
DISPlay:WINDow:FORMat:ZOOM
DISPlay:WINDow[:SElect] <number>
DISPlay:WINDow[:SElect]?
DISPlay:WINDow[1]:TRACe:GRATICule:GRID[:STATe] OFF | ON | 0 | 1
DISPlay:WINDow[1]:TRACe:GRATICule:GRID[:STATe]?
FETCh:ACP[n]?
FETCh:CHPower:CHPower?
FETCh:CHPower:DENSity?
FETCh:CHPower[n]?
FETCh:EVM[n]?
FETCh:EVMTtwo[n]?
FETCh:MONitor[n]?
FETCh:PStatistic[n]?
FETCh:SEMask[n]?
FETCh:SPURious[n]?
FETCh:WAVEform[n]?
```

```

FORMat:BORDER NORMAl | SWAPped
FORMat:BORDER?
FORMat[:TRACe][:DATA] ASCii | INTeger, 32 | REAL, 32 | REAL, 64
FORMat[:TRACe][:DATA]?
GLOBal:DEFault
GLOBal:FREQuency:CENTer[:STATe] 1 | 0 | ON | OFF
GLOBal:FREQuency:CENTer[:STATe]?
HCOPY:ABORT
HCOPY[:IMMediate]
INITiate:ACP
INITiate:CHPower
INITiate:CONTinuous OFF | ON | 0 | 1
INITiate:CONTinuous?
INITiate:EVM
INITiate:EVMTtwo
INITiate[:IMMediate]
INITiate:MONitor
INITiate:PAUSE
INITiate:PSTATistic
INITiate:REStart
INITiate:RESume
INITiate:SEMask
INITiate:SPURious
INITiate:WAVEform
INPut:COUPling AC | DC
INPut:COUPling?
INPut:COUPling:I|Q DC | LFR1 | LFR2
INPut:COUPling:I|Q?
INPut:IMPedance:IQ U50 | B50 | U1M | B1M
INPut:IMPedance:IQ?
INPut:IMPedance:REFerence <integer>
INPut:IMPedance:REFerence?
INPut[1]:IQ:BALanced[:STATe] OFF | ON | 0 | 1
INPut[1]:IQ:BALanced[:STATe]?
INPut:IQ[:I]:DIFFerential OFF | ON | 0 | 1
INPut:IQ[:I]:DIFFerential?
INPut[1]:IQ[:I]:IMPedance LOW | HIGH
INPut[1]:IQ[:I]:IMPedance?
INPut:IQ:MIRRored OFF | ON | 0 | 1
INPut:IQ:MIRRored?
INPut:IQ:Q:DIFFerential OFF | ON | 0 | 1
INPut:IQ:Q:DIFFerential?
INPut[1]:IQ:Q:IMPedance LOW | HIGH
INPut[1]:IQ:Q:IMPedance?
INPut[1]:IQ:TYPE IQ | I | Q
INPut[1]:IQ:TYPE?
INPut:MIXer EXTernal | INTernal
INPut:MIXer?
INPut:OFFSet:I|Q <voltage>
INPut:OFFSet:I|Q?
INSTrument:CATalog?
INSTrument:COUPlE:DEFault
INSTrument:COUPlE:FREQuency:CENTer ALL | NONE

```

### 3 Programming the Analyzer

#### List of SCPI Commands

```
INSTRument:COUple:FREQuency:CENTer?
INSTRument:DEFault
INSTRument:NSElect <integer>
INSTRument:NSElect?
INSTRument[:SElect] RECeiver
INSTRument[:SElect] SA | RTSA | SEQAN | EMI | BASIC | WCDMA | EDGE GSM |
WIMAXOFDMA | VSA | PNOISE | NFIGure | ADEMOD | BTooth | TDSCDMA | CDMA2K |
CDMA1XEV | LTE | LTETDD | LTEAFDD | LTEATDD | MSR | DVB | DTMB | DCATV |
ISDBT | CMMB | WLAN | CWLAN | CWIMAXOFDM | WIMAXFIXED | IDEN | RLC |
SCPILC | VSA89601
INSTRument[:SElect] 'SA' | 'PNOISE' | 'EDGE' | 'GSM' | 'BASIC'
INSTRument[:SElect] GSM
INSTRument[:SElect] SANalyzer
INSTRument[:SElect]?
INST:SEL EMI
INST:SEL SCPILC
LXI:IDENtify[:STATE] OFF | ON | 0 | 1
LXI:IDENtify[:STATE]?
MEASure:ACP[n]?
MEASure:CHPower:CHPower?
MEASure:CHPower:DENSity?
MEASure:CHPower[n]?
MEASure:EVM[n]?
MEASure:EVMTtwo[n]?
MEASure:MONitor[n]?
MEASure:PStatistic[n]?
MEASure:SEMask[n]?
MEASure:SPURious[n]?
MEASure:WAVEform[n]?
MMEemory:CATalog? [<directory_name>]
MMEemory:CDIRECTory [<directory_name>]
MMEemory:CDIRECTory?
MMEemory:COPY <string>, <string>[, <string>, <string>]
MMEemory:COPY:DEvice <source_string>, <dest_string>
MMEemory:DATA <file_name>, <data>
MMEemory:DATA? <file_name>
MMEemory:DELeTe <file_name>[, <directory_name>]
MMEemory:LOAD:CHTable <string>
MMEemory:LOAD:CORRection ANTenna | CABLE | OTHer | USER, <filename>
MMEemory:LOAD:CORRection 1 | 2 | 3 | 4 | 5 | 6 | 7 | 8, <filename>
MMEemory:LOAD:STATE <filename>
MMEemory:LOAD:STATE 1, <filename>
MMEemory:LOAD:T2Config <string>
MMEemory:MDIRECTory <directory_name>
MMEemory:MOVE <string>, <string>[, <string>, <string>]
MMEemory:RDIRECTory <directory_name>
MMEemory:REGister:STATE:LABEL <regnumber>, "label"
MMEemory:REGister:STATE:LABEL? <regnumber>
MMEemory:STORE:CHTable <string>
MMEemory:STORE:CORRection 1 | 2 | 3 | 4 | 5 | 6, <filename>
MMEemory:STORE:CORRection ANTenna | CABLE | OTHer | USER, <filename>
MMEemory:STORE:RESults <string>
```

```

MMEMory:STORe:RESuLts <string>
MMEMory:STORe:RESuLts <string>
MMEMory:STORe:RESuLts <string>
MMEMory:STORe:RESuLts <string>
MMEMory:STORe:SCReen <filename>
MMEMory:STORe:SCReen:THEME TDColor | TDMonochrome | FCOLOR | FMONochrome
MMEMory:STORe:SCReen:THEME?
MMEMory:STORe:STATe 1, <filename>
MMEMory:STORe:STATe <filename>
MMEMory:STORe:T2Config <string>
OUTPut:ANALog OFF | SVIDeo | LOGVideo | LINVideo | DAUDio
OUTPut:ANALog?
OUTPut:ANALog:AUTO OFF | ON | 0 | 1
OUTPut:ANALog:AUTO?
OUTPut:AUX SIF | AIF | LOGVideo | OFF
OUTPut:AUX?
OUTPut:AUX:AIF <value>
OUTPut:AUX:AIF?
OUTPut:DBUS[1][:STATe] ON | OFF | 1 | 0
OUTPut:DBUS[1][:STATe]?
OUTPut:IQ:OUTPut IQ1 | IQ250 | OFF
OUTPut:IQ:OUTPut?
READ:ACP[n]?
READ:CHPower:CHPower?
READ:CHPower:DENSity
READ:CHPower[n]?
READ:EVM[n]?
READ:EVMTtwo[n]?
READ:MONitor[n]?
READ:PStatistic[n]?
READ:SEMask[n]?
READ:SPURious[n]?
READ:WAVEform[n]?
[:SENSe]:<measurement>:TRIGger:SOURce
[:SENSe]:<measurement>:TRIGger:SOURce IF
[:SENSe]:ACPower:AVERAge:COUNT <integer>
[:SENSe]:ACPower:AVERAge:COUNT?
[:SENSe]:ACPower:AVERAge[:STATe] OFF | ON | 0 | 1
[:SENSe]:ACPower:AVERAge[:STATe]?
[:SENSe]:ACPower:AVERAge:TCONtrol EXPOntial | REPeat
[:SENSe]:ACPower:AVERAge:TCONtrol?
[:SENSe]:ACPower:BANDwidth:INTEgration
[:SENSe]:ACPower:BANDwidth[:RESolution] <freq>
[:SENSe]:ACPower:BANDwidth[:RESolution]?
[:SENSe]:ACPower:BANDwidth[:RESolution]:AUTO ON | OFF | 1 | 0
[:SENSe]:ACPower:BANDwidth[:RESolution]:AUTO?
[:SENSe]:ACPower:BANDwidth:SHAPE GAUSSian | FLATtop
[:SENSe]:ACPower:BANDwidth:SHAPE?
[:SENSe]:ACPower:BANDwidth:TYPE DB3 | DB6
[:SENSe]:ACPower:BANDwidth:TYPE?
[:SENSe]:ACPower:BANDwidth:VIDeo <freq>
[:SENSe]:ACPower:BANDwidth:VIDeo?
[:SENSe]:ACPower:BANDwidth:VIDeo:AUTO OFF | ON | 0 | 1

```

```

[:SENSe]:ACPower:BANDwidth:VIDeo:AUTO?
[:SENSe]:ACPower:BWIDth:INTEgration
[:SENSe]:ACPower:BWIDth[:RESolution]
[:SENSe]:ACPower:BWIDth:SHAPE
[:SENSe]:ACPower:BWIDth:TYPE
[:SENSe]:ACPower:BWIDth:VIDeo
[:SENSe]:ACPower:CARRier[1]|2:AUTO[:STATE] OFF | ON | 0 | 1
[:SENSe]:ACPower:CARRier[1]|2:AUTO[:STATE]?
[:SENSe]:ACPower:CARRier[1]|2:COUNT <integer>
[:SENSe]:ACPower:CARRier[1]|2:COUNT?
[:SENSe]:ACPower:CARRier[1]|2:CPSD <real>
[:SENSe]:ACPower:CARRier[1]|2:CPSD?
[:SENSe]:ACPower:CARRier[1]|2:LIST:BANDwidth[:INTEgration] <freq>, ...
[:SENSe]:ACPower:CARRier[1]|2:LIST:BANDwidth[:INTEgration]?
[:SENSe]:ACPower:CARRier[1]|2:LIST:BWIDth[:INTEgration]
[:SENSe]:ACPower:CARRier[1]|2:LIST:FILTer:ALPHa <real>, ...
[:SENSe]:ACPower:CARRier[1]|2:LIST:FILTer:ALPHa?
[:SENSe]:ACPower:CARRier[1]|2:LIST:FILTer[:RRC][:STATE] ON|OFF|1|0, ...
[:SENSe]:ACPower:CARRier[1]|2:LIST:FILTer[:RRC][:STATE]?
[:SENSe]:ACPower:CARRier[1]|2:LIST:METHod IBW | RRC, ...
[:SENSe]:ACPower:CARRier[1]|2:LIST:METHod?
[:SENSe]:ACPower:CARRier[1]|2:LIST:PPResent YES|NO, ...
[:SENSe]:ACPower:CARRier[1]|2:LIST:PPResent?
[:SENSe]:ACPower:CARRier[1]|2:LIST:WIDTh <freq>, ...
[:SENSe]:ACPower:CARRier[1]|2:LIST:WIDTh?
[:SENSe]:ACPower:CARRier[1]|2[:POWER] <real>
[:SENSe]:ACPower:CARRier[1]|2[:POWER]?
[:SENSe]:ACPower:CARRier[1]|2:RCARrier <integer>
[:SENSe]:ACPower:CARRier[1]|2:RCARrier?
[:SENSe]:ACPower:CARRier[1]|2:RCARrier:AUTO OFF | ON | 0 | 1
[:SENSe]:ACPower:CARRier[1]|2:RCARrier:AUTO?
[:SENSe]:ACPower:CARRier[1]|2:RCFRequency <freq>
[:SENSe]:ACPower:CARRier[1]|2:RCFRequency?
[:SENSe]:ACPower:CARRier[1]|2:RCFRequency:AUTO OFF | ON | 0 | 1
[:SENSe]:ACPower:CARRier[1]|2:RCFRequency:AUTO?
[:SENSe]:ACPower:CORREction:NOISE[:AUTO] OFF | ON | 0 | 1
[:SENSe]:ACPower:CORREction:NOISE[:AUTO]?
[:SENSe]:ACPower:DETEctor:AUTO ON | OFF | 1 | 0
[:SENSe]:ACPower:DETEctor:AUTO?
[:SENSe]:ACPower:DETEctor[:FUNction] AVERage | NEGative | NORMal |
POSitive | SAMPlE
[:SENSe]:ACPower:DETEctor[:FUNction]?
[:SENSe]:ACPower:FILTer[:RRC]:ALPHa <real>
[:SENSe]:ACPower:FILTer[:RRC]:ALPHa?
[:SENSe]:ACPower:FILTer[:RRC][:STATE] OFF | ON | 0 | 1
[:SENSe]:ACPower:FILTer[:RRC][:STATE]?
[:SENSe]:ACPower:FREquency:SPAN <freq>
[:SENSe]:ACPower:FREquency:SPAN?
[:SENSe]:ACPower:FREquency:SPAN:FULL
[:SENSe]:ACPower:FREquency:SPAN:PREVious
[:SENSe]:ACPower:FREquency:SYNThesis:AUTO[:STATE] OFF | ON | 0 | 1
[:SENSe]:ACPower:FREquency:SYNThesis:AUTO[:STATE]?
[:SENSe]:ACPower:FREquency:SYNThesis[:STATE] 1 | 2 | 3

```



```

[:SENSE]:ACPower:FREQuency:SYNThesis[:STATE]?
[:SENSE]:ACPower:LIMit[:STATE]
[:SENSE]:ACPower:METHod IBW | IBWRange | FAST | RBW
[:SENSE]:ACPower:METHod?
[:SENSE]:ACPower:OFFSet[1]|2:LIST:BWIDth[:INTEgration]
[:SENSE]:ACPower:OFFSet[1]|2:LIST:BWIDth:RESolution
[:SENSE]:ACPower:OFFSet[1]|2:LIST:BWIDth:SHAPE
[:SENSE]:ACPower:OFFSet[1]|2:LIST:BWIDth:TYPE
[:SENSE]:ACPower:OFFSet[1]|2:LIST:BWIDth:VIDeo
[:SENSE]:ACPower:OFFSet[1]|2[:OUTer]:LIST:ABSolute <real>, ...
[:SENSE]:ACPower:OFFSet[1]|2[:OUTer]:LIST:ABSolute?
[:SENSE]:ACPower:OFFSet[1]|2[:OUTer]:LIST:BANDwidth[:INTEgration] <freq>,
...
[:SENSE]:ACPower:OFFSet[1]|2[:OUTer]:LIST:BANDwidth[:INTEgration]?
[:SENSE]:ACPower:OFFSet[1]|2[:OUTer]:LIST:BANDwidth:RESolution <freq>, ...
[:SENSE]:ACPower:OFFSet[1]|2[:OUTer]:LIST:BANDwidth:RESolution?
[:SENSE]:ACPower:OFFSet[1]|2[:OUTer]:LIST:BANDwidth:RESolution:AUTO
ON|OFF|1|0, ...
[:SENSE]:ACPower:OFFSet[1]|2[:OUTer]:LIST:BANDwidth:RESolution:AUTO?
[:SENSE]:ACPower:OFFSet[1]|2[:OUTer]:LIST:BANDwidth:SHAPE
GAUSSian|FLATtop, ...
[:SENSE]:ACPower:OFFSet[1]|2[:OUTer]:LIST:BANDwidth:SHAPE?
[:SENSE]:ACPower:OFFSet[1]|2[:OUTer]:LIST:BANDwidth:TYPE DB3|DB6, ...
[:SENSE]:ACPower:OFFSet[1]|2[:OUTer]:LIST:BANDwidth:TYPE?
[:SENSE]:ACPower:OFFSet[1]|2[:OUTer]:LIST:BANDwidth:VIDeo <freq>, ...
[:SENSE]:ACPower:OFFSet[1]|2[:OUTer]:LIST:BANDwidth:VIDeo?
[:SENSE]:ACPower:OFFSet[1]|2[:OUTer]:LIST:BANDwidth:VIDeo:AUTO OFF|ON|0|1,
...
[:SENSE]:ACPower:OFFSet[1]|2[:OUTer]:LIST:BANDwidth:VIDeo:AUTO?
[:SENSE]:ACPower:OFFSet[1]|2[:OUTer]:LIST:FILTer:ALPHa <real>, ...
[:SENSE]:ACPower:OFFSet[1]|2[:OUTer]:LIST:FILTer:ALPHa?
[:SENSE]:ACPower:OFFSet[1]|2[:OUTer]:LIST:FILTer[:RRC][:STATE] ON|OFF|1|0,
...
[:SENSE]:ACPower:OFFSet[1]|2[:OUTer]:LIST:FILTer[:RRC][:STATE]?
[:SENSE]:ACPower:OFFSet[1]|2[:OUTer]:LIST[:FREQuency] <freq>, ...
[:SENSE]:ACPower:OFFSet[1]|2[:OUTer]:LIST[:FREQuency]?
[:SENSE]:ACPower:OFFSet[1]|2[:OUTer]:LIST:RCARrier <real>, ...
[:SENSE]:ACPower:OFFSet[1]|2[:OUTer]:LIST:RCARrier?
[:SENSE]:ACPower:OFFSet[1]|2[:OUTer]:LIST:RPSDensity <rel_ampl>, ...
[:SENSE]:ACPower:OFFSet[1]|2[:OUTer]:LIST:RPSDensity?
[:SENSE]:ACPower:OFFSet[1]|2[:OUTer]:LIST:SIDE NEGative|BOTH|POSitive, ...
[:SENSE]:ACPower:OFFSet[1]|2[:OUTer]:LIST:SIDE?
[:SENSE]:ACPower:OFFSet[1]|2[:OUTer]:LIST:STATE OFF|ON|0|1, ...
[:SENSE]:ACPower:OFFSet[1]|2[:OUTer]:LIST:STATE?
[:SENSE]:ACPower:OFFSet[1]|2[:OUTer]:LIST:TEST ABSolute|AND|OR|RELative,
...
[:SENSE]:ACPower:OFFSet[1]|2[:OUTer]:LIST:TEST?
[:SENSE]:ACPower:OFFSet[1]|2[:OUTer]:TYPE CTOCenter | CTOEdge | ETOCenter
| ETOEdge
[:SENSE]:ACPower:OFFSet[1]|2[:OUTer]:TYPE?
[:SENSE]:ACPower:SWEep:POINts <integer>
[:SENSE]:ACPower:SWEep:POINts?

```

### 3 Programming the Analyzer

#### List of SCPI Commands

```
[ :SENSe]:ACPower:SWEep:TIME <time>
[ :SENSe]:ACPower:SWEep:TIME?
[ :SENSe]:ACPower:SWEep:TIME:AUTO OFF | ON | 0 | 1
[ :SENSe]:ACPower:SWEep:TIME:AUTO?
[ :SENSe]:ACPower:SWEep:TIME:AUTO:RULEs NORMAl | ACCuracy
[ :SENSe]:ACPower:SWEep:TIME:AUTO:RULEs?
[ :SENSe]:ACPower:TYPE TPRef | PSDRef
[ :SENSe]:ACPower:TYPE?
[ :SENSe]:ACPR:AVERAge:COUNT
[ :SENSe]:ACPR:AVERAge:TCONtrol
[ :SENSe]:ACPR:FILTEr[:RRC]:ALPHa
[ :SENSe]:ACPR:FILTEr[:RRC][:STATE]
[ :SENSe]:ACPR:OFFSet[1]|2:LIST:ABSolute (PSAW-CDMA, PSAcdma2000)
[ :SENSe]:ACPR:OFFSet[1]|2:LIST:BANDwidth
[ :SENSe]:ACPR:OFFSet[1]|2:LIST:BWIDth
[ :SENSe]:ACPR:SWEep:DETEctor[:FUNction]
[ :SENSe]:ACPR:SWEep:TYPE
[ :SENSe]:ACPR:TRIGger:SOURce
[ :SENSe]:ACP:SWEep:BANDwidth|BWIDth[:RESolution] (PSAW-CDMA, PSAcdma2000)
[ :SENSe]:CHPower:AVERAge:COUNT <integer>
[ :SENSe]:CHPower:AVERAge:COUNT?
[ :SENSe]:CHPower:AVERAge[:STATE] ON | OFF | 1 | 0
[ :SENSe]:CHPower:AVERAge[:STATE]?
[ :SENSe]:CHPower:AVERAge:TCONtrol EXPonential | REPeat
[ :SENSe]:CHPower:AVERAge:TCONtrol?
[ :SENSe]:CHPower:BANDwidth:INTEgration <bandwidth>
[ :SENSe]:CHPower:BANDwidth:INTEgration?
[ :SENSe]:CHPower:BANDwidth[:RESolution] <bandwidth>
[ :SENSe]:CHPower:BANDwidth[:RESolution]?
[ :SENSe]:CHPower:BANDwidth[:RESolution]:AUTO ON | OFF | 1 | 0
[ :SENSe]:CHPower:BANDwidth[:RESolution]:AUTO?
[ :SENSe]:CHPower:BANDwidth:SHAPE GAUSSian | FLATtop
[ :SENSe]:CHPower:BANDwidth:SHAPE?
[ :SENSe]:CHPower:BANDwidth:VIDeo <bandwidth>
[ :SENSe]:CHPower:BANDwidth:VIDeo?
[ :SENSe]:CHPower:BANDwidth:VIDeo:AUTO ON | OFF | 1 | 0
[ :SENSe]:CHPower:BANDwidth:VIDeo:AUTO?
[ :SENSe]:CHPower:BWIDth[:RESolution]
[ :SENSe]:CHPower:BWIDth:SHAPE
[ :SENSe]:CHPower:DETEctor:AUTO ON | OFF | 1 | 0
[ :SENSe]:CHPower:DETEctor:AUTO?
[ :SENSe]:CHPower:DETEctor[:FUNction] NORMAl | AVERAge | POSitive | SAMPlE
| NEGative
[ :SENSe]:CHPower:DETEctor[:FUNction]?
[ :SENSe]:CHPower:FILTEr[:RRC]:ALPHa <real>
[ :SENSe]:CHPower:FILTEr[:RRC]:ALPHa?
[ :SENSe]:CHPower:FILTEr[:RRC]:BANDwidth <real>
[ :SENSe]:CHPower:FILTEr[:RRC]:BANDwidth?
[ :SENSe]:CHPower:FILTEr[:RRC]:BWIDth
[ :SENSe]:CHPower:FILTEr[:RRC][:STATE] OFF | ON | 0 | 1
[ :SENSe]:CHPower:FILTEr[:RRC][:STATE]?
[ :SENSe]:CHPower:FREQUency:SPAN <freq>
[ :SENSe]:CHPower:FREQUency:SPAN?
```

```

[:SENSe]:CHPower:FREQuency:SPAN:FULL
[:SENSe]:CHPower:FREQuency:SPAN:PREVious
[:SENSe]:CHPower:FREQuency:SYNThesis:AUTO[:STATE] OFF | ON | 0 | 1
[:SENSe]:CHPower:FREQuency:SYNThesis:AUTO[:STATE]?
[:SENSe]:CHPower:FREQuency:SYNThesis[:STATE] 1 | 2 | 3
[:SENSe]:CHPower:FREQuency:SYNThesis[:STATE]?
[:SENSe]:CHPower:IF:GAIN:AUTO[:STATE] ON | OFF | 1 | 0
[:SENSe]:CHPower:IF:GAIN:AUTO[:STATE]?
[:SENSe]:CHPower:IF:GAIN[:STATE] ON | OFF | 1 | 0
[:SENSe]:CHPower:IF:GAIN[:STATE]?
[:SENSe]:CHPower:SHOUlder:OFFSet:FREQuency:STARt <freq>
[:SENSe]:CHPower:SHOUlder:OFFSet:FREQuency:STARt?
[:SENSe]:CHPower:SHOUlder:OFFSet:FREQuency:STOP <freq>
[:SENSe]:CHPower:SHOUlder:OFFSet:FREQuency:STOP?
[:SENSe]:CHPower:SWEep:POINts <integer>
[:SENSe]:CHPower:SWEep:POINts?
[:SENSe]:CHPower:SWEep:TIME <time>
[:SENSe]:CHPower:SWEep:TIME?
[:SENSe]:CHPower:SWEep:TIME:AUTO OFF | ON | 0 | 1
[:SENSe]:CHPower:SWEep:TIME:AUTO?
[:SENSe]:CHPower:SWEep:TIME:AUTO:RULEs NORMal | ACCuracy
[:SENSe]:CHPower:SWEep:TIME:AUTO:RULEs?
[:SENSe]:CORRection:BTS[:RF]:GAIN <rel_ampl>
[:SENSe]:CORRection:BTS[:RF]:GAIN?
[:SENSe]:CORRection:BTS[:RF]:LOSS <rel_ampl>
[:SENSe]:CORRection:BTS[:RF]:LOSS?
[:SENSe]:CORRection:CSET:ALL:DELeTe
[:SENSe]:CORRection:CSET:ALL[:STATE] ON | OFF | 1 | 0
[:SENSe]:CORRection:CSET:ALL[:STATE]?
[:SENSe]:CORRection:CSET[1]:ANTenna[:UNIT] GAUSS | PTESla | UVM | UAM | UA
| NOConversion
[:SENSe]:CORRection:CSET[1]:ANTenna[:UNIT]?
[:SENSe]:CORRection:CSET[1]|2|...|8:COMMeNt "text"
[:SENSe]:CORRection:CSET[1]|2|...|8:COMMeNt?
[:SENSe]:CORRection:CSET[1]|2|...|8:DATA <freq>, <ampl>, ...
[:SENSe]:CORRection:CSET[1]|2|...|8:DATA?
[:SENSe]:CORRection:CSET[1]|2|...|8:DATA:MERGe <freq>, <ampl>, ...
[:SENSe]:CORRection:CSET[1]|2|...|6:DELeTe
[:SENSe]:CORRection:CSET[1]|2|...|8:DESCription "text"
[:SENSe]:CORRection:CSET[1]|2|...|8:DESCription?
[:SENSe]:CORRection:CSET[1]|2|...|8[:STATE] ON | OFF | 1 | 0
[:SENSe]:CORRection:CSET[1]|2|...|8[:STATE]?
[:SENSe]:CORRection:CSET[1]|2|...|8:X:SPACing LINear | LOGarithmic
[:SENSe]:CORRection:CSET[1]|2|...|8:X:SPACing?
[:SENSe]:CORRection:IMPedance[:INPut][:MAGNitude] 50 | 75
[:SENSe]:CORRection:IMPedance[:INPut][:MAGNitude]?
[:SENSe]:CORRection:IQ:I:GAIN <rel_ampl>
[:SENSe]:CORRection:IQ:I:GAIN?
[:SENSe]:CORRection:IQ:I|Q:ATTenuation <rel_ampl>
[:SENSe]:CORRection:IQ:I|Q:ATTenuation?
[:SENSe]:CORRection:IQ:I|Q:ATTenuation:RATio <real>
[:SENSe]:CORRection:IQ:I|Q:ATTenuation:RATio?
[:SENSe]:CORRection:IQ[:I]:SKEW <seconds>

```

### 3 Programming the Analyzer

#### List of SCPI Commands

```
[ :SENSe]:CORRection:IQ[:I]:SKEW?
[ :SENSe]:CORRection:IQ:Q:GAIN <rel_ampl>
[ :SENSe]:CORRection:IQ:Q:GAIN?
[ :SENSe]:CORRection:IQ:Q:SKEW <seconds>
[ :SENSe]:CORRection:IQ:Q:SKEW?
[ :SENSe]:CORRection:MS[:RF]:GAIN <rel_ampl>
[ :SENSe]:CORRection:MS[:RF]:GAIN?
[ :SENSe]:CORRection:MS[:RF]:LOSS <rel_ampl>
[ :SENSe]:CORRection:MS[:RF]:LOSS?
[ :SENSe]:CORRection:NOISe:FLOOr ON | OFF | 1 | 0
[ :SENSe]:CORRection:NOISe:FLOOr?
[ :SENSe]:CORRection:OFFSet[:MAGNitude]
[ :SENSe]:CORRection:SA[:RF]:GAIN <rel_ampl>
[ :SENSe]:CORRection:SA[:RF]:GAIN?
[ :SENSe]:EVM:ALPHa ONE | TWO | FOUR
[ :SENSe]:EVM:ALPHa?
[ :SENSe]:EVM:AVERAge:COUNT <integer>
[ :SENSe]:EVM:AVERAge:COUNT?
[ :SENSe]:EVM:AVERAge[:STATe] OFF | ON | 0 | 1
[ :SENSe]:EVM:AVERAge[:STATe]?
[ :SENSe]:EVM:AVERAge:TCONtrol EXPonential | REPeat
[ :SENSe]:EVM:AVERAge:TCONtrol?
[ :SENSe]:EVM:BERCount:BITS <real>
[ :SENSe]:EVM:BERCount:BITS?
[ :SENSe]:EVM:BERCount:TYPE HBViterbi | HBRS | LBViterbi | LBRS
[ :SENSe]:EVM:BERCount:TYPE?
[ :SENSe]:EVM:CLKRate <freq>
[ :SENSe]:EVM:CLKRate?
[ :SENSe]:EVM:CLKRate:AUTO ON | OFF | 1 | 0
[ :SENSe]:EVM:CLKRate:AUTO?
[ :SENSe]:EVM:CMODE RMS | MAXimum
[ :SENSe]:EVM:CMODE?
[ :SENSe]:EVM:CRATE:HPRatio R1BY2 | R2BY3 | R3BY4 | R5BY6 | R7BY8
[ :SENSe]:EVM:CRATE:HPRatio?
[ :SENSe]:EVM:CRATE:LPRatio R1BY2 | R2BY3 | R3BY4 | R5BY6 | R7BY8
[ :SENSe]:EVM:CRATE:LPRatio?
[ :SENSe]:EVM:DECoding:STATe OFF | ON | 0 | 1
[ :SENSe]:EVM:DECoding:STATe?
[ :SENSe]:EVM:DETEct
[ :SENSe]:EVM:DSYMBOLs <integer>
[ :SENSe]:EVM:DSYMBOLs?
[ :SENSe]:EVM:EQUalization:STATe OFF | ON | 0 | 1
[ :SENSe]:EVM:EQUalization:STATe?
[ :SENSe]:EVM:FFTStart GI08 | GI18 | GI28 | GI38 | GI48 | GI58 | GI68 |
GI78 | GI88
[ :SENSe]:EVM:FFTStart?
[ :SENSe]:EVM:FREQuency:SYNThesis[:STATe] 1 | 2 | 3
[ :SENSe]:EVM:FREQuency:SYNThesis[:STATe]?
[ :SENSe]:EVM:GINTErval:RATio R1BY4 | R1BY8 | R1BY16 | R1BY32
[ :SENSe]:EVM:GINTErval:RATio?
[ :SENSe]:EVM:HIERarchical[:STATe] OFF | ON | 0 | 1
[ :SENSe]:EVM:HIERarchical[:STATe]?
[ :SENSe]:EVM:IF:GAIN:AUTO[:STATe] OFF | ON | 0 | 1
```

```

[:SENSe]:EVM:IF:GAIN:AUTO[:STATE]?
[:SENSe]:EVM:IF:GAIN[:STATE] ON | OFF | 1 | 0
[:SENSe]:EVM:IF:GAIN[:STATE]?
[:SENSe]:EVM:IINTERleaver NATive | IDEPth
[:SENSe]:EVM:IINTERleaver?
[:SENSe]:EVM:IQMismatch STD | FAST
[:SENSe]:EVM:IQMismatch?
[:SENSe]:EVM:MERMOnitor:DPOints <integer>
[:SENSe]:EVM:MERMOnitor:DPOints?
[:SENSe]:EVM:MERMOnitor:FILEs:DELeTe
[:SENSe]:EVM:MERMOnitor:LIMit <rel_ampl>
[:SENSe]:EVM:MERMOnitor:LIMit?
[:SENSe]:EVM:MERMOnitor:LIMit:STATE OFF | ON | 0 | 1
[:SENSe]:EVM:MERMOnitor:LIMit:STATE?
[:SENSe]:EVM:MERMOnitor:RDFiles:MAX <integer>
[:SENSe]:EVM:MERMOnitor:RDFiles:MAX?
[:SENSe]:EVM:MERMOnitor:STATE OFF | ON | 0 | 1
[:SENSe]:EVM:MERMOnitor:STATE?
[:SENSe]:EVM:MODulation QPSK | QAM16 | QAM64
[:SENSe]:EVM:MODulation?
[:SENSe]:EVM:NFFT N2K | N4K | N8K
[:SENSe]:EVM:NFFT?
[:SENSe]:EVM:OBfiltering OFF | ON | 0 | 1
[:SENSe]:EVM:OBfiltering?
[:SENSe]:EVM:PAYLoad DATA | NULL
[:SENSe]:EVM:PAYLoad?
[:SENSe]:EVM:SPECTrum NORMAl | INVert
[:SENSe]:EVM:SPECTrum?
[:SENSe]:EVMTtwo:AVERAge:COUNT <integer>
[:SENSe]:EVMTtwo:AVERAge:COUNT?
[:SENSe]:EVMTtwo:AVERAge[:STATE] OFF | ON | 0 | 1
[:SENSe]:EVMTtwo:AVERAge[:STATE]?
[:SENSe]:EVMTtwo:AVERAge:TCONtrol EXPOntial | REPeat
[:SENSe]:EVMTtwo:AVERAge:TCONtrol?
[:SENSe]:EVMTtwo:BERCount:BITS <real>
[:SENSe]:EVMTtwo:BERCount:BITS?
[:SENSe]:EVMTtwo:BERCount:TYPE BLDPc | BBCH
[:SENSe]:EVMTtwo:BERCount:TYPE?
[:SENSe]:EVMTtwo:BERPlpid <integer>
[:SENSe]:EVMTtwo:BERPlpid?
[:SENSe]:EVMTtwo:CARRier NORMAl | EXTended
[:SENSe]:EVMTtwo:CARRier?
[:SENSe]:EVMTtwo:CLKRate <freq>
[:SENSe]:EVMTtwo:CLKRate?
[:SENSe]:EVMTtwo:CLKRate:AUTO ON | OFF | 1 | 0
[:SENSe]:EVMTtwo:CLKRate:AUTO?
[:SENSe]:EVMTtwo:CRATe R1BY2 | R3BY5 | R2BY3 | R3BY4 | R4BY5 | R5BY6
[:SENSe]:EVMTtwo:CRATe?
[:SENSe]:EVMTtwo:DECOding:STATE OFF | ON | 0 | 1
[:SENSe]:EVMTtwo:DECOding:STATE?
[:SENSe]:EVMTtwo:DETEct:STATE OFF | ON | 0 | 1
[:SENSe]:EVMTtwo:DETEct:STATE?
[:SENSe]:EVMTtwo:DSYMBOLs <integer>

```

### 3 Programming the Analyzer

#### List of SCPI Commands

```
[ :SENSe]:EVMtTwo:DSYMBOLs?
[ :SENSe]:EVMtTwo:EQualization:STATE OFF | ON | 0 | 1
[ :SENSe]:EVMtTwo:EQualization:STATE?
[ :SENSe]:EVMtTwo:FFTStart GI08 | GI18 | GI28 | GI38 | GI48 | GI58 | GI68 |
GI78 | GI88
[ :SENSe]:EVMtTwo:FFTStart?
[ :SENSe]:EVMtTwo:FREQuency:SYNThesis[:STATE] 1 | 2 | 3
[ :SENSe]:EVMtTwo:FREQuency:SYNThesis[:STATE]?
[ :SENSe]:EVMtTwo:FTRacking OFF | ON | 0 | 1
[ :SENSe]:EVMtTwo:FTRacking?
[ :SENSe]:EVMtTwo:GINterval:RATio R1BY4 | R19BY128 | R1BY8 | R19BY256 |
R1BY16 | R1BY32 | R1BY128
[ :SENSe]:EVMtTwo:GINterval:RATio?
[ :SENSe]:EVMtTwo:IF:GAIN:AUTO[:STATE] OFF | ON | 0 | 1
[ :SENSe]:EVMtTwo:IF:GAIN:AUTO[:STATE]?
[ :SENSe]:EVMtTwo:IF:GAIN[:STATE] ON | OFF | 1 | 0
[ :SENSe]:EVMtTwo:IF:GAIN[:STATE]?
[ :SENSe]:EVMtTwo:L1Modulation BPSK | QPSK | QAM16 | QAM64
[ :SENSe]:EVMtTwo:L1Modulation?
[ :SENSe]:EVMtTwo:MERMonitor:DPOints <integer>
[ :SENSe]:EVMtTwo:MERMonitor:DPOints?
[ :SENSe]:EVMtTwo:MERMonitor:FILES:DELeTe
[ :SENSe]:EVMtTwo:MERMonitor:LIMit <real>
[ :SENSe]:EVMtTwo:MERMonitor:LIMit?
[ :SENSe]:EVMtTwo:MERMonitor:LIMit:STATE OFF | ON | 0 | 1
[ :SENSe]:EVMtTwo:MERMonitor:LIMit:STATE?
[ :SENSe]:EVMtTwo:MERMonitor:RDFiles:MAX <integer>
[ :SENSe]:EVMtTwo:MERMonitor:RDFiles:MAX?
[ :SENSe]:EVMtTwo:MERMonitor:STATE OFF | ON | 0 | 1
[ :SENSe]:EVMtTwo:MERMonitor:STATE?
[ :SENSe]:EVMtTwo:MERMonitor:TIME <real>
[ :SENSe]:EVMtTwo:MERMonitor:TIME?
[ :SENSe]:EVMtTwo:MISO:TSEtUp TX1 | TX2 | TX1TX2
[ :SENSe]:EVMtTwo:MISO:TSEtUp?
[ :SENSe]:EVMtTwo:NFFT N1K | N2K | N4K | N8K | N16K | N32K
[ :SENSe]:EVMtTwo:NFFT?
[ :SENSe]:EVMtTwo:OBFiltering OFF | ON | 0 | 1
[ :SENSe]:EVMtTwo:OBFiltering?
[ :SENSe]:EVMtTwo:PAPR OFF | ACE | TR | ACETr | L1P2TR | L1ACE | L1TR |
L1AT
[ :SENSe]:EVMtTwo:PAPR?
[ :SENSe]:EVMtTwo:PLP:FECBlock <integer>
[ :SENSe]:EVMtTwo:PLP:FECBlock?
[ :SENSe]:EVMtTwo:PLP:FECType SHORt | NORMAl
[ :SENSe]:EVMtTwo:PLP:FECType?
[ :SENSe]:EVMtTwo:PLP:MODulation QPSK | QAM16 | QAM64 | QAM256
[ :SENSe]:EVMtTwo:PLP:MODulation?
[ :SENSe]:EVMtTwo:PLP:NUMBer <integer>
[ :SENSe]:EVMtTwo:PLP:NUMBer?
[ :SENSe]:EVMtTwo:PLP:ROTation OFF | ON | 0 | 1
[ :SENSe]:EVMtTwo:PLP:ROTation?
[ :SENSe]:EVMtTwo:PLP:TILLength <integer>
```

```

[:SENSE]:EVMTwo:PLP:TILLength?
[:SENSE]:EVMTwo:PPILot PP1 | PP2 | PP3 | PP4 | PP5 | PP6 | PP7 | PP8
[:SENSE]:EVMTwo:PPILot?
[:SENSE]:EVMTwo:SFRame[:IMMediate]
[:SENSE]:EVMTwo:SPECtrum NORMal | INVert
[:SENSE]:EVMTwo:SPECtrum?
[:SENSE]:FEED RF | AIQ | EMIXer
[:SENSE]:FEED IQ | IONLy | QONLy
[:SENSE]:FEED AREFERENCE
[:SENSE]:FEED?
[:SENSE]:FEED?
[:SENSE]:FEED:AREFERENCE REF50 | REF4800 | OFF
[:SENSE]:FEED:AREFERENCE?
[:SENSE]:FEED:DATA INPut | STORed
[:SENSE]:FEED:DATA?
[:SENSE]:FEED:DATA:STORe
[:SENSE]:FEED:IQ:TYPE IQ | IONLy | QONLy
[:SENSE]:FEED:IQ:TYPE?
[:SENSE]:FEED:SOURce INPut | STORed
[:SENSE]:FEED:SOURce?
[:SENSE]:FEED:SOURce:STORe
[:SENSE]:FREQuency:CENTer <freq>
[:SENSE]:FREQuency:CENTer?
[:SENSE]:FREQuency:CENTer:STEP:AUTO ON | OFF | 1 | 0
[:SENSE]:FREQuency:CENTer:STEP:AUTO?
[:SENSE]:FREQuency:CENTer:STEP[:INCRement] <freq>
[:SENSE]:FREQuency:CENTer:STEP[:INCRement]?
[:SENSE]:FREQuency:CHANnel:NUMBER <integer>
[:SENSE]:FREQuency:CHANnel:NUMBER?
[:SENSE]:FREQuency:CHANnel:STEP <integer>
[:SENSE]:FREQuency:CHANnel:STEP?
[:SENSE]:FREQuency:CHANnel:TABLE:BNTSc[:SELEct] VHF | UHF
[:SENSE]:FREQuency:CHANnel:TABLE:BNTSc[:SELEct]?
[:SENSE]:FREQuency:CHANnel:TABLE:BPAL[:SELEct] VHF | UHF | HRC | S | SCBL
| CEN
[:SENSE]:FREQuency:CHANnel:TABLE:BPAL[:SELEct]?
[:SENSE]:FREQuency:CHANnel:TABLE:DPAL[:SELEct] DS | Z
[:SENSE]:FREQuency:CHANnel:TABLE:DPAL[:SELEct]?
[:SENSE]:FREQuency:CHANnel:TABLE:IPAL[:SELEct] VHF | UHF | HRC
[:SENSE]:FREQuency:CHANnel:TABLE:IPAL[:SELEct]?
[:SENSE]:FREQuency:CHANnel:TABLE:JNTSc[:SELEct] CBL | AIR | DCBL
[:SENSE]:FREQuency:CHANnel:TABLE:JNTSc[:SELEct]?
[:SENSE]:FREQuency:CHANnel:TABLE:MNTSc[:SELEct] STD | AIR | HRC | IRC
[:SENSE]:FREQuency:CHANnel:TABLE:MNTSc[:SELEct]?
[:SENSE]:FREQuency:CHANnel:TABLE:MPAL[:SELEct] STD | AIR | HRC | IRC
[:SENSE]:FREQuency:CHANnel:TABLE:MPAL[:SELEct]?
[:SENSE]:FREQuency:CHANnel:TABLE[:SELEct] MNTSc | JNTSc | BNTSc | MPAL |
IPAL | BPAL | DPAL
[:SENSE]:FREQuency:CHANnel:TABLE[:SELEct]?
[:SENSE]:FREQuency:IQ:CENTer <freq>
[:SENSE]:FREQuency:IQ:CENTer?
[:SENSE]:FREQuency:RF:CENTer <freq>
[:SENSE]:FREQuency:RF:CENTer?

```

### 3 Programming the Analyzer

#### List of SCPI Commands

```
[ :SENSe]:MCPower:AVERage:COUNT (PSAPowerSuite, PSAW-CDMA, PSAcdma2000)
[ :SENSe]:MCPower:CARRier[1]|2:LIST:BANDwidth[:INTEgration] (PSAPowerSuite)
[ :SENSe]:MCPower:CARRier[1]|2:LIST:BWIDth[:INTEgration] (PSAPowerSuite)
[ :SENSe]:MCPower:CARRier[1]|2:LIST:PPResent (PSAPowerSuite)
[ :SENSe]:MCPower:CARRier[1]|2:LIST:WIDTh (PSAPowerSuite)
[ :SENSe]:MCPower:CARRier[1]|2[:POWER]
[ :SENSe]:MCPower:FILTer[:RRC]:ALPHa
[ :SENSe]:MCPower:FILTer[:RRC][:STATE]
[ :SENSe]:MCPower:LIMit[:STATE]
[ :SENSe]:MCPower:METHod (PSAPowerSuite)
[ :SENSe]:MCPower:OFFSet[1]|2:LIST:ABSolute (PSAW-CDMA)
[ :SENSe]:MCPower:OFFSet[1]|2:LIST:BANDwidth[:INTEgration] (PSAPowerSuite)
[ :SENSe]:MCPower:OFFSet[1]|2:LIST:BWIDth[:INTEgration] (PSAPowerSuite)
[ :SENSe]:MCPower:OFFSet[1]|2:LIST[:FREQuency] (PSAPowerSuite)
[ :SENSe]:MCPower:OFFSet[1]|2:LIST:RCARRier (PSAWCDMA)
[ :SENSe]:MCPower:OFFSet[1]|2:LIST:TEST
[ :SENSe]:MCPower:RCARRier[1]|2 (PSAPowerSuite)
[ :SENSe]:MIXer:BAND A | Q | U | V | W | NA | ND | NE | NF | NG | NJ | NK |
NQ | NU | NV | NW | NY | NEXT | DD | DF | DG | DJ | DK | DQ | DV | DW | DY
| DEXT | MA | ME | MU | MCOAX | USB
[ :SENSe]:MIXer:BAND?
[ :SENSe]:MIXer:BIAS <real>
[ :SENSe]:MIXer:BIAS?
[ :SENSe]:MIXer:BIAS:STATE OFF | ON | 0 | 1
[ :SENSe]:MIXer:BIAS:STATE?
[ :SENSe]:MIXer:CIFLoss <rel_ampl>
[ :SENSe]:MIXer:CIFLoss?
[ :SENSe]:MONitor:AVERage:COUNT <integer>
[ :SENSe]:MONitor:AVERage:COUNT?
[ :SENSe]:MONitor:AVERage[:STATE] OFF | ON | 0 | 1
[ :SENSe]:MONitor:AVERage[:STATE]?
[ :SENSe]:MONitor:AVERage:TCONtrol EXPonential | REPeat
[ :SENSe]:MONitor:AVERage:TCONtrol?
[ :SENSe]:MONitor:BANDwidth[:RESolution] <freq>
[ :SENSe]:MONitor:BANDwidth[:RESolution]?
[ :SENSe]:MONitor:BANDwidth[:RESolution]:AUTO OFF | ON | 0 | 1
[ :SENSe]:MONitor:BANDwidth[:RESolution]:AUTO?
[ :SENSe]:MONitor:BANDwidth:VIDeo <bandwidth>
[ :SENSe]:MONitor:BANDwidth:VIDeo?
[ :SENSe]:MONitor:BANDwidth:VIDeo:AUTO ON | OFF | 1 | 0
[ :SENSe]:MONitor:BANDwidth:VIDeo:AUTO?
[ :SENSe]:MONitor:BANDwidth:VIDeo:RATio <real>
[ :SENSe]:MONitor:BANDwidth:VIDeo:RATio?
[ :SENSe]:MONitor:BANDwidth:VIDeo:RATio:AUTO OFF | ON | 0 | 1
[ :SENSe]:MONitor:BANDwidth:VIDeo:RATio:AUTO?
[ :SENSe]:MONitor:BWIDth[:RESolution]
[ :SENSe]:MONitor:BWIDth:VIDeo
[ :SENSe]:MONitor:BWIDth:VIDeo:RATio
[ :SENSe]:MONitor:DETEctor:AUTO ON | OFF | 1 | 0
[ :SENSe]:MONitor:DETEctor:AUTO?
[ :SENSe]:MONitor:DETEctor[:FUNction]
[ :SENSe]:MONitor:DETEctor:TRACe AVERage | NEGative | NORMal | POSitive |
SAMPLE
```



```

[:SENSE]:MONitor:DETEctor:TRACe?
[:SENSE]:MONitor:FREQuency:SPAN <freq>
[:SENSE]:MONitor:FREQuency:SPAN?
[:SENSE]:MONitor:FREQuency:SPAN:BANDwidth[:RESolution]:RATio <integer>
[:SENSE]:MONitor:FREQuency:SPAN:BANDwidth[:RESolution]:RATio?
[:SENSE]:MONitor:FREQuency:SPAN:BANDwidth[:RESolution]:RATio:AUTO OFF | ON
| 0 | 1
[:SENSE]:MONitor:FREQuency:SPAN:BANDwidth[:RESolution]:RATio:AUTO?
[:SENSE]:MONitor:FREQuency:SPAN:BWIDth[:RESolution]:RATio
[:SENSE]:MONitor:FREQuency:SPAN:FULL
[:SENSE]:MONitor:FREQuency:SPAN:PREVious
[:SENSE]:MONitor:SWEep:POINts <integer>
[:SENSE]:MONitor:SWEep:POINts?
[:SENSE]:MONitor:SWEep:TIME <time>
[:SENSE]:MONitor:SWEep:TIME?
[:SENSE]:MONitor:SWEep:TIME:AUTO OFF | ON | 0 | 1
[:SENSE]:MONitor:SWEep:TIME:AUTO?
[:SENSE]:POWER:IQ[:I]:RANGE[:UPPer] <ampl>
[:SENSE]:POWER:IQ[:I]:RANGE[:UPPer]?
[:SENSE]:POWER:IQ:Q:RANGE[:UPPer] <ampl>
[:SENSE]:POWER:IQ:Q:RANGE[:UPPer]?
[:SENSE]:POWER:IQ:RANGE:AUTO OFF | ON | 0 | 1
[:SENSE]:POWER:IQ:RANGE:AUTO?
[:SENSE]:POWER[:RF]:ATTenuation <rel_ampl>
[:SENSE]:POWER[:RF]:ATTenuation?
[:SENSE]:POWER[:RF]:ATTenuation:AUTO OFF | ON | 0 | 1
[:SENSE]:POWER[:RF]:ATTenuation:AUTO?
[:SENSE]:POWER[:RF]:ATTenuation:STEP[:INCRement] 10 dB | 2 dB
[:SENSE]:POWER[:RF]:ATTenuation:STEP[:INCRement]?
[:SENSE]:POWER[:RF]:EATTenuation <rel_ampl>
[:SENSE]:POWER[:RF]:EATTenuation?
[:SENSE]:POWER[:RF]:EATTenuation:STATE OFF | ON | 0 | 1
[:SENSE]:POWER[:RF]:EATTenuation:STATE?
[:SENSE]:POWER[:RF]:GAIN:BAND LOW | FULL
[:SENSE]:POWER[:RF]:GAIN:BAND?
[:SENSE]:POWER[:RF]:GAIN[:STATE] OFF | ON | 0 | 1
[:SENSE]:POWER[:RF]:GAIN[:STATE]?
[:SENSE]:POWER[:RF]:MMW:PADJust
[:SENSE]:POWER[:RF]:MW:PADJust
[:SENSE]:POWER[:RF]:MW:PATH STD | LNPath | MPBypass | FULL
[:SENSE]:POWER[:RF]:MW:PATH?
[:SENSE]:POWER[:RF]:MW:PRESelector[:STATE] ON | OFF | 0 | 1
[:SENSE]:POWER[:RF]:MW:PRESelector[:STATE]?
[:SENSE]:POWER[:RF]:PADJust <freq>
[:SENSE]:POWER[:RF]:PADJust?
[:SENSE]:POWER[:RF]:PADJust:PRESelector MWAVe | MMWave | EXTERNAL
[:SENSE]:POWER[:RF]:PADJust:PRESelector?
[:SENSE]:POWER[:RF]:PCENTER
[:SENSE]:POWER[:RF]:RANGE:AUTO ON | OFF | 1 | 0
[:SENSE]:POWER[:RF]:RANGE:AUTO?
[:SENSE]:POWER[:RF]:RANGE:OPTimize IMMEDIATE
[:SENSE]:POWER[:RF]:RANGE:OPTimize:ATTenuation OFF | ELECTRICAL | COMBINED
[:SENSE]:POWER[:RF]:RANGE:OPTimize:ATTenuation?

```

```
[ :SENSE ]:PStatIstIc:BA NDwidth <freq>
[ :SENSE ]:PStatIstIc:BA NDwidth?
[ :SENSE ]:PStatIstIc:BWIDth
[ :SENSE ]:PStatIstIc:COUNts <integer>
[ :SENSE ]:PStatIstIc:COUNts?
[ :SENSE ]:PStatIstIc:GAUSSian[:STATE]
[ :SENSE ]:PStatIstIc:IF:GAIN:AUTO[:STATE] ON | OFF | 1 | 0
[ :SENSE ]:PStatIstIc:IF:GAIN:AUTO[:STATE]?
[ :SENSE ]:PStatIstIc:IF:GAIN[:STATE] ON | OFF | 1 | 0
[ :SENSE ]:PStatIstIc:IF:GAIN[:STATE]?
[ :SENSE ]:PStatIstIc:RTRace[:STATE]
[ :SENSE ]:PStatIstIc:SRTRace
[ :SENSE ]:PStatIstIc:SWEep:CYCLes <integer>
[ :SENSE ]:PStatIstIc:SWEep:CYCLes?
[ :SENSE ]:PStatIstIc:SWEep:TIME <time>
[ :SENSE ]:PStatIstIc:SWEep:TIME?
[ :SENSE ]:RADIo:STANdard DVBT | DVBH | TTWO
[ :SENSE ]:RADIo:STANdard?
[ :SENSE ]:RADIo:STANdard:ALPha
[ :SENSE ]:RADIo:STANdard:BA NDwidth B1M7 | B5M | B6M | B7M | B8M | B10M
[ :SENSE ]:RADIo:STANdard:BA NDwidth?
[ :SENSE ]:RADIo:STANdard:CRATe:HPRatio
[ :SENSE ]:RADIo:STANdard:CRATe:LPRatio
[ :SENSE ]:RADIo:STANdard:GINterval:RATIo
[ :SENSE ]:RADIo:STANdard:HIERarchical[:STATE]
[ :SENSE ]:RADIo:STANdard:IINterleaver
[ :SENSE ]:RADIo:STANdard:MODulation
[ :SENSE ]:RADIo:STANdard:NFFT
[ :SENSE ]:RADIo:STANdard:TTWO:TMODe SISO | MISO
[ :SENSE ]:RADIo:STANdard:TTWO:TMODe?
[ :SENSE ]:RADIo:STANdard:TTWO:VERSion V111 | V121
[ :SENSE ]:RADIo:STANdard:TTWO:VERSion?
[ :SENSE ]:ROSCillator:BA NDwidth WIDE | NARROW
[ :SENSE ]:ROSCillator:BA NDwidth?
[ :SENSE ]:ROSCillator:COUPling NORMAl | NACQuisition
[ :SENSE ]:ROSCillator:COUPling?
[ :SENSE ]:ROSCillator:EXtErnal:FREQuency <freq>
[ :SENSE ]:ROSCillator:EXtErnal:FREQuency?
[ :SENSE ]:ROSCillator:SOURce INTernal | EXtErnal
[ :SENSE ]:ROSCillator:SOURce?
[ :SENSE ]:ROSCillator:SOURce:TYPE INTernal | EXtErnal | SENSE | PULSe
[ :SENSE ]:ROSCillator:SOURce:TYPE?
[ :SENSE ]:SEMAsk:AVERage:COUNT <integer>
[ :SENSE ]:SEMAsk:AVERage:COUNT?
[ :SENSE ]:SEMAsk:AVERage[:STATE] ON | OFF | 1 | 0
[ :SENSE ]:SEMAsk:AVERage[:STATE]?
[ :SENSE ]:SEMAsk:BA NDwidth[1]|2:INTEgration <bandwidth>
[ :SENSE ]:SEMAsk:BA NDwidth[1]|2:INTEgration?
[ :SENSE ]:SEMAsk:BA NDwidth[1]|2[:RESolution] <bandwidth>
[ :SENSE ]:SEMAsk:BA NDwidth[1]|2[:RESolution]?
[ :SENSE ]:SEMAsk:BA NDwidth[1]|2[:RESolution]:AUTO OFF | ON | 1 | 0
[ :SENSE ]:SEMAsk:BA NDwidth[1]|2[:RESolution]:AUTO?
[ :SENSE ]:SEMAsk:BA NDwidth:SHAPE ASEnse | GAUSSian | FLATtop
```

```

[:SENSE]:SEMask:BANDwidth:SHAPE?
[:SENSE]:SEMask:BANDwidth[1]|2:VIDeo <bandwidth>
[:SENSE]:SEMask:BANDwidth[1]|2:VIDeo?
[:SENSE]:SEMask:BANDwidth[1]|2:VIDeo:AUTO OFF | ON | 1 | 0
[:SENSE]:SEMask:BANDwidth[1]|2:VIDeo:AUTO?
[:SENSE]:SEMask:BANDwidth[1]|2:VIDeo:RATio <real>
[:SENSE]:SEMask:BANDwidth[1]|2:VIDeo:RATio
[:SENSE]:SEMask:BANDwidth[1]|2:VIDeo:RATio:AUTO OFF | ON | 1 | 0
[:SENSE]:SEMask:BANDwidth[1]|2:VIDeo:RATio:AUTO?
[:SENSE]:SEMask:BWIDth[1]|2[:RESolution]
[:SENSE]:SEMask:BWIDth[1]|2:VIDeo
[:SENSE]:SEMask:BWIDth[1]|2:VIDeo:RATio
[:SENSE]:SEMask:CARRier:AUTO[:STATE] OFF | ON | 1 | 0
[:SENSE]:SEMask:CARRier:AUTO[:STATE]?
[:SENSE]:SEMask:CARRier:CPSD <real>
[:SENSE]:SEMask:CARRier:CPSD?
[:SENSE]:SEMask:CARRier:PEAK[:POWER] <real>
[:SENSE]:SEMask:CARRier:PEAK[:POWER]?
[:SENSE]:SEMask:CARRier[:POWER] <real>
[:SENSE]:SEMask:CARRier[:POWER]?
[:SENSE]:SEMask:DETEctor:CARRier:AUTO ON | OFF | 1 | 0
[:SENSE]:SEMask:DETEctor:CARRier:AUTO?
[:SENSE]:SEMask:DETEctor:CARRier[:FUNction] AVERage | NEGative | NORMAl |
Positive | SAMPlE
[:SENSE]:SEMask:DETEctor:CARRier[:FUNction]?
[:SENSE]:SEMask:DETEctor:OFFSet:AUTO ON | OFF | 1 | 0
[:SENSE]:SEMask:DETEctor:OFFSet:AUTO?
[:SENSE]:SEMask:DETEctor:OFFSet[:FUNction] AVERage | NEGative | NORMAl |
Positive | SAMPlE
[:SENSE]:SEMask:DETEctor:OFFSet[:FUNction]?
[:SENSE]:SEMask:FILTer[:RRC]:ALPHa <real>
[:SENSE]:SEMask:FILTer[:RRC]:ALPHa?
[:SENSE]:SEMask:FILTer[:RRC][:STATE] OFF | ON | 0 | 1
[:SENSE]:SEMask:FILTer[:RRC][:STATE]?
[:SENSE]:SEMask:FREQuency[1]|2:SPAN <freq>
[:SENSE]:SEMask:FREQuency[1]|2:SPAN?
[:SENSE]:SEMask:LIMits:TYPE Manual | NONCritical | CRITical
[:SENSE]:SEMask:LIMits:TYPE?
[:SENSE]:SEMask:OFFSet[1]|2:LIST:BWIDth:IMULti
[:SENSE]:SEMask:OFFSet[1]|2:LIST:BWIDth[:RESolution]
[:SENSE]:SEMask:OFFSet[1]|2:LIST:BWIDth:VIDeo
[:SENSE]:SEMask:OFFSet[1]|2:LIST:SWEep[:TIME]
[:SENSE]:SEMask:OFFSet[1]|2[:OUTer]:LIST:BWIDth:IMULti <integer>, ...
[:SENSE]:SEMask:OFFSet[1]|2[:OUTer]:LIST:BWIDth:IMULti?
[:SENSE]:SEMask:OFFSet[1]|2[:OUTer]:LIST:BWIDth[:RESolution]
<bandwidth>, ...
[:SENSE]:SEMask:OFFSet[1]|2[:OUTer]:LIST:BWIDth[:RESolution]?
[:SENSE]:SEMask:OFFSet[1]|2[:OUTer]:LIST:BWIDth[:RESolution]:AUTO OFF |
ON | 1 | 0, ...
[:SENSE]:SEMask:OFFSet[1]|2[:OUTer]:LIST:BWIDth[:RESolution]:AUTO?
[:SENSE]:SEMask:OFFSet[1]|2[:OUTer]:LIST:BWIDth:VIDeo <freq>, ...
[:SENSE]:SEMask:OFFSet[1]|2[:OUTer]:LIST:BWIDth:VIDeo?

```

### 3 Programming the Analyzer

#### List of SCPI Commands

```
[ :SENSe]:SEMAsk:OFFSet[1]|2[:OUTer]:LIST:BANDwidth:VIDeo:AUTO OFF | ON | 0
| 1, ...
[ :SENSe]:SEMAsk:OFFSet[1]|2[:OUTer]:LIST:BANDwidth:VIDeo:AUTO?
[ :SENSe]:SEMAsk:OFFSet[1]|2[:OUTer]:LIST:BANDwidth:VIDeo:RAtio <real>, ...
[ :SENSe]:SEMAsk:OFFSet[1]|2[:OUTer]:LIST:BANDwidth:VIDeo:RAtio?
[ :SENSe]:SEMAsk:OFFSet[1]|2[:OUTer]:LIST:BANDwidth:VIDeo:RAtio:AUTO OFF |
ON | 0 | 1, ...
[ :SENSe]:SEMAsk:OFFSet[1]|2[:OUTer]:LIST:BANDwidth:VIDeo:RAtio:AUTO?
[ :SENSe]:SEMAsk:OFFSet[1]|2[:OUTer]:LIST:FREQuency:STARt <freq>, ...
[ :SENSe]:SEMAsk:OFFSet[1]|2[:OUTer]:LIST:FREQuency:STARt?
[ :SENSe]:SEMAsk:OFFSet[1]|2[:OUTer]:LIST:FREQuency:STOP <freq>, ...
[ :SENSe]:SEMAsk:OFFSet[1]|2[:OUTer]:LIST:FREQuency:STOP?
[ :SENSe]:SEMAsk:OFFSet[1]|2[:OUTer]:LIST:SIDE BOTH | NEgative | POSitive,
...
[ :SENSe]:SEMAsk:OFFSet[1]|2[:OUTer]:LIST:SIDE?
[ :SENSe]:SEMAsk:OFFSet[1]|2[:OUTer]:LIST:STARt:ABSolute <real>, ...
[ :SENSe]:SEMAsk:OFFSet[1]|2[:OUTer]:LIST:STARt:ABSolute?
[ :SENSe]:SEMAsk:OFFSet[1]|2[:OUTer]:LIST:STARt:RCARrier <rel_ampl>, ...
[ :SENSe]:SEMAsk:OFFSet[1]|2[:OUTer]:LIST:STARt:RCARrier?
[ :SENSe]:SEMAsk:OFFSet[1]|2[:OUTer]:LIST:STARt:STATE ON | OFF | 1 | 0, ...
[ :SENSe]:SEMAsk:OFFSet[1]|2[:OUTer]:LIST:STARt:STATE?
[ :SENSe]:SEMAsk:OFFSet[1]|2[:OUTer]:LIST:STOP:ABSolute <real>, ...
[ :SENSe]:SEMAsk:OFFSet[1]|2[:OUTer]:LIST:STOP:ABSolute?
[ :SENSe]:SEMAsk:OFFSet[1]|2[:OUTer]:LIST:STOP:ABSolute:COUple ON | OFF | 1
| 0, ...
[ :SENSe]:SEMAsk:OFFSet[1]|2[:OUTer]:LIST:STOP:ABSolute:COUple?
[ :SENSe]:SEMAsk:OFFSet[1]|2[:OUTer]:LIST:STOP:RCARrier <rel_ampl>, ...
[ :SENSe]:SEMAsk:OFFSet[1]|2[:OUTer]:LIST:STOP:RCARrier?
[ :SENSe]:SEMAsk:OFFSet[1]|2[:OUTer]:LIST:STOP:RCARrier:COUple ON | OFF | 1
| 0, ...
[ :SENSe]:SEMAsk:OFFSet[1]|2[:OUTer]:LIST:STOP:RCARrier:COUple?
[ :SENSe]:SEMAsk:OFFSet[1]|2[:OUTer]:LIST:SWEEp:TIME <time>, ...
[ :SENSe]:SEMAsk:OFFSet[1]|2[:OUTer]:LIST:SWEEp:TIME?
[ :SENSe]:SEMAsk:OFFSet[1]|2[:OUTer]:LIST:SWEEp:TIME:AUTO ON | OFF | 1 | 0,
...
[ :SENSe]:SEMAsk:OFFSet[1]|2[:OUTer]:LIST:SWEEp:TIME:AUTO?
[ :SENSe]:SEMAsk:OFFSet[1]|2[:OUTer]:LIST:TEST ABSolute | AND | OR |
RElative, ...
[ :SENSe]:SEMAsk:OFFSet[1]|2[:OUTer]:LIST:TEST?
[ :SENSe]:SEMAsk:OFFSet[1]|2:TYPE CTOCenter | CTOEdge | ETOCenter | ETOEdge
[ :SENSe]:SEMAsk:OFFSet[1]|2:TYPE?
[ :SENSe]:SEMAsk:SWEEp[1]|2:TIME <time>
[ :SENSe]:SEMAsk:SWEEp[1]|2:TIME?
[ :SENSe]:SEMAsk:SWEEp[1]|2:TIME:AUTO OFF | 0 | ON | 1
[ :SENSe]:SEMAsk:SWEEp[1]|2:TIME:AUTO?
[ :SENSe]:SEMAsk:TYPE PSDRef | TPreF | SPRef
[ :SENSe]:SEMAsk:TYPE?
[ :SENSe]:SIDentify:MODE ISUPpress | ISHift
[ :SENSe]:SIDentify:MODE?
[ :SENSe]:SIDentify[:STATE] OFF | ON | 0 | 1
[ :SENSe]:SIDentify[:STATE]?
[ :SENSe]:SPURious:AVERage:COUNT <integer>
```

```

[:SENSe]:SPURious:AVERAge:COUNT?
[:SENSe]:SPURious:AVERAge[:STATE] ON | OFF | 1 | 0
[:SENSe]:SPURious:AVERAge[:STATE]?
[:SENSe]:SPURious:AVERAge:TCONtrol EXPonential | REPeat
[:SENSe]:SPURious:AVERAge:TCONtrol?
[:SENSe]:SPURious:CARRier:POWer <real>
[:SENSe]:SPURious:CARRier:POWer?
[:SENSe]:SPURious:FSMeas ON | OFF | 1 | 0
[:SENSe]:SPURious:FSMeas?
[:SENSe]:SPURious:IF:GAIN:AUTO[:STATE] OFF|ON|0|1, ...
[:SENSe]:SPURious:IF:GAIN:AUTO[:STATE]?
[:SENSe]:SPURious:IF:GAIN[:STATE] OFF|ON|0|1, ...
[:SENSe]:SPURious:IF:GAIN[:STATE]?
[:SENSe]:SPURious:POWer[:RF]:RANGE:AUTO
[:SENSe]:SPURious[:RANGE]:ALL:SWEep:TYPE:AUTO OFF | ON | 0 | 1
[:SENSe]:SPURious[:RANGE]:ALL:SWEep:TYPE:AUTO?
[:SENSe]:SPURious[:RANGE][:LIST]:ATTenuation <rel_ampl>, ...
[:SENSe]:SPURious[:RANGE][:LIST]:ATTenuation?
[:SENSe]:SPURious[:RANGE][:LIST]:ATTenuation:AUTO OFF|ON|0|1, ...
[:SENSe]:SPURious[:RANGE][:LIST]:ATTenuation:AUTO?
[:SENSe]:SPURious[:RANGE][:LIST]:BANDwidth[:RESolution] <freq>, ...
[:SENSe]:SPURious[:RANGE][:LIST]:BANDwidth[:RESolution]?
[:SENSe]:SPURious[:RANGE][:LIST]:BANDwidth[:RESolution]:AUTO OFF|ON|0|1,
...
[:SENSe]:SPURious[:RANGE][:LIST]:BANDwidth[:RESolution]:AUTO?
[:SENSe]:SPURious[:RANGE][:LIST]:BANDwidth:SHAPE GAUSSian|FLATtop, ...
[:SENSe]:SPURious[:RANGE][:LIST]:BANDwidth:SHAPE?
[:SENSe]:SPURious[:RANGE][:LIST]:BANDwidth:VIDeo <freq>, ...
[:SENSe]:SPURious[:RANGE][:LIST]:BANDwidth:VIDeo?
[:SENSe]:SPURious[:RANGE][:LIST]:BANDwidth:VIDeo:AUTO OFF|ON|0|1, ...
[:SENSe]:SPURious[:RANGE][:LIST]:BANDwidth:VIDeo:AUTO?
[:SENSe]:SPURious[:RANGE][:LIST]:BWIDth[:RESolution]
[:SENSe]:SPURious[:RANGE][:LIST]:BWIDth:SHAPE
[:SENSe]:SPURious[:RANGE][:LIST]:BWIDth:VIDeo
[:SENSe]:SPURious[:RANGE][:LIST]:DETEctor[1][:FUNction]
AVERAge|NEGAtive|NORMAl|POSitive|SAMPle|RMS, ...
[:SENSe]:SPURious[:RANGE][:LIST]:DETEctor2[:FUNction]
OFF|AVERAge|NEGAtive|NORMAl|POSitive|SAMPle|RMS, ...
[:SENSe]:SPURious[:RANGE][:LIST]:DETEctor[1][:FUNction]?
[:SENSe]:SPURious[:RANGE][:LIST]:DETEctor2[:FUNction]?
[:SENSe]:SPURious[:RANGE][:LIST]:FREQuency:START <freq>, ...
[:SENSe]:SPURious[:RANGE][:LIST]:FREQuency:START?
[:SENSe]:SPURious[:RANGE][:LIST]:FREQuency:STOP <freq>, ...
[:SENSe]:SPURious[:RANGE][:LIST]:FREQuency:STOP?
[:SENSe]:SPURious[:RANGE][:LIST]:PEAK:EXCURsion <rel_ampl>, ...
[:SENSe]:SPURious[:RANGE][:LIST]:PEAK:EXCURsion?
[:SENSe]:SPURious[:RANGE][:LIST]:PEAK:THREshold <real>, ...
[:SENSe]:SPURious[:RANGE][:LIST]:PEAK:THREshold?
[:SENSe]:SPURious[:RANGE][:LIST]:STATe ON|OFF|1|0, ...
[:SENSe]:SPURious[:RANGE][:LIST]:STATe?
[:SENSe]:SPURious[:RANGE][:LIST]:SWEep:POINts <integer>
[:SENSe]:SPURious[:RANGE][:LIST]:SWEep:POINts?

```

```

[:SENSe]:SPURious[:RANGe][:LIST]:SWEep:POINTs:AUTO OFF|ON|0|1, ...
[:SENSe]:SPURious[:RANGe][:LIST]:SWEep:POINTs:AUTO?
[:SENSe]:SPURious[:RANGe][:LIST]:SWEep:TIME <time>, ...
[:SENSe]:SPURious[:RANGe][:LIST]:SWEep:TIME?
[:SENSe]:SPURious[:RANGe][:LIST]:SWEep:TIME:AUTO OFF|ON|0|1, ...
[:SENSe]:SPURious[:RANGe][:LIST]:SWEep:TIME:AUTO?
[:SENSe]:SPURious:REPT:MODE ALL | LIMTest | MMARgin
[:SENSe]:SPURious:REPT:MODE?
[:SENSe]:SPURious:SPUR <integer>
[:SENSe]:SPURious:SPUR?
[:SENSe]:SPURious:SWEep:TIME:AUTO:RULEs NORMAl | ACCuracy
[:SENSe]:SPURious:SWEep:TIME:AUTO:RULEs?
[:SENSe]:SPURious:TYPE EXAMine | FULL
[:SENSe]:SPURious:TYPE?
[:SENSe]:SWEep:EGATE:CONTRol EDGE | LEVel
[:SENSe]:SWEep:EGATE:CONTRol?
[:SENSe]:SWEep:EGATE:DELay <time>
[:SENSe]:SWEep:EGATE:DELay?
[:SENSe]:SWEep:EGATE:DELay:COMPensation:TYPE OFF | SETTled | GDELay
[:SENSe]:SWEep:EGATE:DELay:COMPensation:TYPE?
[:SENSe]:SWEep:EGATE:EXTernal[1]|2:LEVel <voltage>
[:SENSe]:SWEep:EGATE:EXTernal[1]|2:LEVel?
[:SENSe]:SWEep:EGATE:HOLDoff <time>
[:SENSe]:SWEep:EGATE:HOLDoff?
[:SENSe]:SWEep:EGATE:HOLDoff:AUTO OFF | ON | 0 | 1
[:SENSe]:SWEep:EGATE:HOLDoff:AUTO?
[:SENSe]:SWEep:EGATE:LENGth <time>
[:SENSe]:SWEep:EGATE:LENGth?
[:SENSe]:SWEep:EGATE:MINFast?
[:SENSe]:SWEep:EGATE:POLarity NEGative | POSitive
[:SENSe]:SWEep:EGATE:POLarity?
[:SENSe]:SWEep:EGATE:SOURce EXTernal1 | EXTernal2 | LINE | FRAME | RFBurst
[:SENSe]:SWEep:EGATE:SOURce?
[:SENSe]:SWEep:EGATE[:STATE] OFF | ON | 0 | 1
[:SENSe]:SWEep:EGATE[:STATE]?
[:SENSe]:SWEep:EGATE:TIME <time>
[:SENSe]:SWEep:EGATE:TIME?
[:SENSe]:SWEep:EGATE:VIEW ON | OFF | 1 | 0
[:SENSe]:SWEep:EGATE:VIEW?
[:SENSe]:SWEep:EGATE:VIEW:STARt <time>
[:SENSe]:SWEep:EGATE:VIEW:STARt?
[:SENSe]:SWEep:TIME:GATE:LEVel HIGH | LOW
[:SENSe]:SWEep:TIME:GATE:LEVel?
[:SENSe]:VOLTage:IQ[:I]:RANGe[:UPPer] <voltage>
[:SENSe]:VOLTage:IQ[:I]:RANGe[:UPPer]?
[:SENSe]:VOLTage:IQ:Q:RANGe[:UPPer] <voltage>
[:SENSe]:VOLTage:IQ:Q:RANGe[:UPPer]?
[:SENSe]:VOLTage:IQ:RANGe:AUTO OFF | ON | 0 | 1
[:SENSe]:VOLTage:IQ:RANGe:AUTO?
[:SENSe]:VOLTage|POWER:IQ:MIRROred OFF | ON | 0 | 1
[:SENSe]:VOLTage|POWER:IQ:MIRROred?
[:SENSe]:WAVEform:ADC:DITHer:AUTO[:STATE] OFF | ON | 0 | 1
[:SENSe]:WAVEform:ADC:DITHer:AUTO[:STATE]?

```

```

[:SENSE]:WAVEform:ADC:DITHer[:STATE] OFF | ON | 0 | 1
[:SENSE]:WAVEform:ADC:DITHer[:STATE]?
[:SENSE]:WAVEform:APERTure?
[:SENSE]:WAVEform:AVERAge:COUNT <integer>
[:SENSE]:WAVEform:AVERAge:COUNT?
[:SENSE]:WAVEform:AVERAge[:STATE] OFF | ON | 0 | 1
[:SENSE]:WAVEform:AVERAge[:STATE]?
[:SENSE]:WAVEform:AVERAge:TACount <integer>
[:SENSE]:WAVEform:AVERAge:TACount?
[:SENSE]:WAVEform:AVERAge:TCONTRol EXPonential | REPEat
[:SENSE]:WAVEform:AVERAge:TCONTRol?
[:SENSE]:WAVEform:AVERAge:TYPE LOG | MAXimum | MINimum | RMS | SCALar
[:SENSE]:WAVEform:AVERAge:TYPE?
[:SENSE]:WAVEform:AVERAge:TYPE:AUTO[:STATE] ON | OFF | 1 | 0
[:SENSE]:WAVEform:AVERAge:TYPE:AUTO[:STATE]?
[:SENSE]:WAVEform:BANDwidth|BWIDth[:RESolution]:TYPE
[:SENSE]:WAVEform:BANDwidth[:RESolution]
[:SENSE]:WAVEform:BANDwidth:SHAPE
[:SENSE]:WAVEform:BWIDth[:RESolution]
[:SENSE]:WAVEform:BWIDth:SHAPE
[:SENSE]:WAVEform:DIF:BANDwidth <freq>
[:SENSE]:WAVEform:DIF:BANDwidth?
[:SENSE]:WAVEform:DIF:FILTer:ALPHa <real>
[:SENSE]:WAVEform:DIF:FILTer:ALPHa?
[:SENSE]:WAVEform:DIF:FILTer:BANDwidth <freq>
[:SENSE]:WAVEform:DIF:FILTer:BANDwidth?
[:SENSE]:WAVEform:DIF:FILTer:BANDwidth:AUTO ON | OFF | 1 | 0
[:SENSE]:WAVEform:DIF:FILTer:BANDwidth:AUTO?
[:SENSE]:WAVEform:DIF:FILTer:TYPE GAUSSian | FLATtop | SNYQuist |
RSNYquist | RCOSine | RRCosine
[:SENSE]:WAVEform:DIF:FILTer:TYPE GAUSSian | FLATtop
[:SENSE]:WAVEform:DIF:FILTer:TYPE?
[:SENSE]:WAVEform:DIF:FILTer:TYPE?
[:SENSE]:WAVEform:FREQuency:SYNThesis:AUTO[:STATE] OFF | ON | 0 | 1
[:SENSE]:WAVEform:FREQuency:SYNThesis:AUTO[:STATE]?
[:SENSE]:WAVEform:FREQuency:SYNThesis[:STATE] 1 | 2 | 3
[:SENSE]:WAVEform:FREQuency:SYNThesis[:STATE]?
[:SENSE]:WAVEform:IF:GAIN:AUTO[:STATE] ON | OFF | 1 | 0
[:SENSE]:WAVEform:IF:GAIN:AUTO[:STATE]?
[:SENSE]:WAVEform:IF:GAIN:OFFSet <rel_ampl>
[:SENSE]:WAVEform:IF:GAIN:OFFSet?
[:SENSE]:WAVEform:IF:GAIN[:STATE] AUTOrange | LOW | HIGH
[:SENSE]:WAVEform:IF:GAIN[:STATE]?
[:SENSE]:WAVEform:PDITHer
[:SENSE]:WAVEform:SRATE <freq>
[:SENSE]:WAVEform:SRATE?
[:SENSE]:WAVEform:SWEep:TIME <time>
[:SENSE]:WAVEform:SWEep:TIME?
[:SENSE]:WAVEform:WBIF:ADC:DITHer
[:SENSE]:WAVEform:WBIF:FILTer:ALPHa
[:SENSE]:WAVEform:WBIF:FILTer:BANDwidth <real>
[:SENSE]:WAVEform:WBIF:FILTer:BANDwidth?

```

```
[ :SENSe ] :WAVEform:WBIF:FILTer[:TYPE] GAUSSian | NONE | NYQuist | RNYQuist  
| RCOSine | RRCosine  
[ :SENSe ] :WAVEform:WBIF:FILTer[:TYPE]?  
STATus:OPERation:CONDition?  
STATus:OPERation:ENABle <integer>  
STATus:OPERation:ENABle?  
STATus:OPERation[:EVENT]?  
STATus:OPERation:NTRansition <integer>  
STATus:OPERation:NTRansition?  
STATus:OPERation:PTRansition <integer>  
STATus:OPERation:PTRansition?  
STATus:PRESet  
STATus:QUESTionable:CALibration:CONDition?  
STATus:QUESTionable:CALibration:ENABle <integer>  
STATus:QUESTionable:CALibration:ENABle?  
STATus:QUESTionable:CALibration[:EVENT]?  
STATus:QUESTionable:CALibration:EXTended:FAILure:CONDition?  
STATus:QUESTionable:CALibration:EXTended:FAILure:ENABle <integer>  
STATus:QUESTionable:CALibration:EXTended:FAILure:ENABle?  
STATus:QUESTionable:CALibration:EXTended:FAILure[:EVENT]?  
STATus:QUESTionable:CALibration:EXTended:FAILure:NTRansition <integer>  
STATus:QUESTionable:CALibration:EXTended:FAILure:NTRansition?  
STATus:QUESTionable:CALibration:EXTended:FAILure:PTRansition <integer>  
STATus:QUESTionable:CALibration:EXTended:FAILure:PTRansition?  
STATus:QUESTionable:CALibration:EXTended:NEEDed:CONDition?  
STATus:QUESTionable:CALibration:EXTended:NEEDed:ENABle <integer>  
STATus:QUESTionable:CALibration:EXTended:NEEDed:ENABle?  
STATus:QUESTionable:CALibration:EXTended:NEEDed[:EVENT]?  
STATus:QUESTionable:CALibration:EXTended:NEEDed:NTRansition <integer>  
STATus:QUESTionable:CALibration:EXTended:NEEDed:NTRansition?  
STATus:QUESTionable:CALibration:EXTended:NEEDed:PTRansition <integer>  
STATus:QUESTionable:CALibration:EXTended:NEEDed:PTRansition?  
STATus:QUESTionable:CALibration:NTRansition <integer>  
STATus:QUESTionable:CALibration:NTRansition?  
STATus:QUESTionable:CALibration:PTRansition <integer>  
STATus:QUESTionable:CALibration:PTRansition?  
STATus:QUESTionable:CALibration:SKIPPed:CONDition?  
STATus:QUESTionable:CALibration:SKIPPed:ENABle <integer>  
STATus:QUESTionable:CALibration:SKIPPed:ENABle?  
STATus:QUESTionable:CALibration:SKIPPed[:EVENT]?  
STATus:QUESTionable:CALibration:SKIPPed:NTRansition <integer>  
STATus:QUESTionable:CALibration:SKIPPed:NTRansition?  
STATus:QUESTionable:CALibration:SKIPPed:PTRansition <integer>  
STATus:QUESTionable:CALibration:SKIPPed:PTRansition?  
STATus:QUESTionable:CONDition?  
STATus:QUESTionable:ENABle <integer>  
STATus:QUESTionable:ENABle?  
STATus:QUESTionable[:EVENT]?  
STATus:QUESTionable:FREQuency:CONDition?  
STATus:QUESTionable:FREQuency:ENABle <integer>  
STATus:QUESTionable:FREQuency:ENABle?  
STATus:QUESTionable:FREQuency[:EVENT]?  
STATus:QUESTionable:FREQuency:NTRansition <integer>
```



```

STATUS:QUESTIONABLE:FREQUENCY:NTRANSITION?
STATUS:QUESTIONABLE:FREQUENCY:PTRANSITION <integer>
STATUS:QUESTIONABLE:FREQUENCY:PTRANSITION?
STATUS:QUESTIONABLE:INTEGRITY:CONDITION?
STATUS:QUESTIONABLE:INTEGRITY:ENABLE <integer>
STATUS:QUESTIONABLE:INTEGRITY:ENABLE?
STATUS:QUESTIONABLE:INTEGRITY[:EVENT]?
STATUS:QUESTIONABLE:INTEGRITY:NTRANSITION <integer>
STATUS:QUESTIONABLE:INTEGRITY:NTRANSITION?
STATUS:QUESTIONABLE:INTEGRITY:PTRANSITION <integer>
STATUS:QUESTIONABLE:INTEGRITY:PTRANSITION?
STATUS:QUESTIONABLE:INTEGRITY:SIGNAL:CONDITION?
STATUS:QUESTIONABLE:INTEGRITY:SIGNAL:ENABLE <integer>
STATUS:QUESTIONABLE:INTEGRITY:SIGNAL:ENABLE?
STATUS:QUESTIONABLE:INTEGRITY:SIGNAL[:EVENT]?
STATUS:QUESTIONABLE:INTEGRITY:SIGNAL:NTRANSITION <integer>
STATUS:QUESTIONABLE:INTEGRITY:SIGNAL:NTRANSITION?
STATUS:QUESTIONABLE:INTEGRITY:SIGNAL:PTRANSITION <integer>
STATUS:QUESTIONABLE:INTEGRITY:SIGNAL:PTRANSITION?
STATUS:QUESTIONABLE:INTEGRITY:UNCALIBRATED:CONDITION?
STATUS:QUESTIONABLE:INTEGRITY:UNCALIBRATED:ENABLE
STATUS:QUESTIONABLE:INTEGRITY:UNCALIBRATED:ENABLE?
STATUS:QUESTIONABLE:INTEGRITY:UNCALIBRATED[:EVENT]?
STATUS:QUESTIONABLE:INTEGRITY:UNCALIBRATED:NTRANSITION <integer>
STATUS:QUESTIONABLE:INTEGRITY:UNCALIBRATED:NTRANSITION?
STATUS:QUESTIONABLE:INTEGRITY:UNCALIBRATED:PTRANSITION <integer>
STATUS:QUESTIONABLE:INTEGRITY:UNCALIBRATED:PTRANSITION?
STATUS:QUESTIONABLE:NTRANSITION <integer>
STATUS:QUESTIONABLE:NTRANSITION?
STATUS:QUESTIONABLE:POWER:CONDITION?
STATUS:QUESTIONABLE:POWER:ENABLE <integer>
STATUS:QUESTIONABLE:POWER:ENABLE?
STATUS:QUESTIONABLE:POWER[:EVENT]?
STATUS:QUESTIONABLE:POWER:NTRANSITION <integer>
STATUS:QUESTIONABLE:POWER:NTRANSITION?
STATUS:QUESTIONABLE:POWER:PTRANSITION <integer>
STATUS:QUESTIONABLE:POWER:PTRANSITION?
STATUS:QUESTIONABLE:PTRANSITION <integer>
STATUS:QUESTIONABLE:PTRANSITION?
STATUS:QUESTIONABLE:TEMPERATURE:CONDITION?
STATUS:QUESTIONABLE:TEMPERATURE:ENABLE <integer>
STATUS:QUESTIONABLE:TEMPERATURE:ENABLE?
STATUS:QUESTIONABLE:TEMPERATURE[:EVENT]?
STATUS:QUESTIONABLE:TEMPERATURE:NTRANSITION <integer>
STATUS:QUESTIONABLE:TEMPERATURE:NTRANSITION?
STATUS:QUESTIONABLE:TEMPERATURE:PTRANSITION <integer>
STATUS:QUESTIONABLE:TEMPERATURE:PTRANSITION?
SYSTEM:APPLICATION:CATALOG[:NAME]?
SYSTEM:APPLICATION:CATALOG[:NAME]:COUNT?
SYSTEM:APPLICATION:CATALOG:OPTION? <model>
SYSTEM:APPLICATION:CATALOG:REVISION? <model>
SYSTEM:APPLICATION[:CURRENT][:NAME]?
SYSTEM:APPLICATION[:CURRENT]:OPTION?

```

### 3 Programming the Analyzer

#### List of SCPI Commands

```
SYSTem:APPLication[:CURRent]:REVision?
SYSTem:COMMunicate:GPIB[1][:SELF]:ADDRess <integer>
SYSTem:COMMunicate:GPIB[1][:SELF]:ADDRess?
SYSTem:COMMunicate:GPIB[1][:SELF]:CONTROLLER[:ENABLE] ON | OFF | 0 | 1
SYSTem:COMMunicate:GPIB[1][:SELF]:CONTROLLER[:ENABLE]?
SYSTem:COMMunicate:LAN:SCPI:HISLip:ENABLE OFF | ON | 0 | 1
SYSTem:COMMunicate:LAN:SCPI:HISLip:ENABLE?
SYSTem:COMMunicate:LAN:SCPI:SICL:ENABLE OFF | ON | 0 | 1
SYSTem:COMMunicate:LAN:SCPI:SICL:ENABLE?
SYSTem:COMMunicate:LAN:SCPI:SOCKET:CONTROL?
SYSTem:COMMunicate:LAN:SCPI:SOCKET:ENABLE OFF | ON | 0 | 1
SYSTem:COMMunicate:LAN:SCPI:SOCKET:ENABLE?
SYSTem:COMMunicate:LAN:SCPI:TELNet:ENABLE OFF | ON | 0 | 1
SYSTem:COMMunicate:LAN:SCPI:TELNet:ENABLE?
SYSTem:COMMunicate:USB:CONNECTION?
SYSTem:COMMunicate:USB:PACKets?
SYSTem:COMMunicate:USB:STATUS?
SYSTem:CONFigure[:SYSTem]?
SYSTem:CSYStem?
SYSTem:DATE "<year>, <month>, <day>"
SYSTem:DATE?
SYSTem:DEFault [ALL] | ALIGn | INPut | MISC | MODes | PON
SYSTem:ERRor[:NEXT]?
SYSTem:ERRor:OVERload[:STATE] 0 | 1 | OFF | ON
SYSTem:ERRor:VERBose OFF | ON | 0 | 1
SYSTem:ERRor:VERBose?
SYSTem:HELP:HEADers?
SYSTem:HID?
SYSTem:IDN <string>
SYSTem:IDN?
SYSTem:KLOCK OFF | ON | 0 | 1
SYSTem:KLOCK?
SYSTem:LKEY <"OptionInfo">, <"LicenseInfo">
SYSTem:LKEY? <"OptionInfo">
SYSTem:LKEY:DELeTe <"OptionInfo">, <"LicenseInfo">
SYSTem:LKEY:LIST?
SYSTem:MRELay:COUNT?
SYSTem:OPTions?
SYSTem:PDOWN [NORMAL | FORCE]
SYSTem:PON:APPLication:LLIST <stringofINSTRument:SElectnames>
SYSTem:PON:APPLication:LLIST?
SYSTem:PON:APPLication:VMEMory[:AVAILable]?
SYSTem:PON:APPLication:VMEMory:TOTAL?
SYSTem:PON:APPLication:VMEMory:USED?
SYSTem:PON:APPLication:VMEMory:USED:NAME? <INSTRument:SElectname>
SYSTem:PON:ETIME?
SYSTem:PON:MODE SA | BASIC | ADEMOD | NFIGURE | PNOISE | CDMA2K | TDSCDMA
| VSA | VSA89601 | WCDMA | WIMAXOFDMA
SYSTem:PON:MODE?
SYSTem:PON:TIME?
SYSTem:PON:TYPE PRESet
SYSTem:PON:TYPE MODE | USER | LAST
SYSTem:PON:TYPE?
```

```

SYSTEM:PRESet
SYSTEM:PRESet:TYPE FACTory | MODE | USER
SYSTEM:PRESet:TYPE?
SYSTEM:PRESet:USER
SYSTEM:PRESet:USER:ALL
SYSTEM:PRESet:USER:SAVE
SYSTEM:PRINT:THEME TDColor | TDMonochrome | FCOLOR | FMONochrome
SYSTEM:PRINT:THEME?
SYSTEM:PUP:PROcEss
SYSTEM:SECurity:USB:WPRotect[:ENABLE] ON | OFF | 0 | 1
SYSTEM:SECurity:USB:WPRotect[:ENABLE]?
SYSTEM:SHOW OFF | ERRor | SYSTem | HARDWare | LXI | HWStatistics |
ALIGNment | SOFTWare | CAPPLication
SYSTEM:SHOW?
SYSTEM:TEMPerature:HEXTreme?
SYSTEM:TEMPerature:LEXTreme?
SYSTEM:TIME "<hour>, <minute>, <second>"
SYSTEM:TIME?
SYSTEM:VERSion?
TRACe[1]|2|3:ACPowEr:DISPlay[:STATE] ON | OFF | 0 | 1
TRACe[1]|2|3:ACPowEr:DISPlay[:STATE]?
TRACe[1]|2|3:ACPowEr:TYPE WRITe | AVERAge | MAXHold | MINHold
TRACe[1]|2|3:ACPowEr:TYPE?
TRACe[1]|2|3:ACPowEr:UPDate[:STATE] ON | OFF | 0 | 1
TRACe[1]|2|3:ACPowEr:UPDate[:STATE]?
TRACe:CHPower:TYPE WRITe | AVERAge | MAXHold | MINHold
TRACe:CHPower:TYPE?
TRACe:EVM:RTRace:DISPlay OFF | ON | 0 | 1
TRACe:EVM:RTRace:DISPlay?
TRACe:EVM:RTRace:STORe[:IMMediate]
TRACe:EVMTtwo:RTRace:DISPlay OFF | ON | 0 | 1
TRACe:EVMTtwo:RTRace:DISPlay?
TRACe:EVMTtwo:RTRace:STORe[:IMMediate]
TRACe:MONitor:CLear [TRACE1] | TRACE2 | TRACE3
TRACe:MONitor:CLear:ALL
TRACe[1]|2|3:MONitor:DISPlay[:STATE] ON | OFF | 0 | 1
TRACe[1]|2|3:MONitor:DISPlay[:STATE]?
TRACe[1]|2|3:MONitor:TYPE WRITe | AVERAge | MAXHold | MINHold
TRACe[1]|2|3:MONitor:TYPE?
TRACe[1]|2|3:MONitor:UPDate[:STATE] ON | OFF | 0 | 1
TRACe[1]|2|3:MONitor:UPDate[:STATE]?
TRACe:SEMAsk:TYPE WRITe | AVERAge | MAXHold | MINHold
TRACe:SEMAsk:TYPE?
TRIGger:<measurement>[:SEQuence]:IQ:SOURce EXTernal1 | EXTernal2 |
IMMediate | IQMag | IDEMod | QDEMod | IINPut | QINPut | AIQMag
TRIGger:<measurement>[:SEQuence]:IQ:SOURce?
TRIGger:<measurement>[:SEQuence]:RF:SOURce EXTernal1 | EXTernal2 |
IMMediate | LINE | FRAME | RFBurst | VIDEo | IF | ALARm | LAN | TV
TRIGger:<measurement>[:SEQuence]:RF:SOURce?
TRIGger:<measurement>[:SEQuence]:SOURce EXTernal1 | EXTernal2 | IMMediate
| LINE | FRAME | RFBurst | VIDEo | IF | ALARm | LAN | IQMag | IDEMod |
QDEMod | IINPut | QINPut | AIQMag | TV

```

```
TRIGger:<measurement>[:SEquence]:SOURce?
TRIGger[:SEquence]:ATRigger <time>
TRIGger[:SEquence]:ATRigger?
TRIGger[:SEquence]:ATRigger:STATE OFF | ON | 0 | 1
TRIGger[:SEquence]:ATRigger:STATE?
TRIGger[:SEquence]:DElay <time>
TRIGger[:SEquence]:DElay?
TRIGger[:SEquence]:DElay:STATE OFF | ON | 0 | 1
TRIGger[:SEquence]:DElay:STATE?
TRIGger[:SEquence]:EXternal2:DElay <time>
TRIGger[:SEquence]:EXternal1:DElay <time>
TRIGger[:SEquence]:EXternal:DElay
TRIGger[:SEquence]:EXternal1:DElay?
TRIGger[:SEquence]:EXternal2:DElay?
TRIGger[:SEquence]:EXternal1:DElay:STATE OFF | ON | 0 | 1
TRIGger[:SEquence]:EXternal2:DElay:STATE OFF | ON | 0 | 1
TRIGger[:SEquence]:EXternal2:DElay:STATE?
TRIGger[:SEquence]:EXternal1:DElay:STATE?
TRIGger[:SEquence]:EXternal1:LEVel <level>
TRIGger[:SEquence]:EXternal2:LEVel
TRIGger[:SEquence]:EXternal:LEVel
TRIGger[:SEquence]:EXternal2:LEVel?
TRIGger[:SEquence]:EXternal1:LEVel?
TRIGger[:SEquence]:EXternal1:SLOPe POSitive | NEGative
TRIGger[:SEquence]:EXternal:SLOPe
TRIGger[:SEquence]:EXternal2:SLOPe POSitive | NEGative
TRIGger[:SEquence]:EXternal2:SLOPe?
TRIGger[:SEquence]:EXternal1:SLOPe?
TRIGger[:SEquence]:FRAME:ADJust <time>
TRIGger[:SEquence]:FRAME:DElay <time>
TRIGger[:SEquence]:FRAME:DElay?
TRIGger[:SEquence]:FRAME:DElay:STATE OFF | ON | 0 | 1
TRIGger[:SEquence]:FRAME:DElay:STATE?
TRIGger[:SEquence]:FRAME:EXternal1:LEVel
TRIGger[:SEquence]:FRAME:EXternal2:LEVel
TRIGger[:SEquence]:FRAME:EXternal2:SLOPe
TRIGger[:SEquence]:FRAME:EXternal1:SLOPe
TRIGger[:SEquence]:FRAME:OFFSet <time>
TRIGger[:SEquence]:FRAME:OFFSet?
TRIGger[:SEquence]:FRAME:OFFSet:DISplay:RESet
TRIGger[:SEquence]:FRAME:PERiod <time>
TRIGger[:SEquence]:FRAME:PERiod?
TRIGger[:SEquence]:FRAME:RFBurst:LEVel:ABSolute
TRIGger[:SEquence]:FRAME:RFBurst:SLOPe
TRIGger[:SEquence]:FRAME:SYNC EXternal
TRIGger[:SEquence]:FRAME:SYNC EXternal1 | EXternal2 | RFBurst | OFF
TRIGger[:SEquence]:FRAME:SYNC?
TRIGger[:SEquence]:FRAME:SYNC:HOLDOff <time>
TRIGger[:SEquence]:FRAME:SYNC:HOLDOff?
TRIGger[:SEquence]:FRAME:SYNC:HOLDOff:STATE OFF | ON | 0 | 1
TRIGger[:SEquence]:FRAME:SYNC:HOLDOff:STATE?
TRIGger[:SEquence]:HOLDOff <time>
TRIGger[:SEquence]:HOLDOff?
```

```

TRIGger[:SEQuence]:HOLDoFF:STATe OFF | ON | 0 | 1
TRIGger[:SEQuence]:HOLDoFF:STATe?
TRIGger[:SEQuence]:IF:LEVel
TRIGger[:SEQuence]:IF:LEVel?
TRIGger[:SEQuence]:IF:SLOPe NEGAtive | POSitive
TRIGger[:SEQuence]:IF:SLOPe?
TRIGger[:SEQuence]:LINE:DELay <time>
TRIGger[:SEQuence]:LINE:DELay?
TRIGger[:SEQuence]:LINE:DELay:STATe OFF | ON | 0 | 1
TRIGger[:SEQuence]:LINE:DELay:STATe?
TRIGger[:SEQuence]:LINE:SLOPe POSitive | NEGAtive
TRIGger[:SEQuence]:LINE:SLOPe?
TRIGger[:SEQuence]:OFFSet <time>
TRIGger[:SEQuence]:OFFSet?
TRIGger[:SEQuence]:OFFSet:STATe OFF | ON | 0 | 1
TRIGger[:SEQuence]:OFFSet:STATe?
TRIGger[:SEQuence]:RFBurst:DELay <time>
TRIGger[:SEQuence]:RFBurst:DELay?
TRIGger[:SEQuence]:RFBurst:DELay:STATe OFF | ON | 0 | 1
TRIGger[:SEQuence]:RFBurst:DELay:STATe?
TRIGger[:SEQuence]:RFBurst:LEVel
TRIGger[:SEQuence]:RFBurst:LEVel:ABSolute <ampl>
TRIGger[:SEQuence]:RFBurst:LEVel:ABSolute?
TRIGger[:SEQuence]:RFBurst:LEVel:RELative <rel_ampl>
TRIGger[:SEQuence]:RFBurst:LEVel:RELative?
TRIGger[:SEQuence]:RFBurst:LEVel:TYPE ABSolute | RELative
TRIGger[:SEQuence]:RFBurst:LEVel:TYPE?
TRIGger[:SEQuence]:RFBurst:SLOPe POSitive | NEGAtive
TRIGger[:SEQuence]:RFBurst:SLOPe?
TRIGger[:SEQuence]:SLOPe POSitive | NEGAtive
TRIGger[:SEQuence]:SLOPe?
TRIGger[:SEQuence]:SOURCe EXTernal
TRIGger[:SEQuence]:VIDeo:DELay <time>
TRIGger[:SEQuence]:VIDeo:DELay?
TRIGger[:SEQuence]:VIDeo:DELay:STATe OFF | ON | 0 | 1
TRIGger[:SEQuence]:VIDeo:DELay:STATe?
TRIGger[:SEQuence]:VIDeo:LEVel <ampl>
TRIGger[:SEQuence]:VIDeo:LEVel?
TRIGger[:SEQuence]:VIDeo:SLOPe POSitive | NEGAtive
TRIGger[:SEQuence]:VIDeo:SLOPe?
TRIGger|TRIGger1|TRIGger2[:SEQuence]:OUTPut HSWP | MEASuring | MAIN | GATE
| GTRigger | OEVEN | SPOint | SSweep | SSETtled | S1Marker | S2Marker |
S3Marker | S4Marker | OFF
TRIGger|TRIGger1|TRIGger2[:SEQuence]:OUTPut?
TRIGger|TRIGger1|TRIGger2[:SEQuence]:OUTPut:POLarity POSitive | NEGAtive
TRIGger|TRIGger1|TRIGger2[:SEQuence]:OUTPut:POLarity?
UNIT:ACPower:POWER:PSD DBMHZ | DBMMHZ
UNIT:ACPower:POWER:PSD?
UNIT:CHPower:POWER:PSD DBMHZ | DBMMHZ
UNIT:CHPower:POWER:PSD?
UNIT:POWER DBM | DBMV | DBMA | V | W | A | DBUV | DBUA | DBPW | DBUVM |
DBUAM | DBPT | DBG

```

UNIT:POWer?

## STATus Subsystem

The following diagram provides a graphical overview of the entire X-Series Status Register System.

For readability, the diagram is split into two sections:

- ["X-Series Status Register System \(1\)" on page 152](#)
- ["X-Series Status Register System \(2\)" on page 153](#)

X-Series Status Register System (1)

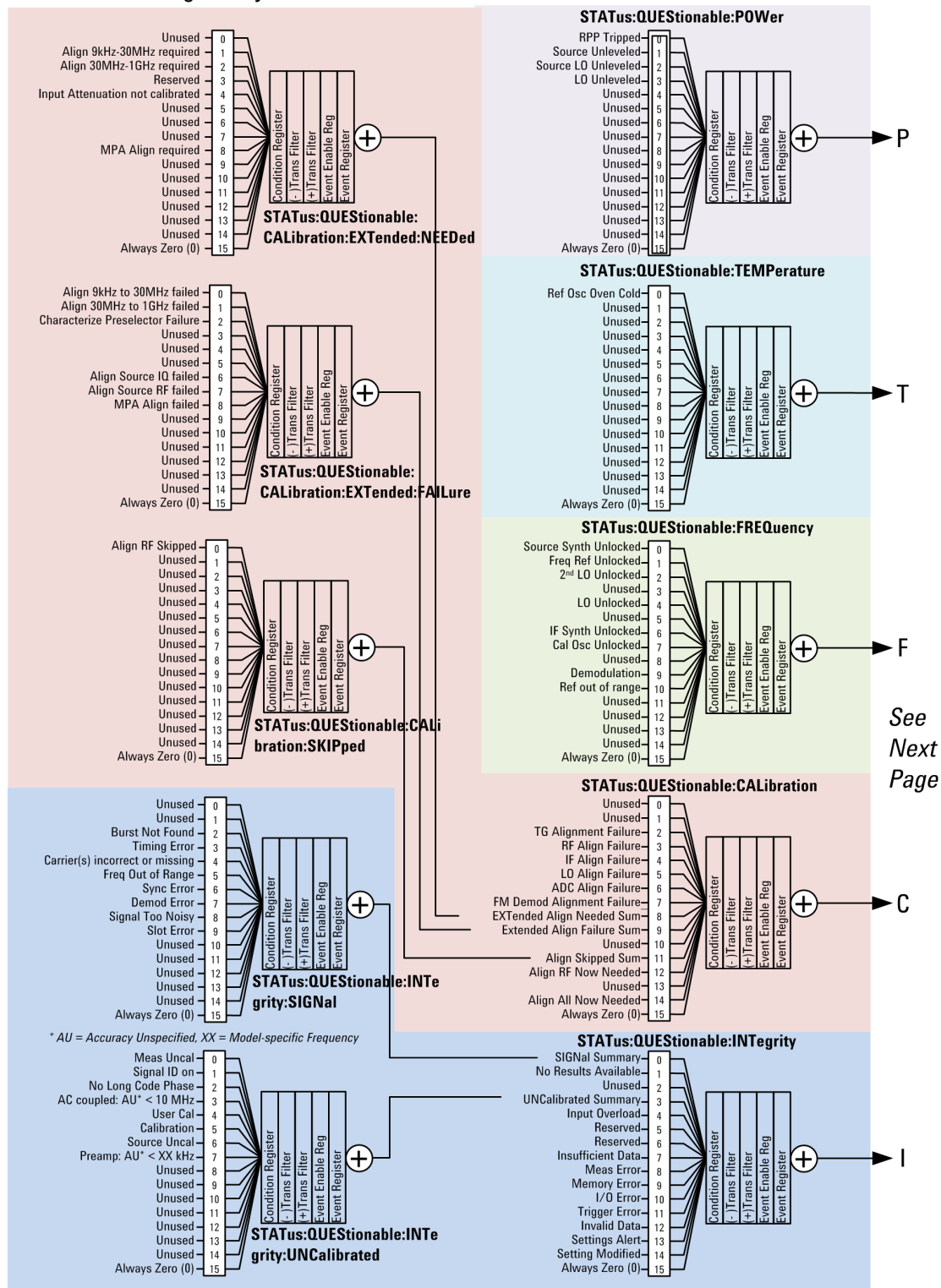



## X-Series Status Register System (2)

See  
Previous  
Page

P  
T  
F  
  
C  
I

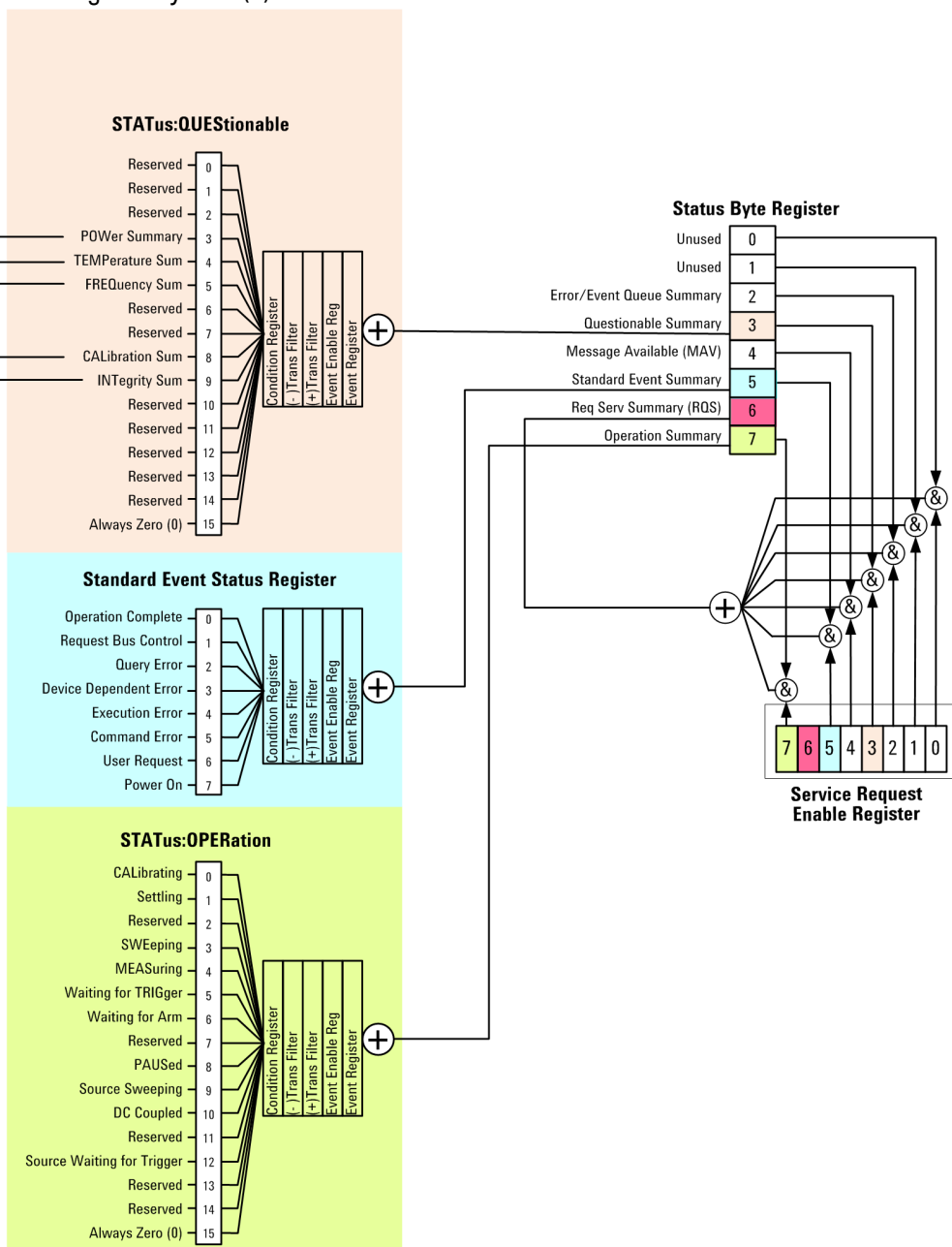

## Detailed Description

The STATUS subsystem remote commands set and query the status hardware registers. This system of registers monitors various events and conditions in the instrument. Software written to control the instrument may need to monitor some of these events and conditions.

### NOTE

All status register commands are sequential. Most commands can be started immediately and will overlap with any existing commands that are already running. This is not true of status commands. All the commands in the spectrum analyzer are assumed to be overlapped unless a command description specifically says that it is sequential.

## What Are Status Registers

The status system contains multiple registers that are arranged in a hierarchical order. The lower-level status registers propagate their data to the higher-level registers in the data structures by means of summary bits. The status byte register is at the top of the hierarchy and contains general status information for the instrument's events and conditions. All other individual registers are used to determine the specific events or conditions. For a diagram of the registers and their interconnections, see above.

The operation and questionable status registers are sets of registers that monitor the overall instrument condition. They are accessed with the STATus:OPERation and STATus:QUEStionable commands in the STATus command subsystem. Each register set is made up of five registers:

- Condition Register—It reports the real-time state of the signals monitored by this register set. There is no latching or buffering for a condition register.
- Positive Transition Register—This filter register controls which signals will set a bit in the event register when the signal makes a low to high transition (when the condition bit changes from 0 to 1).
- Negative Transition Register—This filter register controls which signals will set a bit in the event register when the signal makes a high to low transition (when the condition bit changes from 1 to 0).
- Event Register—It latches any signal state changes, in the way specified by the filter registers. Bits in the event register are never cleared by signal state changes. Event registers are cleared when read. They are also cleared by \*CLS and by presetting the instrument.
- Event Enable Register—It controls which of the bits, being set in the event register, will be summarized as a single output for the register set. Summary bits are then used by the next higher register.

The STATus:QUEStionable registers report abnormal operating conditions. The status register hierarchy is:

1. The summary outputs from the six STATus:QUEStionable:<keyword> detail registers are inputs to the STATus:QUEStionable register.
2. The summary output from the STATus:QUEStionable register is an input to the Status Byte Register. See the overall system in Figure at the beginning of this section.

The STATus:OPERation register set has no summarized inputs. The inputs to the STATus:OPERation:CONDition register indicate the real time state of the instrument. The STATus:OPERation:EVENT register summary output is an input to the Status Byte Register.

## What Are Status Register SCPI Commands

Most monitoring of the instrument conditions is done at the highest level using the IEEE common commands indicated below. Complete command descriptions are available in the IEEE commands section at the beginning of the language reference. Individual status registers can be set and queried using the commands in the STATus subsystem of the language reference.

- \*CLS (clear status) clears the status byte by emptying the error queue and clearing all the event registers.
- \*ESE, \*ESE? (event status enable) sets and queries the bits in the enable register part of the standard event status register.
- \*ESR? (event status register) queries and clears the event register part of the standard event status register.

- \*OPC, \*OPC? (operation complete) sets the standard event status register to monitor the completion of all commands. The query stops any new commands from being processed until the current processing is complete, then returns a '1'.
- \*PSC, \*PSC? (power-on state clear) sets the power-on state so that it clears the service request enable register and the event status enable register at power on.
- \*SRE, \*SRE? (service request enable) sets and queries the value of the service request enable register.
- \*STB? (status byte) queries the value of the status byte register without erasing its contents.

## How to Use the Status Registers

A program often needs to be able to detect and manage error conditions or changes in instrument status. There are two methods you can use to programmatically access the information in status registers:

- The polling method
- The service request (SRQ) method

In the polling method, the instrument has a passive role. It only tells the controller that conditions have changed when the controller asks the right question. In the SRQ method, the instrument takes a more active role. It tells the controller when there has been a condition change without the controller asking. Either method allows you to monitor one or more conditions.

The polling method works well if you do not need to know about changes the moment they occur. The SRQ method should be used if you must know immediately when a condition changes. To detect a change using the polling method, the program must repeatedly read the registers.

Use the SRQ method when:

- you need time-critical notification of changes
- you are monitoring more than one device which supports SRQs
- you need to have the controller do something else while waiting
- you can't afford the performance penalty inherent to polling

Use polling when:

- your programming language/development environment does not support SRQ interrupts
- you want to write a simple, single-purpose program and don't want the added complexity of setting up an SRQ handler
- To monitor a condition:
  - a. Determine which register contains the bit that reports the condition.
  - b. Send the unique SCPI query that reads that register.
  - c. Examine the bit to see if the condition has changed.

You can monitor conditions in different ways.

- Check the current instrument hardware and firmware status.

Do this by querying the condition registers which continuously monitor status. These registers represent the current state of the instrument. Bits in a condition register are updated in real time. When the condition monitored by a particular bit becomes true, the bit is set to 1. When the condition becomes false, the bit is reset to 0.

- Monitor a particular condition (bit).

You can enable a particular bit(s), using the event enable register. The instrument will then monitor that particular condition(s). If the bit becomes true (0 to 1 transition) in the event register, it will stay set until the event register is cleared. Querying the event register allows you to detect that this condition occurred even if the condition no longer exists. The event register can only be cleared by querying it or sending the \*CLS command.

- Monitor a particular type of change in a condition (bit).
  - The transition registers are preset to register if the condition goes from 0 to 1 (false to true, or a positive transition).
  - This can be changed so the selected condition is detected if the bit goes from 1 to 0 (true to false, or a negative transition).
  - It can also be set for both types of transitions occurring.
  - Or it can be set for neither transition. If both transition registers are set to 0 for a particular bit position, that bit will not be set in the event register for either type of change.

### Using a Status Register

Each bit in a register is represented by a numerical value based on its location. See figure below. This number is sent with the command to enable a particular bit. If you want to enable more than one bit, you would send the sum of all the bits that you want to monitor.

Figure: Status Register Bit Values

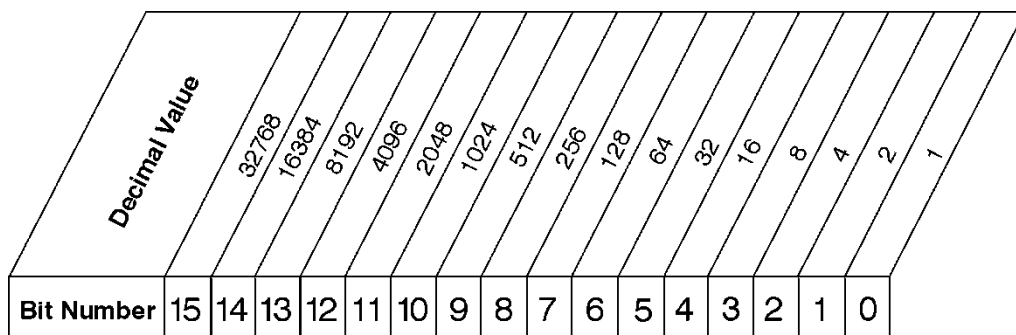

STATus:OPERation:ENABLE < num >  
 STATus:OPERation:ENABLE?

### Standard Operation Event Enable Register

ck730a

Bit 15 is not used to report status.

Example 1:

1. To enable bit 0 and bit 6 of standard event status register, you would send the command \*ESE 65 because 1 + 64 = 65.

2. The results of a query are evaluated in a similar way. If the \*STB? command returns a decimal value of 140, (140 = 128 + 8 + 4) then bit 7 is true, bit 3 is true and bit 2 is true.

Example 2:

1. Suppose you want to know if an Auto-trigger Timeout occurs, but you only cared about that specific condition. So you would want to know what was happening with bit 10 in the Status Questionable Integrity register, and not about any other bits.
2. It's usually a good idea to start by clearing all the status registers with \*CLS.
3. Sending the STAT:QUES:INT:ENAB 1024 command lets you monitor only bit 10 events, instead of the default monitoring all the bits in the register. The register default is for positive transition events (0 to 1 transition). That is, when an auto-trigger timeout occurs. If instead, you wanted to know when the Auto-trigger timeout condition is cleared, then you would set the STAT:QUES:INT:PTR 0 and the STAT:QUES:INT:NTR 32767.
4. So now the only output from the Status Questionable Integrity register will come from a bit 10 positive transition. That output goes to the Integrity Sum bit 9 of the Status Questionable register.
5. You can do a similar thing with this register to only look at bit 9 using, STAT:QUES:ENAB 512.
6. The Status Questionable register output goes to the "Status Questionable Summary" bit 3 of the Status Byte Register. The output from this register can be enabled using the \*SRE 8 command.
7. Finally, you would use the serial polling functionality available for the particular bus/software that you are using to monitor the Status Byte Register. (You could also use \*STB? to poll the Status Byte Register.)

### Using the Service Request (SRQ) Method

Your language, bus, and programming environment must be able to support SRQ interrupts. (For example, BASIC used with VXI-11.3 (GPIB over LAN). When you monitor a condition with the SRQ method, you must:

1. Determine which bit monitors the condition.
2. Determine how that bit reports to the request service (RQS) bit of the status byte.
3. Send SCPI commands to enable the bit that monitors the condition and to enable the summary bits that report the condition to the RQS bit.
4. Enable the controller to respond to service requests.

When the condition changes, the instrument sets its RQS bit. The controller is informed of the change as soon as it occurs. As a result, the time the controller would otherwise have used to monitor the condition can be used to perform other tasks. Your program determines how the controller responds to the SRQ.

### Generating a Service Request

To use the SRQ method, you must understand how service requests are generated. Bit 6 of the status byte register is the request service (RQS) bit. The \*SRE command is used to configure the RQS bit to report changes in instrument status. When such a change occurs, the RQS bit is set. It is cleared when the status byte register is queried using \*SRE? (with a serial poll.) It can be queried without erasing the contents with \*STB?.

When a register set causes a summary bit in the status byte to change from 0 to 1, the instrument can initiate the service request (SRQ) process. However, the process is only initiated if both of the following conditions are true:

- The corresponding bit of the service request enable register is also set to 1.
- The instrument does not have a service request pending. (A service request is considered to be pending between the time the instrument's SRQ process is initiated and the time the controller reads the status byte register.)

The SRQ process sets the SRQ true. It also sets the status byte's request service (RQS) bit to 1. Both actions are necessary to inform the controller that the instrument requires service. Setting the SRQ line only informs the controller that some device on the bus requires service. Setting the RQS bit allows the controller to determine which instrument requires service.

If your program enables the controller to detect and respond to service requests, it should instruct the controller to perform a serial poll when the SRQ is set true. Each device on the bus returns the contents of its status byte register in response to this poll. The device whose RQS bit is set to 1 is the device that requested service.

When you read the instrument's status byte register with a serial poll, the RQS bit is reset to 0. Other bits in the register are not affected.

If the status register is configured to SRQ on end-of-measurement and the measurement is in continuous mode, then restarting a measurement (INIT command) can cause the measuring bit to pulse low. This causes an SRQ when you have not actually reached the "end-of-measurement" condition. To avoid this:

1. Set INITiate:CONTinuous off.
2. Set/enable the status registers.
3. Restart the measurement (send INIT).

## Status Register System

The hardware status registers are combined to form the instrument status system. Specific status bits are assigned to monitor various aspects of the instrument operation and status. See the diagram of the status system above for information about the bit assignments and status register interconnections.

### The Status Byte Register

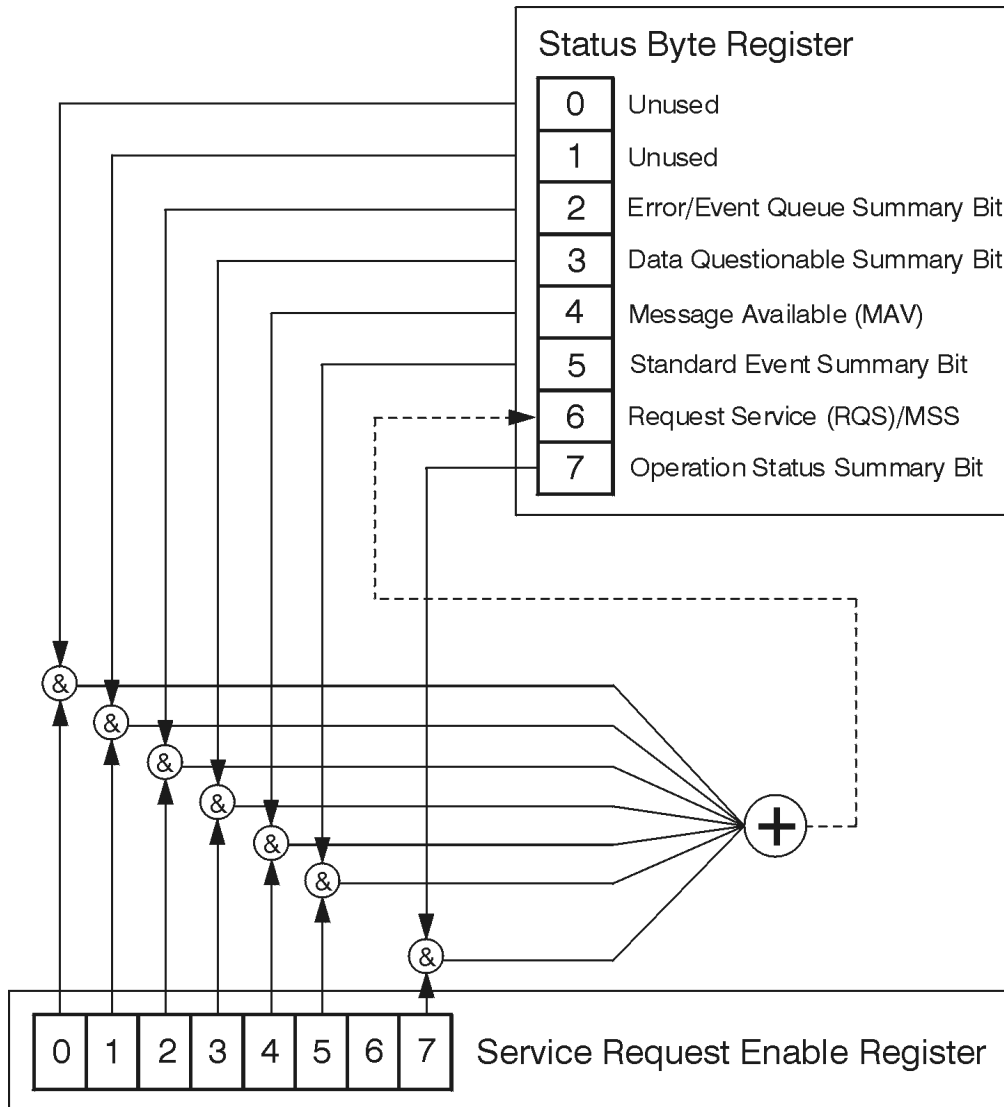

ck776a

The RQS bit is read and reset by a serial poll. The same bit position (MSS) is read, non-destructively by the \*STB? command. If you serial poll bit 6 it is read as RQS, but if you send \*STB it reads bit 6 as MSS. For more information refer to IEEE 488.2 standards, section 11.

Bit Number	7	6	5	4	3	2	1	0
Description	Standard Operation Status Summary Bit	Request Service (RQS) Summary Bit	Standard Event Status Summary Bit	Message Available (MAV)	Data Questionable Status Summary Bit	Error/Event Queue Summary Bit	Unused	Unused

\*STB?

**Status Byte Register**

ck725a

Bit	Description
0, 1	These bits are always set to 0.
2	A 1 in this bit position indicates that the SCPI error queue is not empty which means that it contains at least one error message.
3	A 1 in this bit position indicates that the data questionable summary bit has been set. The data questionable event register can then be read to determine the specific condition that caused this bit to be set.
4	A 1 in this bit position indicates that the instrument has data ready in the output queue. There are no lower status groups that provide input to this bit.
5	A 1 in this bit position indicates that the standard event summary bit has been set. The standard event status register can then be read to determine the specific event that caused this bit to be set.
6	A 1 in this bit position indicates that the instrument has at least one reason to report a status change. This bit is also called the master summary status bit (MSS).
7	A 1 in this bit position indicates that the standard operation summary bit has been set. The standard operation event register can then be read to determine the specific condition that caused this bit to be set.

To query the status byte register, send the command \*STB?. The response will be the decimal sum of the bits which are set to 1. For example, if bit number 7 and bit number 3 are set to 1, the decimal sum of the 2 bits is 128 plus 8. So the decimal value 136 is returned. The \*STB command does not clear the status register.

In addition to the status byte register, the status byte group also contains the service request enable register. This register lets you choose which bits in the status byte register will trigger a service request.

Send the \*SRE <integer> command where <integer> is the sum of the decimal values of the bits you want to enable plus the decimal value of bit 6. For example, assume that you want to enable bit 7 so that whenever the standard operation status register summary bit is set to 1 it will trigger a service request. Send the command \*SRE 192 (because 192 = 128 + 64). You must always add 64 (the numeric value of RQS



bit 6) to your numeric sum when you enable any bits for a service request. The command \*SRE? returns the decimal value of the sum of the bits previously enabled with the \*SRE <integer> command.

The service request enable register presets to zeros (0).

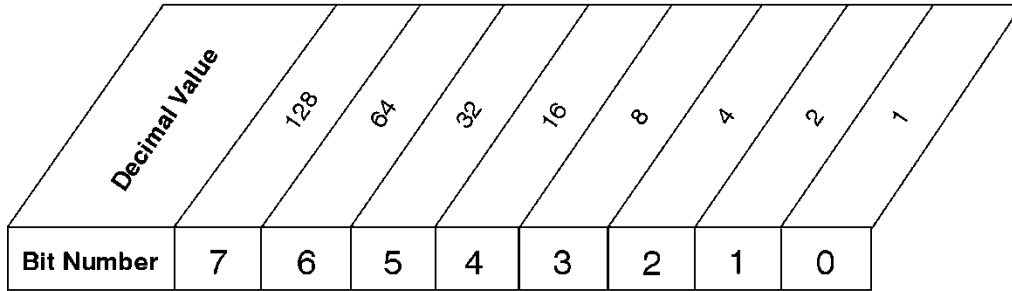

\*SRE <num>  
 \*SRE?

**Service Request Enable Register**

ck726a

**Standard Event Status Register**

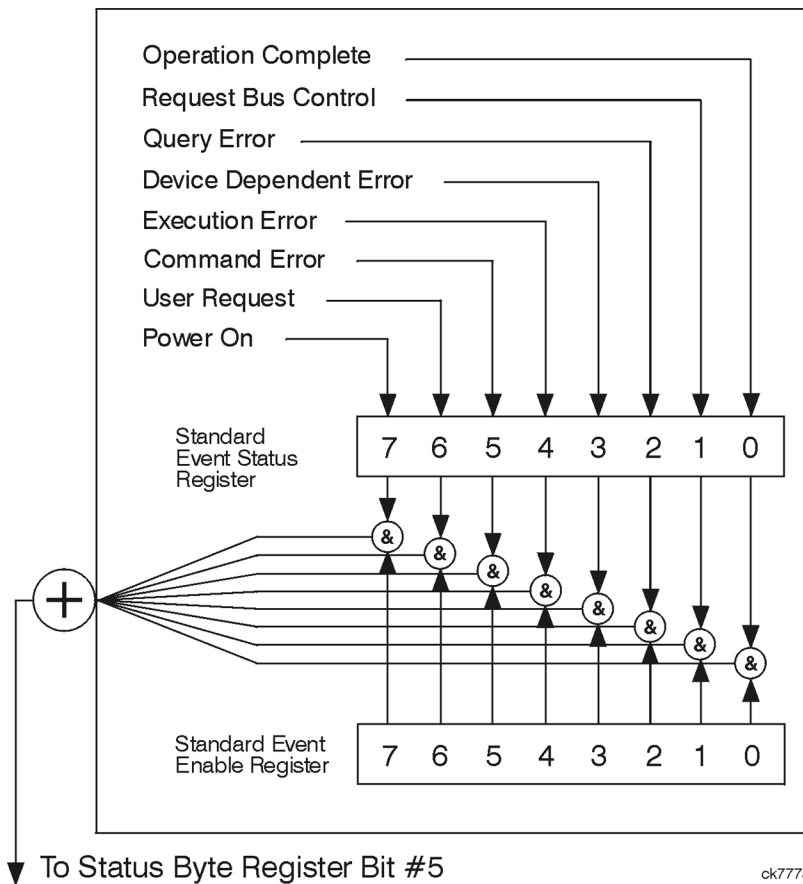

The standard event status register contains the following bits:

<b>Bit Number</b>	<b>7</b>	<b>6</b>	<b>5</b>	<b>4</b>	<b>3</b>	<b>2</b>	<b>1</b>	<b>0</b>	

\*ESR?

**Standard Event Status Register**

ck727a

Bit	Description
0	A 1 in this bit position indicates that all pending operations were completed following execution of the *OPC command.
1	This bit is for GPIB handshaking to request control. Currently it is set to 0 because there are no implementations where the spectrum analyzer controls another instrument.
2	A 1 in this bit position indicates that a query error has occurred. Query errors have SCPI error numbers from -499 to -400.
3	A 1 in this bit position indicates that a device dependent error has occurred. Device dependent errors have SCPI error numbers from -399 to -300 and 1 to 32767.
4	A 1 in this bit position indicates that an execution error has occurred. Execution errors have SCPI error numbers from -299 to -200.
5	A 1 in this bit position indicates that a command error has occurred. Command errors have SCPI error numbers from -199 to -100.
6	A 1 in this bit position indicates that the LOCAL key has been pressed. This is true even if the instrument is in local lockout mode.
7	A 1 in this bit position indicates that the instrument has been turned off and then on.

The standard event status register is used to determine the specific event that set bit 5 in the status byte register. To query the standard event status register, send the command \*ESR?. The response will be the decimal sum of the bits which are enabled (set to 1). For example, if bit number 7 and bit number 3 are enabled, the decimal sum of the 2 bits is 128 plus 8. So the decimal value 136 is returned.

In addition to the standard event status register, the standard event status group also contains a standard event status enable register. This register lets you choose which bits in the standard event status register will set the summary bit (bit 5 of the status byte register) to 1. Send the \*ESE <integer> command where <integer> is the sum of the decimal values of the bits you want to enable. For example, to enable bit 7 and bit 6 so that whenever either of those bits is set to 1, the standard event status summary bit of the status

byte register will be set to 1, send the command \*ESE 192 (128 + 64). The command \*ESE? returns the decimal value of the sum of the bits previously enabled with the \*ESE <integer> command.

The standard event status enable register presets to zeros (0).

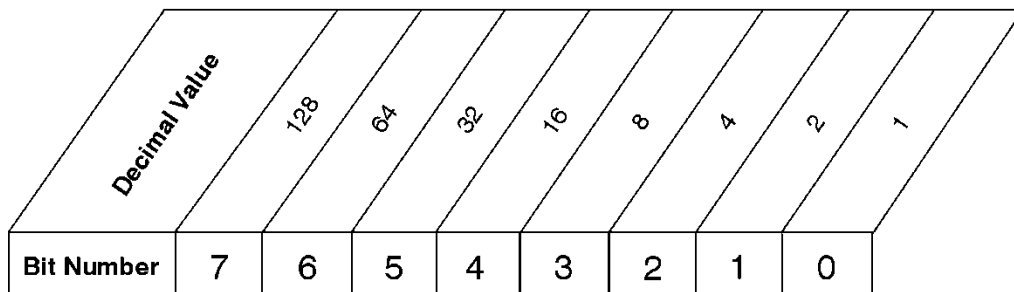

\*ESE <num>  
 \*ESE?

### Standard Event Status Enable Register

ck728a

### Operation and Questionable Status Registers

The operation and questionable status registers are registers that monitor the overall instrument condition. They are accessed with the STATUS:OPERation and STATUS:QUESTionable commands in the STATUS command subsystem. See the figure at the beginning of this chapter.

#### Operation Status Register

The operation status register monitors the current instrument measurement state. It checks to see if the instrument is calibrating, sweeping, or waiting for a trigger. For more information see the \*OPC? command located in the IEEE Common Commands section.

Bit	Condition	Operation
0	Calibrating	The instrument is busy executing its Align Now process
3	Sweeping	The instrument is busy taking a sweep.
4	Measuring	The instrument is busy making a measurement. Measurements often require multiple sweeps. They are initiated by keys under the MEASURE key or with the MEASURE group of commands. The bit is valid for most X-Series Modes.
5	Waiting for trigger	The instrument is waiting for the trigger conditions to be met, then it will trigger a sweep or measurement.

#### Questionable Status Register

The questionable status register monitors the instrument's condition to see if anything questionable has happened to it. It is looking for anything that might cause an error or a bad measurement like a hardware problem, an out of calibration situation, or a unusual signal. All the bits are summary bits from lower-level event registers.

Bit	Condition	Operation
-----	-----------	-----------

3	Power summary	The instrument hardware has detected a power unlevelled condition.
4	Temperature summary	The instrument is still warming up.
5	Frequency summary	The instrument hardware has detected an unlocked condition or a problem with the external frequency reference.
8	Calibration summary	The instrument has detected a hardware problem while doing the automatic internal alignment process.
9	Integrity summary	The instrument has detected a questionable measurement condition such as: bad timing, bad signal/data, timeout problem, signal overload, or "meas uncal".

### STATus Subsystem Command Descriptions

The STATus subsystem controls the SCPI-defined instrument status reporting structures. Each status register has a set of five commands used for querying or masking that particular register.

Numeric values for bit patterns can be entered using decimal or hexadecimal representations. (i.e. 0 to 32767 is equivalent to #H0 to #H7FFF. It is also equal to all ones, 11111111111111) See the SCPI Basics information about using bit patterns for variable parameters.

#### Operation Register

"Operation Condition Query" on page 164

"Operation Enable" on page 165

"Operation Event Query" on page 165

"Operation Negative Transition" on page 165

"Operation Positive Transition" on page 166

#### Operation Condition Query

This query returns the decimal value of the sum of the bits in the Status Operation Condition register.

**NOTE** The data in this register is continuously updated and reflects the current conditions.

Mode	All
<b>Remote Command</b>	:STATus:OPERation:CONDition?
<b>Example</b>	STAT:OPER:COND?
Preset	0
Status Bits/OPC dependencies	Sequential command
Initial S/W Revision	Prior to A.02.00

## Operation Enable

This command determines which bits in the Operation Event register, will set the Operation Status Summary bit (bit 7) in the Status Byte Register. The variable <integer> is the sum of the decimal values of the bits you want to enable.

**NOTE**

The preset condition is to have all bits in this enable register set to 0. To have any Operation Events reported to the Status Byte Register, one or more bits need to be set to 1.

Mode	All
<b>Remote Command</b>	:STATus:OPERation:ENABle <integer> :STATus:OPERation:ENABle?
<b>Example</b>	STAT:OPER:ENAB 1 Sets the register so that Align Now operation will be reported to the Status Byte Register.
Preset	0
Min	0
Max	32767
Status Bits/OPC dependencies	Sequential command
Initial S/W Revision	Prior to A.02.00

## Operation Event Query

This query returns the decimal value of the sum of the bits in the Operation Event register.

**NOTE**

The register requires that the associated PTR or NTR filters be set before a condition register bit can set a bit in the event register. The data in this register is latched until it is queried. Once queried, the register is cleared.

Mode	All
<b>Remote Command</b>	:STATus:OPERation[:EVENT]?
<b>Example</b>	STAT:OPER?
Preset	0
Status Bits/OPC dependencies	Sequential command
Initial S/W Revision	Prior to A.02.00

## Operation Negative Transition

This command determines which bits in the Operation Condition register will set the corresponding bit in the Operation Event register when the condition register bit has a negative transition (1 to 0). The variable <integer> is the sum of the decimal values of the bits that you want to enable.

Mode	All
<b>Remote Command</b>	:STATus:OPERation:NTRansition <integer> :STATus:OPERation:NTRansition?
<b>Example</b>	STAT:OPER:NTR 1 Align Now operation complete will be reported to the Status Byte Register.
Preset	0
Min	0
Max	32767
Status Bits/OPC dependencies	Sequential command
Initial S/W Revision	Prior to A.02.00

### Operation Positive Transition

This command determines which bits in the Operation Condition register will set the corresponding bit in the Operation Event register when the condition register bit has a positive transition (0 to 1). The variable <integer> is the sum of the decimal values of the bits that you want to enable.

Mode	All
<b>Remote Command</b>	:STATus:OPERation:PTRansition <integer> :STATus:OPERation:PTRansition?
<b>Example</b>	STAT:OPER:PTR 1 Align Now operation beginning will be reported to the Status Byte Register.
Preset	32767
Min	0
Max	32767
Status Bits/OPC dependencies	Sequential command
Initial S/W Revision	Prior to A.02.00

### Preset the Status Byte

Sets bits in most of the enable and transition registers to their default state. It presets all the Transition Filters, Enable Registers, and the Error/Event Queue Enable. It has no effect on Event Registers, Error/Event QUEUE, IEEE 488.2 ESE, and SRE Registers as described in IEEE Standard 488.2–1992, IEEE Standard Codes, Formats, Protocols, and Common Commands for Use with ANSI/IEEE Std 488.1–1987. New York, NY, 1992.

<b>Remote Command</b>	:STATus:PRESet
<b>Example</b>	STAT:PRES
Initial S/W Revision	Prior to A.02.00

## Questionable Register

"Questionable Condition " on page 167

"Questionable Enable " on page 167

"Questionable Event Query " on page 168

"Questionable Negative Transition " on page 168

"Questionable Positive Transition" on page 168

## Questionable Condition

This query returns the decimal value of the sum of the bits in the Questionable Condition register.

**NOTE**

The data in this register is continuously updated and reflects the current conditions.

Mode	All
<b>Remote Command</b>	:STATus:QUEStionable:CONDition?
<b>Example</b>	STAT:QUES:COND?
Preset	0
Status Bits/OPC dependencies	Sequential command
Initial S/W Revision	Prior to A.02.00

## Questionable Enable

This command determines which bits in the Questionable Event register will set the Questionable Status Summary bit (bit3) in the Status Byte Register. The variable <integer> is the sum of the decimal values of the bits you want to enable.

**NOTE**

The preset condition is all bits in this enable register set to 0. To have any Questionable Events reported to the Status Byte Register, one or more bits need to be set to 1. The Status Byte Event Register should be queried after each measurement to check the Questionable Status Summary (bit 3). If it is equal to 1, a condition during the test may have made the test results invalid. If it is equal to 0, this indicates that no hardware problem or measurement problem was detected by the analyzer.

Mode	All
<b>Remote Command</b>	:STATus:QUEStionable:ENABle <integer> :STATus:QUEStionable:ENABle?
<b>Example</b>	STAT:OPER:PTR 1 Align Now operation beginning will be reported to the Status Byte Register.
Preset	0
Min	0
Max	32767
Status Bits/OPC dependencies	Sequential command
Initial S/W Revision	Prior to A.02.00

### Questionable Event Query

This query returns the decimal value of the sum of the bits in the Questionable Event register.

**NOTE** The register requires that the associated PTR or NTR filters be set before a condition register bit can set a bit in the event register. The data in this register is latched until it is queried. Once queried, the register is cleared.

Mode	All
<b>Remote Command</b>	:STATus:QUEStionable[:EVENT]?
<b>Example</b>	STAT:QUES?
Preset	0
Status Bits/OPC dependencies	Sequential command
Initial S/W Revision	Prior to A.02.00

### Questionable Negative Transition

This command determines which bits in the Questionable Condition register will set the corresponding bit in the Questionable Event register when the condition register bit has a negative transition (1 to 0). The variable <integer> is the sum of the decimal values of the bits that you want to enable.

Mode	All
<b>Remote Command</b>	:STATus:QUEStionable:NTRansition <integer> :STATus:QUEStionable:NTRansition?
<b>Example</b>	STAT:QUES:NTR 16 Temperature summary 'questionable cleared' will be reported to the Status Byte Register.
Preset	0
Min	0
Max	32767
Status Bits/OPC dependencies	Sequential command
Initial S/W Revision	Prior to A.02.00

### Questionable Positive Transition

This command determines which bits in the Questionable Condition register will set the corresponding bit in the Questionable Event register when the condition register bit has a positive transition (0 to 1). The variable <integer> is the sum of the decimal values of the bits that you want to enable.

Mode	All
------	-----



<b>Remote Command</b>	:STATus:QUESTionable:PTRansition <integer> :STATus:QUESTionable:PTRansition?
<b>Example</b>	STAT:QUES:PTR 16 Temperature summary 'questionable asserted' will be reported to the Status Byte Register.
Preset	32767
Min	0
Max	32767
Status Bits/OPC dependencies	Sequential command
Initial S/W Revision	Prior to A.02.00

## Questionable Calibration Register

"Questionable Calibration Condition " on page 169

"Questionable Calibration Enable " on page 169

"Questionable Calibration Event Query " on page 170

"Questionable Calibration Negative Transition " on page 170

"Questionable Calibration Positive Transition " on page 171

## Questionable Calibration Condition

This query returns the decimal value of the sum of the bits in the Questionable Calibration Condition register.

**NOTE** The data in this register is continuously updated and reflects the current conditions.

Mode	All
<b>Remote Command</b>	:STATus:QUESTionable:CALibration:CONDition?
<b>Example</b>	STAT:QUES:CAL:COND?
Preset	0
Status Bits/OPC dependencies	Sequential command
Initial S/W Revision	Prior to A.02.00

## Questionable Calibration Enable

This command determines which bits in the Questionable Calibration Condition Register will set bits in the Questionable Calibration Event register, which also sets the Calibration Summary bit (bit 8) in the Questionable Register. The variable <integer> is the sum of the decimal values of the bits you want to enable.

Mode	All
<b>Remote Command</b>	:STATus:QUESTionable:CALibration:ENABle <integer> :STATus:QUESTionable:CALibration:ENABle?
<b>Example</b>	STAT:QUES:CAL:ENAB 16384 Can be used to query if an alignment is needed, if you have turned off the automatic alignment process.
Min	0
Max	32767
Status Bits/OPC dependencies	Sequential command
Initial S/W Revision	Prior to A.02.00

### Questionable Calibration Event Query

This query returns the decimal value of the sum of the bits in the Questionable Calibration Event register.

**NOTE**

The register requires that the associated PTR or NTR filters be set before a condition register bit can set a bit in the event register. The data in this register is latched until it is queried. Once queried, the register is cleared.

Mode	All
<b>Remote Command</b>	:STATus:QUESTionable:CALibration[:EVENT]?
<b>Example</b>	STAT:QUES:CAL?
Preset	0
Status Bits/OPC dependencies	Sequential command
Initial S/W Revision	Prior to A.02.00

### Questionable Calibration Negative Transition

This command determines which bits in the Questionable Calibration Condition register will set the corresponding bit in the Questionable Calibration Event register when the condition register bit has a negative transition (1 to 0). The variable <integer> is the sum of the decimal values of the bits that you want to enable.

Mode	All
<b>Remote Command</b>	:STATus:QUESTionable:CALibration:NTRansition <integer> :STATus:QUESTionable:CALibration:NTRansition?
<b>Example</b>	STAT:QUES:CAL:NTR 16384 Alignment is not required.
Preset	0
Min	0

Max	32767
Status Bits/OPC dependencies	Sequential command
Initial S/W Revision	Prior to A.02.00

### Questionable Calibration Positive Transition

This command determines which bits in the Questionable Calibration Condition register will set the corresponding bit in the Questionable Calibration Event register when the condition register bit has a positive transition (0 to 1). The variable <integer> is the sum of the decimal values of the bits that you want to enable.

Mode	All
<b>Remote Command</b>	:STATus:QUESTionable:CALibration:PTRansition <integer> :STATus:QUESTionable:CALibration:PTRansition?
<b>Example</b>	STAT:QUES:CAL:PTR 16384 Alignment is required.
Preset	32767
Min	0
Max	32767
Status Bits/OPC dependencies	Sequential command
Initial S/W Revision	Prior to A.02.00

### Questionable Calibration Skipped Register

"Questionable Calibration Skipped Condition " on page 171

"Questionable Calibration Skipped Enable " on page 172

"Questionable Calibration Skipped Event Query " on page 172

"Questionable Calibration Skipped Negative Transition " on page 173

"Questionable Calibration Skipped Positive Transition " on page 173

### Questionable Calibration Skipped Condition

This query returns the decimal value of the sum of the bits in the Questionable Calibration Skipped Condition register.

**NOTE** The data in this register is continuously updated and reflects the current conditions.

Mode	All
<b>Remote Command</b>	:STATus:QUESTionable:CALibration:SKIpped:CONDition?

<b>Example</b>	STAT:QUES:CAL:SKIP:COND?
Preset	0
Status Bits/OPC dependencies	Sequential command
Initial S/W Revision	Prior to A.02.00

### Questionable Calibration Skipped Enable

This command determines which bits in the Questionable Calibration Skipped Condition Register will set bits in the Questionable Calibration Skipped Event register, which also sets bit 11 of the Questionable Calibration Register. The variable <integer> is the sum of the decimal values of the bits you want to enable.

Mode	All
<b>Remote Command</b>	:STATus:QUESTionable:CALibration:SKIpped:ENABle <integer> :STATus:QUESTionable:CALibration:SKIpped:ENABle?
<b>Example</b>	STAT:QUES:CAL:SKIP:ENAB 1 Can be used to query if an EMI alignment skipped condition is detected
Preset	32767
Min	0
Max	32767
Status Bits/OPC dependencies	Sequential command
Initial S/W Revision	Prior to A.02.00

### Questionable Calibration Skipped Event Query

This query returns the decimal value of the sum of the bits in the Questionable Calibration Event register.

**NOTE**

The register requires that the associated PTR or NTR filters be set before a condition register bit can set a bit in the event register. The data in this register is latched until it is queried. Once queried, the register is cleared.

Mode	All
<b>Remote Command</b>	:STATus:QUESTionable:CALibration:SKIpped[:EVENT]?
<b>Example</b>	STAT:QUES:CAL:SKIP?
Preset	0
Status Bits/OPC dependencies	Sequential command
Initial S/W Revision	Prior to A.02.00

### Questionable Calibration Skipped Negative Transition

This command determines which bits in the Questionable Calibration Skipped Condition register will set the corresponding bit in the Questionable Calibration Skipped Event register when the condition register bit has a negative transition (1 to 0). The variable <integer> is the sum of the decimal values of the bits that you want to enable.

Mode	All
<b>Remote Command</b>	:STATus:QUEStionable:CALibration:SKIPped:NTRansition <integer> :STATus:QUEStionable:CALibration:SKIPped:NTRansition?
<b>Example</b>	STAT:QUES:CAL:SKIP:NTR 1 Align RF skipped is not required.
Preset	0
Min	0
Max	32767
Status Bits/OPC dependencies	Sequential command
Initial S/W Revision	Prior to A.02.00

### Questionable Calibration Skipped Positive Transition

This command determines which bits in the Questionable Calibration Skipped Condition register will set the corresponding bit in the Questionable Calibration Skipped Event register when the condition register bit has a positive transition (0 to 1). The variable <integer> is the sum of the decimal values of the bits that you want to enable.

Mode	All
<b>Remote Command</b>	:STATus:QUEStionable:CALibration:SKIPped:PTRansition <integer> :STATus:QUEStionable:CALibration:SKIPped:PTRansition?
<b>Example</b>	STAT:QUES:CAL:SKIP:PTR 1 Align RF skipped is required.
Preset	32767
Min	0
Max	32767
Status Bits/OPC dependencies	Sequential command
Initial S/W Revision	Prior to A.02.00

### Questionable Calibration Extended Failure Register

["Questionable Calibration Extended Failure Condition " on page 174](#)

["Questionable Calibration Extended Failure Enable " on page 174](#)

["Questionable Calibration Extended Failure Event Query " on page 174](#)

["Questionable Calibration Extended Failure Negative Transition " on page 175](#)

"Questionable Calibration Extended Failure Positive Transition " on page 175

### Questionable Calibration Extended Failure Condition

This query returns the decimal value of the sum of the bits in the Questionable Calibration Extended Failure Condition register.

**NOTE** The data in this register is continuously updated and reflects the current conditions.

Mode	All
<b>Remote Command</b>	:STATus:QUESTionable:CALibration:EXTended:FAILure:CONDition?
<b>Example</b>	STAT:QUES:CAL:EXT:FAIL:COND?
Preset	0
Status Bits/OPC dependencies	Sequential command
Initial S/W Revision	Prior to A.02.00

### Questionable Calibration Extended Failure Enable

This command determines which bits in the Questionable Calibration Extended Failure Condition Register will set bits in the Questionable Calibration Extended Failure Event register, which also sets bit 9 of the Questionable Calibration Register. The variable <integer> is the sum of the decimal values of the bits you want to enable.

Mode	All
<b>Remote Command</b>	:STATus:QUESTionable:CALibration:EXTended:FAILure:ENABle <integer> :STATus:QUESTionable:CALibration:EXTended:FAILure:ENABle?
<b>Example</b>	STAT:QUES:CAL:EXT:FAIL:ENAB 1 Can be used to query if an EMI conducted alignment is needed.
Preset	32767
Min	0
Max	32767
Status Bits/OPC dependencies	Sequential command
Initial S/W Revision	Prior to A.02.00

### Questionable Calibration Extended Failure Event Query

This query returns the decimal value of the sum of the bits in the Questionable Calibration Extended Failure Event register.

**NOTE** The register requires that the associated PTR or NTR filters be set before a condition register bit can set a bit in the event register. The data in this register is latched until it is queried. Once queried, the register is cleared.

Mode	All
<b>Remote Command</b>	:STATus:QUESTionable:CALibration:EXTended:FAILure[:EVENT]?
<b>Example</b>	STAT:QUES:CAL:EXT:FAIL?
Preset	0
Status Bits/OPC dependencies	Sequential command
Initial S/W Revision	Prior to A.02.00

### Questionable Calibration Extended Failure Negative Transition

This command determines which bits in the Questionable Calibration Extended Failure Condition register will set the corresponding bit in the Questionable Calibration Extended Failure Event register when the condition register bit has a negative transition (1 to 0). The variable <integer> is the sum of the decimal values of the bits that you want to enable.

Mode	All
<b>Remote Command</b>	:STATus:QUESTionable:CALibration:EXTended:FAILure:NTRansition <integer> :STATus:QUESTionable:CALibration:EXTended:FAILure:NTRansition?
<b>Example</b>	STAT:QUES:CAL:EXT:FAIL:NTR 1 EMI conducted align failure is not required.
Preset	0
Min	0
Max	32767
Status Bits/OPC dependencies	Sequential command
Initial S/W Revision	Prior to A.02.00

### Questionable Calibration Extended Failure Positive Transition

This command determines which bits in the Questionable Calibration Extended Failure Condition register will set the corresponding bit in the Questionable Calibration Extended Failure Event register when the condition register bit has a positive transition (0 to 1). The variable <integer> is the sum of the decimal values of the bits that you want to enable.

Mode	All
<b>Remote Command</b>	:STATus:QUESTionable:CALibration:EXTended:FAILure:PTRansition <integer> :STATus:QUESTionable:CALibration:EXTended:FAILure:PTRansition?
<b>Example</b>	STAT:QUES:CAL:EXT:FAIL:PTR 1 EMI conducted align failure is required.
Preset	32767
Min	0
Max	32767

Status Bits/OPC dependencies	Sequential command
Initial S/W Revision	Prior to A.02.00

### Questionable Calibration Extended Needed Register

"Questionable Calibration Extended Needed Condition " on page 176

"Questionable Calibration Extended Needed Enable " on page 176

"Questionable Calibration Extended Needed Event Query " on page 177

"Questionable Calibration Extended Needed Negative Transition " on page 177

"Questionable Calibration Extended Needed Positive Transition " on page 178

### Questionable Calibration Extended Needed Condition

This query returns the decimal value of the sum of the bits in the Questionable Calibration Extended Needed Condition register.

**NOTE** The data in this register is continuously updated and reflects the current conditions.

Mode	All
Remote Command	:STATus:QUESTionable:CALibration:EXTended:NEEDed:CONDition?
Example	STAT:QUES:CAL:EXT:NEED:COND?
Preset	0
Status Bits/OPC dependencies	Sequential command
Initial S/W Revision	Prior to A.02.00

### Questionable Calibration Extended Needed Enable

This command determines which bits in the Questionable Calibration Extended Needed Condition Register will set bits in the Questionable Calibration Extended Needed Event register, which also sets bit 14 of the Questionable Calibration Register. The variable <integer> is the sum of the decimal values of the bits you want to enable.

Mode	All
Remote Command	:STATus:QUESTionable:CALibration:EXTended:NEEDed:ENABle <integer> :STATus:QUESTionable:CALibration:EXTended:NEEDed:ENABle?
Example	STAT:QUES:CAL:EXT:NEED:ENAB 2 Can be used to query if an EMI conducted alignment is needed.
Preset	32767
Min	0



Max	32767
Status Bits/OPC dependencies	Sequential command
Initial S/W Revision	Prior to A.02.00

### Questionable Calibration Extended Needed Event Query

This query returns the decimal value of the sum of the bits in the Questionable Calibration Extended Needed Event register.

**NOTE**

The register requires that the associated PTR or NTR filters be set before a condition register bit can set a bit in the event register. The data in this register is latched until it is queried. Once queried, the register is cleared.

Mode	All
<b>Remote Command</b>	:STATus:QUESTionable:CALibration:EXTended:NEEDED[:EVENT]?
<b>Example</b>	STAT:QUES:CAL:EXT:NEED?
Preset	0
Status Bits/OPC dependencies	Sequential command
Initial S/W Revision	Prior to A.02.00

### Questionable Calibration Extended Needed Negative Transition

This command determines which bits in the Questionable Calibration Extended Needed Condition register will set the corresponding bit in the Questionable Calibration Extended Needed Event register when the condition register bit has a negative transition (1 to 0). The variable <integer> is the sum of the decimal values of the bits that you want to enable.

Mode	All
<b>Remote Command</b>	:STATus:QUESTionable:CALibration:EXTended:NEEDED:NTRansition <integer> :STATus:QUESTionable:CALibration:EXTended:NEEDED:NTRansition?
<b>Example</b>	STAT:QUES:CAL:EXT:NEED:NTR 2 Align EMI conducted is not required.
Preset	0
Min	0
Max	32767
Status Bits/OPC dependencies	Sequential command
Initial S/W Revision	Prior to A.02.00

### Questionable Calibration Extended Needed Positive Transition

This command determines which bits in the Questionable Calibration Extended Needed Condition register will set the corresponding bit in the Questionable Calibration Extended Needed Event register when the condition register bit has a positive transition (0 to 1). The variable <integer> is the sum of the decimal values of the bits that you want to enable.

Mode	All
<b>Remote Command</b>	:STATus:QUESTionable:CALibration:EXTended:NEEDed:PTRansition <integer> :STATus:QUESTionable:CALibration:EXTended:NEEDed:PTRansition?
<b>Example</b>	STAT:QUES:CAL:EXT:NEED:PTR 2 Align EMI conducted is required.
Preset	32767
Min	0
Max	32767
Status Bits/OPC dependencies	Sequential command
Initial S/W Revision	Prior to A.02.00

### Questionable Frequency Register

"Questionable Frequency Condition " on page 178

"Questionable Frequency Enable " on page 179

"Questionable Frequency Event Query " on page 179

"Questionable Frequency Negative Transition " on page 179

"Questionable Frequency Positive Transition " on page 180

### Questionable Frequency Condition

This query returns the decimal value of the sum of the bits in the Questionable Frequency Condition register.

**NOTE**

The data in this register is continuously updated and reflects the current conditions.

Mode	All
<b>Remote Command</b>	:STATus:QUESTionable:FREQuency:CONDition?
<b>Example</b>	STAT:QUES:FREQ:COND?
Preset	0
Status Bits/OPC dependencies	Sequential command
Initial S/W Revision	Prior to A.02.00

### Questionable Frequency Enable

This command determines which bits in the Questionable Frequency Condition Register will set bits in the Questionable Frequency Event register, which also sets the Frequency Summary bit (bit 5) in the Questionable Register. The variable <integer> is the sum of the decimal values of the bits you want to enable.

Mode	All
<b>Remote Command</b>	:STATus:QUEStionable:FREQuency:ENABle <integer> :STATus:QUEStionable:FREQuency:ENABle?
<b>Example</b>	STAT:QUES:FREQ:ENAB 2 Frequency Reference Unlocked will be reported to the Frequency Summary of the Status Questionable register.
Preset	32767
Min	0
Max	32767
Status Bits/OPC dependencies	Sequential command
Initial S/W Revision	Prior to A.02.00

### Questionable Frequency Event Query

This query returns the decimal value of the sum of the bits in the Questionable Frequency Event register.

**NOTE**

The register requires that the associated PTR or NTR filters be set before a condition register bit can set a bit in the event register. The data in this register is latched until it is queried. Once queried, the register is cleared.

Mode	All
<b>Remote Command</b>	:STATus:QUEStionable:FREQuency[:EVENT]?
<b>Example</b>	STAT:QUES:FREQ?
Preset	0
Status Bits/OPC dependencies	Sequential command
Initial S/W Revision	Prior to A.02.00

### Questionable Frequency Negative Transition

This command determines which bits in the Questionable Frequency Condition register will set the corresponding bit in the Questionable Frequency Event register when the condition register bit has a negative transition (1 to 0). The variable <integer> is the sum of the decimal values of the bits that you want to enable.

Mode	All
------	-----

<b>Remote Command</b>	:STATus:QUESTionable:FREQuency:NTRansition <integer> :STATus:QUESTionable:FREQuency:NTRansition?
<b>Example</b>	STAT:QUES:FREQ:NTR 2 Frequency Reference 'regained lock' will be reported to the Frequency Summary of the Status Questionable register.
Preset	0
Min	0
Max	32767
Status Bits/OPC dependencies	Sequential command
Initial S/W Revision	Prior to A.02.00

### Questionable Frequency Positive Transition

This command determines which bits in the Questionable Frequency Condition register will set the corresponding bit in the Questionable Frequency Event register when the condition register bit has a positive transition (0 to 1). The variable <integer> is the sum of the decimal values of the bits that you want to enable.

Mode	All
<b>Remote Command</b>	:STATus:QUESTionable:FREQuency:PTRansition <integer> :STATus:QUESTionable:FREQuency:PTRansition?
<b>Example</b>	STAT:QUES:FREQ:PTR 2 Frequency Reference 'became unlocked' will be reported to the Frequency Summary of the Status Questionable register.
Preset	32767
Min	0
Max	32767
Status Bits/OPC dependencies	Sequential command
Initial S/W Revision	Prior to A.02.00

### Questionable Integrity Register

"Questionable Integrity Condition " on page 180

"Questionable Integrity Enable " on page 181

"Questionable Integrity Event Query " on page 181

"Questionable Integrity Negative Transition " on page 182

"Questionable Integrity Positive Transition " on page 182

### Questionable Integrity Condition

This query returns the decimal value of the sum of the bits in the Questionable Integrity Condition register.

**NOTE**

The data in this register is continuously updated and reflects the current conditions.

Mode	All
<b>Remote Command</b>	:STATus:QUESTionable:INTEgrity:CONDition?
<b>Example</b>	STAT:QUES:INT:COND?
Preset	0
Status Bits/OPC dependencies	Sequential command
Initial S/W Revision	Prior to A.02.00

### Questionable Integrity Enable

This command determines which bits in the Questionable Integrity Condition Register will set bits in the Questionable Integrity Event register, which also sets the Integrity Summary bit (bit 9) in the Questionable Register. The variable <integer> is the sum of the decimal values of the bits you want to enable.

Mode	All
<b>Remote Command</b>	:STATus:QUESTionable:INTEgrity:ENABle <integer> :STATus:QUESTionable:INTEgrity:ENABle?
<b>Example</b>	STAT:QUES:INT:ENAB 8 Measurement Uncalibrated Summary will be reported to the Integrity Summary of the Status Questionable register.
Preset	32767
Min	0
Max	32767
Status Bits/OPC dependencies	Sequential command
Initial S/W Revision	Prior to A.02.00

### Questionable Integrity Event Query

This query returns the decimal value of the sum of the bits in the Questionable Integrity Event register.

**NOTE**

The register requires that the associated PTR or NTR filters be set before a condition register bit can set a bit in the event register. The data in this register is latched until it is queried. Once queried, the register is cleared.

Mode	All
<b>Remote Command</b>	:STATus:QUESTionable:INTEgrity[:EVENT]?
<b>Example</b>	STAT:QUES:INT?
Preset	0
Status Bits/OPC dependencies	Sequential command
Initial S/W Revision	Prior to A.02.00

### Questionable Integrity Negative Transition

This command determines which bits in the Questionable Integrity Condition register will set the corresponding bit in the Questionable Integrity Event register when the condition register bit has a negative transition (1 to 0)

The variable <integer> is the sum of the decimal values of the bits that you want to enable.

<b>Mode</b>	All
<b>Remote Command</b>	:STATus:QUEStionable:INTEgrity:NTRansition <integer> :STATus:QUEStionable:INTEgrity:NTRansition?
<b>Example</b>	STAT:QUES:INT:NTR 8 Measurement 'regained calibration' Summary will be reported to the Integrity Summary of the Status Questionable register.
Preset	0
Min	0
Max	32767
Status Bits/OPC dependencies	Sequential command
Initial S/W Revision	Prior to A.02.00

### Questionable Integrity Positive Transition

This command determines which bits in the Questionable Integrity Condition register will set the corresponding bit in the Questionable Integrity Event register when the condition register bit has a positive transition (0 to 1). The variable <integer> is the sum of the decimal values of the bits that you want to enable.

<b>Mode</b>	All
<b>Remote Command</b>	:STATus:QUEStionable:INTEgrity:PTRansition <integer> :STATus:QUEStionable:INTEgrity:PTRansition?
<b>Example</b>	STAT:QUES:INT:PTR 8 Measurement 'became uncalibrated' Summary will be reported to the Integrity Summary of the Status Questionable register.
Preset	32767
Min	0
Max	32767
Status Bits/OPC dependencies	Sequential command
Initial S/W Revision	Prior to A.02.00

### Questionable Integrity Signal Register

"Questionable Integrity Signal Condition" on page 183

"Questionable Integrity Signal Enable" on page 183

"Questionable Integrity Signal Event Query" on page 184

"Questionable Integrity Signal Negative Transition" on page 184

"Questionable Integrity Signal Positive Transition" on page 184

### Questionable Integrity Signal Condition

This query returns the decimal value of the sum of the bits in the Questionable Integrity Signal Condition register.

**NOTE** The data in this register is continuously updated and reflects the current conditions.

Mode	All
<b>Remote Command</b>	:STATus:QUEStionable:INTEgrity:SIGNal:CONDition?
<b>Example</b>	STAT:QUES:INT:SIGN:COND?
Preset	0
Status Bits/OPC dependencies	Sequential command
Initial S/W Revision	Prior to A.02.00

### Questionable Integrity Signal Enable

This command determines which bits in the Questionable Integrity Signal Condition Register will set bits in the Questionable Integrity Signal Event register, which also sets the Integrity Summary bit (bit 9) in the Questionable Register. The variable <integer> is the sum of the decimal values of the bits you want to enable.

Mode	All
<b>Remote Command</b>	:STATus:QUEStionable:INTEgrity:SIGNal:ENABle <integer> :STATus:QUEStionable:INTEgrity:SIGNal:ENABle?
<b>Example</b>	STAT:QUES:INT:SIGN:ENAB 4 Burst Not Found will be reported to the Integrity Summary of the Status Questionable register.
Preset	32767
Min	0
Max	32767
Status Bits/OPC dependencies	Sequential command
Initial S/W Revision	Prior to A.02.00

### Questionable Integrity Signal Event Query

This query returns the decimal value of the sum of the bits in the Questionable Integrity Signal Event register.

**NOTE**

The register requires that the associated PTR or NTR filters be set before a condition register bit can set a bit in the event register. The data in this register is latched until it is queried. Once queried, the register is cleared.

Mode	All
<b>Remote Command</b>	:STATus:QUESTionable:INTEgrity:SIGNal[:EVENT]?
<b>Example</b>	STAT:QUES:INT:SIGN?
Preset	0
Status Bits/OPC dependencies	Sequential command
Initial S/W Revision	Prior to A.02.00

### Questionable Integrity Signal Negative Transition

This command determines which bits in the Questionable Integrity Signal Condition register will set the corresponding bit in the Questionable Integrity Signal Event register when the condition register bit has a negative transition (1 to 0). The variable <integer> is the sum of the decimal values of the bits that you want to enable.

Mode	All
<b>Remote Command</b>	:STATus:QUESTionable:INTEgrity:SIGNal:NTRansition <integer> :STATus:QUESTionable:INTEgrity:SIGNal:NTRansition?
<b>Example</b>	STAT:QUES:INT:SIGN:NTR 4 Burst found will be reported to the Integrity Summary of the Status Questionable register.
Preset	0
Min	0
Max	32767
Status Bits/OPC dependencies	Sequential command
Initial S/W Revision	Prior to A.02.00

### Questionable Integrity Signal Positive Transition

This command determines which bits in the Questionable Integrity Signal Condition register will set the corresponding bit in the Questionable Integrity Signal Event register when the condition register bit has a positive transition (0 to 1). The variable <integer> is the sum of the decimal values of the bits that you want to enable.



Mode	All
<b>Remote Command</b>	:STATus:QUESTionable:INTEgrity:SIGNal:PTRansition <integer> :STATus:QUESTionable:INTEgrity:SIGNal:PTRansition?
<b>Example</b>	STAT:QUES:INT:SIGN:PTR 4 Burst not found will be reported to the Integrity Summary of the Status Questionable register.
Preset	32767
Min	0
Max	32767
Status Bits/OPC dependencies	Sequential command
Initial S/W Revision	Prior to A.02.00

### Questionable Integrity Uncalibrated Register

"Questionable Integrity Uncalibrated Condition " on page 185

"Questionable Integrity Uncalibrated Enable " on page 185

"Questionable Integrity Uncalibrated Event Query " on page 186

"Questionable Integrity Uncalibrated Negative Transition " on page 186

"Questionable Integrity Uncalibrated Positive Transition " on page 187

### Questionable Integrity Uncalibrated Condition

This query returns the decimal value of the sum of the bits in the Questionable Integrity Uncalibrated Condition register.

**NOTE** The data in this register is continuously updated and reflects the current conditions.

Mode	All
<b>Remote Command</b>	:STATus:QUESTionable:INTEgrity:UNCalibrated:CONDition?
<b>Example</b>	STAT:QUES:INT:UNC:COND?
Preset	0
Status Bits/OPC dependencies	Sequential command
Initial S/W Revision	Prior to A.02.00

### Questionable Integrity Uncalibrated Enable

This command determines which bits in the Questionable Integrity Uncalibrated Condition Register will set bits in the Questionable Integrity Uncalibrated Event register, which also sets the Data Uncalibrated Summary bit (bit 3) in the Questionable Integrity Register. The variable <integer> is the sum of the decimal values of the bits you want to enable.

Mode	All
<b>Remote Command</b>	:STATus:QUEStionable:INTEgrity:UNCalibrated:ENABle :STATus:QUEStionable:INTEgrity:UNCalibrated:ENABle?
<b>Example</b>	STAT:QUES:INT:UNC:ENAB 1 Oversweep (Meas Uncal) will be reported to the Integrity Summary of the Status Questionable register.
Preset	32767
Min	0
Max	32767
Status Bits/OPC dependencies	Sequential command
Initial S/W Revision	Prior to A.02.00

### Questionable Integrity Uncalibrated Event Query

This query returns the decimal value of the sum of the bits in the Questionable Integrity Uncalibrated Event register.

**NOTE**

The register requires that the associated PTR or NTR filters be set before a condition register bit can set a bit in the event register. The data in this register is latched until it is queried. Once queried, the register is cleared.

Mode	All
<b>Remote Command</b>	:STATus:QUEStionable:INTEgrity:UNCalibrated[:EVENT]?
<b>Example</b>	STAT:QUES:INT:UNC?
Preset	0
Status Bits/OPC dependencies	Sequential command
Initial S/W Revision	Prior to A.02.00

### Questionable Integrity Uncalibrated Negative Transition

This command determines which bits in the Questionable Integrity Uncalibrated Condition register will set the corresponding bit in the Questionable Integrity Uncalibrated Event register when the condition register bit has a negative transition (1 to 0). The variable <integer> is the sum of the decimal values of the bits that you want to enable.

Mode	All
<b>Remote Command</b>	:STATus:QUEStionable:INTEgrity:UNCalibrated:NTRansition <integer> :STATus:QUEStionable:INTEgrity:UNCalibrated:NTRansition?
<b>Example</b>	STAT:QUES:INT:UNC:NTR 1 Oversweep cleared will be reported to the Integrity Summary of the Status Questionable register.

Preset	0
Min	0
Max	32767
Status Bits/OPC dependencies	Sequential command
Initial S/W Revision	Prior to A.02.00

### Questionable Integrity Uncalibrated Positive Transition

This command determines which bits in the Questionable Integrity Uncalibrated Condition register will set the corresponding bit in the Questionable Integrity Uncalibrated Event register when the condition register bit has a positive transition (0 to 1). The variable <integer> is the sum of the decimal values of the bits that you want to enable.

Mode	All
<b>Remote Command</b>	:STATus:QUEStionable:INTEgrity:UNCalibrated:PTRansition <integer> :STATus:QUEStionable:INTEgrity:UNCalibrated:PTRansition?
<b>Example</b>	STAT:QUES:INT:UNC:PTR 1 Oversweep (Meas Uncal) occurred will be reported to the Integrity Summary of the Status Questionable register.
Preset	32767
Min	0
Max	32767
Status Bits/OPC dependencies	Sequential command
Initial S/W Revision	Prior to A.02.00

### Questionable Power Register

["Questionable Power Condition " on page 187](#)

["Questionable Power Enable " on page 188](#)

["Questionable Power Event Query " on page 188](#)

["Questionable Power Negative Transition " on page 189](#)

["Questionable Power Positive Transition " on page 189](#)

### Questionable Power Condition

This query returns the decimal value of the sum of the bits in the Questionable Power Condition register.

**NOTE**

The data in this register is continuously updated and reflects the current conditions.

Mode	All
<b>Remote Command</b>	:STATus:QUESTionable:POWer:CONDition?
<b>Example</b>	STAT:QUES:POW:COND?
Preset	0
Status Bits/OPC dependencies	Sequential command
Initial S/W Revision	Prior to A.02.00

### Questionable Power Enable

This command determines which bits in the Questionable Power Condition Register will set bits in the Questionable Power Event register, which also sets the Power Summary bit (bit 3) in the Questionable Register. The variable <integer> is the sum of the decimal values of the bits you want to enable.

Mode	All
<b>Remote Command</b>	:STATus:QUESTionable:POWer:ENABle <integer> :STATus:QUESTionable:POWer:ENABle?
<b>Example</b>	STAT:QUES:POW:ENAB 32 50 MHz Input Pwr too High for Cal will be reported to the Power Summary of the Status Questionable register.
Preset	32767
Min	0
Max	32767
Status Bits/OPC dependencies	Sequential command
Initial S/W Revision	Prior to A.02.00

### Questionable Power Event Query

This query returns the decimal value of the sum of the bits in the Questionable Power Event register.

**NOTE** The register requires that the associated PTR or NTR filters be set before a condition register bit can set a bit in the event register. The data in this register is latched until it is queried. Once queried, the register is cleared.

Mode	All
<b>Remote Command</b>	:STATus:QUESTionable:POWer[:EVENT]?
<b>Example</b>	STAT:QUES:POW?
Preset	0
Status Bits/OPC dependencies	Sequential command
Initial S/W Revision	Prior to A.02.00

### Questionable Power Negative Transition

This command determines which bits in the Questionable Power Condition register will set the corresponding bit in the Questionable Power Event register when the condition register bit has a negative transition (1 to 0). The variable <integer> is the sum of the decimal values of the bits that you want to enable.

Mode	All
<b>Remote Command</b>	:STATus:QUESTionable:POWer:NTRansition <integer> :STATus:QUESTionable:POWer:NTRansition?
<b>Example</b>	STAT:QUES:POW:NTR 32 50 MHz Input Power became OK for Cal will be reported to the Power Summary of the Status Questionable register.
Preset	0
Min	0
Max	32767
Status Bits/OPC dependencies	Sequential command
Initial S/W Revision	Prior to A.02.00

### Questionable Power Positive Transition

This command determines which bits in the Questionable Power Condition register will set the corresponding bit in the Questionable Power Event register when the condition register bit has a positive transition (0 to 1). The variable <integer> is the sum of the decimal values of the bits that you want to enable.

Mode	All
<b>Remote Command</b>	:STATus:QUESTionable:POWer:PTRansition <integer> :STATus:QUESTionable:POWer:PTRansition?>
<b>Example</b>	STAT:QUES:POW:PTR 32 50 MHz Input Power became too high for Cal will be reported to the Power Summary of the Status Questionable register.
Preset	32767
Min	0
Max	32767
Status Bits/OPC dependencies	Sequential command
Initial S/W Revision	Prior to A.02.00

### Questionable Temperature Register

"Questionable Temperature Condition" on page 190

"Questionable Temperature Enable" on page 190

"Questionable Temperature Event Query" on page 190

"Questionable Temperature Negative Transition" on page 191

"Questionable Temperature Positive Transition" on page 191

### Questionable Temperature Condition

This query returns the decimal value of the sum of the bits in the Questionable Temperature Condition register.

**NOTE**

The data in this register is continuously updated and reflects the current conditions.

Mode	All
<b>Remote Command</b>	:STATus:QUESTionable:TEMPerature:CONDition?
<b>Example</b>	STAT:QUES:TEMP:COND?
Preset	0
Status Bits/OPC dependencies	Sequential command
Initial S/W Revision	Prior to A.02.00

### Questionable Temperature Enable

This command determines which bits in the Questionable Temperature Condition Register will set bits in the Questionable Temperature Event register, which also sets the Temperature Summary bit (bit 4) in the Questionable Register. The variable <integer> is the sum of the decimal values of the bits you want to enable.

Mode	All
<b>Remote Command</b>	:STATus:QUESTionable:TEMPerature:ENABle <integer> :STATus:QUESTionable:TEMPerature:ENABle?
<b>Example</b>	STAT:QUES:TEMP:ENAB 1 Reference Oscillator Oven Cold will be reported to the Temperature Summary of the Status Questionable register.
Preset	32767
Min	0
Max	32767
Status Bits/OPC dependencies	Sequential command
Initial S/W Revision	Prior to A.02.00

### Questionable Temperature Event Query

This query returns the decimal value of the sum of the bits in the Questionable Temperature Event register.

**NOTE**

The register requires that the associated PTR or NTR filters be set before a condition register bit can set a bit in the event register. The data in this register is latched until it is queried. Once queried, the register is cleared

Mode	All
<b>Remote Command</b>	:STATus:QUEStionable:TEMPerature[:EVENT]?
<b>Example</b>	STAT:QUES:TEMP?
Preset	0
Status Bits/OPC dependencies	Sequential command
Initial S/W Revision	Prior to A.02.00

### Questionable Temperature Negative Transition

This command determines which bits in the Questionable Temperature Condition register will set the corresponding bit in the Questionable Temperature Event register when the condition register bit has a negative transition (1 to 0). The variable <integer> is the sum of the decimal values of the bits that you want to enable.

Mode	All
<b>Remote Command</b>	:STATus:QUEStionable:TEMPerature:NTRansition <integer> :STATus:QUEStionable:TEMPerature:NTRansition?
<b>Example</b>	STAT:QUES:TEMP:NTR 1 Reference Oscillator Oven not cold will be reported to the Temperature Summary of the Status Questionable register.
Preset	0
Min	0
Max	32767
Status Bits/OPC dependencies	Sequential command
Initial S/W Revision	Prior to A.02.00

### Questionable Temperature Positive Transition

This command determines which bits in the Questionable Temperature Condition register will set the corresponding bit in the Questionable Temperature Event register when the condition register bit has a positive transition (0 to 1). The variable <integer> is the sum of the decimal values of the bits that you want to enable.

Mode	All
<b>Remote Command</b>	:STATus:QUEStionable:TEMPerature:PTRansition <integer> :STATus:QUEStionable:TEMPerature:PTRansition?
<b>Example</b>	STAT:QUES:TEMP:PTR 1 Reference Oscillator Oven became cold will be reported to the

---

	Temperature Summary of the Status Questionable register.
Preset	32767
Min	0
Max	32767
Status Bits/OPC dependencies	Sequential command
Initial S/W Revision	Prior to A.02.00

---



## IEEE 488.2 Common Commands

The instrument supports the following subset of IEEE 488.2 Common Commands, as defined in Chapter 10 of [IEEE Standard 488.2–1992](#). As indicated in the detailed descriptions, some of these commands correspond directly to instrument front-panel key functionality, while others are available only as remote commands.

Command	Description
*CAL?	Align Now "All " on page 364
*CLS	"Clear Status " on page 195
*ESE	"Standard Event Status Enable " on page 195
*ESE?	
*ESR?	"Standard Event Status Register Query " on page 196
*IDN?	"Identification Query " on page 196
*OPC	"Operation Complete " on page 197
*OPC?	
*OPT?	"Query Instrument Options " on page 198
*RCL	"Recall Instrument State " on page 198
*RST	"*RST (Remote Command Only)" on page 199
*SAV	"Save Instrument State " on page 199
*SRE	"Service Request Enable " on page 199
*SRE?	
*STB?	"Status Byte Query " on page 200
*TRG	"Trigger " on page 200
*TST?	"Self Test Query " on page 200
*WAI	"Wait-to-Continue " on page 201

### All

(In MXE the key label is "All (plus RF Presel 20 Hz – 3.6 GHz)")Immediately executes an alignment of all subsystems In MXE, the Align Now All is followed by additionally aligning the RF Preselector section, so in MXE, the key label contains the parenthetical note "(plus RF Presel 20 Hz – 3.6 GHz)". The instrument stops any measurement currently underway, performs the alignment, then restarts the measurement from the beginning (similar to pressing the Restart key).

If an interfering user signal is present at the RF Input, the alignment is performed on all subsystems except the RF. After completion, the Error Condition message "Align skipped: 50 MHz interference" or "Align skipped: 4.8 GHz interference" is generated. In addition the Error Condition message "Align Now, RF required" is generated, and bits 11 and 12 are set in the Status Questionable Calibration register.

The query form of the remote commands (:CALibration[:ALL]? or \*CAL?) invokes the alignment of all subsystems and returns a success or failure value. An interfering user signal is not grounds for failure; if the

alignment was able to succeed on all portions but unable to align the RF because of an interfering signal, the resultant will be the success value.

Successful completion of Align Now, All will clear the “Align Now, All required” Error Condition, and clear bit 14 in the Status Questionable Calibration register. It will also begin the elapsed time counter for Last Align Now, All Time, and capture the Last Align Now, All Temperature.

In the MXE, successful completion will also clear the “Align 20 Hz to 30 MHz required” Error Condition, the “Align 30 MHz to 3.6 GHz required” Error Condition, and the “Align 20 Hz to 3.6 GHz required” Error Condition, and clear bits 1 and bit 2 and clear the bit 1 in the Status Questionable Calibration Extended Needed register.

If the Align RF subsystem succeeded in aligning (no interfering signal present), the elapsed time counter begins for Last Align Now, RF Time, and the temperature is captured for the Last Align Now, RF Temperature. In addition the Error Conditions “Align skipped: 50 MHz interference” and “Align skipped: 4.8 GHz interference” are cleared, the Error Condition “Align Now, RF required” is cleared, and bits 11 and 12 are cleared in the Status Questionable Calibration register

Align Now, All can be interrupted by pressing the Cancel (ESC) front-panel key or remotely with Device Clear followed by the :ABORt SCPI command. When this occurs the Error Condition message “Align Now, All required” is generated, and bit 14 is set in the Status Questionable Condition register. This is because new alignment data may be employed for an individual subsystem, but not a cohesive set of data for all subsystems.

In many cases, you might find it more convenient to change alignments to Normal, instead of executing Align Now, All. When the Auto Align process transitions to Normal, the analyzer will immediately start to update only the alignments that have expired, thus efficiently restoring the alignment process.

<b>Key Path</b>	System, Alignments, Align Now
<b>Mode</b>	All
<b>Remote Command</b>	:CALibration[:ALL] :CALibration[:ALL]?
<b>Example</b>	:CAL
<b>Notes</b>	:CALibration[:ALL]? returns 0 if successful :CALibration[:ALL]? returns 1 if failed :CALibration[:ALL]? is the same as *CAL? While Align Now, All is performing the alignment, bit 0 in the Status Operation register is set. Completion, or termination, will clear bit 0 in the Status Operation register. This command is sequential; it must complete before further SCPI commands are processed. Interrupting the alignment from remote is accomplished by invoking Device Clear followed by the :ABORt command. Successful completion will clear bit 14 in the Status Questionable Calibration register. An interfering user signal is not grounds for failure of Align Now, All. However, bits 11 and 12 are set in the Status Questionable Calibration register to indicate Align Now, RF is required. An interfering user supplied signal will result in the instrument requiring an Align Now, RF with the interfering signal removed.
<b>Couplings</b>	Initializes the time for the Last Align Now, All Time. Records the temperature for the Last Align Now, All Temperature.

	If Align RF component succeeded, initializes the time for the Last Align Now, RF Time. If Align RF component succeeded, records the temperature for the Last Align Now, RF Temperature.
Status Bits/OPC dependencies	Bits 11, 12, or 14 may be set in the Status Questionable Calibration register.
Initial S/W Revision	Prior to A.02.00

Mode	All
<b>Remote Command</b>	*CAL?
<b>Example</b>	*CAL?
Notes	*CAL? returns 0 if successful *CAL? returns 1 if failed :CALibration[:ALL]? is the same as *CAL? See additional remarks described with :CALibration[:ALL]? Everything about :CALibration[:ALL]? is synonymous with *CAL? including all conditions, status register bits, and couplings
Initial S/W Revision	Prior to A.02.00

## Clear Status

Clears the status byte register. It does this by emptying the error queue and clearing all bits in all of the event registers. The status byte register summarizes the states of the other registers. It is also responsible for generating service requests.

Key Path	No equivalent key. Related key System, Show Errors, Clear Error Queue
<b>Remote Command</b>	*CLS
<b>Example</b>	*CLS Clears the error queue and the Status Byte Register.
Notes	For related commands, see the SYSTem:ERRor[:NEXT]? command. See also the STATus:PRESet command and all commands in the STATus subsystem.
Status Bits/OPC dependencies	Resets all bits in all event registers to 0, which resets all the status byte register bits to 0 also.
Backwards Compatibility Notes	In general the status bits used in the X-Series status system will be backwards compatible with ESA and PSA. However, note that all conditions will generate events that go into the event log, and some will also generate status bits.
Initial S/W Revision	Prior to A.02.00

## Standard Event Status Enable

Selects the desired bits from the standard event status enable register. This register monitors I/O errors and synchronization conditions such as operation complete, request control, query error, device

dependent error, status execution error, command error, and power on. The selected bits are OR'd to become a summary bit (bit 5) in the byte register which can be queried.

The query returns the state of the standard event status enable register.

<b>Key Path</b>	No equivalent key. Related key System, Show Errors, Clear Error Queue
<b>Remote Command</b>	*ESE <integer> *ESE?
<b>Example</b>	*ESE 36 Enables the Standard Event Status Register to monitor query and command errors (bits 2 and 5). *ESE? Returns a 36 indicating that the query and command status bits are enabled.
<b>Notes</b>	For related commands, see the STATus subsystem and SYSTem:ERRor[:NEXT]? commands.
<b>Preset</b>	255
<b>State Saved</b>	Not saved in state.
<b>Min</b>	0
<b>Max</b>	255
<b>Status Bits/OPC dependencies</b>	Event Enable Register of the Standard Event Status Register.
<b>Initial S/W Revision</b>	Prior to A.02.00

### Standard Event Status Register Query

Queries and clears the standard event status event register. (This is a destructive read.) The value returned is a hexadecimal number that reflects the current state (0/1) of all the bits in the register.

<b>Remote Command</b>	*ESR?
<b>Example</b>	*ESR? Returns a 1 if there is either a query or command error, otherwise it returns a zero.
<b>Notes</b>	For related commands, see the STATus subsystem commands.
<b>Preset</b>	0
<b>Min</b>	0
<b>Max</b>	255
<b>Status Bits/OPC dependencies</b>	Standard Event Status Register (bits 0 – 7).
<b>Initial S/W Revision</b>	Prior to A.02.00

### Identification Query

Returns a string of instrument identification information. The string will contain the model number, serial number, and firmware revision.

The response is organized into four fields separated by commas. The field definitions are as follows:

- Manufacturer

- Model
- Serial number
- Firmware version

<b>Key Path</b>	No equivalent key. See related key System, Show System.
<b>Remote Command</b>	*IDN?
<b>Example</b>	*IDN? Returns instrument identification information, such as: Keysight Technologies, N9020A, US01020004, A.01.02
<b>Initial S/W Revision</b>	Prior to A.02.00

## Operation Complete

The \*OPC command sets bit 0 in the standard event status register (SER) to “1” when pending operations have finished, that is when all overlapped commands are complete. It does not hold off subsequent operations. You can determine when the overlapped commands have completed either by polling the OPC bit in SER, or by setting up the status system such that a service request (SRQ) is asserted when the OPC bit is set.

The \*OPC? query returns a “1” after all the current overlapped commands are complete. So it holds off subsequent commands until the “1” is returned, then the program continues. This query can be used to synchronize events of other instruments on the external bus.

<b>Remote Command</b>	*OPC  *OPC?
<b>Example</b>	INIT:CONT 0 Selects single sweeping. INIT:IMM Initiates a sweep. *OPC? Holds off any further commands until the sweep is complete.
<b>Status Bits/OPC dependencies</b>	Not global to all remote ports or front panel. *OPC only considers operation that was initiated on the same port as the *OPC command was issued from. *OPC is an overlapped command, but *OPC? is sequential.
<b>Backwards Compatibility Notes</b>	<ol style="list-style-type: none"> <li>1. The ESA/PSA/VSA products do not meet all the requirements for the *OPC command specified by IEEE 488.2. This is corrected for X-Series. This will sometimes cause behavior that is not backward compatible, but it will work as customers expect.</li> <li>2. Commands such as, *OPC/*OPC?/*WAI/*RST used to be global. They considered front panel operation in conjunction with the GPIB functionality. Now they are evaluated on a per channel basis. That is, the various rear panel remote ports and the front panel i/o are all considered separately. Only the functionality initiated on the port where the *OPC was sent, is considered for its operation.</li> <li>3. *OPC used to hold off until the operation bits were cleared. Now it holds off until all overlapping commands are completed. Also, earlier instruments did not wait for completion of all processes, only the ones identified here (in the STATus:OPERation register): Calibrating: monitored by PSA, ESA, VSA (E4406A) Sweeping: monitored by PSA, ESA, VSA (E4406A) Waiting for Trigger: monitored by PSA, ESA, VSA (E4406A)</li> </ol>

	Measuring: monitored by PSA and ESA (but not in all Modes). Paused: monitored by VSA (E4406A). Printing: monitored by VSA (E4406A). Mass memory busy: monitored by VSA (E4406A).
Initial S/W Revision	Prior to A.02.00

## Query Instrument Options

Returns a string of all the installed instrument options. It is a comma separated list with quotes, such as: "503,P03,PFR".

To be IEEE compliant, this command should return an arbitrary ascii variable that would not begin and end with quotes. But the quotes are needed to be backward compatible with previous SA products and software. So, the actual implementation will use arbitrary ascii. But quotes will be sent as the first and last ascii characters that are sent with the comma-separated option list.

<b>Remote Command</b>	*OPT?
Initial S/W Revision	Prior to A.02.00

## Recall Instrument State

This command recalls the instrument state from the specified instrument memory register.

- If the state being loaded has a newer firmware revision than the revision of the instrument, no state is recalled and an error is reported
- If the state being loaded has an equal firmware revision than the revision of the instrument, the state will be loaded.
- If the state being loaded has an older firmware revision than the revision of the instrument, the instrument will only load the parts of the state that apply to the older revision.

<b>Remote Command</b>	*RCL <register #>
<b>Example</b>	*RCL 7 Recalls the instrument state that is currently stored in register 7.
Notes	Registers 0 through 6 are accessible from the front panel in menu keys for Recall Registers.
Min	0
Max	127
Status Bits/OPC dependencies	The command is sequential.
Initial S/W Revision	Prior to A.02.00

## \*RST (Remote Command Only)

\*RST is equivalent to :SYST:PRES::INIT:CONT OFF, which is a Mode Preset in the Single measurement state. This remote command is preferred over Mode Preset remote command - :SYST:PRES, as optimal remote programming occurs with the instrument in the single measurement state.

<b>Remote Command</b>	*RST
<b>Example</b>	*RST
<b>Notes</b>	Sequential Clears all pending OPC bits and the Status Byte is set to 0.
<b>Couplings</b>	A *RST will cause the currently running measurement to be aborted and cause the default measurement to be active. *RST gets the mode to a consistent state with all of the default couplings set.
<b>Backwards Compatibility Notes</b>	In legacy analyzers *RST did not set the analyzer to Single, but in the X-Series it does, for compliance with the IEEE 488.2 specification. In the X-Series, *RST does not do a *CLS (clear the status bits and the error queue). In legacy analyzers, *RST used to do the equivalent of SYSTem:PRESet, *CLS and INITiate:CONTinuous OFF. But to be 488.2 compliant, *RST in the X-Series does not do a *CLS.
<b>Initial S/W Revision</b>	Prior to A.02.00

## Save Instrument State

This command saves the current instrument state and mode to the specified instrument memory register.

<b>Remote Command</b>	*SAV <register #>
<b>Example</b>	*SAV 9 Saves the instrument state in register 9.
<b>Notes</b>	Registers 0 through 6 are accessible from the front panel in menu keys for Save Registers.
<b>Min</b>	0
<b>Max</b>	127
<b>Status Bits/OPC dependencies</b>	The command is sequential.
<b>Initial S/W Revision</b>	Prior to A.02.00

## Service Request Enable

This command enables the desired bits of the service request enable register.

The query returns the value of the register, indicating which bits are currently enabled.

<b>Remote Command</b>	*SRE <integer> *SRE?
<b>Example</b>	*SRE 22 Enables bits 1, 2, and 4 in the service request enable register.

Notes	For related commands, see the STATus subsystem and SYSTem:ERRor[:NEXT]? commands.
Preset	0
Min	0
Max	255
Status Bits/OPC dependencies	Service Request Enable Register (all bits, 0 – 7).
Initial S/W Revision	Prior to A.02.00

## Status Byte Query

Returns the value of the status byte register without erasing its contents.

<b>Remote Command</b>	*STB?
<b>Example</b>	*STB? Returns a decimal value for the bits in the status byte register. For example, if a 16 is returned, it indicates that bit 5 is set and one of the conditions monitored in the standard event status register is set.
Notes	See related command *CLS.
Status Bits/OPC dependencies	Status Byte Register (all bits, 0 – 7).
Initial S/W Revision	Prior to A.02.00

## Trigger

This command triggers the instrument. Use the :TRIGger[:SEQuence]:SOURce command to select the trigger source.

Key Path	No equivalent key. See related keys Single and Restart.
<b>Remote Command</b>	*TRG
<b>Example</b>	*TRG Triggers the instrument to take a sweep or start a measurement, depending on the current instrument settings.
Notes	See related command :INITiate:IMMediate.
Initial S/W Revision	Prior to A.02.00

## Self Test Query

This query performs the internal self-test routines and returns a number indicating the success of the testing. A zero is returned if the test is successful, 1 if it fails.

<b>Remote Command</b>	*TST?
<b>Example</b>	*TST? Runs the self-test routines and returns 0=passed, 1=some part failed.
Initial S/W Revision	Prior to A.02.00



## Wait-to-Continue

This command causes the instrument to wait until all overlapped commands are completed before executing any additional commands. There is no query form for the command.

<b>Remote Command</b>	*WAI
<b>Example</b>	INIT:CONT OFF; INIT;*WAI Sets the instrument to single sweep. Starts a sweep and waits for its completion.
<b>Status Bits/OPC dependencies</b>	Not global to all remote ports or front panel. *OPC only considers operation that was initiated on the same port as the *OPC command was issued from.
<b>Initial S/W Revision</b>	Prior to A.02.00



## 4 Input/Output Functions

## Input/Output

The Input/Output features are common across multiple Modes and Measurements. These common features are described in this section. See the Measurement description for information on features that are unique.

The Input/Output key accesses the keys that control the Input/Output parameters of the instrument. In general, these are functions associated with external connections to the analyzer, either to the inputs or the outputs. Since these connections tend to be fairly stable within a given setup, in general, the input/output settings do not change when you Preset the analyzer.

Other functions related to the input/output connections, but which tend to change on a measurement by measurement basis, can be found under the Trigger and AMPTD Y Scale keys. In addition, some of the digital I/O bus configurations can be found under the System key.

**NOTE**

The functions in the Input/Output menu are "global" (common) to all Modes (applications). But individual Input/Output functions only appear in a Mode if they apply to that Mode. Functions that apply to a Mode but not to all measurements in the Mode may be grayed-out in some measurements.

["Input/Output variables - Preset behavior" on page 205](#)

The Input Port selection is the first menu under the Input/Output key:

Key Path	Front-panel key
<b>Remote Command</b>	<code>[ :SENSe ] :FEED RF   AIQ   EMIXer</code> <code>[ :SENSe ] :FEED?</code>
<b>Example</b>	<code>:FEED RF</code> <code>:FEED?</code>
<b>Couplings</b>	The <code>[ :SENSe ] :FEED RF</code> command turns the calibrator OFF
<b>Preset</b>	This setting is unaffected by a Preset or power cycle. It survives a Mode Preset and mode changes. It is set to RF on a "Restore Input/Output Defaults" or "Restore System Defaults->All"
<b>State Saved</b>	Saved in instrument state
<b>Backwards Compatibility SCPI</b>	<code>[ :SENSe ] :FEED AREFERENCE</code> In the PSA the calibrator was one of the inputs and selected using the AREF parameter to the same <code>:FEED</code> command that switched the inputs. In the X-Series it is controlled in a separate menu and overrides the input selection. For code compatibility the <code>[ :SENSe ] :FEED AREFERENCE</code> command is provided, and is aliased to <code>[ :SENSe ] :FEED :AREF REF50</code> , which causes the input to be switched to the 50 MHz calibrator. The <code>[ :SENSe ] :FEED RF</code> command switches the input back to the RF port and turns the calibrator OFF, thus providing full compatibility with the PSA calibrator function. Note that after sending this, the query <code>[ :SENSe ] :FEED?</code> will NOT return "AREF" but instead the currently selected input.
<b>Backwards Compatibility SCPI</b>	<code>[ :SENSe ] :FEED IQ   IONLy   QONLy</code> <code>[ :SENSe ] :FEED?</code> The parameters <code>IQ   IONLy   QONLy</code> are supported for backwards compatibility with the E44406A. <code>[ :SENSe ] :FEED IQ</code> aliases to <code>[ :SENSe ] :FEED :IQ :TYPE IQ</code> <code>[ :SENSe ] :FEED IONLy</code> aliases to <code>[ :SENSe ] :FEED :IQ :TYPE IONLy</code>

	<p>[;SENSe]:FEED QONLy aliases to [;SENSe]:FEED:IQ:TYPE QONLy</p> <p>The query [;SENSe]:FEED? will always returns AIQ whatever the type of legacy parameters IQ   IONLy   QONLy has been used.</p>
Backwards Compatibility Notes	<p>Most of the settings in the X-Series Input/Output system, including External Gain, Amplitude Corrections settings and data, etc., are shared by all modes and are not changed by a mode switch. Furthermore, most variables in the Input/Output system key are not affected by Mode Preset. Both of these behaviors represent a departure from legacy behavior.</p> <p>In the X-Series. Input/Output settings are reset by using the "Restore Input/Output Defaults" function. They can also be reset to their default values through the System-&gt;Restore System Defaults-&gt; In/Out Config key or through the System -&gt;Restore System Defaults -&gt; All key (and corresponding SCPI).</p> <p>While this matches most use cases better, it does create some code compatibility issues. For example, Amplitude Corrections are no longer turned off by a Mode Preset, but instead by using the "Restore Input/Output Defaults" key/SCPI.</p> <p>Although Input/Output settings are not part of each Mode's State, they are saved in the Save State files, so that all of the instrument settings can be recalled with Recall State, as in legacy instruments.</p>
Initial S/W Revision	Prior to A.02.00
<b>Remote Command</b>	<p>:INPut:MIXer EXTernal INTernal</p> <p>:INPut:MIXer?</p>
<b>Example</b>	<p>INP:MIX INT</p> <p>INP:MIX?</p>
Notes	<p>In legacy analyzers you choose between the Internal mixer or an External Mixer. In the X-Series, the External Mixer is one of the choices for the Input and is selected using the FEED command (:SENSe:FEED EXTMIxer).</p> <p>For compatibility, the INPut:MIXer EXTernal INTernal legacy command is mapped as follows:</p> <ol style="list-style-type: none"> <li>1. When INPut:MIXer EXTernal is received, SENSe:FEED EMIXer is executed.</li> <li>2. When INPut:MIXer INTernal is received, SENSe:FEED RF is executed.</li> <li>3. When INPut:MIXer? is received, the response will be INT if any input other than the external mixer is selected and EXT if the external mixer is selected</li> </ol>
Preset	INT
Backwards Compatibility Notes	<p>PSA supports the following SCPI Command :</p> <p>:INPut:MIXer:TYPE PRESelected UNPReselect</p> <p>:INPut:MIXer:TYPE?</p> <p>PXA does not support the :INPut:MIXer:TYPE command.</p>
Initial S/W Revision	A.08.01

## Input/Output variables - Preset behavior

Virtually all the input/output settings are NOT a part of mode preset. They can be set to their default value

by one of the three ways:

- by using the Restore Input/Output Defaults key on the first page of the input/output menu,
- by using the System->Restore System Defaults->Input/Output Settings or,
- by using the System -> Restore System Defaults->All. Also, they survive a Preset and a Power cycle.

A very few of the Input/Output settings do respond to a Mode Preset; for example, if the Calibrator is on it turns off on a Preset, and if DC coupling is in effect it switches to AC on a Preset. These exceptions are made in the interest of reliability and usability, which overrides the need for absolute consistency. Exceptions are noted in the SCPI table for the excepted functions.

## RF Input

Selects the front-panel RF input port to be the analyzer signal input. If RF is already selected, pressing this key accesses the RF input setup functions.

<b>Key Path</b>	<b>Input/Output</b>
<b>Example</b>	[:SENSe]:FEED RF
<b>Couplings</b>	The act of connecting the U7227A USB Preamplifier to one of the analyzer's USB ports will cause the Input to automatically switch to the RF Input. If the RF Calibrator is on, it is turned off. Subsequently disconnecting the USB Preamp from USB does not change the Input selection nor restore the previous selection.
<b>Readback</b>	The RF input port, RF coupling, and current input impedance settings appear on this key as: "XX, YY, ZZ" where XX is RF, RF2, RFIO1, RFIO2, depending on what input is selected (only appears on analyzers with multiple RF inputs) YY is AC or DC ZZ is 50Ω or 75Ω
<b>Initial S/W Revision</b>	Prior to A.02.00
<b>Modified at S/W Revision</b>	A.14.00

## Input Z Correction

Sets the input impedance for unit conversions. This affects the results when the y-axis unit is voltage or current units (dBmV, dBμV, dBμA, V, A), but not when it is power units (dBm, W). The impedance you select is for computational purposes only, since the actual impedance is set by internal hardware to 50 ohms. Setting the computational input impedance to 75 ohms is useful when using a 75 ohm to 50 ohm adapter to measure a 75 ohm device on an analyzer with a 50 ohm input impedance.

There are a variety of ways to make 50 to 75 ohm transitions, such as impedance transformers or minimum loss pads. The choice of the solution that is best for your measurement situation requires balancing the amount of loss that you can tolerate with the amount of measurement frequency range that you need. If you are using one of these pads/adaptors with the Input Z Corr function, you might also want to use the Ext Gain key. This function is used to set a correction value to compensate for the gain (loss) through your pad. This correction factor is applied to the displayed measurement values.

Key Path	Input/Output, RF Input
Remote Command	[ :SENSe ] :CORRection:IMPedance [ :INPut ] [ :MAGNitude ] 50   75 [ :SENSe ] :CORRection:IMPedance [ :INPut ] [ :MAGNitude ] ?
Example	CORR:IMP 75 sets the input impedance correction to 75 ohms. CORR:IMP?
Couplings	In the N9000A option C75, when RF Input 2 is selected, the Input Z Correction will automatically change to 75 ohms. You may then change it to whatever is desired. When the main RF Input is selected, the Input Z Correction will automatically change to 50 ohms. You may then change it to whatever is desired.
Preset	This is unaffected by a Preset but is set to 50 ohms on a "Restore Input/Output Defaults" or "Restore System Defaults->All" Some instruments/options may have 75 ohms available.
State Saved	Saved in instrument state
Readback	50 $\Omega$ or 75 $\Omega$ . Current setting reads back to the RF key.
Initial S/W Revision	Prior to A.02.00

## RF Coupling

Specifies alternating current (AC) or direct current (DC) coupling at the analyzer RF input port. Selecting AC coupling switches in a blocking capacitor that blocks any DC voltage present at the analyzer input. This decreases the input frequency range of the analyzer, but prevents damage to the input circuitry of the analyzer if there is a DC voltage present at the RF input.

In AC coupling mode, you can view signals below the corner frequency of the DC block, but below a certain frequency the amplitude accuracy is not specified. The frequency below which specifications do not apply is:

X-Series Model	Lowest Freq for meeting specs when AC coupled	Lowest Freq for meeting specs when DC coupled
N9000A-503/507	100 kHz	n/a
N9000A-C75 Input 2	1 MHz	n/a
N9000A-513/526	10 MHz	9 kHz
N9010A	10 MHz	9 kHz
N9020A	10 MHz	20 Hz
N9030A	10 MHz	3 Hz

Some amplitude specifications apply only when coupling is set to DC. Refer to the appropriate amplitude specifications and characteristics for your analyzer.

When operating in DC coupled mode, ensure protection of the analyzer input circuitry by limiting the DC part of the input level to within 200 mV of 0 Vdc. In AC or DC coupling, limit the input RF power to +30 dBm (1 Watt).

<b>Key Path</b>	Input/Output, RF Input
<b>Remote Command</b>	:INPut:COUPling AC DC :INPut:COUPling?
<b>Example</b>	INP:COUP DC
<b>Dependencies</b>	This key does not appear in models that are always AC coupled. When the SCPI command to set DC coupling is sent to these models, it results in the error "Illegal parameter value; This model is always AC coupled" In these models, the SCPI query INP:COUP? always returns AC. This key does not appear in models that are always DC coupled. When the SCPI command to set AC coupling is sent to these models, it results in the error "Illegal parameter value; This instrument is always DC coupled" In these models, the SCPI query INP:COUP? always returns DC.
<b>Preset</b>	AC on models that support AC coupling On models that are always DC coupled, such as millimeter wave models (frequency ranges 30 GHz and above), the preset is DC.
<b>State Saved</b>	Saved in instrument state.
<b>Initial S/W Revision</b>	Prior to A.02.00
<b>Modified at S/W Revision</b>	A.03.00

## External Mixer

This key allows you to choose an External Mixer through which to apply signal input to the analyzer. When chosen, the LO/IF port becomes the input to the analyzer.

External Mixing requires option EXM. The External Mixer key will not appear unless option EXM is installed. The presence of the LO/IF connector alone does not indicate that you have Option EXM licensed. To verify that option EXM is installed, press System, Show, System.

When External Mixer is selected, the Center Freq key controls the setting of the Center Freq in external mixing, which is separate from the settings of Center Freq for the RF Input or BBIQ. Each input retains its unique settings for Center Freq. A unique SCPI command is provided solely for the external mixing Center Freq (see the Center Freq key description), which only affects the External Mixer CF, although sending the generic Center Freq command while External Mixer is selected also controls the External Mixer CF.

See "[More Information](#)" on page 209

<b>Key Path</b>	Input/Output
<b>Example</b>	:FEED EMIX
<b>Notes</b>	Not all measurements support the use of the External Mixer input. When External Mixer is selected in a measurement that does not support it, the "No result; Meas invalid with Ext Mixing" error condition occurs.
<b>Dependencies</b>	Unless option EXM is present, the External Mixer key is blanked, and all SCPI commands associated with menus accessed by this key return an error



	Manual FFT mode is available with external mixing, but not with Signal ID.
Preset	All settings under this key are returned to their default state when Restore Input/Output Defaults is pressed.
State Saved	All settings under this key, and all Frequency settings, are remembered when you go out of External Mixer, so that when External Mixer is chosen again, all the external mixer functions will retain their previous settings, with the exception of Signal ID which is set to OFF (Signal ID is also set to Off unless External Mixer is the selected Input).
Readback Text	The readback text on this key shows the currently selected mixer, in square brackets.
Backwards Compatibility Notes	Unlike PSA, all external mixer settings including Center Frequency are retained when you go in and out of External Mixing. Also, Preset does not take you out of External Mixing (Restore Input/Output Defaults does).
Initial S/W Revision	A.08.01

## More Information

X-series analyzers have a combined LO Out/IF In connection, whereas earlier analyzers used separate ports for the LO Out and the IF in. Internal diplexers in the analyzer and the mixer simplify the connection for the user – only a single SMA cable is required.

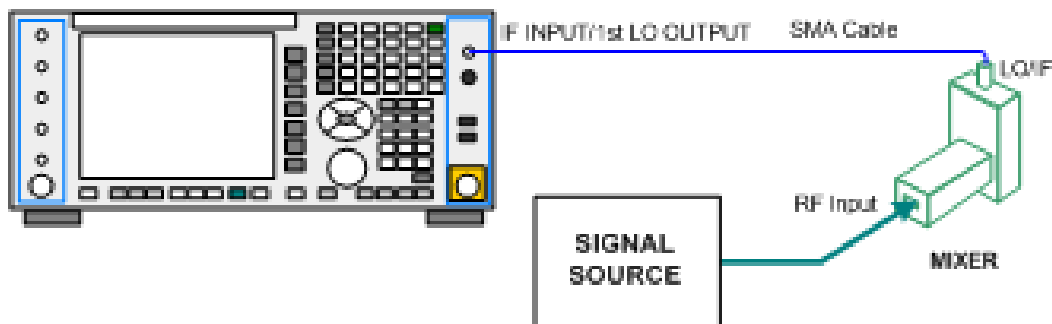

Legacy HP/Agilent and some third party mixers have separate LO In and IF out connections. This requires you to use an external diplexer to connect these mixers. A diplexer can easily be purchased for this purpose (for example, Diplexer Model # DPL.26 or # DPL.313B from OML Inc., Morgan Hill CA)

The connection diagram for such a legacy mixer is:

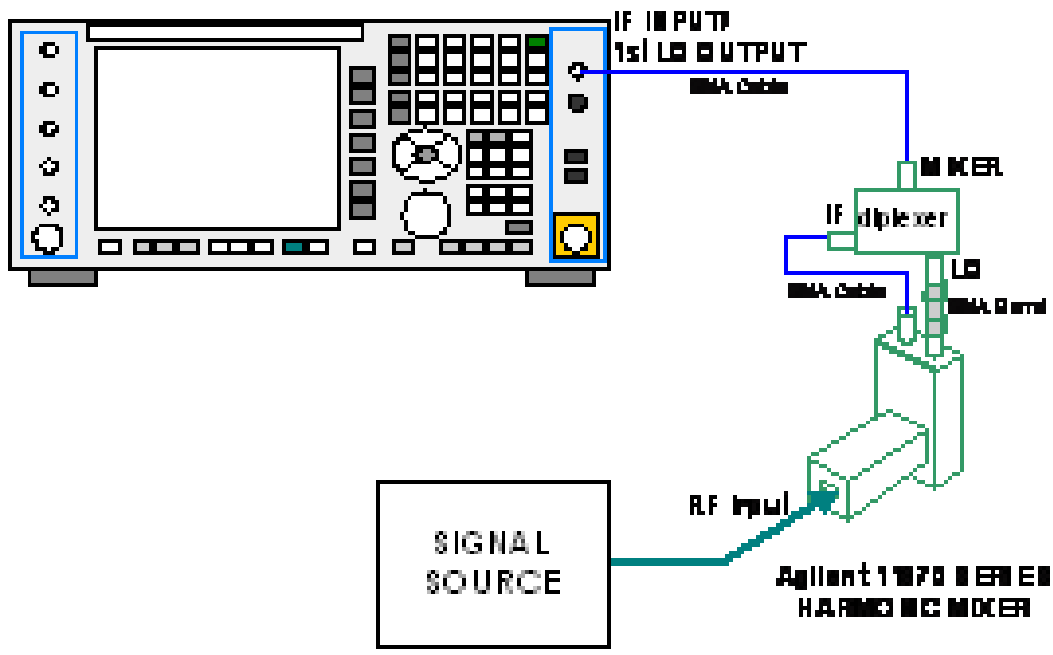

In addition, External Mixing in the X-Series supports the new Agilent M1970 series of Harmonic Mixers, which provide a USB connection for download of calibration data and additional control.

The connection diagram for one of the Agilent USB mixers is:

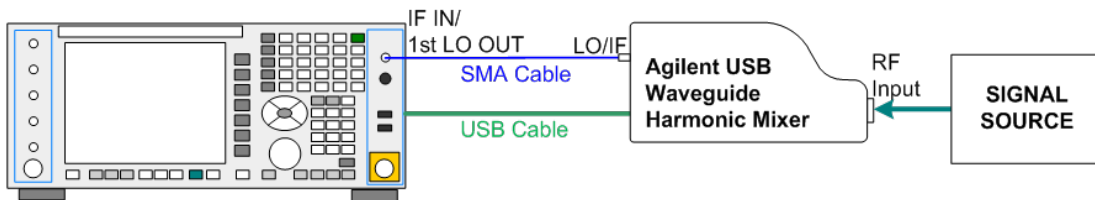

External Mixing is only supported in certain Modes and Measurements in the X-Series, as shown in the table below:

Mode	Measurements	Sig ID (Image Suppress only)
Spectrum Analyzer	Swept SA	Y*
	TOI	Y
	Harmonics	N
	Spurious Emissions	Y
	Channel Power	Y
	Occupied BW	Y
	ACP	Y
	Spectrum Emissions Mask	Y
	CCDF	N

	Burst Power	N
	List Sweep	N
Phase Noise	Monitor Spectrum	Y
	Log Plot	Y
	Spot Frequency	N
	Waveform	N
I/Q Analyzer	Complex Spectrum	N
	Waveform	N
Vector Signal Analyzer	Vector Analysis	N
	Analog Demod	N
	Digital Demod	N

\* the Swept SA measurement also supports Image Shift

## Ext Mix Setup

This menu lets you select the mixer type, and lets you configure your mixer (if necessary). While in this menu, and any of its submenus, the External Mixer Setup screen appears, showing you the current settings for the selected mixer. These settings may be dependent on which IF path is currently in use, whether a + or – harmonic is currently selected, etc.

To apply any amplitude correction factors needed to correct mixer flatness, you enter values into one of the Correction tables (under Input/Output, Corrections). The correction conversion loss values can be extracted from data supplied with the mixer or from manual measurements you make to determine the conversion loss. Note that the correction applied by the Correction tables is global to the analyzer; therefore you should make sure to turn off the External Mixer corrections when you are not using the External Mixer input.

### NOTE

The Agilent USB Mixers automatically give their flatness data to the analyzer, and the correction is applied internally. No correction needs to be entered by the user, and the correction does not appear in the user-accessible Corrections tables. The user is free to enter additional corrections into the Correction tables under Input/Output, Corrections.

Key Path	Input/Output, External Mixer
State Saved	All settings in the Mixer Setup are part of the Input/Output system, and hence are saved whenever State is saved.
Readback Text	The readback line on this key shows the currently selected mixer, in square brackets.
Initial S/W Revision	A.08.01
Modified at S/W Revision	A.08.50

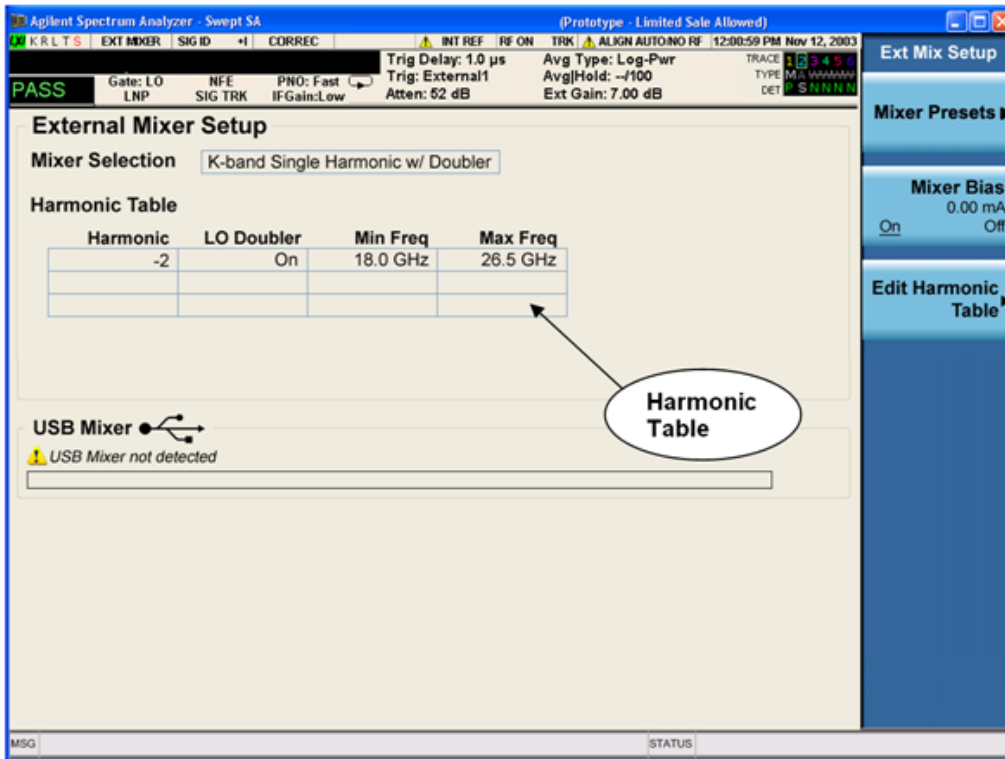

The External Mixer Setup screen looks like this

The current Mixer selection (the current or most recently connected USB Mixer, or the most recent Mixer Preset, or “Custom” if the user has modified the setup) reads out at the top of this screen.

The Harmonic Table currently being used reads out below the Mixer Selection. It shows each range being used for the current mixer. Note that a band may be made up of up to 3 ranges. Each range represents a choice of mixer harmonic and doubler state. When you select a Mixer Preset, it sets the analyzer Start and Stop frequency to the values shown in the Harmonic Table; Start Freq is set to the Min Freq for the bottom range, and Stop Freq is set to the Max Freq for the top range. In many cases you can exceed these nominal values; the absolute maximum and minimum frequency for each preset are shown in the tables that accompany the key descriptions for the Mixer Presets.

**NOTE**

If the current measurement has a limited Span available to it, and cannot achieve the Span shown in the table ( $\text{Span} = \text{Stop Freq} - \text{Start Freq}$ ), the analyzer uses the maximum Span the measurement allows, and sets the Center Freq to the midpoint of the Start and Stop Freq values in the Harmonic Table.

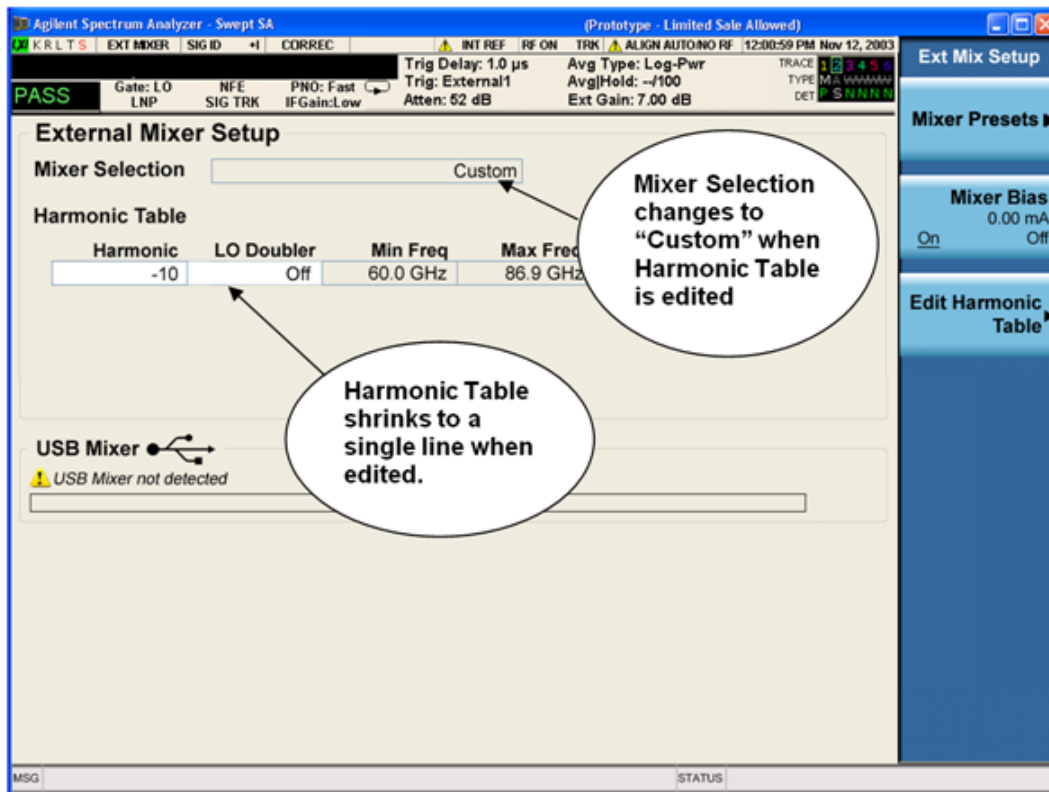

You may customize the Harmonic Table, but when you do this the analyzer goes into “single harmonic” mode. You may enter the harmonic number and whether to use the doubler or not, but now range switching is not supported, so you can only have one harmonic.

When you edit the Harmonic Table, the Mixer Selection changes to “Custom.” To change it back you must go back into the Mixer Presets menu and select a Preset.

When you edit the Harmonic Table, the nominal Min Freq and Max Freq that are available will usually be different than the Preset you were using; and the absolute frequency limits will change as well. This may result in a change to your Start and/or Stop Freq, if the current values fall outside the new range, requiring you to retune your Center Freq to get your signal back in the center.

The analyzer supports the Agilent M1970 Series Harmonic Mixers with USB connection. While in External Mixing, if one of these mixers is plugged in to a USB port, it is automatically detected and displayed in the “USB Mixer” area of the setup screen, including its model number and serial number.

The analyzer assumes that if you plug a mixer into the USB, that is the mixer you want to use. Therefore:

1. If a USB mixer is connected to the USB port, the Mixer Presets menu is grayed out, as none of the presets make sense with a USB Mixer connected. Note that once the analyzer has acquired the USB Mixer, the mixer selection will remain if it is subsequently unplugged from the USB, allowing you to plug it back in with no change to your settings. However, once you unplug it, the Mixer Presets key will stop being grayed out, allowing you to preset to a different mixer.
2. When Restore Input/Output Defaults is performed, if an Agilent USB Mixer is plugged into the analyzer’s USB port, the Mixer Selection remains unchanged.

3. When recalling an instrument state, if an Agilent USB Mixer is plugged into the analyzer's USB port, and the Mixer Selection in the recalled state is for a USB Mixer that does not match the mixer currently plugged in, you will have to unplug your mixer and then plug it back in to get the analyzer to recognize your mixer.

As long as the selection in Ext Mixer Setup shows one of the USB mixers, both the Mixer Bias and Edit Harmonic Table keys will be grayed out.

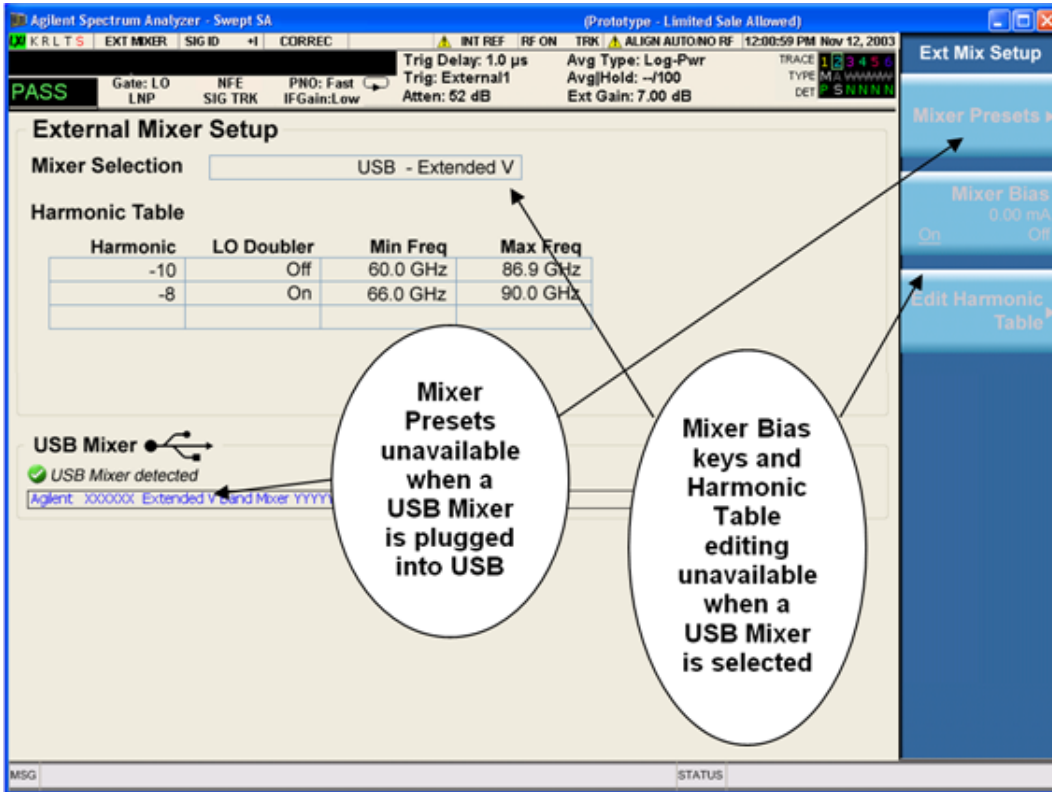

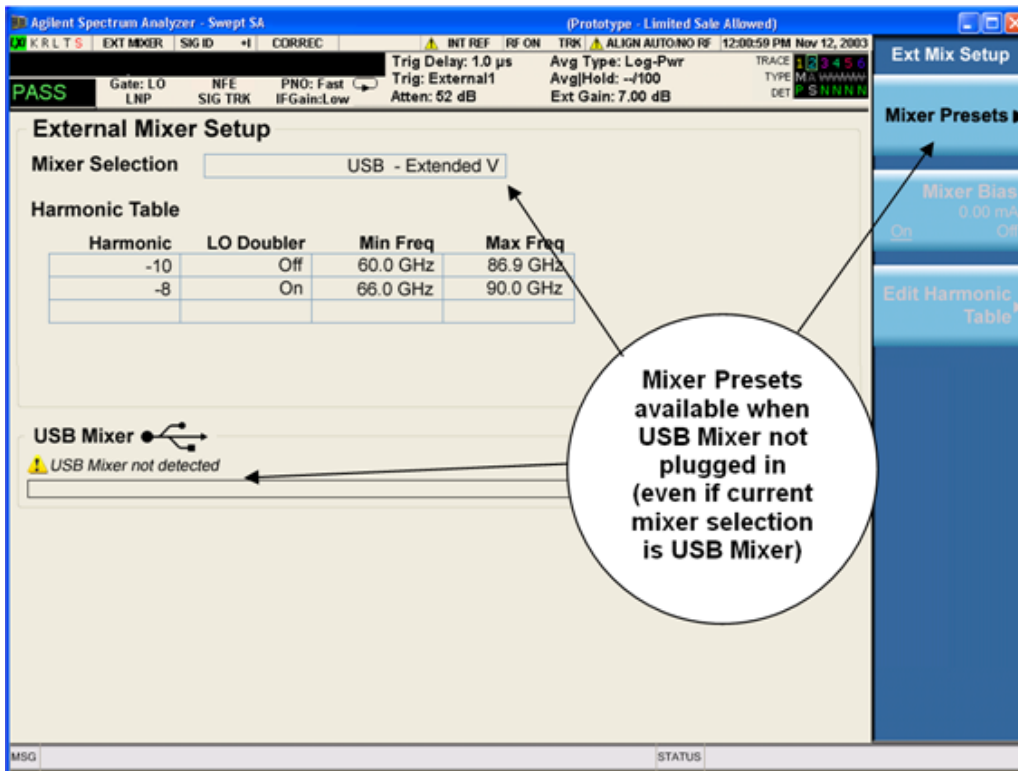

Only one USB Mixer is supported at a time. To switch to a different USB Mixer, disconnect the one that is no longer being used prior to connecting a new one.

The Mixer Selection displayed and softkey readback for the Agilent M1970 series mixers is:

Mixer Model	Mixer Selection display on Setup Screen	Readback on softkeys
Agilent M1970E: Option 001: 60 to 90 GHz Waveguide Harmonic Mixer	USB - M1970E E-Band	USB Mixer E-Band
Agilent M1970V Option 001: 50 to 75 GHz Waveguide Harmonic Mixer	USB - M1970V-001 V-Band	USB Mixer V-Band
Agilent M1970V Option 002: 50 to 80 GHz Waveguide Harmonic Mixer	USB - M1970V-002 Extended V-Band	USB Mixer Extended V
Agilent M1970W: 75 to 110 GHz Waveguide Harmonic Mixer	USB - M1970W W-Band	USB Mixer W-Band

The Agilent USB mixer essentially acts as a “remote front end” and is fully calibrated over the specified frequency range, without requiring any user interaction. This is particularly useful at high mm-wave frequencies, where cable loss is typically quite large, and it is desirable to bring the front end right up to the device under test, rather than bringing the mm-wave signal to the analyzer using a lossy and uncalibrated cable or waveguide connection.

Connecting the mixer to the USB port on the analyzer switches you to External Mixing, aborts the current measurement, and initiates an alignment of the mixer. A popup message, “USB Mixer connected” appears on the display. When a USB mixer and the LO/IF cable are connected the alignment is performed. When the alignment begins, an “Aligning” popup replaces the previous message on the display. When the alignment completes, the current measurement restarts.

### Mixer Presets

This menu lets you preset the mixer setup for the particular type of mixer that you are using.

These presets are divided into four groups:

- one for Agilent legacy mixers,
- three for general purpose mixers:
  - o presets that use a single harmonic and no doubling
  - o presets that use a single harmonic but double the LO
  - o presets that use multiple harmonics

Note that the IF/LO port provides a 3.8–14 GHz LO in two bands: 3.8–8.7 (LO fundamental), and 8.6–14 GHz (doubled LO).

In most cases, once you have executed the preset, you will not need to adjust any further settings.

Key Path	Input/Output, External Mixer, Ext Mix Setup
<b>Remote Command</b>	[:SENSe]:MIXer:BAND A   Q   U   V   W   NA   ND   NE   NF   NG   NJ   NK   NQ   NU   NV   NW   NY   NEXT   DD   DF   DG   DJ   DK   DQ   DV   DW   DY   DEXT   MA   ME   MU   MCOAX   USB  [:SENSe]:MIXer:BAND?
<b>Example</b>	:MIX:BAND A :MIX:BAND?
<b>Notes</b>	A Q U V W select Agilent 11970 mixer presets NA ND NE NF NG NJ NK NQ NU NV NW NY NEXT select single harmonic, non-doubled LO presets DD DF DG DJ DK DQ DV DW DY DEXT select single harmonic, doubled LO presets MA ME MU MCOAX select multiple harmonic presets All of these presets are detailed in their respective key descriptions The query form of this command returns the most recent preset, UNLESS the harmonic table has been edited after the preset was executed. If the harmonic table has been edited it returns CUSTOM The command USB will refresh the USB mixer connection and automatically detect the mixer band. The query form of this command returns the following if an Agilent USB Mixer is plugged into the analyzer’s USB port: USB E Agilent E-Band USB Mixer USB V Agilent V-Band USB Mixer USB VEXT Agilent Extended V-Band USB Mixer USB W Agilent W-Band USB Mixer Note that the parameters CUSTOM, USBV, USBVEXT, and USBW are query responses only, and cannot be sent TO the analyzer.



	<p>The following cross-reference matches the mixer band designators used by Agilent to the EIA waveguide designations:</p> <p>EIAAgilentFreq Range</p> <p>WR-28 A26.5 – 40 GHz</p> <p>WR-22 Q33 – 50 GHz</p> <p>WR-19 U40 – 60 GHz</p> <p>WR-15 V50 – 75 GHz</p> <p>WR-12 E60 – 90 GHz</p> <p>WR-10 W75 – 110 GHz</p> <p>WR-8 F90 – 140 GHz</p> <p>WR-6 D110 – 170 GHz</p> <p>WR-5 G140 – 220 GHz</p> <p>WR-3 J220 – 325 GHz</p>
Preset	<p>When Restore Input/Output Defaults is performed, an “A” mixer preset is also issued (11970A band), unless an Agilent USB Mixer is plugged into the analyzer’s USB port, in which case the Mixer Selection remains unchanged.</p> <p>When using Agilent USB Mixers, if a Restore All Defaults (SCPI command SYSTem:DEFault) has been performed, either remove and reinsert the USB cable or press the Refresh USB Mixer Connection softkey.</p>
Backwards Compatibility Notes	<p>The [:SENSe]:MIXer:BAND command was used in PSA and ESA to select the mixer band. In the X-Series, only the legacy parameters A, Q, U, V, and W are honored, and they preset the analyzer to match the corresponding Agilent 11970 legacy mixer. Parameters D, E, F, G, J, K, Y, which were accepted in ESA and PSA, return an error if sent. If you are using a mixer in one of these bands, you should study the tables of presets and choose the appropriate preset to match your application. Also the USER parameter is no longer accepted, as the control model for mixer customization is very different in the X-Series.</p>
Initial S/W Revision	A.08.01
Modified at S/W Revision	A.14.00

### Agilent 11970

This menu allows you to preset for one of the models in the HP/Agilent 11970 series.

Because the X-Series has an LO range of 3.8 – 14 GHz, and older analyzers had an LO range of 3.0 – 6.8 GHz, the harmonic numbers used in the X-Series may differ from those used on older analyzers for the same mixers. Additionally, some of the 11970 mixers cannot be operated over their full range with the X-Series without switching harmonics. Consequently, you will find that some of the bands (A-Band, for example) are broken into two ranges for use with the X-Series.

See ["More Information" on page 218](#)

Key Path	Input/Output, External Mixer, Ext Mix Setup, Mixer Presets
Example	MIX:BAND A
Initial S/W Revision	A.08.01

## More Information

Below are the 11970A presets. The 11970U and the 11970W use a single harmonic. The other three switch harmonics mid-band. Both harmonic ranges are shown in the table. None of these mixers use LO doubling.

The 11970 K-band mixer and the 11974 preselected mixer series are not supported.

Preset	Readout in setup screen	Readback on softkeys	Range	Harm #	RF start	RF stop	RF center
A-band	Agilent 11970A	Agilent 11970A	1	-6	26.5	30.45	28.475
			2	-8	30.35	40	35.175
Q-band	Agilent 11970Q	Agilent 11970Q	1	-8	33	40.8	36.9
			2	-10	39.8	50	44.9
U-band	Agilent 11970U	Agilent 11970U	..	-10	40	60	50
V-band	Agilent 11970V	Agilent 11970V	1	-12	50	66	58
			2	-14	53	75	64
W-band	Agilent 11970W	Agilent 11970W	..	-18	75	110	92.5

### Single Harmonic

These presets choose a setup that uses a single harmonic and no doubling for the LO.

Key Path	Input/Output, External Mixer, Ext Mix Setup, Mixer Presets
<b>Example</b>	MIX:BAND NA
Initial S/W Revision	A.08.01

These are the presets for single harmonic operation with no doubler:

Mixer	Readout in setup screen	Readback on softkeys	Harm #	RF start	RF stop	RF center
K-band	K-band Single Harmonic, no doubler	Sngl harm LOx1 K-band	-4	18	26.5	22.25
A-band	A-band Single Harmonic, no doubler	Sngl harm LOx1 A-band	-6	26.5	40	33.25
D-band	D-band Single Harmonic, no doubler	Sngl harm LOx1 D-band	-20	110	170	140
E-band	E-band Single Harmonic, no doubler	Sngl harm LOx1 E-band	-12	60	90	75
F-band	F-band Single Harmonic, no doubler	Sngl harm LOx1	-18	90	140	115

Mixer	Readout in setup screen	Readback on softkeys	Harm #	RF start	RF stop	RF center
		F-band				
Q-band	Q-band Single Harmonic, no doubler	Sngl harm LOx1 Q-band	-6	33	50	41.5
U-band	U-band Single Harmonic, no doubler	Sngl harm LOx1 U-band	-8	40	60	50
V-band	V-band Single Harmonic, no doubler	Sngl harm LOx1 V-band	-10	50	75	62.5
W-band	W-band Single Harmonic, no doubler	Sngl harm LOx1 W-band	-14	75	110	92.5
G-band	G-band Single Harmonic, no doubler	Sngl harm LOx1 G-band	-26	140	220	180
Y-band	Y-band Single Harmonic, no doubler	Sngl harm LOx1 Y-band	-30	170	260	215
J-band	J-band Single Harmonic, no doubler	Sngl harm LOx1 J-band	-38	220	325	272.5
Extended	Extended Single Harmonic, no doubler	Sngl harm LOx1 Extended	-40	155	345	250

## Single Harmonic w/doubler

These presets choose a setup that uses a single harmonic and doubling for the LO.

Key Path	Input/Output, External Mixer, Ext Mix Setup, Mixer Presets
<b>Example</b>	MIX:BAND DW
Initial S/W Revision	A.08.01

These are the presets for single harmonic operation with LO doubling:

Mixer	Readout in setup screen	Readback on softkeys	Harm #	RF start	RF stop	RF center
D-band	D-band Single Harmonic w/doubler	Sngl harm LOx2 K-band	-14	110	170	140
F-band	F-band Single Harmonic w/doubler	Sngl harm LOx2 A-band	-10	90	140	115
G-band	G-band Single Harmonic w/doubler	Sngl harm LOx2 A-band	-16	140	220	180
J-band	J-band Single	Sngl harm LOx2	-24	220	325	272.5

Mixer	Readout in setup screen	Readback on softkeys	Harm #	RF start	RF stop	RF center
	Harmonic w/doubler	A-band				
K-band	K-band Single Harmonic w/doubler	Sngl harm LOx2 A-band	-2	18	26.5	22.25
Q-band	Q-band Single Harmonic w/doubler	Sngl harm LOx2 A-band	-4	33	50	41.5
V-band	V-band Single Harmonic w/doubler	Sngl harm LOx2 A-band	-6	50	75	62.5
W-band	W-band Single Harmonic w/doubler	Sngl harm LOx2 A-band	-8	75	110	92.5
Y-band	Y-band Single Harmonic w/doubler	Sngl harm LOx2 A-band	-20	170	260	215
Extended	Extended Single Harmonic w/doubler	Sngl harm LOx2 A-band	-28	245	390	317.5

### Multiple Harmonics

These presets choose a setup that uses multiple harmonics and may or may not use doubling for the LO.

Key Path	Input/Output, External Mixer, Ext Mix Setup, Mixer Presets
<b>Example</b>	MIX:BAND MA
Initial S/W Revision	A.08.01

These are the presets for multiple harmonic operation:

Mixer	Readout in setup screen	Readback on softkeys	Range	Harm #	Dblr?	RF start	RF stop	RF Center
A-band	A-band Multiple Harmonic	Multi harm A-band	1	-4	N	26.5	34.1	30.3
			2	-4	Y	33.1	40	36.55
E-band	E-band Multiple Harmonic	Multi harm E-band	1	-6	Y	60	83	71.5
			2	-8	Y	65	90	77.5
U-band	U-band Multiple Harmonic	Multi harm U-band	1	-6	N	40	51.5	45.75
			2	-6	Y	49.5	60	54.75
Coaxial	Coaxial Multiple Harmonic	Multi harm Coaxial	1	-4	N	26.5	34	30.25
			2	-4	Y	32.5	55	43.75
			3	-6	Y	50	70	60

## Mixer Bias

Adjusts an internal bias source for use with external mixers. The bias signal is present on the center conductor of the IF input connector on the front panel. The shunt current range is from –10 mA to 10 mA and it can be set whether Mixer Bias state is On or Off, but it will only be applied if it is On.

The bias remains as set if the user switches to another input (e.g., the RF Input).

<b>Key Path</b>	Input/Output, External Mixer, Ext Mix Setup
<b>Remote Command</b>	[:SENSe]:MIXer:BIAS <real> [:SENSe]:MIXer:BIAS? [:SENSe]:MIXer:BIAS:STATe OFF ON 0 1 [:SENSe]:MIXer:BIAS:STATe?
<b>Example</b>	:MIX:BIAS 0 :MIX:BIAS? MIX:BIAS:STAT 0 MIX:BIAS:STAT?
<b>Preset</b>	This is unaffected by Preset but is set to OFF and 0 on a "Restore Input/Output Defaults"
<b>State Saved</b>	Saved in instrument state
<b>Min</b>	-10 mA
<b>Max</b>	10 mA
<b>Initial S/W Revision</b>	A.08.01

## Signal ID On/Off

Activates or deactivates an algorithm that aids with the identification of multiple responses

Toggles the Signal ID (signal identification) function On or Off. This function lets you identify multiple responses of a single input signal that are generated when using un-preselected external mixers. The use of mixers without pre-selecting filters offers the advantage of improved receiver sensitivity because of the absence of the filter insertion loss, but results in multiple responses due to images and undesired harmonic mixing products.

While in Signal ID, basic spectrum analyzer functions work normally (for example, you can change Span normally), but some functions are disabled (for example, some traces are unavailable).

There are two forms of Signal ID, Image Suppress and Image Shift. Choose the one most appropriate for your application. For Image Shift, an LO-shifted and an unshifted trace are taken in Trace 1 and Trace 2 and displayed together. Any peaks that are not the same in both traces are images. For Image Suppress, image cancellation is performed in the background using two hidden traces, and the result displayed in Trace 1, which shows only the valid signals.

<b>Key Path</b>	Input/Output, External Mixer
<b>Remote Command</b>	[:SENSe]:SIDentify[:STATe] OFF ON 0 1 [:SENSe]:SIDentify[:STATe]?

<b>Example</b>	:SID 0 :SID?
<b>Notes</b>	Signal ID uses data from two successive sweeps. Therefore, if the analyzer is in single sweep mode, two sweep triggers are used to generate the data needed for signal identification.
<b>Dependencies</b>	<p>Signal ID is not available in some measurements. If the Signal ID key does not appear or is grayed out while in your measurement, then it is not available.</p> <p>Because Signal ID uses data from two successive sweeps, several trace and sweep functions are grayed out in Signal ID. See the documentation for your measurement for details on which trace keys are grayed out.</p> <p>Signal ID is not available with Signal Track so Signal ID will be grayed out if in Signal Track.</p> <p>Signal ID will be turned off when External Mixer is turned off. Signal ID cannot be turned on when using internal mixing.</p> <p>Rules for auto coupling of the Sweep and FFT keys are changed with Signal ID on. For both the dynamic range case and the speed case, swept is chosen whenever any form of Signal ID is on. If Manual FFT is selected, the Signal ID key is grayed out.</p> <p>Whenever Signal ID is on, a warning message will be generated</p> <p>If Signal ID is selected in a measurement that does not support it, a warning message is generated</p>
<b>Couplings</b>	The Auto Rules for detector selection select Normal for all active traces when Signal ID is turned on.
<b>Preset</b>	This is unaffected by Preset but is set to OFF on a "Restore Input/Output Defaults"
<b>Initial S/W Revision</b>	A.08.01

## Signal ID Mode

Lets you set which Signal ID mode you will use, either Image Suppress or Image Shift.

<b>Key Path</b>	Input/Output, External Mixer
<b>Remote Command</b>	[:SENSe]:SIDentify:MODE ISUPpress ISHift [:SENSe]:SIDentify:MODE?
<b>Example</b>	:SID:MODE ISUP :SID:MODE?
<b>Preset</b>	This is unaffected by Preset but is set to ISUPpress on a "Restore Input/Output Defaults"
<b>State Saved</b>	Saved in instrument state
<b>Initial S/W Revision</b>	A.08.01

## Image Suppress

The Image Suppress mode of Signal ID mathematically removes all image and multiple responses of signals present at the mixer input. Two hidden sweeps are taken in succession. The second sweep is offset in LO frequency by  $2 \cdot IF/N$ . For each point in each trace, the smaller amplitude from the two traces is taken and placed in that point in Trace 1. Responses of each trace that lie on top of one another will remain and are valid signals, others are images and are suppressed. The action of taking the smaller of the two traces

will make the average noise level lower in all points that do not have an image, thus reducing the accuracy of the measurement of noise and noise-like signals.

**NOTE**

This function takes control of and uses Trace1. Any data in Trace 1 prior to activating Image Suppress will be lost.

Key Path	Input/Output, External Mixer, Signal ID Mode
<b>Example</b>	:SID:MODE ISUP
Notes	In Image Suppress Mode, synchronization is ensured by first turning off Signal ID, initiating a single sweep, then turning on Signal ID followed by two single sweeps.
Couplings	In Image Suppress the Peak detector is auto-selected to improve the image suppression effectiveness.
Initial S/W Revision	A.08.01
Modified at S/W Revision	A.09.491

### Image Shift

Like the Image Suppress mode, Image Shift is a two sweep sequence. The data from the first sweep is placed in Trace 1 and the data from the second (LO frequency shifted by  $2*IF/N$ ) sweep is placed in Trace 2. On alternate sweeps, the alternate trace (trace 2) is placed in front of trace 1. This way, you can see a signal at the same place on alternate sweeps, showing in yellow (trace1) and blue (trace2). Signal responses of Trace 1 and Trace 2 that have the same horizontal position are considered to be in the current band and therefore can be analyzed with the amplitude and frequency measurement systems of the SA. All other responses are invalid and should be ignored.

**NOTE**

This function takes control of and uses Trace 1 and Trace 2. Any data in these traces prior to activating Image Shift will be lost.

Key Path	Input/Output, External Mixer, Signal ID Mode
<b>Example</b>	:SID:MODE ISH
Notes	To synchronize in Image Shift Mode, turn off Signal ID and then initiate a single sweep. Then turn on Signal ID and initiate two single sweeps. The results of the first sweep after Signal ID is turned on are available in Trace 1. The next sweep is shifted and the data from that sweep is available in Trace 2. The unshifted and shifted data can then be compared.
Couplings	Trace 2 is turned off when Image Shift is turned Off.
Initial S/W Revision	A.08.01

### Cable IF Loss

The loss at the IF in the IF/LO cable can be compensated for with this function, by entering the loss in dB for your cable.

The cable loss will depend on the IF frequency. The IF frequency varies depending on which IF path your measurement is using. For best accuracy, characterize your cable's loss for the IF frequency or frequencies you will be using.

IF Frequencies:

10 MHz path: 322.5 MHz

25 MHz path: 322.5 MHz

40 MHz path: 250 MHz

140 MHz path: 300 MHz

Key Path	Input/Output, External Mixer
Key Path	Input/Output, External Mixer, Calibrate Mixer
Remote Command	[ :SENSe ] :MIXer :CIFLoss <rel_amp1> [ :SENSe ] :MIXer :CIFLoss?
Example	:MIX:CIFL 0.23 DB :MIX:CIFL?
Preset	0.26 dB
State Saved	Saved in instrument state
Min	-100
Max	100
Initial S/W Revision	A.08.01

## I/Q

This feature is not available unless the "[Baseband I/Q \(Option BBA\)](#)" on page 224 is installed.

Selects the front-panel I/Q input ports to be the analyzer signal input. If I/Q is already selected, pressing this key accesses the I/Q setup menu.

Key Path	Input/Output
Mode	BASIC, CDMA2K, EDGE GSM, TDSCDMA, VSA89601, WIMAX OFDMA, LTE, LTETDD, LTEAFDD, LTEATDD, DCATV, DTMB (CTTB), DVB-T/H with T2, CMMB, ISDBT, WCDMA, VXA, CDMA1XEV
Example	FEED AIQ
Notes	Not all measurements support the use of the I/Q signal input. When I/Q is selected in a measurement that does not support it, the "No Result; Meas invalid with I/Q inputs" error condition message appears. This is error 135
Initial S/W Revision	Prior to A.02.00

## Baseband I/Q (Option BBA)

The Baseband I/Q functionality is a hardware option. It is option BBA. If the option is not installed, none of the I/Q functionality is enabled.

The Baseband I/Q has four input ports and one output port. The input ports are I, I-bar, Q, and Q-bar. The I and I-bar together compose the I channel and the Q and Q-bar together compose the Q channel. Each channel has two modes of operation, Single-Ended (also called "unbalanced") and Differential Input (also



called "balanced"). When in Single-Ended operation, only the main port (I or Q) is used and the complementary port (I-bar or Q-bar) is ignored. When in Differential Input mode, both main and complementary ports are used.

The input settings (range, attenuation, skew, impedance, external gain) apply to the channels, not the individual ports.

The system supports a variety of 1 M $\Omega$  input passive probes as well as the Agilent 113x Series active differential probes using the Infinimax probe interface.

The Agilent 113x Series active probes can be used for both single ended and differential measurements. In either case a single connection is made for each channel (on either the I or Q input). The input is automatically configured to 50  $\Omega$  single ended and the probe power is supplied through the Infinimax interface. The probe can be configured for a variety of input coupling and low frequency rejection modes. In addition, a wide range of offset voltages and probe attenuation accessories are supported at the probe interface. The active probe has the advantage that it does not significantly load the circuit under test, even with unity gain probing.

With passive 1 M $\Omega$  probes, the probe will introduce a capacitive load on the circuit, unless higher attenuation is used at the probe interface. Higher attenuation reduces the signal level and degrades the signal-to-noise-ratio of the measurement. Passive probes are available with a variety of attenuation values for a moderate cost. Most Agilent passive probes can be automatically identified by the system, setting the input impedance setting required as well as the nominal attenuation. For single ended measurements a single probe is used for each channel. Other passive probes can be used, with the attenuation and impedance settings configured manually.

For full differential measurements, the system supports probes on each of the four inputs. The attenuation of the probes should be the same for good common mode rejection and channel match.

Both active and passive probes in single ended and differential configurations can be calibrated. This calibration uses the Cal Out BNC connection and a probe connection accessory. The calibration achieves excellent absolute gain flatness in a probed measurement. It matches both the gain and frequency response of the I and Q channels as well as any delay skew, resulting in high accuracy in derived measurements such as Error Vector Magnitude (EVM).

When a probe is connected a status message will be displayed. The message will indicate if calibration data is available or not. Calibration data is saved for each type of probe (including "none") for each port and will be reapplied whenever that type of probe is re-connected to the same port. For probes with EEPROM identification, the calibration data will be stored based on the unique probe identifier and will reapply data for that particular probe if it is available. The data will not follow a probe from one port to another. For probes without EEPROM identification, the instrument cannot distinguish between different probes of the same type and it will use the data from the last calibration for that probe type on that port.

When in differential mode, both the main and complementary probes are expected to be of the same type.

In some situations, the I and Q channels should be configured identically. In other situations it is convenient to control them independently. Some menus have a "Q Same as I" setting that will cause the Q channel configuration to mirror the I channel configuration, avoiding the overhead of double data entry when the channels should be the same.

The output port is for calibrating the I/Q input ports, although it can also be manually controlled.

There are two types of calibrations available: cable calibration and probe calibration. The cable calibration will guide the user through connecting each input port in turn. All ports must be calibrated together. The probe calibration is done for a specific channel (I or Q). If in Single-Ended mode, only the main port is calibrated. When in Differential Input mode, the user is guided through calibrating both main and complementary ports.

The front panel I/Q port LEDs indicate the current state of that port. On (green) indicates it is active, and off (dark) indicates it is not in use. For example, the Cal Out port LED is on if and only if there is signal coming out of that port.

The input is a context and some parameters have separate values for each context. The SCPI for these parameters has an optional "[:RF|IQ]" node. If the specific context is omitted, the command acts on the current input context's value. Here are the parameters that are input context sensitive:

- Center Frequency
- Trigger Source

It is important to distinguish between the I and Q input ports and the displayed I and Q data values. The I and Q input ports feed into a digital receiver that does digital tuning and filtering. The I and Q data seen by the user (either on the display or through SCPI) corresponds to the real ("I") and the imaginary ("Q") output from the digital receiver. When the input path is I+jQ or I Only and the center frequency is 0 Hz the I input ends up in as the real output from the receiver and appears as "I" data. Likewise, when the input path is I+jQ and the center frequency is 0 Hz, the Q input ends up as the imaginary output from the receiver and appears as "Q" data. However, when the input path is Q Only, the Q input is sent to the receiver as Q+j0, so the receiver output has the Q input coming out on the real output, and so in Q Only, the signal from the Q input port appears as the "I" data. Another situation where the I and Q data do not necessarily correspond directly to the I and Q inputs is when the center frequency is non-zero. The digital processing involved in the tuning is a complex operation. This will result in I Only data appearing as both "I" and "Q" data, the same as that signal would appear if seen through the RF input port.

### Baseband I/Q Remote Language Compatibility

For the Agilent E4406A VSA Series Transmitter Tester, Option B7C provided baseband I/Q inputs. Code compatibility has been provided to allow many of the commands for option B7C to function properly with the X-Series. The X-Series has hardware differences and additional capabilities (e.g., E4406A does not have independent settings of I & Q nor does it provide for probe calibrations) which make 100% compatibility impossible.

1. The following commands are supported:

```
:CALibration:IQ:FLATness
```

```
:INPut:IMPedance:IQ U50|B50|U1M|B1M
```

```
:INPut:IMPedance:REFerence <integer>
```

2. The [:SENSe]:FEED RF|IQ|IONLY|QONLY|AREFERENCE|IFALIGN command supports all parameters except IFALIGN. The FEED? query will return only RF|AIQ|AREF.

3. The following commands are not supported:

```
:CALibration:GIQ
```

```
:CALibration:IQ:CMR
```

:INPut:IQ:ALIGn OFF|ON|0|1

The Rohde & Schwarz FSQ-B71 also provides baseband I/Q inputs. A certain amount of code compatibility is provided in the X-Series, however hardware differences make this a somewhat limited set.

Supported:

The "<1|2>" is supported as "[1]".

INPut<1|2>:IQ:BALanced[:STATe] ON | OFF

INPut<1|2>:IQ:TYPE I | Q | IQ

INPut<1|2>:IQ:IMPedance LOW | HIGH

Not Supported:

INPut<1|2>:SELEct AIQ | RF

TRACe<1|2>:IQ:DATA:FORMAt COMPAtible | IQBLock | IQPair>

TRACe<1|2>:IQ:DATA:MEMory? <offset samples>, <# of samples>

TRACe<1|2>:IQ:DATA?

TRACe<1|2>:IQ:SET <filter type>, <rbw>, <sample rate>, <trigger source>, <trigger slope>, <pretrigger samples>, <# of samples>

TRACe<1|2>:IQ:SRATe 10.0kHz to 81.6MHz

TRACe<1|2>:IQ[:STATe] ON|OFF

The Rohde & Schwarz FMU has the following SCPI, which is not supported (these commands start/abort the probe calibration procedure, which is manually interactive from the front panel):

CALibration:ABORt

CALibration:PROBe[:STARt]

## I/Q Path

Selects which I/Q input channels are active. The LED next to each I/Q input port will be on when that port is active.

The analysis bandwidth for each channel is the same as that of the instrument. For example, the base N9020A has a bandwidth of 10 MHz. With I/Q input the I and Q channels would each have an analysis bandwidth of 10 MHz, giving 20 MHz of bandwidth when the I/Q Path is I+jQ. With option B25, the available bandwidth becomes 25 MHz, giving 25 MHz each to I and Q and 50 MHz to I+jQ.

I/Q voltage to power conversion processing is dependent on the I/Q Path selected.

- With I+jQ input we know that the input signal may not be symmetrical about 0 Hz, because it has a complex component. Therefore, above 0 Hz only the positive frequency information is displayed, and below 0 Hz only the negative frequency information is displayed.
- With all other Input Path selections, the input signal has no complex component and therefore is always symmetrical about 0 Hz. In this case, by convention, the power conversion shows the combined voltage for both the positive and negative frequencies. The information displayed below 0 Hz is the mirror of the

information displayed above 0 Hz. This results in a power reading 6.02 dB higher (for both) than would be seen with only the positive frequency voltage. Note also that, in this case the real signal may have complex modulation embedded in it, but that must be recovered by further signal processing.

<b>Key Path</b>	Input/Output, I/Q
<b>Remote Command</b>	[ :SENSe ] :FEED:IQ:TYPE IQ IONLy QONLy [ :SENSe ] :FEED:IQ:TYPE?
<b>Example</b>	Set the input to be both the I and Q channels, combined as $I + j * Q$ . FEED:IQ:TYPE IQ
<b>Preset</b>	IQ
<b>State Saved</b>	Yes This is unaffected by a Preset but is set to the default value on a "Restore Input/Output Defaults" or "Restore System Defaults->All"
<b>Range</b>	I+jQ   I Only   Q Only
<b>Readback Text</b>	I+jQ   I Only   Q Only
<b>Initial S/W Revision</b>	Prior to A.02.00

<b>Remote Command</b>	:INPut [1] :IQ:TYPE IQ I Q :INPut [1] :IQ:TYPE?
<b>Notes</b>	For R&S FSQ-B71 compatibility
<b>Preset</b>	IQ
<b>Initial S/W Revision</b>	Prior to A.02.00

### I+jQ

Sets the signal input to be both the I and Q channels. The I and Q channel data will be combined as  $I + j * Q$ .

<b>Key Path</b>	Input/Output, I/Q, I/Q Path
<b>Example</b>	Set the input to be both the I and Q channels, combined as $I + j * Q$ . FEED:IQ:TYPE IQ
<b>Initial S/W Revision</b>	Prior to A.02.00

### I Only

Sets the signal input to be only the I channel. The Q channel will be ignored. The data collected is still complex. When the center frequency is 0 the imaginary part will always be zero, but for any other center frequency both the real and imaginary parts will be significant.

<b>Key Path</b>	Input/Output, I/Q, I/Q Path
<b>Example</b>	Set the input to be only the I channel.

	FEED:IQ:TYPE IONL
Initial S/W Revision	Prior to A.02.00

### Q Only

Sets the signal input to be only the Q channel. The I channel will be ignored. The Q channel will be sent to the digital receiver block as  $Q+j0$ . The receiver's output is still complex. When the center frequency is 0 the imaginary part will always be zero, but for any other center frequency both the real and imaginary parts will be significant. Note that since the receiver's real output is displayed as the "I" data, when the center frequency is 0, the Q Only input appears as the "I" data.

Key Path	Input/Output, I/Q, I/Q Path
<b>Example</b>	Set the input to be only the Q channel. FEED:IQ:TYPE QONL
Initial S/W Revision	Prior to A.02.00

### I Setup

Access the channel setup parameters for the I channel.

Key Path	Input/Output, I/Q
Initial S/W Revision	Prior to A.02.00

### I Differential Input

Selects differential input on or off for the I channel. For differential input (also called balanced input), the analyzer uses both main and complementary ports. When differential input is off (also called single-ended or unbalanced input), the analyzer uses only the main port.

Key Path	Input/Output, I/Q, I Setup
<b>Remote Command</b>	:INPut:IQ[:I]:DIFFerential OFF ON 0 1 :INPut:IQ[:I]:DIFFerential?
<b>Example</b>	Put the I channel in Differential Input mode INP:IQ:DIFF ON
Notes	When I Differential Input = On, the analyzer will check for attenuation mismatches between the I and I-bar ports. If the difference in attenuation values exceeds 0.5 dB a Settings Alert error condition, error 159 will be set. When I Differential Input = On, and IQ Path is I+jQ, the Q Differential input must also be On. Similarly, when I Differential Input = Off, and IQ Path is I+jQ, the Q Differential input must also be Off. If the states of the two inputs do not match, an error condition message is generated, 159;Settings Alert;I/Q mismatch:Differential.

Couplings	Some active probes include built-in differential capability. When one of these probes is sensed, this key is disabled. Since the differential capability is handled in the probe, the Analyzer will use only the main port and the key will show that the Analyzer's Differential Input mode is Off (indicating that the complementary port is not in use).  When Q Same as I is On, the value set for I will also be copied to Q.
Preset	Off
State Saved	Yes  This is unaffected by a Preset but is set to the default value on a "Restore Input/Output Defaults" or "Restore System Defaults->All"
Range	Off   On
Initial S/W Revision	Prior to A.02.00

<b>Remote Command</b>	:INPut [1] :IQ:BAALanced[:STATe] OFF ON 0 1  :INPut [1] :IQ:BAALanced[:STATe] ?
Notes	For R&S FSQ-B71 compatibility, with no independent settings for the I and Q channels. Therefore, it is tied only to the I channel and does not provide an equivalent for the Q channel. For proper operation of the backwards compatibility command Q Same as I should be set to On.
Preset	OFF
Initial S/W Revision	Prior to A.02.00

### I Input Z

Selects the input impedance for the I channel. The impedance applies to both the I and I-bar ports.

The input impedance controls the hardware signal path impedance match. It is not used for converting voltage to power. The voltage to power conversion always uses the Reference Z parameter. The Reference Z parameter applies to both I and Q channels.

Key Path	Input/Output, I/Q, I Setup
<b>Remote Command</b>	:INPut [1] :IQ[:I] :IMPedance LOW HIGH  :INPut [1] :IQ[:I] :IMPedance?
<b>Example</b>	Set the I channel input impedance to 1 MΩ INP:IQ:IMP HIGH
Notes	LOW = 50 Ω, HIGH = 1 MΩ  When IQ Path is I+jQ, the I Input Z setting must be the same as the Q Input Z setting. If the settings of the two inputs do not match, an error condition message is generated, 159;Settings Alert;I/Q mismatch:Input Z.
Couplings	Input impedance is a built-in characteristic of a probe. Therefore, whenever a probe is sensed, this key is disabled and the value is set to match the probe.  When no probe is sensed on Q and Q Same as I is On, the value set for I will also be copied to Q.
Preset	LOW

State Saved	Yes This is unaffected by a Preset but is set to the default value on a "Restore Input/Output Defaults" or "Restore System Defaults->All"
Range	50 $\Omega$   1 M $\Omega$
Initial S/W Revision	Prior to A.02.00

### I Skew

Sets the skew factor for the I channel. The skew will shift the channel's data in time. Use this to compensate for differences in the electrical lengths of the input paths due to cabling.

Key Path	Input/Output, I/Q, I Setup
<b>Remote Command</b>	<code>[ :SENSe ] :CORRection:IQ[:I]:SKEW &lt;seconds&gt;</code> <code>[ :SENSe ] :CORRection:IQ[:I]:SKEW?</code>
<b>Example</b>	Delay the data for the I channel by 10 ns. CORR:IQ:SKEW 10 ns
Preset	0
State Saved	Yes This is unaffected by Preset but is set to the default value on a "Restore Input/Output Defaults" or "Restore System Defaults->All"
Range	0 s to 100 ns
Min	0 s
Max	+100 ns
Initial S/W Revision	Prior to A.02.00

### I Probe

Access the probe setup parameters for the I channel. See ["I/Q Probe Setup" on page 240](#).

Key Path	Input/Output, I/Q, I Setup
State Saved	No
Readback Text	[<I port probe id>] This is reporting the type of probe sensed on the I port. There is no parameter for overriding what is sensed.
Initial S/W Revision	Prior to A.02.00

### Attenuation

The attenuation is part of the calibration data stored with the probe type and is initially the value that was returned by the last calibration. You can modify this value and any changes will be stored with the

calibration data and will survive power cycles and presets. When a probe calibration is performed the attenuation value will be overwritten by the calibration.

<b>Key Path</b>	Input/Output, I/Q, I Setup   Q Setup, I Probe   Q Probe
<b>Remote Command</b>	[ :SENSe ] :CORRection:IQ:I Q:ATTenuation:RATio <real> [ :SENSe ] :CORRection:IQ:I Q:ATTenuation:RATio?
<b>Example</b>	Set the attenuation for the current I probe to 100.00:1. CORR:IQ:I:ATT:RAT 100
<b>Notes</b>	Each probe type has its own attenuation setting. As probes are changed the attenuation value will reflect the new probe's setting. Changing the attenuation affects only the current probe type's setting and leaves all others unchanged.  When the IQ Path is I+jQ, the Q probe attenuation setting must match the I Probe attenuation setting within 1 dB. If this is not the case, an error condition message is generated, 159;Settings Alert;I/Q mismatch:Attenuation.
<b>Preset</b>	Each probe type has its own default. The default for the "Unknown" probe type is 1:1.
<b>State Saved</b>	Saved with probe calibration data. It survives a power cycle and is not affected by a Preset or Restore.
<b>Range</b>	0.001 to 10000
<b>Min</b>	0.001
<b>Max</b>	10000
<b>Initial S/W Revision</b>	Prior to A.02.00

This is an alternate form of the SCPI that allows input as a power instead of a ratio.

<b>Remote Command</b>	[ :SENSe ] :CORRection:IQ:I Q:ATTenuation <rel_ampl> [ :SENSe ] :CORRection:IQ:I Q:ATTenuation?
<b>Example</b>	Set the attenuation for the current I probe type to 100.00:1. CORR:IQ:I:ATT 20 dB
<b>Range</b>	-60 dB to +80 dB
<b>Min</b>	-60 dB
<b>Max</b>	+80 dB
<b>Initial S/W Revision</b>	Prior to A.02.00

### Calibrate

Invokes the guided probe calibration. The guided probe calibration is context sensitive and depends on the channel (I or Q) and the Differential Input state. The calibration is only performed on the selected channel. When Differential Input is on, both the probe attached to the main port and the probe attached to the complementary port are calibrated. When Differential Input is off, only the probe attached to the main port is calibrated. See "[I/Q Guided Calibration](#)" on page 283.



Key Path	Input/Output, I/Q, I Setup   Q Setup, I Probe   Q Probe, Coupling
Readback Text	The last calibration date, or if no calibration exists, "(empty)". Last: <cal date> <cal time> Example: Last: 8/22/2007 1:02:49 PM
Initial S/W Revision	Prior to A.02.00

### Clear Calibration

Clears the calibration data for the current port and probe. It does not clear the data for other probe types or other ports. If the sensed probe has EEPROM identification, only the data for that specific probe is cleared. After this command has completed, the probe calibration state will be the same as if no probe calibration had ever been performed for the specified channel and probe. The probe attenuation will be the default value for that probe type and the Cable Calibration frequency response corrections will be used. This command is dependent on the Differential Input state. When Differential Input is on, both the data for the probe attached to the main port and the data for the probe attached to the complementary port are cleared. When Differential Input is off, only data for the probe attached to the main port is cleared.

Key Path	Input/Output, I/Q, I Setup   Q Setup, I Probe   Q Probe
Remote Command	:CALibration:IQ:PROBe:I Q:CLEAr
Example	Clear the calibration data for the I channel and the current probe (with EEPROM identification) or probe type (without EEPROM identification). :CAL:IQ:PROBe:I:CLE
Initial S/W Revision	Prior to A.02.00

### Combined Differential/Input Z (Remote Command Only)

This is Remote Command only (no front panel) and is for backwards compatibility only. It combines the Differential Input and Input Z selections into a single SCPI command.

Remote Command	:INPut:IMPedance:IQ U50 B50 U1M B1M :INPut:IMPedance:IQ?
Example	:INPut:IMPedance:IQ U50 This is equivalent to the following two SCPI commands: :INP:IQ:DIFF OFF :INP:IQ:IMP 50
Notes	Provided for E4406A code compatibility. The enum values translate as follows: U50: Differential Input = Off, Input Z = 50Ω

---

	<p>B50: Differential Input = On, Input Z = 50Ω          U1M: Differential Input = Off, Input Z = 1 MΩ          B1M: Differential Input = On, Input Z = 1 MΩ</p> <p>This command is for backwards compatibility. It combines the Input Z (50Ω or 1 MΩ) parameter with the Differential Input (Off = "Unbalanced", On = "Balanced") parameter into a single enumeration.</p> <p>This backwards compatibility SCPI command was for an instrument without independent settings for the I and Q channels. Therefore, it is tied only to the I channel and does not provide an equivalent for the Q channel. For proper operation of the backwards compatibility command Q Same as I should be set to On.</p> <p>Also, note the subtle difference between this SCPI command and the backwards compatibility command for Input Z. The Input Z SCPI has "IQ" before "IMP" while this command has that order reversed.</p>
Couplings	This command does not have an independent parameter, but instead is tied to the Differential Input and Input Z parameters. The coupling for those parameters apply to this command too.
Preset	U50
Initial S/W Revision	Prior to A.02.00

---

## Q Setup

Access the channel setup parameters for the Q channel.

---

Key Path	Input/Output, I/Q
Readback Text	When Q Same as I is On the readback is "Q Same as I".
Initial S/W Revision	Prior to A.02.00

---

## Q Same as I

Many, but not all, usages require the I and Q channels have an identical setup. To simplify channel setup, the Q Same as I will cause the Q channel parameters to be mirrored from the I channel. That way you only need to set up one channel (the I channel). The I channel values are copied to the Q channel, so at the time Q Same as I is turned off the I and Q channel setups will be identical. This does not apply to Probe settings or to parameters that are determined by the probe.

---

Key Path	Input/Output, I/Q, Q Setup
<b>Remote Command</b>	<pre>:INPut:IQ:MIRRored OFF ON 0 1 :INPut:IQ:MIRRored?</pre>
<b>Example</b>	<p>Turn off the mirroring of parameters from I to Q.</p> <pre>INP:IQ:MIRR OFF</pre>
Couplings	Only displayed for the Q channel. When Yes, the I channel values for some parameters are mirrored (copied) to the Q channel. However, when a parameter is determined by the type of probe and a probe is sensed, the probe setting is always used and the I channel setting is ignored. The following

---

	parameters are mirrored: Differential Input (when not determined by probe) Input Z (when not determined by probe)
Preset	This is unaffected by a Preset but is set to the default value (Q Same as I set to "On") on a "Restore Input/Output Defaults" or "Restore System Defaults->All"
State Saved	Saved in instrument state
Range	On   Off
Readback Text	"Q Same as I" when On, otherwise none.
Initial S/W Revision	Prior to A.02.00

### Q Differential Input

Selects differential input on or off for the Q channel. For differential input (also called balanced input), the analyzer uses both the Q and Q-bar ports. When differential input is off (also called single-ended or unbalanced input), the analyzer uses only the Q port.

Key Path	Input/Output, I/Q, Q Setup
Remote Command	:INPut:IQ:Q:DIFFerential OFF ON 0 1 :INPut:IQ:Q:DIFFerential?
Example	Put the Q channel in Differential Input mode INP:IQ:Q:DIFF ON
Notes	When Differential Input = On, the analyzer will check for attenuation mismatches between the Q and Q-bar ports. If the difference in attenuation values exceeds 0.5 dB a Settings Alert error condition, error 159 will be set.  When Q Differential Input = On, and IQ Path is I+jQ, the I Differential input must also be On. Similarly, when Q Differential Input = Off, and IQ Path is I+jQ, the I Differential input must also be Off. If the states of the two inputs do not match, an error condition message is generated, 159;Settings Alert;I/Q mismatch:Differential.
Couplings	Some active probes include built-in differential capability. When one of these probes is sensed, this key is disabled. Since the differential capability is handled in the probe, the Analyzer will use only the main port and the key will show that the Analyzer's Differential Input mode is Off (indicating that the complementary port not in use).  When a differential probe is not sensed and Q Same as I is On, the value set for I will be copied to Q. This key is disabled when Q Same as I is On.
Preset	Off
State Saved	Yes  This is unaffected by a Preset but is set to the default value on a "Restore Input/Output Defaults" or "Restore System Defaults->All"
Range	Off   On
Initial S/W Revision	Prior to A.02.00

### Q Input Z

Selects the input impedance for the Q channel. The impedance applies to both the Q and Q-bar ports.

The input impedance controls the hardware signal path impedance match. It is not used for converting voltage to power. The voltage to power conversion always uses the Reference Z parameter. The Reference Z parameter applies to both I and Q channels.

Key Path	Input/Output, I/Q, Q Setup
Remote Command	:INPut [1] :IQ:Q:IMPedance LOW HIGH :INPut [1] :IQ:Q:IMPedance?
Example	Set the Q channel input impedance to 1 MΩ INP:IQ:Q:IMP HIGH
Notes	LOW = 50 Ω, HIGH = 1 MΩ When IQ Path is I+jQ, the I Input Z setting must be the same as the Q Input Z setting. If the settings of the two inputs do not match, an error condition message is generated, 159;Settings Alert;I/Q mismatch:Input Z.
Couplings	Input impedance is a built-in characteristic of a probe. Therefore, whenever a probe is sensed, this key is disabled and the value is set to match the probe. When no probe is sensed and Q Same as I is On, the value set for I will also be copied to Q. This key is disabled when Q Same as I is On.
Preset	LOW
State Saved	Yes This is unaffected by Preset but is set to the default value on a "Restore Input/Output Defaults" or "Restore System Defaults->All"
Range	50 Ω   1 MΩ
Initial S/W Revision	Prior to A.02.00

### Q Skew

Sets the skew factor for the Q channel. The skew will shift the channel's data in time. Use this to compensate for differences in the electrical lengths of the input paths due to cabling and probes.

Key Path	Input/Output, I/Q, Q Setup
Remote Command	[:SENSe]:CORRection:IQ:Q:SKEW <seconds> [:SENSe]:CORRection:IQ:Q:SKEW?
Example	Delay the data for the Q channel by 10 ns. CORR:IQ:Q:SKEW 10 ns
Preset	0
State Saved	Yes This is unaffected by a Preset but is set to the default value on a "Restore Input/Output Defaults" or "Restore System Defaults->All"
Range	0 s to 100 ns

Min	0 s
Max	+100 ns
Initial S/W Revision	Prior to A.02.00

## Q Probe

Accesses the probe setup parameters for the Q channel. See "[I/Q Probe Setup](#)" on page 240.

Key Path	Input/Output, I/Q, Q Setup
State Saved	No
Readback Text	[<Q port probe id> This is reporting the type of probe sensed on the Q port. There is no parameter for overriding what is sensed.
Initial S/W Revision	Prior to A.02.00

## Attenuation

The attenuation is part of the calibration data stored with the probe type and is initially the value that was returned by the last calibration. You can modify this value and any changes will be stored with the calibration data and will survive power cycles and presets. When a probe calibration is performed the attenuation value will be overwritten by the calibration.

Key Path	Input/Output, I/Q, I Setup   Q Setup, I Probe   Q Probe
<b>Remote Command</b>	[ :SENSE ] :CORREction:IQ:I Q:ATTenuation:RATio <real> [ :SENSE ] :CORREction:IQ:I Q:ATTenuation:RATio?
<b>Example</b>	Set the attenuation for the current I probe to 100.00:1. CORR:IQ:I:ATT:RAT 100
Notes	Each probe type has its own attenuation setting. As probes are changed the attenuation value will reflect the new probe's setting. Changing the attenuation affects only the current probe type's setting and leaves all others unchanged. When the IQ Path is I+jQ, the Q probe attenuation setting must match the I Probe attenuation setting within 1 dB. If this is not the case, an error condition message is generated, 159;Settings Alert;I/Q mismatch:Attenuation.
Preset	Each probe type has its own default. The default for the "Unknown" probe type is 1:1.
State Saved	Saved with probe calibration data. It survives a power cycle and is not affected by a Preset or Restore.
Range	0.001 to 10000
Min	0.001
Max	10000
Initial S/W Revision	Prior to A.02.00

This is an alternate form of the SCPI that allows input as a power instead of a ratio.

<b>Remote Command</b>	<code>[ :SENSe ] :CORRection:IQ:I Q:ATTenuation &lt;rel_amp1&gt;</code> <code>[ :SENSe ] :CORRection:IQ:I Q:ATTenuation?</code>
<b>Example</b>	Set the attenuation for the current I probe type to 100.00:1. <code>CORR:IQ:I:ATT 20 dB</code>
<b>Range</b>	-60 dB to +80 dB
<b>Min</b>	-60 dB
<b>Max</b>	+80 dB
<b>Initial S/W Revision</b>	Prior to A.02.00

### Calibrate

Invokes the guided probe calibration. The guided probe calibration is context sensitive and depends on the channel (I or Q) and the Differential Input state. The calibration is only performed on the selected channel. When Differential Input is on, both the probe attached to the main port and the probe attached to the complementary port are calibrated. When Differential Input is off, only the probe attached to the main port is calibrated. See "[I/Q Guided Calibration](#)" on page 283.

<b>Key Path</b>	Input/Output, I/Q, I Setup   Q Setup, I Probe   Q Probe, Coupling
<b>Readback Text</b>	The last calibration date, or if no calibration exists, "(empty)". Last: <cal date> <cal time> Example: Last: 8/22/2007 1:02:49 PM
<b>Initial S/W Revision</b>	Prior to A.02.00

### Clear Calibration

Clears the calibration data for the current port and probe. It does not clear the data for other probe types or other ports. If the sensed probe has EEPROM identification, only the data for that specific probe is cleared. After this command has completed, the probe calibration state will be the same as if no probe calibration had ever been performed for the specified channel and probe. The probe attenuation will be the default value for that probe type and the Cable Calibration frequency response corrections will be used. This command is dependent on the Differential Input state. When Differential Input is on, both the data for the probe attached to the main port and the data for the probe attached to the complementary port are cleared. When Differential Input is off, only data for the probe attached to the main port is cleared.

<b>Key Path</b>	Input/Output, I/Q, I Setup   Q Setup, I Probe   Q Probe
<b>Remote Command</b>	<code>:CALibration:IQ:PROBE:I Q:CLEar</code>
<b>Example</b>	Clear the calibration data for the I channel and the current probe (with EEPROM identification) or probe type (without EEPROM identification).

	:CAL:IQ:PROBe:I:CLE
Initial S/W Revision	Prior to A.02.00

## Reference Z

Sets the value of the impedance to be used in converting voltage to power for the I and Q channels. This does not change the hardware's path impedance (see "[I Input Z](#)" on page 230).

Key Path	Input/Output, I/Q
<b>Remote Command</b>	:INPut:IMPedance:REFeRence <integer> :INPut:IMPedance:REFeRence?
<b>Example</b>	Set the I/Q reference impedance to 50 $\Omega$ INP:IMP:REF 50
Preset	50 $\Omega$
State Saved	Yes This is unaffected by a Preset but is set to the default value on a "Restore Input/Output Defaults" or "Restore System Defaults->All"
Range	1 $\Omega$ to 1 M $\Omega$
Min	1 $\Omega$
Max	1 M $\Omega$
Initial S/W Revision	Prior to A.02.00

## I/Q Cable Calibrate...

The I/Q cable calibration creates correction data for each of the front panel I/Q ports. This calibration data is used whenever no probe specific calibration data is available. It is important that all ports are calibrated using the same short BNC cable so that the data is comparable from port to port.

The guided calibration (front panel only) will show connection diagrams and guide you through the isolation calibration and calibrating each port. The calibration data for each port is stored separately, so as soon as a port is calibrated that data is saved and will be used. If you press "Exit" to exit the calibration process, the data for the ports already completed will still be used. It is recommended that a calibration be completed once started, or if exited, that it be properly done before the next use of the I/Q ports. The "Next" button will perform the calibration for the current port and then proceed to the next step in the calibration procedure. The "Back" button will return to the prior port in the procedure. Both keys and dialog buttons are supplied for ease of use. The dialog buttons are for mouse use and the softkeys for front panel use.

The calibration can also be done via SCPI, but no connection diagrams will be shown. You will have to make the correct connections before issuing each port calibration command. Again, it is recommended that all ports be calibrated at the same time.

The instrument state remains as it was prior to entering the calibration procedure except while a port is actually being calibrated. Once a port is calibrated it returns to the prior state. A port calibration is in

process only from the time the "Next" button is pressed until the next screen is shown. For SCPI, this corresponds to the time from issuing the CAL:IQ:FLAT:I|B|Q|QB command until the operation is complete.

For example, if the prior instrument state is Cal Out = Off, Input = I+jQ, and Differential = Off, then up until the time the "Next" button is pressed the I Input and Q Input LEDs are on and the Cal Out, I-bar Input and Q-bar Input LEDs are off. Once the "Next" button is pressed for the I port calibration, only the Cal Out and I Input LEDs will be on and the others will be off. When the screen progresses to the next step ("Next" button again enabled), the prior state is restored and only the I Input and Q Input LEDs are on (Cal Out is off again).

The last calibration date and time for each port will be displayed. Any calibrations that are more than a day older than the most recent calibration will be displayed with the color amber.

Key Path	Input/Output, I/Q
Initial S/W Revision	Prior to A.02.00

### I/Q Probe Setup

The set of I/Q probe setup parameters will change based on the type of probe that is sensed. All probe types have the Attenuation parameter, and all probe types can be calibrated. The remaining parameters are only available for some probe types and will not be shown when not available. The probe type is determined by and reported for only for the I and Q ports, never the I-bar or Q-bar ports. The menu title will be "<ch>: <probe id>", where "<ch>" is either "I" or "Q" and "<probe id>" is the type of probe. For example, for the I Probe setup with an Agilent 1130A probe connected to the I port, the title will be "I: 1130A".

Probe calibration data is stored for each probe type for each channel. When no probe is sensed, the probe type "Unknown" is used, and this is also treated like a probe type with its own calibration data. When a probe is changed, the calibration data for that probe type for that port is restored. An advisory message will be displayed showing the new probe type and the calibration status. The calibration data is stored permanently (survives a power cycle) and is not affected by a Preset or any of the Restore commands. When the probe has EEPROM identification (most newer Agilent probes have this), the calibration data is stored by probe serial number and port, so if you have two probes of the same type, the correct calibration data will be used for each. For probes that do not have EEPROM identification, the calibration data is stored by probe type and port and the instrument cannot distinguish between different probes of the same type. In all cases (with or without EEPROM identification), the calibration data is port specific, so it will not follow a specific probe from port to port if the probe is moved.

The "Unknown" probe type is used whenever no probe is sensed. When no calibration data exists for "Unknown" the latest cable calibration data is used (see ["I/Q Guided Calibration" on page 283](#)).

### Attenuation

The attenuation is part of the calibration data stored with the probe type and is initially the value that was returned by the last calibration. You can modify this value and any changes will be stored with the calibration data and will survive power cycles and presets. When a probe calibration is performed the attenuation value will be overwritten by the calibration.

Key Path	Input/Output, I/Q, I Setup   Q Setup, I Probe   Q Probe
Remote Command	[ :SENSe ] :CORRection:IQ:I Q:ATTenuation:RATio <real> [ :SENSe ] :CORRection:IQ:I Q:ATTenuation:RATio?



<b>Example</b>	Set the attenuation for the current I probe to 100.00:1. CORR:IQ:I:ATT:RAT 100
<b>Notes</b>	Each probe type has its own attenuation setting. As probes are changed the attenuation value will reflect the new probe's setting. Changing the attenuation affects only the current probe type's setting and leaves all others unchanged.  When the IQ Path is I+jQ, the Q probe attenuation setting must match the I Probe attenuation setting within 1 dB. If this is not the case, an error condition message is generated, 159;Settings Alert;I/Q mismatch:Attenuation.
<b>Preset</b>	Each probe type has its own default. The default for the "Unknown" probe type is 1:1.
<b>State Saved</b>	Saved with probe calibration data. It survives a power cycle and is not affected by a Preset or Restore.
<b>Range</b>	0.001 to 10000
<b>Min</b>	0.001
<b>Max</b>	10000
<b>Initial S/W Revision</b>	Prior to A.02.00

This is an alternate form of the SCPI that allows input as a power instead of a ratio.

<b>Remote Command</b>	<code>[ :SENSe ] :CORRection:IQ:I Q:ATTenuation &lt;rel_ampl&gt;</code> <code>[ :SENSe ] :CORRection:IQ:I Q:ATTenuation?</code>
<b>Example</b>	Set the attenuation for the current I probe type to 100.00:1. CORR:IQ:I:ATT 20 dB
<b>Range</b>	-60 dB to +80 dB
<b>Min</b>	-60 dB
<b>Max</b>	+80 dB
<b>Initial S/W Revision</b>	Prior to A.02.00

## Offset

Some active probes have DC offset capability. When one of these probes is connected this control will be visible. The signal is adjusted for the DC offset before entering the analyzer's port. This allows for removal of a DC offset before reaching the analyzer's input port voltage limits. For example, a signal that varies 1 V peak-to-peak with a DC offset equal to the analyzer's max input voltage would exceed the input limits of the analyzer for half its cycle. Removing the DC offset allows the analyzer to correctly process the entire signal.

<b>Key Path</b>	Input/Output, I/Q, I Setup   Q Setup, I Probe   Q Probe
<b>Remote Command</b>	<code>:INPut:OFFSet:I Q &lt;voltage&gt;</code> <code>:INPut:OFFSet:I Q?</code>
<b>Example</b>	Remove a DC offset of -0.5 V from the I channel input. INP:OFFS:I -0.5

Notes	Only some probe types support Offset. For those that do, each probe type has its own Offset setting. As probes are changed the Offset value will reflect the new probe's setting. Changing the Offset affects only the current probe type's setting and leaves all others unchanged.
Preset	0 V
State Saved	Saved with probe calibration data. It survives power cycle and is not affected by Preset or Restore.
Range	-18 V to +18 V
Min	-18 V
Max	+18 V
Initial S/W Revision	Prior to A.02.00

### Coupling

Some probe types allow coupling to reject low frequencies. This will filter out the DC component of a signal that is composed of a DC bias plus some AC signal. This control is visible only for probe types that have this capability.

Key Path	Input/Output, I/Q, I Setup   Q Setup, I Probe   Q Probe
Remote Command	:INPut:COUPling:I Q DC LFR1 LFR2 :INPut:COUPling:I Q?
Example	Set the probe to low frequency rejection below 1.7 Hz. INP:COUP:I LFR1
Notes	Only some probe types support Coupling. For those that do, each probe type has its own Coupling setting. As probes are changed the Coupling value will reflect the new probe's setting. Changing the Coupling affects only the current probe type's setting and leaves all others unchanged.
Preset	DC
State Saved	Saved with probe calibration data. It survives a power cycle and is not affected by a Preset or Restore.
Range	DC   AC 1.7 Hz LFR1   AC 0.14 Hz LFR2
Readback Text	DC   LFR1   LFR2
Initial S/W Revision	Prior to A.02.00

### DC

Turns off low frequency rejection, allowing signals down to DC.

Key Path	Input/Output, I/Q, I Setup   Q Setup, I Probe   Q Probe, Coupling
Example	Turn off low frequency rejection on the I channel INP:COUP:I DC
Initial S/W Revision	Prior to A.02.00

## LFR1

Turns on low frequency rejection, rejecting signal component lower than 1.7 Hz.

Key Path	Input/Output, I/Q, I Setup   Q Setup, I Probe   Q Probe, Coupling
<b>Example</b>	Turn on low frequency rejection on the I channel for frequencies lower than 1.7 Hz INP:COUP:I LFR1
Initial S/W Revision	Prior to A.02.00

## LFR2

Turns on low frequency rejection, rejecting signal component lower than 0.14 Hz.

Key Path	Input/Output, I/Q, I Setup   Q Setup, I Probe   Q Probe, Coupling
<b>Example</b>	Turn on low frequency rejection on the I channel for frequencies lower than 0.14 Hz INP:COUP:I LFR2
Initial S/W Revision	Prior to A.02.00

## Calibrate

Invokes the guided probe calibration. The guided probe calibration is context sensitive and depends on the channel (I or Q) and the Differential Input state. The calibration is only performed on the selected channel. When Differential Input is on, both the probe attached to the main port and the probe attached to the complementary port are calibrated. When Differential Input is off, only the probe attached to the main port is calibrated. See "[I/Q Guided Calibration](#)" on page 283.

Key Path	Input/Output, I/Q, I Setup   Q Setup, I Probe   Q Probe, Coupling
Readback Text	The last calibration date, or if no calibration exists, "(empty)". Last: <cal date> <cal time> Example: Last: 8/22/2007 1:02:49 PM
Initial S/W Revision	Prior to A.02.00

## Clear Calibration

Clears the calibration data for the current port and probe. It does not clear the data for other probe types or other ports. If the sensed probe has EEPROM identification, only the data for that specific probe is cleared. After this command has completed, the probe calibration state will be the same as if no probe calibration had ever been performed for the specified channel and probe. The probe attenuation will be the default value for that probe type and the Cable Calibration frequency response corrections will be used. This command is dependent on the Differential Input state. When Differential Input is on, both the data for

the probe attached to the main port and the data for the probe attached to the complementary port are cleared. When Differential Input is off, only data for the probe attached to the main port is cleared.

<b>Key Path</b>	Input/Output, I/Q, I Setup   Q Setup, I Probe   Q Probe
<b>Remote Command</b>	:CALibration:IQ:PROBE:I Q:CLEar
<b>Example</b>	Clear the calibration data for the I channel and the current probe (with EEPROM identification) or probe type (without EEPROM identification). :CAL:IQ:PROBE:I:CLE
<b>Initial S/W Revision</b>	Prior to A.02.00

## RF Calibrator

Lets you choose a calibrator signal to look at or turns the calibrator "off".

<b>Key Path</b>	Input/Output
<b>Remote Command</b>	[[:SENSe]:FEED:AREFERENCE REF50 REF4800 OFF [:SENSe]:FEED:AREFERENCE?
<b>Example</b>	FEED:AREF REF50 selects the 50 MHz amplitude reference as the signal input. FEED:AREF REF4800 selects the 4.8 GHz amplitude reference as the signal input FEED:AREF OFF turns the calibrator "off" (switches back to the selected input – RF or I/Q)
<b>Dependencies</b>	Selecting an input (RF or I/Q) turns the Calibrator OFF. This is true whether the input is selected by the keys or with the [:SENSe]:FEED command.  The 4.8 GHz internal reference is only available in some models and frequency range options. If the 4.8 GHz reference is not present, the 4.8 GHz softkey will be blanked, and if the REF4800 parameter is sent, the analyzer will generate an error.
<b>Couplings</b>	When one of the calibrator signals is selected, the analyzer routes that signal (an internal amplitude reference) to the analyzer, and changes the main input selection to RF so the calibrator signal can be seen. When you turn the calibrator off it does not switch back to the previously selected input.
<b>Preset</b>	OFF
<b>State Saved</b>	Saved in instrument state
<b>Readback</b>	Off, 50 MHz, 4.8 GHz
<b>Initial S/W Revision</b>	Prior to A.02.00

<b>Remote Command</b>	:CALibration:SOURce:STATe OFF ON 0 1 :CALibration:SOURce:STATe?
<b>Notes</b>	For ESA backwards compatibility.  In the ESA the calibrator was a separate output which you connected to the input and switched on with this command.  In the X-Series, the ON parameter is aliased to the [:SENSe]:FEED:AREF REF50 command and the OFF parameter is aliased to [:SENSe]:FEED:AREF OFF.

	When CALibration:SOURce:STATe? is received, 1 will be returned if any of the references is selected and 0 if the Calibrator is "Off"
Preset	OFF
Initial S/W Revision	Prior to A.02.00

## 50 MHz

Selects the 50 MHz internal reference as the input signal.

Key Path	Input/Output, RF Calibrator
<b>Example</b>	:FEED:AREF REF50
Readback	50 MHz
Initial S/W Revision	Prior to A.02.00

## 4.8 GHz

Selects the 4.8 GHz internal reference as the input signal.

Key Path	Input/Output, RF Calibrator
<b>Example</b>	:FEED:AREF REF4800
Dependencies	The 4.8 GHz internal reference is only available in some models and frequency range options. If the 4.8 GHz reference is not present, the 4.8 GHz softkey will be blanked, and if the REF4800 parameter is sent, the analyzer will generate an error.
Readback	4.8 GHz
Initial S/W Revision	Prior to A.02.00
Modified at S/W Revision	A.03.00

## Off

Switches the input back to the selected input (RF or I/Q)

Key Path	Input/Output, RF Calibrator
<b>Example</b>	:FEED:AREF OFF
Readback	Off
Initial S/W Revision	Prior to A.02.00

## External Gain

Compensates for gain or loss in the measurement system outside the spectrum analyzer. The External Gain is subtracted from the amplitude readout (or the loss is added to the amplitude readout). So, the displayed signal level represents the signal level at the output of the device-under-test, which can be the input of an external device that provides gain or loss.

Entering an External Gain value does not affect the Reference Level, therefore the trace position on screen changes, as do all of the values represented by the trace data. Thus, the values of exported trace data, queried trace data, marker amplitudes, trace data used in calculations such as N dB points, trace math, peak threshold, etc., are all affected by External Gain. Changing the External Gain, even on a trace that is not updating, will immediately change all of the above, without new data needing to be taken.

### NOTE

Changing the External Gain causes the analyzer to immediately stop the current sweep and prepare to begin a new sweep. The data will not change until the trace data updates because the offset is applied to the data as it is taken. If a trace is exported with a nonzero External Gain, the exported data will contain the trace data with the offset applied.

In the Spectrum Analyzer mode, a Preamp is the common external device providing gain or loss. In a measurement application mode like GSM or W-CDMA, the gain or loss could be from a BTS (Base Transceiver Station) or an MS (Mobile Station). So in the Spectrum Analyzer mode MS and BTS would be grayed out and the only choice would be Ext Preamp. Similarly in some of the digital communications applications, Ext Preamp will be grayed out and you would have a choice of MS or BTS.

Key Path	Input/Output
Couplings	The Ext Preamp, MS, and BS keys may be grayed out depending on which measurement is currently selected. If any of the grayed out keys are pressed, or the equivalent SCPI command is sent, an advisory message is generated.
Readback	1-of-N selection   [variable]
Initial S/W Revision	Prior to A.02.00

## Ext Preamp

This function is similar to the reference level offset function. Both affect the displayed signal level. Ref Lvl Offset is a mathematical offset only, no analyzer configuration is affected. Ext Preamp gain is used when determining the auto-coupled value of the Attenuator. The External Gain value and the Maximum Mixer Level settings are both part of the automatic setting equation for the RF attenuation setting. (10 dB of Attenuation is added for every 10 dB of External Gain.)

Note that the Ref Lvl Offset and Maximum Mixer Level are described in the Amplitude section. They are reset by the instrument Preset. The External Preamp Gain is reset by the "Restore Input/Output Defaults" or "Restore System Defaults->All functions. . The External Gain is subtracted from the amplitude readout so that the displayed signal level represents the signal level at the output of the device-under-test, which is the input of the external device that is providing gain or loss.

["More Information" on page 247](#)

Key Path	Input/Output, External Gain
----------	-----------------------------

<b>Remote Command</b>	<code>[ :SENSe ] :CORRection:SA[:RF]:GAIN &lt;rel_ampl&gt;</code> <code>[ :SENSe ] :CORRection:SA[:RF]:GAIN?</code>
<b>Example</b>	CORR:SA:GAIN 10 sets the Ext Gain value to 10 dB CORR:SA:GAIN -10 sets the Ext Gain value to -10 dB (that is, an attenuation of 10 dB)
<b>Notes</b>	Does not auto return.
<b>Dependencies</b>	The reference level limits are determined in part by the External Gain/Atten, Max Mixer Level, and RF Atten. This key is grayed out in Modes that do not support External Gain
<b>Preset</b>	This is unaffected by Preset but is set to 0 dB on a "Restore Input/Output Defaults" or "Restore System Defaults->All"
<b>State Saved</b>	Saved in instrument state
<b>Min</b>	-120 dB
<b>Max</b>	120 dB
<b>Readback</b>	Preamp Gain, <Ext Gain value> dB
<b>Backwards Compatibility SCPI</b>	<code>[ :SENSe ] :CORRection:OFFSet[:MAGNitude]</code> The legacy "Ext Preamp Gain" key is now called "Ext Gain" and the sub-menu has choices of Ext Preamp   MS   BTS for backwards compatibility.
<b>Initial S/W Revision</b>	Prior to A.02.00
<b>Modified at S/W Revision</b>	A.14.00

## More Information

The U7227A USB Preamplifier is an accessory for the X-Series Signal Analyzer that provides gain externally, and whose gain settings are automatically loaded into the analyzer over USB whenever it is connected to one of the analyzer's USB ports.

While the USB Preamplifier is plugged into one of the analyzer's USB ports, the analyzer will consider it to be in the signal path of the RF Input and will apply the calibration data from the USB Preamp to measurements taken at the RF Input (on 2 input boxes, it will be considered to be in the signal path of RF Input 1; it is not supported for RF Input 2).

The USB Preamplifier contains its own cal data. This includes a noise trace suitable for use with NFE, for those models which support NFE. The act of connecting the Preamp to USB will cause the cal data to be downloaded from the preamp. When this happens an informational message is provided saying "Cal data loaded from USB Preamp". The analyzer will then automatically apply the calibration factors loaded from the Preamp in any measurement that supports the USB Preamp.

The External Preamp Gain setting may still be used, even though it is not required for the USB Preamp (since the USB Preamp supplies its own gain data to the analyzer which is applied automatically). Connecting the USB Preamp does not change the External Preamp Gain setting, however unless you have another gain or attenuation element in the signal path, the appropriate setting for External Preamp Gain is 0 dB.

Overload detection and reporting will apply when the USB preamplifier is connected to USB. The USB Preamplifier has its own overload detector which reports overloads to the instrument over USB. This generates an error condition, "Input Overload;USB Preamp."

If, while the USB Preamp is connected to USB, a measurement is selected that does not support the USB preamplifier, the "No result; Meas invalid with Preamp" error condition is generated.

## MS

Sets an external gain/attenuation value for MS (Mobile Station) tests.

Key Path	Input/Output, External Gain
Remote Command	<code>[ :SENSe]:CORRection:MS[:RF]:GAIN &lt;rel_ampl&gt;</code> <code>[ :SENSe]:CORRection:MS[:RF]:GAIN?</code>
Example	<code>CORR:MS:GAIN 10</code> sets the Ext Gain value to 10 dB <code>CORR:MS:GAIN -10</code> sets the Ext Gain value to -10 dB (that is, a loss of 10 dB.)
Notes	Does not auto return.
Dependencies	The reference level limits are determined in part by the External Gain, Max Mixer Level, RF Atten This key is grayed out in modes that do not support MS.
Preset	This is unaffected by a Preset but is set to 0 dB on a "Restore Input/Output Defaults" or "Restore System Defaults->All"
State Saved	Saved in instrument state.
Min	-100 dB
Max	100 dB
Readback	MS, <Ext Gain value> dB
Initial S/W Revision	Prior to A.02.00

Remote Command	<code>[ :SENSe]:CORRection:MS[:RF]:LOSS &lt;rel_ampl&gt;</code> <code>[ :SENSe]:CORRection:MS[:RF]:LOSS?</code>
Example	<code>CORR:MS:LOSS 10</code> sets the Ext Gain value to -10 dB, and subsequently querying <code>:LOSS</code> will give 10 dB <code>CORR:MS:LOSS -10</code> sets the Ext Gain value to 10 dB, and subsequently querying <code>:LOSS</code> will give -10 dB
Notes	A positive value of <rel_ampl> in the above command means a loss and a negative value indicates a gain. Anytime <code>:LOSS</code> is set it sets <code>:GAIN</code> to the negative value of the parameter sent. Anytime <code>:LOSS</code> is queried it gives the negative of <code>:GAIN</code>
Preset	This is unaffected by a Preset but is set to 0 dB on a "Restore Input/Output Defaults" or "Restore System Defaults->All"
Min	100 dB
Max	-100 dB
Initial S/W Revision	Prior to A.02.00



## BTS

Sets an external attenuation value for BTS (Base Transceiver Station) tests.

Key Path	Input/Output, External Gain
Remote Command	<code>[ :SENSe]:CORRection:BTS[:RF]:GAIN &lt;rel_ampl&gt;</code> <code>[ :SENSe]:CORRection:BTS[:RF]:GAIN?</code>
Example	<code>CORR:BTS:GAIN 10</code> sets the Ext Gain value to 10 dB <code>CORR:BTS:GAIN -10</code> sets the Ext Gain value to -10 dB (that is, a loss of 10 dB.)
Notes	Does not auto return.
Dependencies	The reference level limits are determined in part by the External Gain, Max Mixer Level, RF Atten This key is grayed out in modes that do not support BTS.
Preset	This is unaffected by a Preset but is set to 0 dB on a "Restore Input/Output Defaults" or "Restore System Defaults->All"
State Saved	Saved in instrument state.
Min	-100 dB
Max	100 dB
Readback	BTS, <Ext Gain value> dB
Initial S/W Revision	Prior to A.02.00

Remote Command	<code>[ :SENSe]:CORRection:BTS[:RF]:LOSS &lt;rel_ampl&gt;</code> <code>[ :SENSe]:CORRection:BTS[:RF]:LOSS?</code>
Example	<code>CORR:BTS:LOSS 10</code> sets the Ext Gain value to -10 dB, and subsequently querying <code>:LOSS</code> will give 10 dB <code>CORR:BTS:LOSS -10</code> sets the Ext Gain value to 10 dB, and subsequently querying <code>:LOSS</code> will give -10 dB
Notes	A positive value of <rel_ampl> in the above command means a loss and a negative value indicates a gain. Anytime <code>:LOSS</code> is set it sets <code>:GAIN</code> to the negative value of the parameter sent. Anytime <code>:LOSS</code> is queried it gives the negative of <code>:GAIN</code>
Preset	This is unaffected by a Preset but is set to 0 dB on a "Restore Input/Output Defaults" or "Restore System Defaults->All"
Min	100 dB
Max	-100 dB
Initial S/W Revision	Prior to A.02.00

## I Ext Gain

This function affects the I channel input. However, when Q Gain in I+jQ is set to Same as I Gain, this value is applied to both I and Q channel inputs.

Key Path	Input/Output, External Gain
Remote Command	<code>[ :SENSe]:CORRection:IQ:I:GAIN &lt;rel_ampl&gt;</code> <code>[ :SENSe]:CORRection:IQ:I:GAIN?</code>
Example	Set the I Ext Gain to 10 dB <code>CORR:IQ:I:GAIN 10</code> Set the I Ext Gain to -10 dB (that is, a loss of 10 dB.) <code>CORR:IQ:I:GAIN -10</code>
Dependencies	Not available unless option BBA is installed
Preset	0 dB This is unaffected by a Preset but is set to 0 dB on a "Restore Input/Output Defaults" or "Restore System Defaults->All"
State Saved	Saved in instrument state.
Min	-100 dB
Max	100 dB
Readback Text	I Gain, <I Ext Gain> dB
Initial S/W Revision	Prior to A.02.00

## Q Ext Gain

This function affects the Q channel input.

Key Path	Input/Output, External Gain
Remote Command	<code>[ :SENSe]:CORRection:IQ:Q:GAIN &lt;rel_ampl&gt;</code> <code>[ :SENSe]:CORRection:IQ:Q:GAIN?</code>
Example	Set the Q Ext Gain to 10 dB <code>CORR:IQ:Q:GAIN 10</code> Set the Q Ext Gain to -10 dB (that is, a loss of 10 dB.) <code>CORR:IQ:Q:GAIN -10</code>
Dependencies	Not available unless option BBA is installed.
Preset	0 dB This is unaffected by a Preset but is set to 0 dB on a "Restore Input/Output Defaults" or "Restore System Defaults->All"
State Saved	Saved in instrument state
Min	-100 dB

Max	100 dB
Readback Text	Q Gain, <I Ext Gain> dB
Initial S/W Revision	Prior to A.02.00

## Restore Input/Output Defaults

This selection causes the group of settings and data associated with the Input/Output key to be a reset to their default values. In addition, when a Source is installed, licensed and selected, Restore Input/Output defaults will initiate a Source Preset.

This level of Restore System Defaults does not affect any other system settings or mode settings and does not cause a mode switch. All the features described in this section are reset using this key, including Input Corrections and Data (described in the Corrections section).

Key Path	Input/Output
<b>Example</b>	:SYST:DEF INP presets all the Input/Output variables to their factory default values.
Notes	Refer to the Utility Functions for information about Restore System Defaults and the complete description of the :SYSTem:DEFAult INPut: command.
Initial S/W Revision	Prior to A.02.00

## Data Source

Gives you the choice of either using a hardware input signal as the input or raw data stored in a data storage buffer from an earlier acquisition. You can also share raw data across certain measurements that support this feature. The measurements must be capable of storing raw data. There are three choices under this menu. You can select "Inputs" which is the same as selecting one of the inputs from the input port, for example RF, AREF, I/Q, or IFAlign. Selecting "Capture Buffer" allows you to use data that has been stored earlier in the same measurement or from a previous measurement using the "Current Meas -> Capture Buffer" feature. Selecting "Recorded Data" allows you to playback long data capture records stored in the record buffer.

Key Path	Input/Output
<b>Remote Command</b>	[ :SENSe ] :FEED:DATA INPut   STORed [ :SENSe ] :FEED:DATA?
<b>Example</b>	FEED:DATA STOR FEED:DATA?
Notes	INPut = Inputs STORed = Capture Buffer
Dependencies	Not all inputs are available in all modes. Unavailable keys are grayed out.
Preset	This is unaffected by Preset but is set to INPut on a "Restore Input/Output Defaults" or "Restore

System Defaults->All"	
State Saved	Saved in instrument state
Readback	Variable
<b>Backwards Compatibility SCPI</b>	[ :SENSe ] :FEED:SOURce INPut STORed
	[ :SENSe ] :FEED:SOURce?
Initial S/W Revision	Prior to A.02.00

## Inputs

Sets the measurement to use the input selections (RF, AREF, I/Q)

Key Path	Input/Output, Data Source
<b>Example</b>	FEED:DATA INP causes the measurement to look at the input selection
Notes	Does not auto return.
Readback	Inputs
Initial S/W Revision	Prior to A.02.00

## Capture Buffer

Some WCDMA and demod measurements support this feature. This allows sharing of the raw data across certain measurements. If you want to make another measurement on the same signal, you would store that raw data using the "Current Meas -> Capture Buffer" key. Then the data is available for the next measurement to use. You must have raw data stored in the instrument memory before the Capture Buffer choice is available for use.

Key Path	Input/Output, Data Source
<b>Example</b>	FEED:DATA STOR causes stored measurement data to be used with a different measurement that supports this.
Notes	Does not auto return. This key is grayed out when you switch to a measurement that does not support this feature.
Dependencies	If you switch to a measurement that does not support this feature, then the instrument switches to use "Inputs" and grays out this key. If the grayed out key is pressed, it generates a message.
Readback	Stored Data
Initial S/W Revision	Prior to A.02.00

## Current Meas -> Capture Buffer

Pressing this key stores the raw data of one measurement in the internal memory of the instrument where it can then be used by a different measurement by pressing "Stored Data". When raw data is stored, then

the data source selection switch automatically changes to "Stored Data". Stored raw data cannot be directly accessed by a user. There is no save/recall function to save the raw data in an external media. However if you want to get the stored raw data, you must first perform a measurement using the stored raw data. Now you can access the used raw data, which is the same as stored raw data, using the FETCh or READ commands.

<b>Key Path</b>	Input/Output, Data Source
<b>Remote Command</b>	[ :SENSe ] :FEED:DATA:STORe
<b>Example</b>	FEED:DATA:STOR stores recorded data
<b>Notes</b>	This is command only, there is no query
<b>Dependencies</b>	Grayed out in the SA measurement.
<b>Backwards Compatibility SCPI</b>	[ :SENSe ] :FEED:SOURce:STORe
<b>Initial S/W Revision</b>	Prior to A.02.00

## Corrections

This key accesses the Amplitude Corrections menu.

Amplitude Corrections arrays can be entered, sent over SCPI, or loaded from a file. They allow you to correct the response of the analyzer for various use cases. The X-series supports four separate Corrections arrays, each of which can contain up to 2000 points. They can be turned on and off individually and any or all can be on at the same time.

Trace data is in absolute units and corrections data is in relative units, but we want to be able to display trace data at the same time as corrections data. Therefore we establish a reference line to be used while building or editing a Corrections table. The reference line is halfway up the display and represents 0 dB of correction. It is labeled "0 dB CORREC". It is drawn in blue.

Corrections data is always in dB. Whatever dB value appears in the correction table represents the correction applied to that trace at that frequency. So if a table entry shows 30 dB that means we ADD 30 dB to each trace to correct it before displaying it.

In zero span, where the frequency is always the center frequency of the analyzer, we apply the (interpolated) correction for the center frequency to all points in the trace. In the event where there are two correction amplitudes at the center frequency, we apply the first one in the table.

Note that the corrections are applied as the data is taken; therefore, a trace in View (Update Off) will not be affected by changes made to the corrections table after the trace is put in View.

<b>Key Path</b>	Input/Output, Corrections
<b>Mode</b>	SA, I/Q Analyzer, Phase Noise, VXA, RTSA, EMI Receiver, DVB-T/H, DTMB, DVB-T/H, DTMB, W-CDMA, LTE & LTE-Adv FDD, LTE & LTE-Adv TDD, Sequence Analyzer, BTooth
<b>Dependencies</b>	This key will only appear if you have the proper option installed in your instrument. Amplitude correction may not be available in all modes; if a mode does not support amplitude correction, the Corrections key should be blanked while in that mode. If an application supports corrections but the current measurement does not, then the key should be grayed out in that

	measurement
Preset	Corrections arrays are reset (deleted) by Restore Input/Output Defaults. They survive shutdown and restarting of the analyzer application, which means they will survive a power cycle.
Initial S/W Revision	A.02.00
Modified at S/W Revision	x.14.50

## Select Correction

Specifies the selected correction. The term "selected correction" is used throughout this document to specify which correction will be affected by the functions.

Key Path	Input/Output, Corrections
Mode	SA, I/Q Analyzer, Phase Noise, VXA, RTSA, EMI Receiver, DVB-T/H, DTMB, DVB-T/H, DTMB, W-CDMA, LTE & LTE-Adv FDD, LTE & LTE-Adv TDD, Sequence Analyzer, BTooth
Notes	The selected correction is remembered even when not in the correction menu.
Preset	Set to Correction 1 by Restore Input/Output Defaults
Readback	Correction 1 Correction 2 Correction 3 Correction 4 Correction 5 Correction 6 Correction 7 Correction 8
Initial S/W Revision	A.02.00
Modified at S/W Revision	x.14.50

## Correction On/Off

Turning the Selected Correction from the OFF state to the ON state allows the values in it to be applied to the data. This state transition also automatically turns on "Apply Corrections" (sets it to ON), otherwise the correction would not take effect.

A new sweep is initiated if an amplitude correction is switched on or off. Note that changing, sending or loading corrections data does NOT directly initiate a sweep, however in general these operations will turn corrections on, which DOES initiate a sweep.

Key Path	Input/Output, Corrections
<b>Remote Command</b>	<code>[[:SENSe]:CORRection:CSET[1] 2 ... 8[:STATe] ON OFF 1 0</code> <code>[[:SENSe]:CORRection:CSET[1] 2 ... 8[:STATe]?</code>
<b>Example</b>	<code>SENS:CORR:CSET1 ON</code>
Dependencies	Changing this from the OFF state to the ON state automatically turns on "Apply Corrections". Only the first correction array (Correction 1) supports antenna units. When this array is turned on, and it contains an Antenna Unit other than "None", the Y Axis Unit of the analyzer is forced to that Antenna Unit. All other Y Axis Unit choices are grayed out. Note that this means that a correction file with an Antenna Unit can only be loaded into the Corrections 1 register. Consequently only for Correction 1 does the dropdown in the Recall dialog

	include.ant, and if an attempt is made to load a correction file into any other Correction register which DOES contain an antenna unit, a Mass Storage error is generated. This command will generate an "Option not available" error unless you have the proper option installed in your instrument.
Preset	Not affected by a Preset. Set to OFF by Restore Input/Output Defaults
State Saved	Saved in instrument state.
Backwards Compatibility Notes	Unlike legacy analyzers, Preset does not turn Corrections off (Restore Input/Output Defaults does).
Initial S/W Revision	A.02.00
Modified at S/W Revision	A.14.00

## Properties

Accesses a menu that lets you set the properties of the selected correction.

Key Path	Input/Output, Corrections
Initial S/W Revision	A.02.00

## Select Correction

Specifies the selected correction. The term "selected correction" is used throughout this document to specify which correction will be affected by the functions.

Key Path	Input/Output, Corrections
Mode	SA, I/Q Analyzer, Phase Noise, VXA, RTSA, EMI Receiver, DVB-T/H, DTMB, DVB-T/H, DTMB, W-CDMA, LTE & LTE-Adv FDD, LTE & LTE-Adv TDD, Sequence Analyzer, BTooth
Notes	The selected correction is remembered even when not in the correction menu.
Preset	Set to Correction 1 by Restore Input/Output Defaults
Readback	Correction 1 Correction 2 Correction 3 Correction 4 Correction 5 Correction 6 Correction7 Correction8
Initial S/W Revision	A.02.00
Modified at S/W Revision	x.14.50

## Antenna Unit

For devices (like antennas) that make measurements of field strength or flux density, the correction array should contain within its values the appropriate conversion factors such that, when the data on the analyzer is presented in dB $\mu$ V, the display is calibrated in the appropriate units. The "Antenna Unit" used for the conversion is contained within the corrections array database. It may be specified or loaded in from an external file or SCPI.

When an array with an Antenna Unit other than "None" is turned on, the Y Axis Unit of the analyzer is forced to that unit. When this array is turned on, and it contains an Antenna Unit other than "None", the Y Axis Unit of the analyzer is forced to that Antenna Unit., and all other Y Axis Unit choices are grayed out.

Antenna Unit does not appear in all Modes that support Corrections. Only the modes listed in the Mode row of the table below support Antenna Units.

<b>Key Path</b>	Input/Output, Corrections, Properties
<b>Mode</b>	SA, I/Q Analyzer, Phase Noise, VXA, RTSA, EMI Receiver, DVB-T/H, DTMB, DVB-T/H, DTMB, W-CDMA, LTE & LTE-Adv FDD, LTE & LTE-Adv TDD, Sequence Analyzer, BTooth
<b>Remote Command</b>	[ :SENSe ] :CORRection:CSET[1]:ANTenna[:UNIT] GAUSS   PTES1a   UVM   UAM   UA   NOConversion  [ :SENSe ] :CORRection:CSET[1]:ANTenna[:UNIT] ?
<b>Example</b>	CORR:CSET:ANT GAUS
<b>Dependencies</b>	Only the first correction array (Correction 1) supports antenna units. Note that this means that a correction file with an Antenna Unit can only be loaded into the Corrections 1 register. Consequently only for Correction 1 does the dropdown in the Recall dialog include.ant, and if an attempt is made to load a correction file into any other Correction register which DOES contain an antenna unit, a Mass Storage error is generated.
<b>Preset</b>	Unaffected by Preset. Set to NOC by Restore Input/Output Defaults
<b>State Saved</b>	Saved in instrument state
<b>Initial S/W Revision</b>	A.02.00
<b>Modified at S/W Revision</b>	x.14.50

#### None

Selects no antenna unit for this Correction set. Thus no Y Axis unit will be forced.

<b>Key Path</b>	Input/Output, Corrections, Properties, Antenna Unit
<b>Example</b>	:CORR:CSET:ANT NOC
<b>Readback</b>	"None"
<b>Initial S/W Revision</b>	A.02.00

#### dBμV/m

Sets the antenna unit to dBμV/m. If this correction is turned on, and Apply Corrections is on, the Y Axis Unit will then be forced to dBμV/m and all other Y Axis Unit selections will be grayed out.

<b>Key Path</b>	Input/Output, Corrections, Properties, Antenna Unit
<b>Example</b>	:CORR:CSET:ANT UVM
<b>Readback</b>	"dBμV/m"
<b>Initial S/W Revision</b>	A.02.00



**dB $\mu$ A/m**

Sets the antenna unit to dB $\mu$ A/m. If this correction is turned on, and Apply Corrections is on, the Y Axis Unit will then be forced to dB $\mu$ A/m and all other Y Axis Unit selections will be grayed out.

Key Path	Input/Output, Corrections, Properties, Antenna Unit
<b>Example</b>	:CORR:CSET:ANT UVA
Readback	" dB $\mu$ A/m"
Initial S/W Revision	A.02.00

**dBpT**

Sets the antenna unit to dBpT. If this correction is turned on, and Apply Corrections is on, the Y Axis Unit will then be forced to dBpT and all other Y Axis Unit selections will be grayed out.

Key Path	Input/Output, Corrections, Properties, Antenna Unit
<b>Example</b>	:CORR:CSET:ANT PTES
Readback	"dBpT"
Initial S/W Revision	A.02.00

**dBG**

Sets the antenna unit to dBG. If this correction is turned on, and Apply Corrections is on, the Y Axis Unit will then be forced to dBG and all other Y Axis Unit selections will be grayed out.

Key Path	Input/Output, Corrections, Properties, Antenna Unit
<b>Example</b>	:CORR:CSET:ANT GAUS
Readback	" dBG"
Initial S/W Revision	A.02.00

**dB $\mu$ A**

Sets the antenna unit to dB $\mu$ A. If this correction is turned on, and Apply Corrections is on, the Y Axis Unit will then be forced to dB $\mu$ A and all other Y Axis Unit selections will be grayed out.

Key Path	Input/Output, Corrections, Properties, Antenna Unit
<b>Example</b>	:CORR:CSET:ANT UA
Readback	" dB $\mu$ A"
Initial S/W Revision	A.11.00

## Frequency Interpolation

This setting controls how the correction values per-bucket are calculated. We interpolate between frequencies in either the logarithmic or linear scale.

This setting is handled and stored individually per correction set.

See "[Interpolation](#)" on page 258

<b>Key Path</b>	Input/Output, Corrections, Properties
<b>Remote Command</b>	[[:SENSe]:CORRection:CSET[1] 2 ... 8:X:SPACing LINear   LOGarithmic [:SENSe]:CORRection:CSET[1] 2 ... 8:X:SPACing?
<b>Example</b>	CORR:CSET:X:SPAC LIN
<b>Preset</b>	Unaffected by a Preset. Set to Linear by Restore Input/Output Defaults.
<b>State Saved</b>	Saved in instrument state.
<b>Initial S/W Revision</b>	A.02.00
<b>Modified at S/W Revision</b>	A.14.00

### Interpolation

For each bucket processed by the application, all of the correction factors at the frequency of interest (center frequency of each bucket) are summed and added to the amplitude. All trace operations and post processing treat this post-summation value as the true signal to use.

To effect this correction, the goal, for any particular start and stop frequency, is to build a correction trace, whose number of points matches the current Sweep Points setting of the instrument, which will be used to apply corrections on a bucket by bucket basis to the data traces.

For amplitudes that lie between two user specified frequency points, we interpolate to determine the amplitude value. You may select either linear or logarithmic interpolation between the frequencies.

If we interpolate on a log scale, we assume that the line between the two points is a straight line on the log scale. For example, let's say the two points are (2,4) and (20,1). A straight line between them on a log scale looks like:

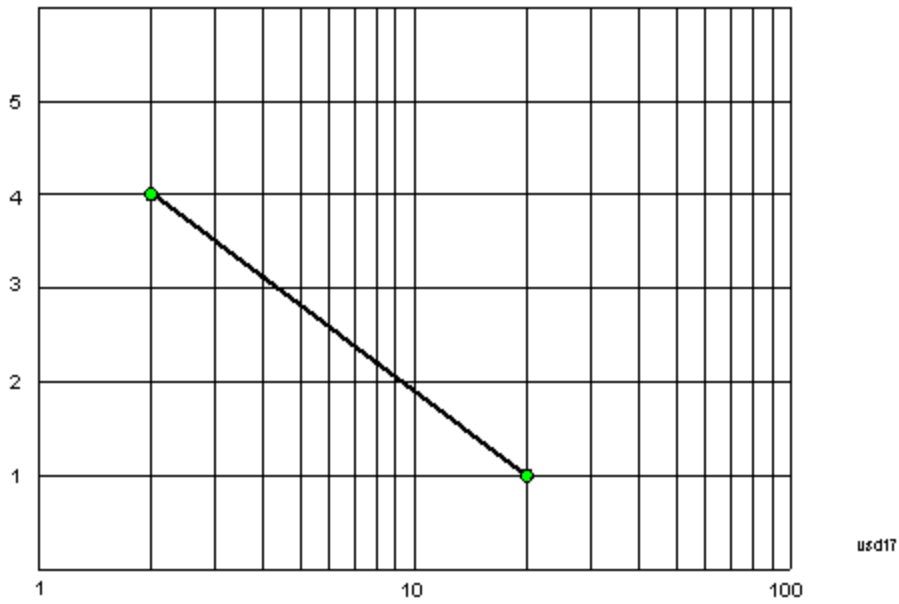

On a linear scale (like that of the spectrum analyzer), this translates to:



If we interpolate on a linear scale, we assume that the two points are connected by a straight line on the linear scale, as below:

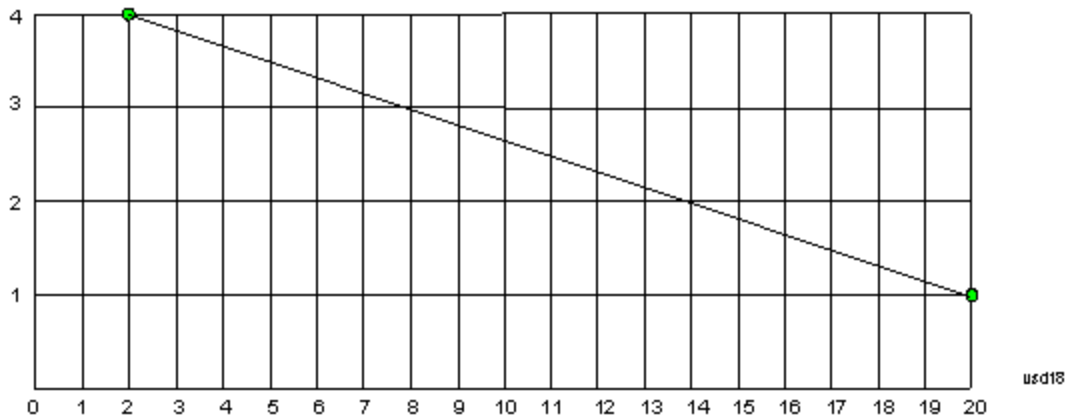

The correction to be used for each bucket is taken from the interpolated correction curve at the center of the bucket.

### Description

Sets an ASCII description field which will be stored in an exported file. Can be displayed in the active function area by selecting as the active function, if desired to appear in a screen capture.

<b>Key Path</b>	Input/Output, Corrections, Properties
<b>Remote Command</b>	<code>[[:SENSe]:CORRection:CSET[1] 2 ... 8:DESCRiption "text"</code> <code>[[:SENSe]:CORRection:CSET[1] 2 ... 8:DESCRiption?</code>
<b>Example</b>	<code>:CORR:CSET1:DESC "11941A Antenna correction"</code>
<b>Notes</b>	45 chars max; may not fit on display if max chars used
<b>Preset</b>	Unaffected by a Preset. Set to empty by Restore Input/Output Defaults
<b>State Saved</b>	Saved in instrument state.
<b>Initial S/W Revision</b>	A.02.00
<b>Modified at S/W Revision</b>	A.14.00

### Comment

Sets an ASCII comment field which will be stored in an exported file. Can be displayed in the active function area by selecting as the active function, if desired to appear in a screen capture.

<b>Key Path</b>	Input/Output, Corrections, Properties
<b>Remote Command</b>	<code>[[:SENSe]:CORRection:CSET[1] 2 ... 8:COMMENT "text"</code> <code>[[:SENSe]:CORRection:CSET[1] 2 ... 8:COMMENT?</code>
<b>Example</b>	<code>:CORR:CSET1:COMM "this is a comment"</code>
<b>Notes</b>	60 chars max; may not fit on display if max chars used
<b>Preset</b>	Unaffected by Preset. Set to empty by Restore Input/Output Defaults
<b>State Saved</b>	Saved in instrument state
<b>Initial S/W Revision</b>	A.02.00
<b>Modified at S/W Revision</b>	A.14.00

### Edit

Invokes the integrated editing facility for this correction set.

When entering the menu, the editor window turns on, the selected correction is turned On, Apply Corrections is set to On, the amplitude scale is set to Log, and the Amplitude Correction (“Ampcor”) trace is displayed. The actual, interpolated correction trace is shown in green for the selected correction. Note that since the actual interpolated correction is shown, the correction trace may have some curvature to it. This trace represents only the correction currently being edited, rather than the total, accumulated amplitude

correction for all amplitude corrections which are currently on, although the total, accumulated correction for all corrections which are turned on is still applied to the data traces.

Because corrections data is always in dB, but the Y-axis of the analyzer is in absolute units, it is necessary to establish a reference line for display of the Corrections data. The reference line is halfway up the display and represents 0 dB of correction. It is labeled "0 dB CORREC". It is drawn in blue.

Corrections data is always in dB. Whatever dB value appears in the correction table represents the correction to be applied to that trace at that frequency. So if a table entry shows 30 dB that means we ADD 30 dB to each trace to correct it before displaying it. By definition all points are connected. If a gap is desired for corrections data, enter 0 dB.

Note that a well-designed Corrections array should start at 0 dB and end at 0 dB. This is because whatever the high end point is will be extended to the top frequency of the instrument, and whatever the low end point is will be extended down to 0 Hz. So for a Corrections array to have no effect outside its range, you should start and end the array at 0 dB.

**NOTE**

The table editor will only operate properly if the analyzer is sweeping, because its updates are tied to the sweep system. Thus, you should not try to use the editor in single sweep, and it will be sluggish during compute-intensive operations like narrow-span FFT sweeps.

When exiting the edit menu (by using the Return key or by pressing an instrument front-panel key), the editor window turns off and the Ampcor trace is no longer displayed; however, Apply Corrections remains On, any correction that was on while in the editor remains on, and the amplitude scale returns to its previous setting.

Corrections arrays are not affected by a Preset, because they are in the Input/Output system. They also survive shutdown and restarting of the analyzer application, which means they will survive a power cycle.

When editing a correction, the editor remembers which correction and which element in the correction array you were editing, and returns you to that correction and that element when you return to the editor after leaving it.

Key Path	Input/Output, Corrections
Initial S/W Revision	A.02.00

**Navigate**

Lets you move through the table to edit the desired point.

Key Path	Input/Output, Corrections, Edit
Notes	There is no value readback on the key
Min	1
Max	2000
Initial S/W Revision	A.02.00

## Frequency

Lets you edit the frequency of the current row.

Key Path	Input/Output, Corrections, Edit
Notes	There is no value readback on the key.
Min	0
Max	1 THz
Initial S/W Revision	A.02.00

## Amplitude

Lets you edit the Amplitude of the current row.

Key Path	Input/Output, Corrections, Edit
Notes	There is no value readback on the key.
Min	-1000 dB
Max	1000 dB
Initial S/W Revision	A.02.00

## Insert Point Below

Inserts a point below the current point. The new point is a copy of the current point and becomes the current point. The new point is not yet entered into the underlying table, and the data in the row is displayed in light gray.

Key Path	Input/Output, Corrections, Edit
Initial S/W Revision	A.02.00

## Delete Point

Deletes the currently-selected point, whether or not that point is being edited, and selects the Navigate functionality. The point following the currently-selected point (or the point preceding if there is none) will be selected.

Key Path	Input/Output, Corrections, Edit
Initial S/W Revision	A.02.00

## Delete Correction

Deletes the correction values for this set. When this key is pressed a prompt is placed on the screen that says "Please press Enter or OK key to delete correction. Press ESC or Cancel to close this dialog." The

deletion is only performed if you press OK or Enter.

Key Path	Input/Output, Corrections
Remote Command	[ :SENSe] :CORRection:CSET[1]   2   . . .   6 :DELete
Example	CORR:CSET:DEL CORR:CSET1:DEL CORR:CSET4:DEL
Notes	Pressing this key when no corrections are present is accepted without error.
Initial S/W Revision	A.02.00

## Apply Corrections

Applies amplitude corrections, which are marked as ON to the measured data. If this is set to OFF, then no amplitude correction sets will be used, regardless of their individual on/off settings. If set to ON, the corrections that are marked as ON (see "[Correction On/Off](#)" on page 254) are used.

Key Path	Input/Output, Corrections
Remote Command	[ :SENSe] :CORRection:CSET:ALL[:STATe] ON OFF 1 0 [ :SENSe] :CORRection:CSET:ALL[:STATe] ?
Example	SENS:CORR:CSET:ALL OFF This command makes sure that no amplitude corrections are applied, regardless of their individual on/off settings.
Preset	Not affected by Preset. Set to OFF by Restore Input/Output Defaults
State Saved	Saved in instrument state.
Initial S/W Revision	A.02.00

## Delete All Corrections

Erases all correction values for all 4 Amplitude Correction sets.

When this key is pressed a prompt is placed on the screen that says "Please press Enter or OK key to delete all corrections. Press ESC or Cancel to close this dialog." The deletion is only performed if you press OK or Enter.

Key Path	Input/Output, Corrections
Remote Command	[ :SENSe] :CORRection:CSET:ALL:DELete
Example	CORR:CSET:ALL:DEL
Initial S/W Revision	A.02.00

## Remote Correction Data Set Commands

This section describes the remote (SCPI) commands used to put values into correction sets. See the correction / table editor section of the Input/Output section for the information on front panel entry of correction data.

"Set (Replace) Data (Remote Command Only)" on page 264

"Merge Correction Data (Remote Command Only)" on page 264

### Set (Replace) Data (Remote Command Only)

The command takes an ASCII series of alternating frequency and amplitude points, each value separated by commas.

The values sent in the command will totally replace all existing correction points in the specified set.

An Ampcor array can contain 2000 points maximum.

<b>Remote Command</b>	<code>[[:SENSe]:CORRection:CSET[1] 2 ... 8:DATA &lt;freq&gt;, &lt;ampl&gt;, . . .</code> <code>[[:SENSe]:CORRection:CSET[1] 2 ... 8:DATA?</code>
<b>Example</b>	<code>CORR:CSET1:DATA 10000000, -1.0, 20000000, 1.0</code> This defines two correction points at (10 MHz, -1.0 dB) and (20 MHz, 1.0 dB) for correction set 1.
<b>Preset</b>	Empty after Restore Input/Output Defaults. Survives a shutdown or restart of analyzer application (including a power cycle).
<b>State Saved</b>	Saved in instrument state.
<b>Min</b>	Freq: 0 Hz Amptd: -1000 dBm
<b>Max</b>	Freq: 1 THz Amptd: +1000 dBm
<b>Initial S/W Revision</b>	A.02.00
<b>Modified at S/W Revision</b>	A.14.00

### Merge Correction Data (Remote Command Only)

The command takes an ASCII series of alternating frequency and amplitude points, each value separated by commas. The difference between this command and Set Data is that this merges new correction points into an existing set.

Any new point with the same frequency as an existing correction point will replace the existing point's amplitude with that of the new point.

An Ampcor array can contain 2000 total points, maximum.

<b>Remote Command</b>	<code>[[:SENSe]:CORRection:CSET[1] 2 ... 8:DATA:MERGE &lt;freq&gt;, &lt;ampl&gt;, ...</code>
<b>Example</b>	<code>CORR:CSET1:DATA:MERGE 15000000, -5.0, 25000000, 5.0</code> This adds two correction points at (15 MHz, -5.0 dB) and (25 MHz, 5.0 dB) to whatever values already exist in correction set 1.



Preset	Empty after Restore Input/Output Defaults. Survives shutdown/restart of analyzer application (including power cycle)
Min	Freq: 0 Hz Amptd: -1000 dBm
Max	Freq: 1 THz Amptd: +1000 dBm
Initial S/W Revision	A.02.00
Modified at S/W Revision	A.14.00

## Freq Ref In

Specifies the frequency reference as being the internal reference at the rear panel input labeled EXT REF IN, a 1 pulse per second signal at the EXT REF IN input, external reference or sensing the presence of a signal at the EXT REF IN input.

When the frequency reference is set to internal, the internal 10 MHz reference is used even if an external reference is connected.

When the frequency reference is set to external, the instrument will use the external reference. However, if there is no external signal present, or it is not within the proper amplitude range, a condition error message is generated. When the external signal becomes valid, the error is cleared.

When the frequency reference is set to Pulse, the instrument expects a 1 pulse per second signal at the EXT REF IN input. The instrument uses this signal to adjust the frequency of the internal reference.

If Sense is selected, the instrument checks whether a signal is present at the external reference connector. If it senses a signal within 5 ppm of the External Ref Freq (as set on the External Ref Freq softkey), it will automatically switch to the external reference. If it senses a 1 pulse per second signal, it enters Pulse mode, wherein the signal is used to adjust the internal reference. When no signal is present, it automatically switches to the internal reference. No message is generated as the reference switches between pulse, external and internal. The monitoring of the external reference occurs approximately on 1 millisecond intervals, and never occurs in the middle of a measurement acquisition, only at the end of the measurement (end of the request).

If for any reason the instrument's frequency reference is not able to obtain lock, Status bit 1 in the Questionable Frequency register will be true and a condition error message is generated. When lock is regained, Status bit 1 in the Questionable Frequency register will be cleared and the condition error will be cleared.

If an external frequency reference is being used, you must enter the frequency of the external reference if it is not exactly 10 MHz. The External Ref Freq key is provided for this purpose.

Key Path	Input/Output
<b>Remote Command</b>	[ :SENSe ] :ROSCillator :SOURCE :TYPE INTernal   EXTernal   SENSE   PULSE [ :SENSe ] :ROSCillator :SOURCE :TYPE ?
<b>Dependencies</b>	The PULSE parameter, and support of the 1 pps signal at the EXT REF IN input, are not available in firmware prior to A.13.00. They are also not available in some model numbers. If not available, the

	Pulse key will be blank, and sending the PULSe parameter via SCPI will generate an error:
Preset	This is unaffected by a Preset but is set to SENSE on a "Restore Input/Output Defaults" or "Restore System Defaults->All".
State Saved	Saved in instrument state.
Status Bits/OPC dependencies	STATus:QUESTIONable:FREQuency bit 1 set if unlocked.
Backwards Compatibility Notes	Freq Ref In was not saved in state in the legacy instruments. It is a part of state in the X-Series.
Initial S/W Revision	Prior to A.02.00
Modified at S/W Revision	A.14.00

<b>Remote Command</b>	<code>[[:SENSe]:ROSCillator:SOURce?</code>
Notes	<p>The query <code>[SENSe]:ROSCillator:SOURce?</code> returns the current switch setting. This means:</p> <ol style="list-style-type: none"> <li>1. If it was set to SENSE but there is no external reference nor 1 pps signal so the instrument is actually using the internal reference, then this query returns INTERNAL and not SENSE.</li> <li>2. If it was set to SENSE and there is an external reference present, the query returns EXTERNAL and not SENSE.</li> <li>3. If it was set to SENSE and there is a 1 pps signal present, the query returns PULSe and not SENSE.</li> <li>4. If it was set to EXTERNAL, then the query returns "EXTERNAL"</li> <li>5. If it was set to INTERNAL, then the query returns "INTERNAL".</li> <li>6. If it was set to PULSe, then the query returns "PULSe"</li> </ol>
Preset	SENSe
Backwards Compatibility Notes	<p>The query <code>[[:SENSe]:ROSCillator:SOURce?</code> was a query-only command in ESA which always returned whichever reference the instrument was using. The instrument automatically switched to the ext ref if it was present.</p> <p>In PSA (which had no sensing) the command <code>[[:SENSe]:ROSCillator:SOURce</code> set the reference (INT or EXT), so again its query returned the actual routing.</p> <p>Thus the query form of this command is 100% backwards compatible with both instruments.</p>
Initial S/W Revision	Prior to A.02.00

<b>Remote Command</b>	<code>[[:SENSe]:ROSCillator:SOURce INTernal EXTernal</code>
Notes	For PSA compatibility the command form is provided and is directly mapped to <code>[[:SENSe]:ROSCillator:SOURce:TYPE</code>
Initial S/W Revision	Prior to A.02.00

## Sense

If Sense is selected, the instrument checks whether a signal is present at the external reference connector. If it senses a signal within 5 ppm of the External Ref Freq (as set on the External Ref Freq softkey), it will use this signal as an External Reference. If it senses a 1 pulse per second signal, it will use this signal to adjust the internal reference by adjusting the User setting of the Timebase DAC. When no signal is present, it automatically switches to the internal reference.

Key Path	Input/Output, Freq Ref In
<b>Example</b>	:ROSC:SOUR:TYPE SENS
Couplings	If set to SENSE and the analyzer senses a 1 pulse per second signal, it sets the System, Alignments, Timebase DAC setting to "User". This setting survives Preset and Power Cycle but is set to "Calibrated" on a System, Restore Defaults, Align or a System, Restore Defaults, All
Readback	Sense
Initial S/W Revision	Prior to A.02.00
Modified at S/W Revision	A.14.00

## Internal

The internal reference is used. A 1 pps signal at the EXT REF IN port, or a signal there between 1 and 50 MHz, will cause a warning triangle to appear in the settings panel next to the word "INTERNAL", but will otherwise be ignored.

Key Path	Input/Output, Freq Ref In
<b>Example</b>	:ROSC:SOUR:TYPE INT
Readback	Internal
Initial S/W Revision	Prior to A.02.00
Modified at S/W Revision	A.14.00

## External

The external reference is used.

Key Path	Input/Output, Freq Ref In
<b>Example</b>	:ROSC:SOUR:TYPE EXT
Readback	External
Initial S/W Revision	Prior to A.02.00

## Ext Ref Freq

This key tells the analyzer the frequency of the external reference. When the external reference is in use (either because the reference has been switched to External or because the Reference has been switched

to Sense and there is a valid external reference present) this information is used by the analyzer to determine the internal settings needed to lock to that particular external reference signal.

For the instrument to stay locked, the value entered must be within 5 ppm of the actual external reference frequency. So it is important to get it close, or you risk an unlock condition.

Note that this value only affects the instrument's ability to lock. It does not affect any calculations or measurement results. See "Freq Offset" in the Frequency section for information on how to offset frequency values.

<b>Key Path</b>	Input/Output, Freq Ref In
<b>Remote Command</b>	[ :SENSe ] :ROSCillator:EXTernal:FREQuency <freq> [ :SENSe ] :ROSCillator:EXTernal:FREQuency?
<b>Example</b>	ROSC:EXT:FREQ 20 MHz sets the external reference frequency to 20 MHz, but does not select the external reference. ROSC:SOUR:TYPE EXT selects the external reference.
<b>Dependencies</b>	Still available with Internal or Pulse selected, to allow setup for when External is in use. However, the setting has no effect if the Internal Reference is in use (Freq Ref In set to Internal, Pulse, or SENSE:INT or SENSE:PULSE).
<b>Preset</b>	This is unaffected by a Preset but is set to 10 MHz on a "Restore Input/Output Defaults" or "Restore System Defaults->All"
<b>Min</b>	CXA: 10 MHz EXA: 10 MHz MXA: 1 MHz PXA: 1 MHz N8973B, N8974B, N8975B, or N8976B: 10 MHz
<b>Max</b>	CXA: 10 MHz EXA: 10 MHz EXA with option R13: 20 MHz MXA: 50 MHz PXA: 50 MHz N8973B, N8974B, N8975B, or N8976B: 10 MHz
<b>Default Unit</b>	Hz
<b>Initial S/W Revision</b>	Prior to A.02.00
<b>Modified at S/W Revision</b>	A.14.00

## External Reference Lock BW

This control lets you adjust the External Reference phase lock bandwidth. This control is available in some models of the X-Series.

The PXA variable reference loop bandwidth allows an external reference to be used and have the analyzer close-in phase noise improved to match that of the reference. This could result in an improvement of tens of decibels. The choice of “Wide” or “Narrow” affects the phase noise at low offset frequencies, especially 4 to 400 Hz offset. When using an external reference with superior phase noise, we recommend setting the external reference phase-locked-loop bandwidth to wide (60 Hz), to take advantage of that superior performance. When using an external reference with inferior phase noise performance, we recommend setting that bandwidth to narrow (15 Hz). In these relationships, inferior and superior phase noise are with respect to  $-134$  dBc/Hz at 30 Hz offset from a 10 MHz reference. Because most reference sources have phase noise behavior that falls off at a rate of 30 dB/decade, this is usually equivalent to  $-120$  dBc/Hz at 10 Hz offset.

Key Path	Input/Output, Freq Ref In
Scope	Mode Global
Remote Command	<code>[ :SENSe ] :ROSCillator :BANDwidth WIDE   NARRow</code> <code>[ :SENSe ] :ROSCillator :BANDwidth ?</code>
Example	ROSC:BAND WIDE
Dependencies	Still available with Internal or Pulse selected, to allow setup for when External is in use. However, the setting has no effect if the Internal Reference is in use (Freq Ref In set to Internal, Pulse, or SENSE:INT or SENSE:PULSE).  This key only appears in analyzers equipped with the required hardware.
Preset	This is unaffected by a Preset but is set to Narrow on a "Restore Input/Output Defaults" or "Restore System Defaults -> All"
State Saved	Saved in Input/Output state.
Initial S/W Revision	A.04.00
Modified at S/W Revision	A.14.00

## External Ref Coupling

Only appears with option ERC installed and licensed.

This function lets you couple the sweep system of the analyzer to the state of the External Reference. If Normal is selected, data acquisition proceeds regardless of the state of the External Reference. When you select Ext Ref Out Of Range Stops Acquisition, the data acquisition (sweep or measurement) stops when either the "521, External ref out of range" or the "503, Frequency Reference unlocked" error message is asserted. Note that this will only take place if the Freq Ref In selection is External.

With the acquisition stopped, the data display will stop updating (even if this occurs in the middle of a sweep or measurement) and no data will be returned to a READ? or MEASure? query; that is, these queries will not complete because the analyzer will not respond to them. Furthermore, no response will be generated to a \*WAI? or \*OPC? query.

Proper SCPI sequences are shown below, which will always fail to return if the acquisition stops during the requested sweep or measurement. Note that, for predictable operation of this function, it is best to operate the analyzer in single measurement mode (INIT:CONT OFF), because if operating in continuous mode, the analyzer may respond to the above queries even after the acquisition stops, with data left over from the previous acquisition.

```
:INIT:CONT OFF
:INIT:IMM;*OPC?
--
:INIT:CONT OFF
:INIT:IMM;*WAI?
--
:INIT:CONT OFF
:READ?
--
:INIT:CONT OFF
:MEASure?
```

When the acquisition ceases, in addition to the error condition(s) described above, a popup error message will be generated informing you that the acquisition has ceased due to an invalid external reference. This message will stay on the screen while the acquisition is suspended.

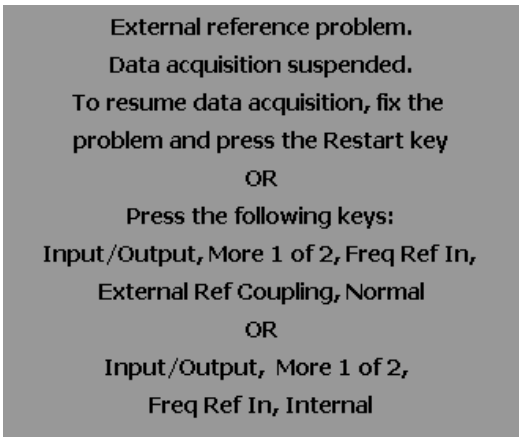

If you press the Restart key this message will be taken off the screen and a new acquisition will be attempted. If the External Reference problem persists the message will re-appear. You can also remove the message by changing back to the Normal setting of Sweep/Ext Ref Coupling, or by pressing Freq Ref In, Internal, or Freq Ref In, Sense, or Restore Input/Output Defaults.

The setting of External Ref Coupling is persistent across power-cycling and is not reset with a Preset. It is reset to the default state (Normal) when Restore Input/Output Defaults is invoked, which will also restart normal data acquisition.

The detection of invalid external reference is under interrupt processing. If the external reference becomes invalid then returns to valid in too short a time, no error condition will be detected or reported and therefore the acquisition will not be stopped.

Key Path	Input/Output, Freq Ref In
Mode	All
Remote Command	<code>[ :SENSe ] :ROSCillator :COUPling NORMal   NACQuisition</code> <code>[ :SENSe ] :ROSCillator :COUPling ?</code>
Preset	This setting is persistent: it survives power-cycling or a Preset and is reset with Restore Input/Output defaults.
State Saved	Not saved in instrument state
Readback	Normal   Stop Acq
Initial S/W Revision	A.02.00

## Output Config

Accesses keys that configure various output settings, like the frequency reference output, trigger output and analog output.

Key Path	Input/Output
Backwards Compatibility Notes	In ESA there was not a user interface to enable the Video Output (Analog Output), Trigger Output, or Gate Output. In the X-Series each of these physical connectors requires configuration, thus the user interface has been added for X-Series, along with the potential for an output you think is always on to be switched off.
Initial S/W Revision	Prior to A.02.00

## Trig Out

Select the type of output signal that will be output from the Trig 1 Out, or Trig 2 Out connectors.

Key Path	Input/Output, Output Config
Remote Command	<code>:TRIGger   TRIGger1   TRIGger2 [ :SEQuence ] :OUTPut HSWP   MEASuring   MAIN   GATE   GTRigger   OEVen   SPOint   SSWeep   SSETtled   S1Marker   S2Marker   S3Marker   S4Marker   OFF</code> <code>:TRIGger   TRIGger1   TRIGger2 [ :SEQuence ] :OUTPut ?</code>
Example	TRIG:OUTP HSWP TRIG2:OUTP GATE
Dependencies	The second Trigger output (Trig 2 Out) does not appear in all models; in models that do not support it, the Trig 2 Out key is blanked, and sending the SCPI command for this output generates an error, "Hardware missing; Not available for this model number" In models that do not support the Trigger 2 output, this error is returned if trying to set Trig 2 Out and a query of Trig 2 Out returns OFF.
Preset	Trigger 1: Sweeping (HSWP)

	Trigger 2: Gate This is unaffected by a Preset but is preset to the above values on a "Restore Input/Output Defaults" or "Restore System Defaults->All"
State Saved	Saved in instrument state
Initial S/W Revision	Prior to A.02.00

### Polarity

Sets the output to the Trig 1 Out, or Trig 2 Out, connector to trigger on either the positive or negative polarity.

Key Path	Input/Output, Output Config, Trig 1/2 Output
Remote Command	:TRIGger TRIGger1 TRIGger2[:SEquence]:OUTPut:POLarity POSitive   NEGative  :TRIGger TRIGger1 TRIGger2[:SEquence]:OUTPut:POLarity?
Example	TRIG1:OUTP:POL POS
Preset	This is unaffected by a Preset but is set to POSitive on a "Restore Input/Output Defaults" or "Restore System Defaults->All"
State Saved	Saved in instrument state
Initial S/W Revision	Prior to A.02.00

### Off

Selects no signal to be output to the Trig 1 Out, or Trig 2 Out, connector.

Key Path	Input/Output, Output Config, Trig 1/2 Output
Example	TRIG1:OUTP OFF
Readback	Off
Initial S/W Revision	Prior to A.02.00

### Sweeping (HSWP)

Selects the Sweeping Trigger signal to be output to the Trig 1 Out, or Trig 2 Out, connector when a measurement is made. This signal has historically been known as "HSWP" (High = Sweeping), and is 5 V TTL level with 50 ohm output impedance.

Key Path	Input/Output, Output Config, Trig 1/2 Output
Example	TRIG1:OUTP HSWP
Readback	Sweeping
Initial S/W Revision	Prior to A.02.00



## Measuring

Selects the Measuring trigger signal to be output to the Trig 1 Out, or Trig 2 Out, connector. This signal is true while the Measuring status bit is true.

Key Path	Input/Output, Output Config, Trig 1/2 Output
<b>Example</b>	TRIG1:OUTP MEAS
Readback	Measuring
Initial S/W Revision	Prior to A.02.00

## Main Trigger

Selects the current instrument trigger signal to be output to the Trig 1 Out, or Trig 2 Out, connector.

Key Path	Input/Output, Output Config, Trig 1/2 Output
<b>Example</b>	TRIG1:OUTP MAIN
Readback	Main Trigger
Initial S/W Revision	Prior to A.02.00

## Gate Trigger

Selects the gate trigger signal to be output to the Trig 1 Out, or Trig 2 Out, connector. This is the source of the gate timing, not the actual gate signal.

Key Path	Input/Output, Output Config, Trig 1/2 Output
<b>Example</b>	TRIG1:OUTP GTR
Readback	Gate Trigger
Initial S/W Revision	Prior to A.02.00

## Gate

Selects the gate signal to be output to the Trig 1 Out, or Trig 2 Out, connector. The gate signal has been delayed and its length determined by delay and length settings. When the polarity is positive, a high on the Trig 1 Out, or Trig 2 Out, represents the time the gate is configured to pass the signal.

Key Path	Input/Output, Output Config, Trig 1/2 Output
<b>Example</b>	TRIG1:OUTP GATE
Readback	Gate
Initial S/W Revision	Prior to A.02.00

### Source Point Trigger

Selects the gate signal to be output to the Trig 1 Out, or Trig 2 Out, connector for use as the Point Trigger when operating an external source in Tracking mode. When Ext Trigger 1 is selected as the Point Trigger under Source, the Source Point Trigger under Trig1 Out automatically gets selected. Similarly, when Ext Trigger 2 is selected as the Point Trigger under Source, the Source Point Trigger key under Trig 2 Out automatically gets selected

Key Path	Input/Output, Output Config, Trig 1/2 Output
<b>Example</b>	TRIG1:OUTP SPO
Readback	Source Point
Initial S/W Revision	Prior to A.02.00

### Odd/Even Trace Point

Selects either the odd or even trace points as the signal to be output to the Trig 1 Out, or Trig 2 Out, connector when performing swept spectrum analysis. When the polarity is positive, this output goes high during the time the analyzer is sweeping past the first point (Point 0) and every other following trace point. The opposite is true if the polarity is negative.

Key Path	Input/Output, Output Config, Trig 1/2 Output
<b>Example</b>	TRIG1:OUTP OEV
Readback	Odd/Even
Initial S/W Revision	Prior to A.02.00

### Analog Out

This menu lets you control which signal is fed to the "Analog Out" connector on the analyzer rear panel.

See ["More Information" on page 275](#)

Key Path	Input/Output, Output Config
<b>Remote Command</b>	:OUTPut:ANALog OFF SVIDeo LOGVIdIo LINVIdIo DAUDIo :OUTPut:ANALog?
Example	OUTP:ANAL SVIDeo ! causes the analog output type to be Screen Video
Preset	This is unaffected by Preset but is set to DAUDIo on a "Restore Input/Output Defaults" or "Restore System Defaults->All
Preset	OFF
State Saved	Saved in Input/Output State
Readback line	1-of-N selection [variable]
Backwards Compatibility Notes	Prior to A.04.00, OFF was the default functionality except when in the Analog Demod application or with Tune and Listen, in which case it was DAUDIo, and there was no selection menu. So for backwards compatibility with earlier X-Series firmware versions, Auto (:OUTP:ANAL:AUTO ON) will

---

duplicate the prior behavior.

The DNWB and SANalyzer parameters, which were legal in PSA but perform no function in the X-Series, are accepted without error.

---

Initial S/W Revision      A.04.00

---

## More Information

The table below gives the range for each output.

Analog Out	Nominal Range exc. (10% overrange)	Scale Factor	Notes
Off	0 V		
Screen Video	0 – 1 V open circuit	10%/division	8566 compatible
Log Video	0 – 1 V terminated	1/(192.66 dB/V)	dB referenced to mixer level, 1V out for –10 dBm at the mixer.
Linear Video	0 – 1 V terminated	100%/V	Linear referenced to Ref Level, 1 V out for RF envelope at the Ref Level.
Demod Audio	(varies with analyzer setting)		

## Auto

Selects the Auto state for the Analog Output menu. In this state, the Analog Output will automatically be set to the most sensible setting for the current mode or measurement.

If you make a selection manually from the Analog Out menu, this selection will remain in force until you change it (or re-select Auto), even if you go to a mode or measurement for which the selected output does not apply.

Key Path	Input/Output, Output Config, Analog Out
Remote Command	OUTPut:ANALog:AUTO OFF ON 0 1 OUTPut:ANALog:AUTO?
Example	OUTP:ANAL:AUTO ON
Preset	ON
State Saved	Saved in Input/Output State
Initial S/W Revision	A.04.00

## Off

Turns off the analog output.

Key Path	Input/Output, Output Config, Analog Out
Example	OUTP:ANAL OFF ! causes the analog output to be off
Readback Text	Off
Initial S/W Revision	A.04.00

### Screen Video

Selects the analog output to be the screen video signal. In this mode, the pre-detector data is output to the Analog Out connector. The output looks very much like the trace displayed on the analyzer's screen, and depends on the Log/Lin display Scale, Reference Level, and dB per division, but is not influenced by the selected detector or any digital flatness corrections or trace post-processing (like Trace Averaging).

Note that this mode is similar to the Analog Output of the HP 8566 family and the Video Out (opt 124) capability of the Agilent PSA analyzer (E444x), although there are differences in the behavior.

Key Path	Input/Output, Output Config, Analog Out
Example	OUTP:ANAL SVID
Dependencies	<p>Because the Screen Video output uses one of the two IF processing channels, only one detector is available while Screen Video is selected. All active traces will change to use the same detector as the selected trace when Screen Video is activated.</p> <p>Screen Video output is not available while any EMI Detector is selected (Quasi Peak, RMS Average or EMI Average), because these detectors use both IF processing channels. Consequently, if the user chooses an EMI Detector, there will be no Screen Video output.</p> <p>The output holds at its last value during an alignment and during a marker count. After a sweep:</p> <ul style="list-style-type: none"> <li>• If a new sweep is to follow (as in Continuous sweep mode), the output holds at its last value during the retrace before the next sweep starts. If the analyzer is in zero-span, there is no retrace, as the analyzer remains tuned to the Center Frequency and does not sweep. Therefore, in zero-span, the output simply remains live between display updates.</li> <li>• If no new sweep is to follow (as in Single sweep mode), the output remains live, and continues to show the pre-detector data</li> </ul> <p>This function depends on optional capability; the key will be blanked and the command will generate an "Option not available" error unless you have Option YAV or YAS licensed in your instrument.</p>
Couplings	Screen Video output changes while in FFT Sweeps, so for measurements that use exclusively FFT Sweeps, or if the user manually chooses FFT Sweeps, the Screen Video output will look different than it does in swept mode.
Readback Text	Screen Video
Backwards Compatibility Notes	See " <a href="#">Backwards Compatibility:</a> " on page 277, below.
Initial S/W Revision	A.04.00

**Backwards Compatibility:**

The Screen Video function is intended to be very similar to the 8566 Video Output and the PSA Option 124. However, unlike the PSA, it is not always on; it must be switched on by the Screen Video key. Also, unlike the PSA, there are certain dependencies (detailed above) – for example, the Quasi Peak Detector is unavailable when Screen Video is on.

Furthermore, the PSA Option 124 hardware was unipolar and its large range was padded to be exactly right for use as a Screen Video output. In the X-Series, the hardware is bipolar and has a wider range to accommodate the other output choices. Therefore, the outputs won't match up exactly and users may have to modify their setup when applying the X-Series in a PSA application.

**Log Video (RF Envelope, Ref=Mixer Level)**

Selects the analog output to be the log of the video signal. In this mode, the pre-detector data is output to the Analog Out connector with a Log scaling. The output is referenced to the current level at the mixer, does not depend on display settings like Reference Level or dB per division, and it is not influenced by the selected detector or any digital flatness corrections or trace post-processing (like Trace Averaging), but does change with input attenuation.

The output is designed so that full scale (1 V) corresponds to –10 dBm at the mixer. The full range (0–1 V) covers 192.66 dB; thus, 0 V corresponds to –202.66 dBm at the mixer.

Key Path	Input/Output, Output Config, Analog Out
Example	OUTP:ANAL LOGV
Dependencies	<p>Because the Log Video output uses one of the two IF processing channels, only one detector is available while Screen Video is selected. All active traces will change to use the same detector as the selected trace when Log Video is activated.</p> <p>Log Video output is not available while any EMI Detector is selected (Quasi Peak, RMS Average or EMI Average), because these detectors use both IF processing channels. Consequently, if the user chooses an EMI Detector, there will be no Log Video output.</p> <p>The output holds at its last value during an alignment, during a marker count, and during retrace (after a sweep and before the next sweep starts).</p> <p>This function depends on optional capability. The key will be blanked and the command will generate an "Option not available" error unless you have Option YAV licensed in your instrument.</p>
Couplings	Log Video output changes while in FFT Sweeps, so for measurements that use exclusively FFT Sweeps, or if the user manually chooses FFT Sweeps, the Log Video output will look different than it does in swept mode.
Readback Text	Log Video
Initial S/W Revision	A.04.00

**Linear Video (RF Envelope, Ref=Ref Level)**

Selects the analog output to be the envelope signal on a linear (voltage) scale. In this mode, the pre-detector data is output to the Analog Out connector with a Linear scaling. The output is based on the current Reference Level, and is not influenced by the selected detector or any digital flatness corrections or trace post-processing (like Trace Averaging).

The scaling is set so that 1 V output occurs with an instantaneous video level equal to the reference level, and 0 V occurs at the bottom of the graticule. This scaling gives you the ability to control the gain without having another setup control for the key. But it requires you to control the look of the display (the reference level) in order to control the analog output.

This mode is ideal for looking at Amplitude Modulated signals, as the linear envelope effectively demodulates the signal.

Key Path	Input/Output, Output Config, Analog Out
Example	OUTP:ANAL LINV
Dependencies	<p>Because the Linear Video output uses one of the two IF processing channels, only one detector is available while Linear Video is selected. All active traces will change to use the same detector as the selected trace when Log Video is activated.</p> <p>Linear Video output is not available while any EMI Detector is selected (Quasi Peak, RMS Average or EMI Average), because these detectors use both IF processing channels. Consequently, if the user chooses an EMI Detector, there will be no Linear Video output.</p> <p>The output holds at its last value during an alignment and during a marker count and during retrace (after a sweep and before the next sweep starts).</p> <p>This function depends on optional capability; the key will be blanked and the command will generate an "Option not available" error unless you have Option YAV licensed in your instrument.</p>
Couplings	Linear Video output changes while in FFT Sweeps, so for measurements that use exclusively FFT Sweeps, or if the user manually chooses FFT Sweeps, the Linear Video output will look different than it does in swept mode.
Readback Text	Linear Video
Initial S/W Revision	A.04.00

### Demod Audio

Selects the analog output to be the demodulation of the video signal.

When Demod Audio is selected, the demodulated audio signal appears at this output whenever the Analog Demod application is demodulating a signal or when Analog Demod Tune and Listen is operating in the Swept SA measurement.

When Analog Out is in the Auto state, this output is auto-selected when in the Analog Demod mode or when Analog Demod Tune and Listen is operating in the Swept SA measurement.

If any other Analog Output is manually selected when in the Analog Demod mode or when Analog Demod Tune and Listen is operating in the Swept SA measurement, a condition warning message appears.

Key Path	Input/Output, Output Config, Analog Out
Example	OUTP:ANAL DAUD
Dependencies	<p>This key only appears if the Analog Demod application (N9063A), the N6141A or W6141A application, or Option EMC is installed and licensed, otherwise the key will be blanked and the command will generate an "Option not available" error.</p> <p>The output holds at its last value during an alignment and during a marker count. It is not held between sweeps, in order for Tune and Listen to work properly.</p>

	When Demod Audio is the selected Analog Output: <ul style="list-style-type: none"> <li>• all active traces are forced to use the same detector.</li> <li>• CISPR detectors (QPD, EMI Avg, RMS Avg) are unavailable</li> </ul>
Readback Text	Demod Audio
Initial S/W Revision	Prior to A.02.00 (this was the default functionality, and there was no selection)
Modified at S/W Revision	A.04.00

## Digital Bus

This menu allows you to configure the LVDS connector located on the rear panel of the instrument. It is a unidirectional link of real time data at a 90 MSa/s rate. The ADC is sampling a 22.5 MHz IF.

The data that appears on this port is raw, uncorrected ADC samples, unless you have option RTL. With option RTL, you get fully corrected I/Q data.

This connector will only be active when the Narrowband IF Path is currently in use.

Key Path	Input/Output, Output Config
Initial S/W Revision	A.04.00

## Bus Out On/Off

When Bus Out is on, all acquisitions are streamed to the output port including acquisitions for internal purposes such as Alignment. The internal processing and routing of acquisitions continues as usual and is unaffected by the state of Bus Out.

When Bus Out is off, no signal appears on the LVDS port.

Key Path	Input/Output, Output Config, Digital Bus
Scope	Mode Global
<b>Remote Command</b>	:OUTPut:DBUS[1][:STATe] ON OFF 1 0 :OUTPut:DBUS[1][:STATe]?
<b>Example</b>	OUTP:DBUS ON
Preset	This is unaffected by a Preset but is set to Off on a "Restore Input/Output Defaults" or "Restore System Defaults -> All"
State Saved	Saved in Input/Output State
Initial S/W Revision	Prior to A.02.00
Modified at S/W Revision	A.04.00

## I/Q Cal Out

The Baseband I/Q "Cal Out" port can be turned on with either a 1 kHz or a 250 kHz square wave. This can be turned on independent of the input selection. A Preset will reset this to Off.

Key Path	Input/Output, Output Config
Remote Command	:OUTPut:IQ:OUTPut IQ1 IQ250 OFF :OUTPut:IQ:OUTPut?
Example	OUTP:IQ:OUTP IQ1
Couplings	An I/Q Cable Calibration or an I/Q Probe Calibration will change the state of the Cal Out port as needed by the calibration routine. When the calibration is finished the I/Q Cal Out is restored to the pre-calibration state.
Preset	Off
State Saved	Saved in instrument state
Range	1 kHz Square Wave 250 kHz Square Wave Off
Readback Text	1 kHz 250 kHz Off
Initial S/W Revision	Prior to A.02.00

### 1 kHz Square Wave

Turns on the 1 kHz square wave signal at the Cal Out port. This choice is only available with option BBA.

Key Path	Input/Output, Output Config, I/Q Cal Out
Readback	I/Q 1kHz
Initial S/W Revision	Prior to A.02.00

### 250 kHz Square Wave

Turns on the 250 kHz square wave signal at the Cal Out port. This choice is only available with option BBA.

Key Path	Input/Output, Output Config, I/Q Cal Out
Readback	I/Q 250kHz
Initial S/W Revision	Prior to A.02.00

### Off

Turns off the signal at the Cal Out port. This choice is only available with option BBA.

Key Path	Input/Output, Output Config, I/Q Cal Out
Readback	Off
Initial S/W Revision	Prior to A.02.00



## Aux IF Out

This menu controls the signals that appear on the SMA output on the rear panel labeled “AUX IF OUT

The Aux IF Out functionality is only valid for RF and External Mixer inputs. When using the External Mixing path, the Aux IF Out levels (for all three Options CR3, CRP, and ALV) will be uncalibrated because the factory default Aux IF level was set to accommodate the expected IF levels for the RF path.

Key Path	Input/Output, Output Config
<b>Remote Command</b>	:OUTPut:AUX SIF AIF LOGVideo OFF :OUTPut:AUX?
Dependencies	The softkey does not appear in models that do not support the Aux IF Out.
Preset	This is unaffected by a Preset but is set to OFF on a "Restore Input/Output Defaults" or "Restore System Defaults->All"
State Saved	Saved in Input/Output state
Readback line	1-of-N selection [variable]
Backwards Compatibility Notes	In the PSA, the IF output has functionality equivalent to the "Second IF" function in the X-Series' Aux IF Out menu. In the X-Series, it is necessary to switch the Aux IF Out to “Second IF” to get this functionality, whereas in PSA it is always on, since there are no other choices. Hence a command to switch this function to “Second IF” will have to be added by customers migrating from PSA who use the IF Output in PSA.
Initial S/W Revision	A.04.00

## Off

In this mode nothing comes out of the “AUX IF OUT” connector on the rear panel. The connector appears as an open-circuit (that is, it is not terminated in any way).

Key Path	Input/Output, Output Config, Aux IF Out
<b>Example</b>	OUTP:AUX OFF causes the aux output type to be off
Readback Text	Off
Initial S/W Revision	A.04.00

## Second IF

In this mode the 2nd IF output is routed to the rear panel connector. The annotation on the key shows the current 2nd IF frequency in use in the analyzer.

The frequency of the 2nd IF depends on the current IF signal path as shown in the table below:

IF Path Selected	Frequency of "Second IF" Output
10 MHz	322.5 MHz
25 MHz	322.5 MHz
40 MHz	250 MHz
140 MHz	300 MHz

The signal quality, such as signal to noise ratio and phase noise, are excellent in this mode.

Key Path	Input/Output, Output Config, Aux IF Out
<b>Example</b>	OUTP:AUX SIF causes the aux output type to be Second IF
Dependencies	Does not appear unless Option CR3 is installed.
Readback Text	Second IF
Initial S/W Revision	A.04.00

### Arbitrary IF

In this mode the 2nd IF output is mixed with a local oscillator and mixer to produce an arbitrary IF output between 10 MHz and 75 MHz with 500 kHz resolution. The phase noise in this mode will not be as good as in Second IF mode.

The IF output frequency is adjustable, through an active function which appears on the Arbitrary IF selection key, from 10 MHz to 75 MHz with 500 kHz resolution.

The bandwidth of this IF output varies with band and center frequency, but is about 40 MHz at the  $-3$  dB width. When the output is centered at lower frequencies in its range, signal frequencies at the bottom of the bandwidth will "fold". For example, with a 40 MHz bandwidth (20 MHz half-bandwidth), and a 15 MHz IF center, a signal  $-20$  MHz relative to the spectrum analyzer center frequency will have a relative response of about  $-3$  dB with a frequency 20 MHz below the 15 MHz IF center. This  $-5$  MHz frequency will fold to become a  $+5$  MHz signal at the IF output. Therefore, lower IF output frequencies are only useful with known band-limited signals.

Key Path	Input/Output, Output Config, Aux IF Out
<b>Example</b>	OUTP:AUX AIF causes the aux output type to be the Arbitrary IF
Dependencies	Does not appear unless Option CRP is installed.
Readback Text	Arbitrary IF
Initial S/W Revision	A.04.00

Key Path	Input/Output, Output Config, Aux IF Out
----------	---

Scope	Mode Global
<b>Remote Command</b>	:OUTPut:AUX:AIF <value> :OUTPut:AUX:AIF?
<b>Example</b>	:OUTP:AUX:AIF 50 MHZ
Preset	This is unaffected by a Preset but is set to 70 MHz on a "Restore Input/Output Defaults" or "Restore System Defaults->All"
State Saved	Saved in Input/Output State
Min	10 MHz
Max	75 MHz
Default Unit	Hz
Initial S/W Revision	A.04.00

### Fast Log Video

In this mode the 2nd IF output is passed through a log amp and the log envelope of the IF signal is sent to the rear panel. The open circuit output level varies by about 25 mV per dB, with a top-of-screen signal producing about 1.6 Volts. The output impedance is nominally 50 ohms.

This mode is intended to meet the same needs as Option E4440A-H7L Fast Rise Time Video Output on the Agilent E4440A PSA Series, allowing you to characterize pulses with fast rise times using standard measurement suites on modern digital scopes.

Key Path	Input/Output, Output Config, Aux IF Out
<b>Example</b>	OUTP:AUX LOGVideo causes the aux output type to be Fast Log Video
Dependencies	Does not appear unless Option ALV is installed. The output is off during an alignment but not during a marker count, and is not blanked during retrace (after a sweep and before the next sweep starts).
Readback Text	Fast Log Video
Initial S/W Revision	A.04.00

### I/Q Guided Calibration

Calibrating the Baseband I/Q ports requires several steps and manual connections. The Guided Calibration will interactively step you through the required steps, displaying diagrams to help with the connections. The steps will vary depending on the setup.

In the Guided Calibration windows, the date and time of the last calibration are displayed. If any of the items listed are displayed in yellow, this indicates that the calibration for that item is inconsistent with the latest calibration, and you should complete the entire calibration process before you exit the calibration.

## I/Q Isolation Calibration

The I/Q Isolation Calibration must be run before calibrating any port with either the I/Q Cable Calibration or I/Q Probe Calibration. This calibration is performed with nothing connected to any of the front panel I/Q ports. This is the first step in both the I/Q Cable Calibration and the I/Q Probe Calibration.

### Next

Perform the I/Q Isolation calibration.

Key Path	Input/Output, I/Q, I/Q Cable Calibration
Remote Command	:CALibration:IQ:ISOLation
Example	CAL:IQ:ISOL
Notes	All front panel I/Q ports must not be connected to anything.
Notes	All cables and probes should be disconnected from the I/Q ports before issuing the SCPI command.
State Saved	No.
Initial S/W Revision	Prior to A.02.00

### Exit

Exits the calibration procedure. All ports calibrated before pressing Exit will use the newly acquired calibration data.

Key Path	Input/Output, I/Q, I/Q Cable Calibration
Notes	Using the Exit button will not restore the calibration data to the state prior to entering the guided calibration. Once a port is calibrated the data is stored immediately and the only way to change it is to redo the calibration step.  When the calibration may be left in an inconsistent state, a confirmation dialog will be displayed (see " <a href="#">Exit Confirmation</a> " on page 295 ).
Initial S/W Revision	Prior to A.02.00

## I/Q Isolation Calibration Time (Remote Command Only)

Returns the last date and time that the I/Q Isolation Calibration was performed. This is a remote query command only.

Remote Command	:CALibration:IQ:ISOLation:TIME?
Example	:CAL:IQ:ISOL:TIME?
Notes	This returns 6 integer values: year, month, day, hour, minute, second. When no calibration has been performed, all values will be 0.
Initial S/W Revision	A.02.00

## I/Q Cable Calibrate...

The I/Q cable calibration creates correction data for each of the front panel I/Q ports. This calibration data is used whenever no probe specific calibration data is available. It is important that all ports are calibrated using the same short BNC cable so that the data is comparable from port to port.

The guided calibration (front panel only) will show connection diagrams and guide you through the isolation calibration and calibrating each port. The calibration data for each port is stored separately, so as soon as a port is calibrated that data is saved and will be used. If you press "Exit" to exit the calibration process, the data for the ports already completed will still be used. It is recommended that a calibration be completed once started, or if exited, that it be properly done before the next use of the I/Q ports. The "Next" button will perform the calibration for the current port and then proceed to the next step in the calibration procedure. The "Back" button will return to the prior port in the procedure. Both keys and dialog buttons are supplied for ease of use. The dialog buttons are for mouse use and the softkeys for front panel use.

The calibration can also be done via SCPI, but no connection diagrams will be shown. You will have to make the correct connections before issuing each port calibration command. Again, it is recommended that all ports be calibrated at the same time.

The instrument state remains as it was prior to entering the calibration procedure except while a port is actually being calibrated. Once a port is calibrated it returns to the prior state. A port calibration is in process only from the time the "Next" button is pressed until the next screen is shown. For SCPI, this corresponds to the time from issuing the CAL:IQ:FLAT:|I|B|Q|QB command until the operation is complete.

For example, if the prior instrument state is Cal Out = Off, Input = I+jQ, and Differential = Off, then up until the time the "Next" button is pressed the I Input and Q Input LEDs are on and the Cal Out, I-bar Input and Q-bar Input LEDs are off. Once the "Next" button is pressed for the I port calibration, only the Cal Out and I Input LEDs will be on and the others will be off. When the screen progresses to the next step ("Next" button again enabled), the prior state is restored and only the I Input and Q Input LEDs are on (Cal Out is off again).

The last calibration date and time for each port will be displayed. Any calibrations that are more than a day older than the most recent calibration will be displayed with the color amber.

Key Path	Input/Output, I/Q
Initial S/W Revision	Prior to A.02.00

## I Port

The I port calibration is performed with the front panel's I port connected via a short BNC cable to the Cal Out port. The guided calibration will show a diagram of the required connections.

### Back

Return to the prior step in the calibration procedure.

Key Path	Input/Output, I/Q, Q Setup, Q Probe, Calibrate
Initial S/W Revision	Prior to A.02.00

### Next

Perform the I port calibration.

Key Path	Input/Output, I/Q, I/Q Cable Calibrate...
Remote Command	:CALibration:IQ:FLATness:I
Example	CAL:IQ:FLAT:I
Notes	The recommended procedure is to use the same BNC cable to calibrate all I/Q ports. All I/Q ports should be calibrated sequentially during the procedure. The calibration data is saved as soon as the port is calibrated and will survive power cycles. It is not reset by any preset or restore data commands.
Notes	The I port must be connected to the Cal Out port before issuing the SCPI command.
State Saved	No.
Initial S/W Revision	Prior to A.02.00

### Exit

Exit the calibration procedure. All ports calibrated before pressing Exit will use the newly acquired calibration data.

Key Path	Input/Output, I/Q, I/Q Cable Calibrate...
Notes	Using the Exit button will not restore the calibration data to the state prior to entering the guided calibration. Once a port is calibrated the data is stored immediately and the only way to change it is to redo the calibration step. When the calibration may be left in an inconsistent state, a confirmation dialog will be displayed (see " <a href="#">Exit Confirmation</a> " on page 295 ).
Initial S/W Revision	Prior to A.02.00

### I-bar Port

The I-bar port calibration is performed with the front panel's I-bar port connected via a short BNC cable to the Cal Out port. The guided calibration will show a diagram of the required connections.

### Back

Return to the prior step in the calibration procedure.

Key Path	Input/Output, I/Q, I/Q Cable Calibration
Notes	Using the Back button will not restore the calibration data to a prior state. Once a port is calibrated the data is stored immediately and the only way to change it is to redo the calibration step. The Back button allows the user to go back to a prior step to redo that calibration step.
Initial S/W Revision	Prior to A.02.00

### Next

Perform the I-bar port calibration.

Key Path	Input/Output, I/Q, I/Q Cable Calibrate...
<b>Remote Command</b>	:CALibration:IQ:FLATness:IBAR
<b>Example</b>	CAL:IQ:FLAT:IBAR
Notes	The recommended procedure is to use the same BNC cable to calibrate all I/Q ports. All I/Q ports should be calibrated sequentially during the procedure. The calibration data is saved as soon as the port is calibrated and will survive power cycles. It is not reset by any preset or restore data commands.
Notes	The I-bar port must be connected to the Cal Out port before issuing the SCPI command.
State Saved	No
Initial S/W Revision	Prior to A.02.00

### Exit

Exit the calibration procedure. All ports calibrated before pressing Exit will use the newly acquired calibration data.

Key Path	Input/Output, I/Q, I/Q Cable Calibrate...
Notes	Using the Exit button will not restore the calibration data to the state prior to entering the guided calibration. Once a port is calibrated the data is stored immediately and the only way to change it is to redo the calibration step. When the calibration may be left in an inconsistent state, a confirmation dialog will be displayed (see <b>"Exit Confirmation" on page 295</b> ).
Initial S/W Revision	Prior to A.02.00

### Q Port

The Q port calibration is performed with the front panel's Q port connected via a short BNC cable to the Cal Out port. The guided calibration will show a diagram of the required connections.

### Back

Return to the prior step in the calibration procedure.

Key Path	Input/Output, I/Q, I/Q Cable Calibrate...
Notes	Using the Back button will not restore the calibration data to a prior state. Once a port is calibrated the data is stored immediately and the only way to change it is to redo the calibration step. The Back button allows the user to go back to a prior step to redo that calibration step.
Initial S/W Revision	Prior to A.02.00

### Next

Perform the Q port calibration.

Key Path	Input/Output, I/Q, I/Q Cable Calibrate...
Remote Command	:CALibration:IQ:FLATness:Q
Example	CAL:IQ:FLAT:Q
Notes	The recommended procedure is to use the same BNC cable to calibrate all I/Q ports. All I/Q ports should be calibrated sequentially during the procedure. The calibration data is saved as soon as the port is calibrated and will survive power cycles. It is not reset by any preset or restore data commands.
Notes	The Q port must be connected to the Cal Out port before issuing the SCPI command.
State Saved	No
Initial S/W Revision	Prior to A.02.00

### Exit

Exit the calibration procedure. All ports calibrated before pressing Exit will use the newly acquired calibration data.

Key Path	Input/Output, I/Q, I/Q Cable Calibrate...
Notes	Using the Exit button will not restore the calibration data to the state prior to entering the guided calibration. Once a port is calibrated the data is stored immediately and the only way to change it is to redo the calibration step. When the calibration may be left in an inconsistent state, a confirmation dialog will be displayed (see " <a href="#">Exit Confirmation</a> " on page 295 ).
Initial S/W Revision	Prior to A.02.00

### Q-bar Port

The Q-bar port calibration is performed with the front panel's Q-bar port connected via a short BNC cable to the Cal Out port. The guided calibration will show a diagram of the required connections.

### Back

Return to the prior step in the calibration procedure.

Key Path	Input/Output, I/Q, I/Q Cable Calibrate...
Notes	Using the Back button will not restore the calibration data to a prior state. Once a port is calibrated the data is stored immediately and the only way to change it is to redo the calibration step. The Back button allows the user to go back to a prior step to redo that calibration step.
Initial S/W Revision	Prior to A.02.00



**Next**

Perform the Q-bar port calibration.

<b>Key Path</b>	Input/Output, I/Q, I/Q Cable Calibrate...
<b>Remote Command</b>	:CALibration:IQ:FLATness:QBAR
<b>Example</b>	CAL:IQ:FLAT:QBAR
<b>Notes</b>	The recommended procedure is to use the same BNC cable to calibrate all I/Q ports. All I/Q ports should be calibrated sequentially during the procedure. The calibration data is saved as soon as the port is calibrated and will survive power cycles. It is not reset by any preset or restore data commands.
<b>Notes</b>	The Q-bar port must be connected to the Cal Out port before issuing the SCPI command.
<b>State Saved</b>	No
<b>Initial S/W Revision</b>	Prior to A.02.00

**Exit**

Exit the calibration procedure. All ports calibrated before pressing Exit will use the newly acquired calibration data.

<b>Key Path</b>	Input/Output, I/Q, I/Q Cable Calibrate...
<b>Notes</b>	Using the Exit button will not restore the calibration data to the state prior to entering the guided calibration. Once a port is calibrated the data is stored immediately and the only way to change it is to redo the calibration step. When the calibration may be left in an inconsistent state, a confirmation dialog will be displayed (see <a href="#">"Exit Confirmation" on page 295</a> ).
<b>Initial S/W Revision</b>	Prior to A.02.00

**I/Q Cable Calibration Time (Remote Command Only)**

Returns the last date and time that the I/Q Cable Calibration was performed for a specific port. This is a remote query command only.

<b>Remote Command</b>	:CALibration:IQ:FLATness:I IBAR Q QBAR:TIME?
<b>Example</b>	:CAL:IQ:FLAT:I:TIME?
<b>Notes</b>	This returns 6 integer values: year, month, day, hour, minute, second. When no calibration has been performed, all values will be 0.
<b>Initial S/W Revision</b>	A.02.00

**I/Q Probe Calibration**

The I/Q probe calibration creates correction data for one of the front panel I/Q channels. When the probe has EEPROM identification, the data is unique to that specific probe. When the probe does not have

EEPROM identification, the data will be used for all probes of the same type. The data is also unique to the channel, so calibration data for the I channel will not be used for the Q channel and vice versa.

The guided calibration (front panel only) will show connection diagrams and guide the user through the I/Q Isolation Calibration and through calibrating each port. The calibration data for each port is stored separately, so as soon as a port is calibrated that data is saved and will be used. If a user presses "Exit" to exit the calibration process, the data for the port already completed will still be used. It is recommended that a calibration be completed once started, or if exited, that it be properly done before the next use of the probe. The "Next" button will perform the calibration for the current port and then proceed to the next step in the calibration procedure. The "Back" button will return to the prior port in the procedure. Both softkeys and dialog buttons are supplied for ease of use. The dialog buttons are for mouse use and the softkeys for front panel use.

The calibration can also be done via SCPI, but no connection diagrams will be shown. The user will have to make the correct connections before issuing each port calibration command. Again, it is recommended that all ports be calibrated at the same time.

For Active probes or when Differential is Off, only the main port is calibrated, otherwise both the main and complementary ports are calibrated.

The instrument state remains as it was prior to entering the calibration procedure except while a port is actually being calibrated. Once a port is calibrated it returns to the prior state. A port calibration is in process only from the time the "Next" button is pressed until the next screen is shown. For SCPI, this corresponds to the time from issuing the CAL:IQ:PROB:I|B|Q|QB command until the operation is complete.

For example, if the prior instrument state is Cal Out = Off, Input = I+jQ, and Differential = Off, then up until the time the "Next" button is pressed the I Input and Q Input LEDs are on and the Cal Out, I-bar Input and Q-bar Input LEDs are off. Once the "Next" button is pressed for the I port calibration, only the Cal Out and I Input LEDs will be on and the others will be off. When the screen progresses to the next step ("Next" button again enabled), the prior state is restored and only the I Input and Q Input LEDs are on (Cal Out is off again).

The last calibration date and time for each relevant port will be displayed. For passive probes with Differential On, any calibration that is more than a day older than the most recent calibration will be displayed with the color amber.

## I Port

The I port calibration is performed with the probe body attached to the front panel's I port and the probe tip connected via an adapter to the Cal Out port. The guided calibration will show a diagram of the required connections.

### Show Adapter

Show a connection diagram and instructions for the probe and adapter. See ["Show Adapter Screen" on page 295](#).

Key Path	Input/Output, I/Q, I Setup, I Probe, Calibrate
Notes	Either a passive or an active probe adapter diagram will be shown, depending on the type of probe attached.
Initial S/W Revision	Prior to A.02.00

**Back**

Return to the prior step in the calibration procedure.

Key Path	Input/Output, I/Q, Q Setup, Q Probe, Calibrate
Initial S/W Revision	Prior to A.02.00

**Next**

Perform the I port calibration.

Key Path	Input/Output, I/Q, I Setup, I Probe, Calibrate
<b>Remote Command</b>	:CALibration:IQ:PROBe:I
<b>Example</b>	CAL:IQ:PROB:I
Notes	The I port must be connected to the Cal Out port before issuing the SCPI command. The calibration data is saved as soon as the port is calibrated and will survive power cycles. It is not reset by any preset or restore data commands.
State Saved	No
Initial S/W Revision	Prior to A.02.00

**Exit**

Exit the calibration procedure. All ports calibrated before pressing Exit will use the newly acquired calibration data.

Key Path	Input/Output, I/Q, I Setup, I Probe, Calibrate
Notes	Using the Exit button will not restore the calibration data to the state prior to entering the guided calibration. Once a port is calibrated the data is stored immediately and the only way to change it is to redo the calibration step. When the calibration may be left in an inconsistent state, a confirmation dialog will be displayed (see <a href="#">"Exit Confirmation" on page 295</a> ).
Initial S/W Revision	Prior to A.02.00

**I-bar Port**

The I-bar port calibration is performed with the probe body attached to the front panel's I-bar port and the probe tip connected via an adapter to the Cal Out port. The I-bar probe calibration is only available for passive probes with Differential On. The guided calibration will show a diagram of the required connections.

**Show Adapter**

Show a connection diagram and instructions for the probe and adapter. See ["Show Adapter Screen" on page 295](#).

Key Path	Input/Output, I/Q, I Setup, I Probe, Calibrate
Notes	Either a passive or an active probe adapter diagram will be shown, depending on the type of probe attached.
Initial S/W Revision	Prior to A.02.00

### Back

Return to the prior step in the calibration procedure.

Key Path	Input/Output, I/Q, I Setup, I Probe, Calibrate
Notes	Using the Back button will not restore the calibration data to a prior state. Once a port is calibrated the data is stored immediately and the only way to change it is to redo the calibration step. The Back button allows the user to go back to a prior step to redo that calibration step.
Initial S/W Revision	Prior to A.02.00

### Next

Perform the I-bar port calibration.

Key Path	Input/Output, I/Q, I Setup, I Probe, Calibrate
<b>Remote Command</b>	:CALibration:IQ:PROBE:IBar
<b>Example</b>	CAL:IQ:PROB:IB
Notes	The I-bar port must be connected to the Cal Out port before issuing the SCPI command. The calibration data is saved as soon as the port is calibrated and will survive power cycles. It is not reset by any preset or restore data commands.
State Saved	No
Initial S/W Revision	Prior to A.02.00

### Exit

Exit the calibration procedure. All ports calibrated before pressing Exit will use the newly acquired calibration data.

Key Path	Input/Output, I/Q, I Setup, I Probe, Calibrate
Notes	Using the Exit button will not restore the calibration data to the state prior to entering the guided calibration. Once a port is calibrated the data is stored immediately and the only way to change it is to redo the calibration step. When the calibration may be left in an inconsistent state, a confirmation dialog will be displayed (see <a href="#">"Exit Confirmation" on page 295</a> ).
Initial S/W Revision	Prior to A.02.00

## Q Port

The Q port calibration is performed with the probe body attached to the front panel's Q port and the probe tip connected via an adapter to the Cal Out port. The guided calibration will show a diagram of the required connections.

### Show Adapter

Show a connection diagram and instructions for the probe and adapter. See ["Show Adapter Screen" on page 295](#).

Key Path	Input/Output, I/Q, Q Setup, Q Probe, Calibrate
Notes	Either a passive or an active probe adapter diagram will be shown, depending on the type of probe attached.
Initial S/W Revision	Prior to A.02.00

### Back

Return to the prior step in the calibration procedure.

Key Path	Input/Output, I/Q, Q Setup, Q Probe, Calibrate
Initial S/W Revision	Prior to A.02.00

### Next

Perform the Q port calibration.

Key Path	Input/Output, I/Q, Q Setup, Q Probe, Calibrate
<b>Remote Command</b>	:CALibration:IQ:PROBe:Q
<b>Example</b>	CAL:IQ:PROB:Q
Notes	The Q port must be connected to the Cal Out port before issuing the SCPI command. The calibration data is saved as soon as the port is calibrated and will survive power cycles. It is not reset by any preset or restore data commands.
State Saved	No
Initial S/W Revision	Prior to A.02.00

### Exit

Exit the calibration procedure. All ports calibrated before pressing Exit will use the newly acquired calibration data.

Key Path	Input/Output, I/Q, Q Setup, Q Probe, Calibrate
Notes	Using the Exit button will not restore the calibration data to the state prior to entering the guided calibration. Once a port is calibrated the data is stored immediately and the only way to change it is

to redo the calibration step.

When the calibration may be left in an inconsistent state, a confirmation dialog will be displayed (see ["Exit Confirmation" on page 295](#) ).

Initial S/W Revision	Prior to A.02.00
----------------------	------------------

### Q-bar Port

The Q-bar port calibration is performed with the probe body attached to the front panel's Q-bar port and the probe tip connected via an adapter to the Cal Out port. The Q-bar probe calibration is only available for passive probes with Differential On. The guided calibration will show a diagram of the required connections.

#### Show Adapter

Show a connection diagram and instructions for the probe and adapter. See ["Show Adapter Screen" on page 295](#).

Key Path	Input/Output, I/Q, Q Setup, Q Probe, Calibrate
Notes	Either a passive or an active probe adapter diagram will be shown, depending on the type of probe attached.
Initial S/W Revision	Prior to A.02.00

#### Back

Return to the prior step in the calibration procedure.

Key Path	Input/Output, I/Q, Q Setup, Q Probe, Calibrate
Notes	Using the Back button will not restore the calibration data to a prior state. Once a port is calibrated the data is stored immediately and the only way to change it is to redo the calibration step. The Back button allows the user to go back to a prior step to redo that calibration step.
Initial S/W Revision	Prior to A.02.00

#### Next

Perform the Q-bar port calibration.

Key Path	Input/Output, I/Q, Q Setup, Q Probe, Calibrate
<b>Remote Command</b>	:CALibration:IQ:PROBE:QBar
<b>Example</b>	CAL:IQ:PROB:QB
Notes	The Q-bar port must be connected to the Cal Out port before issuing the SCPI command. The calibration data is saved as soon as the port is calibrated and will survive power cycles. It is not reset by any preset or restore data commands.
State Saved	No
Initial S/W Revision	Prior to A.02.00

## Exit

Exit the calibration procedure. All ports calibrated before pressing Exit will use the newly acquired calibration data.

Key Path	Input/Output, I/Q, Q Setup, Q Probe, Calibrate
Notes	Using the Exit button will not restore the calibration data to the state prior to entering the guided calibration. Once a port is calibrated the data is stored immediately and the only way to change it is to redo the calibration step.  When the calibration may be left in an inconsistent state, a confirmation dialog will be displayed (see <a href="#">"Exit Confirmation" on page 295</a> ).
Initial S/W Revision	Prior to A.02.00

## Show Adapter Screen

When one of the Probe Calibration Show Adapter buttons is pressed, a diagram of the probe with its adapter will be shown. Depending on the type of probe attached, either the Passive Probe Adapter or the Active Probe Adapter diagram will be shown.

## I/Q Probe Calibration Time (Remote Command Only)

Return the last date and time that the I/Q Probe Calibration was performed for a specific port. This is a remote query command only.

<b>Remote Command</b>	:CALibration:IQ:PROBe:I IBAR Q QBAR:TIME?
<b>Example</b>	:CAL:IQ:PROB:I:TIME?
Notes	This returns 6 integer values: year, month, day, hour, minute, second. When no calibration has been performed, all values will be 0. The value is specific to both the port and probe, so the value will change as probes are connected or disconnected.
Initial S/W Revision	A.02.00

## Exit Confirmation

When Exit is pressed during one of the calibration routines, the calibration may be in an inconsistent state with some of the ports having newly measured calibration data and others with old data. If this is the case, a dialog box will appear to confirm that the user really wants to exit. A "Yes" answer will exit the calibration procedure, leaving potentially inconsistent calibration data in place. A "No" answer will return to the calibration procedure.





## 5 Mode Functions

## Mode

The Mode key allows you to select the available measurement applications or “Modes”. Modes are a collection of measurement capabilities packaged together to provide an instrument personality that is specific to your measurement needs. Each application software product is ordered separately by Model Number and must be licensed to be available. Once an instrument mode is selected, only the commands that are valid for that mode can be executed.

**NOTE**

Key operation can be different between modes. The information displayed in Help is about the current mode.

To access Help for a different Mode you must first exit Help (by pressing the Cancel (Esc) key). Then select the desired mode and re-access Help.

For more information on Modes, preloading Modes, and memory requirements for Modes, see ["More Information" on page 299](#)

Key Path	Front-panel key
<b>Remote Command</b>	:INSTrument[:SElect] SA   RTSA   SEQAN   EMI   BASIC   WCDMA   EDGE GSM   WIMAXOFDMA   VSA   PNOISE   NFIGure   ADEMOD   BTooth   TDSCDMA   CDMA2K   CDMA1XEV   LTE   LTETDD   LTEAFDD   LTEATDD   MSR   DVB   DTMB   DCATV   ISDBT   CM MB   WLAN   CWLAN   CWIMAXOFDM   WIMAXFIXED   IDEN   RLC   SCPI LC   VSA89601  :INSTrument[:SElect]?
<b>Example</b>	:INST SA
<b>Notes</b>	The available parameters are dependent upon installed and licensed applications resident in the instrument. Parameters given here are an example, specific parameters are in the individual Application.  A list of the valid mode choices is returned with the INST:CAT? Query.
<b>Preset</b>	This is unaffected by a Preset but is set on a “Restore System Defaults->All” to: For N9038A: EMI For N8973B, N8974B, N8975B, or N8976B: NFIG For all other models: SA
<b>State Saved</b>	Saved in instrument state
<b>Backwards Compatibility SCPI</b>	:INSTrument[:SElect] GSM provided for backwards compatibility. Mapped to EDGE GSM.
<b>Backwards Compatibility SCPI</b>	:INSTrument[:SElect] SANalyzer provided for ESU compatibility. When this command is received, the analyzer aliases it to the following: INST:SEL SCPI LC  This results in the analyzer being placed in SCPI Language Compatibility Mode, in order to emulate

	the ESU Spectrum Analyzer Mode.
<b>Backwards Compatibility SCPI</b>	:INSTrument[:SElect] RECeiver provided for ESU compatibility. When this command is received, the analyzer aliases it to the following: :INST:SEL EMI :CONF FSC This results in the analyzer being placed in the EMI Receiver Mode, running the Frequency Scan measurement, in order to emulate the ESU Receiver Mode.
Initial S/W Revision	Prior to A.02.00
Modified at S/W Revision	A.13.00

<b>Example</b>	:INST 'SA'
Notes	The query is not a quoted string. It is an enumeration as indicated in the Instrument Select table above. The command must be sequential: i.e. continued parsing of commands cannot proceed until the instrument select is complete and the resultant SCPI trees are available.
<b>Backwards Compatibility SCPI</b>	:INSTrument[:SElect] 'SA'   'PNOISE'   'EDGE'   'GSM'   'BASIC'
Initial S/W Revision	Prior to A.02.00

## More Information

The Mode name appears on the banner after the word “Agilent” followed by the Measurement Title. For example, for the Spectrum Analyzer mode with the Swept SA measurement running:



It is possible to specify the order in which the Modes appear in the Mode menu, using the Configure Applications utility (System, Power On, Configure Applications). It is also possible, using the same utility, to specify a subset of the available applications to load into memory at startup time, which can significantly decrease the startup time of the analyzer. During runtime, if an application that is not loaded into memory is selected (by either pressing that applications Mode key or sending that applications :INST:SEL command over SCPI), there will be a pause while the Application is loaded. During this pause a message box that says “Loading application, please wait...” is displayed.

Each application (Mode) that runs in the X-Series signal analyzers consumes virtual memory. The various applications consume varying amounts of virtual memory, and as more applications run, the memory consumption increases. Once an application is run, some of its memory remains allocated even when it is not running, and is not released until the analyzer program (xSA.exe) is shut down.

Agilent characterizes each Mode and assigns a memory usage quantity based on a conservative estimate. There is a limited amount of virtual memory available to applications (note that this is virtual memory and is independent of how much physical RAM is in the instrument). The instrument keeps track of how much

memory is being used by all loaded applications – which includes those that preloaded at startup, and all of those that have been run since startup.

When you request a Mode that is not currently loaded, the instrument looks up the memory estimate for that Mode, and adds it to the residual total for all currently loaded Modes. If there is not enough virtual memory to load the Mode, a dialog box and menu will appear that gives you four options:

1. Close and restart the analyzer program without changing your configured preloads. This may free up enough memory to load the requested Mode, depending on your configured preloads
2. Clear out all preloads and close and restart the analyzer program with only the requested application preloaded, and with that application running. This choice is guaranteed to allow you to run the requested application; but you will lose your previously configured preloads. In addition, there may be little or no room for other applications, depending on the size of the requested application.
3. Bring up the Configure Applications utility in order to reconfigure the preloaded apps to make room for the applications you want to run (this will then require restarting the analyzer program with your new configuration). This is the recommended choice because it gives you full flexibility to select exactly what you want.
4. Exit the dialog box without doing anything, which means you will be unable to load the application you requested.

In each case except 4, this will cause the analyzer software to close, and you will lose all unsaved traces and results.

If you attempt to load a mode via SCPI that will exceed memory capacity, the Mode does not load and an error message is returned:

```
-225,"Out of memory;Insufficient resources to load Mode (mode name)"
```

where “mode name” is the SCPI parameter for the Mode in question, for example, SA for Spectrum Analyzer Mode.

## Spectrum Analyzer

Selects the Spectrum Analyzer mode for general purpose measurements. There are several measurements available in this mode. General spectrum analysis measurements, in swept and zero span, can be done using the first key in the Meas menu, labeled Swept SA. Other measurements in the Meas Menu are designed to perform specialized measurement tasks, including power and demod measurements.

If you are using the Help feature, this mode must be currently active to access its detailed information. If it is not active, exit the Help feature (Esc key), select the mode, and re-access Help.

Key Path	Mode
<b>Example</b>	INST:SEL SA INST:NSEL 1
Initial S/W Revision	Prior to A.02.00

## DVB-T/H with T2

Selects the DVB-T/H mode for measurements of digital video signals using this format. There are several power and demod measurements available in this mode.

If you are using the Help feature, this mode must be currently active to access its detailed information. If it is not active, exit the Help feature (Esc key), select the mode, and re-access Help.

Key Path	Mode
<b>Example</b>	INST:SEL DVB INST:NSEL 235
Initial S/W Revision	A.02.00
Modified at S/W Revision	A.07.00

## cdma2000

Selects the cdma2000 mode for general purpose measurements of signals following this standard. There are several measurements available in this mode.

If you are using the Help feature, this mode must be currently active to access its detailed information. If it is not active, exit the Help feature (Esc key), select the mode, and re-access Help.

Key Path	Mode
<b>Example</b>	INST:SEL CDMA2K INST:NSEL 10
Initial S/W Revision	Prior to A.02.00

## Vector Signal Analyzer (VXA)

The N9064A (formerly 89601X) VXA Vector signal and WLAN modulation analysis application provides solutions for basic vector signal analysis, analog demodulation, and digital demodulation. The digital demodulation portion of N9064A allows you to perform measurements on standard-based formats such as cellular, wireless networking and digital video as well as general purpose flexible modulation analysis for wide range of digital formats, FSK to 1024QAM, with easy-to-use measurements and display tools such as constellation and eye diagram, EVM traces and up to four simultaneous displays. Analog baseband analysis is available using the MXA and PXA with option BBA. Option 3FP WLAN has been discontinued.

N9064A honors existing 89601X licenses with all features and functionalities found on X-Series software versions prior to A.06.00. Specifically:

N9064A-1 is equivalent to 89601X-205

N9064A-2 is equivalent to 89601X-AYA

If you are using the Help feature, this mode must be currently active to access its detailed information. If it is not active, exit the Help feature (Esc key), select the mode, and re-access Help.

Key Path	Mode
<b>Example</b>	INST:SEL VSA INST:NSEL 100
Initial S/W Revision	Prior to A.02.00

## Analog Demod

Selects the Analog Demod mode for making measurements of AM, FM and phase modulated signals.

If you are using the Help feature, this mode must be currently active to access its detailed information. If it is not active, exit the Help feature (Esc key), select the mode, and re-access Help.

Key Path	Mode
<b>Example</b>	INST:SEL ADEMOM INST:NSEL 234
Initial S/W Revision	Prior to A.02.00

## Phase Noise

The Phase Noise mode provides pre-configured measurements for making general purpose measurements of device phase noise.

If you are using the Help feature, this mode must be currently active to access its detailed information. If it is not active, exit the Help feature (Esc key), select the mode, and re-access Help.

Key Path	Mode
<b>Example</b>	INST:SEL PNOISE or INST:NSEL 14
Initial S/W Revision	Prior to A.02.00

## CMMB

Selects the CMMB mode for measurements of digital video signals using this format. There are several power and demod measurements available in this mode.

If you are using the Help feature, this mode must be currently active to access its detailed information. If it is not active, exit the Help feature (Esc key), select the mode, and re-access Help.

Key Path	Mode
<b>Example</b>	INST:SEL CMMB INST:NSEL 240
Initial S/W Revision	A.03.00

## Combined WLAN

Selects the CWLAN mode for general purpose measurements of signals following this standard. There are several measurements available in this mode.

If you are using the Help feature, this mode must be currently active to access its detailed information. If it is not active, exit the Help feature (Esc key), select the mode, and re-access Help.

Key Path	Mode
<b>Example</b>	INST:SEL CWLAN INST:NSEL 19
Initial S/W Revision	A.02.00

## TD-SCDMA with HSPA/8PSK

Selects the TD-SCDMA mode for general purpose measurements of signals following this standard. There are several measurements available in this mode.

If you are using the Help feature, this mode must be currently active to access its detailed information. If it is not active, exit the Help feature (Esc key), select the mode, and re-access Help.

Key Path	Mode
<b>Example</b>	INST:SEL TDSCDMA INST:NSEL 211
Initial S/W Revision	Prior to A.02.00

## IQ Analyzer (Basic)

The IQ Analyzer Mode makes general purpose frequency domain and time domain measurements. These measurements often use alternate hardware signal paths when compared with a similar measurement in the Signal Analysis Mode using the Swept SA measurement. These frequency domain and time domain measurements can be used to output I/Q data results when measuring complex modulated digital signals.

If you are using the Help feature, this mode must be currently active to access its detailed information. If it is not active, exit the Help feature (Esc key), select the mode, and re-access Help.

Key Path	Mode
<b>Example</b>	INST:SEL BASIC INST:NSEL 8
Initial S/W Revision	Prior to A.02.00

### W-CDMA with HSPA+

Selects the W-CDMA with HSPA+ mode for general purpose measurements of signals following this standard. There are several measurements available in this mode.

If you are using the Help feature, this mode must be currently active to access its detailed information. If it is not active, exit the Help feature (Esc key), select the mode, and re-access Help.

Key Path	Mode
<b>Example</b>	INST:SEL WCDMA INST:NSEL 9
Initial S/W Revision	Prior to A.02.00

### GSM/EDGE/EDGE Evo

Selects the GSM with EDGE mode for general purpose measurements of signals following this standard. There are several measurements available in this mode.

If you are using the Help feature, this mode must be currently active to access its detailed information. If it is not active, exit the Help feature (Esc key), select the mode, and re-access Help.

Key Path	Mode
<b>Example</b>	INST:SEL EDGE GSM INST:NSEL 13
Initial S/W Revision	Prior to A.02.00
Modified at S/W Revision	A.02.00

### Noise Figure

The Noise Figure mode provides pre-configured measurements for making general purpose measurements of device noise figure.

If you are using the Help feature, this mode must be currently active to access its detailed information. If it is not active, exit the Help feature (Esc key), select the mode, and re-access Help.

Key Path	Mode
<b>Example</b>	INST:SEL NFIGURE INST:NSEL 219
Initial S/W Revision	Prior to A.02.00

### WLAN

Selects the WLAN mode for general purpose measurements of signals following this standard. There are several measurements available in this mode.



If you are using the Help feature, this mode must be currently active to access its detailed information. If it is not active, exit the Help feature (Esc key), select the mode, and re-access Help.

Key Path	Mode
<b>Example</b>	INST:SEL WLAN INST:NSEL 217
Initial S/W Revision	A.09.491

## EMI Receiver

The EMI Receiver Mode makes EMC measurements. Several measurements are provided to aid the user in characterizing EMC performance of their systems, including looking at signals with CISPR-16 compliant detectors, performing scans for interfering signals, and determining and charting interfering signals over time.

If you are using the Help feature, this mode must be currently active to access its detailed information. If it is not active, exit the Help feature (Esc key), select the mode, and re-access Help.

Key Path	Mode
<b>Example</b>	INST:SEL EMI INST:NSEL 141
Initial S/W Revision	A.07.01

## 802.16 OFDM (Fixed WiMAX)

Selects the 802.16 OFDM (Fixed WiMAX) mode. This mode allows modulation quality measurements of signals that comply with IEEE 802.16a-2003 and IEEE 802.16-2004 standards, with flexibility to measure nonstandard OFDM formats. Along with the typical digital demodulation measurement results, several additional 802.16 OFDM unique trace data formats and numeric error data results provide enhanced data analysis.

If you are using the Help feature, this mode must be currently active to access its detailed information. If it is not active, exit the Help feature (Esc key), select the mode, and re-access Help.

Key Path	Mode
<b>Example</b>	INST:SEL WIMAXFIXED INST:NSEL 104
Initial S/W Revision	A.02.00

## DTMB (CTTB)

Selects the DTMB (CTTB) mode for measurements of digital video signals using this format. There are several power and demod measurements available in this mode.

If you are using the Help feature, this mode must be currently active to access its detailed information. If it is not active, exit the Help feature (Esc key), select the mode, and re-access Help.

Key Path	Mode
<b>Example</b>	INST:SEL DTMB INST:NSEL 236
Initial S/W Revision	A.02.00

## 1xEV-DO

Selects the 1xEV-DO mode for general purpose measurements of signals following this standard. There are several measurements available in this mode.

If you are using the Help feature, this mode must be currently active to access its detailed information. If it is not active, exit the Help feature (Esc key), select the mode, and re-access Help.

Key Path	Mode
<b>Example</b>	INST:SEL CDMA1XEV INST:NSEL 15
Initial S/W Revision	Prior to A.02.00

## 802.16 OFDMA (WiMAX/WiBro)

Selects the OFDMA mode for general purpose measurements of WiMAX signals. There are several measurements available in this mode.

If you are using the Help feature, this mode must be currently active to access its detailed information. If it is not active, exit the Help feature (Esc key), select the mode, and re-access Help.

Key Path	Mode
<b>Example</b>	INST:SEL WIMAXOFDMA INST:NSEL 75
Initial S/W Revision	Prior to A.02.00

## 89601 VSA

Selecting the 89601 VSA mode will start the 89600 VSA software. The 89600 VSA software is powerful, PC-based software, offering the industry's most sophisticated general purpose and standards specific signal evaluation and troubleshooting tools for R&D engineers. Even for proprietary and non-standard signals in SATCOM or MILCOM applications, you can make signal quality measurements with customized IQ constellation. Reach deeper into signals, gather more data on signal problems, and gain greater insight.

- Over 35 general-purpose analog and digital demodulators ranging from 2FSK to 4096QAM

- Flexible and custom IQ and OFDM signal analysis for single carrier
- Standards specific modulation analysis including:
  - Cellular: GSM/EDGE, cdma2000, W-CDMA, TD-SCDMA, LTE(FDD/TDD),
  - LTE-Advanced and more
  - Wireless networking: 802.11a/b/g, 802.11n, 802.ac, 802.16 WiMAX (fixed/mobile), WiSUN (MR-FSK PHY)
  - RFID
  - Digital satellite video and other satellite signals, radar, LMDS
  - Up to 400K bin FFT, for the highest resolution spectrum analysis
  - A full suite of time domain analysis tools, including signal capture and playback, time gating, and CCDF measurements
  - 20 simultaneous trace displays and the industry's most complete set of marker functions
  - Easy-to-use Microsoft ® Windows ® graphical user interface

For more information see the Agilent 89600 Series VSA web site at [www.agilent.com/find/89600vsa](http://www.agilent.com/find/89600vsa)

To learn more about how to use the 89600 VSA running in the X-Series, after the 89600 VSA software is running, open the 89600 VSA Help and open the "About Agilent X-Series Signal Analyzer with 89600 VSA Software" help topic.

Key Path	Mode
<b>Example</b>	INST:SEL VSA89601 INST:NSEL 101
Initial S/W Revision	Prior to A.02.00

## MSR

Selects the MSR mode. The MSR mode makes several measurements for Cellular Communication devices that can be configured with multiple radio formats simultaneously following the 3GPP standard of Multi-Standard Radio, including GSM/EDGE, WCDMA/HSPA+ and LTE.

If you are using the Help feature, this mode must be currently active to access its detailed information. If it is not active, exit the Help feature (Esc key), select the mode, and re-access Help.

Key Path	Mode
<b>Example</b>	INST:SEL MSR INST:NSEL 106
Initial S/W Revision	A.09.491

## Bluetooth

Selects the Bluetooth mode for Bluetooth specific measurements. There are several measurements available in this mode.

If you are using the Help feature, this mode must be currently active to access its detailed information. If it is not active, exit the Help feature (Esc key), select the mode, and re-access Help.

Key Path	Mode
<b>Example</b>	INST:SEL BT INST:NSEL 228
Initial S/W Revision	A.06.01

## LTE

Selects the LTE mode for general purpose measurements of signals following the LTE FDD standard. There are several measurements available in this mode.

If you are using the Help feature, this mode must be currently active to access its detailed information. If it is not active, exit the Help feature (Esc key), select the mode, and re-access Help.

Key Path	Mode
<b>Example</b>	INST:SEL LTE INST:NSEL 102
Initial S/W Revision	Prior to A.02.00

## SCPI Language Compatibility

The SCPI Language Compatibility mode provides remote language compatibility for SCPI-based instruments, such as the Rohde and Schwartz FSP and related series of spectrum analyzers.

**NOTE** After changing into or out of this mode, allow a 1 second delay before sending any subsequent commands.

If you are using the Help feature, this mode must be currently active to access its detailed information. If it is not active, exit the Help feature (Esc key), select the mode, and re-access Help.

Key Path	Mode
<b>Example</b>	INST:SEL SCPI LC Or INST:NSEL 270
Initial S/W Revision	A.06.00

## Combined Fixed WiMAX

Selects the Combined Fixed WiMAX mode for general purpose measurements of signals following this standard. There are several measurements available in this mode.

If you are using the Help feature, this mode must be currently active to access its detailed information. If it is not active, exit the Help feature (Esc key), select the mode, and re-access Help.

Key Path	Mode
<b>Example</b>	INST:SEL CWIMAXOFDM INST:NSEL 81
Initial S/W Revision	A.02.00

## ISDB-T

Selects the ISDB-T mode for measurements of digital video signals using this format. There are several power and demod measurements available in this mode.

If you are using the Help feature, this mode must be currently active to access its detailed information. If it is not active, exit the Help feature (Esc key), select the mode, and re-access Help.

Key Path	Mode
<b>Example</b>	INST:SEL ISDBT INST:NSEL 239
Initial S/W Revision	A.03.00

## Digital Cable TV

Selects the Digital Cable TV mode for measurements of digital cable television systems. There are several power and demod measurements available in this mode.

If you are using the Help feature, this mode must be currently active to access its detailed information. If it is not active, exit the Help feature (Esc key), select the mode, and re-access Help.

Key Path	Mode
<b>Example</b>	INST:SEL DCATV INST:NSEL 238
Initial S/W Revision	A.07.00

## LTE TDD

Selects the LTE TDD mode for general purpose measurements of signals following the LTE TDD standard. There are several measurements available in this mode.

If you are using the Help feature, this mode must be currently active to access its detailed information. If it is not active, exit the Help feature (Esc key), select the mode, and re-access Help.

Key Path	Mode
<b>Example</b>	INST:SEL LTETDD INST:NSEL 105
Initial S/W Revision	A.03.00

### Remote Language Compatibility

The Remote Language Compatibility (RLC) mode provides remote command backwards compatibility for the 8560 series of spectrum analyzers, known as legacy spectrum analyzers.

**NOTE** After changing into or out of this mode, allow a 1 second delay before sending any subsequent commands.

If you are using the Help feature, this mode must be currently active to access its detailed information. If it is not active, exit the Help feature (Esc key), select the mode, and re-access Help.

Key Path	Mode
<b>Example</b>	INST:SEL RLC Or INST:NSEL 266
Initial S/W Revision	Prior to A.02.00

### iDEN/WiDEN/MOTOTalk

Selects the iDEN/WiDEN/MOTOTalk mode for general purpose measurements of iDEN and iDEN-related signals. There are several measurements available in this mode.

If you are using the Help feature, this mode must be currently active to access its detailed information. If it is not active, exit the Help feature (Esc key), select the mode, and re-access Help.

Key Path	Mode
<b>Example</b>	INST:SEL IDEN INST:NSEL 103
Initial S/W Revision	A.02.00

### Application Mode Number Selection (Remote Command Only)

Select the measurement mode by its mode number. The actual available choices depend upon which applications are installed in your instrument. The modes appear in this table in the same order they appear in the Mode menu (if the order is not changed by the Configure Applications utility found in the System, Power On menu). See "[Detailed List of Modes](#)" on page 315 for Mode details.

The Mode Number is the parameter for use with the :INSTrument:NSElect command. The Mode Parameter is the parameter for use with the :INSTrument[:SElect] command.

Mode	Mode Number	Mode Parameter
Spectrum Analyzer	1	SA
Real Time Spectrum Analyzer	107	RTSA
Sequence Analyzer	400	SEQAN
EMI Receiver	141	EMI
I/Q Analyzer (Basic)	8	BASIC
WCDMA with HSPA+	9	WCDMA
GSM/EDGE/EDGE Evo	13	EDGE GSM
802.16 OFDMA (WiMAX/WiBro)	75	WIMAX OFDMA
Vector Signal Analyzer (VXA)	100	VSA
Phase Noise	14	PNOISE
Noise Figure	219	NFIGure
Analog Demod	234	ADEM0D
Bluetooth	228	BT00th
TD-SCDMA with HSPA/8PSK	211	TDSCDMA
cdma2000	10	CDMA2K
1xEV-DO	15	CDMA1XEV
LTE	102	LTE
LTE TDD	105	LTETDD
LTE-Advanced FDD	107	LTEAFDD
LTE-Advanced TDD	108	LTEATDD
MSR	106	MSR
DVB-T/H with T2	235	DVB
DTMB (CTTB)	236	DTMB
Digital Cable TV	238	DCATV
ISDB-T	239	ISDBT
CMMB	240	CMMB
WLAN	217	WLAN
Combined WLAN	19	CWLAN
Combined Fixed WiMAX	81	CWIMAX OFDM
802.16 OFDM (Fixed WiMAX)	104	WIMAX FIXED
iDEN/WiDEN/MotoTalk	103	IDEN
Remote Language Compatibility	266	RLC
SCPI Language Compatibility	270	SCPILC
89601 VSA	101	VSA89601

<b>Remote Command</b>	:INSTrument:NSElect <integer> :INSTrument:NSElect?
<b>Example</b>	:INST:NSEL 1
<b>Notes</b>	SA mode is 1 The command must be sequential: i.e. continued parsing of commands cannot proceed until the instrument select is complete and the resultant SCPI trees are available.
<b>Preset</b>	Not affected by Preset. Set to default mode (1 for SA mode) following Restore System Defaults.
<b>State Saved</b>	Saved in instrument state
<b>Initial S/W Revision</b>	Prior to A.02.00

### Application Mode Catalog Query (Remote Command Only)

Returns a string containing a comma separated list of names of all the installed and licensed measurement modes (applications). These names can only be used with the :INSTrument[:SElect] command.

<b>Remote Command</b>	:INSTrument:CATalog?
<b>Example</b>	:INST:CAT?
<b>Notes</b>	Query returns a quoted string of the installed and licensed modes separated with a comma. Example: "SA,PNOISE,WCDMA"
<b>Backwards Compatibility Notes</b>	VSA (E4406A) :INSTrument:CATalog? returned a list of installed INSTrument:SELECT items as a comma separated list of string values: "BASIC", "GSM", "EDGE GSM", "CDMA", "NADC", "PDC", "WCDMA", "CDMA2K", "CDMA1XEV", "IDEN", "WIDEN", "WLAN", "SERVICE" X-Series uses the ESA/PSA compatible query of a string contain comma separated values: "SA,PNOISE,NFIGURE,BASIC,CDMA,CDMA2K,WCDMA,CDMA1XEV,EDGE GSM,GSM,NADC,PDC,TDSCDMA,DMODULATION,WLAN"
<b>Initial S/W Revision</b>	Prior to A.02.00

### Application Identification (Remote Commands Only)

Each entry in the Mode Menu will have a Model Number and associated information: Version, and Options. This information is displayed in the Show System screen. The corresponding SCPI remote commands are defined here.

["Current Application Model " on page 313](#)

["Current Application Revision" on page 313](#)



["Current Application Options" on page 313](#)

## Current Application Model

Returns a string that is the Model Number of the currently selected application (mode).

<b>Remote Command</b>	:SYSTem:APPLication[:CURRent] [:NAME] ?
<b>Example</b>	:SYST:APPL?
<b>Notes</b>	Query returns a quoted string that is the Model Number of the currently selected application (Mode). Example: "N9060A" String length is 6 characters.
<b>Preset</b>	Not affected by Preset
<b>State Saved</b>	Not saved in state, the value will be the selected application when a Save is done.
<b>Initial S/W Revision</b>	Prior to A.02.00

## Current Application Revision

Returns a string that is the Revision of the currently selected application (mode).

<b>Remote Command</b>	:SYSTem:APPLication[:CURRent]:REVision?
<b>Example</b>	:SYST:APPL:REV?
<b>Notes</b>	Query returns a quoted string that is the Revision of the currently selected application (Mode). Example: "1.0.0.0" String length is a maximum of 23 characters. (each numeral can be an integer + 3 decimal points)
<b>Preset</b>	Not affected by a Preset
<b>State Saved</b>	Not saved in state, the value will be the selected application when a Save is done.
<b>Initial S/W Revision</b>	Prior to A.02.00

## Current Application Options

Returns a string that is the Options list of the currently selected application (Mode).

<b>Remote Command</b>	:SYSTem:APPLication[:CURRent]:OPTion?
<b>Example</b>	:SYST:APPL:OPT?
<b>Notes</b>	Query returns a quoted string that is the Option list of the currently selected application (Mode). The format is the name as the *OPT? or SYSTem:OPTion command: a comma separated list of option identifiers. Example: "1FP,2FP" String length is a maximum of 255 characters.

Preset	Not affected by a Preset
State Saved	Not saved in state per se, the value will be the selected application when a Save is invoked.
Initial S/W Revision	Prior to A.02.00

### Application Identification Catalog (Remote Commands Only)

A catalog of the installed and licensed applications (Modes) can be queried for their identification.

"Application Catalog Number of Entries" on page 314

"Application Catalog Model Numbers" on page 314

"Application Catalog Revision" on page 314

"Application Catalog Options" on page 315

### Application Catalog Number of Entries

Returns the number of installed and licensed applications (Modes).

<b>Remote Command</b>	:SYSTem:APPLication:CATalog[:NAME]:COUNT?
<b>Example</b>	:SYST:APPL:CAT:COUN?
Preset	Not affected by Preset
State Saved	Not saved in instrument state.
Initial S/W Revision	Prior to A.02.00

### Application Catalog Model Numbers

Returns a list of Model Numbers for the installed and licensed applications (Modes).

<b>Remote Command</b>	:SYSTem:APPLication:CATalog[:NAME]?
<b>Example</b>	:SYST:APPL:CAT?
Notes	Returned value is a quoted string of a comma separated list of Model Numbers. Example, if SAMS and Phase Noise are installed and licensed: "N9060A,N9068A" String length is COUNT * 7 - 1. (7 = Model Number length + 1 for comma. -1 = no comma for the 1st entry.)
Preset	Not affected by a Preset
State Saved	Not saved in instrument state.
Initial S/W Revision	Prior to A.02.00

### Application Catalog Revision

Returns the Revision of the provided Model Number.

<b>Remote Command</b>	:SYSTem:APPLication:CATalog:REVision? <model>
<b>Example</b>	:SYST:APPL:CAT:REV? 'N9060A'
<b>Notes</b>	Returned value is a quoted string of revision for the provided Model Number. The revision will be a null-string ("") if the provided Model Number is not installed and licensed. Example, if SAMS is installed and licensed: "1.0.0.0"
<b>Preset</b>	Not affected by a Preset.
<b>State Saved</b>	Not saved in instrument state.
<b>Initial S/W Revision</b>	Prior to A.02.00

### Application Catalog Options

Returns a list of Options for the provided Model Number

<b>Remote Command</b>	:SYSTem:APPLication:CATalog:OPTion? <model>
<b>Example</b>	:SYST:APPL:CAT:OPT? 'N9060A'
<b>Notes</b>	Returned value is a quoted string of a comma separated list of Options, in the same format as *OPT? or :SYSTem:OPTion?. If the provided Model Number is not installed and licensed a null-string ("") will be returned. Example, if SAMS is installed and licensed: "2FP" String length is a maximum of 255 characters.
<b>Preset</b>	Not affected by a Preset
<b>State Saved</b>	Not saved in instrument state.
<b>Initial S/W Revision</b>	Prior to A.02.00

### Detailed List of Modes

This section contains an alphabetical list of Modes available in the X-Series, along with a brief description of each Mode.

Note that with the exception of the 89601 VSA, only licensed applications appear in the Mode menu. The 89601 will always appear, because it's licensing is handled differently.

#### 1xEV-DO

Selects the 1xEV-DO mode for general purpose measurements of signals following this standard. There are several measurements available in this mode.

If you are using the Help feature, this mode must be currently active to access its detailed information. If it is not active, exit the Help feature (Esc key), select the mode, and re-access Help.

Key Path	Mode
----------	------

---

<b>Example</b>	INST:SEL CDMA1XEV INST:NSEL 15
Initial S/W Revision	Prior to A.02.00

---

### 802.16 OFDMA (WiMAX/WiBro)

Selects the OFDMA mode for general purpose measurements of WiMAX signals. There are several measurements available in this mode.

If you are using the Help feature, this mode must be currently active to access its detailed information. If it is not active, exit the Help feature (Esc key), select the mode, and re-access Help.

---

<b>Key Path</b>	<b>Mode</b>
<b>Example</b>	INST:SEL WIMAXOFDMA INST:NSEL 75
Initial S/W Revision	Prior to A.02.00

---

### 802.16 OFDM (Fixed WiMAX)

Selects the 802.16 OFDM (Fixed WiMAX) mode. This mode allows modulation quality measurements of signals that comply with IEEE 802.16a–2003 and IEEE 802.16–2004 standards, with flexibility to measure nonstandard OFDM formats. Along with the typical digital demodulation measurement results, several additional 802.16 OFDM unique trace data formats and numeric error data results provide enhanced data analysis.

If you are using the Help feature, this mode must be currently active to access its detailed information. If it is not active, exit the Help feature (Esc key), select the mode, and re-access Help.

---

<b>Key Path</b>	<b>Mode</b>
<b>Example</b>	INST:SEL WIMAXFIXED INST:NSEL 104
Initial S/W Revision	A.02.00

---

### 89601 VSA

Selecting the 89601 VSA mode will start the 89600 VSA software. The 89600 VSA software is powerful, PC-based software, offering the industry's most sophisticated general purpose and standards specific signal evaluation and troubleshooting tools for R&D engineers. Even for proprietary and non-standard signals in SATCOM or MILCOM applications, you can make signal quality measurements with customized IQ constellation. Reach deeper into signals, gather more data on signal problems, and gain greater insight.

- Over 35 general-purpose analog and digital demodulators ranging from 2FSK to 4096QAM
- Flexible and custom IQ and OFDM signal analysis for single carrier

- Standards specific modulation analysis including:
  - Cellular: GSM/EDGE, cdma2000, W-CDMA, TD-SCDMA, LTE(FDD/TDD),
  - LTE-Advanced and more
  - Wireless networking: 802.11a/b/g, 802.11n, 802.ac, 802.16 WiMAX (fixed/mobile), WiSUN (MR-FSK PHY)
  - RFID
  - Digital satellite video and other satellite signals, radar, LMDS
  - Up to 400K bin FFT, for the highest resolution spectrum analysis
  - A full suite of time domain analysis tools, including signal capture and playback, time gating, and CCDF measurements
  - 20 simultaneous trace displays and the industry's most complete set of marker functions
  - Easy-to-use Microsoft ® Windows ® graphical user interface

For more information see the Agilent 89600 Series VSA web site at [www.agilent.com/find/89600vsa](http://www.agilent.com/find/89600vsa)

To learn more about how to use the 89600 VSA running in the X-Series, after the 89600 VSA software is running, open the 89600 VSA Help and open the "About Agilent X-Series Signal Analyzer with 89600 VSA Software" help topic.

Key Path	Mode
<b>Example</b>	INST:SEL VSA89601 INST:NSEL 101
Initial S/W Revision	Prior to A.02.00

## Analog Demod

Selects the Analog Demod mode for making measurements of AM, FM and phase modulated signals.

If you are using the Help feature, this mode must be currently active to access its detailed information. If it is not active, exit the Help feature (Esc key), select the mode, and re-access Help.

Key Path	Mode
<b>Example</b>	INST:SEL ADEMODO INST:NSEL 234
Initial S/W Revision	Prior to A.02.00

## Bluetooth

Selects the Bluetooth mode for Bluetooth specific measurements. There are several measurements available in this mode.

If you are using the Help feature, this mode must be currently active to access its detailed information. If it is not active, exit the Help feature (Esc key), select the mode, and re-access Help.

Key Path	Mode
<b>Example</b>	INST:SEL BT INST:NSEL 228
Initial S/W Revision	A.06.01

### cdma2000

Selects the cdma2000 mode for general purpose measurements of signals following this standard. There are several measurements available in this mode.

If you are using the Help feature, this mode must be currently active to access its detailed information. If it is not active, exit the Help feature (Esc key), select the mode, and re-access Help.

Key Path	Mode
<b>Example</b>	INST:SEL CDMA2K INST:NSEL 10
Initial S/W Revision	Prior to A.02.00

### CMMB

Selects the CMMB mode for measurements of digital video signals using this format. There are several power and demod measurements available in this mode.

If you are using the Help feature, this mode must be currently active to access its detailed information. If it is not active, exit the Help feature (Esc key), select the mode, and re-access Help.

Key Path	Mode
<b>Example</b>	INST:SEL CMMB INST:NSEL 240
Initial S/W Revision	A.03.00

### Combined WLAN

Selects the CWLAN mode for general purpose measurements of signals following this standard. There are several measurements available in this mode.

If you are using the Help feature, this mode must be currently active to access its detailed information. If it is not active, exit the Help feature (Esc key), select the mode, and re-access Help.

Key Path	Mode
<b>Example</b>	INST:SEL CWLAN

	INST:NSEL 19
Initial S/W Revision	A.02.00

### Combined Fixed WiMAX

Selects the Combined Fixed WiMAX mode for general purpose measurements of signals following this standard. There are several measurements available in this mode.

If you are using the Help feature, this mode must be currently active to access its detailed information. If it is not active, exit the Help feature (Esc key), select the mode, and re-access Help.

Key Path	Mode
<b>Example</b>	INST:SEL CWIMAXOFDM INST:NSEL 81
Initial S/W Revision	A.02.00

### Digital Cable TV

Selects the Digital Cable TV mode for measurements of digital cable television systems. There are several power and demod measurements available in this mode.

If you are using the Help feature, this mode must be currently active to access its detailed information. If it is not active, exit the Help feature (Esc key), select the mode, and re-access Help.

Key Path	Mode
<b>Example</b>	INST:SEL DCATV INST:NSEL 238
Initial S/W Revision	A.07.00

### DTMB (CTTB)

Selects the DTMB (CTTB) mode for measurements of digital video signals using this format. There are several power and demod measurements available in this mode.

If you are using the Help feature, this mode must be currently active to access its detailed information. If it is not active, exit the Help feature (Esc key), select the mode, and re-access Help.

Key Path	Mode
<b>Example</b>	INST:SEL DTMB INST:NSEL 236
Initial S/W Revision	A.02.00

## DVB-T/H with T2

Selects the DVB-T/H mode for measurements of digital video signals using this format. There are several power and demod measurements available in this mode.

If you are using the Help feature, this mode must be currently active to access its detailed information. If it is not active, exit the Help feature (Esc key), select the mode, and re-access Help.

Key Path	Mode
<b>Example</b>	INST:SEL DVB INST:NSEL 235
Initial S/W Revision	A.02.00
Modified at S/W Revision	A.07.00

## EMI Receiver

The EMI Receiver Mode makes EMC measurements. Several measurements are provided to aid the user in characterizing EMC performance of their systems, including looking at signals with CISPR-16 compliant detectors, performing scans for interfering signals, and determining and charting interfering signals over time.

If you are using the Help feature, this mode must be currently active to access its detailed information. If it is not active, exit the Help feature (Esc key), select the mode, and re-access Help.

Key Path	Mode
<b>Example</b>	INST:SEL EMI INST:NSEL 141
Initial S/W Revision	A.07.01

## GSM/EDGE/EDGE Evo

Selects the GSM with EDGE mode for general purpose measurements of signals following this standard. There are several measurements available in this mode.

If you are using the Help feature, this mode must be currently active to access its detailed information. If it is not active, exit the Help feature (Esc key), select the mode, and re-access Help.

Key Path	Mode
<b>Example</b>	INST:SEL EDGE GSM INST:NSEL 13
Initial S/W Revision	Prior to A.02.00
Modified at S/W Revision	A.02.00



## iDEN/WiDEN/MOTOTalk

Selects the iDEN/WiDEN/MOTOTalk mode for general purpose measurements of iDEN and iDEN-related signals. There are several measurements available in this mode.

If you are using the Help feature, this mode must be currently active to access its detailed information. If it is not active, exit the Help feature (Esc key), select the mode, and re-access Help.

Key Path	Mode
<b>Example</b>	INST:SEL IDEN INST:NSEL 103
Initial S/W Revision	A.02.00

## IQ Analyzer (Basic)

The IQ Analyzer Mode makes general purpose frequency domain and time domain measurements. These measurements often use alternate hardware signal paths when compared with a similar measurement in the Signal Analysis Mode using the Swept SA measurement. These frequency domain and time domain measurements can be used to output I/Q data results when measuring complex modulated digital signals.

If you are using the Help feature, this mode must be currently active to access its detailed information. If it is not active, exit the Help feature (Esc key), select the mode, and re-access Help.

Key Path	Mode
<b>Example</b>	INST:SEL BASIC INST:NSEL 8
Initial S/W Revision	Prior to A.02.00

## ISDB-T

Selects the ISDB-T mode for measurements of digital video signals using this format. There are several power and demod measurements available in this mode.

If you are using the Help feature, this mode must be currently active to access its detailed information. If it is not active, exit the Help feature (Esc key), select the mode, and re-access Help.

Key Path	Mode
<b>Example</b>	INST:SEL ISDBT INST:NSEL 239
Initial S/W Revision	A.03.00

## LTE

Selects the LTE mode for general purpose measurements of signals following the LTE FDD standard. There are several measurements available in this mode.

If you are using the Help feature, this mode must be currently active to access its detailed information. If it is not active, exit the Help feature (Esc key), select the mode, and re-access Help.

Key Path	Mode
<b>Example</b>	INST:SEL LTE INST:NSEL 102
Initial S/W Revision	Prior to A.02.00

### LTE TDD

Selects the LTE TDD mode for general purpose measurements of signals following the LTE TDD standard. There are several measurements available in this mode.

If you are using the Help feature, this mode must be currently active to access its detailed information. If it is not active, exit the Help feature (Esc key), select the mode, and re-access Help.

Key Path	Mode
<b>Example</b>	INST:SEL LTETDD INST:NSEL 105
Initial S/W Revision	A.03.00

### MSR

Selects the MSR mode. The MSR mode makes several measurements for Cellular Communication devices that can be configured with multiple radio formats simultaneously following the 3GPP standard of Multi-Standard Radio, including GSM/EDGE, WCDMA/HSPA+ and LTE.

If you are using the Help feature, this mode must be currently active to access its detailed information. If it is not active, exit the Help feature (Esc key), select the mode, and re-access Help.

Key Path	Mode
<b>Example</b>	INST:SEL MSR INST:NSEL 106
Initial S/W Revision	A.09.491

### Noise Figure

The Noise Figure mode provides pre-configured measurements for making general purpose measurements of device noise figure.

If you are using the Help feature, this mode must be currently active to access its detailed information. If it is not active, exit the Help feature (Esc key), select the mode, and re-access Help.

Key Path	Mode
----------	------

<b>Example</b>	INST:SEL NFIGURE INST:NSEL 219
Initial S/W Revision	Prior to A.02.00

### Phase Noise

The Phase Noise mode provides pre-configured measurements for making general purpose measurements of device phase noise.

If you are using the Help feature, this mode must be currently active to access its detailed information. If it is not active, exit the Help feature (Esc key), select the mode, and re-access Help.

<b>Key Path</b>	<b>Mode</b>
<b>Example</b>	INST:SEL PNOISE or INST:NSEL 14
Initial S/W Revision	Prior to A.02.00

### Remote Language Compatibility

The Remote Language Compatibility (RLC) mode provides remote command backwards compatibility for the 8560 series of spectrum analyzers, known as legacy spectrum analyzers.

**NOTE** After changing into or out of this mode, allow a 1 second delay before sending any subsequent commands.

If you are using the Help feature, this mode must be currently active to access its detailed information. If it is not active, exit the Help feature (Esc key), select the mode, and re-access Help.

<b>Key Path</b>	<b>Mode</b>
<b>Example</b>	INST:SEL RLC Or INST:NSEL 266
Initial S/W Revision	Prior to A.02.00

### SCPI Language Compatibility

The SCPI Language Compatibility mode provides remote language compatibility for SCPI-based instruments, such as the Rohde and Schwartz FSP and related series of spectrum analyzers.

**NOTE** After changing into or out of this mode, allow a 1 second delay before sending any subsequent commands.

If you are using the Help feature, this mode must be currently active to access its detailed information. If it is not active, exit the Help feature (Esc key), select the mode, and re-access Help.

<b>Key Path</b>	<b>Mode</b>
<b>Example</b>	INST:SEL SCPI LC Or INST:NSEL 270
<b>Initial S/W Revision</b>	A.06.00

### Spectrum Analyzer

Selects the Spectrum Analyzer mode for general purpose measurements. There are several measurements available in this mode. General spectrum analysis measurements, in swept and zero span, can be done using the first key in the Meas menu, labeled Swept SA. Other measurements in the Meas Menu are designed to perform specialized measurement tasks, including power and demod measurements.

If you are using the Help feature, this mode must be currently active to access its detailed information. If it is not active, exit the Help feature (Esc key), select the mode, and re-access Help.

<b>Key Path</b>	<b>Mode</b>
<b>Example</b>	INST:SEL SA INST:NSEL 1
<b>Initial S/W Revision</b>	Prior to A.02.00

### TD-SCDMA with HSPA/8PSK

Selects the TD-SCDMA mode for general purpose measurements of signals following this standard. There are several measurements available in this mode.

If you are using the Help feature, this mode must be currently active to access its detailed information. If it is not active, exit the Help feature (Esc key), select the mode, and re-access Help.

<b>Key Path</b>	<b>Mode</b>
<b>Example</b>	INST:SEL TDSCDMA INST:NSEL 211
<b>Initial S/W Revision</b>	Prior to A.02.00

### Vector Signal Analyzer (VXA)

The N9064A (formerly 89601X) VXA Vector signal and WLAN modulation analysis application provides solutions for basic vector signal analysis, analog demodulation, and digital demodulation. The digital demodulation portion of N9064A allows you to perform measurements on standard-based formats such as cellular, wireless networking and digital video as well as general purpose flexible modulation analysis for wide range of digital formats, FSK to 1024QAM, with easy-to-use measurements and display tools such as

constellation and eye diagram, EVM traces and up to four simultaneous displays. Analog baseband analysis is available using the MXA and PXA with option BBA. Option 3FP WLAN has been discontinued.

N9064A honors existing 89601X licenses with all features and functionalities found on X-Series software versions prior to A.06.00. Specifically:

N9064A-1 is equivalent to 89601X-205

N9064A-2 is equivalent to 89601X-AYA

If you are using the Help feature, this mode must be currently active to access its detailed information. If it is not active, exit the Help feature (Esc key), select the mode, and re-access Help.

Key Path	Mode
<b>Example</b>	INST:SEL VSA INST:NSEL 100
Initial S/W Revision	Prior to A.02.00

### W-CDMA with HSPA+

Selects the W-CDMA with HSPA+ mode for general purpose measurements of signals following this standard. There are several measurements available in this mode.

If you are using the Help feature, this mode must be currently active to access its detailed information. If it is not active, exit the Help feature (Esc key), select the mode, and re-access Help.

Key Path	Mode
<b>Example</b>	INST:SEL WCDMA INST:NSEL 9
Initial S/W Revision	Prior to A.02.00

### WLAN

Selects the WLAN mode for general purpose measurements of signals following this standard. There are several measurements available in this mode.

If you are using the Help feature, this mode must be currently active to access its detailed information. If it is not active, exit the Help feature (Esc key), select the mode, and re-access Help.

Key Path	Mode
<b>Example</b>	INST:SEL WLAN INST:NSEL 217
Initial S/W Revision	A.09.491

## Global Settings

Opens a menu that allows you to switch certain Meas Global parameters to a Mode Global state. These switches apply to all Modes that support global settings. No matter what Mode you are in when you set the “Global Center Frequency” switch to on, it applies to all Modes that support Global Settings.

<b>Key Path</b>	<b>Mode Setup</b>
Initial S/W Revision	Prior to A.02.00

## Global Center Freq

The software maintains a Mode Global value called “Global Center Freq”.

When the Global Center Freq key is switched to On in any mode, the current mode’s center frequency is copied into the Global Center Frequency, and from then on all modes that support global settings use the Global Center Frequency. So you can switch between any of these modes and the Center Freq will remain unchanged.

Adjusting the Center Freq of any mode which supports Global Settings, while Global Center Freq is On, will modify the Global Center Frequency.

When Global Center Freq is turned Off, the Center Freq of the current mode is unchanged, but now the Center Freq of each mode is once again independent.

When Mode Preset is pressed while Global Center Freq is On, the Global Center Freq is preset to the preset Center Freq of the current mode.

This function is reset to Off when the Restore Defaults key is pressed in the Global Settings menu, or when System, Restore Defaults, All Modes is pressed.

<b>Key Path</b>	<b>Mode Setup, Global Settings</b>
<b>Scope</b>	<b>Mode Global</b>
<b>Remote Command</b>	:INSTrument:COUPle:FREQuency:CENTer ALL NONE :INSTrument:COUPle:FREQuency:CENTer?
<b>Example</b>	INST:COUP:FREQ:CENT ALL INST:COUP:FREQ:CENT?
<b>Preset</b>	Set to Off on Global Settings, Restore Defaults and System, Restore Defaults, All Modes
<b>Range</b>	On Off
<b>Initial S/W Revision</b>	Prior to A.02.00

<b>Remote Command</b>	:GLOBal:FREQuency:CENTer[:STATe] 1 0 ON OFF :GLOBal:FREQuency:CENTer[:STATe]?
<b>Preset</b>	Off
<b>Initial S/W Revision</b>	Prior to A.02.00

## Restore Defaults

This key resets all of the functions in the Global Settings menu to Off. This also occurs when System, Restore Defaults, All Modes is pressed.

Key Path	Mode Setup, Global Settings
<b>Remote Command</b>	:INSTrument:COUPle:DEFault
<b>Example</b>	INST:COUP:DEF
<b>Backwards Compatibility SCPI</b>	:GLOBal:DEFault
Initial S/W Revision	Prior to A.02.00

## Mode Setup

Accesses a menu that allows you to specify parameters for the mode. These settings will be in effect for all measurements in the current mode.

**NOTE**

The Demod key and its submenus, including the demodulation parameters such as Guard Interval, Alpha, FFT Size, and Modulation Format, are moved to Meas Setup panel of DVB-T/H Mod Accuracy measurement in the current version.

Key Path	Front-panel key
Initial S/W Revision	A.02.00

### Radio Std

Sets the radio standard in use. The available selections include DVB-T (Digital Video Broadcasting - Terrestrial), DVB-H (Digital Video Broadcasting - Handheld), and DVB-T2 (the second generation digital terrestrial television broadcasting system).

If the option N6153A-3FP/3TP is not installed in your instrument, measurements on DVB-T2 signals are not supported and the DVB-T2 key is not visible under this menu.

Key Path	Mode Setup
Mode	DVB-T/H
Remote Command	[ :SENSe ] :RADio:STANdard DVBT DVBH TTWO [ :SENSe ] :RADio:STANdard?
Example	RAD:STAN DVBT RAD:STAN?
Notes	DVB-T is for digital terrestrial TV broadcasting. DVB-H is for mobile video broadcasting based on DVB-T standard. DVB-T2 is for digital terrestrial TV broadcasting based on DVB-T2 standard.
Dependencies	If the current measurement is DVB-T/H Mod Accuracy, the DVB-T2 key is grayed out. If the current measurement is DVB-T2 Mod Accuracy, the DVB-T and DVB-H keys are grayed out. When the value is DVB-T, the following keys in DVB-T/H Mod Accuracy measurement are grayed out: 4K (Meas Setup, Demod, FFT Size) and In-depth (Meas Setup, Decode, Inner Interleaver).
Couplings	If the value is changed from DVB-T2 to DVB-T/H and Channel BW (Mode Setup) is 1.7MHz or 10 MHz, Channel BW will be changed to 8 MHz automatically.
Preset	DVBT
State Saved	Saved in instrument state.
Range	DVB-T   DVB-H   DVB-T2
Initial S/W Revision	A.02.00



## DVB-T

Sets the radio standard to DVB-T.

Key Path	Mode Setup, Radio Std
<b>Example</b>	[[:SENSe]:RADio:STANdard DVBT [:SENSe]:RADio:STANdard?
Dependencies	If the current measurement is DVB-T2 Mod Accuracy, this key is grayed out.
Initial S/W Revision	A.02.00

## DVB-H

Sets the radio standard to DVB-H.

Key Path	Mode Setup, Radio Std
<b>Example</b>	[[:SENSe]:RADio:STANdard DVBH [:SENSe]:RADio:STANdard?
Dependencies	If the current measurement is DVB-T2 Mod Accuracy, this key is grayed out.
Initial S/W Revision	A.02.00

## DVB-T2

Sets the radio standard to DVB-T2.

Key Path	Mode Setup, Radio Std
<b>Example</b>	[[:SENSe]:RADio:STANdard TTWO [:SENSe]:RADio:STANdard?
Dependencies	If the current measurement is DVB-T/H Mod Accuracy, this key is grayed out.
Initial S/W Revision	A.07.00

## Version

Sets the DVB-T2 version in use. The available selections include Version 1.1.1 and Version 1.2.1.

If the option N6153A-3FP/3TP is not installed in your instrument, measurements on DVB-T2 signals are not supported and the DVB-T2 key is not visible under this menu.

Key Path	Mode Setup, Radio Std, DVB-T2
Mode	DVB-T/H
<b>Remote Command</b>	[[:SENSe]:RADio:STANdard:TTWO:VERSion V111 V121 [:SENSe]:RADio:STANdard:TTWO:VERSion?

<b>Example</b>	RAD:STAN:TTWO:VERS V121 RAD:STAN:TTWO:VERS?
Notes	Version 1.1.1 stands for ETSI EN 302 755 V1.1.1 (2009-09); Version 1.2.1 stands for ETSI EN 302 755 V1.2.1 (2010-10);
Dependencies	If the current measurement is DVB-T/H Mod Accuracy or Auto Detect (DVB-T2 Mod Accuracy measurement, Meas Setup) is On, this key is grayed out. When the value is Version 1.1.1, the following keys in DVB-T2 Mod Accuracy measurement are grayed out: Several options of PAPR Type (Meas Setup, Demod): L1-ACE P2-TR, L1ACE ACE, L1-ACE TR, and L1-ACE ACE_TR. When the value is Version 1.2.1, the following keys in DVB-T2 Mod Accuracy measurement are grayed out: Several options of PAPR Type (Meas Setup, Demod): No PAPR, ACE, TR, and ACE_TR.
Preset	V121
State Saved	Saved in instrument state.
Range	Version 1.1.1   Version 1.2.1
Initial S/W Revision	A.10.01
Modified at S/W Revision	A.11.00

## Transmission Mode

Key Path	Mode Setup, Radio Std, DVB-T2
Mode	DVB-T/H
<b>Remote Command</b>	[ :SENSe ] :RADio:STANdard:TTWO:TMODe SISO MISO [ :SENSe ] :RADio:STANdard:TTWO:TMODe?
<b>Example</b>	RAD:STAN:TTWO:TMOD SISO RAD:STAN:TTWO:TMOD?
Dependencies	If the current measurement is DVB-T/H Mod Accuracy or Auto Detect (DVB-T2 Mod Accuracy measurement, Meas Setup) is On, this key is grayed out. If SISO is selected, MISO Test Setup (DVB-T2 Mod Accuracy measurement, Meas Setup, Advanced) is grayed out. If MISO is selected and MISO Test Setup (DVB-T2 Mod Accuracy measurement, Meas Setup, Advanced) is Tx1 + Tx2, Pilot (DVB-T2 Mod Accuracy measurement, View/Display, I/Q Measured Polar Graph, Display Type) is grayed out.
Preset	SISO
State Saved	Saved in instrument state.
Range	SISO   MISO
Initial S/W Revision	A.11.00

## Channel BW

Sets the value of bandwidth in use. The available selections include 1.7 MHz, 5 MHz, 6 MHz, 7 MHz, 8 MHz, and 10 MHz.

If the option N6153A-3FP/3TP is not installed in your instrument, measurements on DVB-T2 signals are not supported and the selections 1.7 MHz and 10 MHz are not visible under Channel BW.

Key Path	Mode Setup
Mode	DVB-T/H
Remote Command	[ :SENSe ] :RADio:STANdard:BANDwidth B1M7 B5M B6M B7M B8M B10M [ :SENSe ] :RADio:STANdard:BANDwidth?
Example	RAD:STAN:BAND B8M RAD:STAN:BAND?
Couplings	If Radio Std (Mode Setup) is changed from DVB-T2 to DVB-T/H and the current selection is 1.7 MHz or 10 MHz, it will be changed to 8 MHz automatically.
Preset	B8M
State Saved	Saved in instrument state.
Range	1.7 MHz   5 MHz   6 MHz   7 MHz   8 MHz   10 MHz
Initial S/W Revision	A.02.00

## Noise Reduction

Noise Reduction accesses a menu for configuring the noise compensation of the instrument. This menu only appears in models that support Noise Reduction.

Key Path	Mode Setup
Initial S/W Revision	A.04.00

## Noise Floor Extension

Turns on the Noise Floor Extension function. When this function is On, the expected noise power of the analyzer (derived from a factory calibration) is subtracted from the trace data. This will usually reduce the apparent noise level by about 10 dB in low band, and 8 dB in high band (>~3.6 GHz).

Noise Floor Extension works with any RBW, VBW, detector, any setting of Average Type, any amount of trace averaging, and any signal type. It is ineffective when the trace is not smoothed (smoothing processes include narrow VBWs, trace averaging, and long sweep times with the detector set to Average or Peak). It works best with extreme amounts of smoothing, and with the average detector, with the Average Type set to Power.

### NOTE

Noise Floor Extensions has no effect unless the RF Input is selected, therefore it does nothing when External Mixing is selected.

In those cases where the cancellation is ineffective, it nonetheless has no undesirable side-effects. There is no significant speed impact to having Noise Floor Extension on.

The best accuracy is achieved when substantial smoothing occurs in each point before trace averaging. Thus, when using the average detector, results are better with long sweep times and fewer trace averages. When using the sample detector, the VBW filter should be set narrow with less trace averaging, instead of a wide VBW filter with more trace averaging.

See "[More Information](#)" on page 332

Key Path	Mode Setup, Noise Reduction
Scope	Meas Global
Remote Command	[ :SENSe]:CORRection:NOISe:FLOor ON OFF 1 0 [ :SENSe]:CORRection:NOISe:FLOor?
Example	CORR:NOIS:FLO ON
Dependencies	This key only appears in instruments with the NFE or NF2 license installed. In all others, the key does not appear, however the SCPI command will be accepted without error (but will have no effect).
Couplings	When NFE is enabled in any mode manually, a prompt will be displayed reminding you to perform the Characterize Noise Floor operation if it is needed. If NFE is enabled through SCPI and a Characterize Noise Floor operation is needed, an error will be entered in the system error queue.
Preset	Unaffected by Mode Preset. Turned off by Restore Mode Defaults.
State Saved	No
Initial S/W Revision	A.04.00

### More Information

The analyzer is characterized in the factory (or during a field calibration) with a model of the noise, referred to the input mixer, versus frequency in each band and path combination. Bands are 0 (low band) and 1 through 4 (high band) in a 26.5 GHz instrument, for example. Paths include normal paths, preamp paths, the electronic attenuator, etc.

In most band/path combinations, the noise can be well characterized based on just two parameters and the analyzer frequency response before compensation for frequency-dependent losses.

After the noise density at the input mixer is estimated, the effects of the input attenuator, RBW, detector, etc. are computed to get the estimated input-port-referred noise level.

In the simplest case, the measured power (signal plus analyzer noise) in each display point (bucket) is compensated by subtracting the estimated noise power, leaving just the signal power. This is the operation when the detector is Average and the Average Type is set to Power.

In other cases, operation is often not quite as good but still highly effective. With peak detection, the noise floor is estimated based on the RBW and the duration of the bucket using the same equations used in the noise marker function. The voltage of the noise is subtracted from the voltage of the observed signal-plus-noise measurement to compute the estimated signal voltage. The peak detector is one example of processing that varies with detector to give good estimates of the signal level without the analyzer noise.

For best operation, the average detector and the power scale are recommended, as already stated. Peak detection for pulsed-RF can still give excellent effectiveness. FFT analysis does not work well, and does not do NFE well, with pulsed-RF signals, so this combination is not recommended. Negative peak detection is not very useful, either. Sample detection works well, but is never better than the average detector because it doesn't smooth as well. The Normal detector is a combination of peak and negative peak behaviors, and works about as well as these.

For best operation, extreme smoothing is desirable, as already stated. Using narrow VBWs works well, but using very long bucket durations and the average detector works best. Reducing the number of trace points will make the buckets longer.

For best operation, the power scale (Average Type = Power) is optimum. When making CW measurements in the presence of noise without NFE, averaging on the decibel scale has the advantage of reducing the effect of noise. When using NFE, the NFE does an even better job than using the log scale ever could. Using NFE with the log scale is not synergistic, though; NFE with the power scale works a little better than NFE with log averaging type.

The results from NFE with internal preamp can often be lower than the theoretical noise in a signal source at room temperature, a noise density of  $-174$  dBm/Hz. This is expected and useful behavior, because NFE is designed to report the amount of input signal that is in excess of the thermal noise, not the amount that includes the thermal noise. This can be a useful behavior because thermal noise often interferes with what you want to measure, instead of being part of what you want to measure. Note that NFE is not adequately accurate to always be able to read below kTB.

On instruments with the NF2 license installed, the calibrated Noise Floor used by Noise Floor Extensions should be refreshed periodically. Agilent recommends that the Characterize Noise Floor operation be performed after the first 500 hours of operation, and once every calendar year. The key to perform this is located in the System, Alignments, Advanced menu. If you have not done this yourself at the recommended interval, then when you turn on Noise Floor Extensions, the analyzer will prompt you to do so with a dialog that says:

“This action will take several minutes to perform. Please disconnect all cables from the RF input and press Enter to proceed. Press ESC to cancel, or Postpone to postpone for a week.”

If you Cancel, you will be prompted again the next time you turn NFE on. If you postpone, you will be prompted again after a week passes and you then turn NFE on.

## Restore Mode Defaults

Resets the state for the currently active mode by resetting the mode persistent settings to their factory default values, clearing mode data and by performing a Mode Preset. This function will never cause a mode switch. This function performs a full preset for the currently active mode; whereas, Mode Preset performs a partial preset. Restore Mode Defaults does not affect any system settings. System settings are reset by the Restore System Defaults function. This function does reset mode data; as well as settings.

<b>Key Path</b>	Mode Setup
<b>Remote Command</b>	:INSTrument:DEFault
<b>Example</b>	:INST:DEF
<b>Notes</b>	Clears all pending OPC bits. The Status Byte is set to 0. A message comes up saying: “If you are sure, press key again”.

---

Couplings	A Restore Mode Defaults will cause the currently running measurement to be aborted and causes the default measurement to be active. It gets the mode to a consistent state with all of the default couplings set.
Initial S/W Revision	Prior to A.02.00

---

## 6 System Functions

## File

Opens a menu that enables you to access various standard and custom Windows functions. Press any other front-panel key to exit

Key Path	Front-panel key
Initial S/W Revision	Prior to A.02.00

## File Explorer

Opens the standard Windows File Explorer. The File Explorer opens in the My Documents directory for the current user.

The File Explorer is a separate Windows application, so to return to the analyzer once you are in the File Explorer, you may either:

Exit the File Explorer by clicking on the red X in the upper right corner, with a mouse

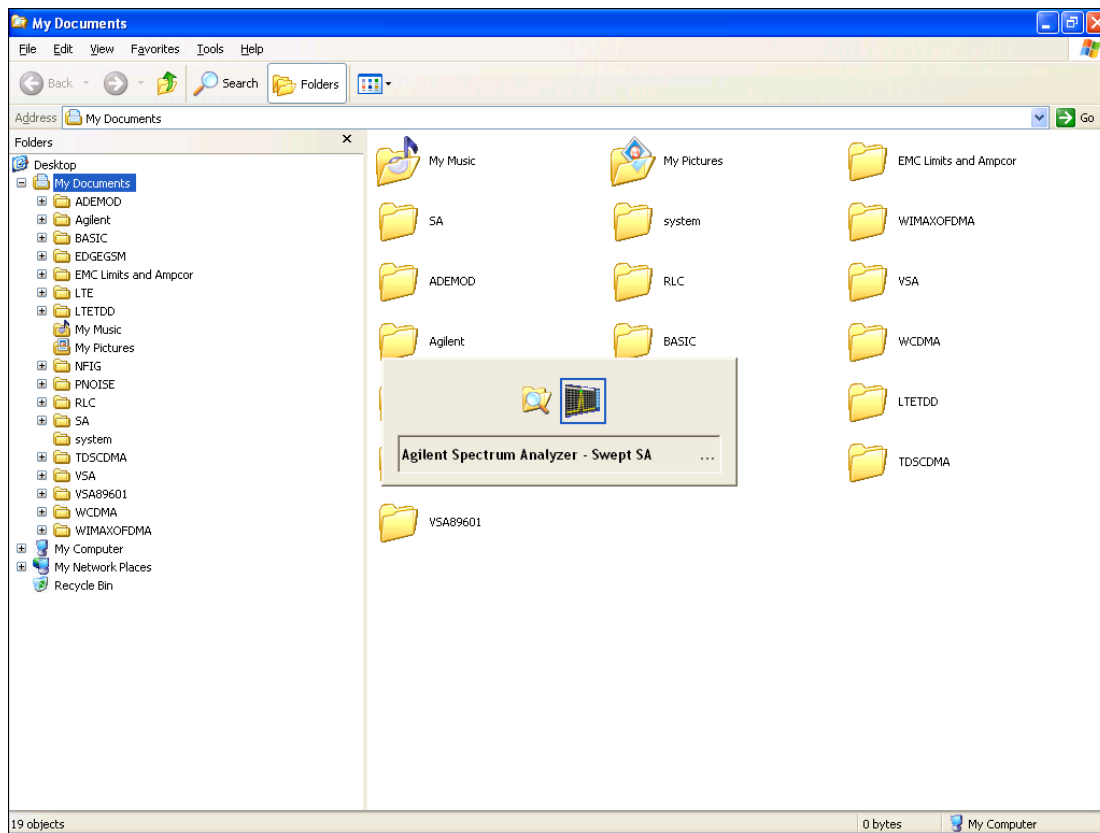

Or use Alt-Tab: press and hold the Alt key and press and release the Tab key until the Analyzer logo is showing in the window in the center of the screen, as shown above, then release the Alt key.

The ability to access File Explorer is not available if Option SF1 is installed.



Key Path	File
Initial S/W Revision	Prior to A.02.00

## Page Setup

The Page Setup key brings up a Windows Page Setup dialog that allows you to control aspects of the pages sent to the printer when the PRINT hardkey is pressed.

Key Path	File
Initial S/W Revision	Prior to A.02.00

Paper size, the printer paper source, the page orientation and the margins are all settable. Just like any standard Windows dialog, you may navigate the dialog using the front-panel keys, or a mouse. There are no SCPI commands for controlling these parameters.

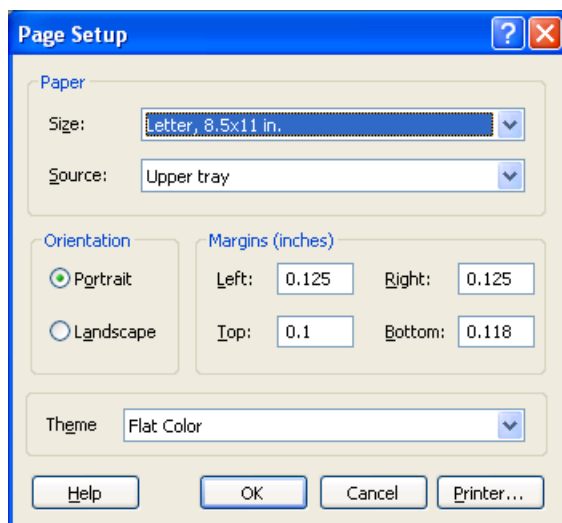

Also contained in this dialog is a drop-down control that lets you select the Theme to use when printing. For more on Themes, see information under View/Display, Display, System Display Settings, Theme. The Theme control has a corresponding SCPI command.

Parameter Name	Print Themes
Parameter Type	Enum
Mode	All
<b>Remote Command</b>	:SYSTem:PRINt:THEME TDCoLor TDMonochrome FCOLor FMONochrome :SYSTem:PRINt:THEME?
<b>Example</b>	:SYST:PRIN:THEM FCOL
Setup	:SYSTem:DEFault MISC
Preset	FCOL; not part of Preset, but is reset by Restore Misc Defaults or Restore System Defaults All and

	survives subsequent running of the modes.
State Saved	No
Initial S/W Revision	Prior to A.02.00

## Print

This front-panel key is equivalent to performing a File, Print, OK. It immediately performs the currently configured Print to the Default printer.

The :HCOPY command is equivalent to pressing the PRINT key. The HCOpy:ABORt command can be used to abort a print which is already in progress. Sending HCOpy:ABORt will cause the analyzer to stop sending data to the printer, although the printer may continue or even complete the print, depending on how much data was sent to the printer before the user sent the ABORt command.

Key Path	Front-panel key
Remote Command	:HCOPY[:IMMEDIATE]
Initial S/W Revision	Prior to A.02.00

Key Path	SCPI command only
Remote Command	:HCOPY:ABORt
Initial S/W Revision	Prior to A.02.00

## Restore Down

This key allows you to Restore Down the Instrument Application and reverses the action taken by Maximize. This key is only visible when the application has been maximized, and after the Restore Down action has been completed this key is replaced by the Maximize key.

Key Path	File
Mode	All
Notes	No equivalent remote command for this key.
State Saved	No
Initial S/W Revision	A.05.01

## Minimize

The Minimize key causes the analyzer display to disappear down into the task bar, allowing you to see the Windows Desktop. You can use Alt-Tab (press and hold the Alt  key and press and release the Tab key) to restore the analyzer display.

Key Path	File
Mode	All
Notes	No equivalent remote command for this key.
State Saved	No
Initial S/W Revision	A.05.01

## Exit

This key, when pressed, will exit the Instrument Application. A dialog box is used to confirm that you intended to exit the application:

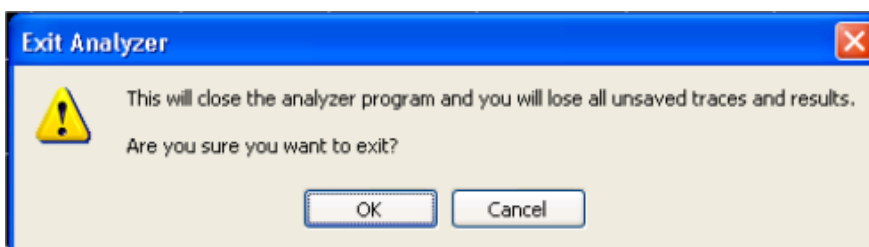

Key Path	File
Mode	All
Notes	The Instrument Application will close. No further SCPI commands can be sent. Use with caution!
Initial S/W Revision	Prior to A.02.00

## Print

The Print key opens a Print dialog for configured printing (for example, to the printer of your choice). Refer to your Microsoft Windows Operating System manual for more information.

## Maximize/Restore Down

These keys allow the Instrument Application to be maximized and then restored to its prior state. Only one of the two keys is visible at a time. When not already maximized the Maximize Application key is visible, and when maximized, the Restore Down Application key is visible and replaces the Maximize Application key.

## Maximize

This key allows you to Maximize the Instrument Application, which causes the analyzer display to fill the screen. Once the application is maximized, this key is replaced by the Restore Down key.

Key Path	File
Mode	All

Notes	No equivalent remote command for this key.
State Saved	No
Initial S/W Revision	A.05.01

## Restore Down

This key allows you to Restore Down the Instrument Application and reverses the action taken by Maximize. This key is only visible when the application has been maximized, and after the Restore Down action has been completed this key is replaced by the Maximize key.

Key Path	File
Mode	All
Notes	No equivalent remote command for this key.
State Saved	No
Initial S/W Revision	A.05.01

## Print

This front-panel key is equivalent to performing a File, Print, OK. It immediately performs the currently configured Print to the Default printer.

The :HCOPY command is equivalent to pressing the PRINT key. The HCOPY:ABORT command can be used to abort a print which is already in progress. Sending HCOPY:ABORT will cause the analyzer to stop sending data to the printer, although the printer may continue or even complete the print, depending on how much data was sent to the printer before the user sent the ABORT command.

Key Path	Front-panel key
<b>Remote Command</b>	:HCOPY[:IMMEDIATE]
Initial S/W Revision	Prior to A.02.00

Key Path	SCPI command only
<b>Remote Command</b>	:HCOPY:ABORT
Initial S/W Revision	Prior to A.02.00

## System

Opens a menu of keys that access various configuration menus and dialogs.

Key Path	Front-panel key
Notes	No remote command for this key specifically.
Initial S/W Revision	Prior to A.02.00

## Show

Accesses a menu of choices that enable you to select the information window you want to view.

Key Path	System
Mode	All
Remote Command	:SYSTem:SHOW OFF   ERRor   SYSTem   HARDware   LXI   HWSTatistics   ALIGNment   SOFTware   CAPplication :SYSTem:SHOW?
Example	:SYST:SHOW SYST
Notes	This command displays (or exits) the various System information screens.
Preset	OFF
State Saved	No
Range	OFF  ERRor   SYSTem   HARDware   LXI   HWSTatistics   ALIGNment   SOFTware CAPplication
Initial S/W Revision	Prior to A.02.00

## Errors

There are two modes for the Errors selection, History and Status.

The list of errors displayed in the Errors screen does not automatically refresh. You must press the Refresh key or leave the screen and return to it to refresh it.

History brings up a screen displaying the event log in chronological order, with the newest event at the top. The history queue can hold up to 100 messages (if a message has a repeat count greater than 1 it only counts once against this number of 100). Note that this count bears no relation to the size of the SCPI queue. If the queue extends onto a second page, a scroll bar appears to allow scrolling with a mouse. Time is displayed to the second.

Status brings up a screen summarizing the status conditions currently in effect. Note that the time is displayed to the second.

The fields on the Errors display are:

Type (unlabeled) - Displays the icon identifying the event or condition as an error or warning.

ID - Displays the error number.

Message - Displays the message text.

Repeat (RPT) - This field shows the number of consecutive instances of the event, uninterrupted by other events. If an event occurs 5 times with no other intervening event, the value of repeat will be 5.

If the value of Repeat is 1 the field does not display. If the value of Repeat is >1, the time and date shown are those of the most recent occurrence. If the value of repeat reaches 999,999 it stops there.

Time - Shows the most recent time (including the date) at which the event occurred.

Key Path	System, Show
Mode	All
Remote Command	:SYSTem:ERRor[:NEXT]?
Example	:SYST:ERR?
Notes	The return string has the format: “<Error Number>,<Error>” Where <Error Number> and <Error> are those shown on the Show Errors screen
Backwards Compatibility Notes	In some legacy analyzers, the Repeat field shows the number of times the message has repeated since the last time the error queue was cleared. In the X-Series, the Repeat field shows the number of times the error has repeated since the last intervening error. So the count may very well be different than in the past even for identical signal conditions  Unlike previous analyzers, in the X-Series all errors are reported through the Message or Status lines and are logged to the event queue. They never appear as text in the graticule area (as they sometimes do in previous analyzers) and they are never displayed in the settings panel at the top of the screen (as they sometimes do, by changing color, in previous analyzers).  As a consequence of the above, the user can only see one status condition (the most recently generated) without looking at the queue. In the past, at least in the Spectrum Analyzer, multiple status conditions might display on the right side of the graticule.  In general, there is no backwards compatibility specified or guaranteed between the error numbers in the X-Series and those of earlier products. Error, event, and status processing code in customers' software will probably need to be rewritten to work with X-Series.  In the legacy analyzers, some conditions report as errors and others simply turn on status bits. Conditions that report as errors often report over and over as long as the condition exists. In the X-series, all conditions report as start and stop events. Consequently, software that repeatedly queries for a condition error until it stops reporting will have to be rewritten for the X-series.
Initial S/W Revision	Prior to A.02.00

## Previous Page

See ["Next Page" on page 344.](#)

Key Path	System, Show, Errors
Initial S/W Revision	Prior to A.02.00

### Next Page

Next Page and Previous Page menu keys move you between pages of the log, if it fills more than one page. These keys are grayed out in some cases:

- If on the last page of the log, the Next Page key is grayed-out
- If on the first page of the log, the Previous Page key is grayed-out.
- If there is only one page, both keys are grayed out.

Key Path	System, Show, Errors
Initial S/W Revision	Prior to A.02.00

### Status

See ["History" on page 344](#).

#### Input Overload Enable (Remote Command Only)

Input Overload errors are reported using the Input Overload status bit (bit 12 in the Measurement Integrity status register). Input Overloads (for example, ADC Overload errors) can come and go with great frequency, generating many error events (for example, for signals just on the verge of overload), and so are not put into the SCPI error queue by default. Normally the status bit is the only way for detecting these errors remotely.

It is possible to enable Input Overload reporting to the SCPI queue, by issuing the :SYSTem:ERRor:OVERload ON command. To return to the default state, issue the :SYSTem:ERRor:OVERload OFF command. In either case, Input Overloads always set the status bit.

**NOTE**

For versions of firmware before A.10.01, the Input Overload was only a Warning and so was never available in the SCPI queue, although it did set the status bit. For A.10.01 and later, the Input Overload is an error and can be enabled to the SCPI queue using this command.

Key Path	SCPI only
Remote Command	:SYSTem:ERRor:OVERload[:STATe] 0 1 OFF ON
Example	:SYST:ERR:OVER 1 Enable overload errors
Preset	Set to OFF by Restore Misc Defaults (no Overload errors go to SCPI)
State Saved	Saved in instrument state.
Initial S/W Revision	A.10.01

### History

The History and Status keys select the Errors view. The Status key has a second line that shows a number in [square brackets]. This is the number of currently open status items.

Key Path	System, Show, Errors
Initial S/W Revision	Prior to A.02.00



## Verbose SCPI On/Off

When you turn Verbose SCPI on, additional information is returned when you send the :SYSTem:ERRor? query. The additional information consists of the characters that stimulated the error. This can aid you in debugging your test programs by indicating where in the parsing of a SCPI command the instrument encountered an invalid command or query.

Specifically, with Verbose SCPI on, the SYSTem:ERRor? query is expanded to show the SCPI data received, with the indicator <Err> at the point in the stream that the error occurred.

Verbose SCPI has no effect on the Show Errors screen or front panel Message Line; it only changes the response to the :SYST:ERR? query.

See the example below, where the invalid command “SENS:BOGUS” is sent:

Normal response to :SYST:ERR (using the Telnet window):

```
SCPI> SENS:BOGUS
```

```
SCPI> SYST:ERR?
```

```
-113,"Undefined header"
```

Now after turning on Verbose SCPI:

```
SCPI> SYST:BOGUS
```

```
SCPI> SYST:ERR?
```

```
-113,"Undefined header;SYST:BOGUS<Err>"
```

Key Path	System, Show, Errors
Mode	All
<b>Remote Command</b>	:SYSTem:ERRor:VERBoSe OFF ON 0 1 :SYSTem:ERRor:VERBoSe?
<b>Example</b>	:SYST:ERR:VERB ON
Preset	This is unaffected by Preset but is set to OFF on a “Restore System Defaults->Misc”
State Saved	No
Range	On   Off
Initial S/W Revision	Prior to A.02.00

## Refresh

When pressed, refreshes the Show Errors display.

Key Path	System, Show, Errors
Initial S/W Revision	Prior to A.02.00

### Clear Error Queue

This clears all errors in all error queues.

Note the following:

- Clear Error Queue does not affect the current status conditions.
- Mode Preset does not clear the error queue.
- Restore System Defaults will clear all error queues.
- \*CLS only clears the queue if it is sent remotely and \*RST does not affect any error queue.
- Switching modes does not affect any error queues.

Key Path	System, Show, Errors
Initial S/W Revision	Prior to A.02.00

### System

The System screen is formatted into three groupings: product descriptive information, options tied to the hardware, and software products:

```

<Product Name> <Product Description>
Product Number: N9020A
Serial Number: US46220924
Firmware Revision: A.01.01
Computer Name: <hostname>
Host ID: N9020A,US44220924

N9020A-503      Frequency Range to 3.6 GHz
N9020A-PFR     Precision Frequency Reference
N9020A-P03     Preamp 3.6 GHz

N9060A-2FP     Spectrum Analysis Measurement Suite  1.0.0.0
N9073A-1FP     WCDMA                               1.0.0.0
N9073A-2FP     WCDMA with HSDPA                     1.0.0.0
  
```

The Previous Page is grayed-out if the first page of information is presently displayed. The Next Page menu key is grayed-out if the last page of information is presently displayed.

Key Path	System, Show
Mode	All
<b>Example</b>	SYST:SHOW SYST

Backwards Compatibility Notes	The hardware statistics that are displayed in the PSA Show System screen have been moved to a dedicated Show Hardware Statistics screen in the Service Menu.
Initial S/W Revision	Prior to A.02.00

### Show System contents (Remote Command Only)

A remote command is available to obtain the contents of the Show System screen (the entire contents, not just the currently displayed page).

<b>Remote Command</b>	:SYSTem:CONFigure[:SYSTem]?
<b>Example</b>	:SYST:CONF?
Notes	The output is an IEEE Block format of the Show System contents. Each line is separated with a new-line character.
Initial S/W Revision	Prior to A.02.00

### Computer System description (Remote Command Only)

A remote command is available to obtain the Computer System description. The Computer System is the operating system and patch level as reported by operating system.

<b>Remote Command</b>	:SYSTem:CSYSem?
<b>Example</b>	:SYST:CSYS?
Notes	The return value is the Computer System name and service pack level.
Initial S/W Revision	Prior to A.12.00

## Hardware

The show hardware screen is used to view details of the installed hardware. This information can be used to determine versions of hardware assemblies and field programmable devices, in the advent of future upgrades or potential repair needs.

The screen is formatted into two groupings: product descriptive information and hardware information. The hardware information is listed in a table format:

<b>Hardware Information</b>							
MXA Signal Analyzer Product Number: N9020A Serial Number: US46220107 Firmware Revision: A.01.14							
Assembly Name	Part #	Serial #	Mat Rev	Rev	OF Rev	Hw Id	Misc
Analog IF	E441060104	78060200131	003	0	C	15	
YIG Tuned Filter	50877305	11061500550	005	0	A	11	
Digital IF	E441060105	78060100559	003	0	F	14	
Front End Controller	E441060101	78060100147	004	2	A	8	
Low Band Switch	E441060170	78060800346	005	1	A	10	
LO Synthesizer	E441060102	78060100226	003	3	G	2	
Reference	E441060108	78060300420	004	1	C	16	
Front End	E441060154	13062800820	010	2	B	9	

The Previous Page is grayed-out if the first page of information is presently displayed. The Next Page menu is grayed-out if the last page is information is presently displayed.

---

<b>Key Path</b>	System, Show
<b>Mode</b>	All
<b>Example</b>	SYST:SHOW HARD
<b>Initial S/W Revision</b>	Prior to A.02.00

---

### LXI

This key shows you the product number, serial number, firmware revision, computer name, IP address, Host ID, LXI Class, LXI Version, MAC Address, and the Auto-MDIX Capability.

---

<b>Key Path</b>	System, Show
<b>Initial S/W Revision</b>	Prior to A.02.00

---

### Power On

Enables you to select how the instrument should power on. The options are: Mode and Input/Output Defaults, User Preset and Last State.

Key Path	System
Mode	All
<b>Remote Command</b>	:SYSTem:PON:TYPE MODE USER LAST :SYSTem:PON:TYPE?
<b>Example</b>	:SYST:PON:TYPE MODE
Preset	This is unaffected by a Preset but is set to Mode on a “Restore System Defaults->All”
State Saved	No
<b>Backwards Compatibility SCPI</b>	:SYSTem:PON:TYPE PRESet the “PRESet” parameter is supported for backward compatibility only and behaves the same as MODE.
Backwards Compatibility Notes	The Preset Type key in legacy analyzers has been removed, and the Power On toggle key has been replaced by this 1-of-N key in the System menu.
Initial S/W Revision	Prior to A.02.00

## Mode and Input/Output Defaults

When the analyzer is powered on in Mode and Input/Output Defaults, it performs a Restore Mode Defaults to all modes in the instrument and also performs a Restore Input/Output Defaults.

Persistent parameters (such as Amplitude Correction tables or Limit tables) are not affected at power on, even though they are normally cleared by Restore Input/Output Defaults and/or Restore Mode Defaults.

Key Path	System, Power On
Mode	All
<b>Example</b>	SYST:PON:TYPE MODE
Readback Text	Defaults
Initial S/W Revision	Prior to A.02.00

## User Preset

Sets Power On to User Preset. When the analyzer is powered on in User Preset, it will User Preset each mode and switch to the power-on mode. Power On User Preset will not affect any settings beyond what a normal User Preset affects.

### NOTE

An instrument could never power up for the first time in User Preset.

Key Path	System, Power On
Mode	All
<b>Example</b>	SYST:PON:TYPE USER
Readback Text	User Preset

Backwards Compatibility Notes	Power On User Preset will cause the instrument to power up in the power-on mode, not the last mode the instrument was in prior to shut down. Also, Power On User Preset will User Preset all modes. This does not exactly match legacy behavior.
Initial S/W Revision	Prior to A.02.00

## Last State

Sets Power On to **Last**. When the analyzer is powered on, it will put all modes in the last state they were in prior to when the analyzer was put into Power Standby and it will wake up in the mode it was last in prior to powering off the instrument. The saving of the active mode prior to shutdown happens behind the scenes when a controlled shutdown is requested by using the front panel power Standby key or by using the remote command SYSTem:PDOWn. The non-active modes are saved as they are deactivated and recalled by Power On Last State.

### NOTE

An instrument can never power up for the first time in Last.

If line power to the analyzer is interrupted, for example by pulling the line cord plug or by switching off power to a test rack, Power On Last State may not work properly. For proper operation, Power On Last State depends on you shutting down the instrument using the Standby key or the SYSTem:PDOWn SCPI command. This will ensure the last state of each mode is saved and can be recalled during a power up.

Key Path	System, Power On
Mode	All
<b>Example</b>	SYST:PON:TYPE LAST
Notes	Power on Last State only works if you have done a controlled shutdown prior to powering on in Last. If a controlled shutdown is not done when in Power On Last State, the instrument will power up in the last active mode, but it may not power up in the active mode's last state. If an invalid mode state is detected, a Mode Preset will occur. To control the shutdown under remote control use the :SYSTem:PDOWn command.
Readback Text	Last State
Backwards Compatibility Notes	It is no longer possible to power-up the analyzer in the last mode the analyzer was running with that mode in the preset state. (ESA/PSA SYST:PRESET:TYPE MODE with SYST:PON:PRESET) You can power-on the analyzer in the last mode the instrument was running in its last state (SYST:PON:TYPE LAST), or you can specify the mode to power-up in its preset state (SYST:PON:MODE <mode>).
Initial S/W Revision	Prior to A.02.00

## Power On Application

Accesses a menu that lists the available Modes and lets you select which Mode is to be the power-on application.

This application is used for Power On Type “Mode and Input/Output Defaults” and Restore System Defaults All.

Key Path	System, Power On
Mode	All
<b>Remote Command</b>	:SYSTem:PON:MODE SA   BASIC   ADEMOD   NFIGURE   PNOISE   CDMA2K   TDSCDMA   VSA   VSA89601   WCDMA   WIMAXOFDMA  :SYSTem:PON:MODE?
<b>Example</b>	SYST:PON:MODE SA
Notes	The list of possible modes (and remote parameters) to choose from is dependent on which modes are installed in the instrument.
Preset	This is unaffected by a Preset but is set on a "Restore System Defaults->All" to: For N9038A: EMI For N8973B, N8974B, N8975B, or N8976B: NFIG For all other models: SA
State Saved	No
Initial S/W Revision	Prior to A.02.00

## Configure Applications

The Configure Applications utility can be used to:

- select applications for preload
- determine how many applications can fit in memory at one time
- specify the order of the Modes in the Mode menu.

This utility consists of a window with instructions, a set of "Select Application" checkboxes, a "fuel bar" style memory gauge, and keys that help you set up your configuration.

For more information, see the following topics:

["Preloading Applications" on page 352](#)

["Access to Configure Applications utility" on page 352](#)

["Virtual memory usage" on page 352](#)

Key Path	System, Power On
<b>Example</b>	:SYST:SHOW CAPP Displays the Config Applications screen
Initial S/W Revision	A.02.00

## Preloading Applications

During runtime, if a Mode that is not preloaded is selected using the Mode menu or sending SCPI commands, there will be a pause while the Application is loaded. During this pause a message that says “Loading application, please wait ...” is displayed. Once loaded, the application stays loaded, so the next time you select it during a session, there is no delay.

Preloading enables you to “preload” at startup, to eliminate the runtime delay. Preloading an application will cause it to be loaded into the analyzer’s memory when the analyzer program starts up. If you do this, the delay will increase the time it takes to start up the analyzer program, but this may be preferable to having to wait the first time you select an application. Note that, once an application is loaded into memory, it cannot be unloaded without exiting and restarting the analyzer program.

Note that there are more applications available for the X-Series than can fit into Windows Virtual Memory. By allowing you to choose which licensed applications to load at startup, the Configure Applications utility allows you to make optimal use of your memory.

## Access to Configure Applications utility

A version of the utility runs the first time you power up the analyzer after purchasing it from Agilent. The utility automatically configures preloads so that as many licensed applications as possible are preloaded while keeping the total estimated virtual memory usage below the limit. This auto-configuration only takes place at the very first run, and after analyzer software upgrades.

You may, at any time, manually call up the Configure Applications utility by pressing System, Power On, Configure Applications, to find a configuration that works best for you, and then restart the analyzer program.

The utility may also be called if, during operation of the analyzer, you attempt to load more applications than can fit in memory at once.

## Virtual memory usage

There are more applications available for the X-Series than can fit into memory at any one time, so the Configure Applications utility includes a memory tracker that serves two purposes:

1. It will not let you preload more applications than will fit into memory at once.
2. You can determine how many of your favorite applications can reside in memory at one time.

The utility provides a graphical representation of the amount of memory (note that the memory in question here is Virtual memory and is a limitation imposed by the operating system, not by the amount of physical memory you have in your analyzer). You select applications to preload by checking the boxes on the left. Checked applications preload at startup. The colored fuel bar indicates the total memory required when all the checked applications are loaded (either preloaded or selected during runtime).

Here is what the fuel bar colors mean:

RED: the applications you have selected cannot all fit into the analyzer’s memory. You must deselect applications until the fuel bar turns yellow.

YELLOW: the applications you have selected can all fit into the analyzer’s memory, but there is less than 10% of the memory left, probably not enough to load any other applications, either via preload or by selecting a Mode while the analyzer is running..



GREEN: The indicator is green when <90% of the memory limit is consumed. This means the applications you have selected can all fit into the analyzer's memory with room to spare. You will likely be able to load one or more other applications without running out of memory.

### Select All

Marks all applications in the selection list. This allows you to enable all applications licensed on the instrument for pre-loading, or is a convenience for selecting all applications in one operation and then letting you deselect individual applications.

Key Path	System, Power On, Configure Applications
Initial S/W Revision	A.02.00

### Deselect All

Clears the marks from all applications in the selection list, except the Power On application. The Power On application cannot be eliminated from the pre-load list.

Key Path	System, Power On, Configure Applications
Initial S/W Revision	A.02.00

### Move Up

The application list is the order that applications appear in the Mode Menu. This key enables you to shift the selected application up in the list, thus moving the selected application earlier in the Mode Menu.

Key Path	System, Power On, Configure Applications
Initial S/W Revision	A.02.00

### Move Down

The application list is the order that applications appear in the Mode Menu. This key enables you to shift the selected application down in the list, thus moving the selected application later in the Mode Menu.

Key Path	System, Power On, Configure Applications
Initial S/W Revision	A.02.00

### Select/Deselect

Toggles the currently highlighted application in the list.

Key Path	System, Power On, Configure Applications
Initial S/W Revision	A.02.00

### Save Changes and Exit

Applies the configuration of the applications list. The marked applications will be pre-loaded in memory the next time the instrument application is started, and the order of the applications in the list will be the order of the applications in the Mode Menu.

After saving your changes, the analyzer asks you if you would like it to restart so that your changes can take effect (see dialog box, below). If you choose not to restart, the changes will not take affect until the next time you shut down and restart the analyzer.

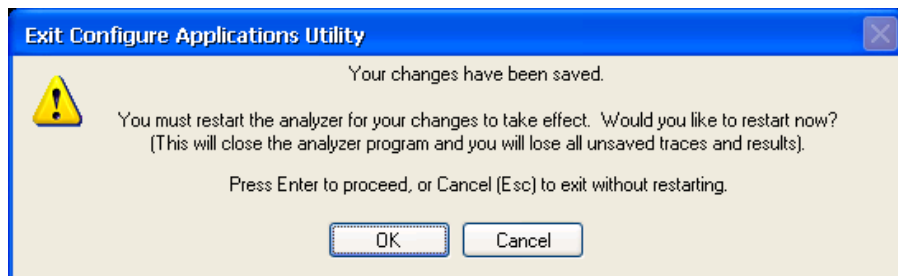

Key Path	System, Power On, Configure Applications
Remote Command	:SYSTem:PUP:PROcess
Example	:SYST:PUP:PROC This is the SCPI command for restarting the analyzer. You must Wait after this command for the instrument application to restart
Notes	The softkey will be grayed-out when the virtual memory of the selected applications exceeds 100% of the limit.
Notes	You cannot use *WAI or *OPC? to synchronize operation after a restart. This command stops and restarts the instrument application, thus the SCPI operation is terminated and restarted. A remote program must use fixed wait time to resume sending commands to the instrument. The wait time will be dependent upon which applications are pre-loaded.
Initial S/W Revision	A.02.00
Modified at S/W Revision	A.04.00

### Exit Without Saving

Pressing this key will exit the Configure Applications utility without saving your changes.

Key Path	System, Power On, Configure Applications
Initial S/W Revision	A.02.00
Modified at S/W Revision	A.04.00

### Restore Power On Defaults

This selection causes the Power On Type and Power On Application settings to be a reset to their default values. This level of Restore System Defaults does not affect any other system settings, mode settings and

does not cause a mode switch. The Power On key, under the Restore System Defaults menu, causes the same action.

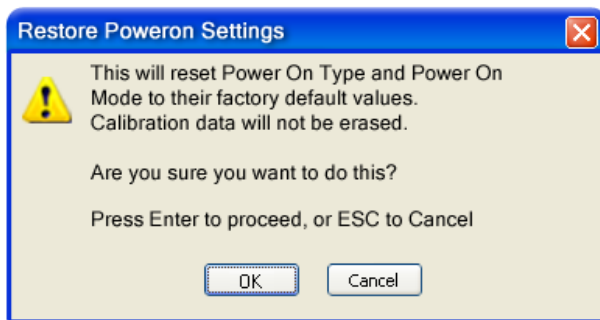

If you press any key other than OK or Enter, it is construed as a Cancel, because the only path that will actually cause the reset to be executed is through OK or Enter.

Key Path	System, Power On
Example	:SYST:DEF PON
Initial S/W Revision	Prior to A.02.00

## Configure Applications - Instrument boot-up

At start-up of the analyzer program a dialog box similar to the one under the System, Power On, Configure Applications key will be displayed allowing you to choose which licensed applications are to be loaded. This dialog will only be displayed if the memory required to pre-load all of the licensed applications exceeds the Virtual Memory available.

## Configure Applications - Windows desktop

The Configure Applications Utility may be run from the Windows Desktop. The utility is launched by double-



clicking the icon on the desktop, which brings-up a dialog box similar to the one under the System, Power On, Configure Applications key, allowing you to choose which licensed applications are to be loaded when the analyzer program starts up. This dialog box has mouse buttons on it that do the job the softkeys normally do in the System, Power On, Configure Applications menu.

## Configure Applications - Remote Commands

The following topics provide details on using remote commands to configure the list of applications you want to load into the instrument memory or query the Virtual Memory utilization for your applications.

- ["Configuration list \(Remote Command Only\)" on page 356](#)
- ["Configuration Memory Available \(Remote Command Only\)" on page 356](#)
- ["Configuration Memory Total \(Remote Command Only\)" on page 356](#)
- ["Configuration Memory Used \(Remote Command Only\)" on page 356](#)

- "Configuration Application Memory (Remote Command Only)" on page 357

### Configuration list (Remote Command Only)

This remote command is used to set or query the list of applications to be loaded in-memory.

<b>Remote Command</b>	:SYSTem:PON:APPLication:LLISt <string of INSTRument:SElect names> :SYSTem:PON:APPLication:LLISt?
<b>Example</b>	:SYST:PON:APPL:LLIS "SA,BASIC,WCDMA"
<b>Notes</b>	<string of INSTRument:SElect names> are from the enums of the :INSTRument:SElect command. The order of the <INSTRument:SElect names> is the order that the applications are loaded into memory, and the order that they appear in the Mode Menu. Error message -225 "Out of Memory" is reported when more applications are listed than can reside in Virtual Memory. When this occurs, the existing applications load list is unchanged.
<b>Preset</b>	Not affected by Preset
<b>State Saved</b>	Not saved in instrument state
<b>Initial S/W Revision</b>	A.02.00

### Configuration Memory Available (Remote Command Only)

This remote command is used to query the amount of Virtual Memory remaining.

<b>Remote Command</b>	:SYSTem:PON:APPLication:VMEMory[:AVAIlable]?
<b>Example</b>	:SYST:PON:APPL:VMEM?
<b>Preset</b>	Not affected by Preset
<b>Initial S/W Revision</b>	A.02.00

### Configuration Memory Total (Remote Command Only)

This remote command is used to query the limit of Virtual Memory allowed for applications.

<b>Remote Command</b>	:SYSTem:PON:APPLication:VMEMory:TOTal?
<b>Example</b>	:SYST:PON:APPL:VMEM:TOT?
<b>Preset</b>	Not affected by Preset
<b>Initial S/W Revision</b>	A.02.00

### Configuration Memory Used (Remote Command Only)

This remote command is a query of the amount of Virtual Memory used by all measurement applications.

<b>Remote Command</b>	:SYSTem:PON:APPLication:VMEMory:USED?
<b>Example</b>	:SYST:PON:APPL:VMEM:USED?

Preset	Not affected by Preset
Initial S/W Revision	A.02.00

### Configuration Application Memory (Remote Command Only)

This remote command is used to query the amount of Virtual Memory a particular application consumes.

<b>Remote Command</b>	:SYSTem:PON:APPLication:VMEMory:USED:NAME? <INSTRument:SElect name>
<b>Example</b>	:SYST:PON:APPL:VMEM:USED:NAME? CDMA2K
Notes	<INSTRument:SElect name> is from the enums of the :INSTRument:SElect command Value returned will be 0 (zero) if the name provided is invalid.
Preset	Not affected by Preset
Initial S/W Revision	Prior to A.02.00

### Alignments

The Alignments Menu controls and displays the automatic alignment of the instrument, and provides the ability to restore the default alignment values.

The current setting of the alignment system is displayed in the system Settings Panel along the top of the display, including a warning icon for conditions that may cause specifications to be impacted.



Key Path	System
Initial S/W Revision	Prior to A.02.00

### Auto Align

Configures the method for which the automatic background alignment is run.

Automatic background alignments are run periodically between measurement acquisitions. The instrument's software determines when alignments are to be performed to maintain warranted operation. The recommended setting for Auto Align is Normal.

An Auto Align execution cannot be aborted with the Cancel (ESC) key. To interrupt an Auto Align execution, select Auto Align Off.

Key Path	System, Alignments
Mode	All
<b>Remote Command</b>	:CALibration:AUTO ON PARTial OFF :CALibration:AUTO?
<b>Example</b>	:CAL:AUTO ON

Notes	While Auto Align is executing, bit 0 of Status Operation register is set.
Couplings	Auto Align is set to Off if Restore Align Data is invoked.
Preset	This is unaffected by Preset but is set to ON upon a "Restore System Defaults->Align".
State Saved	No
Status Bits/OPC dependencies	When Auto Align is executing, bit 0 in the Status Operational register is set.
<b>Backwards Compatibility SCPI</b>	:CALibration:AUTO ALERt Parameter ALERt is for backward compatibility only and is mapped to PARTial
Backwards Compatibility Notes	<ol style="list-style-type: none"> <li>1. ESA SCPI for Auto Align is :CALibration:AUTO &lt;Boolean&gt;. The command for X-Series is an enumeration. Thus the parameters of "0" and "1" are not possible in X-Series.</li> <li>2. Similarly, the ESA SCPI for :CALibration:AUTO? returned the Boolean value 1 or 0, in X-Series it is an Enumeration (string). Thus, queries by customer applications into numeric variables will result in an error</li> <li>3. In PSA Auto Align OFF was not completely off, it is equivalent to PARTial in X-Series. In X-Series, OFF will be fully OFF. This means users of PSA SCPI who choose OFF may see degraded performance and should migrate their software to use PARTial.</li> </ol>
Initial S/W Revision	Prior to A.02.00

## Normal

Auto Align, Normal turns on the automatic alignment of all measurement systems. The Auto Align, Normal selection maintains the instrument in warranted operation across varying temperature and over time.

If the condition "Align Now, All required" is set, transition to Auto Align, Normal will perform the required alignments and clear the "Align Now, All required" condition and then continue with further alignments as required to maintain the instrument adequately aligned for warranted operation.

When Auto Align, Normal is selected the Auto Align Off time is set to zero.

When Auto Align, Normal is selected the Settings Panel indicates ALIGN AUTO.

Key Path	System, Alignments, Auto Align
Mode	All
<b>Example</b>	:CAL:AUTO ON
Notes	<p>Alignment processing as a result of the transition to Normal will be executed sequentially. Thus, *OPC? or *WAI following CAL:AUTO ON will return when the alignment processing is complete.</p> <p>The presence of an external signal may interfere with the RF portion of the alignment. If so, the Error Condition message "Align skipped: 50 MHz interference" or "Align skipped: 4.8 GHz interference" is reported, and bit 11 is set in the Status Questionable Calibration register. After the interfering signal is removed, subsequent alignment of the RF will clear the condition, and clear bit 11 in the Status Questionable Calibration register.</p>
Readback Text	Normal
Status Bits/OPC dependencies	An interfering user signal may prevent automatic alignment of the RF subsystem. If this occurs, the Error Condition message "Align skipped: 50 MHz interference" or "Align skipped: 4.8 GHz

---

interference” is reported, the Status Questionable Calibration bit 11 is set, and the alignment proceeds. When a subsequent alignment of the RF subsystem succeeds, either by the next cycle of automatic alignment or from an Align Now, RF, the Error Condition and Status Questionable Calibration bit 11 are cleared.

---

Initial S/W Revision	Prior to A.02.00
----------------------	------------------

---

## Partial

Auto Align, Partial disables the full automatic alignment and the maintenance of warranted operation for the benefit of improved measurement throughput. Accuracy is retained for the Resolution Bandwidth filters and the IF Passband, which is critical to FFT accuracy, demodulation, and many measurement applications. With Auto Align set to Partial, you are now responsible for maintaining warranted operation by updating the alignments when they expire. The Auto Align, Alert mechanism will notify you when alignments have expired. One solution to expired alignments is to perform the Align All, Now operation. Another is to return the Auto Align selection to Normal.

Auto Align, Partial is recommended for measurements where the throughput is so important that a few percent of improvement is more valued than an increase in the accuracy errors of a few tenths of a decibel. One good application of Auto Align, Partial would be an automated environment where the alignments can be called during overhead time when the device-under-test is exchanged.

When Auto Align, Partial is selected the elapsed time counter begins for Auto Align Off time.

When Auto Align, Partial is selected the Settings Panel indicates ALIGN PARTIAL with a warning icon. The warning icon is to inform the operator that they are responsible for maintaining the warranted operation of the instrument

Key Path	System, Alignments, Auto Align
Mode	All
<b>Example</b>	:CAL:AUTO PART
Notes	Auto Align Partial begins the elapsed time counter for Auto Align Off time.
Readback Text	Partial
Initial S/W Revision	Prior to A.02.00

---

## Off

Auto Align, Off disables automatic alignment and the maintenance of warranted operation, for the benefit of maximum measurement throughput. With Auto Align set to Off, you are now responsible for maintaining warranted operation by updating the alignments when they expire. The Auto Align, Alert mechanism will notify you when alignments have expired. One solution to expired alignments is to perform the Align All, Now operation. Another is to return the Auto Align selection to Normal.

The Auto Align, Off setting is rarely the best choice, because Partial gives almost the same improvement in throughput while maintaining the warranted performance for a much longer time. The choice is intended for unusual circumstances such as the measurement of radar pulses where you might like the revisit time to be as consistent as possible.

When Auto Align, Off is selected the Auto Align Off time is initialized and the elapsed time counter begins.

When Auto Align, Off is selected the Settings Panel indicates ALIGN OFF with a warning icon. The warning icon is to inform the operator that they are responsible for maintaining the warranted operation of the instrument:

Key Path	System, Alignments, Auto Align
Mode	All
Example	:CAL:AUTO OFF
Notes	Auto Align Off begins the elapsed time counter for Auto Align Off time.
Couplings	Auto Align is set to Off if Restore Align Data is invoked.
Readback Text	Off
Initial S/W Revision	Prior to A.02.00

### All but RF

Auto Align, All but RF, configures automatic alignment to include or exclude the RF subsystem. (Eliminating the automatic alignment of the RF subsystem prevents the input impedance from changing. The normal input impedance of 50 ohms can change to an open circuit when alignments are being used. Some devices under test do not behave acceptably under such circumstances, for example by showing instability.) When Auto Align, All but RF ON is selected, the operator is responsible for performing an Align Now, RF when RF-related alignments expire. The Auto Align, Alert mechanism will notify the operator to perform an Align Now, All when the combination of time and temperature variation is exceeded.

When Auto Align, All but RF ON is selected the Settings Panel indicates ALIGN AUTO/NO RF with a warning icon (warning icon is intended to inform the operator they are responsible for the maintaining the RF alignment of the instrument):

Key Path	System, Alignments, Auto Align
Mode	All
Remote Command	:CALibration:AUTO:MODE ALL NRF :CALibration:AUTO:MODE?
Example	:CAL:AUTO:MODE NRF
Preset	This is unaffected by Preset but is set to ALL on a "Restore System Defaults->Align".
State Saved	No
Readback Text	RF or NRF
Initial S/W Revision	Prior to A.02.00

### Alert

The instrument will signal an Alert when conditions exist such that you will need to perform a full alignment (for example, Align Now, All). The Alert can be configured in one of four settings; Time & Temperature, 24 hours, 7 days, or None. A confirmation is required when a selection other than Time & Temperature is chosen. This prevents accidental deactivation of alerts.



With Auto Align set to Normal, the configuration of Alert is not relevant because the instrument's software maintains the instrument in warranted operation.

Key Path	System, Alignments, Auto Align
Mode	All
<b>Remote Command</b>	:CALibration:AUTO:ALERT TTEMperature DAY WEEK NONE :CALibration:AUTO:ALERT?
<b>Example</b>	:CAL:AUTO:ALERTTEM
Notes	The alert that alignment is needed is the setting of bit 14 in the Status Questionable Calibration register.
Preset	This is unaffected by Preset but is set to TTEMperature on a "Restore System Defaults->Align".
State Saved	No
Status Bits/OPC dependencies	The alert is the Error Condition message "Align Now, All required" and bit 14 is set in the Status Questionable Calibration register.
Initial S/W Revision	Prior to A.02.00

### Time & Temperature

With Auto Align Alert set to Time & Temperature the instrument will signal an alert when alignments expire due to the combination of the passage of time and changes in temperature. The alert is the Error Condition message "Align Now, All required". If this choice for Alert is selected, the absence of an alert means that the analyzer alignment is sufficiently up-to-date to maintain warranted accuracy.

Key Path	System, Alignments, Auto Align, Alert
Mode	All
<b>Example</b>	:CAL:AUTO:ALERTTEM
Readback Text	Time & Temp
Status Bits/OPC dependencies	Bit 14 is set in the Status Questionable Calibration register.
Initial S/W Revision	Prior to A.02.00

### 24 hours

With Auto Align Alert set to 24 Hours the instrument will signal an alert after a time span of 24 hours since the last successful full alignment (for example, Align Now, All or completion of a full Auto Align). You may choose this selection in an environment where the temperature is stable on a daily basis at a small risk of accuracy errors in excess of the warranted specifications. The alert is the Error Condition message "Align Now, All required".

For front-panel operation, confirmation is required to transition into this setting of Alert. The confirmation dialog is:

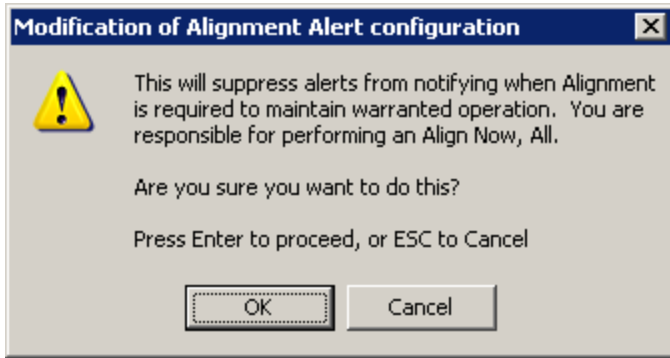

No confirmation is required when Alert is configured through a remote command.

Key Path	System, Alignments, Auto Align, Alert
Mode	All
<b>Example</b>	:CAL:AUTO:ALER DAY
Readback Text	24 hours
Status Bits/OPC dependencies	Bit 14 is set in the Status Questionable Calibration register.
Initial S/W Revision	Prior to A.02.00

### 7 days

With Auto Align Alert is set to 7 days the instrument will signal an alert after a time span of 168 hours since the last successful full alignment (for example, Align Now, All or completion of a full Auto Align). You may choose this selection in an environment where the temperature is stable on a weekly basis, at a modest risk of accuracy degradations in excess of warranted performance. The alert is the Error Condition message “Align Now, All required”.

For front panel operation, confirmation is required for the customer to transition into this setting of Alert. The confirmation dialog is:

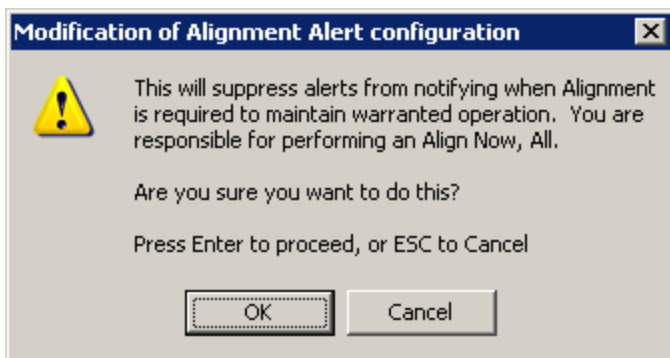

No confirmation is required when Alert is configured through a remote command.

Key Path	System, Alignments, Auto Align, Alert
Mode	All
<b>Example</b>	:CAL:AUTO:ALER WEEK
Readback Text	7 days
Status Bits/OPC dependencies	Bit 14 is set in the Status Questionable Calibration register.
Initial S/W Revision	Prior to A.02.00

### None

With Auto Align Alert set to None the instrument will not signal an alert. This is provided for rare occasions where you are making a long measurement which cannot tolerate Auto Align interruptions, and must have the ability to capture a screen image at the end of the measurement without an alert posted to the display. Agilent does not recommends using this selection in any other circumstances, because of the risk of accuracy performance drifting well beyond expected levels without the operator being informed.

For front panel operation, confirmation is required to transition into this setting of Alert. The confirmation dialog is:

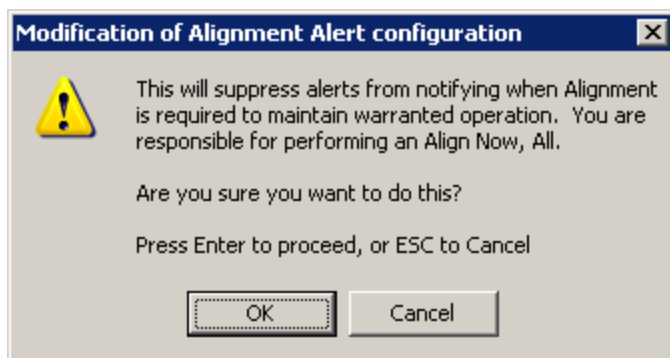

No confirmation is required when Alert is configured through a remote command.

Key Path	System, Alignments, Auto Align, Alert
Mode	All
<b>Example</b>	:CAL:AUTO:ALER NONE
Initial S/W Revision	Prior to A.02.00

### Execute Expired Alignments (Remote Command Only)

Alignments can be expired in the situation where Auto Align is in the state of Partial or Off. This feature runs the alignments that have expired. This is different than performing an Align All, Now operation. Align All, Now performs an alignment of all subsystems regardless of whether they are needed or not, with Execute Expired Alignments, only the individual subsystems that have become due are aligned.

Mode	All
Remote Command	:CALibration:EXPIred?
Example	:CAL:EXP?
Notes	:CALibration:EXPIred? returns 0 if successful :CALibration:EXPIred? returns 1 if failed
Initial S/W Revision	Prior to A.02.00

## Align Now

Accesses alignment processes that are immediate action operations. They perform complete operations and run until they are complete.

Key Path	System, Alignments
Initial S/W Revision	Prior to A.02.00

### All

(In MXE the key label is “All (plus RF Presel 20 Hz – 3.6 GHz)”)Immediately executes an alignment of all subsystems In MXE, the Align Now All is followed by additionally aligning the RF Preselector section, so in MXE, the key label contains the parenthetical note “(plus RF Presel 20 Hz – 3.6 GHz)”. The instrument stops any measurement currently underway, performs the alignment, then restarts the measurement from the beginning (similar to pressing the Restart key).

If an interfering user signal is present at the RF Input, the alignment is performed on all subsystems except the RF. After completion, the Error Condition message “Align skipped: 50 MHz interference” or “Align skipped: 4.8 GHz interference” is generated. In addition the Error Condition message “Align Now, RF required” is generated, and bits 11 and 12 are set in the Status Questionable Calibration register.

The query form of the remote commands (:CALibration[:ALL]? or \*CAL?) invokes the alignment of all subsystems and returns a success or failure value. An interfering user signal is not grounds for failure; if the alignment was able to succeed on all portions but unable to align the RF because of an interfering signal, the resultant will be the success value.

Successful completion of Align Now, All will clear the “Align Now, All required” Error Condition, and clear bit 14 in the Status Questionable Calibration register. It will also begin the elapsed time counter for Last Align Now, All Time, and capture the Last Align Now, All Temperature.

In the MXE, successful completion will also clear the “Align 20 Hz to 30 MHz required” Error Condition, the “Align 30 MHz to 3.6 GHz required” Error Condition, and the “Align 20 Hz to 3.6 GHz required” Error Condition, and clear bits 1 and bit 2 and clear the bit 1 in the Status Questionable Calibration Extended Needed register.

If the Align RF subsystem succeeded in aligning (no interfering signal present), the elapsed time counter begins for Last Align Now, RF Time, and the temperature is captured for the Last Align Now, RF Temperature. In addition the Error Conditions “Align skipped: 50 MHz interference” and “Align skipped: 4.8

GHz interference” are cleared, the Error Condition “Align Now, RF required” is cleared, and bits 11 and 12 are cleared in the Status Questionable Calibration register

Align Now, All can be interrupted by pressing the Cancel (ESC) front-panel key or remotely with Device Clear followed by the :ABORt SCPI command. When this occurs the Error Condition message “Align Now, All required” is generated, and bit 14 is set in the Status Questionable Condition register. This is because new alignment data may be employed for an individual subsystem, but not a cohesive set of data for all subsystems.

In many cases, you might find it more convenient to change alignments to Normal, instead of executing Align Now, All. When the Auto Align process transitions to Normal, the analyzer will immediately start to update only the alignments that have expired, thus efficiently restoring the alignment process.

<b>Key Path</b>	System, Alignments, Align Now
<b>Mode</b>	All
<b>Remote Command</b>	:CALibration[:ALL] :CALibration[:ALL]?
<b>Example</b>	:CAL
<b>Notes</b>	:CALibration[:ALL]? returns 0 if successful :CALibration[:ALL]? returns 1 if failed :CALibration[:ALL]? is the same as *CAL? While Align Now, All is performing the alignment, bit 0 in the Status Operation register is set. Completion, or termination, will clear bit 0 in the Status Operation register. This command is sequential; it must complete before further SCPI commands are processed. Interrupting the alignment from remote is accomplished by invoking Device Clear followed by the :ABORt command. Successful completion will clear bit 14 in the Status Questionable Calibration register. An interfering user signal is not grounds for failure of Align Now, All. However, bits 11 and 12 are set in the Status Questionable Calibration register to indicate Align Now, RF is required. An interfering user supplied signal will result in the instrument requiring an Align Now, RF with the interfering signal removed.
<b>Couplings</b>	Initializes the time for the Last Align Now, All Time. Records the temperature for the Last Align Now, All Temperature. If Align RF component succeeded, initializes the time for the Last Align Now, RF Time. If Align RF component succeeded, records the temperature for the Last Align Now, RF Temperature.
<b>Status Bits/OPC dependencies</b>	Bits 11, 12, or 14 may be set in the Status Questionable Calibration register.
<b>Initial S/W Revision</b>	Prior to A.02.00

<b>Mode</b>	All
<b>Remote Command</b>	*CAL?
<b>Example</b>	*CAL?
<b>Notes</b>	*CAL? returns 0 if successful

	<p>*CAL? returns 1 if failed :CALibration[:ALL]? is the same as *CAL? See additional remarks described with :CALibration[:ALL]? Everything about :CALibration[:ALL]? is synonymous with *CAL? including all conditions, status register bits, and couplings</p>
Initial S/W Revision	Prior to A.02.00

### All but RF

(In MXE the key label is “All but RF (not including RF Presel)”)

Immediately executes an alignment of all subsystems except the RF subsystem . The instrument will stop any measurement currently underway, perform the alignment, and then restart the measurement from the beginning (similar to pressing the Restart key). This can be used to align portions of the instrument that are not impacted by an interfering user input signal.

This operation might be chosen instead of All if you do not want the device under test to experience a large change in input impedance, such as a temporary open circuit at the analyzer input.

The query form of the remote commands (:CALibration:NRF?) will invoke the alignment and return a success or failure value.

Successful completion of Align Now, All but RF will clear the “Align Now, All required” Error Condition, and clear bit 14 in the Status Questionable Calibration register. If “Align Now, All required” was in effect prior to executing the All but RF, the Error Condition message “Align Now, RF required” is generated and bit 12 in the Status Questionable Calibration register is set. It will also begin the elapsed time counter for Last Align Now, All Time, and capture the Last Align Now, All Temperature.

Align Now, All but RF can be interrupted by pressing the Cancel (ESC) front-panel key or remotely with Device Clear followed by the :ABORt SCPI command. When this occurs the Error Condition message “Align Now, All required” is generated, and bit 14 is set in the Status Questionable Condition register. This is because new alignment data may be used for an individual subsystem, but not a full new set of data for all subsystems.

In models with the RF Preselector, such as the N9038A, the “All but RF” alignment will execute an alignment of all subsystems except the RF subsystem of the Spectrum Analyzer, as well as the system gain of the RF Preselector.

Key Path	System, Alignments, Align Now
Mode	All
Remote Command	:CALibration:NRF :CALibration:NRF?
Example	:CAL:NRF
Notes	:CALibration:NRF? returns 0 if successful :CALibration:NRF? returns 1 if failed While Align Now, All but RF is performing the alignment, bit 0 in the Status Operation register is set. Completion, or termination, will clear bit 0 in the Status Operation register.

	This command is sequential; it must complete before further SCPI commands are processed. Interrupting the alignment from remote is accomplished by invoking Device Clear followed by the :ABORt command. Successful completion will clear bit 14 in the Status Questionable Calibration register and set bit 12 if invoked with “Align Now, All required”.
Couplings	Initializes the time for the Last Align Now, All Time. Records the temperature for the Last Align Now, All Temperature.
Status Bits/OPC dependencies	Bits 12 or 14 may be set in the Status Questionable Calibration register.
Initial S/W Revision	Prior to A.02.00

## RF

(In MXE the key label is “RF Only”)

Immediately executes an alignment of the RF subsystem . The instrument stops any measurement currently underway, performs the alignment, then restarts the measurement from the beginning (similar to pressing the Restart key).

This operation might be desirable if the alignments had been set to not include RF alignments, or if previous RF alignments could not complete because of interference which has since been removed.

If an interfering user signal is present at the RF Input, the alignment will terminate and generate the Error Condition message “Align skipped: 50 MHz interference” or “Align skipped: 4.8 GHz interference”, and Error Condition “Align Now, RF required”. In addition, bits 11 and 12 will be set in the Status Questionable Calibration register.

The query form of the remote commands (:CALibration:RF?) will invoke the alignment of the RF subsystem and return a success or failure value. An interfering user signal is grounds for failure.

Successful completion of Align Now, RF will begin the elapsed time counter for Last Align Now, RF Time, and capture the Last Align Now, RF Temperature.

Align Now, RF can be interrupted by pressing the Cancel (ESC) front-panel key or remotely with Device Clear followed by the :ABORt SCPI command. When this occurs, the Error Condition message “Align Now, RF required” is generated, and bit 12 is set in the Status Questionable Condition register. None of the new alignment data is used.

In models with the RF Preselector, such as the N9038A, the RF alignment will execute an alignment of the RF subsystem of the Spectrum Analyzer, as well as the RF subsystem on RF Preselector path.

Key Path	System, Alignments, Align Now
Mode	All
Remote Command	:CALibration:RF :CALibration:RF?
Example	:CAL:RF
Notes	:CALibration:RF? returns 0 if successful

---

:CALibration:RF?	<p>returns 1 if failed (including interfering user signal)</p> <p>While Align Now, RF is performing the alignment, bit 0 in the Status Operation register is set. Completion, or termination, will clear bit 0 in the Status Operation register.</p> <p>This command is sequential; it must complete before further SCPI commands are processed. Interrupting the alignment from remote is accomplished by invoking Device Clear followed by the :ABORt command.</p> <p>Successful completion clears the Error Conditions “Align skipped: 50 MHz interference” and “Align skipped: 4800 MHz interference” and the Error Conditions “Align RF failed” and “Align Now, RF required”, and clears bits 3, 11, and 12 in the Status Questionable Calibration register.</p> <p>A failure encountered during alignment will generate the Error Condition message “Align RF failed” and set bit 3 in the Status Questionable Calibration register.</p> <p>An interfering user signal will result in bits 11 and 12 to be set in the Status Questionable Calibration register to indicate Align Now, RF is required.</p> <p>An interfering user supplied signal will result in the instrument requiring an Align Now, RF with the interfering signal removed.</p>
Couplings	<p>Initializes the time for the Last Align Now, RF Time.</p> <p>Records the temperature for the Last Align Now, RF Temperature.</p>
Status Bits/OPC dependencies	<p>Bits 11, 12, or 14 may be set in the Status Questionable Calibration register.</p>
Initial S/W Revision	<p>Prior to A.02.00</p>

---

### External Mixer

Immediately executes an alignment of the External Mixer that is plugged into the USB port. The instrument stops any measurement currently underway, performs the alignment, then restarts the measurement from the beginning (similar to pressing the Restart key). As this alignment calibrates the LO power to the mixer, this is considered an LO alignment; and failure is classified as an LO alignment failure.

The query form of the remote commands (:CALibration:EMIXer?) will invoke the alignment of the External Mixer and return a success or failure value.

---

<b>Key Path</b>	<p>System, Alignments, Align Now</p>
<b>Mode</b>	<p>All</p>
<b>Remote Command</b>	<p>:CALibration:EMIXer</p> <p>:CALibration:EMIXer?</p>
<b>Example</b>	<p>:CAL:EMIX</p>
<b>Notes</b>	<p>:CAL:EMIX? returns 0 if successful</p> <p>:CAL:EMIX? returns 1 if failed</p> <p>While Align Now, Ext Mix is performing the alignment, bit 0 in the Status Operation register is set. Completion, or termination, will clear bit 0 in the Status Operation register.</p> <p>This command is sequential; it must complete before further SCPI commands are processed. Interrupting the alignment from remote is accomplished by invoking Device Clear followed by the :ABORt command.</p>

---



	A failure encountered during alignment will generate the Error Condition message “Align LO failed” and set bit 5 in the Status Questionable Calibration register. Successful completion will clear the “Align LO failed” message and bit 5 in the Status Questionable Calibration register.
Dependencies	This key does not appear unless option EXM is present and is grayed-out unless a USB mixer is plugged in to the USB.
Status Bits/OPC dependencies	Bit3 may be set in the Status Questionable Calibration Extended Failure register.
Initial S/W Revision	A.08.00

### Show Alignment Statistics

Shows alignment information you can use to ensure that the instrument is operating in a specific manner. The Show Alignment Statistics screen is where you can view time and temperature information.

Values which are displayed are only updated when the Show Alignment Statistics screen is invoked, they are not updated while the Show Alignment Statistics screen is being displayed. The remote commands that access this information obtain current values.

An example of the Show Alignment Statistics screen would be similar to:

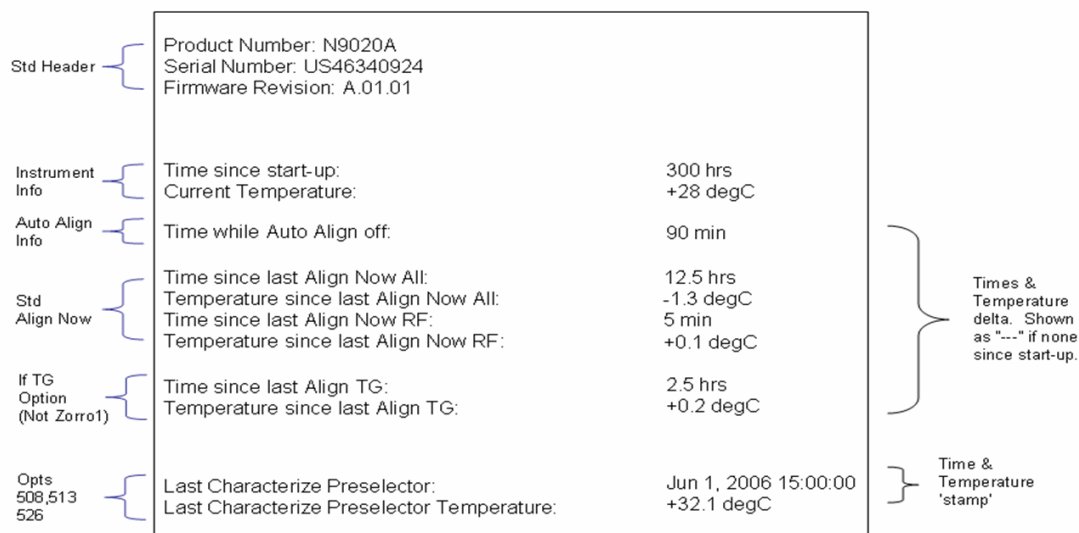

A successful Align Now, RF will set the Last Align RF temperature to the current temperature, and reset the Last Align RF time. A successful Align Now, All or Align Now, All but RF will set the Last Align Now All temperature to the current temperature, and reset the Last Align Now All time. A successful Align Now, All will also reset the Last Align RF items if the RF portion of the Align Now succeeded.

Key Path	System, Alignments
Mode	All

Notes	The values displayed on the screen are only updated upon entry to the screen and not updated while the screen is being displayed.
-------	---

Initial S/W Revision	Prior to A.02.00
----------------------	------------------

Key Path	Visual annotation in the Show Alignment Statistics screen
----------	---

Mode	All
------	-----

<b>Remote Command</b>	:SYSTem:PON:TIME?
-----------------------	-------------------

<b>Example</b>	:SYST:PON:TIME?
----------------	-----------------

Notes	Value is the time since the most recent start-up in seconds.
-------	--

State Saved	No
-------------	----

Initial S/W Revision	Prior to A.02.00
----------------------	------------------

Key Path	Visual annotation in the Show Alignment Statistics screen
----------	---

Mode	All
------	-----

<b>Remote Command</b>	:CALibration:TEMPerature:CURRent?
-----------------------	-----------------------------------

<b>Example</b>	:CAL:TEMP:CURR?
----------------	-----------------

Notes	Value is in degrees Centigrade. Value is invalid if using default alignment data (Align Now, All required)
-------	---

State Saved	No
-------------	----

Initial S/W Revision	Prior to A.02.00
----------------------	------------------

Key Path	Visual annotation in the Show Alignment Statistics screen
----------	---

Mode	All
------	-----

<b>Remote Command</b>	:CALibration:TIME:LALL?
-----------------------	-------------------------

<b>Example</b>	:CAL:TIME:LALL?
----------------	-----------------

Notes	Value is the elapsed time, in seconds, since the last successful Align Now, All or Align Now, All but RF was executed.
-------	--

State Saved	No
-------------	----

Initial S/W Revision	Prior to A.02.00
----------------------	------------------

Key Path	Visual annotation in the Show Alignment Statistics screen
----------	---

Mode	All
------	-----

<b>Remote Command</b>	:CALibration:TEMPerature:LALL?
-----------------------	--------------------------------

<b>Example</b>	:CAL:TEMP:LALL?
----------------	-----------------

Notes	Value is in degrees Centigrade at which the last successful Align Now, All or Align Now, All but RF was executed.
State Saved	No
Initial S/W Revision	Prior to A.02.00

Key Path	Visual annotation in the Show Alignment Statistics screen
Mode	All
<b>Remote Command</b>	:CALibration:TIME:LRF?
<b>Example</b>	:CAL:TIME:LRF?
Notes	Value is the elapsed time, in seconds, since the last successful Align Now, RF was executed, either individually or as a component of Align Now, All.
State Saved	No
Initial S/W Revision	Prior to A.02.00

Key Path	Visual annotation in the Show Alignment Statistics screen
Mode	All
<b>Remote Command</b>	:CALibration:TEMPerature:LRF?
<b>Example</b>	:CAL:TEMP:LRF?
Notes	Value is in degrees Centigrade at which the last successful Align Now, RF was executed, either individually or as a component of Align Now, All.
State Saved	No
Initial S/W Revision	Prior to A.02.00

Key Path	Visual annotation in the Show Alignment Statistics screen
Mode	All
<b>Remote Command</b>	:CALibration:TIME:LPreselector?
<b>Example</b>	:CAL:TIME:LPR?
Notes	Value is the date and time the last successful Characterize Preselector was executed. The date is separated from the time by a space character. Returns "" if no Characterize Preselector has ever been performed on the instrument.
Dependencies	In models that do not include preselectors, this command is not enabled and any attempt to set or query will yield an error.
State Saved	No
Initial S/W Revision	Prior to A.02.00

Key Path	Visual annotation in the Show Alignment Statistics screen
Mode	All
<b>Remote Command</b>	:CALibration:TEMPerature:LPreselector?
<b>Example</b>	:CAL:TEMP:LPR?
Notes	Value is in degrees Centigrade at which the last successful Characterize Preselector was executed.
Dependencies	In models that do not include preselectors, this command is not enabled and any attempt to set or query will yield an error.
State Saved	No
Initial S/W Revision	Prior to A.02.00

Key Path	Visual annotation in the Show Alignment Statistics screen
Mode	All
<b>Remote Command</b>	:CALibration:AUTO:TIME:OFF?
<b>Example</b>	:CAL:AUTO:TIME:OFF?
Notes	Value is the elapsed time, in seconds, since Auto Align has been set to Off or Off with Alert. The value is 0 if Auto Align is ALL or NORF.
State Saved	No
Initial S/W Revision	Prior to A.02.00

Key Path	Visual annotation in the Show Alignment Statistics screen
Mode	All
<b>Remote Command</b>	:CALibration:TIME:RFPSector:LCONducted?
<b>Example</b>	:CAL:TIME:RFPS:LCON?
Notes	Values are the date and time the last successful Align Now, 20 Hz – 30 MHz was executed. The date is separated from the time by a semi-colon character.
State Saved	No

Key Path	Visual annotation in the Show Alignment Statistics screen
Mode	All
<b>Remote Command</b>	:CALibration:TEMPerature:RFPSector:LCONducted?
<b>Example</b>	:CAL:TEMP:RFPS:LCON?
Notes	Value is in degrees Centigrade at which the last successful Align Now, 20 Hz – 30 MHz was executed.
State Saved	No

Key Path	Visual annotation in the Show Alignment Statistics screen
Mode	All
<b>Remote Command</b>	:CALibration:TIME:RFPSector:LRADiated?
<b>Example</b>	:CAL:TIME:RFPS:LRAD?
Notes	Value is the date and time the last successful Align Now, 30 MHz – 3.6 GHz was executed. The date is separated from the time by a semi-colon character.
State Saved	No

Key Path	Visual annotation in the Show Alignment Statistics screen
Mode	All
<b>Remote Command</b>	:CALibration:TEMPerature:RFPSector:LRADiated?
<b>Example</b>	:CAL:TEMP:RFPS:LRAD?
Notes	Value is in degrees Centigrade at which the last successful Align Now, 30 MHz – 3.6 GHz was executed.
State Saved	No

Key Path	Visual annotation in the Show Alignment Statistics screen
Mode	All
<b>Remote Command</b>	:CALibration:RFPSector:SCHeduler:TIME:NEXT? This query returns data using the following format “YYYY/MM/DD; HH:MM:SS”
<b>Example</b>	:CAL:RFPS:SCH:TIME:NEXT?
Notes	The next run time will be updated based on the start date/time and recurrence set by the users. “date” is representation of the date the task will run in the form of “YYYY/MM/DD” where: –YYYY is the four digit representation of year. (for example, 2009) –MM is the two digit representation of month. (for example, 01 to 12) –DD is the two digit representation of the day. (for example, 01 to 28, 29, 30 or 31 depending on the month and year) “time” is a representation of the time of day the task will run in the form of “HH:MM:SS” where: –HH is the two digit representation of the hour in 24 hour format –MM is the two digit representation of minute –SS is the two digit representation of seconds For model N9038A only.
State Saved	No

## Restore Align Defaults

Initializes the alignment user interface settings, not alignment data, to the factory default values. Align Now, All must be executed if the value of the Timebase DAC results in a change.

For front panel operation, you are prompted to confirm action before setting the alignment parameters to factory defaults:

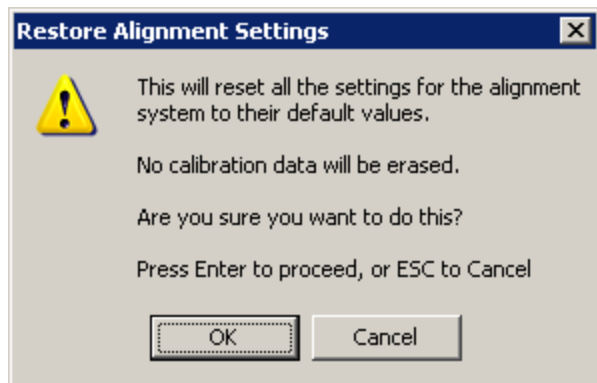

The parameters affected are:

Parameter	Setting
Timebase DAC	Calibrated
Timebase DAC setting	Calibrated value
Auto Align State	Normal (if the instrument is not operating with default alignment data, Off otherwise)
Auto Align All but RF	Off
Auto Align Alert	Time & Temperature

Key Path	System, Alignments
Mode	All
<b>Example</b>	:SYST:DEF ALIG
Notes	Alignment processing that results as the transition to Auto Alignment Normal will be executed sequentially; thus *OPC? or *WAI will wait until the alignment processing is complete.
Initial S/W Revision	Prior to A.02.00

## Backup or Restore Align Data...

Opens the utility for backing-up or restoring the alignment data.

Alignment data for the instrument resides on the hard drive in a database. Agilent uses high quality hard drives; however it is highly recommended the alignment data be backed-up to storage outside of the instrument. Additionally, for customers who use multiple CPU Assemblies or multiple disk drives, the

alignment that pertains to the instrument must be transferred to the resident hard drive after a CPU or hard drive is replaced. This utility facilitates backing-up and restoring the alignment data.

**NOTE**

This utility allows the operator to navigate to any location of the Windows file system. It is intended that the operator use a USB memory device or Mapped Network Drive to back up the alignment data to storage outside of the instrument.

Key Path	System, Alignments
Initial S/W Revision	A.02.00

Key Path	System, Alignments
Mode	All
<b>Remote Command</b>	:CALibration:DATA:Default
<b>Example</b>	:CAL:DATA:DEF
Couplings	Sets Auto Align to Off. Sets bit 14 in the Status Questionable Calibration register. The Error Condition message "Align Now, All required" is generated.
Initial S/W Revision	Prior to A.02.00

### Alignment Data Wizard

The Backup or Restore Alignment Data wizard guides you through the operation of backing-up or restoring the alignment data.

The following dialogue boxes operates without a mouse or external keyboard when you use the default file names.

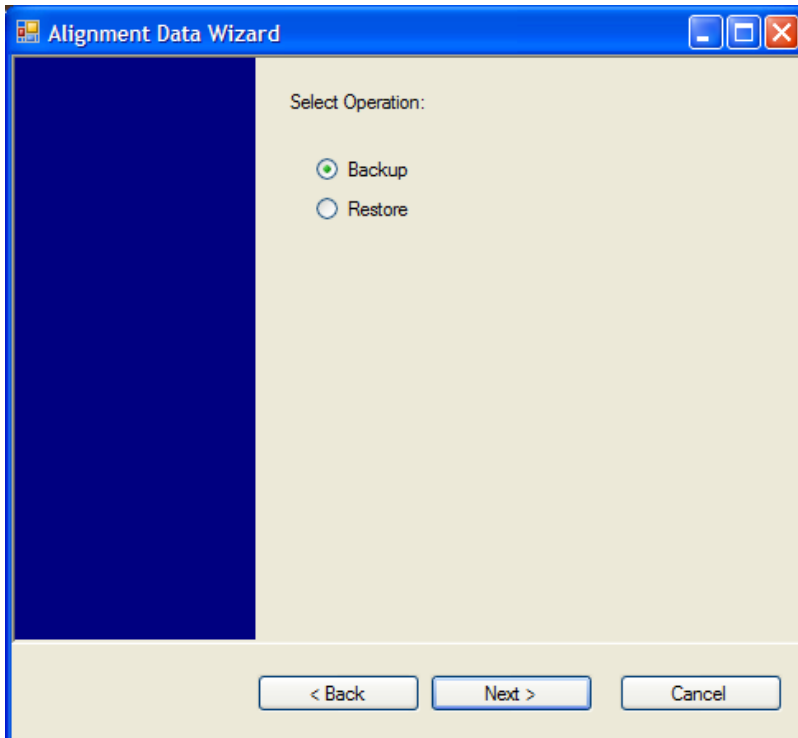
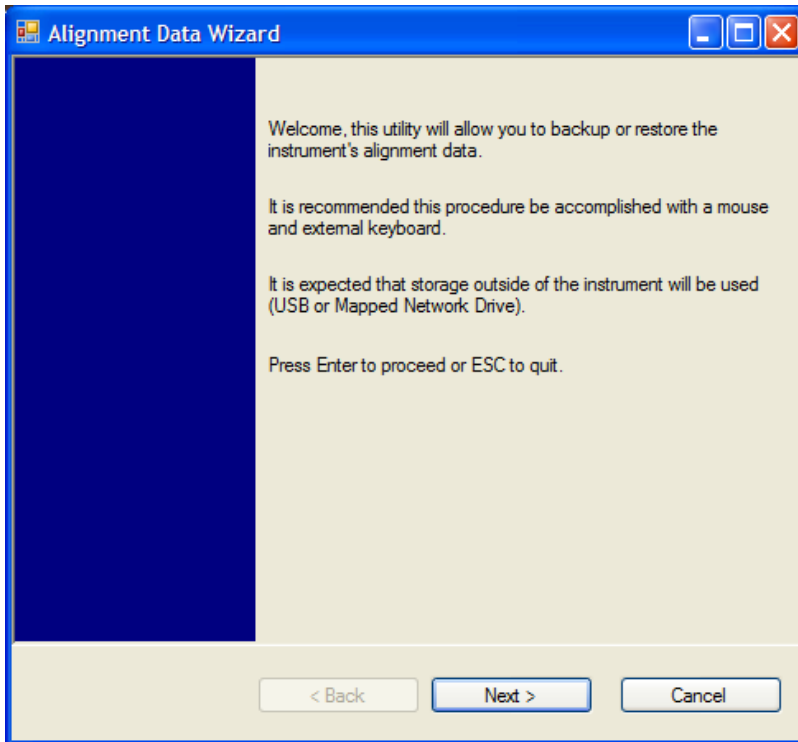

The backup screen indicates the approximate amount of space required to contain the backup file.

The default file name will be AlignDataBackup\_<model number>\_<serial number>\_<date in YYYYMMDDHHMMSS>.bak.



The default backup location will be first drive identified as an external drive (USB or LAN) if such is available; if not, the internal D: partition will be selected.

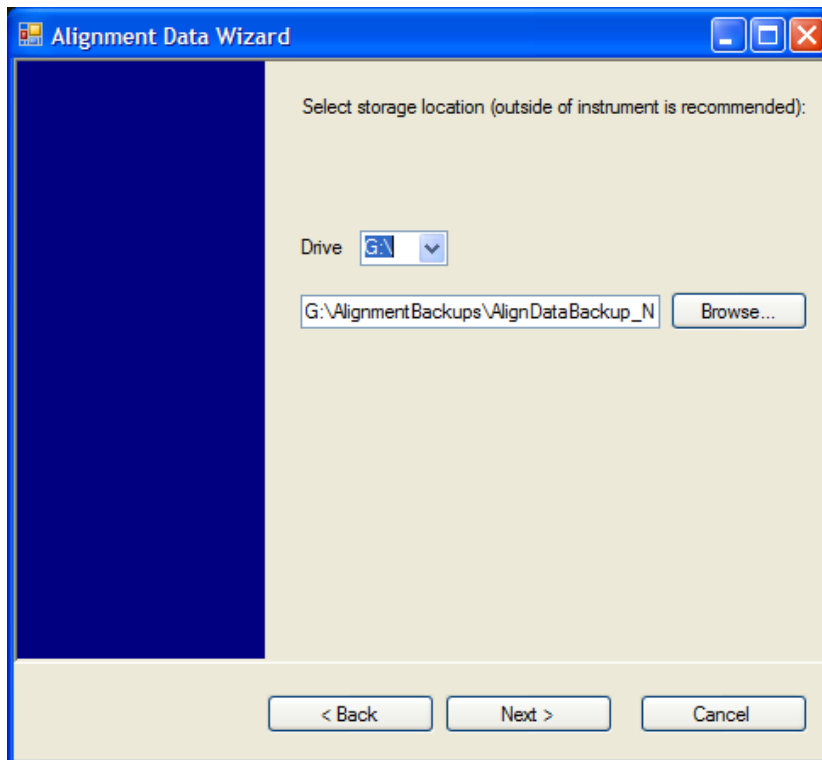

Changing the drive letter will also modify the path displayed in the box below. When this step is first loaded, the drive drop-down menu is populated with connected drives, which provide the user with write access. If there are many unreachable network drives connected to the instrument, this step can take a few seconds. If a USB drive is present, it will be selected by default. The path defaults to the AlignmentBackups folder, and a filename is automatically created in the form of AlignDataBackup\_<model>\_<serial number>\_<date><time>. When the "Next >" button is pressed, you will be prompted to create a new folder if the chosen path does not yet exist.

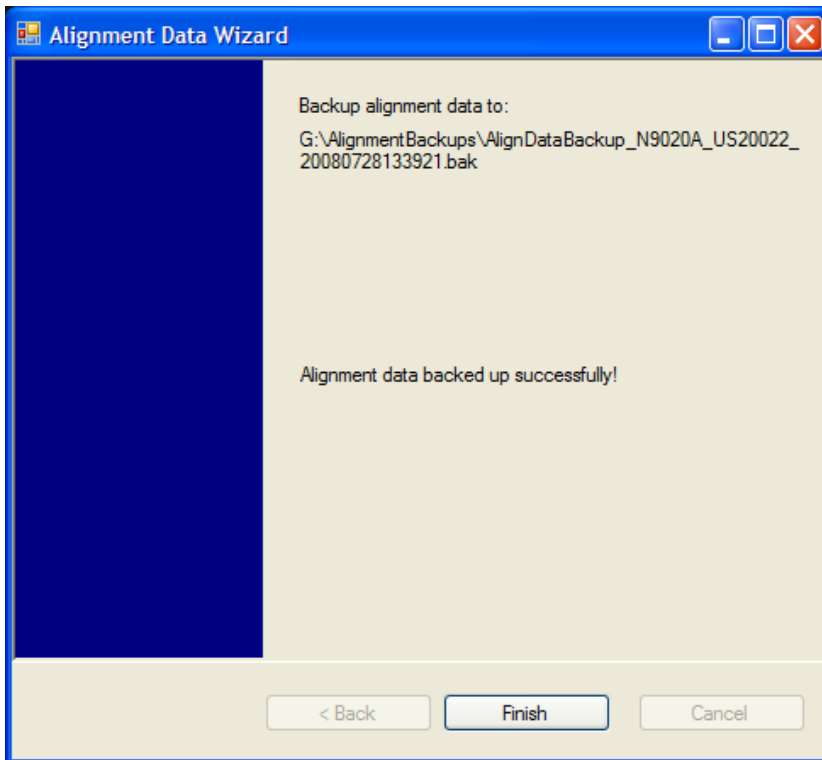
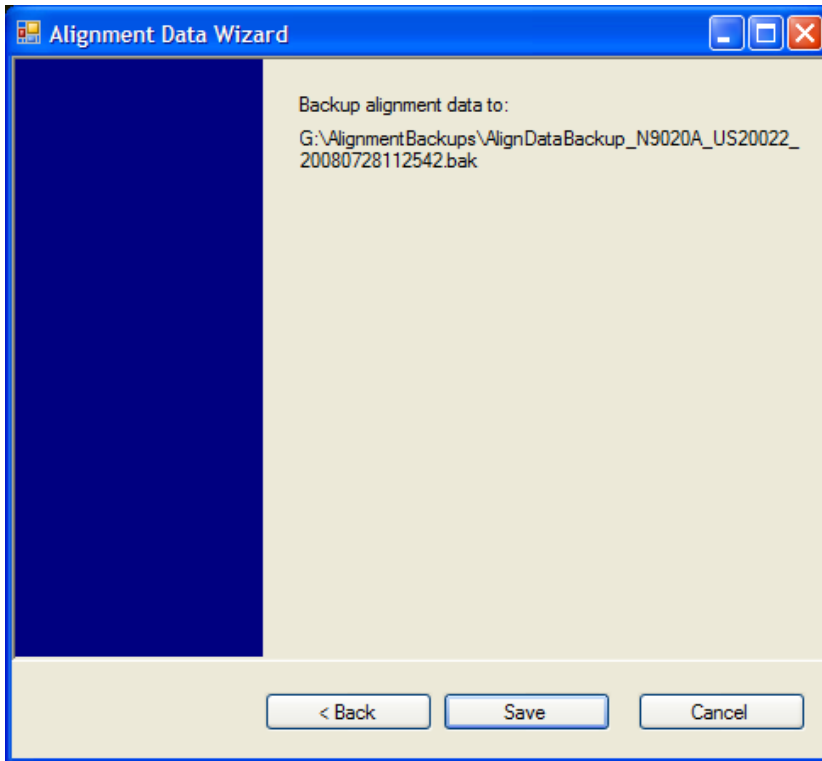

The restore operation checks the validity of the restore file using the database's built-in file validation. If the restore file is corrupt, the existing alignment data will remain in use.

If the serial number information in the backup file being restored is different from that of the instrument, the following message appears (the serial number shown are examples):

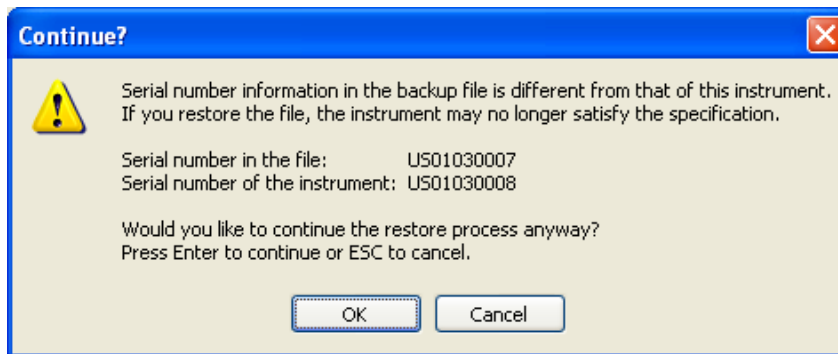

The default restore location will be first drive identified as an external drive (USB or LAN) if such is available; if not, the internal D: partition will be selected. The default restore file will be the most recent file that matches the default backup file name format: AlignDataBackup\_<model number>\_<serial number>\_<date>.bak

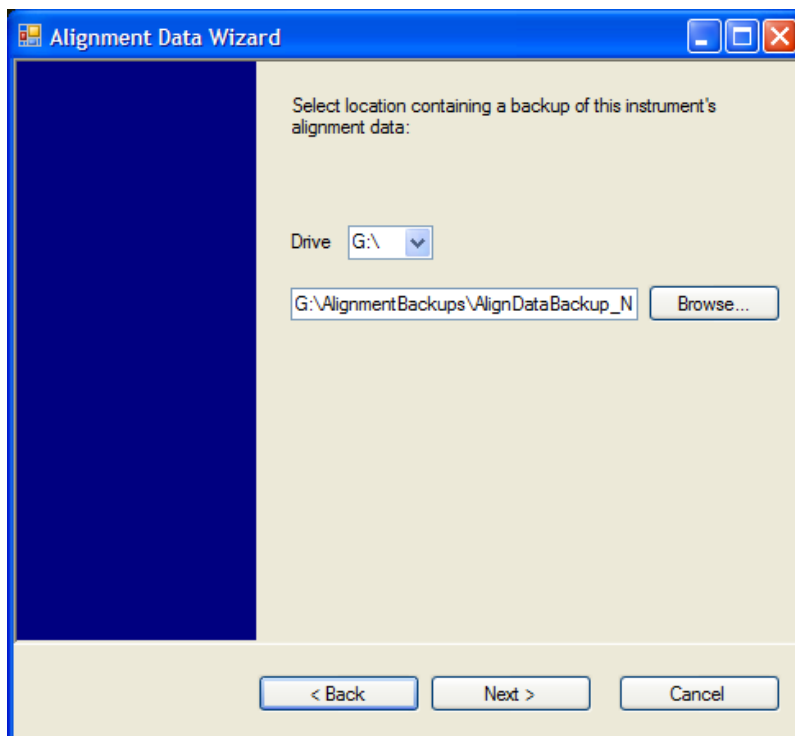

Changing the drive letter also modifies the path displayed in the box below. When this step is first loaded, the drive drop-down menu is populated with connected drives, which provide you with read access. The path defaults to the AlignBackups folder. The most recent \*.bak file in the folder will also be selected by default.

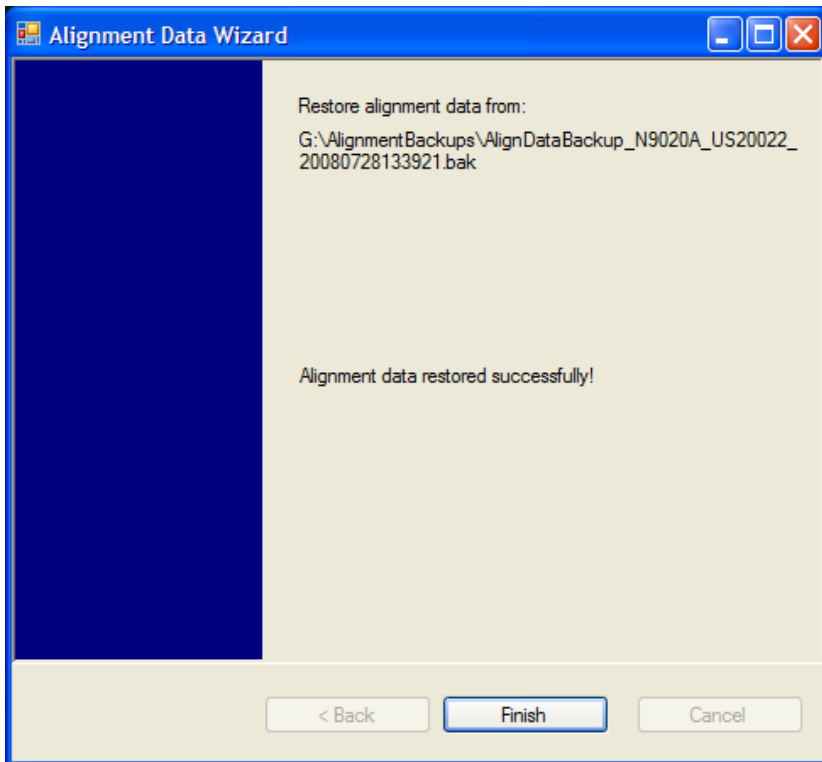
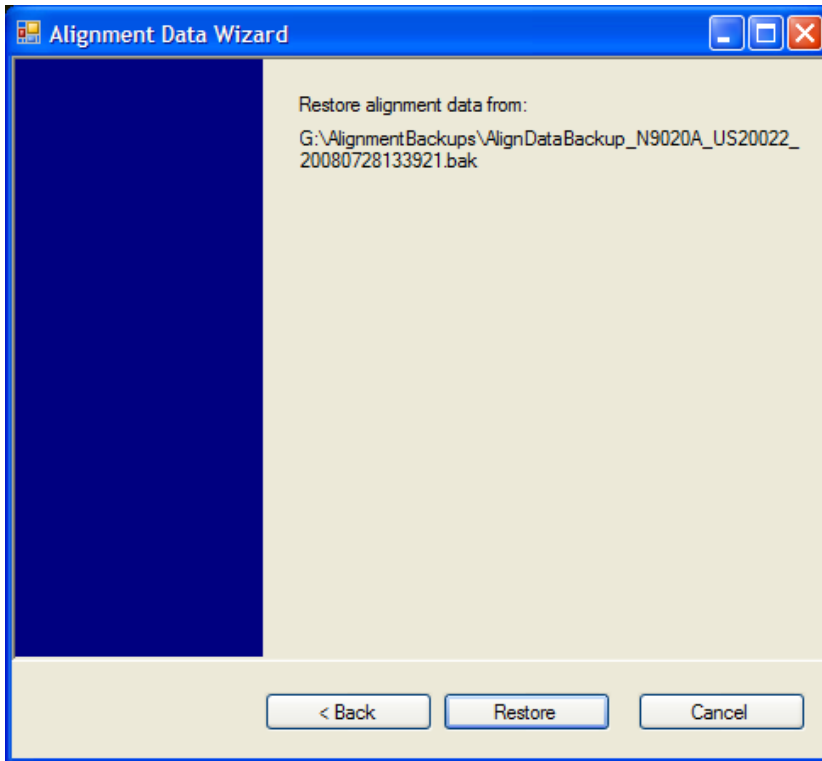

### Perform Backup (Remote Command Only)

Invokes an alignment data backup operation to the provided Folder.

**NOTE**

It is recommended that the Folder provided is outside of the instrument (USB or Mapped Network Drive).

<b>Remote Command</b>	:CALibration:DATA:BACKup <filename>
<b>Example</b>	:CAL:DATA:BACK "F:\AlignDataBackup_N9020A_US00000001_2008140100.bak"
Initial S/W Revision	A.02.00

### Perform Restore (Remote Command Only)

Invokes an alignment data restore operation from the provided filename.

<b>Remote Command</b>	:CALibration:DATA:RESTore <filename>
<b>Example</b>	:CAL:DATA:REST "F:\ AlignDataBackup_N9020A_US00000001_2008140100.bak "
Initial S/W Revision	A.02.00

### Advanced

Accesses alignment processes that are immediate action operations that perform operations that run until complete. Advanced alignments are performed on an irregular basis, or require additional operator interaction

<b>Key Path</b>	System, Alignments
Initial S/W Revision	Prior to A.02.00

### Characterize Preselector

The Preselector tuning curve drifts over temperature and time. Recognize that the Amplitude, Presel Center function adjusts the preselector for accurate amplitude measurements at an individual frequency. Characterize Preselector improves the amplitude accuracy by ensuring the Preselector is approximately centered at all frequencies without the use of the Amplitude, Presel Center function. Characterize Preselector can be useful in situations where absolute amplitude accuracy is not of utmost importance, and the throughput savings or convenience of not performing a Presel Center is desired. Presel Center is required prior to any measurement for best (and warranted) amplitude accuracy.

Agilent recommends that the Characterize Preselector operation be performed yearly as part of any calibration, but performing this operation every three months can be worthwhile.

Characterize Preselector immediately executes a characterization of the Preselector, which is a YIG-tuned filter (YTF). The instrument stops any measurement currently underway, performs the characterization, then restarts the measurement from the beginning (similar to pressing the Restart key).

The query form of the remote commands (:CALibration:YTF?) will invoke the alignment of the YTF subsystem and return a success or failure value.

A failure encountered during alignment will generate the Error Condition message "Characterize Preselector failure" and set bit 3 in the STATus:QUEStionable:CALibration:EXTended:FAILure status register. Successful completion of Characterize Preselector will clear this Condition. It will also begin the

elapsed time counter for Last Characterize Preselector Time, and capture the Last Characterize Preselector Temperature.

The last Characterize Preselector Time and Temperature survives across the power cycle as this operation is performed infrequently.

**NOTE**

The Characterize Preselector function can be interrupted by pressing the Cancel (ESC) front-panel key or remotely with Device Clear followed by the :ABORt SCPI command. None of the new characterization data is then used. However, since the old characterization data is purged at the beginning of the characterization, you now have an uncharacterized preselector. You should re-execute this function and allow it to finish before making any further preselected measurements.

Key Path	System, Alignments, Advanced
Mode	All
Remote Command	:CALibration:YTF :CALibration:YTF?
Example	:CAL:YTF
Notes	:CALibration:YTF? returns 0 if successful :CALibration:YTF? returns 1 if failed (including interfering user signal) While Advanced, Characterize Preselector is performing the alignment, bit 0 in the Status Operation register is set. Completion, or termination, will clear bit 0 in the Status Operation register. This command is sequential; it must complete before further SCPI commands are processed. Interrupting the alignment from remote is accomplished by invoking Device Clear followed by the :ABORt command. Successful completion will clear bit 9 in the Status Questionable Calibration register. A failure encountered during alignment will generate the Error Condition message "Characterize Preselector failed" and set bit 9 in the Status Questionable Calibration register. For Options that support frequencies > 3.6 GHz only.
Dependencies	This key does not appear in models that do not contain preselectors. In these models the SCPI command is accepted without error but no action is taken.
Couplings	Initializes the time for the Last Characterize Preselector Time. Records the temperature for the Last Characterize Preselector Temperature.
Initial S/W Revision	Prior to A.02.00

### Characterize Reference Clock

Characterizing the reference clock is calibrating the Reference Input Phase with the External Reference Output. This feature is only available when either option DP2 or B40 is present. It requires connecting the 10 MHz OUT to the EXT REF IN port with a BNC cable before running the characterization.

See ["Front panel guided calibration sequence" on page 384](#)

Key Path	System, Alignments, Advanced
Mode	All

<b>Remote Command</b>	:CALibration:REFErence:CLOCK?
<b>Example</b>	:CAL:REF:CLOC:INIT? //connect cable :CAL:REF:CLOC? //disconnect cable :CAL:REF:CLOC:END?
<b>Notes</b>	:CALibration:REFErence:CLOCK? returns 0 if successful :CALibration:REFErence:CLOCK? returns 1 if failed
<b>Dependencies</b>	Option DP2 or B40
<b>Couplings</b>	Initializes the time for the Last Characterize Reference Clock Time. Records the temperature for the Last Characterize Reference Clock Temperature. Expected to be run after :CAL:REF:CLOC:INIT, and before :CAL:REF:CLOC:END.
<b>Initial S/W Revision</b>	A.13.00

<b>Parameter Name</b>	Characterize Reference Clock Initialization
<b>Mode</b>	All
<b>Remote Command</b>	:CALibration:REFErence:CLOCK:INITialize?
<b>Example</b>	:CAL:REF:CLOC:INIT?
<b>Notes</b>	:CALibration:REFErence:CLOCK:INIT? returns 0 if successful :CALibration:REFErence:CLOCK:INIT? returns 1 if failed
<b>Dependencies</b>	Option DP2 or B40
<b>Couplings</b>	Expected to be run before sending the :CAL:REF:CLOC? command. This will stop the current measurement when it has completed (does not abort the current data acquisition), and it will prepare the instrument for the expected cabling.
<b>Force Restart</b>	Yes
<b>Initial S/W Revision</b>	A.12.00

<b>Parameter Name</b>	Characterize Reference Clock End
<b>Mode</b>	All
<b>Remote Command</b>	:CALibration:REFErence:CLOCK:END?
<b>Example</b>	:CAL:REF:CLOC:END?
<b>Notes</b>	:CALibration:REFErence:CLOCK:END? returns 0 if successful :CALibration:REFErence:CLOCK:END? returns 1 if failed
<b>Dependencies</b>	Option DP2 or B40
<b>Couplings</b>	Expected to be run after sending the :CAL:REF:CLOC? command, and after removing the cable used in that Characterize Reference Clock step. This will resume any queued measurements, and it concludes the reference clock characterization.
<b>Force Restart</b>	Yes
<b>Initial S/W Revision</b>	A.12.00

Parameter Name	Last Characterize Reference Clock
Key Path	Visual annotation in the Show Alignment Statistics screen
Parameter Type	String
Mode	All
Remote Command	:CALibration:TIME:REFeRence:CLOCK?
Example	:CAL:TIME:REFeRence:CLOCK?
Notes	Value is the date and time the last successful Characterize Reference Clock was executed. The date is separated from the time by a space character. Returns "" if Characterize Reference Clock has never been performed on the instrument.
Dependencies	Option DP2 or B40
State Saved	No
Initial S/W Revision	A.12.00

### Front panel guided calibration sequence

When selecting "Characterize Reference Clock" through the front panel, the following form will be shown.

Step 1 of the guided calibration sequence:

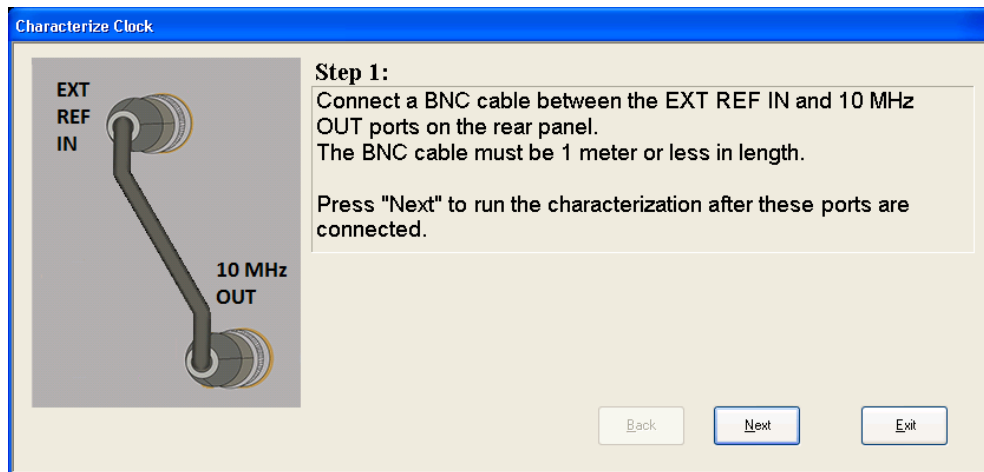

Step 2 of the guided calibration sequence:



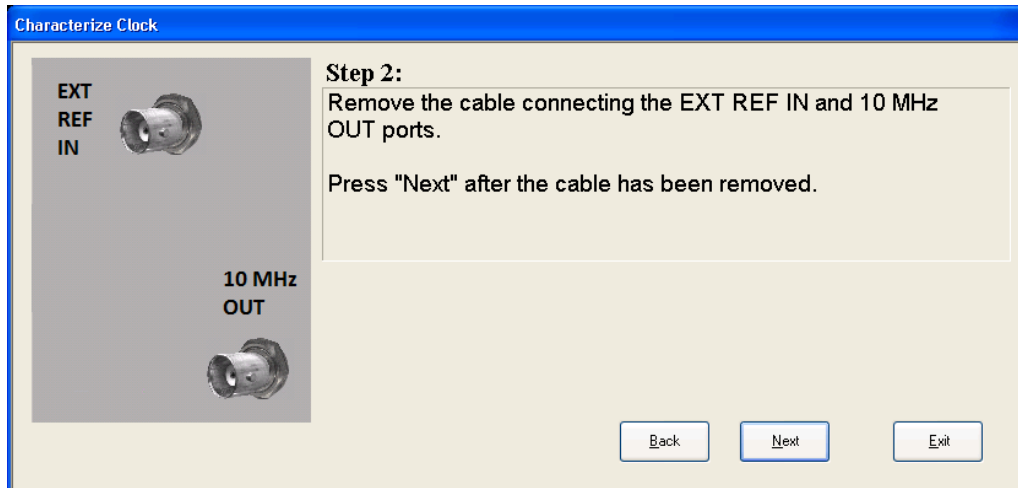

Step 3 of the guided calibration sequence:

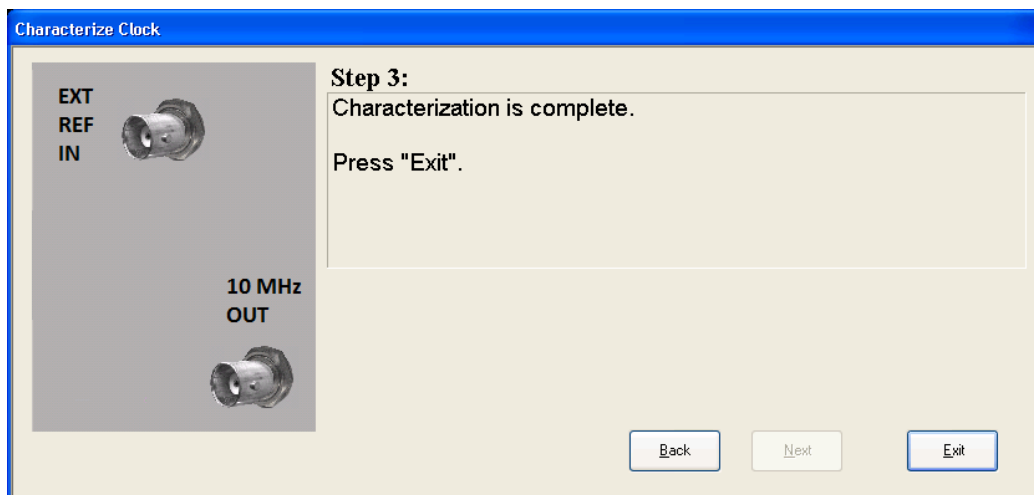

## Timebase DAC

Allows control of the internal 10 MHz reference oscillator timebase. This may be used to adjust for minor frequency alignment between the signal and the internal frequency reference. This adjustment has no effect if the instrument is operating with an External Frequency Reference.

If the value of the Timebase DAC changes (by switching to Calibrated from User with User set to a different value, or in User with a new value entered) an alignment may be necessary. The alignment system will take appropriate action; which will either invoke an alignment or cause an Alert.

Key Path	System, Alignments
Mode	All
Remote Command	:CALibration:FREquency:REFerence:MODE CALibrated USER :CALibration:FREquency:REFerence:MODE?
Example	:CAL:FREQ:REF:MODE CAL
Notes	If the value of the timebase is changed the alignment system automatically performs an alignment or

	alerts that an alignment is due. If the value of the timebase is changed the alignment system automatically performs an alignment or alerts that an alignment is due.
Preset	This is unaffected by Preset but is set to CALibrated on a "Restore System Defaults->Align".
State Saved	No
Initial S/W Revision	Prior to A.02.00

### Calibrated

Sets the Timebase DAC to the value established during factory or field calibration. The value displayed on the menu key is the calibrated value.

Key Path	System, Alignments, Timebase DAC
Mode	All
<b>Example</b>	:CAL:FREQ:REF:MODE CAL
Readback Text	[xxx] < where xxx is the calibrated value
Initial S/W Revision	Prior to A.02.00

### User

Allows setting the Timebase DAC to a value other than the value established during the factory or field calibration. The value displayed on the menu key is the calibrated value.

Key Path	System, Alignments, Timebase DAC
Mode	All
<b>Example</b>	:CAL:FREQ:REF:MODE USER
Readback Text	xxx < where xxx is the Timebase DAC setting
Initial S/W Revision	Prior to A.02.00

Key Path	System, Alignments, Timebase DAC
Mode	All
<b>Remote Command</b>	:CALibration:FREQuency:REFerence:FINE <integer> :CALibration:FREQuency:REFerence:FINE?
<b>Example</b>	:CAL:FREQ:REF:FINE 8191
Notes	If the value of the timebase is changed the alignment system automatically performs an alignment or alerts that an alignment is due.
Couplings	Setting :CAL:FREQ:REF:FINE sets :CAL:FREQ:REF:MODE USER
Preset	This is unaffected by Preset but is set to the factory setting on a "Restore System Defaults->Align".

State Saved	No
Min	0
Max	16383
<b>Backwards Compatibility SCPI</b>	:CALibration:FREQuency:REFeRence:COARse ESA hardware contained two DAC controls for the Timebase. In X-Series the command :CALibration:FREQuency:REFeRence:FINE is the method for adjusting the timebase. The :COARse command is provided as an alias to :FINE.
Initial S/W Revision	Prior to A.02.00

<b>Remote Command</b>	:CALibration:FREQuency:REFeRence:COARse <integer> :CALibration:FREQuency:REFeRence:COARse?
<b>Example</b>	:CAL:FREQ:REF:COAR 8191
Notes	This is an alias for CAL:FREQ:REF:FINE any change to COARse is reflected in FINE and vice-versa. See CAL:FREQ:REF:FINE for description of functionality.
Couplings	Setting :CAL:FREQ:REF:COAR sets :CAL:FREQ:REF:MODE USER
Initial S/W Revision	Prior to A.02.00

## I/O Config

Activates a menu for identifying and changing the I/O configuration for remote control.

Key Path	System
Initial S/W Revision	Prior to A.02.00

## GPIB

Activates a menu for configuring the GPIB I/O port.

Key Path	System, I/O Config
Initial S/W Revision	A.02.00

## GPIB Address

Select the GPIB remote address.

Key Path	System, I/O Config, GPIB
Mode	All
<b>Remote Command</b>	:SYSTem:COMMunicate:GPIB[1][:SELF]:ADDRess <integer> :SYSTem:COMMunicate:GPIB[1][:SELF]:ADDRess?

<b>Example</b>	:SYST:COMM:GPIB:ADDR 17
<b>Notes</b>	Changing the Address on the GPIB port requires all further communication to use the new address.
<b>Preset</b>	This is unaffected by Preset but is set to 18 on a “Restore System Defaults->Misc”
<b>State Saved</b>	No
<b>Range</b>	0 to 30
<b>Min</b>	0
<b>Max</b>	30
<b>Initial S/W Revision</b>	Prior to A.02.00

### GPIB Controller

Sets the GPIB port into controller or device mode. In the normal state, GPIB controller is disabled, which allows the analyzer to be controlled by a remote computer. When GPIB Controller is enabled, the instrument can run software applications that use the instrument's computer as a GPIB controller; controlling devices connected to the instrument's GPIB port.

**NOTE**

When GPIB Controller is enabled, the analyzer application itself cannot be controlled over GPIB. In this case it can easily be controlled via LAN or USB. The GPIB port cannot be a controller and device at the same time. Only one controller can be active on the GPIB bus at any given time. If the analyzer is the controller, an external PC cannot be a controller.

To control the instrument from the software that is performing GPIB controller operation, you can use an internal TCP/IP connection to the analyzer application. Use the address TCPIP0:localhost:inst0:INSTR to send SCPI commands to the analyzer application.

<b>Key Path</b>	System, I/O Config, GPIB
<b>Mode</b>	All
<b>Scope</b>	Mode Global
<b>Remote Command</b>	:SYSTem:COMMunicate:GPIB[1][:SELF]:CONTroller[:ENABle] ON   OFF   0   1 :SYSTem:COMMunicate:GPIB[1][:SELF]:CONTroller[:ENABle]?
<b>Example</b>	:SYST:COMM:GPIB:CONT ON Will set GPIB port to Controller
<b>Notes</b>	When the instrument becomes the Controller bit 0 in the Standard Event Status Register is set (and when the instrument relinquishes Controller capability bit 0 is cleared in the Standard Event Status Register).
<b>Preset</b>	This is unaffected by Preset but is set to OFF on a “Restore System Defaults->Misc”
<b>State Saved</b>	No
<b>Range</b>	Disabled Enabled
<b>Initial S/W Revision</b>	A.02.00

### Disabled

Disables the GPIB Controller capability, this is the default (or normal) setting.

Key Path	System, I/O Config, GPIB, GPIB Controller	
<b>Example</b>	:SYST:COMM:GPIB:CONT OFF	Will set GPIB port to Device
Initial S/W Revision	A.02.00	

### Enabled

Enables the GPIB Controller capability.

Key Path	System, I/O Config, GPIB, GPIB Controller	
<b>Example</b>	:SYST:COMM:GPIB:CONT ON	Will set GPIB port to Controller
Initial S/W Revision	A.02.00	

## SCPI LAN

Activates a menu for identifying and changing the SCPI over a LAN configuration. There are a number of different ways to send SCPI remote commands to the instrument over LAN. It can be a problem to have multiple users simultaneously accessing the instrument over the LAN. These keys limit that somewhat by disabling the telnet, socket, and/or SiCL capability.

Key Path	System, I/O Config
Initial S/W Revision	Prior to A.02.00

## SCPI Telnet

Turns the SCPI LAN telnet capability On or Off allowing you to limit SCPI access over LAN through telnet.

Key Path	System, I/O Config, SCPI LAN
Mode	All
<b>Remote Command</b>	:SYSTem:COMMunicate:LAN:SCPI:TELNet:ENABle OFF ON 0 1 :SYSTem:COMMunicate:LAN:SCPI:TELNet:ENABle?
<b>Example</b>	:SYST:COMM:LAN:SCPI:TELN:ENAB OFF
Preset	This is unaffected by Preset but is set to ON with a "Restore System Defaults->Misc"
State Saved	No
Range	On   Off
Initial S/W Revision	Prior to A.02.00

## SCPI Socket

Turns the capability of establishing Socket LAN sessions On or Off. This allows you to limit SCPI access over LAN through socket sessions.

Key Path	System, I/O Config, SCPI LAN
Mode	All
<b>Remote Command</b>	:SYSTem:COMMunicate:LAN:SCPI:SOCKet:ENABle OFF ON 0 1 :SYSTem:COMMunicate:LAN:SCPI:SOCKet:ENABle?
<b>Example</b>	:SYST:COMM:LAN:SCPI:SOCK:ENAB OFF
Preset	This is unaffected by a Preset but is set to ON with a “Restore System Defaults->Misc”
State Saved	No
Range	On   Off
Initial S/W Revision	Prior to A.02.00

### SICL Server

Turns the SICL server capability On or Off, enabling you to limit SCPI access over LAN through the SICL server. (SICL IEEE 488.2 protocol.)

Parameter	Description	Setting
Maximum Connections	The maximum number of connections that can be accessed simultaneously	5
Instrument Name	The name (same as the remote SICL address) of your analyzer	inst0
Instrument Logical Unit	The unique integer assigned to your analyzer when using SICL LAN	8
Emulated GPIB Name	The name (same as the remote SICL address) of the device used when communicating with your analyzer	gpib7
Emulated GPIB Logical Unit	The unique integer assigned to your device when it is being controlled using SICL LAN	8
Emulated GPIB Address	The emulated GPIB address assigned to your transmitter tester when it is a SICL server (the same as your GPIB address)	18

Key Path	System, I/O Config, SCPI LAN
Mode	All
<b>Remote Command</b>	:SYSTem:COMMunicate:LAN:SCPI:SICL:ENABle OFF ON 0 1 :SYSTem:COMMunicate:LAN:SCPI:SICL:ENABle?
<b>Example</b>	:SYST:COMM:LAN:SCPI:SICL:ENAB OFF
Preset	This is unaffected by Preset, but is set to ON with a “Restore System Defaults->Misc”
State Saved	No
Range	On   Off
Initial S/W Revision	Prior to A.02.00

## HiSLIP Server

Turns the HiSLIP server capability On or Off, enabling you to limit SCPI access over LAN through the HiSLIP server.

HiSLIP stands for High Speed LAN Instrument Protocol and is part of the IVI–6.1 specification.

Here is an example of a VISA connection string used to connect to the HiSLIP Server on an X-Series Spectrum Analyzer:

```
TCPIP0::a-n9030a-93016::hislip0::INSTR
```

In the example above, hislip0 is the HiSLIP device name that VISA users must include in their HiSLIP VISA Address strings. Your HiSLIP device name may be different depending on your VISA settings.

Key Path	System, I/O Config, SCPI LAN
Mode	All
Remote Command	:SYSTem:COMMunicate:LAN:SCPI:HISLip:ENABle OFF ON 0 1 :SYSTem:COMMunicate:LAN:SCPI:HISLip:ENABle?
Example	:SYST:COMM:LAN:SCPI:HISL:ENAB OFF
Preset	This is unaffected by Preset, but is set to ON with a “Restore System Defaults-> Misc”
State Saved	No
Range	On   Off
Initial S/W Revision	A.11.00

## SCPI Socket Control Port (Remote Command Only)

Returns the TCP/IP port number of the control socket associated with the SCPI socket session. This query enables you to obtain the unique port number to open when a device clear is to be sent to the instrument. Every time a connection is made to the SCPI socket, the instrument creates a peer control socket. The port number for this socket is random. The user must use this command to obtain the port number of the control socket. To force a device clear on this socket, open the port and send the string “DCL ” to the instrument.

If this SCPI command is sent to a non SCPI Socket interface, then 0 is returned.

Mode	All
Remote Command	:SYSTem:COMMunicate:LAN:SCPI:SOCKet:CONTRol?
Example	:SYST:COMM:LAN:SCPI:SOCK:CONT?
Preset	This is unaffected by Preset or “Restore System Defaults-> Misc”.
State Saved	No
Range	0 to 65534
Min	0
Max	65534
Initial S/W Revision	Prior to A.02.00

## Reset Web Password

The embedded web server contains certain capability which are password protected; modifying the LAN configuration of the instrument, and access to web pages that can change the settings of the instrument. The default password from the factory is 'agilent' (without the quotes). The control provided here is the means to set the web password as the user desires, or to reset the password to the factory default.

Selecting Reset web password brings up a control for resetting the password as the user desires, or to the factory default. A keyboard is required to change the password from the factory default of 'agilent' or to set a new password that contains alphabetic characters. The control is:

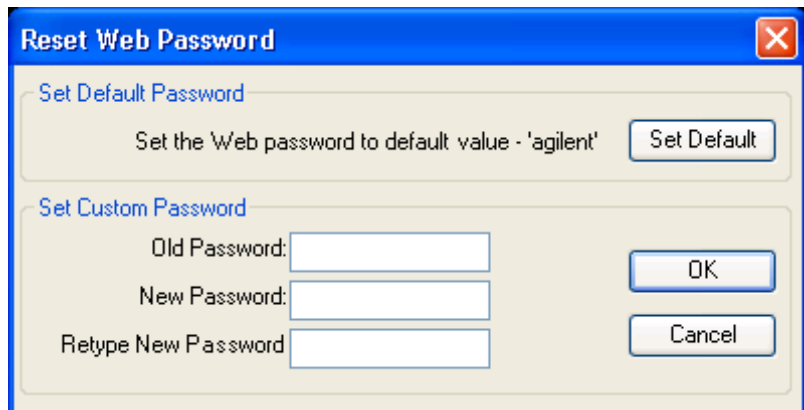

If this control is entered without an external keyboard or mouse connected, you can cancel the control by pressing the Cancel (ESC) front-panel key.

---

Key Path	System, I/O Config
Mode	All
Initial S/W Revision	Prior to A.02.00

---

## LXI

Opens a menu that allows you to access the various LXI configuration properties.

---

Key Path	System, I/O Config
Initial S/W Revision	Prior to A.02.00

---

## LAN Reset

Resets the LAN connection.

---

Key Path	System, I/O Config, LXI
Initial S/W Revision	Prior to A.02.00

---



## Device Identification (Remote Command Only)

Enabling the LXI device identification will place the LXI Status Indicator to the 'Identify' state. Disabling the LXI device identification will place the LXI Status Indicator to the 'No Fault' state. The LXI Status indicator is in the upper left region of the instrument's graphical user interface (.

Mode	All
<b>Remote Command</b>	:LXI:IDENtify[:STATe] OFF ON 0 1 :LXI:IDENtify[:STATe]?
<b>Example</b>	:LXI:IDEN ON
Preset	Not part of Preset, but reset to OFF on Restore System Defaults All
State Saved	No
Range	On   Off
Initial S/W Revision	A.12.50

## System IDN Response

This key allows you to specify a response to the \*IDN? query, or to return the analyzer to the Factory response if you have changed it.

To choose the factory-set response, press the Factory key.

To specify your own response, press the User key, and enter your desired response.

Key Path	System, I/O Config
Mode	All
<b>Remote Command</b>	:SYSTem:IDN <string> :SYSTem:IDN?
Notes	<ul style="list-style-type: none"> <li>• This affects the response given in all Modes of the Analyzer, unless the current Mode has also specified a custom response, in which case the current Mode's custom IDN response takes precedence over the System's, but only while that Mode is the current Mode..</li> <li>• It survives shutdown and restart of the software and therefore survives a power cycle</li> <li>• Null string as parameter restores the Factory setting</li> </ul>
Preset	This is unaffected by Preset but is set to the original factory setting on a "Restore System Defaults->Misc"
State Saved	No
Initial S/W Revision	A.06.00

## Factory

This key selects the factory setting, for example:

"Agilent Technologies,N9020A,MY00012345,A.05.01"

where the fields are manufacturer, model number, serial number, firmware revision.

Key Path	System, I/O Config, IDN Response
<b>Example</b>	:SYST:IDN "" null string, restores the factory setting
Initial S/W Revision	A.06.0

### User

This key allows you to specify your own response to the \*IDN? query. You may enter your desired response with the Alpha Editor or a plugin PC keyboard.

When you press this key, the active function becomes the current User string with the cursor at the end. This makes it easy to edit the existing string.

If you enter a null string (for example, by clearing the User String while editing and then pressing Done) the analyzer automatically reverts to the Factory setting.

Key Path	System, I/O Config, IDN Response
<b>Example</b>	:SYST:IDN "XYZ Corp, Model 12, 012345, A.01.01" user specified response
Initial S/W Revision	A.06.00

### Query USB Connection (Remote Command Only)

Enables you to determine the speed of the USB connection.

Mode	All
<b>Remote Command</b>	:SYSTem:COMMunicate:USB:CONNectioN?
<b>Example</b>	:SYST:COMM:USB:CONN?
Notes	NONE - Indicates no USB connection has been made. LSPeed - Indicates a USB low speed connection (1.5 Mbps).  This is reserved for future use, the T+M488 protocol is not supported on low speed connections. HSPeed - Indicates that a USB high speed connection (480 Mbps) has been negotiated. FSPeed - Indicates that a USB full speed connection (12 Mbps) has been negotiated.
State Saved	No
Range	NONE LSPeed HSPeed FSPeed
Initial S/W Revision	Prior to A.02.00

### USB Connection Status (Remote Command Only)

Enables you to determine the current status of the USB connection.

Mode	All
<b>Remote Command</b>	:SYSTem:COMMunicate:USB:STATus?
<b>Example</b>	:SYST:COMM:USB:STAT?
Notes	<p>SUSPended – Indicates that the USB bus is currently in its suspended state. The bus is in the suspended state when:</p> <ul style="list-style-type: none"> <li>• The bus is not connected to any controller</li> <li>• The controller is currently powered off</li> <li>• The controller has explicitly placed the USB device into the suspended state.</li> </ul> <p>When in the suspended state, no USB activity, including start of frame packets are received.</p> <p>ACTive – Indicates that the USB device is in the active state. When the device is in the active state, it is receiving periodic start of frames but it isn't necessarily receiving or transmitting data.</p>
State Saved	No
Range	SUSPended ACTive
Initial S/W Revision	Prior to A.02.00

### USB Packet Count (Remote Command Only)

Enables you to determine the number of packets received and transmitted on the USB bus.

Mode	All
<b>Remote Command</b>	:SYSTem:COMMunicate:USB:PACKets?
<b>Example</b>	:SYST:COMM:USB:PACK?
Notes	<p>Two integers are returned. The first is the number of packets received since application invocation, the second is the number of packets transmitted since application invocation. If no packets have been received or transmitted the response is 0,0.</p> <p>The packet count is initialized to 0,0 when the instrument application is started.</p>
State Saved	No
Initial S/W Revision	Prior to A.02.00

### Restore Defaults

Provides incremental initialization of the system setting groups along with supporting a comprehensive reset of the entire instrument back to a factory default state. The menu selections are the groups of system settings and when one is selected, that particular group of system settings is reset back to their default values.

Key Path	System
Mode	All
<b>Remote Command</b>	:SYSTem:DEFault [ALL]  ALIGn  INPut  MISC  MODEs  PON
<b>Example</b>	SYST:DEF

---

State Saved	No
Initial S/W Revision	Prior to A.02.00

---

### Restore Input/Output Defaults

Causes the group of settings and data associated with Input/Output front-panel key to be a reset to their default values. This level of Restore System Defaults does not affect any other system settings, mode settings and does not cause a mode switch. .

Confirmation is required to restore the Input/Output setting. The confirmation dialog is:

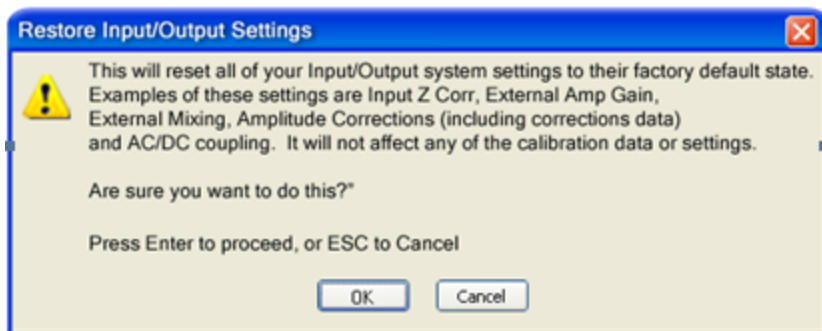

---

Key Path	System, Restore System Defaults
Example	:SYST:DEF INP
Initial S/W Revision	Prior to A.02.00

---

### Restore Power On Defaults

This selection causes the Power On settings to be a reset to their default value. This level of Restore System Defaults does not affect any other system settings, mode settings and does not cause a mode switch. The Power On settings and their default values are Power On Type reset to Mode and Input/Output Defaults and Power On Application reset to whatever the factory set as its default value.

Confirmation is required to restore the factory default values. The confirmation dialog is:

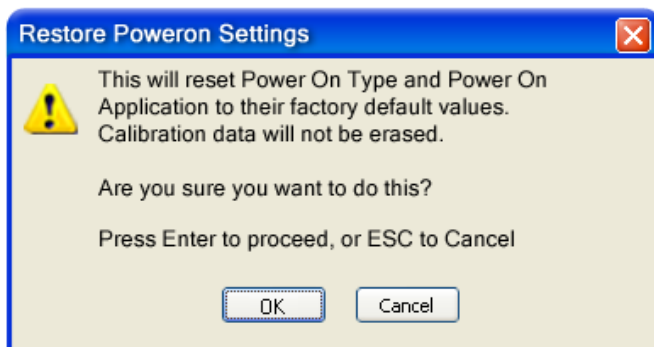

Key Path	System, Restore System Defaults
<b>Example</b>	:SYST:DEF PON
Initial S/W Revision	Prior to A.02.00

## Restore Align Defaults

This selection causes the Alignment system settings to be a reset to their default values. This does not affect any Alignment data stored in the system. This level of Restore System Defaults does not affect any other system settings, mode settings and does not cause a mode switch.

After performing this function, it may impact the auto-alignment time of the instrument until a new alignment baseline has been established.

Confirmation is required to restore the factory default values. The confirmation dialog is:

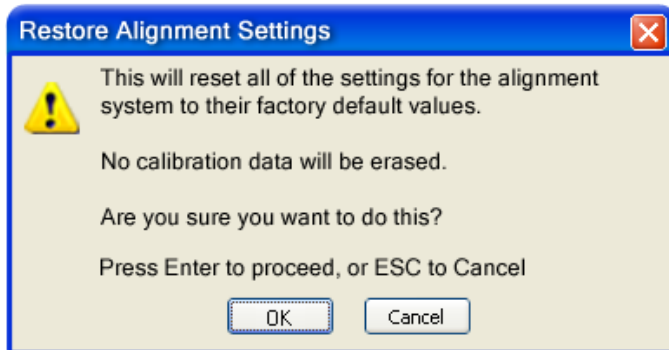

Key Path	System, Restore System Defaults
<b>Example</b>	:SYST:DEF ALIG
Initial S/W Revision	Prior to A.02.00

## Restore Misc Defaults

This selection causes miscellaneous system settings to be reset to their default values. With this reset, you lose the GPIB address and it is reset to 18, so this should be used with caution. This level of Restore System Defaults does not affect any other system settings, mode settings and does not cause a mode switch. This miscellaneous group contains the rest of the settings that have not been part of the other Restore System Defaults groups. The following table is a complete list of settings associated with this group:

Miscellaneous Setting	Default Value
Verbose SCPI	Off
The SYST:PRES:TYPE	MODE
Auto File Name Number	000

Miscellaneous Setting	Default Value
Save Type	State
State Save To	Register 1
Screen Save To	SCREEN000.png
DISP:ENABle	ON
Full Screen	Off
SCPI Telnet	ON
SCPI Socket	ON
SICL Server	ON
Softkey Language	English
System Annotation	ON
Display Theme	TDColor
System IDN Response	Factory result of *IDN?
Display Intensity	100
Display Backlight	ON
GPIB Address	18

Confirmation is required to restore the factory default values. The confirmation dialog is:

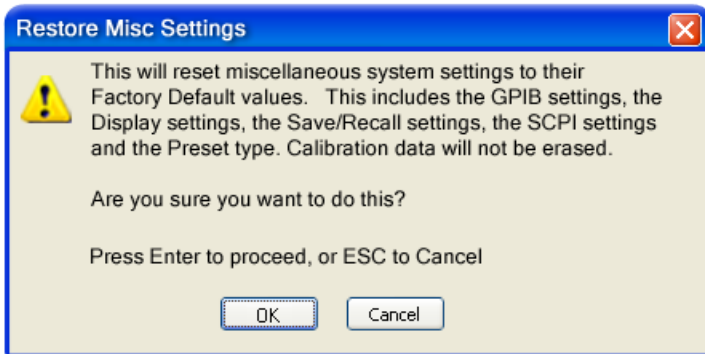

Key Path                      System, Restore System Defaults

**Example**                      :SYST:DEF MISC

Initial S/W Revision        Prior to A.02.00

### Restore Mode Defaults (All Modes)

This selection resets all of the modes in the instrument back to their default state just as a Restore Mode Defaults does and it switches the instrument to the power-on mode and causes the default measurement

for the power-on mode to be active. This level of Restore System Defaults does not affect any system settings, but it does affect the state of all modes and does cause a mode switch unless the instrument was already in the power-on mode.

Confirmation is required to restore the factory default values. The confirmation dialog is:

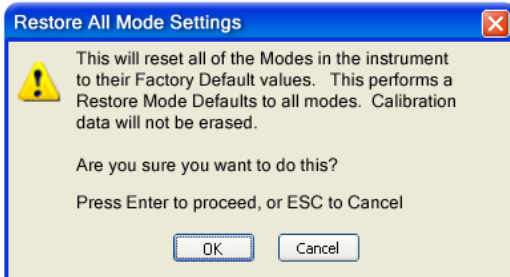

Key Path	System, Restore System Defaults
Example	:SYST:DEF MOD
Couplings	An All Mode will cause the currently running measurement to be aborted, mode switch to the power-on mode and activate the default measurement for the power-on mode.. It gets the mode to a consistent state with all of the default couplings set.
Initial S/W Revision	Prior to A.02.00

## All

This performs a comprehensive reset of ALL analyzer settings to their factory default values. It resets all of the system setting groups, causes a Restore Mode Defaults for all modes in the instrument, and switches back to the power-on mode. It does not affect the User Preset file or any user saved files.

Confirmation is required to restore the factory default values. The confirmation dialog is:

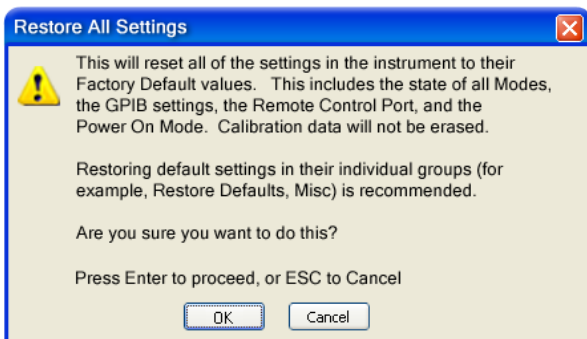

### NOTE

If you are using an Agilent USB External Mixer, then you will need to perform a Refresh USB Mixer Connection after Restoring All Defaults.

Key Path	System, Restore System Defaults
Example	:SYST:DEF ALL
Notes	If using Agilent USB External Mixer, perform a Refresh USB Mixer Connection (SCPI command

---

	:MIX:BAND USB) following a Restore All Defaults.
Couplings	An All will cause the currently running measurement to be aborted and get all modes to a consistent state, so it is unnecessary to couple any settings.
Initial S/W Revision	Prior to A.02.00
Modified at S/W Revision	A.14.00

---

### Control Panel...

Opens the Windows Control Panel. The Control Panel is used to configure certain elements of Windows that are not configured through the hardkey/softkey System menus.

**NOTE** This feature is not available if option SF1 is installed.

The Control Panel is a separate Windows application, so to return to the analyzer once you are in the Control Panel, you may either:

Exit the Control Panel by clicking on the red X in the upper right hand corner, with a mouse

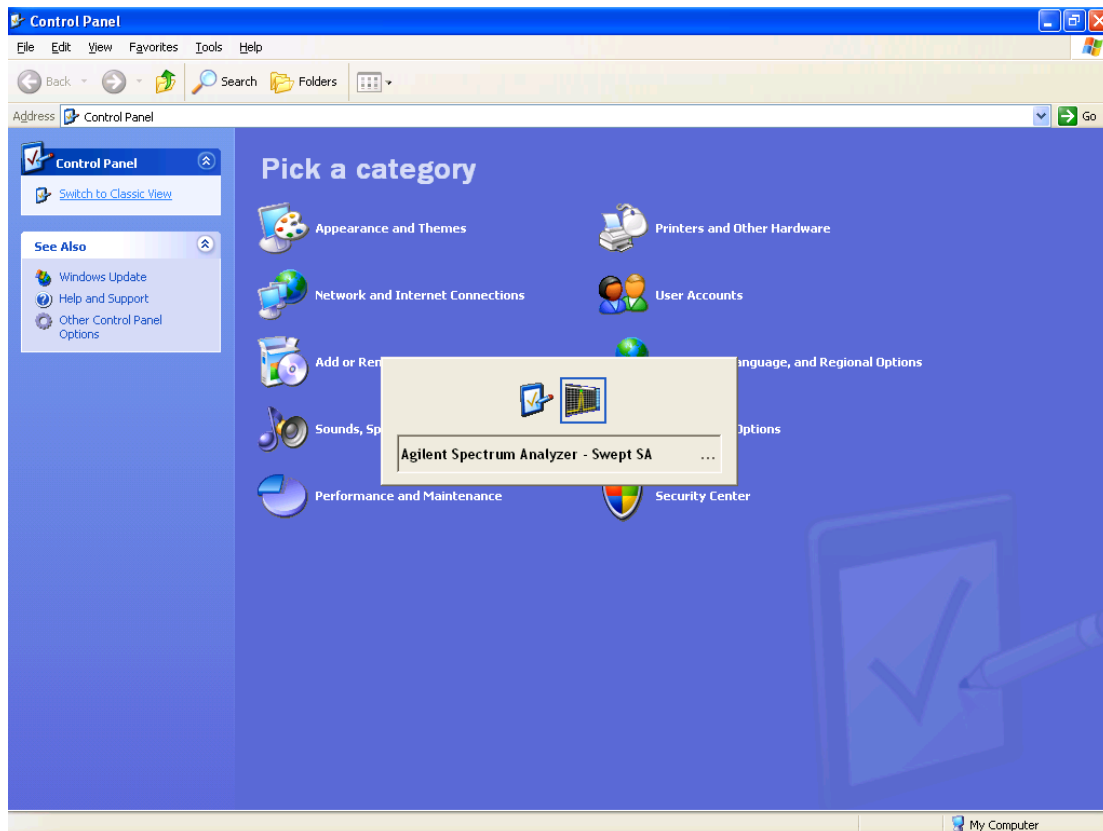

Or use Alt-Tab: press and hold the Alt key and press and release the Tab key until the Analyzer logo is showing in the window in the center of the screen, as above, then release the Alt key.



Key Path	System
Notes	No remote command for this key.
Initial S/W Revision	Prior to A.02.00

## Licensing...

Opens the license explorer.

**NOTE** This feature is not available if option SF1 is installed.

For Help on this key, select Help in the menu bar at the top of the license explorer window.

Key Path	System
Notes	No equivalent remote command for this key.
Backwards Compatibility Notes	In ESA the SCPI command for displaying the Show Licenses screen is: :SYSTem:CONFigure:LKEY:STATe OFF ON 0 1 :SYSTem:CONFigure:LKEY:STATe? There are no equivalent SCPI commands in the X-Series for displaying the License Explorer.
Initial S/W Revision	Prior to A.02.00

<b>Remote Command</b>	:SYSTem:LKEY <"OptionInfo">, <"LicenseInfo">
<b>Example</b>	SYST:LKEY "N9073A-1FP", "027253AD27F83CDA5673A9BA5F427FDA5E4F25AEB1017638211AC9F60D9C639FE539735909C551DE0A91"
Notes	The <"OptionInfo"> contains the feature and the version. You must specify the feature but can omit the version. If you omit the version, the system regards it as the latest one, since the system knows which version is supported for each feature.  The <"LicenseInfo"> contains the signature, the expiration date, and serial number for transport if transportable. You must specify the signature, but you can omit the other information. If you omit the expiration date, the system regards it as permanent. If you omit the serial number, the system regards it as non-transportable. As a result, this supports reverse compatibility.
Initial S/W Revision	Prior to A.02.00

<b>Remote Command</b>	:SYSTem:LKEY:DELeTe <"OptionInfo">,<"LicenseInfo">
<b>Example</b>	SYST:LKEY:DEL "N9073A-1FP", "027253AD27F83CDA5673A9BA5F427FDA5E4F25AEB1017638211AC9F60D9C639FE539735909C551DE0A91"
Notes	The <"OptionInfo"> contains the feature and the version. You must specify the feature but can omit the version. If

---

you omit the version, the system regards it as the latest one, if more than one version is installed.

The <"LicenseInfo"> contains the signature, the expiration date, and whether or not be transportable. You must specify the signature, but you can omit the other information. If you omit the expiration date, the system regards it as permanent. If you omit the transportability, the system regards it as non-transportable. As a result, this supports reverse compatibility.

---

Initial S/W Revision      Prior to A.02.00

---



---

**Remote Command**            :SYSTem:LKEY:LIST?

---

Notes

Return Value:  
 An <arbitrary block data> of all the installed instrument licenses.  
 The format of each license is as follows.  
 <Feature>,<Version>,<Signature>,<Expiration Date>,<Serial Number for Transport>  
 Return Value Example:  
 #3136  
 N9073A-1FP,1.000,B043920A51CA  
 N9060A-2FP,1.000,4D1D1164BE64  
 N9020A-508,1.000,389BC042F920  
 N9073A-1F1,1.000,5D71E9BA814C,13-aug-2005  
 <arbitrary block data> is:  
 #NMMM<data>  
 Where:  
 N is the number of digits that describes the number of MMM characters. For example if the data was 55 bytes, N would be 2.  
 MMM would be the ASCII representation of the number of bytes. In the previous example, N would be 55.  
 <data> ASCII contents of the data

---

Initial S/W Revision      Prior to A.02.00

---



---

**Remote Command**            :SYSTem:LKEY? <"OptionInfo">

---

**Example**                        SYST:LKEY? "N9073A-1FP"

---

Notes                            The <"OptionInfo"> contains the feature and the version. You must specify the feature but can omit the version. If you omit the version, the system regards it as the latest one.

Return Value:  
 <"LicenseInfo"> if the license is valid, null otherwise.  
 <"LicenseInfo"> contains the signature, the expiration date, and serial number if transportable.  
 Return Value Example:  
 "B043920A51CA"

---

Initial S/W Revision      Prior to A.02.00

---

<b>Remote Command</b>	:SYSTem:HID?
Notes	Return value is the host ID as a string
Initial S/W Revision	Prior to A.02.00

## Security

Accesses capabilities for operating the instrument in a security controlled environment.

Key Path	System
Initial S/W Revision	A.04.00

## USB

The Windows operating system can be configured to disable write access to the USB ports for users who are in a secure environment where transferring data from the instrument is prohibited. This user interface is a convenient way for the customer to disable write access to USB.

Key Path	System, Security
Mode	All
Scope	Mode Global
<b>Remote Command</b>	:SYSTem:SECurity:USB:WPRotect[:ENABle] ON OFF 0 1 :SYSTem:SECurity:USB:WPRotect[:ENABle]?
<b>Example</b>	:SYST:SEC:USB:WPR ON Will set USB ports to Read-only
Notes	When the USB ports are in Read-only mode then no data can be stored to USB, including the internal USB memory used for a back-up location for the calibration data.
Dependencies	This key is grayed-out unless the current user has administrator privileges.
Preset	This is unaffected by Preset or any Restore System Defaults. An Agilent Recovery will set the USB to write protect OFF
State Saved	No
Range	Read-Write Read only
Initial S/W Revision	A.04.00

## Read-Write

Selection for allowing full read-write access to the USB ports.

Key Path	System, Security, USB
<b>Example</b>	:SYST:SEC:USB:WPR OFF Will set USB ports to Read-Write
Initial S/W Revision	A.04.00

## Read only

Selection for disabling write access to the USB ports.

Key Path	System, Security, USB	
<b>Example</b>	:SYST:SEC:USB:WPR ON	Will set USB ports to Read only
Initial S/W Revision	A.04.00	

## Diagnostics

The Diagnostics key in the System menu gives you access to basic diagnostic capabilities of the instrument.

Key Path	System
Initial S/W Revision	Prior to A.02.00

## Show Hardware Statistics

Provides a display of various hardware statistics. The statistics include the following:

- Mechanical relay cycles
- High and Low temperature extremes
- Elapsed time that the instrument has been powered-on (odometer)

The display should appear listing the statistics, product number, serial number, and firmware revision.

Hardware Statistical Information	
Agilent MXA Signal Analyzer	
Product Number: N9020A	
Serial Number: US00061145	
Instrument S/W Revision: A.12.00	
Revision Date: 7/11/2012 12:11:10 PM	
Component Name	Value
MechAtten #1 Count Total	457304
Calibrator Switch Cycles	105953
AC/DC Switch Cycles	114240
2 dB #1 Mechanical Atten Cycles	112655
2 dB #2 Mechanical Atten Cycles	124456
MechAtten #2 Count Total	472265
6 dB Mechanical Atten Cycles	115302
10 dB Mechanical Atten Cycles	93602
20 dB Mechanical Atten Cycles	144781
30 dB Mechanical Atten Cycles	118580
Low Noise Path Switch	45668
Preselector Bypass Cycles	31133
High temperature operating extreme	45.75
Low temperature operating extreme	-23.9375
Elapsed Time (On-Time)(hours)	134164

In some CXA models this field is called "Fixed Aten"

Some CXA models omit these fields

Only shown if LNP installed  
Only shown if MPB installed

The CXA models in which the AC/DC Switch field is called Fixed Aten and that omit the mechanical attenuation fields are the N9000A-503/507 models.

Modular HWs only have time and temperature information in Show Hardware Statistics.

The data will be updated only when the Show Hardware Statistics menu key is pressed, it will not be updated while the screen is displayed.

The tabular data should be directly printable.

Key Path	System, Diagnostics
Mode	All
Notes	The values displayed on the screen are only updated upon entry to the screen and not updated while the screen is being displayed.
Initial S/W Revision	Prior to A.02.00

### SCPI for Show Hardware Statistics ( Remote Commands Only)

Each of the hardware statistic items can be queried via SCPI.

- "Query the Mechanical Relay Cycle Count" on page 406
- "Query the Operating Temperature Extremes" on page 406
- "Query the Elapsed Time since 1st power on" on page 406

### Query the Mechanical Relay Cycle Count

Return the count of mechanical relay cycles. For N9038A model, there are additional 2 Mechanical Relays which are <N9038A Input2>, <N9038A Bypass>.

<b>Remote Command</b>	:SYSTem:MRELay:COUNT?
<b>Example</b>	:SYST:MREL:COUN?
<b>Notes</b>	<p>Query Only</p> <p>The return value is a comma separated list of the individual counts for each mechanical relay. The position of the relays in the list is:</p> <p>“&lt;Cal Signal&gt;,&lt;AC/DC&gt;,&lt;2dB #1 Atten&gt;,&lt;2dB #2 Atten&gt;,&lt;6dB Atten&gt;,&lt;10dB Atten&gt;,&lt;20dB Atten&gt;,&lt;30dB Atten&gt;,&lt;Fixed Atten&gt;,&lt;Low Noise Path Switch&gt;,&lt;Presel Bypass&gt;,&lt;N9038A Input2&gt;,&lt;N9038A Bypass&gt;”</p> <p>Items in the list not pertaining to your particular hardware configuration will return as -999 for those items.</p>
Initial S/W Revision	Prior to A.02.00
Modified at S/W Revision	A.08.00

### Query the Operating Temperature Extremes

Returns the low operating temperature extreme value. The value survives a power-cycle and is the temperature extreme encountered since the value was reset by the factory or service center.

Mode	All
<b>Remote Command</b>	:SYSTem:TEMPerature:LEXTreme?
<b>Example</b>	:SYST:TEMP:LEXT?
<b>Notes</b>	Value is in degrees Celsius at which the lowest operating temperature has been recorded since 1st power-up.
State Saved	No
Initial S/W Revision	Prior to A.02.00

Mode	All
<b>Remote Command</b>	:SYSTem:TEMPerature:HEXTreme?
<b>Example</b>	:SYST:TEMP:HEXT?
<b>Notes</b>	Value is in degrees Celsius at which the highest operating temperature has been recorded since 1st power-up.
State Saved	No
Initial S/W Revision	Prior to A.02.00

### Query the Elapsed Time since 1<sup>st</sup> power on

Returns the elapsed on-time in minutes since 1st power-on.

<b>Remote Command</b>	:SYSTem:PON:ETIMe?
<b>Example</b>	:SYST:PON:ETIM?
<b>Notes</b>	Query Only
<b>Initial S/W Revision</b>	Prior to A.02.00

## Internet Explorer...

This key launches Microsoft Internet Explorer. A mouse and external keyboard are highly desired for using Internet Explorer. When Internet Explorer is running, close Internet Explorer to return focus to the Instrument Application (or use Alt-Tab).

**NOTE** This feature is not available if option SF1 is installed.

<b>Key Path</b>	System
<b>Mode</b>	All
<b>Notes</b>	No equivalent remote command for this key.
<b>Initial S/W Revision</b>	A.05.01

## System Remote Commands (Remote Commands Only)

The commands in this section have no front-panel key equivalent.

["System Powerdown \(Remote Command Only\)" on page 407](#)

["List installed Options \(Remote Command Only\)" on page 408](#)

["Lock the Front-panel keys \(Remote Command Only\)" on page 408](#)

["List SCPI Commands \(Remote Command Only\)" on page 408](#)

["SCPI Version Query \(Remote Command Only\)" on page 409](#)

["Date \(Remote Command Only\)" on page 409](#)

["Time \(Remote Command Only\)" on page 409](#)

<b>Initial S/W Revision</b>	Prior to A.02.00
-----------------------------	------------------

## System Powerdown (Remote Command Only)

<b>Remote Command</b>	SYSTem:PDOWn [NORMal FORCe]
<b>Notes</b>	Shuts down the instrument in the normal way (NORMal) or forced way (FORCe). In case there is another application with modified data pending for saving, the application prompt the user. The system waits until the user responds in the normal mode. It will go off after 20 seconds of wait in the force mode and all data will be lost.

### List installed Options (Remote Command Only)

Lists the installed options that pertain to the instrument (signal analyzer).

Mode	All
<b>Remote Command</b>	:SYSTem:OPTions?
<b>Example</b>	:SYST:OPT?
Notes	The return string is a comma separated list of the installed options. For example: "503,P03,PFR" :SYSTem:OPTions? and *OPT? are the same.
State Saved	No
Initial S/W Revision	Prior to A.02.00

### Lock the Front-panel keys (Remote Command Only)

Disables the instrument keyboard to prevent local input when the instrument is controlled remotely. Annunciation showing a "K" for 'Klock" (keyboard lock) alerts the local user that the keyboard is locked. Klock is similar to the GPIB Local Lockout function; namely that no front-panel keys are active with the exception of the Power Standby key. (The instrument is allowed to be turned-off if Klock is ON.) The Klock command is used in remote control situations where Local Lockout cannot be used.

Although primary intent of Klock is to lock-out the front panel, it will lock-out externally connected keyboards through USB. Klock has no effect on externally connected pointing devices (mice).

The front panel 'Local' key (Cancel/Esc) has no effect if Klock is ON.

Mode	All
<b>Remote Command</b>	:SYSTem:KLOCK OFF ON 0 1 :SYSTem:KLOCK?
<b>Example</b>	:SYST:KLOC ON
Notes	Keyboard lock remains in effect until turned-off or the instrument is power-cycled
Preset	Initialized to OFF at startup, unaffected by Preset
State Saved	No
Initial S/W Revision	Prior to A.02.00

### List SCPI Commands (Remote Command Only)

Outputs a list of the valid SCPI commands for the currently selected Mode.

<b>Remote Command</b>	:SYSTem:HELP:HEADers?
<b>Example</b>	:SYST:HELP:HEAD?
Notes	The output is an IEEE Block format with each command separated with the New-Line character (hex



	0x0A)
Initial S/W Revision	Prior to A.02.00

### SCPI Version Query (Remote Command Only)

Returns the SCPI version number with which the instrument complies. The SCPI industry standard changes regularly. This command indicates the version used when the instrument SCPI commands were defined.

<b>Remote Command</b>	:SYSTem:VERSion?
<b>Example</b>	:SYST:VERS?
Initial S/W Revision	Prior to A.02.00

### Date (Remote Command Only)

The recommended access to the Date, Time, and Time zone of the instrument is through the Windows native control (Control Panel or accessing the Task Bar). You may also access this information remotely, as shown in this command and Time (below).

Sets or queries the date in the instrument.

Mode	All
<b>Remote Command</b>	:SYSTem:DATE "<year>,<month>,<day>" :SYSTem:DATE?
<b>Example</b>	:SYST:DATE "2006,05,26"
Notes	<year> is the four digit representation of year. (for example, 2006) <month> is the two digit representation of year. (for example. 01 to 12) <day> is the two digit representation of day. (for example, 01 to 28, 29, 30, or 31) depending on the month and year  Unless the current account has Power User or Administrator privileges, an error will be generated by this command and no action will be taken.
Initial S/W Revision	Prior to A.02.00

### Time (Remote Command Only)

Sets or queries the time in the instrument.

Mode	All
<b>Remote Command</b>	:SYSTem:TIME "<hour>,<minute>,<second>" :SYSTem:TIME?
<b>Example</b>	:SYST:TIME "13,05,26"

---

Notes	<hour> is the two digit representation of the hour in 24 hour format <minute> is the two digit representation of minute <second> is the two digit representation of second Unless the current account has Power User or Administrator privileges, an error will be generated by this command and no action will be taken.
Initial S/W Revision	Prior to A.02.00

---

## 7 Trigger Functions

## Trigger

Accesses a menu of keys to control the selection of the trigger source and the setup of each of the trigger sources. The analyzer is designed to allow triggering from a number of different sources, for example, Free Run, Video, External, RF Burst, and so forth.

The TRIG:SOURCe command (below) will specify the trigger source for the currently selected input (RF or I/Q). If you change inputs, the new input remembers the trigger source it was last programmed to for the current measurement, and uses that trigger source. You can directly set the trigger source for each input using the TRIGger:RF:SOURce and TRIGger:IQ:SOURce commands (later in this section). When in External Mixing, the analyzer uses the RF trigger source.

Note the inclusion of the <measurement> parameter in the command below. Because each measurement remembers its own Trigger Source, the command must be qualified with the measurement name. Note that for the Swept SA measurement this is not the case; for backwards compatibility, no <measurement> parameter is used when setting the Trigger Source for the Swept SA measurement.

See ["Trigger Source Presets" on page 413](#)

See ["RF Trigger Source" on page 416](#)

See ["I/Q Trigger Source" on page 417](#)

See ["More Information" on page 418](#)

Key Path	Front-panel key
<b>Remote Command</b>	<pre>:TRIGger:&lt;measurement&gt;[:SEquence]:SOURce EXTernal1   EXTernal2   IMMediate   LINE   FRAMe   RFBurst   VIDeo   IF   ALARm   LAN   IQMag   IDEMod   QDEMod   IINPut   QINPut   AIQMag   TV  :TRIGger:&lt;measurement&gt;[:SEquence]:SOURce?</pre> <p>where &lt;measurement&gt; is the measurement for which you wish to set the Source (blank for the Swept SA measurement)</p>
<b>Example</b>	<pre>TRIG:ACP:SOUR EXT1</pre> <p>Selects the external 1 trigger input for the ACP measurement and the selected input</p> <pre>TRIG:SOUR VID</pre> <p>Selects video triggering for the Swept SA (SANalyzer) measurement in the Spectrum Analyzer mode. For SAN, do not use the &lt;measurement&gt; keyword. Only send this form in the Spectrum Analyzer mode or you will get an Undefined Header error</p>
<b>Notes</b>	<p>Not all measurements have all the trigger sources available to them. Check the trigger source documentation for your specific measurement to see what sources are available.</p> <p>Not all trigger sources are available for each input. See the <a href="#">"RF Trigger Source" on page 416</a> and <a href="#">"I/Q Trigger Source" on page 417</a> commands for detailed information on which trigger sources are available for each input.</p> <p>Other trigger-related commands are found in the INITiate and ABORt SCPI command subsystems.</p> <p>*OPC should be used after requesting data. This will hold off any subsequent changes to the selected trigger source, until after the sweep is completed and the data is returned.</p> <p>Available ranges and presets can vary from mode to mode.</p>
<b>Dependencies</b>	<p>In some models, there is no second External input. In these models, the External 2 key is blanked and</p>

	the EXternal2 parameter will generate a "Hardware missing; Not available for this model number" message.
Preset	See table below
Status Bits/OPC dependencies	The Status Operation Register bit 5 "Waiting for Trigger" is set at the same time as the Sweeping or Measuring bit is set. It is cleared when the trigger actually occurs (that is, after the trigger event occurs and all the applicable trigger criteria have been met). A corresponding pop-up message ("Waiting for trigger") is generated if no trigger signal appears after approximately 2 sec. This message goes away when a trigger signal appears.
<b>Backwards Compatibility SCPI</b>	:TRIGger[:SEquence]:SOURCe EXTernal For backward compatibility, the parameter EXTernal is mapped to EXTernal1
<b>Backwards Compatibility SCPI</b>	[:SENSe]:<measurement>:TRIGger:SOURce This backwards compatibility alias command is provided for ESA/PSA compatibility This backwards compatibility command does not apply to the Swept SA measurement, for that just use :TRIGger:SOURCe This backwards compatibility command does not apply to the monitor spectrum, log plot and spot frequency measurements
<b>Backwards Compatibility SCPI</b>	[:SENSe]:<measurement>:TRIGger:SOURce IF In earlier instruments, the parameter IF was used by apps for the video trigger, so using the IF parameter selects VIDeo triggering. Sending IF in the command causes VID to be returned to a query.
<b>Backwards Compatibility SCPI</b>	[:SENSe]:ACPr:TRIGger:SOURce This backwards Compatibility SCPI command is provided to support the same functionality as [:SENSe]:ACPr:TRIGger:SOURce (PSA W-CDMA, PSA cdma2000 and PSA 1xEVDO) due to the fact that the ACPr node conflicts with the ACPower node.
Initial S/W Revision	Prior to A.02.00
Modified at S/W Revision	A.03.00

## Trigger Source Presets

Here are the Trigger Source Presets for the various measurements:

Meas	Mode	Preset for RF	Preset for IQ	Notes
Swept SA	SA	IMM	IQ not supported	
CHP	SA, WCDMA, C2K, WIMAX OFDMA, 1xEVDO, DVB-T/H, DTMB, LTE, LTETDD, CMMB, ISDB-T, Digital Cable TV, MSR	IMM	IQ not supported	
OBW	SA, WCDMA, C2K, WIMAX OFDMA,	1xEVDO: EXT1 others: IMM	IQ not supported	For 1xEVDO mode, the trigger source is coupled with the gate state, as well as the gate

	TD-SCDMA, 1xEVDO, LTE, LTETDD, CMMB, ISDB-T, MSR			source. When the trigger source changes to RFBurst, External1 or External2, the gate state is set to on, and the gate source is set identically with the trigger source. When the trigger source changes to IMMEDIATE, VIDEO, LINE, FRAME or IF, the gate state is set to off.
CCDF	SA, WCDMA, C2K, WIMAX OFDMA, TD-SCDMA, 1xEV-DO, DVB-T/H, DTMB, LTE, LTETDD, CMMB, ISDB-T, Digital Cable TV, MSR	WIMAX OFDMA: RFBurst LTETDD: BTS: External 1 MS: Periodic Timer TD-SCDMA and 1xEV-DO: BTS: External 1 MS: RFBurst SA, WCDMA, C2K, LTE, CMMB, ISDB-T, DVB-T/H, DTMB, Digital Cable TV, MSR: IMMEDIATE	TD-SCDMA and 1xEV-DO: BTS: External 1 MS: IQMag LTETDD: BTS: External 1 MS: Periodic Timer Others: IMM	For TD-SCDMA: Trigger source is coupled with radio device. When radio device changes to BTS, trigger source will be changed to EXTERNAL1. When radio device changes to MS, trigger source will be set as RFBurst for RF or IQ Mag for BBIQ. When TriggerSource is RFBurst or IQ Mag, Measure Interval is grayed out.
ACP	SA, WCDMA, C2K, WIMAX OFDMA, TD-SCDMA, 1xEVDO, DVB-T/H, DTMB, LTE, LTETDD, CMMB, ISDB-T, Digital Cable TV, MSR	IMM	IQ not supported	
Tx Power	SA, GSM, TD-SCDMA	SA, GSM: RFBurst TD-SCDMA: EXTERNAL	IMM	TD-SCDMA doesn't support the Line and Periodic Timer parameters. When the mode is TD-SCDMA, if the Radio Device is switched to BTS, the value will be changed to External 1 and if the Radio device is switched to MS, the value will be changed to RFBurst
SPUR	SA, WCDMA, C2K, WIMAX OFDMA, TD-SCDMA, 1xEV-DO, DVB-T/H, LTE, LTETDD, MSR	IMM	IQ not supported	
SEM	SA, WCDMA, C2K, WIMAX OFDMA, TD-SCDMA, 1xEVDO, DVB-	1xEVDO(BTS): EXTERNAL1 All others: IMMEDIATE	IQ not supported	

	T/H, DTMB, LTE, LTETDD, CMMB, ISDB-T, Digital Cable TV, MSR			
CDP	WCDMA	IMM	IMM	
RHO	WCDMA	IMM	IMM	
PCON	WCDMA	IMM	IMM	
QPSK	WCDMA, C2K, 1xEVDO	All except CDMA1xEVDO: IMMediate CDMA1xEVDO: EXT1	IMM	
MON	All except SA and BASIC	IMM	IQ not supported	
WAV		LTETDD: BTS: External 1 MS: Periodic Timer GSM/EDGE: RFBurst All others: IMMediate	LTETDD: BTS: External 1 MS: Periodic Timer GSM/EDGE: IQMag All others: IMMMediate	
PVT	WIMAXOFDMA	RFB	IMM	
EVM	WIMAXOFDMA, DVB-T/H, DTMB, LTE, LTETDD, CMMB, ISDB-T, Digital Cable TV	All but CMMB: IMM CMMB: Periodic Timer	All but CMMB: IMM CMMB: External 1	LTE, LTETDD supports Free Run, Video and External 1 only.
SPEC	BASIC	IMM	IMM	
LOG Plot	PN	IMM	IQ not supported	
Spot Freq	PN	IMM	IQ not supported	
GMSK PVT	EDGE/GSM	RFB	IMM	
GMSK PFER	EDGE/GSM	RFB	IQMag	
GMSK ORFS	EDGE/GSM	RF Burst	IQ not supported	
EDGE PVT	EDGE/GSM	RFB	IMM	

EDGE EVM	EDGE/GSM	RFB	IQMag
EDGE ORFS	EDGE/GSM	Periodic Timer	IQ not supported
Combined WCDMA	WCDMA	IMM	IQ not supported
Combined GSM	EDGE/GSM	RFB	IQ not supported
List Power Step	WCDMA, EDGE/GSM	IMM	IQ not supported
Transmit On/Off Power	LTETDD	LTETDD: BTS: External 1 MS: Periodic Timer	LTETDD: BTS: External 1 MS: Periodic Timer
Transmit Analysis	BLUETOOTH	RFB	IQ not supported
Adjacent Channel Power	BLUETOOTH	IMM	IQ not supported
LE In-band Emissions	BLUETOOTH	IMM	IQ not supported
EDR In-band Spurious Emissions	BLUETOOTH	Periodic Timer	IQ not supported
Conformance EVM	LTE, LTETDD, MSR	IMM	IMM

## RF Trigger Source

The RF Trigger Source command selects the trigger to be used for the specified measurement when RF is the selected input. The RF trigger source can be queried and changed even while another input is selected, but it is inactive until RF becomes the selected input.

Note the inclusion of the <measurement> parameter in the command below. Because each measurement remembers its own Trigger Source, the command must be qualified with the measurement name. Note that for the Swept SA measurement this is not the case; for backwards compatibility, no <measurement> parameter is used when setting the Trigger Source for the Swept SA measurement.

<b>Remote Command</b>	<code>:TRIGger:&lt;measurement&gt;[:SEquence]:RF:SOURce EXTernal1   EXTernal2   IMMEDIATE   LINE   FRAME   RFBurst   VIDEO   IF   ALARm   LAN   TV</code> <code>:TRIGger:&lt;measurement&gt;[:SEquence]:RF:SOURce?</code>
-----------------------	--

<b>Example</b>	<code>TRIG:ACP:RF:SOUR EXT1</code> Selects the external 1 trigger input for the ACP measurement and the RF input
----------------	---



	<p>TRIG:RF:SOUR VID</p> <p>Selects video triggering for the SANalyzer measurement and the RF input. For SAN, do not use the &lt;measurement&gt; keyword.</p>
Notes	<p>Not all measurements have all the trigger sources available to them. Check the trigger source documentation for your specific measurement to see what sources are available.</p> <p>Not all trigger sources are available for each input. For the RF Trigger Source, the following trigger sources are available:</p> <ul style="list-style-type: none"> <li>–IMMediate - free run triggering</li> <li>–VIDeo - triggers on the video signal level</li> <li>–LINE - triggers on the power line signal</li> <li>–EXTernal1 (or EXTernal) - triggers on an externally connected trigger source marked “Trigger 1 In” on the rear panel</li> <li>–EXTernal2 - triggers on an externally connected trigger source marked “Trigger 2 In” on the front panel. In some models, there is no second External input. In these models, the External 2 key is blanked and the EXTernal2 parameter will generate a “Hardware missing; Not available for this model number” message</li> <li>–RFBurst - triggers on the bursted frame</li> <li>–FRAMe - triggers on the periodic timer</li> <li>–IF (video) - same as video, for backwards compatibility only</li> </ul> <p>*OPC should be used after requesting data. This will hold off any subsequent changes to the selected trigger source, until after the sweep is completed and the data is returned.</p> <p>Available ranges, and presets can vary from mode to mode.</p>
Status Bits/OPC dependencies	<p>The Status Operation Register bit 5 "Waiting for Trigger" is set at the same time as the Sweeping or Measuring bit is set. It is cleared when the trigger actually occurs (that is, after the trigger event occurs and all the applicable trigger criteria have been met). A corresponding pop-up message ("Waiting for trigger") is generated if no trigger signal appears after approximately 2 sec. This message goes away when a trigger signal appears.</p>
Initial S/W Revision	<p>Prior to A.02.00</p>

## I/Q Trigger Source

This command selects the trigger to be used for the specified measurement when I/Q (which requires option BBA) is the selected input. The I/Q trigger source can be queried and changed even while another input is selected, but it is inactive until I/Q becomes the selected input.

<b>Remote Command</b>	<pre>:TRIGger:&lt;measurement&gt;[:SEquence]:IQ:SOURce EXTernal1   EXTernal2   IMMediate   IQMag   IDEMod   QDEMod   IINPut   QINPut   AIQMag  :TRIGger:&lt;measurement&gt;[:SEquence]:IQ:SOURce?</pre>
<b>Example</b>	<p>TRIG:WAVeform:SOUR IQM</p> <p>Selects I/Q magnitude triggering for the IQ Waveform measurement and the I/Q input</p>
Notes	<p>Not all measurements have all the trigger sources available to them. Check the trigger source documentation for your specific measurement to see what sources are available.</p> <p>Not all trigger sources are available for each input. For the I/Q Trigger Source, the following trigger sources are available:</p>

---

	<ul style="list-style-type: none"> <li>–IMMediate - free run triggering</li> <li>–EXTernal1 (or EXTernal) - triggers on an externally connected trigger source on the rear panel</li> <li>–EXTernal2 - triggers on an externally connected trigger source on the front panel</li> <li>–IQMag - triggers on the magnitude of the I/Q signal</li> <li>–IDEMod - triggers on the I/Q signal's demodulated I voltage</li> <li>–QDEMod - triggers on the I/Q signal's demodulated Q voltage</li> <li>–IINPut - triggers on the I channel's ADC voltage</li> <li>–QINPut - triggers on the Q channel's ADC voltage</li> <li>–AIQMag - triggers on the magnitude of the auxiliary receiver channel I/Q signal</li> </ul> <p>*OPC should be used after requesting data. This will hold off any subsequent changes to the selected trigger source, until after the sweep is completed and the data is returned.</p> <p>Available ranges, and from mode to mode presets can vary</p>
Status Bits/OPC dependencies	The Status Operation Register bit 5 "Waiting for Trigger" is set at the same time as the Sweeping or Measuring bit is set. It is cleared when the trigger actually occurs (that is, after the trigger event occurs and all the applicable trigger criteria have been met). A corresponding pop-up message ("Waiting for trigger") is generated if no trigger signal appears after approximately 2 sec. This message goes away when a trigger signal appears.
Initial S/W Revision	Prior to A.02.00

---

## More Information

The trigger menus let you select the trigger source and trigger settings for a sweep or measurement. In triggered operation (basically, any trigger source other than Free Run), the analyzer will begin a sweep or measurement only with the selected trigger conditions are met, generally when your trigger source signal meets the specified trigger level and polarity requirements. (In FFT measurements, the trigger controls when the data acquisition begins for FFT conversion.)

For each of the trigger sources, you may define a set of operational parameters or settings which will be applied when that source is selected as the current trigger source. Examples of these settings are Trigger Level, Trigger Delay, and Trigger Slope. You may apply different settings for each source; so, for example, you could have a Trigger Level of 1v for External 1 trigger and –10 dBm for Video trigger.

Once you have established the settings for a given trigger source, they generally will remain unchanged for that trigger source as you go from measurement to measurement within a Mode (although the settings do change as you go from Mode to Mode). Furthermore, the trigger settings within a Mode are the same for the **Trigger** menu, the **Gate Source** menu, and the **Sync Source** menu that is part of the **Periodic Timer Trigger Setup** menu. That is, if **Ext1** trigger level is set to 1v in the **Trigger** menu, it will appear as 1v in both the **Gate Source** and the **Sync Source** menus. For these reasons the trigger settings commands are not qualified with the measurement name, the way the trigger source commands are.

The settings setup menu can be accessed by pressing the key for the current trigger source a second time. For example, one press of Video selects the Video trigger as the source. The Video key becomes highlighted and the hollow arrow on the key turns black. Now a second press of the key takes you into the Video Trigger Setup menu.

Trigger Setup Parameters:

The following examples show trigger setup parameters using an external trigger source.

Example 1 illustrates the trigger conditions with negative slope and no trigger occurs during trigger Holdoff time.

Example 2 illustrates the trigger conditions with positive slope, trigger delay, and auto trigger time.

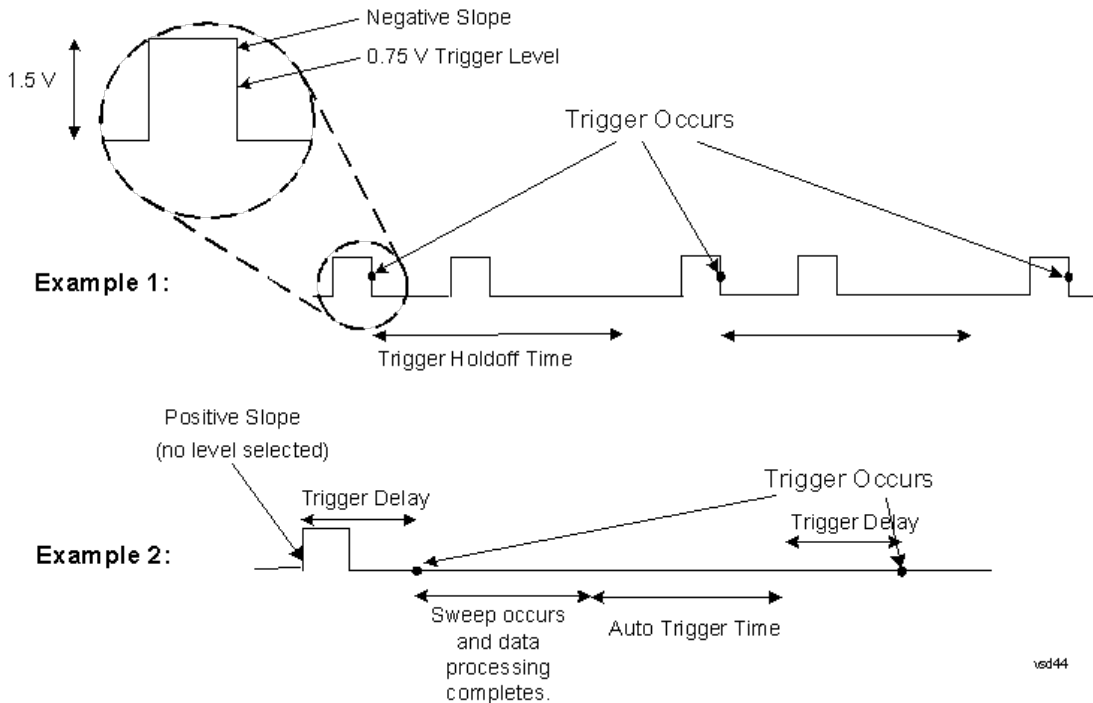

## Free Run

Pressing this key, when it is not selected, selects free-run triggering. Free run triggering occurs immediately after the sweep/measurement is initiated.

Key Path	Trigger
<b>Example</b>	TRIG:SOUR IMM Swept SA measurement TRIG:<meas>:SOUR IMM Measurements other than Swept SA
State Saved	Saved in instrument state
Status Bits/OPC dependencies	The Status Operation Register bit 5 "Waiting for Trigger" is set at the same time as the Sweeping or Measuring bit is set. It is cleared when the trigger actually occurs (that is, after the trigger event occurs and all the applicable trigger criteria have been met). A corresponding pop-up message ("Waiting for trigger") is generated if no trigger signal appears after approximately 2 sec. This message goes away when a trigger signal appears.
Initial S/W Revision	Prior to A.02.00

## Video (IF Envelope)

Pressing this key, when it is not selected, selects the video signal as the trigger. The Video trigger condition is met when the video signal (the filtered and detected version of the input signal, including both RBW and VBW filtering) crosses the video trigger level.

**NOTE** When the detector selected for all active traces is the average detector, the video signal for triggering does not include any VBW filtering.

The video trigger level is shown as a labeled line on the display. The line is displayed as long as video is the selected trigger source.

Pressing this key, when it is already selected, accesses the video trigger setup functions.

Key Path	Trigger
<b>Example</b>	TRIG:SOUR VID Swept SA measurement TRIG:<meas>:SOUR VID Measurements other than Swept SA
Notes	Log Plot and Spot Frequency measurements do not support Video Trigger
Dependencies	Video trigger is allowed in average detector mode.
State Saved	Saved in instrument state
Status Bits/OPC dependencies	The Status Operation Register bit 5 "Waiting for Trigger" is set at the same time as the Sweeping or Measuring bit is set. It is cleared when the trigger actually occurs (that is, after the trigger event occurs and all the applicable trigger criteria have been met). A corresponding pop-up message ("Waiting for trigger") is generated if no trigger signal appears after approximately 2 sec. This message goes away when a trigger signal appears.
Backwards Compatibility Notes	In the past, the Average detector was not available when Video triggering was on, and consequently, functions that set the detector to average (such as Marker Noise or Band/Intvl Power) were not available when the video trigger was on. Similarly, Video triggering was not available when the detector was Average. In the X-Series, these restrictions are removed.
Initial S/W Revision	Prior to A.02.00

## Trigger Level

Sets a level for the video signal trigger. When the video signal crosses this level, with the chosen slope, the trigger occurs. This level is displayed with a horizontal line only if **Video** is the selected trigger source.

Key Path	Trigger, Video
<b>Remote Command</b>	:TRIGger[:SEquence]:VIDeo:LEVel <ampl> :TRIGger[:SEquence]:VIDeo:LEVel?
<b>Example</b>	TRIG:VID:LEV -40 dBm
Notes	When sweep type = FFT, the video trigger uses the amplitude envelope in a bandwidth wider than the FFT width as a trigger source. This might often be useful, but does not have the same relationship between the displayed trace and the trigger level as in swept triggering. Amplitude Corrections are not taken into account by the Video Trig Level. For example, if you have

given yourself effective gain with an amplitude correction factor, the Video Trigger will not fire until you have dropped the trigger line that far below the displayed signal level, rather than simply dropping it down to the displayed signal level.

Note that other corrections, specifically External Gain and Ref Level Offset, modify the actual trace data as it is taken and therefore ARE taken into account by Trig Level.

Couplings	This same level is used for the Video trigger source in the Trigger menu and for the Video selection in the Gate Source menu.
Preset	Set the Video Trigger Level -25 dBm on Preset. When the Video Trigger Level becomes the active function, if the value is off screen, set it to either the top or bottom of screen, depending on which direction off screen it was.
State Saved	Saved in instrument state
Min	-170 dBm
Max	+30 dBm
Default Unit	Depends on the current selected Y axis unit
<b>Backwards Compatibility SCPI</b>	:TRIGger[:SEquence]:IF:LEVel :TRIGger[:SEquence]:IF:LEVel?
Backwards Compatibility Notes	This alias is provided for backward compatibility with VSA/PSA comms apps.
Initial S/W Revision	Prior to A.02.00

## Trig Slope

Controls the trigger polarity. It is set positive to trigger on a rising edge and negative to trigger on a falling edge.

Key Path	Trigger, Video
<b>Remote Command</b>	:TRIGger[:SEquence]:VIDeo:SLOPe POSitive NEGative :TRIGger[:SEquence]:VIDeo:SLOPe?
<b>Example</b>	TRIG:VID:SLOP NEG
Preset	POSitive
State Saved	Saved in instrument state
<b>Backwards Compatibility SCPI</b>	:TRIGger[:SEquence]:IF:SLOPe NEGative POSitive :TRIGger[:SEquence]:IF:SLOPe? For backward compatibility with VSA/PSA comms apps
Backwards Compatibility Notes	The legacy :TRIGger[:SEquence]:SLOPe command affects the slopes for the VID, LINE, EXT1, EXT2, and RFB triggers.
Initial S/W Revision	Prior to A.02.00

<b>Remote Command</b>	:TRIGger[:SEquence]:SLOPe POSitive NEGative :TRIGger[:SEquence]:SLOPe?
<b>Example</b>	TRIG:SLOP NEG
<b>Preset</b>	POSitive
<b>State Saved</b>	Saved in instrument state
<b>Backwards Compatibility Notes</b>	In ESA/PSA, the Trigger Slope was global to all triggers. In the X-Series, the slope can be set individually for each Trigger Source. For backward compatibility, the global SLOPe command updates all instances of trigger slope (VID, LINE, EXT1, EXT2, TV, RFB). The query returns the trigger slope setting of the currently selected trigger source.
<b>Initial S/W Revision</b>	Prior to A.02.00

## Trig Delay

Controls a time delay during that the analyzer will wait to begin a sweep after meeting the trigger criteria. You can use negative delay to pre-trigger the instrument in the time domain or FFT, but not in swept spans.

<b>Key Path</b>	Trigger, Video
<b>Remote Command</b>	:TRIGger[:SEquence]:VIDeo:DELaY <time> :TRIGger[:SEquence]:VIDeo:DELaY? :TRIGger[:SEquence]:VIDeo:DELaY:STATe OFF ON 0 1 :TRIGger[:SEquence]:VIDeo:DELaY:STATe?
<b>Example</b>	TRIG:VID:DEL:STAT ON TRIG:VID:DEL 100 ms
<b>Notes</b>	Video trigger delay may be set to negative values, in time domain, FFT and even swept. It makes intuitive sense in time domain and works well in FFT mode where the bandwidth of the filter before the video trigger is about 1.25 span. In swept spans, negative settings of Trig Delay are treated as a zero setting within the internal hardware and the advisory message "Neg. Trig Delay unavailable in Swept Mode, zero delay used." is generated when such a delay is set.
<b>Preset</b>	Off, 1 us
<b>State Saved</b>	Saved in instrument state
<b>Min</b>	-150 ms
<b>Max</b>	+500 ms
<b>Default Unit</b>	s
<b>Backwards Compatibility Notes</b>	! For backward compatibility with VSA/PSA comms apps :TRIGger[:SEquence]:IF:DELaY :TRIGger[:SEquence]:DELaY The legacy :TRIGger[:SEquence]:DELaY command affects the delay for the VID, LINE, EXT1, EXT2, and RFB triggers.
<b>Initial S/W Revision</b>	Prior to A.02.00

<b>Remote Command</b>	:TRIGger[:SEquence]:DELay <time> :TRIGger[:SEquence]:DELay? :TRIGger[:SEquence]:DELay:STATE OFF ON 0 1 :TRIGger[:SEquence]:DELay:STATE?
<b>Example</b>	TRIG:DEL 1 ms
<b>Preset</b>	1 us
<b>State Saved</b>	Saved in instrument state
<b>Backwards Compatibility Notes</b>	In ESA/PSA, the Trigger Delay was global to all triggers. In the X-Series, the delay can be set individually for each Trigger Source. For backward compatibility, the global DELay command updates all instances of trigger slope (VID, LINE, EXT1, EXT2) except TV and RFBurst. The query returns the trigger delay setting of the currently selected trigger source.
<b>Initial S/W Revision</b>	Prior to A.02.00

<b>Remote Command</b>	:TRIGger[:SEquence]:OFFSet <time> :TRIGger[:SEquence]:OFFSet? :TRIGger[:SEquence]:OFFSet:STATE OFF ON 0 1 :TRIGger[:SEquence]:OFFSet:STATE?
<b>Example</b>	TRIG:OFFS ON TRIG:OFFS -100 ms
<b>Notes</b>	These are ESA commands for trigger offset that allowed you to use a positive or negative delay when in zero span and in a Res BW $\geq$ 1 kHz. For ESA compatibility, X-series analyzers keep track of this offset and adds it to the Trigger Delay for VIDEo, LINE, EXTernal1 or EXTernal2 whenever the value is sent to the hardware, if in Zero Span and RBW $\geq$ 1 kHz.
<b>Preset</b>	Off, 0 s
<b>State Saved</b>	Saved in instrument state
<b>Min</b>	-11 s
<b>Max</b>	+11 s
<b>Initial S/W Revision</b>	Prior to A.02.00

## Line

Pressing this key, when it is not selected, selects the line signal as the trigger. A new sweep/measurement will start synchronized with the next cycle of the line voltage. Pressing this key, when it is already selected, access the line trigger setup menu.

<b>Key Path</b>	Trigger
<b>Example</b>	TRIG:SOUR LINE Swept SA measurement TRIG:<meas>:SOUR LINE Measurements other than Swept SA
<b>Dependencies</b>	Line trigger is not available when operating from a "dc power source", for example, when the

	instrument is powered from batteries.
State Saved	Saved in instrument state
Status Bits/OPC dependencies	The Status Operation Register bit 5 "Waiting for Trigger" is set at the same time as the Sweeping or Measuring bit is set. It is cleared when the trigger actually occurs (that is, after the trigger event occurs and all the applicable trigger criteria have been met). A corresponding pop-up message ("Waiting for trigger") is generated if no trigger signal appears after approximately 2 sec. This message goes away when a trigger signal appears.
Initial S/W Revision	Prior to A.02.00

## Trig Slope

Controls the trigger polarity. It is set positive to trigger on a rising edge and negative to trigger on a falling edge.

Key Path	Trigger, Line
Remote Command	:TRIGger[:SEquence]:LINE:SLOPe POSitive NEGative :TRIGger[:SEquence]:LINE:SLOPe?
Example	TRIG:LINE:SLOP NEG
Preset	POSitive
State Saved	Saved in instrument state
Backwards Compatibility Notes	The legacy :TRIGger[:SEquence]:SLOPe command affects the slopes for the VID, LINE, EXT1, EXT2, and RFB triggers.
Initial S/W Revision	Prior to A.02.00

## Trig Delay

Controls a time delay during which the analyzer will wait to begin a sweep after meeting the trigger criteria. You can use negative delay to pre-trigger the instrument in time domain or FFT, but not in swept spans.

Key Path	Trigger, Line
Remote Command	:TRIGger[:SEquence]:LINE:DELay <time> :TRIGger[:SEquence]:LINE:DELay? :TRIGger[:SEquence]:LINE:DELay:STATe OFF ON 0 1 :TRIGger[:SEquence]:LINE:DELay:STATe?
Example	TRIG:LINE:DEL:STAT ON TRIG:LINE:DEL 100 ms
Notes	Video trigger delay may be set to negative values, in time domain, FFT and even swept. It makes intuitive sense in time domain and works well in FFT mode where the bandwidth of the filter before the video trigger is about 1.25 span. In swept spans, negative settings of Trig Delay are treated as a



	zero setting within the internal hardware and the advisory message "Neg. Trig Delay unavailable in Swept Mode, zero delay used." is generated when such a delay is set.
Preset	Off, 1.000 us
State Saved	Saved in instrument state
Min	-150 ms
Max	500 ms
Default Unit	S
Backwards Compatibility Notes	The legacy :TRIGger[:SEQuence]:DELay command affects the delay for the VID, LINE, EXT1, EXT2, and RFB triggers. The legacy :TRIGger[:SEQuence]:OFFSet command is supported for the VIDeo, LINE, EXT1, and EXT2 triggers.
Initial S/W Revision	Prior to A.02.00

## External 1

Pressing this key, when it is not selected, selects an external input signal as the trigger. A new sweep/measurement will start when the external trigger condition is met using the external 1 input connector on the rear panel.

Pressing this key, when it is already selected, accesses the external 1 trigger setup menu.

Key Path	Trigger
<b>Example</b>	TRIG:SOUR EXT1 Swept SA measurement TRIG:<meas>:SOUR EXT1 Measurements other than Swept SA
Dependencies	Grayed out if in use by Point Trigger in the Source Setup menu. Forced to Free Run if already selected and Point Trigger is set to External 1.
State Saved	Saved in instrument state
Status Bits/OPC dependencies	The Status Operation Register bit 5 "Waiting for Trigger" is set at the same time as the Sweeping or Measuring bit is set. It is cleared when the trigger actually occurs (that is, after the trigger event occurs and all the applicable trigger criteria have been met). A corresponding pop-up message ("Waiting for trigger") is generated if no trigger signal appears after approximately 2 sec. This message goes away when a trigger signal appears.
Initial S/W Revision	Prior to A.02.00

## Trigger Level

Sets the value where the external 1 trigger input will trigger a new sweep/measurement.

Key Path	Trigger, External 1
<b>Remote Command</b>	:TRIGger[:SEQuence]:EXTernal1:LEVel <level>

	:TRIGger[:SEquence]:EXTernal1:LEVel?
<b>Example</b>	TRIG:EXT1:LEV 0.4 V
Couplings	This same level is used for the Ext1 trigger source in the Trigger menu, for the Ext1 selection in the Periodic Timer sync source (in the Trigger menu and in the Gate Source menu), and also for the Ext1 selection in the Gate Source menu.
Preset	1.2 V
State Saved	Saved in instrument state
Min	-5 V
Max	5 V
Default Unit	V
<b>Backwards Compatibility SCPI</b>	:TRIGger[:SEquence]:EXTernal:LEVel
<b>Backwards Compatibility SCPI</b>	For backward compatibility, the parameter EXTernal is mapped to EXTernal1
<b>Backwards Compatibility SCPI</b>	:TRIGger[:SEquence]:FRAMe:EXTernal1:LEVel
Initial S/W Revision	Prior to A.02.00

## Trig Slope

Controls the trigger polarity. It is set positive to trigger on a rising edge and negative to trigger on a falling edge.

Key Path	Trigger, External 1
<b>Remote Command</b>	:TRIGger[:SEquence]:EXTernal1:SLOPe POSitive NEGative :TRIGger[:SEquence]:EXTernal1:SLOPe?
<b>Example</b>	TRIG:EXT1:SLOP NEG
Couplings	This same slope is used in the Ext1 selection for the trigger source in the Trigger menu and for the period timer sync source (in the Trigger menu and in the Gate Source menu).
Preset	POSitive
State Saved	Saved in instrument state
<b>Backwards Compatibility SCPI</b>	:TRIGger[:SEquence]:EXTernal:SLOPe
<b>Backwards Compatibility SCPI</b>	For backward compatibility, the parameter EXTernal is mapped to EXTernal1
<b>Backwards Compatibility SCPI</b>	:TRIGger[:SEquence]:FRAMe:EXTernal1:SLOPe
Backwards Compatibility Notes	The legacy :TRIGger[:SEquence]:SLOPe command affects the slopes for the VID, LINE, EXT1, EXT2, and RFB triggers.
Initial S/W Revision	Prior to A.02.00

## Trig Delay

Controls a time delay during which the analyzer will wait to begin a sweep after meeting the trigger criteria. You can use negative delay to pre-trigger the instrument in time domain or FFT, but not in swept spans.

Key Path	Trigger, External 1
Remote Command	:TRIGger[:SEquence]:EXTernal1:DElay <time> :TRIGger[:SEquence]:EXTernal1:DElay? :TRIGger[:SEquence]:EXTernal1:DElay:STATe OFF ON 0 1 :TRIGger[:SEquence]:EXTernal1:DElay:STATe?
Example	TRIG:EXT1:DEL:STAT ON TRIG:EXT1:DEL 100 ms
Notes	Video trigger delay may be set to negative values, in time domain, FFT and even swept. It makes intuitive sense in time domain and works well in FFT mode where the bandwidth of the filter before the video trigger is about 1.25 span. In swept spans, negative settings of Trig Delay are treated as a zero setting within the internal hardware and the advisory message "Neg. Trig Delay unavailable in Swept Mode, zero delay used." is generated when such a delay is set.
Preset	Off, 1.000 us
State Saved	Saved in instrument state
Min	-150 ms
Max	+500 ms
Default Unit	s
Backwards Compatibility SCPI	:TRIGger[:SEquence]:EXTernal:DElay For backward compatibility, the parameter EXTernal is mapped to EXTernal1
Backwards Compatibility Notes	The legacy :TRIGger[:SEquence]:DElay command affects the delay for the VID, LINE, EXT1, EXT2, and RFB triggers. The legacy :TRIGger[:SEquence]:OFFSet command is supported for the VIDeO, LINE, EXT1, and EXT2 triggers.
Initial S/W Revision	Prior to A.02.00

## External 2

Pressing this key, when it is not selected, selects an external input signal as the trigger. A new sweep/measurement will start when the external trigger condition is met using the external 2 input connector. The external trigger 2 input connector is on the rear panel.

Pressing this key, when it is already selected, accesses the external 2 trigger setup menu.

Key Path	Trigger
Example	TRIG:SOUR EXT2      Swept SA measurement TRIG:<meas>:SOUR EXT2    Measurements other than Swept SA
Dependencies	In some models, there is no second External input. In these models, the External 2 key is blanked and

	<p>the EXTERNAL2 parameter will generate a "Hardware missing; Not available for this model number" message.</p> <p>Grayed out if in use by Point Trigger in the Source Setup menu.</p> <p>Forced to Free Run if already selected and Point Trigger is set to External 2.</p>
State Saved	Saved in instrument state
Status Bits/OPC dependencies	The Status Operation Register bit 5 "Waiting for Trigger" is set at the same time as the Sweeping or Measuring bit is set. It is cleared when the trigger actually occurs (that is, after the trigger event occurs and all the applicable trigger criteria have been met). A corresponding pop-up message ("Waiting for trigger") is generated if no trigger signal appears after approximately 2 sec. This message goes away when a trigger signal appears.
Initial S/W Revision	Prior to A.02.00
Modified at S/W Revision	A.03.00

## Trigger Level

Sets the value where the external 2 trigger input will trigger a new sweep/measurement.

Key Path	Trigger, External 2
Remote Command	:TRIGger[:SEquence]:EXTERNAL2:LEVEL :TRIGger[:SEquence]:EXTERNAL2:LEVEL?
Example	TRIG:EXT2:LEV 1.1 V
Couplings	This same level is used for the Ext2 trigger source in the Trigger menu, for the Ext2 selection in the Periodic Timer sync source (in the Trigger menu and in the Gate Source menu), and also for the Ext2 selection in the Gate Source menu.
Preset	1.2 V
State Saved	Saved in instrument state
Min	-5 V
Max	5 V
Default Unit	V
Backwards Compatibility SCPI	:TRIGger[:SEquence]:FRAME:EXTERNAL2:LEVEL
Initial S/W Revision	Prior to A.02.00

## Trig Slope

Controls the trigger polarity. It is set positive to trigger on a rising edge and negative to trigger on a falling edge.

Key Path	Trigger, External 2
Remote Command	:TRIGger[:SEquence]:EXTERNAL2:SLOPe POSitive NEGative

	:TRIGger[:SEquence]:EXTernal2:SLOPe?
<b>Example</b>	TRIG:EXT2:SLOP NEG
Couplings	This same slope is used in the Ext2 selection for the trigger source in the Trigger menu and for the period timer sync source (in the Trigger menu and in the Gate Source menu).
Preset	POSitive
State Saved	Saved in instrument state
<b>Backwards Compatibility SCPI</b>	:TRIGger[:SEquence]:FRAMe:EXTernal2:SLOPe
Backwards Compatibility Notes	The legacy :TRIGger[:SEquence]:SLOPe command affects the slopes for the VID, LINE, EXT1, EXT2, and RFB triggers.
Initial S/W Revision	Prior to A.02.00

## Trig Delay

Controls a time delay during which the analyzer will wait to begin a sweep after meeting the trigger criteria. You can use negative delay to pre-trigger the instrument in time domain or FFT, but not in swept spans.

Key Path	Trigger, External 2
<b>Remote Command</b>	:TRIGger[:SEquence]:EXTernal2:DELAy <time> :TRIGger[:SEquence]:EXTernal2:DELAy? :TRIGger[:SEquence]:EXTernal2:DELAy:STATe OFF ON 0 1 :TRIGger[:SEquence]:EXTernal2:DELAy:STATe?
<b>Example</b>	TRIG:EXT2:DEL:STAT ON TRIG:EXT2:DEL 100 ms
Notes	Video trigger delay may be set to negative values, in time domain, FFT and even swept. It makes intuitive sense in time domain and works well in FFT mode where the bandwidth of the filter before the video trigger is about 1.25 span. In swept spans, negative settings of Trig Delay are treated as a zero setting within the internal hardware and the advisory message "Neg. Trig Delay unavailable in Swept Mode, zero delay used." is generated when such a delay is set.
Preset	Off, 1.000 us
State Saved	Saved in instrument state
Min	-150 ms
Max	500 ms
Default Unit	s
Backwards Compatibility Notes	The legacy :TRIGger[:SEquence]:DELAy command affects the delay for the VID, LINE, EXT1, EXT2, and RFB triggers. The legacy :TRIGger[:SEquence]:OFFSet command is supported for the VIDeO, LINE, EXT1, and EXT2 triggers.
Initial S/W Revision	Prior to A.02.00

## RF Burst

Pressing this key, when it is not selected, selects the RF Burst as the trigger. A new sweep/measurement will start when an RF burst envelope signal is identified from the signal at the RF Input connector. Pressing this key, when it is already selected, accesses the RF Burst trigger setup menu.

In some models, a variety of burst trigger circuitry is available, resulting in various available burst trigger bandwidths. The analyzer automatically chooses the appropriate trigger path based on the hardware configuration and other settings of the analyzer.

Key Path	Trigger
<b>Example</b>	TRIG:SOUR RFB      Swept SA measurement TRIG:<meas>:SOUR RFB   Measurements other than Swept SA
State Saved	Saved in instrument state
Status Bits/OPC dependencies	The Status Operation Register bit 5 "Waiting for Trigger" is set at the same time as the Sweeping or Measuring bit is set. It is cleared when the trigger actually occurs (that is, after the trigger event occurs and all the applicable trigger criteria have been met). A corresponding pop-up message ("Waiting for trigger") is generated if no trigger signal appears after approximately 2 sec. This message goes away when a trigger signal appears.
Backwards Compatibility Notes	The legacy command: :TRIGger[:SEQuence]:RFBurst:FSElectivity[:STATe] OFF ON 0 1 is not supported in the X-Series, as the hardware to do Frequency Selective burst triggers does not exist in X-Series.
Initial S/W Revision	Prior to A.02.00
Modified at S/W Revision	A.04.00

## Absolute Trigger Level

Sets the absolute trigger level for the RF burst envelope.

When using the External Mixing path, the Absolute Trigger Level is uncalibrated because the factory default was set to accommodate the expected IF levels for the RF path.

Key Path	Trigger, RF Burst
Scope	Meas Global
<b>Remote Command</b>	:TRIGger[:SEQuence]:RFBurst:LEVel:ABSolute <ampl> :TRIGger[:SEQuence]:RFBurst:LEVel:ABSolute?
<b>Example</b>	TRIG:RFB:LEV:ABS 10 dBm sets the trigger level of the RF burst envelope signal to the absolute level of 10 dBm
Notes	Sending this command does not switch the setting from relative to absolute; to switch it you need to send the :TRIGger[:SEQuence]:RFBurst:LEVel:TYPE command, below. Amplitude Corrections are not taken into account by the Absolute Trigger Level. For example, if you have given yourself effective gain with an amplitude correction factor, the Absolute Trigger will not fire until you have set the trigger level that far below the displayed signal level, rather than simply to

	the displayed signal level. This is only true for Amplitude Corrections, not External Gain or Ref Level Offset functions. If mode is Bluetooth, the default value is -50 dBm.
Couplings	This same level is used for the RF Burst trigger source in the Trigger menu, for the RF Burst selection in the Periodic Timer sync source (in the Trigger menu and in the Gate Source menu), and also for the RF Burst selection in the Gate Source menu
Preset	-20 dBm
State Saved	Saved in instrument state
Min	-200 dBm
Max	100 dBm
Default Unit	depends on the current selected Y-Axis unit
<b>Backwards Compatibility SCPI</b>	:TRIGger[:SEquence]:FRAMe:RFBurst:LEVel:ABSolute
Initial S/W Revision	Prior to A.02.00
Modified at S/W Revision	A.04.00
<hr/>	
Key Path	Trigger, RF Burst
<b>Remote Command</b>	:TRIGger[:SEquence]:RFBurst:LEVel:TYPE ABSolute RELative :TRIGger[:SEquence]:RFBurst:LEVel:TYPE?
<b>Example</b>	TRIG:RFB:LEV:TYPE REL sets the trigger level type of the RF burst trigger to Relative.
Preset	ABSolute
State Saved	Saved in instrument state
Initial S/W Revision	Prior to A.02.00
Modified at S/W Revision	A.04.00

## Relative Trigger Level

Sets the relative trigger level for the RF burst envelope.

In some models, the relative burst trigger function is implemented in hardware. In other models, without the advanced triggering hardware required, the relative burst trigger function is implemented in software in some measurements, and is unavailable in other measurements.

When implemented in software, the relative RF Burst trigger function is implemented as follows:

1. The measurement starts with the absolute RF Burst trigger setting. If it cannot get a trigger with that level, auto trigger fires and the acquisition starts anyway. After the acquisition, the measurement searches for the peak in the acquired waveform and saves it.

2. Now, in the next cycle of the measurement, the measurement determines a new absolute RF Burst level based on the peak value from the first measurement and the Relative RF Burst Trigger Level (always 0 or negative dB) set by the user. The following formula is used:
  3. absolute RF Burst level = peak level of the previous acquisition + relative RF Burst level
  4. If the new absolute RF Burst level differs from the previous by more than 0.5 dB, the new level is sent to the hardware; otherwise it is not updated (to avoid slowing down the acquisition)
- Steps 2 and 3 repeat for subsequent measurements.

Key Path	Trigger, RF Burst
Scope	Meas Global
Remote Command	:TRIGger[:SEquence]:RFBurst:LEVel:RELative <rel_ampl> :TRIGger[:SEquence]:RFBurst:LEVel:RELative?
Example	TRIG:RFB:LEV:REL -10 dB sets the trigger level of the RF burst envelope signal to the relative level of -10 dB
Notes	Sending this command does not switch the setting from absolute to relative; to switch it you need to send the :TRIGger[:SEquence]:RFBurst:LEVel:TYPE command, above. The relative trigger level is not available in some measurements. In those measurements the RELative parameter, and the :TRIGger[:SEquence]:RFBurst:LEVel:TYPE command (above), will generate an error if sent.
Dependencies	This key is grayed out and Absolute Trigger Level selected if the required hardware is not present in your analyzer and the current measurement does not support Relative triggering.
Preset	-6 dB GSM: -25 dB
State Saved	Saved in instrument state
Min	-45 dB
Max	0 dB
Default Unit	dB or dBc
Backwards Compatibility SCPI	:TRIGger[:SEquence]:RFBurst:LEVel This legacy command is aliased to :TRIGger[:SEquence]:RFBurst:LEVel:RELative because the PSA had ONLY relative burst triggering
Initial S/W Revision	Prior to A.02.00
Modified at S/W Revision	A.04.00

## Trigger Slope

It is set positive to trigger on a rising edge and negative to trigger on a falling edge.

Key Path	Trigger, RF Burst
Remote Command	:TRIGger[:SEquence]:RFBurst:SLOPe POSitive NEGative :TRIGger[:SEquence]:RFBurst:SLOPe?



<b>Example</b>	TRIG:RFB:SLOP NEG
Couplings	This same slope is used in the RF Burst selection for the trigger source in the Trigger menu and for the period timer sync source (in the Trigger menu and in the Gate Source menu).
Preset	POSitive
State Saved	Saved in instrument state
<b>Backwards Compatibility SCPI</b>	:TRIGger[:SEQuence]:FRAMe:RFBurst:SLOPe
Backwards Compatibility Notes	The legacy :TRIGger[:SEQuence]:SLOPe command affects the slopes for the VID, LINE, EXT1, EXT2, and RFB triggers.
Initial S/W Revision	Prior to A.02.00

## Trig Delay

Controls a time delay during which the analyzer will wait to begin a sweep after meeting the trigger criteria. You can use negative delay to pre-trigger the instrument in time domain or FFT, but not in swept spans.

Key Path	Trigger, RF Burst
<b>Remote Command</b>	:TRIGger[:SEQuence]:RFBurst:DELAy <time> :TRIGger[:SEQuence]:RFBurst:DELAy? :TRIGger[:SEQuence]:RFBurst:DELAy:STATe OFF ON 0 1 :TRIGger[:SEQuence]:RFBurst:DELAy:STATe?
<b>Example</b>	TRIG:RFB:DEL:STAT ON TRIG:RFB:DEL 100 ms
Notes	Video trigger delay may be set to negative values, in time domain, FFT and even swept. It makes intuitive sense in time domain and works well in FFT mode where the bandwidth of the filter before the video trigger is about 1.25 span. In swept spans, negative settings of Trig Delay are treated as a zero setting within the internal hardware and the advisory message "Neg. Trig Delay unavailable in Swept Mode, zero delay used." is generated when such a delay is set.
Preset	Off, 1.000 us
State Saved	Saved in instrument state
Min	-150 ms
Max	500 ms
Default Unit	s
Backwards Compatibility Notes	The legacy :TRIGger[:SEQuence]:DELAy command affects the delay for the VID, LINE, EXT1, EXT2, and RFB triggers.
Initial S/W Revision	Prior to A.02.00

## Periodic Timer (Frame Trigger)

Pressing this key, when it is not selected, selects the internal periodic timer signal as the trigger. Triggering occurrences are set by the **Period** parameter, which is modified by the **Sync Source** and **Offset**. Pressing this key, when it is already selected, accesses the periodic timer trigger setup functions.

If you do not have a sync source selected (it is Off), then the internal timer will not be synchronized with any external timing events.

Key Path	Trigger
Example	TRIG:SOUR FRAM Swept SA measurement
	TRIG:< meas>:SOUR FRAM Measurements other than Swept SA
State Saved	Saved in instrument state
Readback	[Sync: <value of Sync Source>], for example, [Sync: External 1]
Status Bits/OPC dependencies	The Status Operation Register bit 5 "Waiting for Trigger" is set at the same time as the Sweeping or Measuring bit is set. It is cleared when the trigger actually occurs (that is, after the trigger event occurs and all the applicable trigger criteria have been met). A corresponding pop-up message ("Waiting for trigger") is generated if no trigger signal appears after approximately 2 sec. This message goes away when a trigger signal appears.
Initial S/W Revision	Prior to A.02.00

Periodic Timer Triggering:

This feature selects the internal periodic timer signal as the trigger. Trigger occurrences are set by the **Periodic Timer** parameter, which is modified by the **Sync Source** and **Offset**.

The figure below shows the action of the periodic timer trigger. Before reviewing the figure, we'll explain some uses for the periodic trigger.

A common application is measuring periodic burst RF signals for which a trigger signal is not easily available. For example, we might be measuring a TDMA radio which bursts every 20 ms. Let's assume that the 20 ms period is very consistent. Let's also assume that we do not have an external trigger source available that is synchronized with the period, and that the signal-to-noise ratio of the signal is not high enough to provide a clean RF burst trigger at all of the analysis frequencies. For example, we might want to measure spurious transmissions at an offset from the carrier that is larger than the bandwidth of the RF burst trigger. In this application, we can set the Periodic Timer to a 20.00 ms period and adjust the offset from that timer to position our trigger just where we want it. If we find that the 20.00 ms is not exactly right, we can adjust the period slightly to minimize the drift between the period timer and the signal to be measured.

A second way to use this feature would be to use **Sync Source** temporarily, instead of **Offset**. In this case, we might tune to the signal in a narrow span and use the RF Burst trigger to synchronize the periodic timer. Then we would turn the sync source off so that it would not miss-trigger. Miss-triggering can occur when we are tuned so far away from the RF burst trigger that it is no longer reliable.

A third example would be to synchronize to a signal that has a reference time element of much longer period than the period of interest. In some CDMA applications, it is useful to look at signals with a short periodicity, by synchronizing that periodicity to the "even-second clock" edge that happens every two

seconds. Thus, we could connect the even-second clock trigger to Ext1 and use then Ext1 as the sync source for the periodic timer.

The figure below illustrates this third example. The top trace represents the even-second clock. It causes the periodic timer to synchronize with the leading edge shown. The analyzer trigger occurs at a time delayed by the accumulated offset from the period trigger event. The periodic timer continues to run, and triggers continue to occur, with a periodicity determined by the analyzer time base. The timer output (labeled "late event") will drift away from its ideal time due to imperfect matching between the time base of the signal being measured and the time base of the analyzer, and also because of imperfect setting of the period parameter. But the synchronization is restored on the next even-second clock event. ("Accumulated offset" is described in the in the **Offset** function section.)

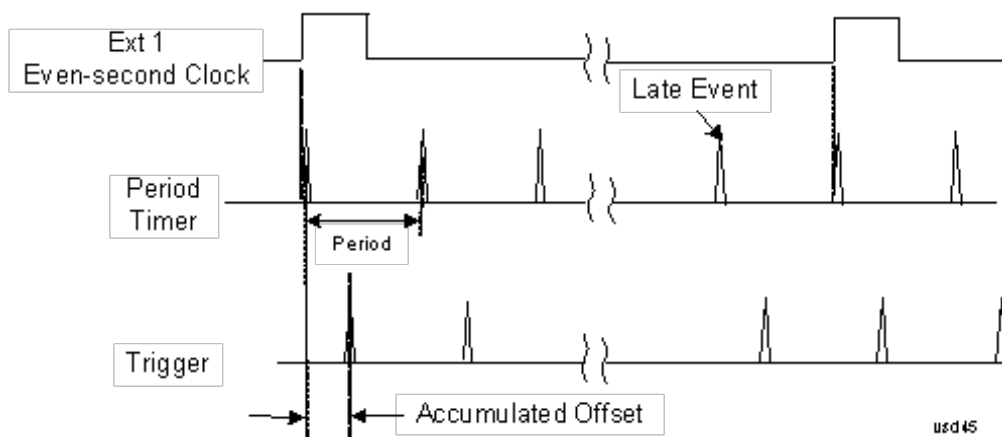

## Period

Sets the period of the internal periodic timer clock. For digital communications signals, this is usually set to the frame period of your current input signal. In the case that sync source is not set to OFF, and the external sync source rate is changed for some reason, the periodic timer is synchronized at the every external synchronization pulse by resetting the internal state of the timer circuit.

Key Path	Trigger, Periodic Timer
Remote Command	:TRIGger[:SEquence]:FRAMe:PERiod <time> :TRIGger[:SEquence]:FRAMe:PERiod?
Example	TRIG:FRAM:PER 100 ms
Dependencies	The invalid data indicator turns on when the period is changed, until the next sweep/measurement completes.
Couplings	The same period is used in the Gate Source selection of the period timer.
Preset	20 ms GSM: 4.615383
State Saved	Saved in instrument state
Min	100.000 ns
Max	559.0000 ms
Default Unit	S
Initial S/W Revision	Prior to A.02.00

## Offset

Adjusts the accumulated offset between the periodic timer events and the trigger event. Adjusting the accumulated offset is different than setting an offset, and requires explanation.

The periodic timer is usually not synchronized with any external events, so the timing of its output events has no absolute meaning. Since the timing relative to external events (RF signals) is important, you need to be able to adjust (offset) it. However, you have no direct way to see when the periodic timer events occur. All that you can see is the trigger timing. When you want to adjust the trigger timing, you will be changing the internal offset between the periodic timer events and the trigger event. Because the absolute value of that internal offset is unknown, we will just call that the accumulated offset. Whenever the Offset parameter is changed, you are changing that accumulated offset. You can reset the displayed offset using Reset Offset Display. Changing the display does not change the value of the accumulated offset, and you can still make additional changes to accumulated offset.

To avoid ambiguity, we define that an increase in the "offset" parameter, either from the knob or the SCPI adjust command, serves to delay the timing of the trigger event.

<b>Key Path</b>	Trigger, Periodic Timer
<b>Remote Command</b>	:TRIGger[:SEquence]:FRAMe:OFFSet <time> :TRIGger[:SEquence]:FRAMe:OFFSet?
<b>Example</b>	TRIG:FRAM:OFFS 1.2 ms
<b>Notes</b>	<p>The front panel interface (for example, the knob), and this command, adjust the accumulated offset, which is shown on the active function display. However, the actual amount sent to the hardware each time the offset is updated is the delta value, that is, the current accumulated offset value minus the previous accumulated offset value. Note that the accumulated offset value is essentially arbitrary; it represents the accumulated offset from the last time the offset was zeroed (with the Reset Offset Display key).</p> <p>Note that this command does not change the period of the trigger waveform. Note also that Offset is used only when the sync source is set to OFF, otherwise delay is used, see section "<a href="#">Trig Delay</a>" on <a href="#">page 443</a>.</p> <p>An increase in the "offset" parameter, either from the knob or the SCPI adjust command, serves to delay the timing of the trigger event.</p>
<b>Notes</b>	<p>When the SCPI command is sent the value shown on the key (and the Active Function, if this happens to be the active function) is updated with the new value. However, the actual amount sent to the hardware is the delta value, that is, the current accumulated offset value minus the previous accumulated offset value.</p> <p>The SCPI query simply returns the value currently showing on the key.</p>
<b>Dependencies</b>	The invalid data indicator turns on when the offset is changed, until the next sweep/measurement completes.
<b>Couplings</b>	The same offset is used in the Gate Source selection of the period timer.
<b>Preset</b>	0 s
<b>State Saved</b>	Saved in instrument state
<b>Min</b>	-10.000 s
<b>Max</b>	10.000 s

Default Unit	S
Initial S/W Revision	Prior to A.02.00

## Reset Offset Display

Resets the value of the periodic trigger offset display setting to 0.0 seconds. The current displayed trigger location may include an offset value defined with the Offset key. Pressing this key redefines the currently displayed trigger location as the new trigger point that is 0.0 s offset. The Offset key can then be used to add offset relative to this new timing.

Key Path	Trigger, Periodic Timer
<b>Remote Command</b>	:TRIGger[:SEquence]:FRAMe:OFFSet:DISPlay:RESet
<b>Example</b>	TRIG:FRAM:OFFS:DISP:RES
Initial S/W Revision	Prior to A.02.00

## Sync Source

Selects a signal source for you to synchronize your periodic timer trigger to, otherwise you are triggering at some arbitrary location in the frame. Synchronization reduces the precision requirements on the setting of the period.

For convenience you may adjust the level and slope of the selected sync source in a conditional branch setup menu accessed from the Sync Source menu. Note that these settings match those in the **Trigger** and **Gate Source** menus; that is, each trigger source has only one value of level and slope, regardless of which menu it is accessed from.

Key Path	Trigger, Periodic Timer
<b>Remote Command</b>	:TRIGger[:SEquence]:FRAMe:SYNC EXTernal1   EXTernal2   RFBurst   OFF :TRIGger[:SEquence]:FRAMe:SYNC?
<b>Example</b>	TRIG:FRAM:SYNC EXT2
Dependencies	In some models, there is no second External input. In these models, the External 2 key is blanked and the EXTernal2 parameter will generate a "Hardware missing; Not available for this model number" message.
Preset	Off GSM/EDGE, MSR,LTE,LTETDD: RFBurst
State Saved	Saved in instrument state
Readback	The current setting is read back to this key and it is also Readback to the previous Periodic Timer trigger key.
<b>Backwards Compatibility SCPI</b>	:TRIGger[:SEquence]:FRAMe:SYNC EXTernal For backward compatibility, the parameter EXTernal is mapped to EXTernal1
Initial S/W Revision	Prior to A.02.00
Modified at S/W Revision	A.03.00, A.14.00

## Off

Turns off the sync source for your periodic trigger. With the sync source off, the timing will drift unless the signal source frequency is locked to the analyzer frequency reference.

Key Path	Trigger, Periodic Timer, Sync Source
<b>Example</b>	TRIG:FRAM:SYNC OFF
Readback	Off
Initial S/W Revision	Prior to A.02.00

## External 1

Pressing this key, when it is not selected, selects an external input signal as the trigger. A new sweep/measurement will start when the external trigger condition is met using the external 1 input connector on the rear panel.

Pressing this key, when it is already selected, accesses the external 1 trigger setup menu.

Key Path	Trigger
<b>Example</b>	TRIG:SOUR EXT1          Swept SA measurement TRIG:<meas>:SOUR EXT1   Measurements other than Swept SA
Dependencies	Grayed out if in use by Point Trigger in the Source Setup menu. Forced to Free Run if already selected and Point Trigger is set to External 1.
State Saved	Saved in instrument state
Status Bits/OPC dependencies	The Status Operation Register bit 5 "Waiting for Trigger" is set at the same time as the Sweeping or Measuring bit is set. It is cleared when the trigger actually occurs (that is, after the trigger event occurs and all the applicable trigger criteria have been met). A corresponding pop-up message ("Waiting for trigger") is generated if no trigger signal appears after approximately 2 sec. This message goes away when a trigger signal appears.
Initial S/W Revision	Prior to A.02.00

## Trigger Level

Sets the value where the external 1 trigger input will trigger a new sweep/measurement.

Key Path	Trigger, External 1
<b>Remote Command</b>	:TRIGger[:SEquence]:EXTernal1:LEVel <level> :TRIGger[:SEquence]:EXTernal1:LEVel?
<b>Example</b>	TRIG:EXT1:LEV 0.4 V
Couplings	This same level is used for the Ext1 trigger source in the Trigger menu, for the Ext1 selection in the Periodic Timer sync source (in the Trigger menu and in the Gate Source menu), and also for the Ext1

	selection in the Gate Source menu.
Preset	1.2 V
State Saved	Saved in instrument state
Min	-5 V
Max	5 V
Default Unit	V
<b>Backwards Compatibility SCPI</b>	:TRIGger[:SEquence]:EXTernal:LEVel
	For backward compatibility, the parameter EXTernal is mapped to EXTernal1
<b>Backwards Compatibility SCPI</b>	:TRIGger[:SEquence]:FRAMe:EXTernal1:LEVel
Initial S/W Revision	Prior to A.02.00

### Trig Slope

Controls the trigger polarity. It is set positive to trigger on a rising edge and negative to trigger on a falling edge.

Key Path	Trigger, External 1
<b>Remote Command</b>	:TRIGger[:SEquence]:EXTernal1:SLOPe POSitive NEGative :TRIGger[:SEquence]:EXTernal1:SLOPe?
<b>Example</b>	TRIG:EXT1:SLOP NEG
Couplings	This same slope is used in the Ext1 selection for the trigger source in the Trigger menu and for the period timer sync source (in the Trigger menu and in the Gate Source menu).
Preset	POSitive
State Saved	Saved in instrument state
<b>Backwards Compatibility SCPI</b>	:TRIGger[:SEquence]:EXTernal:SLOPe
	For backward compatibility, the parameter EXTernal is mapped to EXTernal1
<b>Backwards Compatibility SCPI</b>	:TRIGger[:SEquence]:FRAMe:EXTernal1:SLOPe
Backwards Compatibility Notes	The legacy :TRIGger[:SEquence]:SLOPe command affects the slopes for the VID, LINE, EXT1, EXT2, and RFB triggers.
Initial S/W Revision	Prior to A.02.00

### External 2

Pressing this key, when it is not selected, selects an external input signal as the trigger. A new sweep/measurement will start when the external trigger condition is met using the external 2 input connector. The external trigger 2 input connector is on the rear panel.

Pressing this key, when it is already selected, accesses the external 2 trigger setup menu.

Key Path	Trigger
<b>Example</b>	TRIG:SOUR EXT2 Swept SA measurement TRIG:<meas>:SOUR EXT2 Measurements other than Swept SA
Dependencies	In some models, there is no second External input. In these models, the External 2 key is blanked and the EXTERNAL2 parameter will generate a "Hardware missing; Not available for this model number" message. Grayed out if in use by Point Trigger in the Source Setup menu. Forced to Free Run if already selected and Point Trigger is set to External 2.
State Saved	Saved in instrument state
Status Bits/OPC dependencies	The Status Operation Register bit 5 "Waiting for Trigger" is set at the same time as the Sweeping or Measuring bit is set. It is cleared when the trigger actually occurs (that is, after the trigger event occurs and all the applicable trigger criteria have been met). A corresponding pop-up message ("Waiting for trigger") is generated if no trigger signal appears after approximately 2 sec. This message goes away when a trigger signal appears.
Initial S/W Revision	Prior to A.02.00
Modified at S/W Revision	A.03.00

### Trigger Level

Sets the value where the external 2 trigger input will trigger a new sweep/measurement.

Key Path	Trigger, External 2
<b>Remote Command</b>	:TRIGger[:SEquence]:EXTernal2:LEVel :TRIGger[:SEquence]:EXTernal2:LEVel?
<b>Example</b>	TRIG:EXT2:LEV 1.1 V
Couplings	This same level is used for the Ext2 trigger source in the Trigger menu, for the Ext2 selection in the Periodic Timer sync source (in the Trigger menu and in the Gate Source menu), and also for the Ext2 selection in the Gate Source menu.
Preset	1.2 V
State Saved	Saved in instrument state
Min	-5 V
Max	5 V
Default Unit	V
<b>Backwards Compatibility SCPI</b>	:TRIGger[:SEquence]:FRAMe:EXTernal2:LEVel
Initial S/W Revision	Prior to A.02.00



## Trig Slope

Controls the trigger polarity. It is set positive to trigger on a rising edge and negative to trigger on a falling edge.

Key Path	Trigger, External 2
<b>Remote Command</b>	:TRIGger[:SEquence]:EXTernal2:SLOPe POSitive NEGative :TRIGger[:SEquence]:EXTernal2:SLOPe?
<b>Example</b>	TRIG:EXT2:SLOP NEG
Couplings	This same slope is used in the Ext2 selection for the trigger source in the Trigger menu and for the period timer sync source (in the Trigger menu and in the Gate Source menu).
Preset	POSitive
State Saved	Saved in instrument state
<b>Backwards Compatibility SCPI</b>	:TRIGger[:SEquence]:FRAMe:EXTernal2:SLOPe
Backwards Compatibility Notes	The legacy :TRIGger[:SEquence]:SLOPe command affects the slopes for the VID, LINE, EXT1, EXT2, and RFB triggers.
Initial S/W Revision	Prior to A.02.00

## RF Burst

Pressing this key, when it is not selected, selects the RF Burst as the trigger. A new sweep/measurement will start when an RF burst envelope signal is identified from the signal at the RF Input connector. Pressing this key, when it is already selected, accesses the RF Burst trigger setup menu.

In some models, a variety of burst trigger circuitry is available, resulting in various available burst trigger bandwidths. The analyzer automatically chooses the appropriate trigger path based on the hardware configuration and other settings of the analyzer.

Key Path	Trigger
<b>Example</b>	TRIG:SOUR RFB Swept SA measurement TRIG:<meas>:SOUR RFB Measurements other than Swept SA
State Saved	Saved in instrument state
Status Bits/OPC dependencies	The Status Operation Register bit 5 "Waiting for Trigger" is set at the same time as the Sweeping or Measuring bit is set. It is cleared when the trigger actually occurs (that is, after the trigger event occurs and all the applicable trigger criteria have been met). A corresponding pop-up message ("Waiting for trigger") is generated if no trigger signal appears after approximately 2 sec. This message goes away when a trigger signal appears.
Backwards Compatibility Notes	The legacy command: :TRIGger[:SEquence]:RFBurst:FSElectivity[:STATe] OFF ON 0 1 is not supported in the X-Series, as the hardware to do Frequency Selective burst triggers does not exist in X-Series.
Initial S/W Revision	Prior to A.02.00
Modified at S/W Revision	A.04.00

### Absolute Trigger Level

Sets the absolute trigger level for the RF burst envelope.

When using the External Mixing path, the Absolute Trigger Level is uncalibrated because the factory default was set to accommodate the expected IF levels for the RF path.

Key Path	Trigger, RF Burst
Scope	Meas Global
<b>Remote Command</b>	:TRIGger[:SEquence]:RFBurst:LEVel:ABSolute <ampl> :TRIGger[:SEquence]:RFBurst:LEVel:ABSolute?
<b>Example</b>	TRIG:RFB:LEV:ABS 10 dBm sets the trigger level of the RF burst envelope signal to the absolute level of 10 dBm
Notes	Sending this command does not switch the setting from relative to absolute; to switch it you need to send the :TRIGger[:SEquence]:RFBurst:LEVel:TYPE command, below.  Amplitude Corrections are not taken into account by the Absolute Trigger Level. For example, if you have given yourself effective gain with an amplitude correction factor, the Absolute Trigger will not fire until you have set the trigger level that far below the displayed signal level, rather than simply to the displayed signal level. This is only true for Amplitude Corrections, not External Gain or Ref Level Offset functions.  If mode is Bluetooth, the default value is -50 dBm.
Couplings	This same level is used for the RF Burst trigger source in the Trigger menu, for the RF Burst selection in the Periodic Timer sync source (in the Trigger menu and in the Gate Source menu), and also for the RF Burst selection in the Gate Source menu
Preset	-20 dBm
State Saved	Saved in instrument state
Min	-200 dBm
Max	100 dBm
Default Unit	depends on the current selected Y-Axis unit
<b>Backwards Compatibility SCPI</b>	:TRIGger[:SEquence]:FRAME:RFBurst:LEVel:ABSolute
Initial S/W Revision	Prior to A.02.00
Modified at S/W Revision	A.04.00

Key Path	Trigger, RF Burst
<b>Remote Command</b>	:TRIGger[:SEquence]:RFBurst:LEVel:TYPE ABSolute RELative :TRIGger[:SEquence]:RFBurst:LEVel:TYPE?
<b>Example</b>	TRIG:RFB:LEV:TYPE REL sets the trigger level type of the RF burst trigger to Relative.
Preset	ABSolute

State Saved	Saved in instrument state
Initial S/W Revision	Prior to A.02.00
Modified at S/W Revision	A.04.00

### Trigger Slope

It is set positive to trigger on a rising edge and negative to trigger on a falling edge.

Key Path	Trigger, RF Burst
<b>Remote Command</b>	:TRIGger[:SEquence]:RFBurst:SLOPe POSitive NEGative :TRIGger[:SEquence]:RFBurst:SLOPe?
<b>Example</b>	TRIG:RFB:SLOP NEG
Couplings	This same slope is used in the RF Burst selection for the trigger source in the Trigger menu and for the period timer sync source (in the Trigger menu and in the Gate Source menu).
Preset	POSitive
State Saved	Saved in instrument state
<b>Backwards Compatibility SCPI</b>	:TRIGger[:SEquence]:FRAME:RFBurst:SLOPe
Backwards Compatibility Notes	The legacy :TRIGger[:SEquence]:SLOPe command affects the slopes for the VID, LINE, EXT1, EXT2, and RFB triggers.
Initial S/W Revision	Prior to A.02.00

### Trig Delay

This setting delays the measurement timing relative to the Periodic Timer.

Key Path	Trigger, Periodic Timer
<b>Remote Command</b>	:TRIGger[:SEquence]:FRAME:DELAy <time> :TRIGger[:SEquence]:FRAME:DELAy? :TRIGger[:SEquence]:FRAME:DELAy:STATE OFF ON 0 1 :TRIGger[:SEquence]:FRAME:DELAy:STATE?
Notes	Note that delay is used when the sync source is not set to OFF. If the sync source is set to OFF, offset is used.
Preset	Off, 1.000 us
State Saved	Saved in instrument state
Min	-150 ms
Max	+500 ms
Default Unit	s
Initial S/W Revision	Prior to A.02.00

## Auto/Holdoff

Opens up a menu that lets you adjust Auto Trigger and Trigger Holdoff parameters

Key Path	Trigger
Readback line	<p>Displays a summary of the Auto Trig and Holdoff settings, in square brackets</p> <p>First line: Auto Off or Auto On</p> <p>Second Line: "Hldf" followed by:</p> <ul style="list-style-type: none"> <li>• If Holdoff is Off, readback Off</li> <li>• If Holdoff On and Type = Normal, readback value</li> <li>• If Holdoff On and Type = Above, readback value followed by AL</li> <li>• If Holdoff On and Type = Below, readback value followed by BL</li> <li>• If Holdoff Type selection is not supported by the current measurement, Holdoff Type is always Normal</li> </ul>
Initial S/W Revision	A.02.00

## Auto Trig

Sets the time that the analyzer will wait for the trigger conditions to be met. If they are not met after that much time, then the analyzer is triggered anyway.

Key Path	Trigger, Auto/Holdoff
<b>Remote Command</b>	<pre>:TRIGger[:SEquence]:ATRigger &lt;time&gt; :TRIGger[:SEquence]:ATRigger? :TRIGger[:SEquence]:ATRigger:STATe OFF ON 0 1 :TRIGger[:SEquence]:ATRigger:STATe?</pre>
<b>Example</b>	<pre>TRIG:ATR:STAT ON TRIG:ATR 100 ms</pre>
Notes	The "time that the analyzer will wait" starts when the analyzer is ready for a trigger, which may be hundreds of ms after the data acquisition for a sweep is done. The "time" ends when the trigger condition is satisfied, not when the delay ends.
Preset	Off, 100 ms
State Saved	Saved in instrument state
Min	1 ms
Max	100 s
Default Unit	s
Initial S/W Revision	Prior to A.02.00

## Trig Holdoff

Sets the holdoff time between triggers. When the trigger condition is satisfied, the trigger occurs, the delay begins, and the holdoff time begins. New trigger conditions will be ignored until the holdoff time expires. For a free-running trigger, the holdoff value is the minimum time between triggers.

Key Path	Trigger, Auto/Holdoff
Remote Command	:TRIGger[:SEquence]:HOLDoff <time> :TRIGger[:SEquence]:HOLDoff? :TRIGger[:SEquence]:HOLDoff:STATe OFF ON 0 1 :TRIGger[:SEquence]:HOLDoff:STATe?
Example	TRIG:HOLD:STAT ON TRIG:HOLD 100 ms
Dependencies	Unavailable if the selected Input is BBIQ. If this is the case, the key is grayed out if it is pressed the informational message "Feature not supported for this Input" is displayed. If the SCPI command is sent, the error "Settings conflict; Feature not supported for this Input" is generated.
Preset	Off, 100 ms
State Saved	Saved in instrument state
Min	0 s
Max	0.5 s
Default Unit	s
Initial S/W Revision	Prior to A.02.00



## 8 Channel Power Measurement

The Channel Power measurement is used to find the total power present in a specified bandwidth. The power spectral density (the power in the signal normalized to 1 Hz) is also reported (In WLAN mode or WLAN radio standard in SA mode, the peak power spectral density for 1 MHz is reported). For measurement results and views, see ["View/Display" on page 625](#).

This topic contains the following sections:

["Measurement Commands for Channel Power" on page 448](#)

["Remote CommandResults for Channel Power Measurement" on page 449](#)

## Measurement Commands for Channel Power

These commands are used to measure the total rms power in a specified integration bandwidth.

Use :INSTrument:SElect to set the mode.

```
:CONFigure:CHPower
:CONFigure:CHPower:NDEfault
:INITiate:CHPower
:FETCh:CHPower[n]?
:MEASure:CHPower[n]?
:READ:CHPower[n]?
:FETCh:CHPower:CHPower?
:MEASure:CHPower:CHPower?
:READ:CHPower:CHPower?
:FETCh:CHPower:DENSity?
:MEASure:CHPower:DENSity?
:READ:CHPower:DENSity
```

For more measurement related commands, see the SENSE subsystem, and the section "[Remote Measurement Functions](#)" on page 2165.



## Remote CommandResults for Channel Power Measurement

For DVB-T/H and DTMB (CTTB) mode, see ["DVB-T/H and DTMB \(CTTB\) Mode Remote Command Results" on page 450](#).

For ISDB-T and CMMB mode, see ["ISDB-T and CMMB mode Remote Command Results" on page 452](#).

For MSR, see ["Remote Command Results for WLAN Channel Power Measurement" on page 455](#)

For LTE-Advanced FDD/TDD, see ["LTE-Advanced FDD/TDD Mode Remote Command Results " on page 454](#)

For WLAN, see ["MSR Mode Remote Command Results" on page 453](#)

Command	Return Value
FETCh:CHPower[n]?	Refer to the table below.
MEASure:CHPower[n]?	
READ:CHPower[n]?	
FETCh:CHPower:CHPower?	Returns the Channel Power (dBm) (BW compatibility functionality)
MEASure:CHPower:CHPower?	
READ:CHPower:CHPower?	
FETCh:CHPower:DENSity?	Returns the Power Spectral Density (dBm/Hz) (BW compatibility functionality)
MEASure:CHPower:DENSity?	
READ:CHPower:DENSity?	

n	Results Returned
n=1 (or not specified)	Returns scalar results: <ol style="list-style-type: none"> <li>1. Channel Power is a floating point number representing the total channel power in the specified integration bandwidth.</li> <li>2. PSD (Power Spectral Density) is the power in the specified unit bandwidth. The unit bandwidth is selected by the PSD Unit parameter in either dBm/Hz or dBm/MHz.</li> </ol>
2	Returns floating point numbers that are the captured trace data of the power (in dBm/resolution BW) of the signal. The frequency span of the captured trace data is specified by the Span key.

## DVB-T/H and DTMB (CTTB) Mode Remote Command Results

The following commands are available only for DVB-T/H and DTMB (CTTB) mode.

Condition	n	Results Returned
	n=1 (or not specified)	Returns scalar results: 1. Channel Power is a floating point number representing the total channel power in the specified integration bandwidth. 2. PSD (Power Spectral Density) is the power in the specified unit bandwidth. The unit bandwidth is selected by the PSD Unit parameter in either dBm/Hz or dBm/MHz.
	2	Returns floating point numbers that are the captured trace data of the power (in dBm/resolution BW) of the signal. The frequency span of the captured trace data is specified by the Span key.
Mode = DVB-T/H or Mode = DTMB (CTTB)	3	Returns 7 comma-separated scalar results, in the following order. 1. The shoulder attenuation result (dB) 2. Lower shoulder attenuation result (dB) 3. Upper shoulder attenuation result (dB) 4. Lower Offset - MAX shoulder point power (dBm) 5. Lower Offset - MAX shoulder point frequency (MHz) 6. Upper Offset - MAX shoulder point power (dBm) 7. Upper Offset - MAX shoulder point frequency (MHz) If the results are not available, -999.0 is returned. For example, if current view is RF spectrum or spectrum mask, -999.0 is returned.
Mode = DVB-T/H or Mode = DTMB (CTTB)	4	Returns floating point numbers that are the captured trace data of the power (in dBm/resolution BW) of the signal in the left graph of the shoulder attenuation view. If the results are not available, -999.0 is returned. For example, if current view is RF spectrum or spectrum mask, -999.0 is returned.
Mode = DVB-T/H or Mode = DTMB (CTTB)	5	Returns floating point numbers that are the captured trace data of the power (in dBm/resolution BW) of the signal in the right graph of the shoulder attenuation view. If the results are not available, -999.0 is returned. For example, if current view is RF spectrum or spectrum mask, -999.0 is returned.
Mode = DVB-T/H or Mode = DTMB (CTTB)	6	Returns floating point numbers that are the captured trace data of the power (in dBm/resolution BW) of the mask in the spectrum mask view. If the results are not available, -999.0 is returned. For example, if current view is RF spectrum or shoulder attenuation, -999.0 is returned.
Mode = DVB-T/H or Mode = DTMB (CTTB)	7	Returns the failed point information in the following order: 1. the 1st failed point frequency (MHz) 2. the 1st failed point absolute power (dBm) 3. the 1st failed point relative power (dB) 4. the 2nd failed point frequency (MHz) 5. the 2nd failed point absolute power (dBm)

---

6. the 2nd failed point relative power (dB)

...

$3*N-2$ . the ( $3*N-2$ )th failed point frequency (MHz)

$3*N-1$ . the ( $3*N-1$ )th failed point absolute power (dBm)

$3*N$ . the ( $3*N$ )th failed point relative power (dB)

If the number of failed points is less than 20, it will show all of them (frequency, power and relative power),  $N < 20$ ;

If the number of failed points is great than 20, the first ten failed points and the last ten failed points will be show,  $N = 20$ .

If the results are not available,  $-999.0$  is returned.

For example, if current view is RF spectrum or shoulder attenuation,  $-999.0$  is returned.

---

## ISDB-T and CMMB mode Remote Command Results

The following commands are available only for ISDB-T and CMMB mode.

Condition	n	Results Returned
	n=1 (or not specified)	Returns scalar results: 1. Channel Power is a floating point number representing the total channel power in the specified integration bandwidth. 2. PSD (Power Spectral Density) is the power in the specified unit bandwidth. The unit bandwidth is selected by the PSD Unit parameter in either dBm/Hz or dBm/MHz.
	2	Returns floating point numbers that are the captured trace data of the power (in dBm/resolution BW) of the signal. The frequency span of the captured trace data is specified by the Span key.
Mode = ISDB-T or Mode = CMMB	3	Returns 7 comma-separated scalar results, in the following order. 1. The shoulder attenuation result (dB) 2. Lower shoulder attenuation result (dB) 3. Upper shoulder attenuation result (dB) 4. Lower Offset - MAX shoulder point power (dBm) 5. Lower Offset - MAX shoulder point frequency (MHz) 6. Upper Offset - MAX shoulder point power (dBm) 7. Upper Offset - MAX shoulder point frequency (MHz) If the results are not available, -999.0 is returned. For example, if current view is RF spectrum or spectrum mask, -999.0 is returned.
Mode = ISDB-T or Mode = CMMB	4	Returns floating point numbers that are the captured trace data of the power (in dBm/resolution BW) of the signal in the left window of the shoulder attenuation view. If the results are not available, -999.0 is returned. For example, if current view is RF spectrum or spectrum mask, -999.0 is returned.
Mode = ISDB-T or Mode = CMMB	5	Returns floating point numbers that are the captured trace data of the power (in dBm/resolution BW) of the signal in the right window of the shoulder attenuation view. If the results are not available, -999.0 is returned. For example, if current view is RF spectrum or spectrum mask, -999.0 is returned.

## MSR Mode Remote Command Results

The following commands are available only for MSR mode.

Condition	n	Results Returned
	n=1 (or not specified)	Returns scalar results: 1. Channel Power is a floating point number representing the total channel power in the specified integration bandwidth. 2. PSD (Power Spectral Density) is the power in the specified unit bandwidth. The unit bandwidth is selected by the PSD Unit parameter in either dBm/Hz or dBm/MHz.
	2	Returns floating point numbers that are the captured trace data of the power (in dBm/resolution BW) of the signal. The frequency span of the captured trace data is specified by the Span key.
Mode = MSR	3	Returns [Carriers] comma-separated scalar results, in the following order. 1. Total Power of Carrier 1 (dBm) 2. Total Power of Carrier 2 (dBm) ... [Carriers]. Total Power of Carrier [Carriers] (dBm) If the result is not available, NaN (9.91E+37) is returned. Number of returned values might be changed in future releases.
Mode = MSR	4	Returns comma-separated scalar results, in the following order. 1. Total Power of LTE FDD carriers (dBm) 2. Total Power of W-CDMA carriers (dBm) 3. Total Power of GSM/EDGE carriers (dBm) 4. Total Power of cdma2000 carriers (dBm) 5. Total Power of 1xEV-DO carriers (dBm) ... The number of results is incremented by one when a new format is supported. If the result is not available, NaN (9.91E+37) is returned. Number of returned values will be changed in future releases if the number of supported radio format is increased.

## LTE-Advanced FDD/TDD Mode Remote Command Results

The following commands are available only for LTE-Advanced FDD/TDD mode.

Condition	n	Results Returned
	n=1 (or not specified)	Returns scalar results: 1. Channel Power is a floating point number representing the total channel power in the specified integration bandwidth. 2. PSD (Power Spectral Density) is the power in the specified unit bandwidth. The unit bandwidth is selected by the PSD Unit parameter in either dBm/Hz or dBm/MHz.
	2	Returns floating point numbers that are the captured trace data of the power (in dBm/resolution BW) of the signal. The frequency span of the captured trace data is specified by the Span key.
Mode = LTEATDD/ LTEAFDD	3	Returns comma-separated scalar results, in the following order. 1. Total Power of Component Carrier 0 (dBm) 2. Total Power of Component Carrier 1 (dBm) 3. Total Power of Component Carrier 2 (dBm) 4. Total Power of Component Carrier 3 (dBm) 5. Total Power of Component Carrier 4 (dBm) If the result is not available, NaN (9.91E+37) is returned.
Mode = LTEATDD/ LTEAFDD	4	Returns comma-separated scalar results, in the following order. The unit bandwidth is selected by the PSD Unit parameter in either dBm/Hz or dBm/MHz. 1. Total Power Spectral Density of Component Carrier 0 (PSD Unit) 2. Total Power Spectral Density of Component Carrier 1 (PSD Unit) 3. Total Power Spectral Density of Component Carrier 2 (PSD Unit) 4. Total Power Spectral Density of Component Carrier 3 (PSD Unit) 5. Total Power Spectral Density of Component Carrier 4 (PSD Unit) If the result is not available, NaN (9.91E+37) is returned.

## Remote Command Results for WLAN Channel Power Measurement

n	Results Returned
n=1 (or not specified)	<p>Returns scalar results:</p> <p>When the radio standard is NOT WLAN 802.11ac 80 + 80 MHz:</p> <ol style="list-style-type: none"> <li>1. Channel Power is a floating point number representing the total channel power in the specified integration bandwidth.</li> <li>2. PSD (Power Spectral Density) is the power in the specified unit bandwidth. The unit bandwidth is selected by the PSD Unit parameter in either dBm/Hz or dBm/MHz.</li> </ol> <p>When the radio standard is WLAN 802.11ac 80 + 80 MHz:</p> <ol style="list-style-type: none"> <li>1. Channel Power of the carrier of which the center frequency is indicated by Freq Segment 1 is a floating point number representing the total channel power of the first segment in the specified integration bandwidth.</li> <li>2. PSD (Power Spectral Density) of the carrier of which the center frequency is indicated by Freq Segment 1 is the power in the specified unit bandwidth of the first segment. The unit bandwidth is selected by the PSD Unit parameter in either dBm/Hz or dBm/MHz.</li> <li>3. Channel Power of the carrier of which the center frequency is indicated by Freq Segment 2 is a floating point number representing the total channel power of the second segment in the specified integration bandwidth.</li> <li>4. PSD (Power Spectral Density) of the carrier of which the center frequency is indicated by Freq Segment 2 is the power in the specified unit bandwidth of the second segment. The unit bandwidth is selected by the PSD Unit parameter in either dBm/Hz or dBm/MHz.</li> </ol>
2	Returns floating point numbers that are the captured trace data of the power (in dBm/resolution BW) of the signal. The frequency span of the captured trace data is specified by the Span key.
Key Path	Meas
Mode	SA, WCDMA, C2K, WIMAX OFDMA, 1xEVDO, DVB-T/H, DTMB (CTTB), ISDB-T, CMMB, LTE, LTETDD, Digital Cable TV, WLAN, MSR, LTEAFDD, LTEATDD
Initial S/W Revision	Prior to A.02.00
Modified at S/W Revision	A.03.00

## AMPTD Y Scale

Accesses a menu of functions that enable you to set the vertical scale parameters. The parameter values are measurement independent, except all Attenuation values and the Internal Preamp selection, which are the same across all measurements.

Key Path	Front-panel key
Initial S/W Revision	Prior to A.02.00

### Ref Value

Sets the value for the absolute power reference. However, since the Auto Scaling is defaulted to On, this value is automatically determined by the measurement result. When you set a value manually, Auto Scaling automatically changes to Off.

Key Path	AMPTD Y Scale
Mode	SA, WCDMA, C2K, WIMAX OFDMA, 1xEVDO, DVB-T/H, DTMB (CTTB), ISDB-T, CMMB, LTE, LTETDD, Digital Cable TV, WLAN, MSR, LTEAFDD, LTEATDD
Remote Command	:DISPlay:CHPower:VIEW[1]:WINDow[1]:TRACe:Y[:SCALe]:RLEVel <real> :DISPlay:CHPower:VIEW[1]:WINDow[1]:TRACe:Y[:SCALe]:RLEVel?
Example	DISP:CHP:VIEW:WIND:TRAC:Y:RLEV 10 dBm DISP:CHP:VIEW:WIND:TRAC:Y:RLEV?
Notes	You must be in the Spectrum Analysis mode, W-CDMA mode, cdma2000 mode, DVB-T/H mode, DTMB (CTTB) mode, ISDB-T mode, CMMB mode, Digital Cable TV mode, LTD mode, LTE TDD mode, WLAN mode, 1xEVDO mode, MSR, LTE-Advanced FDD/TDD mode or WIMAX OFDMA mode to use this command. Use :INSTrument:SElect to set the mode.
Couplings	When the Auto Scaling is On, this value is automatically determined by the measurement result. When you set a value manually, Auto Scaling automatically changes to Off.
Preset	10.00 dBm
State Saved	Saved in instrument state.
Min	-250.00 dBm
Max	250.00 dBm
Initial S/W Revision	Prior to A.02.00
Modified at S/W Revision	A.02.00, A.03.00

### Attenuation

This menu controls the attenuator functions and interactions between the attenuation system components.

There are two attenuator configurations in the X-Series. One is a dual attenuator configuration consisting of a mechanical attenuator and an optional electronic attenuator. The other configuration uses a single



attenuator with combined mechanical and electronic sections that controls all the attenuation functions. Different models in the X-Series come with different configurations.

See "Dual Attenuator Configurations:" on page 457

See "Single Attenuator Configuration:" on page 458

Most Attenuation settings are the same for all measurements – they do not change as you change measurements. Settings like these are called “Meas Global” and are unaffected by Meas Preset.

Key Path	AMPTD Y Scale
Scope	Meas Global
Dependencies	In measurements that support the I/Q inputs, this key is unavailable when I/Q is the selected input, and is replaced by the Range key in that case.
Readback Line	Contains a summary in [ ] brackets of the current total attenuation. See the descriptions of the , " (Mech) Atten " on page 2102, and "Enable Elec Atten" on page 2104 keys for more detail on the contributors to the total attenuation.  Note that when "Pre-Adjust for Min Clip" is on, this value can change at the start of every measurement.
Initial S/W Revision	Prior to A.02.00
Modified at S/W Revision	A.03.00

### Dual Attenuator Configurations:

Configuration 1: Mechanical attenuator + optional electronic attenuator

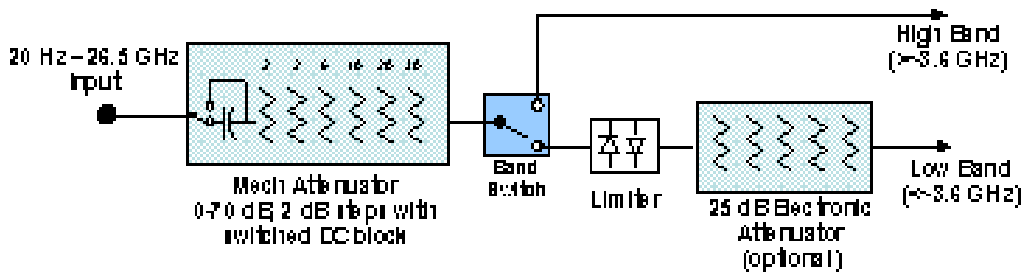

Configuration 2: Mechanical attenuator, no optional electronic attenuator

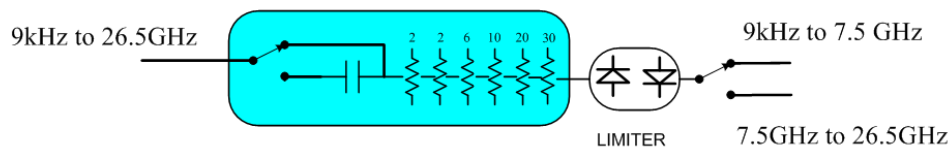

(note that Configuration 2 is not strictly speaking a dual-section attenuator, since there is no electronic section available. However, it behaves exactly like Configuration 1 without the Electronic Attenuator option EA3, therefore for the sake of this document it is grouped into the “Dual Attenuator” configuration)

### Single Attenuator Configuration:

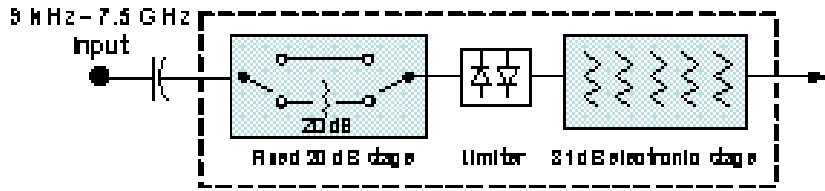

You can tell which attenuator configuration you have by pressing the Attenuation key, which (in most Modes) opens the Attenuation menu. If the first key in the Attenuation menu says Mech Atten you have the dual attenuator configuration. If the first key says Atten you have the single attenuator configuration.

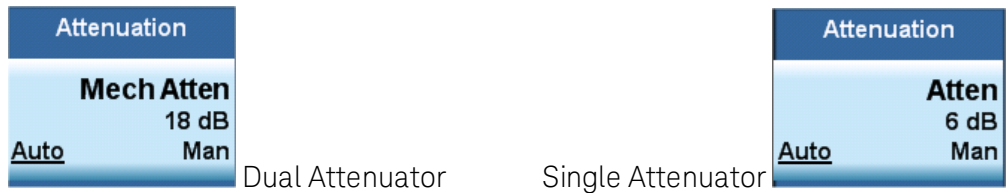

In the single attenuator configuration, you control the attenuation with a single control, as the fixed stage has only two states. In the dual attenuator configuration, both stages have significant range so you are given separate control of the mechanical and electronic attenuator stages.

When you have the dual attenuator configuration, you may still have only a single attenuator, because unless option EA3 (the Electronic Attenuator option) is available, and you purchase it, you will have only the mechanical attenuator.

### (Mech) Atten

This key is labeled Mech Atten in dual attenuator models and Atten in single attenuator models. In the dual attenuator configuration, this key only affects the mechanical attenuator.

This key lets you modify the attenuation applied to the RF input signal path. This value is normally auto coupled to the Ref Level, the Internal Preamp Gain, any External Gain that is entered, and the Max Mixer Level, as described in the table below.

See ["Attenuator Configurations and Auto/Man" on page 460](#)

Key Path	AMPTD Y Scale, Attenuation
<b>Remote Command</b>	<pre>[ :SENSe]:POWer[:RF]:ATTenuation &lt;rel_ampl&gt; [:SENSe]:POWer[:RF]:ATTenuation? [:SENSe]:POWer[:RF]:ATTenuation:AUTO OFF ON 0 1 [:SENSe]:POWer[:RF]:ATTenuation:AUTO?</pre>
<b>Example</b>	<p>POW:ATT 20</p> <p>Dual attenuator configuration: sets the mechanical attenuator to 20 dB</p> <p>Single attenuator mode: sets the main attenuation to 20 dB (see below for definition of “main” attenuation).</p> <p>If the attenuator was in Auto, it sets it to Manual.</p>
<b>Dependencies</b>	Some measurements do not support the Auto setting of (Mech) Atten. In these measurements, the

---

Auto/Man selection is not available, and the Auto/Man line on the key disappears.

In dual attenuator configurations, when the electronic attenuator is enabled, the mechanical attenuator has no auto setting and the Auto/Man line on the key disappears. The state of Auto/Man is remembered and restored when the electronic attenuator is once again disabled. This is described in more detail in the ["Enable Elec Atten" on page 2104](#) key description.

See ["Attenuator Configurations and Auto/Man" on page 460](#) for more information on the Auto/Man functionality of Attenuation.

---

Couplings

When (Mech) Atten is in Auto, it uses the following algorithm to determine a value:

If the USB Preamp is connected to USB, use 0 dB.

Otherwise,  $Atten = ReferenceLevel + PreAmpGain + ExternalGain - RefLevelOffset - MaxMixerLevel + IF\ Gain$ .

Limit this value to be between 6 dB and the Max value. No value below 6 dB can ever be chosen by Auto.

The resulting value is rounded up to the largest value possible given the attenuation step setting. That is, 50.01 dB would change to 60 dB (for a 10 dB attenuation step).

The "IF Gain" term in the equation above is either 0 dB or +10 dB, depending on the settings of FFT IF Gain, Swept IF Gain, max Ref Level and the Auto/Man setting of Mech Atten.

In External Mixing and BBIQ, where the Attenuator is not in the signal path, the Attenuator setting changes as described above when (Mech) Atten is in Auto, but no changes are made to the actual attenuator hardware setting until the input is changed back to the RF Input.

---

Preset                      The preset for Mech Attenuation is "Auto."  
                                  The Auto value of attenuation is:  
                                  CXA, EXA, MXA and PXA: 10 dB

---

State Saved                Saved in instrument state

---

Min                            0 dB

The attenuation set by this key cannot be decreased below 6 dB with the knob or step keys. To get to a value below 6 dB it has to be directly entered from the keypad or via SCPI. This protects from adjusting the attenuation to a dangerously small value which can put the instrument at risk of damage to input circuitry. However, if the current mechanical attenuation is below 6 dB it can be increased with the knob and step keys, but not decreased.

---

Max                            CXA N9000A-503/507: 50 dB  
                                  CXA N9000A-513/526: 70dB  
                                  EXA: 60 dB  
                                  MXA and PXA: 70 dB

In the single attenuator configuration, the total of ATT and EATT cannot exceed 50 dB, so if the EATT is set to 24 dB first, the main attenuation cannot be greater than 26 dB and will be reduced accordingly; if the main attenuator is set to 40 dB first, EATT cannot be greater than 10 dB.

---

Initial S/W Revision      Prior to A.02.00

---

Modified at S/W Revision   A.03.00

---

### Attenuator Configurations and Auto/Man

As described in the Attenuation key description, there are two distinct attenuator configurations available in the X-Series, the single attenuator and dual attenuator configurations. In dual attenuator configurations, we have the mechanical attenuation and the electronic attenuation, and the current total attenuation is the sum of the electronic + mechanical attenuation. In single attenuator configurations, we refer to the attenuation set using the (Mech) Atten key (or POW:ATT SCPI) as the “main” attenuation; and the attenuation that is set by the SCPI command POW:EATT as the “soft” attenuation (the POW:EATT command is honored even in the single attenuator configuration, for compatibility purposes). Then the current total attenuation is the sum of the main + soft attenuation. See the Elec Atten key description for more on “soft” attenuation.

In the dual attenuator configuration, when the electronic attenuator is enabled, there is no Auto/Man functionality for the mechanical attenuator, and the third line of the key label (the Auto/Man line) disappears:



### Enable Elec Atten

Enables the Electronic Attenuator.

The electronic attenuator offers finer steps than the mechanical attenuator, has no acoustical noise, is faster, and is less subject to wear. These advantages primarily aid in remote operation and are negligible for front panel use. See ["Using the Electronic Attenuator: Pros and Cons" on page 462](#) for a detailed discussion of the pros and cons of using the electronic attenuator.

For the single attenuator configuration, for SCPI backwards compatibility, the “soft” attenuation feature replaces the dual attenuator configuration’s electronic attenuator. All the same couplings and limitations apply. See ["Attenuator Configurations and Auto/Man" on page 2103](#)

See ["More Information" on page 461](#)

<b>Key Path</b>	AMPTD Y Scale, Attenuation
<b>Remote Command</b>	[ :SENSe ] : POWer [ :RF ] : EATTenuation : STATE OFF   ON   0   1 [ :SENSe ] : POWer [ :RF ] : EATTenuation : STATE ?
<b>Example</b>	POW:EATT:STAT ON
<b>Dependencies</b>	This key only appears in Dual Attenuator models with an Electronic Attenuator installed. It does not appear in models with the Single Attenuator configuration, as in the single attenuator configuration there is no “electronic attenuator” there is only a single integrated attenuator (which has both a mechanical and electronic stage). However, in the single attenuator configuration, EATT SCPI commands are accepted for compatibility with other X-series instruments and set a “soft” attenuation as described in <a href="#">"Attenuator Configurations and Auto/Man" on page 2103</a> . The electronic attenuator (and the “soft” attenuation function provided in single attenuator configurations) is unavailable above 3.6 GHz. Therefore, if the Stop Frequency of the analyzer is > 3.6 GHz then the Enable Elec Atten key will be OFF and grayed out.

	<p>If the Internal Preamp is on, meaning it is set to Low Band or Full, the electronic attenuator (and the “soft” attenuation function provided in single attenuator configurations) is unavailable. In this case the Enable Elec Atten key will be OFF and grayed out.</p> <p>If either of the above is true, if the SCPI command is sent, an error indicating that the electronic attenuator is unavailable will be sent.</p> <p>If the electronic/soft Attenuator is enabled, then the Stop Freq of the analyzer is limited to 3.6 GHz and the Internal Preamp is unavailable.</p> <p>The SCPI-only “soft” electronic attenuation for the single-attenuator configuration is not available in all measurements; in particular, it is not available in the Swept SA measurement.</p>
Couplings	Enabling and disabling the Electronic Attenuator affects the setting of the Mechanical Attenuator (in dual attenuator configurations). This is described in more detail below this table.
Preset	OFF for Swept SA measurement; ON for all other measurements that support the electronic attenuator
State Saved	Saved in instrument state
Initial S/W Revision	Prior to A.02.00
Modified at S/W Revision	A.03.00

## More Information

### Mechanical Attenuator Transition Rules

When the Electronic Attenuator is enabled, the Mechanical Attenuator transitions to a state that has no Auto function. Below are the rules for transitioning the Mechanical Attenuator. NOTE that the information below ONLY applies to the dual attenuator configurations, and ONLY when the Electronic Attenuator is installed:

#### When the Electronic Attenuation is enabled from a disabled state:

- The Mechanical Attenuator is initialized to 10 dB (this is its optimal performance setting). You can then set it as desired with SCPI, numeric keypad, step keys, or knob, and it behaves as it normally would in manual mode
- The Auto/Man state of (Mech) Atten is saved
- The Auto/Man line on the (Mech) Atten key disappears and the auto rules are disabled
- The Electronic Attenuator is set to 10 dB less than the previous value of the Mechanical Attenuator, within the limitation that it must stay within the range of 0 to 24 dB of attenuation.

#### Examples in the dual attenuator configuration:

- Mech Atten at 20 dB. Elec Atten enabled, Mech Atten set to 10 dB, and Elec Atten set to 10 dB. New total attenuation equals the value before Elec Atten enabled.
- Mech Atten at 0 dB. Elec Atten enabled, Mech Atten set to 10 dB, and Elec Atten set to 0 dB. New total attenuation does not equal the value before Elec Atten enabled.
- Mech Atten at 40 dB. Elec Atten enabled, Mech Atten set to 10 dB, and Elec Atten set to 24 dB. New total attenuation does not equal the value before Elec Atten enabled.

**When the Electronic Attenuation is disabled from an enabled state:**

- The Elec Atten key is grayed out
- The Auto/Man state of (Mech) Atten is restored
- If now in Auto, (Mech) Atten recouples
- If now in Man, (Mech) Atten is set to the value of total attenuation that existed before the Elec Atten was disabled. The resulting value is rounded up to the smallest value possible given the (Mech) Atten Step setting - (That is, 57 dB changes to 58 dB when (Mech) Atten Step is 2 dB.)

**Using the Electronic Attenuator: Pros and Cons**

The electronic attenuator offers finer steps than the mechanical attenuator, has no acoustical noise, is faster, and is less subject to wear.

The “finer steps” advantage of the electronic attenuator is beneficial in optimizing the alignment of the analyzer dynamic range to the signal power in the front panel as well as remote use. Thus, you can achieve improved relative signal measurement accuracy. Compared to a mechanical attenuator with 2 dB steps, the 1 dB resolution of the electronic attenuator only gives better resolution when the odd-decibel steps are used. Those odd-decibel steps are less accurately calibrated than the even-decibel steps, so one tradeoff for this superior relative accuracy is reduced absolute amplitude accuracy.

Another disadvantage of the electronic attenuator is that the spectrum analyzer loses its “Auto” setting, making operation less convenient.

Also, the relationship between the dynamic range specifications (TOI, SHI, compression and noise) and instrument performance are less well-known with the electrical attenuator. With the mechanical attenuator, TOI, SHI and compression threshold levels increase dB-for-dB with increasing attenuation, and the noise floor does as well. With the electronic attenuator, there is an excess attenuation of about 1 to 3 dB between 0 and 3.6 GHz, making the effective TOI, SHI, and so forth, less well known. Excess attenuation is the actual attenuation relative to stated attenuation. Excess attenuation is accounted for in the analyzer calibration

**Elec Atten**

Controls the Electronic Attenuator in dual attenuator configurations. This key does not appear in single attenuator configurations, as the control of both the mechanical and electronic stages of the single attenuator is integrated into the single Atten key.

<b>Key Path</b>	AMPTD Y Scale, Attenuation
<b>Remote Command</b>	[ :SENSe ] : POWer [ :RF ] : EATTenuation <rel_amp> [ :SENSe ] : POWer [ :RF ] : EATTenuation?
<b>Notes</b>	Electronic Attenuation’s specification is defined only when Mechanical Attenuation is 6 dB.
<b>Dependencies</b>	This key only appears in Dual Attenuator models with an Electronic Attenuator installed. It does not appear in models with the Single Attenuator configuration, as in the single attenuator configuration there is no “electronic attenuator” there is only a single integrated attenuator (which has both a mechanical and electronic stage). However, in the single attenuator configuration, EATT SCPI commands are accepted for compatibility with other X-series instruments and set a “soft” attenuation as described in <a href="#">"Attenuator Configurations and Auto/Man" on page 2103</a> . The “soft” attenuation is treated as an addition to the “main” attenuation value set by the Atten softkey or the

	POW:ATT SCPI command and affects the total attenuation displayed on the Attenuation key and the Meas Bar. When Enable Elec Atten is off or grayed out, the Elec Atten key is grayed out.
Preset	0 dB
State Saved	Saved in instrument state
Min	0 dB
Max	Dual attenuator configuration: 24 dB Single attenuator configuration: the total of ATT and EATT cannot exceed 50 dB, so if the EATT is set to 24 dB first, the main attenuation cannot be greater than 26 dB and will be reduced accordingly; if the main attenuator is set to 40 dB first, EATT cannot be greater than 10 dB
Initial S/W Revision	Prior to A.02.00
Modified at S/W Revision	A.03.00

### Adjust Atten for Min Clip

Sets the combination of mechanical and electronic attenuation and gain based on the current measured signal level so that clipping will be at a minimum.

This is an "immediate action" function, that is, it executes once, when the key is pressed.

This key is grayed out in measurements that do not support this functionality. The spectrum analyzer measurement, Swept SA, does not support this functionality.

Key Path	AMPTD Y Scale, Attenuation
Remote Command	<code>[ :SENSe ] :POWer [ :RF ] :RANGe:OPTimize IMMEDIATE</code>
Initial S/W Revision	Prior to A.02.00
Modified at S/W Revision	A.03.00

### Pre-Adjust for Min Clip

If this function is on, it does the adjustment described under "[Adjust Atten for Min Clip](#)" on page 2107 each time a measurement restarts. Therefore, in Continuous measurement mode, it only executes before the first measurement.

In dual attenuator models, you can set Elec+Mech Atten, in which case both attenuators participate in the autoranging, or Elec Atten Only, in which case the mechanical attenuator does not participate in the autoranging. This latter case results in less wear on the mechanical attenuator and is usually faster.

This key is grayed out in measurements that do not support this functionality. The spectrum analyzer measurement, Swept SA, does not support this functionality.

Key Path	AMPTD Y Scale, Attenuation
Remote Command	<code>[ :SENSe ] :POWer [ :RF ] :RANGe:OPTimize:ATTenuation OFF   ELECTRical   COMBined</code>

	<code>[ :SENSe ] :POWer [ :RF ] :RANGe:OPTimize:ATTenuation?</code>
Notes	The SCPI parameter ELECtrical sets this function to On in single attenuator models. The SCPI parameter COMBined is mapped to ELECtrical in single attenuator models; if you send COMBined, it sets the function to On and returns ELEC to a query.
Dependencies	This key only appears in Dual Attenuator models with an Electronic Attenuator installed. In instruments with Dual Attenuator model, when Enable Elec Atten is off or grayed out, the Pre-Adjust for Min Clip key is grayed out.
Preset	OFF for Swept SA measurement; ON for all other measurements that support Pre-Adjust for Min Clip
State Saved	Saved in instrument state
Range	Dual attenuator models: Off   Elec Atten Only   Mech + Elec Atten Single attenuator models: Off   On
Initial S/W Revision	Prior to A.02.00
Modified at S/W Revision	A.03.00

<b>Remote Command</b>	<code>[ :SENSe ] :POWer [ :RF ] :RANGe:AUTO ON OFF 1 0</code> <code>[ :SENSe ] :POWer [ :RF ] :RANGe:AUTO?</code>
Notes	ON aliases to "Elec Atten Only" (:POW:RANG:OPT:ATT ELEC) OFF aliases to "Off" (:POW:RANG:OPT:ATT OFF) The query :POW:RANG:AUTO? returns true if :POW:RANG:OPT:ATT is not "Off"
Initial S/W Revision	Prior to A.02.00

## Off

Turns Pre-Adjust for Min Clip off. This is the default setting.

This key is grayed out in measurements that do not support this functionality. The spectrum analyzer measurement, Swept SA, does not support this functionality.

Key Path	AMPTD Y Scale, Attenuation, Pre-Adjust for Min Clip
Example	:POW:RANGe:OPT:ATT OFF
Initial S/W Revision	Prior to A.02.00

## Elec Atten Only

Selects only the electric attenuator to participate in auto ranging. This offers less wear on the mechanical attenuator and is usually faster.



This key is grayed out in measurements that do not support this functionality. The spectrum analyzer measurement, Swept SA, does not support this functionality.

Key Path	AMPTD Y Scale, Attenuation, Pre-Adjust for Min Clip
Example	:POW:RANGe:OPT:ATT ELEC
Initial S/W Revision	Prior to A.02.00

### Mech + Elec Atten

In dual attenuator models, this selects both attenuators participate in the autoranging.

This key is grayed out in measurements that do not support this functionality. The spectrum analyzer measurement, Swept SA, does not support this functionality.

Key Path	AMPTD Y Scale, Attenuation, Pre-Adjust for Min Clip
Example	:POW:RANGe:OPT:ATT COMB
Initial S/W Revision	Prior to A.02.00

### (Mech) Atten Step

This controls the step size used when making adjustments to the input attenuation.

This key is labeled Mech Atten Step in dual attenuator models and Atten Step in single attenuator models. In the dual attenuator configuration, this key only affects the step size of the mechanical attenuator.

Key Path	AMPTD Y Scale, Attenuation
Remote Command	[[:SENSe]:POWer[:RF]:ATTenuation:STEP[:INCRement] 10 dB   2 dB [:SENSe]:POWer[:RF]:ATTenuation:STEP[:INCRement]?
Example	POW:ATT:STEP 2
Notes	Note this feature works like a 1-N choice from the front panel, but it takes a specific value (in dB) when used remotely. The only valid values are 2 and 10.
Dependencies	Blanked in CXA and EXA if option FSA (2 dB steps) is not present. If blanked, attempts to set it via SCPI will yield an error.
Couplings	When the attenuation step size changes, the current mechanical attenuation value is adjusted (if necessary) to be quantized to the new step size. That is, if step is set to 10 dB, mech atten is increased if necessary so it is a multiple of 10 dB
Preset	PXA and MXA: 2 dB EXA and CXA: 10 dB (2 dB with option FSA)
State Saved	Saved in instrument state
Initial S/W Revision	Prior to A.02.00
Modified at S/W Revision	A.03.00

## Scale/Div

Sets the units per division of the vertical scale in the logarithmic display. However, since the Auto Scaling is defaulted to On, this value is automatically determined by the measurement result. When you set a value manually, Auto Scaling automatically changes to Off.

<b>Key Path</b>	AMPTD Y Scale
<b>Mode</b>	SA, WCDMA, C2K, WIMAX OFDMA, 1xEVDO, DVB-T/H, DTMB (CTTB), ISDB-T, CMMB, LTE, LTETDD, Digital Cable TV, WLAN, MSR, LTEAFDD, LTEATDD
<b>Remote Command</b>	:DISPlay:CHPower:VIEW[1]:WINDow[1]:TRACe:Y[:SCALe]:PDIVision <rel_amp1> :DISPlay:CHPower:VIEW[1]:WINDow[1]:TRACe:Y[:SCALe]:PDIVision?
<b>Example</b>	DISP:CHP:VIEW:WIND:TRAC:Y:PDIV 2 DISP:CHP:VIEW:WIND:TRAC:Y:PDIV?
<b>Notes</b>	You must be in the Spectrum Analysis mode, W-CDMA mode, cdma2000 mode, DVB-T/H mode, DTMB (CTTB) mode, ISDB-T mode, CMMB mode, Digital Cable TV mode, LTE mode, LTE TDD mode, WLAN mode, 1xEVDO mode, MSR, LTE-Advanced FDD/TDD mode or WIMAX OFDMA mode to use this command. Use :INSTrument:SElect to set the mode.
<b>Couplings</b>	When the Auto Scaling is On, this value is automatically determined by the measurement result. When you set a value manually, Auto Scaling automatically changes to Off.
<b>Preset</b>	10.00 dB
<b>State Saved</b>	Saved in instrument state.
<b>Min</b>	0.10 dB
<b>Max</b>	20.00 dB
<b>Initial S/W Revision</b>	Prior to A.02.00
<b>Modified at S/W Revision</b>	A.02.00, A.03.00

## Presel Center

When this key is pressed, the centering of the preselector filter is adjusted to optimize the amplitude accuracy at the frequency of the selected marker. If the selected marker is not on when Presel Center is pressed, the analyzer will turn on the selected marker, perform a peak search, and then perform centering on the marker's center frequency. If the selected marker is already on and between the start and stop frequencies of the analyzer, the analyzer performs the preselector calibration on that marker's frequency. If the selected marker is already on, but outside the frequency range between Start Freq and Stop Freq, the analyzer will first perform a peak search, and then perform centering on the marker's center frequency.

The value displayed on the Presel Adjust key will change to reflect the new preselector tuning (see Presel Adjust).

A number of considerations should be observed to ensure proper operation. See ["Proper Preselector Operation" on page 467](#).

<b>Key Path</b>	AMPTD Y Scale
<b>Remote Command</b>	[:SENSE]:POWer[:RF]:PCENTER

<b>Example</b>	POW:PCEN
Notes	Note that the rules outlined above under the key description apply for the remote command as well as the key. The result of the command is dependent on marker position, and so forth. Any message shown by the key press is also shown in response to the remote command.
Dependencies	<ul style="list-style-type: none"> <li>• Grayed out if the microwave preselector is off. )</li> <li>• If the selected marker's frequency is below Band 1, advisory message 0.5001 is generated and no action is taken.</li> <li>• Grayed out if entirely in Band 0.</li> <li>• Blank in models that do not include a preselector, such as option 503. If the SCPI is sent in these instruments, it is accepted without error, and the query always returns 0.</li> <li>• Grayed out in the Spectrogram View.</li> </ul>
Couplings	<p>The active marker position determines where the centering will be attempted.</p> <p>If the analyzer is in a measurement such as averaging when centering is initiated, the act of centering the preselector will restart averaging but the first average trace will not be taken until the centering is completed.</p>
Status Bits/OPC dependencies	<p>When centering the preselector, *OPC will not return true until the process is complete and a subsequent measurement has completed, nor will results be returned to a READ or MEASure command.</p> <p>The Measuring bit should remain set while this command is operating and should not go false until the subsequent sweep/measurement has completed.</p>
Initial S/W Revision	Prior to A.02.00
Modified at S/W Revision	A.03.00

## Proper Preselector Operation

A number of considerations should be observed to ensure proper operation:

1. If the selected marker is off, the analyzer will turn on a marker, perform a peak search, and adjust the preselector using the selected marker's frequency. It uses the "highest peak" peak search method unqualified by threshold or excursion, so that there is no chance of a 'no peak found' error. It continues with that peak, even if it is the peak of just noise. Therefore, for this operation to work properly, there should be a signal on screen in a preselected range for the peak search to find.
2. If the selected marker is already on, the analyzer will attempt the centering at that marker's frequency. There is no preselector for signals below about 3.6 GHz, therefore if the marker is on a signal below 3.6 GHz, no centering will be attempted and an advisory message generated
3. In some models, the preselector can be bypassed. If it is bypassed, no centering will be attempted in that range and a message will be generated.

## Preselector Adjust

Allows you to manually adjust the preselector filter frequency to optimize its response to the signal of interest. This function is only available when "[Presel Center](#)" on page 2111 is available.

For general purpose signal analysis, using Presel Center is recommended. Centering the filter minimizes the impact of long-term preselector drift. Presel Adjust can be used instead to manually optimize the preselector. One application of manual optimization would be to peak the preselector response, which both optimizes the signal-to-noise ratio and minimizes amplitude variations due to small (short-term) preselector drifting.

<b>Key Path</b>	AMPTD Y Scale
<b>Scope</b>	Meas Global
<b>Remote Command</b>	<code>[ :SENSe ] :POWer [ :RF ] :PADJust &lt;freq&gt;</code> <code>[ :SENSe ] :POWer [ :RF ] :PADJust?</code>
<b>Example</b>	POW:PADJ 100KHz POW:PADJ?
<b>Notes</b>	The value on the key reads out to 0.1 MHz resolution.
<b>Dependencies</b>	<ul style="list-style-type: none"> <li>• Grayed out if microwave preselector is off. )</li> <li>• Grayed out if entirely in Band 0.</li> <li>• Blank in models that do not include a preselector, such as option 503. If the SCPI is sent in these instruments, it is accepted without error, and the query always returns 0.</li> <li>• Grayed out in the Spectrogram View.</li> </ul>
<b>Preset</b>	0 MHz
<b>State Saved</b>	The Presel Adjust value set by Presel Center, or by manually adjusting Presel Adjust, is not saved in instrument state, and does not survive a Preset or power cycle.
<b>Min</b>	-500 MHz
<b>Max</b>	500 MHz
<b>Default Unit</b>	Hz
<b>Backwards Compatibility SCPI</b>	<code>[ :SENSe ] :POWer [ :RF ] :MW :PADJust</code> <code>[ :SENSe ] :POWer [ :RF ] :MMW :PADJust</code> PSA had multiple preselectors, but the X-Series has only one. These commands simply alias to <code>[ :SENSe ] :POWer [ :RF ] :PADJust</code>
<b>Initial S/W Revision</b>	Prior to A.02.00
<b>Modified at S/W Revision</b>	A.03.00

<b>Remote Command</b>	<code>[ :SENSe ] :POWer [ :RF ] :PADJust :PRESelector MWAVE   MMWave   EXTERNAL</code> <code>[ :SENSe ] :POWer [ :RF ] :PADJust :PRESelector?</code>
<b>Notes</b>	PSA had multiple preselectors, and you could select which preselector to adjust. Since the X-Series has only one mm/uW preselector, the preselector selection softkey is no longer available. However, to provide backward compatibility, we accept the legacy remote commands. The command form has no effect, the query always returns MWAVE
<b>Initial S/W Revision</b>	Prior to A.02.00

## Y Axis Unit

Displays the menu keys that enable you to change the vertical (Y) axis amplitude unit. The analyzer retains the entered Y Axis Unit separately for both Log and Lin amplitude scale types. For example, if Scale Type has been set to Log, and you set Y Axis Unit to dBm, pressing Scale Type (Log) sets the Y Axis Unit to dBm. If Scale Type has been set to Lin and you set Y Axis Unit to V, pressing Scale Type (Lin) sets the Y Axis Unit to V. Pressing Scale Type (Log) again sets the Y axis unit back to dBm.

### NOTE

The units of current (A, dBmA, dBuA) are calculated based on 50 ohms input impedance.

All four of the EMI units (dB $\mu$ A/m, dB $\mu$ V/m, dBG, dBpT) are treated by the instrument exactly as though they were dBuV. The user must load an appropriate correction factor using Amplitude Corrections for accurate and meaningful results.

If a SCPI command is sent to the analyzer that uses one of the EMI units as a terminator, the analyzer treats it as though DBUV had been sent as the terminator.

Key Path	AMPTD Y Scale
Mode	SA
Scope	Meas Global
Remote Command	:UNIT:POWer DBM   DBMV   DBMA   V   W   A   DBUV   DBUA   DBPW   DBUVM   DBUAM   DBPT   DBG  :UNIT:POWer?
Example	UNIT:POW dBmV UNIT:POW?
Notes	The Y axis unit has either logarithmic or linear characteristics. The set of units that is logarithmic consists of dBm, dBmV, dBmA, dB $\mu$ V, dB $\mu$ A, dB $\mu$ V/m, dB $\mu$ A/m, dBpT, and dBG. The set of units that are linear consists of V, W, and A. The chosen unit will determine how the reference level and all the amplitude-related outputs like trace data, marker data, etc. read out.
Notes	The settings of Y Axis Unit and Scale Type, affect how the data is read over the remote interface. When using the remote interface no unit is returned, so you must know what the Y axis unit is to interpret the results: Example 1, set the following: Scale Type (Log) Y Axis Unit, dBm Scale/Div, 1 dB Ref Level, 10 dBm This sets the top line to 10 dBm with each vertical division representing 1 dB. Thus, if a point on trace 1 is on the fifth graticule line from the top, it represents 5 dBm and will read out remotely as 5. Example 2, set the following: Scale Type (Lin) Y Axis Unit, Volts Ref Level, 100 mV (10 mV/div) This sets the top line to 100 mV and the bottom line to 0 V, so each vertical division represents 10 mV. Thus, if a point on trace 1 is on the fifth graticule line from the top, it represents 50 mV and will

	read out remotely as 50.
Dependencies	If an amplitude correction with an Antenna Unit other than None is applied and enabled, then that antenna unit is forced and the key with that unit is the only Y Axis Unit available. All other Y Axis Unit keys are grayed out.  If an amplitude correction with an Antenna Unit other than None is applied and enabled, and you then turn off that correction or set Apply Corrections to No, the Y Axis Unit that existed before the Antenna Unit was applied is restored.
Couplings	The analyzer retains the entered Y Axis Unit separately for both Log and Lin amplitude scale types
Preset	dBm for log scale, V for linear. The true 'preset' value is dBm, since at preset the Y Scale type is set to logarithmic.
State Saved	Saved in instrument state
Readback line	1-of-N selection
Initial S/W Revision	Prior to A.02.00
Modified at S/W Revision	A.02.00, A.04.00, A.11.00

## dBm

Sets the amplitude unit for the selected amplitude scale (log/lin) to dBm.

Key Path	AMPTD Y Scale, Y Axis Unit
<b>Example</b>	UNIT:POW DBM
Dependencies	Grayed out if an Amplitude Correction with an Antenna Unit is ON.
Readback	dBm
Initial S/W Revision	Prior to A.02.00
Modified at S/W Revision	A.02.00

## dBmV

Sets the amplitude unit for the selected amplitude scale (log/lin) to dBmV.

Key Path	AMPTD Y Scale, Y Axis Unit
<b>Example</b>	UNIT:POW DBMV
Dependencies	Grayed out if an Amplitude Correction with an Antenna Unit is ON.
Readback	dBmV
Initial S/W Revision	Prior to A.02.00
Modified at S/W Revision	A.02.00

## dBmA

Sets the amplitude unit for the selected amplitude scale (log/lin) to dBmA.

Key Path	AMPTD Y Scale, Y Axis Unit
<b>Example</b>	UNIT:POW DBMA
Dependencies	Grayed out if an Amplitude Correction with an Antenna Unit is ON.
Readback	dBmA
Initial S/W Revision	Prior to A.02.00
Modified at S/W Revision	A.02.00

## W

Sets the amplitude unit for the selected amplitude scale (log/lin) to watt.

Key Path	AMPTD Y Scale, Y Axis Unit
<b>Example</b>	UNIT:POW W
Dependencies	Grayed out if an Amplitude Correction with an Antenna Unit is ON.
Readback	W
Initial S/W Revision	Prior to A.02.00
Modified at S/W Revision	A.02.00

## V

Sets the amplitude unit for the selected amplitude scale (log/lin) to volt.

Key Path	AMPTD Y Scale, Y Axis Unit
<b>Example</b>	UNIT:POW V
Dependencies	Grayed out if an Amplitude Correction with an Antenna Unit is ON.
Readback	V
Initial S/W Revision	Prior to A.02.00
Modified at S/W Revision	A.02.00

## A

Sets the amplitude unit for the selected amplitude scale (log/lin) to Ampere.

Key Path	AMPTD Y Scale, Y Axis Unit
<b>Example</b>	UNIT:POW A
Dependencies	Grayed out if an Amplitude Correction with an Antenna Unit is ON.
Readback	A
Initial S/W Revision	Prior to A.02.00
Modified at S/W Revision	A.02.00

## dB $\mu$ V

Sets the amplitude unit for the selected amplitude scale (log/lin) to dB $\mu$ V.

Key Path	AMPTD Y Scale, Y Axis Unit
<b>Example</b>	UNIT:POW DBUV
Dependencies	Grayed out if an Amplitude Correction with an Antenna Unit is ON.
Readback	dB $\mu$ V
Initial S/W Revision	Prior to A.02.00
Modified at S/W Revision	A.02.00

## dB $\mu$ A

Sets the amplitude unit for the selected amplitude scale (log/lin) to dB $\mu$ A.

### NOTE

The unit dBuA can also appear as an Antenna Unit. This will be used by customers using current probes, because current probes are often supplied with conversion tables that provide the transducer factors. When dBuA is used as an Antenna Unit the normal conversion from power to amps for dBuA (based on the analyzer input impedance) is not done, but instead the conversion is based solely on the Correction that contains the transducer factors. This is what distinguishes dBuA as a normal unit from dBuA as an antenna unit. When querying the Y-Axis unit, you can query the Antenna Unit to distinguish between regular dBuA and the dBuA antenna unit. If :CORR:CSET:ANT? returns NOC (for No Conversion), you are using a normal Y Axis dBuA. If it returns UA you are using an Antenna Unit dBuA.

Key Path	AMPTD Y Scale, Y Axis Unit
<b>Example</b>	UNIT:POW DBUA
Dependencies	Grayed out if an Amplitude Correction with an Antenna Unit is ON.
Readback	dB $\mu$ A
Initial S/W Revision	Prior to A.02.00
Modified at S/W Revision	A.02.00

## dBpW

Sets the amplitude unit for the selected amplitude scale (log/lin) to dBpW.

Key Path	AMPTD Y Scale, Y Axis Unit
<b>Example</b>	UNIT:POW DBPW
Dependencies	Grayed out if an Amplitude Correction with an Antenna Unit is ON.
Readback	dB $\mu$ A
Initial S/W Revision	A.11.00



## Antenna Unit

When a Correction is turned on that uses an Antenna Unit, the Y Axis Unit changes to that Antenna Unit. All of the keys in the Y-Axis Unit menu are then greyed out, except the Antenna Unit key. The unit being used is shown on this key and is shown as selected in the submenu.

Key Path	AMPTD Y Scale, Y Axis Unit
Dependencies	Grayed out if no Amplitude Correction with an Antenna Unit is on.
Readback line	Currently selected unit
Initial S/W Revision	A.11.00

### dB $\mu$ V/m

Sets the amplitude unit for the selected amplitude scale (log/lin) to dB $\mu$ V/m. This is an antenna unit, and this key is grayed out unless a Correction with this Antenna Unit selected is ON. If this is the case, all of the other Antenna Units are grayed out.

Key Path	AMPTD Y Scale, Y Axis Unit, Antenna Unit
<b>Example</b>	UNIT:POW DBUVM
Dependencies	Grayed out if no Amplitude Correction with an Antenna Unit is on.
Readback	dB $\mu$ V/m
Initial S/W Revision	A.02.00

### dB $\mu$ A/m

Sets the amplitude unit for the selected amplitude scale (log/lin) to dB $\mu$ A/m. This is an antenna unit, and this key is grayed out unless a Correction with this Antenna Unit selected is ON. If this is the case, all of the other Antenna Units are grayed out.

Key Path	AMPTD Y Scale, Y Axis Unit, Antenna Unit
<b>Example</b>	UNIT:POW DBUAM
Dependencies	Grayed out if no Amplitude Correction with an Antenna Unit is on.
Readback	dB $\mu$ A/m
Initial S/W Revision	A.02.00

### dB $\mu$ A

Sets the amplitude unit for the selected amplitude scale (log/lin) to dB $\mu$ A. This is an antenna unit, and this key is grayed out unless a Correction with this Antenna Unit selected is ON. If this is the case, all of the other Antenna Units are grayed out.

Key Path	AMPTD Y Scale, Y Axis Unit, Antenna Unit
<b>Example</b>	UNIT:POW DBUAM
Dependencies	Grayed out if no Amplitude Correction with an Antenna Unit is on.
Readback	dB $\mu$ A
Initial S/W Revision	A.11.00

### dBpT

Sets the amplitude unit for the selected amplitude scale (log/lin) to dBpT. This is an antenna unit, and this key is grayed out unless a Correction with this Antenna Unit selected is ON. If this is the case, all of the other Antenna Units are grayed out.

Key Path	AMPTD Y Scale, Y Axis Unit, Antenna Unit
<b>Example</b>	UNIT:POW DBPT
Dependencies	Grayed out if no Amplitude Correction with an Antenna Unit is on.
Readback	dBpT
Initial S/W Revision	A.02.00

### DBG

Sets the amplitude unit for the selected amplitude scale (log/lin) to DBG. This is an antenna unit, and this key is grayed out unless a Correction with this Antenna Unit selected is ON. If this is the case, all of the other Antenna Units are grayed out.

Key Path	AMPTD Y Scale, Y Axis Unit, Antenna Unit
<b>Example</b>	UNIT:POW DBG
Dependencies	Grayed out if no Amplitude Correction with an Antenna Unit is on.
Readback	DBG
Initial S/W Revision	A.02.00

### None

This is selected if no Antenna Unit is currently on, however you cannot actually set this value, since it is always grayed out. The key is included simply to provide an indication on the Readback line of the Antenna Unit key when there is no Antenna Unit selected.

Key Path	AMPTD Y Scale, Y Axis Unit, Antenna Unit
Readback	"None"
Initial S/W Revision	A.11.00

## μW Path Control

The μW Path Control functions include the μW Preselector Bypass (Option MPB) and Low Noise Path (Option LNP) controls in the High Band path circuits.

When the μW Preselector is bypassed, the user has better flatness, but will be subject to spurs from out of band interfering signals. When the Low Noise Path is enabled, the analyzer automatically switches around certain circuitry in the high frequency bands which can contribute to noise, when it is appropriate based on other analyzer settings.

For most applications, the preset state is Standard Path, which gives the best remote-control throughput, minimizes acoustic noise from switching and minimizes the risk of wear out in the hardware switches. For applications that utilize the wideband IF paths, the preset state is the μW Preselector Bypass path, if option MPB is present. This is because, when using a wideband IF such as the 140 MHz IF, the μW Preselector's bandwidth can be narrower than the available IF bandwidth, causing degraded amplitude flatness and phase linearity, so it is desirable to bypass the preselector in the default case.

Users may choose Low Noise Path Enable. It gives a lower noise floor, especially in the 21–26.5 GHz region, though without improving many measures of dynamic range, and without giving the best possible noise floor. The preamp, if purchased and used, gives better noise floor than does the Low Noise Path, however its compression threshold and third-order intercept are much poorer than that of the non-preamp Low Noise Path. There are some applications, typically for signals around –30 dBm, for which the third-order dynamic range of the standard path is good enough, but the noise floor is not low enough even with 0 dB input attenuation. When the third-order dynamic range of the preamp path is too little and the noise floor of the standard path is too high, the Low Noise Path can provide the best dynamic range.

<b>Key Path</b>	AMPTD Y Scale
<b>Mode</b>	SA, BASIC, PNOISE, VSA , LTE, LTETDD
<b>Scope</b>	Meas Global
<b>Remote Command</b>	[ :SENSe ] :POWer [ :RF ] :MW:PATH STD LNPath MPBypass FULL [ :SENSe ] :POWer [ :RF ] :MW:PATH?
<b>Example</b>	:POW:MW:PATH LNP Enables the Low Noise path
<b>Notes</b>	If a Presel Center is performed, the analyzer will momentarily switch to the Standard Path, regardless of the setting of μW Path Control  The DC Block will always be switched in when the low noise path is switched in, to protect succeeding circuitry from DC. Note that this does not mean “when the low noise path is enabled” but when, based on the Low Noise Path rules, the path is actually switched in. This can happen when the selection is Low Noise Path Enable . In the case where the DC Block is switched in the analyzer is now AC coupled. However, if the user has selected DC coupling, the UI will still behave as though it were DC coupled, including all annunciation, warnings, status bits, and responses to SCPI queries. This is because, based on other settings, the analyzer could switch out the low noise path at any time and hence go back to being DC coupled.  Alignment switching ignores the settings in this menu, and restores them when finished.
<b>Dependencies</b>	Unavailable in BBIQ and External Mixing
<b>Preset</b>	All modes other than IQ Analyzer mode and VXA: STD IQ Analyzer, VXA and WLAN mode: MPB option present and licensed: MPB

	MPB option not present and licensed: STD
State Saved	Save in instrument state
Readback	Value selected in the submenu
Initial S/W Revision	A.04.00
Modified at S/W Revision	A.10.00

## Standard Path

This path gives the best remote-control throughput, minimizes acoustic noise from switching and minimizes the risk of wear in the hardware switches, particularly in remote test scenarios where both low band and high band setups will follow in rapid succession.

In this path, the bypass of the low band/high band switch and microwave preamp is never activated, which can cause some noise degradation but preserves the life of the bypass switch.

Key Path	AMPTD Y Scale, $\mu$ W Path Control
<b>Example</b>	:POW:MW:PATH STD
Readback Text	Standard Path
Initial S/W Revision	A.04.00

## Low Noise Path Enable

You may choose Low Noise Path Enable, which gives a lower noise floor under some circumstances, particularly when operating in the 21–26.5 GHz region. With the Low Noise Path enabled, the low band/high band switch and microwave preamp are bypassed whenever all of the following are true:

- The analyzer is not in the Low Band, meaning:
- the start frequency is above 3.5 GHz and
- the stop frequency is above 3.6 GHz.
- the internal preamp is not installed or (if installed) is set to Off or Low Band

Note that this means that, when any part of a sweep is done in Low Band, the Low Noise Path is not used, whether or not the Low Noise Path Enable is selected in the user interface. Also, if the preamp is turned on, the Low Noise Path is not used, whether or not the Low Noise Path Enable is selected in the user interface. The only time the Low Noise Path is used is when Low Noise Path Enable is selected, the sweep is completely in High Band (> 3.6 GHz) and no preamp is in use.

See "[More Information](#)" on page 477

Key Path	AMPTD Y Scale, $\mu$ W Path Control
Measurement	Swept SA
<b>Example</b>	:POW:MW:PATH LNP

Notes	<p>For measurements that use IQ acquisition, the low noise path is used when the Center Frequency is in High Band (&gt; 3.6 GHz) and no preamp is in use.</p> <p>In other words, the rules above are modified to use only the center frequency to qualify which path to switch in.</p> <p>This is not the case for FFT's in the Swept SA measurement; they use the same rules as swept measurements.</p>
Dependencies	<p>Key is blanked if current mode does not support it.</p> <p>Key is grayed out if mode supports it but current measurement does not support it.</p> <p>Unless Option LNP is present and licensed, key is blank and if SCPI command sent, error -241, "Hardware missing; Option not installed" is generated.</p>
Readback Text	Low Noise Path Enable
Initial S/W Revision	A.04.00

### More Information

The user should understand that the Low Noise Path, while giving improved DANL, has the disadvantage of decreased TOI performance and decreased gain compression performance relative to the standard path.

The user should also understand that the bypass switch is a mechanical switch and has finite life, so if the Low Noise Path is enabled, it is possible to cause frequent cycling of this switch by frequently changing analyzer settings such that the above conditions hold true only some of the time. A user making tests of this nature should consider opting for the Standard Path, which will never throw the bypass switch, at the expense of some degraded noise performance.

The low noise path is useful for situations where the signal level is so low that the analyzer performance is dominated by noise even with 0 dB attenuation, but still high enough that the preamp option would have excessive third-order intermodulation or compression. The preamp, if purchased and used, gives better noise floor than does the "Low Noise Path." However, its compression threshold and third-order intercept are much poorer than that of the non-preamp path. There are some applications, typically for signals around -30 dBm, for which the third-order dynamic range of the standard path is good enough, but the noise floor is not low enough even with 0 dB input attenuation. When the third-order dynamic range of the preamp path is too little and the noise floor of the standard path is too high, the Low Noise Path can provide the best dynamic range

The graph below illustrates the concept. It shows, in red, the performance of an analyzer at different attenuation settings, both with the preamp on and off, in a measurement that is affected by both analyzer noise and analyzer TOI. The green shows the best available dynamic range, offset by 0.5 dB for clarity. The blue shows how the best available dynamic range improves for moderate signal levels with the low noise path switched in. In this illustration, the preamp improves the noise floor by 15 dB while degrading the third-order intercept by 30 dB, and the low noise path reduces loss by 8 dB. The attenuator step size is 2 dB.

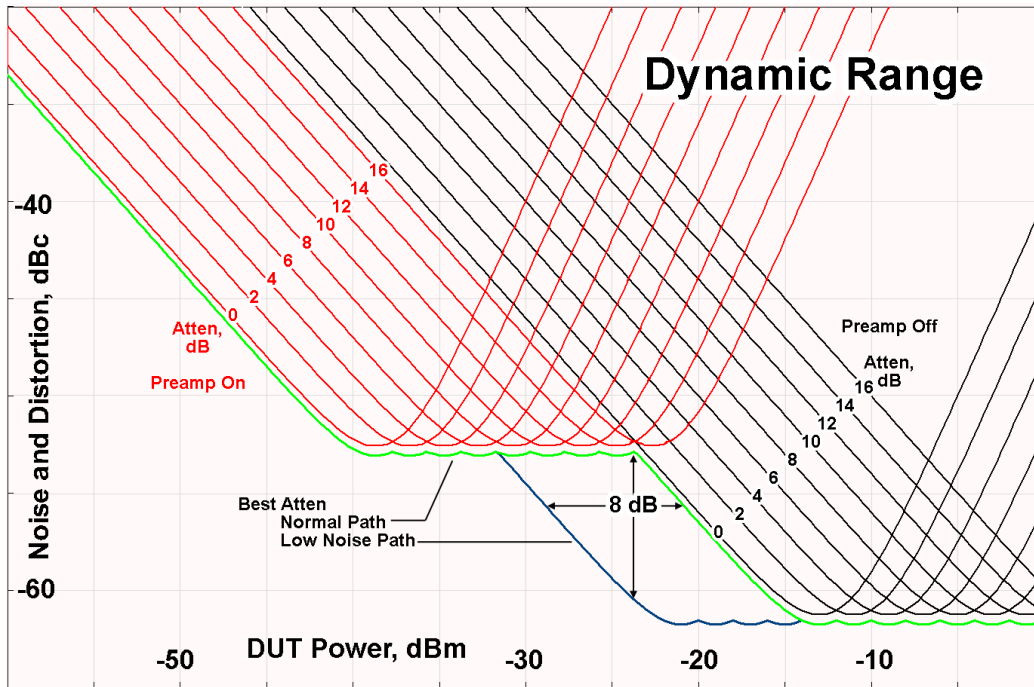

There are other times where selecting the low noise path improves performance, too. Compression-limited measurements such as finding the nulls in a pulsed-RF spectrum can profit from the low noise path in a way similar to the TOI-limited measurement illustrated. Accuracy can be improved when the low noise path allows the optimum attenuation to increase from a small amount like 0, 2 or 4 dB to a larger amount, giving better return loss at the analyzer input. Harmonic measurements, such as second and third harmonic levels, are much improved using the low noise path because of the superiority of that path for harmonic (though not intermodulation) distortion performance.

### μW Preselector Bypass

This key toggles the preselector bypass switch for band 1 and higher. When the microwave preselector is on, the signal path is preselected. When the microwave preselector is off, the signal path is not preselected. The preselected path is the normal path for the analyzer.

The preselector is a tunable bandpass filter which prevents signals away from the frequency of interest from combining in the mixer to generate in-band spurious signals (images). The consequences of using a preselector filter are its limited bandwidth, the amplitude and phase ripple in its passband, and any amplitude and phase instability due to center frequency drift.

Option MPB or pre-selector bypass provides an unpreselected input mixer path for certain X-Series signal analyzers with frequency ranges above 3.6 GHz. This signal path allows a wider bandwidth and less amplitude variability, which is an advantage when doing modulation analysis and broadband signal analysis. The disadvantage is that, without the preselector, image signals will be displayed. Another disadvantage of bypassing the preselector is increased LO emission levels at the front panel input port.

Image responses are separated from the real signal by twice the 1st IF. For IF Paths of 10 MHz and 25 MHz, the 1st IF is 322.5 MHz, so the image response and the real signal will be separated by 645 MHz. The 1st IF will be different for other IF Path settings. When viewing a real signal and its corresponding image response in internal mixing, the image response will be to the left of the real signal.

Also, the image response and the real signal typically have the same amplitude and exhibit the same shape factor.

However, if Option FS1, Fast Sweep Capability, is enabled, the image response in the Swept SA measurement will appear lower in amplitude and have a much wider shape factor compared to the real signal.

Key Path	AMPTD Y Scale, $\mu$ W Path Control
<b>Example</b>	:POW:MW:PATH MPB
Dependencies	Key is blanked if current mode does not support it. Key is grayed out if mode supports it but current measurement does not support it. Key is blank unless Option MPB is present and licensed. If SCPI command sent when MPB not present, error -241, "Hardware missing; Option not installed" is generated.
Readback Text	$\mu$ W Preselector Bypass
Initial S/W Revision	A.04.00

<b>Remote Command</b>	[ :SENSe ] :POWer [ :RF ] :MW:PRESelector [ :STATe ] ON OFF 0 1 [ :SENSe ] :POWer [ :RF ] :MW:PRESelector [ :STATe ] ?
<b>Example</b>	:POW:MW:PRES OFF Bypasses the microwave preselector
Notes	The ON parameter sets the STD path (:POW:MW:PATH STD) The OFF parameter sets path MPB (:POW:MW:PATH MPB)
Preset	ON

## Internal Preamp

Accesses a menu of keys that control the internal preamps. Turning on the preamp gives a better noise figure, but a poorer TOI to noise floor dynamic range. You can optimize this setting for your particular measurement.

The instrument takes the preamp gain into account as it sweeps. If you sweep outside of the range of the preamp the instrument will also account for that. The displayed result will always reflect the correct gain.

For some measurements, when the preamp is on and any part of the displayed frequency range is below the lowest frequency for which the preamp has specifications, a warning condition message appears in the status line. For example ,for a preamp with a 9 kHz lowest specified frequency: "Preamp: Accy unspec'd below 9 kHz".

Key Path	AMPTD Y Scale
Scope	Meas Global
<b>Remote Command</b>	[ :SENSe ] :POWer [ :RF ] :GAIN [ :STATe ] OFF ON 0 1 [ :SENSe ] :POWer [ :RF ] :GAIN [ :STATe ] ?
Dependencies	Preamp is not available on all hardware platforms. If the preamp is not present or is unlicensed, the

---

	key is not shown. The preamp is not available when the electronic/soft attenuator is enabled.
--	--

---

Couplings	<p>The act of connecting the U7227A USB Preamplifier to one of the analyzer's USB ports will cause the Internal Preamp to be switched on. When this happens an informational message will be generated: "Internal Preamp turned on for optimal operation with USB Preamp." Note that if the Internal Preamp was already on, there will be no change to the setting, but if it was Off it will be switched On, to Full Range.</p> <p>Note that this same action occurs when the SA mode is selected while the USB Preamp is connected to one of the analyzer's USB ports, if it is the first time that the SA mode has run since powerup, or if the last time the SA mode was running the USB Preamp was NOT connected.</p> <p>Subsequently disconnecting the USB Preamp from USB does not change the Internal Preamp setting nor restore the previous setting.</p>
Preset	OFF
State Saved	Saved in instrument state
Initial S/W Revision	Prior to A.02.00
Modified at S/W Revision	A.14.00

---

Key Path	AMPTD Y Scale, Internal Preamp
Scope	Meas Global
<b>Remote Command</b>	<pre>[ :SENSe ] :POWer [ :RF ] :GAIN:BAND LOW FULL [ :SENSe ] :POWer [ :RF ] :GAIN:BAND?</pre>
Dependencies	<p>Preamp is not available on all hardware platforms. If the preamp is not present or is unlicensed, the key is not shown.</p> <p>If a POW:GAIN:BAND FULL command is sent when a low band preamp is available, the preamp band parameter is to LOW instead of FULL, and an "Option not installed" message is generated.</p>
Preset	LOW
State Saved	Saved in instrument state
Initial S/W Revision	Prior to A.02.00

---

## Off

Turns the internal preamp off

---

Key Path	AMPTD Y Scale, Internal Preamp
<b>Example</b>	:POW:GAIN OFF
Readback	Off
Initial S/W Revision	Prior to A.02.00

---



## Low Band

Sets the internal preamp to use only the low band.

The frequency range of the installed (optional) low-band preamp is displayed in square brackets on the Low Band key label.

Key Path	AMPTD Y Scale, Internal Preamp
<b>Example</b>	:POW:GAIN ON :POW:GAIN:BAND LOW
Readback	Low Band
Initial S/W Revision	Prior to A.02.00

## Full Range

Sets the internal preamp to use its full range. The low band (0–3.6 GHz or 0–3GHz, depending on the model) is supplied by the low band preamp and the frequencies above low band are supplied by the high band preamp.

The frequency range of the installed (optional) preamp is displayed in square brackets on the Full Range key label. If the high band option is not installed the Full Range key does not appear.

Key Path	AMPTD Y Scale, Internal Preamp
<b>Example</b>	:POW:GAIN ON :POW:GAIN:BAND FULL
Readback	Full Range
Initial S/W Revision	Prior to A.02.00

## Ref Position

Positions the reference level at the top, center, or bottom of the Y Scale display. Changing the reference position does not change the reference level value.

Key Path	AMPTD Y Scale
Mode	SA, WCDMA, C2K, WIMAX OFDMA, 1xEVDO, DVB-T/H, DTMB (CTTB), ISDB-T, CMMB, LTE, LTETDD, Digital Cable TV, WLAN, MSR, LTEAFDD, LTEATDD
<b>Remote Command</b>	:DISPlay:CHPower:VIEW[1]:WINDow[1]:TRACe:Y[:SCALE]:RPOSition TOP   CENTER   BOTTom :DISPlay:CHPower:VIEW[1]:WINDow[1]:TRACe:Y[:SCALE]:RPOSition?
<b>Example</b>	DISP:CHP:VIEW:WIND:TRAC:Y:RPOS CENT DISP:CHP:VIEW:WIND:TRAC:Y:RPOS?
Notes	You must be in the Spectrum Analysis mode, W-CDMA mode, cdma2000 mode, DVB-T/H mode, DTMB (CTTB) mode, ISDB-T mode, CMMB mode, Digital Cable TV mode, LTE mode, LTE TDD mode, WLAN mode, 1xEVDO mode, MSR, LTE-Advanced FDD/TDD mode or WIMAX OFDMA mode to use

	this command. Use :INSTrument:SElect to set the mode.
Preset	TOP
State Saved	Saved in instrument state.
Range	Top Ctr Bot
Initial S/W Revision	Prior to A.02.00
Modified at S/W Revision	A.02.00, A.03.00

## Auto Scaling

Toggles the Auto Scaling function between On and Off.

Key Path	AMPTD Y Scale
Mode	SA, WCDMA, C2K, WIMAX OFDMA, 1xEVDO, DVB-T/H, DTMB (CTTB), ISDB-T, CMMB, LTE, LTETDD, Digital Cable TV, WLAN, MSR, LTEAFDD, LTEATDD
Remote Command	:DISPlay:CHPower:VIEW[1]:WINDow[1]:TRACe:Y[:SCALe]:COUPle 0   1   OFF   ON  :DISPlay:CHPower:VIEW[1]:WINDow[1]:TRACe:Y[:SCALe]:COUPle?
Example	DISP:CHP:VIEW:WIND:TRAC:Y:COUP OFF DISP:CHP:VIEW:WIND:TRAC:Y:COUP?
Couplings	When Auto Scaling is On, and the Restart front-panel key is pressed, this function automatically sets the scale per division to 10 dB and determines the reference values based on the measurement results.  When you set a value to either Scale/Div or Ref Value manually, Auto Scaling automatically changes to Off.
Preset	1
State Saved	Saved in instrument state.
Range	On Off
Initial S/W Revision	Prior to A.02.00
Modified at S/W Revision	A.02.00, A.03.00

## Auto Couple

The Auto Couple feature provides a quick and convenient way to automatically couple multiple instrument settings. This helps ensure accurate measurements and optimum dynamic range. When the Auto Couple feature is activated, either from the front panel or remotely, all parameters of the current measurement that have an Auto/Manual mode are set to Auto mode and all measurement settings dependent on (or coupled to) the Auto/Man parameters are automatically adjusted for optimal performance.

However, the Auto Couple key actions are confined to the current measurement only. It does not affect other measurements in the mode, and it does not affect markers, marker functions, or trace or display attributes.

See "[More Information](#)" on page 483

Key Path	Front-panel key
Remote Command	:COUPle ALL NONE
Example	:COUP ALL
Notes	:COUPle ALL puts all Auto/Man parameters in Auto mode (equivalent to pressing the Auto Couple key). :COUPLE NONE puts all Auto/Man parameters in manual mode. It decouples all the coupled instrument parameters and is not recommended for making measurements.
Initial S/W Revision	Prior to A.02.00

### More Information

There are two types of functions that have Auto/Manual modes.

#### Auto/Man Active Function keys

An Auto/Man toggle key controls the binary state associated with an instrument parameter by toggling between Auto (where the parameter is automatically coupled to the other parameters it is dependent upon) and Man (where the parameter is controlled independent of the other parameters), as well as making the parameter the active function. The current mode is indicated on the softkey with either Auto or Man underlined as illustrated below.



#### Auto/Man 1-of-N keys

An Auto/Man 1-of-N key allows you to manually pick from a list of parameter values, or place the function in Auto, in which case the value is automatically selected (and indicated) as shown below. If in Auto, Auto is underlined on the calling key. If in manual operation, manual is indicated on the calling key. But the calling key does not actually toggle the function, it simply opens the menu.

8 Channel Power Measurement  
Auto Couple

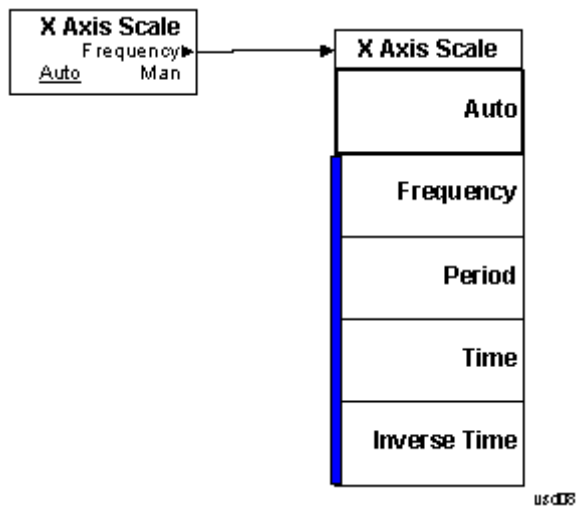

## BW

Accesses a menu of functions that enable you to specify and control the video and resolution bandwidths. You can also select the type of filter for the measurement and set the filter bandwidth.

Key Path	Front-panel key
Initial S/W Revision	Prior to A.02.00

## Res BW

Sets the value of the resolution bandwidth (RBW). If an unavailable bandwidth is entered with the numeric keypad, the closest available bandwidth is selected.

LTE-Advanced FDD/TDD Auto RBW:

Bandwidth	RBW (KHz)
1.4MHz	20
3MHz	43
5MHz	68
10MHz	150
15MHz	220
20MHz	270

the resolution bandwidth is predefined based on the corresponding bandwidth of the single LTE carrier, which is listed above. When ResBW mode is Auto, the narrowest RBW over the active carriers is selected for Multi-carriers.

Key Path	BW
Mode	SA, WCDMA, C2K, WIMAX OFDMA, 1xEVDO, DVB-T/H, DTMB (CTTB), ISDB-T, CMMB, LTE, LTE-TDD, Digital Cable TV, WLAN, MSR, LTEAFDD, LTEATDD
<b>Remote Command</b>	<pre>[ :SENSe]:CHPower:BANDwidth[:RESolution] &lt;bandwidth&gt; [:SENSe]:CHPower:BANDwidth[:RESolution]? [:SENSe]:CHPower:BANDwidth[:RESolution]:AUTO ON OFF 1 0 [:SENSe]:CHPower:BANDwidth[:RESolution]:AUTO?</pre>
<b>Example</b>	<pre>CHP:BAND 5 MHz CHP:BAND? CHP:BAND:AUTO ON CHP:BAND:AUTO?</pre>
Notes	You must be in the Spectrum Analysis mode, W-CDMA mode, cdma2000 mode, DVB-T/H mode, DTMB (CTTB) mode, ISDB-T mode, CMMB mode, Digital Cable TV mode, LTE mode, LTE TDD mode, WLAN mode, 1xEVDO mode, MSR, LTE-Advanced FDD/TDD mode or WIMAX OFDMA mode to use this command. Use :INSTRument:SElect to set the mode.

Couplings	<p>Sweep time is coupled to the RBW. As the RBW changes, the sweep time (if set to Auto) is changed to maintain amplitude calibration.</p> <p>Video bandwidth (VBW) is coupled to the RBW. As the resolution bandwidth changes, the video bandwidth (if set to Auto) changes to maintain the ratio of VBW/RBW (10:1).</p> <p>When the Res BW is set to Auto, the resolution bandwidth is auto-coupled to the span. The ratio of Span/RBW is approximately 106:1 when auto coupled. When Res BW is set to Man, and the bandwidths are entered manually, these bandwidths are used regardless of other analyzer settings.</p>
Preset	<p>SA: Auto</p> <p>WCDMA: 240 kHz</p> <p>C2K: 24 kHz</p> <p>WIMAX OFDMA: 100kHz</p> <p>1xEVDO: 30kHz</p> <p>DVB-T/H: 3.9kHz</p> <p>DTMB (CTTB): 3.9kHz</p> <p>ISDB-T: 30kHz</p> <p>CMMB: 3.9kHz</p> <p>LTE: Auto</p> <p>LTETDD: Auto</p> <p>Digital Cable TV: 3.9kHz</p> <p>WLAN: 100 kHz</p> <p>MSR: 100kHz</p> <p>LTEAFDD/LTEATDD: Auto</p> <p>WCDMA, C2K, 1xEVDO, WIMAX OFDMA, DVB-T/H, DTMB (CTTB), ISDB-T, CMMB, Digital Cable TV, WLAN, MSR, LTEAFDD, LTEATDD: OFF</p> <p>SA, LTE, LTETDD: ON</p>
State Saved	Saved in instrument state.
Min	1 Hz
Max	8 MHz
<b>Backwards Compatibility SCPI</b>	<code>[ :SENSe ] :CHPower:BWIDth [ :RESolution ]</code>
Initial S/W Revision	Prior to A.02.00
Modified at S/W Revision	A.02.00, A.03.00

## Video BW

Changes the analyzer post-detection filter (VBW).

Key Path	BW
Mode	SA, WCDMA, C2K, WIMAX OFDMA, 1xEVDO, DVB-T/H, DTMB (CTTB), ISDB-T, CMMB, LTE, LTETDD, Digital Cable TV, WLAN, MSR, LTEAFDD, LTEATDD
Remote Command	<code>[ :SENSe ] :CHPower:BWIDth:VIDeo &lt;bandwidth&gt;</code>

---

	[:SENSe]:CHPower:BANDwidth:VIDeo?
	[:SENSe]:CHPower:BANDwidth:VIDeo:AUTO ON OFF 1 0
	[:SENSe]:CHPower:BANDwidth:VIDeo:AUTO?
<b>Example</b>	CHP:BAND:VID 2.4 MHz CHP:BAND:VID? CHP:BAND:VID:AUTO OFF CHP:BAND:VID:AUTO?
Notes	You must be in the Spectrum Analysis mode, W-CDMA mode, cdma2000 mode, DVB-T/H mode, DTMB (CTTB) mode, ISDB-T mode, CMMB mode, Digital Cable TV mode, LTE mode, LTE TDD mode, WLAN mode, 1xEVDO mode, MSR,LTE-Advanced FDD/TDD mode or WIMAX OFDMA mode to use this command. Use :INSTrument:SElect to set the mode.
Dependencies	See Couplings
Couplings	<p>Video bandwidth (VBW) is coupled to the RBW. As the resolution bandwidth changes, the video bandwidth (if set to Auto) changes to maintain the ratio set by VBW/RBW.</p> <p>Sweep Time is coupled to the Video Bandwidth (VBW). As the VBW is changed, the sweep time (when set to Auto) is changed to maintain amplitude calibration. This occurs because of common hardware between the two circuits, even though the Video BW filter is not actually “in-circuit” when the detector is set to Average. Because the purpose of the average detector and the VBW filter are the same, either can be used to reduce the variance of the result.</p> <p>Although the VBW filter is not “in-circuit” when using the average detector, the Video BW key can have an effect on (Auto) sweep time, and is not disabled. In this case, reducing the VBW setting increases the sweep time, which increases the averaging time, producing a lower-variance trace.</p> <p>When using the average detector with either Sweep Time set to Man, or in zero span, the VBW setting has no effect and is disabled (grayed out).</p> <p>When the video bandwidth is AUTO coupled, the video bandwidth value is set to: Resolution Bandwidth * Video Bandwidth to Resolution Bandwidth Ratio</p>
Preset	SA: Auto WCDMA: 2.4MHz C2K: 240 kHz WIMAX OFDMA: Auto 1xEVDO: 300 kHz DVB-T/H: 39kHz DTMB (CTTB): 39kHz ISDB-T: 300kHz CMMB: 39kHz LTE, MSR: Auto LTETDD: Auto LTEAFDD,LTEATDD:Auto Digital Cable TV: 39kHz WLAN: Auto ON

---

State Saved	Saved in instrument state.
Min	1 Hz
Max	50 MHz
Initial S/W Revision	Prior to A.02.00
Modified at S/W Revision	A.02.00, A.03.00

## Filter Type

Selects the type of bandwidth filter that is used. The choices are Gaussian or Flat top.

Key Path	BW
Mode	SA, WCDMA, C2K, WIMAX OFDMA, 1xEVDO, DVB-T/H, DTMB (CTTB), ISDB-T, CMMB, LTE, LTE-TDD, Digital Cable TV, WLAN, MSR, LTEAFDD, LTEATDD
<b>Remote Command</b>	[ :SENSe ] :CHPower :BANDwidth :SHAPE GAUSSian FLATtop [ :SENSe ] :CHPower :BANDwidth :SHAPE?
<b>Example</b>	CHP:BAND:SHAP GAUS CHP:BAND:SHAP?
Preset	GAUSSian
State Saved	Saved in instrument state.
Range	Gaussian Flattop
<b>Backwards Compatibility SCPI</b>	[ :SENSe ] :CHPower :BWIDth :SHAPE
Initial S/W Revision	Prior to A.02.00
Modified at S/W Revision	A.02.00, A.03.00



## Cont (Continuous Measurement/Sweep)

Sets the analyzer for Continuous measurement operation. The single/continuous state is Meas Global so the setting will affect all measurements. If you are Paused, pressing Cont does a Resume.

Key Path	Front-panel key
Remote Command	:INITiate:CONTinuous OFF ON 0 1 :INITiate:CONTinuous?
Example	:INIT:CONT 0 puts analyzer in Single measurement operation. :INIT:CONT 1 puts analyzer in Continuous measurement operation
Preset	ON (Note that SYST:PRESet sets INIT:CONT to ON but *RST sets INIT:CONT to OFF)
State Saved	Saved in instrument state
Backwards Compatibility Notes	For Spectrum Analysis mode in ESA and PSA, there is no Cont hardkey, instead there is a Sweep Single/Cont key. In these analyzers, switching the Sweep Single/Cont key from Single to Cont restarts averages (displayed average count reset to 1), but does not restart Max Hold and Min Hold. The X-Series has Single and Cont keys in place of the SweepSingleCont key. In the X-Series, if in single measurement, the Cont key (and INIT:CONT ON ) switches to continuous measurement, but never restarts a measurement and never resets a sweep.
Initial S/W Revision	Prior to A.02.00

In Swept SA Measurement (Spectrum Analysis Mode):

The analyzer takes repetitive sweeps, averages, measurements, etc., when in Continuous mode. When the average count reaches the Average/Hold Number the count stops incrementing, but the analyzer keeps sweeping. See the Trace/Detector section for the averaging formula used both before and after the Average/Hold Number is reached. The trigger condition must be met prior to each sweep. The type of trace processing for multiple sweeps, is set under the Trace/Detector key, with choices of Trace Average, Max Hold, or Min Hold.

In Other Measurements/Modes:

With Avg/Hold Num (in the Meas Setup menu) set to Off or set to On with a value of 1, a sweep is taken after the trigger condition is met; and the analyzer continues to take new sweeps after the current sweep has completed and the trigger condition is again met. However, with Avg/Hold Num set to On with a value >1, multiple sweeps (data acquisitions) are taken for the measurement. The trigger condition must be met prior to each sweep. The sweep is not stopped when the average count k equals the number N set for Avg/Hold Num is reached, but the number k stops incrementing. A measurement average usually applies to all traces, marker results, and numeric results. But sometimes it only applies to the numeric results.

If the analyzer is in Single measurement, pressing the Cont key does not change k and does not cause the sweep to be reset; the only action is to put the analyzer into Continuous measurement operation.

If it is already in continuous sweep:

the INIT:CONT 1 command has no effect

## 8 Channel Power Measurement Cont (Continuous Measurement/Sweep)

the INIT:CONT 0 command will place the analyzer in Single Sweep but will have no effect on the current sequence until  $k = N$ , at which point the current sequence will stop and the instrument will go to the idle state.

File

See "File" on page 336

## FREQ Channel

The key accesses a menu allowing you to set Frequency parameters for the current measurement. All measurements in DVB-T/H mode have the same menu structure under FREQ/Channel menu.

Key Path	Front-panel key
Initial S/W Revision	A.02.00

### Channel

Sets the analyzer to a frequency that corresponds to the Channel Number. If the Center Freq value entered does not exactly correlate with the Channel, the displayed value will be “---”.

Key Path	FREQ Channel
Mode	DVB-T/H
<b>Remote Command</b>	[ :SENSE ] :FREQuency:CHANnel:NUMBer <integer> [ :SENSe ] :FREQuency:CHANnel:NUMBer?
<b>Example</b>	FREQ:CHAN:NUMB 21 FREQ:CHAN:NUMB?
Dependencies	If your analyzer has multiple inputs and the selected input is BBIQ, this key will be grayed out and the displaying value will be “---”.
Couplings	Channel is coupled with Center Freq. A certain Channel corresponds to a certain value of Center Freq. If the Center Freq value entered does not exactly correlate with a Channel, the displaying value will be “---”, and the returned value of the SCPI command “FREQ:CHAN:NUMB?” is “-999”.
Preset	21
State Saved	Saved in instrument state.
Min	Depends on the selected channel table
Max	Depends on the selected channel table
Initial S/W Revision	A.02.00

### Center Freq

Sets the center frequency. If your analyzer has multiple inputs (RF and IQ), the displayed value will be updated according to the selected input. SCPI commands are available to directly set the center frequency for a specific input. This key is coupled with Channel when the selected input is RF.

See also:

["RF Center Freq" on page 494](#)

["IQ Center Freq" on page 494](#)

Key Path	FREQ Channel
Mode	DVB-T/H
<b>Remote Command</b>	[ :SENSe ] :FREQuency:CENTer <freq> [ :SENSe ] :FREQuency:CENTer?
<b>Example</b>	FREQ:CENT 1.0MHZ FREQ:CENT?
Couplings	Center Freq is coupled with Channel. A certain value of center frequency corresponds to a certain Channel. If the Channel changes, the Center Frequency will be changed to the frequency which is the center of the channel.
Preset	474.00MHz
State Saved	Saved in instrument state.
Min	-79.999995 MHz
Max	Hardware Dependent, for details, see " <a href="#">Maximum Frequency in X - Series Signal Analyzers</a> " on page 493.
Initial S/W Revision	A.02.00

## Maximum Frequency in X - Series Signal Analyzers

The following table lists the maximum frequency in different X – Series signal analyzers.

Model numbers: N9020A, N9030A

Freq Option	Stop Freq after Mode Preset	Max Freq (can't tune above)
503	3.6 GHz	3.7 GHz
508	8.4 GHz	8.5 GHz
513	13.6 GHz	13.8 GHz
526	26.5 GHz	27.0 GHz
543 (N9030A only)	43 GHz	
544 (N9030A only)	44 GHz	44.5 GHz
550 (N9030A only)	50 GHz	51 GHz

Model number: N9010A

Freq Option	Stop Freq after Mode Preset	Max Freq (can't tune above)
503	3.6 GHz	3.7 GHz
507	7.0 GHz	7.1 GHz

513	13.6 GHz	13.8 GHz
526	26.5 GHz	27.0 GHz
532	32.0 GHz	32.5 GHz
544	44.0 GHz	44.5 GHz

Model number: N9000A

Freq Option	Stop Freq after Mode Preset	Max Freq (can't tune above)
503	3.0 GHz	3.08 GHz
507	7.5 GHz	7.58 GHz

### RF Center Freq

SCPI command to specify the RF Center Frequency. This will always access the RF value, even when the selected input is not RF.

Key Path	FREQ Channel
Mode	DVB-T/H
Remote Command	<code>[ :SENSe ] :FREQuency:RF:CENTer &lt;freq&gt;</code> <code>[ :SENSe ] :FREQuency:RF:CENTer?</code>
Example	FREQ:RF:CENT 1.0MHZ FREQ:RF:CENT?
Couplings	Center Freq is coupled with Channel. A certain value of center frequency corresponds to a certain Channel. If the Channel changes, the Center Frequency will be changed to the frequency which is the center of the channel.
Preset	474.00MHz
State Saved	Saved in instrument state.
Min	-79.999995 MHz
Max	Hardware Dependent, for details, see <a href="#">"Maximum Frequency in X - Series Signal Analyzers" on page 493.</a>
Initial S/W Revision	A.02.00

### IQ Center Freq

SCPI command to specify the I/Q Center Frequency. This will always access the I/Q value, even when the selected input is not I/Q.

Key Path	FREQ Channel
Mode	DVB-T/H
<b>Remote Command</b>	[ :SENSe ] :FREQuency:IQ:CENTer <freq> [ :SENSe ] :FREQuency:IQ:CENTer?
<b>Example</b>	FREQ:IQ:CENT 1.0MHZ FREQ:IQ:CENT?
Preset	0 Hz
State Saved	Saved in instrument state.
Min	-39.999995 MHz
Max	39.999995 MHz
Initial S/W Revision	A.02.00

## Chan Step

Chan Step changes the step size for the Channel Number.

Key Path	FREQ Channel
Mode	DVB-T/H
<b>Remote Command</b>	[ :SENSe ] :FREQuency:CHANnel:STEP <integer> [ :SENSe ] :FREQuency:CHANnel:STEP?
<b>Example</b>	FREQ:CHAN:STEP 1 FREQ:CHAN:STEP?
Dependencies	If your analyzer has multiple inputs and the selected input is BBIQ, this key will be grayed out.
Preset	1
State Saved	Saved in instrument state.
Min	1
Max	Depends on the selected channel table
Initial S/W Revision	A.02.00

## CF Step

CF Step sets the step size for center frequency. If CF Step State is manual, you can set this value manually. Once CF Step State is changed to auto, CF Step changes to the value of Channel BW automatically.

Key Path	FREQ Channel
Mode	DVB-T/H
<b>Remote Command</b>	[ :SENSe ] :FREQuency:CENTer:STEP [ :INCRement ] <freq> [ :SENSe ] :FREQuency:CENTer:STEP [ :INCRement ] ?

	<code>[ :SENSe ] :FREQuency:CENTer:STEP:AUTO ON OFF 1 0</code>
	<code>[ :SENSe ] :FREQuency:CENTer:STEP:AUTO?</code>
<b>Example</b>	<code>FREQ:CENT:STEP 100KHZ</code> <code>FREQ:CENT:STEP?</code> <code>FREQ:CENT:STEP:AUTO OFF</code> <code>FREQ:CENT:STEP:AUTO?</code>
<b>Couplings</b>	CF Step is coupled to Channel BW (Mode Setup) when CF Step State is 'Auto'.
<b>Preset</b>	8.00MHz ON
<b>State Saved</b>	Saved in instrument state.
<b>Min</b>	1.0 kHz
<b>Max</b>	1 GHz
<b>Initial S/W Revision</b>	A.02.00

### Chan Table

Allows you to choose the appropriate TV standard: NTSC-M, NTSC-J, NTSC-Brazil, PAL-M, PAL-B/G, PAL-D/K, or PAL-I.

<b>Key Path</b>	FREQ Channel
<b>Mode</b>	DVB-T/H
<b>Remote Command</b>	<code>[ :SENSe ] :FREQuency:CHANnel:TABLE[:SELeCt] MNTSc   JNTSc   BNTSc   MPAL</code> <code>  IPAL   BPAL   DPAL</code> <code>[ :SENSe ] :FREQuency:CHANnel:TABLE[:SELeCt]?</code>
<b>Example</b>	<code>FREQ:CHAN:TABL BPAL</code> <code>FREQ:CHAN:TABL?</code>
<b>Dependencies</b>	If your analyzer has multiple inputs and the selected input is BBIQ, this key will be grayed out.
<b>Couplings</b>	Couple with Channel. Setting Chan Table sets the range of Channel to the value corresponding to that Chan Table.
<b>Preset</b>	BPAL
<b>State Saved</b>	Saved in instrument state.
<b>Range</b>	NTSC-M   NTSC-J   NTSC-Brazil   PAL-M   PAL-I   PAL-B/G   PAL-D/K
<b>Initial S/W Revision</b>	A.02.00

### NTSC-M

If the current TV standard is NTSC-M, you can choose the appropriate channel plans in NTSC-M standard: Standard Cable (STD), Broadcast Channel (AIR), HRC Cable (HRC) or IRC Cable (IRC).



Key Path	FREQ Channel, Chan Table
Mode	DVB-T/H
<b>Remote Command</b>	[ :SENSe ] :FREQuency:CHANnel:TABLE:MNTSc [ :SElect ] STD   AIR   HRC   IRC [ :SENSe ] :FREQuency:CHANnel:TABLE:MNTSc [ :SElect ] ?
<b>Example</b>	FREQ:CHAN:TABL:MNTS STD FREQ:CHAN:TABL:MNTS?
Preset	STD
State Saved	Saved in instrument state.
Range	STD   AIR   HRC   IRC
Initial S/W Revision	A.02.00

## NTSC-J

If the current TV standard is NTSC-J, you can choose the appropriate channel plans in NTSC-J standard: Japan Standard Cable (Cable), apan Broadcast channels (AIR), or Japan Digital Cable (Cable Digital).

Key Path	FREQ Channel, Chan Table
Mode	DVB-T/H
<b>Remote Command</b>	[ :SENSe ] :FREQuency:CHANnel:TABLE:JNTSc [ :SElect ] CBL AIR DCBL [ :SENSe ] :FREQuency:CHANnel:TABLE:JNTSc [ :SElect ] ?
<b>Example</b>	FREQ:CHAN:TABL:JNTS AIR FREQ:CHAN:TABL:JNTS?
Preset	AIR
State Saved	Saved in instrument state.
Range	Cable AIR Cable Digital
Initial S/W Revision	A.02.00
Modified at S/W Revision	A.08.00

## NTSC-Brazil

If the current TV standard is NTSC-Brazil, you can choose the appropriate channel plans in NTSC-Brazil standard: NTSC-Brazil VHF or NTSC-Brazil UHF. Please refer to Appendix A for more detailed information.

Key Path	FREQ Channel, Chan Table
Mode	DVB-T/H
<b>Remote Command</b>	[ :SENSe ] :FREQuency:CHANnel:TABLE:BNTSc [ :SElect ] VHF UHF [ :SENSe ] :FREQuency:CHANnel:TABLE:BNTSc [ :SElect ] ?
<b>Example</b>	FREQ:CHAN:TABL:BNTS VHF FREQ:CHAN:TABL:BNTS?

Preset	UHF
State Saved	Saved in instrument state.
Range	VHF UHF
Initial S/W Revision	A.06.00

### PAL-M

If the current TV standard is PAL-M, you can choose the appropriate channel plans in PAL-M standard: Standard Cable (STD), Broadcast Channel (AIR), HRC Cable (HRC) or IRC Cable (IRC).

Key Path	FREQ Channel, Chan Table
Mode	DVB-T/H
<b>Remote Command</b>	[ :SENSe ] :FREQuency:CHANnel:TABLE:MPAL [ :SElect ] STD   AIR   HRC   IRC [ :SENSe ] :FREQuency:CHANnel:TABLE:MPAL [ :SElect ] ?
<b>Example</b>	FREQ:CHAN:TABL:MPAL STD FREQ:CHAN:TABL:MPAL?
Preset	STD
State Saved	Saved in instrument state.
Range	STD   AIR   HRC   IRC
Initial S/W Revision	A.02.00

### PAL-I

If the current TV standard is PAL-I, you can choose the appropriate channel plans in PAL-I standard: HRC Cable (HRC), VHF channels (VHF) or UHF channels (UHF).

Key Path	FREQ Channel, Chan Table
Mode	DVB-T/H
<b>Remote Command</b>	[ :SENSe ] :FREQuency:CHANnel:TABLE:IPAL [ :SElect ] VHF UHF HRC [ :SENSe ] :FREQuency:CHANnel:TABLE:IPAL [ :SElect ] ?
<b>Example</b>	FREQ:CHAN:TABL:IPAL HRC FREQ:CHAN:TABL:IPAL?
Preset	HRC
State Saved	Saved in instrument state.
Range	VHF   UHF   HRC
Initial S/W Revision	A.02.00

## PAL-B/G

If the current TV standard is PAL-B/G, you can choose the appropriate channel plans in PAL-B/G standard: HRC Cable (HRC), VHF channels (VHF), UHF channels (UHF), S channels PAL-B/G Standard (S), S channels PAL-B/G Cable (S-Cable) or CENELEC channels (CENELEC).

Key Path	FREQ Channel, Chan Table
Mode	DVB-T/H
Remote Command	[ :SENSe ] :FREQuency:CHANnel:TABLE:BPAL[ :SElect ] VHF   UHF   HRC   S   SCBL   CEN [ :SENSe ] :FREQuency:CHANnel:TABLE:BPAL[ :SElect ] ?
Example	FREQ:CHAN:TABL:BPAL HRC FREQ:CHAN:TABL:BPAL?
Preset	UHF
State Saved	Saved in instrument state.
Range	VHF   UHF   HRC   S   S-Cable   CENELEC
Initial S/W Revision	A.02.00

## PAL-D/K

If the current TV standard is PAL-D/K, you can choose the appropriate channel plans in PAL-D/K standard: China Broadcast Channels (DS) or China Standard Cable (Z).

Key Path	FREQ Channel, Chan Table
Mode	DVB-T/H
Remote Command	[ :SENSe ] :FREQuency:CHANnel:TABLE:DPAL[ :SElect ] DS   Z [ :SENSe ] :FREQuency:CHANnel:TABLE:DPAL[ :SElect ] ?
Example	FREQ:CHAN:TABL:DPAL DS FREQ:CHAN:TABL:DPAL?
Preset	DS
State Saved	Saved in instrument state.
Range	DS   Z
Initial S/W Revision	A.02.00

8 Channel Power Measurement  
Input/Output

Input/Output

See "Input/Output" on page 204

## Marker

Accesses a menu that enables you to select, set up and control the markers for the current measurement.

Key Path	Front-panel key
Initial S/W Revision	Prior to A.02.00

## Select Marker

Displays 12 markers available for selection.

Key Path	Marker
Initial S/W Revision	Prior to A.02.00

## Marker Type

Sets the marker control mode to Normal, Delta, Fixed or Off. All interactions and dependencies detailed under the key description are enforced when the remote command is sent. If the selected marker is Off, pressing Marker sets it to Normal and places it at the center of the screen on the trace determined by the Marker Trace rules. At the same time, Marker X Axis Value appears on the Active Function area.

The default active function is the active function for the currently selected marker control mode. If the current control mode is Off, there is no active function and the active function is turned off.

Key Path	Marker
Mode	SA, WCDMA, C2K, WIMAX OFDMA, 1xEVDO, DVB-T/H, DTMB (CTTB), ISDB-T, CMMB, LTE, LTE-TDD, Digital Cable TV, WLAN, MSR, LTEAFDD, LTEATDD
Remote Command	:CALCulate:CHPower:MARKer[1] 2 ... 12:MODE Position   DELTa   OFF :CALCulate:CHPower:MARKer[1] 2 ... 12:MODE?
Example	CALC:CHP:MARK3:MODE POS CALC:CHP:MARK3:MODE?
Notes	If the selected marker is Off, pressing Marker sets it to Normal and places it at the center of the screen on the trace determined by the Marker Trace rules. At the same time, Marker X Axis Value appears on the Active Function area.  Default Active Function: the active function for the selected marker's current control mode. If the current control mode is Off, there is no active function and the active function is turned off.  Active Function Display: the marker X axis value entered in the active function area displays the marker value to its full entered precision.
Preset	OFF
State Saved	Saved in instrument state.
Range	Normal Delta Off
Initial S/W Revision	Prior to A.02.00
Modified at S/W Revision	A.02.00, A.03.00

## Properties

Accesses the marker properties menu.

Key Path	Marker
Initial S/W Revision	Prior to A.02.00

## Select Marker

Displays 12 markers available for selection.

Key Path	Marker
Initial S/W Revision	Prior to A.02.00

## Relative To

Sets the reference marker to which the selected marker is relative.

Key Path	Marker, Properties
Mode	SA, WCDMA, C2K, WIMAX OFDMA, 1xEVDO, DVB-T/H, DTMB (CTTB), ISDB-T, CMMB, LTE, LTETDD, Digital Cable TV, WLAN, MSR, LTEAFDD, LTEATDD
Remote Command	:CALCulate:CHPower:MARKer[1] 2 ... 12:REference <integer> :CALCulate:CHPower:MARKer[1] 2 ... 12:REference?
Example	CALC:CHP:MARK:REF 5 CALC:CHP:MARK:REF?
Notes	A marker cannot be relative to itself so that choice is grayed out, and if sent from SCPI generates error -221: "Settings conflict; marker cannot be relative to itself." When queried, a single value is returned (the specified marker numbers relative marker). You must be in the Spectrum Analysis or WCDMA mode to use this command. Use :INSTrument:SElect to set the mode.
Preset	2 3 4 5 6 7 8 9 10 11 12 1
State Saved	Saved in instrument state.
Min	1
Max	12
Initial S/W Revision	Prior to A.02.00
Modified at S/W Revision	A.02.00, A.03.00

## Marker Trace (DVB-T/H, DTMB (CTTB), ISDB-T and CMMB only)

Accesses a menu that allows you to assign a specified marker to the designated trace. This function is only valid for DVB-T/H, DTMB (CTTB) mode, ISDB-T, and CMMB only.

The table below is for DVB-T/H and DTMB mode.

Key Path	Marker, Properties
Mode	DVB-T/H, DTMB (CTTB)
Remote Command	:CALCulate:CHPower:MARKer[1] 2 ... 12:TRACe RFSPectrum   LSHoulder   RSHoulder   MASK :CALCulate:CHPower:MARKer[1] 2 ... 12:TRACe?
Example	CALC:CHP:MARK:TRAC RFSP CALC:CHP:MARK:TRAC?
Preset	RFSPectrum
State Saved	Saved in instrument state.
Range	RF Spectrum Left Shoulder Right Shoulder Spectrum Mask
Initial S/W Revision	A.02.00

The table below is for ISDB-T and CMMB mode.

Key Path	Marker, Properties
Mode	ISDB-T, CMMB
Remote Command	:CALCulate:CHPower:MARKer[1] 2 ... 12:TRACe RFSPectrum   LSHoulder   RSHoulder :CALCulate:CHPower:MARKer[1] 2 ... 12:TRACe?
Example	CALC:CHP:MARK:TRAC RFSP CALC:CHP:MARK:TRAC?
Preset	RFSPectrum
State Saved	Saved in instrument state.
Range	RF Spectrum Left Shoulder Right Shoulder
Initial S/W Revision	A.02.00
Modified at S/W Revision	A.03.00

## All Markers Off

Turns off all markers.

Key Path	Marker
Mode	SA, WCDMA, C2K, WIMAX OFDMA, 1xEVDO, DVB-T/H, DTMB (CTTB), ISDB-T, CMMB, LTE, LTETDD, Digital Cable TV, WLAN, MSR, LTEAFDD, LTEATDD

<b>Remote Command</b>	:CALCulate:CHPower:MARKer:AOff
<b>Example</b>	CALC:CHP:MARK:AOff
Initial S/W Revision	Prior to A.02.00
Modified at S/W Revision	A.02.00, A.03.00

### Marker X Axis Value (Remote Command Only)

Sets the marker X Axis value in the current marker X Axis Scale unit. It has no effect if the control mode is Off, but is the SCPI equivalent of entering an X value if the control mode is Normal, Delta, or Fixed.

<b>Mode</b>	SA, WCDMA, CDMA2K, WIMAXOFDMA, CDMA1XEV, DVB, DTMB, ISDBT, CMMB, LTE, LTETDD, DCATV, WLAN, MSR, LTEAFDD, LTEATDD
<b>Remote Command</b>	:CALCulate:CHPower:MARKer[1] 2 ... 12:X <real> :CALCulate:CHPower:MARKer[1] 2 ... 12:X?
<b>Example</b>	CALC:CHP:MARK3:X 0 CALC:CHP:MARK3:X?
<b>Notes</b>	The query returns the marker's absolute X Axis value if the control mode is Normal, or the offset from the marker's reference marker if the control mode is Delta. The query is returned in the fundamental units for the current marker X Axis scale: Hz for Frequency.
<b>Preset</b>	After a preset, all markers are turned OFF, so Marker X Axis Value query returns a not a number (NAN).
<b>State Saved</b>	Saved in instrument state.
<b>Min</b>	-9.9E+37
<b>Max</b>	9.9E+37
Initial S/W Revision	Prior to A.02.00
Modified at S/W Revision	A.02.00, A.03.00

### Marker X Axis Position (Remote Command Only)

Sets the marker X Axis Scale position in trace points. This setting has no effect if the control mode is Off, but is the SCPI equivalent of entering a value if the control mode is Normal or Delta. The entered value is immediately translated into the current X Axis Scale units for setting the value of the marker.

<b>Mode</b>	SA, WCDMA, CDMA2K, WIMAXOFDMA, CDMA1XEV, DVB, DTMB, ISDBT, CMMB, LTE, LTETDD, DCATV, WLAN, MSR, LTEAFDD, LTEATDD
<b>Remote Command</b>	:CALCulate:CHPower:MARKer[1] 2 ... 12:X:POStion <real> :CALCulate:CHPower:MARKer[1] 2 ... 12:X:POStion?
<b>Example</b>	CALC:CHP:MARK10:X:POS 0 CALC:CHP:MARK10:X:POS?
<b>Notes</b>	The query returns the marker's absolute X Axis value in trace points if the control mode is Normal, or the offset from the marker's reference marker in trace points if the control mode is Delta.



Preset	After a preset, all markers are turned OFF, so Marker X Axis Value query returns a not a number (NAN).
State Saved	Saved in instrument state.
Min	-9.9E+37
Max	9.9E+37
Initial S/W Revision	Prior to A.02.00
Modified at S/W Revision	A.02.00, A.03.00

### Marker Y Axis Value (Remote Command only)

Returns the marker Y Axis value in the current marker Y Axis unit.

Mode	SA, WCDMA, CDMA2K, WIMAXOFDMA, CDMA1XEV, DVB, DTMB, ISDBT, CMMB, LTE, LTETDD, DCATV, WLAN, MSR, LTEAFDD, LTEATDD
<b>Remote Command</b>	:CALCulate:CHPower:MARKer[1] 2 ... 12:Y?
<b>Example</b>	CALC:CHP:MARK11:Y?
Preset	Result dependent on Markers setup and signal source.
State Saved	Saved in instrument state.
Initial S/W Revision	Prior to A.02.00
Modified at S/W Revision	A.02.00, A.03.00

### Backward Compatibility SCPI Commands

Sets or queries the state of a marker. Setting a marker which is OFF to state ON or 1 puts it in Normal mode and places it at the center of the screen.

Mode	SA, WCDMA, CDMA2K, WIMAXOFDMA, CDMA1XEV, DVB, DTMB, ISDBT, CMMB, LTE, LTETDD, DCATV, WLAN, MSR, LTEAFDD, LTEATDD
<b>Remote Command</b>	:CALCulate:CHPower:MARKer[1] 2 ... 12:STATe OFF ON 0 1 :CALCulate:CHPower:MARKer[1] 2 ... 12:STATe?
<b>Example</b>	CALC:CHP:MARK3:STAT ON CALC:CHP:MARK3:STAT?
Preset	OFF
State Saved	Saved in instrument state.
Range	On Off
Initial S/W Revision	Prior to A.02.00
Modified at S/W Revision	A.02.00, A.03.00

## Marker Function

There are no 'Marker Functions' supported in Channel Power, so this front-panel key displays a blank menu when pressed.

---

Key Path	Front-panel key
Initial S/W Revision	Prior to A.02.00

---

## Marker To

There is no 'Marker To' functionality supported in Channel Power measurement, so this front-panel key displays a blank key menu when pressed.

---

Key Path	Front-panel key
Initial S/W Revision	Prior to A.02.00

---

## Meas

The information in this section is common to all measurements. For key and remote command information for a specific measurement, refer to the section that describes the measurement of interest.

Measurements available under the Meas key are specific to the current Mode.

When viewing Help for measurements, note the following:

**NOTE**

Operation for some keys differs between measurements. The information displayed in Help pertains to the current measurement. To see how a key operates in a different measurement, exit Help (press the Cancel Esc key), select the measurement, then reenter Help (press the Help key) and press that key.

---

Key Path	Front-panel key
Initial S/W Revision	Prior to A.02.00

---

### Remote Measurement Functions

This section contains the following topics:

["Measurement Group of Commands" on page 2166](#)

["Current Measurement Query \(Remote Command Only\)" on page 2168](#)

["Limit Test Current Results \(Remote Command Only\)" on page 2168](#)

["Data Query \(Remote Command Only\)" on page 2168](#)

["Calculate/Compress Trace Data Query \(Remote Command Only\)" on page 2169](#)

["Calculate Peaks of Trace Data \(Remote Command Only\)" on page 2174](#)

[Hardware-Accelerated Fast Power Measurement \(Remote Command Only\)](#)

["Format Data: Numeric Data \(Remote Command Only\)" on page 2175](#)

["Format Data: Byte Order \(Remote Command Only\)" on page 2176](#)

---

Initial S/W Revision	Prior to A.02.00
----------------------	------------------

---

## Measurement Group of Commands

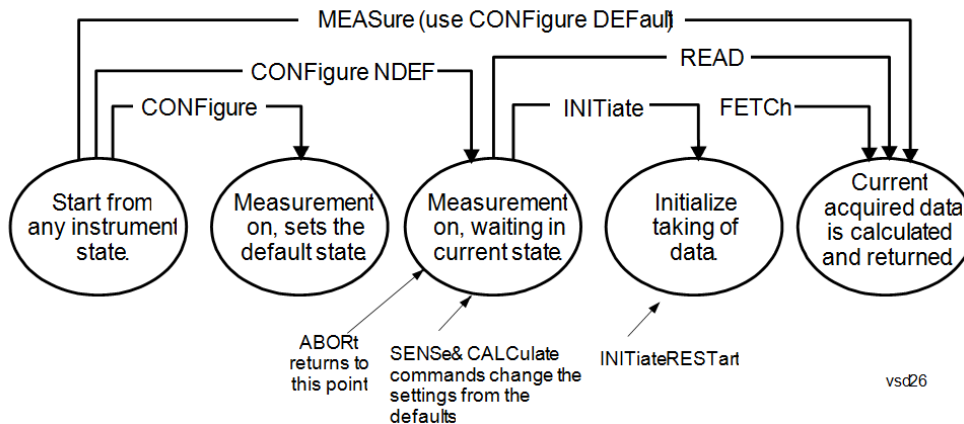

## Measure Commands:

:MEASure:<measurement>[n]?

This is a fast single-command way to make a measurement using the factory default instrument settings. These are the settings and units that conform to the Mode Setup settings (e.g. radio standard) that you have currently selected.

- Stops the current measurement (if any) and sets up the instrument for the specified measurement using the factory defaults
- Initiates the data acquisition for the measurement
- Blocks other SCPI communication, waiting until the measurement is complete before returning results.
- If the function does averaging, it is turned on and the number of averages is set to 10.
- After the data is valid it returns the scalar results, or the trace data, for the specified measurement. The type of data returned may be defined by an [n] value that is sent with the command.
- The scalar measurement results will be returned if the optional [n] value is not included, or is set to 1. If the [n] value is set to a value other than 1, the selected trace data results will be returned. See each command for details of what types of scalar results or trace data results are available.
- ASCII is the default format for the data output. (Older versions of Spectrum Analysis and Phase Noise mode measurements only use ASCII.) The binary data formats should be used for handling large blocks of data since they are smaller and faster than the ASCII format. Refer to the FORMat:DATA command for more information.

If you need to change some of the measurement parameters from the factory default settings you can set up the measurement with the CONFIgure command. Use the commands in the SENSe:<measurement> and CALCulate:<measurement> subsystems to change the settings. Then you can use the READ? command to initiate the measurement and query the results.

If you need to repeatedly make a given measurement with settings other than the factory defaults, you can use the commands in the SENSe:<measurement> and CALCulate:<measurement> subsystems to set up the measurement. Then use the READ? command to initiate the measurement and query results.

Measurement settings persist if you initiate a different measurement and then return to a previous one. Use READ:<measurement>? if you want to use those persistent settings. If you want to go back to the default settings, use MEASure:<measurement>?.

## Configure Commands:

:CONFIgure:<measurement>

This command stops the current measurement (if any) and sets up the instrument for the specified measurement using

---

the factory default instrument settings. It does not initiate the taking of measurement data unless INIT:CONTinuous is ON. If you change any measurement settings after using the CONFigure command, the READ command can be used to initiate a measurement without changing the settings back to their defaults.

In the Swept SA measurement in Spectrum Analyzer mode the CONFigure command also turns the averaging function on and sets the number of averages to 10 for all measurements.

:CONFigure: <measurement>: NDEFault stops the current measurement and changes to the specified measurement. It does not change the settings to the defaults. It does not initiate the taking of measurement data unless INIT:CONTinuous is ON.

The CONFigure? query returns the current measurement name.

The CONFigure:CATalog? query returns a quoted string of all licensed measurement names in the current mode. For example, "SAN, CHP, OBW, ACP, PST, TXP, SPUR, SEM, LIST".

---

#### Fetch Commands:

---

:FETCh:<measurement>[n]?

This command puts selected data from the most recent measurement into the output buffer. Use FETCh if you have already made a good measurement and you want to return several types of data (different [n] values, for example, both scalars and trace data) from a single measurement. FETCh saves you the time of re-making the measurement. You can only FETCh results from the measurement that is currently active, it will not change to a different measurement. An error message is reported if a measurement other than the current one is specified.

If you need to get new measurement data, use the READ command, which is equivalent to an INITiate followed by a FETCh.

The scalar measurement results will be returned if the optional [n] value is not included, or is set to 1. If the [n] value is set to a value other than 1, the selected trace data results will be returned. See each command for details of what types of scalar results or trace data results are available. The binary data formats should be used for handling large blocks of data since they are smaller and transfer faster than the ASCII format. (FORMat:DATA)

FETCh may be used to return results other than those specified with the original READ or MEASure command that you sent.

---

#### INITiate Commands:

---

:INITiate:<measurement>

This command is not available for measurements in all the instrument modes:

- Initiates a trigger cycle for the specified measurement, but does not output any data. You must then use the FETCh<meas> command to return data. If a measurement other than the current one is specified, the instrument will switch to that measurement and then initiate it.
  - For example, suppose you have previously initiated the ACP measurement, but now you are running the channel power measurement. If you send INIT:ACP? it will change from channel power to ACP and will initiate an ACP measurement.
  - Does not change any of the measurement settings. For example, if you have previously started the ACP measurement and you send INIT:ACP? it will initiate a new ACP measurement using the same instrument settings as the last time ACP was run.
  - If your selected measurement is currently active (in the idle state) it triggers the measurement, assuming the trigger conditions are met. Then it completes one trigger cycle. Depending upon the measurement and the number of averages, there may be multiple data acquisitions, with multiple trigger events, for one full trigger cycle. It also holds off additional commands on GPIB until the acquisition is complete.
- 

#### READ Commands:

---

:READ:<measurement>[n]?

- Does not preset the measurement to the factory default settings. For example, if you have previously initiated the ACP
-

---

measurement and you send READ:ACP? it will initiate a new measurement using the same instrument settings.

- Initiates the measurement and puts valid data into the output buffer. If a measurement other than the current one is specified, the instrument will switch to that measurement before it initiates the measurement and returns results.
  - For example, suppose you have previously initiated the ACP measurement, but now you are running the channel power measurement. Then you send READ:ACP? It will change from channel power back to ACP and, using the previous ACP settings, will initiate the measurement and return results.
  - Blocks other SCPI communication, waiting until the measurement is complete before returning the results
  - If the optional [n] value is not included, or is set to 1, the scalar measurement results will be returned. If the [n] value is set to a value other than 1, the selected trace data results will be returned. See each command for details of what types of scalar results or trace data results are available. The binary data formats should be used when handling large blocks of data since they are smaller and faster than the ASCII format. (FORMat:DATA)
- 

---

Initial S/W Revision	Prior to A.02.00
----------------------	------------------

---

### Current Measurement Query (Remote Command Only)

This command returns the name of the measurement that is currently running.

---

<b>Remote Command</b>	:CONFigure?
-----------------------	-------------

<b>Example</b>	CONF?
----------------	-------

Initial S/W Revision	Prior to A.02.00
----------------------	------------------

---

### Limit Test Current Results (Remote Command Only)

Queries the status of the current measurement limit testing. It returns a 0 if the measured results pass when compared with the current limits. It returns a 1 if the measured results fail any limit tests.

---

<b>Remote Command</b>	:CALCulate:CLIMits:FAIL?
-----------------------	--------------------------

<b>Example</b>	CALC:CLIM:FAIL? queries the current measurement to see if it fails the defined limits. Returns a 0 or 1: 0 it passes, 1 it fails.
----------------	--

Initial S/W Revision	Prior to A.02.00
----------------------	------------------

---

### Data Query (Remote Command Only)

Returns the designated measurement data for the currently selected measurement and subopcode.

n = any valid subopcode for the current measurement. See the measurement command results table for your current measurement, for information about what data is returned for the subopcodes.

This command uses the data setting specified by the FORMat:BORDER and FORMat:DATA commands and can return real or ASCII data. (See the format command descriptions under Input/Output in the Analyzer Setup section.)

<b>Remote Command</b>	:CALCulate:DATA[n]?
<b>Notes</b>	The return trace depends on the measurement. In CALCulate:<meas>:DATA[n], n is any valid subopcode for the current measurement. It returns the same data as the FETCH:<measurement>? query where <measurement> is the current measurement.
<b>Initial S/W Revision</b>	Prior to A.02.00

### Calculate/Compress Trace Data Query (Remote Command Only)

Returns compressed data for the currently selected measurement and sub-opcode [n].

n = any valid sub-opcode for that measurement. See the MEASure:<measurement>? command description of your specific measurement for information on the data that can be returned.

The data is returned in the current Y Axis Unit of the analyzer. The command is used with a sub-opcode <n> (default=1) to specify the trace. With trace queries, it is best if the analyzer is not sweeping during the query. Therefore, it is generally advisable to be in Single Sweep, or Update=Off.

This command is used to compress or decimate a long trace to extract and return only the desired data. A typical example would be to acquire N frames of GSM data and return the mean power of the first burst in each frame. The command can also be used to identify the best curve fit for the data.

<b>Remote Command</b>	:CALCulate:DATA<n>:COMPRESS? BLOCK   CFIT   MAXimum   MINimum   MEAN   DMEan   RMS   RMSCubed   SAMPLE   SDEVIation   PPHase [,<soffset> [,<length>[,<roffset>[,<rlimit>]]]]
<b>Example</b>	To query the mean power of a set of GSM bursts: Supply a signal that is a set of GSM bursts. Select the IQ Waveform measurement (in IQ Analyzer Mode). Set the sweep time to acquire at least one burst. Set the triggers such that acquisition happens at a known position relative to a burst. Then query the mean burst levels using, CALC:DATA2:COMP? MEAN, 24e-6, 526e-6 (These parameter values correspond to GSM signals, where 526e-6 is the length of the burst in the slot and you just want 1 burst.)
<b>Notes</b>	The command supports 5 parameters. Note that the last 4 (<soffset>, <length>, <roffset>, <rlimit>) are optional. But these optional parameters must be entered in the specified order. For example, if you want to specify <length>, then you must also specify <soffset>. See details below for a definition of each of these parameters.  This command uses the data in the format specified by FORMat:DATA, returning either binary or ASCII data.
<b>Initial S/W Revision</b>	Prior to A.02.00

- BLOCK or block data - returns all the data points from the region of the trace data that you specify. For example, it could be used to return the data points of an input signal over several timeslots, excluding the portions of the trace data that you do not want. (This is x,y pairs for trace data and I,Q pairs for complex data.)



- CFIT or curve fit - applies curve fitting routines to the data. <soffset> and <length> are required to define the data that you want. <roffset> is an optional parameter for the desired order of the curve equation. The query will return the following values: the x-offset (in seconds) and the curve coefficients ((order + 1) values).

MIN, MAX, MEAN, DME, RMS, RMSC, SAMP, SDEV and PPH return one data value for each specified region (or <length>) of trace data, for as many regions as possible until you run out of trace data (using <roffset> to specify regions). Or they return the number of regions you specify (using <rlimit>) ignoring any data beyond that.

- MINimum - returns the minimum data point (y value) for the specified region(s) of trace data. For I/Q trace data, the minimum magnitude of the I/Q pairs is returned.
- MAXimum - returns the maximum data point (y value) for the specified region(s) of trace data. For I/Q trace data, the maximum magnitude of the I/Q pairs is returned.
- MEAN - returns a single value that is the arithmetic mean of the data point values (in dB/ dBm) for the specified region(s) of trace data. For I/Q trace data, the mean of the magnitudes of the I/Q pairs is returned. See the following equations.

- 

**NOTE**

If the original trace data is in dB, this function returns the arithmetic mean of those log values, not log of the mean power which is a more useful value. The mean of the log is the better measurement technique when measuring CW signals in the presence of noise. The mean of the power, expressed in dB, is useful in power measurements such as Channel Power. To achieve the mean of the power, use the RMS option.

Equation 1

Mean Value of Data Points for Specified Region(s)

$$\text{MEAN} = \frac{1}{n} \sum_{X_i \in \text{region}(s)} X_i$$

where  $X_i$  is a data point value, and  $n$  is the number of data points in the specified region(s).

Equation 2

Mean Value of I/Q Data Pairs for Specified Region(s)

$$\text{MEAN} = \frac{1}{n} \sum_{X_i \in \text{region}(s)} |X_i|$$

where  $|X_i|$  is the magnitude of an I/Q pair, and  $n$  is the number of I/Q pairs in the specified region(s).

- DMEan - returns a single value that is the mean power (in dB/ dBm) of the data point values for the specified region(s) of trace data. See the following equation:

Equation 3

DMEan Value of Data Points for Specified Region(s)

$$\text{DME} = 10 \times \log_{10} \left( \frac{1}{n} \sum_{X_i \in \text{region}(s)} 10^{\frac{X_i}{10}} \right)$$

- RMS - returns a single value that is the average power on a root-mean-squared voltage scale (arithmetic rms) of the data point values for the specified region(s) of trace data. See the following equation.

**NOTE**

For I/Q trace data, the rms of the magnitudes of the I/Q pairs is returned. See the following equation. This function is very useful for I/Q trace data. However, if the original trace data is in dB, this function returns the rms of the log values which is not usually needed.

Equation 4

RMS Value of Data Points for Specified Region(s)

$$\text{RMS} = \sqrt{\frac{1}{n} \sum_{X_i \in \text{region}(s)} X_i^2}$$

where  $X_i$  is a data point value, and  $n$  is the number of data points in the specified region(s).

Equation 5

RMS Value of I/Q Data Pairs for Specified Region(s)

$$\text{RMS} = \sqrt{\frac{1}{n} \sum_{X_i \in \text{region}(s)} X_i X_i^*}$$

where  $X_i$  is the complex value representation of an I/Q pair,  $X_i^*$  its conjugate complex number, and  $n$  is the number of I/Q pairs in the specified region(s).

Once you have the rms value for a region of trace data (linear or I/Q), you may want to calculate the mean power. You must convert this rms value (peak volts) to power in dBm:

$$10 \times \log[10 \times (\text{rms value})^2]$$

- SAMPLe - returns the first data value (x,y pair) for the specified region(s) of trace data. For I/Q trace data, the first I/Q pair is returned.
- SDEViation - returns a single value that is the arithmetic standard deviation for the data point values for the specified region(s) of trace data. See the following equation.
- For I/Q trace data, the standard deviation of the magnitudes of the I/Q pairs is returned. See the following equation.

Equation 6

Standard Deviation of Data Point Values for Specified Region(s)

$$\text{SDEV} = \sqrt{\frac{1}{n} \sum_{X_i \in \text{region}(s)} (X_i - \bar{X})^2}$$

where  $X_i$  is a data point value,  $\bar{X}$  is the arithmetic mean of the data point values for the specified region (s), and  $n$  is the number of data points in the specified region(s).

$$\text{SDEV} = \sqrt{\frac{1}{n} \sum_{X_i \in \text{region}(s)} (|X_i| - \bar{X})^2}$$

where  $|X_i|$  is the magnitude of an I/Q pair,  $\bar{X}$  is the mean of the magnitudes for the specified region(s), and  $n$  is the number of data points in the specified region(s).

- PPHase - returns the x,y pairs of both rms power (dBm) and arithmetic mean phase (radian) for every specified region and frequency offset (Hz). The number of pairs is defined by the specified number of regions. This parameter can be used for I/Q vector ( $n=0$ ) in Waveform (time domain) measurement and all parameters are specified by data point in PPHase.

The rms power of the specified region may be expressed as:

$$\text{Power} = 10 \times \log [10 \times (\text{RMS I/Q value})] + 10.$$

The RMS I/Q value (peak volts) is:

$$\sqrt{\frac{1}{n} \sum_{X_i \in \text{region}} X_i X_i^*}$$

where  $X_i$  is the complex value representation of an I/Q pair,  $X_i^*$  its conjugate complex number, and  $n$  is the number of I/Q pairs in the specified region.

The arithmetic mean phase of the specified region may be expressed as:

$$\frac{1}{n} \sum_{Y_i \in \text{region}} Y_i$$

where  $Y_i$  is the unwrapped phase of I/Q pair with applying frequency correction and  $n$  is the number of I/Q pairs in the specified region.

The frequency correction is made by the frequency offset calculated by the arithmetic mean of every specified region's frequency offset. Each frequency offset is calculated by the least square method against the unwrapped phase of I/Q pair.

Sample Trace Data - Constant Envelope

(See below for explanation of variables.)

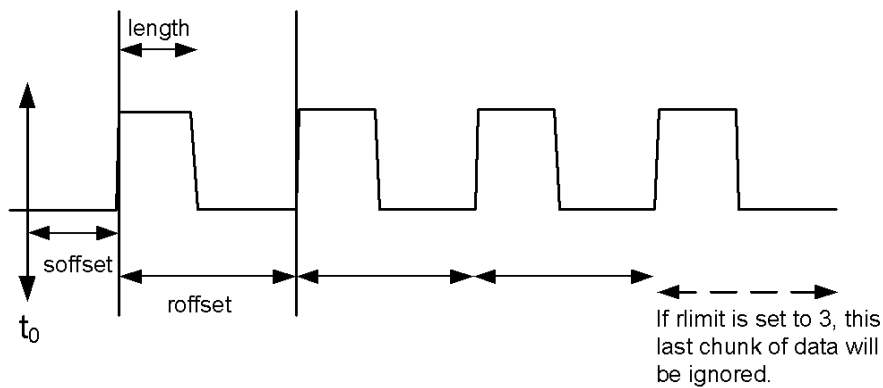

Sample Trace Data - Not Constant Envelope

(See below for explanation of variables.)

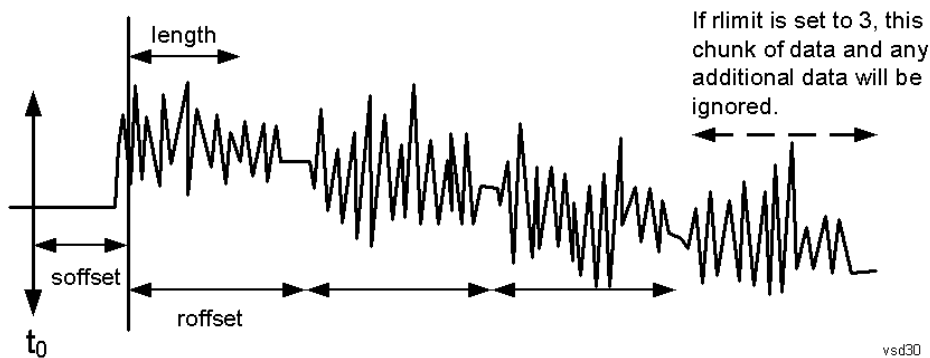

<soffset> - start offset is an optional real number. (It is in seconds for time-domain traces, and is a dimensionless index 0 to Npoints - 1, for frequency-domain traces). It specifies the amount of data at the beginning of the trace that will be ignored before the decimation process starts. It is the time or frequency change from the start of the trace to the point where you want to start using the data. The default value is zero.

<length> - is an optional real number. (It is in seconds for time-domain traces, and is a dimensionless index 0 to Npoints - 1, for frequency-domain traces). It defines how much data will be compressed into one value. This parameter has a default value equal to the current trace length.

<roffset> - repeat offset is an optional real number. (It is in seconds for time-domain traces, and is a dimensionless index 0 to Npoints - 1, for frequency-domain traces). It defines the beginning of the next field of trace elements to be compressed. This is relative to the beginning of the previous field. This parameter has a default value equal to the <length> variable. Note that this parameter is used for a completely different purpose when curve fitting (see CFIT above).

<rlimit> - repeat limit is an optional integer. It specifies the number of data items that you want returned. It will ignore any additional items beyond that number. You can use the Start offset and the Repeat limit to pick out exactly what part of the data you want to use. The default value is all the data.

## Calculate Peaks of Trace Data (Remote Command Only)

Returns a list of all the peaks for the currently selected measurement and sub-opcode [n]. The peaks must meet the requirements of the peak threshold and excursion values.

n = any valid sub-opcode for the current measurement. See the MEASure:<measurement> command description of your specific measurement for information on the data that can be returned.

The command can only be used with specific sub-opcodes with measurement results that are trace data. Both real and complex traces can be searched, but complex traces are converted to magnitude in dBm. In many measurements the sub-opcode n=0, is the raw trace data which cannot be searched for peaks. And Sub-opcode n=1, is often calculated results values which also cannot be searched for peaks.

This command uses the data setting specified by the FORMat:BORDER and FORMat:DATA commands and can return real or ASCII data. If the format is set to INT,32, it returns REAL,32 data.

The command has four types of parameters:

- Threshold (in dBm)
- Excursion (in dB)
- Sorting order (amplitude, frequency, time)
- Optional in some measurements: Display line use (all, > display line, < display line)

---

<b>Remote Command</b>	<p>For Swept SA measurement:</p> <pre>:CALCulate:DATA[1] 2 ... 6:PEAKs? &lt;threshold&gt;,&lt;excursion&gt;[,AMPLitude   FREQuency   TIME[,ALL   GTDLline   LTDLine]]</pre> <p>For most other measurements:</p> <pre>:CALCulate:DATA[1] 2 ... 6:PEAKs? &lt;threshold&gt;,&lt;excursion&gt;[,AMPLitude   FREQuency   TIME]</pre>
-----------------------	---

---

<b>Example</b>	<p>Example for Swept SA measurement in Spectrum Analyzer Mode:</p> <p>CALC:DATA4:PEAK? -40, 10, FREQ, GTDL This will identify the peaks of trace 4 that are above -40 dBm, with excursions of at least 10 dB. The peaks are returned in order of increasing frequency, starting with the lowest frequency. Only the peaks that are above the display line are returned.</p> <p>Query Results 1:</p> <p>With FORMat:DATA REAL, 32 selected, it returns a list of floating-point numbers. The first value in the list is the number of peak points that are in the following list. A peak point consists of two values: a peak amplitude followed by its corresponding frequency (or time).</p> <p>If no peaks are found the peak list will consist of only the number of peaks, (0).</p>
----------------	---

---

<b>Notes</b>	<p>&lt;n&gt; - is the trace that will be used</p> <p>&lt;threshold&gt; - is the level below which trace data peaks are ignored. Note that the threshold value is required and is always used as a peak criterion. To effectively disable the threshold criterion for this command, provide a substantially low threshold value such as -200 dBm. Also note that the threshold value used in this command is independent of and has no effect on the threshold value stored under the Peak Criteria menu.</p> <p>&lt;excursion&gt; - is the minimum amplitude variation (rise and fall) required for a signal to be identified as peak. Note that the excursion value is required and is always used as a peak criterion. To effectively disable the excursion criterion for this command, provide the minimum value of 0.0 dB. Also note that the excursion value used in this command is independent of and has no effect on the</p>
--------------	---

---

excursion value stored under the Peak Criteria menu.

Values must be provided for threshold and excursion. The sorting and display line parameters are optional (defaults are AMPLitude and ALL).

Note that there is always a Y-axis value for the display line, regardless of whether the display line state is on or off. It is the current Y-axis value of the display line which is used by this command to determine whether a peak should be reported

Sorting order:

AMPLitude - lists the peaks in order of descending amplitude, with the highest peak first (default if optional parameter not sent)

FREQuency - lists the peaks in order of occurrence, left to right across the x-axis.

TIME - lists the peaks in order of occurrence, left to right across the x-axis.

Peaks vs. Display Line:

ALL - lists all of the peaks found (default if optional parameter not sent).

GTDLine (greater than display line) - lists all of the peaks found above the display line.

LTDLine (less than display line) - lists all of the peaks found below the display line.

Initial S/W Revision      Prior to A.02.00

### Format Data: Numeric Data (Remote Command Only)

This command specifies the format of the trace data input and output. It specifies the formats used for trace data during data transfer across any remote port. It affects only the data format for setting and querying trace data for the :TRACe[:DATA], TRACe[:DATA]?, :CALCulate:DATA[n]? and FETCh:SANalyzer [n]? commands and queries.

**Remote Command**      :FORMat [:TRACe] [:DATA] ASCii|INTeger,32|REAL,32 |REAL,64  
:FORMat [:TRACe] [:DATA] ?

**Notes**      The query response is:  
ASCii: ASC,8  
REAL,32: REAL,32  
REAL,64: REAL,64  
INTeger,32: INT,32

When the numeric data format is REAL or ASCii, data is output in the current Y Axis unit. When the data format is INTeger, data is output in units of m dBm (.001 dBm).

The INT,32 format returns binary 32-bit integer values in internal units (m dBm), in a definite length block.

**Dependencies**      Sending a data format spec with an invalid number (for example, INT,48) generates no error. The analyzer simply uses the default (8 for ASCii, 32 for INTeger, 32 for REAL).

Sending data to the analyzer which does not conform to the current FORMat specified, results in an error. Sending ASCII data when a definite block is expected generates message -161 "Invalid Block Data" and sending a definite block when ASCII data is expected generates message -121 "Invalid Character in Number".

**Preset**      ASCii

**Backwards Compatibility Notes**      Note that the INT,32 format is only applicable to the command, TRACe:DATA. This preserves backwards compatibility for the Swept SA measurement. For all other commands/queries which honor FORMat:DATA, if INT,32 is sent the analyzer will behave as though it were set to REAL,32.

Initial S/W Revision      Prior to A.02.00

The specs for each output type follow:

ASCIi - Amplitude values are in ASCII, in the current Y Axis Unit, one ASCII character per digit, values separated by commas, each value in the form:

SX.YYYYYEsZZ

Where:

S = sign (+ or -)

X = one digit to left of decimal point

Y = 5 digits to right of decimal point

E = E, exponent header

s = sign of exponent (+ or -)

ZZ = two digit exponent

REAL,32 - Binary 32-bit real values in the current Y Axis Unit, in a definite length block.

REAL,64 - Binary 64-bit real values in the current Y Axis Unit, in a definite length block.

### Format Data: Byte Order (Remote Command Only)

This command selects the binary data byte order for data transfer and other queries. It controls whether binary data is transferred in normal or swapped mode. This command affects only the byte order for setting and querying trace data for the :TRACe[:DATA], TRACe[:DATA]? , :CALCulate:DATA[n]? and FETCh:SANalyzer[n]? commands and queries.

By definition any command that says it uses FORMat:DATA uses any format supported by FORMat:DATA.

The NORMal order is a byte sequence that begins with the most significant byte (MSB) first, and ends with the least significant byte (LSB) last in the sequence: 1|2|3|4. SWAPped order is when the byte sequence begins with the LSB first, and ends with the MSB last in the sequence: 4|3|2|1.

<b>Remote Command</b>	:FORMat:BORDER NORMal SWAPped :FORMat:BORDER?
<b>Preset</b>	NORMal
<b>Initial S/W Revision</b>	Prior to A.02.00

## Meas Setup

Displays the setup menu for the currently selected measurement. The parameters included in this menu are as follows.

Averaging

IF Gain

Channel Power Span

Integrated Bandwidth

Filter Bandwidth

Root Raised Cosine (RRC) Filter

Key Path	Front-panel key
Initial S/W Revision	Prior to A.02.00

### Avg/Hold Num

Specifies the number of measurement averages used to calculate the measurement result. The average is displayed at the end of each sweep. After the specified number of average counts, the averaging mode (terminal control) setting determines the averaging action.

Key Path	Meas Setup
Mode	SA, WCDMA, C2K, WIMAX OFDMA, 1xEVDO, DVB-T/H, DTMB (CTTB), ISDB-T, CMMB, LTE, LTETDD, Digital Cable TV, WLAN, MSR, LTEAFDD, LTEATDD
<b>Remote Command</b>	[:SENSe]:CHPower:AVERage:COUNT <integer> [:SENSe]:CHPower:AVERage:COUNT? [:SENSe]:CHPower:AVERage[:STATe] ON OFF 1 0 [:SENSe]:CHPower:AVERage[:STATe]?
<b>Example</b>	CHP:AVER:COUN 15 CHP:AVER:COUN? CHP:AVER ON CHP:AVER?
Notes	You must be in the Spectrum Analysis mode, W-CDMA mode, cdma2000 mode, DVB-T/H mode, DTMB (CTTB) mode, ISDB-T mode, CMMB mode, Digital Cable TV mode, LTE mode, LTE TDD mode 1xEVDO mode or WIMAX OFDMA mode to use this command. Use :INSTRument:SElect to set the mode.
Preset	SA: 10 WCDMA: 200 WIMAX OFDMA, LTE, LTETDD, MSR: 200 CDMA2K: 20 1xEVDO: 20



	DVB-T/H: 20 DTMB (CTTB): 20 ISDB-T: 10 CMMB: 10 Digital Cable TV: 10 WLAN: 10 LTEAFDD, LTEATDD:200 ON
State Saved	Saved in instrument state.
Min	1
Max	10000
Initial S/W Revision	Prior to A.02.00
Modified at S/W Revision	A.02.00, A.03.00

## Avg Mode

Allows you to select the type of termination control used for the averaging function. This determines the averaging action after the specified number of data acquisitions (average count) is reached.

When set to Exponential (Exp) the measurement averaging continues using the specified number of averages to compute each exponentially-weighted averaged value. The average is displayed at the end of each sweep.

When set to Repeat, the measurement resets the average counter each time the specified number of averages is reached.

Key Path	Meas Setup
Mode	SA, WCDMA, C2K, WIMAX OFDMA, 1xEVDO, DVB-T/H, DTMB (CTTB), ISDB-T, CMMB, LTE, LTEATDD, Digital Cable TV, WLAN, MSR, LTEAFDD, LTEATDD
Remote Command	[ :SENSe ] :CHPower:AVERage:TCONtrol EXPonential REPeat [ :SENSe ] :CHPower:AVERage:TCONtrol?
Example	CHP:AVER:TCON EXP CHP:AVER:TCON?
Notes	You must be in the Spectrum Analysis mode, W-CDMA mode, cdma2000 mode, DVB-T/H mode, DTMB (CTTB) mode, ISDB-T mode, CMMB mode, Digital Cable TV mode, LTE mode, LTE TDD mode, WLAN mode, 1xEVDO mode or WIMAX OFDMA mode to use this command. Use :INSTrument:SElect to set the mode.
Preset	EXP
State Saved	Saved in instrument state.
Range	Exp Repeat
Initial S/W Revision	Prior to A.02.00
Modified at S/W Revision	A.02.00, A.03.00

## Integ BW

Specifies the range of integration used in calculating the power in the channel. The integration bandwidth (IBW) is displayed on the trace as two markers connected by an arrow.

<b>Key Path</b>	<b>Meas Setup</b>
<b>Mode</b>	SA, WCDMA, C2K, WIMAX OFDMA, 1xEVDO, DVB-T/H, DTMB (CTTB), ISDB-T, CMMB, LTE, LTETDD, Digital Cable TV, WLAN
<b>Remote Command</b>	[ :SENSe ] :CHPower:BANDwidth:INTEgration <bandwidth> [ :SENSe ] :CHPower:BANDwidth:INTEgration?
<b>Example</b>	CHP:BAND:INT 10MHz CHP:BAND:INT?
<b>Notes</b>	You must be in the Spectrum Analysis mode, W-CDMA mode, cdma2000 mode, DVB-T/H mode, DTMB (CTTB) mode, ISDB-T mode, CMMB mode, Digital Cable TV mode, LTE mode, LTE TDD mode, WLAN mode, 1xEVDO mode or WIMAX OFDMA mode to use this command. Use :INSTrument:SElect to set the mode.
<b>Dependencies</b>	For MSR/LTE-Advanced FDD/TDD mode, this key is blank.
<b>Couplings</b>	The minimum value of the span is coupled with the integration bandwidth.
<b>Preset</b>	SA: 2 MHz WCDMA: 5 MHz C2K: 1.23 MHz WIMAX OFDMA: 10 MHz 1xEVDO: 1.23 MHz DVB-T/H: 7.61MHz DTMB (CTTB): 8MHz ISDB-T: 5.6MHz CMMB: 8MHz LTE: 5 MHz LTETDD: 5 MHz Digital Cable TV: 8MHz WLAN: if Radio Std is 802.11a/g(OFDM/DSSS-OFDM): 20 MHz if Radio Std is 802.11b: 25 MHz if Radio Std is 802.11n(20MHz): 20 MHz if Radio Std is 802.11n(40MHz): 40 MHz if Radio Std is 802.11ac (20 MHz): 20 MHz if Radio Std is 802.11ac (40 MHz): 40 MHz if Radio Std is 802.11ac (80 MHz): 80 MHz if Radio Std is 802.11ac (160 MHz): 160 MHz if Radio Std is 802.11ac (80 MHz + 80 MHz): 80 MHz

State Saved	Saved in instrument state.
Min	100 Hz
Max	Hardware Maximum Span
Initial S/W Revision	Prior to A.02.00
Modified at S/W Revision	A.02.00, A.03.00

### Shoulder Offset Start (Only for DVB-T/H and ISDB-T mode)

Specifies the start offset frequency from the center frequency used in calculating the shoulder attenuation results.

Key Path	Meas Setup
Mode	DVB-T/H, ISDB-T
<b>Remote Command</b>	<code>[ :SENSe ] :CHPower :SHOUlder :OFFSet :FREQuency :STARt &lt;freq&gt;</code> <code>[ :SENSe ] :CHPower :SHOUlder :OFFSet :FREQuency :STARt?</code>
<b>Example</b>	CHP:SHOU:OFFS:FREQ:STAR 3.3MHz CHP:SHOU:OFFS:FREQ:STAR?
Notes	You must be in the ISDB-T mode to use this command. Use :INSTrument:SElect to set the mode.
Couplings	The minimum value of the shoulder offset start frequency is coupled with integration bandwidth, the maximum value of the shoulder offset start frequency is coupled with shoulder offset stop frequency.
Preset	DVB-T/H: 4.105MHz ISDB-T: 3.3MHz
State Saved	Saved in instrument state.
Min	100 Hz
Max	1.0 GHz
Initial S/W Revision	A.03.00

### Shoulder Offset Stop (Only for DVB-T/H and ISDB-T mode)

Specifies the stop offset frequency from the center frequency used in calculating the shoulder attenuation results.

Key Path	Meas Setup
Mode	DVB-T/H, ISDB-T
<b>Remote Command</b>	<code>[ :SENSe ] :CHPower :SHOUlder :OFFSet :FREQuency :STOP &lt;freq&gt;</code> <code>[ :SENSe ] :CHPower :SHOUlder :OFFSet :FREQuency :STOP?</code>
<b>Example</b>	CHP:SHOU:OFFS:FREQ:STOP 3.5MHz CHP:SHOU:OFFS:FREQ:STOP?

Notes	You must be in the ISDB-T mode to use this command. Use :INSTrument:SElect to set the mode.
Couplings	The minimum value of the shoulder offset stop frequency is coupled with shoulder offset start frequency, the maximum value of the shoulder offset stop frequency is coupled with span.
Preset	DVB-T/H: 4.505MHz ISDB-T: 3.5MHz
State Saved	Saved in instrument state.
Min	100 Hz
Max	1.0 GHz
Initial S/W Revision	A.03.00

### PhNoise Opt

Selects the LO (local oscillator) phase noise behavior for various operating conditions. Refer to PhNoise Opt

in the Swept SA measurement for details.

Key Path	Meas Setup
Initial S/W Revision	A.04.20

### PhNoise Opt Auto

Selects the LO (local oscillator) phase noise behavior to optimize dynamic range and speed for various instrument operating conditions. Refer to PhNoise Opt Auto State in the Swept SA measurement for details.

Key Path	Meas Setup
<b>Remote Command</b>	[ :SENSe ] :CHPower:FREQuency:SYNThesis:AUTO[:STATe] OFF ON 0 1 [ :SENSe ] :CHPower:FREQuency:SYNThesis:AUTO[:STATe] ?
<b>Example</b>	CHP:FREQ:SYNT:AUTO 1 CHP:FREQ:SYNT:AUTO?
Preset	OFF
State Saved	Saved in instrument state.
Range	Auto Man
Readback Text	"Auto" is underlined when Auto is selected, otherwise Man is underlined.
Initial S/W Revision	A.04.20

## PhNoise Opt State

Selects the LO (local oscillator) phase noise behavior for various operating conditions. Refer to PhNoise Opt in the Swept SA measurement for details.

Key Path	Meas Setup
<b>Remote Command</b>	[ :SENSe ] :CHPower:FREQuency:SYNTHeSis[:STATe] 1 2 3 [ :SENSe ] :CHPower:FREQuency:SYNTHeSis[:STATe] ?
<b>Example</b>	CHP:FREQ:SYNT 1 CHP:FREQ:SYNT?
<b>Notes</b>	Parameter key: <ol style="list-style-type: none"> <li>1. optimizes phase noise for close-in from the carrier.</li> <li>2. optimizes phase noise for wide-offset from the carrier.</li> <li>3. optimizes LO for tuning speed.</li> </ol>
<b>Couplings</b>	<p>Best Close-in <math>\Phi</math> Noise</p> <p>The frequency below which the phase noise is optimized is model dependent:            PXA with option EP1: [offset &lt;140 kHz]            Models with option EP2: [offset &lt;70 kHz]            CXA with option EP4: [offset &lt;90 kHz]            CXA without option EP4: n/a            All other models: [offset &lt;20 kHz]</p> <p>Best Wide-offset <math>\Phi</math> Noise</p> <p>The frequency below which the phase noise is optimized is model dependent:            PXA with option EP1: [offset &gt;160 kHz]            Models with option EP2: [offset &gt;100 kHz]            CXA with option EP4: [offset &gt;130 kHz]            CXA without option EP4: n/a            All other models: [offset &gt;30 kHz]</p> <p>Fast Tuning</p> <p>The Fast Tuning details are model dependent:            CXA without option EP4: n/a            PXA with option EP1: [single loop]            Models with option EP2: [medium loop bandwidth]            All other models: [same as Close-in]</p>
<b>Preset</b>	3
<b>State Saved</b>	Saved in instrument state.
<b>Range</b>	Best Close-in $\Phi$ Noise [offset < 140 kHz]   Best Wide-offset $\Phi$ Noise [offset > 160 kHz]   Fast Tuning [same as Close-in] [ ] is model dependent. See Couplings for details.
<b>Initial S/W Revision</b>	A.04.20

## IF Gain

Sets the IF Gain function to Auto, Low Gain or High Gain. These settings affect sensitivity and IF overloads.

Key Path	Meas Setup
Dependencies	The IF Gain keys (FFT IF Gain and Swept IF Gain) have no effect when the U7227A USB Preamplifier is connected. This is not annotated or reflected on any softkey; there are no keys grayed out nor any SCPI locked out. The analyzer simply behaves as though both FFT IF Gain and Swept IF Gain are set to Low regardless of the setting on the keys.
Initial S/W Revision	Prior to A.02.00

## IF Gain Auto

Activates the auto rules for IF Gain. When Auto is active, the IF Gain is set to High Gain under any of the following conditions:

- The input attenuator is set to 0 dB
- The preamp is turned On and the frequency range is under 3.6 GHz

For other settings, Auto sets the IF Gain to Low Gain.

Key Path	Meas Setup, IF Gain
<b>Remote Command</b>	[ :SENSe ] :CHPower:IF:GAIN:AUTO [ :STATe ] ON OFF 1 0 [ :SENSe ] :CHPower:IF:GAIN:AUTO [ :STATe ] ?
<b>Example</b>	CHP:IF:GAIN:AUTO ON CHP:IF:GAIN:AUTO?
Couplings	When the auto attenuation exists (for example, with an electrical attenuator), IF Gain State differs depending on the condition. Auto sets IF Gain to High Gain under any of the following conditions: The input attenuator is set to 0 dB, or the preamp is turned on and the frequency range is under 3.6 GHz. For other conditions, Auto sets IF Gain to Low Gain.
Preset	OFF
State Saved	Saved in instrument state.
Range	Off On
Initial S/W Revision	Prior to A.02.00

## IF Gain State

Selects the range of the IF Gain.

Key Path	Meas Setup, IF Gain
<b>Remote Command</b>	[ :SENSe ] :CHPower:IF:GAIN [ :STATe ] ON OFF 1 0 [ :SENSe ] :CHPower:IF:GAIN [ :STATe ] ?

<b>Example</b>	CHP:IF:GAIN ONCHP:IF:GAIN?
Notes	ON = high gain OFF = low gain
Couplings	When the auto attenuation exists (for example, with an electrical attenuator), IF Gain State differs depending on the condition. Auto sets IF Gain to High Gain under any of the following conditions: The input attenuator is set to 0 dB, or the preamp is turned on and the frequency range is under 3.6 GHz. For other conditions, Auto sets IF Gain to Low Gain.
Preset	OFF
State Saved	Saved in instrument state.
Range	Low Gain High Gain
Initial S/W Revision	Prior to A.02.00

## Method

Turns the Root Raised Cosine (RRC) filter On or Off. The  $\alpha$  value (roll off) for the filter is set to the value of the Filter Alpha parameter, and the RRC filter bandwidth is set to the Filter BW parameter.

Key Path	Meas Setup
Mode	SA, WCDMA, WIMAX OFDMA, DVB-T/H, DTMB (CTTB), ISDB-T, CMMB, LTE, LTETDD, Digital Cable TV, WLAN
<b>Remote Command</b>	<code>[ :SENSe ] :CHPower :FILTer [ :RRC ] [ :STATe ] OFF ON 0 1</code> <code>[ :SENSe ] :CHPower :FILTer [ :RRC ] [ :STATe ] ?</code>
<b>Example</b>	CHP:FILT OFF CHP:FILT?
Notes	This parameter is normally used when TETRA is selected as the Radio Std. You must be in the Spectrum Analysis mode, DVB-T/H mode, DTMB (CTTB) mode, ISDB-T mode, CMMB mode, LTE mode, LTE TDD mode, WLAN mode, WIMAX OFMDA mode or W-CDMA mode to use this command. Use :INSTrument:SElect to set the mode.
Dependencies	For CDMA2K mode, this key is blank. For 1xEVDO mode, this key is blank. For MSR mode, this key is blank. For LTE-Advanced FDD/TDD mode, this key is blank. For WLAN 802.11 ac (80 + 80 MHz ), RRC Weighted is not supported .
Preset	OFF
State Saved	Saved in instrument state.
Range	Integ BW RRC Weighted
Initial S/W Revision	Prior to A.02.00
Modified at S/W Revision	A.02.00, A.03.00, A.10.00

## Method

Turns the Root Raised Cosine (RRC) filter On or Off. The  $\alpha$  value (roll off) for the filter is set to the value of the Filter Alpha parameter, and the RRC filter bandwidth is set to the Filter BW parameter.

Key Path	Meas Setup
Mode	SA, WCDMA,WIMAX OFDMA, DVB-T/H, DTMB (CTTB), ISDB-T, CMMB, LTE, LTETDD, Digital Cable TV, WLAN
Remote Command	<code>[ :SENSe ] :CHPower:FILTer [ :RRC ] [ :STATe ] OFF ON 0 1</code> <code>[ :SENSe ] :CHPower:FILTer [ :RRC ] [ :STATe ] ?</code>
Example	CHP:FILT OFF CHP:FILT?
Notes	This parameter is normally used when TETRA is selected as the Radio Std. You must be in the Spectrum Analysis mode, DVB-T/H mode, DTMB (CTTB) mode, ISDB-T mode, CMMB mode, LTE mode, LTE TDD mode, WLAN mode,WIMAX OFDMA mode or W-CDMA mode to use this command. Use :INSTRument:SElect to set the mode.
Dependencies	For CDMA2K mode, this key is blank. For 1xEVDO mode, this key is blank. For MSR mode, this key is blank. For LTE-Advanced FDD/TDD mode, this key is blank. For WLAN 802.11 ac (80 + 80 MHz ), RRC Weighted is not supported .
Preset	OFF
State Saved	Saved in instrument state.
Range	Integ BW RRC Weighted
Initial S/W Revision	Prior to A.02.00
Modified at S/W Revision	A.02.00, A.03.00, A.10.00

## Filter Alpha

Inputs the alpha value for the Root Raised Cosine (RRC) filter.

Key Path	Meas Setup, Method
Mode	SA, WCDMA,WIMAX OFDMA, DVB-T/H, DTMB (CTTB), ISDB-T, CMMB, LTE, LTETDD, Digital Cable TV, WLAN
Remote Command	<code>[ :SENSe ] :CHPower:FILTer [ :RRC ] :ALPHa &lt;real&gt;</code> <code>[ :SENSe ] :CHPower:FILTer [ :RRC ] :ALPHa ?</code>
Example	CHP:FILT:ALPH 0.5 CHP:FILT:ALPH?
Notes	This parameter is normally used when TETRA is selected as the Radio Std. You must be in the Spectrum Analysis mode, DVB-T/H mode, DTMB (CTTB) mode, ISDB-T mode, CMMB mode, LTE mode, LTE TDD mode, WLAN mode,WIMAX OFDMA mode or W-CDMA mode to use this command. Use :INSTRument:SElect to set the mode.



Dependencies	For CDMA2K mode, this key is blank. For 1xEVDO mode, this key is blank. For MSR mode, this key is blank. For LTE-Advanced FDD/TDD mode, this key is blank
Preset	SA, WCDMA, , WIMAX OFDMA, DVB-T/H, ISDB-T, CMMB, LTE, LTETDD, WLAN: 0.22 DTMB (CTTB): 0.05 Digital Cable TV: 0.15
State Saved	Saved in instrument state.
Min	0.01
Max	1.00
Initial S/W Revision	Prior to A.02.00
Modified at S/W Revision	A.02.00, A.03.00, A.10.00

### Filter BW

Inputs the Root Raised Cosine (RRC) filter bandwidth. Normally, the filter bandwidth is the same as the symbol rate of the signal.

Key Path	Meas Setup, Method, RRC Weighted
Mode	SA, WCDMA, WIMAX OFDMA, DVB-T/H, DTMB (CTTB), ISDB-T, CMMB, LTE, LTETDD, Digital Cable TV, WLAN
<b>Remote Command</b>	<code>[ :SENSe ] :CHPower :FILTer [ :RRC ] :BANDwidth &lt;real&gt;</code> <code>[ :SENSe ] :CHPower :FILTer [ :RRC ] :BANDwidth?</code>
<b>Example</b>	CHP:FILT:BAND 10MHz CHP:FILT:BAND?
Notes	This parameter is normally used when TETRA is selected as the Radio Std. You must be in the Spectrum Analysis mode, DVB-T/H mode, DTMB (CTTB) mode, ISDB-T mode, CMMB mode, LTE mode, LTE TDD mode, WLAN mode, WIMAX OFDMA mode or W-CDMA mode to use this command. Use :INSTrument:SElect to set the mode.
Dependencies	For CDMA2K mode, this key is blank. For 1xEVDO mode, this key is blank. For MSR mode, this key is blank. For LTE-Advanced FDD/TDD, this key is blank.
Preset	SA, LTE, LTETDD: 3.84MHz WCDMA: 3.84MHz WIMAX OFDMA: 10MHz DVB-T/H: 8MHz DTMB (CTTB): 7.56MHz ISDB-T: 5.6MHz CMMB: 7.512MHz

	Digital Cable TV: 6.9MHz WLAN: if Radio Std is 802.11a/g(OFDM/DSSS-OFDM): 16.6 MHz if Radio Std is 802.11b: 22 MHz if Radio Std is 802.11n(20MHz): 17.8 MHz if Radio Std is 802.11n(40MHz): 36.6 MHz
State Saved	Saved in instrument state.
Min	100 Hz
Max	100 MHz
<b>Backwards Compatibility SCPI</b>	[ :SENSE ] :CHPower :FILTer [ :RRC ] :BWIDth
Initial S/W Revision	Prior to A.02.00
Modified at S/W Revision	A.02.00, A.03.00, A.10.00

## Meas Preset

Restores all the measurement parameters to their default values.

Key Path	Meas Setup
Mode	SA, WCDMA, C2K, WIMAX OFDMA, 1xEVDO, DVB-T/H, DTMB (CTTB), ISDB-T, CMMB, LTE, LTETDD, Digital Cable TV, WLAN, MSR, LTEAFDD, LTEATDD
<b>Remote Command</b>	:CONFigure:CHPower
<b>Example</b>	CONF:CHP
Initial S/W Revision	Prior to A.02.00
Modified at S/W Revision	A.02.00, A.03.00

## PSD Unit

Sets the unit bandwidth for Power Spectral Density. The available units are dBm/Hz and dBm/MHz.

Key Path	Meas Setup
Mode	SA, WCDMA, WIMAX OFDMA, 1xEVDO, DVB-T/H, DTMB (CTTB), LTE, LTETDD, Digital Cable TV, WLAN, MSR, LTEAFDD, LTEATDD
<b>Remote Command</b>	:UNIT:CHPower:POWer:PSD DBMHZ   DBMMHZ :UNIT:CHPower:POWer:PSD?
<b>Example</b>	UNIT:CHP:POW:PSD DBMMHZ UNIT:CHP:POW:PSD?
Couplings	When the PSD unit is changed, the PSD result of the "MEAS READ FETCH:CHP1?" is also changed by the PSD unit basis (in either dBm/Hz or dBm/MHz).
Preset	DBMHZ

---

	WLAN: DBMMHZ
State Saved	Saved in instrument state.
Range	dBm/Hz dBm/MHz
Initial S/W Revision	Prior to A.02.00
Modified at S/W Revision	A.02.00, A.03.00

---

8 Channel Power Measurement  
Mode

Mode

See "[Mode](#)" on page 298

## Mode Preset

Returns the active mode to a known state.

Mode Preset does the following for the currently active mode:

- Aborts the currently running measurement.
- Brings up the default menu for the mode, with no active function.
- Sets measurement Global settings to their preset values for the active mode only.
- Activates the default measurement.
- Brings up the default menu for the mode.
- Clears the input and output buffers.
- Sets Status Byte to 0.

Mode Preset does not:

- Cause a mode switch
- Affect mode persistent settings
- Affect system settings

See "[How-To Preset](#)" on page 534 for more information.

Key Path	Front-panel key
<b>Remote Command</b>	:SYSTem:PRESet
<b>Example</b>	:SYST:PRES
Notes	*RST is preferred over :SYST:PRES for remote operation. *RST does a Mode Preset, as done by the :SYST:PRES command, and it sets the measurement mode to Single measurement rather than Continuous for optimal remote control throughput. Clears all pending OPC bits. The Status Byte is set to 0.
Couplings	A Mode Preset aborts the currently running measurement, activates the default measurement, and gets the mode to a consistent state with all of the default couplings set.
Backwards Compatibility Notes	In the X-Series, the legacy "Factory Preset" has been replaced with Mode Preset, which only presets the currently active mode, not the entire instrument. In the X-Series, the way to preset the entire instrument is by using System, Restore System Defaults All, which behaves essentially the same way as restore System Defaults does on ESA and PSA. There is also no "Preset Type" as there is on the PSA. There is a green Mode Preset front-panel key that does a Mode Preset and a white-with-green-letters User Preset front-panel key that does a User Preset. The old PRESet:TYPE command is ignored (without generating an error), and SYST:PRES without a parameter does a Mode Preset, which should cover most backward code compatibility issues. The settings and correction data under the Input/Output front-panel key (examples: Input Z Corr, Ext Amp Gain, etc.) are no longer part of any Mode, so they will not be preset by a Mode Preset. They are preset using Restore Input/Output Defaults, Restore System Defaults All. Note that because User Preset does a Recall State, and all of these settings are saved in State, they ARE recalled when using

	User Preset.
Initial S/W Revision	Prior to A.02.00

## How-To Preset

The table below shows all possible presets, their corresponding SCPI commands and front-panel access (key paths). Instrument settings depend on the current measurement context. Some settings are local to the current measurement, some are global (common) across all the measurements in the current mode, and some are global to all the available modes. In a similar way, restoring the settings to their preset state can be done within the different contexts.

Auto Couple - is a measurement local key. It sets all Auto/Man parameter couplings in the measurement to Auto. Any Auto/Man selection that is local to other measurements in the mode will not be affected.

Meas Preset - is a measurement local key. Meas Preset resets all the variables local to the current measurement except the persistent ones.

Mode Preset - resets all the current mode's measurement local and measurement global variables except the persistent ones.

Restore Mode Defaults - resets ALL the Mode variables (and all the Meas global and Meas local variables), including the persistent ones.

Type Of Preset	SCPI Command	Front Panel Access
Auto Couple	:COUPle ALL	Auto Couple front-panel key
Meas Preset	:CONFigure:<Measurement>	Meas Setup Menu
Mode Preset	:SYSTem:PRESet	Mode Preset (green key)
Restore Mode Defaults	:INSTrument:DEFault	Mode Setup Menu
Restore All Mode Defaults	:SYSTem:DEFault MODEs	System Menu; Restore System Default Menu
*RST	*RST	not possible (Mode Preset with Single)
Restore Input/Output Defaults	:SYSTem:DEFault INPUt	System Menu; Restore System Default Menu
Restore Power On Defaults	:SYSTem:DEFault PON	System Menu; Restore System Default Menu
Restore Alignment Defaults	:SYSTem:DEFault ALIGn	System Menu; Restore System Default Menu
Restore Miscellaneous Defaults	:SYSTem:DEFault MISC	System Menu; Restore System Default Menu
Restore All System Defaults	:SYSTem:DEFault [ALL] :SYSTem:PRESet:PERsistent	System Menu; Restore System Default Menu
User Preset	:SYSTem:PRESet:USER	User Preset Menu
User Preset All Modes	:SYSTem:PRESet:USER:ALL	User Preset Menu

Power On Mode Preset	:SYSTem:PON:TYPE MODE	System Menu
Power On User Preset	:SYSTem:PON:TYPE USER	System Menu
Power On Last State	:SYSTem:PON:TYPE LAST	System Menu

### Preset Type (Remote Command Only)

As stated in the Backward Compatibility section, to be compatible with ESA/PSA the PRESet:TYPE command will be implemented as a no-op.

Mode	All
<b>Remote Command</b>	:SYSTem:PRESet:TYPE FACTory MODE USER :SYSTem:PRESet:TYPE?
<b>Example</b>	:SYST:PRESet:TYPE FACT
Notes	This command is supported for backward compatibility only. It is a no-op which does not change the behavior of any preset operation.
Preset	This is unaffected by Preset but is set to Mode on a "Restore System Defaults->All"
State Saved	No
Initial S/W Revision	Prior to A.02.00

## Mode Setup

See "[Mode Setup](#)" on page 328



## Peak Search

Places the selected marker on the trace point with the maximum y-axis value. Pressing Peak Search with the selected marker Off causes the selected marker to be set to Normal, then a peak search is immediately performed.

<b>Key Path</b>	Front panel key
<b>Mode</b>	SA, WCDMA, C2K, WIMAX OFDMA, 1xEVDO, DVB-T/H, DTMB (CTTB), ISDB-T, CMMB, LTE, LTETDD, Digital Cable TV, WLAN, MSR, LTEAFDD, LTEATDD
<b>Remote Command</b>	:CALCulate:CHPower:MARKer[1] 2 ... 12:MAXimum
<b>Example</b>	CALC:CHP:MARK2:MAX
<b>Initial S/W Revision</b>	Prior to A.02.00
<b>Modified at S/W Revision</b>	A.02.00, A.03.00

8 Channel Power Measurement  
Print

Print

See ["Print" on page 341](#)

## Quick Save

The Quick Save front-panel key repeats the most recent save that was performed from the Save menu, with the following exceptions:

- Register saves are not remembered as Saves for the purpose of the Quick Save function
- If the current measurement does not support the last non-register save that was performed, an informational message is generated, “File type not supported for this measurement”

Quick Save repeats the last type of qualified save (that is, a save qualified by the above criteria) in the last save directory by creating a unique filename using the Auto File Naming algorithm described below.

If Quick Save is pressed after startup and before any qualified Save has been performed, the Quick Save function performs a Screen Image save using the current settings for Screen Image saves (current theme, current directory), which then becomes the “last save” for the purpose of subsequent Quick Saves.

The Auto File Naming feature automatically generates a file name for use when saving a file. The filename consists of a prefix and suffix separated by a dot, as is standard for the Windows® file system. A default prefix exists for each of the available file types:

Type	Default Prefix	Menu
State	State_	(Save/Recall)
Trace + State	State_	(Save/Recall)
Screen	Screen_	(Save/Recall)
Amplitude Corrections	Ampcor_	(Import/Export)
Traces	Trace_	(Import/Export)
Limit Lines	LLine_	(Import/Export)
Measurement Result	MeasR_	(Import/Export)
Capture Buffer	CapBuf_	(Import/Export)

A four digit number is appended to the prefix to create a unique file name. The numbering sequence starts at 0000 within each Mode for each file type and updates incrementally to 9999, then wraps to 0000 again. It remembers where it was through a Mode Preset and when leaving and returning to the Mode. It is reset by Restore Misc Defaults and Restore System Defaults and subsequent running of the instrument application. So, for example, the first auto file name generated for State files is State\_0000.state. The next is State\_0001, and so forth.

One of the key features of Auto File Name is that we guarantee that the Auto File Name will never conflict with an existing file. The algorithm looks for the next available number. If it gets to 9999, then it looks for holes. If it find no holes, that is no more numbers are available, it gives an error.

For example, if when we get to State\_0010.state there is already a State\_0010.state file in the current directory, it advances the counter to State\_0011.state to ensure that no conflict will exist (and then it verifies that State\_0011.state also does not exist in the current directory and advances again if it does, and so forth).

If you enter a file name for a given file type, then the prefix becomes the filename you entered instead of the default prefix, followed by an underscore. The last four letters (the suffix) are the 4-digit number.

For example, if you save a measurement results file as “fred.csv”, then the next auto file name chosen for a measurement results save will be fred\_0000.csv.

**NOTE**

Although 0000 is used in the example above, the number that is used is actually the current number in the Meas Results sequence, that is, the number that would have been used if you had not entered your own file name.

---

**NOTE**

If the filename you entered ends with \_dddd, where d=any number, making it look just like an auto file name, then the next auto file name picks up where you left off with the suffix being dddd + 1.

---

Key Path	Front-panel key
Notes	No remote command for this key specifically.
Initial S/W Revision	Prior to A.02.00

## Recall

The Recall menu lets you choose what you want to recall, and where you want to recall it from. Among the types of files you can recall are **States and Traces**. In addition, an Import (Data) option lets you recall a number of data types stored in CSV files (as used by Excel and other spreadsheet programs).

The default paths for Recall are data type dependent and are the same as for the Save key.

Key Path	Front-panel key
Notes	<p>No remote command for this key specifically, but the :MMEM:LOAD command is available for specific file types. An example is :MMEM:LOAD:STATe &lt;filename&gt;.</p> <p>If you try to recall a State file for a mode that is not licensed or not available in the instrument, an error message will occur and the state will not change.</p>
Backwards Compatibility Notes	<p>In legacy analyzers, it was possible to load a state without affecting the trace data, limit lines or correction data. Similarly (since User Preset is actually loading a state), it was possible to do a User Preset without affecting the trace data, limit lines or correction data.</p> <p>In the X-Series, “state” always includes all of this data; so whenever state is loaded, all of the traces, limit lines and corrections are affected. Although this differs from previous behavior, it is desirable behavior, and should not cause adverse issues for users.</p>
Backwards Compatibility Notes	<p>Recall for the X-Series supports backward compatibility in the sense that you can recall a state file from any X-Series model number and any version of X-Series software. This is only possible if part of the recalling process goes through a limiting step after recalling the mode settings, at least for settings that may vary with version number, model number, option and license differences. If you try to recall a state file onto an instrument with less capability than what was available on the instrument during the save, the recall will ignore the state it doesn't support and it will limit the recalled setting to what it allows.</p> <p>Example: if the saved state includes preamp ON, but the recalling instrument does not have a preamp; the preamp is limited to OFF. Conversely, if you save a state without a preamp, the preamp is OFF in the state file. When this saved file is recalled on an instrument with a licensed preamp, the preamp is changed to OFF. Another example is if the saved state has center frequency set to 20 GHz, but the instrument recalling the saved state is a different model and only supports 13.5 GHz. In this case, the center frequency is limited along with any other frequency based settings. Since the center frequency can't be preserved in this case, the recall limiting tries to at least preserve span to keep the measurement setup as intact as possible.</p> <p>It may be appropriate to issue a warning if the state is limited on the recall; warnings do not go out to SCPI so this would only affect the manual user.</p> <p>Note that there is no state file compatibility outside of the X-Series. For example, you cannot recall a state file from ESA or PSA.</p>
Initial S/W Revision	Prior to A.02.00

## State

The Recall State menu lets you choose a register or file from which to recall the state.

The content of a state file includes all of the settings and data required to return the analyzer as closely as possible to the Mode it was in, with the exact settings that were in place, when the save occurred. The Mode settings in each state file include the settings that are affected by Mode Preset, as well as the

additional settings affected by Restore Mode Defaults; all of the Mode's settings. In addition, all of the settings of the Input/Output system are included, even though they are outside of the Mode's state, because they are needed to restore the complete setup. Persistent System settings (for example, GPIB address) are not affected by either a Mode Preset or Restore Mode Defaults, nor are they included in a saved State file.

Since each state file is only for one Mode, the settings for other Modes are unaffected when it is loaded. Recall State will cause a mode switch if the state being recalled is not from the current active mode.

After the recall completes, the message "File <filename> recalled" or "Recalled State Register <register number>" is displayed.

For rapid recalls, the State menu lists 16 registers that you can choose from to recall. Pressing a Register key initiates the recall. You can also select a file from which to recall.

The default path for all State Files is:

My Documents\<<mode name>\state

where <mode name> is the parameter used to select the mode with the INST:SEL command (for example, SA for the Spectrum Analyzer).

See ["More Information" on page 543](#).

<b>Key Path</b>	Recall
<b>Mode</b>	All
<b>Remote Command</b>	:MMEMory:LOAD:STATe <filename>
<b>Example</b>	:MMEM:LOAD:STAT "myState.state" This recalls the file myState.state on the default path
<b>Example</b>	MMEM:LOAD:STAT "MyStateFile.state" This loads the state file data (on the default file directory path) into the instrument state.
<b>Notes</b>	<p>When you pick a file to recall, the analyzer first verifies that the file is recallable in the current instrument by checking the software version and model number of the instrument. If everything matches, a full recall proceeds by aborting the currently running measurement, clearing any pending operations, and then loading the State from the saved state file. You can open state files from any mode, so recalling a State file switches to the mode that was active when the save occurred. After switching to the mode of the saved state file, mode settings and data (if any for the mode) are loaded with values from the saved file. The saved measurement of the mode becomes the newly active measurement and the data relevant to the measurement (if there is any) is recalled.</p> <p>If there is a mismatch between file version or model number or instrument version or model number, the recall function tries to recall as much as possible and returns a warning message. It may limit settings that differ based on model number, licensing or version number.</p> <p>After recalling the state, the Recall State function does the following:</p> <ul style="list-style-type: none"> <li>• Makes the saved measurement for the mode the active measurement.</li> <li>• Clears the input and output buffers.</li> <li>• Status Byte is set to 0.</li> <li>• Executes a *CLS</li> </ul> <p>If the file specified is empty an error is generated. If the specified file does not exist, another error is generated. If there is a mismatch between the file and the proper file type, an error is generated. If</p>

	there is a mismatch between file version or model number or instrument version or model number, a warning is displayed. Then it returns to the State menu and File Open dialog goes away. After the Recall, the analyzer exits the Recall menu and returns to the previous menu.
<b>Backwards Compatibility SCPI</b>	:MMEMory:LOAD:STATe 1,<filename> For backwards compatibility, the above syntax is supported. The "1" is simply ignored.
Initial S/W Revision	Prior to A.02.00

## More Information

In measurements that support saving Traces, for example, Swept SA, the Trace data is saved along with the State in the State file. When recalling the State, the Trace data is recalled as well. Traces are recalled exactly as they were stored, including the writing mode and update and display modes. If a Trace was updating and visible when the State was saved, it will come back updating and visible, and its data will be rewritten right away. When you use State to save and recall traces, any trace whose data must be preserved should be placed in View or Blank mode before saving.

The following table describes the Trace Save and Recall possibilities:

You want to recall state and one trace's data, leaving other traces unaffected.	Save Trace+State from 1 trace. Make sure that no other traces are updating (they should all be in View or Blank mode) when the save is performed.	On Recall, specify the trace you want to load the one trace's data into. This trace will load in View. All other traces' data will be unaffected, although their trace mode will be as it was when the state save was performed.
You want to recall all traces	Save Trace+State from ALL traces.	On Recall, all traces will come back in View (or Blank if they were in Blank or Background when saved)
You want all traces to load exactly as they were when saved.	Save State	On recall, all traces' mode and data will be exactly as they were when saved. Any traces that were updating will have their data immediately overwritten.

## From File...

When you press "From File", the analyzer brings up a Windows dialog and a menu entitled "File Open." This menu allows you to navigate to the various fields in the Windows dialog without using a keyboard or mouse. The Tab and Arrow keys can also be used for dialog navigation.

## 8 Channel Power Measurement Recall

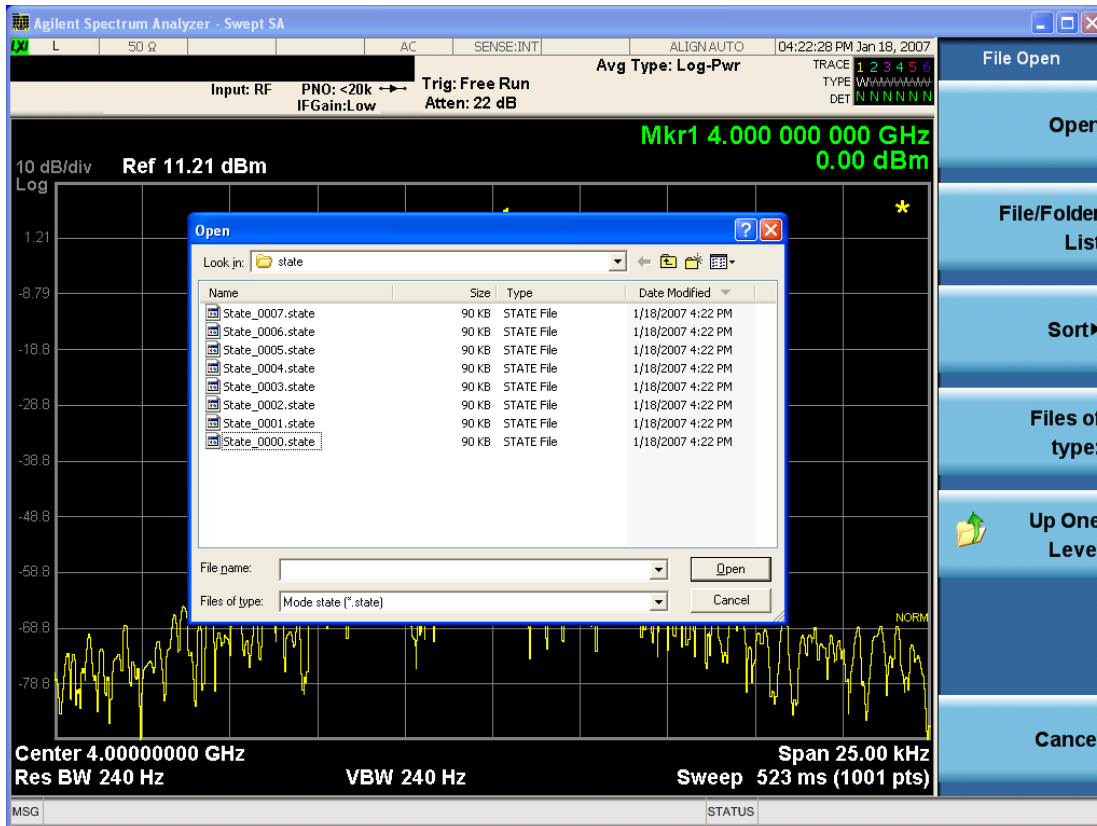

Listed below are the functions of the various fields in the dialog, and the corresponding softkeys:

### Open

Performs the recall of the specified file. While the recall is being performed, the floppy icon appears briefly in the Meas bar.

### File/Folder List

Enables you to navigate to the center of the dialog that contains the list of files and folders. Once here you can get information about the file and use the tab keys to navigate to the other fields in the dialog, such as Look In.

### Look In

The Look In field shows the path from which the file will be recalled and allows you to change the path using the up and down arrow keys to navigate to other paths; the Enter key to open a directory; and the Backspace key to go back one directory. The **Look In field** first uses the last path from the Save As dialog **Save In:** path for that same file type. There is no softkey for directly navigating to the Look In field, but you can use the left tab to get here from the File/Folder List.

User specified paths are remembered when you leave and return to a Mode and are reset back to the default using Restore Mode Defaults.

### Sort



Accesses a menu that enables you to sort the files within the File Open dialog. Only one sorting type can be selected at a time and the sorting happens immediately. The sorting types are By Date, By Name, By extension, and By Size.

#### Files of Type

This field shows the file suffix for the type of file you have selected to recall. For example, if you navigated here while recalling State, "Mode state (\*.state)" is in the field. If you navigated here while recalling Trace, ""Mode state (\*.trace)" is in the field. If you navigated here while importing a trace data file, "Trace Data (\*.csv)" is in the field. For some file types, there is more than one choice in the dropdown menu, which you can select by using the up and down arrow keys and Enter.

#### Up One Level

This key corresponds to the icon of a folder with the up arrow that is in the tool bar of the dialog. When pressed, it causes the file and folder list to navigate up one level in the directory structure. The Backspace key does the same thing.

#### Cancel

This key corresponds to the Cancel selection in the dialog. It causes the current **Open** request to be cancelled. The ESC key does the same thing.

Key Path	Recall, State
Notes	Brings up the Open dialog for recalling a State Save Type
Initial S/W Revision	Prior to A.02.00

### Edit Register Names

You may enter a custom name on any of the Register keys, to help you remember what you are using that state to save. To do this, press the Edit Register Names key, choose the register whose name you wish to edit, and then enter the desired label using the Alpha Editor or an external PC keyboard.

The maximum number of characters that can be added is 30. In most cases, 30 characters will fit on two lines of the key.

For more information and the SCPI command, see Edit Register Names under the Save, State function.

Key Path	Recall, State
Mode	All
Dependencies	N9060A-7FP or N9060B-2FP license required to edit the register names. When the feature is not licensed, sending the SCPI command generates an error, -221, "Settings conflict;Option not available"
Initial S/W Revision	A.11.00

### Register 1 thru Register 16

Selecting any one of these register keys causes the State of the mode from the specified Register to be recalled. Each of the register keys annotates whether it is empty or at what date and time it was last

modified. In addition, you can use the Edit Register Names key under Save, State to enter custom names for each register.

Registers are shared by all modes, so recalling from any one of the registers will cause a mode switch to the mode that was active when the save to the Register occurred.

Although these 16 registers are the only registers available from the front panel, there are 128 state registers available in the instrument. Registers 17–128 are only available from the SCPI interface, using the \*RCL command.

After the recall completes, the message "Register <register number> recalled" appears in the message bar. If you are in the Spectrum Analyzer Mode, and you are recalling a register that was saved in the Spectrum Analyzer Mode, then after the recall, you will still be in the Recall Register menu. If the Recall causes you to switch modes, then after the Recall, you will be in the Frequency menu.

If a requested register is empty an error is generated.

Key Path	Recall, State
<b>Example</b>	*RCL 1
Range	1–16 from front panel, 1–128 from SCPI
Readback	Date and time with seconds resolution are displayed on the key OR A custom name of up to 30 characters entered using the Save, State, Edit Register Names key OR “(empty)” if no prior save operation has been performed to this register.
Initial S/W Revision	Prior to A.02.00
Modified at S/W Revision	Prior to A.11.00

## Register 1 thru Register 16

Selecting any one of these register keys causes the State of the mode from the specified Register to be recalled. Each of the register keys annotates whether it is empty or at what date and time it was last modified. In addition, you can use the Edit Register Names key under Save, State to enter custom names for each register.

Registers are shared by all modes, so recalling from any one of the registers will cause a mode switch to the mode that was active when the save to the Register occurred.

Although these 16 registers are the only registers available from the front panel, there are 128 state registers available in the instrument. Registers 17–128 are only available from the SCPI interface, using the \*RCL command.

After the recall completes, the message "Register <register number> recalled" appears in the message bar. If you are in the Spectrum Analyzer Mode, and you are recalling a register that was saved in the Spectrum Analyzer Mode, then after the recall, you will still be in the Recall Register menu. If the Recall causes you to switch modes, then after the Recall, you will be in the Frequency menu.

If a requested register is empty an error is generated.

Key Path	Recall, State
<b>Example</b>	*RCL 1
Range	1-16 from front panel, 1-128 from SCPI
Readback	Date and time with seconds resolution are displayed on the key OR A custom name of up to 30 characters entered using the Save, State,Edit Register Names key OR “(empty)” if no prior save operation has been performed to this register.
Initial S/W Revision	Prior to A.02.00
Modified at S/W Revision	Prior to A.11.00

## Data (Import)

Importing a data file loads data that was previously saved from the current measurement or from other measurements and/or modes that produce compatible data files. The Import Menu only contains Data Types that are supported by the current measurement.

Since the commonly exported data files are in .csv format, the data can be edited by the user prior to importing. This allows you to export a data file, manipulate the data in Excel (the most common PC Application for manipulating .csv files) and then import it.

Importing Data loads measurement data from the specified file into the specified or default destination, depending on the data type selected. Selecting an Import Data menu key will not actually cause the importing to occur, since the analyzer still needs to know from where to get the data. Pressing the Open key in this menu brings up the Open dialog and Open menu that provides you with the options from where to recall the data. Once a filename has been selected or entered in the Open menu, the recall occurs as soon as the Open button is pressed.

Key Path	Recall
Mode	All
Notes	The menu is built from whatever data types are available for the mode. Some keys will be missing completely, so the key locations in the sub-menu will vary.  No SCPI command directly controls the Data Type that this key controls. The Data Type is included in the MMEM:LOAD commands.
Dependencies	If a file type is not used by a certain measurement, it is grayed out for that measurement. The key for a file type will not show at all if there are no measurements in the Mode that support it.
Preset	Is not affected by Preset or shutdown, but is reset during Restore Mode Defaults
Readback	The data type that is currently selected
Initial S/W Revision	Prior to A.02.00

## Amplitude Correction

This key selects the Amplitude Corrections as the data type to be imported. When pressed a second time, it brings up the Select Menu, which lets you select the Correction into which the data will be imported.

Amplitude Corrections are fully discussed in the documentation of the Input/Output key, under the Corrections key.

A set of preloaded Corrections files can be found in the directory

/My Documents/ EMC Limits and Ampcor.

When the Amplitude Correction is an Antenna correction and the Antenna Unit in the file is not None, the Y Axis Unit setting will change to match the Antenna Unit in the file.

Key Path	Recall
Mode	SA EDGE GSM PN
Remote Command	:MMEMory:LOAD:CORRection 1 2 3 4 5 6 7 8, <filename>
Example	:MMEM:LOAD:CORR 2, "myAmpcor.csv" recalls the Amplitude Correction data from the file myAmpcor.csv in the current directory to the 2nd Amplitude Correction table, and turns on Correction 2.  The default path is D:\User_My_Documents\Instrument\My Documents\amplitudeCorrections\
Dependencies	<p>Only the first correction array (Correction 1) supports antenna units. This means that a correction file with an Antenna Unit can only be loaded into the Corrections 1 register. Consequently only for Correction 1 does the dropdown in the Recall dialog include.ant, and if an attempt is made to load a correction file into any other Correction register which DOES contain an antenna unit, a Mass Storage error is generated.</p> <p>Corrections are not supported by all Measurements. If in a Mode in which some Measurements support it, this key will be grayed out in measurements that do not. The key will not show at all if no measurements in the Mode support it.</p> <p>Errors are reported if the file is empty or missing, or if the file type does not match, or if there is a mismatch between the file type and the destination data type. If any of these occur during manual operation, the analyzer returns to the Import Data menu and the File Open dialog goes away.</p> <p>This key does not appear unless you have the proper option installed in your instrument.</p> <p>This command will generate an "Option not available" error unless you have the proper option installed in your instrument.</p>
Couplings	When a correction file is loaded from mass storage, it is automatically turned on ( <b>Correction ON</b> ) and <b>ApplyCorrections</b> is set to On. This allows you to see its effect, thus confirming the load.
Readback	selected Correction
Backwards Compatibility SCPI	:MMEMory:LOAD:CORRection ANTenna   CABLE   OTHer   USER, <filename>  For backwards compatibility, ANTenna maps to 1, CABLE maps to 2, OTHer maps to 3 and USER maps to 4
Initial S/W Revision	A.02.00

## Amplitude Correction

These keys let you select which Correction to import the data into. Once selected, the key returns back to the Import Data menu and the selected Correction number is annotated on the key. The next step is to select the Open key in the Import Data menu.

Antenna corrections are a particular kind of Amplitude Corrections – they are distinguished in the corrections file by having the Antenna Unit set to a value other than None. Only Correction 1 supports Antenna Units.

Key Path	Recall, Data, Amplitude Correction
Notes	auto return
Dependencies	Only Correction 1 may be used to load a Correction that contains an Antenna Unit other than None
Preset	Not part of Preset, but is reset to Correction 1 by Restore Input/Output Defaults; survives shutdown.
State Saved	The current Correction number is saved in instrument state
Initial S/W Revision	A.02.00

## Chan Table

Imports the channel table from a channel plan file. This function enables you to use your own defined channel tables by importing a modified channel table file.

Instead of creating a brand new channel plan file, you can generate a channel plan file to fit your needs using a saved channel plan file or the default channel plan file ChannelPlan.txt in the directory “My Documents\Digital Video\data\”. The saved channel plan file is obtained by pressing Save, Data, Channel Table, and then Save As...

Note that while editing the channel plan file, you cannot change the channel plan name, such as NTSC\_B.VHF, NTSC\_B.UHF, otherwise your modifications on the corresponding channel plan will not work. You can add, remove, or modify the channel numbers and center frequencies in each channel plan. The value of Start Channel and Channel Count may also need to be changed.

File Location and Extension

**File location:** “My Documents\Digital Video\data”

**File type:** text file

**File extension:** .txt

**Example:**

File Location: My Documents\Digital Video\data

File Name: ChannelPlan\_0001.txt

Key Path	Recall, Data
Mode	DVB-T/H
<b>Remote Command</b>	MMEemory:LOAD:CHTable <string>
<b>Example</b>	MME:LOAD:CHT “ChannelPlan_0001.txt”
Initial S/W Revision	A.07.00

## Capture Buffer

Capture buffer functionality is available only in Mod Accuracy measurement. The captured data is raw data which is not processed.

Key Path	Recall, Data
Mode	DVB-T/H
Example	MMEM:LOAD:CAPT "MyCaptureData.bin" This loads the file of capture data (on the default file directory path) into the instrument.
Dependencies	Capture buffer data is only available for Mod Accuracy measurement. In other measurements, this key is grayed out.
Initial S/W Revision	Prior to A.01.70

## DVB-T2 Config

Imports DVB-T2 configuration from setting files (single PLP or multiple PLPs). This key is available only in DVB-T2 Mod Accuracy measurement and will be grayed out in other measurements.

If the configuration file to be recalled is created with previous instrument S/W revision A.10.52 or before (To check the instrument S/W revision, press System, Show, System on the instrument), it doesn't have Transmission Mode and Version parameters. Then you need to set up the DVB-T2 version and transmission mode manually by pressing Mode Setup, Radio Std, DVB-T2, Version 1.1.1, and toggling Transmission Mode to SISO to select the standard version and transmission mode of the signal under test.

All the modulation parameters can be set from the setting file. These parameters include Version, Transmission Mode, Guard Interval, FFT size, Carrier Mode, Pilot Pattern, L1 Modulation Format, Data Symbols, PAPR Type, PLP Number, SubSlices Number, SubSlices Interval, PLP Modulation Format, PLP Constellation Rotation, FEC Type, Time IL Length, FEC Block Num, PLP ID, PLP Start, PLP Type and PLP Code Rate.

File Location and Extension

**File location:** "My Documents\DVB\data\EVMT2\data"

**File type:** text file

**File extension:** .csv

**Example:**

File Location: My Documents\DVB\data\EVMT2\data

File Name: DVBT2Config\_0001.csv

Key Path	Recall, Data
Mode	DVB-T/H
Remote Command	MMEMory:LOAD:T2Config <string>

<b>Example</b>	MMEM:LOAD:T2C "DVBT2Config_0001.csv"
Dependencies	This key is grayed out in all other measurements except DVB-T2 Mod Accuracy measurement.
Couplings	Auto Detect (Meas, DVB-T2 ModAccuracy, Meas Setup) will be changed to OFF automatically when the DVB-T2 config file is loaded.
Initial S/W Revision	A.07.00

## Open...

When you press "Open", the analyzer brings up a Windows dialog and a menu entitled "**File Open.**" This menu allows you to navigate to the various fields in the Windows dialog without using a keyboard or mouse. The Tab and Arrow keys can also be used for dialog navigation.

See "[From File...](#)" on page 2201 in Recall, State, for a full description of this dialog and menu.

Key Path	Recall, Data
Notes	The key location is mode-dependent and will vary. Brings up Open dialog for recalling a <mode specific> Save Type
Initial S/W Revision	Prior to A.02.00

## Restart

The Restart function restarts the current sweep, or measurement, or set of averaged/held sweeps or measurements. If you are Paused, pressing Restart does a Resume.

The Restart function is accessed in several ways:

- Pressing the Restart key
- Sending the remote command INIT:IMMEDIATE
- Sending the remote command INIT:RESTART

See "[More Information](#)" on page 552

Key Path	Front-panel key
Remote Command	:INITiate[:IMMEDIATE] :INITiate:RESTART
Example	:INIT:IMM :INIT:REST
Notes	:INITiate:RESTART and :INITiate:IMMEDIATE perform exactly the same function.
Couplings	Resets average/hold count k. For the first sweep overwrites all active (update=on) traces with new current data. For application modes, it resets other parameters as required by the measurement.
Status Bits/OPC dependencies	This is an Overlapped command. The STATUS:OPERation register bits 0 through 8 are cleared. The STATUS:QUESTionable register bit 9 (INTEGRITY sum) is cleared. The SWEEPING bit is set. The MEASURING bit is set.
Backwards Compatibility Notes	For Spectrum Analysis mode in ESA and PSA, the Restart hardkey and the INITiate:RESTART command restart trace averages (displayed average count reset to 1) for a trace in Clear Write, but did not restart Max Hold and Min Hold.  In the X-Series, the Restart hardkey and the INITiate:RESTART command restart not only Trace Average, but MaxHold and MinHold traces as well.  For wireless comms modes in ESA and PSA, the Restart hardkey and the INITiate:RESTART command restart every measurement, which includes all traces and numeric results. There is no change to this operation.
Initial S/W Revision	Prior to A.02.00

### More Information

The **Restart** function first aborts the current sweep/measurement as quickly as possible. It then resets the sweep and trigger systems, sets up the measurement and initiates a new data measurement sequence with a new data acquisition (sweep) taken once the trigger condition is met.

If the analyzer is in the process of aligning when **Restart** is executed, the alignment finishes before the restart function is performed.



Even when set for Single operation, multiple sweeps may be taken when Restart is pressed (for example, when averaging/holding is on). Thus when we say that **Restart** "restarts a measurement," we may mean:

- It restarts the current sweep
- It restarts the current measurement
- It restarts the current set of sweeps if any trace is in Trace Average, Max Hold or Min Hold
- It restarts the current set of measurements if Averaging, or Max Hold, or Min Hold is on for the measurement
- depending on the current settings.

With **Average/Hold Number** (in **Meas Setup** menu) set to 1, or Averaging off, or no trace in Trace Average or Hold, a single sweep is equivalent to a single measurement. A single sweep is taken after the trigger condition is met; and the analyzer stops sweeping once that sweep has completed. However, with **Average/Hold Number** >1 and at least one trace set to **Trace Average, Max Hold, or Min Hold (SA Measurement)** or **Averaging on (most other measurements)**, multiple sweeps/data acquisitions are taken for a single measurement. The trigger condition must be met prior to each sweep. The sweep is stopped when the average count  $k$  equals the number  $N$  set for **Average/Hold Number**. A measurement average usually applies to all traces, marker results, and numeric results; but sometimes it only applies to the numeric results.

Once the full set of sweeps has been taken, the analyzer will go to idle state. To take one more sweep without resetting the average count, increment the average count by 1, by pressing the step up key while **Average/Hold Number** is the active function, or sending the remote command `CALC:AVER:TCON UP`.

## Save

The Save menu lets you choose what you want to save and where you want to save it. Among the types of files you can save are **States**, **Traces**, and **Screen Images**. In addition, an Export (Data) option lets you save a number of data types as CSV files for easy import into Excel and other spreadsheet programs.

Key Path	Front-panel key
Mode	All
Notes	No remote command for this key specifically, but the :MMEM:STORe command is available for specific file types. An example is :MMEM:STOR:STATe <filename>.
Initial S/W Revision	Prior to A.02.00

## State

The Save State menu lets you choose a register or file for saving the state.

The content of a state file includes all of the settings and data required to return the analyzer as closely as possible to the Mode it was in, with the exact settings which were in place, when the save occurred. The Mode settings in each state file include the settings that are affected by Mode Preset, as well as the additional settings affected by Restore Mode Defaults; all of the Mode's settings. In addition, all of the settings of the Input/Output system are included, even though they are outside of the Mode's state, because they are needed to restore the complete setup. Persistent System settings (for example, Verbose SCPI) are not affected by either Mode Preset or Restore Mode Defaults, nor are they included in a saved State file.

After the save completes, the message "File <filename> saved" or "State Register <register number> saved" is displayed.

For rapid saving, the State menu lists 16 registers to save to. Pressing a Register key initiates the save. You can also select a file to save to.

The default path for all State Files is:

My Documents\<<mode name>\state

where <mode name> is the parameter used to select the mode with the INST:SEL command (for example, SA for the Spectrum Analyzer).

Key Path	Save
Mode	All
Remote Command	:MMEMory:STORe:STATe <filename>
Example	MMEM:STOR:STATe "MyStateFile.state" This stores the current instrument state data in the file MyStateFile.state in the default directory.
Notes	Both single and double quotes are supported for any filename parameter over remote. After saving to a register, that register's menu key is updated with the date the time, unless a custom label has been entered for that key. After saving to a register, you remain in the Save State menu, so that you can see the Register key

update. After saving to a file, the analyzer automatically returns to the previous menu and any Save As dialog goes away.

<b>Backwards Compatibility SCPI</b>	:MMEMoRY:STORe:STATe 1,<filename>
Initial S/W Revision	Prior to A.02.00

### To File . . .

When you press “To File”, the analyzer brings up a Windows dialog and a menu entitled “**Save As.**” This menu allows you to navigate to the various fields in the Windows dialog without using a keyboard or mouse. The Tab and Arrow keys can also be used for dialog navigation.

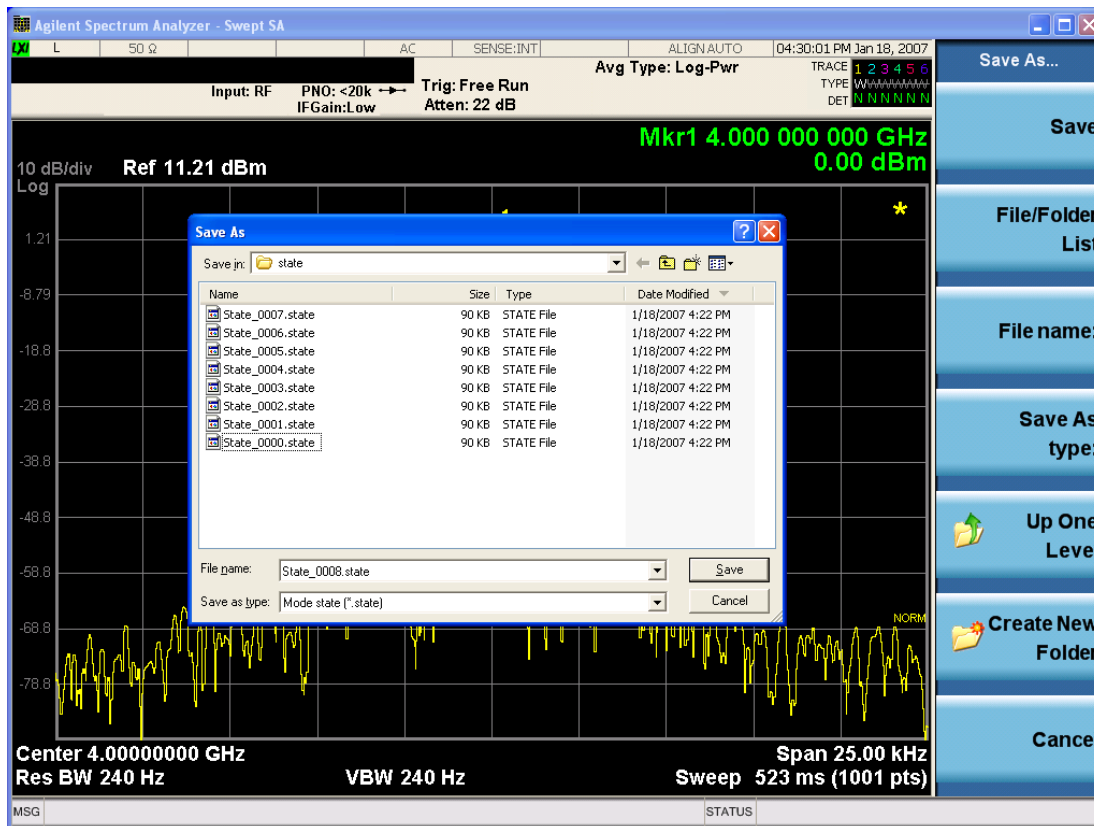

The Listed below

are the functions of the various fields in the dialog, and the corresponding softkeys:

#### Save

Performs the save to the specified file of the selected type. If the file already exists, a dialog will appear that allows you to replace the existing file by selecting OK, or you can Cancel the request. If you select OK, the file will be overwritten. Using the C: drive is strongly discouraged, since it runs the risk of being overwritten during an instrument software upgrade.

While the save is being performed, the floppy icon appears briefly in the Meas bar.

### File/Folder List

Enables you to navigate to the center of the dialog that contains the list of files and folders. Once here you can get information about the file and use the tab keys to navigate to the other fields in the dialog, such as Save In.

### Save In

The Save In field shows the path to which the file will be saved and allows you to change the path using the up and down arrow keys to navigate to other paths; the Enter key to open a directory; and the Backspace key to go back one directory. The **Save In field** defaults to the default path for this type of file and remembers the last path you used to save this type of file. There is no softkey for directly navigating to the Save In field but you can use left tab to get here from the File/Folder List.

User specified paths are remembered when you leave and return to a Mode and are reset back to the default using Restore Mode Defaults.

### File Name

The File Name field is initially loaded with an automatically generated filename specific to the appropriate Save Type. The automatically generated filename is guaranteed not to conflict with any filename currently in the directory. You may replace or modify this filename using the File Name key. See the ["Quick Save " on page 2197](#) documentation for more on the automatic file naming algorithm.

When you press the File Name key the analyzer displays the Alpha Editor. Use the knob to choose the letter to add and the front-panel Enter key to add the letter to the file name. The BK character moves you back and the FW character moves you forward in the filename. The Select key on the front panel generates a space character. When you are done entering the filename press the Done softkey. This returns back to the **File Open** dialog and menu, but does not cause the save to occur.

### Save As Type

This field shows the file suffix for the type of file you have selected to save. For example, if you navigated here while saving State, "Mode state (\*.state)" is in the field. If you navigated here from saving Trace, ""Mode state (\*.trace)" is in the field. If you navigated here while exporting a trace data file, "Trace Data (\*.csv)" is in the field. For some file types, there is more than one choice in the dropdown, which you can select by using the up and down arrow keys and Enter.

### Up One Level

This key corresponds to the icon of a folder with the up arrow that is in the tool bar of the dialog. When pressed, it causes the file and folder list to navigate up one level in the directory structure. The Backspace key does the same thing.

### Create New Folder

This key corresponds to the icon of a folder with the "\*" that is in the tool bar of the dialog. When pressed, a new folder is created in the current directory with the name **New Folder** and you can enter a new folder name using the Alpha Editor.

### Cancel

This key corresponds to the Cancel selection in the dialog. It causes the current **Save As** request to be cancelled. The ESC key does the same thing.

Key Path	Save, State
Mode	All
Notes	Brings up Save As dialog for saving a State Save Type
Initial S/W Revision	Prior to A.02.00

## Edit Register Names

You may enter a custom name on any of the Register keys, to help you remember what you are using that state to save. To do this, press the Edit Register Names key, choose the register whose name you wish to edit, and then enter the desired label using the Alpha Editor or an external PC keyboard.

The maximum number of characters that can be added is 30. In most cases, 30 characters will fit on two lines of the key.

See "[More Information](#)" on page 557

Key Path	Save, State
Mode	All
<b>Remote Command</b>	:MMEMory:REGister:STATe:LABel <reg number>,"label" :MMEMory:REGister:STATe:LABel? <reg number>
<b>Example</b>	:MMEM:REG:STAT:LAB 1,"my label"
Notes	<reg number> is an integer from 1 to 16. If the SCPI specifies an invalid register number an error message is generated, -222,"Data out of range;Invalid register label number" "label" is a string from 0 to 30 characters in length. If a label exceeds 30 characters, an error message is generated, -150,"String data error;Label clipped to 30 characters" "label" of length 0 erases the custom label and restores the default (time and date) label. E.g.: :MMEM:REG:STAT:LAB 1,""
Dependencies	N9060A-7FP or N9060B-2FP license required to edit the register names. When the feature is not licensed, sending this command generates an error, -221,"Settings conflict;Option not available"
Preset	The names are unaffected by Preset or power cycle but are set to the default label (time and date) on a "Restore System Defaults->Misc"
Initial S/W Revision	A.11.00

## More Information

When you edit one of the register names, the time and date field will be replaced by the custom name.

If you delete all the characters in the custom name, it restores the default (time and date).

The register names are stored within the state files, but they are not part of the instrument state; that is, once you have edited a register name, loading a new state will not change that register name. Another consequence of this is that the names will be persistent through a power cycle. Also, if a named state file is transferred to another analyzer, it will bring its custom name along with it.

If you try to edit the name of an empty register, the analyzer will first save the state to have a file to put the name in. If you load a named state file into an analyzer with older firmware it will ignore the metadata.

The \*SAV and \*RCL commands will not be affected by the custom register names, nor will the MMEM commands.

### Register 1 thru Register 16

Selecting any one of these register menu keys causes the State of the currently active mode to be saved to the specified Register. The registers are provided for rapid saving and recalling, since you do not need to specify a filename or navigate to a file. Each of the register menu keys annotates whether it is empty or at what date and time it was last modified. In addition, you can use the Edit Register Names key to enter custom names for each register.

Although these 16 registers are the only registers available from the front panel, there are 128 state registers available in the instrument. Registers 17–128 are only available from the SCPI interface, using the \*SAV command.

There is one set of 128 state registers in the instrument, not one set for each Mode. When a state is saved, the Mode it was saved from is saved with it; then when it is recalled, the instrument switches to that Mode.

After the save completes, the corresponding register menu key annotation is updated with the date and time and the message "Register <register number> saved" is displayed.

Key Path	Save, State
Mode	All
Example	*SAV 1
Range	1–16 from front panel, 1–128 from SCPI
Readback	Date and time with seconds resolution are displayed on the key OR A custom name of up to 30 characters entered using the Edit Register Names key OR “(empty)” if no prior save operation has been performed to this register.
Initial S/W Revision	Prior to A.02.00
Modified at S/W Revision	A.11.00

### Register 1 thru Register 16

Selecting any one of these register menu keys causes the State of the currently active mode to be saved to the specified Register. The registers are provided for rapid saving and recalling, since you do not need to specify a filename or navigate to a file. Each of the register menu keys annotates whether it is empty or at what date and time it was last modified. In addition, you can use the Edit Register Names key to enter custom names for each register.

Although these 16 registers are the only registers available from the front panel, there are 128 state registers available in the instrument. Registers 17–128 are only available from the SCPI interface, using the \*SAV command.

There is one set of 128 state registers in the instrument, not one set for each Mode. When a state is saved, the Mode it was saved from is saved with it; then when it is recalled, the instrument switches to that Mode.

After the save completes, the corresponding register menu key annotation is updated with the date and time and the message "Register <register number> saved" is displayed.

Key Path	Save, State
Mode	All
Example	*SAV 1
Range	1–16 from front panel, 1–128 from SCPI
Readback	Date and time with seconds resolution are displayed on the key OR A custom name of up to 30 characters entered using the Edit Register Names key OR “(empty)” if no prior save operation has been performed to this register.
Initial S/W Revision	Prior to A.02.00
Modified at S/W Revision	A.11.00

## Data (Export)

Exporting a data file stores data from the current measurement to mass storage files. The Export Menu only contains data types that are supported by the current measurement.

Since the commonly exported data files are in .csv format, the data can be edited by you prior to importing. This allows you to export a data file, manipulate the data in Excel (the most common PC Application for manipulating .csv files) and then import it.

Selecting an Export Data menu key will not actually cause the exporting to occur, since the analyzer still needs to know where you wish to save the data. Pressing the Save As key in this menu brings up the Save As dialog and Save As menu that allows you to specify the destination file and directory. Once a filename has been selected or entered in the Open menu, the export will occur as soon as the Save key is pressed.

Key Path	Save
Mode	All
Notes	The menu is built from whatever data types are available for the mode. So the key locations in the sub menu will vary.  No SCPI command directly controls the Data Type that this key controls. The Data Type is included in the MMEM:STORe commands.
Dependencies	If a file type is not used by a certain measurement, that type is grayed out for that measurement. The key for a file type will not show at all if there are no measurements in the Mode that support it.
Preset	Is not affected by a Preset or shutdown, but is reset during Restore Mode Defaults
Readback	The data type that is currently selected
Initial S/W Revision	Prior to A.02.00

## Amplitude Correction

Pressing this key selects **Amplitude Corrections** as the data type to be exported. Pressing this key again brings up the Select Menu, which allows the user to select which **Amplitude Correction** to save.

Amplitude Corrections are fully discussed in the documentation of the Input/Output key, under the Corrections softkey.

See "[Correction Data File](#)" on page 560

Key Path	Save
<b>Remote Command</b>	:MMEMory:STORe:CORRection 1 2 3 4 5 6, <filename>
<b>Example</b>	:MMEM:STOR:CORR 2 "myAmpcor.csv" saves Correction 2 to the file myAmpcor.csv on the current path. The default path is My Documents\amplitudeCorrections.
Notes	If the save is initiated via SCPI, and the file already exists, the file will be overwritten. Using the C: drive is strongly discouraged, since it runs the risk of being overwritten during an instrument software upgrade. Both single and double quotes are supported for any filename parameter over SCPI.
Dependencies	Corrections are not supported by all Measurements. If in a Mode in which some Measurements support it, this key will be grayed out in measurements that do not. The key will not show at all if no measurements in the Mode support it. This key will not appear unless you have the proper option installed in your instrument.
Readback	Selected Correction
<b>Backwards Compatibility SCPI</b>	:MMEMory:STORe:CORRection ANTenna   CABLe   OTHer   USER, <filename> For backwards compatibility, ANTenna maps to 1, CABLe maps to 2, OTHer maps to 3 and USER maps to 4
Initial S/W Revision	A.02.00

## Correction Data File

A Corrections Data File contains a copy of one of the analyzer correction tables. Corrections provide a way to adjust the trace display for predetermined gain curves (such as for cable loss).

Corrections files are text files in .csv (comma separated values) form, to make them importable into Excel or other spreadsheet programs. The format for Corrections files is as follows.

Line #	Type of field	Example	Notes
1	File type, must be "Amplitude Correction"	Amplitude Correction	May not be omitted
2	File Description (in quotes)	"Correction Factors for 11966E"	60 characters max; may be empty but may not be omitted. If exceeds 60 characters, error -233 Too much data reported
3	Comment (in quotes)	"Class B Radiated"	60 characters max; may be empty but



Line #	Type of field	Example	Notes
			may not be omitted. . If exceeds 60 characters, error -233 Too much data reported
4	Instrument Version, Model #	A.02.06,N9020A	May be empty but may not be omitted
5	Option List, File Format Version	K03 LFE EXM ,01	May be empty but may not be omitted
6	Freq Unit to be used for all frequency values in the file	Frequency Unit,MHz	assumed to be Hz if omitted
7	Antenna Unit	Antenna Unit,None	If omitted leaves the Antenna unit unchanged. The amplitude unit in the Antenna Unit field is a conversion factor that is used to adjust the Y Axis Units of the current mode, if the mode supports Antenna Units. For more details on antenna correction data, refer to the Input/Output,Corrections key description. Allowable values: dBuv/m, dBuA/m, dBG, dBpT, None
8	Freq Interpolation	Frequency Interpolation,Linear	if omitted leaves the Freq Interpolation unchanged. Allowable values: Linear, Logarithmic
9	Bias value in mA	Bias,0.00	If omitted leaves the Bias value unchanged (added as of A.08.50)
10	Bias State	Bias State,On	If omitted leaves the Bias State unchanged. Allowable values: On, Off (added as of A.08.50)
11	Overlap, two values, Freq1 and Freq2, separated by commas.	Overlap,33500,40000	Uses Freq Unit from line 6. Thus, in this example Freq1=33.5 GHz, Freq2= 40.0 GHz (see note below). If omitted leaves the overlap unchanged (added as of A.08.50)
12	DATA marker	DATA	Corrections data begins in the next line

Lines 2 through 5 can be empty but must appear in the file. Lines 6 through 11 are optional, the lines can be left out of the file altogether.

The Overlap row and the two Bias rows apply only to external mixing. Both are read-only, they are never written by the analyzer. The only way to insert or modify these rows is to edit the file with a text editor or a spreadsheet editor. These rows are intended for use by mixer manufacturers, as they allow the manufacturer to insert data about how the mixer corrections were generated and how they should be applied. The Bias rows allow you to specify whether to turn Bias on or off when the Correction is turned on and to specify a Bias value (turning off the Correction does not change the Bias, but turning it back on again sets it to the value specified in the file). The Overlap row allows you to specify an overlap region in which

two different corrections may be applied. It is expected that in the corrections data itself, there will be TWO corrections values exactly at Max Freq, otherwise Overlap is ignored. The way the overlap is processed is as follows: if at any given time the current analyzer Start Freq is greater than Freq 1 and lower than Freq 2, and the current Stop Freq is greater than Freq 2, extend the first correction point at or above Freq 2 down to Freq 1, rather than using the correction data between Freq1 and Freq2.

The Antenna Unit row can only be used in Correction register 1, because there can only be one setting for Antenna Unit at any given time. If a Correction whose Antenna Unit is set to anything but None is loaded into any Correction register but 1, an error is generated (Mass storage error; Can only load an Antenna Unit into Correction 1). When a correction file is saved from any Correction register but 1, Antenna Unit is always written as None.

Similarly, the Bias rows can only be used in Correction register 1, because there can only be one setting for Bias at any given time. If a Correction file with a Bias or Bias State row is loaded into any Correction register but 1, an error is generated: Mass storage error; Can only load Bias Settings into Correction 1

The data follows the DATA row, as comma separated X, Y pairs; one pair per line.

For example, suppose you have an Antenna to correct for on an N9020A version A.02.06 and the correction data is:

- 0 dB at 200 MHz
- 17 dB at 210 MHz
- 14.8 dB at 225 MHz

Then the file will look like:

- Amplitude Correction
- "Correction Factors for 11966E"
- "Class B Radiated"
- A.02.06,N9020A
- P13 EA3 UK6,01
- Frequency Unit,MHz
- Antenna Unit,dBuV/m
- Frequency Interpolation,Linear
- DATA
- 200.000000,0.00
- 210.000000,17.00
- 225.000000,14.80

The choices for the 1 of N fields in the metadata are as follows:

- Frequency Unit: Hz, kHz, MHz, GHz
- Antenna Unit: dBuV/m, dBuA/m, dBG, dBpT, None

- Frequency Interpolation: Logarithmic, Linear

### Amplitude Correction

These keys let you choose which Correction to save. Once selected, the key returns back to the Export Data menu and the selected Correction number is annotated on the key.

The next step in the Save process is to select the Save As key in the Export Data menu.

Key Path	Save, Data, Amplitude Correction
Preset	Not part of a Preset, but is reset to Correction 1 by Restore Input/Output Defaults. Survives a shutdown.
Readback	1
Initial S/W Revision	A.02.00

### Chan Table

Exports the current channel table to a channel table file.

The exported channel table file can be edited to meet your requirements, and then imported by pressing Recall, Data, Channel Table, and then Open...

Note that while editing the channel plan file, you can't change the channel plan name, such as NTSC\_B.VHF, NTSC\_B.UHF, otherwise your modifications on the corresponding channel plan will not work. You can add, remove, or modify the channel numbers and center frequencies in each channel plan. The value of Start Channel and Channel Count may also need to be changed.

File Location and Extension

**File location:** "My Documents\Digital Video\data"

**File type:** text file

**File extension:** .txt

**Example:**

File Location: My Documents\Digital Video\data

File Name: ChannelPlan\_0001.txt

Key Path	Save, Data
Mode	DVB-T/H
<b>Remote Command</b>	MMEMemory:STOR:CHTable <string>
<b>Example</b>	MMEM:STOR:CHT "ChannelPlan_0001.txt"
Initial S/W Revision	A.07.00

### Measurement Results

Pressing this key selects Meas Results as the data type to be exported.

The Meas Results file contains information which describes the current state of the analyzer. It is detailed in Meas Result File Contents below.

<b>Key Path</b>	Save, Data
<b>Remote Command</b>	:MMEMory:STORe:RESults <string>
<b>Example</b>	:MMEM:STOR:RES "MeasR_0000.csv"
<b>Notes</b>	<p>If the save is initiated via SCPI and the file already exists, the file will be overwritten.</p> <p>The SCPI command exports Channel Power measurement results to the file specified as the parameter in the current path. The default path is My Documents\<current mode&gt;\data\chp\results.<="" p=""> <p>Using the C: drive is strongly discouraged, since it runs the risk of being overwritten during an instrument software upgrade.</p> <p>The SCPI parameter is a quoted string, which specifies the filename. Both single and double quotes are supported for any filename parameter over SCPI.</p> </current></p>
<b>Dependencies</b>	The current active measurement must be the Channel Power measurement to use this command.
<b>Status Bits/OPC dependencies</b>	Sequential – waits for the previous measurement to complete.
<b>Initial S/W Revision</b>	Prior to A.02.00

### Meas Results File Contents

A Meas Results File contains measurement results with the following information.

- File ID string, which is “MeasResult”
- Measurement ID following Mode ID, which is “SA:CHP” for example.
- Firmware rev and model number
- Option string
- Auto Sweep Time Rules
- Average Mode
- Average Number
- Average State
- Center Frequency
- Detector
- Electrical Atten
- Electrical Atten State
- IFGain
- IFGainAuto
- Impedance

- Integ BW
- Internal Preamp
- Internal Preamp Band
- Mechanical Atten
- MechanicalAttenStepEnum
- PSD Unit
- Resolution Band Width
- Resolution Bandwidth Shape
- RRC Filter Alpha
- RRC Filter BW
- RRC Filter State
- Span
- Sweep Points
- Sweep Time
- Sweep Time Auto
- TriggerSource
- Video Bandwidth
- Y Axis Unit

The file contains these data followed by MeasResult1 and MeasResult2 that flag the start of the measurement results. Each line of Measurement Results consists of two comma separated values, MeasResult1 value and MeasResult2 value. MeasResult1 contains the same results as MEAS/READ/FETCH:CHPower1; MeasResult2, MEAS/READ/FETCH:CHPower2.

Exported file is .csv file. The Meas Results file, when imported into Excel, will show the following data:

<b>MeasResult</b>	
SA:CHP	
A.10.53	N9030A
526 ALV ATP B1X B1Y B25 B40 BBA CR3 CRP DCF DDA DP2 DRD EA3 EDP EMC EP1 ERC ESC ESP EXM FSA LFE LNP MAT MPB NFE NUL P26 PFR PNC RTL RTS S40 SB1 SEC SM1 TVT YAS YAV	1
Auto Sweep Time Rules	Normal
Average Mode	Exponential
Average Number	10
Average State	TRUE

Center Frequency	1325500000
Detector	Average
IFGain	FALSE
IFGainAuto	FALSE
Impedance	50
Integ BW	2000000
Internal Preamp	FALSE
Internal Preamp Band	Low
PSD Unit	DbmHz
Resolution Band Width	27000
Resolution Bandwidth Shape	Gaussian
RRC Filter Alpha	0.22
RRC Filter BW	3840000
RRC Filter State	FALSE
Span	3000000
Sweep Points	1001
Sweep Time	0.004933333
Sweep Time Auto	TRUE
TriggerSource	Free
Video Bandwidth	270000
Y Axis Unit	DecibelMilliwatt
MeasResult1	MeasResult2
-76.8141133132837	-95.29174
-139.824413269924	-94.99601
	-94.95281
	-95.17146

## Capture Buffer

Capture buffer functionality is available only in Mod Accuracy measurement. The captured data is raw data which is not processed.

Key Path	Save, Data
Mode	DVB-T/H
Example	MMEM:STOR:CAPT "MyCaptureData.bin" This stores the capture data in the file MyCaptureData.bin in the default directory.
Dependencies	Capture buffer functionality is only available for Mod Accuracy measurement. In other measurements, this key is grayed out.
Initial S/W Revision	Prior to A.01.70

## DVB-T2 Config

Exports the current DVB-T2 configuration to a file (single PLP or multiple PLPs). This key is available only in DVB-T2 Mod Accuracy measurement and will be grayed out in other measurements.

You can view the exported file for the format of the DVB-T2 configuration files and create your own DVB-T2 configuration file by modifying the exported file.

File Location and Extension

**File location:** "My Documents\DVB\data\EVMT2\data"

**File type:** text file

**File extension:** .csv

**Example:**

File Location: My Documents\DVB\data\EVMT2\data

File Name: DVBT2Config\_0001.csv

Key Path	Save, Data
Mode	DVB-T/H
<b>Remote Command</b>	MMEMoRY:STORe:T2Config <string>
<b>Example</b>	MMEM:STOR:T2C "DVBT2Config_0001.csv"
Dependencies	This key is grayed out in all the other measurements except DVB-T2 Mod Accuracy measurement.
Initial S/W Revision	A.07.00

## Save As . . .

When you press "Save As", the analyzer brings up a Windows dialog and a menu entitled "**Save As.**" This menu allows you to navigate to the various fields in the Windows dialog without using a keyboard or mouse. The Tab and Arrow keys can also be used for dialog navigation.

See "[To File . . .](#)" on page 2213 in Save, State for a full description of this dialog and menu.

The default path for saving files is:

For all of the Trace Data Files:

My Documents\`<mode name>`\data\traces

For all of the Limit Data Files:

My Documents\`<mode name>`\data\limits

For all of the Measurement Results Data Files:

My Documents\`<mode name>`\data\`<measurement name>`\results

For all of the Capture Buffer Data Files:

My Documents\`<mode name>`\data\captureBuffer

Key Path	Save, Data
Mode	All
Notes	The key location is mode-dependent and will vary. Brings up the Save As dialog for saving a <mode specific> Save Type. The save is performed immediately and does not wait until the measurement is complete.
Initial S/W Revision	Prior to A.02.00

### Screen Image

Pressing Screen Image accesses a menu of functions that enable you to specify a format and location for the saved screen image. It brings up a menu that allows you to specify the color scheme of the Screen Image (Themes) or navigate to the Save As dialog to perform the actual save.

Screen Image files contain an exact representation of the analyzer display. They cannot be loaded back onto the analyzer, but they can be loaded into your PC for use in many popular applications.

The image to be saved is actually captured when the Save front panel key is pressed, and kept in temporary storage to be used if you ask for a Screen Image save. When the Screen Image key is pressed, a "thumbnail" of the captured image is displayed, as shown below:

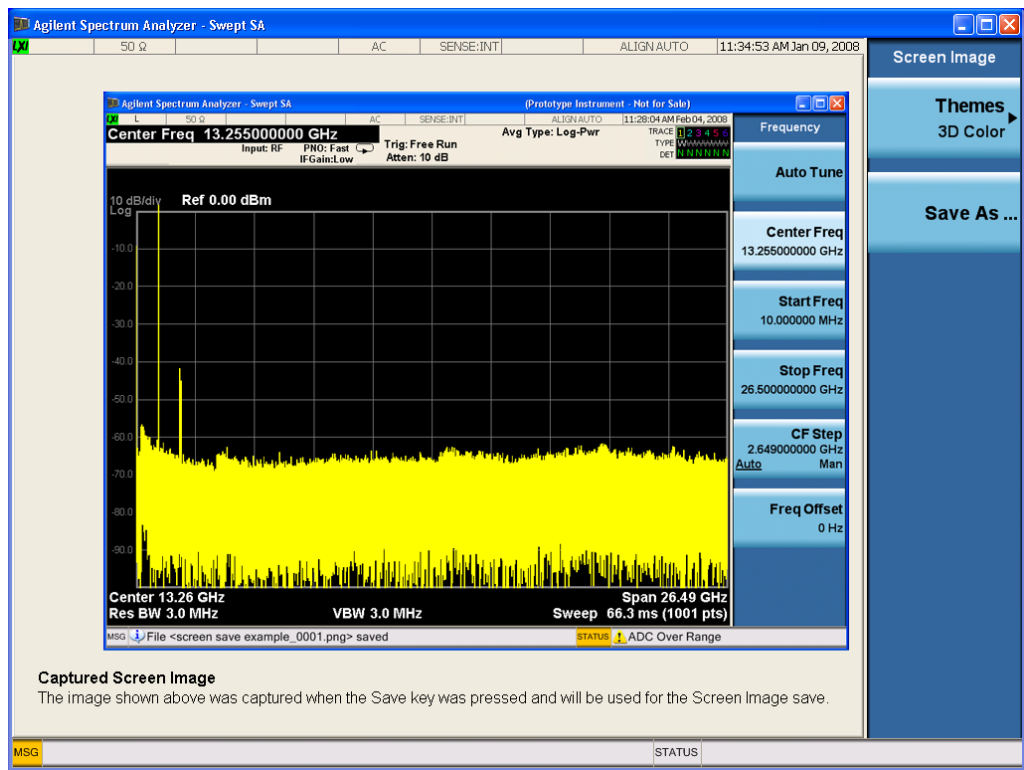

When you continue on into the Save As menu and complete the Screen Image save, the image depicted in the thumbnail is the one that gets saved, showing the menus that were on the screen before going into the Save menus. The save is performed immediately and does not wait until the measurement is complete.



After you have completed the save, the Quick Save front-panel key lets you quickly repeat the last save performed, using an auto-named file, with the current screen data.

**NOTE**

For versions previous to A.01.55, if you initiate a screen image save by navigating through the Save menus, the image that is saved will contain the Save menu softkeys, not the menus and the active function that were on the screen when you first pressed the Save front panel key.

Key Path	Save
Mode	All
Remote Command	:MMEMory:STORe:SCReem <filename>
Example	:MMEM:STOR:SCR "myScreen.png" This stores the current screen image in the file MyScreenFile.png in the default directory.
Initial S/W Revision	Prior to A.02.00

## Themes

Accesses a menu of functions that enable you to choose the theme to be used when saving the screen image.

The **Themes** option is the same as the **Themes** option under the **Display** and **Page Setup** dialogs. It allows you to choose between themes to be used when saving the screen image.

Key Path	Save, Screen Image
Remote Command	:MMEMory:STORe:SCReem:THEMe TDColor   TDMonochrome   FCOLOR   FMONochrome  :MMEMory:STORe:SCReem:THEMe?
Example	:MMEM:STOR:SCR:THEM TDM
Preset	3D Color; Is not part of Preset, but is reset by Restore Misc Defaults or Restore System Defaults All and survives subsequent running of the modes.
Readback	3D Color   3D Mono   Flat Color   Flat Mono
Backwards Compatibility Notes	In ESA and PSA we offer the choice of "Reverse Bitmap" or "Reverse Metafile" when saving screen images. This is much like the "Flat Color" theme available in X-Series. Also, if you selected Reverse Bitmap AND a black & white screen image, that would be much like "Flat Monochrome". In other words, each of the X-Series themes has a similar screen image type in ESA/PSA. But they are not identical.
Initial S/W Revision	Prior to A.02.00

## 3D Color

Selects a standard color theme with each object filled, shaded and colored as designed.

Key Path	Save, Screen Image, Themes
Example	MMEM:STOR:SCR:THEM TDC

Readback	3D Color
Initial S/W Revision	Prior to A.02.00

### 3D Monochrome

Selects a format that is like 3D color but shades of gray are used instead of colors.

Key Path	Save, Screen Image, Themes
<b>Example</b>	MMEM:STOR:SCR:THEM TDM
Readback	3D Mono
Initial S/W Revision	Prior to A.02.00

### Flat Color

Selects a format that is best when the screen is to be printed on an ink printer.

Key Path	Save, Screen Image, Themes
<b>Example</b>	MMEM:STOR:SCR:THEM FCOL
Readback	Flat Color
Initial S/W Revision	Prior to A.02.00

### Flat Monochrome

Selects a format that is like Flat Color. But only black is used (no colors, not even gray), and no fill.

Key Path	Save, Screen Image, Themes
<b>Example</b>	MMEM:STOR:SCR:THEM FMON
Readback	Flat Mono
Initial S/W Revision	Prior to A.02.00

### Save As...

When you press "Save As", the analyzer brings up a Windows dialog and a menu entitled "**Save As.**" This menu allows you to navigate to the various fields in the Windows dialog without using a keyboard or mouse. The Tab and Arrow keys can also be used for dialog navigation.

See "[To File . . .](#)" on page 2213 in Save, State for a full description of this dialog and menu.

The default path for Screen Images is

My Documents\`<mode name>`\screen.

where <mode name> is the parameter used to select the mode with the INST:SEL command (for example, SA for the Spectrum Analyzer).

Key Path	Save, Screen Image
Notes	Brings up Save As dialog for saving a Screen Image Save Type
Initial S/W Revision	Prior to A.02.00

### Mass Storage Catalog (Remote Command Only)

Key path	SCPI Only
<b>Remote Command</b>	:MMEMory:CATalog? [<directory_name>]
Notes	<p>The string must be a valid logical path.</p> <p>Queries disk usage information (drive capacity, free space available) and obtains a list of files and directories in a specified directory in the following format:          &lt;numeric_value&gt;,&lt;numeric_value&gt;,{&lt;file_entry&gt;}</p> <p>It returns two numeric parameters and as many strings as there are files and directories. The first parameter indicates the total amount of storage currently used in bytes. The second parameter indicates the total amount of storage available, also in bytes. The &lt;file_entry&gt; is a string. Each &lt;file_entry&gt; indicates the name, type, and size of one file in the directory list:          &lt;file_name&gt;,&lt;file_type&gt;,&lt;file_size&gt;</p> <p>As the windows file system has an extension that indicates file type, &lt;file_type&gt; is always empty. &lt;file_size&gt; provides the size of the file in bytes. For directories, &lt;file_entry&gt; is surrounded by square brackets and both &lt;file_type&gt; and &lt;file_size&gt; are empty</p>
Initial S/W Revision	Prior to A.02.00

### Mass Storage Change Directory (Remote Command Only)

Key path	SCPI Only
<b>Remote Command</b>	:MMEMory:CDIRectory [<directory_name>] :MMEMory:CDIRectory?
Notes	<p>The string must be a valid logical path.</p> <p>Changes the default directory for a mass memory file system. The &lt;directory_name&gt; parameter is a string. If no parameter is specified, the directory is set to the *RST value.</p> <p>At *RST, this value is set to the default user data storage area, that is defined as System.Environment.SpecialFolder.Personal.</p> <p>Query returns full path of the default directory.</p>
Initial S/W Revision	Prior to A.02.00

## Mass Storage Copy (Remote Command Only)

Key path	SCPI Only
Remote Command	:MMEMory:COpy <string>,<string>[,<string>,<string>]
Notes	<p>The string must be a valid logical path.</p> <p>Copies an existing file to a new file or an existing directory to a new directory.</p> <p>Two forms of parameters are allowed. The first form has two parameters. In this form, the first parameter specifies the source, and the second parameter specifies the destination.</p> <p>The second form has four parameters. In this form, the first and third parameters specify the source. The second and fourth parameters specify the directories. The first pair of parameters specifies the source. The second pair specifies the destination. An error is generated if the source doesn't exist or the destination file already exists.</p> <p>This command will generate an "access denied" error if the destination is a restricted folder (e.g., C:\Windows) and the current user does not have Power User or Administrator privileges.</p>

## Mass Storage Device Copy (Remote Command Only)

This command transfers data to/from a file and a peripheral device.

Key path	SCPI Only
Remote Command	:MMEMory:COpy:DEvice <source_string>,<dest_string>
Notes	<p>The strings must be a valid logical path or a valid device keyword. If the dest_string is a device keyword, the data is copied from the source file to the device. If the source_string is a device keyword, the data is copied to the source file from the device.</p> <p>Valid device keywords are:</p> <p>SNS (smart noise source)</p> <p>An error is generated if the file or device is not found.</p>

## Mass Storage Delete (Remote Command Only)

Key path	SCPI Only
Remote Command	:MMEMory:DElete <file_name>[,<directory_name>]
Notes	<p>The string must be a valid logical path.</p> <p>Removes a file from the specified directory. The &lt;file_name&gt; parameter specifies the file name to be removed. This command will generate an "access denied" error if the file is in a restricted folder (e.g., C:\Windows) and the current user does not have Power User or Administrator privileges.</p>
Initial S/W Revision	Prior to A.02.00

## Mass Storage Data (Remote Command Only)

Creates a file containing the specified data OR queries the data from an existing file.

Key path	SCPI Only
<b>Remote Command</b>	:MMEMory:DATA <file_name>, <data> :MMEMory:DATA? <file_name>
Notes	The string must be a valid logical path. The command form is MMEMory:DATA <file_name>,<data>. It loads <data> into the file <file_name>. <data> is in 488.2 block format. <file_name> is string data. The query form is MMEMory:DATA? <file_name> with the response being the associated <data> in block format.
Initial S/W Revision	Prior to A.02.00

### Mass Storage Make Directory (Remote Command Only)

Key path	SCPI Only
<b>Remote Command</b>	:MMEMory:MDIRectory <directory_name>
Notes	The string must be a valid logical path. Creates a new directory. The <directory_name> parameter specifies the name to be created. This command will generate an “access denied” error if the new directory would be in a restricted folder (e.g., C:\Windows) and the current user does not have Power User or Administrator privileges.
Initial S/W Revision	Prior to A.02.00

### Mass Storage Move (Remote Command Only)

Key path	SCPI Only
<b>Remote Command</b>	:MMEMory:MOVE <string>,<string>[,<string>,<string>]
Notes	The string must be a valid logical path. Moves an existing file to a new file or an existing directory to a new directory. Two forms of parameters are allowed. The first form has two parameters. In this form, the first parameter specifies the source, and the second parameter specifies the destination. The second form has four parameters. In this form, the first and third parameters specify the source. The second and fourth parameters specify the directories. The first pair of parameters specifies the source. The second pair specifies the destination. An error is generated if the source doesn't exist or the destination file already exists. This command will generate an “access denied” error if the destination is a restricted folder (e.g., C:\Windows) and the current user does not have Power User or Administrator privileges.
Initial S/W Revision	Prior to A.02.00

## Mass Storage Remove Directory (Remote Command Only)

Key path	SCPI Only
<b>Remote Command</b>	<code>:MMEMory:RDIRectory &lt;directory_name&gt;</code>
Notes	<p>The string must be a valid logical path.</p> <p>Removes a directory. The &lt;directory_name&gt; parameter specifies the directory name to be removed. All files and directories under the specified directory shall also be removed.</p> <p>This command will generate an “access denied” error if the folder is a restricted folder (e.g., C:\Windows) or is in a restricted folder and the current user does not have Power User or Administrator privileges.</p>
Initial S/W Revision	Prior to A.02.00

## Single (Single Measurement/Sweep)

Sets the analyzer for Single measurement operation. The single/continuous state is Meas Global, so the setting will affect all the measurements. If you are Paused, pressing Single does a Resume.

See "[More Information](#)" on page 575

Key Path	Front-panel key
Example	:INIT:CONT OFF
Notes	See Cont key description.
Backwards Compatibility Notes	<p>For Spectrum Analysis mode in ESA and PSA, the Single hardkey and the INITiate:IMM switched from continuous measurement to single measurement and restarted sweeps and averages (displayed average count reset to 1), but did not restart Max Hold and Min Hold. In the X-Series, the Single hardkey and the INITiate:IMM command initiate a sweep/ measurement/ average sequence/hold sequence including MaxHold and MinHold.</p> <p>For Spectrum Analysis mode in ESA and PSA, the Single hardkey restarted the sweep regardless of whether or not you were in an active sweep or sweep sequence. In the X-Series, Restart does this but Single only restarts the sweep or sweep sequence if you are in the idle state.</p> <p>INIT[:IMM] in ESA &amp; PSA Spectrum Analysis Mode does an implied ABORT. In some other PSA Modes, INIT[:IMM] is ignored if not in the idle state. . The X-Series follows the ESA/PSA SA Mode model, which may cause some Modes to have compatibility problems.</p>
Initial S/W Revision	Prior to A.02.00

### More Information

See "[Restart](#)" on page 2210 for details on the INIT:IMMEDIATE (Restart) function.

If you are already in single sweep, the INIT:CONT OFF command has no effect.

If you are already in Single Sweep, then pressing the Single key in the middle of a sweep does not restart the sweep or sequence. Similarly, pressing the Single key does not restart the sweep or sequence if the sweep is not in the idle state (for example, if you are taking a very slow sweep, or the analyzer is waiting for a trigger). Instead, it results in a message. "Already in Single, press Restart to initiate a new sweep or sequence". Even though pressing the Single key in the middle of a sweep does not restart the sweep, sending INIT:IMMEDIATE does reset it.

To take one more sweep without resetting the average count, increment the average count by 1, by pressing the step up key while **Average/Hold Number** is the active function, or sending the remote command CALC:AVER:TCON UP.

## Source

There is no Source control functionality for this measurement. When this key is pressed, the screen either displays a blank menu, or the previously-selected menu remains unchanged.

---

Key Path	Front-panel key
----------	-----------------

---



## Span X Scale

Accesses a menu of functions that enable you set the horizontal scale parameters.

Key Path	Front-panel key
Initial S/W Revision	Prior to A.02.00

### Span

Changes the frequency range symmetrically about the center frequency.

The default (and minimum) Span is calculated using the number of carriers and the carrier width where;

$$\text{Span} = (\text{Upper Carrier Freq} + (\text{max offset IBW} * (1 + \alpha)) / 2) - (\text{Lower Carrier Freq} - (\text{max offset IBW} * (1 + \alpha)) / 2)$$

The span is increased by a factor of 1 + Filter Alpha if the RRC Filter is on.

Key Path	Span X Scale
Mode	SA, WCDMA, C2K, WIMAX OFDMA, 1xEVDO, DVB-T/H, DTMB (CTTB), ISDB-T, CMMB, LTE, LTETDD, Digital Cable TV, WLAN
Remote Command	[ :SENSe ] :CHPower:FREQuency:SPAN <freq> [ :SENSe ] :CHPower:FREQuency:SPAN?
Example	CHP:FREQ:SPAN 10 MHz CHP:FREQ:SPAN?
Notes	You must be in the Spectrum Analysis mode, W-CDMA mode, cdma2000 mode, DVB-T/H mode, DTMB (CTTB) mode, ISDB-T mode, CMMB mode, Digital Cable TV mode, LTE mode, LTE TDD mode, WLAN mode, 1xEVDO mode or WIMAX OFDMA mode to use this command. Use :INSTrument:SElect to set the mode.
Dependencies	For MSR mode, this key is blank. For LTE-Advanced FDD/TDD mode, this key is blank. For WLAN 802.11ac (80 MHz + 80 MHz), the key is not enabled and its value is coupled with the spacing between the center frequencies of the two carriers. Span =  Center Frequency 1 – Center Frequency 2  + Integ BW + 40 MHz Margin. When the calculated span is over 1 GHz, it's still coupled to its maximum value, which is 1 GHz.
Couplings	When Res BW is set to Auto, the resolution bandwidth is auto-coupled to span. The ratio of span /RBW is approximately 106:1. When the Res BW is set to Man, bandwidths are entered by the user, and these bandwidths are used regardless of other analyzer settings. Since Span is coupled to Integ BW in the factory default condition, if you change the integration bandwidth setting, the span setting changes by a proportional amount until a limit value is reached. However, the span can be individually set. The minimum value of the span is coupled with the integration bandwidth.
Preset	SA: 3 MHz WCDMA: 7.5 MHz

	C2K: 1.845 MHz WIMAX OFDMA: 20 MHz 1xEVDO: 2.0MHz DVB-T/H: 10MHz DTMB (CTTB): 10MHz ISDB-T: 10MHz CMMB: 10MHz LTE: 7.5 MHz LTETDD: 7.5 MHz Digital Cable TV: 10MHz WLAN: if Radio Std is 802.11a/g(OFDM/DSSS-OFDM): 30 MHz if Radio Std is 802.11b: 37.5MHz if Radio Std is 802.11n(20MHz): 30 MHz if Radio Std is 802.11n(40MHz): 60 MHz if Radio Std is 802.11ac (20 MHz): 30 MHz if Radio Std is 802.11ac (40 MHz): 60 MHz if Radio Std is 802.11ac (80 MHz): 120 MHz if Radio Std is 802.11ac (160 MHz): 240 MHz if Radio Std is 802.11ac (80 MHz + 80 MHz): 360 MHz
State Saved	Saved in instrument state.
Min	100 Hz
Max	Hardware Maximum Span
Initial S/W Revision	Prior to A.02.00
Modified at S/W Revision	A.02.00, A.03.00

## Full Span

Changes the span to show the full frequency range of the spectrum analyzer.

Key Path	Span X Scale
Mode	SA, WCDMA, C2K, WIMAX OFDMA, 1xEVDO, DVB-T/H, DTMB (CTTB), ISDB-T, CMMB, LTE, LTETDD, Digital Cable TV, WLAN
Remote Command	[ :SENSE] :CHPower:FREQuency:SPAN:FULL
Example	CHP:FREQ:SPAN:FULL
Notes	You must be in the Spectrum Analysis mode, W-CDMA mode, cdma2000 mode, DVB-T/H mode, DTMB (CTTB) mode, ISDB-T mode, CMMB mode, Digital Cable TV mode, LTE mode, LTE TDD mode, WLAN mode, 1xEVDO mode or WIMAX OFDMA mode to use this command. Use :INSTrument:SElect to set the mode.

Dependencies	For MSR mode, this key is blank. For LTE-Advanced FDD/TDD mode, this key is blank.
Couplings	Selecting full span changes the measurement span value.
Initial S/W Revision	Prior to A.02.00
Modified at S/W Revision	A.02.00, A.03.00

## Last Span

Changes the span to the previous span setting. If no previous span value exists, then the span remains unchanged.

Key Path	Span X Scale
Mode	SA, WCDMA, C2K, WIMAX OFDMA, 1xEVDO, DVB-T/H, DTMB (CTTB), ISDB-T, CMMB, LTE, LTETDD, Digital Cable TV, WLAN
<b>Remote Command</b>	[ :SENSe ] :CHPower :FREQuency :SPAN :PREvious
<b>Example</b>	CHP:FREQ:SPAN:PREV
Notes	You must be in the Spectrum Analysis mode, W-CDMA mode, cdma2000 mode, DVB-T/H mode, DTMB (CTTB) mode, ISDB-T mode, CMMB mode, Digital Cable TV mode, LTE mode, LTE TDD mode, WLAN mode, 1xEVDO mode or WIMAX OFDMA mode to use this command. Use :INSTrument:SElect to set the mode.
Dependencies	For MSR mode, this key is blank. For LTE-Advanced FDD/TDD mode, this key is blank.
Couplings	Selecting last span changes the measurement span value.
Initial S/W Revision	Prior to A.02.00
Modified at S/W Revision	A.02.00, A.03.00

## Sweep/Control

Accesses a menu of functions that enable you to set up and control the sweep time and source for the current measurement. See "[Sweep/Control](#)" on page 2235 for more information.

Key Path	Front-panel key
Initial S/W Revision	Prior to A.02.00

### Sweep Time

Selects the length of time that the spectrum analyzer sweeps the displayed frequency span. Additional overhead time, which impacts the sweep rate, is not calculated as part of the sweep time. In fact:

$$\text{sweep rate} = \text{span} / \text{sweep time}$$

$$\text{update rate} = 1 / (\text{sweep time} + \text{overhead})$$

$$\text{sweep cycle time} = \text{sweep time} + \text{overhead}$$

Sweep time is coupled to RBW and VBW, and is impacted by the number of sweep points, so changing those parameters may change the sweep time.

Key Path	Sweep/Control
Mode	SA, WCDMA, C2K, WIMAX OFDMA, 1xEVDO, DVB-T/H, DTMB (CTTB), ISDB-T, CMMB, LTE, LTETDD, Digital Cable TV, WLAN, MSR, LTEAFDD, LTEATDD
Remote Command	[:SENSe]:CHPower:SWEep:TIME <time> [:SENSe]:CHPower:SWEep:TIME? [:SENSe]:CHPower:SWEep:TIME:AUTO OFF ON 0 1 [:SENSe]:CHPower:SWEep:TIME:AUTO?
Example	CHP:SWE:TIME 25ms CHP:SWE:TIME? CHP:SWE:TIME:AUTO OFF CHP:SWE:TIME:AUTO?
Preset	SA, WIMAX OFDMA: Automatically Calculated WCDMA: 1.0 ms CDMA2K: 9.4ms 1xEVDO: 2.66ms DVB-T/H: Automatically Calculated DTMB (CTTB): Automatically Calculated ISDB-T: Automatically Calculated CMMB: Automatically Calculated LTE, MSR: Automatically Calculated LTETDD: Automatically Calculated Digital Cable TV: Automatically Calculated

	WLAN: Automatically Calculated LTEAFDD,LTEATDD:Automatically Calculated
State Saved	Saved in instrument state.
Min	1 ms
Max	4000 s
Initial S/W Revision	Prior to A.02.00
Modified at S/W Revision	A.02.00, A.03.00

## Sweep Setup

Accesses a menu that enables you to set the sweep state for the current measurement.

Key Path	Sweep/Control
Initial S/W Revision	Prior to A.02.00

## Auto Sweep Time Rules

Switches the analyzer between normal and accuracy sweep states.

Setting Auto Sweep Time to Accy results in slower sweep times, usually about three times as long, but yields better amplitude accuracy for CW signals. The instrument amplitude accuracy specifications only apply when Auto Sweep Time is set to Accy.

Additional amplitude errors which occur when Auto Sweep Time is set to Norm are usually well under 0.1 dB, though this is not guaranteed. Because of the faster sweep times and still low errors, Norm is the preferred setting of Auto Sweep Time. Auto Sweep Time is set to Norm on a Preset or Auto Couple. This means that in the Preset or Auto Coupled state, instrument amplitude accuracy specifications do not apply.

Key Path	Sweep/Control, Sweep Setup
Mode	SA, WCDMA, C2K, WIMAX OFDMA, 1xEVDO, DVB-T/H, DTMB (CTTB), ISDB-T, CMMB, LTE, LTEATDD, Digital Cable TV, WLAN, MSR, LTEAFDD, LTEATDD
Remote Command	[ :SENSe ] :CHPower:SWEep:TIME:AUTO:RULEs NORMal ACCuracy [ :SENSe ] :CHPower:SWEep:TIME:AUTO:RULEs?
Example	CHP:SWE:TIME:AUTO:RUL NORM CHP:SWE:TIME:AUTO:RUL?
Notes	In Zero Span, this key is irrelevant and inaccessible (because the whole Sweep Setup menu is grayed out in Zero Span), however its settings can be changed remotely with no error indication. Set to Norm when Auto Couple is pressed or sent remotely

Preset	NORMal
State Saved	Saved in instrument state.
Range	Norm Accy
Initial S/W Revision	Prior to A.02.00
Modified at S/W Revision	A.02.00, A.03.00

## Pause

Pauses a measurement after the current data acquisition is complete. When Paused, the label on the key changes to Resume. Pressing the Resume key resumes the measurement at the point it was at when paused. See ["Pause/Resume" on page 2235](#) for more details.

Key Path	Sweep/Control
Initial S/W Revision	Prior to A.02.00

## Gate

Accesses a menu that enables you to control the gating function. The Gate functionality is used to view signals best viewed by qualifying them with other events.

Gate setup parameters are the same for all measurements – they do not change as you change measurements. Settings like these are called “Meas Global” and are unaffected by Meas Preset.

Note that Sweep Time autocoupling rules and annotation are changed by Gate being on.

Key Path	Sweep/Control
Scope	Meas Global
Readback	The state and method of Gate, as [Off, LO] or [On, Video]. Note that for measurements that only support gated LO, the method is nonetheless read back, but always as LO.
Initial S/W Revision	Prior to A.02.00

## Gate On/Off

Turns the gate function on and off.

When the Gate Function is on, the selected Gate Method is used along with the gate settings and the signal at the gate source to control the sweep and video system with the gate signal. Not all measurements allow every type of Gate Methods.

When Gate is on, the annunciation in the measurement bar reflects that it is on and what method is used, as seen in the following "Gate: LO" annunciator graphic.

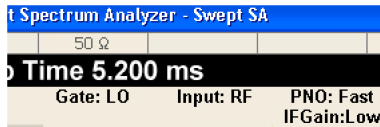

Key Path	Sweep/Control, Gate
Remote Command	[ :SENSe ] :SWEep:EGATe [ :STATe ] OFF ON 0 1 [ :SENSe ] :SWEep:EGATe [ :STATe ] ?
Example	SWE:EGAT ON SWE:EGAT?
Dependencies	<p>The function is unavailable (grayed out) and Off when:</p> <ul style="list-style-type: none"> <li>• Gate Method is LO or Video and FFT Sweep Type is manually selected.</li> <li>• Gate Method is FFT and Swept Sweep Type is manually selected.</li> <li>• Marker Count is ON.</li> </ul> <p>The following are unavailable whenever Gate is on:</p> <ul style="list-style-type: none"> <li>• FFT under Sweep Type when Method=LO or Video or Swept under Sweep Type when Method=FFT</li> <li>• Marker Count</li> </ul> <p>While Gate is on, the Auto Rules for Sweep Type are modified so that the choice agrees with the Gate Method: i.e., FFT for Method = FFT and Swept for Method = LO or Video.</p> <p>The Gate softkey and all SCPI under the [:SENSe]:SWEep:EGATe SCPI node are grayed out when Source Mode is Tracking with an external source. This is because the Gate circuitry is used to sync the external source. If the Tracking Source is turned on, the Gate is turned off.</p> <p>When in the ACP measurement:</p> <ul style="list-style-type: none"> <li>• When Meas Method is RBW or FAST, this function is unavailable and the key is grayed out.</li> <li>• Whenever Gate is on, Meas Method, RBW or FAST is unavailable and keys for those are grayed out.</li> <li>• When Gate is on, Offset Res BW and Offset Video BW are ignored (if you set these values) and the measurement works as if all Offset Res BW and all Offset Video BW are coupled with the Res BW and the Video BW under the BW menu. When Gate is on, the Offset BW key in the Offset/Limit menu is grayed out.</li> </ul>
Preset	Off LTETDD: On
State Saved	Saved in instrument state
Range	On Off
Backwards Compatibility SCPI	[ :SENSe ] :SWEep:TIME:GATE[:STATe] ESA compatibility
Backwards Compatibility Notes	In ESA, Trig Delay (On) and Gate (On) could not be active at the same time.. This dependency does not exist in PSA or in the X-Series.
Initial S/W Revision	Prior to A.02.00

## Gate View On/Off

Turning on Gate View in the Swept SA measurement provides a single-window gate view display..

Turning on Gate View in other measurements shows the split-screen Gate View. In these measurements, when the Gate View is on, the regular view of the current measurement traces and results are reduced vertically to about 70% of the regular height. The Zero Span window, showing the positions of the Gate, is shown between the Measurement Bar and the reduced measurement window. By reducing the height of the measurement window, some of the annotation on the Data Display may not fit and is not shown.

<b>Key Path</b>	Sweep/Control, Gate
<b>Remote Command</b>	[ :SENSe ] :SWEep:EGATe:VIEW ON OFF 1 0 [ :SENSe ] :SWEep:EGATe:VIEW?
<b>Example</b>	SWE:EGAT:VIEW ON turns on the gate view.
<b>Dependencies</b>	In the Swept SA measurement: In Gate View, the regular Sweep Time key is grayed out . When pressed, the grayed out key puts up the informational message "Use Gate View Sweep Time in the Gate menu." In the other measurements: When you turn Gate View on, the lower window takes on the current state of the instrument. Upon leaving Gate View, the instrument takes on the state of the lower window. When you turn Gate View on, the upper window Sweep Time is set to the gate view sweep time.
<b>Couplings</b>	These couplings apply to the Swept SA measurement: <ul style="list-style-type: none"> <li>• When Gate View is turned on, the instrument is set to Zero Span.</li> <li>• Gate View automatically turns off whenever a Span other than Zero is selected.</li> <li>• Gate View automatically turns off if you press the Last Span key while in Gate View, and the instrument returns to the Span it was in before entering Gate View (even if that is Zero Span).</li> <li>• When Gate View is turned on, the sweep time used is the gate view sweep time. This is set according to the rules in section "<a href="#">Gate View Setup</a>" on page 2043</li> <li>• When Gate View is turned off, Sweep Time is set to the normal Swept SA measurement sweep time.</li> <li>• If Gate View is on and Gate is off, then turning on Gate turns off Gate View.</li> </ul>
<b>Preset</b>	OFF
<b>State Saved</b>	Saved in instrument state
<b>Range</b>	On Off
<b>Initial S/W Revision</b>	Prior to A.02.00

A sample of the Gate View screen in the Swept SA measurement is shown in the following graphic :



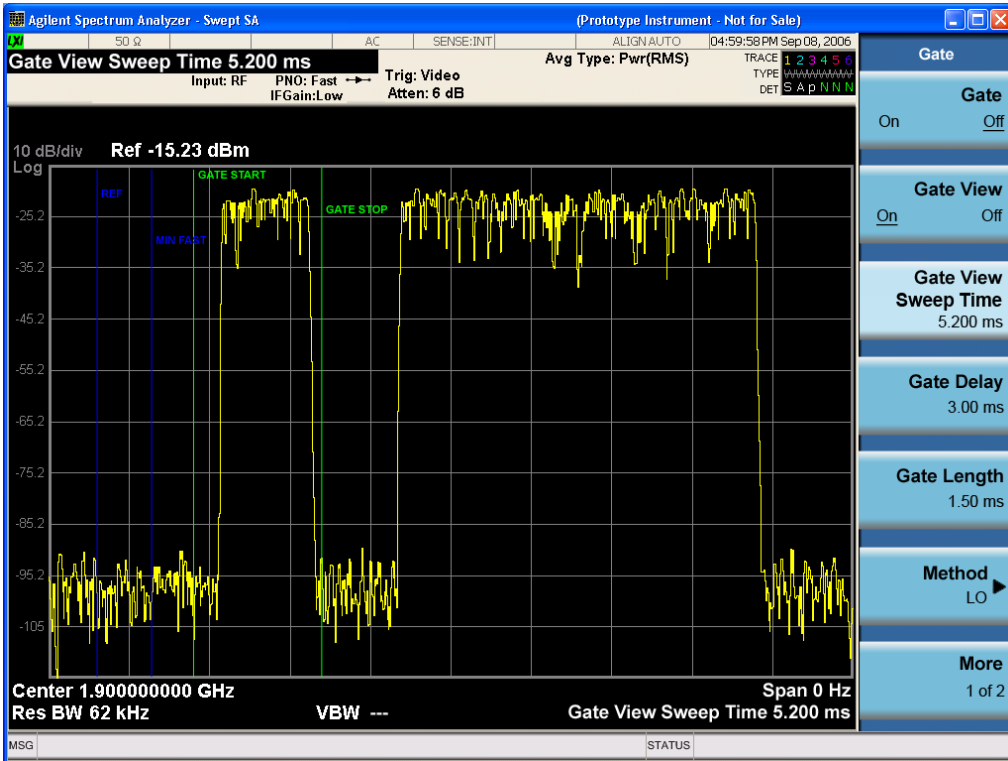

A sample of the Gate View screen in other measurements is shown in the following graphic. This example is for the ACP measurement:

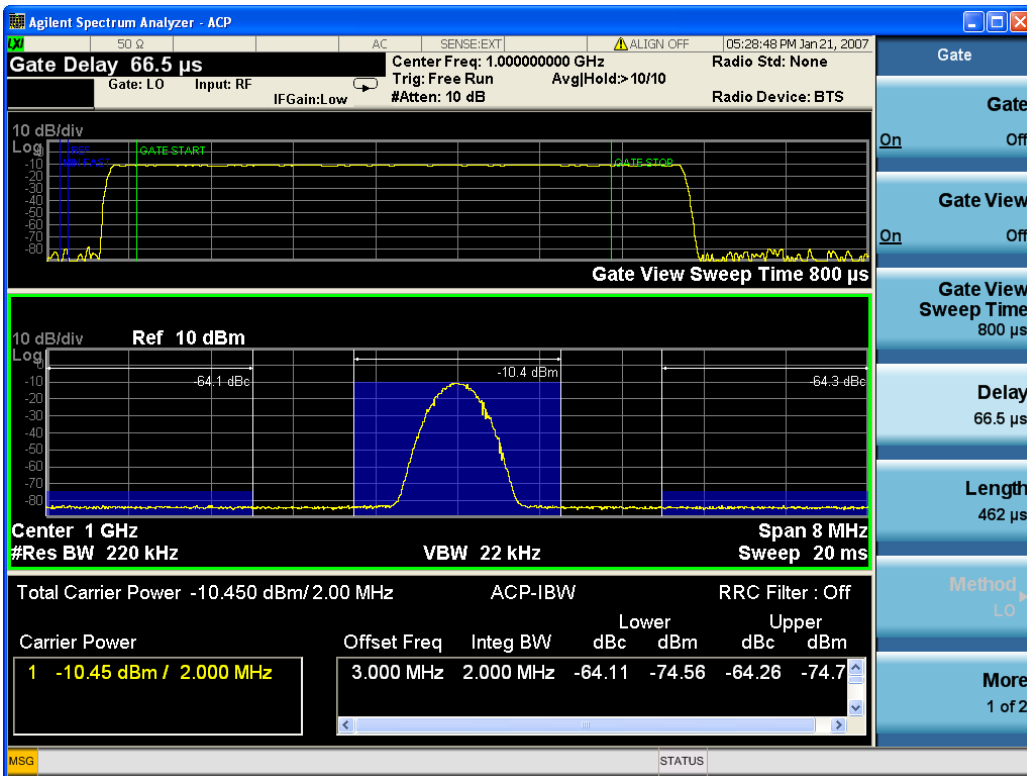

Turning Gate View off returns the analyzer to the Normal measurement view.

In the Swept SA, the normal measurement view is the single-window Swept SA view. When returning to this view, the Swept SA measurement returns to the Span it was in before entering **Gate View** (even if that is Zero Span).

The **Gate View** window is triggered from the Gate Source, with zero trigger delay. Also, when updating the **Gate View** window, the Gate itself must not operate. So it is internally shut off while the gate view window is being updated. For the Swept SA measurement, this means that the Gate is internally shut off whenever the gate view window is displayed. The measurement bar and softkeys continue to show the Trigger source for the main sweep window and give no indication that the Gate is shut off or that the Gate View window is triggered from the Gate Source.

When in **Gate View**, vertical lines are displayed in the Gate View window as follows:

- Green lines are displayed at the gate edges as follows: in Edge Gate, a line is shown for Delay and one for the end of the Gate period, defined by Length. In Level Gate a line is shown only for Delay. You can adjust the position of the green lines by adjusting the gate length and the gate delay. These lines update in the Gate View window as the active function changes, even if the window is not being updated. In Gated LO and Gated Video, these lines are positioned relative to the delay reference line (not relative to 0 time). In Gated FFT, their location is relative to the left edge of the screen.
- A blue line is displayed showing the delay reference, that is, the reference point for the Gate Delay within the Zero Span window. The blue line represents where (in time) the effective location of the gate start would be if the gate were programmed to zero delay.
- 
- The second blue line is labeled "MIN FAST" as shown in the figure above because it represents the minimum Gate Delay for fast Gated LO operation. This line is only displayed in Gated LO. You cannot scroll (knob) or decrement (down key) the Gate Delay to less than that represented by the position of this line, it can only be set below this position manually, although once there it can be moved freely with the knob while below the line.
- A yellow line in the Gated Video case only, is displayed at Blength, where Blength is the display point (bucket) length for the swept trace, which is given by the sweep time for that trace divided by number of Points – 1. So it is referenced to 0 time, not to the delay reference. This line is labeled NEXT PT (it is not shown in the figure above because the figure above is for Gated LO).
- The yellow line represents the edge of a display point (bucket). Normally in Gated Video, the bucket length must be selected so that it exceeds the off time of the burst. There is another way to use the analyzer in Gated Video measurements, and that is to set the bucket width much shorter than the off time of the burst. Then use the Max Hold trace function to fill in "missing" buckets more slowly. This allows you to see some of the patterns of the Gated Video results earlier, though seeing a completely filled-in spectrum later.

## Gate View Setup

Accesses a menu that enables you to setup parameters relevant to the Gate View

Key Path	Sweep/Control, Gate
Scope	Meas Global
Initial S/W Revision	A.10.00

## Gate View Sweep Time

Controls the sweep time in the Gate View window. To provide an optimal view of the gate signal, the analyzer initializes Gate View Sweep Time based on the current settings of Gate Delay and Gate Length.

<b>Key Path</b>	Sweep/Control, Gate, Gate View Setup
<b>Remote Command</b>	[ :SENSe ] :SWEep:EGATe:TIME <time> [ :SENSe ] :SWEep:EGATe:TIME?
<b>Example</b>	SWE:EGAT:TIME 500 ms
<b>Dependencies</b>	Gate View Sweep Time is initialized: <ul style="list-style-type: none"> <li>• On Preset (after initializing delay and length).</li> <li>• Every time the Gate Method is set/changed.</li> </ul> <p>Additionally, in the Swept SA measurement, whenever you do a Preset, or leave Gate View, the analyzer remembers the Gate Delay and Gate Length settings. Then, when returning to Gate View, if the current Gate Delay and/or Gate Length do not match the remembered values Gate View Sweep Time is re-initialized.</p> <ol style="list-style-type: none"> <li>1. Compute the location of the "gate stop" line, which you know is at time <math>t = t_{min} + \text{GateDelay} + \text{GateLength}</math>.</li> </ol>
<b>Preset</b>	519.3 $\mu$ s WiMAX OFDMA: 5 ms GSM/EDGE: 1 ms
<b>State Saved</b>	Saved in instrument state
<b>Max</b>	6000 s
<b>Initial S/W Revision</b>	Prior to A.02.00

## Gate View Start Time

Controls the time at the left edge of the Gate View.

<b>Key Path</b>	Sweep/Control, Gate, Gate View Setup
<b>Remote Command</b>	[ :SENSe ] :SWEep:EGATe:VIEW:STARt <time> [ :SENSe ] :SWEep:EGATe:VIEW:STARt?
<b>Example</b>	SWE:EGAT:VIEW:STAR 10ms
<b>Notes</b>	Units of time are required or no units; otherwise an invalid suffix error message will be generated. See error -131.
<b>Preset</b>	0 ms
<b>State Saved</b>	Saved in instrument state
<b>Min</b>	0
<b>Max</b>	500 ms
<b>Initial S/W Revision</b>	A.10.00

## Gate Delay

Controls the length of time from the time the gate condition goes True until the gate is turned on.

Key Path	Sweep/Control, Gate
Remote Command	[ :SENSe ] :SWEep:EGATe:DELay <time> [ :SENSe ] :SWEep:EGATe:DELay?
Example	SWE:EGAT:DELay 500ms SWE:EGAT:DELay?
Notes	Units of time are required or no units; otherwise an invalid suffix error message will be generated.
Preset	57.7 us WiMAX OFDMA: 71 us GSM/EDGE: 600 us WLAN: 500 us
State Saved	Saved in instrument state
Min	0.0 us
Max	100 s
Backwards Compatibility SCPI	[ :SENSe ] :SWEep:TIME:GATE:DELay ESA compatibility
Initial S/W Revision	Prior to A.02.00

## Gate Length

Controls the length of time that the gate is on after it opens.

Key Path	Sweep/Control, Gate
Remote Command	[ :SENSe ] :SWEep:EGATe:LENGth <time> [ :SENSe ] :SWEep:EGATe:LENGth?
Example	SWE:EGAT:LENG 1 SWE:EGAT:LENG?
Notes	Units of time are required or no units; otherwise an invalid suffix error message will be generated.
Dependencies	<p>Grayed out when Gate Method is set to FFT in which case the label changes to that shown below.</p>  <p>The key is also grayed out if Gate Control = Level.</p>
Preset	461.6 us

	WiMAX OFDMA: 50 us GSM/EDGE: 200 us WLAN: 1.54 ms
State Saved	Saved in instrument state
Min	100 ns
Max	5 s
<b>Backwards Compatibility SCPI</b>	[:SENSe]:SWEep:TIME:GATE:LENGth ESA compatibility
Initial S/W Revision	Prior to A.02.00

## Gate Source

The menus under the Gate Source key are the same as those under the Trigger key, with the exception that neither Free Run nor Video are available as Gate Source selections. However, a different SCPI command is used to select the Gate Source (see table below) because you may independently set the Gate Source and the Trigger Source.

Any changes to the settings in the setup menus under each Gate Source selection key (for example: Trigger Level, Trigger Delay, etc.) also affect the corresponding settings under the Trigger menu keys. The SCPI commands used for these are the same for Trigger and Gate, since there is only one setting which affects both Gate and Trigger. Example: to set the Trigger Level for External 1 you use the command :TRIG:EXT1:LEV regardless of whether you are using External 1 as a Trigger Source or a Gate Source.

Key Path	Sweep/Control, Gate
<b>Remote Command</b>	[:SENSe]:SWEep:EGATe:SOURce EXTernal1   EXTernal2   LINE   FRAME   RFBurst  [:SENSe]:SWEep:EGATe:SOURce?
Dependencies	In some models, there is no second External input. In these models, the External 2 key is blanked and the EXTernal2 parameter will generate a "Hardware missing; Not available for this model number" error.
Preset	EXTernal 1 GSM/EDGE, MSR: FRAME LTETDD: EXTernal 1 When Direction is Downlink, FRAME when Direction is Uplink.
Backwards Compatibility Notes	In ESA, there is a single Gate input port. In PSA, the Gate Source may be taken from one of two specified input ports. In the X-Series, any Trigger Source can be a Gate Source.
Initial S/W Revision	Prior to A.02.00
Modified at S/W Revision	A.03.00, A.14.00

## Line

Pressing this key, when it is not selected, selects the line signal as the trigger. A new sweep/measurement will start synchronized with the next cycle of the line voltage. Pressing this key, when it is already selected, access the line trigger setup menu.

Key Path	Trigger
<b>Example</b>	TRIG:SOUR LINE Swept SA measurement TRIG:< meas>:SOUR LINE Measurements other than Swept SA
Dependencies	Line trigger is not available when operating from a "dc power source", for example, when the instrument is powered from batteries.
State Saved	Saved in instrument state
Status Bits/OPC dependencies	The Status Operation Register bit 5 "Waiting for Trigger" is set at the same time as the Sweeping or Measuring bit is set. It is cleared when the trigger actually occurs (that is, after the trigger event occurs and all the applicable trigger criteria have been met). A corresponding pop-up message ("Waiting for trigger") is generated if no trigger signal appears after approximately 2 sec. This message goes away when a trigger signal appears.
Initial S/W Revision	Prior to A.02.00

## Trig Slope

Controls the trigger polarity. It is set positive to trigger on a rising edge and negative to trigger on a falling edge.

Key Path	Trigger, Line
<b>Remote Command</b>	:TRIGger[:SEquence]:LINE:SLOPe POSitive NEGative :TRIGger[:SEquence]:LINE:SLOPe?
<b>Example</b>	TRIG:LINE:SLOP NEG
Preset	POSitive
State Saved	Saved in instrument state
Backwards Compatibility Notes	The legacy :TRIGger[:SEquence]:SLOPe command affects the slopes for the VID, LINE, EXT1, EXT2, and RFB triggers.
Initial S/W Revision	Prior to A.02.00

## External 1

Pressing this key, when it is not selected, selects an external input signal as the trigger. A new sweep/measurement will start when the external trigger condition is met using the external 1 input connector on the rear panel.

Pressing this key, when it is already selected, accesses the external 1 trigger setup menu.

Key Path	Trigger
<b>Example</b>	TRIG:SOUR EXT1 Swept SA measurement TRIG:<meas>:SOUR EXT1 Measurements other than Swept SA
Dependencies	Grayed out if in use by Point Trigger in the Source Setup menu. Forced to Free Run if already selected and Point Trigger is set to External 1.
State Saved	Saved in instrument state
Status Bits/OPC dependencies	The Status Operation Register bit 5 "Waiting for Trigger" is set at the same time as the Sweeping or Measuring bit is set. It is cleared when the trigger actually occurs (that is, after the trigger event occurs and all the applicable trigger criteria have been met). A corresponding pop-up message ("Waiting for trigger") is generated if no trigger signal appears after approximately 2 sec. This message goes away when a trigger signal appears.
Initial S/W Revision	Prior to A.02.00

### Trigger Level

Sets the value where the external 1 trigger input will trigger a new sweep/measurement.

Key Path	Trigger, External 1
<b>Remote Command</b>	:TRIGger[:SEquence]:EXTernal1:LEVel <level> :TRIGger[:SEquence]:EXTernal1:LEVel?
<b>Example</b>	TRIG:EXT1:LEV 0.4 V
Couplings	This same level is used for the Ext1 trigger source in the Trigger menu, for the Ext1 selection in the Periodic Timer sync source (in the Trigger menu and in the Gate Source menu), and also for the Ext1 selection in the Gate Source menu.
Preset	1.2 V
State Saved	Saved in instrument state
Min	-5 V
Max	5 V
Default Unit	V
<b>Backwards Compatibility SCPI</b>	:TRIGger[:SEquence]:EXTernal:LEVel For backward compatibility, the parameter EXTernal is mapped to EXTernal1
<b>Backwards Compatibility SCPI</b>	:TRIGger[:SEquence]:FRAME:EXTernal1:LEVel
Initial S/W Revision	Prior to A.02.00

### Trig Slope

Controls the trigger polarity. It is set positive to trigger on a rising edge and negative to trigger on a falling edge.

Key Path	Trigger, External 1
Remote Command	:TRIGger[:SEquence]:EXTErnal1:SLOPe POSitive NEGative :TRIGger[:SEquence]:EXTErnal1:SLOPe?
Example	TRIG:EXT1:SLOP NEG
Couplings	This same slope is used in the Ext1 selection for the trigger source in the Trigger menu and for the period timer sync source (in the Trigger menu and in the Gate Source menu).
Preset	POSitive
State Saved	Saved in instrument state
Backwards Compatibility SCPI	:TRIGger[:SEquence]:EXTErnal:SLOPe For backward compatibility, the parameter EXTErnal is mapped to EXTErnal1
Backwards Compatibility SCPI	:TRIGger[:SEquence]:FRAMe:EXTErnal1:SLOPe
Backwards Compatibility Notes	The legacy :TRIGger[:SEquence]:SLOPe command affects the slopes for the VID, LINE, EXT1, EXT2, and RFB triggers.
Initial S/W Revision	Prior to A.02.00

## External 2

Pressing this key, when it is not selected, selects an external input signal as the trigger. A new sweep/measurement will start when the external trigger condition is met using the external 2 input connector. The external trigger 2 input connector is on the rear panel.

Pressing this key, when it is already selected, accesses the external 2 trigger setup menu.

Key Path	Trigger
Example	TRIG:SOUR EXT2 Swept SA measurement TRIG:<meas>:SOUR EXT2 Measurements other than Swept SA
Dependencies	In some models, there is no second External input. In these models, the External 2 key is blanked and the EXTErnal2 parameter will generate a "Hardware missing; Not available for this model number" message.  Grayed out if in use by Point Trigger in the Source Setup menu. Forced to Free Run if already selected and Point Trigger is set to External 2.
State Saved	Saved in instrument state
Status Bits/OPC dependencies	The Status Operation Register bit 5 "Waiting for Trigger" is set at the same time as the Sweeping or Measuring bit is set. It is cleared when the trigger actually occurs (that is, after the trigger event occurs and all the applicable trigger criteria have been met). A corresponding pop-up message ("Waiting for trigger") is generated if no trigger signal appears after approximately 2 sec. This message goes away when a trigger signal appears.
Initial S/W Revision	Prior to A.02.00
Modified at S/W Revision	A.03.00



## Trigger Level

Sets the value where the external 2 trigger input will trigger a new sweep/measurement.

Key Path	Trigger, External 2
<b>Remote Command</b>	:TRIGger[:SEquence]:EXTernal2:LEVel :TRIGger[:SEquence]:EXTernal2:LEVel?
<b>Example</b>	TRIG:EXT2:LEV 1.1 V
Couplings	This same level is used for the Ext2 trigger source in the Trigger menu, for the Ext2 selection in the Periodic Timer sync source (in the Trigger menu and in the Gate Source menu), and also for the Ext2 selection in the Gate Source menu.
Preset	1.2 V
State Saved	Saved in instrument state
Min	-5 V
Max	5 V
Default Unit	V
<b>Backwards Compatibility SCPI</b>	:TRIGger[:SEquence]:FRAMe:EXTernal2:LEVel
Initial S/W Revision	Prior to A.02.00

## Trig Slope

Controls the trigger polarity. It is set positive to trigger on a rising edge and negative to trigger on a falling edge.

Key Path	Trigger, External 2
<b>Remote Command</b>	:TRIGger[:SEquence]:EXTernal2:SLOPe POSitive NEGative :TRIGger[:SEquence]:EXTernal2:SLOPe?
<b>Example</b>	TRIG:EXT2:SLOP NEG
Couplings	This same slope is used in the Ext2 selection for the trigger source in the Trigger menu and for the period timer sync source (in the Trigger menu and in the Gate Source menu).
Preset	POSitive
State Saved	Saved in instrument state
<b>Backwards Compatibility SCPI</b>	:TRIGger[:SEquence]:FRAMe:EXTernal2:SLOPe
Backwards Compatibility Notes	The legacy :TRIGger[:SEquence]:SLOPe command affects the slopes for the VID, LINE, EXT1, EXT2, and RFB triggers.
Initial S/W Revision	Prior to A.02.00

## RF Burst

Pressing this key, when it is not selected, selects the RF Burst as the trigger. A new sweep/measurement will start when an RF burst envelope signal is identified from the signal at the RF Input connector. Pressing this key, when it is already selected, accesses the RF Burst trigger setup menu.

In some models, a variety of burst trigger circuitry is available, resulting in various available burst trigger bandwidths. The analyzer automatically chooses the appropriate trigger path based on the hardware configuration and other settings of the analyzer.

Key Path	Trigger
<b>Example</b>	TRIG:SOUR RFB Swept SA measurement TRIG:< meas>:SOUR RFB Measurements other than Swept SA
State Saved	Saved in instrument state
Status Bits/OPC dependencies	The Status Operation Register bit 5 "Waiting for Trigger" is set at the same time as the Sweeping or Measuring bit is set. It is cleared when the trigger actually occurs (that is, after the trigger event occurs and all the applicable trigger criteria have been met). A corresponding pop-up message ("Waiting for trigger") is generated if no trigger signal appears after approximately 2 sec. This message goes away when a trigger signal appears.
Backwards Compatibility Notes	The legacy command: :TRIGger[:SEQuence]:RFBurst:FSElectivity[:STATe] OFF ON 0 1 is not supported in the X-Series, as the hardware to do Frequency Selective burst triggers does not exist in X-Series.
Initial S/W Revision	Prior to A.02.00
Modified at S/W Revision	A.04.00

## Absolute Trigger Level

Sets the absolute trigger level for the RF burst envelope.

When using the External Mixing path, the Absolute Trigger Level is uncalibrated because the factory default was set to accommodate the expected IF levels for the RF path.

Key Path	Trigger, RF Burst
Scope	Meas Global
<b>Remote Command</b>	:TRIGger[:SEQuence]:RFBurst:LEVel:ABSolute <ampl> :TRIGger[:SEQuence]:RFBurst:LEVel:ABSolute?
<b>Example</b>	TRIG:RFB:LEV:ABS 10 dBm sets the trigger level of the RF burst envelope signal to the absolute level of 10 dBm
Notes	Sending this command does not switch the setting from relative to absolute; to switch it you need to send the :TRIGger[:SEQuence]:RFBurst:LEVel:TYPE command, below. Amplitude Corrections are not taken into account by the Absolute Trigger Level. For example, if you have given yourself effective gain with an amplitude correction factor, the Absolute Trigger will not fire until you have set the trigger level that far below the displayed signal level, rather than simply to

	the displayed signal level. This is only true for Amplitude Corrections, not External Gain or Ref Level Offset functions. If mode is Bluetooth, the default value is -50 dBm.
Couplings	This same level is used for the RF Burst trigger source in the Trigger menu, for the RF Burst selection in the Periodic Timer sync source (in the Trigger menu and in the Gate Source menu), and also for the RF Burst selection in the Gate Source menu
Preset	-20 dBm
State Saved	Saved in instrument state
Min	-200 dBm
Max	100 dBm
Default Unit	depends on the current selected Y-Axis unit
<b>Backwards Compatibility SCPI</b>	:TRIGger[:SEquence]:FRAMe:RFBurst:LEVel:ABSolute
Initial S/W Revision	Prior to A.02.00
Modified at S/W Revision	A.04.00

Key Path	Trigger, RF Burst
<b>Remote Command</b>	:TRIGger[:SEquence]:RFBurst:LEVel:TYPE ABSolute RELative :TRIGger[:SEquence]:RFBurst:LEVel:TYPE?
<b>Example</b>	TRIG:RFB:LEV:TYPE REL sets the trigger level type of the RF burst trigger to Relative.
Preset	ABSolute
State Saved	Saved in instrument state
Initial S/W Revision	Prior to A.02.00
Modified at S/W Revision	A.04.00

### Relative Trigger Level

Sets the relative trigger level for the RF burst envelope.

In some models, the relative burst trigger function is implemented in hardware. In other models, without the advanced triggering hardware required, the relative burst trigger function is implemented in software in some measurements, and is unavailable in other measurements.

When implemented in software, the relative RF Burst trigger function is implemented as follows:

1. The measurement starts with the absolute RF Burst trigger setting. If it cannot get a trigger with that level, auto trigger fires and the acquisition starts anyway. After the acquisition, the measurement searches for the peak in the acquired waveform and saves it.

2. Now, in the next cycle of the measurement, the measurement determines a new absolute RF Burst level based on the peak value from the first measurement and the Relative RF Burst Trigger Level (always 0 or negative dB) set by the user. The following formula is used:
  3. absolute RF Burst level = peak level of the previous acquisition + relative RF Burst level
  4. If the new absolute RF Burst level differs from the previous by more than 0.5 dB, the new level is sent to the hardware; otherwise it is not updated (to avoid slowing down the acquisition)
- Steps 2 and 3 repeat for subsequent measurements.

Key Path	Trigger, RF Burst
Scope	Meas Global
<b>Remote Command</b>	:TRIGger[:SEquence]:RFBurst:LEVel:RELative <rel_ampl> :TRIGger[:SEquence]:RFBurst:LEVel:RELative?
<b>Example</b>	TRIG:RFB:LEV:REL -10 dB sets the trigger level of the RF burst envelope signal to the relative level of -10 dB
Notes	Sending this command does not switch the setting from absolute to relative; to switch it you need to send the :TRIGger[:SEquence]:RFBurst:LEVel:TYPE command, above. The relative trigger level is not available in some measurements. In those measurements the RELative parameter, and the :TRIGger[:SEquence]:RFBurst:LEVel:TYPE command (above), will generate an error if sent.
Dependencies	This key is grayed out and Absolute Trigger Level selected if the required hardware is not present in your analyzer and the current measurement does not support Relative triggering.
Preset	-6 dB GSM: -25 dB
State Saved	Saved in instrument state
Min	-45 dB
Max	0 dB
Default Unit	dB or dBc
<b>Backwards Compatibility SCPI</b>	:TRIGger[:SEquence]:RFBurst:LEVel This legacy command is aliased to :TRIGger[:SEquence]:RFBurst:LEVel:RELative because the PSA had ONLY relative burst triggering
Initial S/W Revision	Prior to A.02.00
Modified at S/W Revision	A.04.00

### Trigger Slope

It is set positive to trigger on a rising edge and negative to trigger on a falling edge.

Key Path	Trigger, RF Burst
<b>Remote Command</b>	:TRIGger[:SEquence]:RFBurst:SLOPe POSitive NEGative :TRIGger[:SEquence]:RFBurst:SLOPe?

<b>Example</b>	TRIG:RFB:SLOP NEG
Couplings	This same slope is used in the RF Burst selection for the trigger source in the Trigger menu and for the period timer sync source (in the Trigger menu and in the Gate Source menu).
Preset	POSitive
State Saved	Saved in instrument state
<b>Backwards Compatibility SCPI</b>	:TRIGger[:SEQuence]:FRAMe:RFBurst:SLOPe
Backwards Compatibility Notes	The legacy :TRIGger[:SEQuence]:SLOPe command affects the slopes for the VID, LINE, EXT1, EXT2, and RFB triggers.
Initial S/W Revision	Prior to A.02.00

### Periodic Timer (Frame Trigger)

Pressing this key, when it is not selected, selects the internal periodic timer signal as the trigger. Triggering occurrences are set by the **Period** parameter, which is modified by the **Sync Source** and **Offset**. Pressing this key, when it is already selected, accesses the periodic timer trigger setup functions.

If you do not have a sync source selected (it is Off), then the internal timer will not be synchronized with any external timing events.

Key Path	Trigger
<b>Example</b>	TRIG:SOUR FRAM      Swept SA measurement TRIG:<meas>:SOUR FRAM      Measurements other than Swept SA
State Saved	Saved in instrument state
Readback	[Sync: <value of Sync Source>], for example, [Sync: External 1]
Status Bits/OPC dependencies	The Status Operation Register bit 5 "Waiting for Trigger" is set at the same time as the Sweeping or Measuring bit is set. It is cleared when the trigger actually occurs (that is, after the trigger event occurs and all the applicable trigger criteria have been met). A corresponding pop-up message ("Waiting for trigger") is generated if no trigger signal appears after approximately 2 sec. This message goes away when a trigger signal appears.
Initial S/W Revision	Prior to A.02.00

### Periodic Timer Triggering:

This feature selects the internal periodic timer signal as the trigger. Trigger occurrences are set by the **Periodic Timer** parameter, which is modified by the **Sync Source** and **Offset**.

The figure below shows the action of the periodic timer trigger. Before reviewing the figure, we'll explain some uses for the periodic trigger.

A common application is measuring periodic burst RF signals for which a trigger signal is not easily available. For example, we might be measuring a TDMA radio which bursts every 20 ms. Let's assume that the 20 ms period is very consistent. Let's also assume that we do not have an external trigger source

available that is synchronized with the period, and that the signal-to-noise ratio of the signal is not high enough to provide a clean RF burst trigger at all of the analysis frequencies. For example, we might want to measure spurious transmissions at an offset from the carrier that is larger than the bandwidth of the RF burst trigger. In this application, we can set the Periodic Timer to a 20.00 ms period and adjust the offset from that timer to position our trigger just where we want it. If we find that the 20.00 ms is not exactly right, we can adjust the period slightly to minimize the drift between the period timer and the signal to be measured.

A second way to use this feature would be to use **Sync Source** temporarily, instead of **Offset**. In this case, we might tune to the signal in a narrow span and use the RF Burst trigger to synchronize the periodic timer. Then we would turn the sync source off so that it would not miss-trigger. Miss-triggering can occur when we are tuned so far away from the RF burst trigger that it is no longer reliable.

A third example would be to synchronize to a signal that has a reference time element of much longer period than the period of interest. In some CDMA applications, it is useful to look at signals with a short periodicity, by synchronizing that periodicity to the "even-second clock" edge that happens every two seconds. Thus, we could connect the even-second clock trigger to Ext1 and use then Ext1 as the sync source for the periodic timer.

The figure below illustrates this third example. The top trace represents the even-second clock. It causes the periodic timer to synchronize with the leading edge shown. The analyzer trigger occurs at a time delayed by the accumulated offset from the period trigger event. The periodic timer continues to run, and triggers continue to occur, with a periodicity determined by the analyzer time base. The timer output (labeled "late event") will drift away from its ideal time due to imperfect matching between the time base of the signal being measured and the time base of the analyzer, and also because of imperfect setting of the period parameter. But the synchronization is restored on the next even-second clock event. ("Accumulated offset" is described in the in the **Offset** function section.)

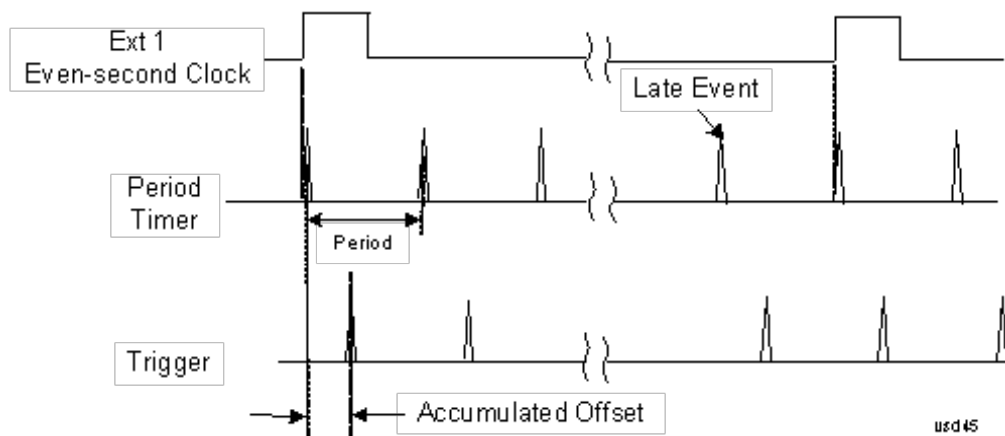

### Period

Sets the period of the internal periodic timer clock. For digital communications signals, this is usually set to the frame period of your current input signal. In the case that sync source is not set to OFF, and the external sync source rate is changed for some reason, the periodic timer is synchronized at the every external synchronization pulse by resetting the internal state of the timer circuit.

<b>Key Path</b>	Trigger, Periodic Timer
<b>Remote Command</b>	:TRIGger[:SEquence]:FRAME:PERiod <time>

	:TRIGger[:SEquence]:FRAMe:PERiod?
<b>Example</b>	TRIG:FRAM:PER 100 ms
Dependencies	The invalid data indicator turns on when the period is changed, until the next sweep/measurement completes.
Couplings	The same period is used in the Gate Source selection of the period timer.
Preset	20 ms GSM: 4.615383
State Saved	Saved in instrument state
Min	100.000 ns
Max	559.0000 ms
Default Unit	S
Initial S/W Revision	Prior to A.02.00

### Offset

Adjusts the accumulated offset between the periodic timer events and the trigger event. Adjusting the accumulated offset is different than setting an offset, and requires explanation.

The periodic timer is usually not synchronized with any external events, so the timing of its output events has no absolute meaning. Since the timing relative to external events (RF signals) is important, you need to be able to adjust (offset) it. However, you have no direct way to see when the periodic timer events occur. All that you can see is the trigger timing. When you want to adjust the trigger timing, you will be changing the internal offset between the periodic timer events and the trigger event. Because the absolute value of that internal offset is unknown, we will just call that the accumulated offset. Whenever the Offset parameter is changed, you are changing that accumulated offset. You can reset the displayed offset using Reset Offset Display. Changing the display does not change the value of the accumulated offset, and you can still make additional changes to accumulated offset.

To avoid ambiguity, we define that an increase in the "offset" parameter, either from the knob or the SCPI adjust command, serves to delay the timing of the trigger event.

Key Path	Trigger, Periodic Timer
<b>Remote Command</b>	:TRIGger[:SEquence]:FRAMe:OFFSet <time> :TRIGger[:SEquence]:FRAMe:OFFSet?
<b>Example</b>	TRIG:FRAM:OFFS 1.2 ms
Notes	The front panel interface (for example, the knob), and this command, adjust the accumulated offset, which is shown on the active function display. However, the actual amount sent to the hardware each time the offset is updated is the delta value, that is, the current accumulated offset value minus the previous accumulated offset value. Note that the accumulated offset value is essentially arbitrary; it represents the accumulated offset from the last time the offset was zeroed (with the Reset Offset Display key).  Note that this command does not change the period of the trigger waveform. Note also that Offset is used only when the sync source is set to OFF, otherwise delay is used, see section " <a href="#">Trig Delay</a> " on <a href="#">page 443</a> .

	An increase in the "offset" parameter, either from the knob or the SCPI adjust command, serves to delay the timing of the trigger event.
Notes	When the SCPI command is sent the value shown on the key (and the Active Function, if this happens to be the active function) is updated with the new value. However, the actual amount sent to the hardware is the delta value, that is, the current accumulated offset value minus the previous accumulated offset value.  The SCPI query simply returns the value currently showing on the key.
Dependencies	The invalid data indicator turns on when the offset is changed, until the next sweep/measurement completes.
Couplings	The same offset is used in the Gate Source selection of the period timer.
Preset	0 s
State Saved	Saved in instrument state
Min	-10.000 s
Max	10.000 s
Default Unit	S
Initial S/W Revision	Prior to A.02.00

#### Offset Adjust (Remote Command Only)

This remote command does not work at all like the related front panel keys. This command lets you advance the phase of the frame trigger by the amount you specify.

It does not change the period of the trigger waveform. If the command is sent multiple times, it advances the phase of the frame trigger an additional amount each time it is sent. Negative numbers are permitted.

<b>Remote Command</b>	:TRIGger[:SEquence]:FRAMe:ADJust <time>
<b>Example</b>	TRIG:FRAM:ADJ 1.2 ms
Notes	Note also that Offset is used only when the sync source is set to OFF, otherwise delay is used, see section <a href="#">"Trig Delay" on page 443</a>  An increase in the "offset" parameter, either from the knob or the SCPI adjust command, serves to delay the timing of the trigger event.
Notes	The front panel interface (for example, the knob) and the :TRIG:FRAM:OFFS command adjust the accumulated offset, which is shown on the active function display. However, the actual amount sent to the hardware is the delta value, that is, the current offset value minus the previous offset value.  When the SCPI command is sent the value shown on the key (and the Active Function, if this happens to be the active function) is updated by increasing it (or decreasing it if the value sent is negative) by the amount specified in the SCPI command.  This is a "command only" SCPI command, with no query.
Dependencies	The invalid data indicator turns on when the offset is changed, until the next sweep/measurement completes.
Couplings	The same offset is used in the Gate Source selection of the period timer.
Preset	0 s



State Saved	Saved in instrument state
Min	-10.000 s
Max	10.000 s
Default Unit	S
Initial S/W Revision	Prior to A.02.00

### Reset Offset Display

Resets the value of the periodic trigger offset display setting to 0.0 seconds. The current displayed trigger location may include an offset value defined with the Offset key. Pressing this key redefines the currently displayed trigger location as the new trigger point that is 0.0 s offset. The Offset key can then be used to add offset relative to this new timing.

Key Path	Trigger, Periodic Timer
<b>Remote Command</b>	:TRIGger[:SEquence]:FRAMe:OFFSet:DISPlay:RESet
<b>Example</b>	TRIG:FRAM:OFFS:DISP:RES
Initial S/W Revision	Prior to A.02.00

### Sync Source

Selects a signal source for you to synchronize your periodic timer trigger to, otherwise you are triggering at some arbitrary location in the frame. Synchronization reduces the precision requirements on the setting of the period.

For convenience you may adjust the level and slope of the selected sync source in a conditional branch setup menu accessed from the Sync Source menu. Note that these settings match those in the **Trigger** and **Gate Source** menus; that is, each trigger source has only one value of level and slope, regardless of which menu it is accessed from.

Key Path	Trigger, Periodic Timer
<b>Remote Command</b>	:TRIGger[:SEquence]:FRAMe:SYNC EXTernal1   EXTernal2   RFBurst   OFF :TRIGger[:SEquence]:FRAMe:SYNC?
<b>Example</b>	TRIG:FRAM:SYNC EXT2
Dependencies	In some models, there is no second External input. In these models, the External 2 key is blanked and the EXTernal2 parameter will generate a "Hardware missing; Not available for this model number" message.
Preset	Off GSM/EDGE, MSR,LTE,LTETDD: RFBurst
State Saved	Saved in instrument state
Readback	The current setting is read back to this key and it is also Readback to the previous Periodic Timer trigger key.

<b>Backwards Compatibility SCPI</b>	:TRIGger[:SEQuence]:FRAMe:SYNC EXTernal
Initial S/W Revision	Prior to A.02.00
Modified at S/W Revision	A.03.00, A.14.00

### Off

Turns off the sync source for your periodic trigger. With the sync source off, the timing will drift unless the signal source frequency is locked to the analyzer frequency reference.

<b>Key Path</b>	Trigger, Periodic Timer, Sync Source
<b>Example</b>	TRIG:FRAM:SYNC OFF
Readback	Off
Initial S/W Revision	Prior to A.02.00

### External 1

Pressing this key, when it is not selected, selects an external input signal as the trigger. A new sweep/measurement will start when the external trigger condition is met using the external 1 input connector on the rear panel.

Pressing this key, when it is already selected, accesses the external 1 trigger setup menu.

<b>Key Path</b>	Trigger
<b>Example</b>	TRIG:SOUR EXT1 Swept SA measurement TRIG:<meas>:SOUR EXT1 Measurements other than Swept SA
<b>Dependencies</b>	Grayed out if in use by Point Trigger in the Source Setup menu. Forced to Free Run if already selected and Point Trigger is set to External 1.
<b>State Saved</b>	Saved in instrument state
<b>Status Bits/OPC dependencies</b>	The Status Operation Register bit 5 "Waiting for Trigger" is set at the same time as the Sweeping or Measuring bit is set. It is cleared when the trigger actually occurs (that is, after the trigger event occurs and all the applicable trigger criteria have been met). A corresponding pop-up message ("Waiting for trigger") is generated if no trigger signal appears after approximately 2 sec. This message goes away when a trigger signal appears.
Initial S/W Revision	Prior to A.02.00

### Trigger Level

Sets the value where the external 1 trigger input will trigger a new sweep/measurement.

Key Path	Trigger, External 1
<b>Remote Command</b>	:TRIGger[:SEquence]:EXTernal1:LEVel <level> :TRIGger[:SEquence]:EXTernal1:LEVel?
<b>Example</b>	TRIG:EXT1:LEV 0.4 V
Couplings	This same level is used for the Ext1 trigger source in the Trigger menu, for the Ext1 selection in the Periodic Timer sync source (in the Trigger menu and in the Gate Source menu), and also for the Ext1 selection in the Gate Source menu.
Preset	1.2 V
State Saved	Saved in instrument state
Min	-5 V
Max	5 V
Default Unit	V
<b>Backwards Compatibility SCPI</b>	:TRIGger[:SEquence]:EXTernal:LEVel For backward compatibility, the parameter EXTernal is mapped to EXTernal1
<b>Backwards Compatibility SCPI</b>	:TRIGger[:SEquence]:FRAMe:EXTernal1:LEVel
Initial S/W Revision	Prior to A.02.00

### Trig Slope

Controls the trigger polarity. It is set positive to trigger on a rising edge and negative to trigger on a falling edge.

Key Path	Trigger, External 1
<b>Remote Command</b>	:TRIGger[:SEquence]:EXTernal1:SLOPe POSitive NEGative :TRIGger[:SEquence]:EXTernal1:SLOPe?
<b>Example</b>	TRIG:EXT1:SLOP NEG
Couplings	This same slope is used in the Ext1 selection for the trigger source in the Trigger menu and for the period timer sync source (in the Trigger menu and in the Gate Source menu).
Preset	POSitive
State Saved	Saved in instrument state
<b>Backwards Compatibility SCPI</b>	:TRIGger[:SEquence]:EXTernal:SLOPe For backward compatibility, the parameter EXTernal is mapped to EXTernal1
<b>Backwards Compatibility SCPI</b>	:TRIGger[:SEquence]:FRAMe:EXTernal1:SLOPe
Backwards Compatibility Notes	The legacy :TRIGger[:SEquence]:SLOPe command affects the slopes for the VID, LINE, EXT1, EXT2, and RFB triggers.
Initial S/W Revision	Prior to A.02.00

## External 2

Pressing this key, when it is not selected, selects an external input signal as the trigger. A new sweep/measurement will start when the external trigger condition is met using the external 2 input connector. The external trigger 2 input connector is on the rear panel.

Pressing this key, when it is already selected, accesses the external 2 trigger setup menu.

Key Path	Trigger
<b>Example</b>	TRIG:SOUR EXT2 Swept SA measurement TRIG:<meas>:SOUR EXT2 Measurements other than Swept SA
Dependencies	In some models, there is no second External input. In these models, the External 2 key is blanked and the EXTERNAL2 parameter will generate a "Hardware missing; Not available for this model number" message. Grayed out if in use by Point Trigger in the Source Setup menu. Forced to Free Run if already selected and Point Trigger is set to External 2.
State Saved	Saved in instrument state
Status Bits/OPC dependencies	The Status Operation Register bit 5 "Waiting for Trigger" is set at the same time as the Sweeping or Measuring bit is set. It is cleared when the trigger actually occurs (that is, after the trigger event occurs and all the applicable trigger criteria have been met). A corresponding pop-up message ("Waiting for trigger") is generated if no trigger signal appears after approximately 2 sec. This message goes away when a trigger signal appears.
Initial S/W Revision	Prior to A.02.00
Modified at S/W Revision	A.03.00

## Trigger Level

Sets the value where the external 2 trigger input will trigger a new sweep/measurement.

Key Path	Trigger, External 2
<b>Remote Command</b>	:TRIGger[:SEquence]:EXTernal2:LEVel :TRIGger[:SEquence]:EXTernal2:LEVel?
<b>Example</b>	TRIG:EXT2:LEV 1.1 V
Couplings	This same level is used for the Ext2 trigger source in the Trigger menu, for the Ext2 selection in the Periodic Timer sync source (in the Trigger menu and in the Gate Source menu), and also for the Ext2 selection in the Gate Source menu.
Preset	1.2 V
State Saved	Saved in instrument state
Min	-5 V
Max	5 V
Default Unit	V
<b>Backwards Compatibility SCPI</b>	:TRIGger[:SEquence]:FRAME:EXTernal2:LEVel
Initial S/W Revision	Prior to A.02.00

## Trig Slope

Controls the trigger polarity. It is set positive to trigger on a rising edge and negative to trigger on a falling edge.

Key Path	Trigger, External 2
<b>Remote Command</b>	:TRIGger[:SEquence]:EXTernal2:SLOPe POSitive NEGative :TRIGger[:SEquence]:EXTernal2:SLOPe?
<b>Example</b>	TRIG:EXT2:SLOP NEG
Couplings	This same slope is used in the Ext2 selection for the trigger source in the Trigger menu and for the period timer sync source (in the Trigger menu and in the Gate Source menu).
Preset	POSitive
State Saved	Saved in instrument state
<b>Backwards Compatibility SCPI</b>	:TRIGger[:SEquence]:FRAMe:EXTernal2:SLOPe
Backwards Compatibility Notes	The legacy :TRIGger[:SEquence]:SLOPe command affects the slopes for the VID, LINE, EXT1, EXT2, and RFB triggers.
Initial S/W Revision	Prior to A.02.00

## RF Burst

Pressing this key, when it is not selected, selects the RF Burst as the trigger. A new sweep/measurement will start when an RF burst envelope signal is identified from the signal at the RF Input connector. Pressing this key, when it is already selected, accesses the RF Burst trigger setup menu.

In some models, a variety of burst trigger circuitry is available, resulting in various available burst trigger bandwidths. The analyzer automatically chooses the appropriate trigger path based on the hardware configuration and other settings of the analyzer.

Key Path	Trigger
<b>Example</b>	TRIG:SOUR RFB      Swept SA measurement TRIG:<meas>:SOUR RFB    Measurements other than Swept SA
State Saved	Saved in instrument state
Status Bits/OPC dependencies	The Status Operation Register bit 5 "Waiting for Trigger" is set at the same time as the Sweeping or Measuring bit is set. It is cleared when the trigger actually occurs (that is, after the trigger event occurs and all the applicable trigger criteria have been met). A corresponding pop-up message ("Waiting for trigger") is generated if no trigger signal appears after approximately 2 sec. This message goes away when a trigger signal appears.
Backwards Compatibility Notes	The legacy command: :TRIGger[:SEquence]:RFBurst:FSElectivity[:STATe] OFF ON 0 1 is not supported in the X-Series, as the hardware to do Frequency Selective burst triggers does not exist in X-Series.

Initial S/W Revision	Prior to A.02.00
Modified at S/W Revision	A.04.00

### Absolute Trigger Level

Sets the absolute trigger level for the RF burst envelope.

When using the External Mixing path, the Absolute Trigger Level is uncalibrated because the factory default was set to accommodate the expected IF levels for the RF path.

Key Path	Trigger, RF Burst
Scope	Meas Global
<b>Remote Command</b>	:TRIGger[:SEquence]:RFBurst:LEVel:ABSolute <ampl> :TRIGger[:SEquence]:RFBurst:LEVel:ABSolute?
<b>Example</b>	TRIG:RFB:LEV:ABS 10 dBm sets the trigger level of the RF burst envelope signal to the absolute level of 10 dBm
Notes	Sending this command does not switch the setting from relative to absolute; to switch it you need to send the :TRIGger[:SEquence]:RFBurst:LEVel:TYPE command, below.  Amplitude Corrections are not taken into account by the Absolute Trigger Level. For example, if you have given yourself effective gain with an amplitude correction factor, the Absolute Trigger will not fire until you have set the trigger level that far below the displayed signal level, rather than simply to the displayed signal level. This is only true for Amplitude Corrections, not External Gain or Ref Level Offset functions.  If mode is Bluetooth, the default value is -50 dBm.
Couplings	This same level is used for the RF Burst trigger source in the Trigger menu, for the RF Burst selection in the Periodic Timer sync source (in the Trigger menu and in the Gate Source menu), and also for the RF Burst selection in the Gate Source menu
Preset	-20 dBm
State Saved	Saved in instrument state
Min	-200 dBm
Max	100 dBm
Default Unit	depends on the current selected Y-Axis unit
<b>Backwards Compatibility SCPI</b>	:TRIGger[:SEquence]:FRAME:RFBurst:LEVel:ABSolute
Initial S/W Revision	Prior to A.02.00
Modified at S/W Revision	A.04.00

Key Path	Trigger, RF Burst
<b>Remote Command</b>	:TRIGger[:SEquence]:RFBurst:LEVel:TYPE ABSolute RELative :TRIGger[:SEquence]:RFBurst:LEVel:TYPE?

<b>Example</b>	TRIG:RFB:LEV:TYPE REL sets the trigger level type of the RF burst trigger to Relative.
Preset	ABSolute
State Saved	Saved in instrument state
Initial S/W Revision	Prior to A.02.00
Modified at S/W Revision	A.04.00

### Trigger Slope

It is set positive to trigger on a rising edge and negative to trigger on a falling edge.

Key Path	Trigger, RF Burst
<b>Remote Command</b>	:TRIGger[:SEQuence]:RFBurst:SLOPe POSitive NEGative :TRIGger[:SEQuence]:RFBurst:SLOPe?
<b>Example</b>	TRIG:RFB:SLOP NEG
Couplings	This same slope is used in the RF Burst selection for the trigger source in the Trigger menu and for the period timer sync source (in the Trigger menu and in the Gate Source menu).
Preset	POSitive
State Saved	Saved in instrument state
<b>Backwards Compatibility SCPI</b>	:TRIGger[:SEQuence]:FRAME:RFBurst:SLOPe
Backwards Compatibility Notes	The legacy :TRIGger[:SEQuence]:SLOPe command affects the slopes for the VID, LINE, EXT1, EXT2, and RFB triggers.
Initial S/W Revision	Prior to A.02.00

### Sync Holdoff

Sync Holdoff specifies the duration that the sync source signal must be kept false before the transition to true to be recognized as the sync timing. The periodic timer phase is aligned when the sync source signal becomes true, after the Holdoff time is satisfied.

A holdoff of 2 ms will work with most WiMAX signals, but there may be cases where the burst off duration is less than 1 ms and this value will need to be changed.

Key Path	Trigger, Periodic Timer
<b>Remote Command</b>	:TRIGger[:SEQuence]:FRAME:SYNC:HOLDoff <time> :TRIGger[:SEQuence]:FRAME:SYNC:HOLDoff? :TRIGger[:SEQuence]:FRAME:SYNC:HOLDoff:STATe OFF ON 0 1 :TRIGger[:SEQuence]:FRAME:SYNC:HOLDoff:STATe?
Preset	On, 1.000 ms

State Saved	Saved in instrument state
Min	0 ms
Max	+500 ms
Default Unit	s
Initial S/W Revision	Prior to A.02.00

## Control Edge/Level

Sets the method of controlling the gating function from the gating signal.

### Edge

In Edge triggering, the gate opens (after the Delay) on the selected edge (for example, positive) of the gate signal and closes on the alternate edge (for example, negative).

### Level

In Level triggering, the gate opens (after the Delay) when the gate signal has achieved a certain level and stays open as long as that level is maintained.

Key Path	Sweep/Control, Gate
Remote Command	[ :SENSe ] :SWEp:EGATe:CONTRol EDGE LEVeL [ :SENSe ] :SWEp:EGATe:CONTRol?
Example	SWE:EGAT:CONT EDGE
Dependencies	If the Gate Method is FFT the Control key is grayed out and Edge is selected. If the Gate Source is TV, Frame or Line, the Control key is grayed out and Edge is selected.
Preset	EDGE
State Saved	Saved in instrument state
Backwards Compatibility SCPI	[ :SENSe ] :SWEp:TIME:GATE:TYPE ESA Compatibility
Initial S/W Revision	Prior to A.02.00

## Gate Holdoff

Lets you increase or decrease the wait time after a gate event ends before the analyzer will respond to the next gate signal.

After any Gate event finishes, the analyzer must wait for the sweep system to settle before it can respond to another Gate signal. The analyzer calculates a "wait time," taking into account a number of factors, including RBW and Phase Noise Optimization settings. The goal is to achieve the same accuracy when gated as in ungated operation. The figure below illustrates this concept:



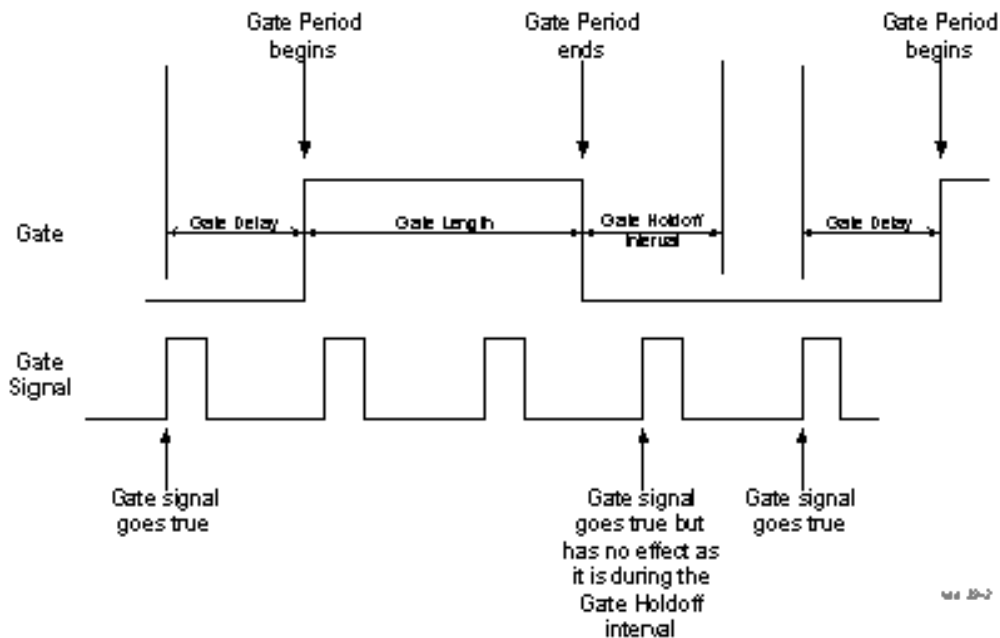

When Gate Holdoff is in Auto, the wait time calculated by the analyzer is used. When Gate Time is in Manual, the user may adjust the wait time, usually decreasing it in order to achieve greater speed, but at the risk of decreasing accuracy.

When the Method key is set to Video or FFT, the Gate Holdoff function has no effect.

In measurements that do not support Auto, the value shown when Auto is selected is “---” and the manually set holdoff is returned to a query.

Key Path	Sweep/Control, Gate
<b>Remote Command</b>	<pre>[ :SENSe ] :SWEep:EGATe:HOLDoff &lt;time&gt; [ :SENSe ] :SWEep:EGATe:HOLDoff? [ :SENSe ] :SWEep:EGATe:HOLDoff:AUTO OFF ON 0 1 [ :SENSe ] :SWEep:EGATe:HOLDoff:AUTO?</pre>
<b>Example</b>	<pre>SWE:EGAT:HOLD 0.0002 SWE:EGAT:HOLD? SWE:EGAT:HOLD:AUTO ON SWE:EGAT:HOLD:AUTO?</pre>
<b>Couplings</b>	<p>When Gate Holdoff is Auto, the Gate Holdoff key shows the value calculated by the analyzer for the wait time.</p> <p>Pressing the Gate Holdoff key while it is in Auto and not selected, causes the key to become selected and allows the user to adjust the value. If the value is adjusted, the setting changes to Man.</p> <p>Pressing the Gate Holdoff key, while it is in Auto and selected, does not change the value of Gate Holdoff, but causes the setting to change to Man. Now the user can adjust the value.</p> <p>Pressing the key while it is in Man and selected, cause the value to change back to Auto.</p> <p>Pressing the key while it is in Man and not selected, causes the key to become selected and allows the user to adjust the value.</p>

	When Method is set to Video or FFT, the Gate Holdoff function has no effect.
Preset	Auto Auto/On
State Saved	Saved in instrument state
Min	1 µsec
Max	1 sec
Initial S/W Revision	Prior to A.02.00

## Gate Delay Compensation

This function allows you to select an RBW-dependent value by which to adjust the gate delay, to compensate for changes in the delay caused by RBW effects.

You can select between uncompensated operation and two types of compensation, Delay Until RBW Settled and Compensate for RBW Group Delay.

See "[More Information](#)" on page 611

Key Path	Sweep/Control, Gate
Scope	Meas Global
Remote Command	[ :SENSe ] :SWEep:EGATe:DELay:COMPensation:TYPE OFF   SETTled   GDELay [ :SENSe ] :SWEep:EGATe:DELay:COMPensation:TYPE?
Example	SWE:EGAT:DEL:COMP:TYPE SETT SWE:EGAT:DEL:COMP:TYPE?
Notes	Although this function is Meas Global, there are some measurements that do not support this function. In those measurements the operation will be Uncompensated. Going into one of those measurements will not change the Meas Global selection; it will simply display the grayed-out menu key with "Uncompensated" showing as the selection. This is a non-forceful grayout, so the SCPI command is still accepted.  If Gate Delay Compensation is not supported at all within a particular mode, the key is not displayed, and if the SCPI command is sent while in a measurement within that mode, an "Undefined Header" message is generated.  Measurements that do not support this function include: Swept SA
Preset	TD-SCDMA mode: Compensate for RBW Group Delay All other modes: Delay Until RBW Settled
State Saved	Saved in instrument state
Range	Uncompensated Delay Until RBW Settled Compensate for RBW Group Delay
Readback text	Uncompensated Settled Group Delay
Initial S/W Revision	Prior to A.02.00
Modified at S/W Revision	A.11.0

## More Information

Selecting Uncompensated means that the actual gate delay is as you sets it.

Selecting Delay Until RBW Settled causes the gate delay to be increased above the user setting by an amount equal to  $3.06/\text{RBW}$ . This compensated delay causes the GATE START and GATE STOP lines on the display to move by the compensation amount, and the actual hardware gate delay to be increased by the same amount. All the other gate lines (for example, MIN FAST) are unaffected. If the RBW subsequently changes, the compensation is readjusted for the new RBW. The value shown on the Gate Delay key does NOT change.

Delay Until RBW Settled allows excellent measurements of gated signals, by allowing the IF to settle following any transient that affects the burst. Excellent measurements also require that the analysis region not extend into the region affected by the falling edge of the burst. Thus, excellent measurements can only be made over a width that declines with narrowing RBWs, which is achieved by decreasing the gate length below the user setting by an amount equal to  $2.53/\text{RBW}$ . Therefore, for general purpose compensation, you will still want to change the gate length with changes in RBW even if the gate delay is compensated. The compensated Gate Length is limited by the analyzer so that it will never go below 10% of the value shown on the Gate Length key, as otherwise the sweep times could get very long. Anytime the Gate Length and RBW values combine in such a way that this limiting takes place, a warning is displayed. For measurements which contain multiple sweeps with different RBW like SEM and SPUR, the smallest RBW is used for this limiting.

Selecting Compensate for RBW Group Delay causes the gate delay to be increased above the user setting by an amount equal to  $1.81/\text{RBW}$ . This compensated delay causes the GATE START, GATE STOP lines on the display to move by the compensation amount, and the actual hardware gate delay to be increased by the same amount. All the other gate lines (for example, MIN FAST) are unaffected. If the RBW subsequently changes, the compensation is readjusted for the new RBW. The value shown on the Gate Delay key does NOT change. Compensate for RBW Group Delay also includes gate length compensation; the gate length itself is adjusted as necessary to attempt to compensate for delay effects imposed by the RBW.

Compensate for RBW Group Delay is similar to Delay Until RBW Settled, but compensates for the group delay of the RBW filter, rather than the filter settling time. As the RBW gets narrow, this can allow the settling tail of the RBW to affect the beginning part of the gated measurement, and allow the beginning of the RBW settling transient to affect the end of the gated measurement. These two effects are symmetric because the RBW response is symmetric. Because the gate length is not automatically compensated, some users might find this compensation to be more intuitive than compensation for RBW settling.

## Min Fast Position Query (Remote Command Only)

This command queries the position of the MIN FAST line, relative to the delay reference (REF) line. See section "[Gate View On/Off](#)" on page 2040. If this query is sent while not in gate view, the MinFast calculation is performed based on the current values of the appropriate parameters and the result is returned. Knowing this value lets you set an optimal gate delay value for the current measurement setup.

<b>Remote Command</b>	<code>[ :SENSe ] :SWEep:EGATe:MINFast?</code>
<b>Example</b>	<code>SWE:EGAT:MIN?</code>
<b>Initial S/W Revision</b>	Prior to A.02.00

### Gate Preset (Remote Command Only)

Presets the time-gated spectrum analysis capability.

This command sets gate parameter values to the ESA preset values, as follows:

Gate trigger type = edge

Gate polarity = positive

Gate delay = 1 us

Gate length = 1 us

<b>Remote Command</b>	<code>[:SENSe]:SWEep:TIME:GATE:PRESet</code> ESA Compatibility
Initial S/W Revision	Prior to A.02.00

### Gate Level (Remote Command Only)

Sets the gate input transition point level for the external TRIGGER inputs on the front and rear panel. This is a legacy command for PSA compatibility. It is simply an alias to the equivalent trigger level command.

<b>Remote Command</b>	<code>[:SENSe]:SWEep:EGATE:EXTErnal[1] 2:LEVel &lt;voltage&gt;</code> <code>[:SENSe]:SWEep:EGATE:EXTErnal[1] 2:LEVel?</code>
Notes	This command is simply an alias to <code>:TRIGger[:SEQuence]:EXTErnal[1] 2:LEVel</code> For details refer
Initial S/W Revision	Prior to A.02.00

### Gate Polarity (Remote Command Only)

Sets the polarity for the gate signal. This setup is now done using the gate trigger's slope setting.

When Positive (Pos) is selected, a positive-going edge (Edge) or a high voltage (Level) will satisfy the gate condition, after the delay set with the Gate Delay key. When Negative (Neg) is selected, a negative-going edge (Edge) or a low voltage (Level) will satisfy the gate condition after the delay.

<b>Remote Command</b>	<code>[:SENSe]:SWEep:EGATE:POLarity</code> NEGative POSitive <code>[:SENSe]:SWEep:EGATE:POLarity?</code>
<b>Example</b>	<code>SWE:EGAT:POL</code> NEG <code>SWE:EGAT:POL?</code>
Preset	POSitive
State Saved	Saved in instrument state
<b>Backwards Compatibility SCPI</b>	<code>[:SENSe]:SWEep:TIME:GATE:POLarity</code> ESA compatibility
Initial S/W Revision	Prior to A.02.00

<b>Remote Command</b>	[ :SENSe ] :SWEep:TIME:GATE:LEVel HIGH LOW [ :SENSe ] :SWEep:TIME:GATE:LEVel? ESA compatibility
Preset	HIGH
Initial S/W Revision	Prior to A.02.00

## Points

Sets the number of points per sweep. The resolution of setting the sweep time depends on the number of points selected. If Preset is selected, the number of points per sweep defaults to 1001. The current value of points is displayed parenthetically, next to the sweep time in the lower-right corner of the display.

Changing the number of points has several effects on the analyzer. Since markers are read at the point location, the marker reading may change. All trace data is cleared.

Key Path	Sweep/Control
Mode	SA, WCDMA, C2K, WIMAX OFDMA, 1xEVDO, DVB-T/H, DTMB (CTTB), ISDB-T, CMMB, LTE, LTEFDD, Digital Cable TV, WLAN, MSR, LTEAFDD, LTEATDD
<b>Remote Command</b>	[ :SENSe ] :CHPower:SWEep:POINts <integer> [ :SENSe ] :CHPower:SWEep:POINts?
<b>Example</b>	CHP:SWE:POIN 501 CHP:SWE:POIN?
Notes	Whenever the number of sweep points changes: All trace data is erased Any traces with Update Off also go to Display Off (like going from View to Blank in the older analyzers) Sweep time is re-quantized Any limit lines that are on are updated If averaging/hold is on, averaging/hold starts over
Couplings	Whenever the number of sweep points changes, the sweep time is re-quantized.
Preset	DVB-T/H: 2001 DTMB (CTTB): 2001 Other: 1001 ISDB-T: 2001 CMMB: 2001 1xEVDO: 512 Digital Cable TV: 2001
State Saved	Saved in instrument state.
Min	101

8 Channel Power Measurement  
Sweep/Control

Max	20001
Initial S/W Revision	Prior to A.02.00
Modified at S/W Revision	A.02.00, A.03.00

## System

See "System" on page 342

## Trace/Detector

Accesses a menu of functions that enable you to control the detectors for the current measurement.

Key Path	Front-panel key
Initial S/W Revision	Prior to A.02.00

### Trace Type

Allows you to select the type of trace you want to use for the current measurement. The first page of this menu contains a 1-of-N selection of the trace type (Clear Write, Average, Max Hold, Min Hold) for the selected trace.

Key Path	Trace/Detector
Mode	SA, WCDMA, C2K, WIMAX OFDMA, 1xEVDO, DVB-T/H, DTMB (CTTB), ISDB-T, CMMB, LTE, LTETDD, Digital Cable TV, WLAN, MSR, LTEAFDD, LTEATDD
Remote Command	:TRACe:CHPower:TYPE WRITe AVERAge MAXHold MINHold :TRACe:CHPower:TYPE?
Example	TRAC:CHP:TYPE WRIT TRAC:CHP:TYPE?
Notes	WRITe = Clear Write AVERAge = Average MAXHold = Maximum Hold MINHold = Minimum Hold
Couplings	When Detector setting is "Auto" ([:SENSe]:CHPower:DETEctor:AUTO?), Detector ([:SENSe]:CHPower:DETEctor[:FUNCTION]?) switches aligning with the switch of this parameter: "NORMal" with WRITe (Clear Write), "AVERAge" with AVERAge, "POSitive (peak)" with MAXHold, and "NEGative (peak)" with MINHold.
Preset	AVERAge
State Saved	Saved in instrument state.
Range	ClearWrite Average MaxHold MinHold
Initial S/W Revision	Prior to A.02.00
Modified at S/W Revision	A.02.00, A.03.00

### Detector

Accesses a menu of functions that enable you to control the detectors for the current measurement. The following choices are available:

- Auto– the detector selected depends on marker functions, trace functions, average type, and the trace averaging function.



- Normal—the detector determines the peak of the CW-like signals, and it yields alternating maximums and minimums of noise-like signals. This is also referred to as Rosenfell detection.
- Average—the detector determines the average of the signal within the sweep points. The averaging method depends upon the Average Type selection (voltage, power or log scales).
- Peak—the detector determines the maximum of the signal within the sweep points.
- Sample—the detector indicates the instantaneous level of the signal at the center of the sweep points represented by each display point.
- Negative Peak—the detector determines the minimum of the signal within the sweep points.

Key Path	Detector
Initial S/W Revision	Prior to A.02.00

## Auto

Sets the detector for the currently selected trace to Auto.

Key Path	Trace/Detector
Mode	SA, WCDMA, C2K, WIMAX OFDMA, 1xEVDO, DVB-T/H, DTMB (CTTB), ISDB-T, CMMB, LTE, LTETDD, Digital Cable TV, WLAN, MSR, LTEAFDD, LTEATDD
<b>Remote Command</b>	<code>[ :SENSe ] :CHPower:DETEctor:AUTO ON OFF 1 0</code> <code>[ :SENSe ] :CHPower:DETEctor:AUTO?</code>
<b>Example</b>	CHP:DET:AUTO ON CHP:DET:AUTO?
Couplings	When Detector setting is “Auto” ( <code>[ :SENSe ] :CHPower:DETEctor:AUTO?</code> ), Detector ( <code>[ :SENSe ] :CHPower:DETEctor[:FUNCTION]?</code> ) switches aligning with the switch of this parameter: “NORMal” with Clear Write, “AVERage” with AVERage, “POSitive (peak)” with MAXHold, and “NEGative (peak)” with MINHold.
Preset	Others: ON DVB-T/H, DTMB (CTTB), ISDB-T, CMMB, Digital Cable TV: OFF
State Saved	Saved in instrument state.
Initial S/W Revision	Prior to A.02.00
Modified at S/W Revision	A.02.00, A.03.00

## Detector Selection

Selects a detector to be used by the analyzer for the current measurement.

Key Path	Trace/Detector
Mode	SA, WCDMA, C2K, WIMAX OFDMA, 1xEVDO, DVB-T/H, DTMB (CTTB), ISDB-T, CMMB, LTE, LTETDD, Digital Cable TV, WLAN, MSR, LTEAFDD, LTEATDD

<b>Remote Command</b>	[:SENSe]:CHPower:DETEctor[:FUNction] NORMal   AVERage   POSitive   SAMPlE   NEGative  [:SENSe]:CHPower:DETEctor[:FUNction]?
<b>Example</b>	CHP:DET NORM CHP:DET?
<b>Notes</b>	<p>When you manually select a detector (instead of selecting Auto), that detector is used regardless of other analyzer settings.</p> <p>The Normal detector determines the peak of CW-like signals, and it yields alternating maximums and minimums of noise-like signals. This method of detection is also referred to as Rosenfell detection.</p> <p>The Average detector determines the average of the signal within the sweep points. The averaging method is Power Average (RMS).</p> <p>The Peak detector determines the maximum of the signal within the sweep points.</p> <p>The Sample detector indicates the instantaneous level of the signal at the center of the sweep points represented by each display point.</p> <p>The Negative Peak detector determines the minimum of the signal within the sweep points.</p>
<b>Couplings</b>	When Detector setting is "Auto" ([:SENSe]:CHPower:DETEctor:AUTO?), Detector ([:SENSe]:CHPower:DETEctor[:FUNction]?) switches aligning with the switch of this parameter: "NORMal" with Clear Write, "AVERage" with AVERage, "POSitive (peak)" with MAXHold, and "NEGative (peak)" with MINHold.
<b>Preset</b>	AVERage
<b>State Saved</b>	Saved in instrument state.
<b>Range</b>	Normal Average Peak Sample Negative Peak
<b>Initial S/W Revision</b>	Prior to A.02.00
<b>Modified at S/W Revision</b>	A.02.00, A.03.00

## Trigger

See ["Trigger" on page 412](#)

### Free Run

See ["Free Run " on page 419](#)

### Video

See ["Video \(IF Envelope\) " on page 420](#)

### Trigger Level

See ["Trigger Level " on page 420](#)

### Trig Slope

See ["Trig Slope " on page 421](#)

### Trig Delay

See ["Trig Delay " on page 422](#)

### Line

See ["Line " on page 2047](#)

### Trig Slope

See ["Trig Slope " on page 2047](#)

### Trig Delay

See ["Trig Delay " on page 424](#)

### External 1

See ["External 1 " on page 2059](#)

### Trigger Level

See ["Trigger Level " on page 2059](#)

### Trig Slope

See ["Trig Slope " on page 2060](#)

### Trig Delay

See ["Trig Delay " on page 427](#)

### External 2

See ["External 2 " on page 2061](#)

### **Trigger Level**

See ["Trigger Level "](#) on page 2061

### **Trig Slope**

See ["Trig Slope "](#) on page 2062

### **Trig Delay**

See ["Trig Delay "](#) on page 429

### **RF Burst**

See ["RF Burst "](#) on page 2062

### **Absolute Trigger**

See ["Absolute Trigger Level"](#) on page 2063

### **Relative Trigger**

See ["Relative Trigger Level"](#) on page 2052

### **Trig Slope**

See ["Trigger Slope "](#) on page 2064

### **Trig Delay**

See ["Trig Delay "](#) on page 433

### **Periodic Timer**

See ["Periodic Timer \(Frame Trigger\) "](#) on page 2054

### **Period**

See ["Period "](#) on page 2055

### **Offset**

See ["Offset "](#) on page 2056

### **Reset Offset Display**

See ["Reset Offset Display "](#) on page 2058

### **Sync Source**

See ["Sync Source "](#) on page 2058

### **Off**

See ["Off "](#) on page 2059

### External 1

See "External 1 " on page 2059

#### Trigger Level

See "Trigger Level " on page 2059

#### Trig Slope

See "Trig Slope " on page 2060

### External 2

See "External 2 " on page 2061

#### Trigger Level

See "Trigger Level " on page 2061

#### Trig Slope

See "Trig Slope " on page 2062

### RF Burst

See "RF Burst " on page 2062

### Absolute Trigger

See "Absolute Trigger Level" on page 2063

#### Trig Slope

See "Trigger Slope " on page 2064

### Trig Delay

See "Trig Delay" on page 443

### Auto/Holdoff

See "Auto/Holdoff " on page 444

### Auto Trig

See "Auto Trig " on page 444

### Trig Holdoff

See "Trig Holdoff " on page 445

## User Preset

Accesses a menu that gives you the following three choices:

- User Preset – recalls a state previously saved using the Save User Preset function.
- User Preset All Modes – presets all of the modes in the analyzer
- Save User Preset– saves the current state for the current mode

Key Path	Front-panel key
Backwards Compatibility Notes	<p>User Preset is actually loading a state, and in legacy analyzers, it was possible to load a state without affecting the trace data, limit lines or correction data. Similarly it was possible to do a User Preset without affecting the trace data, limit lines or correction data.</p> <p>In the X-Series, “state” always includes all of this data; so whenever state is loaded, or User Preset is executed, all of the traces, limit lines and corrections are affected. Although this differs from previous behavior, it is desirable behavior, and should not cause adverse issues for users.</p> <p>On ESA and PSA, User Preset affected the entire instrument’s state. In the X-Series, User Preset only recalls the state for the active mode. There is a User Preset file for each mode. User Preset can never cause a mode switch as it can in legacy analyzers. If you want to recall all modes to their user preset file state, you will need to do a User Preset after mode switching into each mode.</p> <p>User Preset recalls mode state which can now include data like traces; whereas on ESA and PSA, User Preset did not affect data.</p>
Initial S/W Revision	Prior to A.02.00

## User Preset

User Preset sets the state of the currently active mode back to the state that was previously saved for this mode using the Save User Preset menu key or the SCPI command, SYST:PRES:USER:SAV. It not only recalls the Mode Preset settings, but it also recalls all of the mode persistent settings, and the Input/Output system setting that existed at the time Save User Preset was executed.

If a Save User Preset has not been done at any time, User Preset recalls the default user preset file for the currently active mode. The default user preset files are created if, at power-on, a mode detects there is no user preset file. There will never be a scenario when there is no user preset file to restore. For each mode, the default user preset state is the same state that would be saved if a Save User Preset is performed in each mode right after doing a Restore Mode Default and after a Restore Input/Output Defaults.

The User Preset function does the following:

- Aborts the currently running measurement.
- Sets the mode State to the values defined by Save User Preset.
- Makes the saved measurement for the currently running mode the active measurement.
- Brings up the saved menu for the power-on mode.
- Clears the input and output buffers.
- Sets the Status Byte to 0.

Key Path	User Preset
<b>Remote Command</b>	:SYSTem:PRESet:USER
<b>Example</b>	:SYST:PRES:USER:SAVE:SYST:PRES:USER
Notes	:SYST:PRES:USER:SAVE is used to save the current state as the user preset state. Clears all pending OPC bits. The Status Byte is set to 0. Pressing the User Preset front-panel key while already in the User Preset menu will cause the User Preset to get executed
Couplings	A user preset will cause the currently running measurement to be aborted and cause the saved measurement to be active. Recalling a User Preset file has the same issues that recalling a Save State file has. Some settings may need to be limited and therefore re-coupled, since the capabilities of the mode may have changes when the User Preset file was last saved.
Initial S/W Revision	Prior to A.02.00

## User Preset All Modes

Recalls all of the User Preset files for each mode, switches to the power-on mode, and activates the saved measurement from the power-on mode User Preset file.

### NOTE

When the instrument is secured, all of the user preset files are converted back to their default user preset files.

The User Preset function does the following:

- Aborts the currently running measurement.
- Switches the Mode to the power-on mode.
- Restores the User Preset files for each mode.
- Makes the saved measurement for the power-on mode the active measurement.
- Brings up the saved menu for the power-on mode.
- Clears the input and output buffers.
- Sets the Status Byte to 0.

Key Path	User Preset
<b>Remote Command</b>	:SYSTem:PRESet:USER:ALL
<b>Example</b>	:SYST:PRES:USER:SAVE:SYST:PRES:USER:ALL
Notes	Clears all pending OPC bits. The Status Byte is set to 0. :SYST:PRES:USER:SAVE is used to save the current state as the user preset state.
Couplings	A user preset will cause the currently running measurement to be aborted, cause a mode switch to the power-on mode, and cause the saved measurement to be active in the power-on mode. Recalling a User Preset file has the same issues that recalling a Save State file has. Some settings may need to be limited and therefore re-coupled, since the capabilities of the mode may have changes when the User Preset file was last saved.
Initial S/W Revision	Prior to A.02.00

## Save User Preset

Saves the currently active mode and its State. You can recall this User Preset file by pressing the User Preset menu key or sending the SYST:PRES:USER remote command. This same state is also saved by the Save State function.

Key Path	User Preset
Remote Command	:SYSTem:PRESet:USER:SAVE
Example	:SYST:PRES:USER:SAVE
Notes	:SYST:PRES:SAVE creates the same file as if the user requested a *SAV or a MMEM:STOR:STAT, except User Preset Save does not allow the user to specify the filename or the location of the file.
Initial S/W Revision	Prior to A.02.00



## View/Display

Accesses a menu of functions that enable you to control the instrument display as well as turn the bar graph On and Off.

If current mode is NOT DVB-T/H, DTMB (CTTB), ISDB-T, MSR, LTE-Advanced FDD/TDD or CMMB mode, the front panel views only contain one view: Spectrum View. The results of the measurement can be displayed as a single spectrum trace view or displayed with a Bar Graph trace on the spectrum trace.

### Spectrum View with Bar Graph off

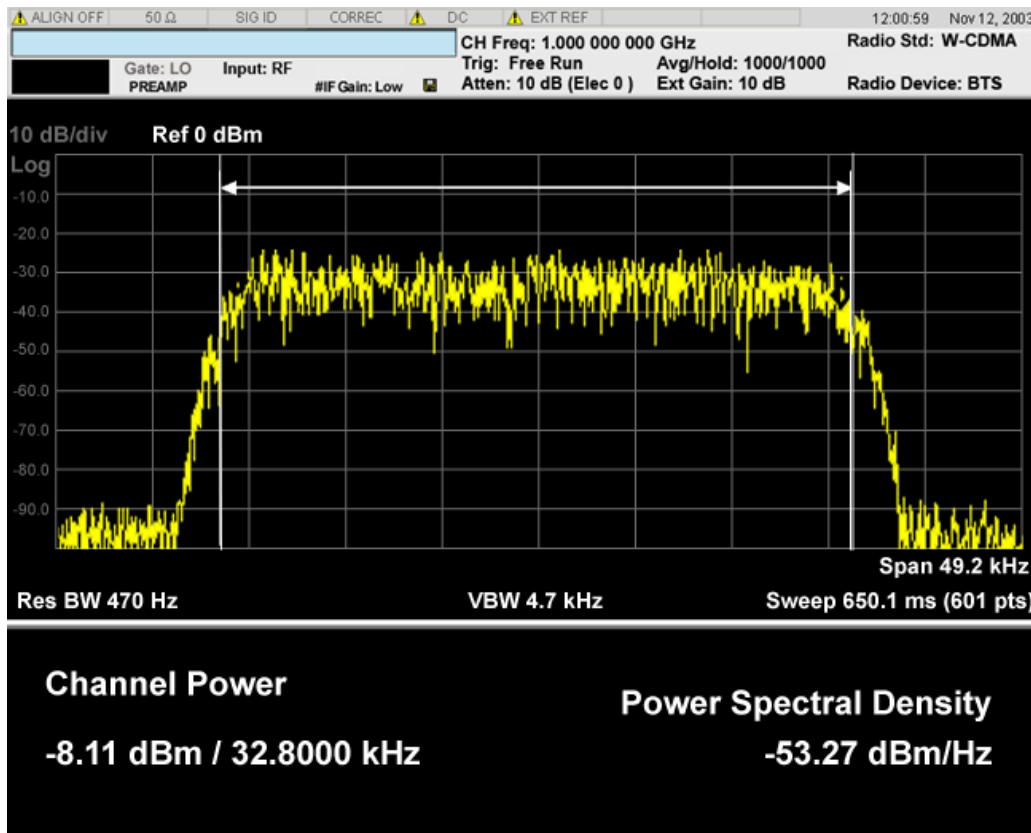

### Spectrum View with Bar Graph on

This View is the same as the 'Spectrum' view, but has a blue bar between the markers that indicates the measured output power level. The bar graph is activated when the "Bar Graph" Soft Key is set to ON under the View/Display menu. The actual measured output power level is displayed on the display at the bottom of the bar.

8 Channel Power Measurement  
View/Display

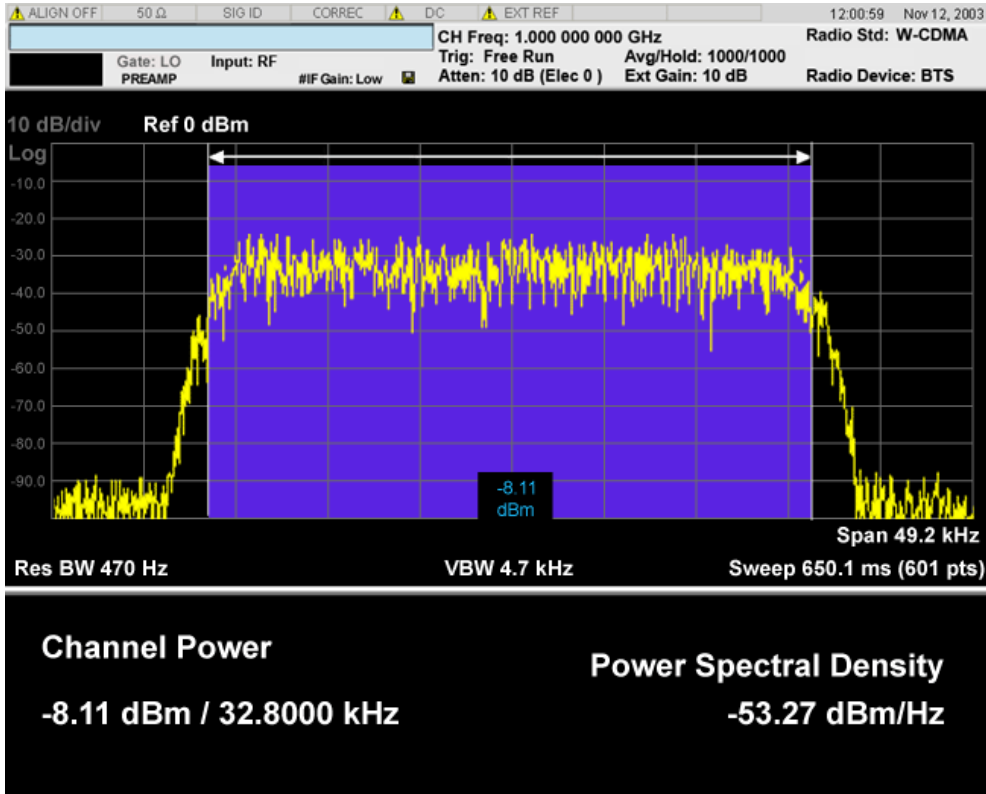

If current mode is MSR and LTE-Advanced FDD/TDD, there are two views, Power Results and Carrier Info. Power Results view is almost the same as the common CHP view.

If the current mode is WLAN and the format is WLAN 802.11ac 80+80 MHz, the spectrum view is changed a little so that the results of both carrier segments can be displayed.

Spectrum View with Bar Graph off for WLAN 802.11ac (80 + 80 MHz):

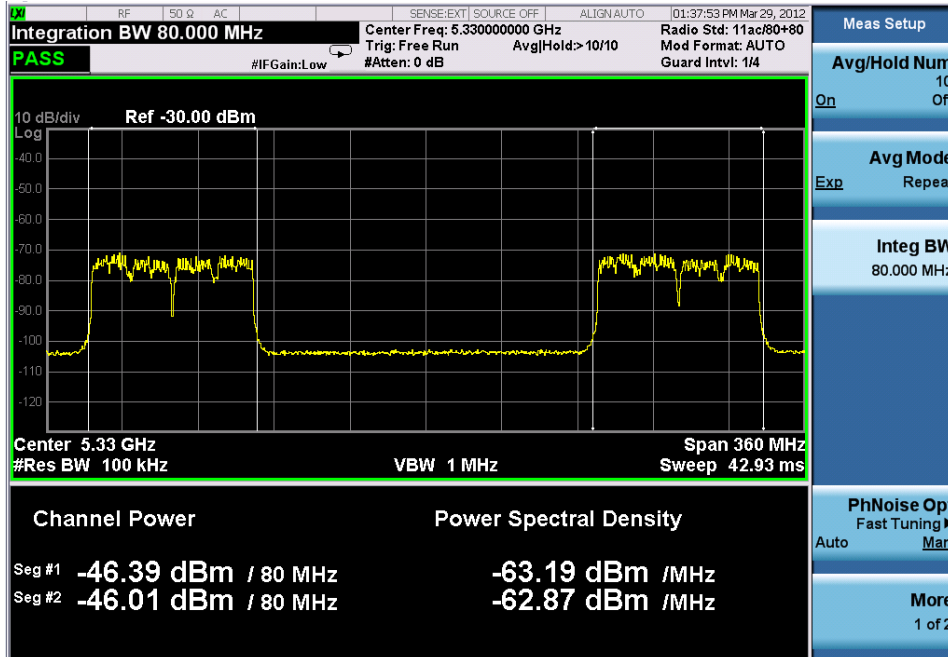

Spectrum View with Bar Graph on for WLAN 802.11ac (80 + 80 MHz):

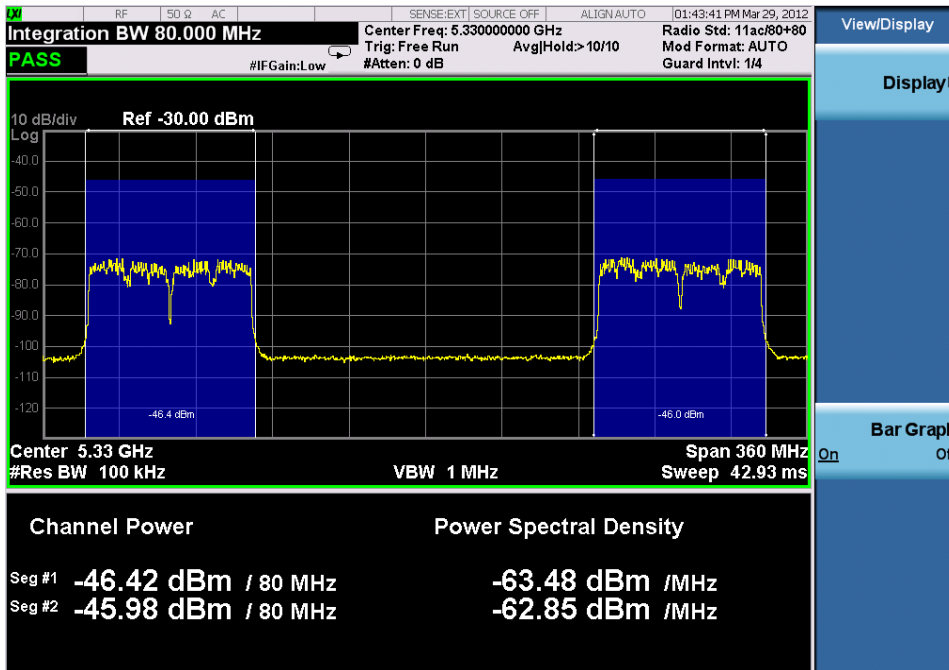

### Power Results:

The spectrum trace and power bars are displayed in the upper window. Total carrier power, total PSD and total format carrier power are displayed in the lower window. Total format carrier power is total power of carriers of the same Radio Format. If there is no carrier of the corresponding format, it is not displayed. Thus items in the total format power table changes depending on the carrier configuration. Since the metrics window of MSR and LTE-Advanced FDD/TDD is a bit denser than the common CHP, vertical positions of total power and power spectral density goes up a little bit.

### Carrier Info:

The lower window of Power Results view is replaced by the carrier info table in this view. Carrier center frequency can be displayed in either offset or absolute frequency depending on Carrier Freq. The table can be scrolled by Carrier Result on Meas Setup menu or by Select Carrier on Config Carriers menu. The highlighted row changes as either Carrier Result or Select Carrier is changed. The highlighted row and these keys are not coupled.

### View selection by name (MSR and LTE-Advanced FDD/TDD only)

Selects the results view. The following SCPI command allows you to select the desired measurement view by enumeration.

Key Path	No equivalent front-panel key
Mode	MSR, LTEAFDD, LTEATDD
Remote Command	:DISPlay:CHPower:VIEW[:SElect] PRESult CINformation :DISPlay:CHPower:VIEW[:SElect]?
Example	:DISP:CHP:VIEW PRES :DISP:CHP:VIEW?

Preset	PRESult
State Saved	Saved in instrument state
Range	Power Results Carrier Info
Initial S/W Revision	A.10.00

Selects the results view. The following SCPI command allows you to select the desired measurement view by enumeration.

Key Path	No equivalent front-panel key
Mode	MSR, LTEAFDD, LTEATDD
<b>Remote Command</b>	:DISPlay:CHPower:VIEW:NSElect <integer> :DISPlay:CHPower:VIEW:NSElect?
<b>Example</b>	DISP:CHP:VIEW:NSEL 1 DISP:CHP:VIEW:NSEL?
Preset	1
State Saved	Saved in instrument state
Min	1
Max	2
Initial S/W Revision	A.10.00

### View selection by name (DTMB (CTTB), DVB-T/H only)

Selects the results view. The following SCPI command allows you to select the desired measurement view by enumeration.

Key Path	No equivalent front-panel key
Mode	DVB-T/H, DTMB (CTTB)
<b>Remote Command</b>	:DISPlay:CHPower:VIEW[:SElect] RFSpectrum SHOULder MASK :DISPlay:CHPower:VIEW[:SElect]?
<b>Example</b>	DISP:CHP:VIEW RFSP DISP:CHP:VIEW?
Preset	RFSpectrum
State Saved	Saved in instrument state.
Range	RF Spectrum   Shoulder Attenuation   Spectrum Mask
Initial S/W Revision	A.02.00

## View selection by name (ISDB-T, CMMB only)

Selects the results view. The following SCPI command allows you to select the desired measurement view by enumeration.

Key Path	No equivalent front-panel key
Mode	ISDB-T, CMMB
<b>Remote Command</b>	:DISPlay:CHPower:VIEW[:SElect] RFSpectrum SHOUlder :DISPlay:CHPower:VIEW[:SElect]?
<b>Example</b>	DISP:CHP:VIEW RFSP DISP:CHP:VIEW?
Preset	RFSpectrum
State Saved	Saved in instrument state.
Range	RF Spectrum   Shoulder Attenuation
Initial S/W Revision	A.03.00

Key Path	Front-panel key
Initial S/W Revision	Prior to A.02.00

## Display

The Display menu is common to most measurements, and is used for configuring items on the display. Some Display menu settings apply to all the measurements in a mode, and some only to the current measurement. Those under the System Display Settings key apply to all measurements in all modes.

Key Path	Display
Key Path	View/Display
Initial S/W Revision	Prior to A.02.00

## Annotation

Turns on and off various parts of the display annotation. The annotation is divided up into four categories:

1. Meas Bar: This is the measurement bar at the top of the screen. It does not include the settings panel or the Active Function. Turning off the Meas Bar turns off the settings panel and the Active Function. When the Meas Bar is off, the graticule area expands to fill the area formerly occupied by the Meas Bar.
2. Screen Annotation: this is the annotation and annunciation around the graticule, including any annotation on lines (such as the display line, the threshold line, etc.) This does NOT include the marker number or the N dB result. When off, the graticule expands to fill the entire graticule area.
3. Trace annotation: these are the labels on the traces, showing their detector (or their math mode).

8 Channel Power Measurement  
View/Display

4. Active Function annotation: this is the active function display in the meas bar, and all of the active function values displayed on softkeys.

See the figure below. Each type of annotation can be turned on and off individually.

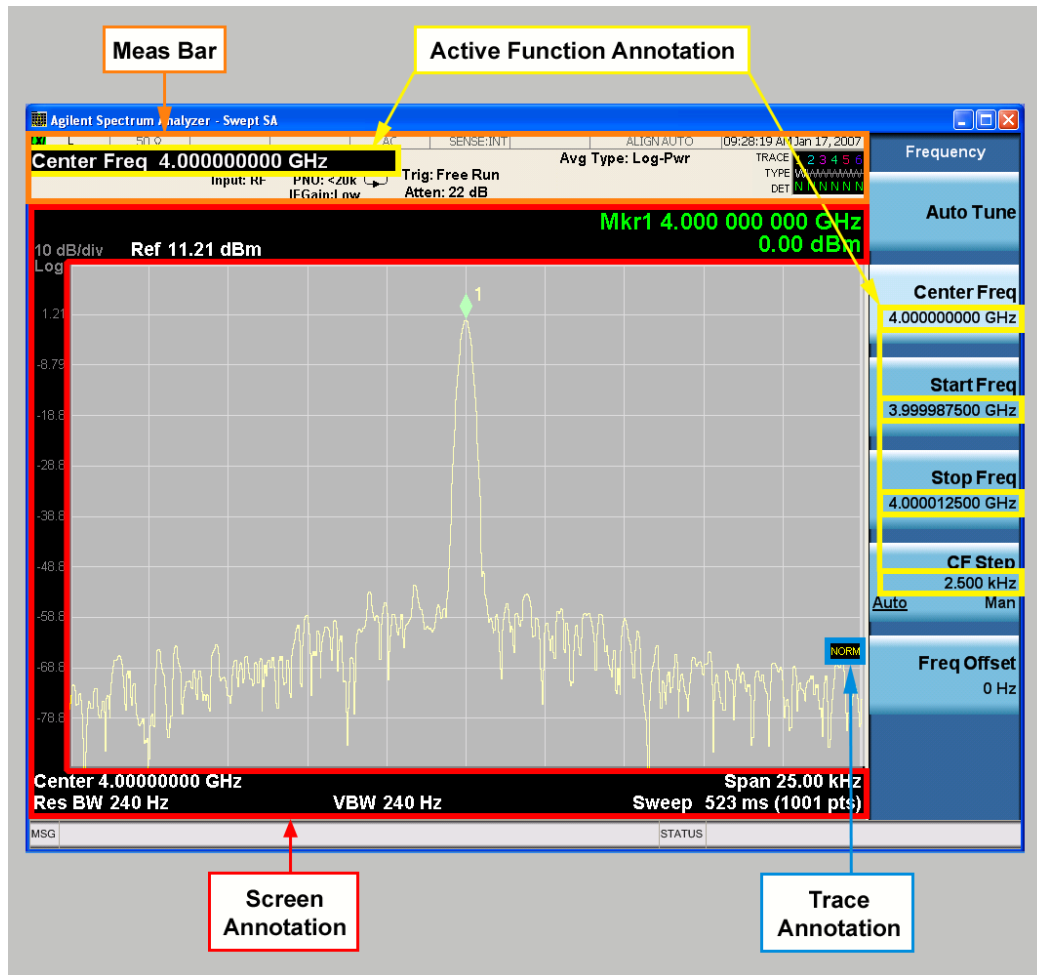

Key Path	View/Display, Display
Initial S/W Revision	Prior to A.02.00

Meas Bar On/Off

This function turns the Measurement Bar on and off, including the settings panel. When off, the graticule area expands to fill the area formerly occupied by the Measurement Bar.

Key Path	View/Display, Display, Annotation
Remote Command	:DISPlay:ANNotation:MBAR[:STATe] OFF ON 0 1 :DISPlay:ANNotation:MBAR[:STATe]?
Example	DISP:ANN:MBAR OFF

Dependencies	Grayed out and forced to OFF when System Display Settings, Annotation is set to Off.
Preset	On This should remain Off through a Preset when System DisplaySettings, Annotation is set to Off.
State Saved	Saved in instrument state.
Initial S/W Revision	Prior to A.02.00

## Screen

This controls the display of the annunciation and annotation around the graticule, including any annotation on lines (such as the display line, the threshold line, etc.) and the y-axis annotation. This does NOT include marker annotation (or the N dB result). When off, the graticule expands to fill the entire graticule area, leaving only the 1.5% gap above the graticule as described in the Trace/Detector chapter.

Key Path	View/Display, Display, Annotation
<b>Remote Command</b>	:DISPlay:ANNotation:SCReen[:STATe] OFF ON 0 1 :DISPlay:ANNotation:SCReen[:STATe]?
<b>Example</b>	DISP:ANN:SCR OFF
Dependencies	Grayed-out and forced to OFF when System Display Settings, Annotation is set to Off.
Preset	On This should remain Off through a Preset when System DisplaySettings, Annotation is set to Off
State Saved	Saved in instrument state.
Initial S/W Revision	Prior to A.02.00

## Active Function Values On/Off

Turns on and off the active function display in the Meas Bar, and all of the active function values displayed on the softkeys.

Note that all of the softkeys that have active functions have these numeric values blanked when this function is on. This is a security feature..

8 Channel Power Measurement  
View/Display

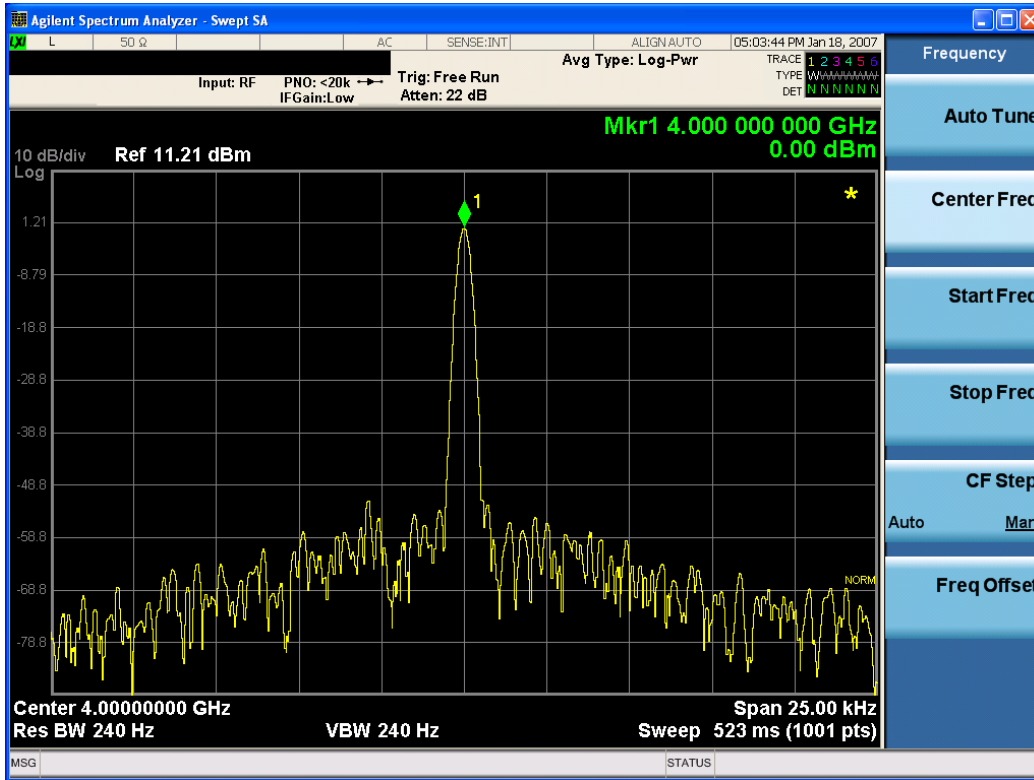

Key Path	View/Display, Display, Annotation
Remote Command	:DISPlay:ACTivefunc[:STATE] ON OFF 1 0 :DISPlay:ACTivefunc[:STATE]?
Example	DISP:ACT OFF
Dependencies	Grayed out and forced to OFF when System Display Settings, Annotation is set to Off.
Preset	On This should remain Off through a Preset when System DisplaySettings, Annotation is set to Off
State Saved	Saved in instrument state.
Initial S/W Revision	Prior to A.02.00

Title

Displays menu keys that enable you to change or clear a title on your display.

Key Path	View/Display, Display
Initial S/W Revision	Prior to A.02.00

Change Title

Writes a title into the "measurement name" field in the banner, for example, "Swept SA".



Press Change Title to enter a new title through the alpha editor. Press Enter or Return to complete the entry. Press ESC to cancel the entry and preserve your existing title.

The display title will replace the measurement name. It remains for this measurement until you press Change Title again, or you recall a state, or a Preset is performed. A title can also be cleared by pressing Title, Clear Title.

**NOTE**

Notice the inclusion of the <measurement> parameter in the command below. Because each measurement remembers the Display Title, the command must be qualified with the measurement name. For the Swept SA measurement this is not the case; no <measurement> parameter is used when changing the Display Title for the Swept SA measurement.

Key Path	View/Display, Display, Title
Mode	All
<b>Remote Command</b>	:DISPlay:<measurement>:ANNotation:TITLe:DATA <string> :DISPlay:<measurement>:ANNotation:TITLe:DATA?
<b>Example</b>	DISP:ANN:TITL:DATA "This Is My Title" This example is for the Swept SA measurement in the Spectrum Analyzer mode. The SANalyzer <measurement> name is not used. DISP:ACP:ANN:TITL:DATA "This Is My Title" This example is for Measurements other than Swept SA. Both set the title to: This Is My Title
Notes	Pressing this key cancels any active function. When a title is edited the previous title remains intact (it is not cleared) and the cursor goes at the end so that characters can be added or BKSP can be used to go back over previous characters.
Preset	No title (measurement name instead)
State Saved	Saved in instrument state.
Initial S/W Revision	Prior to A.02.00

### Clear Title

Clears a title from the front-panel display. Once cleared, the title cannot be retrieved. After the title is cleared, the current Measurement Name replaces it in the title bar.

Key Path	View/Display, Display, Title
<b>Example</b>	The following commands clear the title and restore the measurement's original title: DISP:ANN:TITL:DATA "" This example is for the Swept SA measurement in the Spectrum Analyzer mode. The SANalyzer <measurement> name is not used. DISP:ACP:ANN:TITL:DATA "" This example is for ACP; in measurements other than Swept SA the measurement name is required.
Notes	Uses the :DISPlay:<measurement>:ANNotation:TITLe:DATA <string> command with an empty string (in the Swept SA, the <measurement> is omitted).
Preset	Performed on Preset.
Initial S/W Revision	Prior to A.02.00

## Graticule

Pressing Graticule turns the display graticule On or Off. It also turns the graticule y-axis annotation on and off.

Key Path	View/Display, Display
Remote Command	:DISPlay:WINDow[1]:TRACe:GRATicule:GRID[:STATe] OFF ON 0 1 :DISPlay:WINDow[1]:TRACe:GRATicule:GRID[:STATe]?
Example	DISP:WIND:TRAC:GRAT:GRID OFF
Notes	The graticule is the set of horizontal and vertical lines that make up the grid/divisions for the x-axis and y-axis.
Preset	On
State Saved	Saved in instrument state
Initial S/W Revision	Prior to A.02.00

## System Display Settings

These settings are "Mode Global" – they affect all modes and measurements and are reset only by Restore Misc Defaults or Restore System Defaults under System.

Key Path	View/Display, Display
Initial S/W Revision	Prior to A.02.00

## Annotation Local Settings

This is a Mode Global override of the meas local annotation settings. When it is All Off, it forces ScreenAnnotation, Meas Bar, Trace, and Active Function Values settings to be OFF for all measurements in all modes. This provides the security based "annotation off" function of previous analyzers; hence it uses the legacy SCPI command.

When it is All Off, the Screen, Meas Bar, Trace, and Active Function Values keys under the Display, Annotation menu are grayed out and forced to Off. When Local Settings is selected, you are able to set the local annotation settings on a measurement by measurement basis.

Key Path	View/Display, Display, System Display Settings
Remote Command	:DISPlay:WINDow[1]:ANNotation[:ALL] OFF ON 0 1 :DISPlay:WINDow[1]:ANNotation[:ALL]?
Example	:DISP:WIND:ANN OFF
Preset	On (Set by Restore Misc Defaults)
State Saved	Not saved in instrument state.
Backwards Compatibility Notes	The WINDow parameter and optional subopcode is included for backwards compatibility but ignored – all windows are equally affected.
Initial S/W Revision	Prior to A.02.00

## Themes

Accesses a menu of functions that enable you to choose the theme to be used when saving the screen image.

The **Themes** option is the same as the **Themes** option under the **Display** and **Page Setup** dialogs. It allows you to choose between themes to be used when saving the screen image.

<b>Key Path</b>	Save, Screen Image
<b>Remote Command</b>	:MMEMory:STORe:SCReem:THEMe TDColor   TDMonochrome   FCOLOR   FMONochrome  :MMEMory:STORe:SCReem:THEMe?
<b>Example</b>	:MMEM:STOR:SCR:THEM TDM
<b>Preset</b>	3D Color; Is not part of Preset, but is reset by Restore Misc Defaults or Restore System Defaults All and survives subsequent running of the modes.
<b>Readback</b>	3D Color   3D Mono   Flat Color   Flat Mono
<b>Backwards Compatibility Notes</b>	In ESA and PSA we offer the choice of "Reverse Bitmap" or "Reverse Metafile" when saving screen images. This is much like the "Flat Color" theme available in X-Series. Also, if you selected Reverse Bitmap AND a black & white screen image, that would be much like "Flat Monochrome". In other words, each of the X-Series themes has a similar screen image type in ESA/PSA. But they are not identical.
<b>Initial S/W Revision</b>	Prior to A.02.00

### 3D Color

Selects a standard color theme with each object filled, shaded and colored as designed.

<b>Key Path</b>	Save, Screen Image, Themes
<b>Example</b>	MMEM:STOR:SCR:THEM TDC
<b>Readback</b>	3D Color
<b>Initial S/W Revision</b>	Prior to A.02.00

### 3D Monochrome

Selects a format that is like 3D color but shades of gray are used instead of colors.

<b>Key Path</b>	Save, Screen Image, Themes
<b>Example</b>	MMEM:STOR:SCR:THEM TDM
<b>Readback</b>	3D Mono
<b>Initial S/W Revision</b>	Prior to A.02.00

### Flat Color

Selects a format that is best when the screen is to be printed on an ink printer.

Key Path	Save, Screen Image, Themes
<b>Example</b>	MMEM:STOR:SCR:THEM FCOL
Readback	Flat Color
Initial S/W Revision	Prior to A.02.00

### Flat Monochrome

Selects a format that is like Flat Color. But only black is used (no colors, not even gray), and no fill.

Key Path	Save, Screen Image, Themes
<b>Example</b>	MMEM:STOR:SCR:THEM FMON
Readback	Flat Mono
Initial S/W Revision	Prior to A.02.00

### Backlight

Accesses the display backlight on/off keys. This setting may interact with settings under the Windows "Power" menu.

When the backlight is off, pressing ESC, TAB, SPACE, ENTER, UP, DOWN, LEFT, RIGHT, DEL, BKSP, CTRL, or ALT turns the backlight on without affecting the application. Pressing any other key will turn backlight on and could potentially perform the action as well.

Key Path	View/Display, Display, System Display Settings
<b>Remote Command</b>	:DISPlay:BACKlight ON OFF :DISPlay:BACKlight?
Preset	ON (Set by Restore Misc Defaults)
Initial S/W Revision	Prior to A.02.00

### Backlight Intensity

An active function used to set the backlight intensity. It goes from 0 to 100 where 100 is full on and 0 is off. This value is independent of the values set under the Backlight on/off key.

Key Path	View/Display, Display, System Display Settings
<b>Remote Command</b>	:DISPlay:BACKlight:INTensity <integer> :DISPlay:BACKlight:INTensity?
<b>Example</b>	DISP:BACK:INT 50

Preset	100 (Set by Restore Misc Defaults)
Min	0
Max	100
Initial S/W Revision	Prior to A.02.00

### RF Spectrum (Only for DVB-T/H, DTMB (CTTB), ISDB-T and CMMB)

**NOTE** This view is the same as the Spectrum View above.

Selects the RF Spectrum view. This view consists of the following two windows:

"Traces Window" on page 638

"Results Window" on page 638

The measurement results are shown in a graph window and in a text window. The text window shows the absolute power and its mean power spectral density values over the specified bandwidth. This view also supports bar graph functionality. The bar graph is activated when the "Bar Graph" Soft Key is set to ON under the RF Spectrum menu. The actual measured output power level is displayed on the display at the bottom of the bar.

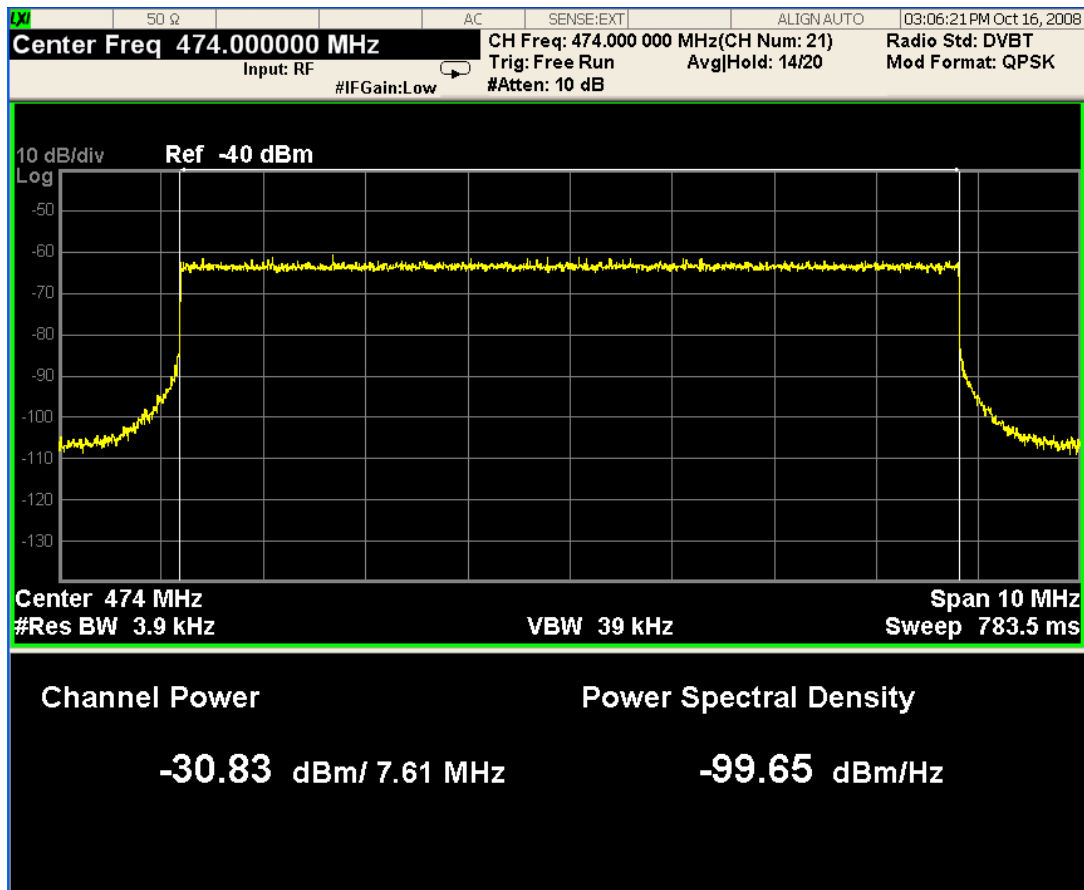

## Traces Window

Corresponding Trace	yellow - spectrum trace;
---------------------	--------------------------

## Results Window

Name	Corresponding Results
Channel Power	n=1, 1st element Total channel power in the specified integration bandwidth Channel Integration Bandwidth
Power Spectral Density	n=1, 2nd element The power in the specified unit bandwidth

Key Path	View/Display
Example	DISP:CHP:VIEW RFSP DISP:CHP:VIEW?
Initial S/W Revision	A.02.00

## Bar Graph

Turns the Bar Graph On and Off.

Key Path	DVB-T/H, DTMB (CTTB), ISDB-T, CMMB: View/Display, RF Spectrum Others: View/Display
Mode	SA, WCDMA, C2K, WIMAX OFDMA, 1xEVDO, DVB-T/H, DTMB (CTTB), ISDB-T, CMMB, LTE, LTE-TDD, Digital Cable TV, WLAN, MSR, LTEAFDD, LTEATDD
Remote Command	:DISPlay:CHPower:VIEW[1]:WINDow[1]:BGRaph ON OFF 1 0 :DISPlay:CHPower:VIEW[1]:WINDow[1]:BGRaph?
Example	DISP:CHP:VIEW:WIND:BGR ON DISP:CHP:VIEW:WIND:BGR?
Notes	You must be in the Spectrum Analysis mode, W-CDMA mode, cdma2000 mode, DVB-T/H mode, DTMB (CTTB) mode, ISDB-T mode, CMMB mode, Digital Cable TV mode, LTE mode, LTE TDD mode, WLAN mode, 1xEVDO mode, MSR, LTE-Advanced FDD/TDD mode or WIMAX OFDMA mode to use this command. Use :INSTrument:SElect to set the mode.
Preset	OFF
State Saved	Saved in instrument state.
Range	On Off
Initial S/W Revision	Prior to A.02.00
Modified at S/W Revision	A.02.00, A.03.00

### Shoulder Attenuation (Only for DVB-T/H, DTMB (CTTB), ISDB-T and CMMB)

Selects the Shoulder Attenuation view. This view is only available in DVB-T/H, DTMB (CTTB), ISDB-T and CMMB mode:

"Shoulder Attenuation view for DVB-T/H and ISDB-T mode" on page 639

"Shoulder Attenuation view for DTMB (CTTB) and CMMB mode" on page 640

This view consists of the following three windows:

"Lower Shoulder Trace Window" on page 640

"Upper Shoulder Trace Window" on page 640

"Results Window" on page 641

### Shoulder Attenuation view for DVB-T/H and ISDB-T mode

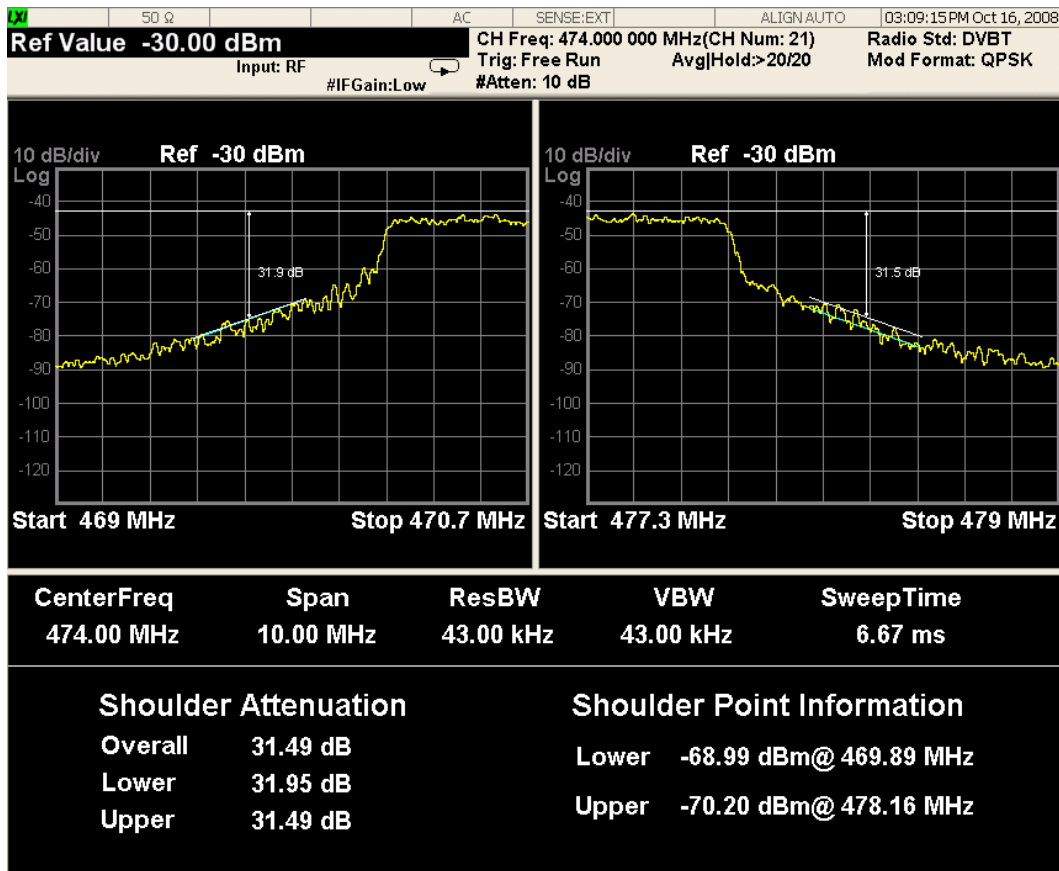

Shoulder Attenuation view for DTMB (CTTB) and CMMB mode

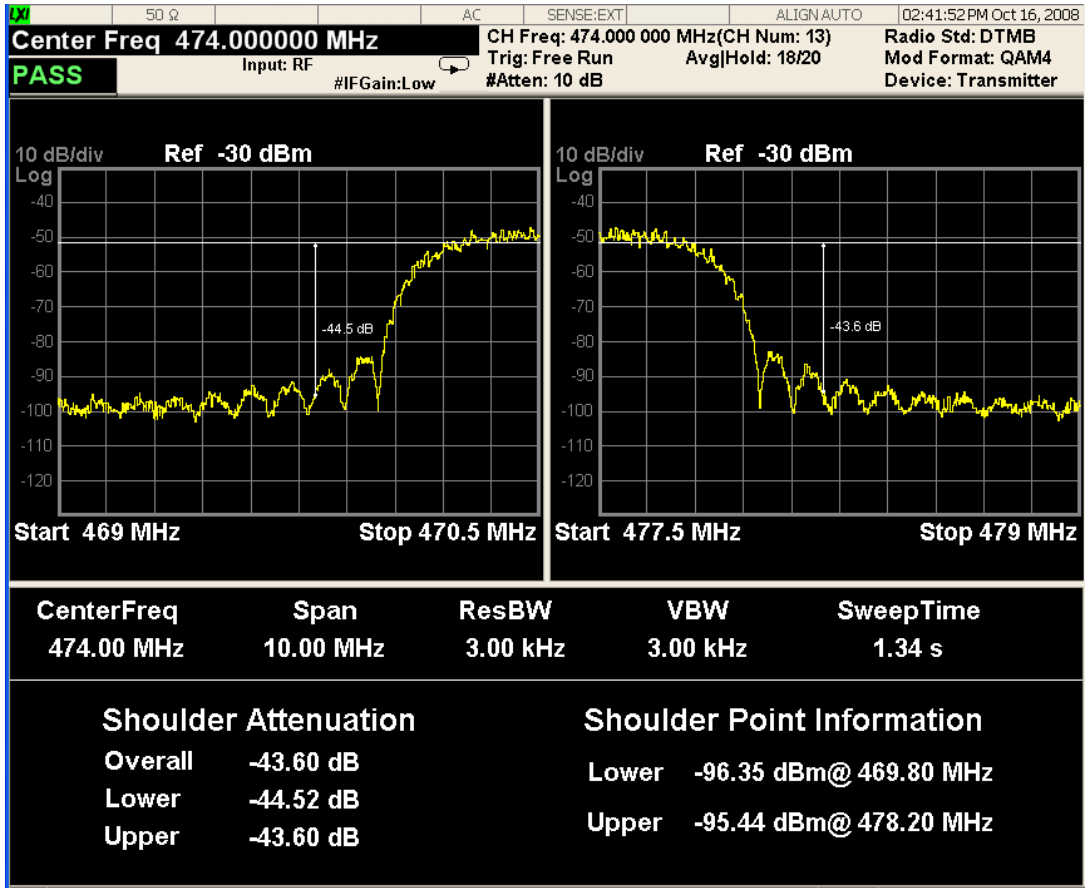

**NOTE**

The pass/fail function is valid only in DTMB (CTTB) and CMMB mode:

In DTMB (CTTB) mode, when the device type (under mode setup panel) is Transmitter, the pass/fail limit is -36 dBc, and for the other type - Exciter, the pass/fail limit is -48 dBc.

In CMMB mode, when the device type (under mode setup panel) is Transmitter, the pass/fail limit is -35dBc, and for the other type - Exciter, the pass/fail limit is -50dBc.

Lower Shoulder Trace Window

Corresponding Trace *	yellow - lower edge of the spectrum trace; white - assistant lines to indicate the lower shoulder attenuation; (Only for DVB-T/H) cyan - assistant beeline from shoulder range begin point to the range end point;
-----------------------	--

Upper Shoulder Trace Window

Corresponding Trace *	yellow - upper edge of the spectrum trace; white - assistant lines to indicate the upper shoulder attenuation; (Only for DVB-T/H) cyan - assistant beeline from shoulder range begin point to the range end point;
-----------------------	--



## Results Window

Name	Corresponding Results
CenterFreq (MHz)	The center frequency of the measurement
Span (MHz)	The span of the measurement
ResBW (kHz)	The resolution bandwidth of the measurement
VBW (kHz)	The video bandwidth of the measurement
SweepTime (ms)	The sweep time of the measurement
Overall Shoulder Attenuation (dB)	n=3, 1st element Shoulder attenuation result
Lower Shoulder Attenuation (dB)	n=3, 2nd element Lower shoulder attenuation result
Upper Shoulder Attenuation (dB)	n=3, 3rd element Upper shoulder attenuation result
Lower Shoulder Point Power (dBm) **	n=3, 4th element The power value of the point with maximum power level in the lower edge of the spectrum
Lower Shoulder Point Frequency (MHz) **	n=3, 5th element The frequency of the point with maximum power level in the lower edge of the spectrum
Upper Shoulder Point Power (dBm) **	n=3, 6th element The power value of the point with maximum power level in the upper edge of the spectrum
Upper Shoulder Point Frequency (MHz) **	n=3, 7th element The frequency of the point with maximum power level in the upper edge of the spectrum

\*: For DVB-T/H mode: All three traces are valid. The cyan line is connecting the measurement points 300kHz and 700kHz from each of the upper and lower edges of the spectrum (yellow trace).

For DTMB (CTTB), ISDB-T, and CMMB mode: There are only two traces: yellow trace and white trace.

\*\* : For DVB-T/H mode: Shoulder Point Information shows the information of the maximum power level point between the points at 300 kHz and 700 kHz from each of the upper and lower edges of the spectrum trace. It contains two parts: the frequency and the power level.

For DTMB (CTTB) mode: Shoulder Point Information shows the power level of the fixed point, which is  $\pm 4.2$  MHz away from center frequency for 8 MHz radio bandwidth and  $\pm 3.2$  MHz away from center frequency for 6 MHz radio bandwidth.

For ISDB-T mode: Shoulder Point Information shows the information of the maximum power level point between the frequency range of  $-3.3$  MHz to  $-3.5$  MHz away from center frequency of the lower channel

and of +3.3 MHz to +3.5 MHz away from the center frequency of the upper channel. It contains two parts: the frequency and the power level.

For CMMB mode: Shoulder Point Information shows the power level of the fixed point, which is  $\pm 4.2$  MHz away from center frequency for 8 MHz radio bandwidth. It contains the frequency and the power level of the point.

Key Path	View/Display
<b>Example</b>	DISP:CHP:VIEW SHOU DISP:CHP:VIEW?
Initial S/W Revision	A.02.00

### Spectrum Mask(DTMB (CTTB), DVB-T/H only)

Selects the Spectrum Mask view. This view consists of the following two windows:

"Trace Window" on page 643

"Results Window" on page 643

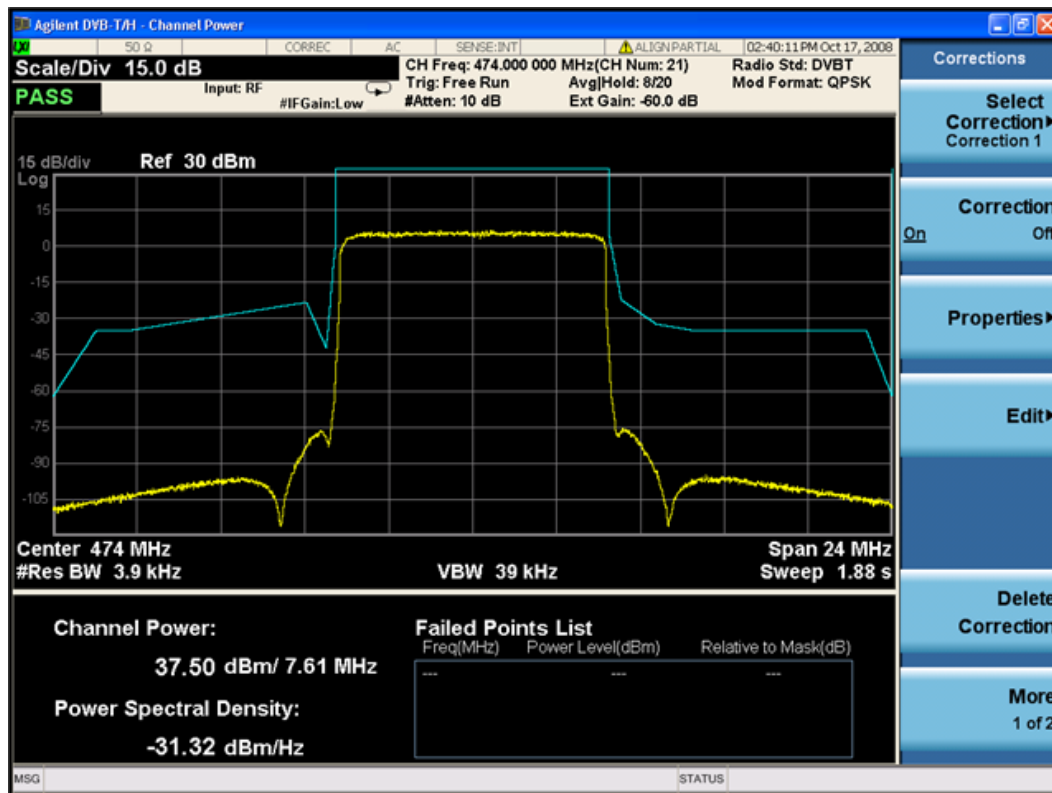

**NOTE**

If the current radio bandwidth is not 8 MHz, the limit line (Mask) is not available and the failed points list shows "---". The STATUS message "No Result; No mask for X MHz" appears. (X may be 5, 6 and 7 for DVB-T/H mode and 6 for DTMB (CTTB) mode.)

## Trace Window

Corresponding Trace	yellow - spectrum trace; cyan - limit line trace;
---------------------	--

## Results Window

Name	Corresponding Results
Channel Power	n=1, 1st element Total channel power in the specified integration bandwidth
	Channel Integration Bandwidth
Power Spectral Density	n=1, 2nd element The power in the specified unit bandwidth
Failed Points List *	n=7 The failed point's information: frequency, absolute power and relative power

\*: If the number of the failed points is less than twenty, all of them (frequency, power and relative power) will be shown in the failed points list; and if the number of the failed points is more than twenty, only the first ten and the last ten failed points will be shown.

Key Path	View/Display
<b>Example</b>	DISP:CHP:VIEW MASK DISP:CHP:VIEW?
Initial S/W Revision	A.02.00

## Mask - selection by Enum (Only for DVB-T/H mode)

Selects the mask line in the spectrum mask view. The following SCPI command allows you to select the desired mask by enumeration. It includes six kinds of limit line: L/SECAM/NICAM, G/PAL/NICAM, I/PAL/NICAM, G/PAL/A2, K/SECAM and K/PAL.

Key Path	View/Display, Spectrum Mask
Mode	DVB-T/H
<b>Remote Command</b>	:DISPlay:CHPower:VIEW:MASK[:SElect] LSNI   GPNI   IPNI   GPA2   KSKP :DISPlay:CHPower:VIEW:MASK[:SElect]?
<b>Example</b>	DISP:CHP:VIEW:MASK LSNI DISP:CHP:VIEW:MASK?
Dependencies	If current Radio BW is not 8 MHz, the STATUS message "No result" will be displayed. But the keys under the Spectrum Mask are still displayed.

Preset	LSNI
State Saved	Saved in instrument state.
Range	LSecam_Nicam   GPal_Nicam   IPal_Nicam   GPal_A2   KSecam_KPal
Initial S/W Revision	A.02.00

### Limit Mask (DTMB (CTTB), DVB-T/H only)

Turns the Mask Line On and Off.

Key Path	View/Display, Spectrum Mask
Mode	DVB-T/H, DTMB (CTTB)
<b>Remote Command</b>	:CALCulate:CHPower:MASK:STATe ON OFF 1 0 :CALCulate:CHPower:MASK:STATe?
<b>Example</b>	:CALC:CHP:MASK:STAT ON :CALC:CHP:MASK:STATe?
Notes	You must be in DVB-T/H mode and DTMB (CTTB) mode to use this command. Use :INSTrument:SElect to set the mode.
Preset	On
State Saved	Saved in instrument state.
Range	On Off
Initial S/W Revision	A.06.00

### Scroll

Accesses the Scroll menu, which contains features that enable you to navigate the display.

Key Path	View/Display, Spectrum Mask
Mode	DVB, DTMB
Initial S/W Revision	A.02.00

### Prev Page

Moves the display one page back to the previous page of the result metrics window in Spectrum Mask view.

Key Path	View/Display, Spectrum Mask, Scroll
Mode	DVB-T/H, DTMB (CTTB)
Initial S/W Revision	A.02.00

## Next Page

Moves the display one page forward to the next page of the result metrics window in Spectrum Mask view.

Key Path	View/Display, Spectrum Mask, Scroll
Mode	DVB-T/H, DTMB (CTTB)
Initial S/W Revision	A.02.00

## Scroll Up

Moves one line upward from the current line of the result metrics window in Spectrum Mask view.

Pressing the up arrow hard key has the same effect as this function, if no active function is shown. If an active function is shown, the up arrow hard key controls the active function, but has no effect on line movement.

Key Path	View/Display, Spectrum Mask, Scroll
Mode	DVB-T/H, DTMB (CTTB)
Initial S/W Revision	A.02.00

## Scroll Down

Moves one line downward from the current line of the result metrics window in Spectrum Mask view.

Pressing the down arrow hard key has the same effect as this function, if no active function is shown. If an active function is shown, the up arrow hard key controls the active function, but has no effect on line movement, as the Scroll Down function does.

Key Path	View/Display, Spectrum Mask, Scroll
Mode	DVB-T/H, DTMB (CTTB)
Initial S/W Revision	A.02.00

## First Page

Moves the display to the first page of the result metrics window in Spectrum Mask view.

Key Path	View/Display, Spectrum Mask, Scroll
Mode	DVB-T/H, DTMB (CTTB)
Initial S/W Revision	A.02.00

## Last Page

Moves the display to the last page of the result metrics window in Spectrum Mask view.

8 Channel Power Measurement  
View/Display

Key Path	View/Display, Spectrum Mask, Scroll
Mode	DVB-T/H, DTMB (CTTB)
Initial S/W Revision	A.02.00

## 9 ACP Measurement

ACP is a measurement of the amount of interference, or power, in an adjacent frequency channel. The results are displayed as a bar graph or as spectrum data, with measurement data at specified offsets. For measurement results and views, see ["View/Display" on page 867](#).

This topic contains the following sections:

["Measurement Commands for ACP" on page 648](#)

["Remote Command Results for ACP Measurement" on page 649](#)

## Measurement Commands for ACP

The following commands are used to retrieve the measurement results:

```
:CONFigure:ACP  
:CONFigure:ACP:NDEFault  
:INITiate:ACP  
:FETCh:ACP[n]?  
:READ:ACP[n]?  
:MEASure:ACP[n]?
```

For more measurement related commands, see the SENSE subsystem, and the section "[Remote Measurement Functions](#)" on page 2165.



## Remote Command Results for ACP Measurement

Condition	N	Results Returned
Mode = SA mode, Radio Std = None, Number of carriers = 1 and only offset A is on	Not specified or n = 1	Returns 3 comma-separated values that correspond to: Reference carrier power, lower-adjacent channel power (dBc), and upper-adjacent channel power (dBc).
Mode = DTMB (CTTB) or CMMB, Radio BW = 8 MHz, Number of carriers = 1 and Meas Type = Total power reference	Not specified or n = 1	Returns 32 comma-separated scalar results, in the following order. 1. 0.0 2. Total carrier power (dBm) 3. 0.0 4. Reference carrier power (dBm) 5. Lower offset A - relative power (dB) 6. Lower offset A - absolute power (dBm) 7. Upper offset A - relative power (dB) 8. Upper offset A - absolute power (dBm) 9. Lower offset B - relative power (dB) 10. Lower offset B - absolute power (dBm) 11. Upper offset B - relative power (dB) 12. Upper offset B - absolute power (dBm) ... 25. Lower offset F - relative power (dB) 26. Lower offset F - absolute power (dBm) 27. Upper offset F - relative power (dB) 28. Upper offset F - absolute power (dBm) 29. Inside Adjacent Channel - relative power (dB) 30. Inside Adjacent Channel - absolute power (dBm) 31. Outside Adjacent Channel - relative power (dB) 32. Outside Adjacent Channel - absolute power (dBm) If Radio Device = Exciter, the last four (29, 30, 31 and 32) results returned -999.0. If the results are not available, -999.0 is returned. Note: * Inside Adjacent Channel - absolute power: the maximum of the Lower offset A - absolute power and the Upper offset A - absolute power; ** Inside Adjacent Channel - relative power: the result of Reference carrier power subtracted from Inside Adjacent Channel - absolute power; *** Outside Adjacent Channel - absolute power: the root mean square of the absolute power of the offset B upper/lower, the offset C upper/lower and the offset D upper/lower; **** Outside Adjacent Channel - relative power: the result of Reference carrier power subtracted from Outside Adjacent Channel - absolute power;
Mode = DTMB (CTTB) or	not specified	Returns 32 comma-separated scalar results, in the following order.

Condition	N	Results Returned
CMMB, Radio BW = 8 MHz, Number of carriers = 1 and Meas Type = Power spectral density reference	or n = 1	<ol style="list-style-type: none"> <li>1. 0.0</li> <li>2. Total carrier power (dBm/Hz or dBm/MHz)</li> <li>3. 0.0</li> <li>4. Reference carrier power (dBm/Hz or dBm/MHz)</li> <li>5. Lower offset A - relative power (dB)</li> <li>6. Lower offset A - absolute power (dBm/Hz or dBm/MHz)</li> <li>7. Upper offset A - relative power (dB)</li> <li>8. Upper offset A - absolute power (dBm/Hz or dBm/MHz)</li> <li>9. Lower offset B - relative power (dB)</li> <li>10. Lower offset B - absolute power (dBm/Hz or dBm/MHz)</li> <li>11. Upper offset B - relative power (dB)</li> <li>12. Upper offset B - absolute power (dBm/Hz or dBm/MHz)</li> <li>...</li> <li>25. Lower offset F - relative power (dB)</li> <li>26. Lower offset F - absolute power (dBm/Hz or dBm/MHz)</li> <li>27. Upper offset F - relative power (dB)</li> <li>28. Upper offset F - absolute power (dBm/Hz or dBm/MHz)</li> <li>29. -999.0</li> <li>30. -999.0</li> <li>31. -999.0</li> <li>32. -999.0</li> </ol> <p>The last four (29, 30, 31 and 32) results always returned -999.0. If the results are not available, -999.0 is returned.</p>
Meas Type = Total power reference	Not specified or n = 1	<p>Returns 28 comma-separated scalar results, in the following order.</p> <ol style="list-style-type: none"> <li>1. 0.0</li> <li>2. Total carrier power (dBm)</li> <li>3. 0.0</li> <li>4. Reference carrier power (dBm)</li> <li>5. Lower offset A - relative power (dB)</li> <li>6. Lower offset A - absolute power (dBm)</li> <li>7. Upper offset A - relative power (dB)</li> <li>8. Upper offset A - absolute power (dBm)</li> <li>9. Lower offset B - relative power (dB)</li> <li>10. Lower offset B - absolute power (dBm)</li> <li>11. Upper offset B - relative power (dB)</li> <li>12. Upper offset B - absolute power (dBm)</li> <li>...</li> <li>25. Lower offset F - relative power (dB)</li> <li>26. Lower offset F - absolute power (dBm)</li> </ol>

Condition	N	Results Returned
		27. Upper offset F - relative power (dB) 28. Upper offset F - absolute power (dBm) If the results are not available, -999.0 is returned. When in MSR and LTE-Advanced FDD/TDD, this trace includes only outer offset results and their reference value(s).
Meas Type = Power spectral density reference	not specified or n = 1	Returns 28 comma-separated scalar results, in the following order. 1. 0.0 2. Total carrier power (dBm/Hz or dBm/MHz) 3. 0.0 4. Reference carrier power (dBm/Hz or dBm/MHz) 5. Lower offset A - relative power (dB) 6. Lower offset A - absolute power (dBm/Hz or dBm/MHz) 7. Upper offset A - relative power (dB) 8. Upper offset A - absolute power (dBm/Hz or dBm/MHz) 9. Lower offset B - relative power (dB) 10. Lower offset B - absolute power (dBm/Hz or dBm/MHz) 11. Upper offset B - relative power (dB) 12. Upper offset B - absolute power (dBm/Hz or dBm/MHz) ... 25. Lower offset F - relative power (dB) 26. Lower offset F - absolute power (dBm/Hz or dBm/MHz) 27. Upper offset F - relative power (dB) 28. Upper offset F - absolute power (dBm/Hz or dBm/MHz) If the results are not available, -999.0 is returned. When in MSR and LTE-Advanced FDD/TDD, this trace includes only outer offset results and their reference value(s).
Meas Method = FAST	not specified or n = 1	Returns 5 comma-separated results, in the following order: 1. Reference carrier - absolute power (dBm) 2. Lower offset A - absolute power (dBm) 3. Upper offset A - absolute power (dBm) 4. Lower offset B - absolute power (dBm) 5. Upper offset B - absolute power (dBm)
Mode = MSR, LTEAFDD, LTEATDD, Meas Type = Total power reference and Power Ref = Left & Right Carriers	Not specified or n = 1	Returns 28 comma-separated scalar results, in the following order. 1. 0.0 2. Total carrier power (dBm) 3. Left Reference carrier power (dBm) 4. Right Reference carrier power (dBm) 5. Lower offset A - relative power (dB) 6. Lower offset A - absolute power (dBm) 7. Upper offset A - relative power (dB)

Condition	N	Results Returned
		8. Upper offset A - absolute power (dBm) 9. Lower offset B - relative power (dB) 10. Lower offset B - absolute power (dBm) 11. Upper offset B - relative power (dB) 12. Upper offset B - absolute power (dBm) ... 25. Lower offset F - relative power (dB) 26. Lower offset F - absolute power (dBm) 27. Upper offset F - relative power (dB) 28. Upper offset F - absolute power (dBm) If the results are not available, -999.0 is returned.
Mode = MSR , LTEAFDD, LTEATDD, Meas Type = Power spectral density reference and Power Ref = Left & Right Carriers	not specified or n = 1	Returns 28 comma-separated scalar results, in the following order. 1. 0.0 2. Total carrier power (dBm/Hz or dBm/MHz) 3. Left reference carrier power (dBm/Hz or dBm/MHz) 4. Right reference carrier power (dBm/Hz or dBm/MHz) 5. Lower offset A - relative power (dB) 6. Lower offset A - absolute power (dBm/Hz or dBm/MHz) 7. Upper offset A - relative power (dB) 8. Upper offset A - absolute power (dBm/Hz or dBm/MHz) 9. Lower offset B - relative power (dB) 10. Lower offset B - absolute power (dBm/Hz or dBm/MHz) 11. Upper offset B - relative power (dB) 12. Upper offset B - absolute power (dBm/Hz or dBm/MHz) ... 25. Lower offset F - relative power (dB) 26. Lower offset F - absolute power (dBm/Hz or dBm/MHz) 27. Upper offset F - relative power (dB) 28. Upper offset F - absolute power (dBm/Hz or dBm/MHz) If the results are not available, -999.0 is returned. When in MSR and LTE-Advanced FDD/TDD, this trace includes only outer offset results and their reference value(s).
Meas Type = Total power reference	n = 2	Returns 48 scalar results, in the following order: 1. Channel (1) - relative power (dB) 2. Channel (1) - absolute power (dBm) 3. Channel (2) - relative power (dB) 4. Channel (2) - absolute power (dBm) ... 23. Channel (12) - relative power (dB) 24. Channel (12) - absolute power (dBm)

Condition	N	Results Returned
		25. Lower offset A - relative power (dB) 26. Lower offset A - absolute power (dBm) 27. Upper offset A - relative power (dB) 28. Upper offset A - absolute power (dBm) 29. Lower offset B - relative power (dB) 30. Lower offset B - absolute power (dBm) 31. Upper offset B - relative power (dB) 32. Upper offset B - absolute power (dBm) ... 45. Lower offset F - relative power (dB) 46. Lower offset F - absolute power (dBm) 47. Upper offset F - relative power (dB) 48. Upper offset F - absolute power (dBm) If the results are not available, -999.0 is returned. When in MSR and LTE-Advanced FDD/TDD, this trace includes only outer offset results and their reference value(s).
Meas Type = Power spectral density reference	n = 2	Returns 48 scalar results, in the following order: 1. Channel (1) - relative power (dB) 2. Channel (1) - absolute power (dBm/Hz or dBm/MHz) 3. Channel (2) - relative power (dB) 4. Channel (2) - absolute power (dBm/Hz or dBm/MHz) ... 23. Channel (12) - relative power (dB) 24. Channel (12) - absolute power (dBm/Hz or dBm/MHz) 25. Lower offset A - relative power (dB) 26. Lower offset A - absolute power (dBm/Hz or dBm/MHz) 27. Upper offset A - relative power (dB) 28. Upper offset A - absolute power (dBm/Hz or dBm/MHz) 29. Lower offset B - relative power (dB) 30. Lower offset B - absolute power (dBm/Hz or dBm/MHz) 31. Upper offset B - relative power (dB) 32. Upper offset B - absolute power (dBm/Hz or dBm/MHz) ... 45. Lower offset F - relative power (dB) 46. Lower offset F - absolute power (dBm/Hz or dBm/MHz) 47. Upper offset F - relative power (dB) 48. Upper offset F - absolute power (dBm/Hz or dBm/MHz) If the results are not available, -999.0 is returned. When in MSR and LTE-Advanced FDD/TDD, this trace includes only outer offset

Condition	N	Results Returned
Mode = DTMB (CTTB) or CMMB, Radio BW = 8 MHz and Meas Type = Total power reference	n = 3	<p>results.</p> <hr/> <p>Returns 28 scalar values of the pass/fail (0 = passed, or 1 = failed) determined by testing the relative to the reference carrier and by testing the absolute power limit of the offset frequencies (measured as total power in dB):</p> <ol style="list-style-type: none"> <li>1. Lower offset A - relative limit result</li> <li>2. Lower offset A - absolute limit result</li> <li>3. Upper offset A - relative limit result</li> <li>4. Upper offset A - absolute limit result</li> <li>5. Lower offset B - relative limit result</li> <li>6. Lower offset B - absolute limit result</li> <li>7. Upper offset B - relative limit result</li> <li>8. Upper offset B - absolute limit result</li> </ol> <p>...</p> <ol style="list-style-type: none"> <li>21. Lower offset F - relative limit result</li> <li>22. Lower offset F - absolute limit result</li> <li>23. Upper offset F - relative limit result</li> <li>24. Upper offset F - absolute limit result</li> <li>25. Inside Adjacent Channel - relative limit result</li> <li>26. Inside Adjacent Channel - absolute limit result</li> <li>27. Outside Adjacent Channel - relative limit result</li> <li>28. Outside Adjacent Channel - absolute limit result</li> </ol> <p>If Radio Device = Exciter, the last four (25, 26, 27 and 28) results returned -999.0.</p>
Mode = DTMB (CTTB) or CMMB, Radio BW = 8 MHz and Meas Type = Power spectral density reference	n = 3	<p>Returns 28 scalar values of the pass/fail (0 = passed, or 1 = failed) determined by testing the relative to the reference carrier and by testing the absolute power limit of the offset frequencies (measured as power spectral density in dB):</p> <ol style="list-style-type: none"> <li>1. Lower offset A - relative limit result</li> <li>2. Lower offset A - absolute limit result</li> <li>3. Upper offset A - relative limit result</li> <li>4. Upper offset A - absolute limit result</li> <li>5. Lower offset B - relative limit result</li> <li>6. Lower offset B - absolute limit result</li> <li>7. Upper offset B - relative limit result</li> <li>8. Upper offset B - absolute limit result</li> </ol> <p>...</p> <ol style="list-style-type: none"> <li>21. Lower offset F - relative limit result</li> <li>22. Lower offset F - absolute limit result</li> <li>23. Upper offset F - relative limit result</li> <li>24. Upper offset F - absolute limit result</li> <li>25. -999.0</li> </ol>

Condition	N	Results Returned
		26. -999.0 27. -999.0 28. -999.0 The last four results always returned -999.0.
Meas Type = Total power reference	n = 3	Returns 24 scalar values of the pass/fail (0 = passed, or 1 = failed) determined by testing the relative to the reference carrier and by testing the absolute power limit of the offset frequencies (measured as total power in dB): <ol style="list-style-type: none"> <li>1. Lower offset A - relative limit result</li> <li>2. Lower offset A - absolute limit result</li> <li>3. Upper offset A - relative limit result</li> <li>4. Upper offset A - absolute limit result</li> <li>5. Lower offset B - relative limit result</li> <li>6. Lower offset B - absolute limit result</li> <li>7. Upper offset B - relative limit result</li> <li>8. Upper offset B - absolute limit result</li> </ol> ... <ol style="list-style-type: none"> <li>21 Lower offset F - relative limit result</li> <li>22 Lower offset F - absolute limit result</li> <li>23 Upper offset F - relative limit result</li> <li>24 Upper offset F - absolute limit result</li> </ol> When in MSR and LTE-Advanced FDD/TDD, this trace includes only outer offset results.
Meas Type = Power spectral density reference	n = 3	Returns 24 scalar values of the pass/fail (0 = passed, or 1 = failed) determined by testing the relative to the reference carrier and by testing the absolute power limit of the offset frequencies (measured as power spectral density in dB): <ol style="list-style-type: none"> <li>1. Lower offset A - relative limit result</li> <li>2. Lower offset A - absolute limit result</li> <li>3. Upper offset A - relative limit result</li> <li>4. Upper offset A - absolute limit result</li> <li>5. Lower offset B - relative limit result</li> <li>6. Lower offset B - absolute limit result</li> <li>7. Upper offset B - relative limit result</li> <li>8. Upper offset B - absolute limit result</li> </ol> ... <ol style="list-style-type: none"> <li>21 Lower offset F - relative limit result</li> <li>22 Lower offset F - absolute limit result</li> <li>23 Upper offset F - relative limit result</li> <li>24 Upper offset F - absolute limit result</li> </ol> When in MSR and LTE-Advanced FDD/TDD, this trace includes only outer offset results.

Condition	N	Results Returned
	n = 4	Returns <Num Pts> comma-separated scalar values representing the Y values in Trace 1
	n = 5	Returns <Num Pts> comma-separated scalar values representing the Y values in Trace 2
	n = 6	Returns <Num Pts> comma-separated scalar values representing the Y values in Trace 3
Meas Type = Total power reference	n = 7	<p>Returns (2 * Number of Carriers) scalar results, in the following order:</p> <p>The Number of Carriers is the value filled in Carriers under Carrier Setup menu. If license N9060A-5FP is enabled, max value of Number of Carriers is 18, otherwise, max value of Number of Carriers is 12. In MSR mode, max value of Number of Carriers is 100. In LTE-Advanced FDD/TDD mode, max value of number of carriers is 5.</p> <ol style="list-style-type: none"> <li>1. Channel (1) - relative power (dB)</li> <li>2. Channel (1) - absolute power (dBm)</li> <li>3. Channel (2) - relative power (dB)</li> <li>4. Channel (2) - absolute power (dBm)</li> </ol> <p>...</p> <p>2 * Number of Carriers -1. Channel (Number of Carriers) - relative power (dB)</p> <p>2 * Number of Carriers. Channel (Number of Carriers) - absolute power (dBm)</p> <p>If the results are not available, 9.91E+37 is returned.</p>
Meas Type = Power spectral density reference	n = 7	<p>Returns (2 * Number of Carriers) scalar results, in the following order: The Number of Carriers is the value filled in Carriers under Carrier Setup menu.</p> <p>If license N9060A-5FP is enabled, max value of Number of Carriers is 18, otherwise, max value of Number of Carriers is 12. In MSR mode, max value of Number of Carriers is 100. In LTE-Advanced FDD/TDD mode, max value of number of carriers is 5.</p> <ol style="list-style-type: none"> <li>1. Channel (1) - relative power (dB)</li> <li>2. Channel (1) - absolute power (dBm/Hz or dBm/MHz)</li> <li>3. Channel (2) - relative power (dB)</li> <li>4. Channel (2) - absolute power (dBm/Hz or dBm/MHz)</li> </ol> <p>...</p> <p>2 * Number of Carriers -1. Channel (Number of Carriers) - relative power (dB)</p> <p>2 * Number of Carriers. Channel (Number of Carriers) - absolute power (dBm/Hz or dBm/MHz)</p> <p>If the results are not available, 9.91E+37 is returned</p>
Mode = MSR,LTEAFDD,LTEATDD	n = 8	<p>Returns scalar results, in the following order:</p> <ol style="list-style-type: none"> <li>1. 0.0</li> <li>2. Total carrier power (dBm)</li> <li>3. 0.0</li> </ol>



Condition	N	Results Returned
		<p>4. Reference carrier power (dBm, dBm/Hz or dBm/MHz)</p> <p>5. Inner Lower offset A - relative power (dB)</p> <p>6. Inner Lower offset A - absolute power (dBm, dBm/Hz or dBm/MHz)</p> <p>7. Inner Upper offset A - relative power (dB)</p> <p>8. Inner Upper offset A - absolute power (dBm, dBm/Hz or dBm/MHz)</p> <p>9. Inner Lower offset B - relative power (dB)</p> <p>10. Inner Lower offset B - absolute power (dBm, dBm/Hz or dBm/MHz)</p> <p>11. Inner Upper offset B - relative power (dB)</p> <p>12. Inner Upper offset B - absolute power (dBm, dBm/Hz or dBm/MHz)</p> <p>...</p> <p>25. Inner Lower offset F - relative power (dB)</p> <p>26. Inner Lower offset F - absolute power (dBm, dBm/Hz or dBm/MHz)</p> <p>27. Inner Upper offset F - relative power (dB)</p> <p>28. Inner Upper offset F - absolute power (dBm, dBm/Hz or dBm/MHz)</p> <p>When Power Ref is either Left &amp; Right Carriers or Max Power Carrier in Sub-block, the first four values are</p> <p>1. 0.0</p> <p>2. Total carrier power (dBm)</p> <p>3. Reference carrier in the lower sub-block (dBm, dBm/Hz or dBm/MHz)</p> <p>4. Reference carrier in the upper sub-block (dBm, dBm/Hz or dBm/MHz)</p> <p>Unit of absolute power results.</p> <p>dBm: Meas Type = Total Pwr Ref</p> <p>dBm/Hz: Meas Type = PSD Ref, PSD Unit = dBm/Hz</p> <p>dBm/MHz: Meas Type = PSD Ref, PSD Unit = dBm/MHz</p> <p>If the results are not available, 9.91E+37 is returned.</p>
Mode = MSR, LTEAFDD,LTEATDD	n = 9	<p>Returns scalar values of the pass/fail (0 = passed, or 1 = failed) determined by testing the relative to the reference carrier and by testing the absolute power limit of the offset frequencies.</p> <p>1. Inner Lower offset A - relative limit result</p> <p>2. Inner Lower offset A - absolute limit result</p> <p>3. Inner Upper offset A - relative limit result</p> <p>4. Inner Upper offset A - absolute limit result</p> <p>5. Inner Lower offset B - relative limit result</p> <p>6. Inner Lower offset B - absolute limit result</p> <p>7. Inner Upper offset B - relative limit result</p> <p>8. Inner Upper offset B - absolute limit result</p> <p>...</p> <p>21. Inner Lower offset F - relative limit result</p> <p>22. Inner Lower offset F - absolute limit result</p> <p>23. Inner Upper offset F - relative limit result</p>

Condition	N	Results Returned
		24. Inner Upper offset F - absolute limit result
Mode = MSR, LTEAFDD,LTEATDD	n = 10	<p>Returns scalar values of offset results. Numbers returned in this trace is 10 x actually measured offsets. Note that upper and lower sides of an offset are returned separately. For example, when only outer offset A is measured with offset side both, 10 x 2 = 20 values are returned.</p> <ol style="list-style-type: none"> <li>1. Inner = 1 or Outer = 2.</li> <li>2. Offset A~F. (A=1, B=2, ... F=6)</li> <li>3. Offset Side. Lower=1 or Upper=2</li> <li>4. Relative power or relative PSD (dBc or dB)</li> <li>5. Absolute power (dBm) or absolute PSD (dBm/Hz or dBm/MHz)</li> <li>6. Reference power (dBm) or reference PSD (dBm/Hz or dBm/MHz)</li> <li>7. Reference Index 1</li> <li>8. Reference Index 2</li> <li>9. 0 (Reserved)</li> <li>10. 0 (Reserved)</li> </ol> <p>...</p> <ol style="list-style-type: none"> <li>10(n-1)+1. Inner = 1 or Outer = 2.</li> <li>10(n-1)+2. Offset A~F. (A=1, B=2, ... F=6)</li> <li>10(n-1)+3. Offset Side. Lower=1 or Upper=2</li> <li>10(n-1)+4. Relative power or relative PSD (dBc or dB)</li> <li>10(n-1)+5. Absolute power (dBm) or absolute PSD (dBm/Hz or dBm/MHz)</li> <li>10(n-1)+6. Reference power (dBm) or reference PSD (dBm/Hz or dBm/MHz)</li> <li>10(n-1)+7. Reference Index 1</li> <li>10(n-1)+8. Reference Index 2</li> <li>10(n-1)+9. 0 (Reserved)</li> <li>10(n-1)+10. 0 (Reserved)</li> </ol> <p>Where n is number of offsets.</p> <p>Meas Type determines which type of power result is returned, i.e. power or PSD. Unit for PSD results is determined by PSD Unit.</p> <p>If result is not available, 9.91E+37 is returned.</p>

Key Path	Front-panel key
Initial S/W Revision	Prior to A.02.00
Modified at S/W Revision	A.13.00

## AMPTD Y Scale

Accesses a menu of functions that enable you to set the vertical scale parameters. The parameter values are measurement independent, except all Attenuation values and the Internal Preamp selections, which are the same across all measurements.

Key Path	Front-panel key
Initial S/W Revision	Prior to A.02.00

### Ref Value

Sets the value for the absolute power reference. However, since the Auto Scaling is defaulted to On, this value is automatically determined by the measurement result. When you set a value manually, Auto Scaling automatically changes to Off.

Key Path	AMPTD Y Scale
Mode	SA, WCDMA, C2K, WIMAX OFDMA, TD-SCDMA, 1xEVDO, DVB-T/H, DTMB (CTTB), ISDB-T, CMMB, LTE, LTE-TDD, Digital Cable TV, MSR, LTEAFDD, LTEATDD
<b>Remote Command</b>	:DISPlay:ACPower:VIEW[1]:WINDow[1]:TRACe:Y[:SCALe]:RLEVel <real> :DISPlay:ACPower:VIEW[1]:WINDow[1]:TRACe:Y[:SCALe]:RLEVel?
<b>Example</b>	DISP:ACP:VIEW:WIND:TRAC:Y:RLEV 100 DISP:ACP:VIEW:WIND:TRAC:Y:RLEV?
Notes	You must be in the mode that includes ACP measurements to use this command. Use :INSTrument:SElect to set the mode.
Couplings	When the Auto Scaling is On, this value is automatically determined by the measurement result. When you set a value manually, Auto Scaling automatically changes to Off.
Preset	10dBm
State Saved	Saved in instrument state.
Min	-250.00 dBm
Max	250.00 dBm
Initial S/W Revision	Prior to A.02.00
Modified at S/W Revision	A.02.00, A.03.00

### Attenuation

This menu controls the attenuator functions and interactions between the attenuation system components.

There are two attenuator configurations in the X-Series. One is a dual attenuator configuration consisting of a mechanical attenuator and an optional electronic attenuator. The other configuration uses a single attenuator with combined mechanical and electronic sections that controls all the attenuation functions. Different models in the X-Series come with different configurations.

See "Dual Attenuator Configurations:" on page 660

See "Single Attenuator Configuration:" on page 661

Most Attenuation settings are the same for all measurements – they do not change as you change measurements. Settings like these are called “Meas Global” and are unaffected by Meas Preset.

Key Path	AMPTD Y Scale
Scope	Meas Global
Dependencies	In measurements that support the I/Q inputs, this key is unavailable when I/Q is the selected input, and is replaced by the Range key in that case.
Readback Line	Contains a summary in [ ] brackets of the current total attenuation. See the descriptions of the , " <a href="#">(Mech) Atten</a> " on page 2102, and " <a href="#">Enable Elec Atten</a> " on page 2104 keys for more detail on the contributors to the total attenuation.  Note that when "Pre-Adjust for Min Clip" is on, this value can change at the start of every measurement.
Initial S/W Revision	Prior to A.02.00
Modified at S/W Revision	A.03.00

### Dual Attenuator Configurations:

Configuration 1: Mechanical attenuator + optional electronic attenuator

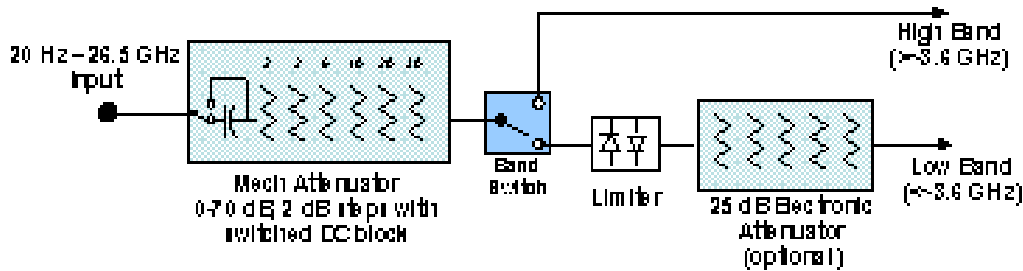

Configuration 2: Mechanical attenuator, no optional electronic attenuator

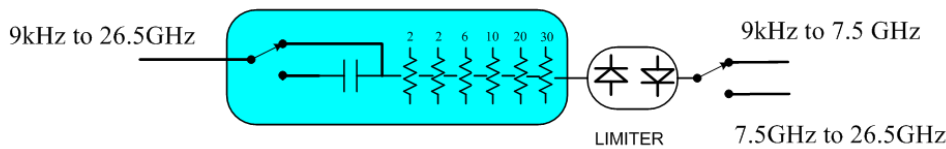

(note that Configuration 2 is not strictly speaking a dual-section attenuator, since there is no electronic section available. However, it behaves exactly like Configuration 1 without the Electronic Attenuator option EA3, therefore for the sake of this document it is grouped into the “Dual Attenuator” configuration)

### Single Attenuator Configuration:

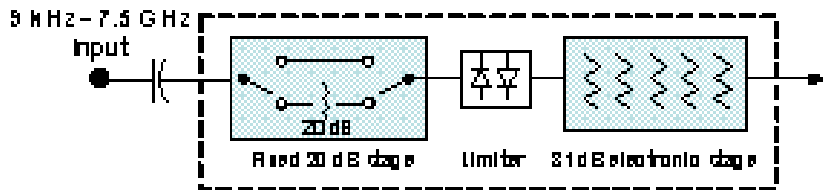

You can tell which attenuator configuration you have by pressing the Attenuation key, which (in most Modes) opens the Attenuation menu. If the first key in the Attenuation menu says Mech Atten you have the dual attenuator configuration. If the first key says Atten you have the single attenuator configuration.

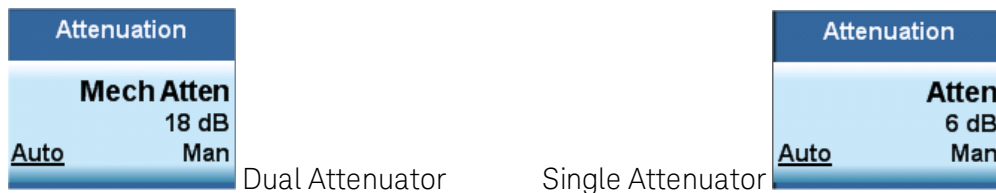

In the single attenuator configuration, you control the attenuation with a single control, as the fixed stage has only two states. In the dual attenuator configuration, both stages have significant range so you are given separate control of the mechanical and electronic attenuator stages.

When you have the dual attenuator configuration, you may still have only a single attenuator, because unless option EA3 (the Electronic Attenuator option) is available, and you purchase it, you will have only the mechanical attenuator.

### (Mech) Atten

This key is labeled Mech Atten in dual attenuator models and Atten in single attenuator models. In the dual attenuator configuration, this key only affects the mechanical attenuator.

This key lets you modify the attenuation applied to the RF input signal path. This value is normally auto coupled to the Ref Level, the Internal Preamp Gain, any External Gain that is entered, and the Max Mixer Level, as described in the table below.

See "[Attenuator Configurations and Auto/Man](#)" on page 663

Key Path	AMPTD Y Scale, Attenuation
<b>Remote Command</b>	<pre>[ :SENSe]:POWer[:RF]:ATTenuation &lt;rel_amp1&gt; [ :SENSe]:POWer[:RF]:ATTenuation? [ :SENSe]:POWer[:RF]:ATTenuation:AUTO OFF ON 0 1 [ :SENSe]:POWer[:RF]:ATTenuation:AUTO?</pre>
<b>Example</b>	<p>POW:ATT 20</p> <p>Dual attenuator configuration: sets the mechanical attenuator to 20 dB</p> <p>Single attenuator mode: sets the main attenuation to 20 dB (see below for definition of "main" attenuation).</p> <p>If the attenuator was in Auto, it sets it to Manual.</p>
<b>Dependencies</b>	Some measurements do not support the Auto setting of (Mech) Atten. In these measurements, the

---

Auto/Man selection is not available, and the Auto/Man line on the key disappears.

In dual attenuator configurations, when the electronic attenuator is enabled, the mechanical attenuator has no auto setting and the Auto/Man line on the key disappears. The state of Auto/Man is remembered and restored when the electronic attenuator is once again disabled. This is described in more detail in the ["Enable Elec Atten" on page 2104](#) key description.

See ["Attenuator Configurations and Auto/Man" on page 663](#) for more information on the Auto/Man functionality of Attenuation.

---

Couplings

When (Mech) Atten is in Auto, it uses the following algorithm to determine a value:

If the USB Preamp is connected to USB, use 0 dB.

Otherwise,  $Atten = ReferenceLevel + PreAmpGain + ExternalGain - RefLevelOffset - MaxMixerLevel + IF\ Gain$ .

Limit this value to be between 6 dB and the Max value. No value below 6 dB can ever be chosen by Auto.

The resulting value is rounded up to the largest value possible given the attenuation step setting. That is, 50.01 dB would change to 60 dB (for a 10 dB attenuation step).

The "IF Gain" term in the equation above is either 0 dB or +10 dB, depending on the settings of FFT IF Gain, Swept IF Gain, max Ref Level and the Auto/Man setting of Mech Atten.

In External Mixing and BBIQ, where the Attenuator is not in the signal path, the Attenuator setting changes as described above when (Mech) Atten is in Auto, but no changes are made to the actual attenuator hardware setting until the input is changed back to the RF Input.

---

Preset

The preset for Mech Attenuation is "Auto."

The Auto value of attenuation is:

CXA, EXA, MXA and PXA: 10 dB

---

State Saved

Saved in instrument state

---

Min

0 dB

The attenuation set by this key cannot be decreased below 6 dB with the knob or step keys. To get to a value below 6 dB it has to be directly entered from the keypad or via SCPI. This protects from adjusting the attenuation to a dangerously small value which can put the instrument at risk of damage to input circuitry. However, if the current mechanical attenuation is below 6 dB it can be increased with the knob and step keys, but not decreased.

---

Max

CXA N9000A-503/507: 50 dB

CXA N9000A-513/526: 70dB

EXA: 60 dB

MXA and PXA: 70 dB

In the single attenuator configuration, the total of ATT and EATT cannot exceed 50 dB, so if the EATT is set to 24 dB first, the main attenuation cannot be greater than 26 dB and will be reduced accordingly; if the main attenuator is set to 40 dB first, EATT cannot be greater than 10 dB.

---

Initial S/W Revision

Prior to A.02.00

Modified at S/W Revision

A.03.00

---

## Attenuator Configurations and Auto/Man

As described in the Attenuation key description, there are two distinct attenuator configurations available in the X-Series, the single attenuator and dual attenuator configurations. In dual attenuator configurations, we have the mechanical attenuation and the electronic attenuation, and the current total attenuation is the sum of the electronic + mechanical attenuation. In single attenuator configurations, we refer to the attenuation set using the (Mech) Atten key (or POW:ATT SCPI) as the “main” attenuation; and the attenuation that is set by the SCPI command POW:EATT as the “soft” attenuation (the POW:EATT command is honored even in the single attenuator configuration, for compatibility purposes). Then the current total attenuation is the sum of the main + soft attenuation. See the Elec Atten key description for more on “soft” attenuation.

In the dual attenuator configuration, when the electronic attenuator is enabled, there is no Auto/Man functionality for the mechanical attenuator, and the third line of the key label (the Auto/Man line) disappears:

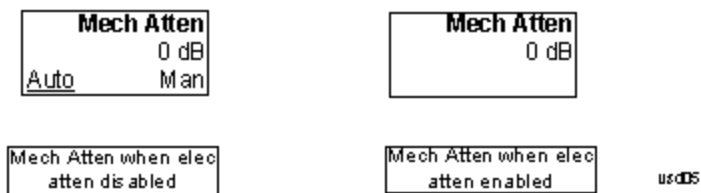

## Enable Elec Atten

Enables the Electronic Attenuator.

The electronic attenuator offers finer steps than the mechanical attenuator, has no acoustical noise, is faster, and is less subject to wear. These advantages primarily aid in remote operation and are negligible for front panel use. See ["Using the Electronic Attenuator: Pros and Cons" on page 665](#) for a detailed discussion of the pros and cons of using the electronic attenuator.

For the single attenuator configuration, for SCPI backwards compatibility, the “soft” attenuation feature replaces the dual attenuator configuration’s electronic attenuator. All the same couplings and limitations apply. See ["Attenuator Configurations and Auto/Man" on page 2103](#)

See ["More Information" on page 664](#)

Key Path	AMPTD Y Scale, Attenuation
Remote Command	[ :SENSe ] :POWer [ :RF ] :EATTenuation :STATE OFF   ON   0   1 [ :SENSe ] :POWer [ :RF ] :EATTenuation :STATE ?
Example	POW:EATT:STAT ON
Dependencies	This key only appears in Dual Attenuator models with an Electronic Attenuator installed. It does not appear in models with the Single Attenuator configuration, as in the single attenuator configuration there is no “electronic attenuator” there is only a single integrated attenuator (which has both a mechanical and electronic stage). However, in the single attenuator configuration, EATT SCPI commands are accepted for compatibility with other X-series instruments and set a “soft” attenuation as described in <a href="#">"Attenuator Configurations and Auto/Man" on page 2103</a> . The electronic attenuator (and the “soft” attenuation function provided in single attenuator configurations) is unavailable above 3.6 GHz. Therefore, if the Stop Frequency of the analyzer is > 3.6 GHz then the Enable Elec Atten key will be OFF and grayed out.

---

	<p>If the Internal Preamp is on, meaning it is set to Low Band or Full, the electronic attenuator (and the “soft” attenuation function provided in single attenuator configurations) is unavailable. In this case the Enable Elec Atten key will be OFF and grayed out.</p> <p>If either of the above is true, if the SCPI command is sent, an error indicating that the electronic attenuator is unavailable will be sent.</p> <p>If the electronic/soft Attenuator is enabled, then the Stop Freq of the analyzer is limited to 3.6 GHz and the Internal Preamp is unavailable.</p> <p>The SCPI-only “soft” electronic attenuation for the single-attenuator configuration is not available in all measurements; in particular, it is not available in the Swept SA measurement.</p>
Couplings	Enabling and disabling the Electronic Attenuator affects the setting of the Mechanical Attenuator (in dual attenuator configurations). This is described in more detail below this table.
Preset	OFF for Swept SA measurement; ON for all other measurements that support the electronic attenuator
State Saved	Saved in instrument state
Initial S/W Revision	Prior to A.02.00
Modified at S/W Revision	A.03.00

---

## More Information

### Mechanical Attenuator Transition Rules

When the Electronic Attenuator is enabled, the Mechanical Attenuator transitions to a state that has no Auto function. Below are the rules for transitioning the Mechanical Attenuator. NOTE that the information below ONLY applies to the dual attenuator configurations, and ONLY when the Electronic Attenuator is installed:

#### When the Electronic Attenuation is enabled from a disabled state:

- The Mechanical Attenuator is initialized to 10 dB (this is its optimal performance setting). You can then set it as desired with SCPI, numeric keypad, step keys, or knob, and it behaves as it normally would in manual mode
- The Auto/Man state of (Mech) Atten is saved
- The Auto/Man line on the (Mech) Atten key disappears and the auto rules are disabled
- The Electronic Attenuator is set to 10 dB less than the previous value of the Mechanical Attenuator, within the limitation that it must stay within the range of 0 to 24 dB of attenuation.

#### Examples in the dual attenuator configuration:

- Mech Atten at 20 dB. Elec Atten enabled, Mech Atten set to 10 dB, and Elec Atten set to 10 dB. New total attenuation equals the value before Elec Atten enabled.
- Mech Atten at 0 dB. Elec Atten enabled, Mech Atten set to 10 dB, and Elec Atten set to 0 dB. New total attenuation does not equal the value before Elec Atten enabled.
- Mech Atten at 40 dB. Elec Atten enabled, Mech Atten set to 10 dB, and Elec Atten set to 24 dB. New total attenuation does not equal the value before Elec Atten enabled.



### When the Electronic Attenuation is disabled from an enabled state:

- The Elec Atten key is grayed out
- The Auto/Man state of (Mech) Atten is restored
- If now in Auto, (Mech) Atten recouples
- If now in Man, (Mech) Atten is set to the value of total attenuation that existed before the Elec Atten was disabled. The resulting value is rounded up to the smallest value possible given the (Mech) Atten Step setting - (That is, 57 dB changes to 58 dB when (Mech) Atten Step is 2 dB.)

### Using the Electronic Attenuator: Pros and Cons

The electronic attenuator offers finer steps than the mechanical attenuator, has no acoustical noise, is faster, and is less subject to wear.

The “finer steps” advantage of the electronic attenuator is beneficial in optimizing the alignment of the analyzer dynamic range to the signal power in the front panel as well as remote use. Thus, you can achieve improved relative signal measurement accuracy. Compared to a mechanical attenuator with 2 dB steps, the 1 dB resolution of the electronic attenuator only gives better resolution when the odd-decibel steps are used. Those odd-decibel steps are less accurately calibrated than the even-decibel steps, so one tradeoff for this superior relative accuracy is reduced absolute amplitude accuracy.

Another disadvantage of the electronic attenuator is that the spectrum analyzer loses its “Auto” setting, making operation less convenient.

Also, the relationship between the dynamic range specifications (TOI, SHI, compression and noise) and instrument performance are less well-known with the electrical attenuator. With the mechanical attenuator, TOI, SHI and compression threshold levels increase dB-for-dB with increasing attenuation, and the noise floor does as well. With the electronic attenuator, there is an excess attenuation of about 1 to 3 dB between 0 and 3.6 GHz, making the effective TOI, SHI, and so forth, less well known. Excess attenuation is the actual attenuation relative to stated attenuation. Excess attenuation is accounted for in the analyzer calibration

### Elec Atten

Controls the Electronic Attenuator in dual attenuator configurations. This key does not appear in single attenuator configurations, as the control of both the mechanical and electronic stages of the single attenuator is integrated into the single Atten key.

Key Path	AMPTD Y Scale, Attenuation
<b>Remote Command</b>	<code>[:SENSe]:POWer[:RF]:EATTenuation &lt;rel_ampl&gt;</code> <code>[:SENSe]:POWer[:RF]:EATTenuation?</code>
<b>Notes</b>	Electronic Attenuation's specification is defined only when Mechanical Attenuation is 6 dB.
<b>Dependencies</b>	This key only appears in Dual Attenuator models with an Electronic Attenuator installed. It does not appear in models with the Single Attenuator configuration, as in the single attenuator configuration there is no “electronic attenuator” there is only a single integrated attenuator (which has both a mechanical and electronic stage). However, in the single attenuator configuration, EATT SCPI commands are accepted for compatibility with other X-series instruments and set a “soft” attenuation as described in <a href="#">"Attenuator Configurations and Auto/Man" on page 2103</a> . The “soft” attenuation is treated as an addition to the “main” attenuation value set by the Atten softkey or the

	POW:ATT SCPI command and affects the total attenuation displayed on the Attenuation key and the Meas Bar. When Enable Elec Atten is off or grayed out, the Elec Atten key is grayed out.
Preset	0 dB
State Saved	Saved in instrument state
Min	0 dB
Max	Dual attenuator configuration: 24 dB Single attenuator configuration: the total of ATT and EATT cannot exceed 50 dB, so if the EATT is set to 24 dB first, the main attenuation cannot be greater than 26 dB and will be reduced accordingly; if the main attenuator is set to 40 dB first, EATT cannot be greater than 10 dB
Initial S/W Revision	Prior to A.02.00
Modified at S/W Revision	A.03.00

### Adjust Atten for Min Clip

Sets the combination of mechanical and electronic attenuation and gain based on the current measured signal level so that clipping will be at a minimum.

This is an "immediate action" function, that is, it executes once, when the key is pressed.

This key is grayed out in measurements that do not support this functionality. The spectrum analyzer measurement, Swept SA, does not support this functionality.

Key Path	AMPTD Y Scale, Attenuation
Remote Command	<code>[ :SENSe ] :POWer [ :RF ] :RANGe:OPTimize IMMEDIATE</code>
Initial S/W Revision	Prior to A.02.00
Modified at S/W Revision	A.03.00

### Pre-Adjust for Min Clip

If this function is on, it does the adjustment described under "[Adjust Atten for Min Clip](#)" on page 2107 each time a measurement restarts. Therefore, in Continuous measurement mode, it only executes before the first measurement.

In dual attenuator models, you can set Elec+Mech Atten, in which case both attenuators participate in the autoranging, or Elec Atten Only, in which case the mechanical attenuator does not participate in the autoranging. This latter case results in less wear on the mechanical attenuator and is usually faster.

This key is grayed out in measurements that do not support this functionality. The spectrum analyzer measurement, Swept SA, does not support this functionality.

Key Path	AMPTD Y Scale, Attenuation
Remote Command	<code>[ :SENSe ] :POWer [ :RF ] :RANGe:OPTimize:ATTenuation OFF   ELECTRical   COMBined</code>

	<code>[ :SENSe ] :POWer [ :RF ] :RANGe:OPTimize:ATTenuation?</code>
Notes	The SCPI parameter <code>ELECTrical</code> sets this function to On in single attenuator models. The SCPI parameter <code>COMBined</code> is mapped to <code>ELECTrical</code> in single attenuator models; if you send <code>COMBined</code> , it sets the function to On and returns <code>ELEC</code> to a query.
Dependencies	This key only appears in Dual Attenuator models with an Electronic Attenuator installed. In instruments with Dual Attenuator model, when Enable Elec Atten is off or grayed out, the Pre-Adjust for Min Clip key is grayed out.
Preset	OFF for Swept SA measurement; ON for all other measurements that support Pre-Adjust for Min Clip
State Saved	Saved in instrument state
Range	Dual attenuator models: Off   Elec Atten Only   Mech + Elec Atten Single attenuator models: Off   On
Initial S/W Revision	Prior to A.02.00
Modified at S/W Revision	A.03.00

<b>Remote Command</b>	<code>[ :SENSe ] :POWer [ :RF ] :RANGe:AUTO ON OFF 1 0</code> <code>[ :SENSe ] :POWer [ :RF ] :RANGe:AUTO?</code>
Notes	ON aliases to "Elec Atten Only" ( <code>:POW:RANG:OPT:ATT ELEC</code> ) OFF aliases to "Off" ( <code>:POW:RANG:OPT:ATT OFF</code> ) The query <code>:POW:RANG:AUTO?</code> returns true if <code>:POW:RANG:OPT:ATT</code> is not "Off"
Initial S/W Revision	Prior to A.02.00

## Off

Turns Pre-Adjust for Min Clip off. This is the default setting.

This key is grayed out in measurements that do not support this functionality. The spectrum analyzer measurement, Swept SA, does not support this functionality.

Key Path	AMPTD Y Scale, Attenuation, Pre-Adjust for Min Clip
Example	<code>:POW:RANGe:OPT:ATT OFF</code>
Initial S/W Revision	Prior to A.02.00

## Elec Atten Only

Selects only the electric attenuator to participate in auto ranging. This offers less wear on the mechanical attenuator and is usually faster.

This key is grayed out in measurements that do not support this functionality. The spectrum analyzer measurement, Swept SA, does not support this functionality.

Key Path	AMPTD Y Scale, Attenuation, Pre-Adjust for Min Clip
Example	:POW:RANGe:OPT:ATT ELEC
Initial S/W Revision	Prior to A.02.00

### Mech + Elec Atten

In dual attenuator models, this selects both attenuators participate in the autoranging.

This key is grayed out in measurements that do not support this functionality. The spectrum analyzer measurement, Swept SA, does not support this functionality.

Key Path	AMPTD Y Scale, Attenuation, Pre-Adjust for Min Clip
Example	:POW:RANGe:OPT:ATT COMB
Initial S/W Revision	Prior to A.02.00

### (Mech) Atten Step

This controls the step size used when making adjustments to the input attenuation.

This key is labeled Mech Atten Step in dual attenuator models and Atten Step in single attenuator models. In the dual attenuator configuration, this key only affects the step size of the mechanical attenuator.

Key Path	AMPTD Y Scale, Attenuation
<b>Remote Command</b>	[ :SENSe ] :POWer [ :RF ] :ATTenuation :STEP [ :INCRement ] 10 dB   2 dB [ :SENSe ] :POWer [ :RF ] :ATTenuation :STEP [ :INCRement ] ?
<b>Example</b>	POW:ATT:STEP 2
Notes	Note this feature works like a 1-N choice from the front panel, but it takes a specific value (in dB) when used remotely. The only valid values are 2 and 10.
Dependencies	Blanked in CXA and EXA if option FSA (2 dB steps) is not present. If blanked, attempts to set it via SCPI will yield an error.
Couplings	When the attenuation step size changes, the current mechanical attenuation value is adjusted (if necessary) to be quantized to the new step size. That is, if step is set to 10 dB, mech atten is increased if necessary so it is a multiple of 10 dB
Preset	PXA and MXA: 2 dB EXA and CXA: 10 dB (2 dB with option FSA)
State Saved	Saved in instrument state
Initial S/W Revision	Prior to A.02.00
Modified at S/W Revision	A.03.00

## Scale/Div

Sets the units-per-division of the vertical scale in the logarithmic display. However, since the Auto Scaling is defaulted to On, this value is automatically determined by the measurement result. When you set a value manually, Auto Scaling automatically changes to Off.

Key Path	AMPTD Y Scale
Mode	SA, WCDMA, C2K, WIMAX OFDMA, TD-SCDMA, 1xEVDO, DVB-T/H, DTMB (CTTB), ISDB-T, CMMB, LTE, LTE-TDD, Digital Cable TV, MSR, LTEAFDD, LTEATDD
Remote Command	:DISPlay:ACPower:VIEW[1]:WINDow[1]:TRACe:Y[:SCALe]:PDIVision <rel_ampl> :DISPlay:ACPower:VIEW[1]:WINDow[1]:TRACe:Y[:SCALe]:PDIVision?
Example	DISP:ACP:VIEW:WIND:TRAC:Y:PDIV 5 DISP:ACP:VIEW:WIND:TRAC:Y:PDIV?
Notes	You must be in the mode that includes ACP measurements to use this command. Use :INSTrument:SElect to set the mode.
Couplings	When the Auto Scaling is On, this value is automatically determined by the measurement result. When you set a value manually, Auto Scaling automatically changes to Off.
Preset	10.00 dB
State Saved	Saved in instrument state.
Min	0.10 dB
Max	20.00 dB
Initial S/W Revision	Prior to A.02.00
Modified at S/W Revision	A.02.00, A.03.00

## Presel Center

When this key is pressed, the centering of the preselector filter is adjusted to optimize the amplitude accuracy at the frequency of the selected marker. If the selected marker is not on when Presel Center is pressed, the analyzer will turn on the selected marker, perform a peak search, and then perform centering on the marker's center frequency. If the selected marker is already on and between the start and stop frequencies of the analyzer, the analyzer performs the preselector calibration on that marker's frequency. If the selected marker is already on, but outside the frequency range between Start Freq and Stop Freq, the analyzer will first perform a peak search, and then perform centering on the marker's center frequency.

The value displayed on the Presel Adjust key will change to reflect the new preselector tuning (see Presel Adjust).

A number of considerations should be observed to ensure proper operation. See ["Proper Preselector Operation" on page 670](#).

Key Path	AMPTD Y Scale
Remote Command	[:SENSe]:POWer[:RF]:PCENter
Example	POW:PCEN
Notes	Note that the rules outlined above under the key description apply for the remote command as well

---

	as the key. The result of the command is dependent on marker position, and so forth. Any message shown by the key press is also shown in response to the remote command.
Dependencies	<ul style="list-style-type: none"><li>• Grayed out if the microwave preselector is off. )</li><li>• If the selected marker's frequency is below Band 1, advisory message 0.5001 is generated and no action is taken.</li><li>• Grayed out if entirely in Band 0.</li><li>• Blank in models that do not include a preselector, such as option 503. If the SCPI is sent in these instruments, it is accepted without error, and the query always returns 0.</li><li>• Grayed out in the Spectrogram View.</li></ul>
Couplings	The active marker position determines where the centering will be attempted. If the analyzer is in a measurement such as averaging when centering is initiated, the act of centering the preselector will restart averaging but the first average trace will not be taken until the centering is completed.
Status Bits/OPC dependencies	When centering the preselector, *OPC will not return true until the process is complete and a subsequent measurement has completed, nor will results be returned to a READ or MEASURE command. The Measuring bit should remain set while this command is operating and should not go false until the subsequent sweep/measurement has completed.
Initial S/W Revision	Prior to A.02.00
Modified at S/W Revision	A.03.00

---

## Proper Preselector Operation

A number of considerations should be observed to ensure proper operation:

1. If the selected marker is off, the analyzer will turn on a marker, perform a peak search, and adjust the preselector using the selected marker's frequency. It uses the "highest peak" peak search method unqualified by threshold or excursion, so that there is no chance of a 'no peak found' error. It continues with that peak, even if it is the peak of just noise. Therefore, for this operation to work properly, there should be a signal on screen in a preselected range for the peak search to find.
2. If the selected marker is already on, the analyzer will attempt the centering at that marker's frequency. There is no preselector for signals below about 3.6 GHz, therefore if the marker is on a signal below 3.6 GHz, no centering will be attempted and an advisory message generated
3. In some models, the preselector can be bypassed. If it is bypassed, no centering will be attempted in that range and a message will be generated.

## Preselector Adjust

Allows you to manually adjust the preselector filter frequency to optimize its response to the signal of interest. This function is only available when "[Presel Center](#)" on page 2111 is available.

For general purpose signal analysis, using Presel Center is recommended. Centering the filter minimizes the impact of long-term preselector drift. Presel Adjust can be used instead to manually optimize the

preselector. One application of manual optimization would be to peak the preselector response, which both optimizes the signal-to-noise ratio and minimizes amplitude variations due to small (short-term) preselector drifting.

Key Path	AMPTD Y Scale
Scope	Meas Global
<b>Remote Command</b>	<code>[ :SENSe ] :POWer [ :RF ] :PADJust &lt;freq&gt;</code> <code>[ :SENSe ] :POWer [ :RF ] :PADJust?</code>
<b>Example</b>	POW:PADJ 100KHz POW:PADJ?
Notes	The value on the key reads out to 0.1 MHz resolution.
Dependencies	<ul style="list-style-type: none"> <li>• Grayed out if microwave preselector is off. )</li> <li>• Grayed out if entirely in Band 0.</li> <li>• Blank in models that do not include a preselector, such as option 503. If the SCPI is sent in these instruments, it is accepted without error, and the query always returns 0.</li> <li>• Grayed out in the Spectrogram View.</li> </ul>
Preset	0 MHz
State Saved	The Presel Adjust value set by Presel Center, or by manually adjusting Presel Adjust, is not saved in instrument state, and does not survive a Preset or power cycle.
Min	-500 MHz
Max	500 MHz
Default Unit	Hz
<b>Backwards Compatibility SCPI</b>	<code>[ :SENSe ] :POWer [ :RF ] :MW:PADJust</code> <code>[ :SENSe ] :POWer [ :RF ] :MMW:PADJust</code> PSA had multiple preselectors, but the X-Series has only one. These commands simply alias to <code>[ :SENSe ] :POWer [ :RF ] :PADJust</code>
Initial S/W Revision	Prior to A.02.00
Modified at S/W Revision	A.03.00

<b>Remote Command</b>	<code>[ :SENSe ] :POWer [ :RF ] :PADJust:PRESelector MWAVE   MMWave   EXTernal</code> <code>[ :SENSe ] :POWer [ :RF ] :PADJust:PRESelector?</code>
Notes	PSA had multiple preselectors, and you could select which preselector to adjust. Since the X-Series has only one mm/uW preselector, the preselector selection softkey is no longer available. However, to provide backward compatibility, we accept the legacy remote commands. The command form has no effect, the query always returns MWAVE
Initial S/W Revision	Prior to A.02.00

## Y Axis Unit

Displays the menu keys that enable you to change the vertical (Y) axis amplitude unit. The analyzer retains the entered Y Axis Unit separately for both Log and Lin amplitude scale types. For example, if Scale Type has been set to Log, and you set Y Axis Unit to dBm, pressing Scale Type (Log) sets the Y Axis Unit to dBm. If Scale Type has been set to Lin and you set Y Axis Unit to V, pressing Scale Type (Lin) sets the Y Axis Unit to V. Pressing Scale Type (Log) again sets the Y axis unit back to dBm.

### NOTE

The units of current (A, dBmA, dBuA) are calculated based on 50 ohms input impedance.

All four of the EMI units (dBμA/m, dBμV/m, dBG, dBpT) are treated by the instrument exactly as though they were dBuV. The user must load an appropriate correction factor using Amplitude Corrections for accurate and meaningful results.

If a SCPI command is sent to the analyzer that uses one of the EMI units as a terminator, the analyzer treats it as though DBUV had been sent as the terminator.

Key Path	AMPTD Y Scale
Mode	SA
Scope	Meas Global
Remote Command	:UNIT:POWer DBM   DBMV   DBMA   V   W   A   DBUV   DBUA   DBPW   DBUVM   DBUAM   DBPT   DBG  :UNIT:POWer?
Example	UNIT:POW dBmV UNIT:POW?
Notes	The Y axis unit has either logarithmic or linear characteristics. The set of units that is logarithmic consists of dBm, dBmV, dBmA, dBμV, dBμA, dBμV/m, dBμA/m, dBpT, and dBG. The set of units that are linear consists of V, W, and A. The chosen unit will determine how the reference level and all the amplitude-related outputs like trace data, marker data, etc. read out.
Notes	The settings of Y Axis Unit and Scale Type, affect how the data is read over the remote interface. When using the remote interface no unit is returned, so you must know what the Y axis unit is to interpret the results:  Example 1, set the following: Scale Type (Log) Y Axis Unit, dBm Scale/Div, 1 dB Ref Level, 10 dBm  This sets the top line to 10 dBm with each vertical division representing 1 dB. Thus, if a point on trace 1 is on the fifth graticule line from the top, it represents 5 dBm and will read out remotely as 5.  Example 2, set the following: Scale Type (Lin) Y Axis Unit, Volts Ref Level, 100 mV (10 mV/div)  This sets the top line to 100 mV and the bottom line to 0 V, so each vertical division represents 10 mV. Thus, if a point on trace 1 is on the fifth graticule line from the top, it represents 50 mV and will read out remotely as 50.



Dependencies	If an amplitude correction with an Antenna Unit other than None is applied and enabled, then that antenna unit is forced and the key with that unit is the only Y Axis Unit available. All other Y Axis Unit keys are grayed out.  If an amplitude correction with an Antenna Unit other than None is applied and enabled, and you then turn off that correction or set Apply Corrections to No, the Y Axis Unit that existed before the Antenna Unit was applied is restored.
Couplings	The analyzer retains the entered Y Axis Unit separately for both Log and Lin amplitude scale types
Preset	dBm for log scale, V for linear. The true 'preset' value is dBm, since at preset the Y Scale type is set to logarithmic.
State Saved	Saved in instrument state
Readback line	1-of-N selection
Initial S/W Revision	Prior to A.02.00
Modified at S/W Revision	A.02.00, A.04.00, A.11.00

## dBm

Sets the amplitude unit for the selected amplitude scale (log/lin) to dBm.

Key Path	AMPTD Y Scale, Y Axis Unit
<b>Example</b>	UNIT:POW DBM
Dependencies	Grayed out if an Amplitude Correction with an Antenna Unit is ON.
Readback	dBm
Initial S/W Revision	Prior to A.02.00
Modified at S/W Revision	A.02.00

## dBmV

Sets the amplitude unit for the selected amplitude scale (log/lin) to dBmV.

Key Path	AMPTD Y Scale, Y Axis Unit
<b>Example</b>	UNIT:POW DBMV
Dependencies	Grayed out if an Amplitude Correction with an Antenna Unit is ON.
Readback	dBmV
Initial S/W Revision	Prior to A.02.00
Modified at S/W Revision	A.02.00

## dBmA

Sets the amplitude unit for the selected amplitude scale (log/lin) to dBmA.

Key Path	AMPTD Y Scale, Y Axis Unit
<b>Example</b>	UNIT:POW DBMA
Dependencies	Grayed out if an Amplitude Correction with an Antenna Unit is ON.
Readback	dBmA
Initial S/W Revision	Prior to A.02.00
Modified at S/W Revision	A.02.00

## W

Sets the amplitude unit for the selected amplitude scale (log/lin) to watt.

Key Path	AMPTD Y Scale, Y Axis Unit
<b>Example</b>	UNIT:POW W
Dependencies	Grayed out if an Amplitude Correction with an Antenna Unit is ON.
Readback	W
Initial S/W Revision	Prior to A.02.00
Modified at S/W Revision	A.02.00

## V

Sets the amplitude unit for the selected amplitude scale (log/lin) to volt.

Key Path	AMPTD Y Scale, Y Axis Unit
<b>Example</b>	UNIT:POW V
Dependencies	Grayed out if an Amplitude Correction with an Antenna Unit is ON.
Readback	V
Initial S/W Revision	Prior to A.02.00
Modified at S/W Revision	A.02.00

## A

Sets the amplitude unit for the selected amplitude scale (log/lin) to Ampere.

Key Path	AMPTD Y Scale, Y Axis Unit
<b>Example</b>	UNIT:POW A
Dependencies	Grayed out if an Amplitude Correction with an Antenna Unit is ON.
Readback	A
Initial S/W Revision	Prior to A.02.00
Modified at S/W Revision	A.02.00

## dB $\mu$ V

Sets the amplitude unit for the selected amplitude scale (log/lin) to dB $\mu$ V.

Key Path	AMPTD Y Scale, Y Axis Unit
<b>Example</b>	UNIT:POW DBUV
Dependencies	Grayed out if an Amplitude Correction with an Antenna Unit is ON.
Readback	dB $\mu$ V
Initial S/W Revision	Prior to A.02.00
Modified at S/W Revision	A.02.00

## dB $\mu$ A

Sets the amplitude unit for the selected amplitude scale (log/lin) to dB $\mu$ A.

**NOTE**

The unit dBuA can also appear as an Antenna Unit. This will be used by customers using current probes, because current probes are often supplied with conversion tables that provide the transducer factors. When dBuA is used as an Antenna Unit the normal conversion from power to amps for dBuA (based on the analyzer input impedance) is not done, but instead the conversion is based solely on the Correction that contains the transducer factors. This is what distinguishes dBuA as a normal unit from dBuA as an antenna unit. When querying the Y-Axis unit, you can query the Antenna Unit to distinguish between regular dBuA and the dBuA antenna unit. If :CORR:CSET:ANT? returns NOC (for No Conversion), you are using a normal Y Axis dBuA. If it returns UA you are using an Antenna Unit dBuA.

Key Path	AMPTD Y Scale, Y Axis Unit
<b>Example</b>	UNIT:POW DBUA
Dependencies	Grayed out if an Amplitude Correction with an Antenna Unit is ON.
Readback	dB $\mu$ A
Initial S/W Revision	Prior to A.02.00
Modified at S/W Revision	A.02.00

## dBpW

Sets the amplitude unit for the selected amplitude scale (log/lin) to dBpW.

Key Path	AMPTD Y Scale, Y Axis Unit
<b>Example</b>	UNIT:POW DBPW
Dependencies	Grayed out if an Amplitude Correction with an Antenna Unit is ON.
Readback	dB $\mu$ A
Initial S/W Revision	A.11.00

## Antenna Unit

When a Correction is turned on that uses an Antenna Unit, the Y Axis Unit changes to that Antenna Unit. All of the keys in the Y-Axis Unit menu are then greyed out, except the Antenna Unit key. The unit being used is shown on this key and is shown as selected in the submenu.

Key Path	AMPTD Y Scale, Y Axis Unit
Dependencies	Grayed out if no Amplitude Correction with an Antenna Unit is on.
Readback line	Currently selected unit
Initial S/W Revision	A.11.00

### dB $\mu$ V/m

Sets the amplitude unit for the selected amplitude scale (log/lin) to dB $\mu$ V/m. This is an antenna unit, and this key is grayed out unless a Correction with this Antenna Unit selected is ON. If this is the case, all of the other Antenna Units are grayed out.

Key Path	AMPTD Y Scale, Y Axis Unit, Antenna Unit
<b>Example</b>	UNIT:POW DBUVM
Dependencies	Grayed out if no Amplitude Correction with an Antenna Unit is on.
Readback	dB $\mu$ V/m
Initial S/W Revision	A.02.00

### dB $\mu$ A/m

Sets the amplitude unit for the selected amplitude scale (log/lin) to dB $\mu$ A/m. This is an antenna unit, and this key is grayed out unless a Correction with this Antenna Unit selected is ON. If this is the case, all of the other Antenna Units are grayed out.

Key Path	AMPTD Y Scale, Y Axis Unit, Antenna Unit
<b>Example</b>	UNIT:POW DBUAM
Dependencies	Grayed out if no Amplitude Correction with an Antenna Unit is on.
Readback	dB $\mu$ A/m
Initial S/W Revision	A.02.00

### dB $\mu$ A

Sets the amplitude unit for the selected amplitude scale (log/lin) to dB $\mu$ A. This is an antenna unit, and this key is grayed out unless a Correction with this Antenna Unit selected is ON. If this is the case, all of the other Antenna Units are grayed out.

Key Path	AMPTD Y Scale, Y Axis Unit, Antenna Unit
<b>Example</b>	UNIT:POW DBUAM
Dependencies	Grayed out if no Amplitude Correction with an Antenna Unit is on.
Readback	dB $\mu$ A
Initial S/W Revision	A.11.00

### dBpT

Sets the amplitude unit for the selected amplitude scale (log/lin) to dBpT. This is an antenna unit, and this key is grayed out unless a Correction with this Antenna Unit selected is ON. If this is the case, all of the other Antenna Units are grayed out.

Key Path	AMPTD Y Scale, Y Axis Unit, Antenna Unit
<b>Example</b>	UNIT:POW DBPT
Dependencies	Grayed out if no Amplitude Correction with an Antenna Unit is on.
Readback	dBpT
Initial S/W Revision	A.02.00

### dBG

Sets the amplitude unit for the selected amplitude scale (log/lin) to dBG. This is an antenna unit, and this key is grayed out unless a Correction with this Antenna Unit selected is ON. If this is the case, all of the other Antenna Units are grayed out.

Key Path	AMPTD Y Scale, Y Axis Unit, Antenna Unit
<b>Example</b>	UNIT:POW DBG
Dependencies	Grayed out if no Amplitude Correction with an Antenna Unit is on.
Readback	dBG
Initial S/W Revision	A.02.00

### None

This is selected if no Antenna Unit is currently on, however you cannot actually set this value, since it is always grayed out. The key is included simply to provide an indication on the Readback line of the Antenna Unit key when there is no Antenna Unit selected.

Key Path	AMPTD Y Scale, Y Axis Unit, Antenna Unit
Readback	"None"
Initial S/W Revision	A.11.00

## μW Path Control

The μW Path Control functions include the μW Preselector Bypass (Option MPB) and Low Noise Path (Option LNP) controls in the High Band path circuits.

When the μW Preselector is bypassed, the user has better flatness, but will be subject to spurs from out of band interfering signals. When the Low Noise Path is enabled, the analyzer automatically switches around certain circuitry in the high frequency bands which can contribute to noise, when it is appropriate based on other analyzer settings.

For most applications, the preset state is Standard Path, which gives the best remote-control throughput, minimizes acoustic noise from switching and minimizes the risk of wear out in the hardware switches. For applications that utilize the wideband IF paths, the preset state is the μW Preselector Bypass path, if option MPB is present. This is because, when using a wideband IF such as the 140 MHz IF, the μW Preselector's bandwidth can be narrower than the available IF bandwidth, causing degraded amplitude flatness and phase linearity, so it is desirable to bypass the preselector in the default case.

Users may choose Low Noise Path Enable. It gives a lower noise floor, especially in the 21–26.5 GHz region, though without improving many measures of dynamic range, and without giving the best possible noise floor. The preamp, if purchased and used, gives better noise floor than does the Low Noise Path, however its compression threshold and third-order intercept are much poorer than that of the non-preamp Low Noise Path. There are some applications, typically for signals around –30 dBm, for which the third-order dynamic range of the standard path is good enough, but the noise floor is not low enough even with 0 dB input attenuation. When the third-order dynamic range of the preamp path is too little and the noise floor of the standard path is too high, the Low Noise Path can provide the best dynamic range.

<b>Key Path</b>	AMPTD Y Scale
<b>Mode</b>	SA, BASIC, PNOISE, VSA , LTE, LTETDD
<b>Scope</b>	Meas Global
<b>Remote Command</b>	[ :SENSe ] :POWer [ :RF ] :MW:PATH STD LNPath MPBypass FULL [ :SENSe ] :POWer [ :RF ] :MW:PATH?
<b>Example</b>	:POW:MW:PATH LNP Enables the Low Noise path
<b>Notes</b>	If a Presel Center is performed, the analyzer will momentarily switch to the Standard Path, regardless of the setting of μW Path Control  The DC Block will always be switched in when the low noise path is switched in, to protect succeeding circuitry from DC. Note that this does not mean “when the low noise path is enabled” but when, based on the Low Noise Path rules, the path is actually switched in. This can happen when the selection is Low Noise Path Enable . In the case where the DC Block is switched in the analyzer is now AC coupled. However, if the user has selected DC coupling, the UI will still behave as though it were DC coupled, including all annunciation, warnings, status bits, and responses to SCPI queries. This is because, based on other settings, the analyzer could switch out the low noise path at any time and hence go back to being DC coupled.  Alignment switching ignores the settings in this menu, and restores them when finished.
<b>Dependencies</b>	Unavailable in BBIQ and External Mixing
<b>Preset</b>	All modes other than IQ Analyzer mode and VXA: STD IQ Analyzer, VXA and WLAN mode: MPB option present and licensed: MPB

	MPB option not present and licensed: STD
State Saved	Save in instrument state
Readback	Value selected in the submenu
Initial S/W Revision	A.04.00
Modified at S/W Revision	A.10.00

## Standard Path

This path gives the best remote-control throughput, minimizes acoustic noise from switching and minimizes the risk of wear in the hardware switches, particularly in remote test scenarios where both low band and high band setups will follow in rapid succession.

In this path, the bypass of the low band/high band switch and microwave preamp is never activated, which can cause some noise degradation but preserves the life of the bypass switch.

Key Path	AMPTD Y Scale, $\mu$ W Path Control
<b>Example</b>	:POW:MW:PATH STD
Readback Text	Standard Path
Initial S/W Revision	A.04.00

## Low Noise Path Enable

You may choose Low Noise Path Enable, which gives a lower noise floor under some circumstances, particularly when operating in the 21–26.5 GHz region. With the Low Noise Path enabled, the low band/high band switch and microwave preamp are bypassed whenever all of the following are true:

- The analyzer is not in the Low Band, meaning:
- the start frequency is above 3.5 GHz and
- the stop frequency is above 3.6 GHz.
- the internal preamp is not installed or (if installed) is set to Off or Low Band

Note that this means that, when any part of a sweep is done in Low Band, the Low Noise Path is not used, whether or not the Low Noise Path Enable is selected in the user interface. Also, if the preamp is turned on, the Low Noise Path is not used, whether or not the Low Noise Path Enable is selected in the user interface. The only time the Low Noise Path is used is when Low Noise Path Enable is selected, the sweep is completely in High Band (> 3.6 GHz) and no preamp is in use.

See "[More Information](#)" on page 680

Key Path	AMPTD Y Scale, $\mu$ W Path Control
Measurement	Swept SA
<b>Example</b>	:POW:MW:PATH LNP

Notes	<p>For measurements that use IQ acquisition, the low noise path is used when the Center Frequency is in High Band (&gt; 3.6 GHz) and no preamp is in use.</p> <p>In other words, the rules above are modified to use only the center frequency to qualify which path to switch in.</p> <p>This is not the case for FFT's in the Swept SA measurement; they use the same rules as swept measurements.</p>
Dependencies	<p>Key is blanked if current mode does not support it.</p> <p>Key is grayed out if mode supports it but current measurement does not support it.</p> <p>Unless Option LNP is present and licensed, key is blank and if SCPI command sent, error -241, "Hardware missing; Option not installed" is generated.</p>
Readback Text	Low Noise Path Enable
Initial S/W Revision	A.04.00

### More Information

The user should understand that the Low Noise Path, while giving improved DANL, has the disadvantage of decreased TOI performance and decreased gain compression performance relative to the standard path.

The user should also understand that the bypass switch is a mechanical switch and has finite life, so if the Low Noise Path is enabled, it is possible to cause frequent cycling of this switch by frequently changing analyzer settings such that the above conditions hold true only some of the time. A user making tests of this nature should consider opting for the Standard Path, which will never throw the bypass switch, at the expense of some degraded noise performance.

The low noise path is useful for situations where the signal level is so low that the analyzer performance is dominated by noise even with 0 dB attenuation, but still high enough that the preamp option would have excessive third-order intermodulation or compression. The preamp, if purchased and used, gives better noise floor than does the "Low Noise Path." However, its compression threshold and third-order intercept are much poorer than that of the non-preamp path. There are some applications, typically for signals around -30 dBm, for which the third-order dynamic range of the standard path is good enough, but the noise floor is not low enough even with 0 dB input attenuation. When the third-order dynamic range of the preamp path is too little and the noise floor of the standard path is too high, the Low Noise Path can provide the best dynamic range

The graph below illustrates the concept. It shows, in red, the performance of an analyzer at different attenuation settings, both with the preamp on and off, in a measurement that is affected by both analyzer noise and analyzer TOI. The green shows the best available dynamic range, offset by 0.5 dB for clarity. The blue shows how the best available dynamic range improves for moderate signal levels with the low noise path switched in. In this illustration, the preamp improves the noise floor by 15 dB while degrading the third-order intercept by 30 dB, and the low noise path reduces loss by 8 dB. The attenuator step size is 2 dB.



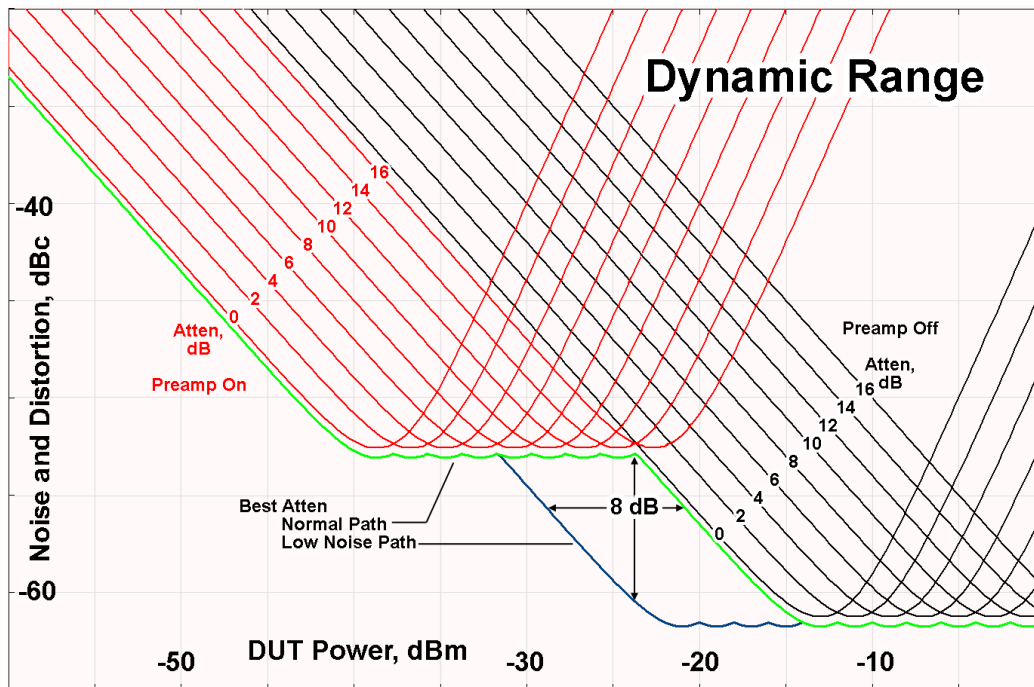

There are other times where selecting the low noise path improves performance, too. Compression-limited measurements such as finding the nulls in a pulsed-RF spectrum can profit from the low noise path in a way similar to the TOI-limited measurement illustrated. Accuracy can be improved when the low noise path allows the optimum attenuation to increase from a small amount like 0, 2 or 4 dB to a larger amount, giving better return loss at the analyzer input. Harmonic measurements, such as second and third harmonic levels, are much improved using the low noise path because of the superiority of that path for harmonic (though not intermodulation) distortion performance.

### $\mu$ W Preselector Bypass

This key toggles the preselector bypass switch for band 1 and higher. When the microwave preselector is on, the signal path is preselected. When the microwave preselector is off, the signal path is not preselected. The preselected path is the normal path for the analyzer.

The preselector is a tunable bandpass filter which prevents signals away from the frequency of interest from combining in the mixer to generate in-band spurious signals (images). The consequences of using a preselector filter are its limited bandwidth, the amplitude and phase ripple in its passband, and any amplitude and phase instability due to center frequency drift.

Option MPB or pre-selector bypass provides an unpreselected input mixer path for certain X-Series signal analyzers with frequency ranges above 3.6 GHz. This signal path allows a wider bandwidth and less amplitude variability, which is an advantage when doing modulation analysis and broadband signal analysis. The disadvantage is that, without the preselector, image signals will be displayed. Another disadvantage of bypassing the preselector is increased LO emission levels at the front panel input port.

Image responses are separated from the real signal by twice the 1st IF. For IF Paths of 10 MHz and 25 MHz, the 1st IF is 322.5 MHz, so the image response and the real signal will be separated by 645 MHz. The 1st IF will be different for other IF Path settings. When viewing a real signal and its corresponding image response in internal mixing, the image response will be to the left of the real signal.

Also, the image response and the real signal typically have the same amplitude and exhibit the same shape factor.

However, if Option FS1, Fast Sweep Capability, is enabled, the image response in the Swept SA measurement will appear lower in amplitude and have a much wider shape factor compared to the real signal.

Key Path	AMPTD Y Scale, $\mu$ W Path Control
<b>Example</b>	:POW:MW:PATH MPB
Dependencies	Key is blanked if current mode does not support it. Key is grayed out if mode supports it but current measurement does not support it. Key is blank unless Option MPB is present and licensed. If SCPI command sent when MPB not present, error -241, "Hardware missing; Option not installed" is generated.
Readback Text	$\mu$ W Preselector Bypass
Initial S/W Revision	A.04.00

<b>Remote Command</b>	[ :SENSe ] :POWeR [ :RF ] :MW :PRESelector [ :STATe ] ON   OFF   0   1 [ :SENSe ] :POWeR [ :RF ] :MW :PRESelector [ :STATe ] ?
<b>Example</b>	:POW:MW:PRES OFF Bypasses the microwave preselector
Notes	The ON parameter sets the STD path (:POW:MW:PATH STD) The OFF parameter sets path MPB (:POW:MW:PATH MPB)
Preset	ON

## Internal Preamp

Accesses a menu of keys that control the internal preamps. Turning on the preamp gives a better noise figure, but a poorer TOI to noise floor dynamic range. You can optimize this setting for your particular measurement.

The instrument takes the preamp gain into account as it sweeps. If you sweep outside of the range of the preamp the instrument will also account for that. The displayed result will always reflect the correct gain.

For some measurements, when the preamp is on and any part of the displayed frequency range is below the lowest frequency for which the preamp has specifications, a warning condition message appears in the status line. For example, for a preamp with a 9 kHz lowest specified frequency: "Preamp: Accy unspec'd below 9 kHz".

Key Path	AMPTD Y Scale
Scope	Meas Global
<b>Remote Command</b>	[ :SENSe ] :POWeR [ :RF ] :GAIN [ :STATe ] OFF   ON   0   1 [ :SENSe ] :POWeR [ :RF ] :GAIN [ :STATe ] ?
Dependencies	Preamp is not available on all hardware platforms. If the preamp is not present or is unlicensed, the

key is not shown.  
The preamp is not available when the electronic/soft attenuator is enabled.

Couplings	<p>The act of connecting the U7227A USB Preamplifier to one of the analyzer's USB ports will cause the Internal Preamp to be switched on. When this happens an informational message will be generated: "Internal Preamp turned on for optimal operation with USB Preamp." Note that if the Internal Preamp was already on, there will be no change to the setting, but if it was Off it will be switched On, to Full Range.</p> <p>Note that this same action occurs when the SA mode is selected while the USB Preamp is connected to one of the analyzer's USB ports, if it is the first time that the SA mode has run since powerup, or if the last time the SA mode was running the USB Preamp was NOT connected.</p> <p>Subsequently disconnecting the USB Preamp from USB does not change the Internal Preamp setting nor restore the previous setting.</p>
Preset	OFF
State Saved	Saved in instrument state
Initial S/W Revision	Prior to A.02.00
Modified at S/W Revision	A.14.00

Key Path	AMPTD Y Scale, Internal Preamp
Scope	Meas Global
<b>Remote Command</b>	<pre>[ :SENSe] :POWer [ :RF] :GAIN:BAND LOW FULL [ :SENSe] :POWer [ :RF] :GAIN:BAND?</pre>
Dependencies	<p>Preamp is not available on all hardware platforms. If the preamp is not present or is unlicensed, the key is not shown.</p> <p>If a POW:GAIN:BAND FULL command is sent when a low band preamp is available, the preamp band parameter is to LOW instead of FULL, and an "Option not installed" message is generated.</p>
Preset	LOW
State Saved	Saved in instrument state
Initial S/W Revision	Prior to A.02.00

## Off

Turns the internal preamp off

Key Path	AMPTD Y Scale, Internal Preamp
<b>Example</b>	:POW:GAIN OFF
Readback	Off
Initial S/W Revision	Prior to A.02.00

## Low Band

Sets the internal preamp to use only the low band.

The frequency range of the installed (optional) low-band preamp is displayed in square brackets on the Low Band key label.

Key Path	AMPTD Y Scale, Internal Preamp
<b>Example</b>	:POW:GAIN ON :POW:GAIN:BAND LOW
Readback	Low Band
Initial S/W Revision	Prior to A.02.00

## Full Range

Sets the internal preamp to use its full range. The low band (0–3.6 GHz or 0–3GHz, depending on the model) is supplied by the low band preamp and the frequencies above low band are supplied by the high band preamp.

The frequency range of the installed (optional) preamp is displayed in square brackets on the Full Range key label. If the high band option is not installed the Full Range key does not appear.

Key Path	AMPTD Y Scale, Internal Preamp
<b>Example</b>	:POW:GAIN ON :POW:GAIN:BAND FULL
Readback	Full Range
Initial S/W Revision	Prior to A.02.00

## Ref Position

Positions the reference level at the top, center, or bottom of the Y- scale display. Changing the reference position does not change the reference level value.

Key Path	AMPTD Y Scale
Mode	SA, WCDMA, C2K, WIMAX OFDMA, TD-SCDMA, 1xEVDO, DVB-T/H, DTMB (CTTB), ISDB-T, CMMB, LTE, LTETDD, Digital Cable TV, MSR, LTEAFDD, LTEATDD
<b>Remote Command</b>	:DISPlay:ACP:Power:VIEW[1]:WINDow[1]:TRACe:Y[:SCALe]:RPOSition TOP   CENTer   BOTTom :DISPlay:ACP:Power:VIEW[1]:WINDow[1]:TRACe:Y[:SCALe]:RPOSition?
<b>Example</b>	DISP:ACP:VIEW:WIND:TRAC:Y:RPOS CENT DISP:ACP:VIEW:WIND:TRAC:Y:RPOS?
Notes	You must be in the mode that includes ACP measurements to use this command. Use :INSTRument:SElect to set the mode.
Preset	TOP

State Saved	Saved in instrument state.
Range	Top Ctr Bot
Initial S/W Revision	Prior to A.02.00
Modified at S/W Revision	A.02.00, A.03.00

## Auto Scaling

Toggles the Auto Scaling function between On and Off.

Key Path	AMPTD Y Scale
Mode	SA, WCDMA, C2K, WIMAX OFDMA, TD-SCDMA, 1xEVDO, DVB-T/H, DTMB (CTTB), ISDB-T, CMMB, LTE, LTE-TDD, Digital Cable TV, MSR, LTEAFDD, LTEATDD
Remote Command	:DISPlay:ACPower:VIEW[1]:WINDow[1]:TRACe:Y[:SCALe]:COUPlE 0   1   OFF   ON  :DISPlay:ACPower:VIEW[1]:WINDow[1]:TRACe:Y[:SCALe]:COUPlE?
Example	DISP:ACP:VIEW:WIND:TRAC:Y:COUP ON DISP:ACP:VIEW:WIND:TRAC:Y:COUP?
Notes	You must be in the mode that includes ACP measurements to use this command. Use :INSTrument:SElect to set the mode.
Couplings	When Auto Scaling is On and the Restart front-panel key is pressed, this function automatically determines the scale per division and reference values based on the measurement results. When you set a value to either Scale/Div or Ref Value manually, Auto Scaling automatically changes to Off.
Preset	ON
State Saved	Saved in instrument state.
Range	On Off
Initial S/W Revision	Prior to A.02.00
Modified at S/W Revision	A.02.00, A.03.00

## Auto Couple

The Auto Couple feature provides a quick and convenient way to automatically couple multiple instrument settings. This helps ensure accurate measurements and optimum dynamic range. When the Auto Couple feature is activated, either from the front panel or remotely, all parameters of the current measurement that have an Auto/Manual mode are set to Auto mode and all measurement settings dependent on (or coupled to) the Auto/Man parameters are automatically adjusted for optimal performance.

However, the Auto Couple key actions are confined to the current measurement only. It does not affect other measurements in the mode, and it does not affect markers, marker functions, or trace or display attributes.

See ["More Information" on page 686](#)

<b>Key Path</b>	Front-panel key
<b>Remote Command</b>	:COUPLe ALL NONE
<b>Example</b>	:COUP ALL
<b>Notes</b>	:COUPLe ALL puts all Auto/Man parameters in Auto mode (equivalent to pressing the Auto Couple key). :COUPLE NONE puts all Auto/Man parameters in manual mode. It decouples all the coupled instrument parameters and is not recommended for making measurements.
<b>Initial S/W Revision</b>	Prior to A.02.00

### More Information

There are two types of functions that have Auto/Manual modes.

#### Auto/Man Active Function keys

An Auto/Man toggle key controls the binary state associated with an instrument parameter by toggling between Auto (where the parameter is automatically coupled to the other parameters it is dependent upon) and Man (where the parameter is controlled independent of the other parameters), as well as making the parameter the active function. The current mode is indicated on the softkey with either Auto or Man underlined as illustrated below.



#### Auto/Man 1-of-N keys

An Auto/Man 1-of-N key allows you to manually pick from a list of parameter values, or place the function in Auto, in which case the value is automatically selected (and indicated) as shown below. If in Auto, Auto is underlined on the calling key. If in manual operation, manual is indicated on the calling key. But the calling key does not actually toggle the function, it simply opens the menu.

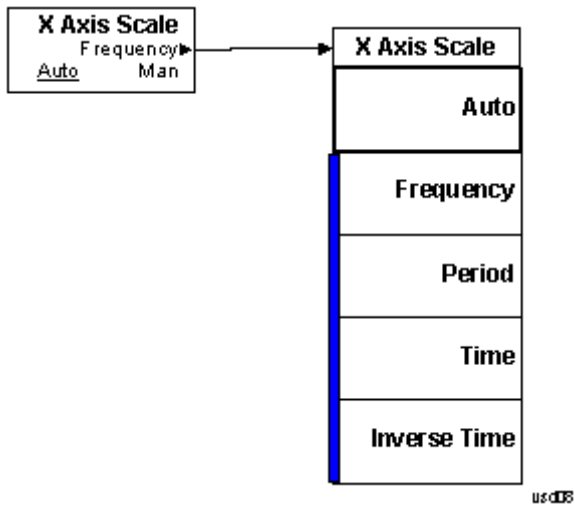

## BW

Accesses a menu of functions that enable you to specify and control the video and resolution bandwidths. You can also select the type of filter for the measurement and set the filter bandwidth.

Key Path	Front-panel key
Initial S/W Revision	Prior to A.02.00

## Res BW

Sets the value of the resolution bandwidth. If an unavailable bandwidth is entered with the numeric keypad, the closest available bandwidth is selected.

LTE-Advanced FDD/TDD Auto RBW:

Bandwidth	RBW (KHz)
1.4MHz	51KHz
3MHz	
5MHz	100 KHz
10MHz	
15MHz	
20MHz	

the resolution bandwidth is predefined based on the corresponding bandwidth of the single LTE carrier, which is listed above. When ResBW mode is Auto, the narrowest RBW over the active carriers is selected for Multi-carriers.

Key Path	BW
Mode	SA, WCDMA, C2K, WIMAX OFDMA, TD-SCDMA, 1xEVDO, DVB-T/H, DTMB (CTTB), ISDB-T, CMMB, LTE, LTE-TDD, Digital Cable TV, MSR, LTEAFDD, LTEATDD
Remote Command	[:SENSe]:ACPower:BANDwidth[:RESolution] <freq> [:SENSe]:ACPower:BANDwidth[:RESolution]? [:SENSe]:ACPower:BANDwidth[:RESolution]:AUTO ON OFF 1 0 [:SENSe]:ACPower:BANDwidth[:RESolution]:AUTO?
Example	ACP:BAND 25kHz ACP:BAND? ACP:BAND:AUTO ON ACP:BAND:AUTO?
Notes	This key is available only in IBW mode. This parameter is preset by the Meas Method selection. Preset values are as follows: IBW: 100 kHz



	IBWR: 27 kHz FAST (WCDMA): 390 kHz You must be in the mode that includes ACP measurements to use this command. Use :INSTrument:SElect to set the mode.
Dependencies	When Meas Method is RBW or FAST, this key is grayed out and disabled. If the key is pressed, an advisory message is generated. If the equivalent remote command is sent, a "Setting conflict" warning is generated.
Couplings	The resolution bandwidth is coupled to the video bandwidth based on the video to resolution bandwidth ratio setting if AUTO is selected.
Preset	SA: 220 kHz WCDMA: 100 kHz WIMAX OFDMA: 100 kHz C2K: 15 kHz TD-SCDMA: 30 kHz 1xEVDO: 30 kHz DVB-T/H: 39 kHz DTMB (CTTB): 39 kHz ISDB-T: 39 kHz CMMB: 39 kHz LTE: 100 kHz LTETDD: 100 kHz Digital Cable TV: 39 kHz MSR: 100 kHz LTEAFDD, LTEATDD: 100kHz LTEAFDD, LTEATDD: 1 Others:0
State Saved	Saved in instrument state.
Min	1 Hz
Max	8 MHz
<b>Backwards Compatibility SCPI</b>	[ :SENSe ] :ACPpower:BWIDth[:RESolution] [ :SENSe ] :ACP:SWEep:BWIDth BWIDth[:RESolution] (PSA W-CDMA, PSA cdma2000 )
Initial S/W Revision	Prior to A.02.00
Modified at S/W Revision	A.02.00, A.03.00

## Video BW

Changes the analyzer post-detection filter (VBW).

Key Path	BW
Mode	SA, WCDMA, C2K, WIMAX OFDMA, TD-SCDMA, 1xEVDO, DVB-T/H, DTMB (CTTB), ISDB-T, CMMB,

	LTE, LTETDD, Digital Cable TV, MSR, LTEAFDD, LTEATDD
<b>Remote Command</b>	<pre>[ :SENSe ] :ACPower :BANDwidth :VIDeo &lt;freq&gt; [ :SENSe ] :ACPower :BANDwidth :VIDeo? [ :SENSe ] :ACPower :BANDwidth :VIDeo :AUTO OFF ON 0 1 [ :SENSe ] :ACPower :BANDwidth :VIDeo :AUTO?</pre>
<b>Example</b>	<pre>ACP:BAND:VID 1kHz ACP:BAND:VID? ACP:BWID:VID:AUTO ON ACP:BWID:VID:AUTO?</pre>
<b>Notes</b>	The values shown in this table reflect the conditions after a Mode Preset.
<b>Dependencies</b>	When Meas Method is RBW or FAST, this key is grayed out and disabled. If the key is pressed, an advisory message is generated. If the equivalent remote command is sent, a "Setting conflict" warning is generated.
<b>Preset</b>	<pre>SA: 22 kHz WCDMA, WIMAX OFDMA: 1 MHz C2K: Method RBW: grayed out (1.2 MHz) Method IBW: 150 kHz TD-SCDMA: 300 kHz 1xEVDO: 300 kHz DVB-T/H: 390 kHz DTMB (CTTB): 390 kHz ISDB-T: 390 kHz CMMB: 390 kHz LTE, LTETDD, MSR: Auto LTETDD: 1 MHz Digital Cable TV: 390 kHz LTEAFDD, LTEATDD: Auto SA: ON WCDMA: OFF WIMAX OFDMA: OFF TD-SCDMA: OFF DVB-T/H: OFF DTMB (CTTB): OFF CDMA1xEVDO: OFF ISDB-T: OFF CMMB: OFF LTE, MSR: ON LTETDD: ON Digital Cable TV: OFF</pre>

	LTEAFDD, LTEATDD: ON
State Saved	Saved in instrument state.
Min	1 Hz
Max	50 MHz
<b>Backwards Compatibility SCPI</b>	[ :SENSe ] :ACPower :BWIDth :VIDeo
Initial S/W Revision	Prior to A.02.00
Modified at S/W Revision	A.02.00, A.03.00

## RBW Control

Accesses a menu that enables you to select the filter bandwidth and type.

Key Path	BW
Initial S/W Revision	Prior to A.02.00

## Filter Type

Selects the type of bandwidth filter that is used. The choices are Gaussian or Flat top.

Key Path	BW, RBW Control
Mode	SA, WCDMA, C2K, WIMAX OFDMA, TD-SCDMA, 1xEVDO, DVB-T/H, DTMB (CTTB), ISDB-T, CMMB, LTE, LTE-TDD, Digital Cable TV, MSR, LTEAFDD, LTEATDD
<b>Remote Command</b>	[ :SENSe ] :ACPower :BANDwidth :SHAPE GAUSSian   FLATtop [ :SENSe ] :ACPower :BANDwidth :SHAPE?
<b>Example</b>	ACP:BAND:SHAP GAUS ACP:BAND:SHAP?
Dependencies	When Meas Method is FAST, this key is grayed out and disabled. If the key is pressed, an advisory message is generated. If the equivalent remote command is sent, a "Setting conflict" warning is generated.
Preset	GAUSSian C2K: FLATtop
State Saved	Saved in instrument state.
Range	Gaussian (Normal) Flattop
<b>Backwards Compatibility SCPI</b>	[ :SENSe ] :ACPower :BWIDth :SHAPE
Initial S/W Revision	Prior to A.02.00
Modified at S/W Revision	A.02.00, A.03.00

## Filter BW

Selects a Gaussian filter based on its -3 dB (Normal) bandwidth or its -6 dB bandwidth.

Key Path	BW, RBW Control
Mode	SA, WCDMA, C2K, WIMAX OFDMA, TD-SCDMA, 1xEVDO, DVB-T/H, DTMB (CTTB), ISDB-T, CMMB, LTE, LTEFDD, Digital Cable TV, MSR, LTEAFDD, LTEATDD
<b>Remote Command</b>	<code>[ :SENSe ] :ACPower :BANDwidth :TYPE DB3   DB6</code> <code>[ :SENSe ] :ACPower :BANDwidth :TYPE ?</code>
<b>Example</b>	ACP:BAND:TYPE DB3 ACP:BAND:TYPE?
Dependencies	When Filter Type is Flattop or Meas Method is RBW or FAST, this key is grayed out and disabled. If the key is pressed, an advisory message is generated. If the equivalent remote command is sent, a "Setting conflict" warning is generated.
Preset	DB3
State Saved	Saved in instrument state.
Range	-3 dB (Normal) -6 dB
<b>Backwards Compatibility SCPI</b>	<code>[ :SENSe ] :ACPower :BWIDth :TYPE</code>
Initial S/W Revision	Prior to A.02.00
Modified at S/W Revision	A.02.00, A.03.00

## Cont (Continuous Measurement/Sweep)

Sets the analyzer for Continuous measurement operation. The single/continuous state is Meas Global so the setting will affect all measurements. If you are Paused, pressing Cont does a Resume.

Key Path	Front-panel key
Remote Command	:INITiate:CONTinuous OFF ON 0 1 :INITiate:CONTinuous?
Example	:INIT:CONT 0 puts analyzer in Single measurement operation. :INIT:CONT 1 puts analyzer in Continuous measurement operation
Preset	ON (Note that SYST:PRESet sets INIT:CONT to ON but *RST sets INIT:CONT to OFF)
State Saved	Saved in instrument state
Backwards Compatibility Notes	For Spectrum Analysis mode in ESA and PSA, there is no Cont hardkey, instead there is a Sweep Single/Cont key. In these analyzers, switching the Sweep Single/Cont key from Single to Cont restarts averages (displayed average count reset to 1), but does not restart Max Hold and Min Hold. The X-Series has Single and Cont keys in place of the SweepSingleCont key. In the X-Series, if in single measurement, the Cont key (and INIT:CONT ON ) switches to continuous measurement, but never restarts a measurement and never resets a sweep.
Initial S/W Revision	Prior to A.02.00

In Swept SA Measurement (Spectrum Analysis Mode):

The analyzer takes repetitive sweeps, averages, measurements, etc., when in Continuous mode. When the average count reaches the Average/Hold Number the count stops incrementing, but the analyzer keeps sweeping. See the Trace/Detector section for the averaging formula used both before and after the Average/Hold Number is reached. The trigger condition must be met prior to each sweep. The type of trace processing for multiple sweeps, is set under the Trace/Detector key, with choices of Trace Average, Max Hold, or Min Hold.

In Other Measurements/Modes:

With Avg/Hold Num (in the Meas Setup menu) set to Off or set to On with a value of 1, a sweep is taken after the trigger condition is met; and the analyzer continues to take new sweeps after the current sweep has completed and the trigger condition is again met. However, with Avg/Hold Num set to On with a value >1, multiple sweeps (data acquisitions) are taken for the measurement. The trigger condition must be met prior to each sweep. The sweep is not stopped when the average count k equals the number N set for Avg/Hold Num is reached, but the number k stops incrementing. A measurement average usually applies to all traces, marker results, and numeric results. But sometimes it only applies to the numeric results.

If the analyzer is in Single measurement, pressing the Cont key does not change k and does not cause the sweep to be reset; the only action is to put the analyzer into Continuous measurement operation.

If it is already in continuous sweep:

the INIT:CONT 1 command has no effect

9 ACP Measurement  
Cont (Continuous Measurement/Sweep)

the INIT:CONT 0 command will place the analyzer in Single Sweep but will have no effect on the current sequence until  $k = N$ , at which point the current sequence will stop and the instrument will go to the idle state.

File

See "File" on page 336

## FREQ Channel

The key accesses a menu allowing you to set Frequency parameters for the current measurement. All measurements in DVB-T/H mode have the same menu structure under FREQ/Channel menu.

Key Path	Front-panel key
Initial S/W Revision	A.02.00

### Channel

Sets the analyzer to a frequency that corresponds to the Channel Number. If the Center Freq value entered does not exactly correlate with the Channel, the displayed value will be “---”.

Key Path	FREQ Channel
Mode	DVB-T/H
<b>Remote Command</b>	[ :SENSe ] :FREQuency:CHANnel:NUMBer <integer> [ :SENSe ] :FREQuency:CHANnel:NUMBer?
<b>Example</b>	FREQ:CHAN:NUMB 21 FREQ:CHAN:NUMB?
Dependencies	If your analyzer has multiple inputs and the selected input is BBIQ, this key will be grayed out and the displaying value will be “---”.
Couplings	Channel is coupled with Center Freq. A certain Channel corresponds to a certain value of Center Freq. If the Center Freq value entered does not exactly correlate with a Channel, the displaying value will be “---”, and the returned value of the SCPI command “FREQ:CHAN:NUMB?” is “-999”.
Preset	21
State Saved	Saved in instrument state.
Min	Depends on the selected channel table
Max	Depends on the selected channel table
Initial S/W Revision	A.02.00

### Center Freq

Sets the center frequency. If your analyzer has multiple inputs (RF and IQ), the displayed value will be updated according to the selected input. SCPI commands are available to directly set the center frequency for a specific input. This key is coupled with Channel when the selected input is RF.

See also:

["RF Center Freq" on page 698](#)

["IQ Center Freq" on page 698](#)



Key Path	FREQ Channel
Mode	DVB-T/H
<b>Remote Command</b>	[ :SENSe ] :FREQuency:CENTer <freq> [ :SENSe ] :FREQuency:CENTer?
<b>Example</b>	FREQ:CENT 1.0MHZ FREQ:CENT?
Couplings	Center Freq is coupled with Channel. A certain value of center frequency corresponds to a certain Channel. If the Channel changes, the Center Frequency will be changed to the frequency which is the center of the channel.
Preset	474.00MHz
State Saved	Saved in instrument state.
Min	-79.999995 MHz
Max	Hardware Dependent, for details, see " <a href="#">Maximum Frequency in X - Series Signal Analyzers</a> " on page 697.
Initial S/W Revision	A.02.00

## Maximum Frequency in X - Series Signal Analyzers

The following table lists the maximum frequency in different X – Series signal analyzers.

Model numbers: N9020A, N9030A

Freq Option	Stop Freq after Mode Preset	Max Freq (can't tune above)
503	3.6 GHz	3.7 GHz
508	8.4 GHz	8.5 GHz
513	13.6 GHz	13.8 GHz
526	26.5 GHz	27.0 GHz
543 (N9030A only)	43 GHz	
544 (N9030A only)	44 GHz	44.5 GHz
550 (N9030A only)	50 GHz	51 GHz

Model number: N9010A

Freq Option	Stop Freq after Mode Preset	Max Freq (can't tune above)
503	3.6 GHz	3.7 GHz
507	7.0 GHz	7.1 GHz

513	13.6 GHz	13.8 GHz
526	26.5 GHz	27.0 GHz
532	32.0 GHz	32.5 GHz
544	44.0 GHz	44.5 GHz

Model number: N9000A

Freq Option	Stop Freq after Mode Preset	Max Freq (can't tune above)
503	3.0 GHz	3.08 GHz
507	7.5 GHz	7.58 GHz

## RF Center Freq

SCPI command to specify the RF Center Frequency. This will always access the RF value, even when the selected input is not RF.

Key Path	FREQ Channel
Mode	DVB-T/H
Remote Command	[ :SENSe ] :FREQuency:RF:CENTer <freq> [ :SENSe ] :FREQuency:RF:CENTer?
Example	FREQ:RF:CENT 1.0MHZ FREQ:RF:CENT?
Couplings	Center Freq is coupled with Channel. A certain value of center frequency corresponds to a certain Channel. If the Channel changes, the Center Frequency will be changed to the frequency which is the center of the channel.
Preset	474.00MHz
State Saved	Saved in instrument state.
Min	-79.999995 MHz
Max	Hardware Dependent, for details, see <a href="#">"Maximum Frequency in X - Series Signal Analyzers" on page 697</a> .
Initial S/W Revision	A.02.00

## IQ Center Freq

SCPI command to specify the I/Q Center Frequency. This will always access the I/Q value, even when the selected input is not I/Q.

Key Path	FREQ Channel
Mode	DVB-T/H
<b>Remote Command</b>	[ :SENSe ] :FREQuency:IQ:CENTer <freq> [ :SENSe ] :FREQuency:IQ:CENTer?
<b>Example</b>	FREQ:IQ:CENT 1.0MHZ FREQ:IQ:CENT?
Preset	0 Hz
State Saved	Saved in instrument state.
Min	-39.999995 MHz
Max	39.999995 MHz
Initial S/W Revision	A.02.00

## Chan Step

Chan Step changes the step size for the Channel Number.

Key Path	FREQ Channel
Mode	DVB-T/H
<b>Remote Command</b>	[ :SENSe ] :FREQuency:CHANnel:STEP <integer> [ :SENSe ] :FREQuency:CHANnel:STEP?
<b>Example</b>	FREQ:CHAN:STEP 1 FREQ:CHAN:STEP?
Dependencies	If your analyzer has multiple inputs and the selected input is BBIQ, this key will be grayed out.
Preset	1
State Saved	Saved in instrument state.
Min	1
Max	Depends on the selected channel table
Initial S/W Revision	A.02.00

## CF Step

CF Step sets the step size for center frequency. If CF Step State is manual, you can set this value manually. Once CF Step State is changed to auto, CF Step changes to the value of Channel BW automatically.

Key Path	FREQ Channel
Mode	DVB-T/H
<b>Remote Command</b>	[ :SENSe ] :FREQuency:CENTer:STEP [ :INCRement ] <freq> [ :SENSe ] :FREQuency:CENTer:STEP [ :INCRement ] ?

	<code>[ :SENSe ] :FREQuency:CENTer:STEP:AUTO ON OFF 1 0</code>
	<code>[ :SENSe ] :FREQuency:CENTer:STEP:AUTO?</code>
<b>Example</b>	<code>FREQ:CENT:STEP 100KHZ</code> <code>FREQ:CENT:STEP?</code> <code>FREQ:CENT:STEP:AUTO OFF</code> <code>FREQ:CENT:STEP:AUTO?</code>
<b>Couplings</b>	CF Step is coupled to Channel BW (Mode Setup) when CF Step State is 'Auto'.
<b>Preset</b>	8.00MHz ON
<b>State Saved</b>	Saved in instrument state.
<b>Min</b>	1.0 kHz
<b>Max</b>	1 GHz
<b>Initial S/W Revision</b>	A.02.00

## Chan Table

Allows you to choose the appropriate TV standard: NTSC-M, NTSC-J, NTSC-Brazil, PAL-M, PAL-B/G, PAL-D/K, or PAL-I.

<b>Key Path</b>	FREQ Channel
<b>Mode</b>	DVB-T/H
<b>Remote Command</b>	<code>[ :SENSe ] :FREQuency:CHANnel:TABLE[:SElect] MNTSc   JNTSc   BNTSc   MPAL</code> <code>  IPAL   BPAL   DPAL</code> <code>[ :SENSe ] :FREQuency:CHANnel:TABLE[:SElect]?</code>
<b>Example</b>	<code>FREQ:CHAN:TABL BPAL</code> <code>FREQ:CHAN:TABL?</code>
<b>Dependencies</b>	If your analyzer has multiple inputs and the selected input is BBIQ, this key will be grayed out.
<b>Couplings</b>	Couple with Channel. Setting Chan Table sets the range of Channel to the value corresponding to that Chan Table.
<b>Preset</b>	BPAL
<b>State Saved</b>	Saved in instrument state.
<b>Range</b>	NTSC-M   NTSC-J   NTSC-Brazil   PAL-M   PAL-I   PAL-B/G   PAL-D/K
<b>Initial S/W Revision</b>	A.02.00

## NTSC-M

If the current TV standard is NTSC-M, you can choose the appropriate channel plans in NTSC-M standard: Standard Cable (STD), Broadcast Channel (AIR), HRC Cable (HRC) or IRC Cable (IRC).

Key Path	FREQ Channel, Chan Table
Mode	DVB-T/H
<b>Remote Command</b>	[ :SENSe ] :FREQuency:CHANnel:TABLE:MNTSc [ :SElect ] STD   AIR   HRC   IRC [ :SENSe ] :FREQuency:CHANnel:TABLE:MNTSc [ :SElect ] ?
<b>Example</b>	FREQ:CHAN:TABL:MNTS STD FREQ:CHAN:TABL:MNTS?
Preset	STD
State Saved	Saved in instrument state.
Range	STD   AIR   HRC   IRC
Initial S/W Revision	A.02.00

## NTSC-J

If the current TV standard is NTSC-J, you can choose the appropriate channel plans in NTSC-J standard: Japan Standard Cable (Cable), apan Broadcast channels (AIR), or Japan Digital Cable (Cable Digital).

Key Path	FREQ Channel, Chan Table
Mode	DVB-T/H
<b>Remote Command</b>	[ :SENSe ] :FREQuency:CHANnel:TABLE:JNTSc [ :SElect ] CBL AIR DCBL [ :SENSe ] :FREQuency:CHANnel:TABLE:JNTSc [ :SElect ] ?
<b>Example</b>	FREQ:CHAN:TABL:JNTS AIR FREQ:CHAN:TABL:JNTS?
Preset	AIR
State Saved	Saved in instrument state.
Range	Cable AIR Cable Digital
Initial S/W Revision	A.02.00
Modified at S/W Revision	A.08.00

## NTSC-Brazil

If the current TV standard is NTSC-Brazil, you can choose the appropriate channel plans in NTSC-Brazil standard: NTSC-Brazil VHF or NTSC-Brazil UHF. Please refer to Appendix A for more detailed information.

Key Path	FREQ Channel, Chan Table
Mode	DVB-T/H
<b>Remote Command</b>	[ :SENSe ] :FREQuency:CHANnel:TABLE:BNTSc [ :SElect ] VHF UHF [ :SENSe ] :FREQuency:CHANnel:TABLE:BNTSc [ :SElect ] ?
<b>Example</b>	FREQ:CHAN:TABL:BNTS VHF FREQ:CHAN:TABL:BNTS?

Preset	UHF
State Saved	Saved in instrument state.
Range	VHF UHF
Initial S/W Revision	A.06.00

## PAL-M

If the current TV standard is PAL-M, you can choose the appropriate channel plans in PAL-M standard: Standard Cable (STD), Broadcast Channel (AIR), HRC Cable (HRC) or IRC Cable (IRC).

Key Path	FREQ Channel, Chan Table
Mode	DVB-T/H
<b>Remote Command</b>	[ :SENSe ] :FREQuency:CHANnel:TABLE:MPAL [ :SElect ] STD   AIR   HRC   IRC [ :SENSe ] :FREQuency:CHANnel:TABLE:MPAL [ :SElect ] ?
<b>Example</b>	FREQ:CHAN:TABL:MPAL STD FREQ:CHAN:TABL:MPAL?
Preset	STD
State Saved	Saved in instrument state.
Range	STD   AIR   HRC   IRC
Initial S/W Revision	A.02.00

## PAL-I

If the current TV standard is PAL-I, you can choose the appropriate channel plans in PAL-I standard: HRC Cable (HRC), VHF channels (VHF) or UHF channels (UHF).

Key Path	FREQ Channel, Chan Table
Mode	DVB-T/H
<b>Remote Command</b>	[ :SENSe ] :FREQuency:CHANnel:TABLE:IPAL [ :SElect ] VHF UHF HRC [ :SENSe ] :FREQuency:CHANnel:TABLE:IPAL [ :SElect ] ?
<b>Example</b>	FREQ:CHAN:TABL:IPAL HRC FREQ:CHAN:TABL:IPAL?
Preset	HRC
State Saved	Saved in instrument state.
Range	VHF   UHF   HRC
Initial S/W Revision	A.02.00

## PAL-B/G

If the current TV standard is PAL-B/G, you can choose the appropriate channel plans in PAL-B/G standard: HRC Cable (HRC), VHF channels (VHF), UHF channels (UHF), S channels PAL-B/G Standard (S), S channels PAL-B/G Cable (S-Cable) or CENELEC channels (CENELEC).

Key Path	FREQ Channel, Chan Table
Mode	DVB-T/H
Remote Command	[ :SENSe ] :FREQuency:CHANnel:TABLE:BPAL[ :SElect ] VHF   UHF   HRC   S   SCBL   CEN [ :SENSe ] :FREQuency:CHANnel:TABLE:BPAL[ :SElect ] ?
Example	FREQ:CHAN:TABL:BPAL HRC FREQ:CHAN:TABL:BPAL?
Preset	UHF
State Saved	Saved in instrument state.
Range	VHF   UHF   HRC   S   S-Cable   CENELEC
Initial S/W Revision	A.02.00

## PAL-D/K

If the current TV standard is PAL-D/K, you can choose the appropriate channel plans in PAL-D/K standard: China Broadcast Channels (DS) or China Standard Cable (Z).

Key Path	FREQ Channel, Chan Table
Mode	DVB-T/H
Remote Command	[ :SENSe ] :FREQuency:CHANnel:TABLE:DPAL[ :SElect ] DS   Z [ :SENSe ] :FREQuency:CHANnel:TABLE:DPAL[ :SElect ] ?
Example	FREQ:CHAN:TABL:DPAL DS FREQ:CHAN:TABL:DPAL?
Preset	DS
State Saved	Saved in instrument state.
Range	DS   Z
Initial S/W Revision	A.02.00

## Input/Output

See "[Input/Output](#)" on page 204



## Marker

Accesses a menu that enables you to select, set up and control the markers for the current measurement. Note that this hard key and all sub keys are unavailable when "Meas Method" on page 757 is set to RBW.

Key Path	Front-panel key
Initial S/W Revision	Prior to A.02.00

## Select Marker

Displays 12 markers available for selection. Note that this key is unavailable when "Meas Method" on page 757 is set to RBW.

Key Path	Marker
Initial S/W Revision	Prior to A.02.00

## Marker Type

Sets the marker control mode to Normal, Delta, Fixed or Off. All interactions and dependencies detailed under the key description are enforced when the remote command is sent. If the selected marker is Off, pressing Marker sets it to Normal and places it at the center of the screen on the trace determined by the Marker Trace rules. At the same time, Marker X Axis Value appears on the Active Function area.

The default active function is the active function for the currently selected marker control mode. If the current control mode is Off, there is no active function and the active function is turned off.

Key Path	Marker
Mode	SA, WCDMA, C2K, WIMAX OFDMA, TD-SCDMA, 1xEVDO, DVB-T/H, DTMB (CTTB), ISDB-T, CMMB, LTE, LTE-TDD, Digital Cable TV, MSR, LTEAFDD, LTEATDD
Remote Command	:CALCulate:ACPower:MARKer[1] 2 ... 12:MODE POSITION   DELTa   OFF :CALCulate:ACPower:MARKer[1] 2 ... 12:MODE?
Example	CALC:ACP:MARK2:MODE DELT CALC:ACP:MARK2:MODE?
Notes	If the selected marker is Off, pressing Marker sets it to Normal and places it at the center of the screen on the trace determined by the Marker Trace rules. At the same time, Marker X Axis Value appears on the Active Function area.  Default Active Function: the active function for the selected marker's current control mode. If the current control mode is Off, there is no active function and the active function is turned off.  Active Function Display: the marker X axis value entered in the active function area will display the marker value to its full entered precision.  You must be in the mode that includes ACP measurements to use this command. Use :INSTrument:SElect to set the mode.
Dependencies	This key is unavailable when "Meas Method" on page 757 is set to RBW.

Preset	OFF OFF OFF OFF OFF OFF OFF OFF OFF OFF OFF OFF
State Saved	Saved in instrument state.
Range	Normal Delta Off
Initial S/W Revision	Prior to A.02.00
Modified at S/W Revision	A.02.00, A.03.00

## Properties

Accesses the marker properties menu. Note that this key is unavailable when "Meas Method" on page 757 is set to RBW.

Key Path	Marker
Initial S/W Revision	Prior to A.02.00

## Select Marker

Displays 12 markers available for selection. Note that this key is unavailable when "Meas Method" on page 757 is set to RBW.

Key Path	Marker
Initial S/W Revision	Prior to A.02.00

## Relative To

Selects the desired marker. The selected marker will be relative to its reference marker.

Key Path	Marker, Properties
Mode	SA, WCDMA, C2K, WIMAX OFDMA, TD-SCDMA, 1xEVDO, DVB-T/H, DTMB (CTTB), ISDB-T, CMMB, LTE, LTETDD, Digital Cable TV, MSR, LTEAFDD, LTEATDD
Remote Command	:CALCulate:ACPpower:MARKer[1] 2 ... 12:REFerence <integer> :CALCulate:ACPpower:MARKer[1] 2 ... 12:REFerence?
Example	CALC:ACP:MARK2:REF 6 CALC:ACP:MARK2:REF?
Notes	A marker cannot be relative to itself so that choice is grayed out, and if sent from a remote command, generates error -221: "Settings conflict; marker cannot be relative to itself." When queried a single value will be returned (the specified marker numbers relative marker). You must be in the mode that includes ACP measurements to use this command. Use :INSTrument:SElect to set the mode.
Dependencies	This key is unavailable when "Meas Method" on page 757 is set to RBW.

Preset	2 3 4 5 6 7 8 9 10 11 12 1
State Saved	Saved in instrument state.
Min	1
Max	12
Initial S/W Revision	Prior to A.02.00
Modified at S/W Revision	A.02.00, A.03.00

## Marker Trace

Selects the trace that you want your marker to be placed on. A marker is associated with one and only one trace. This trace is used to determine the placement, result, and X Axis Scale of the marker. All markers have an associated trace, even Fixed markers; it is from that trace that they determine their attributes and behaviors, and it is to that trace that they go when they become Normal or Delta markers.

Key Path	Marker, Properties
Mode	SA, WCDMA, C2K, WIMAX OFDMA, TD-SCDMA, 1xEVDO, DVB-T/H, DTMB (CTTB), ISDB-T, CMMB, LTE, LTE-TDD, Digital Cable TV, MSR, LTEAFDD, LTEATDD
Remote Command	:CALCulate:ACPower:MARKer[1] 2 ... 12:TRACe 1 2 3 :CALCulate:ACPower:MARKer[1] 2 ... 12:TRACe?
Example	CALC:ACP:MARK2:TRAC 2 CALC:ACP:MARK2:TRAC?
Notes	If the selected marker is Off, pressing Marker sets it to Normal and places it at the center of the screen on the trace determined by the Marker Trace rules. At the same time, Marker X Axis Value appears on the Active Function area.  Default Active Function: the active function for the selected marker's current control mode. If the current control mode is Off, there is no active function and the active function is turned off.  Active Function Display: the marker X axis value entered in the active function area will display the marker value to its full entered precision.
Dependencies	This key is unavailable when " <b>Meas Method</b> " on page 757 is set to RBW.
Couplings	This is not affected by Auto Coupling.  Sending the remote command causes the addressed marker to become selected.
Preset	All Markers Off
State Saved	Saved in instrument state.
Range	1 2 3
Initial S/W Revision	Prior to A.02.00
Modified at S/W Revision	A.02.00, A.03.00

## Couple Markers

When this function is On, moving any marker causes an equal X axis movement of every other marker which is not Off. By “equal X axis movement” we mean that we preserve the difference between each marker’s X axis value (in the fundamental x-axis units of the trace that marker is on) and the X axis value of the marker being moved (in the same fundamental x-axis units).

Key Path	Marker
Mode	SA, WCDMA, C2K, WIMAX OFDMA, TD-SCDMA, 1xEVDO, DVB-T/H, DTMB (CTTB), ISDB-T, CMMB, LTE, LTETDD, Digital Cable TV, MSR, LTEAFDD,LTEATDD
Remote Command	:CALCulate:ACPower:MARKer:COUPle[:STATe] ON OFF 1 0 :CALCulate:ACPower:MARKer:COUPle[:STATe]?
Example	CALC:ACP:MARK:COUP ON
Dependencies	This key is unavailable when "Meas Method" on page 757 is set to RBW.
Preset	OFF
State Saved	Saved in instrument state.
Range	On Off
Initial S/W Revision	Prior to A.02.00
Modified at S/W Revision	A.02.00, A.03.00

## Marker All Off

Turns all active markers off.

Key Path	Marker
Mode	SA, WCDMA, C2K, WIMAX OFDMA, TD-SCDMA, 1xEVDO, DVB-T/H, DTMB (CTTB), ISDB-T, CMMB, LTE, LTETDD, Digital Cable TV, MSR, LTEAFDD,LTEATDD
Remote Command	:CALCulate:ACPower:MARKer:AOFF
Example	CALC:ACP:MARK:AOFF
Dependencies	This key is unavailable when "Meas Method" on page 757 is set to RBW.
Initial S/W Revision	Prior to A.02.00
Modified at S/W Revision	A.02.00, A.03.00

## Marker X Axis Value (Remote Command only)

Sets the marker X axis value in the current marker X Axis Scale unit. This value has no effect if the control mode is Off, but is the SCPI equivalent of entering an X value if the control mode is Normal,Delta or Fixed.

Mode	SA, WCDMA, C2K, WIMAX OFDMA, TD-SCDMA, 1xEVDO, DVB-T/H, DTMB (CTTB), ISDB-T, CMMB, LTE, LTETDD, Digital Cable TV, MSR, LTEAFDD,LTEATDD
Remote Command	:CALCulate:ACPower:MARKer[1] 2 ... 12:X <freq> :CALCulate:ACPower:MARKer[1] 2 ... 12:X?

<b>Example</b>	CALC:ACP:MARK3:X 0 CALC:ACP:MARK3:X?
Notes	The query returns the marker's absolute X Axis value if the control mode is Normal, or the offset from the marker's reference marker if the control mode is Delta. If the marker is Off the response is not a number.
Dependencies	Unavailable when " <b>Meas Method</b> " on page 757 is set to RBW.
Preset	After a preset, all Markers are turned OFF, so Marker X Axis Value query will return a not a number (NAN).
State Saved	No
Min	-9.9E+37
Max	9.9E+37
Initial S/W Revision	Prior to A.02.00
Modified at S/W Revision	A.02.00, A.03.00

### Marker X Axis Position (Remote Command only)

Sets the marker X position in trace points. It has no effect if the control mode is Off, but is the SCPI equivalent of entering a value if the control mode is Normal, Delta or Fixed. The entered value is immediately translated into the current X Axis Scale units for setting the value of the marker.

Mode	SA, WCDMA, C2K, WIMAX OFDMA, TD-SCDMA, 1xEVDO, DVB-T/H, DTMB (CTTB), ISDB-T, CMMB, LTE, LTE-TDD, Digital Cable TV, MSR, LTEAFDD, LTEATDD
<b>Remote Command</b>	:CALCulate:ACPower:MARKer[1] 2 ... 12:X:POSition <real> :CALCulate:ACPower:MARKer[1] 2 ... 12:X:POSition?
<b>Example</b>	CALC:ACP:MARK10:X:POS 0 CALC:ACP:MARK10:X:POS?
Notes	The query returns the marker's absolute X Axis value in trace points if the control mode is Normal, or the offset from the marker's reference marker in trace points if the control mode is Delta. The value is returned as a real number, not an integer, corresponding to the translation from X Axis Scale units to trace points (see "Fractional Trace Points"). If the marker is Off the response is not a number.  When a Marker is turned on, it is placed center of the screen on the trace. Therefore the default value depends on instrument condition, although the Preset/Default is defined as 500 (this value might be expected value when all offset is on).
Dependencies	Unavailable when " <b>Meas Method</b> " on page 757 is set to RBW.
Preset	After a preset, all Markers are turned OFF, so Marker X Axis Value query will return a not a number (NAN).
State Saved	No
Min	-9.9E+37
Max	9.9E+37
Initial S/W Revision	Prior to A.02.00
Modified at S/W Revision	A.02.00, A.03.00

## Marker Y Axis Value (Remote Command only)

Returns the marker Y axis value in the current marker Y axis unit.

Mode	SA, WCDMA, C2K, WIMAX OFDMA, TD-SCDMA, 1xEVDO, DVB-T/H, DTMB (CTTB), ISDB-T, CMMB, LTE, LTETDD, Digital Cable TV, MSR, LTEAFDD, LTEATDD
Remote Command	:CALCulate:ACPower:MARKer[1] 2 ... 12:Y?
Example	CALC:ACP:MARK11:Y?
Notes	Since the result value is always calculated from acquisition data, the default value is arbitrary. Although the Preset/Default values are defined.
Dependencies	Unavailable when " <b>Meas Method</b> " on page 757 is set to RBW.
Preset	Result dependent on markers setup and signal source.
State Saved	No
Backwards Compatibility SCPI	:CALCulate:ACPower:MARKer[1] 2 ... 12:FUNCTION:RESULT?
Initial S/W Revision	Prior to A.02.00
Modified at S/W Revision	A.02.00, A.03.00

## Backward Compatibility Remote Commands

Sets or queries the state of a marker. Setting a marker which is off to the on state or 1 puts it in Normal mode and places it at the center of the screen.

Mode	SA, WCDMA, WIMAXOFDMA, CDMA2K, TDSCDMA, CDMA1XEV, DVB, DTMB, ISDBT, CMMB, LTE, LTETDD, DCATV, MSR, LTEAFDD, LTEATDD
Remote Command	:CALCulate:ACPower:MARKer[1] 2 ... 12:STATe OFF ON 0 1 :CALCulate:ACPower:MARKer[1] 2 ... 12:STATe?
Example	CALC:ACP:MARK2:STAT ON CALC:ACP:MARK2:STAT?
Notes	This parameter is also accessed from Marker, Properties, 1 You must be in the mode that includes ACP measurements to use this command. Use :INSTrument:SElect to set the mode.
Preset	OFF OFF OFF OFF OFF OFF OFF OFF OFF OFF OFF OFF
State Saved	Saved in instrument state.
Range	On Off
Initial S/W Revision	Prior to A.02.00
Modified at S/W Revision	A.02.00, A.03.00

## Marker Function

There are no Marker Functions supported in the ACP measurement. The front-panel key will display a blank key menu when pressed.

---

Key Path	Front-panel key
Initial S/W Revision	Prior to A.02.00

---

## Marker To

There is no Marker To functionality supported in ACP. The front-panel key will display a blank key menu when pressed.

---

Key Path	Front-panel key
Initial S/W Revision	Prior to A.02.00

---



## Meas

The information in this section is common to all measurements. For key and remote command information for a specific measurement, refer to the section that describes the measurement of interest.

Measurements available under the Meas key are specific to the current Mode.

When viewing Help for measurements, note the following:

**NOTE**

Operation for some keys differs between measurements. The information displayed in Help pertains to the current measurement. To see how a key operates in a different measurement, exit Help (press the Cancel Esc key), select the measurement, then reenter Help (press the Help key) and press that key.

---

Key Path	Front-panel key
Initial S/W Revision	Prior to A.02.00

---

### Remote Measurement Functions

This section contains the following topics:

"Measurement Group of Commands" on page 2166

"Current Measurement Query (Remote Command Only)" on page 2168

"Limit Test Current Results (Remote Command Only)" on page 2168

"Data Query (Remote Command Only)" on page 2168

"Calculate/Compress Trace Data Query (Remote Command Only)" on page 2169

"Calculate Peaks of Trace Data (Remote Command Only)" on page 2174

Hardware-Accelerated Fast Power Measurement (Remote Command Only)

"Format Data: Numeric Data (Remote Command Only)" on page 2175

"Format Data: Byte Order (Remote Command Only)" on page 2176

---

Initial S/W Revision	Prior to A.02.00
----------------------	------------------

---

## Measurement Group of Commands

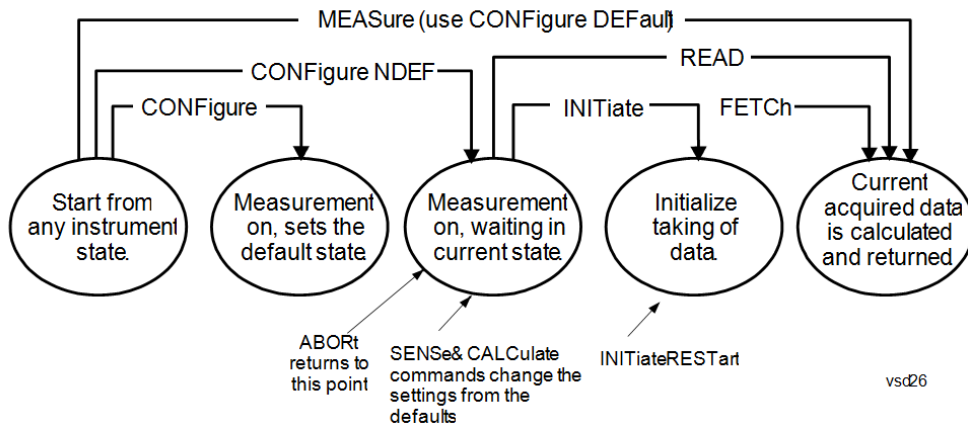

---

### Measure Commands:

:MEASure:<measurement>[n]?

This is a fast single-command way to make a measurement using the factory default instrument settings. These are the settings and units that conform to the Mode Setup settings (e.g. radio standard) that you have currently selected.

- Stops the current measurement (if any) and sets up the instrument for the specified measurement using the factory defaults
- Initiates the data acquisition for the measurement
- Blocks other SCPI communication, waiting until the measurement is complete before returning results.
- If the function does averaging, it is turned on and the number of averages is set to 10.
- After the data is valid it returns the scalar results, or the trace data, for the specified measurement. The type of data returned may be defined by an [n] value that is sent with the command.
- The scalar measurement results will be returned if the optional [n] value is not included, or is set to 1. If the [n] value is set to a value other than 1, the selected trace data results will be returned. See each command for details of what types of scalar results or trace data results are available.
- ASCII is the default format for the data output. (Older versions of Spectrum Analysis and Phase Noise mode measurements only use ASCII.) The binary data formats should be used for handling large blocks of data since they are smaller and faster than the ASCII format. Refer to the FORMat:DATA command for more information.

If you need to change some of the measurement parameters from the factory default settings you can set up the measurement with the CONFigure command. Use the commands in the SENSe:<measurement> and CALCulate:<measurement> subsystems to change the settings. Then you can use the READ? command to initiate the measurement and query the results.

If you need to repeatedly make a given measurement with settings other than the factory defaults, you can use the commands in the SENSe:<measurement> and CALCulate:<measurement> subsystems to set up the measurement. Then use the READ? command to initiate the measurement and query results.

Measurement settings persist if you initiate a different measurement and then return to a previous one. Use READ:<measurement>? if you want to use those persistent settings. If you want to go back to the default settings, use MEASure:<measurement>?.

---

### Configure Commands:

:CONFigure:<measurement>

This command stops the current measurement (if any) and sets up the instrument for the specified measurement using

---

---

the factory default instrument settings. It does not initiate the taking of measurement data unless INIT:CONTInuous is ON. If you change any measurement settings after using the CONFigure command, the READ command can be used to initiate a measurement without changing the settings back to their defaults.

In the Swept SA measurement in Spectrum Analyzer mode the CONFigure command also turns the averaging function on and sets the number of averages to 10 for all measurements.

:CONFigure: <measurement>: NDEFault stops the current measurement and changes to the specified measurement. It does not change the settings to the defaults. It does not initiate the taking of measurement data unless INIT:CONTInuous is ON.

The CONFigure? query returns the current measurement name.

The CONFigure:CATalog? query returns a quoted string of all licensed measurement names in the current mode. For example, "SAN, CHP, OBW, ACP, PST, TXP, SPUR, SEM, LIST".

---

#### Fetch Commands:

:FETCh:<measurement>[n]?

This command puts selected data from the most recent measurement into the output buffer. Use FETCh if you have already made a good measurement and you want to return several types of data (different [n] values, for example, both scalars and trace data) from a single measurement. FETCh saves you the time of re-making the measurement. You can only FETCh results from the measurement that is currently active, it will not change to a different measurement. An error message is reported if a measurement other than the current one is specified.

If you need to get new measurement data, use the READ command, which is equivalent to an INITiate followed by a FETCh.

The scalar measurement results will be returned if the optional [n] value is not included, or is set to 1. If the [n] value is set to a value other than 1, the selected trace data results will be returned. See each command for details of what types of scalar results or trace data results are available. The binary data formats should be used for handling large blocks of data since they are smaller and transfer faster than the ASCII format. (FORMat:DATA)

FETCh may be used to return results other than those specified with the original READ or MEASure command that you sent.

---

#### INITiate Commands:

:INITiate:<measurement>

This command is not available for measurements in all the instrument modes:

- Initiates a trigger cycle for the specified measurement, but does not output any data. You must then use the FETCh<meas> command to return data. If a measurement other than the current one is specified, the instrument will switch to that measurement and then initiate it.
- For example, suppose you have previously initiated the ACP measurement, but now you are running the channel power measurement. If you send INIT:ACP? it will change from channel power to ACP and will initiate an ACP measurement.
- Does not change any of the measurement settings. For example, if you have previously started the ACP measurement and you send INIT:ACP? it will initiate a new ACP measurement using the same instrument settings as the last time ACP was run.
- If your selected measurement is currently active (in the idle state) it triggers the measurement, assuming the trigger conditions are met. Then it completes one trigger cycle. Depending upon the measurement and the number of averages, there may be multiple data acquisitions, with multiple trigger events, for one full trigger cycle. It also holds off additional commands on GPIB until the acquisition is complete.

---

#### READ Commands:

:READ:<measurement>[n]?

- Does not preset the measurement to the factory default settings. For example, if you have previously initiated the ACP
-

---

measurement and you send READ:ACP? it will initiate a new measurement using the same instrument settings.

- Initiates the measurement and puts valid data into the output buffer. If a measurement other than the current one is specified, the instrument will switch to that measurement before it initiates the measurement and returns results.
  - For example, suppose you have previously initiated the ACP measurement, but now you are running the channel power measurement. Then you send READ:ACP? It will change from channel power back to ACP and, using the previous ACP settings, will initiate the measurement and return results.
  - Blocks other SCPI communication, waiting until the measurement is complete before returning the results
  - If the optional [n] value is not included, or is set to 1, the scalar measurement results will be returned. If the [n] value is set to a value other than 1, the selected trace data results will be returned. See each command for details of what types of scalar results or trace data results are available. The binary data formats should be used when handling large blocks of data since they are smaller and faster than the ASCII format. (FORMat:DATA)
- 

---

Initial S/W Revision	Prior to A.02.00
----------------------	------------------

---

### Current Measurement Query (Remote Command Only)

This command returns the name of the measurement that is currently running.

---

<b>Remote Command</b>	:CONFigure?
-----------------------	-------------

<b>Example</b>	CONF?
----------------	-------

Initial S/W Revision	Prior to A.02.00
----------------------	------------------

---

### Limit Test Current Results (Remote Command Only)

Queries the status of the current measurement limit testing. It returns a 0 if the measured results pass when compared with the current limits. It returns a 1 if the measured results fail any limit tests.

---

<b>Remote Command</b>	:CALCulate:CLIMits:FAIL?
-----------------------	--------------------------

<b>Example</b>	CALC:CLIM:FAIL? queries the current measurement to see if it fails the defined limits. Returns a 0 or 1: 0 it passes, 1 it fails.
----------------	--

Initial S/W Revision	Prior to A.02.00
----------------------	------------------

---

### Data Query (Remote Command Only)

Returns the designated measurement data for the currently selected measurement and subopcode.

n = any valid subopcode for the current measurement. See the measurement command results table for your current measurement, for information about what data is returned for the subopcodes.

This command uses the data setting specified by the FORMat:BORDER and FORMat:DATA commands and can return real or ASCII data. (See the format command descriptions under Input/Output in the Analyzer Setup section.)

<b>Remote Command</b>	:CALCulate:DATA[n]?
<b>Notes</b>	The return trace depends on the measurement. In CALCulate:<meas>:DATA[n], n is any valid subopcode for the current measurement. It returns the same data as the FETCH:<measurement>? query where <measurement> is the current measurement.
<b>Initial S/W Revision</b>	Prior to A.02.00

## Calculate/Compress Trace Data Query (Remote Command Only)

Returns compressed data for the currently selected measurement and sub-opcode [n].

n = any valid sub-opcode for that measurement. See the MEASure:<measurement>? command description of your specific measurement for information on the data that can be returned.

The data is returned in the current Y Axis Unit of the analyzer. The command is used with a sub-opcode <n> (default=1) to specify the trace. With trace queries, it is best if the analyzer is not sweeping during the query. Therefore, it is generally advisable to be in Single Sweep, or Update=Off.

This command is used to compress or decimate a long trace to extract and return only the desired data. A typical example would be to acquire N frames of GSM data and return the mean power of the first burst in each frame. The command can also be used to identify the best curve fit for the data.

<b>Remote Command</b>	:CALCulate:DATA<n>:COMPRESS? BLOCK   CFIT   MAXimum   MINimum   MEAN   DMEan   RMS   RMSCubed   SAMPLE   SDEVIation   PPHase [,<soffset> [,<length>[,<roffset>[,<rlimit>]]]]
<b>Example</b>	To query the mean power of a set of GSM bursts: Supply a signal that is a set of GSM bursts. Select the IQ Waveform measurement (in IQ Analyzer Mode). Set the sweep time to acquire at least one burst. Set the triggers such that acquisition happens at a known position relative to a burst. Then query the mean burst levels using, CALC:DATA2:COMP? MEAN, 24e-6, 526e-6 (These parameter values correspond to GSM signals, where 526e-6 is the length of the burst in the slot and you just want 1 burst.)
<b>Notes</b>	The command supports 5 parameters. Note that the last 4 (<soffset>, <length>, <roffset>, <rlimit>) are optional. But these optional parameters must be entered in the specified order. For example, if you want to specify <length>, then you must also specify <soffset>. See details below for a definition of each of these parameters.  This command uses the data in the format specified by FORMat:DATA, returning either binary or ASCII data.
<b>Initial S/W Revision</b>	Prior to A.02.00

- BLOCK or block data - returns all the data points from the region of the trace data that you specify. For example, it could be used to return the data points of an input signal over several timeslots, excluding the portions of the trace data that you do not want. (This is x,y pairs for trace data and I,Q pairs for complex data.)

- CFIT or curve fit - applies curve fitting routines to the data. <soffset> and <length> are required to define the data that you want. <roffset> is an optional parameter for the desired order of the curve equation. The query will return the following values: the x-offset (in seconds) and the curve coefficients ((order + 1) values).

MIN, MAX, MEAN, DME, RMS, RMSC, SAMP, SDEV and PPH return one data value for each specified region (or <length>) of trace data, for as many regions as possible until you run out of trace data (using <roffset> to specify regions). Or they return the number of regions you specify (using <rlimit>) ignoring any data beyond that.

- MINimum - returns the minimum data point (y value) for the specified region(s) of trace data. For I/Q trace data, the minimum magnitude of the I/Q pairs is returned.
- MAXimum - returns the maximum data point (y value) for the specified region(s) of trace data. For I/Q trace data, the maximum magnitude of the I/Q pairs is returned.
- MEAN - returns a single value that is the arithmetic mean of the data point values (in dB/ dBm) for the specified region(s) of trace data. For I/Q trace data, the mean of the magnitudes of the I/Q pairs is returned. See the following equations.

**NOTE** If the original trace data is in dB, this function returns the arithmetic mean of those log values, not log of the mean power which is a more useful value. The mean of the log is the better measurement technique when measuring CW signals in the presence of noise. The mean of the power, expressed in dB, is useful in power measurements such as Channel Power. To achieve the mean of the power, use the RMS option.

Equation 1

Mean Value of Data Points for Specified Region(s)

$$MEAN = \frac{1}{n} \sum_{X_i \in \text{region}(s)} X_i$$

where  $X_i$  is a data point value, and  $n$  is the number of data points in the specified region(s).

Equation 2

Mean Value of I/Q Data Pairs for Specified Region(s)

$$MEAN = \frac{1}{n} \sum_{X_i \in \text{region}(s)} |X_i|$$

where  $|X_i|$  is the magnitude of an I/Q pair, and  $n$  is the number of I/Q pairs in the specified region(s).

- DMEan - returns a single value that is the mean power (in dB/ dBm) of the data point values for the specified region(s) of trace data. See the following equation:

Equation 3

DMEan Value of Data Points for Specified Region(s)

$$\text{DME} = 10 \times \log_{10} \left( \frac{1}{n} \sum_{X_i \in \text{region}(s)} 10^{\frac{X_i}{10}} \right)$$

- RMS - returns a single value that is the average power on a root-mean-squared voltage scale (arithmetic rms) of the data point values for the specified region(s) of trace data. See the following equation.

**NOTE**

For I/Q trace data, the rms of the magnitudes of the I/Q pairs is returned. See the following equation. This function is very useful for I/Q trace data. However, if the original trace data is in dB, this function returns the rms of the log values which is not usually needed.

Equation 4

RMS Value of Data Points for Specified Region(s)

$$\text{RMS} = \sqrt{\frac{1}{n} \sum_{X_i \in \text{region}(s)} X_i^2}$$

where  $X_i$  is a data point value, and  $n$  is the number of data points in the specified region(s).

Equation 5

RMS Value of I/Q Data Pairs for Specified Region(s)

$$\text{RMS} = \sqrt{\frac{1}{n} \sum_{X_i \in \text{region}(s)} X_i X_i^*}$$

where  $X_i$  is the complex value representation of an I/Q pair,  $X_i^*$  its conjugate complex number, and  $n$  is the number of I/Q pairs in the specified region(s).

Once you have the rms value for a region of trace data (linear or I/Q), you may want to calculate the mean power. You must convert this rms value (peak volts) to power in dBm:

$$10 \times \log[10 \times (\text{rms value})^2]$$

- SAMPLe - returns the first data value (x,y pair) for the specified region(s) of trace data. For I/Q trace data, the first I/Q pair is returned.
- SDEViation - returns a single value that is the arithmetic standard deviation for the data point values for the specified region(s) of trace data. See the following equation.
- For I/Q trace data, the standard deviation of the magnitudes of the I/Q pairs is returned. See the following equation.

Equation 6

Standard Deviation of Data Point Values for Specified Region(s)

$$\text{SDEV} = \sqrt{\frac{1}{n} \sum_{X_i \in \text{region}(s)} (X_i - \bar{X})^2}$$

where  $X_i$  is a data point value,  $\bar{X}$  is the arithmetic mean of the data point values for the specified region (s), and  $n$  is the number of data points in the specified region(s).

$$\text{SDEV} = \sqrt{\frac{1}{n} \sum_{X_i \in \text{region}(s)} (|X_i| - \bar{X})^2}$$

where  $|X_i|$  is the magnitude of an I/Q pair,  $\bar{X}$  is the mean of the magnitudes for the specified region(s), and  $n$  is the number of data points in the specified region(s).

- PPHase - returns the x,y pairs of both rms power (dBm) and arithmetic mean phase (radian) for every specified region and frequency offset (Hz). The number of pairs is defined by the specified number of regions. This parameter can be used for I/Q vector ( $n=0$ ) in Waveform (time domain) measurement and all parameters are specified by data point in PPHase.

The rms power of the specified region may be expressed as:

$$\text{Power} = 10 \times \log [10 \times (\text{RMS I/Q value})] + 10.$$

The RMS I/Q value (peak volts) is:

$$\sqrt{\frac{1}{n} \sum_{X_i \in \text{region}} X_i X_i^*}$$

where  $X_i$  is the complex value representation of an I/Q pair,  $X_i^*$  its conjugate complex number, and  $n$  is the number of I/Q pairs in the specified region.

The arithmetic mean phase of the specified region may be expressed as:

$$\frac{1}{n} \sum_{Y_i \in \text{region}} Y_i$$

where  $Y_i$  is the unwrapped phase of I/Q pair with applying frequency correction and  $n$  is the number of I/Q pairs in the specified region.

The frequency correction is made by the frequency offset calculated by the arithmetic mean of every specified region's frequency offset. Each frequency offset is calculated by the least square method against the unwrapped phase of I/Q pair.

Sample Trace Data - Constant Envelope

(See below for explanation of variables.)



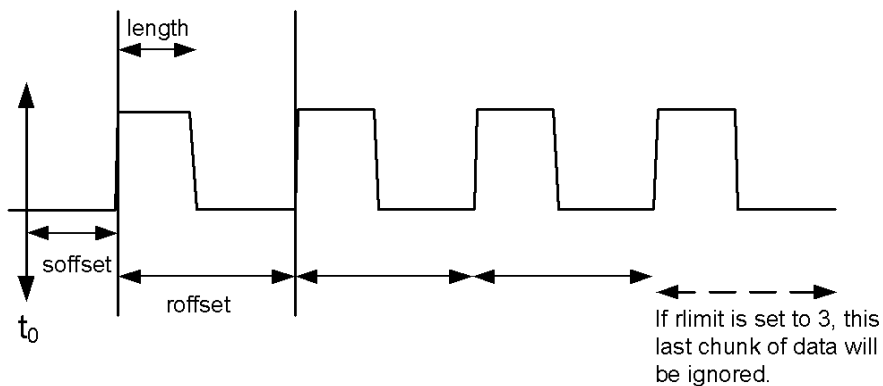

### Sample Trace Data - Not Constant Envelope

(See below for explanation of variables.)

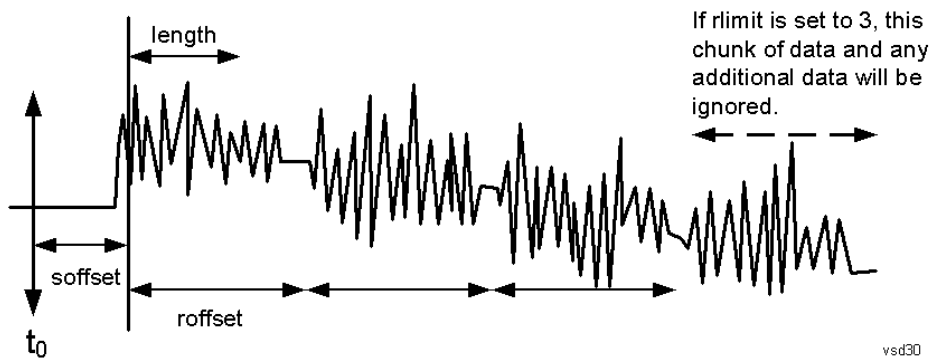

<soffset> - start offset is an optional real number. (It is in seconds for time-domain traces, and is a dimensionless index 0 to Npoints - 1, for frequency-domain traces). It specifies the amount of data at the beginning of the trace that will be ignored before the decimation process starts. It is the time or frequency change from the start of the trace to the point where you want to start using the data. The default value is zero.

<length> - is an optional real number. (It is in seconds for time-domain traces, and is a dimensionless index 0 to Npoints - 1, for frequency-domain traces). It defines how much data will be compressed into one value. This parameter has a default value equal to the current trace length.

<roffset> - repeat offset is an optional real number. (It is in seconds for time-domain traces, and is a dimensionless index 0 to Npoints - 1, for frequency-domain traces). It defines the beginning of the next field of trace elements to be compressed. This is relative to the beginning of the previous field. This parameter has a default value equal to the <length> variable. Note that this parameter is used for a completely different purpose when curve fitting (see CFIT above).

<rlimit> - repeat limit is an optional integer. It specifies the number of data items that you want returned. It will ignore any additional items beyond that number. You can use the Start offset and the Repeat limit to pick out exactly what part of the data you want to use. The default value is all the data.

## Calculate Peaks of Trace Data (Remote Command Only)

Returns a list of all the peaks for the currently selected measurement and sub-opcode [n]. The peaks must meet the requirements of the peak threshold and excursion values.

n = any valid sub-opcode for the current measurement. See the MEASure:<measurement> command description of your specific measurement for information on the data that can be returned.

The command can only be used with specific sub-opcodes with measurement results that are trace data. Both real and complex traces can be searched, but complex traces are converted to magnitude in dBm. In many measurements the sub-opcode n=0, is the raw trace data which cannot be searched for peaks. And Sub-opcode n=1, is often calculated results values which also cannot be searched for peaks.

This command uses the data setting specified by the FORMat:BORDER and FORMat:DATA commands and can return real or ASCII data. If the format is set to INT,32, it returns REAL,32 data.

The command has four types of parameters:

- Threshold (in dBm)
- Excursion (in dB)
- Sorting order (amplitude, frequency, time)
- Optional in some measurements: Display line use (all, > display line, < display line)

---

<b>Remote Command</b>	<p>For Swept SA measurement:</p> <pre>:CALCulate:DATA[1] 2 ... 6:PEAKs? &lt;threshold&gt;,&lt;excursion&gt;[,AMPLitude   FREQuency   TIME[,ALL   GTDLLine   LTDLine]]</pre> <p>For most other measurements:</p> <pre>:CALCulate:DATA[1] 2 ... 6:PEAKs? &lt;threshold&gt;,&lt;excursion&gt;[,AMPLitude   FREQuency   TIME]</pre>
-----------------------	---

---

<b>Example</b>	<p>Example for Swept SA measurement in Spectrum Analyzer Mode:</p> <p>CALC:DATA4:PEAK? -40, 10, FREQ, GTDL This will identify the peaks of trace 4 that are above -40 dBm, with excursions of at least 10 dB. The peaks are returned in order of increasing frequency, starting with the lowest frequency. Only the peaks that are above the display line are returned.</p> <p>Query Results 1:</p> <p>With FORMat:DATA REAL, 32 selected, it returns a list of floating-point numbers. The first value in the list is the number of peak points that are in the following list. A peak point consists of two values: a peak amplitude followed by its corresponding frequency (or time).</p> <p>If no peaks are found the peak list will consist of only the number of peaks, (0).</p>
----------------	---

---

<b>Notes</b>	<p>&lt;n&gt; - is the trace that will be used</p> <p>&lt;threshold&gt; - is the level below which trace data peaks are ignored. Note that the threshold value is required and is always used as a peak criterion. To effectively disable the threshold criterion for this command, provide a substantially low threshold value such as -200 dBm. Also note that the threshold value used in this command is independent of and has no effect on the threshold value stored under the Peak Criteria menu.</p> <p>&lt;excursion&gt; - is the minimum amplitude variation (rise and fall) required for a signal to be identified as peak. Note that the excursion value is required and is always used as a peak criterion. To effectively disable the excursion criterion for this command, provide the minimum value of 0.0 dB. Also note that the excursion value used in this command is independent of and has no effect on the</p>
--------------	---

---

---

excursion value stored under the Peak Criteria menu.

Values must be provided for threshold and excursion. The sorting and display line parameters are optional (defaults are AMPLitude and ALL).

Note that there is always a Y-axis value for the display line, regardless of whether the display line state is on or off. It is the current Y-axis value of the display line which is used by this command to determine whether a peak should be reported. Sorting order:

AMPLitude - lists the peaks in order of descending amplitude, with the highest peak first (default if optional parameter not sent)

FREQUENCY - lists the peaks in order of occurrence, left to right across the x-axis.

TIME - lists the peaks in order of occurrence, left to right across the x-axis.

Peaks vs. Display Line:

ALL - lists all of the peaks found (default if optional parameter not sent).

GTDLine (greater than display line) - lists all of the peaks found above the display line.

LTDLine (less than display line) - lists all of the peaks found below the display line.

---

Initial S/W Revision      Prior to A.02.00

---

## Format Data: Numeric Data (Remote Command Only)

This command specifies the format of the trace data input and output. It specifies the formats used for trace data during data transfer across any remote port. It affects only the data format for setting and querying trace data for the :TRACe[:DATA], TRACe[:DATA]?, :CALCulate:DATA[n]? and FETCh:SANalyzer[n]? commands and queries.

---

**Remote Command**      :FORMat[:TRACe][:DATA] ASCii|INTeger,32|REAL,32 |REAL,64  
:FORMat[:TRACe][:DATA]?

---

**Notes**      The query response is:  
ASCii: ASC,8  
REAL,32: REAL,32  
REAL,64: REAL,64  
INTeger,32: INT,32  
When the numeric data format is REAL or ASCii, data is output in the current Y Axis unit. When the data format is INTeger, data is output in units of m dBm (.001 dBm).  
The INT,32 format returns binary 32-bit integer values in internal units (m dBm), in a definite length block.

---

**Dependencies**      Sending a data format spec with an invalid number (for example, INT,48) generates no error. The analyzer simply uses the default (8 for ASCii, 32 for INTeger, 32 for REAL).  
Sending data to the analyzer which does not conform to the current FORMat specified, results in an error. Sending ASCII data when a definite block is expected generates message -161 "Invalid Block Data" and sending a definite block when ASCII data is expected generates message -121 "Invalid Character in Number".

---

**Preset**      ASCii

---

**Backwards Compatibility Notes**      Note that the INT,32 format is only applicable to the command, TRACe:DATA. This preserves backwards compatibility for the Swept SA measurement. For all other commands/queries which honor FORMat:DATA, if INT,32 is sent the analyzer will behave as though it were set to REAL,32.

---

Initial S/W Revision      Prior to A.02.00

---

The specs for each output type follow:

AScii - Amplitude values are in ASCII, in the current Y Axis Unit, one ASCII character per digit, values separated by commas, each value in the form:

SX.YYYYYEsZZ

Where:

S = sign (+ or -)

X = one digit to left of decimal point

Y = 5 digits to right of decimal point

E = E, exponent header

s = sign of exponent (+ or -)

ZZ = two digit exponent

REAL,32 - Binary 32-bit real values in the current Y Axis Unit, in a definite length block.

REAL,64 - Binary 64-bit real values in the current Y Axis Unit, in a definite length block.

### Format Data: Byte Order (Remote Command Only)

This command selects the binary data byte order for data transfer and other queries. It controls whether binary data is transferred in normal or swapped mode. This command affects only the byte order for setting and querying trace data for the :TRACe[:DATA], TRACe[:DATA]? , :CALCulate:DATA[n]? and FETCh:SANalyzer[n]? commands and queries.

By definition any command that says it uses FORMat:DATA uses any format supported by FORMat:DATA.

The NORMal order is a byte sequence that begins with the most significant byte (MSB) first, and ends with the least significant byte (LSB) last in the sequence: 1|2|3|4. SWAPped order is when the byte sequence begins with the LSB first, and ends with the MSB last in the sequence: 4|3|2|1.

---

<b>Remote Command</b>	:FORMat:BORDER NORMal   SWAPped :FORMat:BORDER?
<b>Preset</b>	NORMal
<b>Initial S/W Revision</b>	Prior to A.02.00

---

## Meas Setup

Displays the setup menu for the currently selected measurement. The functions included in the measurement setup menu include setting the parameters for the carriers, offsets, bandwidths, measurement methods and types. This menu also allows you to turn noise correction on and off.

Key Path	Front-panel key
Initial S/W Revision	Prior to A.02.00

### Average/Hold Number

Specifies the number of measurement averages used to calculate the measurement result. The average will be displayed at the end of each sweep. After the specified number of average counts, the average mode (termination control) setting determines the average action.

Key Path	Meas Setup
Mode	SA, WCDMA, C2K, WIMAX OFDMA, TD-SCDMA, 1xEVDO, DVB-T/H, DTMB (CTTB), ISDB-T, CMMB, LTE, LTE-TDD, Digital Cable TV, MSR, LTEAFDD, LTEATDD
<b>Remote Command</b>	[:SENSe]:ACPower:AVERage:COUNT <integer> [:SENSe]:ACPower:AVERage:COUNT? [:SENSe]:ACPower:AVERage[:STATe] OFF ON 0 1 [:SENSe]:ACPower:AVERage[:STATe]?
<b>Example</b>	ACP:AVER:COUN 250 ACP:AVER:COUN? ACP:AVER OFF ACP:AVER?
Notes	You must be in the mode that includes ACP measurements to use this command. Use :INSTRument:SElect to set the mode.
Preset	10 ON
State Saved	Saved in instrument state.
Min	1
Max	1000
<b>Backwards Compatibility SCPI</b>	[:SENSe]:ACPR:AVERage:COUNT [:SENSe]:MCPower:AVERage:COUNT (PSA Power Suite, PSA W-CDMA, PSA cdma2000 )
Initial S/W Revision	Prior to A.02.00
Modified at S/W Revision	A.02.00, A.03.00

## Avg Mode

Enables you to set the averaging mode. This determines the averaging action after the specified number of data acquisitions (average count) is reached.

When set to Exponential (Exp) the measurement averaging continues using the specified number of averages to compute each averaged value. The average will be displayed at the end of each sweep.

When set to Repeat, the measurement resets the average counter each time the specified number of averages is reached.

Key Path	Meas Setup
Mode	SA, WCDMA, C2K, WIMAX OFDMA, TD-SCDMA, 1xEVDO, DVB-T/H, DTMB (CTTB), ISDB-T, CMMB, LTE, LTETDD, Digital Cable TV, MSR, LTEAFDD, LTEATDD
Remote Command	[ :SENSe ] :ACPpower:AVERage:TCONtrol EXPonential   REPeat [ :SENSe ] :ACPpower:AVERage:TCONtrol ?
Example	ACP:AVER:TCON EXP ACP:AVER:TCON ?
Notes	You must be in the mode that includes ACP measurements to use this command. Use :INSTRument:SElect to set the mode.
Preset	EXPonential
State Saved	Saved in instrument state.
Range	Exp Repeat
Backwards Compatibility SCPI	[ :SENSe ] :ACPR:AVERage:TCONtrol
Initial S/W Revision	Prior to A.02.00
Modified at S/W Revision	A.02.00, A.03.00

## Carrier Setup (This menu is unavailable in MSR and LTE-Advanced FDD/TDD)

Accesses a menu that contains Carriers, Ref Carrier, Ref Car Freq, Ref Car Pwr and Configure Carriers.

Key Path	Meas Setup
Initial S/W Revision	Prior to A.02.00

## Carriers

Specifies the number of carriers to be measured.

Key Path	Meas Setup, Carrier Setup, Configure Carriers
Mode	SA, WCDMA, C2K, WIMAX OFDMA, 1xEVDO, TD-SCDMA, DVB-T/H, DTMB (CTTB), ISDB-T, CMMB, LTE, LTETDD, Digital Cable TV

<b>Remote Command</b>	<code>[:SENSe]:ACPower:CARRier[1] 2:COUNT &lt;integer&gt;</code> <code>[:SENSe]:ACPower:CARRier[1] 2:COUNT?</code>
<b>Example</b>	ACP:CARR:COUN 1 ACP:CARR:COUN?
<b>Notes</b>	Carrier sub op code. 1 for BTS, 2 for MS. Default is BTS. Note that Carrier sub op code 2 is supported only in Non-SA modes. In the SA mode, Carrier sub op code 1 is used for both BTS and MS. You must be in the mode that includes ACP measurements to use this command. Use :INSTrument:SElect to set the mode.
<b>Dependencies</b>	When Number of Carriers is 1, Ref Carrier is grayed out. If N9060A-5FP license is enabled, Max of Carrier is 18, otherwise, Max of Carrier is 12.
<b>Couplings</b>	Changing this parameter might affect the Span.
<b>Preset</b>	1
<b>State Saved</b>	Saved in instrument state.
<b>Min</b>	1
<b>Max</b>	Refer to Dependencies item.
<b>Initial S/W Revision</b>	Prior to A.02.00
<b>Modified at S/W Revision</b>	A.02.00, A.03.00

## Ref Carrier

Sets the reference carrier. Relative power measurements are made from the reference carrier.

If set to Auto, the measurement selects the carrier with the highest power as the reference carrier and the Ref Carrier parameter is updated. If a value is entered when Ref Carrier Mode is set to Auto, the mode changes to Man.

If set to Man, the value that you enter for the Ref Carrier is used as the reference carrier.

<b>Key Path</b>	Meas Setup, Carrier Setup
<b>Mode</b>	SA, WCDMA, C2K, WIMAX OFDMA, 1xEVDO, TD-SCDMA, DVB-T/H, DTMB (CTTB), ISDB-T, CMMB, LTE, LTE-TDD, Digital Cable TV
<b>Remote Command</b>	<code>[:SENSe]:ACPower:CARRier[1] 2:RCARrier &lt;integer&gt;</code> <code>[:SENSe]:ACPower:CARRier[1] 2:RCARrier?</code> <code>[:SENSe]:ACPower:CARRier[1] 2:RCARrier:AUTO OFF ON 0 1</code> <code>[:SENSe]:ACPower:CARRier[1] 2:RCARrier:AUTO?</code>
<b>Example</b>	ACP:CARR:RCAR 1 ACP:CARR:RCAR? ACP:CARR:RCAR:AUTO OFF ACP:CARR:RCAR:AUTO?

Notes	Carrier sub op code. 1 for BTS, 2 for MS. Default is BTS. Note that Carrier sub op code 2 is supported only in Non-SA modes. In the SA mode, Carrier sub op code 1 is used for both BTS and MS. You must be in the mode that includes ACP measurements to use this command. Use :INSTrument:SElect to set the mode.
Dependencies	If there is only one carrier, this key will be grayed out.
Couplings	If you enter a carrier value that is currently configured as having no power present, that carrier will be changed to having power present. If you enter a ref carrier this parameter will be set to manual.
Preset	Auto determined
State Saved	Saved in instrument state.
Min	1
Max	Number of available carriers
<b>Backwards Compatibility SCPI</b>	[ :SENSe ] :MCPower :RCARrier [ 1 ]   2 (PSA Power Suite)
Initial S/W Revision	Prior to A.02.00
Modified at S/W Revision	A.02.00, A.03.00

## Ref Car Freq

Sets the reference carrier frequency.

Key Path	Meas Setup, Carrier Setup
Mode	SA, WCDMA, C2K, WIMAX OFDMA, 1xEVDO, TD-SCDMA, DVB-T/H, DTMB (CTTB), ISDB-T, CMMB, LTE, LTETDD, Digital Cable TV
<b>Remote Command</b>	[ :SENSe ] :ACPpower :CARRier [ 1 ]   2 :RCFRrequency <freq> [ :SENSe ] :ACPpower :CARRier [ 1 ]   2 :RCFRrequency? [ :SENSe ] :ACPpower :CARRier [ 1 ]   2 :RCFRrequency :AUTO OFF   ON   0   1 [ :SENSe ] :ACPpower :CARRier [ 1 ]   2 :RCFRrequency :AUTO?
<b>Example</b>	ACP:CARR:RCFR 250 MHz ACP:CARR:RCFR? ACP:CARR:RCFR:AUTO OFF ACP:CARR:RCFR:AUTO?

Notes	Carrier sub op code. 1 for BTS, 2 for MS. Default is BTS. Note that Carrier sub op code 2 is supported only in Non-SA modes. In the SA mode, Carrier sub op code 1 is used for both BTS and MS. You must be in the mode that includes ACP measurements to use this command. Use :INSTrument:SElect to set the mode.
-------	--



Couplings	<p>Coupled to the Center Frequency.</p> <p>If the center frequency changes, the Ref Carrier Frequency is calculated using the following three steps;</p> $\text{Ref Freq1} = \text{Ctr Freq} - (\text{Total of all Carrier Widths} / 2)$ $\text{Ref Freq2} = \text{Ref Freq1} + (\text{Total of all Carrier Widths up to Ref Carrier})$ $\text{Ref Freq} = \text{Ref Freq2} + (0.5 * \text{Carrier Width of Ref Carrier})$ <p>If reference carrier frequency changes the Center Frequency is calculated using the following three steps;</p> $\text{Ctr Freq1} = \text{Ref Freq} - (0.5 * \text{Carrier Width of Ref Carrier})$ $\text{Ctr Freq2} = \text{Ctr Freq1} - (\text{Total of all Carrier Widths up to Ref Carrier})$ $\text{Ctr Freq} = \text{Ctr Freq2} + (\text{Total of all Carrier Widths} / 2)$ <p>This ensures that the carriers are always centered on the screen.</p> <p>If there is only one carrier present the Reference Carrier Frequency will be the same as the Center Frequency.</p>
Preset	Calculated based on the current Center Frequency
State Saved	Saved in instrument state.
Min	-79.999995 MHz
Max	<p>Hardware Dependent:</p> <p>Option 503 = 3.699999995 GHz</p> <p>Option 508 = 8.499999995 GHz</p> <p>Option 513 = 13.799999995 GHz</p> <p>Option 526 = 26.999999995 GHz</p>
Initial S/W Revision	Prior to A.02.00
Modified at S/W Revision	A.02.00, A.03.00

## Power Ref

Sets the power reference in the carrier that will be used to compute the relative values for the offsets.

Key Path	Meas Setup, Carrier Setup
Initial S/W Revision	Prior to A.02.00
Modified at S/W Revision	A.03.00, A.04.00

## Total Power

Sets the multi-carrier power reference.

When set to Auto, the carrier power result reflects the measured power value in the selected reference carrier.

When set to Man, the result is referenced to the last measured value, or you may specify the reference for the multi-carrier power measurement. Relative values are displayed, referenced to the “Power Reference” value.

<b>Key Path</b>	Meas Setup, Carrier Setup, Power Ref
<b>Mode</b>	SA, WCDMA, C2K, WIMAX OFDMA, TD-SCDMA, DVB-T/H, DTMB (CTTB), ISDB-T, CMMB, LTE, LTETDD, Digital Cable TV, MSR
<b>Remote Command</b>	[:SENSe]:ACPower:CARRier[1] 2[:POWer] <real> [:SENSe]:ACPower:CARRier[1] 2[:POWer]? [:SENSe]:ACPower:CARRier[1] 2:AUTO[:STATe] OFF ON 0 1 [:SENSe]:ACPower:CARRier[1] 2:AUTO[:STATe]?
<b>Example</b>	ACP:CARR 10 ACP:CARR? ACP:CARR:AUTO OFF ACP:CARR:AUTO?
<b>Notes</b>	Although the default value is defined, the value is recalculated by the measurement result just after measurement. Carrier sub op code: 1 for BTS, 2 for MS. Default is BTS. Carrier sub op code 2 is supported only in Non-SA modes. MS is not supported in MSR. In the SA mode, Carrier sub op code 1 is used for both BTS and MS. The Unit Terminator keys differ depending on whether or not the mode supports Y Axis Unit and also which Y Axis Unit is selected. You must be in the mode that includes ACP measurements to use this command. Use :INSTrument:SElect to set the mode. Power Ref State ([:SENSe]:ACPower:CARRier[1] 2:AUTO[:STATe]) is not available in MSR mode.
<b>Dependencies</b>	This key is available only when the Meas Type is TPref. If the Meas Type is not TPref, this key is grayed out.
<b>Preset</b>	0.0 ON
<b>State Saved</b>	Saved in instrument state.
<b>Min</b>	-200 dBm
<b>Max</b>	200 dBm
<b>Backwards Compatibility SCPI</b>	[:SENSe]:MCPower:CARRier[1] 2[:POWer]
<b>Initial S/W Revision</b>	Prior to A.02.00
<b>Modified at S/W Revision</b>	A.02.00, A.03.00, A.04.00, A.10.00

## PSD

Sets the power spectral density in the carrier (main channel) that is used to compute the relative power spectral density values for the offsets when Meas Type is set to PSD Ref. When the PSD Ref state is set to Auto, this will be set to the measured carrier power spectral density.

Key Path	Meas Setup, Carrier Setup, Power Ref
Mode	SA, WCDMA, C2K, WIMAX OFDMA, TD-SCDMA, DVB-T/H, DTMB (CTTB), ISDB-T, CMMB, LTE, LTETDD, Digital Cable TV, MSR
Remote Command	<code>[ :SENSe] :ACPower:CARRier[1]  2:CPSD &lt;real&gt;</code> <code>[ :SENSe] :ACPower:CARRier[1]  2:CPSD?</code>
Example	ACP:CARR:CPSD 25 ACP:CARR:CPSD?
Notes	Although the default value is defined, the value is recalculated by the measurement result just after measurement. Carrier sub op code. 1 for BTS, 2 for MS. Default is BTS. MS is not supported in MSR. Note that Carrier sub op code 2 is supported only in Non-SA modes. In the SA mode, Carrier sub op code 1 is used for both BTS and MS. You must be in the mode that includes ACP measurements to use this command. Use <code>:INSTrument:SElect</code> to set the mode.
Dependencies	This key is available only when the Meas Type is PSDRef. If the Meas Type is not PSDRef, this key is grayed out.
Couplings	The value of PSD is automatically converted when PSD Unit is changed.
Preset	0.0
State Saved	Saved in instrument state.
Min	-999
Max	999
Initial S/W Revision	Prior to A.02.00
Modified at S/W Revision	A.02.00, A.03.00, A.04.00, A.10.00

## Configure Carriers

Accesses a menu that contains Carrier, Carrier Pwr Present, Carrier Width and Carrier Integ BW parameters.

Key Path	Meas Setup, Carrier Setup
Initial S/W Revision	Prior to A.02.00

## Carrier

Selects the carrier to configure for the current measurement.

Key Path	Meas Setup, Carrier Setup, Configure Carriers
Mode	SA, WCDMA, C2K, WIMAX OFDMA, 1xEVDO, TD-SCDMA, DVB-T/H, DTMB (CTTB), ISDB-T, CMMB, LTE, LTETDD, Digital Cable TV

Couplings	Max value is the number of available carriers, so this value might change when the number of carriers is changed.
Preset	1
State Saved	No
Min	1
Max	Number of available carriers
Initial S/W Revision	Prior to A.02.00
Modified at S/W Revision	A.02.00, A.03.00

### Carrier Pwr Present

Configures the carriers for this measurement. It allows spaces to be inserted between carriers. Carriers with the power present parameter set to Yes are carriers, and those with the power present parameter set to No are spaces. Each carrier power present is set to Yes or No. The individual carriers can be set by selecting the desired carrier on the carrier menu key using the up down arrows, the knob, or numeric keypad, then toggling the carrier power present using the carrier power present menu key.

The query for this parameter returns the current values for all of the carriers. If a carrier is defined as having no power present, the power displayed will be relative to the reference carrier, otherwise the absolute power will be displayed.

If you change the carrier power present to no and that carrier is currently configured as the reference carrier, the next carrier to the left (or the right if there are no carriers to the left) will be assigned as the reference carrier. This also applies to the scenario where there are only two carriers configured as having power present and you configure only one carrier to have no power present.

Key Path	Meas Setup, Carrier Setup, Configure Carriers
Mode	SA, WCDMA, C2K, WIMAX OFDMA, 1xEVDO, TD-SCDMA, DVB-T/H, DTMB (CTTB), ISDB-T, CMMB, LTE, LTE-TDD, Digital Cable TV
Remote Command	[ :SENSe ] :ACPpower:CARRier [ 1 ]   2 :LIST:PPresent YES   NO, YES   NO, YES   NO, YES   NO, YES   NO, YES   NO, YES   NO [ :SENSe ] :ACPpower:CARRier [ 1 ]   2 :LIST:PPresent?
Example	ACP:CARR2:LIST:PPR YES ACP:CARR2:LIST:PPR?
Notes	Carrier sub op code. 1 for BTS, 2 for MS. Default is BTS. Note that Carrier sub op code 2 is supported only in Non-SA modes. In the SA mode, Carrier sub op code 1 is used for both BTS and MS. When setting these values remotely, the position in the list sent corresponds to the carrier. Missing values are not permitted, therefore if you want to change values 2 and 6 you must send all values up to 6. Subsequent values will remain unchanged, unless the number of values sent is greater than the number of carriers, then subsequent values will be ignored.
Dependencies	If there is only one carrier, this key will be grayed out.
Couplings	Coupled to the number of carriers. When the SCPI command is sent, the number of carriers will be set to the number of entries in the parameter list.

Preset	YES
State Saved	Saved in instrument state.
Range	Yes No
<b>Backwards Compatibility SCPI</b>	<code>[ :SENSE ] :MCPower:CARRier [ 1 ]   2 :LIST:PPResent (PSA Power Suite)</code>
Initial S/W Revision	Prior to A.02.00
Modified at S/W Revision	A.02.00, A.03.00

## Carrier Spacing

Sets the width of the carrier spacing. This will be the value applied to all the current slots, whether they are carriers or spaces.

Enter each carrier spacing value individually by selecting the desired carrier on the carrier menu key using the up down arrows, the knob, or the numeric keypad, then enter the carrier width using the carrier spacing menu key.

Key Path	Meas Setup, Carrier Setup, Configure Carriers
Mode	SA, WCDMA, C2K, WIMAX OFDMA, 1xEVDO, TD-SCDMA, DVB-T/H, DTMB (CTTB), ISDB-T, CMMB, LTE, LTETDD, Digital Cable TV
Remote Command	<code>[ :SENSE ] :ACPPower:CARRier [ 1 ]   2 :LIST:WIDTh &lt;freq&gt;, &lt;freq&gt;, &lt;freq&gt;, &lt;freq&gt;, &lt;freq&gt;, &lt;freq&gt;</code> <code>[ :SENSE ] :ACPPower:CARRier [ 1 ]   2 :LIST:WIDTh?</code>
Example	ACP:CARR2:LIST:WIDT 25kHz ACP:CARR2:LIST:WIDT?
Notes	Carrier sub op code. 1 for BTS, 2 for MS. Default is BTS. Note that Carrier sub op code 2 is supported only in Non-SA modes. In the SA mode, Carrier sub op code 1 is used for both BTS and MS. When setting these values remotely, the position in the list sent corresponds to the carrier. Missing values are not permitted, therefore if you want to change values 2 and 6 you must send all values up to 6. Subsequent values will remain unchanged, unless the number of values sent is greater than the number of carriers, then subsequent values will be ignored. You must be in the mode that includes ACP measurements to use this command. Use :INSTrument:SElect to set the mode.
Couplings	Coupled to the number of carriers. When the SCPI command is sent, the number of carriers will be set to the number of entries in the parameter list. Changing Carrier Spacing might affect the Span.
Preset	SA, WCDMA: 5 MHz WIMAX OFDMA: 10 MHz C2K: 1.25 MHz 1xEVDO: 1.25 MHz

	TD-SCDMA: 1.6 MHz DVB-T/H: 8 MHz DTMB (CTTB): 8 MHz ISDB-T: 6 MHz CMMB: 8 MHz LTE: 5 MHz LTETDD: 5 MHz Digital Cable TV: 8 MHz
State Saved	Saved in instrument state.
Min	0 Hz
Max	1 GHz
<b>Backwards Compatibility SCPI</b>	<code>[[:SENSe]:MCPower:CARRier[1] 2:LIST:WIDTh (PSA Power Suite)</code>
Initial S/W Revision	Prior to A.02.00
Modified at S/W Revision	A.02.00, A.03.00

### Measurement Noise Bandwidth

Specifies the Measurement Noise Bandwidth used to calculate the power in the carriers.

Each Measurement Noise Bandwidth value is entered individually by selecting the desired carrier on the carrier menu key using the up down arrows, the knob, or the numeric keypad. Then enter the measurement noise bandwidth using the measurement noise bandwidth key.

Key Path	Meas Setup, Carrier Setup, Configure Carriers
Mode	SA, WCDMA, C2K, WIMAX OFDMA, TD-SCDMA, 1xEVDO, DVB-T/H, DTMB (CTTB), ISDB-T, CMMB, LTE, LTETDD, Digital Cable TV
Remote Command	<code>[[:SENSe]:ACPpower:CARRier[1] 2:LIST:BANDwidth[:INTEgration] &lt;freq&gt;, &lt;freq&gt;, &lt;freq&gt;, &lt;freq&gt;, &lt;freq&gt;</code>  <code>[[:SENSe]:ACPpower:CARRier[1] 2:LIST:BANDwidth[:INTEgration]?</code>
Example	ACP:CARR2:LIST:BAND 25kHz ACP:CARR2:LIST:BAND?
Notes	In the WCDMA mode, the preset/default value is defined as 3.84 MHz. But internally, 4.6848 MHz is used as the default value. Carrier sub op code. 1 for BTS, 2 for MS. Default is BTS. Note that Carrier sub op code 2 is supported only in Non-SA modes. In the SA mode, Carrier sub op code 1 is used for both BTS and MS. When setting these values remotely, the position in the list sent corresponds to the carrier. Missing values are not permitted, therefore if you want to change values 2 and 6 you must send all values up to 6. Subsequent values will remain unchanged, unless the number of values sent is greater than the number of carriers, then subsequent values will be ignored. You must be in the mode that includes ACP measurements to use this command. Use

	:INSTrument:SElect to set the mode.
Couplings	Coupled to the number of carriers. When the SCPI command is sent, the number of carriers is set to the number of entries in the parameter list.
Preset	SA: 2 MHz WCDMA: 3.84 MHz WIMAX OFDMA: 10 MHz C2K: 1.23MHz TD-SCDMA: 1.28 MHz 1xEVDO: 1.23 MHz DVB-T/H: 7.61 MHz DTMB (CTTB): 7.56 MHz ISDB-T: 5.6 MHz CMMB: 7.512 MHz LTE, LTE-TDD: 4.515 MHz 4.5 MHz Digital Cable TV: 8.0 MHz
State Saved	Saved in instrument state.
Min	10 Hz
Max	1 GHz
<b>Backwards Compatibility SCPI</b>	[ :SENSe ] :ACPower :BANDwidth :INTEgration [ :SENSe ] :ACPower :BWIDth :INTEgration [ :SENSe ] :ACPower :CARRier [ 1 ]   2 :LIST :BWIDth [ :INTEgration ] [ :SENSe ] :MCPower :CARRier [ 1 ]   2 :LIST :BANDwidth [ :INTEgration ] (PSA Power Suite) [ :SENSe ] :MCPower :CARRier [ 1 ]   2 :LIST :BWIDth [ :INTEgration ] (PSA Power Suite)
Initial S/W Revision	Prior to A.02.00
Modified at S/W Revision	A.02.00, A.03.00

### Method for Carrier

Accesses the carrier configuration method settings.

Key Path	Meas Setup, Carrier Setup, Configure Carriers
Mode	SA, WCDMA, WIMAX OFDMA, TD-SCDMA, DVB-T/H, DTMB (CTTB), ISDB-T, CMMB, LTE, LTE-TDD, Digital Cable TV
<b>Remote Command</b>	[ :SENSe ] :ACPower :CARRier [ 1 ]   2 :LIST :FILTEr [ :RRC ] [ :STATE ] ON   OFF   1   0, ON   OFF   1   0, ON   OFF   1   0, ON   OFF   1   0, ON   OFF   1   0 [ :SENSe ] :ACPower :CARRier [ 1 ]   2 :LIST :FILTEr [ :RRC ] [ :STATE ] ?
<b>Example</b>	ACP:CARR:LIST:FILT 0,0,0,0 ACP:CARR:LIST:FILT?

Notes	The binary values translate as follows: 1 ON = RRC Weighted 0 OFF = Integ BW Maximum of Array length depends on the number of carriers. You must be in the mode that includes ACP measurements to use this command. Use :INSTRument:SElect to set the mode.
Preset	SA, LTE, LTETDD: OFF WCDMA: ON WIMAX OFDMA: OFF TD-SCDMA: ON DVB-T/H: OFF DTMB (CTTB): ON ISDB-T, CMMB: OFF Digital Cable TV: OFF
State Saved	Saved in instrument state.
Range	IntegBW RRC Weight
Initial S/W Revision	Prior to A.02.00
Modified at S/W Revision	A.02.00, A.03.00

#### Filter Alpha for Carrier

Inputs the alpha value for the filter used in the current carrier configuration.

Key Path	Meas Setup, Carrier Setup, Configure Carriers, Method, RRC Weighted
Mode	SA, WCDMA, WIMAX OFDMA, TD-SCDMA, DVB-T/H, DTMB (CTTB), ISDB-T, CMMB, LTE, LTETDD, Digital Cable TV
Remote Command	[ :SENSE ] :ACPpower:CARRier [ 1 ]   2 :LIST:FILTer:ALPHA <real>, <real>, <real>, <real>, <real>, <real> [ :SENSe ] :ACPpower:CARRier [ 1 ]   2 :LIST:FILTer:ALPHA?
Example	ACP:CARR2:LIST:FILT:ALPH 0.5 ACP:CARR2:LIST:FILT:ALPH?
Notes	You must be in the mode that includes ACP measurements to use this command. Use :INSTRument:SElect to set the mode.
Preset	0.22 C2K: No DTMB (CTTB): 0.05 Digital Cable TV: 0.15
State Saved	Saved in instrument state.
Min	0.01
Max	1.0



Initial S/W Revision	Prior to A.02.00
Modified at S/W Revision	A.02.00, A.03.00

## Offset/Limits

Accesses a menu of functions that contains Offset, Offset Freq/Offset To Edge, Offset Integ BW, Upper Offset Limit and Lower Offset parameters. When in the MSR and LTE-Advanced FDD/TDD mode, the softkey label changes to Outer Offset/Limits.

Key Path	Meas Setup
Initial S/W Revision	Prior to A.02.00
Modified at S/W Revision	A.13.00

## Select Offset

Selects the offset to configure.

Key Path	Meas Setup, Offset/Limits, Limits
Mode	SA, WCDMA, C2K, WIMAX OFDMA, TD-SCDMA, 1xEVDO, DVB-T/H, DTMB (CTTB), ISDB-T, CMMB, LTE, LTE-TDD, Digital Cable TV, MSR, LTEAFDD, LTEATDD
Preset	A
State Saved	Saved in instrument state.
Range	Offset A Offset B Offset C Offset D Offset E Offset F
Initial S/W Revision	Prior to A.02.00
Modified at S/W Revision	A.02.00, A.03.00, A.13.00

## Offset Freq

This parameter determines the frequency difference between the center of the main channel and the center of the carrier.

Each Offset Freq state value is entered individually by selecting the desired carrier on the carrier menu key using the up down arrows, RPG or numeric keypad. Then enter the Offset Freq State using the Offset Frequency key.

The list contains up to six (6) entries, depending on the mode selected, for offset frequencies. Each offset frequency in the list corresponds to a reference bandwidth in the bandwidth list.

An offset frequency of zero turns the display of the measurement for that offset off, but the measurement is still made and reported. You can turn off (not use) specific offsets with the [:SENSe]:ACP:OFFSet:LIST:STATe command.

Turning the offset off has the same effect as setting the frequency of the offset to 0 Hz and will cause it to be removed from the results screen.

<b>Key Path</b>	Meas Setup, Offset/Limits
<b>Mode</b>	SA, WCDMA, C2K, WIMAX OFDMA, TD-SCDMA, 1xEVDO, DVB-T/H, DTMB (CTTB), ISDB-T, CMMB, LTE, LTETDD, Digital Cable TV, MSR, LTEAFDD, LTEATDD
<b>Remote Command</b>	<pre>[ :SENSE]:ACPpower:OFFSet [1]   2[:OUTer]:LIST[:FREQuency] &lt;freq&gt;, &lt;freq&gt;, &lt;freq&gt;, &lt;freq&gt;, &lt;freq&gt;, &lt;freq&gt;  [:SENSE]:ACPpower:OFFSet [1]   2[:OUTer]:LIST[:FREQuency]?  [:SENSE]:ACPpower:OFFSet [1]   2[:OUTer]:LIST:STATe OFF   ON   0   1, OFF   ON   0   1, OFF   ON   0   1, OFF   ON   0   1, OFF   ON   0   1, OFF   ON   0   1  [:SENSE]:ACPpower:OFFSet [1]   2[:OUTer]:LIST:STATe?</pre>
<b>Example</b>	<pre>ACP:OFFS1:LIST 0,0,0,0,0,0 ACP:OFFS1:LIST? ACP:OFFS2:LIST:STAT 1,1,0,0,0,0 ACP:OFFS2:LIST:STAT?</pre>
<b>Notes</b>	<p>The label for this menu key will change depending on the currently selected radio standard or mode. For cdma2000 the label for the menu key will be Offset to Edge. For all other supported standards the label will be Offset Freq.</p> <p>When setting these values remotely, the position in the list sent corresponds to the offset. Missing values are not permitted, unless the number of values sent is greater than the number of carriers, then subsequent values will be ignored.</p> <p>Offset sub op code. 1 for BTS, 2 for MS. Default is BTS.</p> <p>Note that Offset sub op code 2 is supported only in Non-SA modes.</p> <p>In the SA mode, Offset sub op code 1 is used for both BTS and MS.</p> <p>You must be in the mode that includes ACP measurements to use this command. Use :INSTRument:SElect to set the mode.</p>
<b>Couplings</b>	Changing Offset Frequency might affect the Span. See the Span key section for details.
<b>Preset</b>	<pre>SA: 3 MHz, 0 Hz, 0 Hz, 0 Hz, 0 Hz, 0 Hz 3 MHz, 0 Hz, 0 Hz, 0 Hz, 0 Hz, 0 Hz WCDMA: 5.0 MHz, 10.0 MHz, 0 Hz, 0 Hz, 0 Hz, 0 Hz 5.0 MHz, 10.0 MHz, 0 Hz, 0 Hz, 0 Hz, 0 Hz WIMAX OFDMA: 10 MHz, 20 MHz, 0 Hz, 0 Hz, 0 Hz, 0 Hz  10 MHz, 20 MHz, 0 Hz, 0 Hz, 0 Hz, 0 Hz C2K:750KHz, 1.980 MHz, 0 Hz, 0 Hz, 0 Hz, 0 Hz  885 kHz, 1.980 MHz, 0 Hz, 0 Hz, 0 Hz, 0 Hz TD-SCDMA: 1.6 MHz, 3.2 MHz, 0 Hz, 0 Hz, 0 Hz, 0 Hz 1.6 MHz, 3.2 MHz, 0 Hz, 0 Hz, 0 Hz, 0 Hz 1xEVDO: 750KHz, 1.98MHz, 3.125MHz, 4.000MHz, 7.500MHz, 7.500MHz 885KHz, 1.98MHz, 3.125MHz, 4.000MHz, 7.500MHz, 7.500MHz DVB-T/H: 8 MHz, 16 MHz, 0 Hz, 0 Hz, 0 Hz, 0 Hz  8 MHz, 16 MHz, 0 Hz, 0 Hz, 0 Hz, 0 Hz DTMB (CTTB): 8 MHz, 16 MHz, 24 MHz, 32 MHz, 0 Hz, 0 Hz  8 MHz, 16 MHz, 24 MHz, 32 MHz, 0 Hz, 0 Hz ISDB-T: 6 MHz, 12 MHz, 0 Hz, 0 Hz, 0 Hz, 0 Hz  6 MHz, 12 MHz, 0 Hz, 0 Hz, 0 Hz, 0 Hz CMMB: 8 MHz, 16 MHz, 24 MHz, 32 MHz, 0 Hz, 0 Hz  8 MHz, 16 MHz, 24 MHz, 32 MHz, 0 Hz, 0 Hz LTE, LTETDD, MSR, LTEAFDD, LTEATDD: 5 MHz, 10 MHz, 0, 0, 0, 0 5 MHz, 10 MHz, 0, 0, 0, 0 Digital Cable TV: 8 MHz, 16 MHz, 0 Hz, 0 Hz, 0 Hz, 0 Hz 8 MHz, 16 MHz, 0 Hz, 0 Hz, 0 Hz, 0 Hz</pre>

	SA: ON, OFF, OFF, OFF, OFF, OFF ON, OFF, OFF, OFF, OFF, OFF WCDMA: ON, ON, OFF, OFF, OFF, OFF ON, ON, OFF, OFF, OFF, OFF WIMAX OFDMA: ON, ON, OFF, OFF, OFF, OFF ON, ON, OFF, OFF, OFF, OFF TD-SCDMA: ON, ON, OFF, OFF, OFF, OFF ON, ON, OFF, OFF, OFF, OFF DVB-T/H: ON, ON, OFF, OFF, OFF, OFF ON, ON, OFF, OFF, OFF, OFF DTMB (CTTB): ON, ON, OFF, OFF, OFF, OFF ON, ON, OFF, OFF, OFF, OFF CDMA1xEVDO: ON, ON, OFF, OFF, OFF, OFF ON, ON, OFF, OFF, OFF, OFF ISDB-T: ON, ON, OFF, OFF, OFF, OFF ON, ON, OFF, OFF, OFF, OFF CMMB: ON, ON, ON, ON, OFF, OFF ON, ON, ON, ON, OFF, OFF LTE, LTE-TDD, MSR, LTEAFDD, LTEATDD: ON, ON, OFF, OFF, OFF, OFF ON, OFF, OFF, OFF, OFF, OFF Digital Cable TV: ON, ON, OFF, OFF, OFF, OFF ON, ON, OFF, OFF, OFF, OFF
State Saved	Saved in instrument state.
Min	0 Hz
Max	500 MHz
<b>Backwards Compatibility SCPI</b>	<code>[[:SENSe]:MCPower:OFFSet[1] 2:LIST[:FREQuency] (PSA Power Suite)</code>
Initial S/W Revision	Prior to A.02.00
Modified at S/W Revision	A.02.00, A.03.00, A.13.00

## Integ BW

Sets the Integration Bandwidth for the offsets. Each resolution bandwidth in the list corresponds to an offset frequency in the list defined by `[[:SENSe]:ACP:OFFSet[n]::OUTer]:LIST[:FREQuency]`.

Enter each value individually by selecting the desired offset on the offset menu key using the up down arrows, the knob, or the numeric keypad, then enter the Offset Integration Bandwidth using the Offset Integration Bandwidth menu key.

You can turn off (not use) specific offsets with the `[[:SENSe]:ACP:OFFSet[n]::OUTer]:LIST:STATe` command.

Key Path	Meas Setup, Offset/Limits
Mode	SA, WCDMA, C2K, WIMAX OFDMA, TD-SCDMA, 1xEVDO, DVB-T/H, DTMB (CTTB), ISDB-T, CMMB, LTE, LTE-TDD, Digital Cable TV, MSR, LTEAFDD, LTEATDD
Remote Command	<code>[[:SENSe]:ACP:OFFSet[1] 2[:OUTer]:LIST:BANDwidth[:INTegration]</code> <code>&lt;freq&gt;, &lt;freq&gt;, &lt;freq&gt;, &lt;freq&gt;, &lt;freq&gt;, &lt;freq&gt;</code> <code>[[:SENSe]:ACP:OFFSet[1] 2[:OUTer]:LIST:BANDwidth[:INTegration]?</code>
Example	ACP:OFFS2:LIST:BAND 2MHz, 2MHz, 2MHz, 2MHz, 2MHz, 2MHz ACP:OFFS2:LIST:BAND?
Notes	When setting these values remotely, the position in the list sent corresponds to the offset. Missing values are not permitted i.e. if you want to change the second value, you must send all values up to it. Subsequent values will remain unchanged, unless the number of values sent is greater than the number of carriers, then subsequent values will be ignored.

	<p>Offset sub op code. 1 for BTS, 2 for MS. Default is BTS.</p> <p>Note that Offset sub op code 2 is supported only in Non-SA modes.</p> <p>In the SA mode, Offset sub op code 1 is used for both BTS and MS.</p> <p>You must be in the mode that includes ACP measurements to use this command. Use :INSTRument:SElect to set the mode.</p>
Couplings	Changing Integ BW might affect the Span. See Span section for details.
Preset	<p>SA: 2 MHz, 2 MHz, 2 MHz, 2 MHz, 2 MHz, 2 MHz 2 MHz, 2 MHz, 2 MHz, 2 MHz, 2 MHz, 2 MHz</p> <p>WCDMA: 3.84 MHz, 3.84 MHz, 3.84 MHz, 3.84 MHz, 3.84 MHz, 3.84 MHz 3.84 MHz, 3.84 MHz, 3.84 MHz, 3.84 MHz, 3.84 MHz, 3.84 MHz</p> <p>WIMAX OFDMA: 10 MHz, 10 MHz, 10 MHz, 10 MHz, 10 MHz, 10 MHz 10 MHz, 10 MHz, 10 MHz, 10 MHz, 10 MHz, 10 MHz</p> <p>C2K: 30 kHz, 30 kHz, 30 kHz, 30 kHz, 30 kHz, 30 kHz 30 kHz, 30 kHz, 30 kHz, 30 kHz, 30 kHz, 30 kHz</p> <p>TD-SCDMA: 1.28 MHz, 1.28 MHz, 1.28 MHz, 1.28 MHz, 1.28 MHz, 1.28 MHz</p> <p>1xEVDO: C2K: 30 kHz, 30 kHz, 30 kHz, 30 kHz, 30 kHz, 30 kHz 30 kHz, 30 kHz, 30 kHz, 30 kHz, 30 kHz, 30 kHz</p> <p>DVB-T/H: 7.61 MHz, 7.61 MHz, 7.61 MHz, 7.61 MHz, 7.61 MHz, 7.61 MHz 7.61 MHz, 7.61 MHz, 7.61 MHz, 7.61 MHz, 7.61 MHz, 7.61 MHz</p> <p>DTMB (CTTB): 7.56 MHz, 7.56 MHz, 7.56 MHz, 7.56 MHz, 7.56 MHz, 7.56 MHz 7.56 MHz, 7.56 MHz, 7.56 MHz, 7.56 MHz, 7.56 MHz, 7.56 MHz</p> <p>ISDB-T: 5.6 MHz, 5.6 MHz, 5.6 MHz, 5.6 MHz, 5.6 MHz, 5.6 MHz 5.6 MHz, 5.6 MHz, 5.6 MHz, 5.6 MHz, 5.6 MHz, 5.6 MHz</p> <p>CMMB: 7.512 MHz, 7.512 MHz, 7.512 MHz, 7.512 MHz, 7.512 MHz, 7.512 MHz 7.512 MHz, 7.512 MHz, 7.512 MHz, 7.512 MHz, 7.512 MHz, 7.512 MHz</p> <p>LTE, LTE-TDD, MSR, LTEAFDD, LTEATDD: 4.515 MHz, 4.515 MHz, 4.515 MHz, 4.515 MHz, 4.515 MHz, 4.515 MHz 4.5 MHz, 4.5 MHz, 4.5 MHz, 4.5 MHz, 4.5 MHz, 4.5 MHz</p> <p>Digital Cable TV: 8.0 MHz, 8.0 MHz, 8.0 MHz, 8.0 MHz, 8.0 MHz, 8.0 MHz 8.0 MHz, 8.0 MHz, 8.0 MHz, 8.0 MHz, 8.0 MHz, 8.0 MHz</p>
State Saved	Saved in instrument state.
Min	10 Hz
Max	1 GHz
<b>Backwards Compatibility SCPI</b>	<pre>[ :SENSe]:ACPower:OFFSet [1]   2:LIST:BWIDth[:INTEgration]</pre> <pre>[ :SENSe]:ACPR:OFFSet [1]   2:LIST:BANDwidth</pre> <pre>[ :SENSe]:ACPR:OFFSet [1]   2:LIST:BWIDth</pre> <pre>[ :SENSe]:MCPower:OFFSet [1]   2:LIST:BANDwidth[:INTEgration] (PSA Power Suite)</pre> <pre>[ :SENSe]:MCPower:OFFSet [1]   2:LIST:BWIDth[:INTEgration] (PSA Power Suite)</pre>
Initial S/W Revision	Prior to A.02.00
Modified at S/W Revision	A.02.00, A.03.00, A.13.00

## Offset BW

Accesses the offset bandwidth menu.

Key Path	Meas Setup, Offset/Limits
Initial S/W Revision	Prior to A.02.00

## Res BW

Sets the resolution bandwidth. If an unavailable bandwidth is entered with the numeric keypad, the closest available bandwidth is selected.

Key Path	Meas Setup, Offset/Limits
Mode	SA, WCDMA, C2K, WIMAX OFDMA, TD-SCDMA, 1xEVDO, DVB-T/H, DTMB (CTTB), ISDB-T, CMMB, LTE, LTE-TDD, Digital Cable TV, MSR, LTEAFDD, LTEATDD
Remote Command	<pre>[ :SENSe]:ACPower:OFFSet [1]   2[:OUTer]:LIST:BANDwidth:RESolution &lt;freq&gt;, &lt;freq&gt;, &lt;freq&gt;, &lt;freq&gt;, &lt;freq&gt;  [:SENSe]:ACPower:OFFSet [1]   2[:OUTer]:LIST:BANDwidth:RESolution?  [:SENSe]:ACPower:OFFSet [1]   2[:OUTer]:LIST:BANDwidth:RESolution:AUTO ON   OFF   1   0, ON   OFF   1   0, ON   OFF   1   0, ON   OFF   1   0, ON   OFF   1   0, ON   OFF   1   0  [:SENSe]:ACPower:OFFSet [1]   2[:OUTer]:LIST:BANDwidth:RESolution:AUTO?</pre>
Example	<pre>ACP:OFFS2:LIST:BAND:RES 220kHz, 220kHz, 220kHz, 220kHz, 220kHz, 220kHz ACP:OFFS2:LIST:BAND:RES? ACP:OFFS2:LIST:BAND:RES:AUTO 1,1,1,1,1,1 ACP:OFFS2:LIST:BAND:RES:AUTO?</pre>
Notes	<p>Offset sub op code. 1 for BTS, 2 for MS. Default is BTS.</p> <p>Note that Offset sub op code 2 is supported only in Non-SA modes.</p> <p>In the SA mode, Offset sub op code 1 is used for both BTS and MS.</p> <p>You must be in the mode that includes ACP measurements to use this command. Use :INSTrument:SElect to set the mode.</p>
Dependencies	When Meas Method is RBW or FAST, this key is grayed out and disabled. If the key is pressed, an advisory message is generated. If the equivalent remote command is sent, a "Setting conflict" warning is generated.
Couplings	When Res BW Mode is AUTO, this value is exactly same as Res BW under BW key. And when this value is changed by user, Res BW Mode is also changed to Man.
Preset	<pre>SA: 220 kHz, 220 kHz, 220 kHz, 220 kHz, 220 kHz, 220 kHz WCDMA: 100 kHz, 100 kHz, 100 kHz, 100 kHz, 100 kHz, 100 kHz WIMAX OFDMA: 100 kHz, 100 kHz, 100 kHz, 100 kHz, 100 kHz, 100 kHz C2K: Method:RBW 30 kHz</pre>

	<p>Method: IBW  C2K: 15 kHz, 15 kHz, 15 kHz, 15 kHz, 15 kHz, 15 kHz 15 kHz, 15 kHz, 15 kHz, 15 kHz, 15 kHz, 15 kHz  TD-SCDMA: 30 kHz, 30 kHz, 30 kHz, 30 kHz, 30 kHz, 30 kHz  1xEVDO: 30KHz, 30KHz, 30KHz, 30KHz, 30KHz, 30KHz  30KHz, 30KHz, 30KHz, 30KHz, 30KHz, 30KHz  DVB-T/H: 39 kHz, 39 kHz, 39 kHz, 39 kHz, 39 kHz, 39 kHz 39 kHz, 39 kHz, 39 kHz, 39 kHz, 39 kHz, 39 kHz  DTMB (CTTB): 39 kHz, 39 kHz, 39 kHz, 39 kHz, 39 kHz, 39 kHz 39 kHz, 39 kHz, 39 kHz, 39 kHz, 39 kHz, 39 kHz  ISDB-T: 39 kHz, 39 kHz, 39 kHz, 39 kHz, 39 kHz, 39 kHz 39 kHz, 39 kHz, 39 kHz, 39 kHz, 39 kHz, 39 kHz  CMMB: 39 kHz, 39 kHz, 39 kHz, 39 kHz, 39 kHz, 39 kHz 39 kHz, 39 kHz, 39 kHz, 39 kHz, 39 kHz, 39 kHz  LTE, LTETDD, MSR, LTEAFDD, LTEATDD: 100 kHz, 100 kHz, 100 kHz, 100 kHz, 100kHz, 100 kHz 100 kHz, 100 kHz, 100 kHz, 100 kHz, 100 kHz, 100 kHz  Digital Cable TV: 39 kHz, 39 kHz, 39 kHz, 39 kHz, 39 kHz, 39 kHz 39 kHz, 39 kHz, 39 kHz, 39 kHz, 39 kHz, 39 kHz  1, 1, 1, 1, 1, 1</p>
State Saved	Saved in instrument state.
Min	1 Hz
Max	8 MHz
<b>Backwards Compatibility SCPI</b>	<code>[ :SENSe ] :ACPower:OFFSet [ 1 ]   2 [ :OUTer ] :LIST:BWIDth:RESolution</code>
Initial S/W Revision	Prior to A.02.00
Modified at S/W Revision	A.02.00, A.03.00, A.13.00

## Video BW

Enables you to change the analyzer post-detection filter (VBW).

Key Path	Meas Setup, Offset/Limits, Offset BW
Mode	SA, WCDMA, C2K, WIMAX OFDMA, TD-SCDMA, 1xEVDO, DVB-T/H, DTMB (CTTB), ISDB-T, CMMB, LTE, LTETDD, Digital Cable TV, MSR, LTEAFDD, LTEATDD
Remote Command	<pre>[ :SENSe ] :ACPower:OFFSet [ 1 ]   2 [ :OUTer ] :LIST:BA NDwidth:VIDeo &lt;freq&gt;, &lt;freq&gt;, &lt;freq&gt;, &lt;freq&gt;, &lt;freq&gt;  [ :SENSe ] :ACPower:OFFSet [ 1 ]   2 [ :OUTer ] :LIST:BA NDwidth:VIDeo?  [ :SENSe ] :ACPower:OFFSet [ 1 ]   2 [ :OUTer ] :LIST:BA NDwidth:VIDeo:AUTO OFF   ON   0   1, OFF   ON   0   1, OFF   ON   0   1, OFF   ON   0   1, OFF   ON   0   1, OFF   ON   0   1  [ :SENSe ] :ACPower:OFFSet [ 1 ]   2 [ :OUTer ] :LIST:BA NDwidth:VIDeo:AUTO?</pre>
Example	ACP:OFFS2:LIST:BA ND:VID 5MHz, 5MHz, 5MHz, 5MHz, 5MHz, 5MHz

	<p>ACP:OFFS2:LIST:BAND:VID?</p> <p>ACP:OFFS2:LIST:BAND:VID:AUTO 0,0,0,1,1</p> <p>ACP:OFFS2:LIST:BAND:VID:AUTO?</p>
Notes	<p>The values shown in this table reflect the conditions after a Mode Preset.</p> <p>Offset sub op code. 1 for BTS, 2 for MS. Default is BTS.</p> <p>Note that Offset sub op code 2 is supported only in Non-SA modes.</p> <p>In the SA mode, Offset sub op code 1 is used for both BTS and MS.</p> <p>You must be in the mode that includes ACP measurements to use this command. Use :INSTrument:SElect to set the mode.</p> <p>.</p>
Dependencies	<p>When Meas Method is RBW or FAST, this key is grayed out and disabled. If the key is pressed, an advisory message is generated. If the equivalent remote command is sent, a "Setting conflict" warning is generated.</p>
Preset	<p>SA: 22 kHz, 22 kHz, 22 kHz, 22 kHz, 22 kHz, 22 kHz</p> <p>WCDMA, WIMAX OFDMA: 1 MHz, 1 MHz, 1 MHz, 1 MHz, 1 MHz, 1 MHz</p> <p>C2K: 150 kHz, 150 kHz, 150 kHz, 150 kHz, 150 kHz, 150 kHz  150 kHz, 150 kHz, 150 kHz, 1150 kHz, 1150 kHz, 150 kHz</p> <p>TD-SCDMA: 300 kHz, 300 kHz, 300 kHz, 300 kHz, 300 kHz, 300 kHz</p> <p>1xEVDO: 300KHz, 300KHz, 300KHz, 300KHz, 300KHz, 300KHz   300KHz, 300KHz, 300KHz, 300KHz, 300KHz, 300KHz</p> <p>DVB-T/H: 390 kHz, 390 kHz, 390 kHz, 390 kHz, 390 kHz, 390 kHz 390 kHz, 390 kHz, 390 kHz, 390 kHz, 390 kHz, 390 kHz</p> <p>DTMB (CTTB): 390 kHz, 390 kHz, 390 kHz, 390 kHz, 390 kHz, 390 kHz 390 kHz, 390 kHz, 390 kHz, 390 kHz, 390 kHz, 390 kHz</p> <p>ISDB-T: 390 kHz, 390 kHz, 390 kHz, 390 kHz, 390 kHz, 390 kHz 390 kHz, 390 kHz, 390 kHz, 390 kHz, 390 kHz, 390 kHz</p> <p>CMMB: 390 kHz, 390 kHz, 390 kHz, 390 kHz, 390 kHz, 390 kHz 390 kHz, 390 kHz, 390 kHz, 390 kHz, 390 kHz, 390 kHz</p> <p>LTE, LTEFDD, MSR, LTEAFDD, LTEATDD: 1 MHz, 1 MHz, 1 MHz, 1 MHz, 1 MHz, 1 MHz</p> <p>Digital Cable TV: 390 kHz, 390 kHz, 390 kHz, 390 kHz, 390 kHz, 390 kHz 390 kHz, 390 kHz, 390 kHz, 390 kHz, 390 kHz, 390 kHz</p> <p>ON, ON, ON, ON, ON, ON</p>
State Saved	<p>Saved in instrument state.</p>
Min	<p>1 Hz</p>
Max	<p>50 MHz</p>
<b>Backwards Compatibility SCPI</b>	<p>[ :SENSe ] :ACPowEr:OFFSet [ 1 ]   2 :LIST:BWIDth:VIDeo</p>
Initial S/W Revision	<p>Prior to A.02.00</p>
Modified at S/W Revision	<p>A.02.00, A.03.00, A.13.00</p>

## RBW Control

Accesses the resolution bandwidth control menu.

Key Path	Meas Setup, Offset/Limits, Offset BW
Initial S/W Revision	Prior to A.02.00

## Filter Type

Selects the type of bandwidth filter that is used.

Key Path	Meas Setup, Offset/Limits, Offset BW, RBW Control
Mode	SA, WCDMA, C2K, WIMAX OFDMA, TD-SCDMA, 1xEVDO, DVB-T/H, DTMB (CTTB), ISDB-T, CMMB, LTE, LTEFDD, Digital Cable TV, MSR, LTEAFDD, LTEATDD
Remote Command	[:SENSe]:ACPower:OFFSet[1] 2[:OUTer]:LIST:BANDwidth:SHAPE GAUSSian   FLATtop, GAUSSian   FLATtop, GAUSSian   FLATtop, GAUSSian   FLATtop, GAUSSian   FLATtop, GAUSSian   FLATtop [:SENSe]:ACPower:OFFSet[1] 2[:OUTer]:LIST:BANDwidth:SHAPE?
Example	ACP:OFFS2:LIST:BAND:SHAP FLAT, GAUS, GAUS, GAUS, GAUS, GAUS ACP:OFFS2:LIST:BAND:SHAP?
Notes	Offset sub op code. 1 for BTS, 2 for MS. Default is BTS. Note that Offset sub op code 2 is supported only in Non-SA modes. In the SA mode, Offset sub op code 1 is used for both BTS and MS. You must be in the mode that includes ACP measurements to use this command. Use :INSTrument:SElect to set the mode.
Dependencies	When Res BW Mode for the offset is Auto, this key is grayed out and disabled. Since Res BW Mode for the offset is preset to Auto on changing Meas Method to RBW or FAST, this key is grayed out and disabled too. If the key is pressed, an advisory message is generated. If the equivalent remote command is sent, a "Setting conflict" warning is generated.
Couplings	See the description above
Preset	GAUSSian, GAUSSian, GAUSSian, GAUSSian, GAUSSian, GAUSSian
State Saved	Saved in instrument state.
Range	GAUSSian FLATtop
Backwards Compatibility SCPI	[:SENSe]:ACPower:OFFSet[1] 2:LIST:BWIDth:SHAPE
Initial S/W Revision	Prior to A.02.00
Modified at S/W Revision	A.02.00, A.03.00, A.13.00

## Filter BW

Selects a Gaussian filter based on its -3 dB (Normal) bandwidth or its -6 dB bandwidth.



Key Path	Meas Setup, Offset/Limits, Offset BW, RBW Control
Mode	SA, WCDMA, C2K, WIMAX OFDMA, TD-SCDMA, 1xEVDO, DVB-T/H, DTMB (CTTB), ISDB-T, CMMB, LTE, LTE-TDD, Digital Cable TV, MSR, LTEAFDD, LTEATDD
Remote Command	<code>[ :SENSe]:ACPower:OFFSet [1]   2[:OUTer]:LIST:BANDwidth:TYPE DB3   DB6, DB3   DB6, DB3   DB6, DB3   DB6, DB3   DB6, DB3   DB6</code> <code>[ :SENSe]:ACPower:OFFSet [1]   2[:OUTer]:LIST:BANDwidth:TYPE?</code>
Example	ACP:OFFS2:LIST:BAND:TYPE DB3, DB3, DB3, DB3, DB3, DB3 ACP:OFFS2:LIST:BAND:TYPE?
Notes	Offset sub op code. 1 for BTS, 2 for MS. Default is BTS. Note that Offset sub op code 2 is supported only in Non-SA modes. In the SA mode, Offset sub op code 1 is used for both BTS and MS. You must be in the mode that includes ACP measurements to use this command. Use :INSTRument:SElect to set the mode.
Dependencies	When Filter Type if Flattop or Res BW Mode for the offset is Auto, this key is grayed out and disabled. Since Res BW Mode for the offset is preset to Auto on changing Meas Method to RBW or FAST, this key is grayed out and disabled too. If the key is pressed, an advisory message is generated. If the equivalent remote command is sent, a "Setting conflict" warning is generated.
Preset	DB3, DB3, DB3, DB3, DB3, DB3
State Saved	Saved in instrument state.
Range	-3 dB (Normal)   -6 dB
Backwards Compatibility SCPI	<code>[ :SENSe]:ACPower:OFFSet [1]   2:LIST:BWIDth:TYPE</code>
Initial S/W Revision	Prior to A.02.00
Modified at S/W Revision	A.02.00, A.03.00, A.13.00

## Limits

Limits key accesses a menu of functions that contains Select Offset, Abs Limit, Rel Limit and Fail Mask parameters.

Key Path	Meas Setup, Offset/Limits
Initial S/W Revision	A.03.00

## Select Offset

Selects the offset to configure.

Key Path	Meas Setup, Offset/Limits, Limits
Mode	SA, WCDMA, C2K, WIMAX OFDMA, TD-SCDMA, 1xEVDO, DVB-T/H, DTMB (CTTB), ISDB-T, CMMB, LTE, LTE-TDD, Digital Cable TV, MSR, LTEAFDD, LTEATDD

Preset	A
State Saved	Saved in instrument state.
Range	Offset A Offset B Offset C Offset D Offset E Offset F
Initial S/W Revision	Prior to A.02.00
Modified at S/W Revision	A.02.00, A.03.00, A.13.00

### Abs Limit

Enters an absolute limit value, which sets the absolute amplitude levels to test against for each of the custom offsets. The list must contain six (6) entries. If there is more than one offset, the offset closest to the carrier channel is the first one in the list. [:SENSe]:ACP:OFFSet[n][:OUTer]:LIST:TEST selects the type of testing to be done at each offset.

You can turn off (not use) specific offsets with the [:SENSe]:ACP:OFFSet[n][:OUTer]:LIST:STATe command.

The query returns the six (6) sets of real numbers that are the current absolute amplitude test limits.

Key Path	Meas Setup, Offset/Limits, Limits
Mode	SA, WCDMA, C2K, WIMAX OFDMA, TD-SCDMA, 1xEVDO, DVB-T/H, DTMB (CTTB), ISDB-T, CMMB, LTE, LTETDD, Digital Cable TV, MSR,LTEAFDD,LTEATDD
Remote Command	[:SENSe]:ACP:Power:OFFSet [1]   2[:OUTer]:LIST:ABSolute <real>, <real>, <real>, <real>, <real>, <real> [:SENSe]:ACP:Power:OFFSet [1]   2[:OUTer]:LIST:ABSolute?
Example	ACP:OFFS2:LIST:ABS -10, -10, -10, -10, -10, -10 ACP:OFFS2:LIST:ABS?
Notes	Offset sub op code. 1 for BTS, 2 for MS. Default is BTS. Note that Offset sub op code 2 is supported only in Non-SA modes. In the SA mode, Offset sub op code 1 is used for both BTS and MS. You must be in the mode that includes ACP measurements to use this command. Use :INSTrument:SElect to set the mode.
Couplings	None If current mode is DTMB (CTTB) or CMMB and current device type is Transmitter, the value from position 2 to position 4 are coupled, changing any one will change the others.
Preset	SA: 0dBm, 0 dBm, 0 dBm, 0 dBm, 0 dBm, 0 dBm 0dBm, 0 dBm, 0 dBm, 0 dBm, 0 dBm, 0 dBm WCDMA: 50 dBm, 50 dBm, 50 dBm, 50 dBm, 50 dBm, 50 dBm 50 dBm, 50 dBm, 50 dBm, 50 dBm, 50 dBm, 50 dBm C2K: 50 dBm, 50 dBm, 50 dBm, 50 dBm, 50 dBm, 50 dBm 50 dBm, 50 dBm, 50 dBm, 50 dBm, 50 dBm, 50 dBm WIMAX OFDMA: 50,50,50,50,50,50 TD-SCDMA: 50 dBm, 50 dBm, 50 dBm, 50 dBm, 50 dBm, 50 dBm 50 dBm, 50 dBm, 50 dBm, 50 dBm, 50 dBm, 50 dBm 1xEVDO: -27dBm, -27dBm, -13dBm, -13dBm, -13dBm, -13dBm  -27dBm, -27dBm, -13dBm, -13dBm, -13dBm, -13dBm

	DVB-T/H: 50 dBm, 50 dBm, 50 dBm, 50 dBm, 50 dBm, 50 dBm 50 dBm, 50 dBm, 50 dBm, 50 dBm, 50 dBm, 50 dBm
	DTMB (CTTB): 11.14 dBm, 11.14dBm, 11.14 dBm, 11.14 dBm, 50 dBm, 50 dBm 11.14 dBm, 11.14 dBm, 11.14 dBm, 11.14 dBm, 50 dBm, 50 dBm
	ISDB-T: 50 dBm, 50 dBm, 50 dBm, 50 dBm, 50 dBm, 50 dBm 50 dBm, 50 dBm, 50 dBm, 50 dBm, 50 dBm, 50 dBm
	CMMB: 11.14 dBm, 11.14dBm, 11.14 dBm, 11.14 dBm, 50 dBm, 50 dBm 11.14 dBm, 11.14 dBm, 11.14 dBm, 11.14 dBm, 50 dBm, 50 dBm
	LTE, LTE-TDD, MSR, LTEAFDD, LTEATDD: -8.45, -8.45, -8.45, -8.45, -8.45, -8.45 -50.0, -50.0, -50.0, -50.0, -50.0, -50.0
	Digital Cable TV: 50 dBm, 50 dBm, 50 dBm, 50 dBm, 50 dBm, 50 dBm 50 dBm, 50 dBm, 50 dBm, 50 dBm, 50 dBm, 50 dBm
State Saved	Saved in instrument state.
Min	-200.0 dBm
Max	50.0 dBm
<b>Backwards Compatibility SCPI</b>	[[:SENSE]:ACPR:OFFSet[1] 2:LIST:ABSolute (PSA W-CDMA, PSA cdma2000 ) [:SENSE]:MCPower:OFFSet[1] 2:LIST:ABSolute (PSA W-CDMA)
Initial S/W Revision	Prior to A.02.00
Modified at S/W Revision	A.02.00, A.03.00, A.13.00

### Rel Lim (Car)

Enters a relative limit value for the carrier level. This sets the amplitude levels to test against for the specified offsets.

The amplitude level is relative to the carrier amplitude. If multiple offsets are available, the list contains six (6) entries. The offset closest to the carrier channel is the first one in the list.

[[:SENSE]:ACP:OFFSet[n]:OUTer]:LIST:TEST selects the type of testing to be done at each offset.

You can turn off (not use) specific offsets with the [[:SENSE]:ACP:OFFSet[n]:OUTer]:LIST:STATe command.

The query returns the six (6) sets of real numbers that are the current amplitude test limits, relative to the carrier, for each offset.

Offset[n] n = 1 is base station and n = 2 is mobiles. The default is base station (1).

Key Path	Meas Setup, Offset/Limits, Limits,
Mode	SA, WCDMA, C2K, WIMAX OFDMA, TD-SCDMA, 1xEVDO, DVB-T/H, DTMB (CTTB), ISDB-T, CMMB, LTE, LTE-TDD, Digital Cable TV, MSR, LTEAFDD, LTEATDD
<b>Remote Command</b>	[[:SENSE]:ACPower:OFFSet[1] 2[:OUTer]:LIST:RCARrier <real>, <real>, <real>, <real>, <real>, <real> [:SENSE]:ACPower:OFFSet[1] 2[:OUTer]:LIST:RCARrier?
<b>Example</b>	ACP:OFFS2:LIST:RCAR 0,0,0,0,0,0 ACP:OFFS2:LIST:RCAR?

Notes	<p>Offset sub op code. 1 for BTS, 2 for MS. Default is BTS.</p> <p>Note that Offset sub op code 2 is supported only in Non-SA modes.</p> <p>In the SA mode, Offset sub op code 1 is used for both BTS and MS.</p> <p>You must be in the mode that includes ACP measurements to use this command. Use :INSTrument:SElect to set the mode.</p>
Couplings	<p>None</p> <p>If current mode is DTMB (CTTB) or CMMB and current device type is Transmitter, the value from position 2 to position 4 are coupled, changing any one will change the others.</p>
Preset	<p>SA: -45, -60, 0, 0, 0, 0 -45, -60, 0, 0, 0, 0</p> <p>WCDMA: -44.2, -49.2, -49.2, -49.2, -49.2, -49.2 -32.2, -42.2, -42.2, -42.2, -42.2, -42.2</p> <p>C2K: 0, 0, 0, 0, 0, 0 0, 0, 0, 0, 0, 0</p> <p>WIMAX OFDMA: -50,-60,0,0,0,0</p> <p>TD-SCDMA: -40, -45, -45, -45, -45, -45 -33, -43, -43, -43, -43, -43</p> <p>1xEVDO: -45, -55, -55, -55, -55, -55 -45, -55, -55, -55, -55, -55</p> <p>DVB-T/H: -60, -60, 0, 0, 0, 0 -60, -60, 0, 0, 0, 0</p> <p>DTMB (CTTB): -45, -60, -60, -60, 50, 50 -45, -60, -60, -60, 50, 50</p> <p>ISDB-T: -60, -60, 0, 0, 0, 0 -60, -60, 0, 0, 0, 0</p> <p>CMMB: -45, -60, -60, -60, 50, 50 -45, -60, -60, -60, 50, 50</p> <p>LTE, LTEFDD, MSR, LTEAFDD, LTEATDD: -44.2, -44.2, -44.2, -44.2, -44.2, -44.2 -29.2, -29.2, -29.2, -29.2, -29.2, -29.2</p> <p>Digital Cable TV: -58, -62, -65, -73, -73, -73 -58, -62, -65, -73, -73, -73</p>
State Saved	Saved in instrument state.
Min	-150
Max	50.0
<b>Backwards Compatibility SCPI</b>	[[:SENSE]:MCPower:OFFSet[1] 2:LIST:RCARrier (PSA WCDMA)
Initial S/W Revision	Prior to A.02.00
Modified at S/W Revision	A.02.00, A.03.00, A.04.00, A.13.00

### Positive Offset Limit (SCPI only)

Enables you to set the upper limit for the upper segment of the specified offset pair.

Mode	SA, WCDMA, CDMA2K, WIMAXOFDMA, TDSCDMA, CDMA1XEV, DVB, DTMB, LTE, LTEFDD, DCATV, MSR, LTEAFDD, LTEATDD
Remote Command	<p>:CALCulate:ACPower:OFFSet[:OUTer]:LIST:LIMit:POSitive[:UPPer]:DATA &lt;real&gt;, &lt;real&gt;, &lt;real&gt;, &lt;real&gt;, &lt;real&gt;, &lt;real&gt;</p> <p>:CALCulate:ACPower:OFFSet[:OUTer]:LIST:LIMit:POSitive[:UPPer]:DATA?</p>
Example	<p>CALC:ACP:OFFS:LIST:LIM:POS:DATA 0, 0, 0, 0, 0, 0</p> <p>CALC:ACP:OFFS:LIST:LIM:POS:DATA?</p>

Notes	SCPI only command
Preset	SA: -45, -60, 0, 0, 0, 0 -45, -60, 0, 0, 0, 0 WCDMA: -44.2, -49.2, -49.2, -49.2, -49.2, -49.2 -32.2, -42.2, -42.2, -42.2, -42.2 C2K: 0, 0, 0, 0, 0, 0 0, 0, 0, 0, 0, 0 WIMAX OFDMA: -50, -60, 0, 0, 0, 0 TD-SCDMA: -40, -45, -45, -45, -45, -45 -33, -43, -43, -43, -43, -43 1xEVDO: -45, -55, -55, -55, -55, -55 -45, -55, -55, -55, -55, -55 DVB-T/H: -60, -60, 0, 0, 0, 0 -60, -60, 0, 0, 0, 0 DTMB (CTTB): -45, -60, -60, -60, 0, 0 -45, -60, -60, -60, 0, 0 Digital Cable TV: -58, -62, -65, -73, -73, -73 -58, -62, -65, -73, -73, -73 LTE, LTETDD, MSR, LTEAFDD, LTEATDD: -44.2, -44.2, -44.2, -44.2, -44.2, -44.2 -29.2, -29.2, -29.2, -29.2, -29.2, -29.2
State Saved	Saved in instrument state.
Min	-150.0
Max	50.0
<b>Backwards Compatibility SCPI</b>	:CALCulate:MCPower:OFFSet:LIST:LIMit:POSitive[:UPPer]:DATA (PSA Power Suite)
Initial S/W Revision	A.04.00
Modified at S/W Revision	A.13.00

### Negative Offset Limit

Enables you to set the upper limit for the lower segment of the specified offset pair.

Mode	SA, WCDMA, CDMA2K, WIMAXOFDMA, TDSCDMA, CDMA1XEV, DVB, DTMB, LTE, LTETDD, DCATV, MSR, LTEAFDD, LTEATDD
<b>Remote Command</b>	:CALCulate:ACPower:OFFSet[:OUTer]:LIST:LIMit:NEGative[:UPPer]:DATA <real>, <real>, <real>, <real>, <real>, <real> :CALCulate:ACPower:OFFSet[:OUTer]:LIST:LIMit:NEGative[:UPPer]:DATA?
<b>Example</b>	CALC:ACP:OFFS:LIST:LIM:NEG:DATA 0, 0, 0, 0, 0, 0 CALC:ACP:OFFS:LIST:LIM:NEG:DATA?
Notes	SCPI only command
Preset	SA: -45, -60, 0, 0, 0, 0 -45, -60, 0, 0, 0, 0 WCDMA: -44.2, -49.2, -49.2, -49.2, -49.2, -49.2 -32.2, -42.2, -42.2, -42.2, -42.2 C2K: 0, 0, 0, 0, 0, 0 0, 0, 0, 0, 0, 0 WIMAX OFDMA: -50, -60, 0, 0, 0, 0 TD-SCDMA: -40, -45, -45, -45, -45, -45 -33, -43, -43, -43, -43, -43 1xEVDO: -45, -55, -55, -55, -55, -55 -45, -55, -55, -55, -55, -55 DVB-T/H: -60, -60, 0, 0, 0, 0 -60, -60, 0, 0, 0, 0 DTMB (CTTB): -45, -60, -60, -60, 0, 0 -45, -60, -60, -60, 0, 0 Digital Cable TV: -58, -62, -65, -73, -73, -73 -58, -62, -65, -73, -73, -73

	LTE, LTE_TDD, MSR, LTEAFDD, LTEATDD: -44.2, -44.2, -44.2, -44.2, -44.2, -44.2 -29.2, -29.2, -29.2, -29.2, -29.2, -29.2
State Saved	Saved in instrument state.
Min	-150.0
Max	50.0
<b>Backwards Compatibility SCPI</b>	:CALCulate:MCPower:OFFSet:LIST:LIMit:NEGative[:UPPer]:DATA (PSA Power Suite)
Initial S/W Revision	A.04.00
Modified at S/W Revision	A.13.00

### Rel Limit (PSD)

Enters a relative limit value for the level of the power spectral density. This sets the amplitude levels to test against for any custom offsets. The amplitude level is relative to the power spectral density. If multiple offsets are available, the list contains six (6) entries. The offset closest to the carrier channel is the first one in the list.

[[:SENSe]:ACP:OFFSet[n]:OUTer]:LIST:TEST selects the type of testing to be done at each offset.

You can turn off (not use) specific offsets with the [[:SENSe]:ACP:OFFSet[n]:OUTer]:LIST:STATe command.

The query returns the six (6) sets of real numbers that are the current amplitude test limits, relative to the power spectral density, for each offset.

Offset[n] n = 1 is base station and n = 2 is mobiles. The default is base station (1).

Key Path	Meas Setup, Offset/Limits, Limits
Mode	SA, WCDMA, C2K, WIMAX OFDMA, TD-SCDMA, 1xEVDO, DVB-T/H, DTMB (CTTB), ISDB-T, CMMB, LTE, LTE_TDD, Digital Cable TV, MSR, LTEAFDD, LTEATDD
Remote Command	[[:SENSe]:ACP:OFFSet[1] 2[:OUTer]:LIST:RPSDensity <rel_ampl>, <rel_ampl>, <rel_ampl>, <rel_ampl>, <rel_ampl> [[:SENSe]:ACP:OFFSet[1] 2[:OUTer]:LIST:RPSDensity?
Example	ACP:OFFS2:LIST:RPSD 10,10,10,10,10,10 ACP:OFFS2:LIST:RPSD?
Notes	Offset sub op code. 1 for BTS, 2 for MS. Default is BTS. Note that Offset sub op code 2 is supported only in Non-SA modes. In the SA mode, Offset sub op code 1 is used for both BTS and MS. You must be in the mode that includes ACP measurements to use this command. Use :INSTrument:SElect to set the mode.
Preset	SA: -28.87 dB, -43.87 dB, 0 dB, 0 dB, 0 dB, 0 dB -28.87 dB, -43.87 dB, 0 dB, 0 dB, 0 dB, 0 dB WCDMA: -44.2 dB, -49.2 dB, -49.2 dB, -49.2 dB, -49.2 dB, -49.2 dB -32.2 dB, -42.2 dB, -42.2 dB, -42.2 dB C2K: 0 dB, 0 dB, 0 dB, 0 dB, 0 dB, 0 dB 0 dB, 0 dB, 0 dB, 0 dB, 0 dB, 0 dB WIMAX OFDMA: -25,-35,0,0,0,0

	TD-SCDMA: -40 dB, -45 dB, -45 dB, -45 dB, -45 dB, -45 dB -33 dB, -43 dB, -43 dB, -43 dB, -43 dB, -43 dB 1xEVDO: -45, -55, -55, -55, -55, -55 -45, -55, -55, -55, -55, -55 DVB-T/H: -60 dB, -60 dB, 0 dB, 0 dB, 0 dB, 0 dB -60 dB, -60 dB, 0 dB, 0 dB, 0 dB, 0 dB DTMB (CTTB): 50 dB, 50 dB, 50 dB, 50 dB, 50 dB, 50 dB 50 dB, 50 dB, 50 dB, 50 dB, 50 dB, 50 dB ISDB-T: -60 dB, -60 dB, 0 dB, 0 dB, 0 dB, 0 dB -60 dB, -60 dB, 0 dB, 0 dB, 0 dB, 0 dB CMMB: 50 dB, 50 dB, 50 dB, 50 dB, 50 dB, 50 dB 50 dB, 50 dB, 50 dB, 50 dB, 50 dB, 50 dB LTE, LTE-TDD, MSR, LTE-AFDD, LTE-A-TDD: 0, 0, 0, 0, 0, 0 0, 0, 0, 0, 0, 0 Digital Cable TV: 50 dB, 50 dB, 50 dB, 50 dB, 50 dB, 50 dB 50 dB, 50 dB, 50 dB, 50 dB, 50 dB, 50 dB
State Saved	Saved in instrument state.
Min	-150.0 dB
Max	50.0 dB
Initial S/W Revision	Prior to A.02.00
Modified at S/W Revision	A.02.00, A.03.00, A.13.00

## Fail Mask

Accesses a menu that enables you to select one of the logic keys for the fail conditions between the measurement results and the test limits. The setting defines the type of testing to be done at any custom offset frequencies. The measured powers are tested against the absolute values defined with [:SENSe]:ACP:OFFSet[n][:OUTer]:LIST:ABSolute, or the relative values defined with [:SENSe]:ACP:OFFSet[n][:OUTer]:LIST:RPSDensity and [:SENSe]:ACP:OFFSet[n][:OUTer]:LIST:RCARrier.

You can turn off (not use) specific offsets with the [:SENSe]:ACP:OFFSet[n][:OUTer]:LIST:STATe command.

- Absolute – Fail is shown if one of the absolute ACP measurement results is larger than the limit for Abs Limit.
- Relative – Fail is shown if one of the relative ACP measurement results is larger than the limit for Rel Lim (Car) or Rel Lim (PSD).
- Abs AND Rel – Fail is shown if one of the absolute ACP measurement results is larger than the limit for Abs Limit AND one of the relative ACP measurement results is larger than the limit for Rel Lim (Car) or Rel Lim (PSD).
- Abs OR Rel – Fail is shown if one of the absolute ACP measurement results is larger than the limit for Abs Limit OR one of the relative ACP measurement results is larger than the limit for Rel Lim (Car) or Rel Lim (PSD).

Key Path	Meas Setup, Offset/Limits, Limits
Mode	SA, WCDMA, C2K, WIMAX OFDMA, TD-SCDMA, 1xEVDO, DVB-T/H, DTMB (CTTB), ISDB-T, CMMB, LTE, LTE-TDD, Digital Cable TV, MSR, LTE-AFDD, LTE-A-TDD
Remote Command	[:SENSe]:ACPower:OFFSet[1] 2[:OUTer]:LIST:TEST ABSolute   AND   OR   RELative, ABSolute   AND   OR   RELative, ABSolute   AND   OR   RELative, ABSolute   AND   OR   RELative, ABSolute   AND   OR

	RELative, ABSolute   AND   OR   RELative [:SENSe]:ACPpower:OFFSet [1]   2 [:OUTer]:LIST:TEST?
<b>Example</b>	ACP:OFFS2:LIST:TEST ABS, ABS, ABS, ABS, ABS, ABS ACP:OFFS2:LIST:TEST?
<b>Notes</b>	Offset sub op code. 1 for BTS, 2 for MS. Default is BTS. Note that Offset sub op code 2 is supported only in Non-SA modes. In the SA mode, Offset sub op code 1 is used for both BTS and MS. You must be in the mode that includes ACP measurements to use this command. Use :INSTRument:SElect to set the mode.
<b>Couplings</b>	None If current mode is DTMB (CTTB) or CMMB and current device type is Transmitter, the value from position 2 to position 4 are coupled, changing any one will change the others.
<b>Preset</b>	SA, WCDMA, C2K, TD-SCDMA: REL, REL, REL, REL, REL, REL REL, REL, REL, REL, REL, REL WIMAX OFDMA: REL, REL, REL, REL, REL, REL DVB-T/H: REL, REL, REL, REL, REL, REL DTMB (CTTB): OR,AND, AND,AND, REL, REL CDMA1xEVDO: REL, REL, ABS, REL, REL, REL  REL, REL, ABS, REL, REL, REL ISDB-T : REL, REL, REL, REL, REL, REL CMMB : OR,AND, AND,AND, REL, REL LTE, LTETDD, MSR, LTEAFDD, LTEATDD: AND, AND, AND, AND, AND, AND AND, AND, AND, AND, AND, AND Digital Cable TV: REL, REL, REL, REL, REL, REL
<b>State Saved</b>	Saved in instrument state.
<b>Range</b>	Absolute Relative Abs AND Rel (fail if both fail) Abs OR Rel (fail if either fails)
<b>Backwards Compatibility SCPI</b>	[:SENSe]:MCPower:OFFSet [1]   2 :LIST:TEST
<b>Initial S/W Revision</b>	Prior to A.02.00
<b>Modified at S/W Revision</b>	A.02.00, A.03.00, A.04.00, A13.00

### Offset Side

Enables you to turn off (not use) specific offsets with [:SENSe]:ACPpower:OFFSet[1]|2[:Outer]:LIST:SIDE.

- NEGative - Negative (lower) sideband only
- BOTH - Both of the negative (lower) and positive (upper) sidebands
- POSitive - Positive (upper) sideband only

The figure below shows the relation between the negative/positive offset side setups and the upper/lower results in the MSR and LTE-Advanced FDD/TDD.



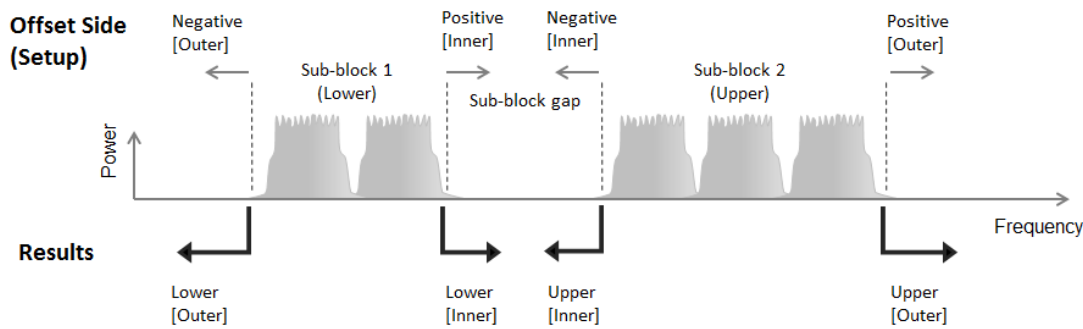

Key Path	Meas Setup, Offset/Limits
Mode	SA, WCDMA, C2K, WIMAX OFDMA, TD-SCDMA, 1xEVDO, DTMB (CTTB), DVB-T/H, LTE, LTETDD, Digital Cable TV, MSR, LTEAFDD, LTEATDD
Remote Command	<code>[[:SENSE]:ACPower:OFFSet[1] 2[:OUTer]:LIST:SIDE NEGative   BOTH   POSitive,NEGative   BOTH   POSitive,NEGative   BOTH   POSitive,NEGative   BOTH   POSitive,NEGative   BOTH   POSitive</code> <code>[[:SENSe]:ACPower:OFFSet[1] 2[:OUTer]:LIST:SIDE?</code>
Example	ACP:OFFS:LIST:SIDE BOTH ACP:OFFS:LIST:SIDE?
Notes	OFFSet1 is for BTS, 2 for MS. Default is BTS. You must be in the Spectrum Analysis mode, W-CDMA mode, cdma2000 mode, TD-SCDMA mode, DTMB (CTTB) mode, DVB-T/H mode, ISDB-T mode, CMMP mode, Digital Cable TV mode, 1xEVDO mode, WIMAX OFDMA mode, LTE mode, LTETDD, LTEAFDD, LTEATDD or MSR mode to use this command. Use :INSTRument:SElect to set the mode. If you set POS or NEG in an offset, result of the inactive side will return -999.
Preset	BOTH, BOTH, BOTH, BOTH, BOTH, BOTH BOTH, BOTH, BOTH, BOTH, BOTH, BOTH
State Saved	Saved in instrument state.
Range	Neg Both Pos
Initial S/W Revision	A.03.00
Modified at S/W Revision	A.13.00

### Method for Offset

This key allows you to turn RRC filtering of each offset on or off. The value (roll off) for the filter will be set to the value of the Filter Alpha parameter.

Key Path	Meas Setup, Offset/Limits
Mode	SA, WCDMA, WIMAX OFDMA, TD-SCDMA, DVB-T/H, DTMB (CTTB), ISDB-T, CMMP, LTE, LTETDD, Digital Cable TV, MSR, LTEAFDD, LTEATDD
Remote Command	<code>[[:SENSe]:ACPower:OFFSet[1] 2[:OUTer]:LIST:FILTer[:RRC][:STATe] ON   OFF</code> <code>  1   0, ON   OFF   1   0, ON   OFF   1   0, ON   OFF   1   0, ON   OFF</code> <code>  1   0, ON   OFF   1   0</code> <code>[[:SENSe]:ACPower:OFFSet[1] 2[:OUTer]:LIST:FILTer[:RRC][:STATe]?</code>

<b>Example</b>	ACP:OFFS:LIST:FILT 1,0,0 ACP:OFFS:LIST:FILT?
<b>Notes</b>	1 ON = RRC Weighted, 0 OFF = Integ BW This parameter is not available for cdma2000 and 1xEVDO. You must be in the mode that includes ACP measurements to use this command. Use :INSTrument:SElect to set the mode.
<b>Preset</b>	SA: 0, 0, 0, 0, 0, 0 0, 0, 0, 0, 0, 0 WCDMA:1, 1, 1, 1, 1, 1 1, 1, 1, 1, 1, 1 C2K: NO WIMAX OFDMA: 0, 0, 0, 0, 0, 0 0, 0, 0, 0, 0, 0 TD-SCDMA: 1, 1, 1, 1, 1, 1 1, 1, 1, 1, 1, 1 DVB-T/H: 0, 0, 0, 0, 0, 0 0, 0, 0, 0, 0, 0 DTMB (CTTB): 1, 1, 1, 1, 1, 1 1, 1, 1, 1, 1, 1 ISDB-T: 0, 0, 0, 0, 0, 0 0, 0, 0, 0, 0, 0 CMMB: 1, 1, 1, 1, 1, 1 1, 1, 1, 1, 1, 1 LTE: 0, 0, 0, 0, 0, 0 0, 0, 0, 0, 0, 0 LTETDD: 0, 0, 0, 0, 0, 0 0, 0, 0, 0, 0, 0 Digital Cable TV: 0, 0, 0, 0, 0, 0 0, 0, 0, 0, 0, 0 MSR, LTEAFDD, LTEATDD: 0, 0, 0, 0, 0, 0 0, 0, 0, 0, 0, 0
<b>State Saved</b>	Saved in instrument state.
<b>Range</b>	Integ BW RRC Weighted
<b>Initial S/W Revision</b>	A.03.00
<b>Modified at S/W Revision</b>	A.13.00

### Method for Offset

This key allows you to turn RRC filtering of each offset on or off. The value (roll off) for the filter will be set to the value of the Filter Alpha parameter.

<b>Key Path</b>	Meas Setup, Offset/Limits
<b>Mode</b>	SA, WCDMA, WIMAX OFDMA, TD-SCDMA, DVB-T/H, DTMB (CTTB), ISDB-T, CMMB, LTE, LTETDD, Digital Cable TV, MSR, LTEAFDD, LTEATDD
<b>Remote Command</b>	[ :SENSe ] :ACPpower:OFFSet [ 1 ]   2 [ :OUTer ] :LIST:FILTER [ :RRC ] [ :STATe ] ON   OFF   1   0, ON   OFF   1   0, ON   OFF   1   0, ON   OFF   1   0, ON   OFF   1   0, ON   OFF   1   0  [ :SENSe ] :ACPpower:OFFSet [ 1 ]   2 [ :OUTer ] :LIST:FILTER [ :RRC ] [ :STATe ] ?
<b>Example</b>	ACP:OFFS:LIST:FILT 1,0,0 ACP:OFFS:LIST:FILT?
<b>Notes</b>	1 ON = RRC Weighted, 0 OFF = Integ BW This parameter is not available for cdma2000 and 1xEVDO. You must be in the mode that includes ACP measurements to use this command. Use

	:INSTrument:SElect to set the mode.
Preset	SA: 0, 0, 0, 0, 0, 0 0, 0, 0, 0, 0, 0 WCDMA:1, 1, 1, 1, 1, 1 1, 1, 1, 1, 1, 1 C2K: NO WIMAX OFDMA: 0, 0, 0, 0, 0, 0 0, 0, 0, 0, 0, 0 TD-SCDMA: 1, 1, 1, 1, 1, 1 1, 1, 1, 1, 1, 1 DVB-T/H: 0, 0, 0, 0, 0, 0 0, 0, 0, 0, 0, 0 DTMB (CTTB): 1, 1, 1, 1, 1, 1 1, 1, 1, 1, 1, 1 ISDB-T: 0, 0, 0, 0, 0, 0 0, 0, 0, 0, 0, 0 CMMB: 1, 1, 1, 1, 1, 1 1, 1, 1, 1, 1, 1 LTE: 0, 0, 0, 0, 0, 0 0, 0, 0, 0, 0, 0 LTETDD: 0, 0, 0, 0, 0, 0 0, 0, 0, 0, 0, 0 Digital Cable TV: 0, 0, 0, 0, 0, 0 0, 0, 0, 0, 0, 0 MSR, LTEAFDD, LTEATDD: 0, 0, 0, 0, 0, 0 0, 0, 0, 0, 0, 0
State Saved	Saved in instrument state.
Range	Integ BW RRC Weighted
Initial S/W Revision	A.03.00
Modified at S/W Revision	A.13.00

#### Filter Alpha for Offset

Sets the alpha value for the RRC Filter for each offset.

Key Path	Meas Setup, Offset/Limits, Method, RRC Weighted
Mode	SA, WCDMA, WIMAX OFDMA,TD-SCDMA, DVB-T/H, DTMB (CTTB), ISDB-T, CMMB, LTE, LTETDD, Digital Cable TV, MSR, LTEAFDD,LTEATDD
Remote Command	[ :SENSe ] :ACPoweR:OFFSet [ 1 ]   2 [ :OUTer ] :LIST:FILTer:ALPHa <real>, <real>, <real>, <real>, <real> [ :SENSe ] :ACPoweR:OFFSet [ 1 ]   2 [ :OUTer ] :LIST:FILTer:ALPHa?
Example	ACP:OFFS:LIST:FILT:ALPH 0.5, 0.5, 0.5, 0.5, 0.5, 0.5 ACP:OFFS:LIST:FILT:ALPH?
Notes	This parameter is not available for cdma2000 and 1xEVDO. You must be in the mode that includes ACP measurements to use this command. Use :INSTrument:SElect to set the mode.
Preset	SA: 0.22, 0.22, 0.22, 0.22, 0.22, 0.22 0.22, 0.22, 0.22, 0.22, 0.22, 0.22 WCDMA: 0.22, 0.22, 0.22, 0.22, 0.22, 0.22 0.22, 0.22, 0.22, 0.22, 0.22, 0.22 WIMAX OFDMA: 0.22, 0.22, 0.22, 0.22, 0.22, 0.22 0.22, 0.22, 0.22, 0.22, 0.22, 0.22 C2K: NO TD-SCDMA: 0.22, 0.22, 0.22, 0.22, 0.22, 0.22 0.22, 0.22, 0.22, 0.22, 0.22, 0.22 DVB-T/H: 0.22, 0.22, 0.22, 0.22, 0.22, 0.22 0.22, 0.22, 0.22, 0.22, 0.22, 0.22

	DTMB (CTTB): 0.05, 0.05, 0.05, 0.05, 0.05, 0.05 0.05, 0.05, 0.05, 0.05, 0.05, 0.05
	ISDB-T : 0.22, 0.22, 0.22, 0.22, 0.22, 0.22 0.22, 0.22, 0.22, 0.22, 0.22, 0.22
	CMMB : 0.22, 0.22, 0.22, 0.22, 0.22, 0.22 0.22, 0.22, 0.22, 0.22, 0.22, 0.22
	LTE: 0.22, 0.22, 0.22, 0.22, 0.22, 0.22 0.22, 0.22, 0.22, 0.22, 0.22, 0.22
	LTETDD: 0.22, 0.22, 0.22, 0.22, 0.22, 0.22 0.22, 0.22, 0.22, 0.22, 0.22, 0.22
	Digital Cable TV: 0.15, 0.15, 0.15, 0.15, 0.15, 0.15 0.15, 0.15, 0.15, 0.15, 0.15, 0.15
	MSR, LTEAFDD, LTEATDD: 0.22, 0.22, 0.22, 0.22, 0.22, 0.22 0.22, 0.22, 0.22, 0.22, 0.22, 0.22
State Saved	Saved in instrument state.
Min	0.01
Max	1.00
Initial S/W Revision	A.03.00
Modified at S/W Revision	A.13.00

## Offset Frequency Define

This key allows you to select “Offset” definition. Each standard defines each “Offset” from Carrier.

3GPP2 requires the “From Carrier Center to MeasBW Closer Edge” definition. LTE conformance test requires “From Carrier Edge to MeasBW Center” and/or “From Carrier Edge to MeasBW Closer Edge” definition.

- CTOCenter – From the center of the carrier closest to the adjacent channel to the center of the adjacent channel Offset Integ BW
- CTOEdge - From the center of the carrier closest to the adjacent channel to the edge of the closest adjacent channel Offset Integ BW
- ETOCenter – From Center Frequency - Carrier Spacing / 2 (for lower offset), Center Frequency + Carrier Spacing / 2 (for upper offset) of the carrier closest to the adjacent channel's to the center of the adjacent channel Offset Integ BW
- ETOEdge - From Center Frequency - Carrier Spacing / 2 (for lower offset), Center Frequency + Carrier Spacing / 2 (for upper offset) of the carrier closest to the adjacent channel's to the edge of the closest adjacent channel Offset Integ BW

Key Path	Meas Setup, Offset/Limits
Mode	SA, WCDMA, C2K, WIMAX OFDMA, TD-SCDMA, 1xEVDO, DVB-T/H, DTMB (CTTB), ISDB-T, CMMB, LTE, LTETDD, Digital Cable TV, MSR,LTEAFDD,LTEATDD
Remote Command	[[:SENSe]:ACPpower:OFFSet[1] 2[:OUTer]:TYPE CTOCenter   CTOEdge   ETOCenter   ETOEdge [:SENSe]:ACPpower:OFFSet[1] 2[:OUTer]:TYPE?
Example	ACP:OFFS:TYPE ETOC ACP:OFFS:TYPE?
Notes	You must be in the mode that includes ACP measurements to use this command. Use :INSTrument:SElect to set the mode.

Preset	All Except C2K and 1xEVDO: CTOCenter C2K and 1xEVDO: CTOEdge
State Saved	Saved in instrument state.
Range	Carrier Center To Meas BW Center Carrier Center To Meas BW Edge Carrier Edge To Meas BW Center Carrier Edge To Meas BW Edge
Initial S/W Revision	A.03.00
Modified at S/W Revision	A.13.00

## Carrier Result

Allows you to view and scroll through the carrier power results.

Key Path	Meas Setup
Mode	SA, WCDMA, C2K, WIMAX OFDMA, TD-SCDMA, 1xEVDO, DVB-T/H, DTMB (CTTB), ISDB-T, CMMB, LTE, LTE-TDD, Digital Cable TV, MSR, LTEAFDD, LTEATDD
Couplings	This key will be grayed out if there is only one carrier.
Preset	1
State Saved	No
Min	1
Max	Number of carriers.
Initial S/W Revision	Prior to A.02.00
Modified at S/W Revision	A.02.00, A.03.00

## Meas Method

Sets the desired method to measure ACP.

Integration BW – one sweep of the trace is taken, and the band power for each offset is computed. Depending on the status of the Meas Type parameter (Total Power Reference or PSD Reference), results are displayed relative to the total power or the power spectral density. The display reflects either the current trace or a bar graph view.

Filtered IBW (max dynamic range) – the ACP Path is used to compute ACP when an ACP path is available. This method increases dynamic range, but increases measurement time as it limits the resolution bandwidth. This method is useful for improving dynamic range on a W-CDMA signal because a sharp cutoff bandpass filter is used. The accuracy of the adjacent channel power ratio is not degraded by this method, but the absolute accuracy of both adjacent channel power and carrier power are degraded by up to about 0.5 dB.

RBW – the algorithm uses zero-span and an appropriate RBW setting to capture all of the power in the carrier channel and the offsets. The zero-span algorithm (RBW method) is slower than the IBW method, but greatly improves repeatability.

Fast (in WCDMA mode or SA mode with 3GPP WCDMA radio standard selected) – this provides the same method as the Integration BW method, but is optimized for speed to measure a W-CDMA signal.

Fast (in CDMA2K mode or SA mode with CDMA2K radio standard selected) – this provides faster measurement using the FFT method with a limited parameter flexibility. When this is selected, CDMA2K preset offsets are given and control of the following are grayed out:

BW menu, Sweep/Control menu except Pause/Resume, Trace/Detector menu, Carrier Setup, Offset Limit, RRC Weighting, Filter Alpha, and Noise Correction softkeys in Meas Setup menu.

<b>Key Path</b>	<b>Meas Setup</b>
<b>Mode</b>	SA, WCDMA, C2K, WIMAX OFDMA, 1xEVDO, DVB-T/H, DTMB (CTTB), ISDB-T, CMMB, LTE, LTETDD, Digital Cable TV, MSR,, LTEAFDD, LTEATDD
<b>Remote Command</b>	[ :SENSe ] :ACPower:METhod IBW IBWRange FAST RBW [ :SENSe ] :ACPower:METhod?
<b>Example</b>	ACP:METH IBW ACP:METH?
<b>Notes</b>	<p>FAST mode is only supported for WCDMA and C2K signal. You must be in the WCDMA or C2K mode or SA mode with 3GPP WCDMA or CDMA2K radio standard. Otherwise a setting conflict error message will be reported.</p> <p>In the TDSCDMA mode, only the IBW method is available to use. Therefore, the measure method key is not displayed in the TD-SCDMA mode.</p> <p>CDMA1xEVDO mode only supports RBW and Integration BW method.</p> <p>C2K mode only supports RBW, Integration BW and FAST method.</p> <p>LTETDD mode only supports Integration BW and Filtered IBW method.</p> <p>MSR mode only supports Integration BW and Filtered IBW method.</p> <p>LTE-Advanced FDD/TDD mode only support IBW and Filtered IBW method.</p> <p>You must be in the mode that includes ACP measurements to use this command. Use :INSTRument:SElect to set the mode.</p>
<b>Dependencies</b>	<p>When RBW or FAST is selected, Gate function is not available. If you try to turn Gate On while Meas Method is RBW or FAST, an error is generated.</p> <p>When Gate function is ON, RBW and FAST method is not available. If you try to change Meas Method to RBW or FAST, an error is generated.</p>
<b>Couplings</b>	IBW (Range) restricts the Res BW available for making this measurement to 30 kHz. When selected, the Res BW is clipped to this value if required and an error number displayed.
<b>Preset</b>	SA, LTE, LTETDD, MSR, LTEAFDD, LTEATDD: IBW WCDMA: IBW C2K: RBW WIMAX OFDMA: IBW 1xEVDO: IBW DVB-T/H: IBW DTMB (CTTB): IBW ISDB-T: IBW CMMB: IBW

	Digital Cable TV: IBW
State Saved	Saved in instrument state.
Range	Integration BW Filtered IBW (max dynamic range) RBW Fast
Readback Text	IBW Filtered IBW RBW Fast
<b>Backwards Compatibility SCPI</b>	[ :SENSe ] :ACPR :SWEp :TYPE [ :SENSe ] :MCPower :METHod (PSA Power Suite)
Initial S/W Revision	Prior to A.02.00
Modified at S/W Revision	A.02.00, A.03.00

## Meas Type

Changes the reference used for the measurement. This allows you to make absolute and relative power measurements of either total power or the power normalized to the measurement bandwidth.

Total Pwr Ref (TPR) sets the reference to the total carrier power. PSD Ref (PSDR) sets the reference to the power spectral density of the carrier.

Key Path	Meas Setup
Mode	SA, WCDMA, C2K, WIMAX OFDMA, TD-SCDMA, 1xEVDO, DVB-T/H, DTMB (CTTB), ISDB-T, CMMB, LTE, LTE-TDD, Digital Cable TV, MSR, LTEAFDD, LTEATDD
<b>Remote Command</b>	[ :SENSe ] :ACPower :TYPE TPRef   PSDRef [ :SENSe ] :ACPower :TYPE?
<b>Example</b>	ACP:TYPE PSDR ACP:TYPE?
Notes	You must be in the mode that includes ACP measurements to use this command. Use :INSTRument:SElect to set the mode.
Preset	TPRef
State Saved	Saved in instrument state.
Range	Total Power Ref PSD Ref
Initial S/W Revision	Prior to A.02.00
Modified at S/W Revision	A.02.00, A.03.00

## PSD Ref

Sets the unit bandwidth for Power Spectral Density. The available units are dBm/Hz and dBm/MHz.

Key Path	Meas Setup
Mode	A, WCDMA, C2K, WIMAX OFDMA, TD-SCDMA, 1xEVDO, DVB-T/H, DTMB (CTTB), ISDB-T, CMMB, LTE, LTE-TDD, Digital Cable TV, MSR, LTEAFDD, LTEATDD
<b>Remote Command</b>	:UNIT:ACPower:POWer:PSD DBMHZ   DBMMHZ

	:UNIT:ACPower:POW:PSD?
<b>Example</b>	UNIT:ACP:POW:PSD DBMMHZ UNIT:ACP:POW:PSD?
Couplings	When the PSD unit is changed, the PSD reference result of the "MEAS READ FETCH:ACP[n]?" is also changed by the PSD unit basis (in either dBm/Hz or dBm/MHz).
Preset	DBMMHZ
State Saved	Saved in instrument state.
Range	dBm/Hz dBm/MHz
Initial S/W Revision	Prior to A.02.00
Modified at S/W Revision	A.02.00, A.03.00

## Limit Test

Turns limit checking for each offset On or Off. The limits may be specified within the Offset menu, for each offset, both sides of the carrier. For results that fail the limit, a red F is appended. In the Combined view, the bar turns red.

<b>Key Path</b>	Meas Setup
<b>Mode</b>	SA, WCDMA, C2K, WIMAX OFDMA, TD-SCDMA, 1xEVDO, DVB-T/H, DTMB (CTTB), ISDB-T, CMMB, LTE, LTETDD, Digital Cable TV, MSR, LTEAFDD, LTEATDD
<b>Remote Command</b>	:CALCulate:ACPower:LIMit:STATe OFF ON 0 1 :CALCulate:ACPower:LIMit:STATe?
<b>Example</b>	CALC:ACP:LIM:STAT OFF CALC:ACP:LIM:STAT?
<b>Notes</b>	You must be in the mode that includes ACP measurements to use this command. Use :INSTrument:SElect to set the mode.
<b>Preset</b>	SA: OFF WCDMA: ON C2K: ON WIMAX OFDMA: OFF TD-SCDMA: ON 1xEVDO: ON DVB-T/H: OFF DTMB (CTTB): ON ISDB-T: OFF CMMB: ON LTE, LTETDD, MSR, LTEAFDD, LTEATDD: ON Digital Cable TV: OFF
<b>State Saved</b>	Saved in instrument state.
<b>Range</b>	On Off



<b>Backwards Compatibility SCPI</b>	<code>[:SENSe]:MCPower:LIMit[:STATe]</code>
	<code>[:SENSe]:ACPower:LIMit[:STATe]</code>
Initial S/W Revision	Prior to A.02.00
Modified at S/W Revision	A.02.00, A.03.00

## Noise Correction

Sets the measurement noise floor correction function to On or Off. On enables measurement noise correction when the measured power in the reference channel or any offset is close to the noise floor of the analyzer. Off turns these corrections off.

In analyzers with the noise floor extensions option (option NFE) enabled, there are two ways to compensate for the analyzer noise floor: through the NFE and through this noise corrections key. The techniques are results are similar but not identical. NFE uses a model of the analyzer noise floor, adapted to the current conditions such as center frequency, RBW and ambient temperature. The parameters of this model are measured in the factory or field calibration in a highly averaged measurement. So they are consistent. However, because the model is imperfect, the corrections are imperfect. Using NFE is very convenient; the user need not wait for the ACP noise corrections calibration to occur. The ACP NC calibration, though, has advantages of being measured very recently, at the current ambient, and the exact center frequency, with no requirement that the model be perfect. So it will often (but not always) have slightly better dynamic range. If both ACP NC is turned on and NFE is turned on, the analyzer uses only the ACP NC. When ACP NC is turned off but NFE is on, NFE is used and performance should still be excellent.

<b>Key Path</b>	<b>Meas Setup</b>
Mode	SA, WCDMA, C2K, WIMAX OFDMA, TD-SCDMA, 1xEVDO, DVB-T/H, DTMB (CTTB), ISDB-T, CMMB, LTE, LTEFDD, Digital Cable TV, MSR, LTEAFDD, LTEATDD
<b>Remote Command</b>	<code>[:SENSe]:ACPower:CORRection:NOISe[:AUTO] OFF ON 0 1</code> <code>[:SENSe]:ACPower:CORRection:NOISe[:AUTO]?</code>
<b>Example</b>	ACP:CORR:NOIS OFF ACP:CORR:NOIS?
Notes	You must be in the mode that includes ACP measurements to use this command. Use <code>:INSTrument:SElect</code> to set the mode.
Dependencies	This parameter is unavailable when Meas Method is set to RBW or Fast.
Preset	0
State Saved	Saved in instrument state.
Range	On Off
Initial S/W Revision	Prior to A.02.00
Modified at S/W Revision	A.02.00, A.03.00, A.04.00

## Meas Preset

Restores all the measurement parameters to their default values.

Key Path	Meas Setup
Mode	SA, WCDMA, C2K, WIMAX OFDMA, TD-SCDMA, 1xEVDO, DVB-T/H, DTMB (CTTB), ISDB-T, CMMB, LTE, LTETDD, Digital Cable TV, MSR, LTEAFDD,LTEATDD
Remote Command	:CONFigure:ACPover
Example	CONF:ACP
Notes	You must be in the mode that includes ACP measurements to use this command. Use :INSTrument:SElect to set the mode.
Couplings	Selecting Meas Preset will restore all measurement parameters to their default values.
Initial S/W Revision	Prior to A.02.00
Modified at S/W Revision	A.02.00, A.03.00

### Offset RRC Weighting (Backward Compatibility SCPI)

Mode	SA, WCDMA, TD-SCDMA, WIMAX OFDMA, DVB-T/H, DTMB (CTTB), ISDB-T, CMMB, LTE, LTETDD, Digital Cable TV, MSR, LTEAFDD,LTEATDD
Remote Command	[ :SENSe ] :ACPover:FILTer [ :RRC ] [ :STATe ] OFF ON 0 1 [ :SENSe ] :ACPover:FILTer [ :RRC ] [ :STATe ] ?
Example	ACP:FILT OFF ACP:FILT?
Notes	This parameter is not available for cdma2000 and 1xEVDO The backwards Compatibility SCPI command, [ :SENSe ] :ACPover:FILTer [ :RRC ] [ :STATe ], is provided to support same functionality as [ :SENSe ] :ACPover:FILTer [ :RRC ] [ :STATe ] (PSA W-CDMA, PSA cdma2000 and PSA 1xEVDO) due to ACPover node conflicts with ACPover node. You must be in the mode that includes ACP measurements to use this command. Use :INSTrument:SElect to set the mode.
Couplings	This command is an alias to [ :SENSe ] :ACPover:OFFSet[1]2:LIST:FILTer [ :RRC ] [ :STATe ] Sending the commands to set values of all offsets for BS and MS, however, sending the query always return a value of BS Offset A.
Preset	SA, WIMAX OFDMA, LTE, LTETDD, MSR: OFF WCDMA: ON C2K: NO TD-SCDMA: ON DVB-T/H: OFF DTMB (CTTB):ON ISDB-T: OFF CMMB: OFF Digital Cable TV: ON LTEAFDD,LTEATDD: OFF

State Saved	Saved in instrument state.
<b>Backwards Compatibility SCPI</b>	[ :SENSe ] :ACPR:FILTer [ :RRC ] [ :STATe ] [ :SENSe ] :MCPower:FILTer [ :RRC ] [ :STATe ]
Initial S/W Revision	Prior to A.02.00
Modified at S/W Revision	A.03.00

### Offset Filter Alpha (Backward Compatibility SCPI)

Mode	SA, WCDMA, WIMAX OFDMA, TD-SCDMA, DVB-T/H, DTMB (CTTB), ISDB-T, CMMB, LTE, LTEATDD, Digital Cable TV, MSR, LTEAFDD, LTEATDD
<b>Remote Command</b>	[ :SENSe ] :ACPower:FILTer [ :RRC ] :ALPHa <real> [ :SENSe ] :ACPower:FILTer [ :RRC ] :ALPHa?
<b>Example</b>	ACP:FILT:ALPH 0.5 ACP:FILT:ALPH?
Notes	This parameter is not available for cdma2000 and 1xEVDO The backwards Compatibility SCPI command, [ :SENSe ] :ACPR:FILTer [ :RRC ] :ALPHa, is provided to support same functionality as [ :SENSe ] :ACPr:FILTer [ :RRC ] :ALPHa (PSA W-CDMA, PSA cdma2000 and PSA 1xEVDO) due to ACPr node conflicts with ACPower node. You must be in the mode that includes ACP measurements to use this command. Use :INSTrument:SElect to set the mode.
Couplings	This command is an alias to [ :SENSe ] :ACPower:OFFSet [ 1 ] 2 :LIST:FILTer:ALPHa Sending the commands to set values of all offsets for BS and MS, however, sending the query always return a value of BS Offset A.
Preset	SA, WCDMA, WIMAX OFDMA, TD-SCDMA, DVB-T/H, ISDB-T, CMMB, LTE, LTEATDD, MSR: 0.22 C2K: NO DTMB (CTTB): 0.05 Digital Cable TV: 0.15 LTEAFDD, LTEATDD: 0.22
State Saved	Saved in instrument state.
Min	0.01
Max	1.00
<b>Backwards Compatibility SCPI</b>	[ :SENSe ] :ACPR:FILTer [ :RRC ] :ALPHa [ :SENSe ] :MCPower:FILTer [ :RRC ] :ALPHa
Initial S/W Revision	Prior to A.02.00
Modified at S/W Revision	A.03.00

## Method for Carrier (Backward Compatibility SCPI)

<b>Mode</b>	SA, WCDMA, WIMAX OFDMA, TD-SCDMA, DVB-T/H, DTMB (CTTB), ISDB-T, CMMB, LTE, LTETDD, Digital Cable TV, MSR
<b>Remote Command</b>	[[:SENSe]:ACPower:CARRier[1] 2:LIST:METhod IBW RRC, ... [:SENSe]:ACPower:CARRier[1] 2:LIST:METhod?
<b>Example</b>	ACP:CARR2:LIST:METh RRC ACP:CARR2:LIST:METh?
<b>Notes</b>	You must be in the mode that includes ACP measurements to use this command. Use :INSTrument:SElect to set the mode. Maximum of Array length depends on the number of carriers.
<b>Couplings</b>	This command is an alias to [:SENSe]:ACPower:CARRier[1] 2:LIST:FiLTer[:RRC][:STATe] The enum value translates as follows: RRC Weighted = 1 ON Integ BW = 0 OFF Maximum of Array length depends on the number of carriers.
<b>Preset</b>	SA: IBW WCDMA: RRC WIMAX OFDMA: IBW TD-SCDMA: RRC DVB-T/H: IBW DTMB (CTTB): RRC ISDB-T: IBW CMMB: IBW LTE, MSR: IBW LTETDD: IBW Digital Cable TV: RRC
<b>State Saved</b>	Saved in instrument state.
<b>Initial S/W Revision</b>	Prior to A.02.00
<b>Modified at S/W Revision</b>	A.03.00

## Mode

See "Mode" on page 298

## Mode Preset

Returns the active mode to a known state.

Mode Preset does the following for the currently active mode:

- Aborts the currently running measurement.
- Brings up the default menu for the mode, with no active function.
- Sets measurement Global settings to their preset values for the active mode only.
- Activates the default measurement.
- Brings up the default menu for the mode.
- Clears the input and output buffers.
- Sets Status Byte to 0.

Mode Preset does not:

- Cause a mode switch
- Affect mode persistent settings
- Affect system settings

See "[How-To Preset](#)" on page 767 for more information.

Key Path	Front-panel key
Remote Command	:SYSTem:PRESet
Example	:SYST:PRES
Notes	<p>*RST is preferred over :SYST:PRES for remote operation. *RST does a Mode Preset, as done by the :SYST:PRES command, and it sets the measurement mode to Single measurement rather than Continuous for optimal remote control throughput.</p> <p>Clears all pending OPC bits. The Status Byte is set to 0.</p>
Couplings	A Mode Preset aborts the currently running measurement, activates the default measurement, and gets the mode to a consistent state with all of the default couplings set.
Backwards Compatibility Notes	<p>In the X-Series, the legacy "Factory Preset" has been replaced with Mode Preset, which only presets the currently active mode, not the entire instrument. In the X-Series, the way to preset the entire instrument is by using System, Restore System Defaults All, which behaves essentially the same way as restore System Defaults does on ESA and PSA.</p> <p>There is also no "Preset Type" as there is on the PSA. There is a green Mode Preset front-panel key that does a Mode Preset and a white-with-green-letters User Preset front-panel key that does a User Preset. The old PRESet:TYPE command is ignored (without generating an error), and SYST:PRES without a parameter does a Mode Preset, which should cover most backward code compatibility issues.</p> <p>The settings and correction data under the Input/Output front-panel key (examples: Input Z Corr, Ext Amp Gain, etc.) are no longer part of any Mode, so they will not be preset by a Mode Preset. They are preset using Restore Input/Output Defaults, Restore System Defaults All. Note that because User Preset does a Recall State, and all of these settings are saved in State, they ARE recalled when using</p>

	User Preset.
Initial S/W Revision	Prior to A.02.00

## How-To Preset

The table below shows all possible presets, their corresponding SCPI commands and front-panel access (key paths). Instrument settings depend on the current measurement context. Some settings are local to the current measurement, some are global (common) across all the measurements in the current mode, and some are global to all the available modes. In a similar way, restoring the settings to their preset state can be done within the different contexts.

Auto Couple - is a measurement local key. It sets all Auto/Man parameter couplings in the measurement to Auto. Any Auto/Man selection that is local to other measurements in the mode will not be affected.

Meas Preset - is a measurement local key. Meas Preset resets all the variables local to the current measurement except the persistent ones.

Mode Preset - resets all the current mode's measurement local and measurement global variables except the persistent ones.

Restore Mode Defaults - resets ALL the Mode variables (and all the Meas global and Meas local variables), including the persistent ones.

Type Of Preset	SCPI Command	Front Panel Access
Auto Couple	:COUPlE ALL	Auto Couple front-panel key
Meas Preset	:CONFIgure:<Measurement>	Meas Setup Menu
Mode Preset	:SYSTem:PRESet	Mode Preset (green key)
Restore Mode Defaults	:INSTrument:DEFault	Mode Setup Menu
Restore All Mode Defaults	:SYSTem:DEFault MODEs	System Menu; Restore System Default Menu
*RST	*RST	not possible (Mode Preset with Single)
Restore Input/Output Defaults	:SYSTem:DEFault INPut	System Menu; Restore System Default Menu
Restore Power On Defaults	:SYSTem:DEFault PON	System Menu; Restore System Default Menu
Restore Alignment Defaults	:SYSTem:DEFault ALIGn	System Menu; Restore System Default Menu
Restore Miscellaneous Defaults	:SYSTem:DEFault MISC	System Menu; Restore System Default Menu
Restore All System Defaults	:SYSTem:DEFault [ALL] :SYSTem:PRESet:PERSistent	System Menu; Restore System Default Menu
User Preset	:SYSTem:PRESet:USER	User Preset Menu
User Preset All Modes	:SYSTem:PRESet:USER:ALL	User Preset Menu

Power On Mode Preset	:SYSTem:PON:TYPE MODE	System Menu
Power On User Preset	:SYSTem:PON:TYPE USER	System Menu
Power On Last State	:SYSTem:PON:TYPE LAST	System Menu

### Preset Type (Remote Command Only)

As stated in the Backward Compatibility section, to be compatible with ESA/PSA the PRESet:TYPE command will be implemented as a no-op.

<b>Mode</b>	All
<b>Remote Command</b>	:SYSTem:PRESet:TYPE FACTory MODE USER :SYSTem:PRESet:TYPE?
<b>Example</b>	:SYST:PRESet:TYPE FACT
<b>Notes</b>	This command is supported for backward compatibility only. It is a no-op which does not change the behavior of any preset operation.
<b>Preset</b>	This is unaffected by Preset but is set to Mode on a "Restore System Defaults->All"
<b>State Saved</b>	No
<b>Initial S/W Revision</b>	Prior to A.02.00



## Mode Setup

See ["Mode Setup" on page 328](#)

## Peak Search

Places the selected marker on the trace point with the maximum y-axis value.

Key Path	Peak Search
Mode	SA, WCDMA, C2K, WIMAX OFDMA, TD-SCDMA, 1xEVDO, DVB-T/H, DTMB (CTTB), ISDB-T, CMMB, LTE, LTETDD, Digital Cable TV, MSR, LTEAFDD,LTEATDD
Remote Command	:CALCulate:ACPower:MARKer[1] 2 ... 12:MAXimum
Example	CALC:ACP:MARK2:MAX
Initial S/W Revision	Prior to A.02.00
Modified at S/W Revision	A.02.00, A.03.00

## Next Peak

Moves the selected marker to the peak that has the next highest amplitude.

Key Path	Peak Search
Mode	SA, WCDMA, C2K, WIMAX OFDMA, TD-SCDMA, 1xEVDO, DVB-T/H, DTMB (CTTB), ISDB-T, CMMB, LTE, LTETDD, Digital Cable TV, MSR, LTEAFDD,LTEATDD
Remote Command	:CALCulate:ACPower:MARKer[1] 2 ... 12:MAXimum:NEXT
Example	CALC:ACP:MARK2:MAX:NEXT
Initial S/W Revision	Prior to A.02.00
Modified at S/W Revision	A.02.00, A.03.00

## Next Pk Right

Moves the selected marker to the nearest peak to the right of the current marker that meets all enabled peak criteria.

Key Path	Peak Search
Mode	SA, WCDMA, C2K, WIMAX OFDMA, TD-SCDMA, 1xEVDO, DVB-T/H, DTMB (CTTB), ISDB-T, CMMB, LTE, LTETDD, Digital Cable TV, MSR, LTEAFDD,LTEATDD
Remote Command	:CALCulate:ACPower:MARKer[1] 2 ... 12:MAXimum:RIGHT
Example	CALC:ACP:MARK2:MAX:RIGH
Initial S/W Revision	Prior to A.02.00
Modified at S/W Revision	A.02.00, A.03.00

## Next Pk Left

Moves the selected marker to the nearest peak to the left of the current marker that meets all enabled peak criteria.

Key Path	Peak Search
Mode	SA, WCDMA, C2K, WIMAX OFDMA, TD-SCDMA, 1xEVDO, DVB-T/H, DTMB (CTTB), ISDB-T, CMMB, LTE, LTE-TDD, Digital Cable TV, MSR, LTEAFDD, LTEATDD
<b>Remote Command</b>	:CALCulate:ACPower:MARKer [1]   2   . . .   12:MAXimum:LEFT
<b>Example</b>	CALC:ACP:MARK2:MAX:LEFT
Initial S/W Revision	Prior to A.02.00
Modified at S/W Revision	A.02.00, A.03.00

## Marker Delta

Sets the control mode for the selected marker to Delta mode.

See Marker Delta in the "Marker Functions" section for more information.

Key Path	Peak Search
Initial S/W Revision	Prior to A.02.00

## Pk-Pk Search

Finds and displays the amplitude and frequency (or time, if in zero span) differences between the highest and lowest y-axis value.

Key Path	Peak Search
Mode	SA, WCDMA, C2K, WIMAX OFDMA, TD-SCDMA, 1xEVDO, DVB-T/H, DTMB (CTTB), ISDB-T, CMMB, LTE, LTE-TDD, Digital Cable TV, MSR, LTEAFDD, LTEATDD
<b>Remote Command</b>	:CALCulate:ACPower:MARKer [1]   2   . . .   12:PTPeak
<b>Example</b>	CALC:ACP:MARK:PTP
Notes	Turns on the Marker $\Delta$ active function.
Couplings	This key is not available (key is grayed out) when Coupled Markers is on.
Initial S/W Revision	Prior to A.02.00
Modified at S/W Revision	A.02.00, A.03.00

## Min Search

Moves the selected marker to the minimum y-axis value on the current trace.

<b>Key Path</b>	Peak Search
<b>Mode</b>	SA, WCDMA, C2K, WIMAX OFDMA, TD-SCDMA, 1xEVDO, DVB-T/H, DTMB (CTTB), ISDB-T, CMMB, LTE, LTEFDD, Digital Cable TV, MSR, LTEAFDD, LTEATDD
<b>Remote Command</b>	:CALCulate:ACPower:MARKer[1] 2 ... 12:MINimum
<b>Example</b>	CALC:ACP:MARK:MIN
<b>Initial S/W Revision</b>	Prior to A.02.00
<b>Modified at S/W Revision</b>	A.02.00, A.03.00

Print

See "Print" on page 341

## Quick Save

The Quick Save front-panel key repeats the most recent save that was performed from the Save menu, with the following exceptions:

- Register saves are not remembered as Saves for the purpose of the Quick Save function
- If the current measurement does not support the last non-register save that was performed, an informational message is generated, “File type not supported for this measurement”

Quick Save repeats the last type of qualified save (that is, a save qualified by the above criteria) in the last save directory by creating a unique filename using the Auto File Naming algorithm described below.

If Quick Save is pressed after startup and before any qualified Save has been performed, the Quick Save function performs a Screen Image save using the current settings for Screen Image saves (current theme, current directory), which then becomes the “last save” for the purpose of subsequent Quick Saves.

The Auto File Naming feature automatically generates a file name for use when saving a file. The filename consists of a prefix and suffix separated by a dot, as is standard for the Windows® file system. A default prefix exists for each of the available file types:

Type	Default Prefix	Menu
State	State_	(Save/Recall)
Trace + State	State_	(Save/Recall)
Screen	Screen_	(Save/Recall)
Amplitude Corrections	Ampcor_	(Import/Export)
Traces	Trace_	(Import/Export)
Limit Lines	LLine_	(Import/Export)
Measurement Result	MeasR_	(Import/Export)
Capture Buffer	CapBuf_	(Import/Export)

A four digit number is appended to the prefix to create a unique file name. The numbering sequence starts at 0000 within each Mode for each file type and updates incrementally to 9999, then wraps to 0000 again. It remembers where it was through a Mode Preset and when leaving and returning to the Mode. It is reset by Restore Misc Defaults and Restore System Defaults and subsequent running of the instrument application. So, for example, the first auto file name generated for State files is State\_0000.state. The next is State\_0001, and so forth.

One of the key features of Auto File Name is that we guarantee that the Auto File Name will never conflict with an existing file. The algorithm looks for the next available number. If it gets to 9999, then it looks for holes. If it find no holes, that is no more numbers are available, it gives an error.

For example, if when we get to State\_0010.state there is already a State\_0010.state file in the current directory, it advances the counter to State\_0011.state to ensure that no conflict will exist (and then it verifies that State\_0011.state also does not exist in the current directory and advances again if it does, and so forth).

If you enter a file name for a given file type, then the prefix becomes the filename you entered instead of the default prefix, followed by an underscore. The last four letters (the suffix) are the 4-digit number.

For example, if you save a measurement results file as “fred.csv”, then the next auto file name chosen for a measurement results save will be fred\_0000.csv.

---

**NOTE** Although 0000 is used in the example above, the number that is used is actually the current number in the Meas Results sequence, that is, the number that would have been used if you had not entered your own file name.

---

**NOTE** If the filename you entered ends with \_dddd, where d=any number, making it look just like an auto file name, then the next auto file name picks up where you left off with the suffix being dddd + 1.

---

---

Key Path	Front-panel key
Notes	No remote command for this key specifically.
Initial S/W Revision	Prior to A.02.00

---

## Recall

The Recall menu lets you choose what you want to recall, and where you want to recall it from. Among the types of files you can recall are **States and Traces**. In addition, an Import (Data) option lets you recall a number of data types stored in CSV files (as used by Excel and other spreadsheet programs).

The default paths for Recall are data type dependent and are the same as for the Save key.

Key Path	Front-panel key
Notes	<p>No remote command for this key specifically, but the :MMEM:LOAD command is available for specific file types. An example is :MMEM:LOAD:STATe &lt;filename&gt;.</p> <p>If you try to recall a State file for a mode that is not licensed or not available in the instrument, an error message will occur and the state will not change.</p>
Backwards Compatibility Notes	<p>In legacy analyzers, it was possible to load a state without affecting the trace data, limit lines or correction data. Similarly (since User Preset is actually loading a state), it was possible to do a User Preset without affecting the trace data, limit lines or correction data.</p> <p>In the X-Series, "state" always includes all of this data; so whenever state is loaded, all of the traces, limit lines and corrections are affected. Although this differs from previous behavior, it is desirable behavior, and should not cause adverse issues for users.</p>
Backwards Compatibility Notes	<p>Recall for the X-Series supports backward compatibility in the sense that you can recall a state file from any X-Series model number and any version of X-Series software. This is only possible if part of the recalling process goes through a limiting step after recalling the mode settings, at least for settings that may vary with version number, model number, option and license differences. If you try to recall a state file onto an instrument with less capability than what was available on the instrument during the save, the recall will ignore the state it doesn't support and it will limit the recalled setting to what it allows.</p> <p>Example: if the saved state includes preamp ON, but the recalling instrument does not have a preamp; the preamp is limited to OFF. Conversely, if you save a state without a preamp, the preamp is OFF in the state file. When this saved file is recalled on an instrument with a licensed preamp, the preamp is changed to OFF. Another example is if the saved state has center frequency set to 20 GHz, but the instrument recalling the saved state is a different model and only supports 13.5 GHz. In this case, the center frequency is limited along with any other frequency based settings. Since the center frequency can't be preserved in this case, the recall limiting tries to at least preserve span to keep the measurement setup as intact as possible.</p> <p>It may be appropriate to issue a warning if the state is limited on the recall; warnings do not go out to SCPI so this would only affect the manual user.</p> <p>Note that there is no state file compatibility outside of the X-Series. For example, you cannot recall a state file from ESA or PSA.</p>
Initial S/W Revision	Prior to A.02.00

## State

The Recall State menu lets you choose a register or file from which to recall the state.

The content of a state file includes all of the settings and data required to return the analyzer as closely as possible to the Mode it was in, with the exact settings that were in place, when the save occurred. The Mode settings in each state file include the settings that are affected by Mode Preset, as well as the



additional settings affected by Restore Mode Defaults; all of the Mode's settings. In addition, all of the settings of the Input/Output system are included, even though they are outside of the Mode's state, because they are needed to restore the complete setup. Persistent System settings (for example, GPIB address) are not affected by either a Mode Preset or Restore Mode Defaults, nor are they included in a saved State file.

Since each state file is only for one Mode, the settings for other Modes are unaffected when it is loaded. Recall State will cause a mode switch if the state being recalled is not from the current active mode.

After the recall completes, the message "File <filename> recalled" or "Recalled State Register <register number>" is displayed.

For rapid recalls, the State menu lists 16 registers that you can choose from to recall. Pressing a Register key initiates the recall. You can also select a file from which to recall.

The default path for all State Files is:

My Documents\<<mode name>\state

where <mode name> is the parameter used to select the mode with the INST:SEL command (for example, SA for the Spectrum Analyzer).

See ["More Information" on page 778](#).

<b>Key Path</b>	Recall
<b>Mode</b>	All
<b>Remote Command</b>	:MMEMory:LOAD:STATe <filename>
<b>Example</b>	:MMEM:LOAD:STAT "myState.state" This recalls the file myState.state on the default path
<b>Example</b>	MMEM:LOAD:STAT "MyStateFile.state" This loads the state file data (on the default file directory path) into the instrument state.
<b>Notes</b>	<p>When you pick a file to recall, the analyzer first verifies that the file is recallable in the current instrument by checking the software version and model number of the instrument. If everything matches, a full recall proceeds by aborting the currently running measurement, clearing any pending operations, and then loading the State from the saved state file. You can open state files from any mode, so recalling a State file switches to the mode that was active when the save occurred. After switching to the mode of the saved state file, mode settings and data (if any for the mode) are loaded with values from the saved file. The saved measurement of the mode becomes the newly active measurement and the data relevant to the measurement (if there is any) is recalled.</p> <p>If there is a mismatch between file version or model number or instrument version or model number, the recall function tries to recall as much as possible and returns a warning message. It may limit settings that differ based on model number, licensing or version number.</p> <p>After recalling the state, the Recall State function does the following:</p> <ul style="list-style-type: none"> <li>• Makes the saved measurement for the mode the active measurement.</li> <li>• Clears the input and output buffers.</li> <li>• Status Byte is set to 0.</li> <li>• Executes a *CLS</li> </ul> <p>If the file specified is empty an error is generated. If the specified file does not exist, another error is generated. If there is a mismatch between the file and the proper file type, an error is generated. If</p>

	there is a mismatch between file version or model number or instrument version or model number, a warning is displayed. Then it returns to the State menu and File Open dialog goes away. After the Recall, the analyzer exits the Recall menu and returns to the previous menu.
<b>Backwards Compatibility SCPI</b>	:MMEMory:LOAD:STATe 1,<filename> For backwards compatibility, the above syntax is supported. The "1" is simply ignored.
Initial S/W Revision	Prior to A.02.00

### More Information

In measurements that support saving Traces, for example, Swept SA, the Trace data is saved along with the State in the State file. When recalling the State, the Trace data is recalled as well. Traces are recalled exactly as they were stored, including the writing mode and update and display modes. If a Trace was updating and visible when the State was saved, it will come back updating and visible, and its data will be rewritten right away. When you use State to save and recall traces, any trace whose data must be preserved should be placed in View or Blank mode before saving.

The following table describes the Trace Save and Recall possibilities:

You want to recall state and one trace's data, leaving other traces unaffected.	Save Trace+State from 1 trace. Make sure that no other traces are updating (they should all be in View or Blank mode) when the save is performed.	On Recall, specify the trace you want to load the one trace's data into. This trace will load in View. All other traces' data will be unaffected, although their trace mode will be as it was when the state save was performed.
You want to recall all traces	Save Trace+State from ALL traces.	On Recall, all traces will come back in View (or Blank if they were in Blank or Background when saved)
You want all traces to load exactly as they were when saved.	Save State	On recall, all traces' mode and data will be exactly as they were when saved. Any traces that were updating will have their data immediately overwritten.

### From File...

When you press "From File", the analyzer brings up a Windows dialog and a menu entitled "File Open." This menu allows you to navigate to the various fields in the Windows dialog without using a keyboard or mouse. The Tab and Arrow keys can also be used for dialog navigation.

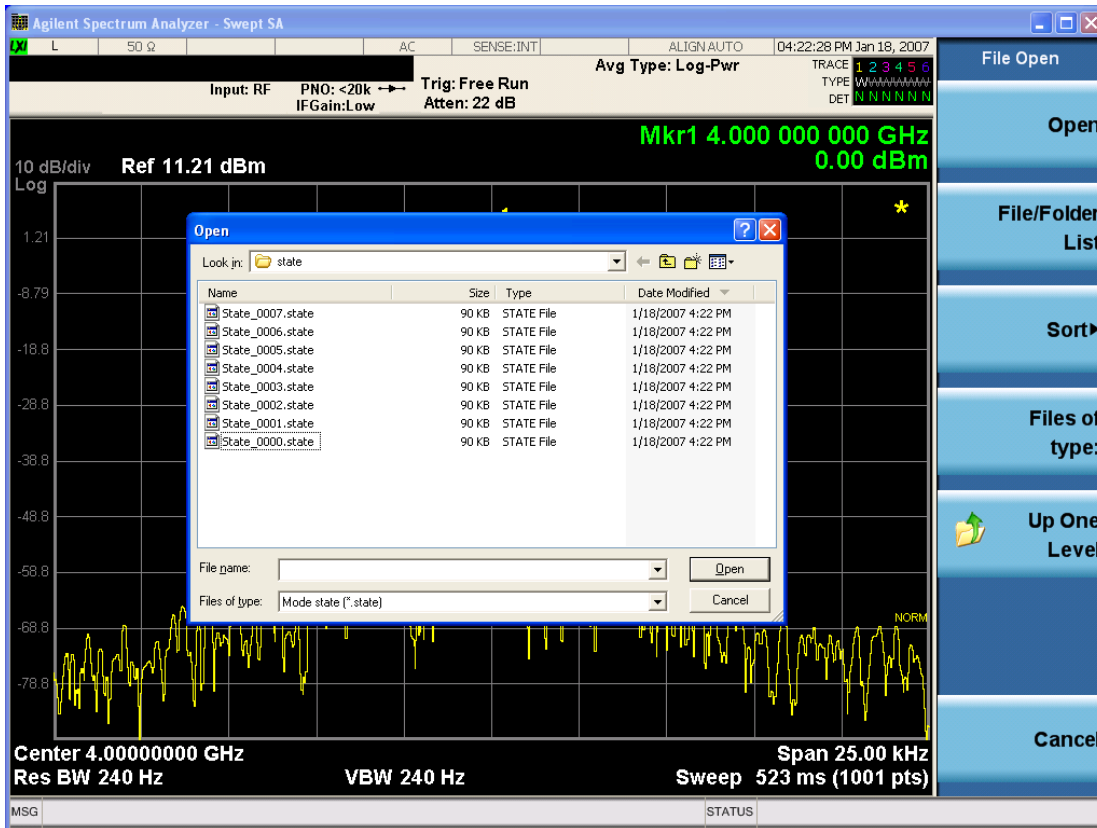

Listed below are the functions of the various fields in the dialog, and the corresponding softkeys:

#### Open

Performs the recall of the specified file. While the recall is being performed, the floppy icon appears briefly in the Meas bar.

#### File/Folder List

Enables you to navigate to the center of the dialog that contains the list of files and folders. Once here you can get information about the file and use the tab keys to navigate to the other fields in the dialog, such as Look In.

#### Look In

The Look In field shows the path from which the file will be recalled and allows you to change the path using the up and down arrow keys to navigate to other paths; the Enter key to open a directory; and the Backspace key to go back one directory. The **Look In field** first uses the last path from the Save As dialog **Save In:** path for that same file type. There is no softkey for directly navigating to the Look In field, but you can use the left tab to get here from the File/Folder List.

User specified paths are remembered when you leave and return to a Mode and are reset back to the default using Restore Mode Defaults.

#### Sort

Accesses a menu that enables you to sort the files within the File Open dialog. Only one sorting type can be selected at a time and the sorting happens immediately. The sorting types are By Date, By Name, By extension, and By Size.

#### Files of Type

This field shows the file suffix for the type of file you have selected to recall. For example, if you navigated here while recalling State, "Mode state (\*.state)" is in the field. If you navigated here while recalling Trace, ""Mode state (\*.trace)" is in the field. If you navigated here while importing a trace data file, "Trace Data (\*.csv)" is in the field. For some file types, there is more than one choice in the dropdown menu, which you can select by using the up and down arrow keys and Enter.

#### Up One Level

This key corresponds to the icon of a folder with the up arrow that is in the tool bar of the dialog. When pressed, it causes the file and folder list to navigate up one level in the directory structure. The Backspace key does the same thing.

#### Cancel

This key corresponds to the Cancel selection in the dialog. It causes the current **Open** request to be cancelled. The ESC key does the same thing.

Key Path	Recall, State
Notes	Brings up the Open dialog for recalling a State Save Type
Initial S/W Revision	Prior to A.02.00

### Edit Register Names

You may enter a custom name on any of the Register keys, to help you remember what you are using that state to save. To do this, press the Edit Register Names key, choose the register whose name you wish to edit, and then enter the desired label using the Alpha Editor or an external PC keyboard.

The maximum number of characters that can be added is 30. In most cases, 30 characters will fit on two lines of the key.

For more information and the SCPI command, see Edit Register Names under the Save, State function.

Key Path	Recall, State
Mode	All
Dependencies	N9060A-7FP or N9060B-2FP license required to edit the register names. When the feature is not licensed, sending the SCPI command generates an error, -221, "Settings conflict;Option not available"
Initial S/W Revision	A.11.00

### Register 1 thru Register 16

Selecting any one of these register keys causes the State of the mode from the specified Register to be recalled. Each of the register keys annotates whether it is empty or at what date and time it was last

modified. In addition, you can use the Edit Register Names key under Save, State to enter custom names for each register.

Registers are shared by all modes, so recalling from any one of the registers will cause a mode switch to the mode that was active when the save to the Register occurred.

Although these 16 registers are the only registers available from the front panel, there are 128 state registers available in the instrument. Registers 17–128 are only available from the SCPI interface, using the \*RCL command.

After the recall completes, the message "Register <register number> recalled" appears in the message bar. If you are in the Spectrum Analyzer Mode, and you are recalling a register that was saved in the Spectrum Analyzer Mode, then after the recall, you will still be in the Recall Register menu. If the Recall causes you to switch modes, then after the Recall, you will be in the Frequency menu.

If a requested register is empty an error is generated.

Key Path	Recall, State
<b>Example</b>	*RCL 1
Range	1–16 from front panel, 1–128 from SCPI
Readback	Date and time with seconds resolution are displayed on the key OR A custom name of up to 30 characters entered using the Save, State, Edit Register Names key OR “(empty)” if no prior save operation has been performed to this register.
Initial S/W Revision	Prior to A.02.00
Modified at S/W Revision	Prior to A.11.00

## Register 1 thru Register 16

Selecting any one of these register keys causes the State of the mode from the specified Register to be recalled. Each of the register keys annotates whether it is empty or at what date and time it was last modified. In addition, you can use the Edit Register Names key under Save, State to enter custom names for each register.

Registers are shared by all modes, so recalling from any one of the registers will cause a mode switch to the mode that was active when the save to the Register occurred.

Although these 16 registers are the only registers available from the front panel, there are 128 state registers available in the instrument. Registers 17–128 are only available from the SCPI interface, using the \*RCL command.

After the recall completes, the message "Register <register number> recalled" appears in the message bar. If you are in the Spectrum Analyzer Mode, and you are recalling a register that was saved in the Spectrum Analyzer Mode, then after the recall, you will still be in the Recall Register menu. If the Recall causes you to switch modes, then after the Recall, you will be in the Frequency menu.

If a requested register is empty an error is generated.

Key Path	Recall, State
<b>Example</b>	*RCL 1
Range	1-16 from front panel, 1-128 from SCPI
Readback	Date and time with seconds resolution are displayed on the key OR A custom name of up to 30 characters entered using the Save, State, Edit Register Names key OR “(empty)” if no prior save operation has been performed to this register.
Initial S/W Revision	Prior to A.02.00
Modified at S/W Revision	Prior to A.11.00

## Data (Import)

Importing a data file loads data that was previously saved from the current measurement or from other measurements and/or modes that produce compatible data files. The Import Menu only contains Data Types that are supported by the current measurement.

Since the commonly exported data files are in .csv format, the data can be edited by the user prior to importing. This allows you to export a data file, manipulate the data in Excel (the most common PC Application for manipulating .csv files) and then import it.

Importing Data loads measurement data from the specified file into the specified or default destination, depending on the data type selected. Selecting an Import Data menu key will not actually cause the importing to occur, since the analyzer still needs to know from where to get the data. Pressing the Open key in this menu brings up the Open dialog and Open menu that provides you with the options from where to recall the data. Once a filename has been selected or entered in the Open menu, the recall occurs as soon as the Open button is pressed.

Key Path	Recall
Mode	All
Notes	The menu is built from whatever data types are available for the mode. Some keys will be missing completely, so the key locations in the sub-menu will vary. No SCPI command directly controls the Data Type that this key controls. The Data Type is included in the MMEM:LOAD commands.
Dependencies	If a file type is not used by a certain measurement, it is grayed out for that measurement. The key for a file type will not show at all if there are no measurements in the Mode that support it.
Preset	Is not affected by Preset or shutdown, but is reset during Restore Mode Defaults
Readback	The data type that is currently selected
Initial S/W Revision	Prior to A.02.00

## Amplitude Correction

This key selects the Amplitude Corrections as the data type to be imported. When pressed a second time, it brings up the Select Menu, which lets you select the Correction into which the data will be imported.

Amplitude Corrections are fully discussed in the documentation of the Input/Output key, under the Corrections key.

A set of preloaded Corrections files can be found in the directory

/My Documents/ EMC Limits and Ampcor.

When the Amplitude Correction is an Antenna correction and the Antenna Unit in the file is not None, the Y Axis Unit setting will change to match the Antenna Unit in the file.

Key Path	Recall
Mode	SA EDGE GSM PN
Remote Command	:MMEMory:LOAD:CORRection 1 2 3 4 5 6 7 8, <filename>
Example	:MMEM:LOAD:CORR 2, "myAmpcor.csv" recalls the Amplitude Correction data from the file myAmpcor.csv in the current directory to the 2nd Amplitude Correction table, and turns on Correction 2. The default path is D:\User_My_Documents\Instrument\My Documents\amplitudeCorrections\
Dependencies	<p>Only the first correction array (Correction 1) supports antenna units. This means that a correction file with an Antenna Unit can only be loaded into the Corrections 1 register. Consequently only for Correction 1 does the dropdown in the Recall dialog include.ant, and if an attempt is made to load a correction file into any other Correction register which DOES contain an antenna unit, a Mass Storage error is generated.</p> <p>Corrections are not supported by all Measurements. If in a Mode in which some Measurements support it, this key will be grayed out in measurements that do not. The key will not show at all if no measurements in the Mode support it.</p> <p>Errors are reported if the file is empty or missing, or if the file type does not match, or if there is a mismatch between the file type and the destination data type. If any of these occur during manual operation, the analyzer returns to the Import Data menu and the File Open dialog goes away.</p> <p>This key does not appear unless you have the proper option installed in your instrument.</p> <p>This command will generate an "Option not available" error unless you have the proper option installed in your instrument.</p>
Couplings	When a correction file is loaded from mass storage, it is automatically turned on ( <b>Correction ON</b> ) and <b>ApplyCorrections</b> is set to On. This allows you to see its effect, thus confirming the load.
Readback	selected Correction
Backwards Compatibility SCPI	:MMEMory:LOAD:CORRection ANTenna   CABLe   OTHer   USER, <filename> For backwards compatibility, ANTenna maps to 1, CABLe maps to 2, OTHer maps to 3 and USER maps to 4
Initial S/W Revision	A.02.00

## Amplitude Correction

These keys let you select which Correction to import the data into. Once selected, the key returns back to the Import Data menu and the selected Correction number is annotated on the key. The next step is to select the Open key in the Import Data menu.

Antenna corrections are a particular kind of Amplitude Corrections – they are distinguished in the corrections file by having the Antenna Unit set to a value other than None. Only Correction 1 supports Antenna Units.

Key Path	Recall, Data, Amplitude Correction
Notes	auto return
Dependencies	Only Correction 1 may be used to load a Correction that contains an Antenna Unit other than None
Preset	Not part of Preset, but is reset to Correction 1 by Restore Input/Output Defaults; survives shutdown.
State Saved	The current Correction number is saved in instrument state
Initial S/W Revision	A.02.00

## Chan Table

Imports the channel table from a channel plan file. This function enables you to use your own defined channel tables by importing a modified channel table file.

Instead of creating a brand new channel plan file, you can generate a channel plan file to fit your needs using a saved channel plan file or the default channel plan file ChannelPlan.txt in the directory “My Documents\Digital Video\data”. The saved channel plan file is obtained by pressing Save, Data, Channel Table, and then Save As...

Note that while editing the channel plan file, you cannot change the channel plan name, such as NTSC\_B.VHF, NTSC\_B.UHF, otherwise your modifications on the corresponding channel plan will not work. You can add, remove, or modify the channel numbers and center frequencies in each channel plan. The value of Start Channel and Channel Count may also need to be changed.

File Location and Extension

**File location:** “My Documents\Digital Video\data”

**File type:** text file

**File extension:** .txt

**Example:**

File Location: My Documents\Digital Video\data

File Name: ChannelPlan\_0001.txt

Key Path	Recall, Data
Mode	DVB-T/H
Remote Command	MMEMoRY:LOAD:CHTable <string>
Example	MMEM:LOAD:CHT “ChannelPlan_0001.txt”
Initial S/W Revision	A.07.00



## Capture Buffer

Capture buffer functionality is available only in Mod Accuracy measurement. The captured data is raw data which is not processed.

Key Path	Recall, Data
Mode	DVB-T/H
Example	MMEM:LOAD:CAPT "MyCaptureData.bin" This loads the file of capture data (on the default file directory path) into the instrument.
Dependencies	Capture buffer data is only available for Mod Accuracy measurement. In other measurements, this key is grayed out.
Initial S/W Revision	Prior to A.01.70

## DVB-T2 Config

Imports DVB-T2 configuration from setting files (single PLP or multiple PLPs). This key is available only in DVB-T2 Mod Accuracy measurement and will be grayed out in other measurements.

If the configuration file to be recalled is created with previous instrument S/W revision A.10.52 or before (To check the instrument S/W revision, press System, Show, System on the instrument), it doesn't have Transmission Mode and Version parameters. Then you need to set up the DVB-T2 version and transmission mode manually by pressing Mode Setup, Radio Std, DVB-T2, Version 1.1.1, and toggling Transmission Mode to SISO to select the standard version and transmission mode of the signal under test.

All the modulation parameters can be set from the setting file. These parameters include Version, Transmission Mode, Guard Interval, FFT size, Carrier Mode, Pilot Pattern, L1 Modulation Format, Data Symbols, PAPR Type, PLP Number, SubSlices Number, SubSlices Interval, PLP Modulation Format, PLP Constellation Rotation, FEC Type, Time IL Length, FEC Block Num, PLP ID, PLP Start, PLP Type and PLP Code Rate.

File Location and Extension

**File location:** "My Documents\DVB\data\EVMT2\data"

**File type:** text file

**File extension:** .csv

**Example:**

File Location: My Documents\DVB\data\EVMT2\data

File Name: DVBT2Config\_0001.csv

Key Path	Recall, Data
Mode	DVB-T/H
<b>Remote Command</b>	MMEMory:LOAD:T2Config <string>

<b>Example</b>	MMEM:LOAD:T2C "DVBT2Config_0001.csv"
<b>Dependencies</b>	This key is grayed out in all other measurements except DVB-T2 Mod Accuracy measurement.
<b>Couplings</b>	Auto Detect (Meas, DVB-T2 ModAccuracy, Meas Setup) will be changed to OFF automatically when the DVB-T2 config file is loaded.
<b>Initial S/W Revision</b>	A.07.00

### Open...

When you press "Open", the analyzer brings up a Windows dialog and a menu entitled "**File Open.**" This menu allows you to navigate to the various fields in the Windows dialog without using a keyboard or mouse. The Tab and Arrow keys can also be used for dialog navigation.

See "[From File...](#)" on page 2201 in Recall, State, for a full description of this dialog and menu.

<b>Key Path</b>	Recall, Data
<b>Notes</b>	The key location is mode-dependent and will vary. Brings up Open dialog for recalling a <mode specific> Save Type
<b>Initial S/W Revision</b>	Prior to A.02.00

## Restart

The Restart function restarts the current sweep, or measurement, or set of averaged/held sweeps or measurements. If you are Paused, pressing Restart does a Resume.

The Restart function is accessed in several ways:

- Pressing the Restart key
- Sending the remote command INIT:IMMEDIATE
- Sending the remote command INIT:RESTART

See "[More Information](#)" on page 787

Key Path	Front-panel key
Remote Command	:INITiate[:IMMEDIATE] :INITiate:RESTART
Example	:INIT:IMM :INIT:REST
Notes	:INITiate:RESTART and :INITiate:IMMEDIATE perform exactly the same function.
Couplings	Resets average/hold count k. For the first sweep overwrites all active (update=on) traces with new current data. For application modes, it resets other parameters as required by the measurement.
Status Bits/OPC dependencies	This is an Overlapped command. The STATUS:OPERation register bits 0 through 8 are cleared. The STATUS:QUESTIONable register bit 9 (INTEgrity sum) is cleared. The SWEEPING bit is set. The MEASURING bit is set.
Backwards Compatibility Notes	For Spectrum Analysis mode in ESA and PSA, the Restart hardkey and the INITiate:RESTART command restart trace averages (displayed average count reset to 1) for a trace in Clear Write, but did not restart Max Hold and Min Hold. In the X-Series, the Restart hardkey and the INITiate:RESTART command restart not only Trace Average, but MaxHold and MinHold traces as well. For wireless comms modes in ESA and PSA, the Restart hardkey and the INITiate:RESTART command restart every measurement, which includes all traces and numeric results. There is no change to this operation.
Initial S/W Revision	Prior to A.02.00

### More Information

The **Restart** function first aborts the current sweep/measurement as quickly as possible. It then resets the sweep and trigger systems, sets up the measurement and initiates a new data measurement sequence with a new data acquisition (sweep) taken once the trigger condition is met.

If the analyzer is in the process of aligning when **Restart** is executed, the alignment finishes before the restart function is performed.

Even when set for Single operation, multiple sweeps may be taken when Restart is pressed (for example, when averaging/holding is on). Thus when we say that **Restart** "restarts a measurement," we may mean:

- It restarts the current sweep
- It restarts the current measurement
- It restarts the current set of sweeps if any trace is in Trace Average, Max Hold or Min Hold
- It restarts the current set of measurements if Averaging, or Max Hold, or Min Hold is on for the measurement
- depending on the current settings.

With **Average/Hold Number** (in **Meas Setup** menu) set to 1, or Averaging off, or no trace in Trace Average or Hold, a single sweep is equivalent to a single measurement. A single sweep is taken after the trigger condition is met; and the analyzer stops sweeping once that sweep has completed. However, with **Average/Hold Number** >1 and at least one trace set to **Trace Average, Max Hold, or Min Hold (SA Measurement)** or **Averaging on (most other measurements)**, multiple sweeps/data acquisitions are taken for a single measurement. The trigger condition must be met prior to each sweep. The sweep is stopped when the average count  $k$  equals the number  $N$  set for **Average/Hold Number**. A measurement average usually applies to all traces, marker results, and numeric results; but sometimes it only applies to the numeric results.

Once the full set of sweeps has been taken, the analyzer will go to idle state. To take one more sweep without resetting the average count, increment the average count by 1, by pressing the step up key while **Average/Hold Number** is the active function, or sending the remote command `CALC:AVER:TCON UP`.

## Save

The Save menu lets you choose what you want to save and where you want to save it. Among the types of files you can save are **States**, **Traces**, and **Screen Images**. In addition, an Export (Data) option lets you save a number of data types as CSV files for easy import into Excel and other spreadsheet programs.

Key Path	Front-panel key
Mode	All
Notes	No remote command for this key specifically, but the :MMEM:STORe command is available for specific file types. An example is :MMEM:STOR:STATe <filename>.
Initial S/W Revision	Prior to A.02.00

## State

The Save State menu lets you choose a register or file for saving the state.

The content of a state file includes all of the settings and data required to return the analyzer as closely as possible to the Mode it was in, with the exact settings which were in place, when the save occurred. The Mode settings in each state file include the settings that are affected by Mode Preset, as well as the additional settings affected by Restore Mode Defaults; all of the Mode's settings. In addition, all of the settings of the Input/Output system are included, even though they are outside of the Mode's state, because they are needed to restore the complete setup. Persistent System settings (for example, Verbose SCPI) are not affected by either Mode Preset or Restore Mode Defaults, nor are they included in a saved State file.

After the save completes, the message "File <filename> saved" or "State Register <register number> saved" is displayed.

For rapid saving, the State menu lists 16 registers to save to. Pressing a Register key initiates the save. You can also select a file to save to.

The default path for all State Files is:

My Documents\<<mode name>\state

where <mode name> is the parameter used to select the mode with the INST:SEL command (for example, SA for the Spectrum Analyzer).

Key Path	Save
Mode	All
Remote Command	:MMEMory:STORe:STATe <filename>
Example	MMEM:STOR:STATe "MyStateFile.state" This stores the current instrument state data in the file MyStateFile.state in the default directory.
Notes	Both single and double quotes are supported for any filename parameter over remote. After saving to a register, that register's menu key is updated with the date the time, unless a custom label has been entered for that key. After saving to a register, you remain in the Save State menu, so that you can see the Register key

update. After saving to a file, the analyzer automatically returns to the previous menu and any Save As dialog goes away.

**Backwards Compatibility SCPI** :MMEMory:STORe:STATe 1,<filename>

For backwards compatibility, the above syntax is supported. The "1" is simply ignored. The command is sequential.

Initial S/W Revision Prior to A.02.00

### To File . . .

When you press “To File”, the analyzer brings up a Windows dialog and a menu entitled “Save As.” This menu allows you to navigate to the various fields in the Windows dialog without using a keyboard or mouse. The Tab and Arrow keys can also be used for dialog navigation.

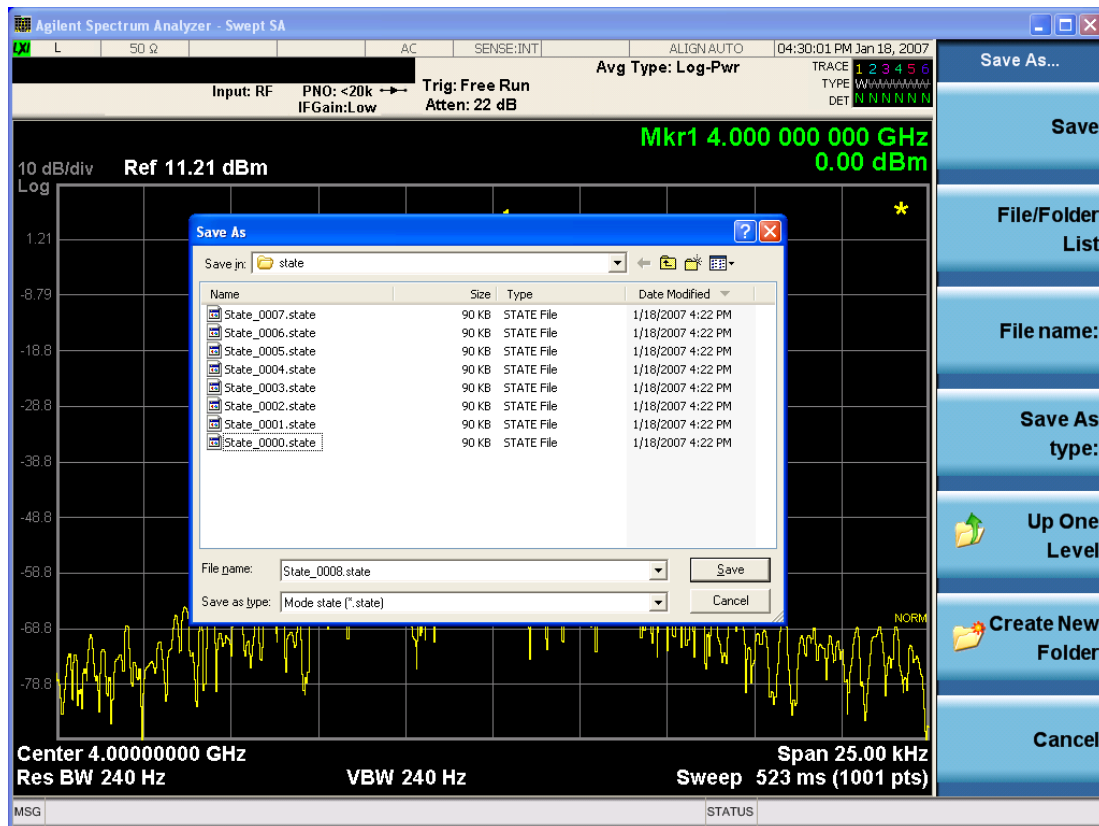

The Listed below

are the functions of the various fields in the dialog, and the corresponding softkeys:

#### Save

Performs the save to the specified file of the selected type. If the file already exists, a dialog will appear that allows you to replace the existing file by selecting OK, or you can Cancel the request. If you select OK, the file will be overwritten. Using the C: drive is strongly discouraged, since it runs the risk of being overwritten during an instrument software upgrade.

While the save is being performed, the floppy icon appears briefly in the Meas bar.

## File/Folder List

Enables you to navigate to the center of the dialog that contains the list of files and folders. Once here you can get information about the file and use the tab keys to navigate to the other fields in the dialog, such as Save In.

## Save In

The Save In field shows the path to which the file will be saved and allows you to change the path using the up and down arrow keys to navigate to other paths; the Enter key to open a directory; and the Backspace key to go back one directory. The **Save In field** defaults to the default path for this type of file and remembers the last path you used to save this type of file. There is no softkey for directly navigating to the Save In field but you can use left tab to get here from the File/Folder List.

User specified paths are remembered when you leave and return to a Mode and are reset back to the default using Restore Mode Defaults.

## File Name

The File Name field is initially loaded with an automatically generated filename specific to the appropriate Save Type. The automatically generated filename is guaranteed not to conflict with any filename currently in the directory. You may replace or modify this filename using the File Name key. See the ["Quick Save " on page 2197](#) documentation for more on the automatic file naming algorithm.

When you press the File Name key the analyzer displays the Alpha Editor. Use the knob to choose the letter to add and the front-panel Enter key to add the letter to the file name. The BK character moves you back and the FW character moves you forward in the filename. The Select key on the front panel generates a space character. When you are done entering the filename press the Done softkey. This returns back to the **File Open** dialog and menu, but does not cause the save to occur.

## Save As Type

This field shows the file suffix for the type of file you have selected to save. For example, if you navigated here while saving State, "Mode state (\*.state)" is in the field. If you navigated here from saving Trace, ""Mode state (\*.trace)" is in the field. If you navigated here while exporting a trace data file, "Trace Data (\*.csv)" is in the field. For some file types, there is more than one choice in the dropdown, which you can select by using the up and down arrow keys and Enter.

## Up One Level

This key corresponds to the icon of a folder with the up arrow that is in the tool bar of the dialog. When pressed, it causes the file and folder list to navigate up one level in the directory structure. The Backspace key does the same thing.

## Create New Folder

This key corresponds to the icon of a folder with the "\*" that is in the tool bar of the dialog. When pressed, a new folder is created in the current directory with the name **New Folder** and you can enter a new folder name using the Alpha Editor.

## Cancel

This key corresponds to the Cancel selection in the dialog. It causes the current **Save As** request to be cancelled. The ESC key does the same thing.

Key Path	Save, State
Mode	All
Notes	Brings up Save As dialog for saving a State Save Type
Initial S/W Revision	Prior to A.02.00

## Edit Register Names

You may enter a custom name on any of the Register keys, to help you remember what you are using that state to save. To do this, press the Edit Register Names key, choose the register whose name you wish to edit, and then enter the desired label using the Alpha Editor or an external PC keyboard.

The maximum number of characters that can be added is 30. In most cases, 30 characters will fit on two lines of the key.

See ["More Information" on page 792](#)

Key Path	Save, State
Mode	All
<b>Remote Command</b>	:MMEMory:REGister:STATe:LABel <reg number>,"label" :MMEMory:REGister:STATe:LABel? <reg number>
<b>Example</b>	:MMEM:REG:STAT:LAB 1,"my label"
Notes	<reg number> is an integer from 1 to 16. If the SCPI specifies an invalid register number an error message is generated, -222,"Data out of range;Invalid register label number" "label" is a string from 0 to 30 characters in length. If a label exceeds 30 characters, an error message is generated, -150,"String data error;Label clipped to 30 characters" "label" of length 0 erases the custom label and restores the default (time and date) label. E.g.: :MMEM:REG:STAT:LAB 1,""
Dependencies	N9060A-7FP or N9060B-2FP license required to edit the register names. When the feature is not licensed, sending this command generates an error, -221,"Settings conflict;Option not available"
Preset	The names are unaffected by Preset or power cycle but are set to the default label (time and date) on a "Restore System Defaults->Misc"
Initial S/W Revision	A.11.00

## More Information

When you edit one of the register names, the time and date field will be replaced by the custom name.

If you delete all the characters in the custom name, it restores the default (time and date).

The register names are stored within the state files, but they are not part of the instrument state; that is, once you have edited a register name, loading a new state will not change that register name. Another consequence of this is that the names will be persistent through a power cycle. Also, if a named state file is transferred to another analyzer, it will bring its custom name along with it.



If you try to edit the name of an empty register, the analyzer will first save the state to have a file to put the name in. If you load a named state file into an analyzer with older firmware it will ignore the metadata.

The \*SAV and \*RCL commands will not be affected by the custom register names, nor will the MMEM commands.

### Register 1 thru Register 16

Selecting any one of these register menu keys causes the State of the currently active mode to be saved to the specified Register. The registers are provided for rapid saving and recalling, since you do not need to specify a filename or navigate to a file. Each of the register menu keys annotates whether it is empty or at what date and time it was last modified. In addition, you can use the Edit Register Names key to enter custom names for each register.

Although these 16 registers are the only registers available from the front panel, there are 128 state registers available in the instrument. Registers 17–128 are only available from the SCPI interface, using the \*SAV command.

There is one set of 128 state registers in the instrument, not one set for each Mode. When a state is saved, the Mode it was saved from is saved with it; then when it is recalled, the instrument switches to that Mode.

After the save completes, the corresponding register menu key annotation is updated with the date and time and the message "Register <register number> saved" is displayed.

Key Path	Save, State
Mode	All
<b>Example</b>	*SAV 1
Range	1–16 from front panel, 1–128 from SCPI
Readback	Date and time with seconds resolution are displayed on the key OR A custom name of up to 30 characters entered using the Edit Register Names key OR “(empty)” if no prior save operation has been performed to this register.
Initial S/W Revision	Prior to A.02.00
Modified at S/W Revision	A.11.00

### Register 1 thru Register 16

Selecting any one of these register menu keys causes the State of the currently active mode to be saved to the specified Register. The registers are provided for rapid saving and recalling, since you do not need to specify a filename or navigate to a file. Each of the register menu keys annotates whether it is empty or at what date and time it was last modified. In addition, you can use the Edit Register Names key to enter custom names for each register.

Although these 16 registers are the only registers available from the front panel, there are 128 state registers available in the instrument. Registers 17–128 are only available from the SCPI interface, using the \*SAV command.

There is one set of 128 state registers in the instrument, not one set for each Mode. When a state is saved, the Mode it was saved from is saved with it; then when it is recalled, the instrument switches to that Mode.

After the save completes, the corresponding register menu key annotation is updated with the date and time and the message "Register <register number> saved" is displayed.

Key Path	Save, State
Mode	All
Example	*SAV 1
Range	1-16 from front panel, 1-128 from SCPI
Readback	Date and time with seconds resolution are displayed on the key OR A custom name of up to 30 characters entered using the Edit Register Names key OR “(empty)” if no prior save operation has been performed to this register.
Initial S/W Revision	Prior to A.02.00
Modified at S/W Revision	A.11.00

## Data (Export)

Exporting a data file stores data from the current measurement to mass storage files. The Export Menu only contains data types that are supported by the current measurement.

Since the commonly exported data files are in .csv format, the data can be edited by you prior to importing. This allows you to export a data file, manipulate the data in Excel (the most common PC Application for manipulating .csv files) and then import it.

Selecting an Export Data menu key will not actually cause the exporting to occur, since the analyzer still needs to know where you wish to save the data. Pressing the Save As key in this menu brings up the Save As dialog and Save As menu that allows you to specify the destination file and directory. Once a filename has been selected or entered in the Open menu, the export will occur as soon as the Save key is pressed.

Key Path	Save
Mode	All
Notes	The menu is built from whatever data types are available for the mode. So the key locations in the sub menu will vary.  No SCPI command directly controls the Data Type that this key controls. The Data Type is included in the MMEM:STORe commands.
Dependencies	If a file type is not used by a certain measurement, that type is grayed out for that measurement. The key for a file type will not show at all if there are no measurements in the Mode that support it.
Preset	Is not affected by a Preset or shutdown, but is reset during Restore Mode Defaults
Readback	The data type that is currently selected
Initial S/W Revision	Prior to A.02.00

## Amplitude Correction

Pressing this key selects **Amplitude Corrections** as the data type to be exported. Pressing this key again brings up the Select Menu, which allows the user to select which **Amplitude Correction** to save.

Amplitude Corrections are fully discussed in the documentation of the Input/Output key, under the Corrections softkey.

See "[Correction Data File](#)" on page 795

Key Path	Save
<b>Remote Command</b>	:MMEMory:STORe:CORRection 1 2 3 4 5 6, <filename>
<b>Example</b>	:MMEM:STOR:CORR 2 "myAmpcor.csv" saves Correction 2 to the file myAmpcor.csv on the current path. The default path is My Documents\amplitudeCorrections.
Notes	If the save is initiated via SCPI, and the file already exists, the file will be overwritten. Using the C: drive is strongly discouraged, since it runs the risk of being overwritten during an instrument software upgrade. Both single and double quotes are supported for any filename parameter over SCPI.
Dependencies	Corrections are not supported by all Measurements. If in a Mode in which some Measurements support it, this key will be grayed out in measurements that do not. The key will not show at all if no measurements in the Mode support it. This key will not appear unless you have the proper option installed in your instrument.
Readback	Selected Correction
<b>Backwards Compatibility SCPI</b>	:MMEMory:STORe:CORRection ANTenna   CABLe   OTHer   USER, <filename> For backwards compatibility, ANTenna maps to 1, CABLe maps to 2, OTHer maps to 3 and USER maps to 4
Initial S/W Revision	A.02.00

## Correction Data File

A Corrections Data File contains a copy of one of the analyzer correction tables. Corrections provide a way to adjust the trace display for predetermined gain curves (such as for cable loss).

Corrections files are text files in .csv (comma separated values) form, to make them importable into Excel or other spreadsheet programs. The format for Corrections files is as follows.

Line #	Type of field	Example	Notes
1	File type, must be "Amplitude Correction"	Amplitude Correction	May not be omitted
2	File Description (in quotes)	"Correction Factors for 11966E"	60 characters max; may be empty but may not be omitted. If exceeds 60 characters, error -233 Too much data reported
3	Comment (in quotes)	"Class B Radiated"	60 characters max; may be empty but

Line #	Type of field	Example	Notes
			may not be omitted. . If exceeds 60 characters, error -233 Too much data reported
4	Instrument Version, Model #	A.02.06,N9020A	May be empty but may not be omitted
5	Option List, File Format Version	K03 LFE EXM ,01	May be empty but may not be omitted
6	Freq Unit to be used for all frequency values in the file	Frequency Unit,MHz	assumed to be Hz if omitted
7	Antenna Unit	Antenna Unit,None	If omitted leaves the Antenna unit unchanged. The amplitude unit in the Antenna Unit field is a conversion factor that is used to adjust the Y Axis Units of the current mode, if the mode supports Antenna Units. For more details on antenna correction data, refer to the Input/Output,Corrections key description. Allowable values: dBuV/m, dBuA/m, dBG, dBpT, None
8	Freq Interpolation	Frequency Interpolation,Linear	if omitted leaves the Freq Interpolation unchanged. Allowable values: Linear, Logarithmic
9	Bias value in mA	Bias,0.00	If omitted leaves the Bias value unchanged (added as of A.08.50)
10	Bias State	Bias State,On	If omitted leaves the Bias State unchanged. Allowable values: On, Off (added as of A.08.50)
11	Overlap, two values, Freq1 and Freq2, separated by commas.	Overlap,33500,40000	Uses Freq Unit from line 6. Thus, in this example Freq1=33.5 GHz, Freq2= 40.0 GHz (see note below). If omitted leaves the overlap unchanged (added as of A.08.50)
12	DATA marker	DATA	Corrections data begins in the next line

Lines 2 through 5 can be empty but must appear in the file. Lines 6 through 11 are optional, the lines can be left out of the file altogether.

The Overlap row and the two Bias rows apply only to external mixing. Both are read-only, they are never written by the analyzer. The only way to insert or modify these rows is to edit the file with a text editor or a spreadsheet editor. These rows are intended for use by mixer manufacturers, as they allow the manufacturer to insert data about how the mixer corrections were generated and how they should be applied. The Bias rows allow you to specify whether to turn Bias on or off when the Correction is turned on and to specify a Bias value (turning off the Correction does not change the Bias, but turning it back on again sets it to the value specified in the file). The Overlap row allows you to specify an overlap region in which

two different corrections may be applied. It is expected that in the corrections data itself, there will be TWO corrections values exactly at Max Freq, otherwise Overlap is ignored. The way the overlap is processed is as follows: if at any given time the current analyzer Start Freq is greater than Freq 1 and lower than Freq 2, and the current Stop Freq is greater than Freq 2, extend the first correction point at or above Freq 2 down to Freq 1, rather than using the correction data between Freq1 and Freq2.

The Antenna Unit row can only be used in Correction register 1, because there can only be one setting for Antenna Unit at any given time. If a Correction whose Antenna Unit is set to anything but None is loaded into any Correction register but 1, an error is generated (Mass storage error; Can only load an Antenna Unit into Correction 1). When a correction file is saved from any Correction register but 1, Antenna Unit is always written as None.

Similarly, the Bias rows can only be used in Correction register 1, because there can only be one setting for Bias at any given time. If a Correction file with a Bias or Bias State row is loaded into any Correction register but 1, an error is generated: Mass storage error; Can only load Bias Settings into Correction 1

The data follows the DATA row, as comma separated X, Y pairs; one pair per line.

For example, suppose you have an Antenna to correct for on an N9020A version A.02.06 and the correction data is:

- 0 dB at 200 MHz
- 17 dB at 210 MHz
- 14.8 dB at 225 MHz

Then the file will look like:

- Amplitude Correction
- "Correction Factors for 11966E"
- "Class B Radiated"
- A.02.06,N9020A
- P13 EA3 UK6,01
- Frequency Unit,MHz
- Antenna Unit,dBuV/m
- Frequency Interpolation,Linear
- DATA
- 200.000000,0.00
- 210.000000,17.00
- 225.000000,14.80

The choices for the 1 of N fields in the metadata are as follows:

- Frequency Unit: Hz, kHz, MHz, GHz
- Antenna Unit: dBuv/m, dBuA/m, dBG, dBpT, None

- Frequency Interpolation: Logarithmic, Linear

### Amplitude Correction

These keys let you choose which Correction to save. Once selected, the key returns back to the Export Data menu and the selected Correction number is annotated on the key.

The next step in the Save process is to select the Save As key in the Export Data menu.

Key Path	Save, Data, Amplitude Correction
Preset	Not part of a Preset, but is reset to Correction 1 by Restore Input/Output Defaults. Survives a shutdown.
Readback	1
Initial S/W Revision	A.02.00

### Chan Table

Exports the current channel table to a channel table file.

The exported channel table file can be edited to meet your requirements, and then imported by pressing Recall, Data, Channel Table, and then Open...

Note that while editing the channel plan file, you can't change the channel plan name, such as NTSC\_B.VHF, NTSC\_B.UHF, otherwise your modifications on the corresponding channel plan will not work. You can add, remove, or modify the channel numbers and center frequencies in each channel plan. The value of Start Channel and Channel Count may also need to be changed.

File Location and Extension

**File location:** "My Documents\Digital Video\data"

**File type:** text file

**File extension:** .txt

**Example:**

File Location: My Documents\Digital Video\data

File Name: ChannelPlan\_0001.txt

Key Path	Save, Data
Mode	DVB-T/H
Remote Command	MMEMory:STORe:CHTable <string>
Example	MMEM:STOR:CHT "ChannelPlan_0001.txt"
Initial S/W Revision	A.07.00

### Measurement Results

Pressing this key selects Meas Results as the data type to be exported.

The Meas Results file contains information which describes the current state of the analyzer. It is detailed in Meas Result File Contents below.

Key Path	Save, Data
<b>Remote Command</b>	:MMEMory:STORe:RESults <string>
<b>Example</b>	:MMEM:STOR:RES "MeasR_0000.csv"
Notes	<p>If the save is initiated via SCPI and the file already exists, the file will be overwritten.</p> <p>The SCPI command exports ACP measurement results to the file specified as the parameter in the current path. The default path is My Documents\<current mode&gt;\data\acp\results.<="" p=""> <p>Using the C: drive is strongly discouraged, since it runs the risk of being overwritten during an instrument software upgrade.</p> <p>The SCPI parameter is a quoted string that specifies the filename. Both single and double quotes are supported for any filename parameter over SCPI.</p> </current></p>
Dependencies	The current active measurement must be the ACP measurement to use this command.
Status Bits/OPC dependencies	Sequential – waits for the previous measurement to complete
Initial S/W Revision	Prior to A.02.00

### Meas Results File Contents

A Meas Results File contains measurement results with the following information.

- File ID string, which is “MeasResult”
- Measurement ID following Mode ID, which is “SA:ACP” for example.
- Firmware rev and model number
- Option string
- Auto Scaling
- Auto Sweep Time Rules
- Automatic Trigger Time
- Automatic Trigger Time State
- Average Mode
- Average Number
- Average State
- Bar Graph
- Carrier Coupling
- Carrier Pwr Present
- Carrier Spacing
- Carriers

- Center Frequency
- Center Frequency Step
- Center Frequency Step State
- Detector Auto
- Detector Selection
- Electrical Atten
- Electrical Atten State
- External Array Trigger Delay
- External Array Trigger Delay State
- External Array Trigger Level
- External Array Trigger Slope
- Filter Alpha
- Filter BW
- Filter Type
- Internal Preamp
- Internal Preamp Band
- Limit Test
- Line Trigger Delay
- Line Trigger Delay State
- Line Trigger Slope
- Meas Method
- Meas Type
- Measurement Noise Bandwidth
- Mechanical Atten
- MechanicalAttenStepEnum
- Method
- Noise Correction
- Offset Abs Limit
- Offset Fail
- Offset Filter Alpha
- Offset Filter BW



- Offset Filter Type
- Offset Freq
- Offset Freq State
- Offset Integ BW
- Offset Method
- Offset Rel Lim (Car)
- Offset Rel Lim (PSD)
- Offset Res BW
- Offset Res BW Mode
- Offset Video BW
- Offset Video BW Mode
- Periodic Timer Period
- Periodic Timer Sync Source
- Periodic Timer Trigger Delay
- Periodic Timer Trigger Delay State
- Points
- Power Ref
- Power Ref State
- Preselector Adjust
- PSD Ref
- PSD Unit
- Ref Car Freq
- Ref Car Freq State
- Ref Carrier
- Ref Carrier Mode
- Ref Position
- Ref Value
- Res BW
- Res BW Mode
- RFBurst Trigger Delay
- RFBurst Trigger Delay State

- RFBurst Trigger Level Abs
- RFBurst Trigger Level Rel
- RFBurst Trigger Level Type
- RFBurst Trigger Slope
- Scale/Div
- Span
- Sweep Time
- Sweep Time Auto
- Trigger Holdoff
- Trigger Holdoff State
- Trigger Source
- Video BW
- Video BW Auto

The file contains these data followed by MeasResult1, MeasResult2, and MeasResult3 that flag the start of the measurement results. Each line of Measurement Results consists of three comma separated values, MeasResult1 value, MeasResult2 value, and MeasResult3 value. MeasResult1 contains the same result as MEAS/READ/FETCh:ACPower1; MeasResult2, MEAS/READ/FETCh:ACPower2; MeasResult3, MEAS/READ/FETCh:ACPower3.

Exported file is .csv file. The Meas Results file, when imported into Excel, will show the following data:

MeasResult	
SA:ACP	
A.10.53	N9030A
526 ALV ATP	1
B1X B1Y B25	
B40 BBA CR3	
CRP DCF DDA	
DP2 DRD EA3	
EDP EMC EP1	
ERC ESC ESP	
EXM FSA LFE	
LNP MAT MPB	
NFE NUL P26	
PFR PNC RTL	
RTS S40 SB1	
SEC SM1 TVT	
YAS YAV	
Auto Scaling	TRUE
Auto Sweep	Accy
Time Rules	

Automatic Trigger Time	0.1												
Automatic Trigger Time State	FALSE												
Average Mode	Exponential												
Average Number	10												
Average State	TRUE												
Bar Graph	TRUE												
Carrier Coupling	TRUE	TRUE	TRUE	TRUE	TRUE	TRUE	TRUE	TRUE	TRUE	TRUE	TRUE	TRUE	TRUE
Carrier Pwr Present	Yes	Yes	Yes	Yes	Yes	Yes	Yes	Yes	Yes	Yes	Yes	Yes	Yes
Carrier Spacing	5000000	500000	500000	500000	500000	500000	500000	500000	500000	500000	500000	500000	500000
Carriers	1												
Center Frequency	1.33E+10												
Center Frequency Step	800000												
Center Frequency Step State	TRUE												
Detector Auto	TRUE												
Detector Selection	Average												
Electrical Atten	0												
Electrical Atten State	FALSE												
External Array Trigger Delay	1.00E-06	1.00E-06											
External Array Trigger Delay State	FALSE	FALSE											
External Array Trigger Level	1.2	1.2											
External Array Trigger Slope	Positive	Positive											
Filter Alpha	0.22	0.22	0.2	0.2	0.2	0.2	0.2	0.2	0.2	0.2	0.2	0.2	0.2

		2	2	2	2	2	2	2	2	2	2	2
Filter BW	Minus3dB											
Filter Type	Gaussian											
Internal Preamp	FALSE											
Internal Preamp Band	Low											
Limit Test	FALSE											
Line Trigger Delay	1.00E-06											
Line Trigger Delay State	FALSE											
Line Trigger Slope	Positive											
Meas Method	IbwSpeed											
Meas Type	TPRef											
Measurement Noise Bandwidth	2000000	2000000	200000	200000	200000	200000	200000	200000	200000	200000	200000	200000
Mechanical Atten	10											
MechanicalAttenStepEnum	S2dB											
Method	IBW	IBW	IBW	IBW	IBW	IBW	IBW	IBW	IBW	IBW	IBW	IBW
Noise Correction	FALSE											
Offset Abs Limit	0	0	0	0	0	0						
Offset Fail	Relative	Relative	Relative	Relative	Relative	Relative						
Offset Filter Alpha	0.22											
Offset Filter BW	Minus3dB	Minus3dB	Minus3dB	Minus3dB	Minus3dB	Minus3dB						
Offset Filter Type	Gaussian	Gaussian	Gaussian	Gaussian	Gaussian	Gaussian						
Offset Freq	3000000	0	0	0	0	0						
Offset Freq State	TRUE	FALSE	FALSE	FALSE	FALSE	FALSE						
Offset Integ	2000000	2000	200	200	200	200						

BW		000	000	000	000	000
			0	0	0	0
Offset Method	FALSE					
Offset Rel Lim (Car)	-45	-60	0	0	0	0
Offset Rel Lim (PSD)	-28.87	-	0	0	0	0
		43.87				
Offset Res BW	220000	2200	220	220	220	220
		00	000	000	000	000
Offset Res BW Mode	TRUE	TRUE	TRU	TRU	TRU	TRU
			E	E	E	E
Offset Video BW	22000	2200	220	220	220	220
		0	00	00	00	00
Offset Video BW Mode	TRUE	TRUE	TRU	TRU	TRU	TRU
			E	E	E	E
Periodic Timer Period	0.02					
Periodic Timer Sync Source	None					
Periodic Timer Trigger Delay	1.00E-06					
Periodic Timer Trigger Delay State	FALSE					
Points	1001					
Power Ref	-76.81					
	dBm					
Power Ref State	On					
Preselector Adjust	0					
PSD Ref	-139.82					
	dBm/Hz					
PSD Unit	DbmHz					
Ref Car Freq	13.25500					
	0000 GHz					
Ref Car Freq State	On					
Ref Carrier	1					
Ref Carrier Mode	On					
Ref Position	Top					

Ref Value	-30	
Res BW	220000	
Res BW Mode	FALSE	
RFBurst Trigger Delay	1.00E-06	
RFBurst Trigger Delay State	FALSE	
RFBurst Trigger Level Abs	-20	
RFBurst Trigger Level Rel	-6	
RFBurst Trigger Level Type	Absolute	
RFBurst Trigger Slope	Positive	
Scale/Div	10	
Span	8000000	
Sweep Time	0.02	
Sweep Time Auto	TRUE	
Trigger Holdoff	0.1	
Trigger Holdoff State	FALSE	
Trigger Source	Free	
Video BW	22000	
Video BW Auto	TRUE	
MeasResult1	MeasResult 2	Meas Result 3
- 76.80585177 44559	0	1
0.084790019 950006	- 76.80585 17744559	0
0.028392912 8313787	-999	1
	-999	0
	-999	1

## Capture Buffer

Capture buffer functionality is available only in Mod Accuracy measurement. The captured data is raw data which is not processed.

Key Path	Save, Data
Mode	DVB-T/H
Example	MMEM:STOR:CAPT "MyCaptureData.bin" This stores the capture data in the file MyCaptureData.bin in the default directory.
Dependencies	Capture buffer functionality is only available for Mod Accuracy measurement. In other measurements, this key is grayed out.
Initial S/W Revision	Prior to A.01.70

## DVB-T2 Config

Exports the current DVB-T2 configuration to a file (single PLP or multiple PLPs). This key is available only in DVB-T2 Mod Accuracy measurement and will be grayed out in other measurements.

You can view the exported file for the format of the DVB-T2 configuration files and create your own DVB-T2 configuration file by modifying the exported file.

File Location and Extension

**File location:** "My Documents\DVB\data\EVMT2\data"

**File type:** text file

**File extension:** .csv

**Example:**

File Location: My Documents\DVB\data\EVMT2\data

File Name: DVBT2Config\_0001.csv

Key Path	Save, Data
Mode	DVB-T/H
<b>Remote Command</b>	MMEMory:STORe:T2Config <string>
<b>Example</b>	MMEM:STOR:T2C "DVBT2Config_0001.csv"
Dependencies	This key is grayed out in all the other measurements except DVB-T2 Mod Accuracy measurement.
Initial S/W Revision	A.07.00

## Save As . . .

When you press "Save As", the analyzer brings up a Windows dialog and a menu entitled "**Save As.**" This menu allows you to navigate to the various fields in the Windows dialog without using a keyboard or mouse. The Tab and Arrow keys can also be used for dialog navigation.

See "To File . . ." on page 2213 in Save, State for a full description of this dialog and menu.

The default path for saving files is:

For all of the Trace Data Files:

My Documents\<<mode name>\data\traces

For all of the Limit Data Files:

My Documents\<<mode name>\data\limits

For all of the Measurement Results Data Files:

My Documents\<<mode name>\data\<<measurement name>\results

For all of the Capture Buffer Data Files:

My Documents\<<mode name>\data\captureBuffer

Key Path	Save, Data
Mode	All
Notes	The key location is mode-dependent and will vary. Brings up the Save As dialog for saving a <mode specific> Save Type. The save is performed immediately and does not wait until the measurement is complete.
Initial S/W Revision	Prior to A.02.00

## Screen Image

Pressing Screen Image accesses a menu of functions that enable you to specify a format and location for the saved screen image. It brings up a menu that allows you to specify the color scheme of the Screen Image (Themes) or navigate to the Save As dialog to perform the actual save.

Screen Image files contain an exact representation of the analyzer display. They cannot be loaded back onto the analyzer, but they can be loaded into your PC for use in many popular applications.

The image to be saved is actually captured when the Save front panel key is pressed, and kept in temporary storage to be used if you ask for a Screen Image save. When the Screen Image key is pressed, a "thumbnail" of the captured image is displayed, as shown below:



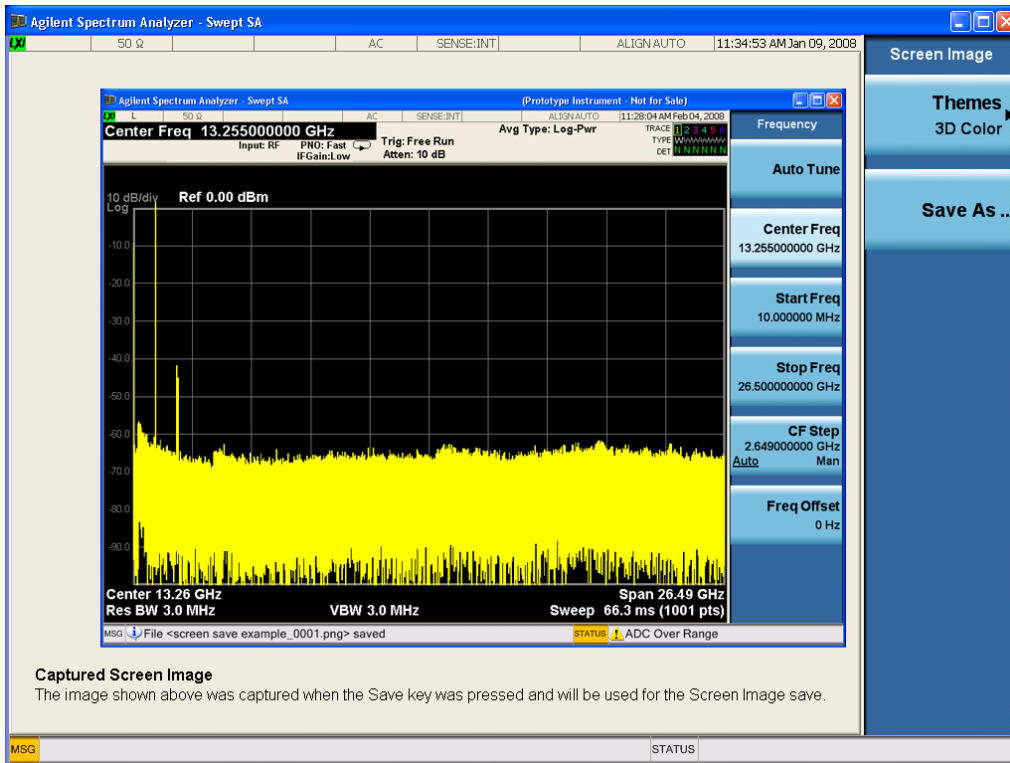

When you continue on into the Save As menu and complete the Screen Image save, the image depicted in the thumbnail is the one that gets saved, showing the menus that were on the screen before going into the Save menus. The save is performed immediately and does not wait until the measurement is complete.

After you have completed the save, the Quick Save front-panel key lets you quickly repeat the last save performed, using an auto-named file, with the current screen data.

**NOTE**

For versions previous to A.01.55, if you initiate a screen image save by navigating through the Save menus, the image that is saved will contain the Save menu softkeys, not the menus and the active function that were on the screen when you first pressed the Save front panel key.

Key Path	Save
Mode	All
Remote Command	:MMEMory:STORe:SCREen <filename>
Example	:MMEM:STOR:SCR "myScreen.png" This stores the current screen image in the file MyScreenFile.png in the default directory.
Initial S/W Revision	Prior to A.02.00

## Themes

Accesses a menu of functions that enable you to choose the theme to be used when saving the screen image.

The **Themes** option is the same as the **Themes** option under the **Display** and **Page Setup** dialogs. It allows you to choose between themes to be used when saving the screen image.

<b>Key Path</b>	Save, Screen Image
<b>Remote Command</b>	:MMEMory:STORe:SCReem:THEMe TDColor   TDMonochrome   FCOLor   FMONochrome  :MMEMory:STORe:SCReem:THEMe?
<b>Example</b>	:MMEM:STOR:SCR:THEM TDM
<b>Preset</b>	3D Color; Is not part of Preset, but is reset by Restore Misc Defaults or Restore System Defaults All and survives subsequent running of the modes.
<b>Readback</b>	3D Color   3D Mono   Flat Color   Flat Mono
<b>Backwards Compatibility Notes</b>	In ESA and PSA we offer the choice of "Reverse Bitmap" or "Reverse Metafile" when saving screen images. This is much like the "Flat Color" theme available in X-Series. Also, if you selected Reverse Bitmap AND a black & white screen image, that would be much like "Flat Monochrome". In other words, each of the X-Series themes has a similar screen image type in ESA/PSA. But they are not identical.
<b>Initial S/W Revision</b>	Prior to A.02.00

### 3D Color

Selects a standard color theme with each object filled, shaded and colored as designed.

<b>Key Path</b>	Save, Screen Image, Themes
<b>Example</b>	MMEM:STOR:SCR:THEM TDC
<b>Readback</b>	3D Color
<b>Initial S/W Revision</b>	Prior to A.02.00

### 3D Monochrome

Selects a format that is like 3D color but shades of gray are used instead of colors.

<b>Key Path</b>	Save, Screen Image, Themes
<b>Example</b>	MMEM:STOR:SCR:THEM TDM
<b>Readback</b>	3D Mono
<b>Initial S/W Revision</b>	Prior to A.02.00

### Flat Color

Selects a format that is best when the screen is to be printed on an ink printer.

<b>Key Path</b>	Save, Screen Image, Themes
-----------------	----------------------------

<b>Example</b>	MMEM:STOR:SCR:THEM FCOL
Readback	Flat Color
Initial S/W Revision	Prior to A.02.00

### Flat Monochrome

Selects a format that is like Flat Color. But only black is used (no colors, not even gray), and no fill.

Key Path	Save, Screen Image, Themes
<b>Example</b>	MMEM:STOR:SCR:THEM FMON
Readback	Flat Mono
Initial S/W Revision	Prior to A.02.00

### Save As...

When you press "Save As", the analyzer brings up a Windows dialog and a menu entitled "**Save As.**" This menu allows you to navigate to the various fields in the Windows dialog without using a keyboard or mouse. The Tab and Arrow keys can also be used for dialog navigation.

See "[To File . . .](#)" on page 2213 in Save, State for a full description of this dialog and menu.

The default path for Screen Images is

My Documents\`<mode name>`\screen.

where `<mode name>` is the parameter used to select the mode with the INST:SEL command (for example, SA for the Spectrum Analyzer).

Key Path	Save, Screen Image
Notes	Brings up Save As dialog for saving a Screen Image Save Type
Initial S/W Revision	Prior to A.02.00

### Mass Storage Catalog (Remote Command Only)

Key path	SCPI Only
<b>Remote Command</b>	:MMEMory:CATalog? [ <code>&lt;directory_name&gt;</code> ]
Notes	<p>The string must be a valid logical path.</p> <p>Queries disk usage information (drive capacity, free space available) and obtains a list of files and directories in a specified directory in the following format:</p> <pre>&lt;numeric_value&gt;,&lt;numeric_value&gt;,{&lt;file_entry&gt;}</pre> <p>It returns two numeric parameters and as many strings as there are files and directories. The first parameter indicates the total amount of storage currently used in bytes. The second parameter</p>

---

	<p>indicates the total amount of storage available, also in bytes. The &lt;file_entry&gt; is a string. Each &lt;file_entry&gt; indicates the name, type, and size of one file in the directory list: &lt;file_name&gt;,&lt;file_type&gt;,&lt;file_size&gt;</p> <p>As the windows file system has an extension that indicates file type, &lt;file_type&gt; is always empty. &lt;file_size&gt; provides the size of the file in bytes. For directories, &lt;file_entry&gt; is surrounded by square brackets and both &lt;file_type&gt; and &lt;file_size&gt; are empty</p>
Initial S/W Revision	Prior to A.02.00

---

### Mass Storage Change Directory (Remote Command Only)

---

Key path	SCPI Only
<b>Remote Command</b>	:MMEMory:CDIRectory [<directory_name>] :MMEMory:CDIRectory?
Notes	<p>The string must be a valid logical path.</p> <p>Changes the default directory for a mass memory file system. The &lt;directory_name&gt; parameter is a string. If no parameter is specified, the directory is set to the *RST value.</p> <p>At *RST, this value is set to the default user data storage area, that is defined as System.Environment.SpecialFolder.Personal.</p> <p>Query returns full path of the default directory.</p>
Initial S/W Revision	Prior to A.02.00

---

### Mass Storage Copy (Remote Command Only)

---

Key path	SCPI Only
<b>Remote Command</b>	:MMEMory:COPY <string>,<string>[,<string>,<string>]
Notes	<p>The string must be a valid logical path.</p> <p>Copies an existing file to a new file or an existing directory to a new directory.</p> <p>Two forms of parameters are allowed. The first form has two parameters. In this form, the first parameter specifies the source, and the second parameter specifies the destination.</p> <p>The second form has four parameters. In this form, the first and third parameters specify the source. The second and fourth parameters specify the directories. The first pair of parameters specifies the source. The second pair specifies the destination. An error is generated if the source doesn't exist or the destination file already exists.</p> <p>This command will generate an "access denied" error if the destination is a restricted folder (e.g., C:\Windows) and the current user does not have Power User or Administrator privileges.</p>

---

### Mass Storage Device Copy (Remote Command Only)

This command transfers data to/from a file and a peripheral device.

Key path	SCPI Only
<b>Remote Command</b>	:MMEMory:COpy:DEvice <source_string>,<dest_string>
Notes	<p>The strings must be a valid logical path or a valid device keyword. If the dest_string is a device keyword, the data is copied from the source file to the device. If the source_string is a device keyword, the data is copied to the source file from the device.</p> <p>Valid device keywords are:          SNS (smart noise source)</p> <p>An error is generated if the file or device is not found.</p>

### Mass Storage Delete (Remote Command Only)

Key path	SCPI Only
<b>Remote Command</b>	:MMEMory:DElete <file_name>[,<directory_name>]
Notes	<p>The string must be a valid logical path.</p> <p>Removes a file from the specified directory. The &lt;file_name&gt; parameter specifies the file name to be removed. This command will generate an “access denied” error if the file is in a restricted folder (e.g., C:\Windows) and the current user does not have Power User or Administrator privileges.</p>
Initial S/W Revision	Prior to A.02.00

### Mass Storage Data (Remote Command Only)

Creates a file containing the specified data OR queries the data from an existing file.

Key path	SCPI Only
<b>Remote Command</b>	:MMEMory:DATA <file_name>, <data> :MMEMory:DATA? <file_name>
Notes	<p>The string must be a valid logical path.</p> <p>The command form is MMEMory:DATA &lt;file_name&gt;,&lt;data&gt;. It loads &lt;data&gt; into the file &lt;file_name&gt;. &lt;data&gt; is in 488.2 block format. &lt;file_name&gt; is string data.</p> <p>The query form is MMEMory:DATA? &lt;file_name&gt; with the response being the associated &lt;data&gt; in block format.</p>
Initial S/W Revision	Prior to A.02.00

### Mass Storage Make Directory (Remote Command Only)

Key path	SCPI Only
<b>Remote Command</b>	:MMEMory:MDIRectory <directory_name>
Notes	<p>The string must be a valid logical path.</p> <p>Creates a new directory. The &lt;directory_name&gt; parameter specifies the name to be created.</p>

---

	This command will generate an “access denied” error if the new directory would be in a restricted folder (e.g., C:\Windows) and the current user does not have Power User or Administrator privileges.
Initial S/W Revision	Prior to A.02.00

---

### Mass Storage Move (Remote Command Only)

---

Key path	SCPI Only
<b>Remote Command</b>	:MMEMory:MOVE <string>,<string>[,<string>,<string>]
Notes	<p>The string must be a valid logical path.</p> <p>Moves an existing file to a new file or an existing directory to a new directory.</p> <p>Two forms of parameters are allowed. The first form has two parameters. In this form, the first parameter specifies the source, and the second parameter specifies the destination.</p> <p>The second form has four parameters. In this form, the first and third parameters specify the source. The second and fourth parameters specify the directories. The first pair of parameters specifies the source. The second pair specifies the destination. An error is generated if the source doesn't exist or the destination file already exists.</p> <p>This command will generate an “access denied” error if the destination is a restricted folder (e.g., C:\Windows) and the current user does not have Power User or Administrator privileges.</p>
Initial S/W Revision	Prior to A.02.00

---

### Mass Storage Remove Directory (Remote Command Only)

---

Key path	SCPI Only
<b>Remote Command</b>	:MMEMory:RDIRECTory <directory_name>
Notes	<p>The string must be a valid logical path.</p> <p>Removes a directory. The &lt;directory_name&gt; parameter specifies the directory name to be removed. All files and directories under the specified directory shall also be removed.</p> <p>This command will generate an “access denied” error if the folder is a restricted folder (e.g., C:\Windows) or is in a restricted folder and the current user does not have Power User or Administrator privileges.</p>
Initial S/W Revision	Prior to A.02.00

---

## Single (Single Measurement/Sweep)

Sets the analyzer for Single measurement operation. The single/continuous state is Meas Global, so the setting will affect all the measurements. If you are Paused, pressing Single does a Resume.

See "[More Information](#)" on page 815

Key Path	Front-panel key
Example	:INIT:CONT OFF
Notes	See Cont key description.
Backwards Compatibility Notes	<p>For Spectrum Analysis mode in ESA and PSA, the Single hardkey and the INITiate:IMM switched from continuous measurement to single measurement and restarted sweeps and averages (displayed average count reset to 1), but did not restart Max Hold and Min Hold. In the X-Series, the Single hardkey and the INITiate:IMM command initiate a sweep/ measurement/ average sequence/hold sequence including MaxHold and MinHold.</p> <p>For Spectrum Analysis mode in ESA and PSA, the Single hardkey restarted the sweep regardless of whether or not you were in an active sweep or sweep sequence. In the X-Series, Restart does this but Single only restarts the sweep or sweep sequence if you are in the idle state.</p> <p>INIT[:IMM] in ESA &amp; PSA Spectrum Analysis Mode does an implied ABORT. In some other PSA Modes, INIT[:IMM] is ignored if not in the idle state. . The X-Series follows the ESA/PSA SA Mode model, which may cause some Modes to have compatibility problems.</p>
Initial S/W Revision	Prior to A.02.00

### More Information

See "[Restart](#)" on page 2210 for details on the INIT:IMMEDIATE (Restart) function.

If you are already in single sweep, the INIT:CONT OFF command has no effect.

If you are already in Single Sweep, then pressing the Single key in the middle of a sweep does not restart the sweep or sequence. Similarly, pressing the Single key does not restart the sweep or sequence if the sweep is not in the idle state (for example, if you are taking a very slow sweep, or the analyzer is waiting for a trigger). Instead, it results in a message. "Already in Single, press Restart to initiate a new sweep or sequence". Even though pressing the Single key in the middle of a sweep does not restart the sweep, sending INIT:IMMEDIATE does reset it.

To take one more sweep without resetting the average count, increment the average count by 1, by pressing the step up key while **Average/Hold Number** is the active function, or sending the remote command CALC:AVER:TCON UP.

## Source

There is no Source control functionality for this measurement. When this key is pressed, the screen either displays a blank menu, or the previously-selected menu remains unchanged.

---

Key Path	Front-panel key
----------	-----------------

---



## SPAN X Scale

Accesses a menu of functions that enable you set the horizontal scale parameters.

Key Path	Front-panel key
Initial S/W Revision	Prior to A.02.00

### Span

Changes the frequency range symmetrically about the center frequency.

The default (and minimum) span is calculated using the number of carriers and the carrier width where;

$$\text{Span} = (\text{Upper Carrier Freq} + (\text{max offset IBW} * (1 + \alpha)) / 2) - (\text{Lower Carrier Freq} - (\text{max offset IBW} * (1 + \alpha)) / 2)$$

The span is increased by a factor of 1 + Filter Alpha if the RRC Filter is on.

Key Path	SPAN X Scale
Mode	SA, WCDMA, C2K, WIMAX OFDMA, TD-SCDMA, 1xEVDO, DVB-T/H, DTMB (CTTB), ISDB-T, CMMB, LTE, LTE-TDD, Digital Cable TV, MSR, LTEAFDD, LTEATDD
Remote Command	[ :SENSe] :ACPower:FREQuency:SPAN <freq> [ :SENSe] :ACPower:FREQuency:SPAN?
Example	ACP:FREQ:SPAN 25MHz ACP:FREQ:SPAN?
Notes	You must be in the mode that includes ACP measurements to use this command. Use :INSTrument:SElect to set the mode.
Couplings	The span value is clipped when the carrier settings and/or the offset settings are changed. The value is changed to satisfy following formula: $\text{Span} = (\text{Upper Carrier Freq} + (\text{max offset IBW} * (1 + \alpha)) / 2) - (\text{Lower Carrier Freq} - (\text{max offset IBW} * (1 + \alpha)) / 2)$
Preset	SA: 8 MHz WCDMA: 24.6848 MHz WIMAX OFDMA: 50 MHz C2K: 4.5 MHz TD-SCDMA: 8 MHz 1xEVDO: 4.05 MHz DVB-T/H: 40 MHz DTMB (CTTB): 72 MHz ISDB-T: 30 MHz CMMB: 72 MHz LTE, LTE-TDD, MSR: 25 MHz Digital Cable TV: 40 MHz LTEAFDD, LTEATDD: 25MHz

State Saved	Saved in instrument state.
Min	10 Hz
Max	Hardware Dependent: Option 503 = 3.7 GHz Option 507 = 7.1 GHz Option 508 = 8.5 GHz Option 513 = 13.8 GHz Option 526 = 27.0 GHz
Initial S/W Revision	Prior to A.02.00
Modified at S/W Revision	A.02.00, A.03.00

## Full Span

Changes the span to show the full frequency range of the spectrum analyzer.

Key Path	SPAN X Scale
Mode	SA, WCDMA, C2K, WiMAX OFDMA, TD-SCDMA, 1xEVDO, DVB-T/H, DTMB (CTTB), ISDB-T, CMMB, LTE, LTETDD, Digital Cable TV
<b>Remote Command</b>	<code>[ :SENSe ] :ACPpower:FREQuency:SPAN:FULL</code>
<b>Example</b>	<code>ACP:FREQ:SPAN:FULL</code>
Notes	You must be in the mode that includes ACP measurements to use this command. Use <code>:INSTrument:SElect</code> to set the mode.
Dependencies	For MSR and LTE-Advanced FDD/TDD mode, this key is blank.
Initial S/W Revision	Prior to A.02.00
Modified at S/W Revision	A.02.00, A.03.00

## Last Span

Changes the span to the previous span setting. If no previous span value exists, then the span will remain unchanged.

Key Path	SPAN X Scale
Mode	SA, WCDMA, C2K, WIMAX OFDMA, TD-SCDMA, 1xEVDO, DVB-T/H, DTMB (CTTB), ISDB-T, CMMB, LTE, LTETDD, Digital Cable TV, MSR, LTEAFDD, LTEATDD
<b>Remote Command</b>	<code>[ :SENSe ] :ACPpower:FREQuency:SPAN:PREVious</code>
<b>Example</b>	<code>ACP:FREQ:SPAN:PREV</code>
Notes	You must be in the mode that includes ACP measurements to use this command. Use <code>:INSTrument:SElect</code> to set the mode.
Initial S/W Revision	Prior to A.02.00
Modified at S/W Revision	A.02.00, A.03.00



## Sweep/Control

Accesses a menu of functions that enable you to set up and control the sweep time, and source.

See "[Sweep/Control](#)" on page 2235 for more information.

Key Path	Front-panel key
Initial S/W Revision	Prior to A.02.00

### Sweep Time

Selects the length of time in which the spectrum analyzer sweeps the displayed frequency span. In swept spans, the sweep time varies from 1 millisecond to 2000 seconds. Additional overhead time, which impacts the sweep rate, is not calculated as part of the sweep time. In fact:

sweep rate = span/sweep time

update rate = 1/(sweep time + overhead)

sweep cycle time = sweep time + overhead

Sweep time is coupled to RBW and VBW, and is impacted by the number of sweep points, so changing those parameters may change the sweep time.

If you increase the sweep time, you increase the length of the time data captured and the number of points measured. You might need to specify a specific sweep speed to accommodate a specific condition in your transmitter. For example, you may have a burst signal and need to measure an exact portion of the burst.

Selecting a specific sweep time may result in a long measurement time since the resulting number of data points may not be the optimum  $2n$ . Use `[[:SENSe]:ACP:OFFSet:LIST:SWEEp:TIME` to set the number of points used for measuring the offset channels for Basic and cdmaOne.

For cdma2000 and W-CDMA, this command sets the sweep time when using the sweep mode. See `[[:SENSe]:ACP:SWEEp:TYPE`

Key Path	Sweep/Control
Mode	SA, WCDMA, C2K, WIMAX OFDMA, TD-SCDMA, 1xEVDO, DVB-T/H, DTMB (CTTB), ISDB-T, CMMB, LTE, LTEFDD, Digital Cable TV, MSR, LTEAFDD, LTEATDD
Remote Command	<pre>[[:SENSe]:ACP:Power:SWEEp:TIME &lt;time&gt; [:SENSe]:ACP:Power:SWEEp:TIME? [:SENSe]:ACP:Power:SWEEp:TIME:AUTO OFF ON 0 1 [:SENSe]:ACP:Power:SWEEp:TIME:AUTO?</pre>
Example	<pre>ACP:SWEEp:TIME 50ms ACP:SWEEp:TIME? ACP:SWEEp:TIME:AUTO OFF ACP:SWEEp:TIME:AUTO?</pre>
Notes	This parameter is preset by Meas Method selection. Preset values are as follows:

	IBW: 29 ms IBWR: 108 ms FAST (WCDMA): 7.5 ms
Preset	SA, LTE, LTETDD, MSR: Automatically calculated WCDMA: 29 ms WIMAX OFDMA: Automatically calculated C2K: Automatically calculated TD-SCDMA: Automatically calculated 1xEVDO: Automatically calculated DVB-T/H: Automatically calculated DTMB (CTTB): Automatically calculated ISDB-T: Automatically calculated CMMB: Automatically calculated Digital Cable TV: Automatically calculated LTEAFDD, LTEATDD: Automatically calculated SA, LTE, LTETDD, MSR, LTEAFDD, LTEATDD: ON WCDMA: OFF C2K: OFF (mehtod IBW) WIMAX OFDMA: ON TD-SCDMA: ON DVB-T/H: ON DTMB (CTTB): ON ISDB-T: ON CMMB: ON Digital Cable TV: ON
State Saved	Saved in instrument state.
Min	1 ms
Max	4000 s
Initial S/W Revision	Prior to A.02.00
Modified at S/W Revision	A.02.00, A.03.00

## Sweep Setup

Accesses the sweep setup menu.

Key Path	Sweep/Control
Initial S/W Revision	Prior to A.02.00

## Auto Sweep Time Rules

Switches the analyzer between normal and accuracy sweep states.

Key Path	Sweep/Control, Sweep Setup
Mode	SA, WCDMA, C2K, WIMAX OFDMA, TD-SCDMA, 1xEVDO, DVB-T/H, DTMB (CTTB), ISDB-T, CMMB, LTE, LTETDD, Digital Cable TV, MSR, LTEAFDD, LTEATDD
Remote Command	[ :SENSe ] :ACPoweR :SWEep :TIME :AUTO :RULes NORMal   ACCuracy [ :SENSe ] :ACPoweR :SWEep :TIME :AUTO :RULes?
Example	ACP:SWE:TIME:AUTO:RUL NORM ACP:SWE:TIME:AUTO:RUL?
Notes	Set to Norm when Auto Couple is pressed or sent remotely.
Preset	SA, WCDMA, C2K, TD-SCDMA, 1xEVDO, DTMB (CTTB), LTE, LTETDD, MSR, LTEAFDD, LTEATDD: ACCuracy WIMAX OFDMA, DVB-T/H: NORMal ISDB-T, CMMB: NORMal Digital Cable TV: NORMal
State Saved	Saved in instrument state.
Range	Norm Accy
Initial S/W Revision	Prior to A.02.00
Modified at S/W Revision	A.02.00, A.03.00

## Pause

Pauses a measurement after the current data acquisition is complete. When Paused, the label on the key changes to Resume. Pressing the Resume key resumes the measurement at the point where it was paused. When Paused, pressing Restart, Single, or Cont does a Resume

See "[Pause/Resume](#)" on page 2235 for more details.

Key Path	Sweep/Control
Initial S/W Revision	Prior to A.02.00

## Gate

Accesses a menu that enables you to control the gating function. The Gate functionality is used to view signals best viewed by qualifying them with other events.

Gate setup parameters are the same for all measurements – they do not change as you change measurements. Settings like these are called “Meas Global” and are unaffected by Meas Preset.

Note that Sweep Time autocoupling rules and annotation are changed by Gate being on.

Key Path	Sweep/Control
Scope	Meas Global
Readback	The state and method of Gate, as [Off, LO] or [On, Video]. Note that for measurements that only support gated LO, the method is nonetheless read back, but always as LO.
Initial S/W Revision	Prior to A.02.00

## Gate On/Off

Turns the gate function on and off.

When the Gate Function is on, the selected Gate Method is used along with the gate settings and the signal at the gate source to control the sweep and video system with the gate signal. Not all measurements allow every type of Gate Methods.

When Gate is on, the annunciation in the measurement bar reflects that it is on and what method is used, as seen in the following "Gate: LO" annunciator graphic.

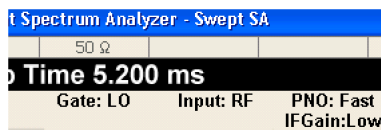

Key Path	Sweep/Control, Gate
Remote Command	[ :SENSE ] :SWEep:EGATE [ :STATE ] OFF   ON   0   1 [ :SENSE ] :SWEep:EGATE [ :STATE ] ?
Example	SWE:EGAT ON SWE:EGAT?

### Dependencies

The function is unavailable (grayed out) and Off when:

- Gate Method is LO or Video and FFT Sweep Type is manually selected.
- Gate Method is FFT and Swept Sweep Type is manually selected.
- Marker Count is ON.

The following are unavailable whenever Gate is on:

- FFT under Sweep Type when Method=LO or Video or Swept under Sweep Type when Method=FFT
- Marker Count

While Gate is on, the Auto Rules for Sweep Type are modified so that the choice agrees with the Gate Method: i.e., FFT for Method = FFT and Swept for Method = LO or Video.

The Gate softkey and all SCPI under the [:SENSE]:SWEep:EGATE SCPI node are grayed out when Source Mode is Tracking with an external source. This is because the Gate circuitry is used to sync the external source. If the Tracking Source is turned on, the Gate is turned off.

When in the ACP measurement:

- When Meas Method is RBW or FAST, this function is unavailable and the key is grayed out.

	<ul style="list-style-type: none"> <li>• Whenever Gate is on, Meas Method, RBW or FAST is unavailable and keys for those are grayed out.</li> <li>• When Gate is on, Offset Res BW and Offset Video BW are ignored (if you set these values) and the measurement works as if all Offset Res BW and all Offset Video BW are coupled with the Res BW and the Video BW under the BW menu. When Gate is on, the Offset BW key in the Offset/Limit menu is grayed out.</li> </ul>
Preset	Off LTETDD: On
State Saved	Saved in instrument state
Range	On Off
<b>Backwards Compatibility SCPI</b>	[:SENSe]:SWEep:TIME:GATE[:STATe] ESA compatibility
Backwards Compatibility Notes	In ESA, Trig Delay (On) and Gate (On) could not be active at the same time.. This dependency does not exist in PSA or in the X-Series.
Initial S/W Revision	Prior to A.02.00

## Gate View On/Off

Turning on Gate View in the Swept SA measurement provides a single-window gate view display..

Turning on Gate View in other measurements shows the split-screen Gate View. In these measurements, when the Gate View is on, the regular view of the current measurement traces and results are reduced vertically to about 70% of the regular height. The Zero Span window, showing the positions of the Gate, is shown between the Measurement Bar and the reduced measurement window. By reducing the height of the measurement window, some of the annotation on the Data Display may not fit and is not shown.

Key Path	Sweep/Control, Gate
<b>Remote Command</b>	[:SENSe]:SWEep:EGATe:VIEW ON OFF 1 0 [:SENSe]:SWEep:EGATe:VIEW?
<b>Example</b>	SWE:EGAT:VIEW ON turns on the gate view.
Dependencies	<p>In the Swept SA measurement:</p> <p>In Gate View, the regular Sweep Time key is grayed out . When pressed, the grayed out key puts up the informational message "Use Gate View Sweep Time in the Gate menu."</p> <p>In the other measurements:</p> <p>When you turn Gate View on, the lower window takes on the current state of the instrument. Upon leaving Gate View, the instrument takes on the state of the lower window.</p> <p>When you turn Gate View on, the upper window Sweep Time is set to the gate view sweep time.</p>
Couplings	<p>These couplings apply to the Swept SA measurement:</p> <ul style="list-style-type: none"> <li>• When Gate View is turned on, the instrument is set to Zero Span.</li> <li>• Gate View automatically turns off whenever a Span other than Zero is selected.</li> <li>• Gate View automatically turns off if you press the Last Span key while in Gate View, and the instrument returns to the Span it was in before entering Gate View (even if that is Zero Span).</li> <li>• When Gate View is turned on, the sweep time used is the gate view sweep time. This is set</li> </ul>



according to the rules in section "Gate View Setup " on page 2043

- When Gate View is turned off, Sweep Time is set to the normal Swept SA measurement sweep time.
- If Gate View is on and Gate is off, then turning on Gate turns off Gate View.

Preset	OFF
State Saved	Saved in instrument state
Range	On Off
Initial S/W Revision	Prior to A.02.00

A sample of the Gate View screen in the Swept SA measurement is shown in the following graphic :

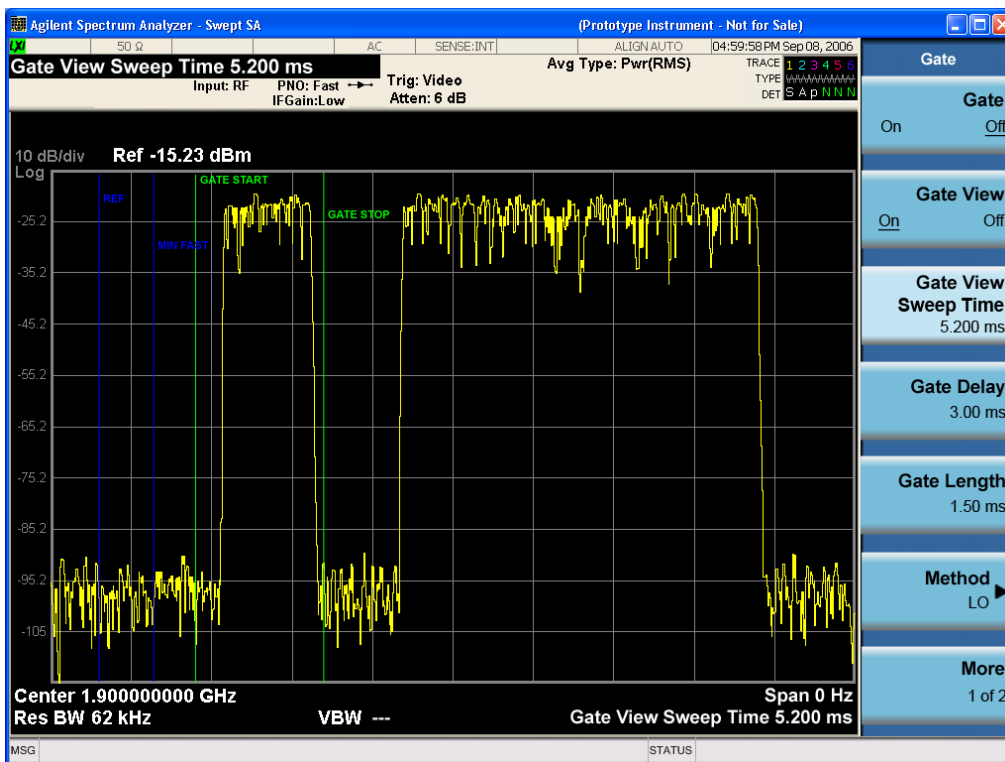

A sample of the Gate View screen in other measurements is shown in the following graphic . This example is for the ACP measurement:

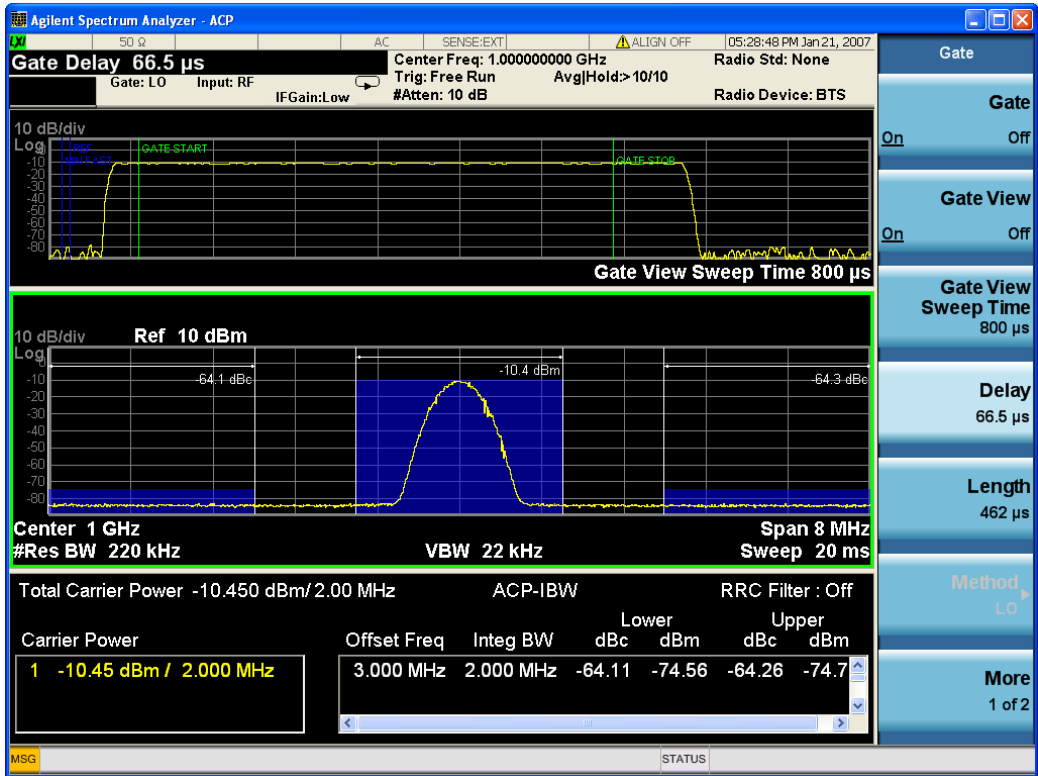

Turning Gate View off returns the analyzer to the Normal measurement view.

In the Swept SA, the normal measurement view is the single-window Swept SA view. When returning to this view, the Swept SA measurement returns to the Span it was in before entering **Gate View** (even if that is Zero Span).

The **Gate View** window is triggered from the Gate Source, with zero trigger delay. Also, when updating the **Gate View** window, the Gate itself must not operate. So it is internally shut off while the gate view window is being updated. For the Swept SA measurement, this means that the Gate is internally shut off whenever the gate view window is displayed. The measurement bar and softkeys continue to show the Trigger source for the main sweep window and give no indication that the Gate is shut off or that the Gate View window is triggered from the Gate Source.

When in **Gate View**, vertical lines are displayed in the Gate View window as follows:

- Green lines are displayed at the gate edges as follows: in Edge Gate, a line is shown for Delay and one for the end of the Gate period, defined by Length. In Level Gate a line is shown only for Delay. You can adjust the position of the green lines by adjusting the gate length and the gate delay. These lines update in the Gate View window as the active function changes, even if the window is not being updated. In Gated LO and Gated Video, these lines are positioned relative to the delay reference line (not relative to 0 time). In Gated FFT, their location is relative to the left edge of the screen.
- A blue line is displayed showing the delay reference, that is, the reference point for the Gate Delay within the Zero Span window. The blue line represents where (in time) the effective location of the gate start would be if the gate were programmed to zero delay.

- The second blue line is labeled "MIN FAST" as shown in the figure above because it represents the minimum Gate Delay for fast Gated LO operation. This line is only displayed in Gated LO. You cannot scroll (knob) or decrement (down key) the Gate Delay to less than that represented by the position of this line, it can only be set below this position manually, although once there it can be moved freely with the knob while below the line.
- A yellow line in the Gated Video case only, is displayed at  $Blength$ , where  $Blength$  is the display point (bucket) length for the swept trace, which is given by the sweep time for that trace divided by number of Points - 1. So it is referenced to 0 time, not to the delay reference. This line is labeled NEXT PT (it is not shown in the figure above because the figure above is for Gated LO).
- The yellow line represents the edge of a display point (bucket). Normally in Gated Video, the bucket length must be selected so that it exceeds the off time of the burst. There is another way to use the analyzer in Gated Video measurements, and that is to set the bucket width much shorter than the off time of the burst. Then use the Max Hold trace function to fill in "missing" buckets more slowly. This allows you to see some of the patterns of the Gated Video results earlier, though seeing a completely filled-in spectrum later.

## Gate View Setup

Accesses a menu that enables you to setup parameters relevant to the Gate View

Key Path	Sweep/Control, Gate
Scope	Meas Global
Initial S/W Revision	A.10.00

## Gate View Sweep Time

Controls the sweep time in the Gate View window. To provide an optimal view of the gate signal, the analyzer initializes Gate View Sweep Time based on the current settings of Gate Delay and Gate Length.

Key Path	Sweep/Control, Gate, Gate View Setup
<b>Remote Command</b>	[ :SENSe ] :SWEep:EGATe:TIME <time> [ :SENSe ] :SWEep:EGATe:TIME?
<b>Example</b>	SWE:EGAT:TIME 500 ms
Dependencies	Gate View Sweep Time is initialized: <ul style="list-style-type: none"> <li>• On Preset (after initializing delay and length).</li> <li>• Every time the Gate Method is set/changed.</li> </ul> <p>Additionally, in the Swept SA measurement, whenever you do a Preset, or leave Gate View, the analyzer remembers the Gate Delay and Gate Length settings. Then, when returning to Gate View, if the current Gate Delay and/or Gate Length do not match the remembered values Gate View Sweep Time is re-initialized.</p> <ol style="list-style-type: none"> <li>1. Compute the location of the "gate stop" line, which you know is at time <math>t = t_{min} + GateDelay + GateLength</math>.</li> </ol>
Preset	519.3 $\mu$ s

	WiMAX OFDMA: 5 ms GSM/EDGE: 1 ms
State Saved	Saved in instrument state
Max	6000 s
Initial S/W Revision	Prior to A.02.00

### Gate View Start Time

Controls the time at the left edge of the Gate View.

Key Path	Sweep/Control, Gate, Gate View Setup
Remote Command	[ :SENSe ] :SWEep:EGATe:VIEW:STARt <time> [ :SENSe ] :SWEep:EGATe:VIEW:STARt?
Example	SWE:EGAT:VIEW:STAR 10ms
Notes	Units of time are required or no units; otherwise an invalid suffix error message will be generated. See error -131.
Preset	0 ms
State Saved	Saved in instrument state
Min	0
Max	500 ms
Initial S/W Revision	A.10.00

### Gate Delay

Controls the length of time from the time the gate condition goes True until the gate is turned on.

Key Path	Sweep/Control, Gate
Remote Command	[ :SENSe ] :SWEep:EGATe:DELAy <time> [ :SENSe ] :SWEep:EGATe:DELAy?
Example	SWE:EGAT:DELAy 500ms SWE:EGAT:DELAy?
Notes	Units of time are required or no units; otherwise an invalid suffix error message will be generated.
Preset	57.7 us WiMAX OFDMA: 71 us GSM/EDGE: 600 us WLAN: 500 us
State Saved	Saved in instrument state

Min	0.0 us
Max	100 s
<b>Backwards Compatibility SCPI</b>	[:SENSe]:SWEep:TIME:GATE:DELay ESA compatibility
Initial S/W Revision	Prior to A.02.00

## Gate Length

Controls the length of time that the gate is on after it opens.

Key Path	Sweep/Control, Gate
<b>Remote Command</b>	[:SENSe]:SWEep:EGATe:LENGth <time> [:SENSe]:SWEep:EGATe:LENGth?
<b>Example</b>	SWE:EGAT:LENG 1 SWE:EGAT:LENG?
Notes	Units of time are required or no units; otherwise an invalid suffix error message will be generated.

### Dependencies

Grayed out when Gate Method is set to FFT in which case the label changes to that shown below.



The key is also grayed out if Gate Control = Level.

Preset	461.6 us WiMAX OFDMA: 50 us GSM/EDGE: 200 us WLAN: 1.54 ms
State Saved	Saved in instrument state
Min	100 ns
Max	5 s
<b>Backwards Compatibility SCPI</b>	[:SENSe]:SWEep:TIME:GATE:LENGth ESA compatibility
Initial S/W Revision	Prior to A.02.00

## Gate Source

The menus under the Gate Source key are the same as those under the Trigger key, with the exception that neither Free Run nor Video are available as Gate Source selections. However, a different SCPI command

is used to select the Gate Source (see table below) because you may independently set the Gate Source and the Trigger Source.

Any changes to the settings in the setup menus under each Gate Source selection key (for example: Trigger Level, Trigger Delay, etc.) also affect the corresponding settings under the Trigger menu keys. The SCPI commands used for these are the same for Trigger and Gate, since there is only one setting which affects both Gate and Trigger. Example: to set the Trigger Level for External 1 you use the command :TRIG:EXT1:LEV regardless of whether you are using External 1 as a Trigger Source or a Gate Source.

Key Path	Sweep/Control, Gate
Remote Command	[ :SENSe ] :SWEep:EGATe:SOURce EXTernal1   EXTernal2   LINE   FRAMe   RFBurst  [ :SENSe ] :SWEep:EGATe:SOURce?
Dependencies	In some models, there is no second External input. In these models, the External 2 key is blanked and the EXTernal2 parameter will generate a "Hardware missing; Not available for this model number" error.
Preset	EXTernal 1 GSM/EDGE, MSR: FRAMe LTETDD: EXTernal 1When Direction is Downlink, FRAMe when Direction is Uplink.
Backwards Compatibility Notes	In ESA, there is a single Gate input port. In PSA, the Gate Source may be taken from one of two specified input ports. In the X-Series, any Trigger Source can be a Gate Source.
Initial S/W Revision	Prior to A.02.00
Modified at S/W Revision	A.03.00, A.14.00

## Line

Pressing this key, when it is not selected, selects the line signal as the trigger. A new sweep/measurement will start synchronized with the next cycle of the line voltage. Pressing this key, when it is already selected, access the line trigger setup menu.

Key Path	Trigger
Example	TRIG:SOUR LINE Swept SA measurement TRIG:<meas>:SOUR LINE Measurements other than Swept SA
Dependencies	Line trigger is not available when operating from a "dc power source", for example, when the instrument is powered from batteries.
State Saved	Saved in instrument state
Status Bits/OPC dependencies	The Status Operation Register bit 5 "Waiting for Trigger" is set at the same time as the Sweeping or Measuring bit is set. It is cleared when the trigger actually occurs (that is, after the trigger event occurs and all the applicable trigger criteria have been met). A corresponding pop-up message ("Waiting for trigger") is generated if no trigger signal appears after approximately 2 sec. This message goes away when a trigger signal appears.
Initial S/W Revision	Prior to A.02.00

## Trig Slope

Controls the trigger polarity. It is set positive to trigger on a rising edge and negative to trigger on a falling edge.

Key Path	Trigger, Line
<b>Remote Command</b>	:TRIGger[:SEquence]:LINE:SLOPe POSitive NEGative :TRIGger[:SEquence]:LINE:SLOPe?
<b>Example</b>	TRIG:LINE:SLOP NEG
Preset	POSitive
State Saved	Saved in instrument state
Backwards Compatibility Notes	The legacy :TRIGger[:SEquence]:SLOPe command affects the slopes for the VID, LINE, EXT1, EXT2, and RFB triggers.
Initial S/W Revision	Prior to A.02.00

## External 1

Pressing this key, when it is not selected, selects an external input signal as the trigger. A new sweep/measurement will start when the external trigger condition is met using the external 1 input connector on the rear panel.

Pressing this key, when it is already selected, accesses the external 1 trigger setup menu.

Key Path	Trigger
<b>Example</b>	TRIG:SOUR EXT1 Swept SA measurement TRIG:<meas>:SOUR EXT1 Measurements other than Swept SA
Dependencies	Grayed out if in use by Point Trigger in the Source Setup menu. Forced to Free Run if already selected and Point Trigger is set to External 1.
State Saved	Saved in instrument state
Status Bits/OPC dependencies	The Status Operation Register bit 5 "Waiting for Trigger" is set at the same time as the Sweeping or Measuring bit is set. It is cleared when the trigger actually occurs (that is, after the trigger event occurs and all the applicable trigger criteria have been met). A corresponding pop-up message ("Waiting for trigger") is generated if no trigger signal appears after approximately 2 sec. This message goes away when a trigger signal appears.
Initial S/W Revision	Prior to A.02.00

## Trigger Level

Sets the value where the external 1 trigger input will trigger a new sweep/measurement.

Key Path	Trigger, External 1
<b>Remote Command</b>	:TRIGger[:SEquence]:EXTernal1:LEVel <level>

	:TRIGger[:SEquence]:EXTernal:LEVel?
<b>Example</b>	TRIG:EXT1:LEV 0.4 V
Couplings	This same level is used for the Ext1 trigger source in the Trigger menu, for the Ext1 selection in the Periodic Timer sync source (in the Trigger menu and in the Gate Source menu), and also for the Ext1 selection in the Gate Source menu.
Preset	1.2 V
State Saved	Saved in instrument state
Min	-5 V
Max	5 V
Default Unit	V
<b>Backwards Compatibility SCPI</b>	:TRIGger[:SEquence]:EXTernal:LEVel
<b>Backwards Compatibility SCPI</b>	For backward compatibility, the parameter EXTernal is mapped to EXTernal1
<b>Backwards Compatibility SCPI</b>	:TRIGger[:SEquence]:FRAME:EXTernal1:LEVel
Initial S/W Revision	Prior to A.02.00

### Trig Slope

Controls the trigger polarity. It is set positive to trigger on a rising edge and negative to trigger on a falling edge.

Key Path	Trigger, External 1
<b>Remote Command</b>	:TRIGger[:SEquence]:EXTernal:SLOPe POSitive NEGative :TRIGger[:SEquence]:EXTernal:SLOPe?
<b>Example</b>	TRIG:EXT1:SLOP NEG
Couplings	This same slope is used in the Ext1 selection for the trigger source in the Trigger menu and for the period timer sync source (in the Trigger menu and in the Gate Source menu).
Preset	POSitive
State Saved	Saved in instrument state
<b>Backwards Compatibility SCPI</b>	:TRIGger[:SEquence]:EXTernal:SLOPe
<b>Backwards Compatibility SCPI</b>	For backward compatibility, the parameter EXTernal is mapped to EXTernal1
<b>Backwards Compatibility SCPI</b>	:TRIGger[:SEquence]:FRAME:EXTernal1:SLOPe
Backwards Compatibility Notes	The legacy :TRIGger[:SEquence]:SLOPe command affects the slopes for the VID, LINE, EXT1, EXT2, and RFB triggers.
Initial S/W Revision	Prior to A.02.00



## External 2

Pressing this key, when it is not selected, selects an external input signal as the trigger. A new sweep/measurement will start when the external trigger condition is met using the external 2 input connector. The external trigger 2 input connector is on the rear panel.

Pressing this key, when it is already selected, accesses the external 2 trigger setup menu.

Key Path	Trigger
<b>Example</b>	TRIG:SOUR EXT2 Swept SA measurement TRIG:<meas>:SOUR EXT2 Measurements other than Swept SA
Dependencies	In some models, there is no second External input. In these models, the External 2 key is blanked and the EXTernal2 parameter will generate a "Hardware missing; Not available for this model number" message. Grayed out if in use by Point Trigger in the Source Setup menu. Forced to Free Run if already selected and Point Trigger is set to External 2.
State Saved	Saved in instrument state
Status Bits/OPC dependencies	The Status Operation Register bit 5 "Waiting for Trigger" is set at the same time as the Sweeping or Measuring bit is set. It is cleared when the trigger actually occurs (that is, after the trigger event occurs and all the applicable trigger criteria have been met). A corresponding pop-up message ("Waiting for trigger") is generated if no trigger signal appears after approximately 2 sec. This message goes away when a trigger signal appears.
Initial S/W Revision	Prior to A.02.00
Modified at S/W Revision	A.03.00

## Trigger Level

Sets the value where the external 2 trigger input will trigger a new sweep/measurement.

Key Path	Trigger, External 2
<b>Remote Command</b>	:TRIGger[:SEquence]:EXTernal2:LEVel :TRIGger[:SEquence]:EXTernal2:LEVel?
<b>Example</b>	TRIG:EXT2:LEV 1.1 V
Couplings	This same level is used for the Ext2 trigger source in the Trigger menu, for the Ext2 selection in the Periodic Timer sync source (in the Trigger menu and in the Gate Source menu), and also for the Ext2 selection in the Gate Source menu.
Preset	1.2 V
State Saved	Saved in instrument state
Min	-5 V
Max	5 V
Default Unit	V
<b>Backwards Compatibility SCPI</b>	:TRIGger[:SEquence]:FRAMe:EXTernal2:LEVel
Initial S/W Revision	Prior to A.02.00

### Trig Slope

Controls the trigger polarity. It is set positive to trigger on a rising edge and negative to trigger on a falling edge.

<b>Key Path</b>	Trigger, External 2
<b>Remote Command</b>	:TRIGger[:SEquence]:EXTernal2:SLOPe POSitive NEGative :TRIGger[:SEquence]:EXTernal2:SLOPe?
<b>Example</b>	TRIG:EXT2:SLOP NEG
<b>Couplings</b>	This same slope is used in the Ext2 selection for the trigger source in the Trigger menu and for the period timer sync source (in the Trigger menu and in the Gate Source menu).
<b>Preset</b>	POSitive
<b>State Saved</b>	Saved in instrument state
<b>Backwards Compatibility SCPI</b>	:TRIGger[:SEquence]:FRAMe:EXTernal2:SLOPe
<b>Backwards Compatibility Notes</b>	The legacy :TRIGger[:SEquence]:SLOPe command affects the slopes for the VID, LINE, EXT1, EXT2, and RFB triggers.
<b>Initial S/W Revision</b>	Prior to A.02.00

### RF Burst

Pressing this key, when it is not selected, selects the RF Burst as the trigger. A new sweep/measurement will start when an RF burst envelope signal is identified from the signal at the RF Input connector. Pressing this key, when it is already selected, accesses the RF Burst trigger setup menu.

In some models, a variety of burst trigger circuitry is available, resulting in various available burst trigger bandwidths. The analyzer automatically chooses the appropriate trigger path based on the hardware configuration and other settings of the analyzer.

<b>Key Path</b>	Trigger
<b>Example</b>	TRIG:SOUR RFB                      Swept SA measurement TRIG:<meas>:SOUR RFB      Measurements other than Swept SA
<b>State Saved</b>	Saved in instrument state
<b>Status Bits/OPC dependencies</b>	The Status Operation Register bit 5 "Waiting for Trigger" is set at the same time as the Sweeping or Measuring bit is set. It is cleared when the trigger actually occurs (that is, after the trigger event occurs and all the applicable trigger criteria have been met). A corresponding pop-up message ("Waiting for trigger") is generated if no trigger signal appears after approximately 2 sec. This message goes away when a trigger signal appears.
<b>Backwards Compatibility Notes</b>	The legacy command: :TRIGger[:SEquence]:RFBurst:FSElectivity[:STATe] OFF ON 0 1 is not supported in the X-Series, as the hardware to do Frequency Selective burst triggers does not exist in X-Series.

Initial S/W Revision	Prior to A.02.00
Modified at S/W Revision	A.04.00

### Absolute Trigger Level

Sets the absolute trigger level for the RF burst envelope.

When using the External Mixing path, the Absolute Trigger Level is uncalibrated because the factory default was set to accommodate the expected IF levels for the RF path.

Key Path	Trigger, RF Burst
Scope	Meas Global
<b>Remote Command</b>	:TRIGger[:SEquence]:RFBurst:LEVel:ABSolute <ampl> :TRIGger[:SEquence]:RFBurst:LEVel:ABSolute?
<b>Example</b>	TRIG:RFB:LEV:ABS 10 dBm sets the trigger level of the RF burst envelope signal to the absolute level of 10 dBm
Notes	Sending this command does not switch the setting from relative to absolute; to switch it you need to send the :TRIGger[:SEquence]:RFBurst:LEVel:TYPE command, below.  Amplitude Corrections are not taken into account by the Absolute Trigger Level. For example, if you have given yourself effective gain with an amplitude correction factor, the Absolute Trigger will not fire until you have set the trigger level that far below the displayed signal level, rather than simply to the displayed signal level. This is only true for Amplitude Corrections, not External Gain or Ref Level Offset functions.  If mode is Bluetooth, the default value is -50 dBm.
Couplings	This same level is used for the RF Burst trigger source in the Trigger menu, for the RF Burst selection in the Periodic Timer sync source (in the Trigger menu and in the Gate Source menu), and also for the RF Burst selection in the Gate Source menu
Preset	-20 dBm
State Saved	Saved in instrument state
Min	-200 dBm
Max	100 dBm
Default Unit	depends on the current selected Y-Axis unit
<b>Backwards Compatibility SCPI</b>	:TRIGger[:SEquence]:FRAME:RFBurst:LEVel:ABSolute
Initial S/W Revision	Prior to A.02.00
Modified at S/W Revision	A.04.00

Key Path	Trigger, RF Burst
<b>Remote Command</b>	:TRIGger[:SEquence]:RFBurst:LEVel:TYPE ABSolute RELative :TRIGger[:SEquence]:RFBurst:LEVel:TYPE?

<b>Example</b>	TRIG:RFB:LEV:TYPE REL sets the trigger level type of the RF burst trigger to Relative.
Preset	ABSolute
State Saved	Saved in instrument state
Initial S/W Revision	Prior to A.02.00
Modified at S/W Revision	A.04.00

### Relative Trigger Level

Sets the relative trigger level for the RF burst envelope.

In some models, the relative burst trigger function is implemented in hardware. In other models, without the advanced triggering hardware required, the relative burst trigger function is implemented in software in some measurements, and is unavailable in other measurements.

When implemented in software, the relative RF Burst trigger function is implemented as follows:

1. The measurement starts with the absolute RF Burst trigger setting. If it cannot get a trigger with that level, auto trigger fires and the acquisition starts anyway. After the acquisition, the measurement searches for the peak in the acquired waveform and saves it.
2. Now, in the next cycle of the measurement, the measurement determines a new absolute RF Burst level based on the peak value from the first measurement and the Relative RF Burst Trigger Level (always 0 or negative dB) set by the user. The following formula is used:
3. absolute RF Burst level = peak level of the previous acquisition + relative RF Burst level
4. If the new absolute RF Burst level differs from the previous by more than 0.5 dB, the new level is sent to the hardware; otherwise it is not updated (to avoid slowing down the acquisition)

Steps 2 and 3 repeat for subsequent measurements.

<b>Key Path</b>	Trigger, RF Burst
<b>Scope</b>	Meas Global
<b>Remote Command</b>	:TRIGger[:SEquence]:RFBurst:LEVel:RELative <rel_amp1> :TRIGger[:SEquence]:RFBurst:LEVel:RELative?
<b>Example</b>	TRIG:RFB:LEV:REL -10 dB sets the trigger level of the RF burst envelope signal to the relative level of -10 dB
<b>Notes</b>	Sending this command does not switch the setting from absolute to relative; to switch it you need to send the :TRIGger[:SEquence]:RFBurst:LEVel:TYPE command, above. The relative trigger level is not available in some measurements. In those measurements the RELative parameter, and the :TRIGger[:SEquence]:RFBurst:LEVel:TYPE command (above), will generate an error if sent.
<b>Dependencies</b>	This key is grayed out and Absolute Trigger Level selected if the required hardware is not present in your analyzer and the current measurement does not support Relative triggering.
<b>Preset</b>	-6 dB

	GSM: -25 dB
State Saved	Saved in instrument state
Min	-45 dB
Max	0 dB
Default Unit	dB or dBc
<b>Backwards Compatibility SCPI</b>	:TRIGger[:SEquence]:RFBurst:LEVel
	This legacy command is aliased to :TRIGger[:SEquence]:RFBurst:LEVel:RELative because the PSA had ONLY relative burst triggering
Initial S/W Revision	Prior to A.02.00
Modified at S/W Revision	A.04.00

### Trigger Slope

It is set positive to trigger on a rising edge and negative to trigger on a falling edge.

Key Path	Trigger, RF Burst
<b>Remote Command</b>	:TRIGger[:SEquence]:RFBurst:SLOPe POSitive NEGative :TRIGger[:SEquence]:RFBurst:SLOPe?
<b>Example</b>	TRIG:RFB:SLOP NEG
Couplings	This same slope is used in the RF Burst selection for the trigger source in the Trigger menu and for the period timer sync source (in the Trigger menu and in the Gate Source menu).
Preset	POSitive
State Saved	Saved in instrument state
<b>Backwards Compatibility SCPI</b>	:TRIGger[:SEquence]:FRAMe:RFBurst:SLOPe
Backwards Compatibility Notes	The legacy :TRIGger[:SEquence]:SLOPe command affects the slopes for the VID, LINE, EXT1, EXT2, and RFB triggers.
Initial S/W Revision	Prior to A.02.00

### Periodic Timer (Frame Trigger)

Pressing this key, when it is not selected, selects the internal periodic timer signal as the trigger. Triggering occurrences are set by the **Period** parameter, which is modified by the **Sync Source** and **Offset**. Pressing this key, when it is already selected, accesses the periodic timer trigger setup functions.

If you do not have a sync source selected (it is Off), then the internal timer will not be synchronized with any external timing events.

Key Path	Trigger
<b>Example</b>	TRIG:SOUR FRAM      Swept SA measurement TRIG:<meas>:SOUR FRAM      Measurements other than Swept SA

State Saved	Saved in instrument state
Readback	[Sync: <value of Sync Source>], for example, [Sync: External 1]
Status Bits/OPC dependencies	The Status Operation Register bit 5 "Waiting for Trigger" is set at the same time as the Sweeping or Measuring bit is set. It is cleared when the trigger actually occurs (that is, after the trigger event occurs and all the applicable trigger criteria have been met). A corresponding pop-up message ("Waiting for trigger") is generated if no trigger signal appears after approximately 2 sec. This message goes away when a trigger signal appears.
Initial S/W Revision	Prior to A.02.00

### Periodic Timer Triggering:

This feature selects the internal periodic timer signal as the trigger. Trigger occurrences are set by the **Periodic Timer** parameter, which is modified by the **Sync Source** and **Offset**.

The figure below shows the action of the periodic timer trigger. Before reviewing the figure, we'll explain some uses for the periodic trigger.

A common application is measuring periodic burst RF signals for which a trigger signal is not easily available. For example, we might be measuring a TDMA radio which bursts every 20 ms. Let's assume that the 20 ms period is very consistent. Let's also assume that we do not have an external trigger source available that is synchronized with the period, and that the signal-to-noise ratio of the signal is not high enough to provide a clean RF burst trigger at all of the analysis frequencies. For example, we might want to measure spurious transmissions at an offset from the carrier that is larger than the bandwidth of the RF burst trigger. In this application, we can set the Periodic Timer to a 20.00 ms period and adjust the offset from that timer to position our trigger just where we want it. If we find that the 20.00 ms is not exactly right, we can adjust the period slightly to minimize the drift between the period timer and the signal to be measured.

A second way to use this feature would be to use **Sync Source** temporarily, instead of **Offset**. In this case, we might tune to the signal in a narrow span and use the RF Burst trigger to synchronize the periodic timer. Then we would turn the sync source off so that it would not miss-trigger. Miss-triggering can occur when we are tuned so far away from the RF burst trigger that it is no longer reliable.

A third example would be to synchronize to a signal that has a reference time element of much longer period than the period of interest. In some CDMA applications, it is useful to look at signals with a short periodicity, by synchronizing that periodicity to the "even-second clock" edge that happens every two seconds. Thus, we could connect the even-second clock trigger to Ext1 and use then Ext1 as the sync source for the periodic timer.

The figure below illustrates this third example. The top trace represents the even-second clock. It causes the periodic timer to synchronize with the leading edge shown. The analyzer trigger occurs at a time delayed by the accumulated offset from the period trigger event. The periodic timer continues to run, and triggers continue to occur, with a periodicity determined by the analyzer time base. The timer output (labeled "late event") will drift away from its ideal time due to imperfect matching between the time base of the signal being measured and the time base of the analyzer, and also because of imperfect setting of the period parameter. But the synchronization is restored on the next even-second clock event. ("Accumulated offset" is described in the in the **Offset** function section.)

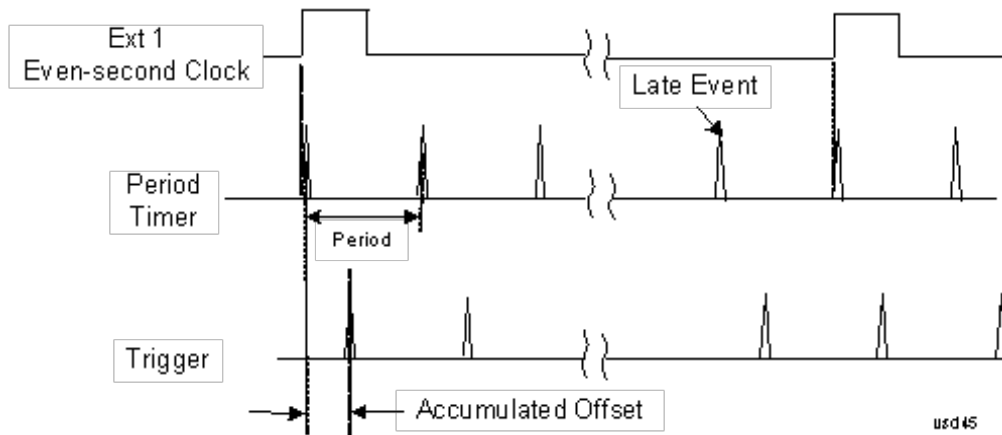

### Period

Sets the period of the internal periodic timer clock. For digital communications signals, this is usually set to the frame period of your current input signal. In the case that sync source is not set to OFF, and the external sync source rate is changed for some reason, the periodic timer is synchronized at the every external synchronization pulse by resetting the internal state of the timer circuit.

Key Path	Trigger, Periodic Timer
Remote Command	:TRIGger[:SEquence]:FRAMe:PERiod <time> :TRIGger[:SEquence]:FRAMe:PERiod?
Example	TRIG:FRAM:PER 100 ms
Dependencies	The invalid data indicator turns on when the period is changed, until the next sweep/measurement completes.
Couplings	The same period is used in the Gate Source selection of the period timer.
Preset	20 ms GSM: 4.615383
State Saved	Saved in instrument state
Min	100.000 ns
Max	559.0000 ms
Default Unit	S
Initial S/W Revision	Prior to A.02.00

### Offset

Adjusts the accumulated offset between the periodic timer events and the trigger event. Adjusting the accumulated offset is different than setting an offset, and requires explanation.

The periodic timer is usually not synchronized with any external events, so the timing of its output events has no absolute meaning. Since the timing relative to external events (RF signals) is important, you need to be able to adjust (offset) it. However, you have no direct way to see when the periodic timer events occur. All that you can see is the trigger timing. When you want to adjust the trigger timing, you will be changing the internal offset between the periodic timer events and the trigger event. Because the absolute value of

that internal offset is unknown, we will just call that the accumulated offset. Whenever the Offset parameter is changed, you are changing that accumulated offset. You can reset the displayed offset using Reset Offset Display. Changing the display does not change the value of the accumulated offset, and you can still make additional changes to accumulated offset.

To avoid ambiguity, we define that an increase in the "offset" parameter, either from the knob or the SCPI adjust command, serves to delay the timing of the trigger event.

<b>Key Path</b>	Trigger, Periodic Timer
<b>Remote Command</b>	:TRIGger[:SEquence]:FRAMe:OFFSet <time> :TRIGger[:SEquence]:FRAMe:OFFSet?
<b>Example</b>	TRIG:FRAM:OFFS 1.2 ms
<b>Notes</b>	The front panel interface (for example, the knob), and this command, adjust the accumulated offset, which is shown on the active function display. However, the actual amount sent to the hardware each time the offset is updated is the delta value, that is, the current accumulated offset value minus the previous accumulated offset value. Note that the accumulated offset value is essentially arbitrary; it represents the accumulated offset from the last time the offset was zeroed (with the Reset Offset Display key).  Note that this command does not change the period of the trigger waveform. Note also that Offset is used only when the sync source is set to OFF, otherwise delay is used, see section " <a href="#">Trig Delay</a> " on <a href="#">page 443</a> .  An increase in the "offset" parameter, either from the knob or the SCPI adjust command, serves to delay the timing of the trigger event.
<b>Notes</b>	When the SCPI command is sent the value shown on the key (and the Active Function, if this happens to be the active function) is updated with the new value. However, the actual amount sent to the hardware is the delta value, that is, the current accumulated offset value minus the previous accumulated offset value.  The SCPI query simply returns the value currently showing on the key.
<b>Dependencies</b>	The invalid data indicator turns on when the offset is changed, until the next sweep/measurement completes.
<b>Couplings</b>	The same offset is used in the Gate Source selection of the period timer.
<b>Preset</b>	0 s
<b>State Saved</b>	Saved in instrument state
<b>Min</b>	-10.000 s
<b>Max</b>	10.000 s
<b>Default Unit</b>	S
<b>Initial S/W Revision</b>	Prior to A.02.00

#### Offset Adjust (Remote Command Only)

This remote command does not work at all like the related front panel keys. This command lets you advance the phase of the frame trigger by the amount you specify.

It does not change the period of the trigger waveform. If the command is sent multiple times, it advances the phase of the frame trigger an additional amount each time it is sent. Negative numbers are permitted.



<b>Remote Command</b>	:TRIGger[:SEquence]:FRAMe:ADJust <time>
<b>Example</b>	TRIG:FRAM:ADJ 1.2 ms
<b>Notes</b>	Note also that Offset is used only when the sync source is set to OFF, otherwise delay is used, see section "Trig Delay" on page 443 An increase in the "offset" parameter, either from the knob or the SCPI adjust command, serves to delay the timing of the trigger event.
<b>Notes</b>	The front panel interface (for example, the knob) and the :TRIG:FRAM:OFFS command adjust the accumulated offset, which is shown on the active function display. However, the actual amount sent to the hardware is the delta value, that is, the current offset value minus the previous offset value. When the SCPI command is sent the value shown on the key (and the Active Function, if this happens to be the active function) is updated by increasing it (or decreasing it if the value sent is negative) by the amount specified in the SCPI command. This is a "command only" SCPI command, with no query.
<b>Dependencies</b>	The invalid data indicator turns on when the offset is changed, until the next sweep/measurement completes.
<b>Couplings</b>	The same offset is used in the Gate Source selection of the period timer.
<b>Preset</b>	0 s
<b>State Saved</b>	Saved in instrument state
<b>Min</b>	-10.000 s
<b>Max</b>	10.000 s
<b>Default Unit</b>	S
<b>Initial S/W Revision</b>	Prior to A.02.00

### Reset Offset Display

Resets the value of the periodic trigger offset display setting to 0.0 seconds. The current displayed trigger location may include an offset value defined with the Offset key. Pressing this key redefines the currently displayed trigger location as the new trigger point that is 0.0 s offset. The Offset key can then be used to add offset relative to this new timing.

<b>Key Path</b>	Trigger, Periodic Timer
<b>Remote Command</b>	:TRIGger[:SEquence]:FRAMe:OFFSet:DISPlay:RESet
<b>Example</b>	TRIG:FRAM:OFFS:DISP:RES
<b>Initial S/W Revision</b>	Prior to A.02.00

### Sync Source

Selects a signal source for you to synchronize your periodic timer trigger to, otherwise you are triggering at some arbitrary location in the frame. Synchronization reduces the precision requirements on the setting of the period.

For convenience you may adjust the level and slope of the selected sync source in a conditional branch setup menu accessed from the Sync Source menu. Note that these settings match those in the **Trigger** and **Gate Source** menus; that is, each trigger source has only one value of level and slope, regardless of which menu it is accessed from.

<b>Key Path</b>	Trigger, Periodic Timer
<b>Remote Command</b>	:TRIGger[:SEquence]:FRAMe:SYNC EXTernal1   EXTernal2   RFBurst   OFF :TRIGger[:SEquence]:FRAMe:SYNC?
<b>Example</b>	TRIG:FRAM:SYNC EXT2
<b>Dependencies</b>	In some models, there is no second External input. In these models, the External 2 key is blanked and the EXTernal2 parameter will generate a “Hardware missing; Not available for this model number” message.
<b>Preset</b>	Off GSM/EDGE, MSR,LTE,LTETDD: RFBurst
<b>State Saved</b>	Saved in instrument state
<b>Readback</b>	The current setting is read back to this key and it is also Readback to the previous Periodic Timer trigger key.
<b>Backwards Compatibility SCPI</b>	:TRIGger[:SEquence]:FRAMe:SYNC EXTernal For backward compatibility, the parameter EXTernal is mapped to EXTernal1
<b>Initial S/W Revision</b>	Prior to A.02.00
<b>Modified at S/W Revision</b>	A.03.00, A.14.00

### Off

Turns off the sync source for your periodic trigger. With the sync source off, the timing will drift unless the signal source frequency is locked to the analyzer frequency reference.

<b>Key Path</b>	Trigger, Periodic Timer, Sync Source
<b>Example</b>	TRIG:FRAM:SYNC OFF
<b>Readback</b>	Off
<b>Initial S/W Revision</b>	Prior to A.02.00

### External 1

Pressing this key, when it is not selected, selects an external input signal as the trigger. A new sweep/measurement will start when the external trigger condition is met using the external 1 input connector on the rear panel.

Pressing this key, when it is already selected, accesses the external 1 trigger setup menu.

<b>Key Path</b>	Trigger
<b>Example</b>	TRIG:SOUR EXT1 Swept SA measurement

	TRIG:<meas>:SOUR EXT1 Measurements other than Swept SA
Dependencies	Grayed out if in use by Point Trigger in the Source Setup menu. Forced to Free Run if already selected and Point Trigger is set to External 1.
State Saved	Saved in instrument state
Status Bits/OPC dependencies	The Status Operation Register bit 5 "Waiting for Trigger" is set at the same time as the Sweeping or Measuring bit is set. It is cleared when the trigger actually occurs (that is, after the trigger event occurs and all the applicable trigger criteria have been met). A corresponding pop-up message ("Waiting for trigger") is generated if no trigger signal appears after approximately 2 sec. This message goes away when a trigger signal appears.
Initial S/W Revision	Prior to A.02.00

### Trigger Level

Sets the value where the external 1 trigger input will trigger a new sweep/measurement.

Key Path	Trigger, External 1
<b>Remote Command</b>	:TRIGger[:SEquence]:EXTernal1:LEVel <level> :TRIGger[:SEquence]:EXTernal1:LEVel?
<b>Example</b>	TRIG:EXT1:LEV 0.4 V
Couplings	This same level is used for the Ext1 trigger source in the Trigger menu, for the Ext1 selection in the Periodic Timer sync source (in the Trigger menu and in the Gate Source menu), and also for the Ext1 selection in the Gate Source menu.
Preset	1.2 V
State Saved	Saved in instrument state
Min	-5 V
Max	5 V
Default Unit	V
<b>Backwards Compatibility SCPI</b>	:TRIGger[:SEquence]:EXTernal:LEVel For backward compatibility, the parameter EXTernal is mapped to EXTernal1
<b>Backwards Compatibility SCPI</b>	:TRIGger[:SEquence]:FRAME:EXTernal1:LEVel
Initial S/W Revision	Prior to A.02.00

### Trig Slope

Controls the trigger polarity. It is set positive to trigger on a rising edge and negative to trigger on a falling edge.

Key Path	Trigger, External 1
<b>Remote Command</b>	:TRIGger[:SEquence]:EXTernal1:SLOPe POSitive NEGative

	:TRIGger[:SEquence]:EXTernal1:SLOPe?
<b>Example</b>	TRIG:EXT1:SLOP NEG
Couplings	This same slope is used in the Ext1 selection for the trigger source in the Trigger menu and for the period timer sync source (in the Trigger menu and in the Gate Source menu).
Preset	POSitive
State Saved	Saved in instrument state
<b>Backwards Compatibility SCPI</b>	:TRIGger[:SEquence]:EXTernal:SLOPe For backward compatibility, the parameter EXTernal is mapped to EXTernal1
<b>Backwards Compatibility SCPI</b>	:TRIGger[:SEquence]:FRAMe:EXTernal1:SLOPe
Backwards Compatibility Notes	The legacy :TRIGger[:SEquence]:SLOPe command affects the slopes for the VID, LINE, EXT1, EXT2, and RFB triggers.
Initial S/W Revision	Prior to A.02.00

## External 2

Pressing this key, when it is not selected, selects an external input signal as the trigger. A new sweep/measurement will start when the external trigger condition is met using the external 2 input connector. The external trigger 2 input connector is on the rear panel.

Pressing this key, when it is already selected, accesses the external 2 trigger setup menu.

Key Path	Trigger
<b>Example</b>	TRIG:SOUR EXT2          Swept SA measurement TRIG:<meas>:SOUR EXT2   Measurements other than Swept SA
Dependencies	In some models, there is no second External input. In these models, the External 2 key is blanked and the EXTernal2 parameter will generate a "Hardware missing; Not available for this model number" message.  Grayed out if in use by Point Trigger in the Source Setup menu.  Forced to Free Run if already selected and Point Trigger is set to External 2.
State Saved	Saved in instrument state
Status Bits/OPC dependencies	The Status Operation Register bit 5 "Waiting for Trigger" is set at the same time as the Sweeping or Measuring bit is set. It is cleared when the trigger actually occurs (that is, after the trigger event occurs and all the applicable trigger criteria have been met). A corresponding pop-up message ("Waiting for trigger") is generated if no trigger signal appears after approximately 2 sec. This message goes away when a trigger signal appears.
Initial S/W Revision	Prior to A.02.00
Modified at S/W Revision	A.03.00

## Trigger Level

Sets the value where the external 2 trigger input will trigger a new sweep/measurement.

Key Path	Trigger, External 2
<b>Remote Command</b>	:TRIGger[:SEquence]:EXTernal2:LEVel :TRIGger[:SEquence]:EXTernal2:LEVel?
<b>Example</b>	TRIG:EXT2:LEV 1.1 V
Couplings	This same level is used for the Ext2 trigger source in the Trigger menu, for the Ext2 selection in the Periodic Timer sync source (in the Trigger menu and in the Gate Source menu), and also for the Ext2 selection in the Gate Source menu.
Preset	1.2 V
State Saved	Saved in instrument state
Min	-5 V
Max	5 V
Default Unit	V
<b>Backwards Compatibility SCPI</b>	:TRIGger[:SEquence]:FRAMe:EXTernal2:LEVel
Initial S/W Revision	Prior to A.02.00

### Trig Slope

Controls the trigger polarity. It is set positive to trigger on a rising edge and negative to trigger on a falling edge.

Key Path	Trigger, External 2
<b>Remote Command</b>	:TRIGger[:SEquence]:EXTernal2:SLOPe POSitive NEGative :TRIGger[:SEquence]:EXTernal2:SLOPe?
<b>Example</b>	TRIG:EXT2:SLOP NEG
Couplings	This same slope is used in the Ext2 selection for the trigger source in the Trigger menu and for the period timer sync source (in the Trigger menu and in the Gate Source menu).
Preset	POSitive
State Saved	Saved in instrument state
<b>Backwards Compatibility SCPI</b>	:TRIGger[:SEquence]:FRAMe:EXTernal2:SLOPe
Backwards Compatibility Notes	The legacy :TRIGger[:SEquence]:SLOPe command affects the slopes for the VID, LINE, EXT1, EXT2, and RFB triggers.
Initial S/W Revision	Prior to A.02.00

### RF Burst

Pressing this key, when it is not selected, selects the RF Burst as the trigger. A new sweep/measurement will start when an RF burst envelope signal is identified from the signal at the RF Input connector. Pressing this key, when it is already selected, accesses the RF Burst trigger setup menu.

In some models, a variety of burst trigger circuitry is available, resulting in various available burst trigger bandwidths. The analyzer automatically chooses the appropriate trigger path based on the hardware configuration and other settings of the analyzer.

Key Path	Trigger
<b>Example</b>	TRIG:SOUR RFB Swept SA measurement TRIG:<meas>:SOUR RFB Measurements other than Swept SA
State Saved	Saved in instrument state
Status Bits/OPC dependencies	The Status Operation Register bit 5 "Waiting for Trigger" is set at the same time as the Sweeping or Measuring bit is set. It is cleared when the trigger actually occurs (that is, after the trigger event occurs and all the applicable trigger criteria have been met). A corresponding pop-up message ("Waiting for trigger") is generated if no trigger signal appears after approximately 2 sec. This message goes away when a trigger signal appears.
Backwards Compatibility Notes	The legacy command: :TRIGger[:SEQuence]:RFBurst:FSElectivity[:STATe] OFF ON 0 1 is not supported in the X-Series, as the hardware to do Frequency Selective burst triggers does not exist in X-Series.
Initial S/W Revision	Prior to A.02.00
Modified at S/W Revision	A.04.00

### Absolute Trigger Level

Sets the absolute trigger level for the RF burst envelope.

When using the External Mixing path, the Absolute Trigger Level is uncalibrated because the factory default was set to accommodate the expected IF levels for the RF path.

Key Path	Trigger, RF Burst
Scope	Meas Global
<b>Remote Command</b>	:TRIGger[:SEQuence]:RFBurst:LEVel:ABSolute <ampl> :TRIGger[:SEQuence]:RFBurst:LEVel:ABSolute?
<b>Example</b>	TRIG:RFB:LEV:ABS 10 dBm sets the trigger level of the RF burst envelope signal to the absolute level of 10 dBm
Notes	Sending this command does not switch the setting from relative to absolute; to switch it you need to send the :TRIGger[:SEQuence]:RFBurst:LEVel:TYPE command, below.  Amplitude Corrections are not taken into account by the Absolute Trigger Level. For example, if you have given yourself effective gain with an amplitude correction factor, the Absolute Trigger will not fire until you have set the trigger level that far below the displayed signal level, rather than simply to the displayed signal level. This is only true for Amplitude Corrections, not External Gain or Ref Level Offset functions.  If mode is Bluetooth, the default value is -50 dBm.
Couplings	This same level is used for the RF Burst trigger source in the Trigger menu, for the RF Burst selection in the Periodic Timer sync source (in the Trigger menu and in the Gate Source menu), and also for the

	RF Burst selection in the Gate Source menu
Preset	-20 dBm
State Saved	Saved in instrument state
Min	-200 dBm
Max	100 dBm
Default Unit	depends on the current selected Y-Axis unit
<b>Backwards Compatibility SCPI</b>	:TRIGger[:SEquence]:FRAME:RFBurst:LEVel:ABSolute
Initial S/W Revision	Prior to A.02.00
Modified at S/W Revision	A.04.00

Key Path	Trigger, RF Burst
<b>Remote Command</b>	:TRIGger[:SEquence]:RFBurst:LEVel:TYPE ABSolute RELative :TRIGger[:SEquence]:RFBurst:LEVel:TYPE?
<b>Example</b>	TRIG:RFB:LEV:TYPE REL sets the trigger level type of the RF burst trigger to Relative.
Preset	ABSolute
State Saved	Saved in instrument state
Initial S/W Revision	Prior to A.02.00
Modified at S/W Revision	A.04.00

### Trigger Slope

It is set positive to trigger on a rising edge and negative to trigger on a falling edge.

Key Path	Trigger, RF Burst
<b>Remote Command</b>	:TRIGger[:SEquence]:RFBurst:SLOPe POSitive NEGative :TRIGger[:SEquence]:RFBurst:SLOPe?
<b>Example</b>	TRIG:RFB:SLOP NEG
Couplings	This same slope is used in the RF Burst selection for the trigger source in the Trigger menu and for the period timer sync source (in the Trigger menu and in the Gate Source menu).
Preset	POSitive
State Saved	Saved in instrument state
<b>Backwards Compatibility SCPI</b>	:TRIGger[:SEquence]:FRAME:RFBurst:SLOPe
Backwards Compatibility Notes	The legacy :TRIGger[:SEquence]:SLOPe command affects the slopes for the VID, LINE, EXT1, EXT2, and RFB triggers.
Initial S/W Revision	Prior to A.02.00

### Sync Holdoff

Sync Holdoff specifies the duration that the sync source signal must be kept false before the transition to true to be recognized as the sync timing. The periodic timer phase is aligned when the sync source signal becomes true, after the Holdoff time is satisfied.

A holdoff of 2 ms will work with most WiMAX signals, but there may be cases where the burst off duration is less than 1 ms and this value will need to be changed.

Key Path	Trigger, Periodic Timer
Remote Command	:TRIGger[:SEquence]:FRAMe:SYNC:HOLDoff <time> :TRIGger[:SEquence]:FRAMe:SYNC:HOLDoff? :TRIGger[:SEquence]:FRAMe:SYNC:HOLDoff:STATe OFF ON 0 1 :TRIGger[:SEquence]:FRAMe:SYNC:HOLDoff:STATe?
Preset	On, 1.000 ms
State Saved	Saved in instrument state
Min	0 ms
Max	+500 ms
Default Unit	s
Initial S/W Revision	Prior to A.02.00

### Control Edge/Level

Sets the method of controlling the gating function from the gating signal.

#### Edge

In Edge triggering, the gate opens (after the Delay) on the selected edge (for example, positive) of the gate signal and closes on the alternate edge (for example, negative).

#### Level

In Level triggering, the gate opens (after the Delay) when the gate signal has achieved a certain level and stays open as long as that level is maintained.

Key Path	Sweep/Control, Gate
Remote Command	[:SENSe]:SWEep:EGATe:CONTRol EDGE LEVEL [:SENSe]:SWEep:EGATe:CONTRol?
Example	SWE:EGAT:CONT EDGE
Dependencies	If the Gate Method is FFT the Control key is grayed out and Edge is selected. If the Gate Source is TV, Frame or Line, the Control key is grayed out and Edge is selected.
Preset	EDGE
State Saved	Saved in instrument state
Backwards Compatibility SCPI	[:SENSe]:SWEep:TIME:GATE:TYPE ESA Compatibility
Initial S/W Revision	Prior to A.02.00



## Gate Holdoff

Lets you increase or decrease the wait time after a gate event ends before the analyzer will respond to the next gate signal.

After any Gate event finishes, the analyzer must wait for the sweep system to settle before it can respond to another Gate signal. The analyzer calculates a "wait time," taking into account a number of factors, including RBW and Phase Noise Optimization settings. The goal is to achieve the same accuracy when gated as in ungated operation. The figure below illustrates this concept:

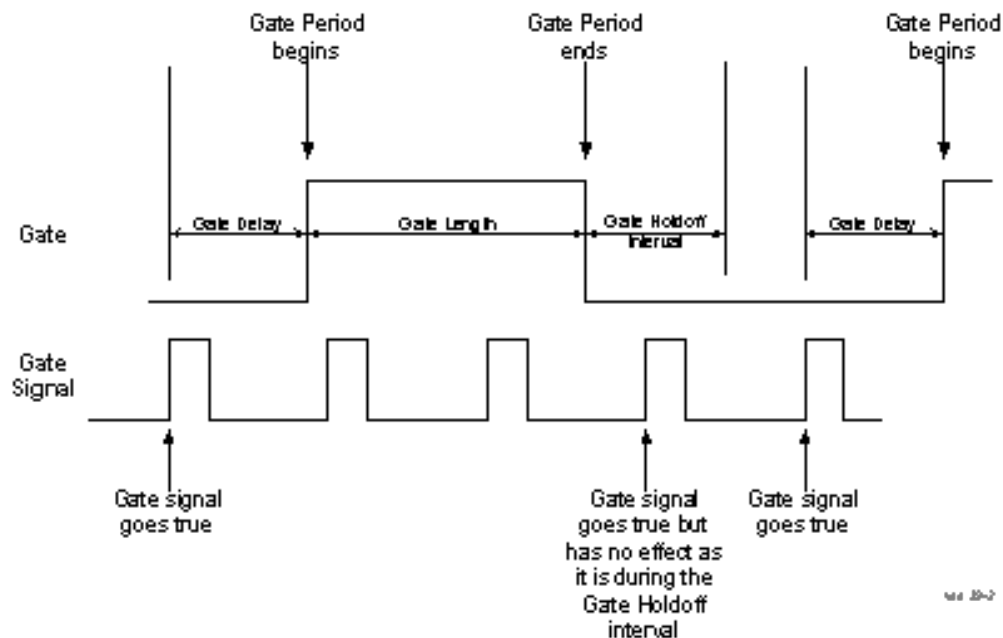

When Gate Holdoff is in Auto, the wait time calculated by the analyzer is used. When Gate Time is in Manual, the user may adjust the wait time, usually decreasing it in order to achieve greater speed, but at the risk of decreasing accuracy.

When the Method key is set to Video or FFT, the Gate Holdoff function has no effect.

In measurements that do not support Auto, the value shown when Auto is selected is "----" and the manually set holdoff is returned to a query.

Key Path	Sweep/Control, Gate
<b>Remote Command</b>	<pre>[ :SENSe ] :SWEep:EGATe:HOLDoff &lt;time&gt; [ :SENSe ] :SWEep:EGATe:HOLDoff? [ :SENSe ] :SWEep:EGATe:HOLDoff:AUTO OFF ON 0 1 [ :SENSe ] :SWEep:EGATe:HOLDoff:AUTO?</pre>
<b>Example</b>	<pre>SWE:EGAT:HOLD 0.0002 SWE:EGAT:HOLD? SWE:EGAT:HOLD:AUTO ON</pre>

SWE:EGAT:HOLD:AUTO?	
Couplings	<p>When Gate Holdoff is Auto, the Gate Holdoff key shows the value calculated by the analyzer for the wait time.</p> <p>Pressing the Gate Holdoff key while it is in Auto and not selected, causes the key to become selected and allows the user to adjust the value. If the value is adjusted, the setting changes to Man.</p> <p>Pressing the Gate Holdoff key, while it is in Auto and selected, does not change the value of Gate Holdoff, but causes the setting to change to Man. Now the user can adjust the value.</p> <p>Pressing the key while it is in Man and selected, cause the value to change back to Auto.</p> <p>Pressing the key while it is in Man and not selected, causes the key to become selected and allows the user to adjust the value.</p> <p>When Method is set to Video or FFT, the Gate Holdoff function has no effect.</p>
Preset	<p>Auto</p> <p>Auto/On</p>
State Saved	Saved in instrument state
Min	1 $\mu$ sec
Max	1 sec
Initial S/W Revision	Prior to A.02.00

## Gate Delay Compensation

This function allows you to select an RBW-dependent value by which to adjust the gate delay, to compensate for changes in the delay caused by RBW effects.

You can select between uncompensated operation and two types of compensation, Delay Until RBW Settled and Compensate for RBW Group Delay.

See ["More Information" on page 851](#)

Key Path	Sweep/Control, Gate
Scope	Meas Global
Remote Command	<pre>[ :SENSe ] :SWEep:EGATe:DELAy:COMPensation:TYPE OFF   SETTled   GDELAy [ :SENSe ] :SWEep:EGATe:DELAy:COMPensation:TYPE?</pre>
Example	<pre>SWE:EGAT:DEL:COMP:TYPE SETT SWE:EGAT:DEL:COMP:TYPE?</pre>
Notes	<p>Although this function is Meas Global, there are some measurements that do not support this function. In those measurements the operation will be Uncompensated. Going into one of those measurements will not change the Meas Global selection; it will simply display the grayed-out menu key with "Uncompensated" showing as the selection. This is a non-forceful grayout, so the SCPI command is still accepted.</p> <p>If Gate Delay Compensation is not supported at all within a particular mode, the key is not displayed, and if the SCPI command is sent while in a measurement within that mode, an "Undefined Header" message is generated.</p> <p>Measurements that do not support this function include:</p>

Swept SA	
Preset	TD-SCDMA mode: Compensate for RBW Group Delay All other modes: Delay Until RBW Settled
State Saved	Saved in instrument state
Range	Uncompensated Delay Until RBW Settled Compensate for RBW Group Delay
Readback text	Uncompensated Settled Group Delay
Initial S/W Revision	Prior to A.02.00
Modified at S/W Revision	A.11.0

### More Information

Selecting Uncompensated means that the actual gate delay is as you sets it.

Selecting Delay Until RBW Settled causes the gate delay to be increased above the user setting by an amount equal to  $3.06/\text{RBW}$ . This compensated delay causes the GATE START and GATE STOP lines on the display to move by the compensation amount, and the actual hardware gate delay to be increased by the same amount. All the other gate lines (for example, MIN FAST) are unaffected. If the RBW subsequently changes, the compensation is readjusted for the new RBW. The value shown on the Gate Delay key does NOT change.

Delay Until RBW Settled allows excellent measurements of gated signals, by allowing the IF to settle following any transient that affects the burst. Excellent measurements also require that the analysis region not extend into the region affected by the falling edge of the burst. Thus, excellent measurements can only be made over a width that declines with narrowing RBWs, which is achieved by decreasing the gate length below the user setting by an amount equal to  $2.53/\text{RBW}$ . Therefore, for general purpose compensation, you will still want to change the gate length with changes in RBW even if the gate delay is compensated. The compensated Gate Length is limited by the analyzer so that it will never go below 10% of the value shown on the Gate Length key, as otherwise the sweep times could get very long. Anytime the Gate Length and RBW values combine in such a way that this limiting takes place, a warning is displayed. For measurements which contain multiple sweeps with different RBW like SEM and SPUR, the smallest RBW is used for this limiting.

Selecting Compensate for RBW Group Delay causes the gate delay to be increased above the user setting by an amount equal to  $1.81/\text{RBW}$ . This compensated delay causes the GATE START, GATE STOP lines on the display to move by the compensation amount, and the actual hardware gate delay to be increased by the same amount. All the other gate lines (for example, MIN FAST) are unaffected. If the RBW subsequently changes, the compensation is readjusted for the new RBW. The value shown on the Gate Delay key does NOT change. Compensate for RBW Group Delay also includes gate length compensation; the gate length itself is adjusted as necessary to attempt to compensate for delay effects imposed by the RBW.

Compensate for RBW Group Delay is similar to Delay Until RBW Settled, but compensates for the group delay of the RBW filter, rather than the filter settling time. As the RBW gets narrow, this can allow the settling tail of the RBW to affect the beginning part of the gated measurement, and allow the beginning of the RBW settling transient to affect the end of the gated measurement. These two effects are symmetric

because the RBW response is symmetric. Because the gate length is not automatically compensated, some users might find this compensation to be more intuitive than compensation for RBW settling.

### Min Fast Position Query (Remote Command Only)

This command queries the position of the MIN FAST line, relative to the delay reference (REF) line. See section "Gate View On/Off" on page 2040. If this query is sent while not in gate view, the MinFast calculation is performed based on the current values of the appropriate parameters and the result is returned. Knowing this value lets you set an optimal gate delay value for the current measurement setup.

<b>Remote Command</b>	<code>[ :SENSe ] :SWEep:EGATe:MINFast?</code>
<b>Example</b>	<code>SWE:EGAT:MIN?</code>
<b>Initial S/W Revision</b>	Prior to A.02.00

### Gate Preset (Remote Command Only)

Presets the time-gated spectrum analysis capability.

This command sets gate parameter values to the ESA preset values, as follows:

Gate trigger type = edge

Gate polarity = positive

Gate delay = 1 us

Gate length = 1 us

<b>Remote Command</b>	<code>[ :SENSe ] :SWEep:TIME:GATE:PRESet</code> ESA Compatibility
<b>Initial S/W Revision</b>	Prior to A.02.00

### Gate Level (Remote Command Only)

Sets the gate input transition point level for the external TRIGGER inputs on the front and rear panel. This is a legacy command for PSA compatibility. It is simply an alias to the equivalent trigger level command.

<b>Remote Command</b>	<code>[ :SENSe ] :SWEep:EGATe:EXTernal [ 1 ]   2 :LEVel &lt;voltage&gt;</code> <code>[ :SENSe ] :SWEep:EGATe:EXTernal [ 1 ]   2 :LEVel?</code>
<b>Notes</b>	This command is simply an alias to <code>:TRIGger[:SEQUence]:EXTernal[1]2:LEVel</code> For details refer
<b>Initial S/W Revision</b>	Prior to A.02.00

### Gate Polarity (Remote Command Only)

Sets the polarity for the gate signal. This setup is now done using the gate trigger's slope setting.

When Positive (Pos) is selected, a positive-going edge (Edge) or a high voltage (Level) will satisfy the gate condition, after the delay set with the Gate Delay key. When Negative (Neg) is selected, a negative-going edge (Edge) or a low voltage (Level) will satisfy the gate condition after the delay.

<b>Remote Command</b>	<code>[ :SENSe ] :SWEep:EGATe:POLarity NEGative POSitive</code> <code>[ :SENSe ] :SWEep:EGATe:POLarity?</code>
<b>Example</b>	<code>SWE:EGAT:POL NEG</code> <code>SWE:EGAT:POL?</code>
Preset	POSitive
State Saved	Saved in instrument state
<b>Backwards Compatibility SCPI</b>	<code>[ :SENSe ] :SWEep:TIME:GATE:POLarity</code> ESA compatibility
Initial S/W Revision	Prior to A.02.00

<b>Remote Command</b>	<code>[ :SENSe ] :SWEep:TIME:GATE:LEVel HIGH LOW</code> <code>[ :SENSe ] :SWEep:TIME:GATE:LEVel?</code> ESA compatibility
Preset	HIGH
Initial S/W Revision	Prior to A.02.00

## Points

Sets the number of points per sweep, from 1 to 20001. The sweep time resolution setting will depend on the number of points selected.

Key Path	Sweep/Control
Mode	SA, WCDMA, C2K, WIMAX OFDMA, TD-SCDMA, 1xEVDO, DVB-T/H, DTMB (CTTB), ISDB-T, CMMB, LTE, LTE-TDD, Digital Cable TV, MSR, LTEAFDD, LTEATDD
<b>Remote Command</b>	<code>[ :SENSe ] :ACPower:SWEep:POINts &lt;integer&gt;</code> <code>[ :SENSe ] :ACPower:SWEep:POINts?</code>
<b>Example</b>	<code>ACP:SWE:POIN 500</code> <code>ACP:SWE:POIN?</code>
Notes	Whenever the number of sweep points changes: <ul style="list-style-type: none"> <li>• All trace data is erased</li> <li>• Any traces with Update Off will also go to Display Off (like going from View to Blank in the older analyzers)</li> <li>• Sweep time is re-quantized</li> <li>• Any limit lines that are on will be updated</li> <li>• If averaging/hold is on, averaging/hold starts over</li> </ul>
Couplings	Whenever the number of sweep points changes, the sweep time is re-quantized.

---

Preset	Others: 1001 DVB-T/H:2001 DTMB (CTTB): 2001 ISDB-T: 2001 CMMB: 2001 Digital Cable TV: 2001
State Saved	Saved in instrument state.
Min	1
Max	20001
Initial S/W Revision	Prior to A.02.00
Modified at S/W Revision	A.02.00, A.03.00

---

## System

See "System" on page 342

## Trace/Detector

Accesses a menu of functions that enable you to control the detectors for the current measurement.

Key Path	Front-panel key
Initial S/W Revision	Prior to A.02.00

### Select Trace (Front-panel Only)

This key selects which trace the other parameters under the Trace/Detector menu will apply to.

Key Path	Trace/Detector
Notes	Front-panel only.
Couplings	When Meas Method is RBW or FAST, Select Trace is disabled.
Preset	1
State Saved	Saved in instrument state.
Range	1   2   3
Initial S/W Revision	Prior to A.02.00

### Trace Type

Allows you to select the type of trace for the current measurement. The first page of this menu contains a selection of the trace type (Clear Write, Trace Average, Max Hold, Min Hold) for the selected trace.

Key Path	Trace/Detector
Mode	SA, WCDMA, C2K, WIMAX OFDMA, TD-SCDMA, 1xEVDO, DVB-T/H, DTMB (CTTB), ISDB-T, CMMB, LTE, LTEFDD, Digital Cable TV, MSR, LTEAFDD, LTEATDD
<b>Remote Command</b>	:TRACe [1]   2   3 :ACPoweR:TYPE WRITe   AVERAge   MAXHold   MINHold :TRACe [1]   2   3 :ACPoweR:TYPE?
<b>Example</b>	TRAC:ACP:TYPE MINH TRAC:ACP:TYPE?
Notes	WRITe = Clear Write AVERAge = Average MAXHold = Maximum Hold MINHold = Minimum Hold
Couplings	When Detector setting is "Auto" ([:SENSe]:ACPoweR:DETEctor:AUTO?), Detector is set to what the Radio Standard defaults states (see detector section below) for all conditions of Trace Type and for all traces. When set to Manual, all Traces use the same detector type. When Average State = Off then Trace Types AVERAge, MaxHold and MinHold will not function, since Averaging is required to be 'on' for them to operate.



	When Meas Method is RBW or FAST, Trace Type is disabled.
Preset	AVERage
State Saved	Saved in instrument state.
Initial S/W Revision	Prior to A.02.00
Modified at S/W Revision	A.02.00, A.03.00

## View/Blank

Enables you to select how to view the displayed trace.

Key Path	Trace/Detector
Mode	SA,WCDMA, C2K, WIMAX OFDMA, TD-SCDMA, 1xEVDO, DVB-T/H, DTMB (CTTB), ISDB-T, CMMB, LTE, LTE-TDD, Digital Cable TV, MSR, LTEAFDD,LTEATDD
Notes	No remote control. Front panel only.
Couplings	The four states of this 1-of-N actually set two variables, Update and Display, to their four possible combinations. Trace On: Update and Display both On View: Update Off and Display On (Not implemented) Blank: Update Off and Display Off Background: Update On, Display Off (Not implemented) See tables below for detail on remote commands to control these two variables. Selecting a trace type (Clear Write, Trace Average, Max Hold, Min Hold) for a trace (pressing the key or sending the equivalent remote command) puts the trace in 'Trace On' state (Update On and Display On), even if that trace type was already selected. When Meas Method is RBW or FAST, this key is grayed out.
Preset	Trace On
State Saved	Saved in instrument state.
Range	Trace On Blank
Initial S/W Revision	Prior to A.02.00
Modified at S/W Revision	A.03.00

Key Path	Trace/Detector
Mode	WCDMA, C2K, WIMAX OFDMA, TD-SCDMA, 1xEVDO, DVB-T/H, DTMB (CTTB), ISDB-T, CMMB, LTE, LTE-TDD, Digital Cable TV, MSR, LTEAFDD,LTEATDD
<b>Remote Command</b>	:TRACe [1]   2   3 :ACPpower:UPDate [:STATe] ON OFF 0 1 :TRACe [1]   2   3 :ACPpower:UPDate [:STATe] ?
<b>Example</b>	TRAC:ACP:UPD ON TRAC:ACP:UPD?
Couplings	Whenever you set Update to On for any trace, the Display is set to On for that trace. When Meas Method is RBW or FAST, Trace Update is disabled.
Preset	1 0 0 (On for Trace 1; Off for 2 & 3)

State Saved	Saved in instrument state.
Range	0 1
Initial S/W Revision	Prior to A.02.00
Modified at S/W Revision	A.03.00

Key Path	Trace/Detector
Mode	WCDMA, C2K, WIMAX OFDMA, TD-SCDMA, 1xEVDO, DVB-T/H, DTMB (CTTB), ISDB-T, CMMB, LTE, LTETDD, Digital Cable TV, MSR, LTEAFDD, LTEATDD
<b>Remote Command</b>	:TRACe [1]   2   3 :ACPoweR:DISPlay [ :STATe] ON OFF 0 1 :TRACe [1]   2   3 :ACPoweR:DISPlay [ :STATe] ?
<b>Example</b>	TRAC:ACP:DISP ON TRAC:ACP:DISP?
Couplings	Whenever you set Update to On for any trace, the Display is set to On for that trace. When Meas Method is RBW or FAST, Trace Display is disabled.
Preset	1 0 0 (On for Trace 1; Off for 2 & 3)
State Saved	Saved in instrument state.
Range	0 1
Initial S/W Revision	Prior to A.02.00
Modified at S/W Revision	A.03.00

## Detector

Accesses a menu of functions that enables you to control the detectors for the current measurement. Allows up to three (3) traces, but each use the same detector type choice. The following choices are available:

- Auto—the detector selected is set to AVERage, unless the Radio Standard defaults state otherwise e.g. it is set to Peak for Radio Standard = PDC when Device = both MS and BTS, and when Radio Standard = NADC and Device = MS.
- Normal—the detector determines the peak of the CW-like signals, and it yields alternating maximums and minimums of noise-like signals. This is also referred to as Rosenfell detection.
- Average—the detector determines the average of the signal within the sweep points. The averaging method is Power (RMS).
- Peak—the detector determines the maximum of the signal within the sweep points.
- Sample—the detector indicates the instantaneous level of the signal at the center of the sweep points represented by each display point.
- Negative Peak—the detector determines the minimum of the signal within the sweep points.

In swept analysis, the time interval of the data collection for the display sweep points also represents a frequency interval. In FFT analysis, the sweep points represents just a frequency interval. The detector

determines the relationship between the spectrum computed by the FFT and the single data point displayed for the sweep points.

Key Path	Trace/Detector
Initial S/W Revision	Prior to A.02.00

## Auto

Sets the detector for the currently selected trace to auto.

Key Path	Trace/Detector
Mode	SA, WCDMA, C2K, WIMAX OFDMA, TD-SCDMA, 1xEVDO, DVB-T/H, DTMB (CTTB), ISDB-T, CMMB, LTE, LTE-TDD, Digital Cable TV, MSR, LTEAFDD, LTEATDD
<b>Remote Command</b>	<code>[ :SENSe ] :ACPower:DETECTOR:AUTO ON OFF 1 0</code> <code>[ :SENSe ] :ACPower:DETECTOR:AUTO?</code>
<b>Example</b>	ACP:DET:AUTO 1 ACP:DET?
Couplings	When Detector setting is "Auto" ( <code>[ :SENSe ] :ACPower:DETECTOR:AUTO?</code> ), Detector is set to what the Radio Standard defaults states (see detector section) for all conditions of Trace Type and for all traces. When set to Manual, all Traces use the same detector type. When Average State = Off then Trace Types AVERage, MaxHold and MinHold will not function, since Averaging is required to be 'on' for them to operate.
Preset	ON
State Saved	Saved in instrument state.
Range	ON OFF
Initial S/W Revision	Prior to A.02.00
Modified at S/W Revision	A.02.00, A.03.00

## Detector Selection

Selects a detector to be used by the analyzer for the current measurement. All traces will use the same detector type, similar to Monitor Spectrum measurement

Key Path	Trace/Detector
Mode	SA, WCDMA, C2K, WIMAX OFDMA, TD-SCDMA, 1xEVDO, DVB-T/H, DTMB (CTTB), ISDB-T, CMMB, LTE, LTE-TDD, Digital Cable TV, MSR, LTEAFDD, LTEATDD
<b>Remote Command</b>	<code>[ :SENSe ] :ACPower:DETECTOR[:FUNCTION] AVERage   NEGative   NORMal   POSitive   SAMPlE</code> <code>[ :SENSe ] :ACPower:DETECTOR[:FUNCTION]?</code>
<b>Example</b>	ACP:DET NORM ACP:DET?
Notes	When you manually select a detector (instead of selecting Auto), that detector is used regardless of

---

other analyzer settings.

The detector choices are:

- The Normal detector determines the peak of CW-like signals, and it yields alternating maximums and minimums of noise-like signals. This is also referred to as Rosenfell detection.
- The Average detector determines the average of the signal within the data range. The averaging method is Power (RMS).
- The Peak detector determines the maximum of the signal within the data range.
- The Sample detector indicates the instantaneous level of the signal at the center of the data represented by each display point.
- The Negative Peak detector determines the minimum of the signal within the data range.

Because they may not find a spectral component's true peak, neither average nor sample detectors measure amplitudes of CW signals as accurately as peak or normal, but they do measure noise without the biases of peak detection.

When a detector selection is made, the menu returns to the previous menu.

---

Couplings	When Detector setting is "Auto" (:SENSe]:ACPower:DETECTOR:AUTO?), Detector is set to what the Radio Standard defaults states (see detector section) for all conditions of Trace Type and for all traces. When set to Manual, all Traces use the same detector type. When Average State = Off then Trace Types AVERage, MaxHold and MinHold will not function, since Averaging is required to be 'on' for them to operate.
-----------	---

Only one detector type for all 3 traces is allowed.

When Meas Method is RBW or FAST, Detector is disabled.

---

Preset	AVERage
--------	---------

---

State Saved	Saved in instrument state.
-------------	----------------------------

---

Range	Normal Average Peak Sample Negative Peak
-------	--

---

<b>Backwards Compatibility SCPI</b>	[ :SENSe ] :ACPR :SWEep :DETECTOR [ :FUNCTion ]
---	---

---

Initial S/W Revision	Prior to A.02.00
----------------------	------------------

---

Modified at S/W Revision	A.02.00, A.03.00
--------------------------	------------------

---

## Trigger

See ["Trigger" on page 412](#)

### Free Run

See ["Free Run " on page 419](#)

### Video

See ["Video \(IF Envelope\) " on page 420](#)

### Trigger Level

See ["Trigger Level " on page 420](#)

### Trig Slope

See ["Trig Slope " on page 421](#)

### Trig Delay

See ["Trig Delay " on page 422](#)

### Line

See ["Line " on page 2047](#)

### Trig Slope

See ["Trig Slope " on page 2047](#)

### Trig Delay

See ["Trig Delay " on page 424](#)

### External 1

See ["External 1 " on page 2059](#)

### Trigger Level

See ["Trigger Level " on page 2059](#)

### Trig Slope

See ["Trig Slope " on page 2060](#)

### Trig Delay

See ["Trig Delay " on page 427](#)

### External 2

See ["External 2 " on page 2061](#)

### **Trigger Level**

See "[Trigger Level](#) " on page 2061

### **Trig Slope**

See "[Trig Slope](#) " on page 2062

### **Trig Delay**

See "[Trig Delay](#) " on page 429

### **RF Burst**

See "[RF Burst](#) " on page 2062

### **Absolute Trigger**

See "[Absolute Trigger Level](#)" on page 2063

### **Relative Trigger**

See "[Relative Trigger Level](#)" on page 2052

### **Trig Slope**

See "[Trigger Slope](#) " on page 2064

### **Trig Delay**

See "[Trig Delay](#) " on page 433

### **Periodic Timer**

See "[Periodic Timer \(Frame Trigger\)](#) " on page 2054

### **Period**

See "[Period](#) " on page 2055

### **Offset**

See "[Offset](#) " on page 2056

### **Reset Offset Display**

See "[Reset Offset Display](#) " on page 2058

### **Sync Source**

See "[Sync Source](#) " on page 2058

### **Off**

See "[Off](#) " on page 2059

### External 1

See "External 1 " on page 2059

#### Trigger Level

See "Trigger Level " on page 2059

#### Trig Slope

See "Trig Slope " on page 2060

### External 2

See "External 2 " on page 2061

#### Trigger Level

See "Trigger Level " on page 2061

#### Trig Slope

See "Trig Slope " on page 2062

### RF Burst

See "RF Burst " on page 2062

### Absolute Trigger

See "Absolute Trigger Level" on page 2063

#### Trig Slope

See "Trigger Slope " on page 2064

### Trig Delay

See "Trig Delay" on page 443

### Auto/Holdoff

See "Auto/Holdoff " on page 444

### Auto Trig

See "Auto Trig " on page 444

### Trig Holdoff

See "Trig Holdoff " on page 445

## User Preset

Accesses a menu that gives you the following three choices:

- User Preset – recalls a state previously saved using the Save User Preset function.
- User Preset All Modes – presets all of the modes in the analyzer
- Save User Preset– saves the current state for the current mode

Key Path	Front-panel key
Backwards Compatibility Notes	<p>User Preset is actually loading a state, and in legacy analyzers, it was possible to load a state without affecting the trace data, limit lines or correction data. Similarly it was possible to do a User Preset without affecting the trace data, limit lines or correction data.</p> <p>In the X-Series, “state” always includes all of this data; so whenever state is loaded, or User Preset is executed, all of the traces, limit lines and corrections are affected. Although this differs from previous behavior, it is desirable behavior, and should not cause adverse issues for users.</p> <p>On ESA and PSA, User Preset affected the entire instrument’s state. In the X-Series, User Preset only recalls the state for the active mode. There is a User Preset file for each mode. User Preset can never cause a mode switch as it can in legacy analyzers. If you want to recall all modes to their user preset file state, you will need to do a User Preset after mode switching into each mode.</p> <p>User Preset recalls mode state which can now include data like traces; whereas on ESA and PSA, User Preset did not affect data.</p>
Initial S/W Revision	Prior to A.02.00

## User Preset

User Preset sets the state of the currently active mode back to the state that was previously saved for this mode using the Save User Preset menu key or the SCPI command, SYST:PRES:USER:SAV. It not only recalls the Mode Preset settings, but it also recalls all of the mode persistent settings, and the Input/Output system setting that existed at the time Save User Preset was executed.

If a Save User Preset has not been done at any time, User Preset recalls the default user preset file for the currently active mode. The default user preset files are created if, at power-on, a mode detects there is no user preset file. There will never be a scenario when there is no user preset file to restore. For each mode, the default user preset state is the same state that would be saved if a Save User Preset is performed in each mode right after doing a Restore Mode Default and after a Restore Input/Output Defaults.

The User Preset function does the following:

- Aborts the currently running measurement.
- Sets the mode State to the values defined by Save User Preset.
- Makes the saved measurement for the currently running mode the active measurement.
- Brings up the saved menu for the power-on mode.
- Clears the input and output buffers.
- Sets the Status Byte to 0.



Key Path	User Preset
<b>Remote Command</b>	:SYSTem:PRESet:USER
<b>Example</b>	:SYST:PRES:USER:SAVE:SYST:PRES:USER
Notes	:SYST:PRES:USER:SAVE is used to save the current state as the user preset state. Clears all pending OPC bits. The Status Byte is set to 0. Pressing the User Preset front-panel key while already in the User Preset menu will cause the User Preset to get executed
Couplings	A user preset will cause the currently running measurement to be aborted and cause the saved measurement to be active. Recalling a User Preset file has the same issues that recalling a Save State file has. Some settings may need to be limited and therefore re-coupled, since the capabilities of the mode may have changes when the User Preset file was last saved.
Initial S/W Revision	Prior to A.02.00

## User Preset All Modes

Recalls all of the User Preset files for each mode, switches to the power-on mode, and activates the saved measurement from the power-on mode User Preset file.

### NOTE

When the instrument is secured, all of the user preset files are converted back to their default user preset files.

The User Preset function does the following:

- Aborts the currently running measurement.
- Switches the Mode to the power-on mode.
- Restores the User Preset files for each mode.
- Makes the saved measurement for the power-on mode the active measurement.
- Brings up the saved menu for the power-on mode.
- Clears the input and output buffers.
- Sets the Status Byte to 0.

Key Path	User Preset
<b>Remote Command</b>	:SYSTem:PRESet:USER:ALL
<b>Example</b>	:SYST:PRES:USER:SAVE:SYST:PRES:USER:ALL
Notes	Clears all pending OPC bits. The Status Byte is set to 0. :SYST:PRES:USER:SAVE is used to save the current state as the user preset state.
Couplings	A user preset will cause the currently running measurement to be aborted, cause a mode switch to the power-on mode, and cause the saved measurement to be active in the power-on mode. Recalling a User Preset file has the same issues that recalling a Save State file has. Some settings may need to be limited and therefore re-coupled, since the capabilities of the mode may have changes when the User Preset file was last saved.
Initial S/W Revision	Prior to A.02.00

## Save User Preset

Saves the currently active mode and its State. You can recall this User Preset file by pressing the User Preset menu key or sending the SYST:PRES:USER remote command. This same state is also saved by the Save State function.

Key Path	User Preset
Remote Command	:SYSTem:PRESet:USER:SAVE
Example	:SYST:PRES:USER:SAVE
Notes	:SYST:PRES:SAVE creates the same file as if the user requested a *SAV or a MMEM:STOR:STAT, except User Preset Save does not allow the user to specify the filename or the location of the file.
Initial S/W Revision	Prior to A.02.00

## View/Display

Accesses a menu of functions that enable you to control the instrument display as well as turn the bar graph On and Off.

If current mode is NOT MSR and LTE-Advanced FDD/TDD mode, the front panel views only contain one view: Spectrum View.

The results of the measurement can be displayed as a single spectrum trace view or displayed with a Bar Graph trace on the spectrum trace.

The display consists of the following two windows:

"Spectrum Window" on page 869

"Results Window" on page 869

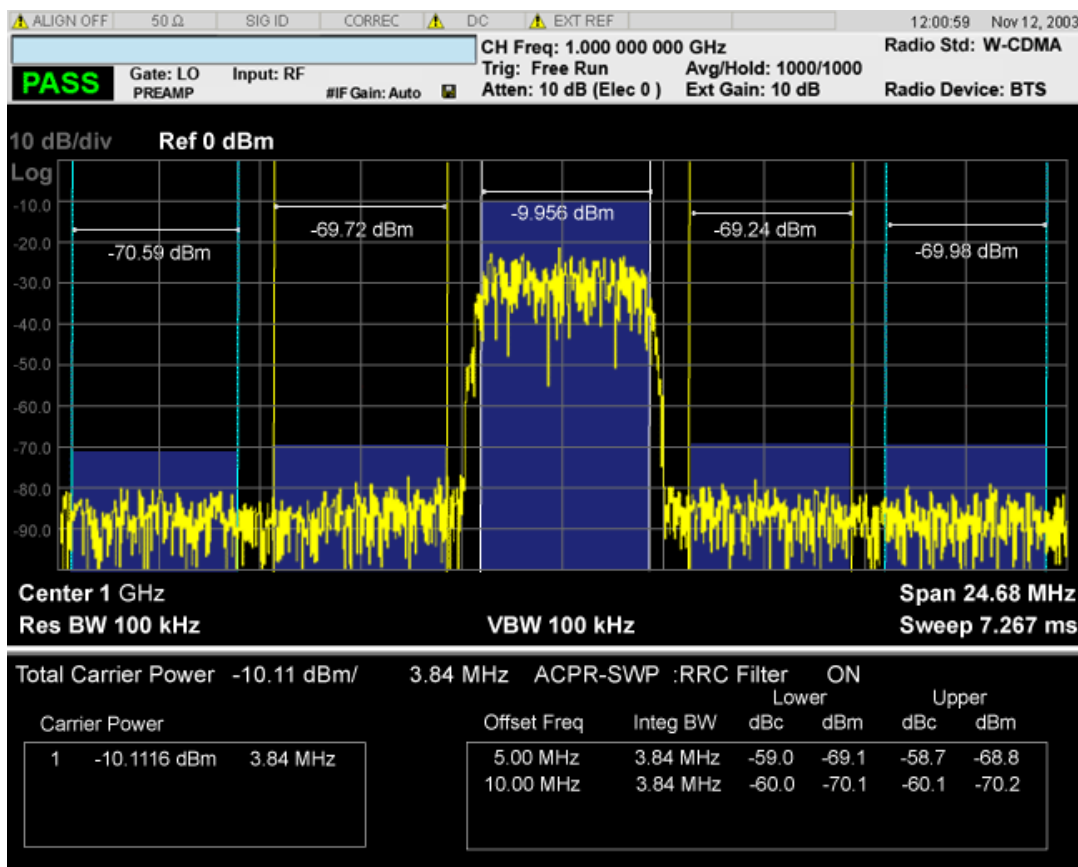

The following two views are only for DTMB (CTTB) and CMMB:

DTMB and CMMB Transmitter:

9 ACP Measurement  
View/Display

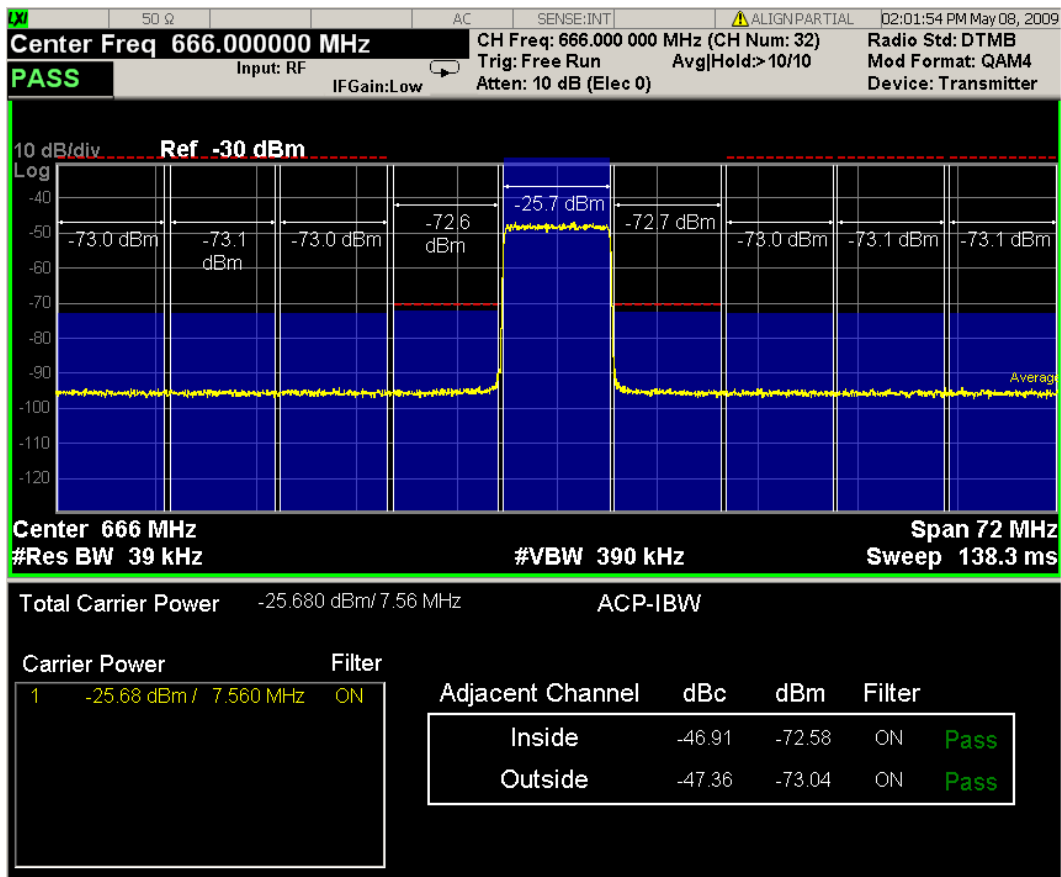

DTMB and CMMB Exciter:

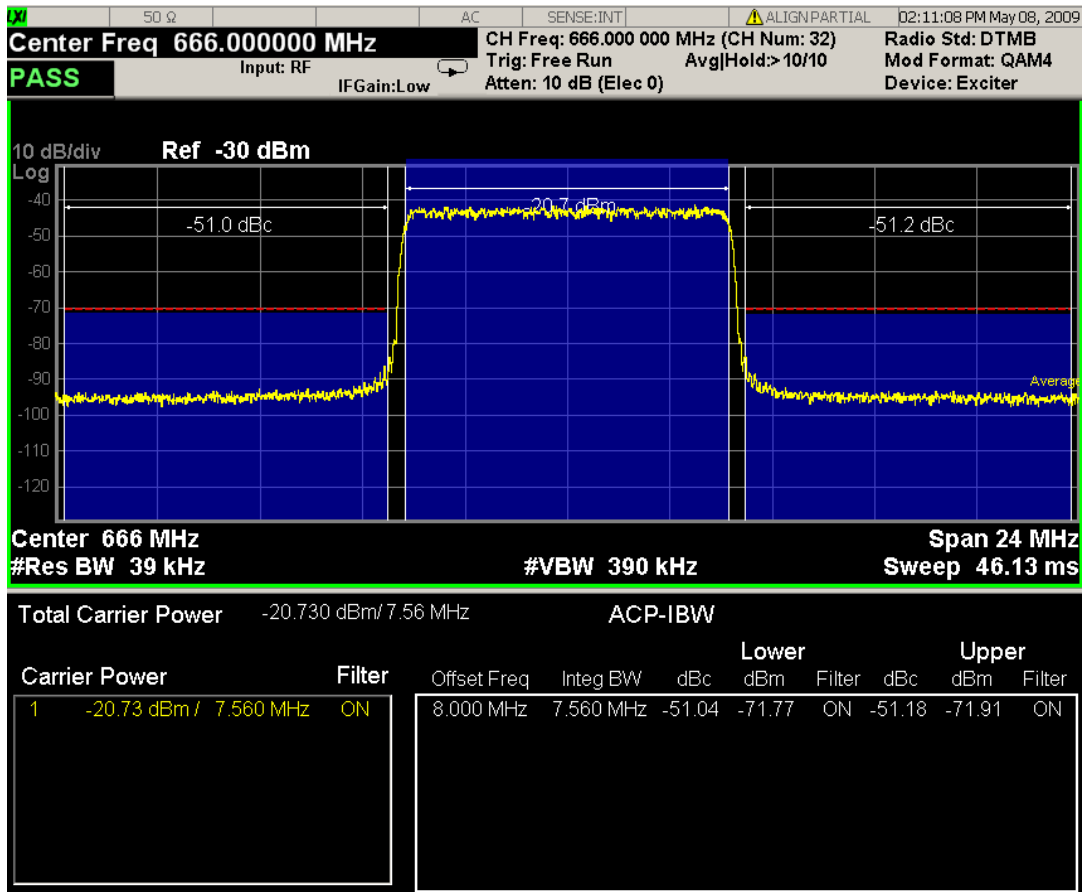

## Spectrum Window

When the Bar Graph is On and Limit Test is On, the color of each bar graph reflects the limit test result. When the limit test fails, the bar color is red, and when limit test passes, the bar color is blue.

When RBW is selected as the measurement method, the spectrum trace is not displayed, only the bar graph is displayed. In addition, the Bar Graph key (under the View/Display front-panel key) is set to ON and is grayed out.

The RRC Filter display item is only displayed when RRC filter is on.

## Results Window

The text window displays the following results:

### Total Carrier Power

This is the total power of all the carriers with carrier power present set to yes. The power is calculated by integrating across the bandwidth declared by the Carrier Integ Bw parameter for each carrier and then totaling the sums. The total integration bandwidth is shown as part of the result. This will be the total of the Carrier Integ Bw of the carriers used in calculating the total carrier power. If the RRC Filter is on, then the integration bandwidth used is  $(1 + \alpha)/T$  where  $T = 1/(\text{Carrier Integ Bw})$  multiplied by the number of carriers with carrier power present set to yes.

### Ref Carrier Power

This is the power in the reference carrier. The power is calculated by integrating across the bandwidth declared by the Carrier Integ Bw parameter for that carrier. The integration bandwidth is shown as part of the result. This is the value of the Carrier Integ Bw for that carrier unless the RRC Filter is on, then the integration bandwidth used is the displayed value, which is  $(1 + \alpha)/T$  where  $T = 1/(\text{Carrier Integ Bw})$ .

#### **Carrier Power**

This is the power in all the currently defined carriers. If the carrier has carrier power present, the power will be absolute. If the carrier is defined as not having power present, the power will be relative to the reference carrier. The power is calculated by integrating across the bandwidth declared by the Carrier Integ Bw parameter. The integration bandwidth is shown as part of the result. This is the value of the Carrier Integ Bw for the carrier unless the RRC Filter is on, then the integration bandwidth used is the displayed value, which is  $(1 + \alpha)/T$  where  $T = 1/(\text{Carrier Integ Bw})$ .

As there are potentially more results than can be easily viewed on the display, a scrollable list is used to display all results. The Carrier Results menu key is used to index the carrier amplitude results. This key is grayed out unless the measurement is in single mode (as in continual measurement mode). The display is continuously updating and will not need to be accessed. The currently selected Carrier Result is displayed on the last line of the carrier power result list unless:

- The selected Carrier Result is 4 or less in normal multi carrier power results view. In this case the first 4 carrier power results will be displayed.
- The selected Carrier Result is 9 or greater in normal multi carrier power results view. In this case the last 4 carrier power results will be displayed.
- The zoom mode is selected. In this case all carrier power ranges can be displayed.

#### **Offset Relative Power**

This is the power in the offsets relative to the reference carrier. The power is calculated by integrating across the bandwidth declared by the Offset Integ Bw parameter. The offset integration bandwidth is shown as part of the result. This is the value on the Offset Integ Bw menu key unless the RRC Filter is on, then the integration bandwidth used is the displayed value, which is  $(1 + \alpha)/T$  where  $T = 1/(\text{Offset Integ Bw})$ .

#### **Offset Absolute Power**

This is the absolute power in the offsets. The power is calculated by integrating across the bandwidth declared by the Offset Integ Bw parameter. The offset integration bandwidth is shown as part of the result. This is the value on the Offset Integ Bw menu key unless the RRC Filter is on, then the integration bandwidth used is the displayed value, which is  $(1 + \alpha)/T$  where  $T = 1/(\text{Offset Integ Bw})$ .

#### **Inside Adjacent Channel Power (DTMB (CTTB) and CMMB only)**

This result is only valid for DTMB (CTTB) transmitter and CMMB transmitter. It contains two parts: Relative Power and Absolute Power. The power is calculated by integrating across the bandwidth (Integ Bw) at the frequency Offset A.

Inside Absolute Power = MAX (P<sub>Lower Offset A</sub>, P<sub>Upper Offset A</sub>);

Inside Relative Power = Inside Absolute Power – Carrier Power;

#### **Outside Adjacent Channel Absolute Power (DTMB (CTTB) and CMMB only)**

This result is only valid for DTMB (CTTB) transmitter and CMMB transmitter. It contains two parts: Relative Power and Absolute Power. The power is the Root-Mean-Square of the power calculated by integrating across the bandwidth (Integ Bw) at frequency Offset B, C and D.

$$\text{Outside Absolute Power} = \sqrt{\frac{P_{\text{Lower OffsetB}}^2 + P_{\text{Upper OffsetB}}^2 + P_{\text{Lower OffsetC}}^2 + P_{\text{Upper OffsetC}}^2 + P_{\text{Lower OffsetD}}^2 + P_{\text{Upper OffsetD}}^2}{6}}$$

Outside Relative Power = Outside Absolute Power – Carrier Power;

If current mode is MSR, there are two views, Result Trace and Carrier Info.

**NOTE**

Y Scale/Div, Y Ref Position, Y Auto Scale, Y Ref Value and Bar Graph affect both views. For example, power bars on the traces in both views appear or disappear when Bar Graph is toggled.

View Selection by Name (MSR and LTE-Advanced FDD/TDD Only)

Selects the results view. The following SCPI command allows you to select the desired measurement view by enumeration.

Key Path	No equivalent front-panel key
Mode	MSR, LTEAFDD,LTEATDD
Remote Command	:DISPlay:ACPower:VIEW[:SElect] PRESult CINformation :DISPlay:ACPower:VIEW[:SElect]?
Example	DISP:ACP:VIEW PRES DISP:ACP:VIEW?
Notes	This SCPI is only available in MSR and LTE-Advanced FDD/TDD.
Preset	PRESult
State Saved	Saved in instrument state
Range	Power Results Carrier Info
Initial S/W Revision	A.10.00

Key Path	No equivalent front-panel key
Mode	MSR, LTEAFDD,LTEATDD
Remote Command	:DISPlay:ACPower:VIEW:NSElect <integer> :DISPlay:ACPower:VIEW:NSElect?
Example	DISP:ACP:VIEW:NSEL 1 DISP:ACP:VIEW:NSEL?
Notes	This SCPI is only available in MSR and LTE-Advanced FDD/TDD.
Preset	1
State Saved	Saved in instrument state
Min	1
Max	2
Initial S/W Revision	A.10.00

---

Key Path	Front-panel key
Initial S/W Revision	Prior to A.02.00

---

## Display

The Display menu is common to most measurements, and is used for configuring items on the display. Some Display menu settings apply to all the measurements in a mode, and some only to the current measurement. Those under the System Display Settings key apply to all measurements in all modes.

---

Key Path	Display
Key Path	View/Display
Initial S/W Revision	Prior to A.02.00

---

## Annotation

Turns on and off various parts of the display annotation. The annotation is divided up into four categories:

1. Meas Bar: This is the measurement bar at the top of the screen. It does not include the settings panel or the Active Function. Turning off the Meas Bar turns off the settings panel and the Active Function. When the Meas Bar is off, the graticule area expands to fill the area formerly occupied by the Meas Bar.
2. Screen Annotation: this is the annotation and annunciation around the graticule, including any annotation on lines (such as the display line, the threshold line, etc.) This does NOT include the marker number or the N dB result. When off, the graticule expands to fill the entire graticule area.
3. Trace annotation: these are the labels on the traces, showing their detector (or their math mode).
4. Active Function annotation: this is the active function display in the meas bar, and all of the active function values displayed on softkeys.

See the figure below. Each type of annotation can be turned on and off individually.



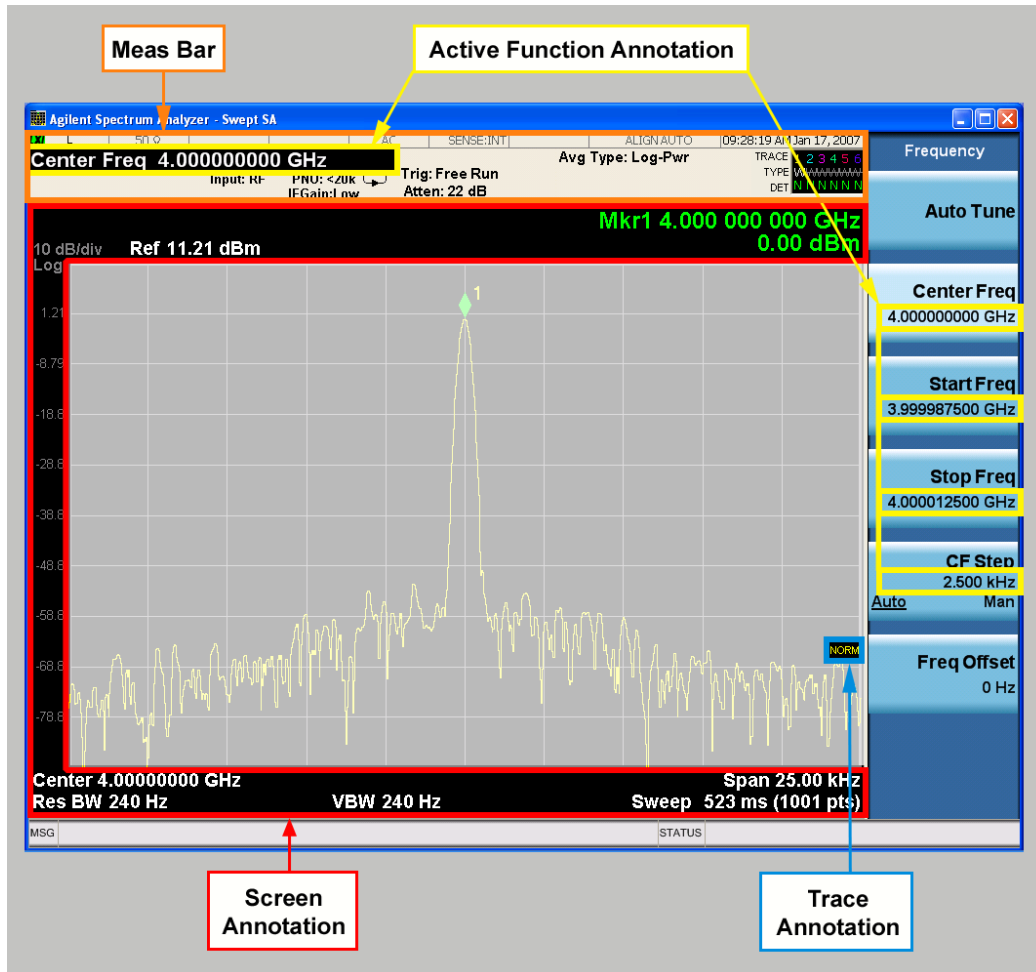

Key Path	View/Display, Display
Initial S/W Revision	Prior to A.02.00

### Meas Bar On/Off

This function turns the Measurement Bar on and off, including the settings panel. When off, the graticule area expands to fill the area formerly occupied by the Measurement Bar.

Key Path	View/Display, Display, Annotation
<b>Remote Command</b>	:DISPlay:ANNotation:MBAR[:STATE] OFF ON 0 1 :DISPlay:ANNotation:MBAR[:STATE]?
<b>Example</b>	DISP:ANN:MBAR OFF
Dependencies	Grayed out and forced to OFF when System Display Settings, Annotation is set to Off.
Preset	On This should remain Off through a Preset when System DisplaySettings, Annotation is set to Off.
State Saved	Saved in instrument state.
Initial S/W Revision	Prior to A.02.00

## Screen

This controls the display of the annunciation and annotation around the graticule, including any annotation on lines (such as the display line, the threshold line, etc.) and the y-axis annotation. This does NOT include marker annotation (or the N dB result). When off, the graticule expands to fill the entire graticule area, leaving only the 1.5% gap above the graticule as described in the Trace/Detector chapter.

<b>Key Path</b>	View/Display, Display, Annotation
<b>Remote Command</b>	:DISPlay:ANNotation:SCReen[:STATe] OFF ON 0 1 :DISPlay:ANNotation:SCReen[:STATe]?
<b>Example</b>	DISP:ANN:SCR OFF
<b>Dependencies</b>	Grayed-out and forced to OFF when System Display Settings, Annotation is set to Off.
<b>Preset</b>	On This should remain Off through a Preset when System DisplaySettings, Annotation is set to Off
<b>State Saved</b>	Saved in instrument state.
<b>Initial S/W Revision</b>	Prior to A.02.00

## Active Function Values On/Off

Turns on and off the active function display in the Meas Bar, and all of the active function values displayed on the softkeys.

Note that all of the softkeys that have active functions have these numeric values blanked when this function is on. This is a security feature..

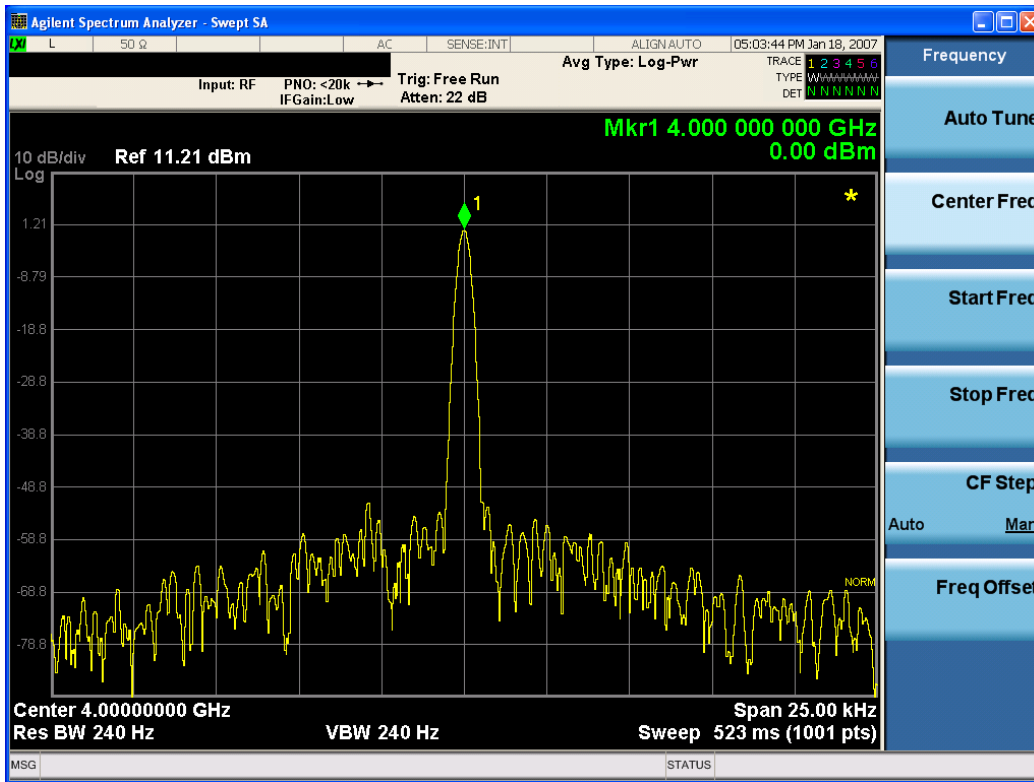

Key Path	View/Display, Display, Annotation
Remote Command	:DISPlay:ACTivefunc[:STATE] ON OFF 1 0 :DISPlay:ACTivefunc[:STATE]?
Example	DISP:ACT OFF
Dependencies	Grayed out and forced to OFF when System Display Settings, Annotation is set to Off.
Preset	On This should remain Off through a Preset when System DisplaySettings, Annotation is set to Off
State Saved	Saved in instrument state.
Initial S/W Revision	Prior to A.02.00

## Title

Displays menu keys that enable you to change or clear a title on your display.

Key Path	View/Display, Display
Initial S/W Revision	Prior to A.02.00

## Change Title

Writes a title into the "measurement name" field in the banner, for example, "Swept SA".

Press Change Title to enter a new title through the alpha editor. Press Enter or Return to complete the entry. Press ESC to cancel the entry and preserve your existing title.

The display title will replace the measurement name. It remains for this measurement until you press Change Title again, or you recall a state, or a Preset is performed. A title can also be cleared by pressing Title, Clear Title.

**NOTE**

Notice the inclusion of the <measurement> parameter in the command below. Because each measurement remembers the Display Title, the command must be qualified with the measurement name. For the Swept SA measurement this is not the case; no <measurement> parameter is used when changing the Display Title for the Swept SA measurement.

Key Path	View/Display, Display, Title
Mode	All
Remote Command	:DISPlay:<measurement>:ANNotation:TITLe:DATA <string> :DISPlay:<measurement>:ANNotation:TITLe:DATA?
Example	DISP:ANN:TITL:DATA "This Is My Title" This example is for the Swept SA measurement in the Spectrum Analyzer mode. The SANalyzer <measurement> name is not used. DISP:ACP:ANN:TITL:DATA "This Is My Title" This example is for Measurements other than Swept SA. Both set the title to: This Is My Title
Notes	Pressing this key cancels any active function. When a title is edited the previous title remains intact (it is not cleared) and the cursor goes at the end so that characters can be added or BKSP can be used to go back over previous characters.
Preset	No title (measurement name instead)
State Saved	Saved in instrument state.
Initial S/W Revision	Prior to A.02.00

**Clear Title**

Clears a title from the front-panel display. Once cleared, the title cannot be retrieved. After the title is cleared, the current Measurement Name replaces it in the title bar.

Key Path	View/Display, Display, Title
Example	The following commands clear the title and restore the measurement's original title: DISP:ANN:TITL:DATA "" This example is for the Swept SA measurement in the Spectrum Analyzer mode. The SANalyzer <measurement> name is not used. DISP:ACP:ANN:TITL:DATA "" This example is for ACP; in measurements other than Swept SA the measurement name is required.
Notes	Uses the :DISPlay:<measurement>:ANNotation:TITLe:DATA <string> command with an empty string (in the Swept SA, the <measurement> is omitted).
Preset	Performed on Preset.
Initial S/W Revision	Prior to A.02.00

## Graticule

Pressing Graticule turns the display graticule On or Off. It also turns the graticule y-axis annotation on and off.

Key Path	View/Display, Display
Remote Command	:DISPlay:WINDow[1]:TRACe:GRATicule:GRID[:STATe] OFF ON 0 1 :DISPlay:WINDow[1]:TRACe:GRATicule:GRID[:STATe]?
Example	DISP:WIND:TRAC:GRAT:GRID OFF
Notes	The graticule is the set of horizontal and vertical lines that make up the grid/divisions for the x-axis and y-axis.
Preset	On
State Saved	Saved in instrument state
Initial S/W Revision	Prior to A.02.00

## System Display Settings

These settings are "Mode Global" – they affect all modes and measurements and are reset only by Restore Misc Defaults or Restore System Defaults under System.

Key Path	View/Display, Display
Initial S/W Revision	Prior to A.02.00

## Annotation Local Settings

This is a Mode Global override of the meas local annotation settings. When it is All Off, it forces ScreenAnnotation, Meas Bar, Trace, and Active Function Values settings to be OFF for all measurements in all modes. This provides the security based "annotation off" function of previous analyzers; hence it uses the legacy SCPI command.

When it is All Off, the Screen, Meas Bar, Trace, and Active Function Values keys under the Display, Annotation menu are grayed out and forced to Off. When Local Settings is selected, you are able to set the local annotation settings on a measurement by measurement basis.

Key Path	View/Display, Display, System Display Settings
Remote Command	:DISPlay:WINDow[1]:ANNotation[:ALL] OFF ON 0 1 :DISPlay:WINDow[1]:ANNotation[:ALL]?
Example	:DISP:WIND:ANN OFF
Preset	On (Set by Restore Misc Defaults)
State Saved	Not saved in instrument state.
Backwards Compatibility Notes	The WINDow parameter and optional subopcode is included for backwards compatibility but ignored – all windows are equally affected.
Initial S/W Revision	Prior to A.02.00

## Themes

Accesses a menu of functions that enable you to choose the theme to be used when saving the screen image.

The **Themes** option is the same as the **Themes** option under the **Display** and **Page Setup** dialogs. It allows you to choose between themes to be used when saving the screen image.

<b>Key Path</b>	Save, Screen Image
<b>Remote Command</b>	:MMEMory:STORe:SCReen:THEMe TDColor   TDMonochrome   FCOLor   FMONochrome  :MMEMory:STORe:SCReen:THEMe?
<b>Example</b>	:MMEM:STOR:SCR:THEM TDM
<b>Preset</b>	3D Color; Is not part of Preset, but is reset by Restore Misc Defaults or Restore System Defaults All and survives subsequent running of the modes.
<b>Readback</b>	3D Color   3D Mono   Flat Color   Flat Mono
<b>Backwards Compatibility Notes</b>	In ESA and PSA we offer the choice of "Reverse Bitmap" or "Reverse Metafile" when saving screen images. This is much like the "Flat Color" theme available in X-Series. Also, if you selected Reverse Bitmap AND a black & white screen image, that would be much like "Flat Monochrome". In other words, each of the X-Series themes has a similar screen image type in ESA/PSA. But they are not identical.
<b>Initial S/W Revision</b>	Prior to A.02.00

### 3D Color

Selects a standard color theme with each object filled, shaded and colored as designed.

<b>Key Path</b>	Save, Screen Image, Themes
<b>Example</b>	MMEM:STOR:SCR:THEM TDC
<b>Readback</b>	3D Color
<b>Initial S/W Revision</b>	Prior to A.02.00

### 3D Monochrome

Selects a format that is like 3D color but shades of gray are used instead of colors.

<b>Key Path</b>	Save, Screen Image, Themes
<b>Example</b>	MMEM:STOR:SCR:THEM TDM
<b>Readback</b>	3D Mono
<b>Initial S/W Revision</b>	Prior to A.02.00

## Flat Color

Selects a format that is best when the screen is to be printed on an ink printer.

Key Path	Save, Screen Image, Themes
<b>Example</b>	MMEM:STOR:SCR:THEM FCOL
Readback	Flat Color
Initial S/W Revision	Prior to A.02.00

## Flat Monochrome

Selects a format that is like Flat Color. But only black is used (no colors, not even gray), and no fill.

Key Path	Save, Screen Image, Themes
<b>Example</b>	MMEM:STOR:SCR:THEM FMON
Readback	Flat Mono
Initial S/W Revision	Prior to A.02.00

## Backlight

Accesses the display backlight on/off keys. This setting may interact with settings under the Windows "Power" menu.

When the backlight is off, pressing ESC, TAB, SPACE, ENTER, UP, DOWN, LEFT, RIGHT, DEL, BKSP, CTRL, or ALT turns the backlight on without affecting the application. Pressing any other key will turn backlight on and could potentially perform the action as well.

Key Path	View/Display, Display, System Display Settings
<b>Remote Command</b>	:DISPlay:BACKlight ON OFF :DISPlay:BACKlight?
Preset	ON (Set by Restore Misc Defaults)
Initial S/W Revision	Prior to A.02.00

## Backlight Intensity

An active function used to set the backlight intensity. It goes from 0 to 100 where 100 is full on and 0 is off. This value is independent of the values set under the Backlight on/off key.

Key Path	View/Display, Display, System Display Settings
<b>Remote Command</b>	:DISPlay:BACKlight:INTensity <integer> :DISPlay:BACKlight:INTensity?
<b>Example</b>	DISP:BACK:INT 50

Preset	100 (Set by Restore Misc Defaults)
Min	0
Max	100
Initial S/W Revision	Prior to A.02.00

## Bar Graph

Turns the Bar Graph On and Off.

Key Path	View/Display
Mode	SA, WCDMA, C2K, WIMAX OFDMA, TD-SCDMA, 1xEVDO, DVB-T/H, DTMB (CTTB), ISDB-T, CMMB, LTE, LTETDD, Digital Cable TV, MSR, LTEAFDD, LTEATDD
Remote Command	:DISPlay:ACPower:VIEW[1]:WINDow[1]:BGRaph OFF ON 0 1 :DISPlay:ACPower:VIEW[1]:WINDow[1]:BGRaph?
Example	DISP:ACP:VIEW:WIND:BGR OFF DISP:ACP:VIEW:WIND:BGR?
Notes	You must be in the mode that includes ACP measurements to use this command. Use :INSTrument:SElect to set the mode.
Dependencies	When the method is RBW, this key is always set to On and grayed out.
Preset	ON
State Saved	Saved in instrument state.
Range	On Off
Initial S/W Revision	Prior to A.02.00
Modified at S/W Revision	A.02.00, A.03.00



## 10 Power Stat CCDF Measurement

Many of the digitally modulated signals now look noise-like in the time and frequency domain. This means that statistical measurements of the signals can be a useful characterization. The Power Complementary Cumulative Distribution Function (CCDF) curves characterize the higher level power statistics of a digitally modulated signal. The curves can be useful in determining design parameters for digital communications systems.

For more details, see ["Power Stat CCDF Measurement Description" on page 885](#).

For measurement results and views, see ["View/Display" on page 1010](#).

This topic contains the following sections:

["Measurement Commands for Power Stat CCDF" on page 882](#)

["Remote Command Results for Power Stat CCDF" on page 883](#)

["Power Stat CCDF Measurement Description" on page 885](#)

## Measurement Commands for Power Stat CCDF

The following commands and queries can be used to retrieve the measurement results:

`:CONFigure:PStatistic`

`:CONFigure:PStatistic:NDEFault`

`:INITiate:PStatistic`

`:FETCh:PStatistic[n]?`

`:READ:PStatistic[n]?`

`:MEASure:PStatistic[n]?`

For more measurement related commands, see the SENSE subsystem, and the section "[Remote Measurement Functions](#)" on page 2165.

## Remote Command Results for Power Stat CCDF

The following table describes the results returned by the FETCh, MEASure, and READ queries listed above, according to the index value n.

n	Results Returned
0	Returns unprocessed I/Q trace data, as a series of trace point values, in volts. The I values are listed first in each pair, using the 0 through even-indexed values. The Q values are the odd-indexed values,
not specified or 1	Returns 10 scalar results: <ol style="list-style-type: none"> <li>1. Average input power (in dBm)</li> <li>2. Probability at the average input power level (in %)</li> <li>3. Power level that has 10% of the power</li> <li>4. Power level that has 1% of the power</li> <li>5. Power level that has 0.1% of the power</li> <li>6. Power level that has 0.01% of the power</li> <li>7. Power level that has 0.001% of the power</li> <li>8. Power level that has 0.0001% of the power</li> <li>9. Peak power (in dB)</li> <li>10.Count</li> </ol>
2	Returns a series of 5001 floating point numbers (in percent) that represent the current measured power stat trace. This is the probability at particular power levels (average power), in the following order: <ol style="list-style-type: none"> <li>1. Probability at 0.0 dB power</li> <li>2. Probability at 0.01 dB power</li> <li>3. Probability at 0.02 dB power</li> <li>...</li> <li>5000. Probability at 49.9 dB power</li> <li>5001. Probability at 50.0 dB power</li> </ol>
3	Returns a series of 5001 floating point numbers (in percent) that represent the Gaussian trace. This is the probability at particular power levels (average power), in the following order: <ol style="list-style-type: none"> <li>1. Probability at 0.0 dB power</li> <li>2. Probability at 0.01 dB power</li> <li>3. Probability at 0.02 dB power</li> <li>...</li> <li>5000. Probability at 49.9 dB power</li> <li>5001. Probability at 50.0 dB power</li> </ol>
4	Returns a series of 5001 floating point numbers (in percent) that represent the user-definable reference trace. This is the probability at particular power levels (average power), in the following order: <ol style="list-style-type: none"> <li>1. Probability at 0.0 dB power</li> <li>2. Probability at 0.01 dB power</li> <li>3. Probability at 0.02 dB power</li> <li>...</li> <li>5000. Probability at 49.9 dB power</li> <li>5001. Probability at 50.0 dB power</li> </ol>



## Power Stat CCDF Measurement Description

The power statistics CCDF measurement can be affected by many factors. For example, modulation filtering, modulation format, combining the multiple signals at different frequencies, number of active codes, and correlation between symbols on different codes with spread spectrum systems will all affect measurement results. These factors are all related to modulation and signal parameters. External factors such as signal compression and expansion by nonlinear components, group delay distortion from filtering, and power control within the observation interval also affect the measurement.

The power measured in power statistics CCDF curves is actually instantaneous envelope power defined by the equation:

$$P = (I^2 + Q^2) / Z_0$$

where I & Q are the quadrature voltage components of the waveform, and  $Z_0$  is the characteristic impedance.

A CCDF curve is defined by how much time the waveform spends at or above a given power level. The percent of time the signal spends at or above the level defines the probability for that particular power level. For capturing a lower probability down to 0.0001%, this measurement is made in the single mode by pressing Single. To make the power statistics CCDF measurement, the instrument uses digital signal processing (DSP) to sample the input signal in the channel bandwidth. The Gaussian distribution line as the band-limited Gaussian noise CCDF reference line, the user-definable reference trace, and the currently measured trace can be displayed on a semi-log graph. If the currently measured trace is above the user reference trace, it means that the higher peak power levels against the average power are included in the input signal.

Key Path	Meas
Initial S/W Revision	Prior to A.02.00

## AMPTD Y Scale

Accesses a menu of functions that enable you to set the vertical scale parameters. The parameter values are measurement independent except all Attenuation values, and the Internal Preamp selection, which are the same across all measurements.

Key Path	Front-panel key
Initial S/W Revision	Prior to A.02.00

### Attenuation

This menu controls the attenuator functions and interactions between the attenuation system components.

There are two attenuator configurations in the X-Series. One is a dual attenuator configuration consisting of a mechanical attenuator and an optional electronic attenuator. The other configuration uses a single attenuator with combined mechanical and electronic sections that controls all the attenuation functions. Different models in the X-Series come with different configurations.

See "[Dual Attenuator Configurations:](#)" on page 886

See "[Single Attenuator Configuration:](#)" on page 887

Most Attenuation settings are the same for all measurements – they do not change as you change measurements. Settings like these are called “Meas Global” and are unaffected by Meas Preset.

Key Path	AMPTD Y Scale
Scope	Meas Global
Dependencies	In measurements that support the I/Q inputs, this key is unavailable when I/Q is the selected input, and is replaced by the Range key in that case.
Readback Line	Contains a summary in [ ] brackets of the current total attenuation. See the descriptions of the , " <a href="#">(Mech) Atten</a> " on page 2102, and " <a href="#">Enable Elec Atten</a> " on page 2104 keys for more detail on the contributors to the total attenuation.  Note that when "Pre-Adjust for Min Clip" is on, this value can change at the start of every measurement.
Initial S/W Revision	Prior to A.02.00
Modified at S/W Revision	A.03.00

### Dual Attenuator Configurations:

Configuration 1: Mechanical attenuator + optional electronic attenuator

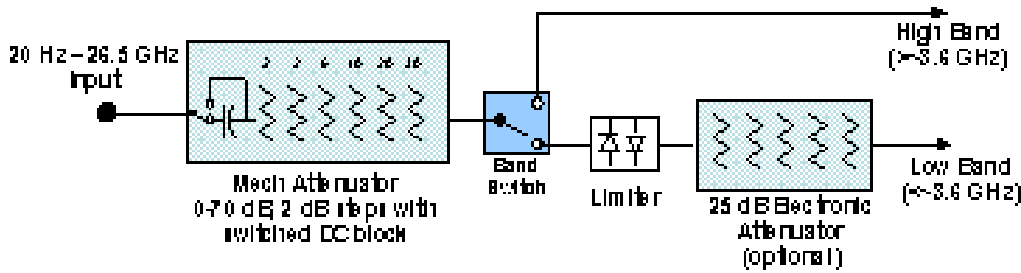

Configuration 2: Mechanical attenuator, no optional electronic attenuator

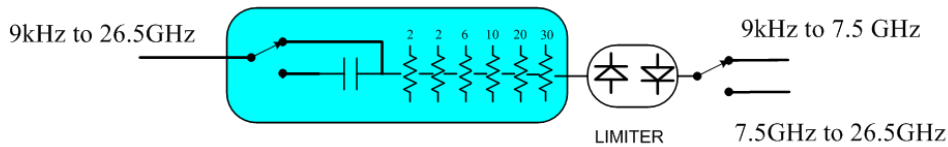

(note that Configuration 2 is not strictly speaking a dual-section attenuator, since there is no electronic section available. However, it behaves exactly like Configuration 1 without the Electronic Attenuator option EA3, therefore for the sake of this document it is grouped into the “Dual Attenuator” configuration)

**Single Attenuator Configuration:**

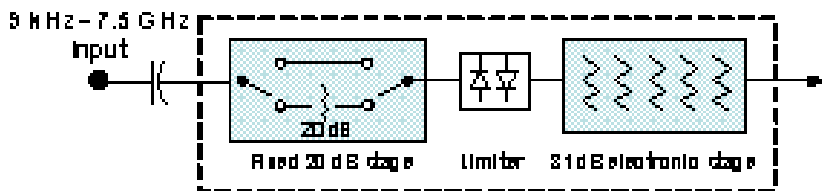

You can tell which attenuator configuration you have by pressing the Attenuation key, which (in most Modes) opens the Attenuation menu. If the first key in the Attenuation menu says Mech Atten you have the dual attenuator configuration. If the first key says Atten you have the single attenuator configuration.

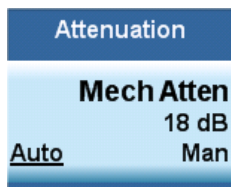

Dual Attenuator

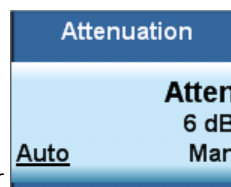

Single Attenuator

In the single attenuator configuration, you control the attenuation with a single control, as the fixed stage has only two states. In the dual attenuator configuration, both stages have significant range so you are given separate control of the mechanical and electronic attenuator stages.

When you have the dual attenuator configuration, you may still have only a single attenuator, because unless option EA3 (the Electronic Attenuator option) is available, and you purchase it, you will have only the mechanical attenuator.

## (Mech) Atten

This key is labeled Mech Atten in dual attenuator models and Atten in single attenuator models. In the dual attenuator configuration, this key only affects the mechanical attenuator.

This key lets you modify the attenuation applied to the RF input signal path. This value is normally auto coupled to the Ref Level, the Internal Preamp Gain, any External Gain that is entered, and the Max Mixer Level, as described in the table below.

See "[Attenuator Configurations and Auto/Man](#)" on page 889

<b>Key Path</b>	AMPTD Y Scale, Attenuation
<b>Remote Command</b>	<pre>[ :SENSe] :POWer [:RF] :ATTenuation &lt;rel_amp1&gt; [ :SENSe] :POWer [:RF] :ATTenuation? [ :SENSe] :POWer [:RF] :ATTenuation:AUTO OFF ON 0 1 [ :SENSe] :POWer [:RF] :ATTenuation:AUTO?</pre>
<b>Example</b>	<p>POW:ATT 20</p> <p>Dual attenuator configuration: sets the mechanical attenuator to 20 dB</p> <p>Single attenuator mode: sets the main attenuation to 20 dB (see below for definition of “main” attenuation).</p> <p>If the attenuator was in Auto, it sets it to Manual.</p>
<b>Dependencies</b>	<p>Some measurements do not support the Auto setting of (Mech) Atten. In these measurements, the Auto/Man selection is not available, and the Auto/Man line on the key disappears.</p> <p>In dual attenuator configurations, when the electronic attenuator is enabled, the mechanical attenuator has no auto setting and the Auto/Man line on the key disappears. The state of Auto/Man is remembered and restored when the electronic attenuator is once again disabled. This is described in more detail in the "<a href="#">Enable Elec Atten</a>" on page 2104 key description.</p> <p>See "<a href="#">Attenuator Configurations and Auto/Man</a>" on page 889 for more information on the Auto/Man functionality of Attenuation.</p>
<b>Couplings</b>	<p>When (Mech) Atten is in Auto, it uses the following algorithm to determine a value:</p> <p>If the USB Preamp is connected to USB, use 0 dB.</p> <p>Otherwise, <math>Atten = ReferenceLevel + PreAmpGain + ExternalGain - RefLevelOffset - MaxMixerLevel + IF\ Gain</math>.</p> <p>Limit this value to be between 6 dB and the Max value. No value below 6 dB can ever be chosen by Auto.</p> <p>The resulting value is rounded up to the largest value possible given the attenuation step setting. That is, 50.01 dB would change to 60 dB (for a 10 dB attenuation step).</p> <p>The “IF Gain” term in the equation above is either 0 dB or +10 dB, depending on the settings of FFT IF Gain, Swept IF Gain, max Ref Level and the Auto/Man setting of Mech Atten.</p> <p>In External Mixing and BBIQ, where the Attenuator is not in the signal path, the Attenuator setting changes as described above when (Mech) Atten is in Auto, but no changes are made to the actual attenuator hardware setting until the input is changed back to the RF Input.</p>
<b>Preset</b>	<p>The preset for Mech Attenuation is “Auto.”</p> <p>The Auto value of attenuation is:</p> <p>CXA, EXA, MXA and PXA: 10 dB</p>



State Saved	Saved in instrument state
Min	0 dB The attenuation set by this key cannot be decreased below 6 dB with the knob or step keys. To get to a value below 6 dB it has to be directly entered from the keypad or via SCPI. This protects from adjusting the attenuation to a dangerously small value which can put the instrument at risk of damage to input circuitry. However, if the current mechanical attenuation is below 6 dB it can be increased with the knob and step keys, but not decreased.
Max	CXA N9000A-503/507: 50 dB CXA N9000A-513/526: 70dB EXA: 60 dB MXA and PXA: 70 dB In the single attenuator configuration, the total of ATT and EATT cannot exceed 50 dB, so if the EATT is set to 24 dB first, the main attenuation cannot be greater than 26 dB and will be reduced accordingly; if the main attenuator is set to 40 dB first, EATT cannot be greater than 10 dB.
Initial S/W Revision	Prior to A.02.00
Modified at S/W Revision	A.03.00

### Attenuator Configurations and Auto/Man

As described in the Attenuation key description, there are two distinct attenuator configurations available in the X-Series, the single attenuator and dual attenuator configurations. In dual attenuator configurations, we have the mechanical attenuation and the electronic attenuation, and the current total attenuation is the sum of the electronic + mechanical attenuation. In single attenuator configurations, we refer to the attenuation set using the (Mech) Atten key (or POW:ATT SCPI) as the “main” attenuation; and the attenuation that is set by the SCPI command POW:EATT as the “soft” attenuation (the POW:EATT command is honored even in the single attenuator configuration, for compatibility purposes). Then the current total attenuation is the sum of the main + soft attenuation. See the Elec Atten key description for more on “soft” attenuation.

In the dual attenuator configuration, when the electronic attenuator is enabled, there is no Auto/Man functionality for the mechanical attenuator, and the third line of the key label (the Auto/Man line) disappears:

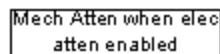
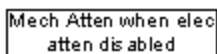
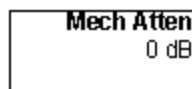
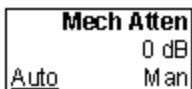

usdB

### Enable Elec Atten

Enables the Electronic Attenuator.

The electronic attenuator offers finer steps than the mechanical attenuator, has no acoustical noise, is faster, and is less subject to wear. These advantages primarily aid in remote operation and are negligible

for front panel use. See ["Using the Electronic Attenuator: Pros and Cons" on page 891](#) for a detailed discussion of the pros and cons of using the electronic attenuator.

For the single attenuator configuration, for SCPI backwards compatibility, the “soft” attenuation feature replaces the dual attenuator configuration’s electronic attenuator. All the same couplings and limitations apply. See ["Attenuator Configurations and Auto/Man" on page 2103](#)

See ["More Information" on page 890](#)

<b>Key Path</b>	AMPTD Y Scale, Attenuation
<b>Remote Command</b>	[ :SENSe ] :POWER [ :RF ] :EATTenuation :STATe OFF   ON   0   1 [ :SENSe ] :POWER [ :RF ] :EATTenuation :STATe?
<b>Example</b>	POW:EATT:STAT ON
<b>Dependencies</b>	<p>This key only appears in Dual Attenuator models with an Electronic Attenuator installed. It does not appear in models with the Single Attenuator configuration, as in the single attenuator configuration there is no “electronic attenuator” there is only a single integrated attenuator (which has both a mechanical and electronic stage). However, in the single attenuator configuration, EATT SCPI commands are accepted for compatibility with other X-series instruments and set a “soft” attenuation as described in <a href="#">"Attenuator Configurations and Auto/Man" on page 2103</a>.</p> <p>The electronic attenuator (and the “soft” attenuation function provided in single attenuator configurations) is unavailable above 3.6 GHz. Therefore, if the Stop Frequency of the analyzer is &gt; 3.6 GHz then the Enable Elec Atten key will be OFF and grayed out.</p> <p>If the Internal Preamp is on, meaning it is set to Low Band or Full, the electronic attenuator (and the “soft” attenuation function provided in single attenuator configurations) is unavailable. In this case the Enable Elec Atten key will be OFF and grayed out.</p> <p>If either of the above is true, if the SCPI command is sent, an error indicating that the electronic attenuator is unavailable will be sent.</p> <p>If the electronic/soft Attenuator is enabled, then the Stop Freq of the analyzer is limited to 3.6 GHz and the Internal Preamp is unavailable.</p> <p>The SCPI-only “soft” electronic attenuation for the single-attenuator configuration is not available in all measurements; in particular, it is not available in the Swept SA measurement.</p>
<b>Couplings</b>	Enabling and disabling the Electronic Attenuator affects the setting of the Mechanical Attenuator (in dual attenuator configurations). This is described in more detail below this table.
<b>Preset</b>	OFF for Swept SA measurement; ON for all other measurements that support the electronic attenuator
<b>State Saved</b>	Saved in instrument state
<b>Initial S/W Revision</b>	Prior to A.02.00
<b>Modified at S/W Revision</b>	A.03.00

## More Information

### Mechanical Attenuator Transition Rules

When the Electronic Attenuator is enabled, the Mechanical Attenuator transitions to a state that has no Auto function. Below are the rules for transitioning the Mechanical Attenuator. NOTE that the information

below ONLY applies to the dual attenuator configurations, and ONLY when the Electronic Attenuator is installed:

#### When the Electronic Attenuation is enabled from a disabled state:

- The Mechanical Attenuator is initialized to 10 dB (this is its optimal performance setting). You can then set it as desired with SCPI, numeric keypad, step keys, or knob, and it behaves as it normally would in manual mode
- The Auto/Man state of (Mech) Atten is saved
- The Auto/Man line on the (Mech) Atten key disappears and the auto rules are disabled
- The Electronic Attenuator is set to 10 dB less than the previous value of the Mechanical Attenuator, within the limitation that it must stay within the range of 0 to 24 dB of attenuation.

#### Examples in the dual attenuator configuration:

- Mech Atten at 20 dB. Elec Atten enabled, Mech Atten set to 10 dB, and Elec Atten set to 10 dB. New total attenuation equals the value before Elec Atten enabled.
- Mech Atten at 0 dB. Elec Atten enabled, Mech Atten set to 10 dB, and Elec Atten set to 0 dB. New total attenuation does not equal the value before Elec Atten enabled.
- Mech Atten at 40 dB. Elec Atten enabled, Mech Atten set to 10 dB, and Elec Atten set to 24 dB. New total attenuation does not equal the value before Elec Atten enabled.

#### When the Electronic Attenuation is disabled from an enabled state:

- The Elec Atten key is grayed out
- The Auto/Man state of (Mech) Atten is restored
- If now in Auto, (Mech) Atten recouples
- If now in Man, (Mech) Atten is set to the value of total attenuation that existed before the Elec Atten was disabled. The resulting value is rounded up to the smallest value possible given the (Mech) Atten Step setting - (That is, 57 dB changes to 58 dB when (Mech) Atten Step is 2 dB.)

#### Using the Electronic Attenuator: Pros and Cons

The electronic attenuator offers finer steps than the mechanical attenuator, has no acoustical noise, is faster, and is less subject to wear.

The “finer steps” advantage of the electronic attenuator is beneficial in optimizing the alignment of the analyzer dynamic range to the signal power in the front panel as well as remote use. Thus, you can achieve improved relative signal measurement accuracy. Compared to a mechanical attenuator with 2 dB steps, the 1 dB resolution of the electronic attenuator only gives better resolution when the odd-decibel steps are used. Those odd-decibel steps are less accurately calibrated than the even-decibel steps, so one tradeoff for this superior relative accuracy is reduced absolute amplitude accuracy.

Another disadvantage of the electronic attenuator is that the spectrum analyzer loses its “Auto” setting, making operation less convenient.

Also, the relationship between the dynamic range specifications (TOI, SHI, compression and noise) and instrument performance are less well-known with the electrical attenuator. With the mechanical

attenuator, TOI, SHI and compression threshold levels increase dB-for-dB with increasing attenuation, and the noise floor does as well. With the electronic attenuator, there is an excess attenuation of about 1 to 3 dB between 0 and 3.6 GHz, making the effective TOI, SHI, and so forth, less well known. Excess attenuation is the actual attenuation relative to stated attenuation. Excess attenuation is accounted for in the analyzer calibration

### Elec Atten

Controls the Electronic Attenuator in dual attenuator configurations. This key does not appear in single attenuator configurations, as the control of both the mechanical and electronic stages of the single attenuator is integrated into the single Atten key.

Key Path	AMPTD Y Scale, Attenuation
Remote Command	[ :SENSe ] :POWer [ :RF ] :EATTenuation <rel_ampl> [ :SENSe ] :POWer [ :RF ] :EATTenuation?
Notes	Electronic Attenuation's specification is defined only when Mechanical Attenuation is 6 dB.
Dependencies	This key only appears in Dual Attenuator models with an Electronic Attenuator installed. It does not appear in models with the Single Attenuator configuration, as in the single attenuator configuration there is no "electronic attenuator" there is only a single integrated attenuator (which has both a mechanical and electronic stage). However, in the single attenuator configuration, EATT SCPI commands are accepted for compatibility with other X-series instruments and set a "soft" attenuation as described in <a href="#">"Attenuator Configurations and Auto/Man" on page 2103</a> . The "soft" attenuation is treated as an addition to the "main" attenuation value set by the Atten softkey or the POW:ATT SCPI command and affects the total attenuation displayed on the Attenuation key and the Meas Bar.  When Enable Elec Atten is off or grayed out, the Elec Atten key is grayed out.
Preset	0 dB
State Saved	Saved in instrument state
Min	0 dB
Max	Dual attenuator configuration: 24 dB Single attenuator configuration: the total of ATT and EATT cannot exceed 50 dB, so if the EATT is set to 24 dB first, the main attenuation cannot be greater than 26 dB and will be reduced accordingly; if the main attenuator is set to 40 dB first, EATT cannot be greater than 10 dB
Initial S/W Revision	Prior to A.02.00
Modified at S/W Revision	A.03.00

### Adjust Atten for Min Clip

Sets the combination of mechanical and electronic attenuation and gain based on the current measured signal level so that clipping will be at a minimum.

This is an "immediate action" function, that is, it executes once, when the key is pressed.

This key is grayed out in measurements that do not support this functionality. The spectrum analyzer measurement, Swept SA, does not support this functionality.

Key Path	AMPTD Y Scale, Attenuation
<b>Remote Command</b>	<code>[ :SENSe ] :POWer [ :RF ] :RANGe:OPTimize IMMEDIATE</code>
Initial S/W Revision	Prior to A.02.00
Modified at S/W Revision	A.03.00

## Pre-Adjust for Min Clip

If this function is on, it does the adjustment described under "[Adjust Atten for Min Clip](#)" on page 2107 each time a measurement restarts. Therefore, in Continuous measurement mode, it only executes before the first measurement.

In dual attenuator models, you can set Elec+Mech Atten, in which case both attenuators participate in the autoranging, or Elec Atten Only, in which case the mechanical attenuator does not participate in the autoranging. This latter case results in less wear on the mechanical attenuator and is usually faster.

This key is grayed out in measurements that do not support this functionality. The spectrum analyzer measurement, Swept SA, does not support this functionality.

Key Path	AMPTD Y Scale, Attenuation
<b>Remote Command</b>	<code>[ :SENSe ] :POWer [ :RF ] :RANGe:OPTimize:ATTenuation OFF   ELECTrical   COMBined</code>  <code>[ :SENSe ] :POWer [ :RF ] :RANGe:OPTimize:ATTenuation?</code>
Notes	The SCPI parameter ELECTrical sets this function to On in single attenuator models. The SCPI parameter COMBined is mapped to ELECTrical in single attenuator models; if you send COMBined, it sets the function to On and returns ELEC to a query.
Dependencies	This key only appears in Dual Attenuator models with an Electronic Attenuator installed. In instruments with Dual Attenuator model, when Enable Elec Atten is off or grayed out, the Pre-Adjust for Min Clip key is grayed out.
Preset	OFF for Swept SA measurement; ON for all other measurements that support Pre-Adjust for Min Clip
State Saved	Saved in instrument state
Range	Dual attenuator models: Off   Elec Atten Only   Mech + Elec Atten Single attenuator models: Off   On
Initial S/W Revision	Prior to A.02.00
Modified at S/W Revision	A.03.00

<b>Remote Command</b>	<code>[ :SENSe ] :POWer [ :RF ] :RANGe:AUTO ON OFF 1 0</code>  <code>[ :SENSe ] :POWer [ :RF ] :RANGe:AUTO?</code>
Notes	ON aliases to "Elec Atten Only" (:POW:RANG:OPT:ATT ELEC)

---

	OFF aliases to "Off" (:POW:RANG:OPT:ATT OFF) The query :POW:RANG:AUTO? returns true if :POW:RANG:OPT:ATT is not "Off"
Initial S/W Revision	Prior to A.02.00

---

## Off

Turns Pre-Adjust for Min Clip off. This is the default setting.

This key is grayed out in measurements that do not support this functionality. The spectrum analyzer measurement, Swept SA, does not support this functionality.

---

Key Path	AMPTD Y Scale, Attenuation, Pre-Adjust for Min Clip
Example	:POW:RANGe:OPT:ATT OFF
Initial S/W Revision	Prior to A.02.00

---

## Elec Atten Only

Selects only the electric attenuator to participate in auto ranging. This offers less wear on the mechanical attenuator and is usually faster.

This key is grayed out in measurements that do not support this functionality. The spectrum analyzer measurement, Swept SA, does not support this functionality.

---

Key Path	AMPTD Y Scale, Attenuation, Pre-Adjust for Min Clip
Example	:POW:RANGe:OPT:ATT ELEC
Initial S/W Revision	Prior to A.02.00

---

## Mech + Elec Atten

In dual attenuator models, this selects both attenuators participate in the autoranging.

This key is grayed out in measurements that do not support this functionality. The spectrum analyzer measurement, Swept SA, does not support this functionality.

---

Key Path	AMPTD Y Scale, Attenuation, Pre-Adjust for Min Clip
Example	:POW:RANGe:OPT:ATT COMB
Initial S/W Revision	Prior to A.02.00

---

## (Mech) Atten Step

This controls the step size used when making adjustments to the input attenuation.

This key is labeled Mech Atten Step in dual attenuator models and Atten Step in single attenuator models. In the dual attenuator configuration, this key only affects the step size of the mechanical attenuator.

Key Path	AMPTD Y Scale, Attenuation
Remote Command	[ :SENSe ] :POWer [ :RF ] :ATTenuation:STEP [ :INCRement ] 10 dB   2 dB [ :SENSe ] :POWer [ :RF ] :ATTenuation:STEP [ :INCRement ] ?
Example	POW:ATT:STEP 2
Notes	Note this feature works like a 1-N choice from the front panel, but it takes a specific value (in dB) when used remotely. The only valid values are 2 and 10.
Dependencies	Blanked in CXA and EXA if option FSA (2 dB steps) is not present. If blanked, attempts to set it via SCPI will yield an error.
Couplings	When the attenuation step size changes, the current mechanical attenuation value is adjusted (if necessary) to be quantized to the new step size. That is, if step is set to 10 dB, mech atten is increased if necessary so it is a multiple of 10 dB
Preset	PXA and MXA: 2 dB EXA and CXA: 10 dB (2 dB with option FSA)
State Saved	Saved in instrument state
Initial S/W Revision	Prior to A.02.00
Modified at S/W Revision	A.03.00

## Presel Center

When this key is pressed, the centering of the preselector filter is adjusted to optimize the amplitude accuracy at the frequency of the selected marker. If the selected marker is not on when Presel Center is pressed, the analyzer will turn on the selected marker, perform a peak search, and then perform centering on the marker's center frequency. If the selected marker is already on and between the start and stop frequencies of the analyzer, the analyzer performs the preselector calibration on that marker's frequency. If the selected marker is already on, but outside the frequency range between Start Freq and Stop Freq, the analyzer will first perform a peak search, and then perform centering on the marker's center frequency.

The value displayed on the Presel Adjust key will change to reflect the new preselector tuning (see Presel Adjust).

A number of considerations should be observed to ensure proper operation. See ["Proper Preselector Operation" on page 896](#).

Key Path	AMPTD Y Scale
Remote Command	[ :SENSe ] :POWer [ :RF ] :PCENter
Example	POW:PCEN
Notes	Note that the rules outlined above under the key description apply for the remote command as well as the key. The result of the command is dependent on marker position, and so forth. Any message shown by the key press is also shown in response to the remote command.
Dependencies	• Grayed out if the microwave preselector is off. )

---

	<ul style="list-style-type: none"><li>• If the selected marker's frequency is below Band 1, advisory message 0.5001 is generated and no action is taken.</li><li>• Grayed out if entirely in Band 0.</li><li>• Blank in models that do not include a preselector, such as option 503. If the SCPI is sent in these instruments, it is accepted without error, and the query always returns 0.</li><li>• Grayed out in the Spectrogram View.</li></ul>
Couplings	<p>The active marker position determines where the centering will be attempted.</p> <p>If the analyzer is in a measurement such as averaging when centering is initiated, the act of centering the preselector will restart averaging but the first average trace will not be taken until the centering is completed.</p>
Status Bits/OPC dependencies	<p>When centering the preselector, *OPC will not return true until the process is complete and a subsequent measurement has completed, nor will results be returned to a READ or MEASure command.</p> <p>The Measuring bit should remain set while this command is operating and should not go false until the subsequent sweep/measurement has completed.</p>
Initial S/W Revision	Prior to A.02.00
Modified at S/W Revision	A.03.00

---

## Proper Preselector Operation

A number of considerations should be observed to ensure proper operation:

1. If the selected marker is off, the analyzer will turn on a marker, perform a peak search, and adjust the preselector using the selected marker's frequency. It uses the "highest peak" peak search method unqualified by threshold or excursion, so that there is no chance of a 'no peak found' error. It continues with that peak, even if it is the peak of just noise. Therefore, for this operation to work properly, there should be a signal on screen in a preselected range for the peak search to find.
2. If the selected marker is already on, the analyzer will attempt the centering at that marker's frequency. There is no preselector for signals below about 3.6 GHz, therefore if the marker is on a signal below 3.6 GHz, no centering will be attempted and an advisory message generated
3. In some models, the preselector can be bypassed. If it is bypassed, no centering will be attempted in that range and a message will be generated.

## Preselector Adjust

Allows you to manually adjust the preselector filter frequency to optimize its response to the signal of interest. This function is only available when **"Presel Center" on page 2111** is available.

For general purpose signal analysis, using Presel Center is recommended. Centering the filter minimizes the impact of long-term preselector drift. Presel Adjust can be used instead to manually optimize the preselector. One application of manual optimization would be to peak the preselector response, which both optimizes the signal-to-noise ratio and minimizes amplitude variations due to small (short-term) preselector drifting.



Key Path	AMPTD Y Scale
Scope	Meas Global
<b>Remote Command</b>	<code>[ :SENSe ] :POWer [ :RF ] :PADJust &lt;freq&gt;</code> <code>[ :SENSe ] :POWer [ :RF ] :PADJust?</code>
<b>Example</b>	POW:PADJ 100KHz POW:PADJ?
Notes	The value on the key reads out to 0.1 MHz resolution.
Dependencies	<ul style="list-style-type: none"> <li>• Grayed out if microwave preselector is off. )</li> <li>• Grayed out if entirely in Band 0.</li> <li>• Blank in models that do not include a preselector, such as option 503. If the SCPI is sent in these instruments, it is accepted without error, and the query always returns 0.</li> <li>• Grayed out in the Spectrogram View.</li> </ul>
Preset	0 MHz
State Saved	The Presel Adjust value set by Presel Center, or by manually adjusting Presel Adjust, is not saved in instrument state, and does not survive a Preset or power cycle.
Min	-500 MHz
Max	500 MHz
Default Unit	Hz
<b>Backwards Compatibility SCPI</b>	<code>[ :SENSe ] :POWer [ :RF ] :MW :PADJust</code> <code>[ :SENSe ] :POWer [ :RF ] :MMW :PADJust</code> PSA had multiple preselectors, but the X-Series has only one. These commands simply alias to <code>[ :SENSe ] :POWer [ :RF ] :PADJust</code>
Initial S/W Revision	Prior to A.02.00
Modified at S/W Revision	A.03.00
<b>Remote Command</b>	<code>[ :SENSe ] :POWer [ :RF ] :PADJust :PRESelector MWAVE   MMWave   EXTernal</code> <code>[ :SENSe ] :POWer [ :RF ] :PADJust :PRESelector?</code>
Notes	PSA had multiple preselectors, and you could select which preselector to adjust. Since the X-Series has only one mm/uW preselector, the preselector selection softkey is no longer available. However, to provide backward compatibility, we accept the legacy remote commands. The command form has no effect, the query always returns MWAVE
Initial S/W Revision	Prior to A.02.00

## μW Path Control

The μW Path Control functions include the μW Preselector Bypass (Option MPB) and Low Noise Path (Option LNP) controls in the High Band path circuits.

When the μW Preselector is bypassed, the user has better flatness, but will be subject to spurs from out of band interfering signals. When the Low Noise Path is enabled, the analyzer automatically switches around certain circuitry in the high frequency bands which can contribute to noise, when it is appropriate based on other analyzer settings.

For most applications, the preset state is Standard Path, which gives the best remote-control throughput, minimizes acoustic noise from switching and minimizes the risk of wear out in the hardware switches. For applications that utilize the wideband IF paths, the preset state is the μW Preselector Bypass path, if option MPB is present. This is because, when using a wideband IF such as the 140 MHz IF, the μW Preselector's bandwidth can be narrower than the available IF bandwidth, causing degraded amplitude flatness and phase linearity, so it is desirable to bypass the preselector in the default case.

Users may choose Low Noise Path Enable. It gives a lower noise floor, especially in the 21–26.5 GHz region, though without improving many measures of dynamic range, and without giving the best possible noise floor. The preamp, if purchased and used, gives better noise floor than does the Low Noise Path, however its compression threshold and third-order intercept are much poorer than that of the non-preamp Low Noise Path. There are some applications, typically for signals around –30 dBm, for which the third-order dynamic range of the standard path is good enough, but the noise floor is not low enough even with 0 dB input attenuation. When the third-order dynamic range of the preamp path is too little and the noise floor of the standard path is too high, the Low Noise Path can provide the best dynamic range.

<b>Key Path</b>	AMPTD Y Scale
<b>Mode</b>	SA, BASIC, PNOISE, VSA , LTE, LTETDD
<b>Scope</b>	Meas Global
<b>Remote Command</b>	[ :SENSe ] :POWer [ :RF ] :MW:PATH STD LNPath MPBypass FULL [ :SENSe ] :POWer [ :RF ] :MW:PATH?
<b>Example</b>	:POW:MW:PATH LNP Enables the Low Noise path
<b>Notes</b>	If a Presel Center is performed, the analyzer will momentarily switch to the Standard Path, regardless of the setting of μW Path Control The DC Block will always be switched in when the low noise path is switched in, to protect succeeding circuitry from DC. Note that this does not mean “when the low noise path is enabled” but when, based on the Low Noise Path rules, the path is actually switched in. This can happen when the selection is Low Noise Path Enable . In the case where the DC Block is switched in the analyzer is now AC coupled. However, if the user has selected DC coupling, the UI will still behave as though it were DC coupled, including all annunciation, warnings, status bits, and responses to SCPI queries. This is because, based on other settings, the analyzer could switch out the low noise path at any time and hence go back to being DC coupled. Alignment switching ignores the settings in this menu, and restores them when finished.
<b>Dependencies</b>	Unavailable in BBIQ and External Mixing
<b>Preset</b>	All modes other than IQ Analyzer mode and VXA: STD IQ Analyzer, VXA and WLAN mode: MPB option present and licensed: MPB

	MPB option not present and licensed: STD
State Saved	Save in instrument state
Readback	Value selected in the submenu
Initial S/W Revision	A.04.00
Modified at S/W Revision	A.10.00

## Standard Path

This path gives the best remote-control throughput, minimizes acoustic noise from switching and minimizes the risk of wear in the hardware switches, particularly in remote test scenarios where both low band and high band setups will follow in rapid succession.

In this path, the bypass of the low band/high band switch and microwave preamp is never activated, which can cause some noise degradation but preserves the life of the bypass switch.

Key Path	AMPTD Y Scale, $\mu$ W Path Control
<b>Example</b>	:POW:MW:PATH STD
Readback Text	Standard Path
Initial S/W Revision	A.04.00

## Low Noise Path Enable

You may choose Low Noise Path Enable, which gives a lower noise floor under some circumstances, particularly when operating in the 21–26.5 GHz region. With the Low Noise Path enabled, the low band/high band switch and microwave preamp are bypassed whenever all of the following are true:

- The analyzer is not in the Low Band, meaning:
- the start frequency is above 3.5 GHz and
- the stop frequency is above 3.6 GHz.
- the internal preamp is not installed or (if installed) is set to Off or Low Band

Note that this means that, when any part of a sweep is done in Low Band, the Low Noise Path is not used, whether or not the Low Noise Path Enable is selected in the user interface. Also, if the preamp is turned on, the Low Noise Path is not used, whether or not the Low Noise Path Enable is selected in the user interface. The only time the Low Noise Path is used is when Low Noise Path Enable is selected, the sweep is completely in High Band (> 3.6 GHz) and no preamp is in use.

See "[More Information](#)" on page 900

Key Path	AMPTD Y Scale, $\mu$ W Path Control
Measurement	Swept SA
<b>Example</b>	:POW:MW:PATH LNP

Notes	<p>For measurements that use IQ acquisition, the low noise path is used when the Center Frequency is in High Band (&gt; 3.6 GHz) and no preamp is in use.</p> <p>In other words, the rules above are modified to use only the center frequency to qualify which path to switch in.</p> <p>This is not the case for FFT's in the Swept SA measurement; they use the same rules as swept measurements.</p>
Dependencies	<p>Key is blanked if current mode does not support it.</p> <p>Key is grayed out if mode supports it but current measurement does not support it.</p> <p>Unless Option LNP is present and licensed, key is blank and if SCPI command sent, error -241, "Hardware missing; Option not installed" is generated.</p>
Readback Text	Low Noise Path Enable
Initial S/W Revision	A.04.00

### More Information

The user should understand that the Low Noise Path, while giving improved DANL, has the disadvantage of decreased TOI performance and decreased gain compression performance relative to the standard path.

The user should also understand that the bypass switch is a mechanical switch and has finite life, so if the Low Noise Path is enabled, it is possible to cause frequent cycling of this switch by frequently changing analyzer settings such that the above conditions hold true only some of the time. A user making tests of this nature should consider opting for the Standard Path, which will never throw the bypass switch, at the expense of some degraded noise performance.

The low noise path is useful for situations where the signal level is so low that the analyzer performance is dominated by noise even with 0 dB attenuation, but still high enough that the preamp option would have excessive third-order intermodulation or compression. The preamp, if purchased and used, gives better noise floor than does the "Low Noise Path." However, its compression threshold and third-order intercept are much poorer than that of the non-preamp path. There are some applications, typically for signals around -30 dBm, for which the third-order dynamic range of the standard path is good enough, but the noise floor is not low enough even with 0 dB input attenuation. When the third-order dynamic range of the preamp path is too little and the noise floor of the standard path is too high, the Low Noise Path can provide the best dynamic range

The graph below illustrates the concept. It shows, in red, the performance of an analyzer at different attenuation settings, both with the preamp on and off, in a measurement that is affected by both analyzer noise and analyzer TOI. The green shows the best available dynamic range, offset by 0.5 dB for clarity. The blue shows how the best available dynamic range improves for moderate signal levels with the low noise path switched in. In this illustration, the preamp improves the noise floor by 15 dB while degrading the third-order intercept by 30 dB, and the low noise path reduces loss by 8 dB. The attenuator step size is 2 dB.

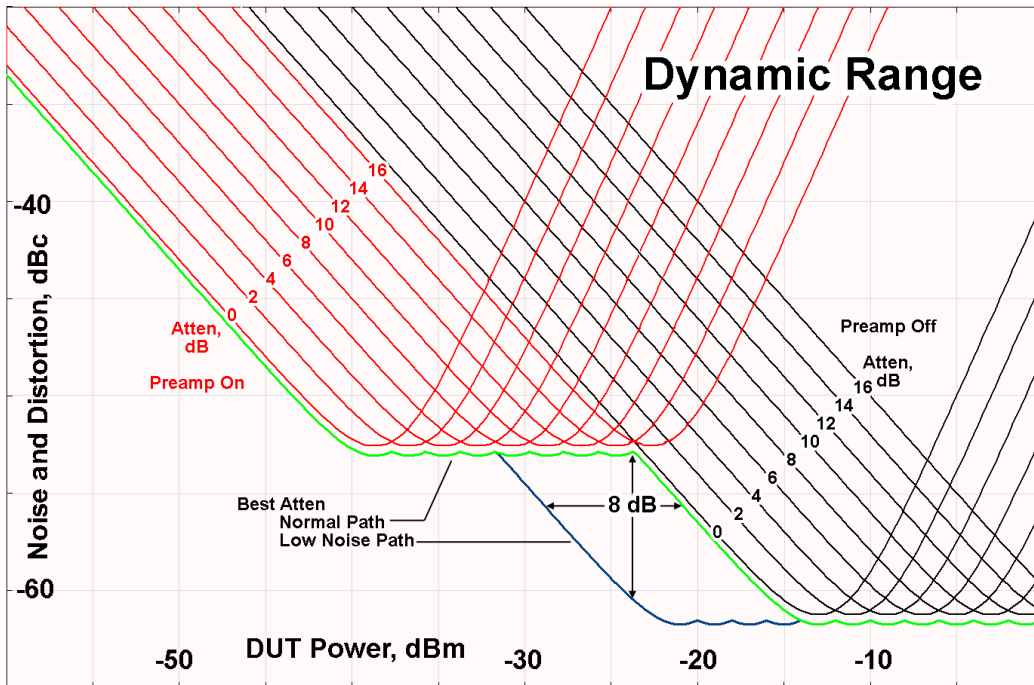

There are other times where selecting the low noise path improves performance, too. Compression-limited measurements such as finding the nulls in a pulsed-RF spectrum can profit from the low noise path in a way similar to the TOI-limited measurement illustrated. Accuracy can be improved when the low noise path allows the optimum attenuation to increase from a small amount like 0, 2 or 4 dB to a larger amount, giving better return loss at the analyzer input. Harmonic measurements, such as second and third harmonic levels, are much improved using the low noise path because of the superiority of that path for harmonic (though not intermodulation) distortion performance.

### μW Preselector Bypass

This key toggles the preselector bypass switch for band 1 and higher. When the microwave preselector is on, the signal path is preselected. When the microwave preselector is off, the signal path is not preselected. The preselected path is the normal path for the analyzer.

The preselector is a tunable bandpass filter which prevents signals away from the frequency of interest from combining in the mixer to generate in-band spurious signals (images). The consequences of using a preselector filter are its limited bandwidth, the amplitude and phase ripple in its passband, and any amplitude and phase instability due to center frequency drift.

Option MPB or pre-selector bypass provides an unpreselected input mixer path for certain X-Series signal analyzers with frequency ranges above 3.6 GHz. This signal path allows a wider bandwidth and less amplitude variability, which is an advantage when doing modulation analysis and broadband signal analysis. The disadvantage is that, without the preselector, image signals will be displayed. Another disadvantage of bypassing the preselector is increased LO emission levels at the front panel input port.

Image responses are separated from the real signal by twice the 1st IF. For IF Paths of 10 MHz and 25 MHz, the 1st IF is 322.5 MHz, so the image response and the real signal will be separated by 645 MHz. The 1st IF will be different for other IF Path settings. When viewing a real signal and its corresponding image response in internal mixing, the image response will be to the left of the real signal.

Also, the image response and the real signal typically have the same amplitude and exhibit the same shape factor.

However, if Option FS1, Fast Sweep Capability, is enabled, the image response in the Swept SA measurement will appear lower in amplitude and have a much wider shape factor compared to the real signal.

<b>Key Path</b>	AMPTD Y Scale, $\mu$ W Path Control
<b>Example</b>	:POW:MW:PATH MPB
<b>Dependencies</b>	Key is blanked if current mode does not support it. Key is grayed out if mode supports it but current measurement does not support it. Key is blank unless Option MPB is present and licensed. If SCPI command sent when MPB not present, error -241, "Hardware missing; Option not installed" is generated.
<b>Readback Text</b>	$\mu$ W Preselector Bypass
<b>Initial S/W Revision</b>	A.04.00

<b>Remote Command</b>	[ :SENSe ] :POWeR [ :RF ] :MW :PRESelector [ :STATe ] ON   OFF   0   1 [ :SENSe ] :POWeR [ :RF ] :MW :PRESelector [ :STATe ] ?
<b>Example</b>	:POW:MW:PRES OFF Bypasses the microwave preselector
<b>Notes</b>	The ON parameter sets the STD path (:POW:MW:PATH STD) The OFF parameter sets path MPB (:POW:MW:PATH MPB)
<b>Preset</b>	ON

### Internal Preamp

Accesses a menu of keys that control the internal preamps. Turning on the preamp gives a better noise figure, but a poorer TOI to noise floor dynamic range. You can optimize this setting for your particular measurement.

The instrument takes the preamp gain into account as it sweeps. If you sweep outside of the range of the preamp the instrument will also account for that. The displayed result will always reflect the correct gain.

For some measurements, when the preamp is on and any part of the displayed frequency range is below the lowest frequency for which the preamp has specifications, a warning condition message appears in the status line. For example ,for a preamp with a 9 kHz lowest specified frequency: "Preamp: Accy unspec'd below 9 kHz".

<b>Key Path</b>	AMPTD Y Scale
<b>Scope</b>	Meas Global
<b>Remote Command</b>	[ :SENSe ] :POWeR [ :RF ] :GAIN [ :STATe ] OFF   ON   0   1 [ :SENSe ] :POWeR [ :RF ] :GAIN [ :STATe ] ?
<b>Dependencies</b>	Preamp is not available on all hardware platforms. If the preamp is not present or is unlicensed, the

---

	key is not shown. The preamp is not available when the electronic/soft attenuator is enabled.
--	--

---

Couplings	<p>The act of connecting the U7227A USB Preamplifier to one of the analyzer's USB ports will cause the Internal Preamp to be switched on. When this happens an informational message will be generated: "Internal Preamp turned on for optimal operation with USB Preamp." Note that if the Internal Preamp was already on, there will be no change to the setting, but if it was Off it will be switched On, to Full Range.</p> <p>Note that this same action occurs when the SA mode is selected while the USB Preamp is connected to one of the analyzer's USB ports, if it is the first time that the SA mode has run since powerup, or if the last time the SA mode was running the USB Preamp was NOT connected.</p> <p>Subsequently disconnecting the USB Preamp from USB does not change the Internal Preamp setting nor restore the previous setting.</p>
Preset	OFF
State Saved	Saved in instrument state
Initial S/W Revision	Prior to A.02.00
Modified at S/W Revision	A.14.00

---

Key Path	AMPTD Y Scale, Internal Preamp
Scope	Meas Global
<b>Remote Command</b>	[:SENSe]:POWer[:RF]:GAIN:BAND LOW FULL [:SENSe]:POWer[:RF]:GAIN:BAND?
Dependencies	<p>Preamp is not available on all hardware platforms. If the preamp is not present or is unlicensed, the key is not shown.</p> <p>If a POW:GAIN:BAND FULL command is sent when a low band preamp is available, the preamp band parameter is to LOW instead of FULL, and an "Option not installed" message is generated.</p>
Preset	LOW
State Saved	Saved in instrument state
Initial S/W Revision	Prior to A.02.00

---

## Off

Turns the internal preamp off

Key Path	AMPTD Y Scale, Internal Preamp
<b>Example</b>	:POW:GAIN OFF
Readback	Off
Initial S/W Revision	Prior to A.02.00

---

## Low Band

Sets the internal preamp to use only the low band.

The frequency range of the installed (optional) low-band preamp is displayed in square brackets on the Low Band key label.

Key Path	AMPTD Y Scale, Internal Preamp
<b>Example</b>	:POW:GAIN ON :POW:GAIN:BAND LOW
Readback	Low Band
Initial S/W Revision	Prior to A.02.00

## Full Range

Sets the internal preamp to use its full range. The low band (0–3.6 GHz or 0–3GHz, depending on the model) is supplied by the low band preamp and the frequencies above low band are supplied by the high band preamp.

The frequency range of the installed (optional) preamp is displayed in square brackets on the Full Range key label. If the high band option is not installed the Full Range key does not appear.

Key Path	AMPTD Y Scale, Internal Preamp
<b>Example</b>	:POW:GAIN ON :POW:GAIN:BAND FULL
Readback	Full Range
Initial S/W Revision	Prior to A.02.00

## Range

This key is only available when I/Q is the selected input. It replaces the Attenuation key in that case.

Each input channel (I and Q) has four internal gain ranges. The maximum allowed voltage in each gain range is slightly more than the nominal value, so the break point between ranges is a couple of millivolts higher than the nominal (setting a peak voltage of 0.502 mV will still map to the 0.5 V Peak range).

Gain Setting	Volts RMS	Volts Peak	Volts Peak - Peak	dBm (50Ω)	Break Point
0 dB	0.7071	1.0	2.0	10	n/a
6 dB	0.3536	0.5	1.0	4	0.502 V Peak
12 dB	0.1768	0.25	0.5	-2	0.252 V Peak
18 dB	0.0884	0.125	0.25	-8	0.127 V Peak



Key Path	AMPTD Y Scale
Notes	Visible only when the selected input is I/Q.
State Saved	No
Readback Text	When Range is Auto, "[Auto]" When Range is Man and I & Q are the same, "[<range value>]" When Range is Man and I & Q are different: "[: <I range value> Q: <Q range value>]" See I Range and Q Range for the <range value> enumeration definition.
Initial S/W Revision	Prior to A.02.00

## Range Auto/Man

The Auto setting for Range causes the range to be set based on the Y Scale settings. When Range is "Auto", the I & Q Range are set based on the top of the Y Scale when the Y scale is in dB units (for example, power), or to the max(abs(top), abs(bottom)) when the Y scale reference is not at the top of the screen.

Not all measurements support Range Auto/Man. If Auto is not supported in the current measurement, this key is grayed out and shows "Man" and MAN is returned to a SCPI query, but this does NOT change the Auto/Man setting for Range. When you go to a measurement that supports Auto, it goes back to Auto if it was previously in Auto mode.

Key Path	AMPTD Y Scale, Range
Scope	Meas Global
<b>Remote Command</b>	[:SENSe]:VOLTage:IQ:RANGe:AUTO OFF ON 0 1 [:SENSe]:VOLTage:IQ:RANGe:AUTO?
<b>Example</b>	Put the I Range and Q Range in manual. VOLT:IQ:RANG:AUTO OFF
Dependencies	If Auto is not supported, sending the SCPI command will generate an error.
Couplings	When in Auto, both I Range and Q Range are set to the same value, computed as follows: Maximum absolute value is computed for the Y Scale. The top and bottom of the graph are computed based on Ref Value, Scale/Div, and Ref Position. Formula: YMax = max(abs(top), abs(bottom)). The I Range and Q Range are then set to YMax.
Preset	ON
State Saved	Saved in instrument state
Range	Auto   Man
Initial S/W Revision	Prior to A.02.00

<b>Remote Command</b>	[:SENSe]:POWer:IQ:RANGe:AUTO OFF ON 0 1 [:SENSe]:POWer:IQ:RANGe:AUTO?
-----------------------	--

<b>Example</b>	Put the I Range and Q Range in manual. POW:IQ:RANG:AUTO OFF
Notes	The POW:IQ:RANG:AUTO is an alternate form of the VOLT:IQ:RANG:AUTO command. This is to maintain consistency with I Range and Q Range, which support both the POWer and VOLTage forms of the command.
Preset	ON
Range	Auto   Man
Initial S/W Revision	Prior to A.02.00

## I Range

This is the internal gain range for the I channel when Input Path is I Only or I and I/Q, and it is used for both the I and Q channels when the Input Path is I+jQ. See "[I/Q Gain Ranges](#)" on page 2127.

<b>Key Path</b>	AMPTD Y Scale, Range
<b>Remote Command</b>	[ :SENSe ] :VOLTage :IQ [ : I ] :RANGe [ :UPPer ] <voltage> [ :SENSe ] :VOLTage :IQ [ : I ] :RANGe [ :UPPer ] ?
<b>Example</b>	Set the I Range to 0.5 V Peak VOLT:IQ:RANG 0.5 V
Notes	The numeric entries are mapped to the smallest gain range whose break point is greater than or equal to the value, or 1 V Peak if the value is greater than 1 V.
Couplings	When Q Same as I is On, the I Range value will be copied to the Q Range. Changing the value will also set Range = Man.
Preset	1 V Peak
State Saved	Saved in instrument state
Range	1 V Peak   0.5 V Peak   0.25 V Peak   0.125 V Peak
Min	0.125 V
Max	1 V
Initial S/W Revision	Prior to A.02.00

<b>Remote Command</b>	[ :SENSe ] :POWer :IQ [ : I ] :RANGe [ :UPPer ] <ampl> [ :SENSe ] :POWer :IQ [ : I ] :RANGe [ :UPPer ] ?
<b>Example</b>	Set the I Range to 0.5 V Peak when Reference Z is 50Ω, and to 1.0 V Peak when Reference Z is 75Ω. POW:IQ:RANG 4 dBm
Notes	The POWer form of the command is provided for convenience. It maps to the same underlying gain range parameter as the VOLTage form of the command. The Reference Z (not the I channel Input Z) is used to convert the power to peak voltage, which is then used to set the I Range as with the VOLTage form of the command. The power values of the 4

range states (1V Peak, 0.5V Peak, 0.25V Peak, and 0.125V Peak) will vary with Reference Z. Here are some examples:

50Ω: 10, 4, -2, -8  
75Ω: 8.2, 2.2, -3.8, -9.8  
600Ω: -0.8, -6.8, -12.8, -18.9

Preset	10.0 dBm
Range	-20 dBm to 10 dBm
Min	-20 dBm
Max	10 dBm
Initial S/W Revision	Prior to A.02.00

### 1 V Peak

Set the channel gain state to 1 Volt Peak.

Key Path	AMPTD Y Scale, I Range   Q Range
Initial S/W Revision	Prior to A.02.00

### 0.5 V Peak

Set the channel gain state to 0.5 Volt Peak.

Key Path	AMPTD Y Scale, I Range   Q Range
Initial S/W Revision	Prior to A.02.00

### 0.25 V Peak

Set the channel gain state to 0.25 Volt Peak.

Key Path	AMPTD Y Scale, I Range   Q Range
Initial S/W Revision	Prior to A.02.00

### 0.125 V Peak

Set the channel gain state to 0.125 Volt Peak.

Key Path	AMPTD Y Scale, I Range   Q Range
Initial S/W Revision	Prior to A.02.00

## Q Range Value

This is the internal gain range for the Q channel. See "[I/Q Gain Ranges](#)" on page 2127. The Q Range only applies to Input Path Q Only and Ind I/Q. For input I+jQ the I Range determines both I and Q channel range settings.

Key Path	AMPTD Y Scale, Range
Remote Command	<code>[ :SENSe ] :VOLTage:IQ:Q:RANGe[:UPPer] &lt;voltage&gt;</code> <code>[ :SENSe ] :VOLTage:IQ:Q:RANGe[:UPPer] ?</code>
Example	Set the Q Range to 0.5 V Peak <code>VOLT:IQ:Q:RANG 0.5 V</code>
Notes	The numeric entries are mapped to the smallest gain range whose break point is greater than or equal to the value, or 1 V Peak if the value is greater than 1 V. The Q Range is only used for Input Path Q Only and Ind I/Q. For input I+jQ the I Range determines both I and Q channel range settings.
Couplings	When Q Same as I is On, the I Range value will be copied to the Q Range and the range value keys are disabled. Changing the value will also set Range = Man.
Preset	1 V Peak
State Saved	Saved in instrument state
Range	1 V Peak   0.5 V Peak   0.25 V Peak   0.125 V Peak
Min	0.125 V
Max	1 V
Initial S/W Revision	Prior to A.02.00

Remote Command	<code>[ :SENSe ] :POWer:IQ:Q:RANGe[:UPPer] &lt;ampl&gt;</code> <code>[ :SENSe ] :POWer:IQ:Q:RANGe[:UPPer] ?</code>
Example	Will set the Q Range to 0.5 V Peak when Reference Z is 50Ω, and to 1.0 V Peak when Reference Z is 75Ω. <code>POW:IQ:Q:RANG 4 dBm</code>
Notes	The POWER form of the command is provided for convenience. It maps to the same underlying gain range parameter as the VOLTage form of the command. The Reference Z (not the Q channel Input Z) is used to convert the power to peak voltage, which is then used to set the Q Range as with the VOLTage form of the command. The power values of the 4 range states (1V Peak, 0.5V Peak, 0.25V Peak, and 0.125V Peak) will vary with Reference Z. Here are some examples: 50Ω: 10, 4, -2, -8 75Ω: 8.2, 2.2, -3.8, -9.8 600Ω: -0.8, -6.8, -12.8, -18.9
Preset	10.0 dBm
Range	-20 dBm to 10 dBm

Min	-20 dBm
Max	10 dBm
Initial S/W Revision	Prior to A.02.00

### Q Same as I

Many, but not all, usages require the I and Q channels to have an identical setup. To simplify channel setup, the Q Same as I will cause the Q channel range to be mirrored from the I channel. That way you only need to set up one channel (the I channel). The I channel values are copied to the Q channel, so at the time Q Same as I is Off, the I and Q channel setups will be identical.

Key Path	AMPTD Y Scale, Range, Q Range
Remote Command	[ :SENSE ] :VOLTage   POWer : IQ :MIRRed OFF   ON   0   1 [ :SENSE ] :VOLTage   POWer : IQ :MIRRed ?
Example	Turn off the mirroring of I Range to Q Range. VOLT:IQ:MIRR OFF POW:IQ:MIRR OFF
Couplings	When On, the I Range value is mirrored (copied) to the Q Range.
Preset	On
State Saved	Saved in instrument state.
Range	On   Off
Readback Text	"Q Same as I" when On, otherwise none.
Initial S/W Revision	Prior to A.02.00

### 1 V Peak

Set the channel gain state to 1 Volt Peak.

Key Path	AMPTD Y Scale, I Range   Q Range
Initial S/W Revision	Prior to A.02.00

### 0.5 V Peak

Set the channel gain state to 0.5 Volt Peak.

Key Path	AMPTD Y Scale, I Range   Q Range
Initial S/W Revision	Prior to A.02.00

### 0.25 V Peak

Set the channel gain state to 0.25 Volt Peak.

---

Key Path	AMPTD Y Scale, I Range   Q Range
Initial S/W Revision	Prior to A.02.00

---

### 0.125 V Peak

Set the channel gain state to 0.125 Volt Peak.

---

Key Path	AMPTD Y Scale, I Range   Q Range
Initial S/W Revision	Prior to A.02.00

---

### I/Q Gain Ranges

See the following sections:

["1 V Peak" on page 2127](#)

["0.5 V Peak" on page 2128](#)

["0.25 V Peak" on page 2128](#)

["0.125 V Peak" on page 2128](#)

### 1 V Peak

Set the channel gain state to 1 Volt Peak.

---

Key Path	AMPTD Y Scale, I Range   Q Range
Initial S/W Revision	Prior to A.02.00

---

### 0.5 V Peak

Set the channel gain state to 0.5 Volt Peak.

---

Key Path	AMPTD Y Scale, I Range   Q Range
Initial S/W Revision	Prior to A.02.00

---

### 0.25 V Peak

Set the channel gain state to 0.25 Volt Peak.

---

Key Path	AMPTD Y Scale, I Range   Q Range
Initial S/W Revision	Prior to A.02.00

---

### 0.125 V Peak

Set the channel gain state to 0.125 Volt Peak.

Key Path	AMPTD Y Scale, I Range   Q Range
Initial S/W Revision	Prior to A.02.00

### Presel Center

When this key is pressed, the centering of the preselector filter is adjusted to optimize the amplitude accuracy at the frequency of the selected marker.

See AMPTD Y Scale, "[Presel Center](#)" on page 2111 for more information.

This is only available when the selected input is RF.

Key Path	AMPTD Y Scale
Initial S/W Revision	Prior to A.02.00

## Auto Couple

The Auto Couple feature provides a quick and convenient way to automatically couple multiple instrument settings. This helps ensure accurate measurements and optimum dynamic range. When the Auto Couple feature is activated, either from the front panel or remotely, all parameters of the current measurement that have an Auto/Manual mode are set to Auto mode and all measurement settings dependent on (or coupled to) the Auto/Man parameters are automatically adjusted for optimal performance.

However, the Auto Couple key actions are confined to the current measurement only. It does not affect other measurements in the mode, and it does not affect markers, marker functions, or trace or display attributes.

See ["More Information" on page 912](#)

Key Path	Front-panel key
Remote Command	:COUPLe ALL NONE
Example	:COUP ALL
Notes	:COUPLe ALL puts all Auto/Man parameters in Auto mode (equivalent to pressing the Auto Couple key). :COUPLE NONE puts all Auto/Man parameters in manual mode. It decouples all the coupled instrument parameters and is not recommended for making measurements.
Initial S/W Revision	Prior to A.02.00

### More Information

There are two types of functions that have Auto/Manual modes.

#### Auto/Man Active Function keys

An Auto/Man toggle key controls the binary state associated with an instrument parameter by toggling between Auto (where the parameter is automatically coupled to the other parameters it is dependent upon) and Man (where the parameter is controlled independent of the other parameters), as well as making the parameter the active function. The current mode is indicated on the softkey with either Auto or Man underlined as illustrated below.

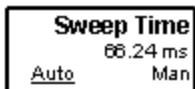

usd07

#### Auto/Man 1-of-N keys

An Auto/Man 1-of-N key allows you to manually pick from a list of parameter values, or place the function in Auto, in which case the value is automatically selected (and indicated) as shown below. If in Auto, Auto is underlined on the calling key. If in manual operation, manual is indicated on the calling key. But the calling key does not actually toggle the function, it simply opens the menu.



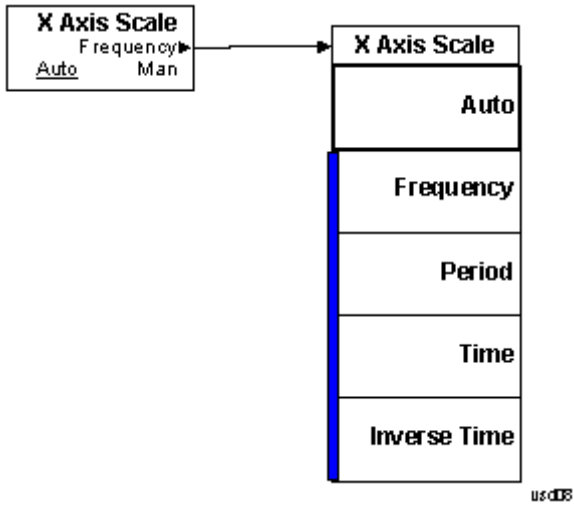

## BW

Opens the BW menu, which contains keys to control the information bandwidth functions of the instrument.

Key Path	Front-panel key
Initial S/W Revision	Prior to A.02.00

### Info BW

Allows you to enter a frequency value to set the channel bandwidth that will be used for data acquisition.

Key Path	BW
Mode	SA, WCDMA, C2K, WIMAXOFDMA, TD-SCDMA, 1xEV-DO, DVB-T/H, DTMB (CTTB), ISDB-T, CMMB, LTE, LTETDD, Digital Cable TV, WLAN, MSR, LTEATDD, LTEAFDD
Remote Command	[ :SENSe ] :PStatistic :BANDwidth <freq> [ :SENSe ] :PStatistic :BANDwidth?
Example	PST:BAND 8 MHz PST:BAND?
Couplings	WiMAX OFDMA: The default value depends on the Radio Standard selection..
Preset	SA, WCDM: 5 MHz C2K:1.5 MHz 1xEV-DO:1.3 MHz WiMAX OFDMA: Hardware Dependent No Option = 10 MHz WB (25 MHz or wider) = 25 MHz TD-SCDMA: 1.3 MHz DVB-T/H, DTMB (CTTB): 8 MHz ISDB-T: 6 MHz CMMB: 8 MHz LTE, LTETDD, LTEATDD, LTEAFDD: 6 MHz Digital Cable TV: 8MHz WLAN: Hardware Dependent No option = 10 MHz Option B25 = 25 MHz Option B40: if Radio Std is 802.11a/b/g/n(20MHz) = 25 MHz if Radio Std is 802.11n(40MHz) = 40 MHz if Radio Std is 802.11ac(20MHz) = 25 MHz if Radio Std is 802.11ac(40MHz) = 40 MHz Option B1X: if Radio Std is 802.11ac(80MHz) = 80 MHz

	<p>Option B1Y:  if Radio Std is 802.11ac(160MHz) = 160 MHz  MSR: same as max value</p>
State Saved	Saved in instrument state.
Min	10.0 kHz
Max	<p>Hardware Dependent:  RF Input:  No Option = 10 MHz  WB (25MHz or wider) = Hardware Option Limit  I/Q Input (for I+jQ):  No Option = 20 MHz  Option B25 = 50 MHz</p>
<b>Backwards Compatibility SCPI</b>	<code>[ :SENSe ] :PStatistic:BWIDth</code>
Initial S/W Revision	Prior to A.02.00
Modified at S/W Revision	A.02.00, A.03.00, A.06.00

## Cont (Continuous Measurement/Sweep)

Sets the analyzer for Continuous measurement operation. The single/continuous state is Meas Global so the setting will affect all measurements. If you are Paused, pressing Cont does a Resume.

<b>Key Path</b>	Front-panel key
<b>Remote Command</b>	:INITiate:CONTinuous OFF ON 0 1 :INITiate:CONTinuous?
<b>Example</b>	:INIT:CONT 0 puts analyzer in Single measurement operation. :INIT:CONT 1 puts analyzer in Continuous measurement operation
<b>Preset</b>	ON (Note that SYST:PRESet sets INIT:CONT to ON but *RST sets INIT:CONT to OFF)
<b>State Saved</b>	Saved in instrument state
<b>Backwards Compatibility Notes</b>	For Spectrum Analysis mode in ESA and PSA, there is no Cont hardkey, instead there is a Sweep Single/Cont key. In these analyzers, switching the Sweep Single/Cont key from Single to Cont restarts averages (displayed average count reset to 1), but does not restart Max Hold and Min Hold. The X-Series has Single and Cont keys in place of the SweepSingleCont key. In the X-Series, if in single measurement, the Cont key (and INIT:CONT ON ) switches to continuous measurement, but never restarts a measurement and never resets a sweep.
<b>Initial S/W Revision</b>	Prior to A.02.00

In Swept SA Measurement (Spectrum Analysis Mode):

The analyzer takes repetitive sweeps, averages, measurements, etc., when in Continuous mode. When the average count reaches the Average/Hold Number the count stops incrementing, but the analyzer keeps sweeping. See the Trace/Detector section for the averaging formula used both before and after the Average/Hold Number is reached. The trigger condition must be met prior to each sweep. The type of trace processing for multiple sweeps, is set under the Trace/Detector key, with choices of Trace Average, Max Hold, or Min Hold.

In Other Measurements/Modes:

With Avg/Hold Num (in the Meas Setup menu) set to Off or set to On with a value of 1, a sweep is taken after the trigger condition is met; and the analyzer continues to take new sweeps after the current sweep has completed and the trigger condition is again met. However, with Avg/Hold Num set to On with a value >1, multiple sweeps (data acquisitions) are taken for the measurement. The trigger condition must be met prior to each sweep. The sweep is not stopped when the average count k equals the number N set for Avg/Hold Num is reached, but the number k stops incrementing. A measurement average usually applies to all traces, marker results, and numeric results. But sometimes it only applies to the numeric results.

If the analyzer is in Single measurement, pressing the Cont key does not change k and does not cause the sweep to be reset; the only action is to put the analyzer into Continuous measurement operation.

If it is already in continuous sweep:

the INIT:CONT 1 command has no effect

the INIT:CONT 0 command will place the analyzer in Single Sweep but will have no effect on the current sequence until  $k = N$ , at which point the current sequence will stop and the instrument will go to the idle state.

10 Power Stat CCDF Measurement  
File

File

See "File" on page 336

## FREQ Channel

The key accesses a menu allowing you to set Frequency parameters for the current measurement. All measurements in DVB-T/H mode have the same menu structure under FREQ/Channel menu.

Key Path	Front-panel key
Initial S/W Revision	A.02.00

### Channel

Sets the analyzer to a frequency that corresponds to the Channel Number. If the Center Freq value entered does not exactly correlate with the Channel, the displayed value will be "---".

Key Path	FREQ Channel
Mode	DVB-T/H
<b>Remote Command</b>	<code>[ :SENSe ] :FREQuency:CHANnel:NUMBer &lt;integer&gt;</code> <code>[ :SENSe ] :FREQuency:CHANnel:NUMBer?</code>
<b>Example</b>	FREQ:CHAN:NUMB 21 FREQ:CHAN:NUMB?
Dependencies	If your analyzer has multiple inputs and the selected input is BBIQ, this key will be grayed out and the displaying value will be "---".
Couplings	Channel is coupled with Center Freq. A certain Channel corresponds to a certain value of Center Freq. If the Center Freq value entered does not exactly correlate with a Channel, the displaying value will be "---", and the returned value of the SCPI command "FREQ:CHAN:NUMB?" is "-999".
Preset	21
State Saved	Saved in instrument state.
Min	Depends on the selected channel table
Max	Depends on the selected channel table
Initial S/W Revision	A.02.00

### Center Freq

Sets the center frequency. If your analyzer has multiple inputs (RF and IQ), the displayed value will be updated according to the selected input. SCPI commands are available to directly set the center frequency for a specific input. This key is coupled with Channel when the selected input is RF.

See also:

["RF Center Freq" on page 921](#)

["IQ Center Freq" on page 921](#)

Key Path	FREQ Channel
Mode	DVB-T/H
<b>Remote Command</b>	<code>[ :SENSe ] :FREQuency:CENTer &lt;freq&gt;</code> <code>[ :SENSe ] :FREQuency:CENTer?</code>
<b>Example</b>	FREQ:CENT 1.0MHZ FREQ:CENT?
Couplings	Center Freq is coupled with Channel. A certain value of center frequency corresponds to a certain Channel. If the Channel changes, the Center Frequency will be changed to the frequency which is the center of the channel.
Preset	474.00MHz
State Saved	Saved in instrument state.
Min	-79.999995 MHz
Max	Hardware Dependent, for details, see <a href="#">"Maximum Frequency in X - Series Signal Analyzers" on page 920.</a>
Initial S/W Revision	A.02.00

### Maximum Frequency in X - Series Signal Analyzers

The following table lists the maximum frequency in different X – Series signal analyzers.

Model numbers: N9020A, N9030A

Freq Option	Stop Freq after Mode Preset	Max Freq (can't tune above)
503	3.6 GHz	3.7 GHz
508	8.4 GHz	8.5 GHz
513	13.6 GHz	13.8 GHz
526	26.5 GHz	27.0 GHz
543 (N9030A only)	43 GHz	
544 (N9030A only)	44 GHz	44.5 GHz
550 (N9030A only)	50 GHz	51 GHz

Model number: N9010A

Freq Option	Stop Freq after Mode Preset	Max Freq (can't tune above)
503	3.6 GHz	3.7 GHz
507	7.0 GHz	7.1 GHz



513	13.6 GHz	13.8 GHz
526	26.5 GHz	27.0 GHz
532	32.0 GHz	32.5 GHz
544	44.0 GHz	44.5 GHz

Model number: N9000A

Freq Option	Stop Freq after Mode Preset	Max Freq (can't tune above)
503	3.0 GHz	3.08 GHz
507	7.5 GHz	7.58 GHz

## RF Center Freq

SCPI command to specify the RF Center Frequency. This will always access the RF value, even when the selected input is not RF.

Key Path	FREQ Channel
Mode	DVB-T/H
Remote Command	<code>[ :SENSe ] :FREQuency:RF:CENTer &lt;freq&gt;</code> <code>[ :SENSe ] :FREQuency:RF:CENTer?</code>
Example	FREQ:RF:CENT 1.0MHZ FREQ:RF:CENT?
Couplings	Center Freq is coupled with Channel. A certain value of center frequency corresponds to a certain Channel. If the Channel changes, the Center Frequency will be changed to the frequency which is the center of the channel.
Preset	474.00MHz
State Saved	Saved in instrument state.
Min	-79.999995 MHz
Max	Hardware Dependent, for details, see <a href="#">"Maximum Frequency in X - Series Signal Analyzers" on page 920.</a>
Initial S/W Revision	A.02.00

## IQ Center Freq

SCPI command to specify the I/Q Center Frequency. This will always access the I/Q value, even when the selected input is not I/Q.

Key Path	FREQ Channel
Mode	DVB-T/H
<b>Remote Command</b>	<code>[ :SENSe ] :FREQuency:IQ:CENTer &lt;freq&gt;</code> <code>[ :SENSe ] :FREQuency:IQ:CENTer?</code>
<b>Example</b>	FREQ:IQ:CENT 1.0MHZ FREQ:IQ:CENT?
Preset	0 Hz
State Saved	Saved in instrument state.
Min	-39.999995 MHz
Max	39.999995 MHz
Initial S/W Revision	A.02.00

### Chan Step

Chan Step changes the step size for the Channel Number.

Key Path	FREQ Channel
Mode	DVB-T/H
<b>Remote Command</b>	<code>[ :SENSe ] :FREQuency:CHANnel:STEP &lt;integer&gt;</code> <code>[ :SENSe ] :FREQuency:CHANnel:STEP?</code>
<b>Example</b>	FREQ:CHAN:STEP 1 FREQ:CHAN:STEP?
Dependencies	If your analyzer has multiple inputs and the selected input is BBIQ, this key will be grayed out.
Preset	1
State Saved	Saved in instrument state.
Min	1
Max	Depends on the selected channel table
Initial S/W Revision	A.02.00

### CF Step

CF Step sets the step size for center frequency. If CF Step State is manual, you can set this value manually. Once CF Step State is changed to auto, CF Step changes to the value of Channel BW automatically.

Key Path	FREQ Channel
Mode	DVB-T/H
<b>Remote Command</b>	<code>[ :SENSe ] :FREQuency:CENTer:STEP [ :INCRement ] &lt;freq&gt;</code> <code>[ :SENSe ] :FREQuency:CENTer:STEP [ :INCRement ] ?</code>

	<code>[ :SENSe ] :FREQuency:CENTer:STEP:AUTO ON OFF 1 0</code>
	<code>[ :SENSe ] :FREQuency:CENTer:STEP:AUTO?</code>
<b>Example</b>	<code>FREQ:CENT:STEP 100KHZ</code> <code>FREQ:CENT:STEP?</code> <code>FREQ:CENT:STEP:AUTO OFF</code> <code>FREQ:CENT:STEP:AUTO?</code>
<b>Couplings</b>	CF Step is coupled to Channel BW (Mode Setup) when CF Step State is 'Auto'.
<b>Preset</b>	8.00MHz ON
<b>State Saved</b>	Saved in instrument state.
<b>Min</b>	1.0 kHz
<b>Max</b>	1 GHz
<b>Initial S/W Revision</b>	A.02.00

## Chan Table

Allows you to choose the appropriate TV standard: NTSC-M, NTSC-J, NTSC-Brazil, PAL-M, PAL-B/G, PAL-D/K, or PAL-I.

<b>Key Path</b>	FREQ Channel
<b>Mode</b>	DVB-T/H
<b>Remote Command</b>	<code>[ :SENSe ] :FREQuency:CHANnel:TABLE[:SElect] MNTSc   JNTSc   BNTSc   MPAL</code> <code>  IPAL   BPAL   DPAL</code> <code>[ :SENSe ] :FREQuency:CHANnel:TABLE[:SElect]?</code>
<b>Example</b>	<code>FREQ:CHAN:TABL BPAL</code> <code>FREQ:CHAN:TABL?</code>
<b>Dependencies</b>	If your analyzer has multiple inputs and the selected input is BBIQ, this key will be grayed out.
<b>Couplings</b>	Couple with Channel. Setting Chan Table sets the range of Channel to the value corresponding to that Chan Table.
<b>Preset</b>	BPAL
<b>State Saved</b>	Saved in instrument state.
<b>Range</b>	NTSC-M   NTSC-J   NTSC-Brazil   PAL-M   PAL-I   PAL-B/G   PAL-D/K
<b>Initial S/W Revision</b>	A.02.00

## NTSC-M

If the current TV standard is NTSC-M, you can choose the appropriate channel plans in NTSC-M standard: Standard Cable (STD), Broadcast Channel (AIR), HRC Cable (HRC) or IRC Cable (IRC).

Key Path	FREQ Channel, Chan Table
Mode	DVB-T/H
<b>Remote Command</b>	[ :SENSE ] :FREQuency:CHANnel:TABLE:MNTSc [ :SElect ] STD   AIR   HRC   IRC [ :SENSe ] :FREQuency:CHANnel:TABLE:MNTSc [ :SElect ] ?
<b>Example</b>	FREQ:CHAN:TABL:MNTS STD FREQ:CHAN:TABL:MNTS?
Preset	STD
State Saved	Saved in instrument state.
Range	STD   AIR   HRC   IRC
Initial S/W Revision	A.02.00

### NTSC-J

If the current TV standard is NTSC-J, you can choose the appropriate channel plans in NTSC-J standard: Japan Standard Cable (Cable), apan Broadcast channels (AIR), or Japan Digital Cable (Cable Digital).

Key Path	FREQ Channel, Chan Table
Mode	DVB-T/H
<b>Remote Command</b>	[ :SENSE ] :FREQuency:CHANnel:TABLE:JNTSc [ :SElect ] CBL   AIR   DCBL [ :SENSe ] :FREQuency:CHANnel:TABLE:JNTSc [ :SElect ] ?
<b>Example</b>	FREQ:CHAN:TABL:JNTS AIR FREQ:CHAN:TABL:JNTS?
Preset	AIR
State Saved	Saved in instrument state.
Range	Cable AIR Cable Digital
Initial S/W Revision	A.02.00
Modified at S/W Revision	A.08.00

### NTSC-Brazil

If the current TV standard is NTSC-Brazil, you can choose the appropriate channel plans in NTSC-Brazil standard: NTSC-Brazil VHF or NTSC-Brazil UHF. Please refer to Appendix A for more detailed information.

Key Path	FREQ Channel, Chan Table
Mode	DVB-T/H
<b>Remote Command</b>	[ :SENSE ] :FREQuency:CHANnel:TABLE:BNTSc [ :SElect ] VHF   UHF [ :SENSe ] :FREQuency:CHANnel:TABLE:BNTSc [ :SElect ] ?
<b>Example</b>	FREQ:CHAN:TABL:BNTS VHF FREQ:CHAN:TABL:BNTS?

Preset	UHF
State Saved	Saved in instrument state.
Range	VHF UHF
Initial S/W Revision	A.06.00

## PAL-M

If the current TV standard is PAL-M, you can choose the appropriate channel plans in PAL-M standard: Standard Cable (STD), Broadcast Channel (AIR), HRC Cable (HRC) or IRC Cable (IRC).

Key Path	FREQ Channel, Chan Table
Mode	DVB-T/H
<b>Remote Command</b>	[ :SENSe ] :FREQuency:CHANnel:TABLE:MPAL[ :SElect ] STD   AIR   HRC   IRC [ :SENSe ] :FREQuency:CHANnel:TABLE:MPAL[ :SElect ] ?
<b>Example</b>	FREQ:CHAN:TABL:MPAL STD FREQ:CHAN:TABL:MPAL?
Preset	STD
State Saved	Saved in instrument state.
Range	STD   AIR   HRC   IRC
Initial S/W Revision	A.02.00

## PAL-I

If the current TV standard is PAL-I, you can choose the appropriate channel plans in PAL-I standard: HRC Cable (HRC), VHF channels (VHF) or UHF channels (UHF).

Key Path	FREQ Channel, Chan Table
Mode	DVB-T/H
<b>Remote Command</b>	[ :SENSe ] :FREQuency:CHANnel:TABLE:IPAL[ :SElect ] VHF UHF HRC [ :SENSe ] :FREQuency:CHANnel:TABLE:IPAL[ :SElect ] ?
<b>Example</b>	FREQ:CHAN:TABL:IPAL HRC FREQ:CHAN:TABL:IPAL?
Preset	HRC
State Saved	Saved in instrument state.
Range	VHF   UHF   HRC
Initial S/W Revision	A.02.00

## PAL-B/G

If the current TV standard is PAL-B/G, you can choose the appropriate channel plans in PAL-B/G standard: HRC Cable (HRC), VHF channels (VHF), UHF channels (UHF), S channels PAL-B/G Standard (S), S channels PAL-B/G Cable (S-Cable) or CENELEC channels (CENELEC).

<b>Key Path</b>	FREQ Channel, Chan Table
<b>Mode</b>	DVB-T/H
<b>Remote Command</b>	[ :SENSE ] :FREQuency:CHANnel:TABLE:BPAL [ :SElect ] VHF   UHF   HRC   S   SCBL   CEN  [ :SENSe ] :FREQuency:CHANnel:TABLE:BPAL [ :SElect ] ?
<b>Example</b>	FREQ:CHAN:TABL:BPAL HRC FREQ:CHAN:TABL:BPAL?
<b>Preset</b>	UHF
<b>State Saved</b>	Saved in instrument state.
<b>Range</b>	VHF   UHF   HRC   S   S-Cable   CENELEC
<b>Initial S/W Revision</b>	A.02.00

## PAL-D/K

If the current TV standard is PAL-D/K, you can choose the appropriate channel plans in PAL-D/K standard: China Broadcast Channels (DS) or China Standard Cable (Z).

<b>Key Path</b>	FREQ Channel, Chan Table
<b>Mode</b>	DVB-T/H
<b>Remote Command</b>	[ :SENSE ] :FREQuency:CHANnel:TABLE:DPAL [ :SElect ] DS   Z  [ :SENSe ] :FREQuency:CHANnel:TABLE:DPAL [ :SElect ] ?
<b>Example</b>	FREQ:CHAN:TABL:DPAL DS FREQ:CHAN:TABL:DPAL?
<b>Preset</b>	DS
<b>State Saved</b>	Saved in instrument state.
<b>Range</b>	DS   Z
<b>Initial S/W Revision</b>	A.02.00

## Input/Output

See ["Input/Output" on page 204](#)

## Marker

Accesses a menu that enables you to select, set up and control the markers for the current measurement.

Key Path	Front-panel key
Initial S/W Revision	Prior to A.02.00

### Select Marker

Accesses a menu that allows you to select one of 12 markers for control and function

Key Path	Marker
Initial S/W Revision	Prior to A.02.00

### Marker Type

Sets the marker control mode to Normal, Delta, Fixed or Off.

If the selected marker is Off, pressing Marker sets it to Normal and places it at the center of the screen on the trace determined by the Marker Trace rules. At the same time, Marker X Axis Value appears on the Active Function area.

The Active function for the selected marker's current control mode is the default active function. If the current control mode is Off, there is no active function and the active function is turned off. The active function display is the marker X axis value entered in the active function area, which displays the marker value to its full entered precision.

All interactions and dependencies detailed under the key description are enforced when the remote command is sent.

Key Path	Marker
Mode	SA, WCDMA, C2K, WiMAX OFDMA, TD-SCDMA, 1xEV-DO, DVB-T/H, DTMB (CTTB), ISDB-T, CMMB, LTE, LTE-TDD, Digital Cable TV, WLAN, MSR, LTE-TDD, LTE-FDD
Remote Command	:CALCulate:PStatistic:MARKer[1] 2 ... 12:MODE POSition   DELTa   OFF :CALCulate:PStatistic:MARKer[1] 2 ... 12:MODE?
Example	CALC:PST:MARK:MODE POS CALC:PST:MARK:MODE?
Notes	If the selected marker is Off, pressing Marker sets it to Normal and places it at the center of the screen on the trace determined by the Marker Trace rules. At the same time, Marker X Axis Value appears on the Active Function area.  Default Active Function: the active function for the selected marker's current control mode. If the current control mode is Off, there is no active function and the active function is turned off.  Active Function Display: the marker X axis value entered in the active function area displays the marker value to its full entered precision.



Preset	OFF
State Saved	Saved in instrument state.
Range	Normal Delta Off
Initial S/W Revision	Prior to A.02.00
Modified at S/W Revision	A.02.00, A.03.00

## Properties

Accesses the marker properties menu.

Key Path	Marker
Initial S/W Revision	Prior to A.02.00

## Select Marker

Accesses a menu that allows you to select one of 12 markers for control and function

Key Path	Marker
Initial S/W Revision	Prior to A.02.00

## Relative To

Sets the reference marker that the selected marker will be relative to.

Key Path	Marker, Properties
Mode	SA, WCDMA, C2K, WIMAXOFDMA, TD-SCDMA, 1xEV-DO, DVB-T/H, DTMB (CTTB), ISDB-T, CMMB, LTE, LTE-TDD, Digital Cable TV, WLAN, MSR, LTE-TDD, LTE-FDD
<b>Remote Command</b>	:CALCulate:PSStatistic:MARKer[1] 2 ... 12:REFerence <integer> :CALCulate:PSStatistic:MARKer[1] 2 ... 12:REFerence?
<b>Example</b>	CALC:PST:MARK:REF 3 CALC:PST:MARK:REF?
Notes	A marker cannot be relative to itself so that choice is grayed out, and if sent from SCPI generates error -221: "Settings conflict; marker cannot be relative to itself." When queried a single value will be returned (the specified marker numbers relative marker).
Preset	2 3 4 5 6 7 8 9 10 11 12 1
State Saved	Saved in instrument state.
Min	1
Max	12
Initial S/W Revision	Prior to A.02.00
Modified at S/W Revision	A.02.00, A.03.00

## Marker Trace

Assigns the specified marker to the designated trace. The trace choices are:

- Measured
- Gaussian
- Reference

<b>Key Path</b>	Marker
<b>Mode</b>	SA, WCDMA, C2K, WIMAXOFDMA, TD-SCDMA, 1xEV-DO, DVB-T/H, DTMB (CTTB), ISDB-T, CMMB, LTE, LTE-TDD, Digital Cable TV, WLAN, MSR, LTE-TDD, LTE-FDD
<b>Remote Command</b>	:CALCulate:PStatistic:MARKer[1] 2 ... 12:TRACe MEASured   GAUSSian   REFerence  :CALCulate:PStatistic:MARKer[1] 2 ... 12:TRACe?
<b>Example</b>	CALC:PST:MARK3:TRAC MEAS CALC:PST:MARK:TRACE?
<b>Preset</b>	MEASured
<b>State Saved</b>	Saved in instrument state.
<b>Range</b>	Measured Gaussian Reference
<b>Initial S/W Revision</b>	Prior to A.02.00
<b>Modified at S/W Revision</b>	A.02.00, A.03.00

## Couple Markers

When this function is on, moving any marker causes an equal X axis movement of every other marker that is not off. By “equal X axis movement” we mean that we preserve the difference between each marker’s X axis value (in the fundamental x-axis units of the trace that marker is on) and the X axis value of the marker being moved (in the same fundamental x-axis units).

<b>Key Path</b>	Marker
<b>Initial S/W Revision</b>	Prior to A.02.00

## All Markers Off

Turns off all markers.

<b>Key Path</b>	Marker, More
<b>Mode</b>	SA, WCDMA, C2K, WIMAXOFDMA, TD-SCDMA, 1xEV-DO, DVB-T/H, DTMB (CTTB), ISDB-T, CMMB, LTE, LTE-TDD, Digital Cable TV, WLAN, MSR, LTE-TDD, LTE-FDD
<b>Remote Command</b>	:CALCulate:PStatistic:MARKer:AOFF

<b>Example</b>	CALC:PST:MARK:AOFF
Initial S/W Revision	Prior to A.02.00
Modified at S/W Revision	A.02.00, A.03.00

### Marker X Axis Value (Remote Command Only)

Sets the marker X Axis value in the current marker X Axis Scale unit. This function has no effect if the control mode is Off, but is the remote command equivalent of entering an X value if the control mode is Normal or Delta.

<b>Mode</b>	SA, WCDMA, C2K, WIMAXOFDMA, TD-SCDMA, 1xEV-DO, DVB-T/H, DTMB (CTTB), ISDB-T, CMMB, LTE, LTEFDD, Digital Cable TV, WLAN, MSR, LTEATDD, LTEAFDD
<b>Remote Command</b>	:CALCulate:PStatistic:MARKer[1] 2 ... 12:X <rel_amp1> :CALCulate:PStatistic:MARKer[1] 2 ... 12:X?
<b>Example</b>	CALC:PST:MARK3:X 0 CALC:PST:MARK3:X?
<b>Notes</b>	If no suffix is sent, it will use the fundamental units for the current marker X Axis Scale. If a suffix is sent that does not match the current marker X Axis Scale unit, an error "Invalid suffix" will be generated. If the specified marker is Fixed and a Marker Function is on, error -221 "Settings conflict; cannot adjust Fixed marker while Marker Function is on" is generated.  The query returns the marker's absolute X Axis value if the control mode is Normal, or the offset from the marker's reference marker if the control mode is Delta. The query is returned in the fundamental units for the current marker X Axis scale: Hz for Frequency and Inverse Time, seconds for Period and Time. If the marker is Off the response is not a number.
<b>Preset</b>	After a preset, all Markers are turned OFF, so Marker X Axis Value query will return a not a number (NAN).
<b>State Saved</b>	No
<b>Min</b>	-9.9E+37
<b>Max</b>	9.9E+37
Initial S/W Revision	Prior to A.02.00
Modified at S/W Revision	A.02.00, A.03.00

### Marker Y Axis Value (Remote Command Only)

Queries the marker Y Axis value in the current marker Y Axis unit.

<b>Mode</b>	SA, WCDMA, C2K, WIMAXOFDMA, TD-SCDMA, 1xEV-DO, DVB-T/H, DTMB (CTTB), ISDB-T, CMMB, LTE, LTEFDD, Digital Cable TV, WLAN, MSR, LTEATDD, LTEAFDD
<b>Remote Command</b>	:CALCulate:PStatistic:MARKer[1] 2 ... 12:Y?
<b>Example</b>	CALC:PST:MARK11:Y?
<b>Notes</b>	The query returns the marker Y-axis result, if the control mode is Normal, or Delta. If the marker is

---

	Off the response is not a number.
Preset	0
State Saved	No
<b>Backwards Compatibility SCPI</b>	:CALCulate:PStAtistic:MARKer[1] 2 ... 12:FUNCTion:RESult?
Initial S/W Revision	Prior to A.02.00
Modified at S/W Revision	A.02.00, A.03.00

---

## Marker Function

There are no 'Marker Functions' supported in Power Stat CCDF measurement. The front-panel key displays a blank menu when pressed.

---

Key Path	Front-panel key
Initial S/W Revision	Prior to A.02.00

---

## Marker To

There is no 'Marker To' functionality supported in Power Stat CCDF measurement. The front-panel key displays a blank menu when pressed.

---

Key Path	Front-panel key
Initial S/W Revision	Prior to A.02.00

---

## Meas

The information in this section is common to all measurements. For key and remote command information for a specific measurement, refer to the section that describes the measurement of interest.

Measurements available under the Meas key are specific to the current Mode.

When viewing Help for measurements, note the following:

**NOTE**

Operation for some keys differs between measurements. The information displayed in Help pertains to the current measurement. To see how a key operates in a different measurement, exit Help (press the Cancel Esc key), select the measurement, then reenter Help (press the Help key) and press that key.

---

Key Path	Front-panel key
Initial S/W Revision	Prior to A.02.00

---

### Remote Measurement Functions

This section contains the following topics:

"Measurement Group of Commands" on page 2166

"Current Measurement Query (Remote Command Only)" on page 2168

"Limit Test Current Results (Remote Command Only)" on page 2168

"Data Query (Remote Command Only)" on page 2168

"Calculate/Compress Trace Data Query (Remote Command Only)" on page 2169

"Calculate Peaks of Trace Data (Remote Command Only)" on page 2174

Hardware-Accelerated Fast Power Measurement (Remote Command Only)

"Format Data: Numeric Data (Remote Command Only)" on page 2175

"Format Data: Byte Order (Remote Command Only)" on page 2176

---

Initial S/W Revision	Prior to A.02.00
----------------------	------------------

---

## Measurement Group of Commands

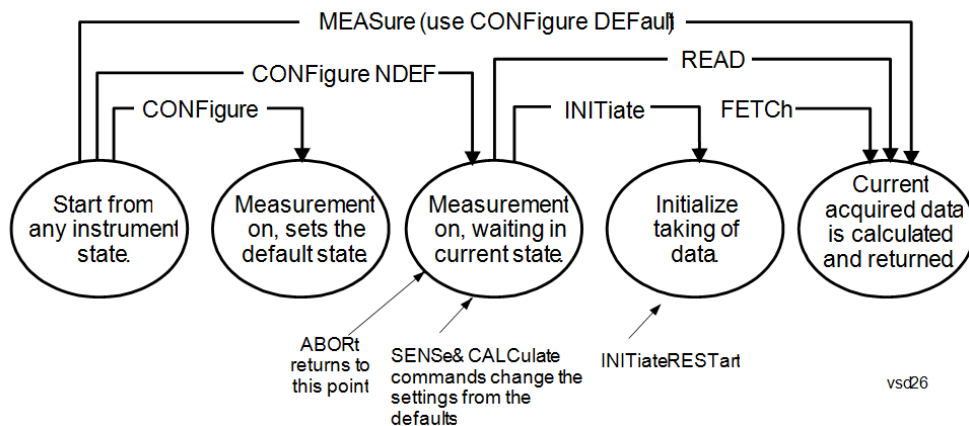

---

### Measure Commands:

:MEASure:<measurement>[n]?

This is a fast single-command way to make a measurement using the factory default instrument settings. These are the settings and units that conform to the Mode Setup settings (e.g. radio standard) that you have currently selected.

- Stops the current measurement (if any) and sets up the instrument for the specified measurement using the factory defaults
- Initiates the data acquisition for the measurement
- Blocks other SCPI communication, waiting until the measurement is complete before returning results.
- If the function does averaging, it is turned on and the number of averages is set to 10.
- After the data is valid it returns the scalar results, or the trace data, for the specified measurement. The type of data returned may be defined by an [n] value that is sent with the command.
- The scalar measurement results will be returned if the optional [n] value is not included, or is set to 1. If the [n] value is set to a value other than 1, the selected trace data results will be returned. See each command for details of what types of scalar results or trace data results are available.
- ASCII is the default format for the data output. (Older versions of Spectrum Analysis and Phase Noise mode measurements only use ASCII.) The binary data formats should be used for handling large blocks of data since they are smaller and faster than the ASCII format. Refer to the FORMat:DATA command for more information.

If you need to change some of the measurement parameters from the factory default settings you can set up the measurement with the CONFigure command. Use the commands in the SENSe:<measurement> and CALCulate:<measurement> subsystems to change the settings. Then you can use the READ? command to initiate the measurement and query the results.

If you need to repeatedly make a given measurement with settings other than the factory defaults, you can use the commands in the SENSe:<measurement> and CALCulate:<measurement> subsystems to set up the measurement. Then use the READ? command to initiate the measurement and query results.

Measurement settings persist if you initiate a different measurement and then return to a previous one. Use READ:<measurement>? if you want to use those persistent settings. If you want to go back to the default settings, use MEASure:<measurement>?.

---

### Configure Commands:

:CONFigure:<measurement>

This command stops the current measurement (if any) and sets up the instrument for the specified measurement using

---



---

the factory default instrument settings. It does not initiate the taking of measurement data unless INIT:CONTInuous is ON. If you change any measurement settings after using the CONFigure command, the READ command can be used to initiate a measurement without changing the settings back to their defaults.

In the Swept SA measurement in Spectrum Analyzer mode the CONFigure command also turns the averaging function on and sets the number of averages to 10 for all measurements.

:CONFigure: <measurement>: NDEFault stops the current measurement and changes to the specified measurement. It does not change the settings to the defaults. It does not initiate the taking of measurement data unless INIT:CONTInuous is ON.

The CONFigure? query returns the current measurement name.

The CONFigure:CATalog? query returns a quoted string of all licensed measurement names in the current mode. For example, "SAN, CHP, OBW, ACP, PST, TXP, SPUR, SEM, LIST".

---

#### Fetch Commands:

---

:FETCh:<measurement>[n]?

This command puts selected data from the most recent measurement into the output buffer. Use FETCh if you have already made a good measurement and you want to return several types of data (different [n] values, for example, both scalars and trace data) from a single measurement. FETCh saves you the time of re-making the measurement. You can only FETCh results from the measurement that is currently active, it will not change to a different measurement. An error message is reported if a measurement other than the current one is specified.

If you need to get new measurement data, use the READ command, which is equivalent to an INITiate followed by a FETCh.

The scalar measurement results will be returned if the optional [n] value is not included, or is set to 1. If the [n] value is set to a value other than 1, the selected trace data results will be returned. See each command for details of what types of scalar results or trace data results are available. The binary data formats should be used for handling large blocks of data since they are smaller and transfer faster than the ASCII format. (FORMat:DATA)

FETCh may be used to return results other than those specified with the original READ or MEASure command that you sent.

---

#### INITiate Commands:

---

:INITiate:<measurement>

This command is not available for measurements in all the instrument modes:

- Initiates a trigger cycle for the specified measurement, but does not output any data. You must then use the FETCh<meas> command to return data. If a measurement other than the current one is specified, the instrument will switch to that measurement and then initiate it.
  - For example, suppose you have previously initiated the ACP measurement, but now you are running the channel power measurement. If you send INIT:ACP? it will change from channel power to ACP and will initiate an ACP measurement.
  - Does not change any of the measurement settings. For example, if you have previously started the ACP measurement and you send INIT:ACP? it will initiate a new ACP measurement using the same instrument settings as the last time ACP was run.
  - If your selected measurement is currently active (in the idle state) it triggers the measurement, assuming the trigger conditions are met. Then it completes one trigger cycle. Depending upon the measurement and the number of averages, there may be multiple data acquisitions, with multiple trigger events, for one full trigger cycle. It also holds off additional commands on GPIB until the acquisition is complete.
- 

#### READ Commands:

---

:READ:<measurement>[n]?

- Does not preset the measurement to the factory default settings. For example, if you have previously initiated the ACP
-

---

measurement and you send READ:ACP? it will initiate a new measurement using the same instrument settings.

- Initiates the measurement and puts valid data into the output buffer. If a measurement other than the current one is specified, the instrument will switch to that measurement before it initiates the measurement and returns results.
  - For example, suppose you have previously initiated the ACP measurement, but now you are running the channel power measurement. Then you send READ:ACP? It will change from channel power back to ACP and, using the previous ACP settings, will initiate the measurement and return results.
  - Blocks other SCPI communication, waiting until the measurement is complete before returning the results
  - If the optional [n] value is not included, or is set to 1, the scalar measurement results will be returned. If the [n] value is set to a value other than 1, the selected trace data results will be returned. See each command for details of what types of scalar results or trace data results are available. The binary data formats should be used when handling large blocks of data since they are smaller and faster than the ASCII format. (FORMat:DATA)
- 

---

Initial S/W Revision	Prior to A.02.00
----------------------	------------------

---

### Current Measurement Query (Remote Command Only)

This command returns the name of the measurement that is currently running.

---

<b>Remote Command</b>	:CONFigure?
-----------------------	-------------

<b>Example</b>	CONF?
----------------	-------

Initial S/W Revision	Prior to A.02.00
----------------------	------------------

---

### Limit Test Current Results (Remote Command Only)

Queries the status of the current measurement limit testing. It returns a 0 if the measured results pass when compared with the current limits. It returns a 1 if the measured results fail any limit tests.

---

<b>Remote Command</b>	:CALCulate:CLIMits:FAIL?
-----------------------	--------------------------

<b>Example</b>	CALC:CLIM:FAIL? queries the current measurement to see if it fails the defined limits. Returns a 0 or 1: 0 it passes, 1 it fails.
----------------	--

Initial S/W Revision	Prior to A.02.00
----------------------	------------------

---

### Data Query (Remote Command Only)

Returns the designated measurement data for the currently selected measurement and subopcode.

n = any valid subopcode for the current measurement. See the measurement command results table for your current measurement, for information about what data is returned for the subopcodes.

This command uses the data setting specified by the FORMat:BORDER and FORMat:DATA commands and can return real or ASCII data. (See the format command descriptions under Input/Output in the Analyzer Setup section.)

<b>Remote Command</b>	:CALCulate:DATA[n]?
<b>Notes</b>	The return trace depends on the measurement. In CALCulate:<meas>:DATA[n], n is any valid subopcode for the current measurement. It returns the same data as the FETCH:<measurement>? query where <measurement> is the current measurement.
<b>Initial S/W Revision</b>	Prior to A.02.00

### Calculate/Compress Trace Data Query (Remote Command Only)

Returns compressed data for the currently selected measurement and sub-opcode [n].

n = any valid sub-opcode for that measurement. See the MEASure:<measurement>? command description of your specific measurement for information on the data that can be returned.

The data is returned in the current Y Axis Unit of the analyzer. The command is used with a sub-opcode <n> (default=1) to specify the trace. With trace queries, it is best if the analyzer is not sweeping during the query. Therefore, it is generally advisable to be in Single Sweep, or Update=Off.

This command is used to compress or decimate a long trace to extract and return only the desired data. A typical example would be to acquire N frames of GSM data and return the mean power of the first burst in each frame. The command can also be used to identify the best curve fit for the data.

<b>Remote Command</b>	:CALCulate:DATA<n>:COMPRESS? BLOCK   CFIT   MAXimum   MINimum   MEAN   DMEan   RMS   RMSCubed   SAMPLE   SDEVIation   PPHase [,<soffset> [,<length>[,<roffset>[,<rlimit>]]]]
<b>Example</b>	To query the mean power of a set of GSM bursts: Supply a signal that is a set of GSM bursts. Select the IQ Waveform measurement (in IQ Analyzer Mode). Set the sweep time to acquire at least one burst. Set the triggers such that acquisition happens at a known position relative to a burst. Then query the mean burst levels using, CALC:DATA2:COMP? MEAN, 24e-6, 526e-6 (These parameter values correspond to GSM signals, where 526e-6 is the length of the burst in the slot and you just want 1 burst.)
<b>Notes</b>	The command supports 5 parameters. Note that the last 4 (<soffset>, <length>, <roffset>, <rlimit>) are optional. But these optional parameters must be entered in the specified order. For example, if you want to specify <length>, then you must also specify <soffset>. See details below for a definition of each of these parameters.  This command uses the data in the format specified by FORMat:DATA, returning either binary or ASCII data.
<b>Initial S/W Revision</b>	Prior to A.02.00

- BLOCK or block data - returns all the data points from the region of the trace data that you specify. For example, it could be used to return the data points of an input signal over several timeslots, excluding the portions of the trace data that you do not want. (This is x,y pairs for trace data and I,Q pairs for complex data.)

- CFIT or curve fit - applies curve fitting routines to the data. <soffset> and <length> are required to define the data that you want. <roffset> is an optional parameter for the desired order of the curve equation. The query will return the following values: the x-offset (in seconds) and the curve coefficients ((order + 1) values).

MIN, MAX, MEAN, DME, RMS, RMSC, SAMP, SDEV and PPH return one data value for each specified region (or <length>) of trace data, for as many regions as possible until you run out of trace data (using <roffset> to specify regions). Or they return the number of regions you specify (using <rlimit>) ignoring any data beyond that.

- MINimum - returns the minimum data point (y value) for the specified region(s) of trace data. For I/Q trace data, the minimum magnitude of the I/Q pairs is returned.
- MAXimum - returns the maximum data point (y value) for the specified region(s) of trace data. For I/Q trace data, the maximum magnitude of the I/Q pairs is returned.
- MEAN - returns a single value that is the arithmetic mean of the data point values (in dB/ dBm) for the specified region(s) of trace data. For I/Q trace data, the mean of the magnitudes of the I/Q pairs is returned. See the following equations.

•

**NOTE**

If the original trace data is in dB, this function returns the arithmetic mean of those log values, not log of the mean power which is a more useful value. The mean of the log is the better measurement technique when measuring CW signals in the presence of noise. The mean of the power, expressed in dB, is useful in power measurements such as Channel Power. To achieve the mean of the power, use the RMS option.

Equation 1

Mean Value of Data Points for Specified Region(s)

$$\text{MEAN} = \frac{1}{n} \sum_{X_i \in \text{region}(s)} X_i$$

where  $X_i$  is a data point value, and  $n$  is the number of data points in the specified region(s).

Equation 2

Mean Value of I/Q Data Pairs for Specified Region(s)

$$\text{MEAN} = \frac{1}{n} \sum_{X_i \in \text{region}(s)} |X_i|$$

where  $|X_i|$  is the magnitude of an I/Q pair, and  $n$  is the number of I/Q pairs in the specified region(s).

- DMEan - returns a single value that is the mean power (in dB/ dBm) of the data point values for the specified region(s) of trace data. See the following equation:

Equation 3

DMEan Value of Data Points for Specified Region(s)

$$\text{DME} = 10 \times \log_{10} \left( \frac{1}{n} \sum_{X_i \in \text{region}(s)} 10^{\frac{X_i}{10}} \right)$$

- RMS - returns a single value that is the average power on a root-mean-squared voltage scale (arithmetic rms) of the data point values for the specified region(s) of trace data. See the following equation.

**NOTE** For I/Q trace data, the rms of the magnitudes of the I/Q pairs is returned. See the following equation. This function is very useful for I/Q trace data. However, if the original trace data is in dB, this function returns the rms of the log values which is not usually needed.

Equation 4

RMS Value of Data Points for Specified Region(s)

$$\text{RMS} = \sqrt{\frac{1}{n} \sum_{X_i \in \text{region}(s)} X_i^2}$$

where  $X_i$  is a data point value, and  $n$  is the number of data points in the specified region(s).

Equation 5

RMS Value of I/Q Data Pairs for Specified Region(s)

$$\text{RMS} = \sqrt{\frac{1}{n} \sum_{X_i \in \text{region}(s)} X_i X_i^*}$$

where  $X_i$  is the complex value representation of an I/Q pair,  $X_i^*$  its conjugate complex number, and  $n$  is the number of I/Q pairs in the specified region(s).

Once you have the rms value for a region of trace data (linear or I/Q), you may want to calculate the mean power. You must convert this rms value (peak volts) to power in dBm:

$$10 \times \log[10 \times (\text{rms value})^2]$$

- SAMPLe - returns the first data value (x,y pair) for the specified region(s) of trace data. For I/Q trace data, the first I/Q pair is returned.
- SDEViation - returns a single value that is the arithmetic standard deviation for the data point values for the specified region(s) of trace data. See the following equation.
- For I/Q trace data, the standard deviation of the magnitudes of the I/Q pairs is returned. See the following equation.

Equation 6

Standard Deviation of Data Point Values for Specified Region(s)

$$\text{SDEV} = \sqrt{\frac{1}{n} \sum_{X_i \in \text{region}(s)} (X_i - \bar{X})^2}$$

where  $X_i$  is a data point value,  $\bar{X}$  is the arithmetic mean of the data point values for the specified region (s), and  $n$  is the number of data points in the specified region(s).

$$\text{SDEV} = \sqrt{\frac{1}{n} \sum_{X_i \in \text{region}(s)} (|X_i| - \bar{X})^2}$$

where  $|X_i|$  is the magnitude of an I/Q pair,  $\bar{X}$  is the mean of the magnitudes for the specified region(s), and  $n$  is the number of data points in the specified region(s).

- PPHase - returns the x,y pairs of both rms power (dBm) and arithmetic mean phase (radian) for every specified region and frequency offset (Hz). The number of pairs is defined by the specified number of regions. This parameter can be used for I/Q vector ( $n=0$ ) in Waveform (time domain) measurement and all parameters are specified by data point in PPHase.

The rms power of the specified region may be expressed as:

$$\text{Power} = 10 \times \log [10 \times (\text{RMS I/Q value})] + 10.$$

The RMS I/Q value (peak volts) is:

$$\sqrt{\frac{1}{n} \sum_{X_i \in \text{region}} X_i X_i^*}$$

where  $X_i$  is the complex value representation of an I/Q pair,  $X_i^*$  its conjugate complex number, and  $n$  is the number of I/Q pairs in the specified region.

The arithmetic mean phase of the specified region may be expressed as:

$$\frac{1}{n} \sum_{Y_i \in \text{region}} Y_i$$

where  $Y_i$  is the unwrapped phase of I/Q pair with applying frequency correction and  $n$  is the number of I/Q pairs in the specified region.

The frequency correction is made by the frequency offset calculated by the arithmetic mean of every specified region's frequency offset. Each frequency offset is calculated by the least square method against the unwrapped phase of I/Q pair.

Sample Trace Data - Constant Envelope

(See below for explanation of variables.)

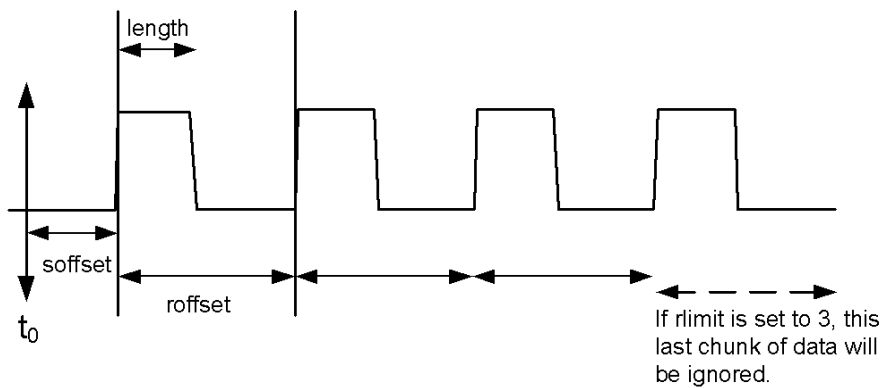

### Sample Trace Data - Not Constant Envelope

(See below for explanation of variables.)

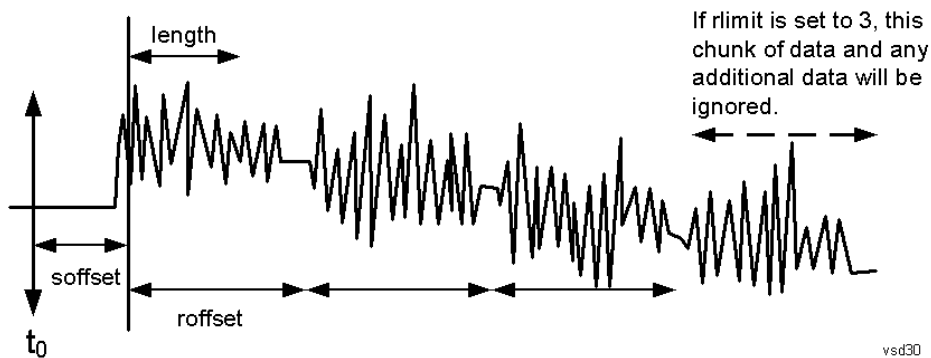

<soffset> - start offset is an optional real number. (It is in seconds for time-domain traces, and is a dimensionless index 0 to Npoints - 1, for frequency-domain traces). It specifies the amount of data at the beginning of the trace that will be ignored before the decimation process starts. It is the time or frequency change from the start of the trace to the point where you want to start using the data. The default value is zero.

<length> - is an optional real number. (It is in seconds for time-domain traces, and is a dimensionless index 0 to Npoints - 1, for frequency-domain traces). It defines how much data will be compressed into one value. This parameter has a default value equal to the current trace length.

<roffset> - repeat offset is an optional real number. (It is in seconds for time-domain traces, and is a dimensionless index 0 to Npoints - 1, for frequency-domain traces). It defines the beginning of the next field of trace elements to be compressed. This is relative to the beginning of the previous field. This parameter has a default value equal to the <length> variable. Note that this parameter is used for a completely different purpose when curve fitting (see CFIT above).

<rlimit> - repeat limit is an optional integer. It specifies the number of data items that you want returned. It will ignore any additional items beyond that number. You can use the Start offset and the Repeat limit to pick out exactly what part of the data you want to use. The default value is all the data.

## Calculate Peaks of Trace Data (Remote Command Only)

Returns a list of all the peaks for the currently selected measurement and sub-opcode [n]. The peaks must meet the requirements of the peak threshold and excursion values.

n = any valid sub-opcode for the current measurement. See the MEASure:<measurement> command description of your specific measurement for information on the data that can be returned.

The command can only be used with specific sub-opcodes with measurement results that are trace data. Both real and complex traces can be searched, but complex traces are converted to magnitude in dBm. In many measurements the sub-opcode n=0, is the raw trace data which cannot be searched for peaks. And Sub-opcode n=1, is often calculated results values which also cannot be searched for peaks.

This command uses the data setting specified by the FORMat:BORDER and FORMat:DATA commands and can return real or ASCII data. If the format is set to INT,32, it returns REAL,32 data.

The command has four types of parameters:

- Threshold (in dBm)
- Excursion (in dB)
- Sorting order (amplitude, frequency, time)
- Optional in some measurements: Display line use (all, > display line, < display line)

---

<b>Remote Command</b>	<p>For Swept SA measurement:</p> <pre>:CALCulate:DATA[1] 2 ... 6:PEAKs? &lt;threshold&gt;,&lt;excursion&gt;[,AMPLitude   FREQuency   TIME[,ALL   GTDLLine   LTDLine]]</pre> <p>For most other measurements:</p> <pre>:CALCulate:DATA[1] 2 ... 6:PEAKs? &lt;threshold&gt;,&lt;excursion&gt;[,AMPLitude   FREQuency   TIME]</pre>
-----------------------	---

---

<b>Example</b>	<p>Example for Swept SA measurement in Spectrum Analyzer Mode:</p> <p>CALC:DATA4:PEAK? -40, 10, FREQ, GTDL This will identify the peaks of trace 4 that are above -40 dBm, with excursions of at least 10 dB. The peaks are returned in order of increasing frequency, starting with the lowest frequency. Only the peaks that are above the display line are returned.</p> <p>Query Results 1:</p> <p>With FORMat:DATA REAL, 32 selected, it returns a list of floating-point numbers. The first value in the list is the number of peak points that are in the following list. A peak point consists of two values: a peak amplitude followed by its corresponding frequency (or time).</p> <p>If no peaks are found the peak list will consist of only the number of peaks, (0).</p>
----------------	---

---

<b>Notes</b>	<p>&lt;n&gt; - is the trace that will be used</p> <p>&lt;threshold&gt; - is the level below which trace data peaks are ignored. Note that the threshold value is required and is always used as a peak criterion. To effectively disable the threshold criterion for this command, provide a substantially low threshold value such as -200 dBm. Also note that the threshold value used in this command is independent of and has no effect on the threshold value stored under the Peak Criteria menu.</p> <p>&lt;excursion&gt; - is the minimum amplitude variation (rise and fall) required for a signal to be identified as peak. Note that the excursion value is required and is always used as a peak criterion. To effectively disable the excursion criterion for this command, provide the minimum value of 0.0 dB. Also note that the excursion value used in this command is independent of and has no effect on the</p>
--------------	---

---



excursion value stored under the Peak Criteria menu.

Values must be provided for threshold and excursion. The sorting and display line parameters are optional (defaults are AMPLitude and ALL).

Note that there is always a Y-axis value for the display line, regardless of whether the display line state is on or off. It is the current Y-axis value of the display line which is used by this command to determine whether a peak should be reported

Sorting order:

AMPLitude - lists the peaks in order of descending amplitude, with the highest peak first (default if optional parameter not sent)

FREQUency - lists the peaks in order of occurrence, left to right across the x-axis.

TIME - lists the peaks in order of occurrence, left to right across the x-axis.

Peaks vs. Display Line:

ALL - lists all of the peaks found (default if optional parameter not sent).

GTDLine (greater than display line) - lists all of the peaks found above the display line.

LTDLine (less than display line) - lists all of the peaks found below the display line.

---

Initial S/W Revision      Prior to A.02.00

---

### Format Data: Numeric Data (Remote Command Only)

This command specifies the format of the trace data input and output. It specifies the formats used for trace data during data transfer across any remote port. It affects only the data format for setting and querying trace data for the :TRACe[:DATA], TRACe[:DATA]?, :CALCulate:DATA[n]? and FETCh:SANalyzer [n]? commands and queries.

---

**Remote Command**      :FORMat[:TRACe] [:DATA] ASCii|INTeger,32|REAL,32 |REAL,64  
:FORMat[:TRACe] [:DATA] ?

---

**Notes**      The query response is:  
ASCii: ASC,8  
REAL,32: REAL,32  
REAL,64: REAL,64  
INTeger,32: INT,32

When the numeric data format is REAL or ASCii, data is output in the current Y Axis unit. When the data format is INTeger, data is output in units of m dBm (.001 dBm).

The INT,32 format returns binary 32-bit integer values in internal units (m dBm), in a definite length block.

---

**Dependencies**      Sending a data format spec with an invalid number (for example, INT,48) generates no error. The analyzer simply uses the default (8 for ASCii, 32 for INTeger, 32 for REAL).

Sending data to the analyzer which does not conform to the current FORMat specified, results in an error. Sending ASCII data when a definite block is expected generates message -161 "Invalid Block Data" and sending a definite block when ASCII data is expected generates message -121 "Invalid Character in Number".

---

**Preset**      ASCii

---

**Backwards Compatibility Notes**      Note that the INT,32 format is only applicable to the command, TRACe:DATA. This preserves backwards compatibility for the Swept SA measurement. For all other commands/queries which honor FORMat:DATA, if INT,32 is sent the analyzer will behave as though it were set to REAL,32.

---

Initial S/W Revision      Prior to A.02.00

---

The specs for each output type follow:

AScii - Amplitude values are in ASCII, in the current Y Axis Unit, one ASCII character per digit, values separated by commas, each value in the form:

SX.YYYYYEsZZ

Where:

S = sign (+ or -)

X = one digit to left of decimal point

Y = 5 digits to right of decimal point

E = E, exponent header

s = sign of exponent (+ or -)

ZZ = two digit exponent

REAL,32 - Binary 32-bit real values in the current Y Axis Unit, in a definite length block.

REAL,64 - Binary 64-bit real values in the current Y Axis Unit, in a definite length block.

### Format Data: Byte Order (Remote Command Only)

This command selects the binary data byte order for data transfer and other queries. It controls whether binary data is transferred in normal or swapped mode. This command affects only the byte order for setting and querying trace data for the :TRACe[:DATA], TRACe[:DATA]? , :CALCulate:DATA[n]? and FETCh:SANalyzer[n]? commands and queries.

By definition any command that says it uses FORMat:DATA uses any format supported by FORMat:DATA.

The NORMal order is a byte sequence that begins with the most significant byte (MSB) first, and ends with the least significant byte (LSB) last in the sequence: 1|2|3|4. SWAPped order is when the byte sequence begins with the LSB first, and ends with the MSB last in the sequence: 4|3|2|1.

---

<b>Remote Command</b>	:FORMat:BORDER NORMal   SWAPped :FORMat:BORDER?
<b>Preset</b>	NORMal
<b>Initial S/W Revision</b>	Prior to A.02.00

---

## Meas Setup

Accesses the functions that allow you to change the settings for your measurement requirements.

Key Path	Front-panel key
Initial S/W Revision	Prior to A.02.00

### Counts

Sets the accumulated number of sampling points for data acquisition. The range is 1.000 kpt (k point) to 2.00000 Gpt (G point) with 1 kpt resolution. Counts couples to Meas Cycles. When the value for counts is changed, the Meas Cycles value will be  $(\text{Counts} / \text{SamplingFrequency} * \text{MeasInterval})$ .

Key Path	Meas Setup
Mode	SA, WCDMA, C2K, WIMAXOFDMA, TD-SCDMA, 1xEV-DO, DVB-T/H, DTMB (CTTB), ISDB-T, CMMB, LTE, LTE-TDD, Digital Cable TV, WLAN, MSR, LTEATDD, LTEAFDD
Remote Command	<code>[[:SENSe]:PStatistic:COUNTs &lt;integer&gt;</code> <code>[[:SENSe]:PStatistic:COUNTs?</code>
Example	PST:COUN 5001 PST:COUN?
Couplings	This value is coupled to Meas Cycles. When Counts is changed, the MeasCycles value will be $(\text{Counts} / \text{SamplingFrequency} * \text{MeasInterval})$ . TD-SCDMA: When Counts is changed, the MeasCycles value will be $(\text{Counts} / (\text{Sampling Frequency} * \text{Time duration of measured time slots} / 5 \text{ msec}))$ , Time duration of measured time slots is determined by Analysis Time Slot and Measure Interval.
Preset	10000000
State Saved	Saved in instrument state.
Min	1000
Max	2000000000
Default Unit	Kpt
Initial S/W Revision	Prior to A.02.00
Modified at S/W Revision	A.02.00, A.03.00

### Meas Cycles

Set the number of measurement cycles to calculate power statistic data. This number couples to Counts. The Counts value is  $(\text{MeasCycles} * \text{Sampling Frequency} * \text{MeasInterval})$ .

When the counts value cannot be divided by  $(\text{Sampling Frequency} * \text{MeasInterval})$ , this value is displayed as a decimal fraction.

Key Path	Meas Setup
----------	------------

Mode	SA, WCDMA, C2K, WiMAX OFDMA, TD-SCDMA, 1xEV-DO, DVB-T/H, DTMB (CTTB), ISDB-T, CMMB, LTE, LTE-TDD, Digital Cable TV, WLAN, MSR, LTE-TDD, LTE-FDD
Remote Command	[ :SENSe ] :PStatistic:SWEp:CYCLes <integer> [ :SENSe ] :PStatistic:SWEp:CYCLes?
Example	PST:SWE:CYCL 1001 PST:SWE:CYCL?
Notes	.
Couplings	The Counts value will be (MeasCycles * Sampling Frequency * MeasInterval). TD-SCDMA: The Counts value will be (MeasCycles * Sampling Frequency * Time duration of measured time slots / 5 msec), Time duration of measured time slots is determined by Analysis Time Slot and Measure Interval.
Preset	Depends on the sampling frequency.
Min	1
Max	Depends on the sampling frequency.
Initial S/W Revision	Prior to A.02.00
Modified at S/W Revision	A.02.00, A.03.00

### Meas Interval (Not 1xEVDO)

Sets the number of data points to be used as the measurement interval. This value couples to Counts. The Counts value is (MeasCycles \* Sampling Frequency \* MeasInterval).

Key Path	Meas Setup
Mode	SA, WCDMA, C2K, WiMAX OFDMA, TD-SCDMA, DVB-T/H, DTMB (CTTB), ISDB-T, CMMB, LTE, LTE-TDD, Digital Cable TV, WLAN, MSR, LTE-TDD, LTE-FDD
Remote Command	[ :SENSe ] :PStatistic:SWEp:TIME <time> [ :SENSe ] :PStatistic:SWEp:TIME?
Example	PST:SWE:TIME 2 ms PST:SWE:TIME?
Couplings	The Counts value will be (MeasCycles * Sampling Frequency * MeasInterval). WiMAX OFDMA: The default value depends on Radio Device status. TD-SCDMA: The Counts value will be (MeasCycles * Sampling Frequency * Time duration of measured time slots / 5 msec), Time duration of measured time slots is determined by Analysis Time Slot and Measure Interval. When TriggerSource is RFBurst, this button is grayed.
Preset	Others: 1.0 ms TD-SCDMA: 1 slot LTE-TDD, LTE-TDD: 500 us
Min	Others: 50.0 us TD-SCDMA: 1 slot

Max	Others: 10.0 ms TD-SCDMA: 9 slot
Initial S/W Revision	Prior to A.02.00
Modified at S/W Revision	A.02.00, A.03.00

## IF Gain

Sets the IF Gain function to Auto, Low Gain or High Gain. These settings affect sensitivity and IF overloads. This only applies to the RF input. It does not apply to baseband I/Q input.

Key Path	Meas Setup
Dependencies	The IF Gain keys (FFT IF Gain and Swept IF Gain) have no effect when the U7227A USB Preamplifier is connected. This is not annotated or reflected on any softkey; there are no keys grayed out nor any SCPI locked out. The analyzer simply behaves as though both FFT IF Gain and Swept IF Gain are set to Low regardless of the setting on the keys.
Initial S/W Revision	Prior to A.02.00

## IF Gain Auto

Activates the Auto Rules for IF Gain When Auto is active, the IF Gain is set to High Gain under any of the following conditions:

- the input attenuator is set to 0 dB
- the preamp is turned On
- the Max Mixer Level is -20 dBm or lower

For other settings, Auto sets IF Gain to Off.

Key Path	Meas Setup, IF Gain
Mode	SA, WCDMA, C2K, WiMAX OFDMA, TD-SCDMA, 1xEV-DO, DVB-T/H, DTMB (CTTB), ISDB-T, CMMB, LTE, LTE-TDD, Digital Cable TV, WLAN, MSR, LTE-TDD, LTE-FDD
<b>Remote Command</b>	<code>[ :SENSe ] :PStatistic:IF:GAIN:AUTO[ :STATe ] ON OFF 1 0</code> <code>[ :SENSe ] :PStatistic:IF:GAIN:AUTO[ :STATe ] ?</code>
<b>Example</b>	PST:IF:GAIN:AUTO ON PST:IF:GAIN:AUTO?
Notes	IF Gain only applies to the RF input. It does not apply to baseband I/Q input.
Couplings	When either the auto attenuation is active (for example, with electrical attenuator), or the optimize mechanical attenuator range is requested, the IF Gain setting is changed using the following rule. The Auto selection sets IF Gain On under any of the following conditions: <ul style="list-style-type: none"> <li>• the input attenuator is set to 0 dB</li> <li>• the preamp is turned on,</li> </ul>

	<ul style="list-style-type: none"> <li>the Max Mixer Level is -20 dBm or lower.</li> </ul> For other settings, Auto sets IF Gain to Off.
Preset	OFF
State Saved	Saved in instrument state.
Range	Auto Man
Initial S/W Revision	Prior to A.02.00
Modified at S/W Revision	A.02.00, A.03.00

### IF Gain State

Selects the range of IF gain. On sets the high gain option, which allows for better noise level measurements and Off sets low gain when measuring large signals.

Key Path	Meas Setup, IF Gain
Mode	SA, WCDMA, C2K, WIMAXOFDMA, TD-SCDMA, 1xEV-DO, DVB-T/H, DTMB (CTTB), ISDB-T, CMMB, LTE, LTE-TDD, Digital Cable TV, WLAN, MSR, LTE-TDD, LTEAFDD
Remote Command	[:SENSe]:PStatistic:IF:GAIN[:STATe] ON OFF 1 0 [:SENSe]:PStatistic:IF:GAIN[:STATe]?
Example	PST:IF:GAIN ON PST:IF:GAIN?
Notes	IF Gain only applies to the RF input. It does not apply to baseband I/Q input. where ON = high gain OFF = low gain
Preset	OFF
State Saved	Saved in instrument state.
Range	Low Gain (Best for Large Signals) High Gain (Best Noise Level)
Readback Text	Low Gain High Gain
Initial S/W Revision	Prior to A.02.00
Modified at S/W Revision	A.02.00, A.03.00

### Meas Preset

Restores all measurement settings to their default values.

Key Path	Meas Setup
Mode	SA, WCDMA, C2K, WIMAXOFDMA, TD-SCDMA, 1xEV-DO, DVB-T/H, DTMB (CTTB), ISDB-T, CMMB, LTE, LTE-TDD, Digital Cable TV, WLAN, MSR, LTE-TDD, LTEAFDD
Remote Command	:CONFigure:PStatistic
Example	CONF:PST

---

Notes	You must be in the Spectrum Analysis mode, W-CDMA mode, cdma2000 mode, TD-SCDMA mode, DVB-T/H mode, DTMB (CTTB) mode, SDB-T mode, CMMB mode, Digital Cable TV mode or WIMAX OFDMA mode to use this command. Use :INSTRument:SElect to set the mode.
Couplings	Selecting Meas Preset will restore all measurement parameters to their default values.
Initial S/W Revision	Prior to A.02.00
Modified at S/W Revision	A.02.00, A.03.00

---

10 Power Stat CCDF Measurement  
Mode

Mode

See "[Mode](#)" on page 298



## Mode Preset

Returns the active mode to a known state.

Mode Preset does the following for the currently active mode:

- Aborts the currently running measurement.
- Brings up the default menu for the mode, with no active function.
- Sets measurement Global settings to their preset values for the active mode only.
- Activates the default measurement.
- Brings up the default menu for the mode.
- Clears the input and output buffers.
- Sets Status Byte to 0.

Mode Preset does not:

- Cause a mode switch
- Affect mode persistent settings
- Affect system settings

See "[How-To Preset](#)" on page 954 for more information.

Key Path	Front-panel key
<b>Remote Command</b>	:SYSTem:PRESet
<b>Example</b>	:SYST:PRES
Notes	*RST is preferred over :SYST:PRES for remote operation. *RST does a Mode Preset, as done by the :SYST:PRES command, and it sets the measurement mode to Single measurement rather than Continuous for optimal remote control throughput. Clears all pending OPC bits. The Status Byte is set to 0.
Couplings	A Mode Preset aborts the currently running measurement, activates the default measurement, and gets the mode to a consistent state with all of the default couplings set.
Backwards Compatibility Notes	In the X-Series, the legacy "Factory Preset" has been replaced with Mode Preset, which only presets the currently active mode, not the entire instrument. In the X-Series, the way to preset the entire instrument is by using System, Restore System Defaults All, which behaves essentially the same way as restore System Defaults does on ESA and PSA. There is also no "Preset Type" as there is on the PSA. There is a green Mode Preset front-panel key that does a Mode Preset and a white-with-green-letters User Preset front-panel key that does a User Preset. The old PRESet:TYPE command is ignored (without generating an error), and SYST:PRES without a parameter does a Mode Preset, which should cover most backward code compatibility issues. The settings and correction data under the Input/Output front-panel key (examples: Input Z Corr, Ext Amp Gain, etc.) are no longer part of any Mode, so they will not be preset by a Mode Preset. They are preset using Restore Input/Output Defaults, Restore System Defaults All. Note that because User Preset does a Recall State, and all of these settings are saved in State, they ARE recalled when using

	User Preset.
Initial S/W Revision	Prior to A.02.00

## How-To Preset

The table below shows all possible presets, their corresponding SCPI commands and front-panel access (key paths). Instrument settings depend on the current measurement context. Some settings are local to the current measurement, some are global (common) across all the measurements in the current mode, and some are global to all the available modes. In a similar way, restoring the settings to their preset state can be done within the different contexts.

Auto Couple - is a measurement local key. It sets all Auto/Man parameter couplings in the measurement to Auto. Any Auto/Man selection that is local to other measurements in the mode will not be affected.

Meas Preset - is a measurement local key. Meas Preset resets all the variables local to the current measurement except the persistent ones.

Mode Preset - resets all the current mode's measurement local and measurement global variables except the persistent ones.

Restore Mode Defaults - resets ALL the Mode variables (and all the Meas global and Meas local variables), including the persistent ones.

Type Of Preset	SCPI Command	Front Panel Access
Auto Couple	:COUPle ALL	Auto Couple front-panel key
Meas Preset	:CONFigure:<Measurement>	Meas Setup Menu
Mode Preset	:SYSTem:PRESet	Mode Preset (green key)
Restore Mode Defaults	:INSTrument:DEFault	Mode Setup Menu
Restore All Mode Defaults	:SYSTem:DEFault MODes	System Menu; Restore System Default Menu
*RST	*RST	not possible (Mode Preset with Single)
Restore Input/Output Defaults	:SYSTem:DEFault INPUt	System Menu; Restore System Default Menu
Restore Power On Defaults	:SYSTem:DEFault PON	System Menu; Restore System Default Menu
Restore Alignment Defaults	:SYSTem:DEFault ALIGN	System Menu; Restore System Default Menu
Restore Miscellaneous Defaults	:SYSTem:DEFault MISC	System Menu; Restore System Default Menu
Restore All System Defaults	:SYSTem:DEFault [ALL] :SYSTem:PRESet:PERsistent	System Menu; Restore System Default Menu
User Preset	:SYSTem:PRESet:USER	User Preset Menu
User Preset All Modes	:SYSTem:PRESet:USER:ALL	User Preset Menu

Power On Mode Preset	:SYSTem:PON:TYPE MODE	System Menu
Power On User Preset	:SYSTem:PON:TYPE USER	System Menu
Power On Last State	:SYSTem:PON:TYPE LAST	System Menu

### Preset Type (Remote Command Only)

As stated in the Backward Compatibility section, to be compatible with ESA/PSA the PRESet:TYPE command will be implemented as a no-op.

Mode	All
<b>Remote Command</b>	:SYSTem:PRESet:TYPE FACTory MODE USER :SYSTem:PRESet:TYPE?
<b>Example</b>	:SYST:PRESet:TYPE FACT
Notes	This command is supported for backward compatibility only. It is a no-op which does not change the behavior of any preset operation.
Preset	This is unaffected by Preset but is set to Mode on a "Restore System Defaults->All"
State Saved	No
Initial S/W Revision	Prior to A.02.00

## Mode Setup

See "[Mode Setup](#)" on page 328

## Peak Search

There is no 'Peak Search' functionality supported in Power Stat CCDF measurement. The front-panel key displays a blank menu when pressed.

---

Key Path	Front-panel key
Initial S/W Revision	Prior to A.02.00

---

10 Power Stat CCDF Measurement  
Print

Print

See "Print" on page 341

## Quick Save

The Quick Save front-panel key repeats the most recent save that was performed from the Save menu, with the following exceptions:

- Register saves are not remembered as Saves for the purpose of the Quick Save function
- If the current measurement does not support the last non-register save that was performed, an informational message is generated, “File type not supported for this measurement”

Quick Save repeats the last type of qualified save (that is, a save qualified by the above criteria) in the last save directory by creating a unique filename using the Auto File Naming algorithm described below.

If Quick Save is pressed after startup and before any qualified Save has been performed, the Quick Save function performs a Screen Image save using the current settings for Screen Image saves (current theme, current directory), which then becomes the “last save” for the purpose of subsequent Quick Saves.

The Auto File Naming feature automatically generates a file name for use when saving a file. The filename consists of a prefix and suffix separated by a dot, as is standard for the Windows® file system. A default prefix exists for each of the available file types:

Type	Default Prefix	Menu
State	State_	(Save/Recall)
Trace + State	State_	(Save/Recall)
Screen	Screen_	(Save/Recall)
Amplitude Corrections	Ampcor_	(Import/Export)
Traces	Trace_	(Import/Export)
Limit Lines	LLine_	(Import/Export)
Measurement Result	MeasR_	(Import/Export)
Capture Buffer	CapBuf_	(Import/Export)

A four digit number is appended to the prefix to create a unique file name. The numbering sequence starts at 0000 within each Mode for each file type and updates incrementally to 9999, then wraps to 0000 again. It remembers where it was through a Mode Preset and when leaving and returning to the Mode. It is reset by Restore Misc Defaults and Restore System Defaults and subsequent running of the instrument application. So, for example, the first auto file name generated for State files is State\_0000.state. The next is State\_0001, and so forth.

One of the key features of Auto File Name is that we guarantee that the Auto File Name will never conflict with an existing file. The algorithm looks for the next available number. If it gets to 9999, then it looks for holes. If it find no holes, that is no more numbers are available, it gives an error.

For example, if when we get to State\_0010.state there is already a State\_0010.state file in the current directory, it advances the counter to State\_0011.state to ensure that no conflict will exist (and then it verifies that State\_0011.state also does not exist in the current directory and advances again if it does, and so forth).

If you enter a file name for a given file type, then the prefix becomes the filename you entered instead of the default prefix, followed by an underscore. The last four letters (the suffix) are the 4-digit number.

For example, if you save a measurement results file as “fred.csv”, then the next auto file name chosen for a measurement results save will be fred\_0000.csv.

**NOTE**

Although 0000 is used in the example above, the number that is used is actually the current number in the Meas Results sequence, that is, the number that would have been used if you had not entered your own file name.

---

**NOTE**

If the filename you entered ends with \_dddd, where d=any number, making it look just like an auto file name, then the next auto file name picks up where you left off with the suffix being dddd + 1.

---

Key Path	Front-panel key
Notes	No remote command for this key specifically.
Initial S/W Revision	Prior to A.02.00



## Recall

The Recall menu lets you choose what you want to recall, and where you want to recall it from. Among the types of files you can recall are **States and Traces**. In addition, an Import (Data) option lets you recall a number of data types stored in CSV files (as used by Excel and other spreadsheet programs).

The default paths for Recall are data type dependent and are the same as for the Save key.

Key Path	Front-panel key
Notes	<p>No remote command for this key specifically, but the :MMEM:LOAD command is available for specific file types. An example is :MMEM:LOAD:STATe &lt;filename&gt;.</p> <p>If you try to recall a State file for a mode that is not licensed or not available in the instrument, an error message will occur and the state will not change.</p>
Backwards Compatibility Notes	<p>In legacy analyzers, it was possible to load a state without affecting the trace data, limit lines or correction data. Similarly (since User Preset is actually loading a state), it was possible to do a User Preset without affecting the trace data, limit lines or correction data.</p> <p>In the X-Series, “state” always includes all of this data; so whenever state is loaded, all of the traces, limit lines and corrections are affected. Although this differs from previous behavior, it is desirable behavior, and should not cause adverse issues for users.</p>
Backwards Compatibility Notes	<p>Recall for the X-Series supports backward compatibility in the sense that you can recall a state file from any X-Series model number and any version of X-Series software. This is only possible if part of the recalling process goes through a limiting step after recalling the mode settings, at least for settings that may vary with version number, model number, option and license differences. If you try to recall a state file onto an instrument with less capability than what was available on the instrument during the save, the recall will ignore the state it doesn't support and it will limit the recalled setting to what it allows.</p> <p>Example: if the saved state includes preamp ON, but the recalling instrument does not have a preamp; the preamp is limited to OFF. Conversely, if you save a state without a preamp, the preamp is OFF in the state file. When this saved file is recalled on an instrument with a licensed preamp, the preamp is changed to OFF. Another example is if the saved state has center frequency set to 20 GHz, but the instrument recalling the saved state is a different model and only supports 13.5 GHz. In this case, the center frequency is limited along with any other frequency based settings. Since the center frequency can't be preserved in this case, the recall limiting tries to at least preserve span to keep the measurement setup as intact as possible.</p> <p>It may be appropriate to issue a warning if the state is limited on the recall; warnings do not go out to SCPI so this would only affect the manual user.</p> <p>Note that there is no state file compatibility outside of the X-Series. For example, you cannot recall a state file from ESA or PSA.</p>
Initial S/W Revision	Prior to A.02.00

## State

The Recall State menu lets you choose a register or file from which to recall the state.

The content of a state file includes all of the settings and data required to return the analyzer as closely as possible to the Mode it was in, with the exact settings that were in place, when the save occurred. The Mode settings in each state file include the settings that are affected by Mode Preset, as well as the

additional settings affected by Restore Mode Defaults; all of the Mode's settings. In addition, all of the settings of the Input/Output system are included, even though they are outside of the Mode's state, because they are needed to restore the complete setup. Persistent System settings (for example, GPIB address) are not affected by either a Mode Preset or Restore Mode Defaults, nor are they included in a saved State file.

Since each state file is only for one Mode, the settings for other Modes are unaffected when it is loaded. Recall State will cause a mode switch if the state being recalled is not from the current active mode.

After the recall completes, the message "File <filename> recalled" or "Recalled State Register <register number>" is displayed.

For rapid recalls, the State menu lists 16 registers that you can choose from to recall. Pressing a Register key initiates the recall. You can also select a file from which to recall.

The default path for all State Files is:

My Documents\<mode name>\state

where <mode name> is the parameter used to select the mode with the INST:SEL command (for example, SA for the Spectrum Analyzer).

See ["More Information" on page 963](#).

<b>Key Path</b>	Recall
<b>Mode</b>	All
<b>Remote Command</b>	:MMEMory:LOAD:STATe <filename>
<b>Example</b>	:MMEM:LOAD:STAT "myState.state" This recalls the file myState.state on the default path
<b>Example</b>	MMEM:LOAD:STAT "MyStateFile.state" This loads the state file data (on the default file directory path) into the instrument state.
<b>Notes</b>	<p>When you pick a file to recall, the analyzer first verifies that the file is recallable in the current instrument by checking the software version and model number of the instrument. If everything matches, a full recall proceeds by aborting the currently running measurement, clearing any pending operations, and then loading the State from the saved state file. You can open state files from any mode, so recalling a State file switches to the mode that was active when the save occurred. After switching to the mode of the saved state file, mode settings and data (if any for the mode) are loaded with values from the saved file. The saved measurement of the mode becomes the newly active measurement and the data relevant to the measurement (if there is any) is recalled.</p> <p>If there is a mismatch between file version or model number or instrument version or model number, the recall function tries to recall as much as possible and returns a warning message. It may limit settings that differ based on model number, licensing or version number.</p> <p>After recalling the state, the Recall State function does the following:</p> <ul style="list-style-type: none"> <li>• Makes the saved measurement for the mode the active measurement.</li> <li>• Clears the input and output buffers.</li> <li>• Status Byte is set to 0.</li> <li>• Executes a *CLS</li> </ul> <p>If the file specified is empty an error is generated. If the specified file does not exist, another error is generated. If there is a mismatch between the file and the proper file type, an error is generated. If</p>

	there is a mismatch between file version or model number or instrument version or model number, a warning is displayed. Then it returns to the State menu and File Open dialog goes away. After the Recall, the analyzer exits the Recall menu and returns to the previous menu.
<b>Backwards Compatibility SCPI</b>	:MMEMory:LOAD:STATe 1,<filename> For backwards compatibility, the above syntax is supported. The "1" is simply ignored.
Initial S/W Revision	Prior to A.02.00

## More Information

In measurements that support saving Traces, for example, Swept SA, the Trace data is saved along with the State in the State file. When recalling the State, the Trace data is recalled as well. Traces are recalled exactly as they were stored, including the writing mode and update and display modes. If a Trace was updating and visible when the State was saved, it will come back updating and visible, and its data will be rewritten right away. When you use State to save and recall traces, any trace whose data must be preserved should be placed in View or Blank mode before saving.

The following table describes the Trace Save and Recall possibilities:

You want to recall state and one trace's data, leaving other traces unaffected.	Save Trace+State from 1 trace. Make sure that no other traces are updating (they should all be in View or Blank mode) when the save is performed.	On Recall, specify the trace you want to load the one trace's data into. This trace will load in View. All other traces' data will be unaffected, although their trace mode will be as it was when the state save was performed.
You want to recall all traces	Save Trace+State from ALL traces.	On Recall, all traces will come back in View (or Blank if they were in Blank or Background when saved)
You want all traces to load exactly as they were when saved.	Save State	On recall, all traces' mode and data will be exactly as they were when saved. Any traces that were updating will have their data immediately overwritten.

## From File...

When you press "From File", the analyzer brings up a Windows dialog and a menu entitled "File Open." This menu allows you to navigate to the various fields in the Windows dialog without using a keyboard or mouse. The Tab and Arrow keys can also be used for dialog navigation.

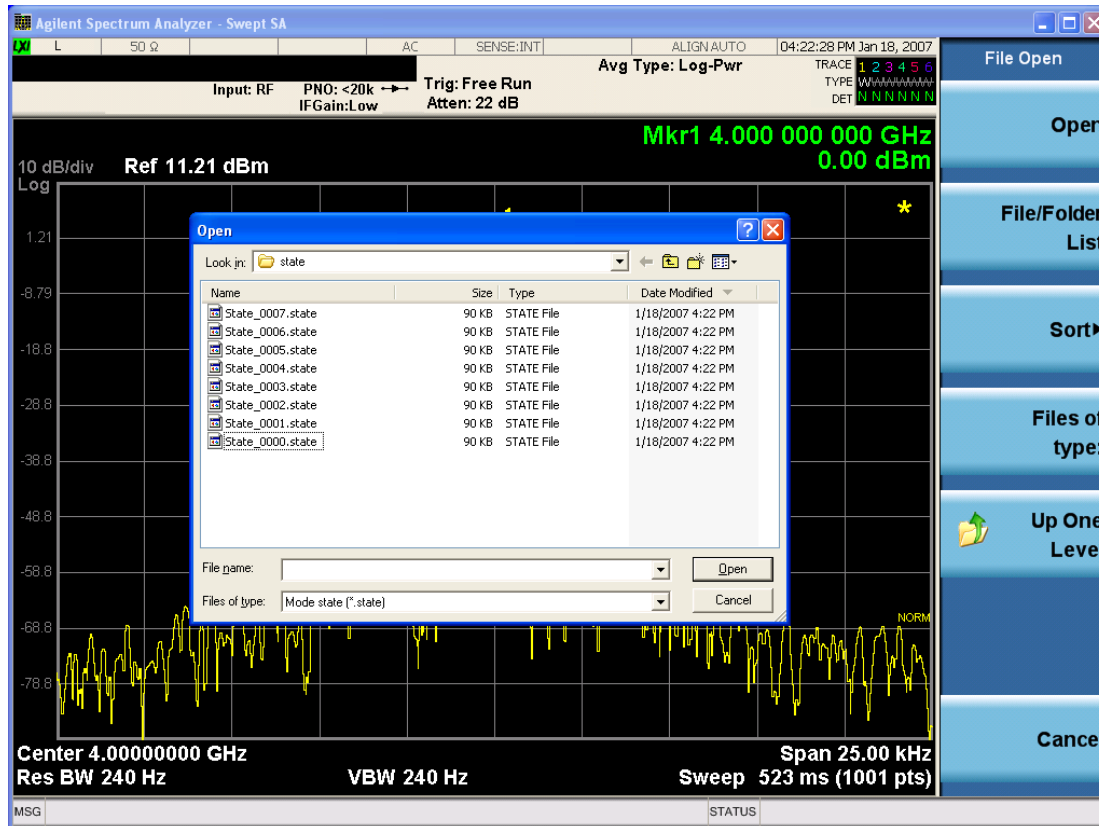

Listed below are the functions of the various fields in the dialog, and the corresponding softkeys:

#### Open

Performs the recall of the specified file. While the recall is being performed, the floppy icon appears briefly in the Meas bar.

#### File/Folder List

Enables you to navigate to the center of the dialog that contains the list of files and folders. Once here you can get information about the file and use the tab keys to navigate to the other fields in the dialog, such as Look In.

#### Look In

The Look In field shows the path from which the file will be recalled and allows you to change the path using the up and down arrow keys to navigate to other paths; the Enter key to open a directory; and the Backspace key to go back one directory. The **Look In field** first uses the last path from the Save As dialog **Save In:** path for that same file type. There is no softkey for directly navigating to the Look In field, but you can use the left tab to get here from the File/Folder List.

User specified paths are remembered when you leave and return to a Mode and are reset back to the default using Restore Mode Defaults.

#### Sort

Accesses a menu that enables you to sort the files within the File Open dialog. Only one sorting type can be selected at a time and the sorting happens immediately. The sorting types are By Date, By Name, By extension, and By Size.

#### Files of Type

This field shows the file suffix for the type of file you have selected to recall. For example, if you navigated here while recalling State, "Mode state (\*.state)" is in the field. If you navigated here while recalling Trace, ""Mode state (\*.trace)" is in the field. If you navigated here while importing a trace data file, "Trace Data (\*.csv)" is in the field. For some file types, there is more than one choice in the dropdown menu, which you can select by using the up and down arrow keys and Enter.

#### Up One Level

This key corresponds to the icon of a folder with the up arrow that is in the tool bar of the dialog. When pressed, it causes the file and folder list to navigate up one level in the directory structure. The Backspace key does the same thing.

#### Cancel

This key corresponds to the Cancel selection in the dialog. It causes the current **Open** request to be cancelled. The ESC key does the same thing.

Key Path	Recall, State
Notes	Brings up the Open dialog for recalling a State Save Type
Initial S/W Revision	Prior to A.02.00

### Edit Register Names

You may enter a custom name on any of the Register keys, to help you remember what you are using that state to save. To do this, press the Edit Register Names key, choose the register whose name you wish to edit, and then enter the desired label using the Alpha Editor or an external PC keyboard.

The maximum number of characters that can be added is 30. In most cases, 30 characters will fit on two lines of the key.

For more information and the SCPI command, see Edit Register Names under the Save, State function.

Key Path	Recall, State
Mode	All
Dependencies	N9060A-7FP or N9060B-2FP license required to edit the register names. When the feature is not licensed, sending the SCPI command generates an error, -221, "Settings conflict;Option not available"
Initial S/W Revision	A.11.00

### Register 1 thru Register 16

Selecting any one of these register keys causes the State of the mode from the specified Register to be recalled. Each of the register keys annotates whether it is empty or at what date and time it was last

modified. In addition, you can use the Edit Register Names key under Save, State to enter custom names for each register.

Registers are shared by all modes, so recalling from any one of the registers will cause a mode switch to the mode that was active when the save to the Register occurred.

Although these 16 registers are the only registers available from the front panel, there are 128 state registers available in the instrument. Registers 17–128 are only available from the SCPI interface, using the \*RCL command.

After the recall completes, the message "Register <register number> recalled" appears in the message bar. If you are in the Spectrum Analyzer Mode, and you are recalling a register that was saved in the Spectrum Analyzer Mode, then after the recall, you will still be in the Recall Register menu. If the Recall causes you to switch modes, then after the Recall, you will be in the Frequency menu.

If a requested register is empty an error is generated.

<b>Key Path</b>	Recall, State
<b>Example</b>	*RCL 1
<b>Range</b>	1–16 from front panel, 1–128 from SCPI
<b>Readback</b>	Date and time with seconds resolution are displayed on the key OR A custom name of up to 30 characters entered using the Save, State, Edit Register Names key OR “(empty)” if no prior save operation has been performed to this register.
<b>Initial S/W Revision</b>	Prior to A.02.00
<b>Modified at S/W Revision</b>	Prior to A.11.00

## Register 1 thru Register 16

Selecting any one of these register keys causes the State of the mode from the specified Register to be recalled. Each of the register keys annotates whether it is empty or at what date and time it was last modified. In addition, you can use the Edit Register Names key under Save, State to enter custom names for each register.

Registers are shared by all modes, so recalling from any one of the registers will cause a mode switch to the mode that was active when the save to the Register occurred.

Although these 16 registers are the only registers available from the front panel, there are 128 state registers available in the instrument. Registers 17–128 are only available from the SCPI interface, using the \*RCL command.

After the recall completes, the message "Register <register number> recalled" appears in the message bar. If you are in the Spectrum Analyzer Mode, and you are recalling a register that was saved in the Spectrum Analyzer Mode, then after the recall, you will still be in the Recall Register menu. If the Recall causes you to switch modes, then after the Recall, you will be in the Frequency menu.

If a requested register is empty an error is generated.

Key Path	Recall, State
<b>Example</b>	*RCL 1
Range	1-16 from front panel, 1-128 from SCPI
Readback	Date and time with seconds resolution are displayed on the key OR A custom name of up to 30 characters entered using the Save, State,Edit Register Names key OR “(empty)” if no prior save operation has been performed to this register.
Initial S/W Revision	Prior to A.02.00
Modified at S/W Revision	Prior to A.11.00

## Data (Import)

Importing a data file loads data that was previously saved from the current measurement or from other measurements and/or modes that produce compatible data files. The Import Menu only contains Data Types that are supported by the current measurement.

Since the commonly exported data files are in .csv format, the data can be edited by the user prior to importing. This allows you to export a data file, manipulate the data in Excel (the most common PC Application for manipulating .csv files) and then import it.

Importing Data loads measurement data from the specified file into the specified or default destination, depending on the data type selected. Selecting an Import Data menu key will not actually cause the importing to occur, since the analyzer still needs to know from where to get the data. Pressing the Open key in this menu brings up the Open dialog and Open menu that provides you with the options from where to recall the data. Once a filename has been selected or entered in the Open menu, the recall occurs as soon as the Open button is pressed.

Key Path	Recall
Mode	All
Notes	The menu is built from whatever data types are available for the mode. Some keys will be missing completely, so the key locations in the sub-menu will vary.  No SCPI command directly controls the Data Type that this key controls. The Data Type is included in the MMEM:LOAD commands.
Dependencies	If a file type is not used by a certain measurement, it is grayed out for that measurement. The key for a file type will not show at all if there are no measurements in the Mode that support it.
Preset	Is not affected by Preset or shutdown, but is reset during Restore Mode Defaults
Readback	The data type that is currently selected
Initial S/W Revision	Prior to A.02.00

## Amplitude Correction

This key selects the Amplitude Corrections as the data type to be imported. When pressed a second time, it brings up the Select Menu, which lets you select the Correction into which the data will be imported.

Amplitude Corrections are fully discussed in the documentation of the Input/Output key, under the Corrections key.

A set of preloaded Corrections files can be found in the directory

/My Documents/ EMC Limits and Ampcor.

When the Amplitude Correction is an Antenna correction and the Antenna Unit in the file is not None, the Y Axis Unit setting will change to match the Antenna Unit in the file.

Key Path	Recall
Mode	SA EDGE GSM PN
Remote Command	:MMEMory:LOAD:CORRection 1 2 3 4 5 6 7 8, <filename>
Example	:MMEM:LOAD:CORR 2, "myAmpcor.csv" recalls the Amplitude Correction data from the file myAmpcor.csv in the current directory to the 2nd Amplitude Correction table, and turns on Correction 2. The default path is D:\User_My_Documents\Instrument\My Documents\amplitudeCorrections\
Dependencies	<p>Only the first correction array (Correction 1) supports antenna units. This means that a correction file with an Antenna Unit can only be loaded into the Corrections 1 register. Consequently only for Correction 1 does the dropdown in the Recall dialog include.ant, and if an attempt is made to load a correction file into any other Correction register which DOES contain an antenna unit, a Mass Storage error is generated.</p> <p>Corrections are not supported by all Measurements. If in a Mode in which some Measurements support it, this key will be grayed out in measurements that do not. The key will not show at all if no measurements in the Mode support it.</p> <p>Errors are reported if the file is empty or missing, or if the file type does not match, or if there is a mismatch between the file type and the destination data type. If any of these occur during manual operation, the analyzer returns to the Import Data menu and the File Open dialog goes away.</p> <p>This key does not appear unless you have the proper option installed in your instrument.</p> <p>This command will generate an "Option not available" error unless you have the proper option installed in your instrument.</p>
Couplings	When a correction file is loaded from mass storage, it is automatically turned on ( <b>Correction ON</b> ) and <b>ApplyCorrections</b> is set to On. This allows you to see its effect, thus confirming the load.
Readback	selected Correction
Backwards Compatibility SCPI	:MMEMory:LOAD:CORRection ANTenna   CABLE   OTHER   USER, <filename> For backwards compatibility, ANTenna maps to 1, CABLE maps to 2, OTHER maps to 3 and USER maps to 4
Initial S/W Revision	A.02.00



## Amplitude Correction

These keys let you select which Correction to import the data into. Once selected, the key returns back to the Import Data menu and the selected Correction number is annotated on the key. The next step is to select the Open key in the Import Data menu.

Antenna corrections are a particular kind of Amplitude Corrections – they are distinguished in the corrections file by having the Antenna Unit set to a value other than None. Only Correction 1 supports Antenna Units.

Key Path	Recall, Data, Amplitude Correction
Notes	auto return
Dependencies	Only Correction 1 may be used to load a Correction that contains an Antenna Unit other than None
Preset	Not part of Preset, but is reset to Correction 1 by Restore Input/Output Defaults; survives shutdown.
State Saved	The current Correction number is saved in instrument state
Initial S/W Revision	A.02.00

## Chan Table

Imports the channel table from a channel plan file. This function enables you to use your own defined channel tables by importing a modified channel table file.

Instead of creating a brand new channel plan file, you can generate a channel plan file to fit your needs using a saved channel plan file or the default channel plan file ChannelPlan.txt in the directory “My Documents\Digital Video\data\”. The saved channel plan file is obtained by pressing Save, Data, Channel Table, and then Save As...

Note that while editing the channel plan file, you cannot change the channel plan name, such as NTSC\_B.VHF, NTSC\_B.UHF, otherwise your modifications on the corresponding channel plan will not work. You can add, remove, or modify the channel numbers and center frequencies in each channel plan. The value of Start Channel and Channel Count may also need to be changed.

File Location and Extension

**File location:** “My Documents\Digital Video\data”

**File type:** text file

**File extension:** .txt

**Example:**

File Location: My Documents\Digital Video\data

File Name: ChannelPlan\_0001.txt

Key Path	Recall, Data
Mode	DVB-T/H
<b>Remote Command</b>	MMEemory:LOAD:CHTable <string>
<b>Example</b>	MME:LOAD:CHT “ChannelPlan_0001.txt”
Initial S/W Revision	A.07.00

## Capture Buffer

Capture buffer functionality is available only in Mod Accuracy measurement. The captured data is raw data which is not processed.

Key Path	Recall, Data
Mode	DVB-T/H
Example	MMEM:LOAD:CAPT "MyCaptureData.bin" This loads the file of capture data (on the default file directory path) into the instrument.
Dependencies	Capture buffer data is only available for Mod Accuracy measurement. In other measurements, this key is grayed out.
Initial S/W Revision	Prior to A.01.70

## DVB-T2 Config

Imports DVB-T2 configuration from setting files (single PLP or multiple PLPs). This key is available only in DVB-T2 Mod Accuracy measurement and will be grayed out in other measurements.

If the configuration file to be recalled is created with previous instrument S/W revision A.10.52 or before (To check the instrument S/W revision, press System, Show, System on the instrument), it doesn't have Transmission Mode and Version parameters. Then you need to set up the DVB-T2 version and transmission mode manually by pressing Mode Setup, Radio Std, DVB-T2, Version 1.1.1, and toggling Transmission Mode to SISO to select the standard version and transmission mode of the signal under test.

All the modulation parameters can be set from the setting file. These parameters include Version, Transmission Mode, Guard Interval, FFT size, Carrier Mode, Pilot Pattern, L1 Modulation Format, Data Symbols, PAPR Type, PLP Number, SubSlices Number, SubSlices Interval, PLP Modulation Format, PLP Constellation Rotation, FEC Type, Time IL Length, FEC Block Num, PLP ID, PLP Start, PLP Type and PLP Code Rate.

File Location and Extension

**File location:** "My Documents\DVB\data\EVMT2\data"

**File type:** text file

**File extension:** .csv

**Example:**

File Location: My Documents\DVB\data\EVMT2\data

File Name: DVBT2Config\_0001.csv

Key Path	Recall, Data
Mode	DVB-T/H
Remote Command	MMEMory:LOAD:T2Config <string>

<b>Example</b>	MMEM:LOAD:T2C "DVBT2Config_0001.csv"
Dependencies	This key is grayed out in all other measurements except DVB-T2 Mod Accuracy measurement.
Couplings	Auto Detect (Meas, DVB-T2 ModAccuracy, Meas Setup) will be changed to OFF automatically when the DVB-T2 config file is loaded.
Initial S/W Revision	A.07.00

## Open...

When you press "Open", the analyzer brings up a Windows dialog and a menu entitled "**File Open.**" This menu allows you to navigate to the various fields in the Windows dialog without using a keyboard or mouse. The Tab and Arrow keys can also be used for dialog navigation.

See "[From File...](#)" on page 2201 in Recall, State, for a full description of this dialog and menu.

Key Path	Recall, Data
Notes	The key location is mode-dependent and will vary. Brings up Open dialog for recalling a <mode specific> Save Type
Initial S/W Revision	Prior to A.02.00

## Restart

The Restart function restarts the current sweep, or measurement, or set of averaged/held sweeps or measurements. If you are Paused, pressing Restart does a Resume.

The Restart function is accessed in several ways:

- Pressing the Restart key
- Sending the remote command INIT:IMMEDIATE
- Sending the remote command INIT:RESTART

See "[More Information](#)" on page 972

Key Path	Front-panel key
Remote Command	:INITiate[:IMMEDIATE] :INITiate:RESTART
Example	:INIT:IMM :INIT:REST
Notes	:INITiate:RESTART and :INITiate:IMMEDIATE perform exactly the same function.
Couplings	Resets average/hold count k. For the first sweep overwrites all active (update=on) traces with new current data. For application modes, it resets other parameters as required by the measurement.
Status Bits/OPC dependencies	This is an Overlapped command. The STATus:OPERation register bits 0 through 8 are cleared. The STATus:QUESTionable register bit 9 (INTegrity sum) is cleared. The SWEEPING bit is set. The MEASURING bit is set.
Backwards Compatibility Notes	For Spectrum Analysis mode in ESA and PSA, the Restart hardkey and the INITiate:RESTART command restart trace averages (displayed average count reset to 1) for a trace in Clear Write, but did not restart Max Hold and Min Hold.  In the X-Series, the Restart hardkey and the INITiate:RESTART command restart not only Trace Average, but MaxHold and MinHold traces as well.  For wireless comms modes in ESA and PSA, the Restart hardkey and the INITiate:RESTART command restart every measurement, which includes all traces and numeric results. There is no change to this operation.
Initial S/W Revision	Prior to A.02.00

### More Information

The **Restart** function first aborts the current sweep/measurement as quickly as possible. It then resets the sweep and trigger systems, sets up the measurement and initiates a new data measurement sequence with a new data acquisition (sweep) taken once the trigger condition is met.

If the analyzer is in the process of aligning when **Restart** is executed, the alignment finishes before the restart function is performed.

Even when set for Single operation, multiple sweeps may be taken when Restart is pressed (for example, when averaging/holding is on). Thus when we say that **Restart** "restarts a measurement," we may mean:

- It restarts the current sweep
- It restarts the current measurement
- It restarts the current set of sweeps if any trace is in Trace Average, Max Hold or Min Hold
- It restarts the current set of measurements if Averaging, or Max Hold, or Min Hold is on for the measurement
- depending on the current settings.

With **Average/Hold Number** (in **Meas Setup** menu) set to 1, or Averaging off, or no trace in Trace Average or Hold, a single sweep is equivalent to a single measurement. A single sweep is taken after the trigger condition is met; and the analyzer stops sweeping once that sweep has completed. However, with **Average/Hold Number** >1 and at least one trace set to **Trace Average, Max Hold, or Min Hold (SA Measurement)** or **Averaging on (most other measurements)**, multiple sweeps/data acquisitions are taken for a single measurement. The trigger condition must be met prior to each sweep. The sweep is stopped when the average count  $k$  equals the number  $N$  set for **Average/Hold Number**. A measurement average usually applies to all traces, marker results, and numeric results; but sometimes it only applies to the numeric results.

Once the full set of sweeps has been taken, the analyzer will go to idle state. To take one more sweep without resetting the average count, increment the average count by 1, by pressing the step up key while **Average/Hold Number** is the active function, or sending the remote command `CALC:AVER:TCON UP`.

## Save

The Save menu lets you choose what you want to save and where you want to save it. Among the types of files you can save are **States**, **Traces**, and **Screen Images**. In addition, an Export (Data) option lets you save a number of data types as CSV files for easy import into Excel and other spreadsheet programs.

Key Path	Front-panel key
Mode	All
Notes	No remote command for this key specifically, but the :MMEM:STORe command is available for specific file types. An example is :MMEM:STOR:STATe <filename>.
Initial S/W Revision	Prior to A.02.00

## State

The Save State menu lets you choose a register or file for saving the state.

The content of a state file includes all of the settings and data required to return the analyzer as closely as possible to the Mode it was in, with the exact settings which were in place, when the save occurred. The Mode settings in each state file include the settings that are affected by Mode Preset, as well as the additional settings affected by Restore Mode Defaults; all of the Mode's settings. In addition, all of the settings of the Input/Output system are included, even though they are outside of the Mode's state, because they are needed to restore the complete setup. Persistent System settings (for example, Verbose SCPI) are not affected by either Mode Preset or Restore Mode Defaults, nor are they included in a saved State file.

After the save completes, the message "File <filename> saved" or "State Register <register number> saved" is displayed.

For rapid saving, the State menu lists 16 registers to save to. Pressing a Register key initiates the save. You can also select a file to save to.

The default path for all State Files is:

My Documents\<mode name>\state

where <mode name> is the parameter used to select the mode with the INST:SEL command (for example, SA for the Spectrum Analyzer).

Key Path	Save
Mode	All
Remote Command	:MMEMory:STORe:STATe <filename>
Example	MMEM:STOR:STATe "MyStateFile.state" This stores the current instrument state data in the file MyStateFile.state in the default directory.
Notes	Both single and double quotes are supported for any filename parameter over remote. After saving to a register, that register's menu key is updated with the date the time, unless a custom label has been entered for that key. After saving to a register, you remain in the Save State menu, so that you can see the Register key

update. After saving to a file, the analyzer automatically returns to the previous menu and any Save As dialog goes away.

<b>Backwards Compatibility SCPI</b>	:MMEMoRY:STORe:STATe 1,<filename>
Initial S/W Revision	Prior to A.02.00

### To File . . .

When you press “To File”, the analyzer brings up a Windows dialog and a menu entitled “**Save As.**” This menu allows you to navigate to the various fields in the Windows dialog without using a keyboard or mouse. The Tab and Arrow keys can also be used for dialog navigation.

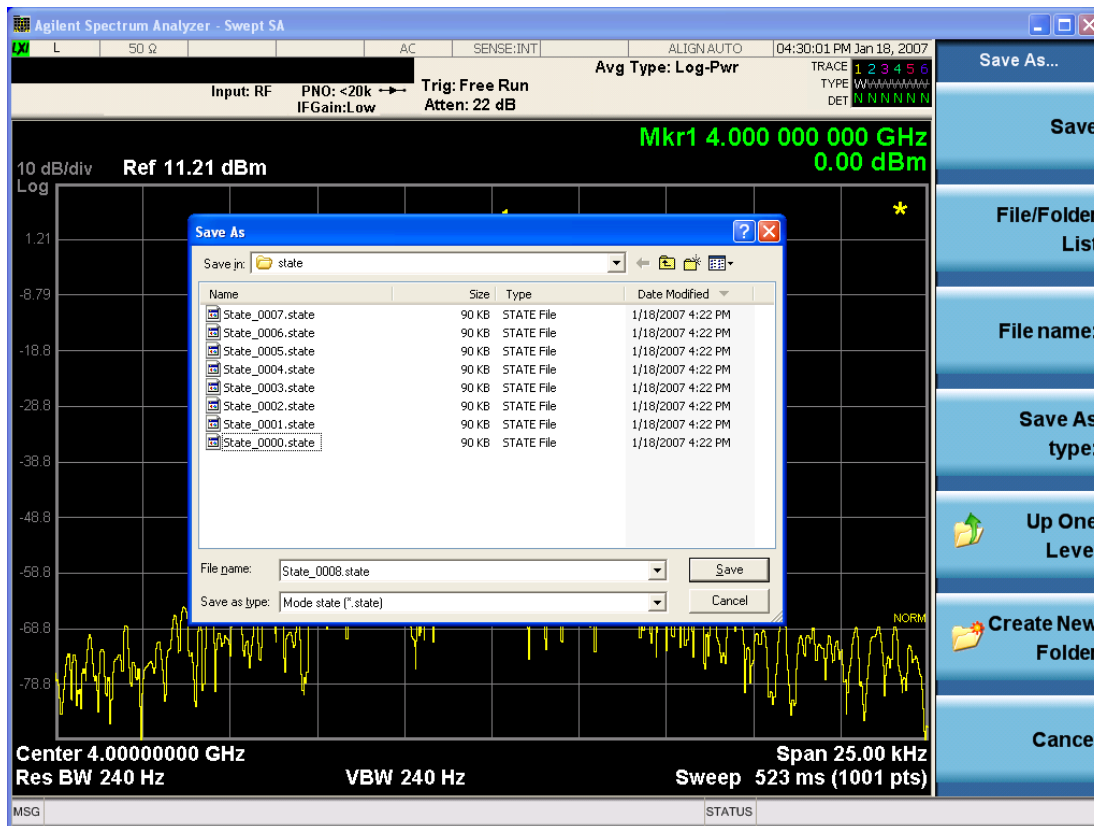

The Listed below

are the functions of the various fields in the dialog, and the corresponding softkeys:

#### Save

Performs the save to the specified file of the selected type. If the file already exists, a dialog will appear that allows you to replace the existing file by selecting OK, or you can Cancel the request. If you select OK, the file will be overwritten. Using the C: drive is strongly discouraged, since it runs the risk of being overwritten during an instrument software upgrade.

While the save is being performed, the floppy icon appears briefly in the Meas bar.

### File/Folder List

Enables you to navigate to the center of the dialog that contains the list of files and folders. Once here you can get information about the file and use the tab keys to navigate to the other fields in the dialog, such as Save In.

### Save In

The Save In field shows the path to which the file will be saved and allows you to change the path using the up and down arrow keys to navigate to other paths; the Enter key to open a directory; and the Backspace key to go back one directory. The **Save In field** defaults to the default path for this type of file and remembers the last path you used to save this type of file. There is no softkey for directly navigating to the Save In field but you can use left tab to get here from the File/Folder List.

User specified paths are remembered when you leave and return to a Mode and are reset back to the default using Restore Mode Defaults.

### File Name

The File Name field is initially loaded with an automatically generated filename specific to the appropriate Save Type. The automatically generated filename is guaranteed not to conflict with any filename currently in the directory. You may replace or modify this filename using the File Name key. See the ["Quick Save " on page 2197](#) documentation for more on the automatic file naming algorithm.

When you press the File Name key the analyzer displays the Alpha Editor. Use the knob to choose the letter to add and the front-panel Enter key to add the letter to the file name. The BK character moves you back and the FW character moves you forward in the filename. The Select key on the front panel generates a space character. When you are done entering the filename press the Done softkey. This returns back to the **File Open** dialog and menu, but does not cause the save to occur.

### Save As Type

This field shows the file suffix for the type of file you have selected to save. For example, if you navigated here while saving State, "Mode state (\*.state)" is in the field. If you navigated here from saving Trace, ""Mode state (\*.trace)" is in the field. If you navigated here while exporting a trace data file, "Trace Data (\*.csv)" is in the field. For some file types, there is more than one choice in the dropdown, which you can select by using the up and down arrow keys and Enter.

### Up One Level

This key corresponds to the icon of a folder with the up arrow that is in the tool bar of the dialog. When pressed, it causes the file and folder list to navigate up one level in the directory structure. The Backspace key does the same thing.

### Create New Folder

This key corresponds to the icon of a folder with the "\*" that is in the tool bar of the dialog. When pressed, a new folder is created in the current directory with the name **New Folder** and you can enter a new folder name using the Alpha Editor.

### Cancel

This key corresponds to the Cancel selection in the dialog. It causes the current **Save As** request to be cancelled. The ESC key does the same thing.



Key Path	Save, State
Mode	All
Notes	Brings up Save As dialog for saving a State Save Type
Initial S/W Revision	Prior to A.02.00

## Edit Register Names

You may enter a custom name on any of the Register keys, to help you remember what you are using that state to save. To do this, press the Edit Register Names key, choose the register whose name you wish to edit, and then enter the desired label using the Alpha Editor or an external PC keyboard.

The maximum number of characters that can be added is 30. In most cases, 30 characters will fit on two lines of the key.

See ["More Information" on page 977](#)

Key Path	Save, State
Mode	All
<b>Remote Command</b>	:MMEMory:REGister:STATe:LABel <reg number>,"label" :MMEMory:REGister:STATe:LABel? <reg number>
<b>Example</b>	:MMEM:REG:STAT:LAB 1,"my label"
Notes	<reg number> is an integer from 1 to 16. If the SCPI specifies an invalid register number an error message is generated, -222,"Data out of range;Invalid register label number" "label" is a string from 0 to 30 characters in length. If a label exceeds 30 characters, an error message is generated, -150,"String data error;Label clipped to 30 characters" "label" of length 0 erases the custom label and restores the default (time and date) label. E.g.: :MMEM:REG:STAT:LAB 1,""
Dependencies	N9060A-7FP or N9060B-2FP license required to edit the register names. When the feature is not licensed, sending this command generates an error, -221,"Settings conflict;Option not available"
Preset	The names are unaffected by Preset or power cycle but are set to the default label (time and date) on a "Restore System Defaults->Misc"
Initial S/W Revision	A.11.00

## More Information

When you edit one of the register names, the time and date field will be replaced by the custom name.

If you delete all the characters in the custom name, it restores the default (time and date).

The register names are stored within the state files, but they are not part of the instrument state; that is, once you have edited a register name, loading a new state will not change that register name. Another consequence of this is that the names will be persistent through a power cycle. Also, if a named state file is transferred to another analyzer, it will bring its custom name along with it.

If you try to edit the name of an empty register, the analyzer will first save the state to have a file to put the name in. If you load a named state file into an analyzer with older firmware it will ignore the metadata.

The \*SAV and \*RCL commands will not be affected by the custom register names, nor will the MMEM commands.

### Register 1 thru Register 16

Selecting any one of these register menu keys causes the State of the currently active mode to be saved to the specified Register. The registers are provided for rapid saving and recalling, since you do not need to specify a filename or navigate to a file. Each of the register menu keys annotates whether it is empty or at what date and time it was last modified. In addition, you can use the Edit Register Names key to enter custom names for each register.

Although these 16 registers are the only registers available from the front panel, there are 128 state registers available in the instrument. Registers 17–128 are only available from the SCPI interface, using the \*SAV command.

There is one set of 128 state registers in the instrument, not one set for each Mode. When a state is saved, the Mode it was saved from is saved with it; then when it is recalled, the instrument switches to that Mode.

After the save completes, the corresponding register menu key annotation is updated with the date and time and the message "Register <register number> saved" is displayed.

Key Path	Save, State
Mode	All
Example	*SAV 1
Range	1–16 from front panel, 1–128 from SCPI
Readback	Date and time with seconds resolution are displayed on the key OR A custom name of up to 30 characters entered using the Edit Register Names key OR “(empty)” if no prior save operation has been performed to this register.
Initial S/W Revision	Prior to A.02.00
Modified at S/W Revision	A.11.00

### Register 1 thru Register 16

Selecting any one of these register menu keys causes the State of the currently active mode to be saved to the specified Register. The registers are provided for rapid saving and recalling, since you do not need to specify a filename or navigate to a file. Each of the register menu keys annotates whether it is empty or at what date and time it was last modified. In addition, you can use the Edit Register Names key to enter custom names for each register.

Although these 16 registers are the only registers available from the front panel, there are 128 state registers available in the instrument. Registers 17–128 are only available from the SCPI interface, using the \*SAV command.

There is one set of 128 state registers in the instrument, not one set for each Mode. When a state is saved, the Mode it was saved from is saved with it; then when it is recalled, the instrument switches to that Mode.

After the save completes, the corresponding register menu key annotation is updated with the date and time and the message "Register <register number> saved" is displayed.

Key Path	Save, State
Mode	All
Example	*SAV 1
Range	1-16 from front panel, 1-128 from SCPI
Readback	Date and time with seconds resolution are displayed on the key OR A custom name of up to 30 characters entered using the Edit Register Names key OR "(empty)" if no prior save operation has been performed to this register.
Initial S/W Revision	Prior to A.02.00
Modified at S/W Revision	A.11.00

## Data (Export)

Exporting a data file stores data from the current measurement to mass storage files. The Export Menu only contains data types that are supported by the current measurement.

Since the commonly exported data files are in .csv format, the data can be edited by you prior to importing. This allows you to export a data file, manipulate the data in Excel (the most common PC Application for manipulating .csv files) and then import it.

Selecting an Export Data menu key will not actually cause the exporting to occur, since the analyzer still needs to know where you wish to save the data. Pressing the Save As key in this menu brings up the Save As dialog and Save As menu that allows you to specify the destination file and directory. Once a filename has been selected or entered in the Open menu, the export will occur as soon as the Save key is pressed.

Key Path	Save
Mode	All
Notes	The menu is built from whatever data types are available for the mode. So the key locations in the sub menu will vary.  No SCPI command directly controls the Data Type that this key controls. The Data Type is included in the MMEM:STORe commands.
Dependencies	If a file type is not used by a certain measurement, that type is grayed out for that measurement. The key for a file type will not show at all if there are no measurements in the Mode that support it.
Preset	Is not affected by a Preset or shutdown, but is reset during Restore Mode Defaults
Readback	The data type that is currently selected
Initial S/W Revision	Prior to A.02.00

## Amplitude Correction

Pressing this key selects **Amplitude Corrections** as the data type to be exported. Pressing this key again brings up the Select Menu, which allows the user to select which **Amplitude Correction** to save.

Amplitude Corrections are fully discussed in the documentation of the Input/Output key, under the Corrections softkey.

See "[Correction Data File](#)" on page 980

Key Path	Save
<b>Remote Command</b>	:MMEMory:STORe:CORRection 1 2 3 4 5 6, <filename>
<b>Example</b>	:MMEM:STOR:CORR 2 "myAmpcor.csv" saves Correction 2 to the file myAmpcor.csv on the current path. The default path is My Documents\amplitudeCorrections.
Notes	If the save is initiated via SCPI, and the file already exists, the file will be overwritten. Using the C: drive is strongly discouraged, since it runs the risk of being overwritten during an instrument software upgrade. Both single and double quotes are supported for any filename parameter over SCPI.
Dependencies	Corrections are not supported by all Measurements. If in a Mode in which some Measurements support it, this key will be grayed out in measurements that do not. The key will not show at all if no measurements in the Mode support it. This key will not appear unless you have the proper option installed in your instrument.
Readback	Selected Correction
<b>Backwards Compatibility SCPI</b>	:MMEMory:STORe:CORRection ANTenna   CABLe   OTHer   USER, <filename> For backwards compatibility, ANTenna maps to 1, CABLe maps to 2, OTHer maps to 3 and USER maps to 4
Initial S/W Revision	A.02.00

## Correction Data File

A Corrections Data File contains a copy of one of the analyzer correction tables. Corrections provide a way to adjust the trace display for predetermined gain curves (such as for cable loss).

Corrections files are text files in .csv (comma separated values) form, to make them importable into Excel or other spreadsheet programs. The format for Corrections files is as follows.

Line #	Type of field	Example	Notes
1	File type, must be "Amplitude Correction"	Amplitude Correction	May not be omitted
2	File Description (in quotes)	"Correction Factors for 11966E"	60 characters max; may be empty but may not be omitted. If exceeds 60 characters, error -233 Too much data reported
3	Comment (in quotes)	"Class B Radiated"	60 characters max; may be empty but

Line #	Type of field	Example	Notes
			may not be omitted. . If exceeds 60 characters, error -233 Too much data reported
4	Instrument Version, Model #	A.02.06,N9020A	May be empty but may not be omitted
5	Option List, File Format Version	K03 LFE EXM ,01	May be empty but may not be omitted
6	Freq Unit to be used for all frequency values in the file	Frequency Unit,MHz	assumed to be Hz if omitted
7	Antenna Unit	Antenna Unit,None	If omitted leaves the Antenna unit unchanged. The amplitude unit in the Antenna Unit field is a conversion factor that is used to adjust the Y Axis Units of the current mode, if the mode supports Antenna Units. For more details on antenna correction data, refer to the Input/Output,Corrections key description. Allowable values: dBuv/m, dBuA/m, dBG, dBpT, None
8	Freq Interpolation	Frequency Interpolation,Linear	if omitted leaves the Freq Interpolation unchanged. Allowable values: Linear, Logarithmic
9	Bias value in mA	Bias,0.00	If omitted leaves the Bias value unchanged (added as of A.08.50)
10	Bias State	Bias State,On	If omitted leaves the Bias State unchanged. Allowable values: On, Off (added as of A.08.50)
11	Overlap, two values, Freq1 and Freq2, separated by commas.	Overlap,33500,40000	Uses Freq Unit from line 6. Thus, in this example Freq1=33.5 GHz, Freq2= 40.0 GHz (see note below). If omitted leaves the overlap unchanged (added as of A.08.50)
12	DATA marker	DATA	Corrections data begins in the next line

Lines 2 through 5 can be empty but must appear in the file. Lines 6 through 11 are optional, the lines can be left out of the file altogether.

The Overlap row and the two Bias rows apply only to external mixing. Both are read-only, they are never written by the analyzer. The only way to insert or modify these rows is to edit the file with a text editor or a spreadsheet editor. These rows are intended for use by mixer manufacturers, as they allow the manufacturer to insert data about how the mixer corrections were generated and how they should be applied. The Bias rows allow you to specify whether to turn Bias on or off when the Correction is turned on and to specify a Bias value (turning off the Correction does not change the Bias, but turning it back on again sets it to the value specified in the file). The Overlap row allows you to specify an overlap region in which

two different corrections may be applied. It is expected that in the corrections data itself, there will be TWO corrections values exactly at Max Freq, otherwise Overlap is ignored. The way the overlap is processed is as follows: if at any given time the current analyzer Start Freq is greater than Freq 1 and lower than Freq 2, and the current Stop Freq is greater than Freq 2, extend the first correction point at or above Freq 2 down to Freq 1, rather than using the correction data between Freq1 and Freq2.

The Antenna Unit row can only be used in Correction register 1, because there can only be one setting for Antenna Unit at any given time. If a Correction whose Antenna Unit is set to anything but None is loaded into any Correction register but 1, an error is generated (Mass storage error; Can only load an Antenna Unit into Correction 1). When a correction file is saved from any Correction register but 1, Antenna Unit is always written as None.

Similarly, the Bias rows can only be used in Correction register 1, because there can only be one setting for Bias at any given time. If a Correction file with a Bias or Bias State row is loaded into any Correction register but 1, an error is generated: Mass storage error; Can only load Bias Settings into Correction 1

The data follows the DATA row, as comma separated X, Y pairs; one pair per line.

For example, suppose you have an Antenna to correct for on an N9020A version A.02.06 and the correction data is:

- 0 dB at 200 MHz
- 17 dB at 210 MHz
- 14.8 dB at 225 MHz

Then the file will look like:

- Amplitude Correction
- "Correction Factors for 11966E"
- "Class B Radiated"
- A.02.06,N9020A
- P13 EA3 UK6,01
- Frequency Unit,MHz
- Antenna Unit,dBuV/m
- Frequency Interpolation,Linear
- DATA
- 200.000000,0.00
- 210.000000,17.00
- 225.000000,14.80

The choices for the 1 of N fields in the metadata are as follows:

- Frequency Unit: Hz, kHz, MHz, GHz
- Antenna Unit: dBuV/m, dBuA/m, dBG, dBpT, None

- Frequency Interpolation: Logarithmic, Linear

### Amplitude Correction

These keys let you choose which Correction to save. Once selected, the key returns back to the Export Data menu and the selected Correction number is annotated on the key.

The next step in the Save process is to select the Save As key in the Export Data menu.

Key Path	Save, Data, Amplitude Correction
Preset	Not part of a Preset, but is reset to Correction 1 by Restore Input/Output Defaults. Survives a shutdown.
Readback	1
Initial S/W Revision	A.02.00

### Chan Table

Exports the current channel table to a channel table file.

The exported channel table file can be edited to meet your requirements, and then imported by pressing Recall, Data, Channel Table, and then Open...

Note that while editing the channel plan file, you can't change the channel plan name, such as NTSC\_B.VHF, NTSC\_B.UHF, otherwise your modifications on the corresponding channel plan will not work. You can add, remove, or modify the channel numbers and center frequencies in each channel plan. The value of Start Channel and Channel Count may also need to be changed.

File Location and Extension

**File location:** "My Documents\Digital Video\data"

**File type:** text file

**File extension:** .txt

**Example:**

File Location: My Documents\Digital Video\data

File Name: ChannelPlan\_0001.txt

Key Path	Save, Data
Mode	DVB-T/H
<b>Remote Command</b>	MMEMemory:STOR:CHTable <string>
<b>Example</b>	MME:STOR:CHT "ChannelPlan_0001.txt"
Initial S/W Revision	A.07.00

### Measurement Results

Pressing this key selects Meas Results as the data type to be exported.

The Meas Results file contains measurement result sets, plus information describing the current state of the analyzer, as detailed in ["Meas Results File Definition" on page 984](#) and ["Meas Results File Example" on page 986](#) below.

Key Path	Save, Data
Remote Command	:MMEMory:STORe:RESults <string>
Example	:MMEM:STOR:RES "MeasR_0000.csv"
Notes	<p>If the save is initiated via SCPI and the file already exists, the file will be overwritten.</p> <p>The SCPI command exports Power Stat CCDF measurement results to the file specified as the parameter in the current path. The default path is My Documents\<current mode="">\data\PST\results. Using the C: drive is strongly discouraged, since it runs the risk of being overwritten during an instrument software upgrade.</current></p> <p>The SCPI parameter is a quoted string that specifies the filename. Both single and double quotes are supported for any filename parameter over SCPI.</p>
Dependencies	The current active measurement must be the Power Stat CCDF measurement to use this command.
Status Bits/OPC dependencies	Sequential – waits for the previous measurement to complete
Initial S/W Revision	Prior to A.02.00

### Meas Results File Definition

The content of a Meas Results File is defined in this section.

The first lines in the file consist of identification and instrument configuration details, as follows.

- File ID string, which is "MeasResult"
- Measurement ID following Mode ID, which is "SA:PST" for example.
- Firmware rev and model number
- Option string
- Automatic Trigger Time
- Automatic Trigger Time State
- CcdfCurrentCounts
- Center Frequency
- Center Frequency Step
- Center Frequency Step State
- Counts
- Electrical Atten
- Electrical Atten State
- External Array Trigger Delay



- External Array Trigger Delay State
- External Array Trigger Level
- External Array Trigger Slope
- Gaussian Line
- IF Gain Auto
- IF Gain State
- Info BW
- Internal Preamp
- Internal Preamp Band
- Line Trigger Delay
- Line Trigger Delay State
- Line Trigger Slope
- Meas Cycles
- MeasInterval
- Mechanical Atten
- MechanicalAttenStepEnum
- Periodic Timer Period
- Periodic Timer Sync Source
- Periodic Timer Trigger Delay
- Periodic Timer Trigger Delay State
- Preselector Adjust
- Ref Trace
- RFBurst Trigger Delay
- RFBurst Trigger Delay State
- RFBurst Trigger Level Abs
- RFBurst Trigger Level Rel
- RFBurst Trigger Level Type
- RFBurst Trigger Slope
- Scale/Div
- Trigger Holdoff
- Trigger Holdoff State

- TriggerSource

The data above is followed in the file by a line containing “MeasResult1” to “MeasResult4”. This line forms a header for each set of measurement results, which appear in subsequent lines. Each line of Measurement Results consists of 4 comma-separated values, from the MeasResult1 value to the MeasResult4 value.

The MeasResult1 set in the file corresponds to the data returned by MEAS|READ|FETCh:PStatistic1; the MeasResult2 set corresponds to the data returned by MEAS|READ|FETCh:PStatistic2, and so on.

The exported file is in CSV format, with a .csv extension.

### Meas Results File Example

When imported into Microsoft Excel, a typical Meas Results CSV file appears as shown in the example below.

MeasResult			
SA:PST			
A.10.53	N9030A		
526 ALV ATP B1X B1Y B25	1		
B40 BBA CR3 CRP DCF DDA			
DP2 DRD EA3 EDP EMC EP1			
ERC ESC ESP EXM FSA LFE			
LNP MAT MPB NFE NUL P26			
PFR PNC RTL RTS S40 SB1			
SEC SM1 TVT YAS YAV			
Automatic Trigger Time	0.1		
Automatic Trigger Time State	FALSE		
CcdfCurrentCounts	6087500		
Center Frequency	1.33E+10		
Center Frequency Step	5000000		
Center Frequency Step State	TRUE		
Counts	10000000		
Electrical Atten	0		
Electrical Atten State	FALSE		
External Array Trigger Delay	1.00E-06	1.00E-06	
External Array Trigger Delay State	FALSE	FALSE	
External Array Trigger Level	1.2	1.2	
External Array Trigger Slope	Positive	Positive	
Gaussian Line	TRUE		
IF Gain AUto	FALSE		
IF Gain State	FALSE		

Info BW	5000000		
Internal Preamp	FALSE		
Internal Preamp Band	Low		
Line Trigger Delay	1.00E-06		
Line Trigger Delay State	FALSE		
Line Trigger Slope	Positive		
Meas Cycles	1600		
MeasInterval	0.001		
Mechanical Atten	10		
MechanicalAttenStepEnum	S2dB		
Periodic Timer Period	0.02		
Periodic Timer Sync Source	None		
Periodic Timer Trigger Delay	1.00E-06		
Periodic Timer Trigger Delay State	FALSE		
Preselector Adjust	0		
Ref Trace	FALSE		
RFBurst Trigger Delay	1.00E-06		
RFBurst Trigger Delay State	FALSE		
RFBurst Trigger Level Abs	-20		
RFBurst Trigger Level Rel	-6		
RFBurst Trigger Level Type	Absolute		
RFBurst Trigger Slope	Positive		
Scale/Div	2		
Trigger Holdoff	0.1		
Trigger Holdoff State	FALSE		
TriggerSource	Free		
MeasResult1	MeasResult2	MeasResult3	MeasResult4
-73.0651058869747	36.9712197125257	36.7879441171442	
36.9712197125257	36.8850431211499	36.7032368203129	

### Capture Buffer

Capture buffer functionality is available only in Mod Accuracy measurement. The captured data is raw data which is not processed.

Key Path	Save, Data
----------	------------

Mode	DVB-T/H
Example	MMEM:STOR:CAPT "MyCaptureData.bin" This stores the capture data in the file MyCaptureData.bin in the default directory.
Dependencies	Capture buffer functionality is only available for Mod Accuracy measurement. In other measurements, this key is grayed out.
Initial S/W Revision	Prior to A.01.70

## DVB-T2 Config

Exports the current DVB-T2 configuration to a file (single PLP or multiple PLPs). This key is available only in DVB-T2 Mod Accuracy measurement and will be grayed out in other measurements.

You can view the exported file for the format of the DVB-T2 configuration files and create your own DVB-T2 configuration file by modifying the exported file.

File Location and Extension

**File location:** "My Documents\DVB\data\EVMT2\data"

**File type:** text file

**File extension:** .csv

**Example:**

File Location: My Documents\DVB\data\EVMT2\data

File Name: DVBT2Config\_0001.csv

Key Path	Save, Data
Mode	DVB-T/H
Remote Command	MMEMory:STORe:T2Config <string>
Example	MMEM:STOR:T2C "DVBT2Config_0001.csv"
Dependencies	This key is grayed out in all the other measurements except DVB-T2 Mod Accuracy measurement.
Initial S/W Revision	A.07.00

## Save As . . .

When you press "Save As", the analyzer brings up a Windows dialog and a menu entitled "**Save As.**" This menu allows you to navigate to the various fields in the Windows dialog without using a keyboard or mouse. The Tab and Arrow keys can also be used for dialog navigation.

See "[To File . . .](#)" on page 2213 in Save, State for a full description of this dialog and menu.

The default path for saving files is:

For all of the Trace Data Files:

My Documents\`<mode name>`\data\traces

For all of the Limit Data Files:

My Documents\`<mode name>`\data\limits

For all of the Measurement Results Data Files:

My Documents\`<mode name>`\data\`<measurement name>`\results

For all of the Capture Buffer Data Files:

My Documents\`<mode name>`\data\captureBuffer

Key Path	Save, Data
Mode	All
Notes	The key location is mode-dependent and will vary. Brings up the Save As dialog for saving a <code>&lt;mode specific&gt;</code> Save Type. The save is performed immediately and does not wait until the measurement is complete.
Initial S/W Revision	Prior to A.02.00

## Screen Image

Pressing Screen Image accesses a menu of functions that enable you to specify a format and location for the saved screen image. It brings up a menu that allows you to specify the color scheme of the Screen Image (Themes) or navigate to the Save As dialog to perform the actual save.

Screen Image files contain an exact representation of the analyzer display. They cannot be loaded back onto the analyzer, but they can be loaded into your PC for use in many popular applications.

The image to be saved is actually captured when the Save front panel key is pressed, and kept in temporary storage to be used if you ask for a Screen Image save. When the Screen Image key is pressed, a "thumbnail" of the captured image is displayed, as shown below:

## 10 Power Stat CCDF Measurement

### Save

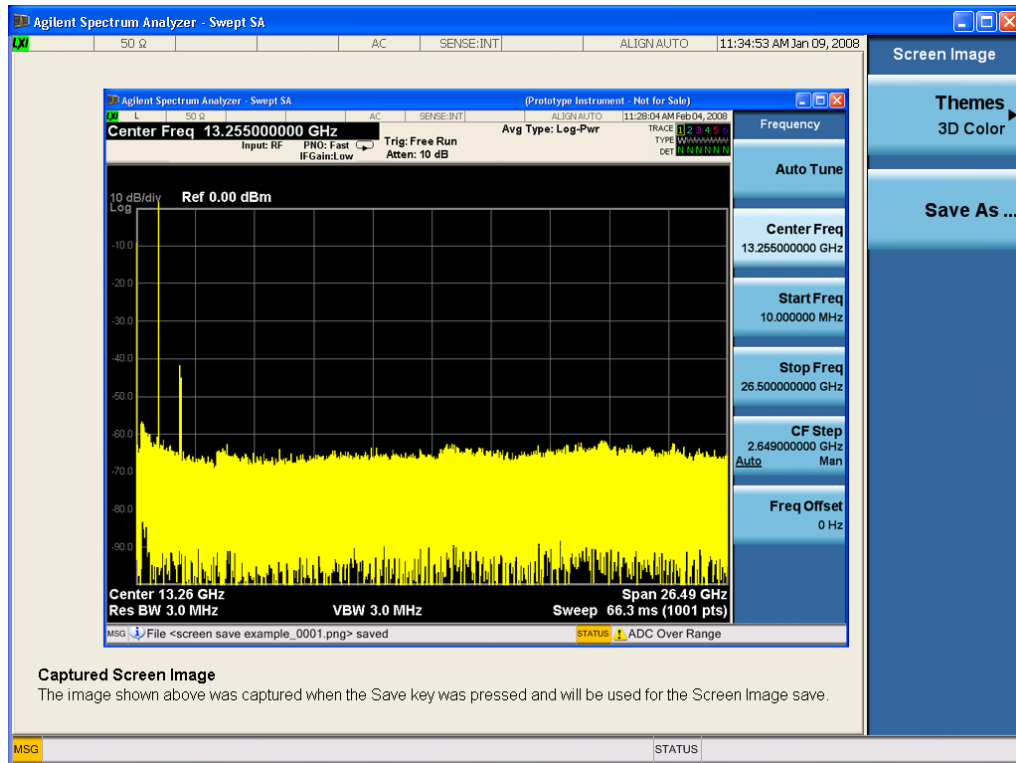

When you continue on into the Save As menu and complete the Screen Image save, the image depicted in the thumbnail is the one that gets saved, showing the menus that were on the screen before going into the Save menus. The save is performed immediately and does not wait until the measurement is complete.

After you have completed the save, the Quick Save front-panel key lets you quickly repeat the last save performed, using an auto-named file, with the current screen data.

#### NOTE

For versions previous to A.01.55, if you initiate a screen image save by navigating through the Save menus, the image that is saved will contain the Save menu softkeys, not the menus and the active function that were on the screen when you first pressed the Save front panel key.

Key Path	Save
Mode	All
Remote Command	:MMEMory:STOR:SCReen <filename>
Example	:MMEM:STOR:SCR "myScreen.png" This stores the current screen image in the file MyScreenFile.png in the default directory.
Initial S/W Revision	Prior to A.02.00

## Themes

Accesses a menu of functions that enable you to choose the theme to be used when saving the screen image.

The **Themes** option is the same as the **Themes** option under the **Display** and **Page Setup** dialogs. It allows you to choose between themes to be used when saving the screen image.

Key Path	Save, Screen Image
Remote Command	:MMEMory:STORe:SCReen:THEMe TDColor   TDMonochrome   FCOLOR   FMONochrome  :MMEMory:STORe:SCReen:THEMe?
Example	:MMEM:STOR:SCR:THEM TDM
Preset	3D Color; Is not part of Preset, but is reset by Restore Misc Defaults or Restore System Defaults All and survives subsequent running of the modes.
Readback	3D Color   3D Mono   Flat Color   Flat Mono
Backwards Compatibility Notes	In ESA and PSA we offer the choice of "Reverse Bitmap" or "Reverse Metafile" when saving screen images. This is much like the "Flat Color" theme available in X-Series. Also, if you selected Reverse Bitmap AND a black & white screen image, that would be much like "Flat Monochrome". In other words, each of the X-Series themes has a similar screen image type in ESA/PSA. But they are not identical.
Initial S/W Revision	Prior to A.02.00

### 3D Color

Selects a standard color theme with each object filled, shaded and colored as designed.

Key Path	Save, Screen Image, Themes
Example	MMEM:STOR:SCR:THEM TDC
Readback	3D Color
Initial S/W Revision	Prior to A.02.00

### 3D Monochrome

Selects a format that is like 3D color but shades of gray are used instead of colors.

Key Path	Save, Screen Image, Themes
Example	MMEM:STOR:SCR:THEM TDM
Readback	3D Mono
Initial S/W Revision	Prior to A.02.00

### Flat Color

Selects a format that is best when the screen is to be printed on an ink printer.

Key Path	Save, Screen Image, Themes
----------	----------------------------

<b>Example</b>	MMEM:STOR:SCR:THEM FCOL
Readback	Flat Color
Initial S/W Revision	Prior to A.02.00

### Flat Monochrome

Selects a format that is like Flat Color. But only black is used (no colors, not even gray), and no fill.

Key Path	Save, Screen Image, Themes
<b>Example</b>	MMEM:STOR:SCR:THEM FMON
Readback	Flat Mono
Initial S/W Revision	Prior to A.02.00

### Save As...

When you press “Save As”, the analyzer brings up a Windows dialog and a menu entitled “**Save As.**” This menu allows you to navigate to the various fields in the Windows dialog without using a keyboard or mouse. The Tab and Arrow keys can also be used for dialog navigation.

See "[To File . . .](#)" on page 2213 in Save, State for a full description of this dialog and menu.

The default path for Screen Images is

My Documents\<<mode name>\screen.

where <mode name> is the parameter used to select the mode with the INST:SEL command (for example, SA for the Spectrum Analyzer).

Key Path	Save, Screen Image
Notes	Brings up Save As dialog for saving a Screen Image Save Type
Initial S/W Revision	Prior to A.02.00

### Mass Storage Catalog (Remote Command Only)

Key path	SCPI Only
<b>Remote Command</b>	:MMEMory:CATalog? [<directory_name>]
Notes	<p>The string must be a valid logical path.</p> <p>Queries disk usage information (drive capacity, free space available) and obtains a list of files and directories in a specified directory in the following format:</p> <p>&lt;numeric_value&gt;,&lt;numeric_value&gt;,{&lt;file_entry&gt;}</p> <p>It returns two numeric parameters and as many strings as there are files and directories. The first parameter indicates the total amount of storage currently used in bytes. The second parameter</p>



indicates the total amount of storage available, also in bytes. The <file\_entry> is a string. Each <file\_entry> indicates the name, type, and size of one file in the directory list:

<file\_name>,<file\_type>,<file\_size>

As the windows file system has an extension that indicates file type, <file\_type> is always empty. <file\_size> provides the size of the file in bytes. For directories, <file\_entry> is surrounded by square brackets and both <file\_type> and <file\_size> are empty

---

Initial S/W Revision      Prior to A.02.00

---

## Mass Storage Change Directory (Remote Command Only)

---

Key path                      SCPI Only

**Remote Command**        :MMEMory:CDIRectory [<directory\_name>]  
                                  :MMEMory:CDIRectory?

**Notes**                      The string must be a valid logical path.  
  
Changes the default directory for a mass memory file system. The <directory\_name> parameter is a string. If no parameter is specified, the directory is set to the \*RST value.  
  
At \*RST, this value is set to the default user data storage area, that is defined as System.Environment.SpecialFolder.Personal.  
  
Query returns full path of the default directory.

---

Initial S/W Revision      Prior to A.02.00

---

## Mass Storage Copy (Remote Command Only)

---

Key path                      SCPI Only

**Remote Command**        :MMEMory:COPY <string>,<string>[,<string>,<string>]

**Notes**                      The string must be a valid logical path.  
  
Copies an existing file to a new file or an existing directory to a new directory.  
  
Two forms of parameters are allowed. The first form has two parameters. In this form, the first parameter specifies the source, and the second parameter specifies the destination.  
  
The second form has four parameters. In this form, the first and third parameters specify the source. The second and fourth parameters specify the directories. The first pair of parameters specifies the source. The second pair specifies the destination. An error is generated if the source doesn't exist or the destination file already exists.  
  
This command will generate an "access denied" error if the destination is a restricted folder (e.g., C:\Windows) and the current user does not have Power User or Administrator privileges.

## Mass Storage Device Copy (Remote Command Only)

This command transfers data to/from a file and a peripheral device.

Key path	SCPI Only
<b>Remote Command</b>	:MMEMory:COpy:DEvice <source_string>,<dest_string>
Notes	The strings must be a valid logical path or a valid device keyword. If the dest_string is a device keyword, the data is copied from the source file to the device. If the source_string is a device keyword, the data is copied to the source file from the device.  Valid device keywords are: SNS (smart noise source)  An error is generated if the file or device is not found.

### Mass Storage Delete (Remote Command Only)

Key path	SCPI Only
<b>Remote Command</b>	:MMEMory:DELeTe <file_name>[,<directory_name>]
Notes	The string must be a valid logical path.  Removes a file from the specified directory. The <file_name> parameter specifies the file name to be removed. This command will generate an "access denied" error if the file is in a restricted folder (e.g., C:\Windows) and the current user does not have Power User or Administrator privileges.
Initial S/W Revision	Prior to A.02.00

### Mass Storage Data (Remote Command Only)

Creates a file containing the specified data OR queries the data from an existing file.

Key path	SCPI Only
<b>Remote Command</b>	:MMEMory:DATA <file_name>, <data> :MMEMory:DATA? <file_name>
Notes	The string must be a valid logical path.  The command form is MMEMory:DATA <file_name>,<data>. It loads <data> into the file <file_name>. <data> is in 488.2 block format. <file_name> is string data.  The query form is MMEMory:DATA? <file_name> with the response being the associated <data> in block format.
Initial S/W Revision	Prior to A.02.00

### Mass Storage Make Directory (Remote Command Only)

Key path	SCPI Only
<b>Remote Command</b>	:MMEMory:MDIRectory <directory_name>
Notes	The string must be a valid logical path.  Creates a new directory. The <directory_name> parameter specifies the name to be created.

	This command will generate an “access denied” error if the new directory would be in a restricted folder (e.g., C:\Windows) and the current user does not have Power User or Administrator privileges.
Initial S/W Revision	Prior to A.02.00

### Mass Storage Move (Remote Command Only)

Key path	SCPI Only
<b>Remote Command</b>	:MMEMory:MOVE <string>,<string>[,<string>,<string>]
Notes	<p>The string must be a valid logical path.</p> <p>Moves an existing file to a new file or an existing directory to a new directory.</p> <p>Two forms of parameters are allowed. The first form has two parameters. In this form, the first parameter specifies the source, and the second parameter specifies the destination.</p> <p>The second form has four parameters. In this form, the first and third parameters specify the source. The second and fourth parameters specify the directories. The first pair of parameters specifies the source. The second pair specifies the destination. An error is generated if the source doesn't exist or the destination file already exists.</p> <p>This command will generate an “access denied” error if the destination is a restricted folder (e.g., C:\Windows) and the current user does not have Power User or Administrator privileges.</p>
Initial S/W Revision	Prior to A.02.00

### Mass Storage Remove Directory (Remote Command Only)

Key path	SCPI Only
<b>Remote Command</b>	:MMEMory:RDIRECTory <directory_name>
Notes	<p>The string must be a valid logical path.</p> <p>Removes a directory. The &lt;directory_name&gt; parameter specifies the directory name to be removed. All files and directories under the specified directory shall also be removed.</p> <p>This command will generate an “access denied” error if the folder is a restricted folder (e.g., C:\Windows) or is in a restricted folder and the current user does not have Power User or Administrator privileges.</p>
Initial S/W Revision	Prior to A.02.00

## Single (Single Measurement/Sweep)

Sets the analyzer for Single measurement operation. The single/continuous state is Meas Global, so the setting will affect all the measurements. If you are Paused, pressing Single does a Resume.

See "[More Information](#)" on page 996

Key Path	Front-panel key
Example	:INIT:CONT OFF
Notes	See Cont key description.
Backwards Compatibility Notes	<p>For Spectrum Analysis mode in ESA and PSA, the Single hardkey and the INITiate:IMM switched from continuous measurement to single measurement and restarted sweeps and averages (displayed average count reset to 1), but did not restart Max Hold and Min Hold. In the X-Series, the Single hardkey and the INITiate:IMM command initiate a sweep/ measurement/ average sequence/hold sequence including MaxHold and MinHold.</p> <p>For Spectrum Analysis mode in ESA and PSA, the Single hardkey restarted the sweep regardless of whether or not you were in an active sweep or sweep sequence. In the X-Series, Restart does this but Single only restarts the sweep or sweep sequence if you are in the idle state.</p> <p>INIT[:IMM] in ESA &amp; PSA Spectrum Analysis Mode does an implied ABORT. In some other PSA Modes, INIT[:IMM] is ignored if not in the idle state. . The X-Series follows the ESA/PSA SA Mode model, which may cause some Modes to have compatibility problems.</p>
Initial S/W Revision	Prior to A.02.00

### More Information

See "[Restart](#)" on page 2210 for details on the INIT:IMMEDIATE (Restart) function.

If you are already in single sweep, the INIT:CONT OFF command has no effect.

If you are already in Single Sweep, then pressing the Single key in the middle of a sweep does not restart the sweep or sequence. Similarly, pressing the Single key does not restart the sweep or sequence if the sweep is not in the idle state (for example, if you are taking a very slow sweep, or the analyzer is waiting for a trigger). Instead, it results in a message. "Already in Single, press Restart to initiate a new sweep or sequence". Even though pressing the Single key in the middle of a sweep does not restart the sweep, sending INIT:IMMEDIATE does reset it.

To take one more sweep without resetting the average count, increment the average count by 1, by pressing the step up key while **Average/Hold Number** is the active function, or sending the remote command CALC:AVER:TCON UP.

## Source

There is no Source control functionality for this measurement. When this key is pressed, the screen either displays a blank menu, or the previously-selected menu remains unchanged.

---

Key Path	Front-panel key
----------	-----------------

---

## Span X Scale

The SPAN X Scale key accesses the menu to set the desired horizontal scale.

Key Path	Front-panel key
Initial S/W Revision	Prior to A.02.00

### Scale/Div

Enables you to enter a time value to change the horizontal scale.

Key Path	Span X Scale
Mode	SA, WCDMA, C2K, WIMAXOFDMA, TD-SCDMA, 1xEV-DO, DVB-T/H, DTMB (CTTB), ISDB-T, CMMB, LTE, LTE-TDD, Digital Cable TV, WLAN, MSR,, LTE-TDD, LTE-FDD
<b>Remote Command</b>	:DISPlay:PSTatistic:VIEW[1]:WINDow2:TRACe:X[:SCALE]:PDIVision <rel_ ampl> :DISPlay:PSTatistic:VIEW[1]:WINDow2:TRACe:X[:SCALE]:PDIVision?
<b>Example</b>	DISP:PST:VIEW:WIND2:TRAC:X:PDIV 10 DISP:PST:VIEW:WIND2:TRAC:X:PDIV?
Notes	CCDF measurement has the trace display only at Window 2.
Couplings	See Notes
Preset	2.00
State Saved	Saved in instrument state.
Min	0.1
Max	20
<b>Backwards Compatibility SCPI</b>	:DISPlay:PSTatistic:XScale
Initial S/W Revision	Prior to A.02.00
Modified at S/W Revision	A.02.00, A.03.00

## Sweep/Control

Enables you to pause the power statistics CCDF measurement after the current data acquisition is complete. When Paused, the label on the menu key changes to Resume. Press Resume to resume the measurement where it was when it was paused.

Key Path	Front-panel key
Initial S/W Revision	Prior to A.02.00

## Pause/Resume

Pauses a measurement after the current data acquisition is complete. When Paused, the label on the key changes to Resume. Press Resume to resume the measurement where it was when it was paused. See ["Pause/Resume" on page 2235](#) for details.

Key Path	Sweep/Control
Initial S/W Revision	Prior to A.02.00

## System

See ["System" on page 342](#)



## Trace/Detector

Accesses a menu of functions that enable you to control the storage and manipulation of the reference trace, as well as controls the display of the trace data.

Key Path	Front-panel key
Initial S/W Revision	Prior to A.02.00

### Store Ref Trace

Copies the currently measured curve as the user-definable reference trace. The captured data remains until the other mode is chosen. Pressing this key also refreshes the reference trace.

No query command is available.

Key Path	Trace/Detector
Mode	SA, WCDMA, C2K, WIMAXOFDMA, TD-SCDMA, 1xEV-DO, DVB-T/H, DTMB (CTTB), ISDB-T, CMMB, LTE, LTE-TDD, Digital Cable TV, WLAN, MSR, LTE-TDD, LTEAFDD
<b>Remote Command</b>	:CALCulate:PSTatistic:STORe:REFerence
<b>Example</b>	CALC:PST:STOR:REF
<b>Backwards Compatibility SCPI</b>	[ :SENSe ] :PSTatistic:SRTRace
Initial S/W Revision	Prior to A.02.00
Modified at S/W Revision	A.02.00, A.03.00

### Ref Trace

Toggles the reference trace display between On and Off.

Key Path	Trace/Detector
Mode	SA, WCDMA, C2K, WIMAXOFDMA, TD-SCDMA, 1xEV-DO, DVB-T/H, DTMB (CTTB), ISDB-T, CMMB, LTE, LTE-TDD, Digital Cable TV, WLAN, MSR, LTE-TDD, LTEAFDD
<b>Remote Command</b>	:DISPlay:PSTatistic:RTRace[:STATe] OFF ON 0 1 :DISPlay:PSTatistic:RTRace[:STATe]?
<b>Example</b>	DISP:PST:RTR OFF DISP:PST:RTR?
Preset	OFF
State Saved	Saved in instrument state.
Range	On Off
<b>Backwards Compatibility SCPI</b>	[ :SENSe ] :PSTatistic:RTRace[:STATe]
Initial S/W Revision	Prior to A.02.00
Modified at S/W Revision	A.02.00, A.03.00, A.04.00

## Gaussian Line

Toggles the Gaussian trace display between On and Off.

<b>Key Path</b>	Trace/Detector
<b>Mode</b>	SA, WCDMA, C2K, WIMAXOFDMA, TD-SCDMA, 1xEV-DO, DVB-T/H, DTMB (CTTB), ISDB-T, CMMB, LTE, LTE-TDD, Digital Cable TV, WLAN, MSR, LTE-TDD, LTE-FDD
<b>Remote Command</b>	:DISPlay:PStatistic:GAUSSian[:STATe] OFF ON 0 1 :DISPlay:PStatistic:GAUSSian[:STATe]?
<b>Example</b>	DISP:PST:GAUS OFF DISP:PST:GAUS?
<b>Preset</b>	ON
<b>State Saved</b>	Saved in instrument state.
<b>Range</b>	On Off
<b>Backwards Compatibility SCPI</b>	[:SENSe]:PStatistic:GAUSSian[:STATe]
<b>Initial S/W Revision</b>	Prior to A.02.00
<b>Modified at S/W Revision</b>	A.02.00, A.03.00, A.04.00

## Trigger

See ["Trigger" on page 412](#)

### Free Run

See ["Free Run " on page 419](#)

### External 1

See ["External 1 " on page 2059](#)

### Trigger Level

See ["Trigger Level " on page 2059](#)

### Trig Slope

See ["Trig Slope " on page 2060](#)

### Trig Delay

See ["Trig Delay " on page 427](#)

### External 2

See ["External 2 " on page 2061](#)

### Trigger Level

See ["Trigger Level " on page 2061](#)

### Trig Slope

See ["Trig Slope " on page 2062](#)

### Trig Delay

See ["Trig Delay " on page 429](#)

### RF Burst

See ["RF Burst " on page 2062](#)

### Absolute Trigger

See ["Absolute Trigger Level" on page 2063](#)

### Relative Trigger

See ["Relative Trigger Level" on page 2052](#)

### Trig Slope

See ["Trigger Slope " on page 2064](#)

### Trig Delay

See ["Trig Delay "](#) on page 433

### Auto/Holdoff

See ["Auto/Holdoff "](#) on page 444

### Auto Trig

See ["Auto Trig "](#) on page 444

### Trig Holdoff

See ["Trig Holdoff "](#) on page 445

### Baseband I/Q

See [\\_\\_](#) on page X

### I/Q Mag

See [\\_\\_](#) on page X

### Trigger Level

See [\\_\\_](#) on page X

### Trig Slope

See [\\_\\_](#) on page X

### Trig Delay

See [\\_\\_](#) on page X

### I

See [\\_\\_](#) on page X

### Trigger Level

See [\\_\\_](#) on page X

### Trig Slope

See [\\_\\_](#) on page X

### Trig Delay

See [\\_\\_](#) on page X

### Q

See [\\_\\_](#) on page X

**Trigger Level**

See \_\_\_ on page X

**Trig Slope**

See \_\_\_ on page X

**Trig Delay**

See \_\_\_ on page X

**Input I**

See \_\_\_ on page X

**Trigger Level**

See \_\_\_ on page X

**Trig Slope**

See \_\_\_ on page X

**Trig Delay**

See \_\_\_ on page X

**Input Q**

See \_\_\_ on page X

**Trigger Level**

See \_\_\_ on page X

**Trig Slope**

See \_\_\_ on page X

**Trig Delay**

See \_\_\_ on page X

**Aux Channel Center Freq**

See \_\_\_ on page X

**Trigger Level**

See \_\_\_ on page X

**Trig Slope**

See \_\_\_ on page X

**Trig Delay**

See \_\_\_ on page X

10 Power Stat CCDF Measurement  
Trigger

**Trigger Center Freq**

See \_\_\_ on page X

**Trigger BW**

See \_\_\_ on page X

## User Preset

Accesses a menu that gives you the following three choices:

- User Preset – recalls a state previously saved using the Save User Preset function.
- User Preset All Modes – presets all of the modes in the analyzer
- Save User Preset– saves the current state for the current mode

Key Path	Front-panel key
Backwards Compatibility Notes	<p>User Preset is actually loading a state, and in legacy analyzers, it was possible to load a state without affecting the trace data, limit lines or correction data. Similarly it was possible to do a User Preset without affecting the trace data, limit lines or correction data.</p> <p>In the X-Series, “state” always includes all of this data; so whenever state is loaded, or User Preset is executed, all of the traces, limit lines and corrections are affected. Although this differs from previous behavior, it is desirable behavior, and should not cause adverse issues for users.</p> <p>On ESA and PSA, User Preset affected the entire instrument’s state. In the X-Series, User Preset only recalls the state for the active mode. There is a User Preset file for each mode. User Preset can never cause a mode switch as it can in legacy analyzers. If you want to recall all modes to their user preset file state, you will need to do a User Preset after mode switching into each mode.</p> <p>User Preset recalls mode state which can now include data like traces; whereas on ESA and PSA, User Preset did not affect data.</p>
Initial S/W Revision	Prior to A.02.00

## User Preset

User Preset sets the state of the currently active mode back to the state that was previously saved for this mode using the Save User Preset menu key or the SCPI command, SYST:PRES:USER:SAV. It not only recalls the Mode Preset settings, but it also recalls all of the mode persistent settings, and the Input/Output system setting that existed at the time Save User Preset was executed.

If a Save User Preset has not been done at any time, User Preset recalls the default user preset file for the currently active mode. The default user preset files are created if, at power-on, a mode detects there is no user preset file. There will never be a scenario when there is no user preset file to restore. For each mode, the default user preset state is the same state that would be saved if a Save User Preset is performed in each mode right after doing a Restore Mode Default and after a Restore Input/Output Defaults.

The User Preset function does the following:

- Aborts the currently running measurement.
- Sets the mode State to the values defined by Save User Preset.
- Makes the saved measurement for the currently running mode the active measurement.
- Brings up the saved menu for the power-on mode.
- Clears the input and output buffers.
- Sets the Status Byte to 0.

Key Path	User Preset
Remote Command	:SYSTem:PRESet:USER
Example	:SYST:PRES:USER:SAVE:SYST:PRES:USER
Notes	:SYST:PRES:USER:SAVE is used to save the current state as the user preset state. Clears all pending OPC bits. The Status Byte is set to 0. Pressing the User Preset front-panel key while already in the User Preset menu will cause the User Preset to get executed
Couplings	A user preset will cause the currently running measurement to be aborted and cause the saved measurement to be active. Recalling a User Preset file has the same issues that recalling a Save State file has. Some settings may need to be limited and therefore re-coupled, since the capabilities of the mode may have changes when the User Preset file was last saved.
Initial S/W Revision	Prior to A.02.00

### User Preset All Modes

Recalls all of the User Preset files for each mode, switches to the power-on mode, and activates the saved measurement from the power-on mode User Preset file.

**NOTE**

When the instrument is secured, all of the user preset files are converted back to their default user preset files.

The User Preset function does the following:

- Aborts the currently running measurement.
- Switches the Mode to the power-on mode.
- Restores the User Preset files for each mode.
- Makes the saved measurement for the power-on mode the active measurement.
- Brings up the saved menu for the power-on mode.
- Clears the input and output buffers.
- Sets the Status Byte to 0.

Key Path	User Preset
Remote Command	:SYSTem:PRESet:USER:ALL
Example	:SYST:PRES:USER:SAVE:SYST:PRES:USER:ALL
Notes	Clears all pending OPC bits. The Status Byte is set to 0. :SYST:PRES:USER:SAVE is used to save the current state as the user preset state.
Couplings	A user preset will cause the currently running measurement to be aborted, cause a mode switch to the power-on mode, and cause the saved measurement to be active in the power-on mode. Recalling a User Preset file has the same issues that recalling a Save State file has. Some settings may need to be limited and therefore re-coupled, since the capabilities of the mode may have changes when the User Preset file was last saved.
Initial S/W Revision	Prior to A.02.00



## Save User Preset

Saves the currently active mode and its State. You can recall this User Preset file by pressing the User Preset menu key or sending the SYST:PRES:USER remote command. This same state is also saved by the Save State function.

Key Path	User Preset
<b>Remote Command</b>	:SYSTem:PRESet:USER:SAVE
<b>Example</b>	:SYST:PRES:USER:SAVE
Notes	:SYST:PRES:SAVE creates the same file as if the user requested a *SAV or a MMEM:STOR:STAT, except User Preset Save does not allow the user to specify the filename or the location of the file.
Initial S/W Revision	Prior to A.02.00

## View/Display

Accesses a menu of functions that enable you to control the instrument display as well as turn the bar graph On and Off.

The Power Stat CCDF measurement provides a single view. This is common for both Uplink (MS) and Downlink (BTS). The view consists of the following windows:

"Metrics window" on page 1012

"Graph window" on page 1013

"Wave window (TD-SCDMA and LTE TDD only)" on page 1013

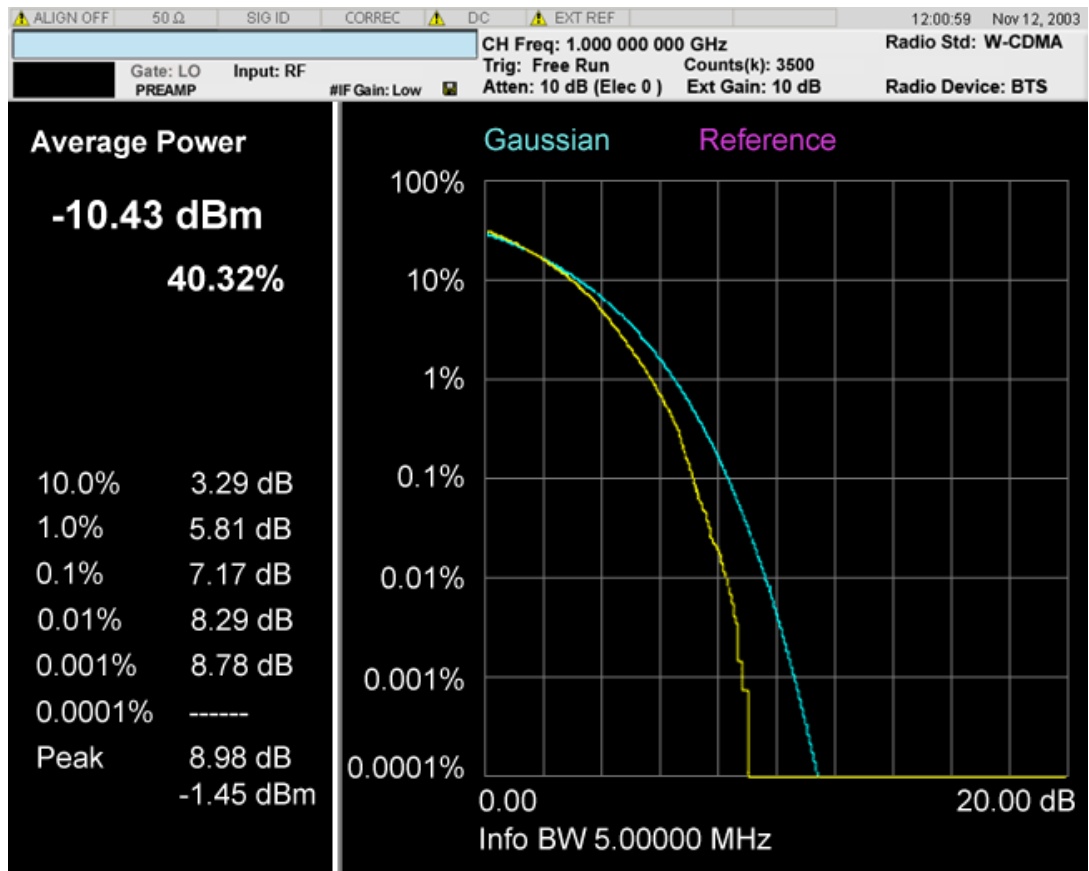

Above: View for Power Stat CCDF Measurement.

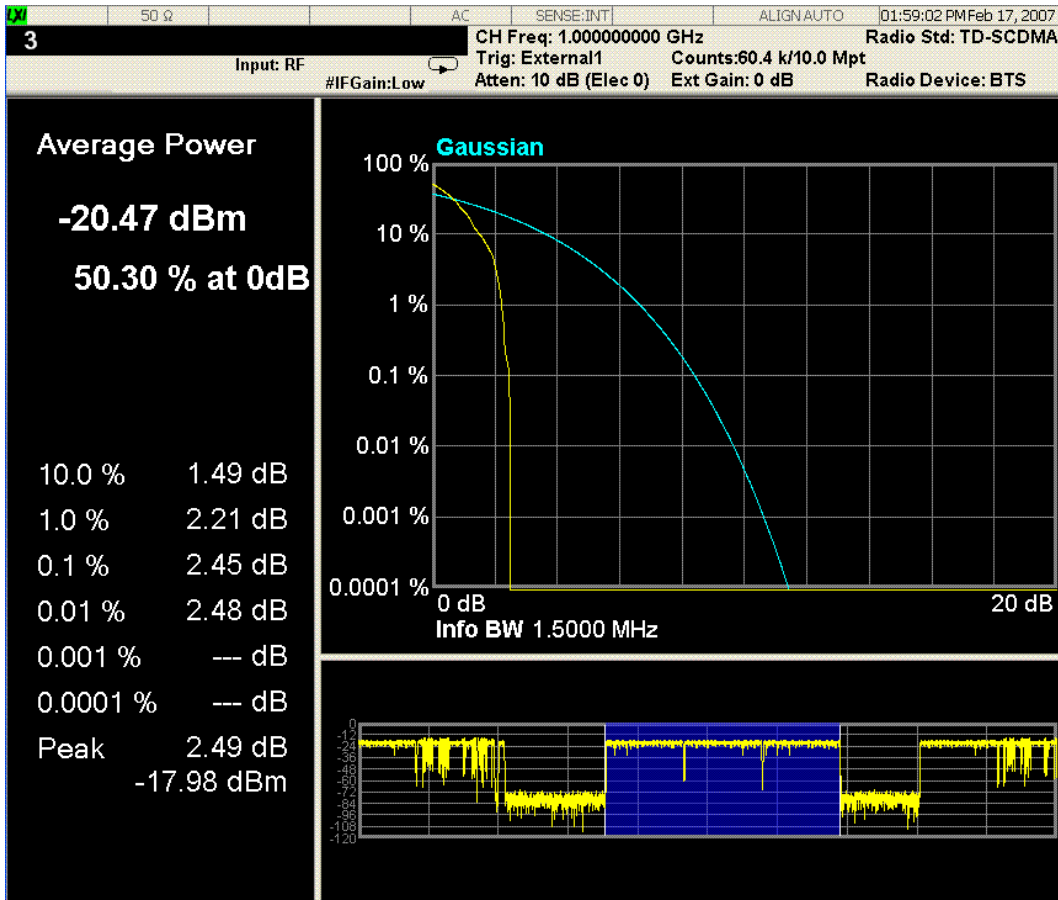

Above: Slot View for Power Stat CCDF Measurement in TD-SCDMA mode.

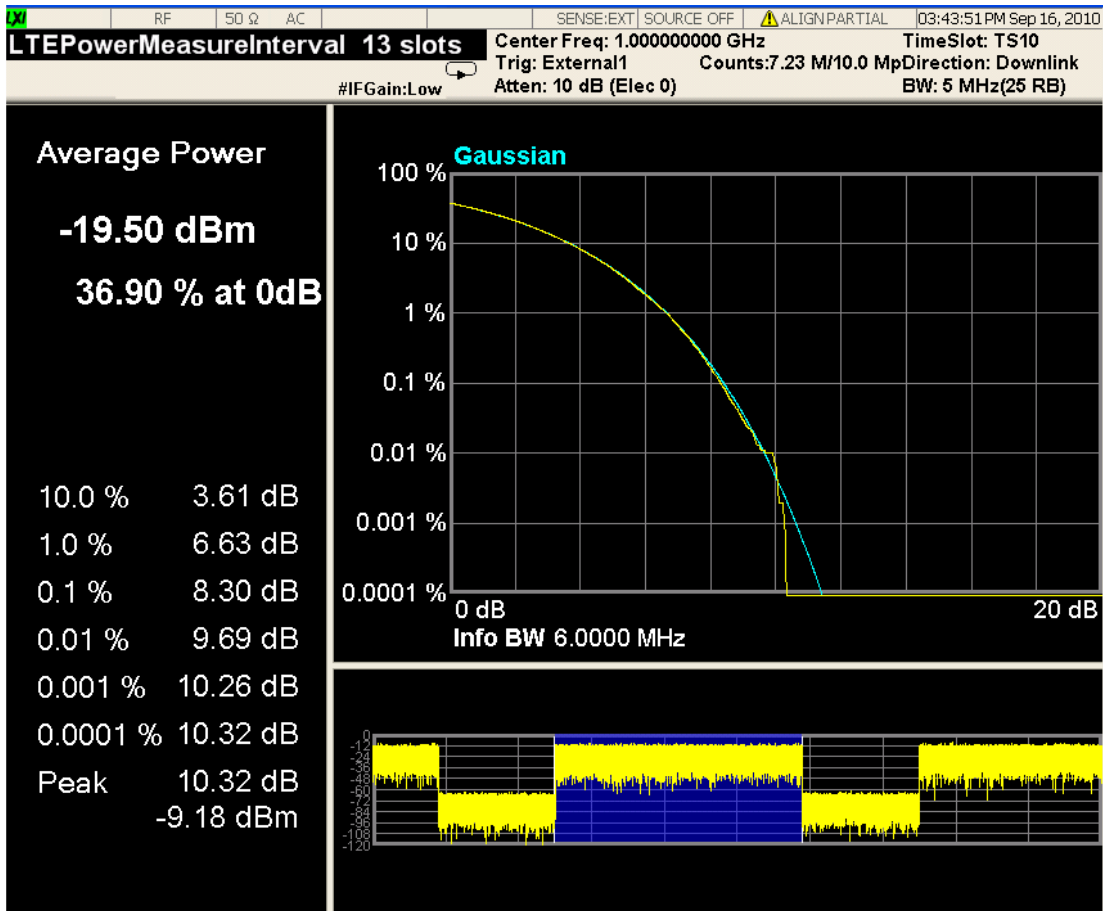

Above: View for Power Stat CCDF Measurement in LTE TDD mode.

### Metrics window

Name	Corresponding Results	Explanation
Average Power [dBm]	n=1 1st Average input power	99.99 dBm
Average Power [%]	n=1 2nd Probability at the average input power level	99.99 %
10.0% [dB]	n=1 3rd Power level that has 10% of the power	99.99 dB
1.0% [dB]	n=1 4th Power level that has 1% of the power	99.99 dB
0.1% [dB]	n=1 5th Power level that has 0.1% of the power	99.99 dB
0.01% [dB]	n=1 6th Power level that has 0.01% of the power	99.99 dB
0.001% [dB]	n=1 7th	99.99 dB

Name	Corresponding Results	Explanation
	Power level that has 0.001% of the power	
0.0001% [dB]	n=1 8th	99.99 dB
	Power level that has 0.0001% of the power	
Peak [dB]	n=1 9th	99.99 dB
	Peak power	
Peak[dBm]	This is not available from SCPI using remote commands.	99.99 dBm

## Graph window

Marker Operation	Yes
Corresponding Trace	<p>Yellow: Series of 5001 floating the current measured power stat trace. (n=2) Initially all markers refer this trace.</p> <p>Light Blue: Series of 5001 floating point numbers (in percent) that represent the Gaussian trace. (n=3)</p> <p>Violet: series of 5001 floating point numbers (in percent) that represent the user-definable reference trace. (n=4)</p> <p>The Gaussian and Reference trace/line can be removed using the functions under the Trace/Detector key</p>

## Wave window (TD-SCDMA and LTE TDD only)

This window is only available under TD-SCDMA mode and LTE TDD mode, and by default this window is closed, it can be turned on or off by using the softkey "Slot View". For more details, refer to the section [Slot View](#).

Marker Operation	No
Corresponding Trace	<p>Yellow: For TD-SCDMA, Waveform of entire TD-SCDMA frame. If measurement range specified by Analysis Time Slot and Measured Time Slot is out of the first frame, the display range extends to two TD-SCDMA frames. For LTETDD, Waveform of 2 continuous LTE type2 frames.</p> <p>Blue: Indicates current measurement range</p>

Key Path	Front-panel key
Initial S/W Revision	Prior to A.02.00

## Display

The Display menu is common to most measurements, and is used for configuring items on the display. Some Display menu settings apply to all the measurements in a mode, and some only to the current measurement. Those under the System Display Settings key apply to all measurements in all modes.

Key Path	Display
Key Path	View/Display
Initial S/W Revision	Prior to A.02.00

## Annotation

Turns on and off various parts of the display annotation. The annotation is divided up into four categories:

1. Meas Bar: This is the measurement bar at the top of the screen. It does not include the settings panel or the Active Function. Turning off the Meas Bar turns off the settings panel and the Active Function. When the Meas Bar is off, the graticule area expands to fill the area formerly occupied by the Meas Bar.
2. Screen Annotation: this is the annotation and annunciation around the graticule, including any annotation on lines (such as the display line, the threshold line, etc.) This does NOT include the marker number or the N dB result. When off, the graticule expands to fill the entire graticule area.
3. Trace annotation: these are the labels on the traces, showing their detector (or their math mode).
4. Active Function annotation: this is the active function display in the meas bar, and all of the active function values displayed on softkeys.

See the figure below. Each type of annotation can be turned on and off individually.

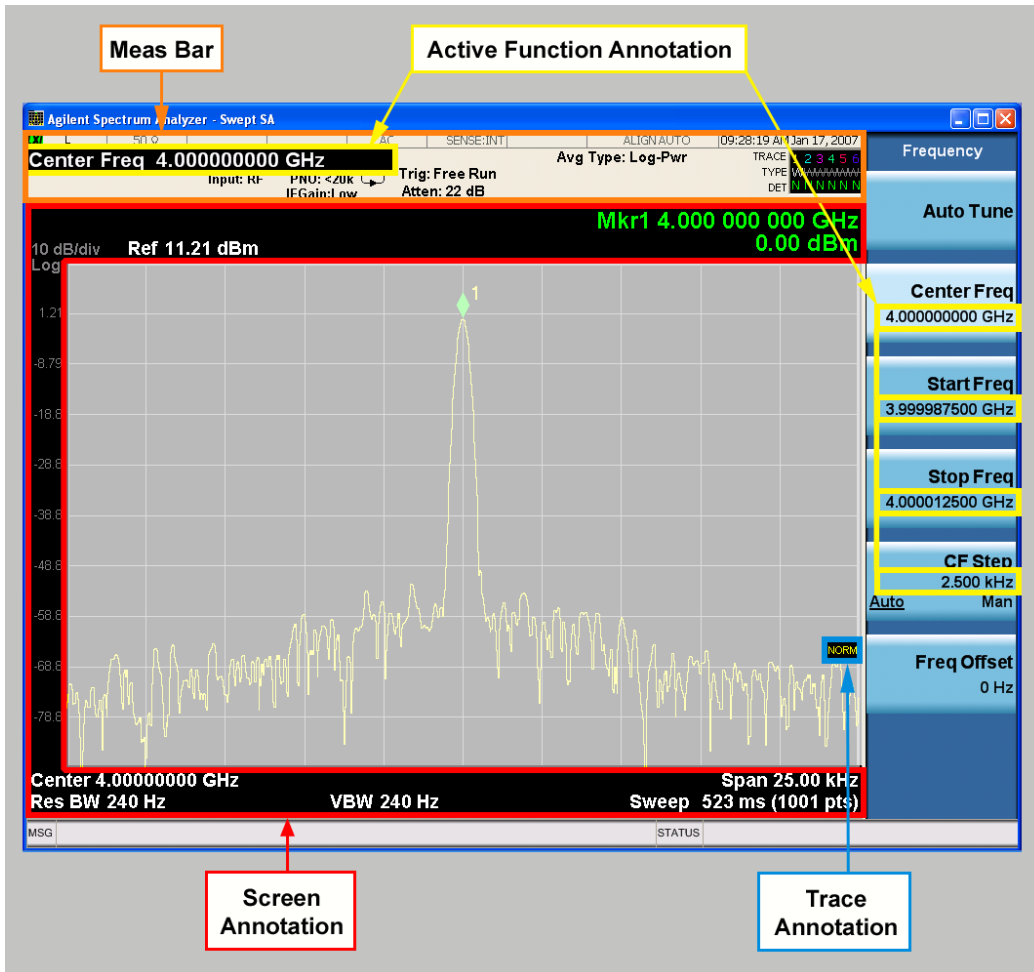

Key Path	View/Display, Display
Initial S/W Revision	Prior to A.02.00

### Meas Bar On/Off

This function turns the Measurement Bar on and off, including the settings panel. When off, the graticule area expands to fill the area formerly occupied by the Measurement Bar.

Key Path	View/Display, Display, Annotation
Remote Command	:DISPlay:ANNotation:MBAR[:STATE] OFF ON 0 1 :DISPlay:ANNotation:MBAR[:STATE]?
Example	DISP:ANN:MBAR OFF
Dependencies	Grayed out and forced to OFF when System Display Settings, Annotation is set to Off.
Preset	On This should remain Off through a Preset when System DisplaySettings, Annotation is set to Off.
State Saved	Saved in instrument state.
Initial S/W Revision	Prior to A.02.00

## Screen

This controls the display of the annunciation and annotation around the graticule, including any annotation on lines (such as the display line, the threshold line, etc.) and the y-axis annotation. This does NOT include marker annotation (or the N dB result). When off, the graticule expands to fill the entire graticule area, leaving only the 1.5% gap above the graticule as described in the Trace/Detector chapter.

<b>Key Path</b>	View/Display, Display, Annotation
<b>Remote Command</b>	:DISPlay:ANNotation:SCReen[:STATe] OFF ON 0 1 :DISPlay:ANNotation:SCReen[:STATe]?
<b>Example</b>	DISP:ANN:SCR OFF
<b>Dependencies</b>	Grayed-out and forced to OFF when System Display Settings, Annotation is set to Off.
<b>Preset</b>	On This should remain Off through a Preset when System DisplaySettings, Annotation is set to Off
<b>State Saved</b>	Saved in instrument state.
<b>Initial S/W Revision</b>	Prior to A.02.00

## Active Function Values On/Off

Turns on and off the active function display in the Meas Bar, and all of the active function values displayed on the softkeys.

Note that all of the softkeys that have active functions have these numeric values blanked when this function is on. This is a security feature..



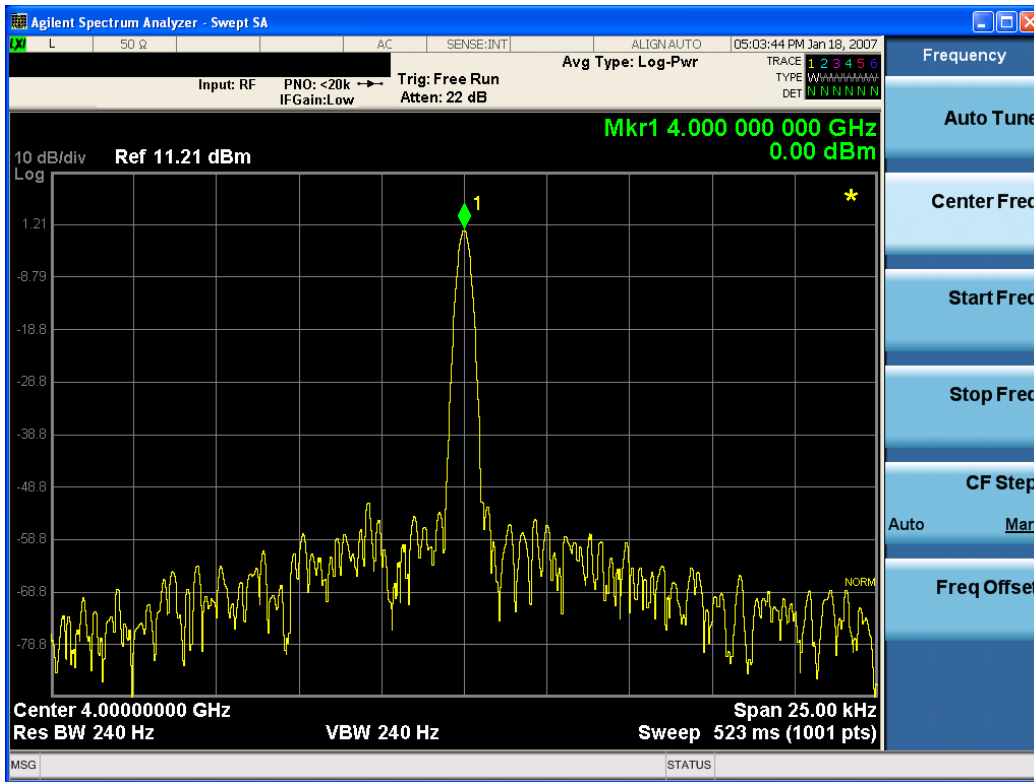

Key Path	View/Display, Display, Annotation
Remote Command	:DISPlay:ACTivefunc[:STATE] ON OFF 1 0 :DISPlay:ACTivefunc[:STATE]?
Example	DISP:ACT OFF
Dependencies	Grayed out and forced to OFF when System Display Settings, Annotation is set to Off.
Preset	On This should remain Off through a Preset when System DisplaySettings, Annotation is set to Off
State Saved	Saved in instrument state.
Initial S/W Revision	Prior to A.02.00

## Title

Displays menu keys that enable you to change or clear a title on your display.

Key Path	View/Display, Display
Initial S/W Revision	Prior to A.02.00

## Change Title

Writes a title into the "measurement name" field in the banner, for example, "Swept SA".

Press Change Title to enter a new title through the alpha editor. Press Enter or Return to complete the entry. Press ESC to cancel the entry and preserve your existing title.

The display title will replace the measurement name. It remains for this measurement until you press Change Title again, or you recall a state, or a Preset is performed. A title can also be cleared by pressing Title, Clear Title.

**NOTE**

Notice the inclusion of the <measurement> parameter in the command below. Because each measurement remembers the Display Title, the command must be qualified with the measurement name. For the Swept SA measurement this is not the case; no <measurement> parameter is used when changing the Display Title for the Swept SA measurement.

Key Path	View/Display, Display, Title
Mode	All
Remote Command	:DISPlay:<measurement>:ANNotation:TITLe:DATA <string> :DISPlay:<measurement>:ANNotation:TITLe:DATA?
Example	DISP:ANN:TITL:DATA "This Is My Title" This example is for the Swept SA measurement in the Spectrum Analyzer mode. The SANalyzer <measurement> name is not used. DISP:ACP:ANN:TITL:DATA "This Is My Title" This example is for Measurements other than Swept SA. Both set the title to: This Is My Title
Notes	Pressing this key cancels any active function. When a title is edited the previous title remains intact (it is not cleared) and the cursor goes at the end so that characters can be added or BKSP can be used to go back over previous characters.
Preset	No title (measurement name instead)
State Saved	Saved in instrument state.
Initial S/W Revision	Prior to A.02.00

**Clear Title**

Clears a title from the front-panel display. Once cleared, the title cannot be retrieved. After the title is cleared, the current Measurement Name replaces it in the title bar.

Key Path	View/Display, Display, Title
Example	The following commands clear the title and restore the measurement's original title: DISP:ANN:TITL:DATA "" This example is for the Swept SA measurement in the Spectrum Analyzer mode. The SANalyzer <measurement> name is not used. DISP:ACP:ANN:TITL:DATA "" This example is for ACP; in measurements other than Swept SA the measurement name is required.
Notes	Uses the :DISPlay:<measurement>:ANNotation:TITLe:DATA <string> command with an empty string (in the Swept SA, the <measurement> is omitted).
Preset	Performed on Preset.
Initial S/W Revision	Prior to A.02.00

## Graticule

Pressing Graticule turns the display graticule On or Off. It also turns the graticule y-axis annotation on and off.

Key Path	View/Display, Display
Remote Command	:DISPlay:WINDow[1]:TRACe:GRATicule:GRID[:STATe] OFF ON 0 1 :DISPlay:WINDow[1]:TRACe:GRATicule:GRID[:STATe]?
Example	DISP:WIND:TRAC:GRAT:GRID OFF
Notes	The graticule is the set of horizontal and vertical lines that make up the grid/divisions for the x-axis and y-axis.
Preset	On
State Saved	Saved in instrument state
Initial S/W Revision	Prior to A.02.00

## System Display Settings

These settings are "Mode Global" – they affect all modes and measurements and are reset only by Restore Misc Defaults or Restore System Defaults under System.

Key Path	View/Display, Display
Initial S/W Revision	Prior to A.02.00

## Annotation Local Settings

This is a Mode Global override of the meas local annotation settings. When it is All Off, it forces ScreenAnnotation, Meas Bar, Trace, and Active Function Values settings to be OFF for all measurements in all modes. This provides the security based "annotation off" function of previous analyzers; hence it uses the legacy SCPI command.

When it is All Off, the Screen, Meas Bar, Trace, and Active Function Values keys under the Display, Annotation menu are grayed out and forced to Off. When Local Settings is selected, you are able to set the local annotation settings on a measurement by measurement basis.

Key Path	View/Display, Display, System Display Settings
Remote Command	:DISPlay:WINDow[1]:ANNOtation[:ALL] OFF ON 0 1 :DISPlay:WINDow[1]:ANNOtation[:ALL]?
Example	:DISP:WIND:ANN OFF
Preset	On (Set by Restore Misc Defaults)
State Saved	Not saved in instrument state.
Backwards Compatibility Notes	The WINDow parameter and optional subopcode is included for backwards compatibility but ignored – all windows are equally affected.
Initial S/W Revision	Prior to A.02.00

## Themes

Accesses a menu of functions that enable you to choose the theme to be used when saving the screen image.

The **Themes** option is the same as the **Themes** option under the **Display** and **Page Setup** dialogs. It allows you to choose between themes to be used when saving the screen image.

<b>Key Path</b>	Save, Screen Image
<b>Remote Command</b>	:MMEMory:STORe:SCReen:THEMe TDColor   TDMonochrome   FCOLor   FMONochrome  :MMEMory:STORe:SCReen:THEMe?
<b>Example</b>	:MMEM:STOR:SCR:THEM TDM
<b>Preset</b>	3D Color; Is not part of Preset, but is reset by Restore Misc Defaults or Restore System Defaults All and survives subsequent running of the modes.
<b>Readback</b>	3D Color   3D Mono   Flat Color   Flat Mono
<b>Backwards Compatibility Notes</b>	In ESA and PSA we offer the choice of "Reverse Bitmap" or "Reverse Metafile" when saving screen images. This is much like the "Flat Color" theme available in X-Series. Also, if you selected Reverse Bitmap AND a black & white screen image, that would be much like "Flat Monochrome". In other words, each of the X-Series themes has a similar screen image type in ESA/PSA. But they are not identical.
<b>Initial S/W Revision</b>	Prior to A.02.00

### 3D Color

Selects a standard color theme with each object filled, shaded and colored as designed.

<b>Key Path</b>	Save, Screen Image, Themes
<b>Example</b>	MMEM:STOR:SCR:THEM TDC
<b>Readback</b>	3D Color
<b>Initial S/W Revision</b>	Prior to A.02.00

### 3D Monochrome

Selects a format that is like 3D color but shades of gray are used instead of colors.

<b>Key Path</b>	Save, Screen Image, Themes
<b>Example</b>	MMEM:STOR:SCR:THEM TDM
<b>Readback</b>	3D Mono
<b>Initial S/W Revision</b>	Prior to A.02.00

### Flat Color

Selects a format that is best when the screen is to be printed on an ink printer.

Key Path	Save, Screen Image, Themes
<b>Example</b>	MMEM:STOR:SCR:THEM FCOL
Readback	Flat Color
Initial S/W Revision	Prior to A.02.00

### Flat Monochrome

Selects a format that is like Flat Color. But only black is used (no colors, not even gray), and no fill.

Key Path	Save, Screen Image, Themes
<b>Example</b>	MMEM:STOR:SCR:THEM FMON
Readback	Flat Mono
Initial S/W Revision	Prior to A.02.00

### Backlight

Accesses the display backlight on/off keys. This setting may interact with settings under the Windows "Power" menu.

When the backlight is off, pressing ESC, TAB, SPACE, ENTER, UP, DOWN, LEFT, RIGHT, DEL, BKSP, CTRL, or ALT turns the backlight on without affecting the application. Pressing any other key will turn backlight on and could potentially perform the action as well.

Key Path	View/Display, Display, System Display Settings
<b>Remote Command</b>	:DISPlay:BACKlight ON OFF :DISPlay:BACKlight?
Preset	ON (Set by Restore Misc Defaults)
Initial S/W Revision	Prior to A.02.00

### Backlight Intensity

An active function used to set the backlight intensity. It goes from 0 to 100 where 100 is full on and 0 is off. This value is independent of the values set under the Backlight on/off key.

Key Path	View/Display, Display, System Display Settings
<b>Remote Command</b>	:DISPlay:BACKlight:INTensity <integer> :DISPlay:BACKlight:INTensity?
<b>Example</b>	DISP:BACK:INT 50

10 Power Stat CCDF Measurement  
View/Display

Preset	100 (Set by Restore Misc Defaults)
Min	0
Max	100
Initial S/W Revision	Prior to A.02.00

## 11 Spectrum Emission Mask Measurement

The spectrum emission mask measures spurious signal levels in up to six pairs of offset frequencies and relates them to the carrier power. For measurement results and views, see ["View/Display" on page 1245](#).

This topic contains the following sections:

["Measurement Commands for Spectrum Emission Mask" on page 1024](#)

["Remote Command Results for Spectrum Emission Mask Measurement" on page 1025](#)

["Number of Offsets" on page 1045](#)

## Measurement Commands for Spectrum Emission Mask

Offsets that are turned off (inactive) return -999.0 when their results are queried via SCPI.

```
:CONFigure:SEMask  
:CONFigure:SEMask:NDEFault  
:INITiate:SEMask  
:FETCh:SEMask[n]?  
:MEASure:SEMask[n]?  
:READ:SEMask[n]?
```

For more measurement related commands, see the SENSE subsystem, and the section "[Remote Measurement Functions](#)" on page 2165.



## Remote Command Results for Spectrum Emission Mask Measurement

The following table describes the results returned by the FETCh, MEASure, and READ queries listed above, according to the index value n:

Modes	n	Return Value
All except MSR, WLAN, LTEAFDD, LTEATDD	1	<p><b>Meas Type: Total Power Reference</b></p> <p>Returns 82 comma-separated scalar results, in the following order:</p> <ol style="list-style-type: none"> <li>1. Reserved for the future use, returns -999.0</li> <li>2. Absolute power at the center frequency (reference) area (dBm)</li> <li>3. Reserved for the future use, returns -999.0</li> <li>4. Reserved for the future use, returns -999.0</li> <li>5. Peak frequency in the center frequency (reference) area (Hz)</li> <li>6. Reserved for the future use, returns -999.0</li> <li>7. Reserved for the future use, returns -999.0</li> <li>8. Reserved for the future use, returns -999.0</li> <li>9. Reserved for the future use, returns -999.0</li> <li>10. Reserved for the future use, returns -999.0</li> <li>11. Relative integrated power on the negative offset A (dBc)</li> <li>12. Absolute integrated power on the negative offset A (dBm)</li> <li>13. Relative peak power on the negative offset A (dBc)</li> <li>14. Absolute peak power on the negative offset A (dBm)</li> <li>15. Peak power offset frequency from the center or carrier edge frequency in the negative offset A, depending on Offset Frequency Define settings (Hz)</li> <li>16. Relative integrated power on the positive offset A (dBc)</li> <li>17. Absolute integrated power on the positive offset A (dBm)</li> <li>18. Relative peak power on the positive offset A (dBc)</li> <li>19. Absolute peak power on the positive offset A (dBm)</li> <li>20. Peak power offset frequency from the center or carrier edge frequency in the positive offset A, depending on Offset Frequency Define settings (Hz)</li> <li>21. Relative integrated power on the negative offset B (dBc)</li> <li>---</li> <li>69. Absolute peak power on the positive offset F (dBm)</li> <li>70. Peak power offset frequency from the center or carrier edge frequency in the positive offset F, depending on Offset Frequency Define settings (Hz)</li> <li>71. Minimum margin from limit line on the negative offset A (dB)</li> <li>72. Minimum margin from limit line on the positive offset A (dB)</li> <li>73. Minimum margin from limit line on the negative offset B (dB)</li> <li>74. Minimum margin from limit line on the positive offset B (dB)</li> <li>75. Minimum margin from limit line on the negative offset C (dB)</li> <li>76. Minimum margin from limit line on the positive offset C (dB)</li> </ol>

Modes	n	Return Value
		77. Minimum margin from limit line on the negative offset D (dB) 78. Minimum margin from limit line on the positive offset D (dB) 79. Minimum margin from limit line on the negative offset E (dB) 80. Minimum margin from limit line on the positive offset E (dB) 81. Minimum margin from limit line on the negative offset F (dB) 82. Minimum margin from limit line on the positive offset F (dB)
All except MSR, WLAN, LTEAFDD, LTEATDD	1	<b>Meas Type: Power Spectral Density Reference</b> Returns 82 comma-separated scalar results, in the following order: <ol style="list-style-type: none"> <li>1. Reserved for the future use, returns -999.0</li> <li>2. Absolute power at the center frequency (reference) area (dBm/Hz)</li> <li>3. Reserved for the future use, returns -999.0</li> <li>4. Reserved for the future use, returns -999.0</li> <li>5. Peak frequency in the center frequency (reference) area (Hz)</li> <li>6. Reserved for the future use, returns -999.0</li> <li>7. Reserved for the future use, returns -999.0</li> <li>8. Reserved for the future use, returns -999.0</li> <li>9. Reserved for the future use, returns -999.0</li> <li>10. Reserved for the future use, returns -999.0</li> <li>11. Relative integrated power on the negative offset A (dB)</li> <li>12. Absolute integrated power on the negative offset A (dBm/Hz)</li> <li>13. Relative peak power on the negative offset A (dB)</li> <li>14. Absolute peak power on the negative offset A (dBm/Hz)</li> <li>15. Peak power offset frequency from the center or carrier edge frequency in the negative offset A, depending on Offset Frequency Define settings (Hz)</li> <li>16. Relative integrated power on the positive offset A (dB)</li> <li>17. Absolute integrated power on the positive offset A (dBm/Hz)</li> <li>18. Relative peak power on the positive offset A (dB)</li> <li>19. Absolute peak power on the positive offset A (dBm/Hz)</li> <li>20. Peak power offset frequency from the center or carrier edge frequency in the positive offset A, depending on Offset Frequency Define settings (Hz)</li> <li>21. Relative integrated power on the negative offset B (dB)</li> <li>---</li> <li>69. Absolute peak power on the positive offset F (dBm/Hz)</li> <li>70. Peak power offset frequency from the center or carrier edge frequency in the positive offset F, depending on Offset Frequency Define settings (Hz)</li> <li>71. Minimum margin from limit line on the negative offset A (dB)</li> <li>72. Minimum margin from limit line on the positive offset A (dB)</li> <li>73. Minimum margin from limit line on the negative offset B (dB)</li> <li>74. Minimum margin from limit line on the positive offset B (dB)</li> </ol>

Modes	n	Return Value
		75. Minimum margin from limit line on the negative offset C (dB) 76. Minimum margin from limit line on the positive offset C (dB) 77. Minimum margin from limit line on the negative offset D (dB) 78. Minimum margin from limit line on the positive offset D (dB) 79. Minimum margin from limit line on the negative offset E (dB) 80. Minimum margin from limit line on the positive offset E (dB) 81. Minimum margin from limit line on the negative offset F (dB) 82. Minimum margin from limit line on the positive offset F (dB)
All except MSR, WLAN, LTEAFDD, LTEATDD	1	<b>Meas Type: Spectrum Peak Reference</b> Returns 82 comma-separated scalar results, in the following order: <ol style="list-style-type: none"> <li>1. Reserved for the future use, returns -999.0</li> <li>2. Peak power at the center frequency (reference) area (dBm)</li> <li>3. Reserved for the future use, returns -999.0</li> <li>4. Reserved for the future use, returns -999.0</li> <li>5. Peak frequency in the center frequency (reference) area (Hz)</li> <li>6. Reserved for the future use, returns -999.0</li> <li>7. Reserved for the future use, returns -999.0</li> <li>8. Reserved for the future use, returns -999.0</li> <li>9. Reserved for the future use, returns -999.0</li> <li>10. Reserved for the future use, returns -999.0</li> <li>11. Reserved for the future use, returns -999.0</li> <li>12. Reserved for the future use, returns -999.0</li> <li>13. Relative peak power on the negative offset A (dB)</li> <li>14. Absolute peak power on the negative offset A (dBm)</li> <li>15. Peak power offset frequency from the center or carrier edge frequency in the negative offset A, depending on Offset Frequency Define settings (Hz)</li> <li>16. Reserved for the future use, returns -999.0</li> <li>17. Reserved for the future use, returns -999.0</li> <li>18. Relative peak power on the positive offset A (dB)</li> <li>19. Absolute peak power on the positive offset A (dBm)</li> <li>20. Peak power offset frequency from the center or carrier edge frequency in the positive offset A, depending on Offset Frequency Define settings (Hz)</li> <li>21. Reserved for the future use, returns -999.0</li> <li>---</li> <li>69. Absolute peak power on the positive offset F (dBm)</li> <li>70. Peak power offset frequency from the center or carrier edge frequency in the positive offset F, depending on Offset Frequency Define settings (Hz)</li> <li>71. Minimum margin from limit line on the negative offset A (dB)</li> <li>72. Minimum margin from limit line on the positive offset A (dB)</li> </ol>

Modes	n	Return Value
		73. Minimum margin from limit line on the negative offset B (dB) 74. Minimum margin from limit line on the positive offset B (dB) 75. Minimum margin from limit line on the negative offset C (dB) 76. Minimum margin from limit line on the positive offset C (dB) 77. Minimum margin from limit line on the negative offset D (dB) 78. Minimum margin from limit line on the positive offset D (dB) 79. Minimum margin from limit line on the negative offset E (dB) 80. Minimum margin from limit line on the positive offset E (dB) 81. Minimum margin from limit line on the negative offset F (dB) 82. Minimum margin from limit line on the positive offset F (dB)
MSR, LTEAFDD, LTEATDD	1	<p data-bbox="467 730 818 758"><b>Meas Type: Total Power Reference</b></p> <p data-bbox="467 760 1419 821">Returns outer offset results when Non-Contiguous Meas Region is set to Outer, and returns inner offset results when it is set to Inner, in the following order.</p> <ol data-bbox="467 831 1419 1843" style="list-style-type: none"> <li data-bbox="467 831 1360 892">1. Total Absolute power of carriers of Measure Carrier On if available. Otherwise -999.0 is returned.</li> <li data-bbox="467 903 1419 995">2. Absolute reference power. Absolute power at the left reference carrier if Power Ref type is "Left &amp; Right Carriers." Absolute power at the reference carrier of the left sub-block if Power Ref type is "Max Power Carrier in Sub-block." (dBm)</li> <li data-bbox="467 1005 1419 1098">3. Absolute power at the right reference carrier if Power Ref type is "Left &amp; Right Carriers." Absolute power at the reference carrier of the right sub-block if Power Ref type is "Max Power Carrier in Sub-block." Otherwise -999.0 is returned. (dBm)</li> <li data-bbox="467 1108 919 1136">4. Reserved for the future use, returns -999.0</li> <li data-bbox="467 1146 1419 1270">5. Peak frequency in the ref carrier channel spacing frequency range. Peak frequency in the left ref carrier frequency range if Power Ref Type is "Left &amp; Right Carriers." Peak frequency in the ref carrier frequency range of the left sub-block if Power Ref type is "Max Power Carrier in Sub-block."</li> <li data-bbox="467 1281 1419 1373">6. Peak frequency in the right ref carrier channel spacing frequency range if Power Ref type is "Left &amp; Right Carriers." Peak frequency in the ref carrier frequency range of the right sub-block if Power Ref type is "Max Power Carrier in Sub-block." Otherwise -999.0 is returned.</li> <li data-bbox="467 1383 919 1411">7. Reserved for the future use, returns -999.0</li> <li data-bbox="467 1421 919 1449">8. Reserved for the future use, returns -999.0</li> <li data-bbox="467 1459 919 1486">9. Reserved for the future use, returns -999.0</li> <li data-bbox="467 1497 932 1524">10. Reserved for the future use, returns -999.0</li> <li data-bbox="467 1535 1057 1562">11. Relative integrated power on the negative offset A (dBc)</li> <li data-bbox="467 1572 1070 1600">12. Absolute integrated power on the negative offset A (dBm)</li> <li data-bbox="467 1610 1003 1638">13. Relative peak power on the negative offset A (dBc)</li> <li data-bbox="467 1648 1016 1675">14. Absolute peak power on the negative offset A (dBm)</li> <li data-bbox="467 1686 1419 1747">15. Peak power offset frequency from the center or carrier edge frequency in the negative offset A, depending on Offset Frequency Define settings (Hz)</li> <li data-bbox="467 1757 1049 1785">16. Relative integrated power on the positive offset A (dBc)</li> <li data-bbox="467 1795 1062 1822">17. Absolute integrated power on the positive offset A (dBm)</li> </ol>

Modes	n	Return Value
		18. Relative peak power on the positive offset A (dBc)
		19. Absolute peak power on the positive offset A (dBm)
		20. Peak power offset frequency from the center or carrier edge frequency in the positive offset A, depending on Offset Frequency Define settings (Hz)
		21. Relative integrated power on the negative offset B (dBc)
		---
		69. Absolute peak power on the positive offset F (dBm)
		70. Peak power offset frequency from the center or carrier edge frequency in the positive offset F, depending on Offset Frequency Define settings (Hz)
		71. Minimum margin from limit line on the negative offset A (dB)
		72. Minimum margin from limit line on the positive offset A (dB)
		73. Minimum margin from limit line on the negative offset B (dB)
		74. Minimum margin from limit line on the positive offset B (dB)
		75. Minimum margin from limit line on the negative offset C (dB)
		76. Minimum margin from limit line on the positive offset C (dB)
		77. Minimum margin from limit line on the negative offset D (dB)
		78. Minimum margin from limit line on the positive offset D (dB)
		79. Minimum margin from limit line on the negative offset E (dB)
		80. Minimum margin from limit line on the positive offset E (dB)
		81. Minimum margin from limit line on the negative offset F (dB)
		82. Minimum margin from limit line on the positive offset F (dB)
MSR , LTEAFDD, LTEATDD	1	<p><b>Meas Type: Power Spectral Density Reference</b> Returns outer offset results when Non-Contiguous Meas Region is set to Outer, and returns inner offset results when it is set to Inner, in the following order.</p> <ol style="list-style-type: none"> <li>1. Total Absolute power of carriers of Measure Carrier On if available. Otherwise -999.0 is returned. (dBm)</li> <li>2. Absolute reference power. Absolute power at the left reference carrier if Power Ref type is "Left &amp; Right Carriers." Absolute power at the reference carrier of the left sub-block if Power Ref type is "Max Power Carrier in Sub-block." (dBm/Hz)</li> <li>3. Absolute power at the right reference carrier if Power Ref type is "Left &amp; Right Carriers." Absolute power at the reference carrier of the right sub-block if Power Ref type is "Max Power Carrier in Sub-block." Otherwise -999.0 is returned. (dBm/Hz)</li> <li>4. Reserved for the future use, returns -999.0</li> <li>5. Peak frequency in the ref carrier channel spacing frequency range . Peak frequency in the left ref carrier frequency range if Power Ref type is "Left &amp; Right Carriers." Peak frequency in the ref carrier frequency range of the left sub-block if Power Ref type is "Max Power Carrier in Sub-block."</li> <li>6. Peak frequency in the right ref carrier channel spacing frequency range if Power Ref type is "Left &amp; Right Carriers." Peak frequency in the ref carrier frequency range of the right sub-block if Power Ref type is "Max Power Carrier in Sub-block." Otherwise -999.0 is returned.</li> <li>7. Reserved for the future use, returns -999.0</li> </ol>

Modes	n	Return Value
		8. Reserved for the future use, returns -999.0
		9. Reserved for the future use, returns -999.0
		10. Reserved for the future use, returns -999.0
		11. Relative integrated power on the negative offset A (dBc)
		12. Absolute integrated power on the negative offset A (dBm/Hz)
		13. Relative peak power on the negative offset A (dBc)
		14. Absolute peak power on the negative offset A (dBm/Hz)
		15. Peak power offset frequency from the center or carrier edge frequency in the negative offset A, depending on Offset Frequency Define settings (Hz)
		16. Relative integrated power on the positive offset A (dBc)
		17. Absolute integrated power on the positive offset A (dBm/Hz)
		18. Relative peak power on the positive offset A (dBc)
		19. Absolute peak power on the positive offset A (dBm/Hz)
		20. Peak power offset frequency from the center or carrier edge frequency in the positive offset A, depending on Offset Frequency Define settings (Hz)
		21. Relative integrated power on the negative offset B (dBc)
		---
		69. Absolute peak power on the positive offset F (dBm/Hz)
		70. Peak power offset frequency from the center or carrier edge frequency in the positive offset F, depending on Offset Frequency Define settings (Hz)
		71. Minimum margin from limit line on the negative offset A (dB)
		72. Minimum margin from limit line on the positive offset A (dB)
		73. Minimum margin from limit line on the negative offset B (dB)
		74. Minimum margin from limit line on the positive offset B (dB)
		75. Minimum margin from limit line on the negative offset C (dB)
		76. Minimum margin from limit line on the positive offset C (dB)
		77. Minimum margin from limit line on the negative offset D (dB)
		78. Minimum margin from limit line on the positive offset D (dB)
		79. Minimum margin from limit line on the negative offset E (dB)
		80. Minimum margin from limit line on the positive offset E (dB)
		81. Minimum margin from limit line on the negative offset F (dB)
		82. Minimum margin from limit line on the positive offset F (dB)
MSR, LTEAFDD, LTEATDD	1	<p><b>Meas Type: Spectrum Peak Reference</b></p> <p>Returns outer offset results when Non-Contiguous Meas Region is set to Outer, and returns inner offset results when it is set to Inner, in the following order.</p> <ol style="list-style-type: none"> <li>1. Total Absolute power of carriers of Measure Carrier On if available. Otherwise -999.0 is returned. (dBm)</li> <li>2. Peak reference power. Peak power at the left reference carrier if Power Ref type is "Left &amp; Right Carriers." Peak power at the reference carrier of the left sub-block if Power Ref type is "Max Power Carrier in Sub-block." (dBm)</li> </ol>

Modes	n	Return Value
		3. Peak power at the right reference carrier if Power Ref type is "Left & Right Carriers." Peak power at the reference carrier of the right sub-block if Power Ref type is "Max Power Carrier in Sub-block." Otherwise -999.0 is returned. (dBm)
		4. Reserved for the future use, returns -999.0
		5. Peak frequency in the ref carrier channel spacing frequency range. Peak frequency in the left ref carrier frequency range if Power Ref type is "Left & Right Carriers." Peak frequency in the ref carrier frequency range of the left sub-block if Power Ref type is "Max Power Carrier in Sub-block."
		6. Peak frequency in the right ref carrier channel spacing frequency range if Power Ref type is "Left & Right Carriers." Peak frequency in the ref carrier frequency range of the right sub-block if Power Ref type is "Max Power Carrier in Sub-block." Otherwise -999.0 is returned.
		7. Reserved for the future use, returns -999.0
		8. Reserved for the future use, returns -999.0
		9. Reserved for the future use, returns -999.0
		10. Reserved for the future use, returns -999.0
		11. Relative integrated power on the negative offset A (dBc)
		12. Absolute integrated power on the negative offset A (dBm)
		13. Relative peak power on the negative offset A (dBc)
		14. Absolute peak power on the negative offset A (dBm)
		15. Peak power offset frequency from the center or carrier edge frequency in the negative offset A, depending on Offset Frequency Define settings (Hz)
		16. Relative integrated power on the positive offset A (dBc)
		17. Absolute integrated power on the positive offset A (dBm)
		18. Relative peak power on the positive offset A (dBc)
		19. Absolute peak power on the positive offset A (dBm)
		20. Peak power offset frequency from the center or carrier edge frequency in the positive offset A, depending on Offset Frequency Define settings (Hz)
		21. Relative integrated power on the negative offset B (dBc)
		---
		69. Absolute peak power on the positive offset F (dBm)
		70. Peak power offset frequency from the center or carrier edge frequency in the positive offset F, depending on Offset Frequency Define settings (Hz)
		71. Minimum margin from limit line on the negative offset A (dB)
		72. Minimum margin from limit line on the positive offset A (dB)
		73. Minimum margin from limit line on the negative offset B (dB)
		74. Minimum margin from limit line on the positive offset B (dB)
		75. Minimum margin from limit line on the negative offset C (dB)
		76. Minimum margin from limit line on the positive offset C (dB)
		77. Minimum margin from limit line on the negative offset D (dB)
		78. Minimum margin from limit line on the positive offset D (dB)
		79. Minimum margin from limit line on the negative offset E (dB)
		80. Minimum margin from limit line on the positive offset E (dB)

Modes	n	Return Value
		81. Minimum margin from limit line on the negative offset F (dB)
		82. Minimum margin from limit line on the positive offset F (dB)
WLAN, with radio standard 802.11 ac (80 MHz + 80 MHz)	1	<p><b>Meas Type: Total Power Reference</b> Returns 82 comma-separated scalar results, in the following order:</p> <ol style="list-style-type: none"> <li>1. Reserved for the future use, returns -999.0</li> <li>2. Absolute reference power (dBm)</li> <li>3. Absolute power of the carrier of which the frequency is indicated by Freq Segment 1 (dBm)</li> <li>4. Absolute power of the carrier of which the frequency is indicated by Freq Segment 2 (dBm)</li> <li>5. Peak frequency in the center frequency (reference) area (Hz)</li> <li>6. Reserved for the future use, returns -999.0</li> <li>7. Reserved for the future use, returns -999.0</li> <li>8. Reserved for the future use, returns -999.0</li> <li>9. Reserved for the future use, returns -999.0</li> <li>10. Reserved for the future use, returns -999.0</li> <li>11. Relative integrated power on the negative offset A (dBc)</li> <li>12. Absolute integrated power on the negative offset A (dBm)</li> <li>13. Relative peak power on the negative offset A (dBc)</li> <li>14. Absolute peak power on the negative offset A (dBm)</li> <li>15. Peak power offset frequency from the center or carrier edge frequency in the negative offset A, depending on Offset Frequency Define settings (Hz)</li> <li>16. Relative integrated power on the positive offset A (dBc)</li> <li>17. Absolute integrated power on the positive offset A (dBm)</li> <li>18. Relative peak power on the positive offset A (dBc)</li> <li>19. Absolute peak power on the positive offset A (dBm)</li> <li>20. Peak power offset frequency from the center or carrier edge frequency in the positive offset A, depending on Offset Frequency Define settings (Hz)</li> <li>21. Relative integrated power on the negative offset B (dBc)</li> </ol> <p>---</p> <ol style="list-style-type: none"> <li>69. Absolute peak power on the positive offset F (dBm)</li> <li>70. Peak power offset frequency from the center or carrier edge frequency in the positive offset F, depending on Offset Frequency Define settings (Hz)</li> <li>71. Minimum margin from limit line on the negative offset A (dB)</li> <li>72. Minimum margin from limit line on the positive offset A (dB)</li> <li>73. Minimum margin from limit line on the negative offset B (dB)</li> <li>74. Minimum margin from limit line on the positive offset B (dB)</li> <li>75. Minimum margin from limit line on the negative offset C (dB)</li> <li>76. Minimum margin from limit line on the positive offset C (dB)</li> <li>77. Minimum margin from limit line on the negative offset D (dB)</li> <li>78. Minimum margin from limit line on the positive offset D (dB)</li> </ol>



Modes	n	Return Value
		79. Minimum margin from limit line on the negative offset E (dB) 80. Minimum margin from limit line on the positive offset E (dB) 81. Minimum margin from limit line on the negative offset F (dB) 82. Minimum margin from limit line on the positive offset F (dB)
WLAN, with radio standard 802.11 ac (80 MHz + 80 MHz)	1	<b>Meas Type: Power Spectral Density Reference</b> Returns 82 comma-separated scalar results, in the following order: 1. Reserved for the future use, returns -999.0 2. Absolute reference power (dBm/Hz) 3. Absolute power of the carrier of which the frequency is indicated by Freq Segment 1 (dBm/Hz) 4. Absolute power of the carrier of which the frequency is indicated by Freq Segment 2 (dBm/Hz) 5. Peak frequency in the center frequency (reference) area (Hz) 6. Reserved for the future use, returns -999.0 7. Reserved for the future use, returns -999.0 8. Reserved for the future use, returns -999.0 9. Reserved for the future use, returns -999.0 10. Reserved for the future use, returns -999.0 11. Relative integrated power on the negative offset A (dB) 12. Absolute integrated power on the negative offset A (dBm/Hz) 13. Relative peak power on the negative offset A (dB) 14. Absolute peak power on the negative offset A (dBm/Hz) 15. Peak power offset frequency from the center or carrier edge frequency in the negative offset A, depending on Offset Frequency Define settings (Hz) 16. Relative integrated power on the positive offset A (dB) 17. Absolute integrated power on the positive offset A (dBm/Hz) 18. Relative peak power on the positive offset A (dB) 19. Absolute peak power on the positive offset A (dBm/Hz) 20. Peak power offset frequency from the center or carrier edge frequency in the positive offset A, depending on Offset Frequency Define settings (Hz) 21. Relative integrated power on the negative offset B (dB) --- 69. Absolute peak power on the positive offset F (dBm/Hz) 70. Peak power offset frequency from the center or carrier edge frequency in the positive offset F, depending on Offset Frequency Define settings (Hz) 71. Minimum margin from limit line on the negative offset A (dB) 72. Minimum margin from limit line on the positive offset A (dB) 73. Minimum margin from limit line on the negative offset B (dB) 74. Minimum margin from limit line on the positive offset B (dB) 75. Minimum margin from limit line on the negative offset C (dB) 76. Minimum margin from limit line on the positive offset C (dB)

Modes	n	Return Value
		77. Minimum margin from limit line on the negative offset D (dB) 78. Minimum margin from limit line on the positive offset D (dB) 79. Minimum margin from limit line on the negative offset E (dB) 80. Minimum margin from limit line on the positive offset E (dB) 81. Minimum margin from limit line on the negative offset F (dB) 82. Minimum margin from limit line on the positive offset F (dB)
All	2	Returns the displayed frequency domain spectrum trace data separated by comma. The number of data points is 2001.
All	3	Returns the displayed frequency domain absolute limit trace data separated by comma. The number of data points is 2001.
All	4	Returns the displayed frequency domain relative limit trace data separated by comma. The number of data points is 2001.
All (see details)	5	<p><b>Meas Type: Total Power Reference</b> Returns comma-separated scalar values (in dBm) of the absolute integrated power of the segment frequencies. The length of the result depends on the number of available offset (See <a href="#">"Number of Offsets" on page 1045</a>).</p> <ol style="list-style-type: none"> <li>1. Total power reference (dBm)</li> <li>2. Reserved for the future use, returns -999.0</li> <li>3. Absolute integrated power at negative offset frequency (A)</li> <li>4. Absolute integrated power at positive offset frequency (A)</li> </ol> <p>---</p> <ol style="list-style-type: none"> <li>25. Absolute integrated power at negative offset frequency (L)</li> <li>26. Absolute integrated power at positive offset frequency (L)</li> </ol> <p>In <b>MSR and LTE-Advanced FDD/TDD</b> mode. Returns outer offset results when Non-Contiguous Meas Region is set to Outer, and returns inner offset results when it is set to Inner, in the following order.</p> <ol style="list-style-type: none"> <li>1. Ref carrier power. Left ref carrier power if Power Ref type is "Left &amp; Right Carriers." Ref carrier power of the left sub-block if Power Ref type is "Max Power Carrier in Sub-block." (dBm)</li> <li>2. Right ref carrier power if Ref channel type is "Left &amp; Right Carriers." Ref carrier power of the right sub-block if Power Ref type is "Max Power Carrier in Sub-block." Otherwise -999.0 is returned. (dBm)</li> <li>3. Absolute integrated power at negative offset frequency (A)</li> <li>4. Absolute integrated power at positive offset frequency (A)</li> </ol> <p>---</p> <ol style="list-style-type: none"> <li>25. Absolute integrated power at negative offset frequency (L)</li> <li>26. Absolute integrated power at positive offset frequency (L)</li> </ol> <p>In <b>WLAN</b> mode. Returns 26 comma-separated scalar values (in dBm) of the absolute integrated power of the segment frequencies:</p> <ol style="list-style-type: none"> <li>1. Ref carrier power (dBm)</li> <li>2. Reserved for the future use, returns -999.0</li> </ol>

Modes	n	Return Value
		3. Absolute integrated power at negative offset frequency (A) 4. Absolute integrated power at positive offset frequency (A) --- 25. Absolute integrated power at negative offset frequency (L) 26. Absolute integrated power at positive offset frequency (L) If the result is not available, -999.0 is returned. The number of values returned is subject to change in future releases.
All (see details)	5	<p><b>Meas Type: Power Spectral Density Reference</b>            Returns comma-separated scalar values (in dBm/Hz) of the absolute integrated power of the segment frequencies. The length of the result depends on the number of available offset (See <a href="#">"Number of Offsets" on page 1045</a>).</p> <p>1. Power spectral density reference (dBm/Hz)            2. Reserved for the future use, returns -999.0            3. Absolute integrated power at negative offset frequency (A)            4. Absolute integrated power at positive offset frequency (A)            ---            25. Absolute integrated power at negative offset frequency (L)            26. Absolute integrated power at positive offset frequency (L)</p> <p>In <b>MSR and LTE-Advanced FDD/TDD</b> mode.            Returns outer offset results when Non-Contiguous Meas Region is set to Outer, and returns inner offset results when it is set to Inner, in the following order.</p> <p>1. Ref carrier power. Left ref carrier power if Power Ref type is "Left &amp; Right Carriers" Ref carrier power of the left sub-block if Power Ref type is "Max Power Carrier in Sub-block." (dBm/Hz)            2. Right ref carrier power if Power Ref type is "Left &amp; Right Carriers." Ref carrier power of the right sub-block if Power Ref type is "Max Power Carrier in Sub-block." Otherwise -999.0 is returned. (dBm/Hz)            3. Absolute integrated power at negative offset frequency (A)            4. Absolute integrated power at positive offset frequency (A)            ---            25. Absolute integrated power at negative offset frequency (L)            26. Absolute integrated power at positive offset frequency (L)</p> <p>In <b>WLAN</b> mode.            Returns 26 comma-separated scalar values (in dBm/Hz) of the absolute integrated power of the segment frequencies:</p> <p>1. Ref carrier power (dBm/Hz)            2. Reserved for the future use, returns -999.0            3. Absolute integrated power at negative offset frequency (A)            4. Absolute integrated power at positive offset frequency (A)            ---            25. Absolute integrated power at negative offset frequency (L)</p>

Modes	n	Return Value
		<p>26. Absolute integrated power at positive offset frequency (L) If the result is not available, -999.0 is returned. The number of values returned is subject to change in future releases.</p>
All (see details)	5	<p><b>Meas Type: Spectrum Peak Reference</b> Returns comma-separated scalar values (in dBm) of the absolute peak power of the segment frequencies. The length of the result depends on the number of available offset (See "<a href="#">Number of Offsets</a>" on page 1045).</p> <ol style="list-style-type: none"> <li>1. Spectrum Peak Power reference (dBm)</li> <li>2. Reserved for the future use, returns -999.0</li> <li>3. Absolute peak power at negative offset frequency (A)</li> <li>4. Absolute peak power at positive offset frequency (A)</li> </ol> <p>---</p> <p>25. Absolute peak power at negative offset frequency (L) 26. Absolute peak power at positive offset frequency (L) In <b>MSR and LTE-Advanced FDD/TDD</b> mode. Returns outer offset results when Non-Contiguous Meas Region is set to Outer, and returns inner offset results when it is set to Inner, in the following order.</p> <ol style="list-style-type: none"> <li>1. Spectrum Peak Power reference of ref carrier. Spectrum Peak Power reference of left ref carrier if Power Ref type is "Left &amp; Right Carriers." Spectrum Peak Power reference of the left sub-block if Power Ref type is "Max Power Carrier in Sub-block." (dBm)</li> <li>2. Spectrum Peak Power reference of right ref carrier power if Power Ref type is "Left &amp; Right carriers." Spectrum Peak Power reference of the right sub-block if Power Ref type is "Max Power Carrier in Sub-block." Otherwise -999.0 is returned. (dBm)</li> <li>3. Absolute peak power at negative offset frequency (A)</li> <li>4. Absolute peak power at positive offset frequency (A)</li> </ol> <p>---</p> <p>25. Absolute peak power at negative offset frequency (L) 26. Absolute peak power at positive offset frequency (L) If the result is not available, -999.0 is returned. The number of values returned is subject to change in future releases.</p>
All	6	<p><b>Meas Type: Total Power Reference</b> Returns comma-separated scalar values (in dBc) of the integrated power relative to the carrier at the segment frequencies. The length of the result depends on the number of available offset (See "<a href="#">Number of Offsets</a>" on page 1045).</p> <p>When in the MSR and LTE-Advanced FDD/TDD mode, returns outer offset results when Non-Contiguous Meas Region is set to Outer, and returns inner offset results when it is set to Inner, in the following order.</p> <ol style="list-style-type: none"> <li>1. Reserved for the future use, returns -999.0</li> <li>2. Reserved for the future use, returns -999.0</li> <li>3. Relative integrated power at negative offset frequency (A)</li> </ol>

Modes	n	Return Value
		<p>4. Relative integrated power at positive offset frequency (A)</p> <p>---</p> <p>25. Relative integrated power at negative offset frequency (L)</p> <p>26. Relative integrated power at positive offset frequency (L)</p> <p>If the result is not available, -999.0 is returned.</p> <p>The number of values returned is subject to change in future releases.</p>
All	6	<p><b>Meas Type: Power Spectral Density Reference</b></p> <p>Returns comma-separated scalar values (in dBc/Hz) of the integrated power relative to the carrier at the segment frequencies. The length of the result depends on the number of available offset (See "<a href="#">Number of Offsets</a>" on page 1045).</p> <p>When in the MSR and LTE-Advanced FDD/TDD mode, returns outer offset results when Non-Contiguous Meas Region is set to Outer, and returns inner offset results when it is set to Inner, in the following order.</p> <p>Returns -999.0 for the offsets if in WLAN:</p> <ol style="list-style-type: none"> <li>1. Reserved for the future use, returns -999.0</li> <li>2. Reserved for the future use, returns -999.0</li> <li>3. Relative integrated power at negative offset frequency (A)</li> <li>4. Relative integrated power at positive offset frequency (A)</li> </ol> <p>---</p> <p>25. Relative integrated power at negative offset frequency (L)</p> <p>26. Relative integrated power at positive offset frequency (L)</p> <p>If the result is not available, -999.0 is returned.</p> <p>The number of values returned is subject to change in future releases.</p>
All	6	<p><b>Meas Type: Spectrum Peak Reference</b></p> <p>Returns comma-separated scalar values (in dB) of the integrated power relative to the carrier at the segment frequencies. The length of the result depends on the number of available offset (See "<a href="#">Number of Offsets</a>" on page 1045).</p> <p>When in the MSR and LTE-Advanced FDD/TDD mode, returns outer offset results when Non-Contiguous Meas Region is set to Outer, and returns inner offset results when it is set to Inner, in the following order.</p> <ol style="list-style-type: none"> <li>1. Reserved for the future use, returns -999.0</li> <li>2. Reserved for the future use, returns -999.0</li> <li>3. Relative peak power at negative offset frequency (A)</li> <li>4. Relative peak power at positive offset frequency (A)</li> </ol> <p>---</p> <p>25. Relative peak power at negative offset frequency (L)</p> <p>26. Relative peak power at positive offset frequency (L)</p> <p>If the result is not available, -999.0 is returned.</p> <p>The number of values returned is subject to change in future releases.</p>
All	7	

Modes	n	Return Value
		<p>Returns comma-separated pass/fail test results (0=passed, or 1=failed) determined by testing the minimum margin point from the limit line that is determined each offset's Limits setting. The length of the result depends on the number of available offset (See <a href="#">"Number of Offsets" on page 1045</a>).</p> <p>When in the MSR and LTE-Advanced FDD/TDD mode, returns outer offset results when Non-Contiguous Meas Region is set to Outer, and returns inner offset results when it is set to Inner, in the following order.</p> <ol style="list-style-type: none"> <li>1. Reserved for the future use, returns -999.0</li> <li>2. Reserved for the future use, returns -999.0</li> <li>3. At negative offset frequency (A)</li> <li>4. At positive offset frequency (A)</li> <li>---</li> <li>25. At negative offset frequency (L)</li> <li>26. At positive offset frequency (L)</li> </ol> <p>The number of values returned is subject to change in future releases.</p>
All	8	<p>Offset Pass/Fail.</p> <p>Returns comma-separated pass/fail test results (0=passed, or 1=failed) determined by testing the minimum margin point from the limit line that is determined each offset's Limits setting. The length of the result depends on the number of available offset (See <a href="#">"Number of Offsets" on page 1045</a>).</p> <p>When in the MSR and LTE-Advanced FDD/TDD mode, returns outer offset results when Non-Contiguous Meas Region is set to Outer, and returns inner offset results when it is set to Inner, in the following order.</p> <p>Note: These results (n=8) are the same as n=7 result.</p> <ol style="list-style-type: none"> <li>1. Reserved for the future use, returns -999.0</li> <li>2. Reserved for the future use, returns -999.0</li> <li>3. At negative offset frequency (A)</li> <li>4. At positive offset frequency (A)</li> <li>---</li> <li>25. At negative offset frequency (L)</li> <li>26. At positive offset frequency (L)</li> </ol> <p>The number of values returned is subject to change in future releases.</p>
All	9	<p>Offset Peak Power Freq.</p> <p>Returns comma-separated scalar values of frequency (in Hz) that have peak power from center or carrier edge frequency in each offset, depending on Offset Frequency Define settings. The length of the result depends on the number of available offset (See <a href="#">"Number of Offsets" on page 1045</a>).</p> <p>When in the MSR and LTE-Advanced FDD/TDD mode, returns outer offset results when Non-Contiguous Meas Region is set to Outer, and returns inner offset results when it is set to Inner, in the following order.</p> <ol style="list-style-type: none"> <li>1. Reserved for the future use, returns -999.0</li> <li>2. Reserved for the future use, returns -999.0</li> <li>3. Negative offset frequency (A)</li> </ol>

Modes	n	Return Value
		<p>4. Positive offset frequency (A)</p> <p>---</p> <p>25. Negative offset frequency (L)</p> <p>26. Positive offset frequency (L)</p> <p>If the result is not available, -999.0 is returned.</p> <p>The number of values returned is subject to change in future releases.</p>
All	10	<p>Offset Abs Peak Power.</p> <p>Returns comma-separated scalar values (in dBm) of the absolute peak power of the segment frequencies. The length of the result depends on the number of available offset (See "<a href="#">Number of Offsets</a>" on page 1045).</p> <p>When in the MSR and LTE-Advanced FDD/TDD mode, returns outer offset results when Non-Contiguous Meas Region is set to Outer, and returns inner offset results when it is set to Inner, in the following order.</p> <ol style="list-style-type: none"> <li>1. Reserved for the future use, returns -999.0</li> <li>2. Reserved for the future use, returns -999.0</li> <li>3. At negative offset frequency (A)</li> <li>4. At positive offset frequency (A)</li> </ol> <p>---</p> <ol style="list-style-type: none"> <li>25. At negative offset frequency (L)</li> <li>26. At positive offset frequency (L)</li> </ol> <p>If the result is not available, -999.0 is returned.</p> <p>The number of values returned is subject to change in future releases.</p>
All	11	<p>Offset Rel Peak Power.</p> <p>Returns comma-separated scalar values in dBc (dB if MeasType = PSD) of the peak power relative to the carrier at the segment frequencies. The length of the result depends on the number of available offset (See "<a href="#">Number of Offsets</a>" on page 1045).</p> <p>When in the MSR and LTE-Advanced FDD/TDD mode, returns outer offset results when Non-Contiguous Meas Region is set to Outer, and returns inner offset results when it is set to Inner, in the following order.</p> <ol style="list-style-type: none"> <li>1. Reserved for the future use, returns -999.0</li> <li>2. Reserved for the future use, returns -999.0</li> <li>3. At negative offset frequency (A)</li> <li>4. At positive offset frequency (A)</li> </ol> <p>---</p> <ol style="list-style-type: none"> <li>25. At negative offset frequency (L)</li> <li>26. At positive offset frequency (L)</li> </ol> <p>If the result is not available, -999.0 is returned.</p> <p>The number of values returned is subject to change in future releases.</p>
All	12	<p>Returns the power result (the peak power of the signal in the ref channel) when Meas Type is Spectrum Peak reference. Otherwise, the value returned will be -999.0.</p> <p>When in the MSR and LTE-Advanced FDD/TDD mode, returns outer offset results when Non-</p>

Modes	n	Return Value
		<p>Contiguous Meas Region is set to Outer, and returns inner offset results when it is set to Inner, in the following order.</p>
MSR, LTEAFDD, LTEATDD only	13	<p><b>Meas Type: Total Power Reference</b>  Returns outer offset results when Non-Contiguous Meas Region is set to Outer, and returns inner offset results when it is set to Inner, in the following order.</p> <ol style="list-style-type: none"> <li>1. Total Absolute power of carriers of Measure Carrier On if Power Ref Type is "Max Power Carrier," "Max Power Carrier in Sub-block," or "RF Bandwidth." Otherwise NaN (9.91E+37) is returned. (dBm)</li> <li>2. Absolute reference power. Absolute power at the left reference carrier if Power Ref type is "Left &amp; Right Carriers." Absolute power at the reference carrier of the left sub-block if Power Ref type is "Max Power Carrier in Sub-block." (dBm)</li> <li>3. Absolute power at the right reference carrier if Power Ref type is "Left &amp; Right Carriers." Absolute power at the reference carrier of the right sub-block if Power Ref type is "Max Power Carrier in Sub-block." Otherwise NaN (9.91E+37) is returned. (dBm)</li> <li>4. Peak frequency in the measured ref carrier frequency range. Peak frequency in the left ref carrier frequency range if Power Ref type is "Left &amp; Right Carriers." Peak frequency in the ref carrier frequency range of the left sub-block if Power Ref type is "Max Power Carrier in Sub-block." (Hz)</li> <li>5. Peak frequency in the right ref carrier frequency range if Power Ref type is "Left &amp; Right Carriers." Peak frequency in the ref carrier frequency range of the right sub-block if Power Ref type is "Max Power Carrier in Sub-block." Otherwise NaN (9.91E+37) is returned. (Hz)</li> </ol> <p>If the result is not available, NaN (9.91E+37) is returned.  The number of values returned is subject to change in future releases.</p>
MSR, LTEAFDD, LTEATDD only	13	<p><b>Meas Type: Power Spectral Density Reference</b>  Returns outer offset results when Non-Contiguous Meas Region is set to Outer, and returns inner offset results when it is set to Inner, in the following order.</p> <ol style="list-style-type: none"> <li>1. Total Absolute power of carriers of Measure Carrier On if Power Ref Type is "Max Power Carrier," "Max Power Carrier in Sub-block," or "RF Bandwidth." Otherwise NaN (9.91E+37) is returned. (dBm)</li> <li>2. Absolute reference power. Absolute power at the left reference carrier if Power Ref type is "Left &amp; Right Carriers." Absolute power at the reference carrier of the left sub-block if Power Ref type is "Max Power Carrier in Sub-block." (dBm/Hz)</li> <li>3. Absolute power at the right reference carrier if Power Ref type is "Left &amp; Right Carriers." Absolute power at the reference carrier of the right sub-block if Power Ref type is "Max Power Carrier in Sub-block." Otherwise NaN (9.91E+37) is returned. (dBm/Hz)</li> <li>4. Peak frequency in the measured ref carrier frequency range. Peak frequency in the left ref carrier frequency range if Power Ref type is "Left &amp; Right Carriers." Peak frequency in the ref carrier frequency range of the left sub-block if Power Ref type is "Max Power Carrier in Sub-block." (Hz)</li> <li>5. Peak frequency in the right ref carrier frequency range if Power Ref type is "Left &amp; Right Carriers." Peak frequency in the ref carrier frequency range of the right sub-block if Power Ref</li> </ol>



Modes	n	Return Value
		<p>type is "Max Power Carrier in Sub-block." Otherwise NaN (9.91E+37) is returned. (Hz)</p> <p>If the result is not available, NaN (9.91E+37) is returned.</p> <p>The number of values returned is subject to change in future releases.</p>
MSR, LTEAFDD, LTEATDD only	13	<p><b>Meas Type: Power Spectrum Peak Reference</b></p> <p>Returns outer offset results when Non-Contiguous Meas Region is set to Outer, and returns inner offset results when it is set to Inner, in the following order.</p> <ol style="list-style-type: none"> <li>1. Total Absolute power of carriers of Measure Carrier On if Power Ref Type is "Max Power Carrier," "Max Power Carrier in Sub-block," or "RF Bandwidth." Otherwise NaN (9.91E+37) is returned. (dBm)</li> <li>2. Peak reference power. Peak power at the left reference carrier if Power Ref type is "Left &amp; Right Carriers." Peak power at the reference carrier of the left sub-block if Power Ref type is "Max Power Carrier in Sub-block." (dBm)</li> <li>3. Peak power at the right reference carrier if Power Ref type is "Left &amp; Right Carriers." Peak power at the reference carrier of the right sub-block if Power Ref type is "Max Power Carrier in Sub-block." Otherwise NaN (9.91E+37) is returned. (dBm)</li> <li>4. Peak frequency in the measured ref carrier frequency range. Peak frequency in the left ref carrier frequency range if Power Ref type is "Left &amp; Right Carriers." Peak frequency in the ref carrier frequency range of the left sub-block if Power Ref type is "Max Power Carrier in Sub-block." (Hz)</li> <li>5. Peak frequency in the right ref carrier frequency range if Power Ref type is "Left &amp; Right Carriers." Peak frequency in the ref carrier frequency range of the right sub-block if Power Ref type is "Max Power Carrier in Sub-block." Otherwise NaN (9.91E+37) is returned. (Hz)</li> </ol> <p>If the result is not available, NaN (9.91E+37) is returned.</p> <p>The number of values returned is subject to change in future releases.</p>
All	14	<p><b>Meas Type: Total Power Reference</b></p> <p>Returns comma-separated scalar results, in the following order:</p> <p>When in the MSR and LTE-Advanced FDD/TDD mode, returns outer offset results when Non-Contiguous Meas Region is set to Outer, and returns inner offset results when it is set to Inner, in the following order.</p> <ol style="list-style-type: none"> <li>1. Relative integrated power on the negative offset A (dBc)</li> <li>2. Absolute integrated power on the negative offset A (dBm)</li> <li>3. Relative peak power on the negative offset A (dBc)</li> <li>4. Absolute peak power on the negative offset A (dBm)</li> <li>5. Peak power offset frequency from the center or carrier edge frequency in the negative offset A, depending on Offset Frequency Define settings (Hz)</li> <li>6. Relative integrated power on the positive offset A (dBc)</li> <li>7. Absolute integrated power on the positive offset A (dBm)</li> <li>8. Relative peak power on the positive offset A (dBc)</li> <li>9. Absolute peak power on the positive offset A (dBm)</li> </ol>

Modes	n	Return Value
		<p>10. Peak power offset frequency from the center or carrier edge frequency in the positive offset A, depending on Offset Frequency Define settings (Hz)</p> <p>11. Relative integrated power on the negative offset B (dBc)</p> <p>---</p> <p>119. Absolute peak power on the positive offset L (dBm)</p> <p>120. Peak power offset frequency from the center or carrier edge frequency in the positive offset L, depending on Offset Frequency Define settings (Hz)</p> <p>If the result is not available, NaN (9.91 E+37) is returned.</p> <p>The length of the result depends on the number of available offset (See <a href="#">"Number of Offsets" on page 1045</a>).</p> <p>The number of values returned is subject to change in future releases.</p>
All	14	<p><b>Meas Type: Power Spectral Density Reference</b></p> <p>Returns comma-separated scalar results, in the following order:</p> <p>When in the MSR and LTE-Advanced FDD/TDD mode, returns outer offset results when Non-Contiguous Meas Region is set to Outer, and returns inner offset results when it is set to Inner, in the following order.</p> <ol style="list-style-type: none"> <li>1. Relative integrated power on the negative offset A (dB)</li> <li>2. Absolute integrated power on the negative offset A (dBm/Hz)</li> <li>3. Relative peak power on the negative offset A (dB)</li> <li>4. Absolute peak power on the negative offset A (dBm/Hz)</li> <li>5. Peak power offset frequency from the center or carrier edge frequency in the negative offset A, depending on Offset Frequency Define settings (Hz)</li> <li>6. Relative integrated power on the positive offset A (dB)</li> <li>7. Absolute integrated power on the positive offset A (dBm/Hz)</li> <li>8. Relative peak power on the positive offset A (dB)</li> <li>9. Absolute peak power on the positive offset A (dBm/Hz)</li> <li>10. Peak power offset frequency from the center or carrier edge frequency in the positive offset A, depending on Offset Frequency Define settings (Hz)</li> <li>11. Relative integrated power on the negative offset B (dB)</li> </ol> <p>---</p> <p>119. Absolute peak power on the positive offset L (dBm/Hz)</p> <p>120. Peak power offset frequency from the center or carrier edge frequency in the positive offset L, depending on Offset Frequency Define settings (Hz)</p> <p>If the result is not available, NaN (9.91 E+37) is returned.</p> <p>The length of the result depends on the number of available offset (See <a href="#">"Number of Offsets" on page 1045</a>).</p> <p>The number of values returned is subject to change in future releases.</p>
All	14	<p><b>Meas Type: Spectrum Peak Reference</b></p> <p>Returns comma-separated scalar results, in the following order:</p>

Modes	n	Return Value
		<p>When in the MSR and LTE-Advanced FDD/TDD mode, returns outer offset results when Non-Contiguous Meas Region is set to Outer, and returns inner offset results when it is set to Inner, in the following order.</p> <ol style="list-style-type: none"> <li>1. Reserved for the future use, returns NaN (9.91E+37)</li> <li>2. Reserved for the future use, returns NaN (9.91E+37)</li> <li>3. Relative peak power on the negative offset A (dB)</li> <li>4. Absolute peak power on the negative offset A (dBm)</li> <li>5. Peak power offset frequency from the center or carrier edge frequency in the negative offset A, depending on Offset Frequency Define settings (Hz)</li> <li>6. Reserved for the future use, returns NaN (9.91E+37)</li> <li>7. Reserved for the future use, returns NaN (9.91E+37)</li> <li>8. Relative peak power on the positive offset A (dB)</li> <li>9. Absolute peak power on the positive offset A (dBm)</li> <li>10. Peak power offset frequency from the center or carrier edge frequency in the positive offset A, depending on Offset Frequency Define settings (Hz)</li> <li>11. Relative integrated power on the negative offset B (dB)</li> </ol> <p>---</p> <ol style="list-style-type: none"> <li>119. Absolute peak power on the positive offset L (dBm)</li> <li>120. Peak power offset frequency from the center or carrier edge frequency in the positive offset L, depending on Offset Frequency Define settings (Hz)</li> </ol> <p>If the result is not available, NaN (9.91E+37) is returned.</p> <p>The length of the result depends on the number of available offset (See <a href="#">"Number of Offsets" on page 1045</a>).</p> <p>The number of values returned is subject to change in future releases.</p>
All	15	<p><b>Meas Type: Total Power Reference</b></p> <p>Returns comma-separated scalar results, in the following order:</p> <p>When in the MSR and LTE-Advanced FDD/TDD mode, returns outer offset results when Non-Contiguous Meas Region is set to Outer, and returns inner offset results when it is set to Inner, in the following order.</p> <ol style="list-style-type: none"> <li>1. Minimum margin from limit line on the negative offset A (dB)</li> <li>2. Minimum margin from limit line on the positive offset A (dB)</li> <li>3. Minimum margin from limit line on the negative offset B (dB)</li> <li>4. Minimum margin from limit line on the positive offset B (dB)</li> </ol> <p>---</p> <ol style="list-style-type: none"> <li>23. Minimum margin from limit line on the negative offset L (dB)</li> <li>24. Minimum margin from limit line on the positive offset L (dB)</li> </ol> <p>If the result is not available, NaN (9.91E+37) is returned.</p> <p>The length of the result depends on the number of available offset (See <a href="#">"Number of Offsets" on page 1045</a>).</p> <p>The number of values returned is subject to change in future releases.</p>
MSR, LTEAFDD,	16	

<b>Modes</b>	<b>n</b>	<b>Return Value</b>
LTEATDD only		Returns number of carriers comma-separated scalar results, in the following order: 1. Absolute power of carrier 1 (dBm) 2. Absolute power of carrier 2 (dBm) --- number of carriers-1. Absolute power of carrier (number of carriers)-1 (dBm) number of carriers. Absolute power of carrier (number of carriers)-1 (dBm) If Measure Carrier of the corresponding carrier is no, NaN (9.91E+37) is returned.
WLAN only	16	Returns two carriers comma-separated scalar results when the radio standard is 802.11 ac 80+80 MHz. And returns NaN otherwise. 1. Absolute power of carrier segment 1 (dBm) 2. Absolute power of carrier segment 2 (dBm)
MSR, LTEAFDD, LTEATDD only	17	Returns the displayed frequency domain combined limit trace data separated by comma. Combined trace is a mixed trace of both absolute limit trace and relative limit trace according to the fail mask condition. The number of data points is 2001.

## Number of Offsets

The number of available offsets varies depending on the mode and option as below.

<b>Mode</b>	<b>The number of available offsets</b>
MSR, LTEAFDD, LTEATDD	12 (Offset A to L)
WLAN	12 (Offset A to L)
Other modes with option N9060A-7FP	12 (Offset A to L)
Other modes without option N9060A-7FP	6 (Offset A to F)

<b>Key Path</b>	<b>Meas</b>
Initial S/W Revision	Prior to A.02.00
Modified at S/W Revision	A.11.00, A.14.00

## AMPTD Y Scale

Accesses a menu of functions that enable you to set the vertical scale parameters. The parameter values are measurement independent except all Attenuation values and Internal Preamp selections that are measurement global.

Key Path	Front-panel key
Initial S/W Revision	Prior to A.02.00

### Ref Value

Sets the value for the absolute power reference. However, since Auto Scaling defaults to On, this value is automatically determined by the measurement result. When you set a value manually, Auto Scaling automatically changes to Off.

Key Path	AMPTD Y Scale
Mode	SA, WCDMA, C2K, WIMAX OFDMA, TD-SCDMA, 1xEVDO, DTMB (CTTB), DVB-T/H, ISDB-T, CMMB, LTE, LTETDD, Digital Cable TV, WLAN, MSR, LTEAFDD, LTEATDD
Remote Command	:DISPlay:SEMAsk:VIEW[1]:WINDow[1]:TRACe:Y[:SCALe]:RLEVel <real> :DISPlay:SEMAsk:VIEW[1]:WINDow[1]:TRACe:Y[:SCALe]:RLEVel?
Example	DISP:SEM:VIEW:WIND:TRAC:Y:RLEV 100 DISP:SEM:VIEW:WIND:TRAC:Y:RLEV?
Notes	You must be in the mode that includes SEM measurement to use this command. Use :INSTrument:SElect to set the mode.
Couplings	When the Auto Scaling is On, this value is automatically determined by the measurement result. When you set a value manually, Auto Scaling automatically changed to Off.
Preset	10.0 dBm
State Saved	Saved in instrument state.
Min	-250 dBm
Max	250 dBm
Initial S/W Revision	Prior to A.02.00
Modified at S/W Revision	A.02.00, A.03.00

### Attenuation

This menu controls the attenuator functions and interactions between the attenuation system components.

There are two attenuator configurations in the X-Series. One is a dual attenuator configuration consisting of a mechanical attenuator and an optional electronic attenuator. The other configuration uses a single attenuator with combined mechanical and electronic sections that controls all the attenuation functions. Different models in the X-Series come with different configurations.

See "Dual Attenuator Configurations:" on page 1047

See "Single Attenuator Configuration:" on page 1048

Most Attenuation settings are the same for all measurements – they do not change as you change measurements. Settings like these are called “Meas Global” and are unaffected by Meas Preset.

Key Path	AMPTD Y Scale
Scope	Meas Global
Dependencies	In measurements that support the I/Q inputs, this key is unavailable when I/Q is the selected input, and is replaced by the Range key in that case.
Readback Line	Contains a summary in [ ] brackets of the current total attenuation. See the descriptions of the , " (Mech) Atten " on page 2102, and "Enable Elec Atten" on page 2104 keys for more detail on the contributors to the total attenuation.  Note that when "Pre-Adjust for Min Clip" is on, this value can change at the start of every measurement.
Initial S/W Revision	Prior to A.02.00
Modified at S/W Revision	A.03.00

Dual Attenuator Configurations:

Configuration 1: Mechanical attenuator + optional electronic attenuator

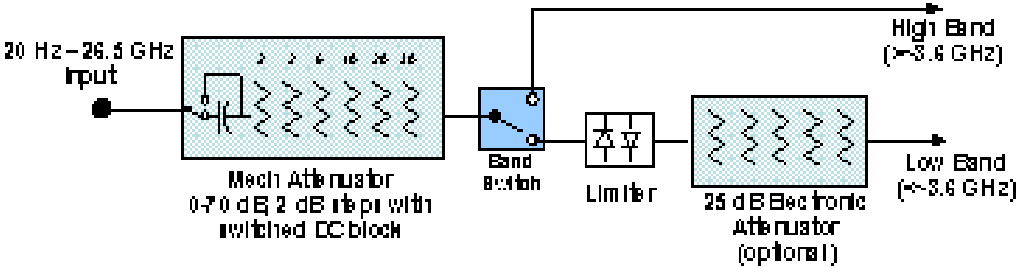

Configuration 2: Mechanical attenuator, no optional electronic attenuator

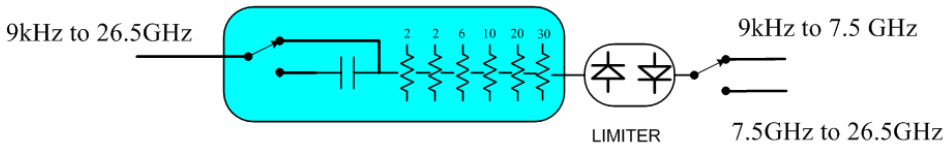

(note that Configuration 2 is not strictly speaking a dual-section attenuator, since there is no electronic section available. However, it behaves exactly like Configuration 1 without the Electronic Attenuator option EA3, therefore for the sake of this document it is grouped into the “Dual Attenuator” configuration)

### Single Attenuator Configuration:

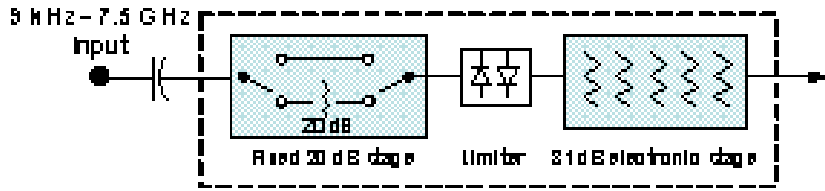

You can tell which attenuator configuration you have by pressing the Attenuation key, which (in most Modes) opens the Attenuation menu. If the first key in the Attenuation menu says Mech Atten you have the dual attenuator configuration. If the first key says Atten you have the single attenuator configuration.

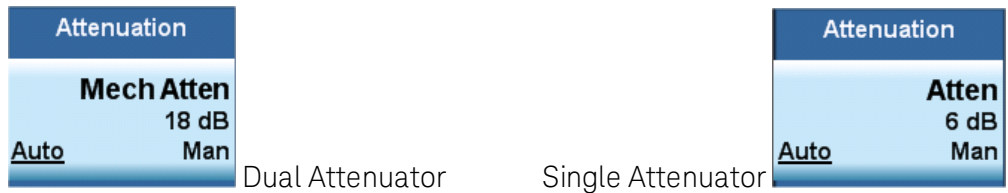

In the single attenuator configuration, you control the attenuation with a single control, as the fixed stage has only two states. In the dual attenuator configuration, both stages have significant range so you are given separate control of the mechanical and electronic attenuator stages.

When you have the dual attenuator configuration, you may still have only a single attenuator, because unless option EA3 (the Electronic Attenuator option) is available, and you purchase it, you will have only the mechanical attenuator.

#### (Mech) Atten

This key is labeled Mech Atten in dual attenuator models and Atten in single attenuator models. In the dual attenuator configuration, this key only affects the mechanical attenuator.

This key lets you modify the attenuation applied to the RF input signal path. This value is normally auto coupled to the Ref Level, the Internal Preamp Gain, any External Gain that is entered, and the Max Mixer Level, as described in the table below.

See "[Attenuator Configurations and Auto/Man](#)" on page 1050

Key Path	AMPTD Y Scale, Attenuation
<b>Remote Command</b>	<pre>[ :SENSe]:POWeR[:RF]:ATTenuation &lt;rel_ampl&gt; [:SENSe]:POWeR[:RF]:ATTenuation? [:SENSe]:POWeR[:RF]:ATTenuation:AUTO OFF ON 0 1 [:SENSe]:POWeR[:RF]:ATTenuation:AUTO?</pre>
<b>Example</b>	<p>POW:ATT 20</p> <p>Dual attenuator configuration: sets the mechanical attenuator to 20 dB</p> <p>Single attenuator mode: sets the main attenuation to 20 dB (see below for definition of “main” attenuation).</p> <p>If the attenuator was in Auto, it sets it to Manual.</p>
<b>Dependencies</b>	Some measurements do not support the Auto setting of (Mech) Atten. In these measurements, the



Auto/Man selection is not available, and the Auto/Man line on the key disappears.

In dual attenuator configurations, when the electronic attenuator is enabled, the mechanical attenuator has no auto setting and the Auto/Man line on the key disappears. The state of Auto/Man is remembered and restored when the electronic attenuator is once again disabled. This is described in more detail in the ["Enable Elec Atten" on page 2104](#) key description.

See ["Attenuator Configurations and Auto/Man" on page 1050](#) for more information on the Auto/Man functionality of Attenuation.

Couplings

When (Mech) Atten is in Auto, it uses the following algorithm to determine a value:  
 If the USB Preamp is connected to USB, use 0 dB.  
 Otherwise,  $Atten = ReferenceLevel + PreAmpGain + ExternalGain - RefLevelOffset - MaxMixerLevel + IF\ Gain$ .  
 Limit this value to be between 6 dB and the Max value. No value below 6 dB can ever be chosen by Auto.  
 The resulting value is rounded up to the largest value possible given the attenuation step setting. That is, 50.01 dB would change to 60 dB (for a 10 dB attenuation step).  
 The "IF Gain" term in the equation above is either 0 dB or +10 dB, depending on the settings of FFT IF Gain, Swept IF Gain, max Ref Level and the Auto/Man setting of Mech Atten.  
 In External Mixing and BBIQ, where the Attenuator is not in the signal path, the Attenuator setting changes as described above when (Mech) Atten is in Auto, but no changes are made to the actual attenuator hardware setting until the input is changed back to the RF Input.

Preset The preset for Mech Attenuation is "Auto."  
 The Auto value of attenuation is:  
 CXA, EXA, MXA and PXA: 10 dB

State Saved Saved in instrument state

Min 0 dB  
 The attenuation set by this key cannot be decreased below 6 dB with the knob or step keys. To get to a value below 6 dB it has to be directly entered from the keypad or via SCPI. This protects from adjusting the attenuation to a dangerously small value which can put the instrument at risk of damage to input circuitry. However, if the current mechanical attenuation is below 6 dB it can be increased with the knob and step keys, but not decreased.

Max CXA N9000A-503/507: 50 dB  
 CXA N9000A-513/526: 70dB  
 EXA: 60 dB  
 MXA and PXA: 70 dB  
 In the single attenuator configuration, the total of ATT and EATT cannot exceed 50 dB, so if the EATT is set to 24 dB first, the main attenuation cannot be greater than 26 dB and will be reduced accordingly; if the main attenuator is set to 40 dB first, EATT cannot be greater than 10 dB.

Initial S/W Revision Prior to A.02.00

Modified at S/W Revision A.03.00

### Attenuator Configurations and Auto/Man

As described in the Attenuation key description, there are two distinct attenuator configurations available in the X-Series, the single attenuator and dual attenuator configurations. In dual attenuator configurations, we have the mechanical attenuation and the electronic attenuation, and the current total attenuation is the sum of the electronic + mechanical attenuation. In single attenuator configurations, we refer to the attenuation set using the (Mech) Atten key (or POW:ATT SCPI) as the “main” attenuation; and the attenuation that is set by the SCPI command POW:EATT as the “soft” attenuation (the POW:EATT command is honored even in the single attenuator configuration, for compatibility purposes). Then the current total attenuation is the sum of the main + soft attenuation. See the Elec Atten key description for more on “soft” attenuation.

In the dual attenuator configuration, when the electronic attenuator is enabled, there is no Auto/Man functionality for the mechanical attenuator, and the third line of the key label (the Auto/Man line) disappears:

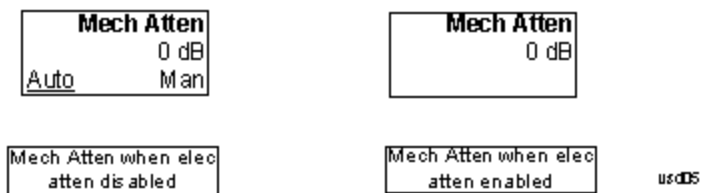

### Enable Elec Atten

Enables the Electronic Attenuator.

The electronic attenuator offers finer steps than the mechanical attenuator, has no acoustical noise, is faster, and is less subject to wear. These advantages primarily aid in remote operation and are negligible for front panel use. See ["Using the Electronic Attenuator: Pros and Cons" on page 1052](#) for a detailed discussion of the pros and cons of using the electronic attenuator.

For the single attenuator configuration, for SCPI backwards compatibility, the “soft” attenuation feature replaces the dual attenuator configuration’s electronic attenuator. All the same couplings and limitations apply. See ["Attenuator Configurations and Auto/Man" on page 2103](#)

See ["More Information" on page 1051](#)

<b>Key Path</b>	AMPTD Y Scale, Attenuation
<b>Remote Command</b>	[ :SENSe ] : POWer [ :RF ] : EATTenuation : STATE OFF   ON   0   1 [ :SENSe ] : POWer [ :RF ] : EATTenuation : STATE ?
<b>Example</b>	POW:EATT:STAT ON
<b>Dependencies</b>	This key only appears in Dual Attenuator models with an Electronic Attenuator installed. It does not appear in models with the Single Attenuator configuration, as in the single attenuator configuration there is no “electronic attenuator” there is only a single integrated attenuator (which has both a mechanical and electronic stage). However, in the single attenuator configuration, EATT SCPI commands are accepted for compatibility with other X-series instruments and set a “soft” attenuation as described in <a href="#">"Attenuator Configurations and Auto/Man" on page 2103</a> . The electronic attenuator (and the “soft” attenuation function provided in single attenuator configurations) is unavailable above 3.6 GHz. Therefore, if the Stop Frequency of the analyzer is > 3.6 GHz then the Enable Elec Atten key will be OFF and grayed out.

---

	<p>If the Internal Preamp is on, meaning it is set to Low Band or Full, the electronic attenuator (and the “soft” attenuation function provided in single attenuator configurations) is unavailable. In this case the Enable Elec Atten key will be OFF and grayed out.</p> <p>If either of the above is true, if the SCPI command is sent, an error indicating that the electronic attenuator is unavailable will be sent.</p> <p>If the electronic/soft Attenuator is enabled, then the Stop Freq of the analyzer is limited to 3.6 GHz and the Internal Preamp is unavailable.</p> <p>The SCPI-only “soft” electronic attenuation for the single-attenuator configuration is not available in all measurements; in particular, it is not available in the Swept SA measurement.</p>
Couplings	Enabling and disabling the Electronic Attenuator affects the setting of the Mechanical Attenuator (in dual attenuator configurations). This is described in more detail below this table.
Preset	OFF for Swept SA measurement; ON for all other measurements that support the electronic attenuator
State Saved	Saved in instrument state
Initial S/W Revision	Prior to A.02.00
Modified at S/W Revision	A.03.00

---

## More Information

### Mechanical Attenuator Transition Rules

When the Electronic Attenuator is enabled, the Mechanical Attenuator transitions to a state that has no Auto function. Below are the rules for transitioning the Mechanical Attenuator. NOTE that the information below ONLY applies to the dual attenuator configurations, and ONLY when the Electronic Attenuator is installed:

#### When the Electronic Attenuation is enabled from a disabled state:

- The Mechanical Attenuator is initialized to 10 dB (this is its optimal performance setting). You can then set it as desired with SCPI, numeric keypad, step keys, or knob, and it behaves as it normally would in manual mode
- The Auto/Man state of (Mech) Atten is saved
- The Auto/Man line on the (Mech) Atten key disappears and the auto rules are disabled
- The Electronic Attenuator is set to 10 dB less than the previous value of the Mechanical Attenuator, within the limitation that it must stay within the range of 0 to 24 dB of attenuation.

#### Examples in the dual attenuator configuration:

- Mech Atten at 20 dB. Elec Atten enabled, Mech Atten set to 10 dB, and Elec Atten set to 10 dB. New total attenuation equals the value before Elec Atten enabled.
- Mech Atten at 0 dB. Elec Atten enabled, Mech Atten set to 10 dB, and Elec Atten set to 0 dB. New total attenuation does not equal the value before Elec Atten enabled.
- Mech Atten at 40 dB. Elec Atten enabled, Mech Atten set to 10 dB, and Elec Atten set to 24 dB. New total attenuation does not equal the value before Elec Atten enabled.

**When the Electronic Attenuation is disabled from an enabled state:**

- The Elec Atten key is grayed out
- The Auto/Man state of (Mech) Atten is restored
- If now in Auto, (Mech) Atten recouples
- If now in Man, (Mech) Atten is set to the value of total attenuation that existed before the Elec Atten was disabled. The resulting value is rounded up to the smallest value possible given the (Mech) Atten Step setting - (That is, 57 dB changes to 58 dB when (Mech) Atten Step is 2 dB.)

**Using the Electronic Attenuator: Pros and Cons**

The electronic attenuator offers finer steps than the mechanical attenuator, has no acoustical noise, is faster, and is less subject to wear.

The “finer steps” advantage of the electronic attenuator is beneficial in optimizing the alignment of the analyzer dynamic range to the signal power in the front panel as well as remote use. Thus, you can achieve improved relative signal measurement accuracy. Compared to a mechanical attenuator with 2 dB steps, the 1 dB resolution of the electronic attenuator only gives better resolution when the odd-decibel steps are used. Those odd-decibel steps are less accurately calibrated than the even-decibel steps, so one tradeoff for this superior relative accuracy is reduced absolute amplitude accuracy.

Another disadvantage of the electronic attenuator is that the spectrum analyzer loses its “Auto” setting, making operation less convenient.

Also, the relationship between the dynamic range specifications (TOI, SHI, compression and noise) and instrument performance are less well-known with the electrical attenuator. With the mechanical attenuator, TOI, SHI and compression threshold levels increase dB-for-dB with increasing attenuation, and the noise floor does as well. With the electronic attenuator, there is an excess attenuation of about 1 to 3 dB between 0 and 3.6 GHz, making the effective TOI, SHI, and so forth, less well known. Excess attenuation is the actual attenuation relative to stated attenuation. Excess attenuation is accounted for in the analyzer calibration

**Elec Atten**

Controls the Electronic Attenuator in dual attenuator configurations. This key does not appear in single attenuator configurations, as the control of both the mechanical and electronic stages of the single attenuator is integrated into the single Atten key.

<b>Key Path</b>	AMPTD Y Scale, Attenuation
<b>Remote Command</b>	<code>[ :SENSe ] :POWer [ :RF ] :EATTenuation &lt;rel_ampl&gt;</code> <code>[ :SENSe ] :POWer [ :RF ] :EATTenuation?</code>
<b>Notes</b>	Electronic Attenuation’s specification is defined only when Mechanical Attenuation is 6 dB.
<b>Dependencies</b>	This key only appears in Dual Attenuator models with an Electronic Attenuator installed. It does not appear in models with the Single Attenuator configuration, as in the single attenuator configuration there is no “electronic attenuator” there is only a single integrated attenuator (which has both a mechanical and electronic stage). However, in the single attenuator configuration, EATT SCPI commands are accepted for compatibility with other X-series instruments and set a “soft” attenuation as described in <a href="#">"Attenuator Configurations and Auto/Man" on page 2103</a> . The “soft” attenuation is treated as an addition to the “main” attenuation value set by the Atten softkey or the

	POW:ATT SCPI command and affects the total attenuation displayed on the Attenuation key and the Meas Bar. When Enable Elec Atten is off or grayed out, the Elec Atten key is grayed out.
Preset	0 dB
State Saved	Saved in instrument state
Min	0 dB
Max	Dual attenuator configuration: 24 dB Single attenuator configuration: the total of ATT and EATT cannot exceed 50 dB, so if the EATT is set to 24 dB first, the main attenuation cannot be greater than 26 dB and will be reduced accordingly; if the main attenuator is set to 40 dB first, EATT cannot be greater than 10 dB
Initial S/W Revision	Prior to A.02.00
Modified at S/W Revision	A.03.00

### Adjust Atten for Min Clip

Sets the combination of mechanical and electronic attenuation and gain based on the current measured signal level so that clipping will be at a minimum.

This is an "immediate action" function, that is, it executes once, when the key is pressed.

This key is grayed out in measurements that do not support this functionality. The spectrum analyzer measurement, Swept SA, does not support this functionality.

Key Path	AMPTD Y Scale, Attenuation
Remote Command	<code>[ :SENSe ] :POWer [ :RF ] :RANGe:OPTimize IMMEDIATE</code>
Initial S/W Revision	Prior to A.02.00
Modified at S/W Revision	A.03.00

### Pre-Adjust for Min Clip

If this function is on, it does the adjustment described under "[Adjust Atten for Min Clip](#)" on page 2107 each time a measurement restarts. Therefore, in Continuous measurement mode, it only executes before the first measurement.

In dual attenuator models, you can set Elec+Mech Atten, in which case both attenuators participate in the autoranging, or Elec Atten Only, in which case the mechanical attenuator does not participate in the autoranging. This latter case results in less wear on the mechanical attenuator and is usually faster.

This key is grayed out in measurements that do not support this functionality. The spectrum analyzer measurement, Swept SA, does not support this functionality.

Key Path	AMPTD Y Scale, Attenuation
Remote Command	<code>[ :SENSe ] :POWer [ :RF ] :RANGe:OPTimize:ATTenuation OFF   ELECTRical   COMBined</code>

	<code>[ :SENSe ] :POWer [ :RF ] :RANGe:OPTimize:ATTenuation?</code>
Notes	The SCPI parameter ELECtrical sets this function to On in single attenuator models. The SCPI parameter COMBined is mapped to ELECtrical in single attenuator models; if you send COMBined, it sets the function to On and returns ELEC to a query.
Dependencies	This key only appears in Dual Attenuator models with an Electronic Attenuator installed. In instruments with Dual Attenuator model, when Enable Elec Atten is off or grayed out, the Pre-Adjust for Min Clip key is grayed out.
Preset	OFF for Swept SA measurement; ON for all other measurements that support Pre-Adjust for Min Clip
State Saved	Saved in instrument state
Range	Dual attenuator models: Off   Elec Atten Only   Mech + Elec Atten Single attenuator models: Off   On
Initial S/W Revision	Prior to A.02.00
Modified at S/W Revision	A.03.00

<b>Remote Command</b>	<code>[ :SENSe ] :POWer [ :RF ] :RANGe:AUTO ON OFF 1 0</code> <code>[ :SENSe ] :POWer [ :RF ] :RANGe:AUTO?</code>
Notes	ON aliases to "Elec Atten Only" (:POW:RANG:OPT:ATT ELEC) OFF aliases to "Off" (:POW:RANG:OPT:ATT OFF) The query :POW:RANG:AUTO? returns true if :POW:RANG:OPT:ATT is not "Off"
Initial S/W Revision	Prior to A.02.00

## Off

Turns Pre-Adjust for Min Clip off. This is the default setting.

This key is grayed out in measurements that do not support this functionality. The spectrum analyzer measurement, Swept SA, does not support this functionality.

Key Path	AMPTD Y Scale, Attenuation, Pre-Adjust for Min Clip
Example	:POW:RANGe:OPT:ATT OFF
Initial S/W Revision	Prior to A.02.00

## Elec Atten Only

Selects only the electric attenuator to participate in auto ranging. This offers less wear on the mechanical attenuator and is usually faster.

This key is grayed out in measurements that do not support this functionality. The spectrum analyzer measurement, Swept SA, does not support this functionality.

Key Path	AMPTD Y Scale, Attenuation, Pre-Adjust for Min Clip
Example	:POW:RANGe:OPT:ATT ELEC
Initial S/W Revision	Prior to A.02.00

### Mech + Elec Atten

In dual attenuator models, this selects both attenuators participate in the autoranging.

This key is grayed out in measurements that do not support this functionality. The spectrum analyzer measurement, Swept SA, does not support this functionality.

Key Path	AMPTD Y Scale, Attenuation, Pre-Adjust for Min Clip
Example	:POW:RANGe:OPT:ATT COMB
Initial S/W Revision	Prior to A.02.00

### (Mech) Atten Step

This controls the step size used when making adjustments to the input attenuation.

This key is labeled Mech Atten Step in dual attenuator models and Atten Step in single attenuator models. In the dual attenuator configuration, this key only affects the step size of the mechanical attenuator.

Key Path	AMPTD Y Scale, Attenuation
Remote Command	[[:SENSe]:POWer[:RF]:ATTenuation:STEP[:INCRement] 10 dB   2 dB [:SENSe]:POWer[:RF]:ATTenuation:STEP[:INCRement]?
Example	POW:ATT:STEP 2
Notes	Note this feature works like a 1-N choice from the front panel, but it takes a specific value (in dB) when used remotely. The only valid values are 2 and 10.
Dependencies	Blanked in CXA and EXA if option FSA (2 dB steps) is not present. If blanked, attempts to set it via SCPI will yield an error.
Couplings	When the attenuation step size changes, the current mechanical attenuation value is adjusted (if necessary) to be quantized to the new step size. That is, if step is set to 10 dB, mech atten is increased if necessary so it is a multiple of 10 dB
Preset	PXA and MXA: 2 dB EXA and CXA: 10 dB (2 dB with option FSA)
State Saved	Saved in instrument state
Initial S/W Revision	Prior to A.02.00
Modified at S/W Revision	A.03.00

## Scale/Div

Sets the units-per-division of the vertical scale in the logarithmic display. When Auto Scaling is On, the scale per division value is automatically determined by the measurement result. When you set a value manually, Auto Scaling automatically changes to Off.

<b>Key Path</b>	AMPTD Y Scale
<b>Mode</b>	SA, WCDMA, C2K, WIMAX OFDMA, TD-SCDMA, 1xEVDO, DTMB (CTTB), DVB-T/H, ISDB-T, CMMB, LTE, LTETDD, Digital Cable TV, WLAN, MSR, LTEAFDD, LTEATDD
<b>Remote Command</b>	:DISPlay:SEMask:VIEW[1]:WINDow[1]:TRACe:Y[:SCALe]:PDIVision <rel_ampl> :DISPlay:SEMask:VIEW[1]:WINDow[1]:TRACe:Y[:SCALe]:PDIVision?
<b>Example</b>	DISP:SEM:VIEW:WIND:TRAC:Y:PDIV 15dB DISP:SEM:VIEW:WIND:TRAC:Y:PDIV?
<b>Notes</b>	You must be in the mode that includes SEM measurement to use this command. Use :INSTrument:SElect to set the mode.
<b>Couplings</b>	When the Auto Scaling is On, this value is automatically determined by the measurement result. When you set a value manually, Auto Scaling automatically changes to Off.
<b>Preset</b>	10 dB
<b>State Saved</b>	Saved in instrument state
<b>Min</b>	0.10 dB
<b>Max</b>	20.00 dB
<b>Initial S/W Revision</b>	Prior to A.02.00
<b>Modified at S/W Revision</b>	A.02.00, A.03.00

## Presel Center

When this key is pressed, the centering of the preselector filter is adjusted to optimize the amplitude accuracy at the frequency of the selected marker. If the selected marker is not on when Presel Center is pressed, the analyzer will turn on the selected marker, perform a peak search, and then perform centering on the marker's center frequency. If the selected marker is already on and between the start and stop frequencies of the analyzer, the analyzer performs the preselector calibration on that marker's frequency. If the selected marker is already on, but outside the frequency range between Start Freq and Stop Freq, the analyzer will first perform a peak search, and then perform centering on the marker's center frequency.

The value displayed on the Presel Adjust key will change to reflect the new preselector tuning (see Presel Adjust).

A number of considerations should be observed to ensure proper operation. See ["Proper Preselector Operation" on page 1057](#).

<b>Key Path</b>	AMPTD Y Scale
<b>Remote Command</b>	[:SENSe]:POWer[:RF]:PCENter
<b>Example</b>	POW:PCEN
<b>Notes</b>	Note that the rules outlined above under the key description apply for the remote command as well



	as the key. The result of the command is dependent on marker position, and so forth. Any message shown by the key press is also shown in response to the remote command.
Dependencies	<ul style="list-style-type: none"> <li>• Grayed out if the microwave preselector is off. )</li> <li>• If the selected marker's frequency is below Band 1, advisory message 0.5001 is generated and no action is taken.</li> <li>• Grayed out if entirely in Band 0.</li> <li>• Blank in models that do not include a preselector, such as option 503. If the SCPI is sent in these instruments, it is accepted without error, and the query always returns 0.</li> <li>• Grayed out in the Spectrogram View.</li> </ul>
Couplings	<p>The active marker position determines where the centering will be attempted.</p> <p>If the analyzer is in a measurement such as averaging when centering is initiated, the act of centering the preselector will restart averaging but the first average trace will not be taken until the centering is completed.</p>
Status Bits/OPC dependencies	<p>When centering the preselector, *OPC will not return true until the process is complete and a subsequent measurement has completed, nor will results be returned to a READ or MEASure command.</p> <p>The Measuring bit should remain set while this command is operating and should not go false until the subsequent sweep/measurement has completed.</p>
Initial S/W Revision	Prior to A.02.00
Modified at S/W Revision	A.03.00

## Proper Preselector Operation

A number of considerations should be observed to ensure proper operation:

1. If the selected marker is off, the analyzer will turn on a marker, perform a peak search, and adjust the preselector using the selected marker's frequency. It uses the "highest peak" peak search method unqualified by threshold or excursion, so that there is no chance of a 'no peak found' error. It continues with that peak, even if it is the peak of just noise. Therefore, for this operation to work properly, there should be a signal on screen in a preselected range for the peak search to find.
2. If the selected marker is already on, the analyzer will attempt the centering at that marker's frequency. There is no preselector for signals below about 3.6 GHz, therefore if the marker is on a signal below 3.6 GHz, no centering will be attempted and an advisory message generated
3. In some models, the preselector can be bypassed. If it is bypassed, no centering will be attempted in that range and a message will be generated.

## Preselector Adjust

Allows you to manually adjust the preselector filter frequency to optimize its response to the signal of interest. This function is only available when **"Presel Center" on page 2111** is available.

For general purpose signal analysis, using Presel Center is recommended. Centering the filter minimizes the impact of long-term preselector drift. Presel Adjust can be used instead to manually optimize the

preselector. One application of manual optimization would be to peak the preselector response, which both optimizes the signal-to-noise ratio and minimizes amplitude variations due to small (short-term) preselector drifting.

<b>Key Path</b>	AMPTD Y Scale
<b>Scope</b>	Meas Global
<b>Remote Command</b>	<code>[ :SENSe ] :POWer [ :RF ] :PADJust &lt;freq&gt;</code> <code>[ :SENSe ] :POWer [ :RF ] :PADJust?</code>
<b>Example</b>	POW:PADJ 100KHz POW:PADJ?
<b>Notes</b>	The value on the key reads out to 0.1 MHz resolution.
<b>Dependencies</b>	<ul style="list-style-type: none"> <li>• Grayed out if microwave preselector is off. )</li> <li>• Grayed out if entirely in Band 0.</li> <li>• Blank in models that do not include a preselector, such as option 503. If the SCPI is sent in these instruments, it is accepted without error, and the query always returns 0.</li> <li>• Grayed out in the Spectrogram View.</li> </ul>
<b>Preset</b>	0 MHz
<b>State Saved</b>	The Presel Adjust value set by Presel Center, or by manually adjusting Presel Adjust, is not saved in instrument state, and does not survive a Preset or power cycle.
<b>Min</b>	-500 MHz
<b>Max</b>	500 MHz
<b>Default Unit</b>	Hz
<b>Backwards Compatibility SCPI</b>	<code>[ :SENSe ] :POWer [ :RF ] :MW:PADJust</code> <code>[ :SENSe ] :POWer [ :RF ] :MMW:PADJust</code> PSA had multiple preselectors, but the X-Series has only one. These commands simply alias to <code>[ :SENSe ] :POWer [ :RF ] :PADJust</code>
<b>Initial S/W Revision</b>	Prior to A.02.00
<b>Modified at S/W Revision</b>	A.03.00

<b>Remote Command</b>	<code>[ :SENSe ] :POWer [ :RF ] :PADJust:PRESelector MWAVE   MMWave   EXTERNAL</code> <code>[ :SENSe ] :POWer [ :RF ] :PADJust:PRESelector?</code>
<b>Notes</b>	PSA had multiple preselectors, and you could select which preselector to adjust. Since the X-Series has only one mm/uW preselector, the preselector selection softkey is no longer available. However, to provide backward compatibility, we accept the legacy remote commands. The command form has no effect, the query always returns MWAVE
<b>Initial S/W Revision</b>	Prior to A.02.00

## Y Axis Unit

Displays the menu keys that enable you to change the vertical (Y) axis amplitude unit. The analyzer retains the entered Y Axis Unit separately for both Log and Lin amplitude scale types. For example, if Scale Type has been set to Log, and you set Y Axis Unit to dBm, pressing Scale Type (Log) sets the Y Axis Unit to dBm. If Scale Type has been set to Lin and you set Y Axis Unit to V, pressing Scale Type (Lin) sets the Y Axis Unit to V. Pressing Scale Type (Log) again sets the Y axis unit back to dBm.

### NOTE

The units of current (A, dBmA, dBuA) are calculated based on 50 ohms input impedance.

All four of the EMI units (dBμA/m, dBμV/m, dBG, dBpT) are treated by the instrument exactly as though they were dBuV. The user must load an appropriate correction factor using Amplitude Corrections for accurate and meaningful results.

If a SCPI command is sent to the analyzer that uses one of the EMI units as a terminator, the analyzer treats it as though DBUV had been sent as the terminator.

Key Path	AMPTD Y Scale
Mode	SA
Scope	Meas Global
Remote Command	:UNIT:POWer DBM   DBMV   DBMA   V   W   A   DBUV   DBUA   DBPW   DBUVM   DBUAM   DBPT   DBG  :UNIT:POWer?
Example	UNIT:POW dBmV UNIT:POW?
Notes	The Y axis unit has either logarithmic or linear characteristics. The set of units that is logarithmic consists of dBm, dBmV, dBmA, dBμV, dBμA, dBμV/m, dBμA/m, dBpT, and dBG. The set of units that are linear consists of V, W, and A. The chosen unit will determine how the reference level and all the amplitude-related outputs like trace data, marker data, etc. read out.
Notes	The settings of Y Axis Unit and Scale Type, affect how the data is read over the remote interface. When using the remote interface no unit is returned, so you must know what the Y axis unit is to interpret the results: Example 1, set the following: Scale Type (Log) Y Axis Unit, dBm Scale/Div, 1 dB Ref Level, 10 dBm This sets the top line to 10 dBm with each vertical division representing 1 dB. Thus, if a point on trace 1 is on the fifth graticule line from the top, it represents 5 dBm and will read out remotely as 5. Example 2, set the following: Scale Type (Lin) Y Axis Unit, Volts Ref Level, 100 mV (10 mV/div) This sets the top line to 100 mV and the bottom line to 0 V, so each vertical division represents 10 mV. Thus, if a point on trace 1 is on the fifth graticule line from the top, it represents 50 mV and will read out remotely as 50.

Dependencies	If an amplitude correction with an Antenna Unit other than None is applied and enabled, then that antenna unit is forced and the key with that unit is the only Y Axis Unit available. All other Y Axis Unit keys are grayed out.  If an amplitude correction with an Antenna Unit other than None is applied and enabled, and you then turn off that correction or set Apply Corrections to No, the Y Axis Unit that existed before the Antenna Unit was applied is restored.
Couplings	The analyzer retains the entered Y Axis Unit separately for both Log and Lin amplitude scale types
Preset	dBm for log scale, V for linear. The true 'preset' value is dBm, since at preset the Y Scale type is set to logarithmic.
State Saved	Saved in instrument state
Readback line	1-of-N selection
Initial S/W Revision	Prior to A.02.00
Modified at S/W Revision	A.02.00, A.04.00, A.11.00

## dBm

Sets the amplitude unit for the selected amplitude scale (log/lin) to dBm.

Key Path	AMPTD Y Scale, Y Axis Unit
<b>Example</b>	UNIT:POW DBM
Dependencies	Grayed out if an Amplitude Correction with an Antenna Unit is ON.
Readback	dBm
Initial S/W Revision	Prior to A.02.00
Modified at S/W Revision	A.02.00

## dBmV

Sets the amplitude unit for the selected amplitude scale (log/lin) to dBmV.

Key Path	AMPTD Y Scale, Y Axis Unit
<b>Example</b>	UNIT:POW DBMV
Dependencies	Grayed out if an Amplitude Correction with an Antenna Unit is ON.
Readback	dBmV
Initial S/W Revision	Prior to A.02.00
Modified at S/W Revision	A.02.00

## dBmA

Sets the amplitude unit for the selected amplitude scale (log/lin) to dBmA.

Key Path	AMPTD Y Scale, Y Axis Unit
<b>Example</b>	UNIT:POW DBMA
Dependencies	Grayed out if an Amplitude Correction with an Antenna Unit is ON.
Readback	dBmA
Initial S/W Revision	Prior to A.02.00
Modified at S/W Revision	A.02.00

## W

Sets the amplitude unit for the selected amplitude scale (log/lin) to watt.

Key Path	AMPTD Y Scale, Y Axis Unit
<b>Example</b>	UNIT:POW W
Dependencies	Grayed out if an Amplitude Correction with an Antenna Unit is ON.
Readback	W
Initial S/W Revision	Prior to A.02.00
Modified at S/W Revision	A.02.00

## V

Sets the amplitude unit for the selected amplitude scale (log/lin) to volt.

Key Path	AMPTD Y Scale, Y Axis Unit
<b>Example</b>	UNIT:POW V
Dependencies	Grayed out if an Amplitude Correction with an Antenna Unit is ON.
Readback	V
Initial S/W Revision	Prior to A.02.00
Modified at S/W Revision	A.02.00

## A

Sets the amplitude unit for the selected amplitude scale (log/lin) to Ampere.

Key Path	AMPTD Y Scale, Y Axis Unit
<b>Example</b>	UNIT:POW A
Dependencies	Grayed out if an Amplitude Correction with an Antenna Unit is ON.
Readback	A
Initial S/W Revision	Prior to A.02.00
Modified at S/W Revision	A.02.00

## dB $\mu$ V

Sets the amplitude unit for the selected amplitude scale (log/lin) to dB $\mu$ V.

Key Path	AMPTD Y Scale, Y Axis Unit
<b>Example</b>	UNIT:POW DBUV
Dependencies	Grayed out if an Amplitude Correction with an Antenna Unit is ON.
Readback	dB $\mu$ V
Initial S/W Revision	Prior to A.02.00
Modified at S/W Revision	A.02.00

## dB $\mu$ A

Sets the amplitude unit for the selected amplitude scale (log/lin) to dB $\mu$ A.

### NOTE

The unit dBuA can also appear as an Antenna Unit. This will be used by customers using current probes, because current probes are often supplied with conversion tables that provide the transducer factors. When dBuA is used as an Antenna Unit the normal conversion from power to amps for dBuA (based on the analyzer input impedance) is not done, but instead the conversion is based solely on the Correction that contains the transducer factors. This is what distinguishes dBuA as a normal unit from dBuA as an antenna unit. When querying the Y-Axis unit, you can query the Antenna Unit to distinguish between regular dBuA and the dBuA antenna unit. If :CORR:CSET:ANT? returns NOC (for No Conversion), you are using a normal Y Axis dBuA. If it returns UA you are using an Antenna Unit dBuA.

Key Path	AMPTD Y Scale, Y Axis Unit
<b>Example</b>	UNIT:POW DBUA
Dependencies	Grayed out if an Amplitude Correction with an Antenna Unit is ON.
Readback	dB $\mu$ A
Initial S/W Revision	Prior to A.02.00
Modified at S/W Revision	A.02.00

## dBpW

Sets the amplitude unit for the selected amplitude scale (log/lin) to dBpW.

Key Path	AMPTD Y Scale, Y Axis Unit
<b>Example</b>	UNIT:POW DBPW
Dependencies	Grayed out if an Amplitude Correction with an Antenna Unit is ON.
Readback	dB $\mu$ A
Initial S/W Revision	A.11.00

## Antenna Unit

When a Correction is turned on that uses an Antenna Unit, the Y Axis Unit changes to that Antenna Unit. All of the keys in the Y-Axis Unit menu are then greyed out, except the Antenna Unit key. The unit being used is shown on this key and is shown as selected in the submenu.

Key Path	AMPTD Y Scale, Y Axis Unit
Dependencies	Grayed out if no Amplitude Correction with an Antenna Unit is on.
Readback line	Currently selected unit
Initial S/W Revision	A.11.00

### dB $\mu$ V/m

Sets the amplitude unit for the selected amplitude scale (log/lin) to dB $\mu$ V/m. This is an antenna unit, and this key is grayed out unless a Correction with this Antenna Unit selected is ON. If this is the case, all of the other Antenna Units are grayed out.

Key Path	AMPTD Y Scale, Y Axis Unit, Antenna Unit
<b>Example</b>	UNIT:POW DBUVM
Dependencies	Grayed out if no Amplitude Correction with an Antenna Unit is on.
Readback	dB $\mu$ V/m
Initial S/W Revision	A.02.00

### dB $\mu$ A/m

Sets the amplitude unit for the selected amplitude scale (log/lin) to dB $\mu$ A/m. This is an antenna unit, and this key is grayed out unless a Correction with this Antenna Unit selected is ON. If this is the case, all of the other Antenna Units are grayed out.

Key Path	AMPTD Y Scale, Y Axis Unit, Antenna Unit
<b>Example</b>	UNIT:POW DBUAM
Dependencies	Grayed out if no Amplitude Correction with an Antenna Unit is on.
Readback	dB $\mu$ A/m
Initial S/W Revision	A.02.00

### dB $\mu$ A

Sets the amplitude unit for the selected amplitude scale (log/lin) to dB $\mu$ A. This is an antenna unit, and this key is grayed out unless a Correction with this Antenna Unit selected is ON. If this is the case, all of the other Antenna Units are grayed out.

Key Path	AMPTD Y Scale, Y Axis Unit, Antenna Unit
<b>Example</b>	UNIT:POW DBUAM
Dependencies	Grayed out if no Amplitude Correction with an Antenna Unit is on.
Readback	dB $\mu$ A
Initial S/W Revision	A.11.00

### dBpT

Sets the amplitude unit for the selected amplitude scale (log/lin) to dBpT. This is an antenna unit, and this key is grayed out unless a Correction with this Antenna Unit selected is ON. If this is the case, all of the other Antenna Units are grayed out.

Key Path	AMPTD Y Scale, Y Axis Unit, Antenna Unit
<b>Example</b>	UNIT:POW DBPT
Dependencies	Grayed out if no Amplitude Correction with an Antenna Unit is on.
Readback	dBpT
Initial S/W Revision	A.02.00

### DBG

Sets the amplitude unit for the selected amplitude scale (log/lin) to DBG. This is an antenna unit, and this key is grayed out unless a Correction with this Antenna Unit selected is ON. If this is the case, all of the other Antenna Units are grayed out.

Key Path	AMPTD Y Scale, Y Axis Unit, Antenna Unit
<b>Example</b>	UNIT:POW DBG
Dependencies	Grayed out if no Amplitude Correction with an Antenna Unit is on.
Readback	DBG
Initial S/W Revision	A.02.00

### None

This is selected if no Antenna Unit is currently on, however you cannot actually set this value, since it is always grayed out. The key is included simply to provide an indication on the Readback line of the Antenna Unit key when there is no Antenna Unit selected.

Key Path	AMPTD Y Scale, Y Axis Unit, Antenna Unit
Readback	"None"
Initial S/W Revision	A.11.00



## μW Path Control

The μW Path Control functions include the μW Preselector Bypass (Option MPB) and Low Noise Path (Option LNP) controls in the High Band path circuits.

When the μW Preselector is bypassed, the user has better flatness, but will be subject to spurs from out of band interfering signals. When the Low Noise Path is enabled, the analyzer automatically switches around certain circuitry in the high frequency bands which can contribute to noise, when it is appropriate based on other analyzer settings.

For most applications, the preset state is Standard Path, which gives the best remote-control throughput, minimizes acoustic noise from switching and minimizes the risk of wear out in the hardware switches. For applications that utilize the wideband IF paths, the preset state is the μW Preselector Bypass path, if option MPB is present. This is because, when using a wideband IF such as the 140 MHz IF, the μW Preselector's bandwidth can be narrower than the available IF bandwidth, causing degraded amplitude flatness and phase linearity, so it is desirable to bypass the preselector in the default case.

Users may choose Low Noise Path Enable. It gives a lower noise floor, especially in the 21–26.5 GHz region, though without improving many measures of dynamic range, and without giving the best possible noise floor. The preamp, if purchased and used, gives better noise floor than does the Low Noise Path, however its compression threshold and third-order intercept are much poorer than that of the non-preamp Low Noise Path. There are some applications, typically for signals around –30 dBm, for which the third-order dynamic range of the standard path is good enough, but the noise floor is not low enough even with 0 dB input attenuation. When the third-order dynamic range of the preamp path is too little and the noise floor of the standard path is too high, the Low Noise Path can provide the best dynamic range.

<b>Key Path</b>	AMPTD Y Scale
<b>Mode</b>	SA, BASIC, PNOISE, VSA , LTE, LTETDD
<b>Scope</b>	Meas Global
<b>Remote Command</b>	[ :SENSe ] :POWer [ :RF ] :MW:PATH STD LNPath MPBypass FULL [ :SENSe ] :POWer [ :RF ] :MW:PATH?
<b>Example</b>	:POW:MW:PATH LNP Enables the Low Noise path
<b>Notes</b>	If a Presel Center is performed, the analyzer will momentarily switch to the Standard Path, regardless of the setting of μW Path Control  The DC Block will always be switched in when the low noise path is switched in, to protect succeeding circuitry from DC. Note that this does not mean “when the low noise path is enabled” but when, based on the Low Noise Path rules, the path is actually switched in. This can happen when the selection is Low Noise Path Enable . In the case where the DC Block is switched in the analyzer is now AC coupled. However, if the user has selected DC coupling, the UI will still behave as though it were DC coupled, including all annunciation, warnings, status bits, and responses to SCPI queries. This is because, based on other settings, the analyzer could switch out the low noise path at any time and hence go back to being DC coupled.  Alignment switching ignores the settings in this menu, and restores them when finished.
<b>Dependencies</b>	Unavailable in BBIQ and External Mixing
<b>Preset</b>	All modes other than IQ Analyzer mode and VXA: STD IQ Analyzer, VXA and WLAN mode: MPB option present and licensed: MPB

	MPB option not present and licensed: STD
State Saved	Save in instrument state
Readback	Value selected in the submenu
Initial S/W Revision	A.04.00
Modified at S/W Revision	A.10.00

## Standard Path

This path gives the best remote-control throughput, minimizes acoustic noise from switching and minimizes the risk of wear in the hardware switches, particularly in remote test scenarios where both low band and high band setups will follow in rapid succession.

In this path, the bypass of the low band/high band switch and microwave preamp is never activated, which can cause some noise degradation but preserves the life of the bypass switch.

Key Path	AMPTD Y Scale, $\mu$ W Path Control
<b>Example</b>	:POW:MW:PATH STD
Readback Text	Standard Path
Initial S/W Revision	A.04.00

## Low Noise Path Enable

You may choose Low Noise Path Enable, which gives a lower noise floor under some circumstances, particularly when operating in the 21–26.5 GHz region. With the Low Noise Path enabled, the low band/high band switch and microwave preamp are bypassed whenever all of the following are true:

- The analyzer is not in the Low Band, meaning:
- the start frequency is above 3.5 GHz and
- the stop frequency is above 3.6 GHz.
- the internal preamp is not installed or (if installed) is set to Off or Low Band

Note that this means that, when any part of a sweep is done in Low Band, the Low Noise Path is not used, whether or not the Low Noise Path Enable is selected in the user interface. Also, if the preamp is turned on, the Low Noise Path is not used, whether or not the Low Noise Path Enable is selected in the user interface. The only time the Low Noise Path is used is when Low Noise Path Enable is selected, the sweep is completely in High Band (> 3.6 GHz) and no preamp is in use.

See "[More Information](#)" on page 1067

Key Path	AMPTD Y Scale, $\mu$ W Path Control
Measurement	Swept SA
<b>Example</b>	:POW:MW:PATH LNP

Notes	<p>For measurements that use IQ acquisition, the low noise path is used when the Center Frequency is in High Band (&gt; 3.6 GHz) and no preamp is in use.</p> <p>In other words, the rules above are modified to use only the center frequency to qualify which path to switch in.</p> <p>This is not the case for FFT's in the Swept SA measurement; they use the same rules as swept measurements.</p>
Dependencies	<p>Key is blanked if current mode does not support it.</p> <p>Key is grayed out if mode supports it but current measurement does not support it.</p> <p>Unless Option LNP is present and licensed, key is blank and if SCPI command sent, error -241, "Hardware missing; Option not installed" is generated.</p>
Readback Text	Low Noise Path Enable
Initial S/W Revision	A.04.00

### More Information

The user should understand that the Low Noise Path, while giving improved DANL, has the disadvantage of decreased TOI performance and decreased gain compression performance relative to the standard path.

The user should also understand that the bypass switch is a mechanical switch and has finite life, so if the Low Noise Path is enabled, it is possible to cause frequent cycling of this switch by frequently changing analyzer settings such that the above conditions hold true only some of the time. A user making tests of this nature should consider opting for the Standard Path, which will never throw the bypass switch, at the expense of some degraded noise performance.

The low noise path is useful for situations where the signal level is so low that the analyzer performance is dominated by noise even with 0 dB attenuation, but still high enough that the preamp option would have excessive third-order intermodulation or compression. The preamp, if purchased and used, gives better noise floor than does the "Low Noise Path." However, its compression threshold and third-order intercept are much poorer than that of the non-preamp path. There are some applications, typically for signals around -30 dBm, for which the third-order dynamic range of the standard path is good enough, but the noise floor is not low enough even with 0 dB input attenuation. When the third-order dynamic range of the preamp path is too little and the noise floor of the standard path is too high, the Low Noise Path can provide the best dynamic range

The graph below illustrates the concept. It shows, in red, the performance of an analyzer at different attenuation settings, both with the preamp on and off, in a measurement that is affected by both analyzer noise and analyzer TOI. The green shows the best available dynamic range, offset by 0.5 dB for clarity. The blue shows how the best available dynamic range improves for moderate signal levels with the low noise path switched in. In this illustration, the preamp improves the noise floor by 15 dB while degrading the third-order intercept by 30 dB, and the low noise path reduces loss by 8 dB. The attenuator step size is 2 dB.

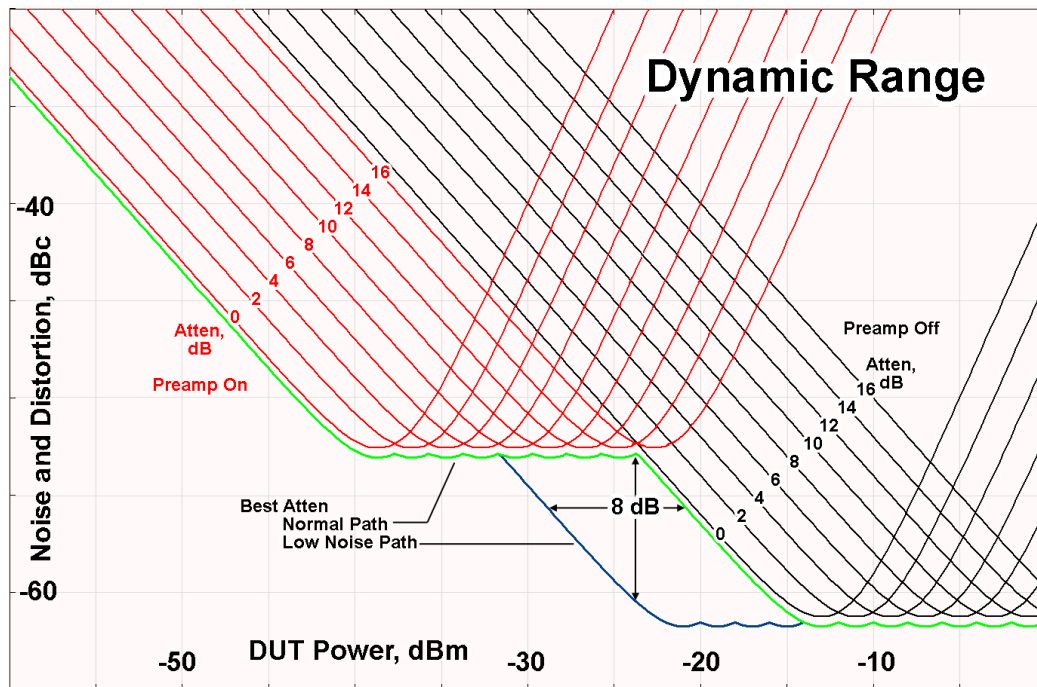

There are other times where selecting the low noise path improves performance, too. Compression-limited measurements such as finding the nulls in a pulsed-RF spectrum can profit from the low noise path in a way similar to the TOI-limited measurement illustrated. Accuracy can be improved when the low noise path allows the optimum attenuation to increase from a small amount like 0, 2 or 4 dB to a larger amount, giving better return loss at the analyzer input. Harmonic measurements, such as second and third harmonic levels, are much improved using the low noise path because of the superiority of that path for harmonic (though not intermodulation) distortion performance.

### μW Preselector Bypass

This key toggles the preselector bypass switch for band 1 and higher. When the microwave preselector is on, the signal path is preselected. When the microwave preselector is off, the signal path is not preselected. The preselected path is the normal path for the analyzer.

The preselector is a tunable bandpass filter which prevents signals away from the frequency of interest from combining in the mixer to generate in-band spurious signals (images). The consequences of using a preselector filter are its limited bandwidth, the amplitude and phase ripple in its passband, and any amplitude and phase instability due to center frequency drift.

Option MPB or pre-selector bypass provides an unpreselected input mixer path for certain X-Series signal analyzers with frequency ranges above 3.6 GHz. This signal path allows a wider bandwidth and less amplitude variability, which is an advantage when doing modulation analysis and broadband signal analysis. The disadvantage is that, without the preselector, image signals will be displayed. Another disadvantage of bypassing the preselector is increased LO emission levels at the front panel input port.

Image responses are separated from the real signal by twice the 1st IF. For IF Paths of 10 MHz and 25 MHz, the 1st IF is 322.5 MHz, so the image response and the real signal will be separated by 645 MHz. The 1st IF will be different for other IF Path settings. When viewing a real signal and its corresponding image response in internal mixing, the image response will be to the left of the real signal.

Also, the image response and the real signal typically have the same amplitude and exhibit the same shape factor.

However, if Option FS1, Fast Sweep Capability, is enabled, the image response in the Swept SA measurement will appear lower in amplitude and have a much wider shape factor compared to the real signal.

Key Path	AMPTD Y Scale, $\mu$ W Path Control
<b>Example</b>	:POW:MW:PATH MPB
Dependencies	Key is blanked if current mode does not support it. Key is grayed out if mode supports it but current measurement does not support it. Key is blank unless Option MPB is present and licensed. If SCPI command sent when MPB not present, error -241, "Hardware missing; Option not installed" is generated.
Readback Text	$\mu$ W Preselector Bypass
Initial S/W Revision	A.04.00

<b>Remote Command</b>	[ :SENSe ] :POWer [ :RF ] :MW:PRESelector [ :STATe ] ON OFF 0 1 [ :SENSe ] :POWer [ :RF ] :MW:PRESelector [ :STATe ] ?
<b>Example</b>	:POW:MW:PRES OFF Bypasses the microwave preselector
Notes	The ON parameter sets the STD path (:POW:MW:PATH STD) The OFF parameter sets path MPB (:POW:MW:PATH MPB)
Preset	ON

## Internal Preamp

Accesses a menu of keys that control the internal preamps. Turning on the preamp gives a better noise figure, but a poorer TOI to noise floor dynamic range. You can optimize this setting for your particular measurement.

The instrument takes the preamp gain into account as it sweeps. If you sweep outside of the range of the preamp the instrument will also account for that. The displayed result will always reflect the correct gain.

For some measurements, when the preamp is on and any part of the displayed frequency range is below the lowest frequency for which the preamp has specifications, a warning condition message appears in the status line. For example ,for a preamp with a 9 kHz lowest specified frequency: "Preamp: Accy unspec'd below 9 kHz".

Key Path	AMPTD Y Scale
Scope	Meas Global
<b>Remote Command</b>	[ :SENSe ] :POWer [ :RF ] :GAIN [ :STATe ] OFF ON 0 1 [ :SENSe ] :POWer [ :RF ] :GAIN [ :STATe ] ?
Dependencies	Preamp is not available on all hardware platforms. If the preamp is not present or is unlicensed, the

---

	key is not shown. The preamp is not available when the electronic/soft attenuator is enabled.
--	--

---

Couplings	The act of connecting the U7227A USB Preamplifier to one of the analyzer's USB ports will cause the Internal Preamp to be switched on. When this happens an informational message will be generated: "Internal Preamp turned on for optimal operation with USB Preamp." Note that if the Internal Preamp was already on, there will be no change to the setting, but if it was Off it will be switched On, to Full Range.  Note that this same action occurs when the SA mode is selected while the USB Preamp is connected to one of the analyzer's USB ports, if it is the first time that the SA mode has run since powerup, or if the last time the SA mode was running the USB Preamp was NOT connected.  Subsequently disconnecting the USB Preamp from USB does not change the Internal Preamp setting nor restore the previous setting.
Preset	OFF
State Saved	Saved in instrument state
Initial S/W Revision	Prior to A.02.00
Modified at S/W Revision	A.14.00

---

Key Path	AMPTD Y Scale, Internal Preamp
Scope	Meas Global
<b>Remote Command</b>	[ :SENSe ] : POWer [ :RF ] : GAIN : BAND LOW   FULL [ :SENSe ] : POWer [ :RF ] : GAIN : BAND ?
Dependencies	Preamp is not available on all hardware platforms. If the preamp is not present or is unlicensed, the key is not shown.  If a POW:GAIN:BAND FULL command is sent when a low band preamp is available, the preamp band parameter is to LOW instead of FULL, and an "Option not installed" message is generated.
Preset	LOW
State Saved	Saved in instrument state
Initial S/W Revision	Prior to A.02.00

---

## Off

Turns the internal preamp off

---

Key Path	AMPTD Y Scale, Internal Preamp
<b>Example</b>	:POW:GAIN OFF
Readback	Off
Initial S/W Revision	Prior to A.02.00

---

## Low Band

Sets the internal preamp to use only the low band.

The frequency range of the installed (optional) low-band preamp is displayed in square brackets on the Low Band key label.

Key Path	AMPTD Y Scale, Internal Preamp
<b>Example</b>	:POW:GAIN ON :POW:GAIN:BAND LOW
Readback	Low Band
Initial S/W Revision	Prior to A.02.00

## Full Range

Sets the internal preamp to use its full range. The low band (0–3.6 GHz or 0–3GHz, depending on the model) is supplied by the low band preamp and the frequencies above low band are supplied by the high band preamp.

The frequency range of the installed (optional) preamp is displayed in square brackets on the Full Range key label. If the high band option is not installed the Full Range key does not appear.

Key Path	AMPTD Y Scale, Internal Preamp
<b>Example</b>	:POW:GAIN ON :POW:GAIN:BAND FULL
Readback	Full Range
Initial S/W Revision	Prior to A.02.00

## Ref Position

Positions the reference level at the top, center or bottom of the Y scale display. Changing the reference position does not affect the reference level value.

Key Path	AMPTD Y Scale
Mode	SA, WCDMA, C2K, WIMAX OFDMA, TD-SCDMA, 1xEVDO, DTMB (CTTB), DVB-T/H, ISDB-T, CMMB, LTE, LTE-TDD, Digital Cable TV, WLAN, MSR, LTEAFDD, LTEATDD
<b>Remote Command</b>	:DISPlay:SEMask:VIEW[1]:WINDow[1]:TRACe:Y[:SCALe]:RPOSition TOP   CENTer   BOTTom :DISPlay:SEMask:VIEW[1]:WINDow[1]:TRACe:Y[:SCALe]:RPOSition?
<b>Example</b>	DISP:SEM:VIEW:WIND:TRAC:Y:RPOS BOTT DISP:SEM:VIEW:WIND:TRAC:Y:RPOS?
Notes	You must be in the mode that includes SEM measurement to use this command. Use :INSTrument:SElect to set the mode.
Preset	TOP

State Saved	Saved in instrument state
Range	Top Ctr Bot
Initial S/W Revision	Prior to A.02.00
Modified at S/W Revision	A.02.00, A.03.00

## Auto Scaling

Toggles the Auto Scaling function between On and Off.

When Auto Scaling is On and the Restart front-panel key is pressed, the analyzer automatically determines the scale per division and reference values based on the measurement results. When you set a value to either Scale/Div or Ref Value manually, Auto Scaling automatically changes to Off.

Key Path	AMPTD Y Scale
Mode	SA, WCDMA, C2K, WIMAX OFDMA, TD-SCDMA, 1xEVDO, DTMB (CTTB), DVB-T/H, ISDB-T, CMMB, LTE, LTEFDD, Digital Cable TV, WLAN, MSR, LTEAFDD, LTEATDD
Remote Command	:DISPlay:SEMask:VIEW[1]:WINDow[1]:TRACe:Y[:SCALe]:COUPLe 0   1   ON   OFF :DISPlay:SEMask:VIEW[1]:WINDow[1]:TRACe:Y[:SCALe]:COUPLe?
Example	DISP:SEM:VIEW:WIND:TRAC:Y:COUP OFF DISP:SEM:VIEW:WIND:TRAC:Y:COUP?
Notes	You must be in the mode that includes SEM measurement to use this command. Use :INSTrument:SElect to set the mode.
Couplings	When Auto Scaling is On, upon pressing the Restart front-panel key, this function automatically determines the scale per division and reference values based on the measurement results. When you set a value to either Scale/Div or Ref Value manually, Auto Scaling automatically changes to Off.
Preset	ON
State Saved	Saved in instrument state
Range	On Off
Initial S/W Revision	Prior to A.02.00
Modified at S/W Revision	A.02.00, A.03.00



## Auto Couple

The Auto Couple feature provides a quick and convenient way to automatically couple multiple instrument settings. This helps ensure accurate measurements and optimum dynamic range. When the Auto Couple feature is activated, either from the front panel or remotely, all parameters of the current measurement that have an Auto/Manual mode are set to Auto mode and all measurement settings dependent on (or coupled to) the Auto/Man parameters are automatically adjusted for optimal performance.

However, the Auto Couple key actions are confined to the current measurement only. It does not affect other measurements in the mode, and it does not affect markers, marker functions, or trace or display attributes.

See "[More Information](#)" on page 1073

Key Path	Front-panel key
Remote Command	:COUPle ALL NONE
Example	:COUP ALL
Notes	:COUPle ALL puts all Auto/Man parameters in Auto mode (equivalent to pressing the Auto Couple key). :COUPLE NONE puts all Auto/Man parameters in manual mode. It decouples all the coupled instrument parameters and is not recommended for making measurements.
Initial S/W Revision	Prior to A.02.00

### More Information

There are two types of functions that have Auto/Manual modes.

#### Auto/Man Active Function keys

An Auto/Man toggle key controls the binary state associated with an instrument parameter by toggling between Auto (where the parameter is automatically coupled to the other parameters it is dependent upon) and Man (where the parameter is controlled independent of the other parameters), as well as making the parameter the active function. The current mode is indicated on the softkey with either Auto or Man underlined as illustrated below.



#### Auto/Man 1-of-N keys

An Auto/Man 1-of-N key allows you to manually pick from a list of parameter values, or place the function in Auto, in which case the value is automatically selected (and indicated) as shown below. If in Auto, Auto is underlined on the calling key. If in manual operation, manual is indicated on the calling key. But the calling key does not actually toggle the function, it simply opens the menu.

11 Spectrum Emission Mask Measurement  
Auto Couple

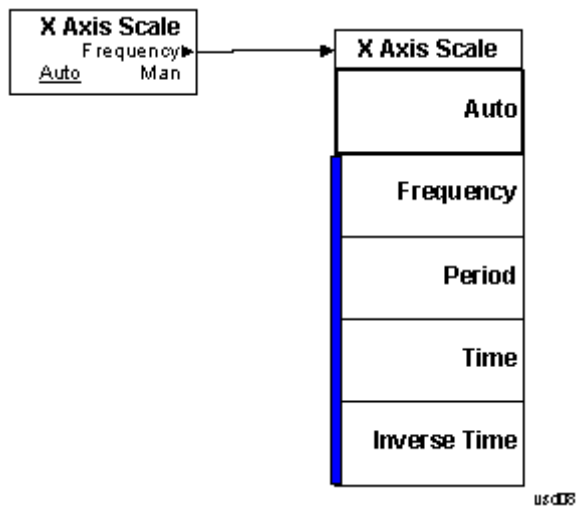

## BW

Accesses a menu of functions that enable you to select the type of filter for the measurement.

Key Path	Front-panel key
Initial S/W Revision	Prior to A.02.00
Modified at S/W Revision	A.03.00

### Filter Type

Selects the type of bandwidth filter that is used in Carrier and Offsets.

When Gaussian or Flattop is selected, selected filter is applied to carriers and all offsets.

When Auto Sense is selected, filter type is automatically selected for each carriers and offsets, so that measurement speed and accuracy is optimized.

Key Path	BW
Mode	SA, WCDMA, C2K, WIMAX OFDMA, TD-SCDMA, 1xEVDO, DVB-T/H, DTMB (CTTB), ISDB-T, CMMB, LTE, LTE-TDD, Digital Cable TV, WLAN, MSR, LTEAFDD, LTEATDD
<b>Remote Command</b>	[ :SENSe ] :SEMask :BANDwidth :SHAPE ASENse   GAUSSian   FLATtop [ :SENSe ] :SEMask :BANDwidth :SHAPE?
<b>Example</b>	SEM:BAND:SHAP GAUS SEM:BAND:SHAP?
Couplings	See the description above
Preset	ASENse
State Saved	Saved in instrument state
Range	Auto Sense (each offset and carrier) Gaussian (all offsets and carriers) Flattop (all offsets and carriers)
Initial S/W Revision	A.03.00

## Cont (Continuous Measurement/Sweep)

Sets the analyzer for Continuous measurement operation. The single/continuous state is Meas Global so the setting will affect all measurements. If you are Paused, pressing Cont does a Resume.

<b>Key Path</b>	Front-panel key
<b>Remote Command</b>	:INITiate:CONTinuous OFF ON 0 1 :INITiate:CONTinuous?
<b>Example</b>	:INIT:CONT 0 puts analyzer in Single measurement operation. :INIT:CONT 1 puts analyzer in Continuous measurement operation
<b>Preset</b>	ON (Note that SYST:PRESet sets INIT:CONT to ON but *RST sets INIT:CONT to OFF)
<b>State Saved</b>	Saved in instrument state
<b>Backwards Compatibility Notes</b>	For Spectrum Analysis mode in ESA and PSA, there is no Cont hardkey, instead there is a Sweep Single/Cont key. In these analyzers, switching the Sweep Single/Cont key from Single to Cont restarts averages (displayed average count reset to 1), but does not restart Max Hold and Min Hold. The X-Series has Single and Cont keys in place of the SweepSingleCont key. In the X-Series, if in single measurement, the Cont key (and INIT:CONT ON ) switches to continuous measurement, but never restarts a measurement and never resets a sweep.
<b>Initial S/W Revision</b>	Prior to A.02.00

In Swept SA Measurement (Spectrum Analysis Mode):

The analyzer takes repetitive sweeps, averages, measurements, etc., when in Continuous mode. When the average count reaches the Average/Hold Number the count stops incrementing, but the analyzer keeps sweeping. See the Trace/Detector section for the averaging formula used both before and after the Average/Hold Number is reached. The trigger condition must be met prior to each sweep. The type of trace processing for multiple sweeps, is set under the Trace/Detector key, with choices of Trace Average, Max Hold, or Min Hold.

In Other Measurements/Modes:

With Avg/Hold Num (in the Meas Setup menu) set to Off or set to On with a value of 1, a sweep is taken after the trigger condition is met; and the analyzer continues to take new sweeps after the current sweep has completed and the trigger condition is again met. However, with Avg/Hold Num set to On with a value >1, multiple sweeps (data acquisitions) are taken for the measurement. The trigger condition must be met prior to each sweep. The sweep is not stopped when the average count k equals the number N set for Avg/Hold Num is reached, but the number k stops incrementing. A measurement average usually applies to all traces, marker results, and numeric results. But sometimes it only applies to the numeric results.

If the analyzer is in Single measurement, pressing the Cont key does not change k and does not cause the sweep to be reset; the only action is to put the analyzer into Continuous measurement operation.

If it is already in continuous sweep:

the INIT:CONT 1 command has no effect

the INIT:CONT 0 command will place the analyzer in Single Sweep but will have no effect on the current sequence until  $k = N$ , at which point the current sequence will stop and the instrument will go to the idle state.

11 Spectrum Emission Mask Measurement  
File

File

See "File" on page 336

## FREQ Channel

The key accesses a menu allowing you to set Frequency parameters for the current measurement. All measurements in DVB-T/H mode have the same menu structure under FREQ/Channel menu.

Key Path	Front-panel key
Initial S/W Revision	A.02.00

### Channel

Sets the analyzer to a frequency that corresponds to the Channel Number. If the Center Freq value entered does not exactly correlate with the Channel, the displayed value will be “---”.

Key Path	FREQ Channel
Mode	DVB-T/H
<b>Remote Command</b>	<code>[ :SENSe ] :FREQuency:CHANnel:NUMBer &lt;integer&gt;</code> <code>[ :SENSe ] :FREQuency:CHANnel:NUMBer?</code>
<b>Example</b>	FREQ:CHAN:NUMB 21 FREQ:CHAN:NUMB?
Dependencies	If your analyzer has multiple inputs and the selected input is BBIQ, this key will be grayed out and the displaying value will be “---”.
Couplings	Channel is coupled with Center Freq. A certain Channel corresponds to a certain value of Center Freq. If the Center Freq value entered does not exactly correlate with a Channel, the displaying value will be “---”, and the returned value of the SCPI command “FREQ:CHAN:NUMB?” is “-999”.
Preset	21
State Saved	Saved in instrument state.
Min	Depends on the selected channel table
Max	Depends on the selected channel table
Initial S/W Revision	A.02.00

### Center Freq

Sets the center frequency. If your analyzer has multiple inputs (RF and IQ), the displayed value will be updated according to the selected input. SCPI commands are available to directly set the center frequency for a specific input. This key is coupled with Channel when the selected input is RF.

See also:

["RF Center Freq" on page 1081](#)

["IQ Center Freq" on page 1081](#)

Key Path	FREQ Channel
Mode	DVB-T/H
<b>Remote Command</b>	[ :SENSe ] :FREQuency:CENTer <freq> [ :SENSe ] :FREQuency:CENTer?
<b>Example</b>	FREQ:CENT 1.0MHZ FREQ:CENT?
Couplings	Center Freq is coupled with Channel. A certain value of center frequency corresponds to a certain Channel. If the Channel changes, the Center Frequency will be changed to the frequency which is the center of the channel.
Preset	474.00MHz
State Saved	Saved in instrument state.
Min	-79.999995 MHz
Max	Hardware Dependent, for details, see <a href="#">"Maximum Frequency in X - Series Signal Analyzers" on page 1080</a> .
Initial S/W Revision	A.02.00

### Maximum Frequency in X - Series Signal Analyzers

The following table lists the maximum frequency in different X – Series signal analyzers.

Model numbers: N9020A, N9030A

Freq Option	Stop Freq after Mode Preset	Max Freq (can't tune above)
503	3.6 GHz	3.7 GHz
508	8.4 GHz	8.5 GHz
513	13.6 GHz	13.8 GHz
526	26.5 GHz	27.0 GHz
543 (N9030A only)	43 GHz	
544 (N9030A only)	44 GHz	44.5 GHz
550 (N9030A only)	50 GHz	51 GHz

Model number: N9010A

Freq Option	Stop Freq after Mode Preset	Max Freq (can't tune above)
503	3.6 GHz	3.7 GHz
507	7.0 GHz	7.1 GHz



513	13.6 GHz	13.8 GHz
526	26.5 GHz	27.0 GHz
532	32.0 GHz	32.5 GHz
544	44.0 GHz	44.5 GHz

Model number: N9000A

Freq Option	Stop Freq after Mode Preset	Max Freq (can't tune above)
503	3.0 GHz	3.08 GHz
507	7.5 GHz	7.58 GHz

## RF Center Freq

SCPI command to specify the RF Center Frequency. This will always access the RF value, even when the selected input is not RF.

Key Path	FREQ Channel
Mode	DVB-T/H
Remote Command	<code>[ :SENSe ] :FREQuency:RF:CENTer &lt;freq&gt;</code> <code>[ :SENSe ] :FREQuency:RF:CENTer?</code>
Example	FREQ:RF:CENT 1.0MHZ FREQ:RF:CENT?
Couplings	Center Freq is coupled with Channel. A certain value of center frequency corresponds to a certain Channel. If the Channel changes, the Center Frequency will be changed to the frequency which is the center of the channel.
Preset	474.00MHz
State Saved	Saved in instrument state.
Min	-79.999995 MHz
Max	Hardware Dependent, for details, see <a href="#">"Maximum Frequency in X - Series Signal Analyzers" on page 1080.</a>
Initial S/W Revision	A.02.00

## IQ Center Freq

SCPI command to specify the I/Q Center Frequency. This will always access the I/Q value, even when the selected input is not I/Q.

Key Path	FREQ Channel
Mode	DVB-T/H
<b>Remote Command</b>	[ :SENSe ] :FREQuency:IQ:CENTer <freq> [ :SENSe ] :FREQuency:IQ:CENTer?
<b>Example</b>	FREQ:IQ:CENT 1.0MHZ FREQ:IQ:CENT?
Preset	0 Hz
State Saved	Saved in instrument state.
Min	-39.999995 MHz
Max	39.999995 MHz
Initial S/W Revision	A.02.00

### Chan Step

Chan Step changes the step size for the Channel Number.

Key Path	FREQ Channel
Mode	DVB-T/H
<b>Remote Command</b>	[ :SENSe ] :FREQuency:CHANnel:STEP <integer> [ :SENSe ] :FREQuency:CHANnel:STEP?
<b>Example</b>	FREQ:CHAN:STEP 1 FREQ:CHAN:STEP?
Dependencies	If your analyzer has multiple inputs and the selected input is BBIQ, this key will be grayed out.
Preset	1
State Saved	Saved in instrument state.
Min	1
Max	Depends on the selected channel table
Initial S/W Revision	A.02.00

### CF Step

CF Step sets the step size for center frequency. If CF Step State is manual, you can set this value manually. Once CF Step State is changed to auto, CF Step changes to the value of Channel BW automatically.

Key Path	FREQ Channel
Mode	DVB-T/H
<b>Remote Command</b>	[ :SENSe ] :FREQuency:CENTer:STEP [ :INCRement ] <freq> [ :SENSe ] :FREQuency:CENTer:STEP [ :INCRement ] ?

	<code>[ :SENSe ] :FREQuency:CENTer:STEP:AUTO ON OFF 1 0</code>
	<code>[ :SENSe ] :FREQuency:CENTer:STEP:AUTO?</code>
<b>Example</b>	<code>FREQ:CENT:STEP 100KHZ</code> <code>FREQ:CENT:STEP?</code> <code>FREQ:CENT:STEP:AUTO OFF</code> <code>FREQ:CENT:STEP:AUTO?</code>
<b>Couplings</b>	CF Step is coupled to Channel BW (Mode Setup) when CF Step State is 'Auto'.
<b>Preset</b>	8.00MHz ON
<b>State Saved</b>	Saved in instrument state.
<b>Min</b>	1.0 kHz
<b>Max</b>	1 GHz
<b>Initial S/W Revision</b>	A.02.00

## Chan Table

Allows you to choose the appropriate TV standard: NTSC-M, NTSC-J, NTSC-Brazil, PAL-M, PAL-B/G, PAL-D/K, or PAL-I.

<b>Key Path</b>	FREQ Channel
<b>Mode</b>	DVB-T/H
<b>Remote Command</b>	<code>[ :SENSe ] :FREQuency:CHANnel:TABLE[:SElect] MNTSc   JNTSc   BNTSc   MPAL</code> <code>  IPAL   BPAL   DPAL</code> <code>[ :SENSe ] :FREQuency:CHANnel:TABLE[:SElect] ?</code>
<b>Example</b>	<code>FREQ:CHAN:TABL BPAL</code> <code>FREQ:CHAN:TABL?</code>
<b>Dependencies</b>	If your analyzer has multiple inputs and the selected input is BBIQ, this key will be grayed out.
<b>Couplings</b>	Couple with Channel. Setting Chan Table sets the range of Channel to the value corresponding to that Chan Table.
<b>Preset</b>	BPAL
<b>State Saved</b>	Saved in instrument state.
<b>Range</b>	NTSC-M   NTSC-J   NTSC-Brazil   PAL-M   PAL-I   PAL-B/G   PAL-D/K
<b>Initial S/W Revision</b>	A.02.00

## NTSC-M

If the current TV standard is NTSC-M, you can choose the appropriate channel plans in NTSC-M standard: Standard Cable (STD), Broadcast Channel (AIR), HRC Cable (HRC) or IRC Cable (IRC).

Key Path	FREQ Channel, Chan Table
Mode	DVB-T/H
<b>Remote Command</b>	[ :SENSE ] :FREQuency:CHANnel:TABLE:MNTSc [ :SElect ] STD   AIR   HRC   IRC [ :SENSe ] :FREQuency:CHANnel:TABLE:MNTSc [ :SElect ] ?
<b>Example</b>	FREQ:CHAN:TABL:MNTS STD FREQ:CHAN:TABL:MNTS?
Preset	STD
State Saved	Saved in instrument state.
Range	STD   AIR   HRC   IRC
Initial S/W Revision	A.02.00

### NTSC-J

If the current TV standard is NTSC-J, you can choose the appropriate channel plans in NTSC-J standard: Japan Standard Cable (Cable), apan Broadcast channels (AIR), or Japan Digital Cable (Cable Digital).

Key Path	FREQ Channel, Chan Table
Mode	DVB-T/H
<b>Remote Command</b>	[ :SENSE ] :FREQuency:CHANnel:TABLE:JNTSc [ :SElect ] CBL   AIR   DCBL [ :SENSe ] :FREQuency:CHANnel:TABLE:JNTSc [ :SElect ] ?
<b>Example</b>	FREQ:CHAN:TABL:JNTS AIR FREQ:CHAN:TABL:JNTS?
Preset	AIR
State Saved	Saved in instrument state.
Range	Cable AIR Cable Digital
Initial S/W Revision	A.02.00
Modified at S/W Revision	A.08.00

### NTSC-Brazil

If the current TV standard is NTSC-Brazil, you can choose the appropriate channel plans in NTSC-Brazil standard: NTSC-Brazil VHF or NTSC-Brazil UHF. Please refer to Appendix A for more detailed information.

Key Path	FREQ Channel, Chan Table
Mode	DVB-T/H
<b>Remote Command</b>	[ :SENSE ] :FREQuency:CHANnel:TABLE:BNTSc [ :SElect ] VHF   UHF [ :SENSe ] :FREQuency:CHANnel:TABLE:BNTSc [ :SElect ] ?
<b>Example</b>	FREQ:CHAN:TABL:BNTS VHF FREQ:CHAN:TABL:BNTS?

Preset	UHF
State Saved	Saved in instrument state.
Range	VHF UHF
Initial S/W Revision	A.06.00

## PAL-M

If the current TV standard is PAL-M, you can choose the appropriate channel plans in PAL-M standard: Standard Cable (STD), Broadcast Channel (AIR), HRC Cable (HRC) or IRC Cable (IRC).

Key Path	FREQ Channel, Chan Table
Mode	DVB-T/H
<b>Remote Command</b>	[ :SENSe ] :FREQuency:CHANnel:TABLE:MPAL[ :SElect ] STD   AIR   HRC   IRC [ :SENSe ] :FREQuency:CHANnel:TABLE:MPAL[ :SElect ] ?
<b>Example</b>	FREQ:CHAN:TABL:MPAL STD FREQ:CHAN:TABL:MPAL?
Preset	STD
State Saved	Saved in instrument state.
Range	STD   AIR   HRC   IRC
Initial S/W Revision	A.02.00

## PAL-I

If the current TV standard is PAL-I, you can choose the appropriate channel plans in PAL-I standard: HRC Cable (HRC), VHF channels (VHF) or UHF channels (UHF).

Key Path	FREQ Channel, Chan Table
Mode	DVB-T/H
<b>Remote Command</b>	[ :SENSe ] :FREQuency:CHANnel:TABLE:IPAL[ :SElect ] VHF UHF HRC [ :SENSe ] :FREQuency:CHANnel:TABLE:IPAL[ :SElect ] ?
<b>Example</b>	FREQ:CHAN:TABL:IPAL HRC FREQ:CHAN:TABL:IPAL?
Preset	HRC
State Saved	Saved in instrument state.
Range	VHF   UHF   HRC
Initial S/W Revision	A.02.00

### PAL-B/G

If the current TV standard is PAL-B/G, you can choose the appropriate channel plans in PAL-B/G standard: HRC Cable (HRC), VHF channels (VHF), UHF channels (UHF), S channels PAL-B/G Standard (S), S channels PAL-B/G Cable (S-Cable) or CENELEC channels (CENELEC).

<b>Key Path</b>	FREQ Channel, Chan Table
<b>Mode</b>	DVB-T/H
<b>Remote Command</b>	[ :SENSE ] :FREQuency:CHANnel:TABLE:BPAL [ :SElect ] VHF   UHF   HRC   S   SCBL   CEN  [ :SENSe ] :FREQuency:CHANnel:TABLE:BPAL [ :SElect ] ?
<b>Example</b>	FREQ:CHAN:TABL:BPAL HRC FREQ:CHAN:TABL:BPAL?
<b>Preset</b>	UHF
<b>State Saved</b>	Saved in instrument state.
<b>Range</b>	VHF   UHF   HRC   S   S-Cable   CENELEC
<b>Initial S/W Revision</b>	A.02.00

### PAL-D/K

If the current TV standard is PAL-D/K, you can choose the appropriate channel plans in PAL-D/K standard: China Broadcast Channels (DS) or China Standard Cable (Z).

<b>Key Path</b>	FREQ Channel, Chan Table
<b>Mode</b>	DVB-T/H
<b>Remote Command</b>	[ :SENSE ] :FREQuency:CHANnel:TABLE:DPAL [ :SElect ] DS   Z  [ :SENSe ] :FREQuency:CHANnel:TABLE:DPAL [ :SElect ] ?
<b>Example</b>	FREQ:CHAN:TABL:DPAL DS FREQ:CHAN:TABL:DPAL?
<b>Preset</b>	DS
<b>State Saved</b>	Saved in instrument state.
<b>Range</b>	DS   Z
<b>Initial S/W Revision</b>	A.02.00

## Input/Output

See "Input/Output" on page 204

## Marker

Accesses a menu that enables you to select, set up and control the markers for the current measurement. If there are no active markers, Marker selects marker 1, sets it to Normal and places it at the center of the display. You can turn on and control up to 12 markers.

Key Path	Front-panel key
Initial S/W Revision	Prior to A.02.00

### Select Marker

Displays 12 markers available for selection.

Key Path	Marker
Initial S/W Revision	Prior to A.02.00

### Marker Type

Sets the marker control mode to Normal and Off. If the selected marker is Off, pressing Marker sets it to Normal and places it at the center of the screen on the trace determined by the Marker Trace rules. At the same time, Marker X Axis Value appears on the Active Function area. The marker X axis value entered in the active function area will display the marker value to its full entered precision. If the current control mode for the measurement is Off, there is no active function and the active function is turned off.

Key Path	Marker
Mode	SA, WCDMA, C2K, WIMAX OFDMA, TD-SCDMA, 1xEVDO, DTMB (CTTB), DVB-T/H, ISDB-T, CMMB, LTE, LTE-TDD, Digital Cable TV, WLAN, MSR, LTEAFDD, LTEATDD
Remote Command	:CALCulate:SEMask:MARKer[1] 2 ... 12:MODE POSition OFF :CALCulate:SEMask:MARKer[1] 2 ... 12:MODE?
Example	CALC:SEM:MARK:MODE POS CALC:SEM:MARK:MODE?
Notes	If the selected marker is Off, pressing Marker sets it to Normal and places it at the center of the screen on the trace determined by the Marker Trace rules. At the same time, Marker X Axis Value appears on the Active Function area.  Default Active Function: the active function for the selected marker's current control mode. Note that if the current control mode is Off, there is no active function and the active function is turned off.  Active Function Display: the marker X axis value entered in the active function area will display the marker value to its full entered precision.
Preset	OFF OFF OFF OFF OFF OFF OFF OFF OFF OFF OFF OFF
State Saved	Saved in instrument state
Range	Normal Off
Initial S/W Revision	Prior to A.02.00
Modified at S/W Revision	A.02.00, A.03.00



## Couple Markers

When this function is true, moving any marker causes an equal X Axis movement of every other marker that is not Off. By “equal X Axis movement” we mean that we preserve the difference between each marker’s X Axis value (in the fundamental x-axis units of the trace that marker is on) and the X Axis value of the marker being moved (in the same fundamental x-axis units).

<b>Key Path</b>	Marker
<b>Mode</b>	SA, WCDMA, C2K, WIMAX OFDMA, TD-SCDMA, 1xEVDO, DTMB (CTTB), DVB-T/H, ISDB-T, CMMB, LTE, LTEFDD, Digital Cable TV, WLAN, MSR, LTEAFDD, LTEATDD
<b>Remote Command</b>	:CALCulate:SEMask:MARKer:COUPle[:STATe] ON OFF 1 0 :CALCulate:SEMask:MARKer:COUPle[:STATe]?
<b>Example</b>	CALC:SEM:MARK:COUP ON CALC:SEM:MARK:COUP?
<b>Preset</b>	OFF
<b>State Saved</b>	Saved in instrument state
<b>Range</b>	On Off
<b>Initial S/W Revision</b>	Prior to A.02.00
<b>Modified at S/W Revision</b>	A.02.00, A.03.00

## All Markers Off

Turns all active markers off in all views.

<b>Key Path</b>	Marker
<b>Mode</b>	SA, WCDMA, C2K, WIMAX OFDMA, TD-SCDMA, 1xEVDO, DTMB (CTTB), DVB-T/H, ISDB-T, CMMB, LTE, LTEFDD, Digital Cable TV, WLAN, MSR, LTEAFDD, LTEATDD
<b>Remote Command</b>	:CALCulate:SEMask:MARKer:AOff
<b>Example</b>	CALC:SEM:MARK:AOff
<b>Initial S/W Revision</b>	Prior to A.02.00
<b>Modified at S/W Revision</b>	A.02.00, A.03.00

## Marker X Axis Value (Remote Command Only)

Sets the marker X Axis value in the current marker X Axis Scale unit. It has no effect if the control mode is Off, but is the SCPI equivalent of entering an X value if the control mode is Normal.

<b>Mode</b>	SA, WCDMA, C2K, WIMAX OFDMA, TD-SCDMA, 1xEVDO, DTMB (CTTB), DVB-T/H ISDB-T, CMMB, LTE, LTEFDD, Digital Cable TV, WLAN, MSR, LTEAFDD, LTEATDD
<b>Remote Command</b>	:CALCulate:SEMask:MARKer[1] 2 ... 12:X <freq>

	:CALCulate:SEMask:MARKer[1] 2 ... 12:X?
<b>Example</b>	CALC:SEM:MARK3:X 1.0 GHz CALC:SEM:MARK3:X?
<b>Notes</b>	<p>If no suffix is sent it will use the fundamental units for the current marker X Axis Scale. If a suffix is sent that does not match the current marker X Axis Scale unit, an error "Invalid suffix" will be generated.</p> <p>The query returns the marker's absolute X Axis value if the control mode is Normal. The query is returned in the fundamental units for the current marker X Axis scale. If the marker is Off the response is not a number.</p> <p>When a Marker is turned on, it is placed center of the screen on the trace. Therefore the default value depends on instrument condition, although the Preset/Default is defined as 1.5 GHz.</p>
<b>Preset</b>	After a preset, , all Markers are turned OFF, , so a Marker X Axis Value query will return a not a number (NAN).
<b>State Saved</b>	No
<b>Min</b>	-9.9E+37
<b>Max</b>	9.9E+37
<b>Initial S/W Revision</b>	Prior to A.02.00
<b>Modified at S/W Revision</b>	A.02.00, A.03.00

### Marker X Axis Position (Remote Command Only)

Sets the marker X position in trace points. It has no effect if the control mode is Off, but is the SCPI equivalent of entering a value if the control mode is Normal, except in trace points rather than X Axis Scale units. The entered value is immediately translated into the current X Axis Scale units for setting the value of the marker.

<b>Mode</b>	SA, WCDMA, C2K, WIMAX OFDMA, TD-SCDMA, 1xEVDO, DTMB (CTTB), DVB-T/H, ISDB-T, CMMB, LTE, LTETDD, Digital Cable TV, WLAN, MSR, LTEAFDD, LTEATDD
<b>Remote Command</b>	:CALCulate:SEMask:MARKer[1] 2 ... 12:X:POSition <real> :CALCulate:SEMask:MARKer[1] 2 ... 12:X:POSition?
<b>Example</b>	CALC:SEM:MARK10:X:POS 1001 CALC:SEM:MARK10:X:POS?
<b>Notes</b>	<p>The query returns the marker's absolute X Axis value in trace points if the control mode is Normal. The value is returned as a real number, not an integer, corresponding to the translation from X Axis Scale units to trace points . If the marker is Off the response is not a number.</p> <p>When a Marker is turned on, it is placed center of the screen on the trace. Therefore the default value depends on the instrument condition although the Preset/Default is defined as 6507 (this value might be the expected value when all the offsets are on).</p>
<b>Preset</b>	After a preset, , all Markers are turned OFF, , so a Marker X Axis Value query will return a not a number (NAN).
<b>State Saved</b>	No

Min	-9.9E+37
Max	9.9E+37
Initial S/W Revision	Prior to A.02.00
Modified at S/W Revision	A.02.00, A.03.00

### Marker Y Axis Value (Remote Command Only)

Returns the marker Y Axis value in the current marker Y Axis unit.

Mode	SA, WCDMA, C2K, WIMAX OFDMA, TD-SCDMA, 1xEVDO, DTMB (CTTB), DVB-T/H, ISDB-T, CMMB, LTE, LTE-TDD, Digital Cable TV, WLAN, MSR, LTEAFDD, LTEATDD
<b>Remote Command</b>	:CALCulate:SEMask:MARKer[1] 2 ... 12:Y?
<b>Example</b>	CALC:SEM:MARK11:Y 10 dBm CALC:SEM:MARK11:Y?
Notes	Since the result value is always calculated from acquisition data, the default value is arbitrary, although the Preset/Default values is defined.
Preset	Result dependent on markers setup and signal source
State Saved	No
<b>Backwards Compatibility SCPI</b>	:CALCulate:SEMask:MARKer[1] 2 ... 12:FUNctIon:RESult?
Initial S/W Revision	Prior to A.02.00
Modified at S/W Revision	A.02.00, A.03.00

## Marker Function

There are no 'Marker Functions' supported in Spectrum Emission Mask so this front-panel key displays a blank menu when pressed.

---

Key Path	Front-panel key
Initial S/W Revision	Prior to A.02.00

---

## Marker To

There is no 'Marker To' functionality supported in Spectrum Emission Mask so this front-panel key displays a blank menu when pressed.

---

Key Path	Front-panel key
Initial S/W Revision	Prior to A.02.00

---

## Meas

The information in this section is common to all measurements. For key and remote command information for a specific measurement, refer to the section that describes the measurement of interest.

Measurements available under the Meas key are specific to the current Mode.

When viewing Help for measurements, note the following:

**NOTE**

Operation for some keys differs between measurements. The information displayed in Help pertains to the current measurement. To see how a key operates in a different measurement, exit Help (press the Cancel Esc key), select the measurement, then reenter Help (press the Help key) and press that key.

---

Key Path	Front-panel key
Initial S/W Revision	Prior to A.02.00

---

### Remote Measurement Functions

This section contains the following topics:

["Measurement Group of Commands" on page 2166](#)

["Current Measurement Query \(Remote Command Only\)" on page 2168](#)

["Limit Test Current Results \(Remote Command Only\)" on page 2168](#)

["Data Query \(Remote Command Only\)" on page 2168](#)

["Calculate/Compress Trace Data Query \(Remote Command Only\)" on page 2169](#)

["Calculate Peaks of Trace Data \(Remote Command Only\)" on page 2174](#)

[Hardware-Accelerated Fast Power Measurement \(Remote Command Only\)](#)

["Format Data: Numeric Data \(Remote Command Only\)" on page 2175](#)

["Format Data: Byte Order \(Remote Command Only\)" on page 2176](#)

---

Initial S/W Revision	Prior to A.02.00
----------------------	------------------

---

## Measurement Group of Commands

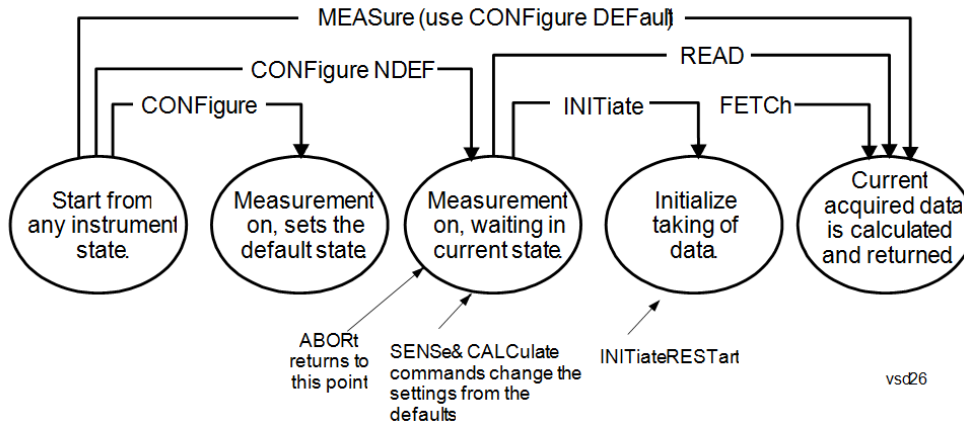

---

### Measure Commands:

:MEASure:<measurement>[n]?

This is a fast single-command way to make a measurement using the factory default instrument settings. These are the settings and units that conform to the Mode Setup settings (e.g. radio standard) that you have currently selected.

- Stops the current measurement (if any) and sets up the instrument for the specified measurement using the factory defaults
- Initiates the data acquisition for the measurement
- Blocks other SCPI communication, waiting until the measurement is complete before returning results.
- If the function does averaging, it is turned on and the number of averages is set to 10.
- After the data is valid it returns the scalar results, or the trace data, for the specified measurement. The type of data returned may be defined by an [n] value that is sent with the command.
- The scalar measurement results will be returned if the optional [n] value is not included, or is set to 1. If the [n] value is set to a value other than 1, the selected trace data results will be returned. See each command for details of what types of scalar results or trace data results are available.
- ASCII is the default format for the data output. (Older versions of Spectrum Analysis and Phase Noise mode measurements only use ASCII.) The binary data formats should be used for handling large blocks of data since they are smaller and faster than the ASCII format. Refer to the FORMat:DATA command for more information.

If you need to change some of the measurement parameters from the factory default settings you can set up the measurement with the CONFIGure command. Use the commands in the SENSe:<measurement> and CALCulate:<measurement> subsystems to change the settings. Then you can use the READ? command to initiate the measurement and query the results.

If you need to repeatedly make a given measurement with settings other than the factory defaults, you can use the commands in the SENSe:<measurement> and CALCulate:<measurement> subsystems to set up the measurement. Then use the READ? command to initiate the measurement and query results.

Measurement settings persist if you initiate a different measurement and then return to a previous one. Use READ:<measurement>? if you want to use those persistent settings. If you want to go back to the default settings, use MEASure:<measurement>?.

---

### Configure Commands:

:CONFigure:<measurement>

This command stops the current measurement (if any) and sets up the instrument for the specified measurement using

---

---

the factory default instrument settings. It does not initiate the taking of measurement data unless INIT:CONTinuous is ON. If you change any measurement settings after using the CONFigure command, the READ command can be used to initiate a measurement without changing the settings back to their defaults.

In the Swept SA measurement in Spectrum Analyzer mode the CONFigure command also turns the averaging function on and sets the number of averages to 10 for all measurements.

:CONFigure: <measurement>: NDEFault stops the current measurement and changes to the specified measurement. It does not change the settings to the defaults. It does not initiate the taking of measurement data unless INIT:CONTinuous is ON.

The CONFigure? query returns the current measurement name.

The CONFigure:CATalog? query returns a quoted string of all licensed measurement names in the current mode. For example, "SAN, CHP, OBW, ACP, PST, TXP, SPUR, SEM, LIST".

---

#### Fetch Commands:

---

:FETCh:<measurement>[n]?

This command puts selected data from the most recent measurement into the output buffer. Use FETCh if you have already made a good measurement and you want to return several types of data (different [n] values, for example, both scalars and trace data) from a single measurement. FETCh saves you the time of re-making the measurement. You can only FETCh results from the measurement that is currently active, it will not change to a different measurement. An error message is reported if a measurement other than the current one is specified.

If you need to get new measurement data, use the READ command, which is equivalent to an INITiate followed by a FETCh.

The scalar measurement results will be returned if the optional [n] value is not included, or is set to 1. If the [n] value is set to a value other than 1, the selected trace data results will be returned. See each command for details of what types of scalar results or trace data results are available. The binary data formats should be used for handling large blocks of data since they are smaller and transfer faster than the ASCII format. (FORMat:DATA)

FETCh may be used to return results other than those specified with the original READ or MEASure command that you sent.

---

#### INITiate Commands:

---

:INITiate:<measurement>

This command is not available for measurements in all the instrument modes:

- Initiates a trigger cycle for the specified measurement, but does not output any data. You must then use the FETCh<meas> command to return data. If a measurement other than the current one is specified, the instrument will switch to that measurement and then initiate it.
  - For example, suppose you have previously initiated the ACP measurement, but now you are running the channel power measurement. If you send INIT:ACP? it will change from channel power to ACP and will initiate an ACP measurement.
  - Does not change any of the measurement settings. For example, if you have previously started the ACP measurement and you send INIT:ACP? it will initiate a new ACP measurement using the same instrument settings as the last time ACP was run.
  - If your selected measurement is currently active (in the idle state) it triggers the measurement, assuming the trigger conditions are met. Then it completes one trigger cycle. Depending upon the measurement and the number of averages, there may be multiple data acquisitions, with multiple trigger events, for one full trigger cycle. It also holds off additional commands on GPIB until the acquisition is complete.
- 

#### READ Commands:

---

:READ:<measurement>[n]?

- Does not preset the measurement to the factory default settings. For example, if you have previously initiated the ACP
-



---

measurement and you send READ:ACP? it will initiate a new measurement using the same instrument settings.

- Initiates the measurement and puts valid data into the output buffer. If a measurement other than the current one is specified, the instrument will switch to that measurement before it initiates the measurement and returns results.
  - For example, suppose you have previously initiated the ACP measurement, but now you are running the channel power measurement. Then you send READ:ACP? It will change from channel power back to ACP and, using the previous ACP settings, will initiate the measurement and return results.
  - Blocks other SCPI communication, waiting until the measurement is complete before returning the results
  - If the optional [n] value is not included, or is set to 1, the scalar measurement results will be returned. If the [n] value is set to a value other than 1, the selected trace data results will be returned. See each command for details of what types of scalar results or trace data results are available. The binary data formats should be used when handling large blocks of data since they are smaller and faster than the ASCII format. (FORMat:DATA)
- 

---

Initial S/W Revision	Prior to A.02.00
----------------------	------------------

---

### Current Measurement Query (Remote Command Only)

This command returns the name of the measurement that is currently running.

---

<b>Remote Command</b>	:CONFigure?
-----------------------	-------------

<b>Example</b>	CONF?
----------------	-------

Initial S/W Revision	Prior to A.02.00
----------------------	------------------

---

### Limit Test Current Results (Remote Command Only)

Queries the status of the current measurement limit testing. It returns a 0 if the measured results pass when compared with the current limits. It returns a 1 if the measured results fail any limit tests.

---

<b>Remote Command</b>	:CALCulate:CLIMits:FAIL?
-----------------------	--------------------------

<b>Example</b>	CALC:CLIM:FAIL? queries the current measurement to see if it fails the defined limits. Returns a 0 or 1: 0 it passes, 1 it fails.
----------------	--

Initial S/W Revision	Prior to A.02.00
----------------------	------------------

---

### Data Query (Remote Command Only)

Returns the designated measurement data for the currently selected measurement and subopcode.

n = any valid subopcode for the current measurement. See the measurement command results table for your current measurement, for information about what data is returned for the subopcodes.

This command uses the data setting specified by the FORMat:BORDER and FORMat:DATA commands and can return real or ASCII data. (See the format command descriptions under Input/Output in the Analyzer Setup section.)

<b>Remote Command</b>	:CALCulate:DATA[n]?
<b>Notes</b>	The return trace depends on the measurement. In CALCulate:<meas>:DATA[n], n is any valid subopcode for the current measurement. It returns the same data as the FETCH:<measurement>? query where <measurement> is the current measurement.
<b>Initial S/W Revision</b>	Prior to A.02.00

### Calculate/Compress Trace Data Query (Remote Command Only)

Returns compressed data for the currently selected measurement and sub-opcode [n].

n = any valid sub-opcode for that measurement. See the MEASure:<measurement>? command description of your specific measurement for information on the data that can be returned.

The data is returned in the current Y Axis Unit of the analyzer. The command is used with a sub-opcode <n> (default=1) to specify the trace. With trace queries, it is best if the analyzer is not sweeping during the query. Therefore, it is generally advisable to be in Single Sweep, or Update=Off.

This command is used to compress or decimate a long trace to extract and return only the desired data. A typical example would be to acquire N frames of GSM data and return the mean power of the first burst in each frame. The command can also be used to identify the best curve fit for the data.

<b>Remote Command</b>	:CALCulate:DATA<n>:COMPRESS? BLOCK   CFIT   MAXimum   MINimum   MEAN   DMEan   RMS   RMSCubed   SAMPLE   SDEVIation   PPHase [,<soffset> [,<length>[,<roffset>[,<rlimit>]]]]
<b>Example</b>	To query the mean power of a set of GSM bursts: Supply a signal that is a set of GSM bursts. Select the IQ Waveform measurement (in IQ Analyzer Mode). Set the sweep time to acquire at least one burst. Set the triggers such that acquisition happens at a known position relative to a burst. Then query the mean burst levels using, CALC:DATA2:COMP? MEAN, 24e-6, 526e-6 (These parameter values correspond to GSM signals, where 526e-6 is the length of the burst in the slot and you just want 1 burst.)
<b>Notes</b>	The command supports 5 parameters. Note that the last 4 (<soffset>, <length>, <roffset>, <rlimit>) are optional. But these optional parameters must be entered in the specified order. For example, if you want to specify <length>, then you must also specify <soffset>. See details below for a definition of each of these parameters.  This command uses the data in the format specified by FORMat:DATA, returning either binary or ASCII data.
<b>Initial S/W Revision</b>	Prior to A.02.00

- BLOCK or block data - returns all the data points from the region of the trace data that you specify. For example, it could be used to return the data points of an input signal over several timeslots, excluding the portions of the trace data that you do not want. (This is x,y pairs for trace data and I,Q pairs for complex data.)

- CFIT or curve fit - applies curve fitting routines to the data. <soffset> and <length> are required to define the data that you want. <roffset> is an optional parameter for the desired order of the curve equation. The query will return the following values: the x-offset (in seconds) and the curve coefficients ((order + 1) values).

MIN, MAX, MEAN, DME, RMS, RMSC, SAMP, SDEV and PPH return one data value for each specified region (or <length>) of trace data, for as many regions as possible until you run out of trace data (using <roffset> to specify regions). Or they return the number of regions you specify (using <rlimit>) ignoring any data beyond that.

- MINimum - returns the minimum data point (y value) for the specified region(s) of trace data. For I/Q trace data, the minimum magnitude of the I/Q pairs is returned.
- MAXimum - returns the maximum data point (y value) for the specified region(s) of trace data. For I/Q trace data, the maximum magnitude of the I/Q pairs is returned.
- MEAN - returns a single value that is the arithmetic mean of the data point values (in dB/ dBm) for the specified region(s) of trace data. For I/Q trace data, the mean of the magnitudes of the I/Q pairs is returned. See the following equations.

•

**NOTE**

If the original trace data is in dB, this function returns the arithmetic mean of those log values, not log of the mean power which is a more useful value. The mean of the log is the better measurement technique when measuring CW signals in the presence of noise. The mean of the power, expressed in dB, is useful in power measurements such as Channel Power. To achieve the mean of the power, use the RMS option.

Equation 1

Mean Value of Data Points for Specified Region(s)

$$\text{MEAN} = \frac{1}{n} \sum_{X_i \in \text{region}(s)} X_i$$

where  $X_i$  is a data point value, and  $n$  is the number of data points in the specified region(s).

Equation 2

Mean Value of I/Q Data Pairs for Specified Region(s)

$$\text{MEAN} = \frac{1}{n} \sum_{X_i \in \text{region}(s)} |X_i|$$

where  $|X_i|$  is the magnitude of an I/Q pair, and  $n$  is the number of I/Q pairs in the specified region(s).

- DMEan - returns a single value that is the mean power (in dB/ dBm) of the data point values for the specified region(s) of trace data. See the following equation:

Equation 3

DMEan Value of Data Points for Specified Region(s)

$$\text{DME} = 10 \times \log_{10} \left( \frac{1}{n} \sum_{X_i \in \text{region}(s)} 10^{\frac{X_i}{10}} \right)$$

- RMS - returns a single value that is the average power on a root-mean-squared voltage scale (arithmetic rms) of the data point values for the specified region(s) of trace data. See the following equation.

**NOTE** For I/Q trace data, the rms of the magnitudes of the I/Q pairs is returned. See the following equation. This function is very useful for I/Q trace data. However, if the original trace data is in dB, this function returns the rms of the log values which is not usually needed.

Equation 4

RMS Value of Data Points for Specified Region(s)

$$\text{RMS} = \sqrt{\frac{1}{n} \sum_{X_i \in \text{region}(s)} X_i^2}$$

where  $X_i$  is a data point value, and  $n$  is the number of data points in the specified region(s).

Equation 5

RMS Value of I/Q Data Pairs for Specified Region(s)

$$\text{RMS} = \sqrt{\frac{1}{n} \sum_{X_i \in \text{region}(s)} X_i X_i^*}$$

where  $X_i$  is the complex value representation of an I/Q pair,  $X_i^*$  its conjugate complex number, and  $n$  is the number of I/Q pairs in the specified region(s).

Once you have the rms value for a region of trace data (linear or I/Q), you may want to calculate the mean power. You must convert this rms value (peak volts) to power in dBm:

$$10 \times \log[10 \times (\text{rms value})^2]$$

- SAMPlE - returns the first data value (x,y pair) for the specified region(s) of trace data. For I/Q trace data, the first I/Q pair is returned.
- SDEViation - returns a single value that is the arithmetic standard deviation for the data point values for the specified region(s) of trace data. See the following equation.
- For I/Q trace data, the standard deviation of the magnitudes of the I/Q pairs is returned. See the following equation.

Equation 6

Standard Deviation of Data Point Values for Specified Region(s)

$$\text{SDEV} = \sqrt{\frac{1}{n} \sum_{X_i \in \text{region}(s)} (X_i - \bar{X})^2}$$

where  $X_i$  is a data point value,  $\bar{X}$  is the arithmetic mean of the data point values for the specified region (s), and  $n$  is the number of data points in the specified region(s).

$$\text{SDEV} = \sqrt{\frac{1}{n} \sum_{X_i \in \text{region}(s)} (|X_i| - \bar{X})^2}$$

where  $|X_i|$  is the magnitude of an I/Q pair,  $\bar{X}$  is the mean of the magnitudes for the specified region(s), and  $n$  is the number of data points in the specified region(s).

- PPHase - returns the x,y pairs of both rms power (dBm) and arithmetic mean phase (radian) for every specified region and frequency offset (Hz). The number of pairs is defined by the specified number of regions. This parameter can be used for I/Q vector (n=0) in Waveform (time domain) measurement and all parameters are specified by data point in PPHase.

The rms power of the specified region may be expressed as:

$$\text{Power} = 10 \times \log [10 \times (\text{RMS I/Q value})] + 10.$$

The RMS I/Q value (peak volts) is:

$$\sqrt{\frac{1}{n} \sum_{X_i \in \text{region}} X_i X_i^*}$$

where  $X_i$  is the complex value representation of an I/Q pair,  $X_i^*$  its conjugate complex number, and  $n$  is the number of I/Q pairs in the specified region.

The arithmetic mean phase of the specified region may be expressed as:

$$\frac{1}{n} \sum_{Y_i \in \text{region}} Y_i$$

where  $Y_i$  is the unwrapped phase of I/Q pair with applying frequency correction and  $n$  is the number of I/Q pairs in the specified region.

The frequency correction is made by the frequency offset calculated by the arithmetic mean of every specified region's frequency offset. Each frequency offset is calculated by the least square method against the unwrapped phase of I/Q pair.

Sample Trace Data - Constant Envelope

(See below for explanation of variables.)

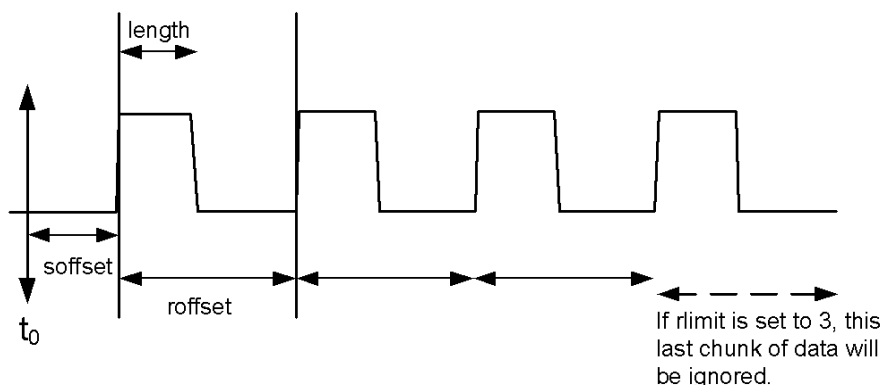

Sample Trace Data - Not Constant Envelope

(See below for explanation of variables.)

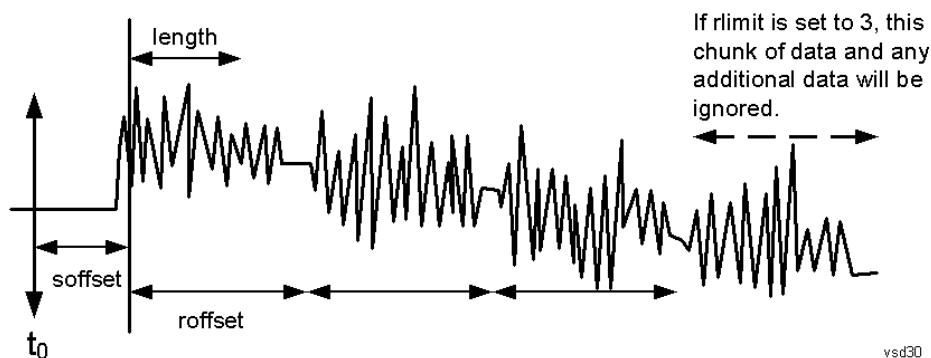

<soffset> - start offset is an optional real number. (It is in seconds for time-domain traces, and is a dimensionless index 0 to Npoints - 1, for frequency-domain traces). It specifies the amount of data at the beginning of the trace that will be ignored before the decimation process starts. It is the time or frequency change from the start of the trace to the point where you want to start using the data. The default value is zero.

<length> - is an optional real number. (It is in seconds for time-domain traces, and is a dimensionless index 0 to Npoints - 1, for frequency-domain traces). It defines how much data will be compressed into one value. This parameter has a default value equal to the current trace length.

<roffset> - repeat offset is an optional real number. (It is in seconds for time-domain traces, and is a dimensionless index 0 to Npoints - 1, for frequency-domain traces). It defines the beginning of the next field of trace elements to be compressed. This is relative to the beginning of the previous field. This parameter has a default value equal to the <length> variable. Note that this parameter is used for a completely different purpose when curve fitting (see CFIT above).

<rlimit> - repeat limit is an optional integer. It specifies the number of data items that you want returned. It will ignore any additional items beyond that number. You can use the Start offset and the Repeat limit to pick out exactly what part of the data you want to use. The default value is all the data.

## Calculate Peaks of Trace Data (Remote Command Only)

Returns a list of all the peaks for the currently selected measurement and sub-opcode [n]. The peaks must meet the requirements of the peak threshold and excursion values.

n = any valid sub-opcode for the current measurement. See the MEASure:<measurement> command description of your specific measurement for information on the data that can be returned.

The command can only be used with specific sub-opcodes with measurement results that are trace data. Both real and complex traces can be searched, but complex traces are converted to magnitude in dBm. In many measurements the sub-opcode n=0, is the raw trace data which cannot be searched for peaks. And Sub-opcode n=1, is often calculated results values which also cannot be searched for peaks.

This command uses the data setting specified by the FORMat:BORDER and FORMat:DATA commands and can return real or ASCII data. If the format is set to INT,32, it returns REAL,32 data.

The command has four types of parameters:

- Threshold (in dBm)
- Excursion (in dB)
- Sorting order (amplitude, frequency, time)
- Optional in some measurements: Display line use (all, > display line, < display line)

<b>Remote Command</b>	<p>For Swept SA measurement:</p> <pre>:CALCulate:DATA[1] 2 ... 6:PEAKs? &lt;threshold&gt;,&lt;excursion&gt;[,AMPLitude   FREQuency   TIME[,ALL   GTDLline   LTDLine]]</pre> <p>For most other measurements:</p> <pre>:CALCulate:DATA[1] 2 ... 6:PEAKs? &lt;threshold&gt;,&lt;excursion&gt;[,AMPLitude   FREQuency   TIME]</pre>
<b>Example</b>	<p>Example for Swept SA measurement in Spectrum Analyzer Mode:</p> <p>CALC:DATA4:PEAK? -40, 10, FREQ, GTDL This will identify the peaks of trace 4 that are above -40 dBm, with excursions of at least 10 dB. The peaks are returned in order of increasing frequency, starting with the lowest frequency. Only the peaks that are above the display line are returned.</p> <p>Query Results 1:</p> <p>With FORMat:DATA REAL, 32 selected, it returns a list of floating-point numbers. The first value in the list is the number of peak points that are in the following list. A peak point consists of two values: a peak amplitude followed by its corresponding frequency (or time).</p> <p>If no peaks are found the peak list will consist of only the number of peaks, (0).</p>
<b>Notes</b>	<p>&lt;n&gt; - is the trace that will be used</p> <p>&lt;threshold&gt; - is the level below which trace data peaks are ignored. Note that the threshold value is required and is always used as a peak criterion. To effectively disable the threshold criterion for this command, provide a substantially low threshold value such as -200 dBm. Also note that the threshold value used in this command is independent of and has no effect on the threshold value stored under the Peak Criteria menu.</p> <p>&lt;excursion&gt; - is the minimum amplitude variation (rise and fall) required for a signal to be identified as peak. Note that the excursion value is required and is always used as a peak criterion. To effectively disable the excursion criterion for this command, provide the minimum value of 0.0 dB. Also note that the excursion value used in this command is independent of and has no effect on the</p>

---

excursion value stored under the Peak Criteria menu.

Values must be provided for threshold and excursion. The sorting and display line parameters are optional (defaults are AMPLitude and ALL).

Note that there is always a Y-axis value for the display line, regardless of whether the display line state is on or off. It is the current Y-axis value of the display line which is used by this command to determine whether a peak should be reported

Sorting order:

AMPLitude - lists the peaks in order of descending amplitude, with the highest peak first (default if optional parameter not sent)

FREQuency - lists the peaks in order of occurrence, left to right across the x-axis.

TIME - lists the peaks in order of occurrence, left to right across the x-axis.

Peaks vs. Display Line:

ALL - lists all of the peaks found (default if optional parameter not sent).

GTDLine (greater than display line) - lists all of the peaks found above the display line.

LTDLine (less than display line) - lists all of the peaks found below the display line.

---

Initial S/W Revision      Prior to A.02.00

---

### Format Data: Numeric Data (Remote Command Only)

This command specifies the format of the trace data input and output. It specifies the formats used for trace data during data transfer across any remote port. It affects only the data format for setting and querying trace data for the :TRACe[:DATA], TRACe[:DATA]?, :CALCulate:DATA[n]? and FETCh:SANalyzer [n]? commands and queries.

---

**Remote Command**      :FORMat [:TRACe] [:DATA] ASCii|INTeger,32|REAL,32 |REAL,64  
:FORMat [:TRACe] [:DATA] ?

---

**Notes**      The query response is:  
ASCii: ASC,8  
REAL,32: REAL,32  
REAL,64: REAL,64  
INTeger,32: INT,32

When the numeric data format is REAL or ASCii, data is output in the current Y Axis unit. When the data format is INTeger, data is output in units of m dBm (.001 dBm).

The INT,32 format returns binary 32-bit integer values in internal units (m dBm), in a definite length block.

---

**Dependencies**      Sending a data format spec with an invalid number (for example, INT,48) generates no error. The analyzer simply uses the default (8 for ASCii, 32 for INTeger, 32 for REAL).

Sending data to the analyzer which does not conform to the current FORMat specified, results in an error. Sending ASCII data when a definite block is expected generates message -161 "Invalid Block Data" and sending a definite block when ASCII data is expected generates message -121 "Invalid Character in Number".

---

**Preset**      ASCii

---

**Backwards Compatibility Notes**      Note that the INT,32 format is only applicable to the command, TRACe:DATA. This preserves backwards compatibility for the Swept SA measurement. For all other commands/queries which honor FORMat:DATA, if INT,32 is sent the analyzer will behave as though it were set to REAL,32.

---

Initial S/W Revision      Prior to A.02.00

---



The specs for each output type follow:

ASCIi - Amplitude values are in ASCII, in the current Y Axis Unit, one ASCII character per digit, values separated by commas, each value in the form:

SX.YYYYYEsZZ

Where:

S = sign (+ or -)

X = one digit to left of decimal point

Y = 5 digits to right of decimal point

E = E, exponent header

s = sign of exponent (+ or -)

ZZ = two digit exponent

REAL,32 - Binary 32-bit real values in the current Y Axis Unit, in a definite length block.

REAL,64 - Binary 64-bit real values in the current Y Axis Unit, in a definite length block.

### Format Data: Byte Order (Remote Command Only)

This command selects the binary data byte order for data transfer and other queries. It controls whether binary data is transferred in normal or swapped mode. This command affects only the byte order for setting and querying trace data for the :TRACe[:DATA], TRACe[:DATA]? , :CALCulate:DATA[n]? and FETCh:SANalyzer[n]? commands and queries.

By definition any command that says it uses FORMat:DATA uses any format supported by FORMat:DATA.

The NORMal order is a byte sequence that begins with the most significant byte (MSB) first, and ends with the least significant byte (LSB) last in the sequence: 1|2|3|4. SWAPPed order is when the byte sequence begins with the LSB first, and ends with the MSB last in the sequence: 4|3|2|1.

<b>Remote Command</b>	:FORMat:BORDER NORMal SWAPPed :FORMat:BORDER?
<b>Preset</b>	NORMal
<b>Initial S/W Revision</b>	Prior to A.02.00

## Meas Setup

Displays the setup menu for the currently selected measurement.

Key Path	Front-panel key
Initial S/W Revision	Prior to A.02.00

### Avg/Hold Num

Toggles averaging On or Off in addition to enabling you to set the number of measurement averages used to calculate the measurement result. The average is displayed at the end of each sweep. After the specified number of average counts, the average mode (termination control) setting determines the average action.

In the remote mode, use the Average State command to turn averaging on or off.

Key Path	Meas Setup
Mode	SA, WCDMA, C2K, WIMAX OFDMA, TD-SCDMA, 1xEVDO, DTMB (CTTB), DVB-T/H, ISDB-T, CMMB, LTE, LTE-TDD, Digital Cable TV, WLAN, MSR, LTEAFDD, LTEATDD
Remote Command	[:SENSe]:SEMAsk:AVERAge:COUNT <integer> [:SENSe]:SEMAsk:AVERAge:COUNT? [:SENSe]:SEMAsk:AVERAge[:STATe] ON OFF 1 0 [:SENSe]:SEMAsk:AVERAge[:STATe]?
Example	SEM:AVER:COUN 100 SEM:AVER:COUN? SEM:AVER ON SEM:AVER?
Notes	You must be in the mode that includes SEM measurement to use this command. Use :INSTrument:SElect to set the mode.
Preset	10 OFF
State Saved	Saved in instrument state.
Min	1
Max	10000
Initial S/W Revision	Prior to A.02.00
Modified at S/W Revision	A.02.00, A.03.00

### Meas Type

Accesses a menu that enables you to select one of the following measurement reference types:

- Total Pwr Ref – Sets the reference to the total carrier power and the measured data is shown in dBc and dBm.
- PSD Ref – Sets the reference to the mean power spectral density of the carrier and the measured data is shown in dB and dBm/Hz.
- Spectrum Peak Ref – Sets the reference to the spectrum peak power of the carrier and the measured data is shown in dB and dBm.

Key Path	Meas Setup
Mode	SA, WCDMA, C2K, WIMAX OFDMA, TD-SCDMA, 1xEVDO, DTMB (CTTB), DVB-T/H, ISDB-T, CMMB, LTE, LTE-TDD, Digital Cable TV, WLAN, MSR, LTEAFDD, LTEATDD
<b>Remote Command</b>	[ :SENSe ] :SEMask:TYPE PSDRef TPRef SPRef [ :SENSe ] :SEMask:TYPE?
<b>Example</b>	SEM:TYPE PSDR SEM:TYPE?
Notes	You must be in the mode that includes SEM measurement to use this command. Use :INSTrument:SElect to set the mode.
Preset	SA, , WCDMA, , C2K, , TD-SCDMA, , 1xEVDO, , DTMB (CTTB), , DVB-T/H, , ISDB-T, , CMMB, , LTE, , LTE-TDD, , Digital Cable TV, , MSR, , LTEAFDD, , LTEATDD: TPRef WIMAX OFDMA, WLAN: SPRef
State Saved	Saved in instrument state.
Range	Total Pwr Ref PSD Ref Spectrum Peak Ref
Initial S/W Revision	Prior to A.02.00
Modified at S/W Revision	A.02.00, A.03.00

## Ref Channel

Accesses a menu that enables you to set up the measurement parameters used to calculate the power in the reference channel.

Key Path	Meas Setup
Initial S/W Revision	Prior to A.02.00

## Integ BW

Specifies the integration bandwidth used to calculate the power in the reference channel.

Key Path	Meas Setup, Ref Channel
Mode	SA, WCDMA, C2K, WIMAX OFDMA, TD-SCDMA, 1xEVDO, DTMB (CTTB), DVB-T/H, ISDB-T, CMMB, LTE, LTE-TDD, Digital Cable TV, WLAN
<b>Remote Command</b>	[ :SENSe ] :SEMask:BANDwidth[1] 2:INTEgration <bandwidth> [ :SENSe ] :SEMask:BANDwidth[1] 2:INTEgration?

<b>Example</b>	SEM:BAND:INT 10 MHz SEM:BAND:INT?
<b>Notes</b>	10% . 100% of Channel Span Parameter Value Bandwidth sub op code, 1 is for BTS, 2 for MS. Default is BTS. You must be in the mode that includes SEM measurement to use this command. Use :INSTrument:SElect to set the mode.
<b>Dependencies</b>	For MSR and LTE-Advanced FDD/TDD mode, this key is blank.
<b>Couplings</b>	Cannot be higher than the channel Span. If lower than 1/10 of channel Span, then the channel Span is reduced to be 10 times the Integ BW.
<b>Preset</b>	SA: 3.84 MHz WCDMA: 3.84 MHz 3.84 MHz C2K: 1.23 MHz 1.23 MHz WIMAX OFDMA: 10 MHz 10 MHz TD-SCDMA: 1.28 MHz 1.28 MHz 1xEVDO: 1.23MHz DTMB (CTTB): 7.56MHz DVB-T/H: 7.61MHz ISDB-T: 5.6MHz CMMB: 7.512MHz LTE: 4.515MHz 4.5MHz LTETDD: 4.515MHz 4.5MHz Digital Cable TV: 6.9MHz WLAN: if Radio Std is 802.11a/g(OFDM/DSSS-OFDM)/802.11n(20 MHz)/ 802.11ac (20 MHz): 18 MHz if Radio Std is 802.11b/g(DSSS/CCK/PBCC): 22 MHz if Radio Std is 802.11n(40MHz)/ 802.11ac (40 MHz): 38 MHz if Radio Std is 802.11ac (80 MHz): 78 MHz if Radio Std is 802.11ac (160 MHz): 158 MHz if Radio Std is 802.11ac (80 MHz + 80 MHz): 78 MHz
<b>State Saved</b>	Saved in instrument state.
<b>Min</b>	1 kHz
<b>Max</b>	645 MHz
<b>Initial S/W Revision</b>	Prior to A.02.00
<b>Modified at S/W Revision</b>	A.02.00, A.03.00

## Span

Specifies the span used to calculate the power in the reference channel.

<b>Key Path</b>	Meas Setup, Ref Channel
-----------------	-------------------------

Mode	SA, WCDMA, C2K, WIMAX OFDMA, TD-SCDMA, 1xEVDO, DTMB (CTTB), DVB-T/H, ISDB-T, LTE, LTETDD, CMMB, Digital Cable TV, WLAN
Remote Command	[ :SENSe] :SEMAsk:FREQuency[1]  2:SPAN <freq> [ :SENSe] :SEMAsk:FREQuency[1]  2:SPAN?
Example	SEM:FREQ:SPAN 3MHz SEM:FREQ:SPAN?
Notes	Frequency sub op code, 1 is for BTS, 2 for MS. Default is BTS. You must be in the mode that includes SEM measurement to use this command. Use :INSTrument:SElect to set the mode.
Dependencies	For MSR and LTE-Advanced FDD/TDD mode, this key is blank.
Couplings	Range 1 kHz to 50 MHz (although restricted by Integ BW). If you set the channel Span lower than channel Integ BW, they will both track each other. As you increase the channel Span, the Integ BW will also increase if it is less than 1/10 of the channel Span. For WLAN 802.11ac (80 + 80 MHz), the channel span is coupled with the difference between the center frequencies of the two carriers. When the difference is either less than 80 MHz or greater than 565 MHz, a "setting conflict" error message is displayed. Chan Span = Carrier Spacing + Chan IntegBW;
Preset	SA: 5.0 MHz WCDMA: 5.0 MHz 5.0 MHz C2K: 1.25 MHz 1.25 MHz WIMAX OFDMA: 10 MHz 10 MHz TD-SCDMA: 1.6 MHz 1.6 MHz 1xEVDO: 1.25 MHz DTMB (CTTB): 10 MHz DVB-T/H: 10 MHz ISDB-T: 8 MHz CMMB: 10 MHz LTE: 5 MHz LTETDD: 5 MHz Digital Cable TV: 10 MHz WLAN: if Radio Std is 802.11a/g(OFDM/DSSS-OFDM)/802.11n(20 MHz)/ 802.11ac (20 MHz): 18 MHz if Radio Std is 802.11b/g(DSSS/CCK/PBCC): 22 MHz if Radio Std is 802.11n(40MHz)/ 802.11ac (40 MHz): 38 MHz if Radio Std is 802.11ac (80 MHz): 78 MHz if Radio Std is 802.11ac (160 MHz): 158 MHz if Radio Std is 802.11ac (80 MHz + 80 MHz): 240 MHz
State Saved	Saved in instrument state.
Min	1 kHz
Max	645 MHz
Initial S/W Revision	Prior to A.02.00
Modified at S/W Revision	A.02.00, A.03.00

## Sweep Time

Sets the sweep time used to calculate the power in the reference channel. Sweep Time can be set manually or put in auto mode.

<b>Key Path</b>	Meas Setup, Ref Channel
<b>Mode</b>	SA, WCDMA, C2K, WIMAX OFDMA, TD-SCDMA, 1xEVDO, DTMB (CTTB), DVB-T/H, ISDB-T, CMMB, LTE, LTETDD, Digital Cable TV, WLAN, MSR, LTEAFDD, LTEATDD
<b>Remote Command</b>	[:SENSe]:SEMAsk:SWEep[1] 2:TIME <time> [:SENSe]:SEMAsk:SWEep[1] 2:TIME? [:SENSe]:SEMAsk:SWEep[1] 2:TIME:AUTO OFF 0 ON 1 [:SENSe]:SEMAsk:SWEep[1] 2:TIME:AUTO?
<b>Example</b>	SEM:SWE:TIME 9ms SEM:SWE:TIME? SEM:SWE:TIME:AUTO OFF SEM:SWE:TIME:AUTO?
<b>Notes</b>	Sub op code, 1 is for BTS, 2 for MS. Default is BTS. You must be in the mode that includes SEM measurement to use this command. Use :INSTrument:SElect to set the mode.
<b>Couplings</b>	When the time is set manually, Auto is set to OFF. Value is coupled with Channel Detector selection, Channel Resolution BW, Channel Video BW if the state is Auto. When set to Auto, the Sweep Time is automatically calculated
<b>Preset</b>	Automatically calculated ON
<b>State Saved</b>	Saved in instrument state.
<b>Min</b>	1 ms
<b>Max</b>	4000 s
<b>Initial S/W Revision</b>	Prior to A.02.00
<b>Modified at S/W Revision</b>	A.02.00, A.03.00

## Res BW

Sets the resolution bandwidth used to calculate the power in the reference channel. The Channel Resolution BW can be set manually or put in to auto mode.

MSR Auto RBW:

In the MSR resolution bandwidth is predefined for each radio format. When carriers are configured with multiple radio formats, the narrowest RBW is selected.

LTE	1.4 MHz	13
	3 MHz	27
	5 MHz	47
	10 MHz	91
	15 MHz	150
	20 MHz	180
W-CDMA		75
GSM		30

In LTE-Advanced FDD/TDD, the resolution bandwidth is predefined based on the corresponding bandwidth of the single LTE carrier, which is listed above. When ResBW mode is Auto, the narrowest RBW is selected.

Key Path	Meas Setup, Ref Channel
Mode	SA, WCDMA, C2K, WIMAX OFDMA, TD-SCDMA, 1xEVDO, DTMB (CTTB), DVB-T/H, ISDB-T, CMMB, LTE, LTE-TDD, Digital Cable TV, WLAN, MSR, LTEAFDD, LTEATDD
Remote Command	<pre>[ :SENSe]:SEMask:BANDwidth[1] 2[:RESolution] &lt;bandwidth&gt; [:SENSe]:SEMask:BANDwidth[1] 2[:RESolution]? [:SENSe]:SEMask:BANDwidth[1] 2[:RESolution]:AUTO OFF ON 1 0 [:SENSe]:SEMask:BANDwidth[1] 2[:RESolution]:AUTO?</pre>
Example	<pre>SEM:BAND 100 kHz SEM:BAND? SEM:BAND:AUTO ON SEM:BAND:AUTO?</pre>
Notes	<p>Bandwidth sub op code, 1 is for BTS, 2 for MS. Default is BTS.</p> <p>You must be in the mode that includes SEM measurement to use this command. Use :INSTrument:SElect to set the mode.</p>
Couplings	<p>When Res BW is set manually, Channel Resolution BW Mode is set to MANual.</p> <p>Value is coupled with Channel Detector selection, Channel Sweep Time, Channel Video BW.</p> <p>When set to Auto, the resolution bandwidth is automatically calculated.</p>
Preset	<pre>SA: 100 kHz WCDMA: 75 kHz C2K: 24 kHz WIMAX OFDMA: 100 kHz TD-SCDMA: 30 kHz 1xEVDO: 30.0 KHz DTMB (CTTB): 3.9 kHz DVB-T/H: 3.9 kHz ISDB-T: 10 kHz CMMB: 3.9 kHz</pre>

	LTE, , LTETDD, , MSR, , LTEAFDD, , LTEATDD:Auto (47 kHz) Digital Cable TV: 3.9 kHz WLAN: 100 kHz ON
State Saved	Saved in instrument state.
Min	1 Hz
Max	8 MHz
<b>Backwards Compatibility SCPI</b>	[ :SENSe ] :SEMAsk :BWIDth [ 1 ]   2 [ :RESolution ]
Initial S/W Revision	Prior to A.02.00
Modified at S/W Revision	A.02.00, A.03.00

## Video BW

Sets the video bandwidth used to calculate the power in the reference channel. The Channel Video BW can be set manually or put in to auto mode.

Key Path	Meas Setup, Ref Channel
Mode	SA, WCDMA, C2K, WIMAX OFDMA, TD-SCDMA, 1xEVDO, DTMB (CTTB), DVB-T/H, ISDB-T, CMMB, LTE, LTETDD, Digital Cable TV, WLAN, MSR, LTEAFDD, LTEATDD
<b>Remote Command</b>	[ :SENSe ] :SEMAsk :BANDwidth [ 1 ]   2 :VIDeo <bandwidth> [ :SENSe ] :SEMAsk :BANDwidth [ 1 ]   2 :VIDeo? [ :SENSe ] :SEMAsk :BANDwidth [ 1 ]   2 :VIDeo :AUTO OFF   ON   1   0 [ :SENSe ] :SEMAsk :BANDwidth [ 1 ]   2 :VIDeo :AUTO?
<b>Example</b>	SEM:BAND:VID 100 kHz SEM:BAND:VID? SEM:BAND:VID:AUTO ON SEM:BAND:VID:AUTO?
Notes	Bandwidth sub op code, 1 is for BTS, 2 for MS. Default is BTS. You must be in the mode that includes SEM measurement to use this command. Use :INSTrument:SElect to set the mode.
Couplings	When Video BW is set manually, Channel Video BW Mode is set to MANual Value is coupled with Channel Detector selection, Channel Sweep Time, Channel Resolution BW. When set to Auto, the video bandwidth is automatically calculated.
Preset	SA: 100 kHz WCDMA: 75 kHz C2K: 24 kHz WIMAX OFDMA: 30 kHz TD-SCDMA: 300 kHz 1xEVDO: 300.0 kHz



	DTMB (CTTB): 39 kHz DVB-T/H: 39 kHz ISDB-T: 1 kHz CMMB: 39 kHz LTE, MSR, LTEAFDD, LTEATDD: Auto LTETDD: Auto Digital Cable TV: 39 kHz WLAN: Auto ON
State Saved	Saved in instrument state.
Min	1 Hz
Max	50 MHz
<b>Backwards Compatibility SCPI</b>	[ :SENSe ] :SEMAsk:BWIDth [ 1 ]   2 :VIDeo
Initial S/W Revision	Prior to A.02.00
Modified at S/W Revision	A.02.00, A.03.00

## VBW/RBW

Sets the Video BW/Resolution BW Ratio to calculate the Channel Resolution BW and Channel Video BW. The VBW/RBW Ratio can be set manually or put in to auto mode.

Key Path	Meas Setup, Ref Channel
Mode	SA, WCDMA, C2K, WIMAX OFDMA, TD-SCDMA mode, 1xEVDO, DTMB (CTTB), DVB-T/H, ISDB-T, CMMB, LTE, LTETDD, Digital Cable TV, WLAN, MSR, LTEAFDD, LTEATDD
<b>Remote Command</b>	[ :SENSe ] :SEMAsk:BA NDwidth [ 1 ]   2 :VIDeo:RATio <real> [ :SENSe ] :SEMAsk:BA NDwidth [ 1 ]   2 :VIDeo:RATio [ :SENSe ] :SEMAsk:BA NDwidth [ 1 ]   2 :VIDeo:RATio:AUTO OFF ON 1 0 [ :SENSe ] :SEMAsk:BA NDwidth [ 1 ]   2 :VIDeo:RATio:AUTO?
<b>Example</b>	SEM:BA ND:VID:RAT 0.1 SEM:BA ND:VID:RAT? SEM:BA ND:VID:RAT:AUTO ON SEM:BA ND:VID:RAT:AUTO?
Notes	Bandwidth sub op code, 1 is for BTS, 2 for MS. Default is BTS. You must be in the mode that includes SEM measurement to use this command. Use :INSTrument:SElect to set the mode.
Couplings	When Video BW/Res BW is set manually, Channel VBW/RBW Ratio Mode is set to MANual When set to Auto, the VBW/RBW Ratio is automatically calculated.
Preset	SA, WCDMA, C2K: 1.0 WIMAX OFDMA: 0.3

	TD-SCDMA: 10 1xEVDO: 10.0 DTMB (CTTB): 10 DVB-T/H: 10 ISDB-T: 0.1 CMMB: 10 LTE, MSR: Auto LTEAFDD,LTEATDD:Auto LTETDD: Auto Digital Cable TV: 10 WLAN: Auto ON
State Saved	Saved in instrument state.
Min	0.00001
Max	3000000
<b>Backwards Compatibility SCPI</b>	[ :SENSe ] :SEMAsk:BWIDth [ 1 ]   2 :VIDeo:RATio
Initial S/W Revision	Prior to A.02.00
Modified at S/W Revision	A.02.00, A.03.00

### Power Ref (for the modes except MSR and LTE-Advanced FDD/TDD)

Sets the power reference in the carrier that will be used to compute the relative values for the offsets.

Key Path	Meas Setup, Ref Channel
Initial S/W Revision	Prior to A.02.00

### Total Power

Sets the power in the carrier (ref channel) that is used to compute the relative power values for the offsets. When the state is set to auto, this value is set to the measured carrier reference power. When set to manual, the result takes on the last measured value, or can be manually entered.

For WLAN 802.11ac (80 MHz + 80 MHz), the higher of the power readouts of the two carriers is used for computing the relative power values for the offset.

Key Path	Meas Setup, Ref Channel, Power Ref
Mode	SA, WCDMA, C2K, WIMAX OFDMA, TD-SCDMA, 1xEVDO, DTMB (CTTB), DVB-T/H, ISDB-T, CMMB, LTE, LTETDD, Digital Cable TV, WLAN, MSR, LTEAFDD, LTEATDD
<b>Remote Command</b>	[ :SENSe ] :SEMAsk:CARRier [ :POWer ] <real> [ :SENSe ] :SEMAsk:CARRier [ :POWer ] ?

	<code>[ :SENSe ] :SEMask:CARRier:AUTO[:STATe] OFF ON 1 0</code> <code>[ :SENSe ] :SEMask:CARRier:AUTO[:STATe] ?</code>
<b>Example</b>	SEM:CARR 100dBm SEM:CARR? SEM:CARR:AUTO OFF SEM:CARR:AUTO?
<b>Notes</b>	The min and max values given are for Meas Type = Total Pwr Ref. You must be in the mode that includes SEM measurement to use this command. Use :INSTrument:SElect to set the mode.. This BAF SCPI command is available in all the Meas Type case. This BAF SCPI command is not available in MSR and LTE-Advanced FDD/TDD mode.
<b>Dependencies</b>	This "Total Power Ref" parameter is coupled with the "Meas Type" parameter. The softkey is active when Meas Type is set to Total Power Ref. Otherwise, it is grayed out.
<b>Preset</b>	Measured carrier reference power
<b>State Saved</b>	Saved in instrument state.
<b>Min</b>	-200 dBm
<b>Max</b>	200 dBm
<b>Initial S/W Revision</b>	Prior to A.02.00
<b>Modified at S/W Revision</b>	A.02.00, A.03.00

## PSD

Sets the power spectral density in the carrier that is used to compute the relative power spectral density values for the offsets when Meas Type is set to PSD Ref. When the state is set to auto, this will be set to the measured carrier power spectral density.

For WLAN 802.11ac (80 MHz + 80 MHz), the higher of the power density readouts of the two carriers is used for computing the relative PSD values for the offset.

<b>Key Path</b>	Meas Setup, Ref Chan, Power Ref
<b>Mode</b>	SA, WCDMA, C2K , WIMAX OFDMA, TD-SCDMA, 1xEVDO, DTMB (CTTB), DVB-T/H, ISDB-T, CMMB, LTE, LTE-TDD, Digital Cable TV, WLAN, MSR, LTEAFDD, LTEATDD
<b>Remote Command</b>	<code>[ :SENSe ] :SEMask:CARRier:CPSD &lt;real&gt;</code> <code>[ :SENSe ] :SEMask:CARRier:CPSD?</code>
<b>Example</b>	SEM:CARR:CPSD -80 SEM:CARR:CPSD?
<b>Notes</b>	Although the default value is defined, the value is recalculated by the measurement result just after completing the measurement. Carrier sub op code. 1 for BTS, 2 for MS. Default is BTS. You must be in the mode that includes SEM measurement to use this command. Use :INSTrument:SElect to set the mode.

Dependencies	See Couplings
Couplings	This "PSD" parameter is coupled with the "Meas Type" parameter. The key will be active if the Meas Type is set to PSD. Otherwise, it is grayed out.
Preset	Measured carrier PSD reference power
State Saved	Saved in instrument state.
Min	-200
Max	200
Initial S/W Revision	Prior to A.02.00
Modified at S/W Revision	A.02.00, A.03.00

### Spectrum Peak

Sets the spectrum peak power in the carrier that is used to compute the relative power spectral density values for the offsets when Meas Type is set to Spectrum Peak. When the state is set to auto, this is set to the measured carrier spectrum peak power. When set to manual, the result takes on the last measured value, or can be manually entered

Key Path	Meas Setup, Ref Channel, Power Ref
Mode	SA, WCDMA, C2K, WIMAX OFDMA, TD-SCDMA, 1xEVDO, DTMB (CTTB), DVB-T/H, ISDB-T, CMMB, LTE, LTETDD, Digital Cable TV, WLAN
Remote Command	[ :SENSe ] :SEMAsk :CARRier :PEAK [ :POWer ] <real> [ :SENSe ] :SEMAsk :CARRier :PEAK [ :POWer ] ?
Example	SEM:CARR:PEAK -80 SEM:CARR:PEAK:POWER?
Notes	Although the default value is defined, the value is recalculated by the measurement result just after completing the measurement. Carrier sub op code. 1 for BTS, 2 for MS. Default is BTS. You must be in the mode that includes SEM measurement to use this command. Use :INSTRument:SElect to set the mode.
Dependencies	See Couplings
Couplings	This "Spectrum Peak Ref" parameter is coupled with the "Meas Type" parameter. This softkey is active when the "Meas Type" is set to "Spectrum Peak Ref". Otherwise, grayout.
Preset	Measured carrier Spectrum Peak reference power
State Saved	Saved in instrument state.
Min	-200
Max	200
Initial S/W Revision	Prior to A.02.00
Modified at S/W Revision	A.02.00, A.03.00

## Offset/Limits

Accesses a menu that enables you to set up the measurement parameters for offset pairs. For example, you can assign the start and stop frequencies, select the resolution bandwidth, and set the sweep time. When in the MSR and LTE-Advanced FDD/TDD mode, the softkey label changes to Outer Offset/Limits.

Key Path	Meas Setup
Initial S/W Revision	Prior to A.02.00
Modified at S/W Revision	A.14.00

## Select Offset

Selects the offset (upper and lower) and displays the memory selection menu that enables you to store a set of parameter values for the offset, such as Start Freq, Stop Freq, Sweep Time, Res BW, Meas BW, Abs Start, and Abs Stop. Only one selection at a time is shown on this menu key label.

Key Path	Meas Setup, Offset/Limits
Mode	SA, WCDMA, C2K, WIMAX OFDMA, TD-SCDMA, 1xEVDO, DTMB (CTTB), DVB-T/H, ISDB-T, CMMB, LTE, LTE-TDD, Digital Cable TV, WLAN, MSR, LTEAFDD, LTEATDD
Preset	A
Range	MSR, LTEATDD, LTEAFDD, WLAN: A B C D E F G H  J K L Other modes without option N9060A-7FP: A B C D E F Other modes with option N9060A-7FP: A B C D E F G H  J K L
Initial S/W Revision	Prior to A.02.00
Modified at S/W Revision	A.02.00, A.03.00, A.10.00, A.11.00, A.14.00

## Start Freq

Specifies the start frequency for the currently selected offset. Also enables you to toggle that offset between On and Off.

Missing values are not permitted; that is, if you want to change values 2 and 6, you must send all values up to 6. Subsequent values will remain as they were. The query for this parameter always returns 12 values.

Key Path	Meas Setup, Offset/Limits
Mode	SA, WCDMA, C2K, WIMAX OFDMA, TD-SCDMA, 1xEVDO, DTMB (CTTB), DVB-T/H, ISDB-T, CMMB, LTE, LTE-TDD, Digital Cable TV, WLAN, MSR, LTEAFDD, LTEATDD
Remote Command	[ :SENSe ] :SEMAsk:OFFSet [ 1 ]   2 [ :OUTer ] :LIST:FREQuency:STARt <freq>, ... [ :SENSe ] :SEMAsk:OFFSet [ 1 ]   2 [ :OUTer ] :LIST:FREQuency:STARt? [ :SENSe ] :SEMAsk:OFFSet [ 1 ]   2 [ :OUTer ] :LIST:STATe ON OFF 1 0, ... [ :SENSe ] :SEMAsk:OFFSet [ 1 ]   2 [ :OUTer ] :LIST:STATe?
Example	SEM:OFFS2:LIST:FREQ:STAR 2.515 MHz, , 2.715 MHz, , 3.515 MHz, , 4.00 MHz, , 8.00 MHz, , 12.50 MHz

	<p>SEM:OFFS2:LIST:FREQ:STAR? SEM:OFFS:LIST:STAT ON, , ON, , ON, , OFF, , OFF, , OFF SEM:OFFS:LIST:STAT?</p>
Notes	<p>Comma separated list of values. OFFSet1 is for BTS, 2 for MS. Default is BTS. You must be in the mode that includes SEM measurement to use this command. Use :INSTrument:SElect to set the mode.</p>
Couplings	<p>Coupled to Stop Freq. When the start freq goes above the stop freq, the stop freq is automatically adjusted to the start freq plus 100 Hz. If the current mode is DVB-T/H, this value will be modified automatically according to the limit type and the output power of the transmitter which is less or more than 25 W. If the current mode is ISDB-T, this value will be modified automatically according to the limit type.</p>
Preset	<p>For modes (except MSR, , LTEAFDD, , LTEATDD and WLAN) without option N9060A-7FP, , the preset value is as follows. SA: 2.515 MHz, , 2.715 MHz, , 3.515 MHz, , 4.00 MHz, , 8.00 MHz, , 12.50 MHz WCDMA: 2.515 MHz, , 2.715 MHz, , 3.515 MHz, , 4.000 MHz, , 8.000 MHz, , 12.50 MHz 2.515MHz, , 4.000 MHz, , 7.500 MHz, , 8.500 MHz, , 12.5 MHz, , 15 MHz C2K: 750.0 kHz, , 780.0 kHz, , 1.980 MHz, , 3.25 MHz, , 7.0 MHz, , 7.0 MHz 885 kHz, , 1.980 MHz, , 2.250 MHz, , 8.0 MHz, , 12.0 MHz, , 12.0 MHz WIMAX OFDMA: 4.75 MHz, 5.45 MHz, 9.75 MHz, 14.75 MHz, 19.75 MHz, 24.75 MHz 4.75 MHz, 5.45 MHz, 9.75 MHz, 14.75 MHz, 19.75 MHz, 24.75 MHz TD-SCDMA: 81 5kHz, 1015 kHz, 1815 kHz, 2.3 MHz, , , 2.3 MHz, , 2.3 MHz  815 kHz, 1.8 MHz, 2.9 MHz, , 2.9 MHz, 2.9 MHz, , 2.9 MHz 1xEVDO: 750.0 kHz, , 780.0 kHz, , 1.98 MHz, , 3.25 MHz, , 7 MHz, , 7 MHz 885.0 kHz, , 1.98 MHz, , 1.98 MHz, , 1.98 MHz, , 1.98 MHz DTMB (CTTB): 3.8 MHz, , 4.2 MHz, , 6 MHz, , 6 MHz, , 6 MHz, 6 MHz  6MHz, , 6MHz, , 6MHz, , 6MHz, , 6MHz, , 6MHz DVB-T/H: 3.81 MHz, , 4.2 MHz, , 6 MHz, , 6 MHz, , 6 MHz, , 6 MHz  6MHz, , 6MHz, , 6MHz, , 6MHz, , 6MHz ISDB-T: 2.79 MHz, , 2.86 MHz, , 3.0 MHz, , 4.36 MHz, , 6 MHz, , 6 MHz  6MHz, , 6MHz, , 6MHz, , 6MHz, , 6MHz, , 6MHz CMMB: 3.8 MHz, , 4.2 MHz, , 8.0 MHz, , 6 MHz, , 6 MHz, , 6 MHz  6MHz, , 6MHz, , 6MHz, , 6MHz, , 6MHz LTE, , LTETDD: 50 kHz, , 5.05 MHz, , 10.5 MHz, , 15.00 MHz, , 30 MHz, , 40 MHz 15.00 kHz, 1.5 MHz, 5.5 MHz, 6.5 MHz, 10 MHz, 20MHz Digital Cable TV: 3.8 MHz, , 4.2 MHz, , 6 MHz, , 6 MHz, , 6 MHz, , 6 MHz  6MHz, , 6MHz, , 6MHz, , 6MHz, , 6MHz When option N9060A-7FP is installed in these modes, , the preset value of Offset G ~ L is the same as the Offset F value. ----- WLAN: if Radio Std is 802.11a/g(OFDM/DSSS-OFDM)/802.11n(20MHz): 9 MHz, , 11 MHz, , 20 MHz, , 30</p>

---

MHz, 50 MHz, 216 MHz, 216 MHz, 216 MHz, 216 MHz, 216 MHz, 216 MHz, 216 MHz, 216 MHz

if Radio Std is 802.11b/g(DSSS/CCK/PBCC): 11 MHz, 22 MHz, 50 MHz, 70 MHz, 90 MHz, 100 MHz, 100 MHz, 100 MHz, 100 MHz, 100 MHz, 100 MHz, 100 MHz

if Radio Std is 802.11n(20MHz): 9 MHz, 11 MHz, 20 MHz, 30 MHz, 50 MHz, 100 MHz, 100 MHz, 100 MHz, 100 MHz, 100 MHz, 100 MHz

if Radio Std is 802.11n(40MHz): 19 MHz, 21 MHz, 40 MHz, 60 MHz, 100 MHz, 200 MHz, 200 MHz, 200 MHz, 200 MHz, 200 MHz, 200 MHz

if Radio Std is 802.11ac(20MHz): 9 MHz, 11 MHz, 20 MHz, 30 MHz, 30 MHz, 30 MHz, 30 MHz, 30 MHz, 30 MHz, 30 MHz, 30 MHz

if Radio Std is 802.11ac(40MHz): 19 MHz, 21 MHz, 40 MHz, 60 MHz, 60 MHz, 60 MHz, 60 MHz, 60 MHz, 60 MHz, 60 MHz, 60 MHz

if Radio Std is 802.11ac(80MHz): 39 MHz, 41 MHz, 80 MHz, 120 MHz, 120 MHz, 120 MHz, 120 MHz, 120 MHz, 120 MHz, 120 MHz, 120 MHz

if Radio Std is 802.11ac(160MHz): 79 MHz, 81 MHz, 160 MHz, 240 MHz, 240 MHz, 240 MHz, 240 MHz, 240 MHz, 240 MHz, 240 MHz, 240 MHz

if Radio Std is 802.11ac(80 MHz + 80MHz): 0 MHz, 40 MHz, 79 MHz, 159 MHz, 161 MHz, 200 MHz, 240 MHz, 240 MHz, 240 MHz, 240 MHz, 240 MHz, 240 MHz

MSR:15 kHz, 215kHz, 1.015MHz, 1.5MHz, 10.5MHz, 15.00MHz, 30MHz, 30MHz, 30MHz, 30MHz, 30MHz | 15kHz, 215kHz, 1.015MHz, 1.5MHz, 10.5MHz, 15.00MHz, 30MHz, 30MHz, 30MHz, 30MHz, 30MHz, 30MHz, 30MHz

LTEAFDD, LTEATDD: 50 kHz, 5.05 MHz, 10.5 MHz, 15.00 MHz, 30 MHz, 40 MHz, 40 MHz, 40 MHz, 40 MHz, 40 MHz, 40 MHz | 15.00 kHz, 1.5 MHz, 5.5 MHz, 6.5 MHz, 10 MHz, 20MHz, 20MHz, 20MHz, 20MHz, 20MHz, 20MHz, 20MHz

For modes (except MSR, LTEAFDD, LTEATDD and WLAN) without option N9060A-7FP, the preset value is as follows.

SA: ON, ON, ON, ON, ON, OFF

WCDMA: ON, ON, ON, ON, ON, OFF|ON, ON, ON, ON, OFF, OFF

C2K: ON, ON, ON, OFF, OFF, OFF|ON, ON, OFF, OFF, OFF, OFF

WIMAX OFDMA: ON, ON, ON, OFF, OFF, OFF|ON, ON, ON, OFF, OFF, OFF

TD-SCDMA: ON, ON, ON, ON, OFF, OFF|ON, ON, ON, OFF, OFF, OFF

1xEVDO: ON, ON, ON, OFF, OFF, OFF|ON, ON, OFF, OFF, OFF, OFF

DTMB (CTTB), DVB-T/H, CMMB, Digital Cable TV: ON, ON, ON, OFF, OFF, OFF

ISDB-T: ON, ON, ON, ON, OFF, OFF

LTE, LTE-TDD: ON, ON, ON, OFF, OFF, OFF|ON, ON, ON, ON, OFF, OFF

When option N9060A-7FP is installed in these modes, the preset value of Offset G ~ L is the same as the Offset F value.

-----

WLAN:

if Radio Std is 802.11b/g(DSSS/CCK/PBCC): ON, ON, OFF, OFF, OFF, OFF, OFF, OFF, OFF, OFF, OFF, OFF

if Radio Std is 802.11a/g(OFDM/DSSS-OFDM)/802.11n(20MHz/40MHz): ON, ON, ON, ON, OFF, OFF, OFF, OFF, OFF, OFF, OFF, OFF

if Radio Std is 802.11ac (20 MHz/ 40 MHz/ 80 MHz/ 160 MHz): ON, ON, ON, ON, OFF, OFF, OFF, OFF, OFF, OFF, OFF, OFF

---

	if Radio Std is 802.11ac (80 MHz + 80 MHz): ON, , ON, , ON, , ON, , ON, , ON, , OFF, , OFF, , OFF, , OFF, , OFF MSR:ON, , ON, , ON, , ON, , ON, , OFF, , OFF, , OFF, , OFF, , OFF, , OFF, , OFF ON, , ON, , ON, , ON, , ON, , OFF, , OFF, , OFF, , OFF, , OFF, , OFF, , OFF LTEAFDD, , LTEATDD: ON, , ON, , ON, , OFF, , OFF, , OFF, OFF, , OFF, , OFF, , OFF, OFF, OFF   ON, , ON, , ON, , ON, , OFF, , OFF, , OFF, , OFF, , OFF, , OFF, , OFF, , OFF, , OFF
State Saved	Saved in instrument state.
Min	0 Hz
Max	499.9999 MHz
Initial S/W Revision	Prior to A.02.00
Modified at S/W Revision	A.02.00, A.03.00, A.10.00, A.11.00, A.14.00

## Stop Freq

Specifies the stop frequency for the currently selected offset.

Missing values are not permitted; that is, if you want to change values 2 and 6, you must send all values up to 6. Subsequent values will remain as they were. The query for this parameter always returns 12 values.

Key Path	Meas Setup, Offset/Limits
Mode	SA, WCDMA, C2K, WIMAX OFDMA, TD-SCDMA, 1xEVDO, DTMB (CTTB), DVB-T/H, ISDB-T, CMMB, LTE, LTE-TDD, Digital Cable TV, WLAN, MSR, LTEAFDD, LTEATDD
Remote Command	[ :SENSE ] :SEMAsk:OFFSet [1]   2 [ :OUTer ] :LIST:FREQuency:STOP <freq>, ... [ :SENSE ] :SEMAsk:OFFSet [1]   2 [ :OUTer ] :LIST:FREQuency:STOP?
Example	SEM:OFFS:LIST:FREQ:STOP 2.715 MHz, , 3.515 MHz, , 4.00 MHz, , 8.00 MHz, , 12.50 MHz, , 15.0 MHz SEM:OFFS:LIST:FREQ:STOP?
Notes	Comma separated list of values. OFFSet1 is for BTS, 2 for MS. Default is BTS. You must be in the mode that includes SEM measurement to use this command. Use :INSTrument:SElect to set the mode.
Couplings	Coupled to Start Freq. When the stop freq goes below the start freq, the start freq is automatically adjusted to the stop freq minus 100 Hz. If the current mode is DVB-T/H, this value will be modified automatically according to the limit type and the output power of the transmitter which is less or more than 25 W. If the current mode is ISDB-T, this value will be modified automatically according to the limit type.
Preset	For modes (except MSR, , LTEAFDD, , LTEATDD and WLAN) without option N9060A-7FP, , the preset value is as follows. SA: 2.715 MHz, , 3.515 MHz, , 4.00 MHz, , 8.00 MHz, , 12.50 MHz, , 15.0 MHz WCDMA:2.715 MHz, , 3.515 MHz, , 4.000 MHz, , 8.000 MHz, , 12.50 MHz, , 15.0 MHz 3.485 MHz, , 7.500 MHz, , 8.500 MHz, , 12.00 MHz, , 15.00 MHz, , 18.0 MHz



---

C2K: 780.0kHz , 1.980 MHz , 4.0 MHz , 4.0 MHz , 12.0 MHz , 12.0 MHz | 1.980 MHz , 4.0 MHz , 4.0 MHz , 11.5 MHz , 14.5 MHz , 14.5 MHz

WIMAX OFDMA: 5.45 MHz , 9.75 MHz , 14.75 MHz , 19.75 MHz , 24.75 MHz , 29.75 MHz | 5.45 MHz , 9.75 MHz , 14.75 MHz , 19.75 MHz , 24.75 MHz , 29.75 MHz

TD-SCDMA:

1015 kHz , 1815kHz , 2.3 MHz , 4 MHz , 4 MHz , 4 MHz | 1.8 MHz , 2385 kHz , 3.5 MHz , 3.5 MHz , 3.5 MHz , 3.5 MHz

1xEVDO: 780.0 kHz , 1.98 MHz , 4.0 MHz , 4.0 MHz , 12 MHz , 12 MHz | 1.98 MHz , 4.0 MHz , 4.0 MHz , 4.0 MHz , 4.0 MHz , 4.0 MHz

DTMB (CTTB): 4.2 MHz , 6 MHz , 12 MHz , 12 MHz , 12 MHz , 12 MHz | 12 MHz , 12 MHz , 12 MHz , 12 MHz , 12 MHz , 12 MHz

DVB-T/H: 4.2 MHz , 6 MHz , 12 MHz , 12 MHz , 12 MHz , 12 MHz | 12 MHz , 12 MHz , 12 MHz , 12 MHz , 12 MHz , 12 MHz

ISDB-T: 2.86 MHz , 3.0 MHz , 4.36 MHz , 15.0 MHz , 15.0 MHz , 15.0 MHz | 15MHz , 15MHz , 15MHz , 15MHz , 15MHz , 15MHz

CMMB: 4.2 MHz , 8.0 MHz , 12.0 MHz , 12.0 MHz , 12.0 MHz , 12.0 MHz | 12 MHz , 12 MHz , 12 MHz , 12 MHz , 12 MHz , 12 MHz

LTE , LTE-TDD: 5.05 MHz , 10.05 MHz , 15 MHz , 30 MHz , 40 MHz , 50 MHz | 985.0 kHz , 4.50 MHz , 5.5001 MHz , 9.50 MHz , 20 MHz , 40 MHz

Digital Cable TV: 4.2 MHz , 6.0 MHz , 12.0 MHz , 12.0 MHz , 12.0 MHz , 12.0 MHz , 12 MHz , 12 MHz , 12 MHz , 12 MHz , 12 MHz , 12 MHz

When option N9060A-7FP is installed in these modes , the preset value of Offset G ~ L is the same as the Offset F value.

-----

WLAN:

if Radio Std is 802.11a/g(OFDM/DSSS-OFDM)/802.11n(20MHz): 11 MHz , 20 MHz , 30 MHz , 50 MHz , 100 MHz , 250 MHz , 250 MHz , 250 MHz , 250 MHz , 250 MHz , 250 MHz , 250 MHz

if Radio Std is 802.11b/g(DSSS/CCK/PBCC): 22 MHz , 50 MHz , 70 MHz , 90 MHz , 100 MHz , 120 MHz , 120 MHz , 120 MHz , 120 MHz , 120 MHz , 120 MHz , 120 MHz

if Radio Std is 802.11n(20MHz): 11 MHz , 20 MHz , 30 MHz , 50 MHz , 100 MHz , 200 MHz , 200 MHz , 200 MHz , 200 MHz , 200 MHz , 200 MHz , 200 MHz

if Radio Std is 802.11n(40MHz): 21 MHz , 40 MHz , 60 MHz , 100 MHz , 200 MHz , 300 MHz , 300 MHz , 300 MHz , 300 MHz , 300 MHz , 300 MHz , 300 MHz

if Radio Std is 802.11ac(20MHz): 11 MHz , 20 MHz , 30 MHz , 50 MHz , 50 MHz , 50 MHz , 50 MHz , 50 MHz , 50 MHz , 50 MHz , 50 MHz , 50 MHz

if Radio Std is 802.11ac(40MHz): 21 MHz , 40 MHz , 60 MHz , 100 MHz , 100 MHz , 100 MHz , 100 MHz , 100 MHz , 100 MHz , 100 MHz , 100 MHz , 100 MHz

if Radio Std is 802.11ac(80MHz): 41 MHz , 80 MHz , 120 MHz , 200 MHz , 200 MHz , 200 MHz , 200 MHz , 200 MHz , 200 MHz , 200 MHz , 200 MHz , 200 MHz

if Radio Std is 802.11ac(160MHz): 81 MHz , 160 MHz , 240 MHz , 400 MHz , 400 MHz , 400 MHz , 400 MHz , 400 MHz , 400 MHz , 400 MHz , 400 MHz , 400 MHz

if Radio Std is 802.11ac(80 MHz + 80MHz): 40 MHz , 79 MHz , 81 MHz , 161 MHz , 200 MHz , 240 MHz , 260 MHz , 260 MHz , 260 MHz , 260 MHz , 260 MHz , 260 MHz

MSR: 215kHz , 1.015MHz , 1.5MHz , 10.5MHz , 50MHz , 50MHz , 50MHz , 50MHz , 50MHz ,

---

	50MHz, , 50MHz, , 50MHz LTEAFDD, , LTEATDD: 5.05 MHz, , 10.05 MHz, , 15 MHz, , 30 MHz, , 40 MHz, , 50 MHz, , 50 MHz, , 50 MHz, , 50 MHz, , 50 MHz, , 50 MHz   985.0 kHz, , 4.50 MHz, , 5.5001 MHz, , 9.50 MHz, 20 MHz, , 40 MHz, , 40 MHz, , 40 MHz, , 40 MHz, , 40 MHz, , 40 MHz, , 40 MHz
State Saved	Saved in instrument state.
Min	100 Hz
Max	500 MHz
Initial S/W Revision	Prior to A.02.00
Modified at S/W Revision	A.02.00, A.03.00, A.10.00, A.11.00, A.14.00

## Sweep Time

Specifies the sweep time for the currently selected offset and enables you to toggle the Sweep Time mode between Auto and Man.

Missing values are not permitted; that is, if you want to change values 2 and 6, you must send all values up to 6. Subsequent values will remain as they were. The query for this parameter always returns 12 values.

Key Path	Meas Setup, Offset/Limits
Mode	SA, WCDMA, C2K, WIMAX OFDMA, TD-SCDMA, 1xEVDO, DTMB (CTTB), DVB-T/H, ISDB-T, CMMB, LTE, LTETDD, Digital Cable TV, WLAN, MSR, LTEAFDD, LTEATDD
Remote Command	[ :SENSE ] :SEMAsk:OFFSet [ 1 ]   2 [ :OUTer ] :LIST:SWEep:TIME <time>, ... [ :SENSE ] :SEMAsk:OFFSet [ 1 ]   2 [ :OUTer ] :LIST:SWEep:TIME? [ :SENSE ] :SEMAsk:OFFSet [ 1 ]   2 [ :OUTer ] :LIST:SWEep:TIME:AUTO ON   OFF   1   0, ... [ :SENSE ] :SEMAsk:OFFSet [ 1 ]   2 [ :OUTer ] :LIST:SWEep:TIME:AUTO?
Example	SEM:OFFS2:LIST:SWE:TIME 1.0 ms, , 3.4 ms, , 2.08 ms, , 1.0 ms, , 1.0 ms, , 1.0 ms SEM:OFFS2:LIST:SWE:TIME? SEM:OFFS2:LIST:SWE:TIME:AUTO ON, , ON, , ON, , ON, , OFF, , OFF SEM:OFFS2:LIST:SWE:TIME:AUTO?
Notes	Comma separated list of values. OFFSet1 is for BTS, 2 for MS. Default is BTS. You must be in the mode that includes SEM measurement to use this command. Use :INSTrument:SElect to set the mode.
Couplings	When the sweep time is set manually, Sweep Time Mode is set to MANual. If the current mode is DVB-T/H, this value will be modified automatically according to the output power of the transmitter which is less or more than 25W. If the current mode is ISDB-T, this value will be modified automatically according to the limit type.
Preset	Automatically calculated Modes (except MSR, , LTEAFDD, , LTEATDD and WLAN) without option N9060A-7FP: ON, ON, ON, ON, ON, ON

	Modes (except MSR, , LTEAFDD, , LTEATDD and WLAN) with option N9060A-7FP: ON, ON, ON, ON, ON, ON, ON, ON, ON, ON, ON, ON, ON, ON, ON, ON WLAN: ON, ON, ON, ON, ON, ON, ON, ON, ON, ON, ON, ON, ON, ON, ON, ON MSR: ON,ON,ON,ON,ON,ON,ON,ON,ON,ON,ON,ON,ON,ON,ON,ON LTEAFDD, , LTEATDD: ON, ON, ON, ON, ON, ON, ON, ON, ON, ON, ON, ON, ON, ON, ON   ON, ON, ON, ON, ON, ON, ON, ON, ON, ON, ON, ON, ON, ON, ON, ON
State Saved	Saved in instrument state.
Min	1 ms
Max	4000 s
<b>Backwards Compatibility SCPI</b>	[ :SENSe ] :SEMask:OFFSet [ 1 ]   2 :LIST:SWEep [ :TIME ]
Initial S/W Revision	Prior to A.02.00
Modified at S/W Revision	A.02.00, A.03.00, A.10.00, A.11.00, A.14.00

### Offset Side

Specifies which offset side to measure.

You can turn off (not use) specific offsets with [:SENSe]:SEMask:OFFSet[n][:OUTer]:LIST:STATe.

- BOTH – Both of the negative (lower) and positive (upper) sidebands
- NEGative – Negative (lower) sideband only
- POSitive – Positive (upper) sideband only

Missing values are not permitted; that is, if you want to change values 2 and 6, you must send all values up to 6. Subsequent values will remain as they were. The query for this parameter always returns 12 values.

The figure below shows the relation between the negative/positive offset side setups and the upper/lower results in the MSR and LTE-Advanced FDD/TDD.

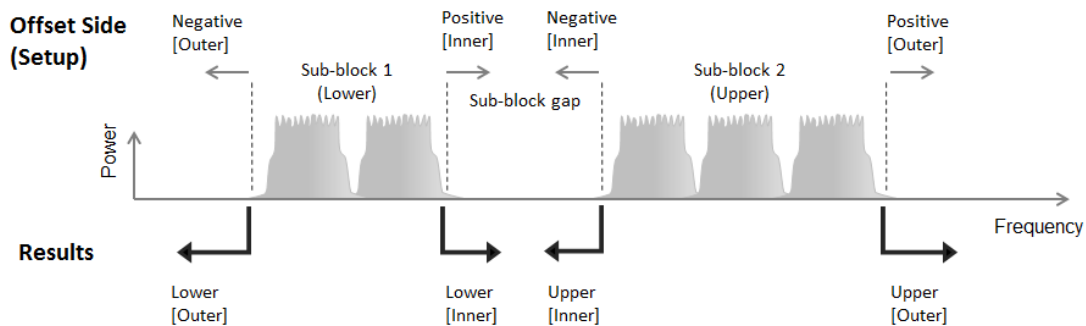

Key Path	Meas Setup, Offset/Limits
Mode	SA, WCDMA, C2K, WIMAX OFDMA, TD-SCDMA, 1xEVDO, DTMB (CTTB), DVB-T/H, ISDB-T, CMMB, LTE, LTEATDD, Digital Cable TV, WLAN, MSR, LTEAFDD, LTEATDD
Remote Command	[ :SENSe ] :SEMask:OFFSet [ 1 ]   2 [ :OUTer ] :LIST:SIDE BOTH   NEGative

	POSitive, ... [:SENSe]:SEMAsk:OFFSet[1] 2[:OUTer]:LIST:SIDE?
<b>Example</b>	SEM:OFFS:LIST:SIDE BOTH, , NEG, , NEG, , POS, , POS, , POS SEM:OFFS:LIST:SIDE?
<b>Notes</b>	Comma separated list of values. OFFSet1 is for BTS, 2 for MS. Default is BTS. You must be in the mode that includes SEM measurement to use this command. Use :INSTrument:SElect to set the mode.
<b>Preset</b>	Modes (except MSR, , LTEAFDD, , LTEATDD and WLAN) without option N9060A-7FP: BOTH, , BOTH, , BOTH, , BOTH, , BOTH, , BOTH Modes (except MSR, , LTEAFDD, , LTEATDD and WLAN) with option N9060A-7FP: BOTH, , BOTH, , BOTH, , BOTH, , BOTH, , BOTH, , BOTH, , BOTH, , BOTH, , BOTH, , BOTH, , BOTH MSR: BOTH, , BOTH, , BOTH, , BOTH, , BOTH, , BOTH, , BOTH, , BOTH, , BOTH, , BOTH, , BOTH, , BOTH LTEAFDD, LTEATDD: BOTH, , BOTH, , BOTH, , BOTH, , BOTH, , BOTH, , BOTH, , BOTH, , BOTH, , BOTH, , BOTH, , BOTH   BOTH, , BOTH, , BOTH, , BOTH, , BOTH, , BOTH, , BOTH, , BOTH, , BOTH, , BOTH, , BOTH, , BOTH WLAN: BOTH, , BOTH, , BOTH, , BOTH, , BOTH, , BOTH, , BOTH, , BOTH, , BOTH, , BOTH, , BOTH, , BOTH
<b>State Saved</b>	Saved in instrument state.
<b>Range</b>	Neg Both Pos
<b>Initial S/W Revision</b>	Prior to A.02.00
<b>Modified at S/W Revision</b>	A.02.00, A.03.00, A.10.00, A.11.00, A.14.00

## Res BW

Specifies which Resolution BW filter to use when measuring the currently selected offset.

Offset Res BW Mode allows the instrument to determine the optimum Resolution BW filter to use when measuring the currently selected offset.. When changing the Meas BW parameter, if the Res BW needs to be changed to adhere to the rule

$$(N \times \text{Res BW}) \leq (\text{Stop freq of the offset} - \text{Start freq of the offset}),$$

where N is the multiplier, this setting will automatically be changed to manual.

Missing values are not permitted; that is, if you want to change values 2 and 6, you must send all values up to 6. Subsequent values will remain as they were. The query for this parameter always returns 12 values.

<b>Key Path</b>	Meas Setup, Offset/Limits
<b>Mode</b>	SA, WCDMA, C2K, WIMAX OFDMA, TD-SCDMA, 1xEVDO mode, DTMB (CTTB), DVB-T/H, ISDB-T, CMMB, LTE, LTE4DD, Digital Cable TV, WLAN, MSR, LTEAFDD, LTEATDD
<b>Remote Command</b>	[:SENSe]:SEMAsk:OFFSet[1] 2[:OUTer]:LIST:BANDwidth[:RESolution] <bandwidth>, ... [:SENSe]:SEMAsk:OFFSet[1] 2[:OUTer]:LIST:BANDwidth[:RESolution]?

	<pre>[ :SENSe ] :SEMask:OFFSet [ 1 ]   2 [ :OUTer ] :LIST:BANDwidth [ :RESolution ] :AUTO OFF   ON   1   0, ...  [ :SENSe ] :SEMask:OFFSet [ 1 ]   2 [ :OUTer ] :LIST:BANDwidth [ :RESolution ] :AUTO?</pre>
<b>Example</b>	<pre>SEM:OFFS2:LIST:BAND 30.0 kHz , 30.0 kHz , 30.0 kHz , 1.00 MHz, 1.00 MHz , 1.00 MHz SEM:OFFS2:LIST:BAND? SEM:OFFS:LIST:BAND:AUTO 1,1,1,1,1,1 SEM:OFFS:LIST:BAND:AUTO?</pre>
<b>Notes</b>	<p>Comma separated list of values.</p> <p>OFFSet1 is for BTS, 2 for MS. Default is BTS.</p> <p>You must be in the mode that includes SEM measurement to use this command. Use :INSTrument:SElect to set the mode.</p>
<b>Couplings</b>	<p>Coupled to Start and Stop offset and Meas BW multiplier. This parameter must adhere to the rule (N x Res BW) &lt;= (Stop freq of the offset - Start freq of the offset), where N is the multiplier. If the multiplier is changed, the Res BW will be changed to ensure this. When set manually, Res BW Coupling is set to manual.</p> <p>The resolution bandwidth is coupled to the offset width determined by the start frequency and stop frequency.</p>
<b>Preset</b>	<p>For modes (except MSR, LTEAFDD, , LTEATDD and WLAN) without option N9060A-7FP, , the preset value is as follows.</p> <p>SA: 30.0 kHz, , 30.0 kHz, , 30.0 kHz, , 1.00 MHz, 1.00 MHz, , 1.00 MHz</p> <p>WCDMA: 30.00 kHz, , 30.00 kHz, , 30.00 kHz, , 100.00 kHz, , 1.000 MHz, , 1.00 MHz 30.00 kHz, , 1.000 MHz, , 1.000 MHz, , 1.000 MHz, , 1.000 MHz, , 1.00 MHz</p> <p>C2K: 3.00 kHz, , 30.00 kHz, , 30.00 kHz, , 6.2 kHz, , 1.000 MHz, , 1.00 MHz 30.00 kHz, , 30.00 kHz, , 6.2 kHz, , 1.000 MHz, , 1.000 MHz, , 1.00 MHz</p> <p>WIMAX OFDMA: 100 KHz, , 100 KHz, , 100 KHz, , 100 KHz, , 100 KHz, , 100 KHz  100 KHz, , 100 KHz, , 100 KHz, , 100 KHz, , 100 KHz, , 100 KHz</p> <p>TD-SCDMA: 30 kHz, , 30 kHz, , 30 kHz, , 50 kHz, , 1 MHz, , 1 MHz  30 kHz, , 30 kHz, , 50 kHz, , 1 MHz, , 1 MHz, , 1 MHz</p> <p>1xEVDO: 30.00 kHz, , 30.00 kHz, , 30.00 kHz, , 6.2 kHz, , 1.000 MHz, , 1.000 MHz 30.00 kHz, , 30.00 kHz, , 30.00 kHz, , 30.00 kHz, , 30.00 kHz</p> <p>DTMB (CTTB), , DVB-T/H, , CMMB, , Digital Cable TV: 3.9 kHz, , 3.9 kHz, , 3.9 kHz, , 3.9 kHz, , 3.9 kHz, , 3.9 kHz  30.00 kHz, , 1.000 MHz, , 1.000 MHz, , 1.000 MHz, , 1.000 MHz, , 1.00 MHz</p> <p>ISDB-T: 10.0 kHz, , 10.0 kHz, , 10.0 kHz, , 10.0 kHz, , 10. kHz, , 10.0 kHz  30.00 kHz, , 1.000 MHz, , 1.000 MHz, , 1.000 MHz, , 1.000 MHz, , 1.00 MHz</p> <p>LTE, , LTETDD: 51 kHz, , 100 kHz, , 1.0 MHz, , 1.0 MHz, 1.0 MHz, , 1.0 MHz 15.0 kHz, , 510 kHz, 1.0 MHz, 1.0 MHz, 1.0 MHz, 1.0 MHz</p> <p>When option N9060A-7FP is installed in these modes, , the preset value of Offset G ~ L is the same as the Offset F value.</p> <p>-----</p> <p>WLAN: 100 KHz, , 100 KHz, , 100 KHz, , 100 KHz, , 100 KHz, , 100 KHz, , 100 KHz, , 100 KHz, , 100 KHz, , 100 KHz, , 100 KHz</p> <p>MSR: 30kHz, , 30kHz, , 30kHz, , 1.0MHz, 1.0MHz, , 1.0MHz, , 1.0MHz, , 1.0MHz, , 1.0MHz, , 1.0MHz, , 1.0MHz   30kHz, , 30kHz, , 30kHz, , 1.0MHz, 1.0MHz, , 1.0MHz, , 1.0MHz, , 1.0MHz, , 1.0MHz, , 1.0MHz</p>

	<p>LTEAFDD, , LTEATDD: 51 kHz, , 100 kHz, , 1.0 MHz, , 1.0 MHz, 1.0 MHz, , 1.0 MHz, 1.0 MHz, 1.0 MHz, 1.0 MHz, 1.0 MHz, 1.0 MHz, 1.0 MHz   15.0 kHz, , 510 kHz, 1.0 MHz, 1.0 MHz, 1.0 MHz, 1.0 MHz, 1.0 MHz, 1.0 MHz, 1.0 MHz, 1.0 MHz, 1.0 MHz, 1.0 MHz</p> <p>Modes (except MSR, , LTEAFDD, , LTEATDD and WLAN) without option N9060A-7FP: OFF, , OFF, , OFF, , OFF, , OFF   OFF, , OFF, , OFF, , OFF, , OFF, , OFF</p> <p>Modes (except MSR, , LTEAFDD, , LTEATDD and WLAN) with option N9060A-7FP: OFF, , OFF, , OFF, , OFF, , OFF, , OFF, , OFF, , OFF, , OFF   OFF, , OFF, , OFF, , OFF, , OFF, , OFF, , OFF, , OFF, , OFF, , OFF, , OFF, , OFF</p> <p>MSR: OFF, , OFF, , OFF, , OFF, , OFF, , OFF, , OFF, , OFF, , OFF, , OFF   OFF, , OFF, , OFF, , OFF, , OFF, , OFF, , OFF, , OFF, , OFF, , OFF</p> <p>LTEAFDD, , LTEATDD: OFF, , OFF, , OFF, , OFF, , OFF, , OFF, , OFF, , OFF, , OFF, , OFF, , OFF, , OFF   OFF, , OFF, , OFF, , OFF, , OFF, , OFF, , OFF, , OFF, , OFF, , OFF, , OFF</p> <p>WLAN: OFF, , OFF, , OFF, , OFF, , OFF, , OFF, , OFF, , OFF, , OFF, , OFF, , OFF   OFF, , OFF, , OFF, , OFF, , OFF, , OFF, , OFF, , OFF, , OFF, , OFF, , OFF</p>
State Saved	Saved in instrument state.
Min	1 Hz
Max	8 MHz
<b>Backwards Compatibility SCPI</b>	[ :SENSE ] :SEMAsk:OFFSet [ 1 ]   2 :LIST:BWIDth [ :RESolution ]
Initial S/W Revision	Prior to A.02.00
Modified at S/W Revision	A.02.00, A.03.00, A.10.00, A.11.00, A.14.00

## Meas BW

Allows you to specify a multiplier of Res BW for the measurement integration bandwidth.

Meas BW is multiplier integer number. It shows a ratio between Integration BW and Resolution BW of the measurement result.

$$\text{Integ BW} = \text{Meas BW} * \text{Resolution BW}$$

Integration BW is desired resolution bandwidth and Resolution BW is actual bandwidth for sweep. Measurement sweeps with Resolution BW and Meas BW compensates sweep resolution bandwidth to Integration BW.

If you set this parameter greater than 1, you can set Resolution BW narrower to avoid carrier power leakage effect to the offset power integration.

Missing values are not permitted; that is, if you want to change values 2 and 6, you must send all values up to 6. Subsequent values will remain as they were. The query for this parameter always returns 12 values.

Key Path	Meas Setup, Offset/Limits
Mode	SA, WCDMA, C2K, WIMAX OFDMA, TD-SCDMA, 1xEVDO, DTMB (CTTB), DVB-T/HISDB-T, CMMB, LTE, LTE-TDD, Digital Cable TV, WLAN
Remote Command	[ :SENSE ] :SEMAsk:OFFSet [ 1 ]   2 [ :OUTer ] :LIST:BWIDth:IMULti <integer>, ... [ :SENSE ] :SEMAsk:OFFSet [ 1 ]   2 [ :OUTer ] :LIST:BWIDth:IMULti?

<b>Example</b>	SEM:OFFS2:LIST:BAND:IMUL 1,1,1,1,1 SEM:OFFS2:LIST:BAND:IMUL?
<b>Notes</b>	Comma separated list of values. OFFSet1 is for BTS, 2 for MS. Default is BTS. You must be in the mode that includes SEM measurement to use this command. Use :INSTrument:SElect to set the mode.
<b>Couplings</b>	This parameter must adhere to the rule (N x Res BW) <= (Stop freq of the offset - Start freq of the offset), where N is the multiplier. If the Res Bw is changed, the multiplier will be changed to ensure this.
<b>Preset</b>	For modes (except MSR, , LTEAFDD, , LTEATDD and WLAN) without option N9060A-7FP, , the preset value is as follows. SA: 1, 1, 1, 1, 1, 1 WCDMA: 1, , 1, , 1, , 10, , 1, , 1 1, , 1, , 1, , 1, , 1 C2K: 10, 1, 1, 1, 1, 1 1, 1, 1, 1, 1, 1 WIMAX OFDMA, , 1xEVDO: 1, , 1, , 1, , 1, , 1 1, , 1, , 1, , 1, , 1 TD-SCDMA:1, , 1, , 1, , 20, , 1, , 1 1, , 1, , 20, , 1, , 1, , 1 DTMB (CTTB), , DVB-T/H, , ISDB-T, , CMMB, , Digital Cable TV: 1, , 1, , 1, , 1, , 1  1, , 1, , 1, , 1, , 1 LTE, , LTETDD: 2, , 1, , 1, , 1, , 1 2, , 2, , 1, , 1, , 1, 1 When option N9060A-7FP is installed in these modes, , the preset value of Offset G ~ L is the same as the Offset F value. ----- WLAN: 1, 1, 1, 1, 1, 1, 1, 1, 1, 1, 1, 1 MSR: 1, , 1, , 1, , 1, , 1, , 1, , 1, , 1, , 1, , 1 1, , 1, , 1, , 1, , 1, , 1, , 1, , 1, , 1, , 1 LTEAFDD, , LTEATDD: 2, , 1, , 1, , 1, , 1, , 1, , 1, , 1, , 1, , 1 2, , 2, , 1, , 1, , 1, , 1, , 1, , 1, , 1, , 1, , 1
<b>State Saved</b>	Saved in instrument state.
<b>Min</b>	1
<b>Max</b>	1000
<b>Backwards Compatibility SCPI</b>	[ :SENSe ] :SEMAsk:OFFSet [ 1 ]   2 :LIST:BWIDth:IMULti
<b>Initial S/W Revision</b>	Prior to A.02.00
<b>Modified at S/W Revision</b>	A.02.00, A.03.00, A.10.00, A.11.00, A.14.00

### Video BW

Changes the analyzer post-detection filter.

Missing values are not permitted; that is, if you want to change values 2 and 6, you must send all values up to 6. Subsequent values will remain as they were. The query for this parameter always returns 12 values.

<b>Key Path</b>	Meas Setup, Offset/Limits
-----------------	---------------------------

Mode	SA, WCDMA, C2K, WIMAXOFDMA, TD-SCDMA, 1xEVDO, DTMB (CTTB), DVB-T/H, ISDB-T, CMMB, LTE, LTEFDD, Digital Cable TV, WLAN, MSR, LTEAFDD, LTEATDD
Remote Command	[:SENSe]:SEMAsk:OFFSet[1] 2[:OUTer]:LIST:BANDwidth:VIDeo <freq>, ... [:SENSe]:SEMAsk:OFFSet[1] 2[:OUTer]:LIST:BANDwidth:VIDeo? [:SENSe]:SEMAsk:OFFSet[1] 2[:OUTer]:LIST:BANDwidth:VIDeo:AUTO OFF   ON   0   1, ... [:SENSe]:SEMAsk:OFFSet[1] 2[:OUTer]:LIST:BANDwidth:VIDeo:AUTO?
Example	SEM:OFFS2:LIST:BAND:VID 3.00 kHz, , 3.00 kHz, , 3.00 kHz, , 100.0 kHz, 100.0 kHz, , 100.0 kHz SEM:OFFS2:LIST:BAND:VID? SEM:OFFS2:LIST:BAND:VID:AUTO ON, , ON, , ON, , ON, , ON SEM:OFFS2:LIST:BAND:VID:AUTO?
Notes	Comma separated list of values. OFFSet1 is for BTS, 2 for MS. Default is BTS. You must be in the mode that includes SEM measurement to use this command. Use :INSTrument:SElect to set the mode.
Preset	ISDB-T: 1.0kHz, , 1.0kHz, , 1.0kHz, , 1.0kHz, , 1.0kHz, , 1.0kHz Other than ISDB-T: Automatically Calculated Modes (except MSR, , LTEAFDD, , LTEATDD, , WLAN, , ISDB-T) without option N9060A-7FP: ON, , ON, , ON, , ON, , ON ON, , ON, , ON, , ON, , ON Modes (except MSR, , LTEAFDD, , LTEATDD, , WLAN, , ISDB-T) with option N9060A-7FP: ON, , ON, , ON, , ON, , ON, , ON, , ON, , ON, , ON, , ON, , ON ON, , ON, , ON, , ON, , ON, , ON, , ON, , ON, , ON ----- MSR, , LTEAFDD, , LTEATDD: ON, , ON, , ON, , ON, , ON, , ON, , ON, , ON, , ON, , ON, , ON ON, , ON, , ON, , ON, , ON, , ON, , ON, , ON, , ON, , ON WLAN: ON, , ON, , ON, , ON, , ON, , ON, , ON, , ON, , ON, , ON, , ON  ON, , ON, , ON, , ON, , ON, , ON, , ON, , ON, , ON, , ON ISDB-T: OFF, , OFF, , OFF, , OFF, , OFF OFF, , OFF, , OFF, , OFF, , OFF, , OFF
State Saved	Saved in instrument state.
Min	1 Hz
Max	50 MHz
Backwards Compatibility SCPI	[:SENSe]:SEMAsk:OFFSet[1] 2:LIST:BWIDth:VIDeo
Initial S/W Revision	Prior to A.02.00
Modified at S/W Revision	A.02.00, A.03.00, A.10.00, A.11.00, A.14.00

## VBW/RBW

Selects the ratio between the video and resolution bandwidths.

Missing values are not permitted; that is, if you want to change values 2 and 6, you must send all values up to 6. Subsequent values will remain as they were. The query for this parameter always returns 12 values.



Key Path	Meas Setup, Offset/Limits
Mode	SA, WCDMA, C2K, WIMAX OFDMA, TD-SCDMA, 1xEVDO, DTMB (CTTB), DVB-T/H, ISDB-T, CMMB, LTE, LTEFDD, Digital Cable TV, WLAN, MSR, LTEAFDD, LTEATDD
Remote Command	<pre>[:SENSe]:SEMask:OFFSet[1] 2[:OUTer]:LIST:BANDwidth:VIDeo:RATio &lt;real&gt;, ... [:SENSe]:SEMask:OFFSet[1] 2[:OUTer]:LIST:BANDwidth:VIDeo:RATio? [:SENSe]:SEMask:OFFSet[1] 2[:OUTer]:LIST:BANDwidth:VIDeo:RATio:AUTO OFF   ON   0   1, ... [:SENSe]:SEMask:OFFSet[1] 2[:OUTer]:LIST:BANDwidth:VIDeo:RATio:AUTO?</pre>
Example	<pre>SEM:OFFS2:LIST:BAND:VID:RAT 0.1, , 0.1, , 0.1, , 0.1, , 0.1, , 0.1 SEM:OFFS2:LIST:BAND:VID:RAT? SEM:OFFS2:LIST:BAND:VID:RAT:AUTO ON, , ON, , ON, , ON, , ON SEM:OFFS2:LIST:BAND:VID:RAT:AUTO?</pre>
Notes	<p>Comma separated list of values.</p> <p>OFFSet1 is for BTS, 2 for MS. Default is BTS.</p> <p>You must be in the mode that includes SEM measurement to use this command. Use :INSTrument:SElect to set the mode.</p>
Preset	<p>For modes (except MSR, , LTEAFDD, , LTEATDD and WLAN) without option N9060A-7FP, , the preset value is as follows.</p> <p>SA, , WCDMA, , C2K, , LTE, , LTEFDD: 0.01, , 0.01, , 0.01, , 0.01, , 0.01, , 0.01 0.01, , 0.01, , 0.01, , 0.01, , 0.01</p> <p>WIMAX OFDMA: 0.3, , 0.3, , 0.3, , 0.3, , 0.3, , 0.3</p> <p>TD-SCDMA: 10, , 10, , 10, , 10, , 1, , 1 10, , 10, , 10, , 1, , 1, , 1</p> <p>1xEVDO: 10, , 10, , 10, , 10, , 10 10, , 10, , 10, , 10, , 10</p> <p>DTMB (CTTB), , DVB-T/H, , CMMB, , Digital Cable TV: 10, , 10, , 10, , 10, , 10, , 10 10, , 10, , 10, , 10, , 10</p> <p>ISDB-T: 0.1, , 0.1, , 0.1, , 0.1, , 0.1, , 0.1 10, , 10, , 10, , 10, , 10</p> <p>When option N9060A-7FP is installed in these modes, , the preset value of Offset G ~ L is the same as the Offset F value.</p> <p>-----</p> <p>WLAN: 0.3, , 0.3, , 0.3, , 0.3, , 0.3, , 0.3, , 0.3, , 0.3, , 0.3, , 0.3</p> <p>MSR, , LTEAFDD, , LTEATDD: 0.01, , 0.01, , 0.01, , 0.01, , 0.01, , 0.01, , 0.01, , 0.01, , 0.01, , 0.01, , 0.01, , 0.01, , 0.01 0.01, , 0.01, , 0.01, , 0.01, , 0.01, , 0.01, , 0.01, , 0.01, , 0.01, , 0.01, , 0.01, , 0.01</p> <p>Modes (except MSR, , LTEAFDD, , LTEATDD and WLAN) without option N9060A-7FP: OFF, , OFF, , OFF, , OFF, , OFF, , OFF OFF, , OFF, , OFF, , OFF, , OFF, , OFF</p> <p>Modes (except MSR, , LTEAFDD, , LTEATDD and WLAN) with option N9060A-7FP: OFF, , OFF, , OFF, , OFF, , OFF, , OFF, , OFF, , OFF, , OFF, , OFF, , OFF, , OFF OFF, , OFF, , OFF, , OFF, , OFF, , OFF, , OFF, , OFF, , OFF, , OFF, , OFF, , OFF, , OFF, , OFF, , OFF</p> <p>MSR, , LTEAFDD, , LTEATDD: OFF, , OFF, , OFF, , OFF, , OFF, , OFF, , OFF, , OFF, , OFF, , OFF, , OFF, , OFF OFF, , OFF, , OFF, , OFF, , OFF, , OFF, , OFF, , OFF, , OFF, , OFF, , OFF, , OFF</p> <p>WLAN: OFF, , OFF, , OFF, , OFF, , OFF, , OFF, , OFF, , OFF, , OFF, , OFF, , OFF, , OFF OFF, , OFF, , OFF, , OFF, , OFF, , OFF, , OFF, , OFF, , OFF, , OFF, , OFF, , OFF, , OFF</p>

State Saved	Saved in instrument state.
Min	0.00001
Max	3000000
Initial S/W Revision	Prior to A.02.00
Modified at S/W Revision	A.02.00, A.03.00, A.10.00, A.11.00, A.14.00

## Limits

Accesses a menu that enables you to set the power limits for start and stop frequencies of the selected offsets.

Key Path	Meas Setup
Initial S/W Revision	Prior to A.02.00

## Select Offset

Selects the offset (upper and lower) and displays the memory selection menu that enables you to store a set of parameter values for the offset, such as Start Freq, Stop Freq, Sweep Time, Res BW, Meas BW, Abs Start, and Abs Stop. Only one selection at a time is shown on this menu key label.

Key Path	Meas Setup, Offset/Limits
Mode	SA, WCDMA, C2K, WIMAX OFDMA, TD-SCDMA, 1xEVDO, DTMB (CTTB), DVB-T/H, ISDB-T, CMMB, LTE, LTE-TDD, Digital Cable TV, WLAN, MSR, LTEAFDD, LTEATDD
Preset	A
Range	MSR, LTEATDD, LTEAFDD, WLAN: A B C D E F G H I J K L Other modes without option N9060A-7FP: A B C D E F Other modes with option N9060A-7FP: A B C D E F G H I J K L
Initial S/W Revision	Prior to A.02.00
Modified at S/W Revision	A.02.00, A.03.00, A.10.00, A.11.00, A.14.00

## Abs Start

Sets the absolute power level limit at the start frequency for the selected offset. The absolute power level limit ranges from -200 to +50 dBm.

The fail condition for each offset channel is set remotely by [:SENSE]:SEMASK:OFFSet[n]  
[:OUTer]:LIST:TEST.

You can turn off (not use) specific offset channels remotely with [:SENSE]:SEMASK:OFFSet[n]  
[:OUTer]:LIST:STATe.

The SCPI query returns values currently set to the absolute power test limits.

Missing values are not permitted; that is, if you want to change values 2 and 6, you must send all values up to 6. Subsequent values will remain as they were. The query for this parameter always returns 12 values.

Key Path	Meas Setup, Offset/Limit, Limits
Mode	SA, WCDMA, C2K, WIMAX OFDMA, TD-SCDMA, 1xEVDO, DTMB (CTTB), DVB-T/H, ISDB-T, CMMB, LTE, LTE-TDD, Digital Cable TV, WLAN, MSR, LTEAFDD, LTEATDD
Remote Command	[ :SENSe ] :SEMAsk:OFFSet [ 1 ]   2 [ :OUTer ] :LIST:STARt:ABSolute <real>, ... [ :SENSe ] :SEMAsk:OFFSet [ 1 ]   2 [ :OUTer ] :LIST:STARt:ABSolute?
Example	SEM:OFFS2:LIST:STAR:ABS -12.50 dBm, , -12.50 dBm, , -24.50 dBm, , -11.50 dBm, , -11.50 dBm, , -11.50 dBm SEM:OFFS2:LIST:STAR:ABS?
Notes	Comma separated list of values. OFFSet1 is for BTS, 2 for MS. Default is BTS. You must be in the mode that includes SEM measurement to use this command. Use :INSTrument:SElect to set the mode.
Couplings	If the current mode is DVB-T/H, this value will be modified automatically according to the limit type and the output power of the transmitter which is less or more than 25W. If the current mode is ISDB-T, this value will be modified automatically according to the limit type.
Preset	For modes (except MSR, LTEAFDD, , LTEATDD and WLAN) without option N9060A-7FP, , the preset value is as follows. SA, , WIMAX OFDMA: -14.00 dBm, , -14.00 dBm, , -26.00 dBm, , -13.00 dBm, , -13.00 dBm, , -13.00 dBm WCDMA: -12.50 dBm, , -12.50 dBm, , -24.50 dBm, , -11.50 dBm, , -11.50 dBm, , -11.50 dBm -69.6 dBm, , -54.3 dBm, , -54.3 dBm, , -54.3 dBm, , -54.3 dBm, , -54.3 dBm C2K: -27.00 dBm, , -27.00 dBm, , -27.00 dBm, , -46.00 dBm, , -13.00 dBm, , -13.00 dBm -70.13 dBm, , -70.13 dBm, , -35.00 dBm, , -13.00 dBm, , -13.00 dBm, , -13.00 dBm TD-SCDMA: -28 dBm, , -28 dBm, , -36 dBm, , -21 dBm, , -21 dBm, , -21 dBm -71.3 dBm, , -71.3 dBm, , -56.07 dBm, , -56.07 dBm, , -56.07 dBm, , -56.07 dBm 1xEVDO: -27.0dBm, , -27.00 dBm, , -27.00 dBm, , -46.00 dBm, , -13.00 dBm, , -13.00 dBm -70.13 dBm, , -70.13 dBm, , -70.13 dBm, , -70.13 dBm, , -70.13 dBm, , -70.13 dBm DTMB (CTTB): -14.0 dBm, , -14.0 dBm, , -26.0 dBm, , -13.0 dBm, , -13.0 dBm, , -13.0 dBm  -13.0 dBm, , -13.0 dBm, , -13.0 dBm, , -13.0 dBm, , -13.0 dBm, , -13.0 dBm DVB-T/H: 11.2 dBm, , -29 dBm, , -41 dBm, , -66 dBm, , -82 dBm, , -82 dBm  -82 dBm, , -82 dBm, , -82 dBm, , -82 dBm, , -82 dBm ISDB-T, , CMMB, , Digital Cable TV: 50.0 dBm, , 50.0 dBm, , 50.0 dBm, , 50.0 dBm, , 50.0 dBm, , 50.0 dBm  50.0 dBm, , 50.0 dBm, , 50.0 dBm, , 50.0 dBm, , 50.0 dBm, , 50.0 dBm LTE, , LTE-TDD: -5.5 dBm, , -12.5 dBm, , -15.0 dBm, , -15.0 dBm, , -15.0 dBm, , -15.0 dBm -13.5 dBm, , -8.5 dBm, , -11.5 dBm, , -23.5 dBm, , -23.5 dBm, , -23.5 dBm When option N9060A-7FP is installed in these modes, , the preset value of Offset G ~ L is the same as the Offset F value. ----- WLAN: if Radio Std is 802.11a/g(OFDM/DSSS-OFDM): 16.00 dBm, , -4.00 dBm, , -12.00 dBm, , -

24.00 dBm, , -24.00 dBm, , -24.00 dBm, , -24.00 dBm, , -24.00 dBm, , -24.00 dBm, , -24.00 dBm, , -24.00 dBm

if Radio Std is 802.11b/g(DSSS/CCK/PBCC): -10 dBm, , -30 dBm, , -30 dBm, , -30 dBm, , -30 dBm, , -30 dBm, , -30 dBm, , -30 dBm, , -30 dBm, , -30 dBm, , -30 dBm

if Radio Std is 802.11n(20MHz) or 802.11ac(20MHz): 16.00 dBm, , -4.00 dBm, , -12.00 dBm, , -63.00 dBm, , -63.00 dBm, , -63.00 dBm, , -63.00 dBm, , -63.00 dBm, , -63.00 dBm, , -63.00 dBm, , -63.00 dBm

if Radio Std is 802.11n(40MHz) or 802.11ac(40MHz): 16.00 dBm, , -4.00 dBm, , -12.00 dBm, , -66.00 dBm, , -66.00 dBm, , -66.00 dBm, , -66.00 dBm, , -66.00 dBm, , -66.00 dBm, , -66.00 dBm, , -66.00 dBm

if Radio Std is 802.11ac(80MHz/160MHz): 16.00 dBm, , -4.00 dBm, , -12.00 dBm, , -69.00 dBm, , -69.00 dBm, , -69.00 dBm, , -69.00 dBm, , -69.00 dBm, , -69.00 dBm, , -69.00 dBm, , -69.00 dBm

if Radio Std is 802.11ac (80 MHz + 80 MHz): -69.00 dBm, , -69.00 dBm, , -69.00 dBm, , -69.00 dBm, , -69.00 dBm, , -69.00 dBm, , -69.00 dBm, , -69.00 dBm, , -69.00 dBm

MSR: -12.5 dBm, , -12.5 dBm, , -24.5 dBm, , -11.5 dBm, , -15.0 dBm, , -15.0 dBm, , -15.0 dBm, , -15.0 dBm, , -15.0 dBm, , -15.0 dBm, , -15.0 dBm, , -15.0 dBm, , -15.0 dBm, , -15.0 dBm, , -15.0 dBm, , -15.0 dBm, , -15.0 dBm, , -15.0 dBm, , -15.0 dBm, , -15.0 dBm

LTEAFDD, , LTEATDD: -5.5 dBm, , -12.5 dBm, , -15.0 dBm, , -15.0 dBm, , -15.0 dBm, , -15.0 dBm, , -15.0 dBm, , -15.0 dBm, , -15.0 dBm, , -15.0 dBm, , -15.0 dBm, , -15.0 dBm, , -13.5 dBm, , -8.5 dBm, , -11.5 dBm, , -23.5 dBm, , -23.5 dBm, , -23.5 dBm, , -23.5 dBm, , -23.5 dBm, , -23.5 dBm, , -23.5 dBm, , -23.5 dBm, , -23.5 dBm

State Saved	Saved in instrument state.
Min	-200 dBm
Max	50 dBm
Initial S/W Revision	Prior to A.02.00
Modified at S/W Revision	A.02.00, A.03.00, A.10.00, A.11.00, A.14.00

### Abs Stop

Sets the absolute power level limit at the stop frequency for the selected offset. The absolute power level limit ranges from -200 to +50 dBm. You can also toggle this function between couple and manual. If set to Couple, the Abs Stop power level limit is coupled to Abs Start to result in a flat limit line. If set to Man, Abs Start and Abs Stop take different values to result in a sloped limit line.

The SCPI query returns values currently set to the offset stop absolute power limits.

Missing values are not permitted; that is, if you want to change values 2 and 6, you must send all values up to 6. Subsequent values will remain as they were. The query for this parameter always returns 12 values.

Key Path	Meas Setup, Offset/Limits, Limits
Mode	SA, WCDMA, C2K, WIMAX OFDMA, TD-SCDMA, 1xEVDO, DTMB (CTTB), DVB-T/H, ISDB-T, CMMB, LTE, LTE-TDD, Digital Cable TV, WLAN, MSR, LTEAFDD, LTEATDD

<b>Remote Command</b>	<pre>[ :SENSe ] :SEMAsk:OFFSet [ 1 ]   2 [ :OUTer ] :LIST:STOP:ABSolute &lt;real&gt;, ... [ :SENSe ] :SEMAsk:OFFSet [ 1 ]   2 [ :OUTer ] :LIST:STOP:ABSolute? [ :SENSe ] :SEMAsk:OFFSet [ 1 ]   2 [ :OUTer ] :LIST:STOP:ABSolute:COUPle ON   OFF   1   0, ... [ :SENSe ] :SEMAsk:OFFSet [ 1 ]   2 [ :OUTer ] :LIST:STOP:ABSolute:COUPle?</pre>
<b>Example</b>	<pre>SEM:OFFS:LIST:STOP:ABS -12.50 dBm, , -24.50 dBm, , -24.50 dBm, , -11.50 dBm, , -11.50 dBm, , -11.50 dBm SEM:OFFS1:LIST:STOP:ABS? SEM:OFFS:LIST:STOP:ABS:COUP ON, , OFF, , ON, , ON, , ON, , ON SEM:OFFS:LIST:STOP:ABS:COUP?</pre>
<b>Notes</b>	<p>Comma separated list of values.          OFFSet1 is for BTS, 2 for MS. Default is BTS.          You must be in the mode that includes SEM measurement to use this command. Use          :INSTrument:SElect to set the mode.</p>
<b>Couplings</b>	<p>Coupled to Abs Start if "Auto" is selected, that is, the Stop value is equal to the Start value.          If the current mode is DVB-T/H, this value will be modified automatically according to the limit type          and the output power of the transmitter which is less or more than 25W.          If the current mode is ISDB-T, this value will be modified automatically according to the limit type.</p>
<b>Preset</b>	<p>For modes (except MSR, LTEAFDD, , LTEATDD and WLAN) without option N9060A-7FP, , the          preset value is as follows.</p> <pre>SA, , WIMAX OFDMA: -14.00 dBm, , -26.00 dBm, , -26.00 dBm, , -13.00 dBm, , -13.00 dBm, , - 13.00 dBm WCDMA: -12.50 dBm, , -24.50 dBm, , -24.50 dBm, , -11.50 dBm, , -11.50 dBm, , -11.50 dBm  -69.6 dBm, , -54.3 dBm, , -54.3 dBm, , -54.3 dBm, , -54.3 dBm, , -54.3 dBm C2K: -27.00 dBm, , -27.00 dBm, , -27.00 dBm, , -46.00 dBm, , -13.00 dBm, , -13.00 dBm  -70.13 dBm, , -70.13 dBm, , -35.00 dBm, , -13.00 dBm, , -13.00 dBm, , -13.00 dBm TD-SCDMA: -28 dBm, , -36 dBm, , -36 dBm, , -21 dBm, , -21 dBm, , -21 dBm -71.3 dBm, , -71.3 dBm, , -56.07 dBm, , -56.07 dBm, , -56.07 dBm, , -56.07 dBm 1xEVDO: -27dBm, , -27.00 dBm, , -27.00 dBm, , -46.00 dBm, , -13.00 dBm, , -13.00 dBm  -70.13 dBm, , -70.13 dBm, , -70.13 dBm, , -70.13 dBm, , -70.13 dBm, , -70.13 dBm DTMB (CTTB): -14.0 dBm, , -26.0 dBm, , -26.0 dBm, , -13.0 dBm, , -13.0 dBm, , -13.0 dBm   -13.0 dBm, , -13.0 dBm, , -13.0 dBm, , -13.0 dBm, , -13.0 dBm DVB-T/H: -29 dBm, , -41 dBm, , -66 dBm, , -82 dBm, , -82 dBm, , -82 dBm  -82 dBm, , -82 dBm, , -82 dBm, , -82 dBm, , -82 dBm, , -82 dBm ISDB-TCMMB, , Digital Cable TV: 50.0 dBm, , 50.0 dBm, , 50.0 dBm, , 50.0 dBm, , 50.0 dBm  50.0 dBm, , 50.0 dBm, , 50.0 dBm, , 50.0 dBm, , 50.0 dBm, , 50.0 dBm LTE, , LTETDD: -12.5 dBm, , -12.5 dBm, , -15.0 dBm, , -15.0 dBm, , -15.0 dBm, , -15.0 dBm  - 13.5 dBm, , -8.5 dBm, , -11.5 dBm, , -23.5 dBm, , -23.5 dBm, , -23.5 dBm When option N9060A-7FP is installed in these modes, , the preset value of Offset G ~ L is the same as the Offset F value. ----- WLAN:</pre>

---

if Radio Std is 802.11a/g(OFDM/DSSS-OFDM): -4.00 dBm , -12.00 dBm , -24.00 dBm , -24.00 dBm , -24.00 dBm , -24.00 dBm , -24.00 dBm , -24.00 dBm , -24.00 dBm , -24.00 dBm , -24.00 dBm , -24.00 dBm , -24.00 dBm

if Radio Std is 802.11b/g(DSSS/CCK/PBCC): -10 dBm , -30 dBm , -30 dBm , -30 dBm , -30 dBm , -30 dBm , -30 dBm , -30 dBm , -30 dBm , -30 dBm , -30 dBm , -30 dBm , -30 dBm

if Radio Std is 802.11n(20MHz) or 802.11ac(20MHz): -4.00 dBm , -12.00 dBm , -24.00 dBm , -63.00 dBm , -63.00 dBm , -63.00 dBm , -63.00 dBm , -63.00 dBm , -63.00 dBm , -63.00 dBm , -63.00 dBm , -63.00 dBm , -63.00 dBm

if Radio Std is 802.11n(40MHz) or 802.11ac(40MHz): -4.00 dBm , -12.00 dBm , -24.00 dBm , -66.00 dBm , -66.00 dBm , -66.00 dBm , -66.00 dBm , -66.00 dBm , -66.00 dBm , -66.00 dBm , -66.00 dBm , -66.00 dBm , -66.00 dBm

if Radio Std is 802.11ac(80MHz/160MHz): -4.00 dBm , -12.00 dBm , -24.00 dBm , -69.00 dBm , -69.00 dBm , -69.00 dBm , -69.00 dBm , -69.00 dBm , -69.00 dBm , -69.00 dBm , -69.00 dBm , -69.00 dBm , -69.00 dBm

if Radio Std is 802.11ac (80 + 80 MHz): -69.00 dBm , -69.00 dBm , -69.00 dBm , -69.00 dBm , -69.00 dBm , -69.00 dBm , -69.00 dBm , -69.00 dBm , -69.00 dBm , -69.00 dBm , -69.00 dBm , -69.00 dBm , -69.00 dBm

MSR:-12.5 dBm , -24.5 dBm , -11.5 dBm , -15.0 dBm , -15.0 dBm , -15.0 dBm , -15.0 dBm , -15.0 dBm , -15.0 dBm , -15.0 dBm , -15.0 dBm , -15.0 dBm , -15.0 dBm , -15.0 dBm , -15.0 dBm | -12.5 dBm , -24.5 dBm , -11.5 dBm , -15.0 dBm , -15.0 dBm , -15.0 dBm , -15.0 dBm , -15.0 dBm , -15.0 dBm , -15.0 dBm , -15.0 dBm , -15.0 dBm , -15.0 dBm , -15.0 dBm

LTEAFDD , LTEATDD:-12.5 dBm , -12.5 dBm , -15.0 dBm , -15.0 dBm , -15.0 dBm , -15.0 dBm , -15.0 dBm , -15.0 dBm , -15.0 dBm , -15.0 dBm , -15.0 dBm , -15.0 dBm , -15.0 dBm , -15.0 dBm | -13.5 dBm , -8.5 dBm , -11.5 dBm , -23.5 dBm , -23.5 dBm , -23.5 dBm -23.5 dBm , -23.5 dBm , -23.5 dBm , -23.5 dBm , -23.5 dBm , -23.5 dBm , -23.5 dBm

For modes (except MSR , LTEAFDD , LTEATDD and WLAN) without option N9060A-7FP , the preset value is as follows.

SA,WIMAX OFDMA: ON, OFF, ON, ON, ON, ON

WCDMA: ON, , OFF, , ON, , ON, , ON, , ON|ON, , ON, , ON, , ON, , ON

C2K: ON, , ON, , ON, , ON, , OFF|ON, , ON, , ON, , ON, , OFF

TD-SCDMA: ON, , OFF, , ON, , ON, , ON, , ON|ON, , ON, , ON, , ON, , ON

1xEVDO: ON, , ON, , ON, , ON, , ON, , OFF|ON, , ON, , ON, , ON, , OFF

DTMB (CTTB): ON, OFF, ON, ON, ON, ON

DVB-T/H, ISDB-T, CMMB, Digital Cable TV: OFF, , OFF, , OFF, , OFF, , OFF, , OFF

LTE, LTETDD: OFF, , ON, , ON, , ON, , ON, , ON|ON, , ON, , ON, , ON, , ON

When option N9060A-7FP is installed in these modes, the preset value of Offset G ~ L is the same as the Offset F value.

-----

WLAN:

if Radio Std is 802.11a/g(OFDM/DSSS-OFDM)/802.11n(20MHz/40MHz)/802.11ac(20MHz/40MHz/80MHz/160MHz): OFF, , OFF, , OFF, , ON, , ON, , ON, , ON, , ON, , ON, , ON

if Radio Std is 802.11ac(80+80 MHz): ON, , ON, , ON, , ON, , ON, , ON, , ON, , ON, , ON, , ON , ON

if Radio Std is 802.11b/g(DSSS/CCK/PBCC): ON, , ON, , ON, , ON, , ON, , ON, , ON, , ON, , ON, , ON

---

---

	, ON, , ON MSR: ON, , OFF, , OFF, , OFF, , ON, , OFF, , OFF, , OFF, , OFF, , OFF, , OFF, , OFF ON, , OFF, , OFF, , OFF, , ON, , OFF, , OFF, , OFF, , OFF, , OFF, , OFF, , OFF, , OFF LTEAFDD, , LTEATDD: OFF, , ON, , ON, , ON, , ON, , ON, , ON, , ON, , ON, , ON, , ON, , ON ON, , ON, , ON, , ON, , ON, , ON, , ON, , ON, , ON, , ON, , ON
State Saved	Saved in instrument state.
Min	-200 dBm
Max	50 dBm
Initial S/W Revision	Prior to A.02.00
Modified at S/W Revision	A.02.00, A.03.00, A.10.00, A.11.00, A.14.00

---

### Rel Start

Sets a relative power level limit at the start frequency for the selected offset. The relative power level limit ranges from -200 to +50 dBc.

The fail condition is set remotely by [:SENSe]:SEMAsk:OFFSet[n][:OUTer]:LIST:TEST for each offset channel test.

You can turn off (not use) specific offset channels remotely with [:SENSe]:SEMAsk:OFFSet[n][:OUTer]:LIST:STATe.

The SCPI query returns values currently set to the relative power test limits.

Missing values are not permitted; that is, if you want to change values 2 and 6, you must send all values up to 6. Subsequent values will remain as they were. The query for this parameter always returns 12 values.

---

<b>Key Path</b>	Meas Setup, Offset/Limits, Limits
<b>Mode</b>	SA, WCDMA, C2K, WIMAX OFDMA, TD-SCDMA, 1xEVDO, DTMB (CTTB), DVB-T/H, ISDB-T, CMMB, LTE, LTE_TDD, Digital Cable TV, WLAN, MSR, LTEAFDD, LTEATDD
<b>Remote Command</b>	[:SENSe]:SEMAsk:OFFSet [1]   2 [:OUTer]:LIST:STARt:RCARrier <rel_ampl>, ... [:SENSe]:SEMAsk:OFFSet [1]   2 [:OUTer]:LIST:STARt:RCARrier?
<b>Example</b>	SEM:OFFS:LIST:STAR:RCAR -30, , -30, , -30, , -30, , -30 SEM:OFFS:LIST:STAR:RCAR?
<b>Notes</b>	Comma separated list of values. OFFSet1 is for BTS, 2 for MS. Default is BTS. You must be in the mode that includes SEM measurement to use this command. Use :INSTrument:SELect to set the mode.
<b>Couplings</b>	If the current mode is DVB-T/H, this value will be modified automatically according to the limit type the output power of the transmitter which is less or more than 25W. If the current mode is ISDB-T, this value will be modified automatically according to the limit type. If the current mode is WLAN and radio std is 802.11n, Rel Start limits will be set to following values

---

---

when frequency changed to above 5GHz:

0 dB, -20.00 dB, -28.00 dB, -40.00 dB, -40.00 dB, -40.00 dB, -40.00 dB, -40.00 dB, -40.00 dB, -40.00 dB, -40.00 dB, -40.00 dB

---

Preset

For modes (except MSR, LTEAFDD, LTEATDD and WLAN) without option N9060A-7FP, the preset value is as follows.

SA: -30.00 dB, -30.00 dB, -30.00 dB, -30.00 dB, -30.00 dB, -30.00 dB

WCDMA: -30.00 dB, -30.00 dB, -30.00 dB, -30.00 dB, -30.00 dB, -30.00 dB|-33.73 dB, -34.00 dB, -37.50 dB, -47.50 dB, -47.50 dB, -47.50 dB

C2K: -45.00 dB, -45.00 dB, -55.00 dB, -55.00 dB, -55.00 dB, -55.00 dB|-42.00 dB, -54.00 dB, -54.00 dB, -54.00 dB, -54.00 dB, -54.00 dB

WIMAX OFDMA: 0 dB, -25 dB, -32 dB, -50 dB, -50 dB, -50 dB

TD-SCDMA: -54.00 dB, -54.00 dB, -62.00 dB, -47.00 dB, -47.00 dB, -47.00 dB|-35.21 dB, -49.00 dB, -44.00 dB, -44.00 dB, -44.00 dB, -44.00 dB

1xEVDO: -45dBc, -45.00 dB, -55.00 dB, -55.00 dB, -55.00 dB, -55.00 dB|-42dBc, -54.00 dB, -54.00 dB, -54.00 dB, -54.00 dB, -54.00 dB

DTMB (CTTB): -32.8 dB, -83 dB, -95 dB, -120 dB, -120 dB, -120 dB|-120 dB, -120 dB, -120 dB, -120 dB, -120 dB, -120 dB

DVB-T/H: -30 dB, -30 dB, -30 dB, -30 dB, -30 dB, -30 dB|-30 dB, -30 dB, -30 dB, -30 dB, -30 dB, -30 dB

ISDB-T: -27.4 dB, -47.4 dB, -54.4 dB, XXX, 50 dB, 50 dB | 50 dB, 50 dB, 50 dB, 50 dB, 50 dB, 50 dB; XXX is coupled with the total power reference, it is -57.4 dB when  $P \leq 0.025$  W, -67.4 dB when  $P = 0.25$  W,  $-(73.4 + 10 \log P)$  dB when  $0.25$  W  $< P \leq 2.5$  W or  $0.025$  W  $< P < 0.25$  W, -77.4 dB when  $P > 2.5$  W.

CMMB: -37 dB, -72 dB, -84 dB, -90 dB, -90 dB, -90 dB|-90 dB, -90 dB, -90 dB, -90 dB, -90 dB, -90 dB

LTE, LTEATDD: 0 dB, 0 dB, 0 dB, 0 dB, 0 dB, 0 dB|0 dB, 0 dB, 0 dB, 0 dB, 0 dB, 0 dB

Digital Cable TV: 0 dB, 0 dB, 0 dB, 0 dB, 0 dB, 0 dB | 0 dB, 0 dB, 0 dB, 0 dB, 0 dB, 0 dB

When option N9060A-7FP is installed in these modes, the preset value of Offset G ~ L is the same as the Offset F value.

-----

WLAN:

if Radio Std is 802.11a/g(OFDM/DSSS-OFDM): 0 dB, -20.00 dB, -28.00 dB, -40.00 dB, -40.00 dB, -47.00 dB, -47.00 dB, -47.00 dB, -47.00 dB, -47.00 dB, -47.00 dB, -47.00 dB

if Radio Std is 802.11b/g(DSSS/CCK/PBCC): -30 dB, -50 dB, -50 dB, -50 dB, -50 dB, -50 dB, -50 dB, -50 dB, -50 dB, -50 dB, -50 dB, -50 dB

if Radio Std is 802.11n(20MHz/40MHz): 0 dB, -20.00 dB, -28.00 dB, -45.00 dB, -45.00 dB, -45.00 dB, -45.00 dB, -45.00 dB, -45.00 dB, -45.00 dB, -45.00 dB, -45.00 dB

if Radio Std is 802.11ac (20 MHz/ 40 MHz/ 80 MHz/ 160 MHz): 0 dB, -20.00 dB, -28.00 dB, -40.00 dB, -40.00 dB, -40.00 dB, -40.00 dB, -40.00 dB, -40.00 dB, -40.00 dB, -40.00 dB, -40.00 dB

if Radio Std is 802.11ac(80 MHz + 80MHz): -40.00 dB, -28.00 dB, -20 dB, 0 dB, -20 dB, -28 dB, -40 dB, -40 dB, -40.00 dB, -40.00 dB, -40.00 dB, -40.00 dB

MSR, LTEAFDD, LTEATDD: 0 dB, 0 dB, 0 dB, 0 dB, 0 dB, 0 dB, 0 dB, 0 dB, 0 dB, 0 dB, 0 dB, 0 dB

---



	0 dB, , 0 dB 0 dB, , 0 dB, , 0 dB, , 0 dB, , 0 dB, , 0 dB, , 0 dB, , 0 dB, , 0 dB, , 0 dB
State Saved	Saved in instrument state.
Min	-200 dB
Max	50 dB
Initial S/W Revision	Prior to A.02.00
Modified at S/W Revision	A.02.00, A.03.00, A.10.00, A.11.00, A.14.00

### Rel Stop

Sets a relative power level limit at the stop frequency for the selected offset. The relative power level limit ranges from -200 to +50 dBc.

The fail condition is set remotely by [:SENSe]:SEMAsk:OFFSet[n][:OUTer]:LIST:TEST for each offset channel.

You can turn off (not use) specific offset channels remotely with [:SENSe]:SEMAsk:OFFSet[n][:OUTer]:LIST:STATe.

The SCPI query returns values currently set to the offset stop relative power limits.

Missing values are not permitted; that is, if you want to change values 2 and 6, you must send all values up to 6. Subsequent values will remain as they were. The query for this parameter always returns 12 values.

Key Path	Meas Setup, Offset/Limits, Limits
Mode	SA, WCDMA, C2K, WIMAX OFDMA, TD-SCDMA, 1xEVDO, DTMB (CTTB), DVB-T/H, ISDB-T, CMMB, LTE, LTEFDD, Digital Cable TV, WLAN, MSR, LTEAFDD, LTEATDD
Remote Command	[:SENSe]:SEMAsk:OFFSet[1] 2[:OUTer]:LIST:STOP:RCARrier <rel_ampl>, ... [:SENSe]:SEMAsk:OFFSet[1] 2[:OUTer]:LIST:STOP:RCARrier? [:SENSe]:SEMAsk:OFFSet[1] 2[:OUTer]:LIST:STOP:RCARrier:COUPle ON   OFF   1   0, ... [:SENSe]:SEMAsk:OFFSet[1] 2[:OUTer]:LIST:STOP:RCARrier:COUPle?
Example	SEM:OFFS:LIST:STOP:RCAR -30, , -30, , -30, , -30, , -30, , -30 SEM:OFFS:LIST:STOP:RCAR? SEM:OFFS:LIST:STOP:RCAR:COUP ON, , ON, , ON, , ON, , ON SEM:OFFS:LIST:STOP:RCAR:COUP?
Notes	Comma separated list of values. OFFSet1 is for BTS, 2 for MS. Default is BTS. You must be in the mode that includes SEM measurement to use this command. Use :INSTrument:SElect to set the mode.
Couplings	Coupled to Rel Start if "Auto" is selected, that is, Start is made the same as Stop. If the current mode is DVB-T/H, this value will be modified automatically according to the limit type and the output power of the transmitter which is less or more than 25W. If the current mode is ISDB-T, this value will be modified automatically according to the limit type.

---

If the current mode is WLAN and radio std is 802.11n, Rel Stop limits will be set to following values when frequency changed to above 5GHz:

-20.00 dB, -28.00 dB, -40.00 dB, -40.00 dB, -40.00 dB, -40.00 dB, -40.00 dB, -40.00 dB, -40.00 dB, -40.00 dB, -40.00 dB, -40.00 dB

---

Preset

For modes (except MSR, LTEAFDD, LTEATDD and WLAN) without option N9060A-7FP, the preset value is as follows.

SA: -30.00 dB, -30.00 dB, -30.00 dB, -30.00 dB, -30.00 dB, -30.00 dB

WCDMA: -30.00 dB, -30.00 dB, -30.00 dB, -30.00 dB, -30.00 dB, -30.00 dB|-48.28 dB, -37.50 dB, -47.50 dB, -47.50 dB, -47.50 dB, -47.50 dB

C2K: -45.00 dB, -45.00 dB, -55.00 dB, -55.00 dB, -55.00 dB, -55.00 dB|-42.00 dB, -54.00 dB, -54.00 dB, -54.00 dB, -54.00 dB, -54.00 dB

WIMAX OFDMA: -25 dB, -32 dB, -50 dB, -50 dB, -50 dB, -50 dB

TD-SCDMA: -54.00 dB, -62.00 dB, -62.00 dB, -47.00 dB, -47.00 dB, -47.00 dB|-49.00 dB, -58.945 dB, -44.00 dB, -44.00 dB, -44.00 dB, -44.00 dB

1xEVDO: -45dB, -45.00 dB, -55.00 dB, -55.00 dB, -55.00 dB, -55.00 dB|-42dB, -54.00 dB, -54.00 dB, -54.00 dB, -54.00 dB, -54.00 dB

DTMB (CTTB): -83 dB, -95 dB, -120 dB, -120 dB, -120 dB, -120 dB|-120 dB, -120 dB, -120 dB, -120 dB, -120 dB, -120 dB

DVB-T/H: -73 dB, -85 dB, -110 dB, -126 dB, -126 dB, -126 dB|-126 dB, -126 dB, -126 dB, -126 dB, -126 dB, -126 dB

ISDB-T: -47.4 dB, -54.4 dB, XXX, 50 dB, 50 dB, 50 dB|50 dB, 50 dB, 50 dB, 50 dB, 50 dB, 50 dB, 50 dB; XXX is coupled with the total power reference P, it is -57.4 dB when  $P \leq 0.025$  W, -67.4 dB when  $P = 0.25$  W,  $-(73.4 + 10\log P)$  dB when  $0.25$  W  $< P \leq 2.5$  W or  $0.025$  W  $< P < 0.25$  W, -77.4 dB when  $P > 2.5$  W.

CMMB: -72 dB, -84 dB, -90 dB, -90 dB, -90 dB, -90 dB|-90 dB, -90 dB, -90 dB, -90 dB, -90 dB, -90 dB

LTE, LTETDD: 0 dB, 0 dB, 0 dB, 0 dB, 0 dB, 0 dB

Digital Cable TV: 0 dB, 0 dB, 0 dB, 0 dB, 0 dB, 0 dB|0 dB, 0 dB, 0 dB, 0 dB, 0 dB, 0 dB

When option N9060A-7FP is installed in these modes, the preset value of Offset G ~ L is the same as the Offset F value.

-----

WLAN:

if Radio Std is 802.11a/g(OFDM/DSSS-OFDM): -20.00 dB, -28.00 dB, -40.00 dB, -40.00 dB, -47.00 dB, -47.00 dB, -47.00 dB, -47.00 dB, -47.00 dB, -47.00 dB, -47.00 dB, -47.00 dB

if Radio Std is 802.11b/g(DSSS/CCK/PBCC): -30 dB, -50 dB, -50 dB, -50 dB, -50 dB, -50 dB, -50 dB, -50 dB, -50 dB, -50 dB, -50 dB, -50 dB

if Radio Std is 802.11n(20MHz/40MHz): -20.00 dB, -28.00 dB, -45.00 dB, -45.00 dB, -45.00 dB, -45.00 dB, -45.00 dB, -45.00 dB, -45.00 dB, -45.00 dB, -45.00 dB, -45.00 dB

if Radio Std is 802.11ac (20 MHz/ 40 MHz/ 80 MHz/ 160 MHz): -20.00 dB, -28.00 dB, -40.00 dB, -40.00 dB, -40.00 dB, -40.00 dB, -40.00 dB, -40.00 dB, -40.00 dB, -40.00 dB, -40.00 dB, -40.00 dB

if Radio Std is 802.11ac(80 MHz + 80MHz): -28.00 dB, -20.00 dB, 0 dB, -20.00 dB, -28.00

---

dB, , -40.00 dB, , -40.00 dB, , -40.00 dB, , -40.00 dB, , -40.00 dB, , -40.00 dB, , -40.00 dB  
MSR, LTEAFDD, , LTEATDD: 0 dB, , 0 dB, , 0 dB, , 0 dB, , 0 dB, , 0 dB, , 0 dB, , 0 dB, , 0 dB, , 0 dB, , 0 dB, , 0 dB, , 0 dB, , 0 dB, , 0 dB, , 0 dB, , 0 dB, , 0 dB, , 0 dB, , 0 dB  
For modes (except MSR, , LTEAFDD, , LTEATDD and WLAN) without option N9060A-7FP, , the preset value is as follows.  
For modes (except MSR, , LTEAFDD, , LTEATDD and WLAN) with option N9060A-7FP, , the preset value of Offset G ~ L is the same as the Offset F value.  
SA: ON, ON, ON, ON, ON, ON, ON  
WCDMA: ON, , ON, , ON, , ON, , ON, , ON|OFF, , OFF, , OFF, , ON, , ON, , ON  
C2K: ON, , ON, , ON, , ON, , ON, , OFF|ON, , ON, , ON, , ON, , ON, , OFF  
WIMAX OFDMA: OFF, , OFF, , OFF, , ON, , ON, , ON|OFF, , OFF, , OFF, , ON, , ON, , ON  
TD-SCDMA: ON, , OFF, , ON, , ON, , ON, ON|OFF, OFF, ON, ON, ON, ON  
1xEVDO: ON, , ON, , ON, , ON, , ON, , OFF|ON, , ON, , ON, , ON, , ON, , OFF  
DTMB (CTTB): OFF, , OFF, , OFF, , OFF, , OFF, , OFF  
DVB-T/H: ON, ON, ON, ON, ON, ON, ON  
ISDB-T: OFF, OFF, OFF, OFF, OFF, OFF, OFF  
CMMB: OFF, OFF, OFF, OFF, OFF, OFF, OFF  
LTE, LTEATDD: ON, ON, ON, ON, ON, ON, ON  
Digital Cable TV: OFF, , OFF, , OFF, , OFF, , OFF, , OFF  
-----  
WLAN:  
if Radio Std is 802.11a/g(OFDM/DSSS-OFDM)/802.11n(20MHz/40MHz): OFF, , OFF, , OFF, , ON, , ON, , ON, , ON, , ON, , ON, , ON, , ON  
if Radio Std is 802.11b/g(DSSS/CCK/PBCC): ON, , ON, , ON, , ON, , ON, , ON, , ON, , ON, , ON, , ON, , ON  
if Radio Std is 802.11ac (20 MHz/ 40 MHz/ 80 MHz/ 160 MHz): OFF, , OFF, , OFF, , ON, , ON, , ON, , ON, , ON, , ON, , ON, , ON  
if Radio Std is 802.11ac(80 MHz + 80MHz): OFF, , OFF, , OFF, , OFF, , OFF, , OFF, , OFF, , OFF, , OFF, , OFF, , OFF  
MSR, LTEAFDD, , LTEATDD: ON, , ON, , ON, , ON, , ON, , ON, , ON, , ON, , ON, , ON, , ON | ON, , ON, , ON, , ON, , ON, , ON, , ON, , ON, , ON, , ON, , ON

State Saved	Saved in instrument state.
Min	-200 dB
Max	50 dB
Initial S/W Revision	Prior to A.02.00
Modified at S/W Revision	A.02.00, A.03.00, A.10.00, A.11.00, A.14.00

### Fail Mask

Selects one of the logic keys for fail conditions between the measurement results and the test limits:

- Absolute and Relative both check the results against the respective limit.

- OR checks against both limits, failing if either of the limits is broken.
- AND will only display a fail if both of the limits are broken.

The absolute or relative power limit value for each offset channel can be set remotely with [:SENSe]:SEMAsk:OFFSet[n][:OUTer]:LIST:ABSolute or [:SENSe]:SEMAsk:OFFSet[n][:OUTer]:LIST:RCARrier.

You can turn off (not use) specific offset channels remotely with [:SENSe]:SEMAsk:OFFSet[n][:OUTer]:LIST:STATe.

Missing values are not permitted; that is, if you want to change values 2 and 6, you must send all values up to 6. Subsequent values will remain as they were. The query for this parameter always returns 12 values.

Key Path	Meas Setup, Offset/Limits, Limits
Mode	SA, WCDMA, C2K, WIMAX OFDMA, TD-SCDMA, 1xEVDO, DTMB (CTTB), DVB-T/H, ISDB-T, CMMB, LTE, LTETDD, Digital Cable TV, WLAN, MSR, LTEAFDD, LTEATDD
Remote Command	[:SENSe]:SEMAsk:OFFSet[1] 2[:OUTer]:LIST:TEST ABSolute   AND   OR   RELative, ... [:SENSe]:SEMAsk:OFFSet[1] 2[:OUTer]:LIST:TEST?
Example	SEM:OFFS:LIST:TEST ABS, , ABS, , ABS, , ABS, , ABS, , ABS SEM:OFFS:LIST:TEST?
Notes	Comma separated list of values. You must be in the mode that includes SEM measurement to use this command. Use :INSTrument:SElect to set the mode.
Couplings	None If the current mode is DVB-T/H, this value will be modified automatically according to the limit type and the output power of the transmitter which is less or more than 25W.
Preset	For modes (except MSR, LTEAFDD, LTEATDD and WLAN) without option N9060A-7FP, the preset value is as follows. SA: ABS, ABS, ABS, ABS, ABS, ABS WCDMA: ABS, , ABS, , ABS, , ABS, , ABS AND, , AND, , AND, , AND, , AND, , AND C2K: REL, , REL, , REL, , ABS, , REL, , REL AND, , AND, , ABS, , REL, , REL, , REL WIMAX OFDMA: REL, , REL, , REL, , REL, , REL REL, , REL, , REL, , REL, , REL, , REL TD-SCDMA: ABS, , ABS, , ABS, , ABS, , ABS AND, , AND, , AND, , AND, , AND, , AND 1xEVDO: REL, , REL, , REL, , ABS, , REL, , REL AND, , AND, , AND, , OR, , AND, , AND DTMB (CTTB), ISDB-T, CMMB: REL, , REL, , REL, , REL, , REL, , REL   REL, , REL, , REL, , REL, , REL, , REL DVB-T/H: ABS, , ABS, , ABS, , ABS, , ABS, , ABS   ABS, , ABS, , ABS, , ABS, , ABS, , ABS LTE, , LTETDD: ABS, , ABS, , ABS, , ABS, , ABS, , ABS Digital Cable TV: REL, , REL, , REL, , REL, , REL, , REL   REL, , REL, , REL, , REL, , REL, , REL When option N9060A-7FP is installed in these modes, the preset value of Offset G ~ L is the same as the Offset F value. ----- WLAN:

	if Radio Std is 802.11a/g(OFDM/DSSS-OFDM) or 802.11b/g(DSSS/CCK/PBCC): REL, , REL, , REL, , REL, , REL, , REL, , REL, , REL, , REL, , REL, , REL if Radio Std is 802.11n(20MHz/40MHz): REL, , REL, , REL, , AND, , AND, , AND, , AND, , AND, , AND, , AND, , AND, , AND, , AND, , AND if Radio Std is 802.11ac (20 MHz/ 40 MHz/ 80 MHz/ 160 MHz): REL, , REL, , REL, , AND, , AND, , AND, , AND, , AND, , AND, , AND, , AND, , AND if Radio Std is 802.11ac (80 MHz + 80MHz): REL, , REL, , REL, , REL, , REL, , REL, , AND, , AND, , AND, , AND, , AND, , AND MSR, LTEAFDD, , LTEATDD: ABS, , ABS, , ABS, , ABS, , ABS, , ABS, , ABS, , ABS, , ABS, , ABS, , ABS, , ABS, , ABS
State Saved	Saved in instrument state.
Range	Absolute Relative Abs AND Rel Abs OR Rel
Initial S/W Revision	Prior to A.02.00
Modified at S/W Revision	A.02.00, A.03.00, A.10.00, A.11.00, A.14.00

### Offset Freq Define

This key enables you to select “Offset” definition. Each standard defines each “Offset” from Carrier.

Meas BW Edge means the edge of resolution band width that is represented by Meas BW and Res BW settings. Actual center frequency of Meas BW and the limit line have ½ Meas BW offset when the Meas BW Edge is selected.

3GPP2 requires the “Carrier Center to Meas BW Edge” definition. LTE conformance test requires “Carrier Edge to Meas BW Center” and/or “Carrier Edge to Meas BW Edge” definition

- **CTOCenter** – From carrier center to the center of offset measuring filter\*
- **CTOEdge** – From carrier center to the nominal –3 dB point of the offset measuring filter\* closer to the carrier
- **ETOCenter** – From Center Frequency – Span of Ref Channel / 2 (for lower offset), Center Frequency + Span of Ref Channel / 2 (for upper offset) of the carrier closest to each offset to the center of offset measuring filter\*
- **ETOEdge** – From Center Frequency – Span of Ref Channel / 2 (for lower offset), Center Frequency + Span of Ref Channel / 2 (for upper offset) of the carrier closest to each offset to the nominal –3 dB point of the offset measuring filter\* closer to the carrier

\*Measuring filter = Meas BW (N) x Res BW

11 Spectrum Emission Mask Measurement  
 Meas Setup

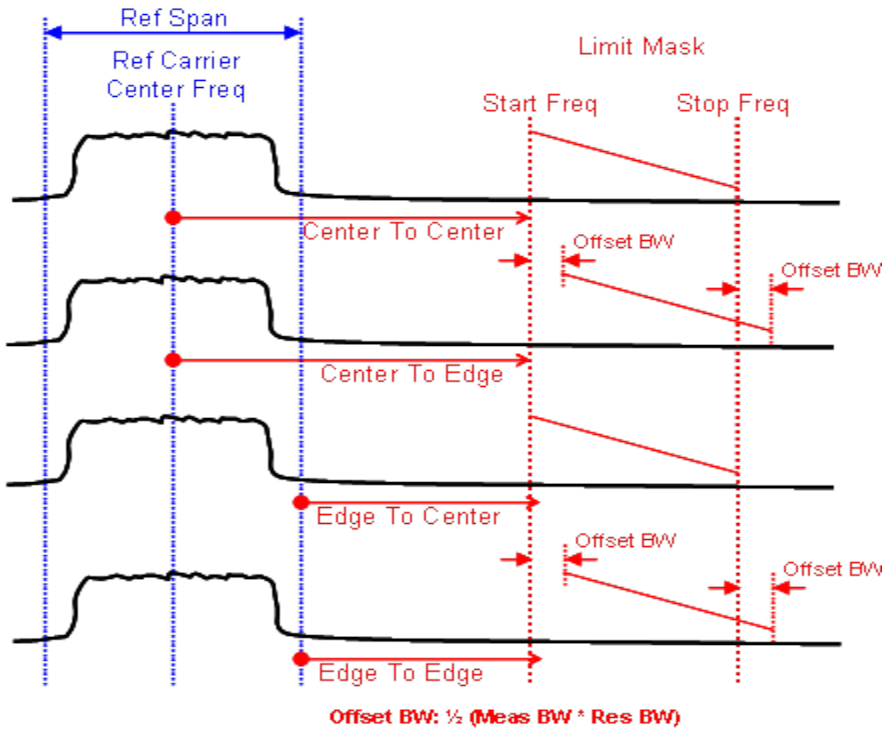
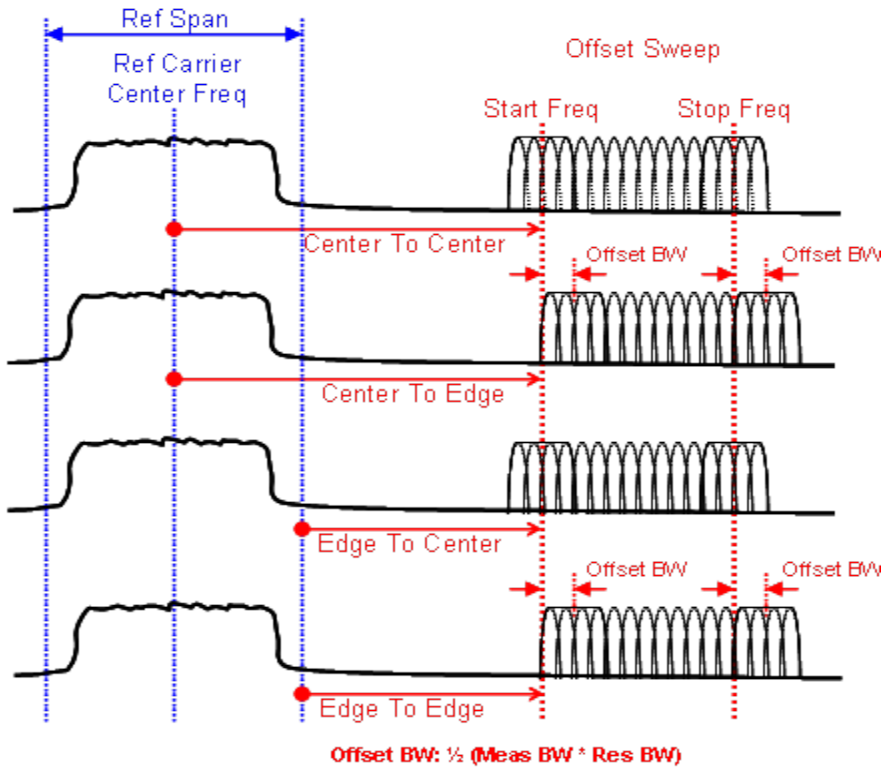

Key Path	Meas Setup, Offset/Limits
Mode	SA, WCDMA, C2K, WIMAX OFDMA, TD-SCDMA, 1xEVDO, DVB-T/H, DTMB (CTTB), ISDB-T, CMMB, LTE, LTE-TDD, Digital Cable TV, WLAN
Remote Command	<code>[ :SENSe ] :SEMAsk:OFFSet [ 1 ]   2 :TYPE CTOCenter   CTOEdge   ETOCenter   ETOEdge</code> <code>[ :SENSe ] :SEMAsk:OFFSet [ 1 ]   2 :TYPE?</code>
Example	SEM:OFFS:TYPE ETOC SEM:OFFS:TYPE?
Notes	You must be in the mode that includes SEM measurements to use this command. Use <code>:INSTrument:SElect</code> to set the mode. For the MSR and LTE-Advanced FDD/TDD mode, see <a href="#">Offset Freq Define (Only for MSR and LTE-Advanced FDD/TDD)</a> .
Preset	SA, , WCDMA, , WIMAX OFDMA, , TD-SCDMA, , DVB-T/H, , DTMB (CTTB), , ISDB-T, , CMMB, , Digital Cable TV: CTOC C2K: CTOE 1xEVDO: CTOE LTE: ETOC LTE-TDD: ETOC
State Saved	Saved in instrument state.
Range	Carrier Center To Meas BW Center Carrier Center To Meas BW Edge Carrier Edge To Meas BW Center Carrier Edge To Meas BW Edge
Initial S/W Revision	A.03.00

### Limit Type (Only for DVB-T/H)

This key is only displayed in the DVB-T/H mode. The mask lines could be drawn in three different ways:

1. according to the non-critical case standard in ETSI 302–296 when the key’s value is “Non-Critical”
2. according to the critical case standard in ETSI 302–296 when the key’s value is “Critical”
3. specifications listed in the Offset/Limits menu or by the user-defined when the key’s value is “Manual”.

Key Path	Meas Setup
Mode	DVB-T/H
Remote Command	<code>[ :SENSe ] :SEMAsk:LIMits:TYPE MANual NONCritical CRITical</code> <code>[ :SENSe ] :SEMAsk:LIMits:TYPE?</code>
Example	SEM:LIM:TYPE NONC SEM:LIM:TYPE?
Notes	You must be in the DVB-T/H mode to use this command. Use <code>:INSTrument:SElect</code> to set the mode.
Couplings	1. When current radio bandwidth is 5 MHz or 6 MHz, this key only has one option: Manual. The “Non-Critical” and “Critical” keys will be grayed out. So the default value is Manual after measurement preset.

2. When current radio bandwidth is 7 MHz or 8 MHz, this key has three options: Manual, Non-Critical and Critical. The default value is Non-Critical after measurement preset.
- When the value of the “Limit Type” key is Non-Critical, the parameters displayed on the Offset/Limits panel will be modified automatically depending on the carrier power, according to the Non-critical case limits definition in ETSI 302-296, and the keys under the Offset/Limit except “Offset”, “Offset Side” and “Limits” will be grayed out. Meanwhile all the keys displayed on the “Limits” panel will be grayed out as well.
  - When the value of the “Limit Type” key is Critical, the parameters displayed on the Offset/Limits panel will be modified automatically depending on the carrier power, according to the critical case limits definition in ETSI 302-296, and the keys under the Offset/Limit except “Offset”, “Offset Side” and “Limits” will be grayed out. Meanwhile all the keys displayed on the “Limits” panel will be grayed out as well.
  - When the value of the “Limit Type” key is Manual, all of the previous manual specifications will be restored, and the keys that were previously grayed out will be enabled again.

Preset	NONCritical (if current radio bandwidth is 7 MHz or 8 MHz) Manual (if current radio bandwidth is 5 MHz or 6 MHz)
State Saved	Saved in instrument state.
Range	Manual Non-Critical Critical
Initial S/W Revision	A.02.00

## Method

Sets the measurement method:

- **Integ BW**—enables you to set the channel integration bandwidth.
- **RRC Weight**—selects Root Raised Cosine (RRC) filtering of the carriers. The  $\alpha$  value (rolloff) for the filter is set to the value of the Filter Alpha parameter.

Key Path	Meas Setup
Mode	SA, WCDMA, WIMAX OFDMA, TD-SCDMA, DTMB (CTTB), DVB-T/H, ISDB-T, CMMB, LTE, LTETDD, Digital Cable TV, WLAN, MSR, LTEAFDD, LTEATDD
Remote Command	[ :SENSe ] :SEMAsk:FILTEr [ :RRC ] [ :STATe ] OFF ON 0 1 [ :SENSe ] :SEMAsk:FILTEr [ :RRC ] [ :STATe ] ?
Example	SEM:FILT ON SEM:FILT?
Notes	For the C2K and 1xEVDO mode, this key is not available. 1 ON = RRC Weight, 0 OFF = IntegBW You must be in the mode that includes SEM measurement to use this command. Use :INSTrument:SElect to set the mode.
Dependencies	WLAN: RRC Weight is not supported when the radio standard is WLAN 802.11ac (80+80MHz).
Preset	SA, , WIMAX OFDMA, , DVB-T/H, , ISDB-T, , CMMB, , LTE, , LTETDD, , WLAN, , MSR, , LTEAFDD, , LTEATDD: OFF WCDMA, , TD-SCDMA, , DTMB (CTTB), , Digital Cable TV: ON



State Saved	Saved in instrument state.
Range	RRCWeight IntegBW
Initial S/W Revision	Prior to A.02.00
Modified at S/W Revision	A.02.00, A.03.00

## Filter Alpha

Sets the alpha value for the RRC Filter.

Key Path	Meas Setup
Mode	SA, WCDMA, WIMAX OFDMA, TD-SCDMA, DTMB (CTTB), DVB-T/H, ISDB-T, CMMB, LTE, LTETDD, Digital Cable TV, MSR, LTEAFDD, LTEATDD
<b>Remote Command</b>	<code>[ :SENSe ] :SEMAsk:FILTer [ :RRC ] :ALPHa &lt;real&gt;</code> <code>[ :SENSe ] :SEMAsk:FILTer [ :RRC ] :ALPHa?</code>
<b>Example</b>	SEM:FILT:ALPH 0.3 SEM:FILT:ALPH?
Notes	For the C2K and 1xEVDO mode, this key is not available. You must be in the mode that includes SEM measurement to use this command. Use :INSTrument:SElect to set the mode.
Preset	0.22 DTMB (CTTB): 0.05 Digital Cable TV: 0.15
State Saved	Saved in instrument state.
Min	0.01
Max	1.0
Initial S/W Revision	Prior to A.02.00
Modified at S/W Revision	A.02.00, A.03.00

## Meas Preset

Restores all the measurement parameters to their default values.

Key Path	Meas Setup
Mode	SA, WCDMA, C2K, WIMAX OFDMA, TD-SCDMA, 1xEVDO, DTMB (CTTB), DVB-T/H, ISDB-T, CMMB, LTE, LTETDD, Digital Cable TV, WLAN, MSR, LTEAFDD, LTEATDD
<b>Remote Command</b>	<code>:CONFigure:SEMAsk</code>
<b>Example</b>	CONF:SEM
Notes	You must be in the mode that includes SEM measurement to use this command. Use :INSTrument:SElect to set the mode.

11 Spectrum Emission Mask Measurement  
Meas Setup

Couplings	Selecting Meas Preset will restore all measurement parameters to their default values.
Initial S/W Revision	Prior to A.02.00
Modified at S/W Revision	A.02.00, A.03.00

Mode

See "Mode" on page 298

## Mode Preset

Returns the active mode to a known state.

Mode Preset does the following for the currently active mode:

- Aborts the currently running measurement.
- Brings up the default menu for the mode, with no active function.
- Sets measurement Global settings to their preset values for the active mode only.
- Activates the default measurement.
- Brings up the default menu for the mode.
- Clears the input and output buffers.
- Sets Status Byte to 0.

Mode Preset does not:

- Cause a mode switch
- Affect mode persistent settings
- Affect system settings

See "[How-To Preset](#)" on page 1149 for more information.

<b>Key Path</b>	Front-panel key
<b>Remote Command</b>	:SYSTem:PRESet
<b>Example</b>	:SYST:PRES
<b>Notes</b>	*RST is preferred over :SYST:PRES for remote operation. *RST does a Mode Preset, as done by the :SYST:PRES command, and it sets the measurement mode to Single measurement rather than Continuous for optimal remote control throughput. Clears all pending OPC bits. The Status Byte is set to 0.
<b>Couplings</b>	A Mode Preset aborts the currently running measurement, activates the default measurement, and gets the mode to a consistent state with all of the default couplings set.
<b>Backwards Compatibility Notes</b>	In the X-Series, the legacy "Factory Preset" has been replaced with Mode Preset, which only presets the currently active mode, not the entire instrument. In the X-Series, the way to preset the entire instrument is by using System, Restore System Defaults All, which behaves essentially the same way as restore System Defaults does on ESA and PSA. There is also no "Preset Type" as there is on the PSA. There is a green Mode Preset front-panel key that does a Mode Preset and a white-with-green-letters User Preset front-panel key that does a User Preset. The old PRESet:TYPE command is ignored (without generating an error), and SYST:PRES without a parameter does a Mode Preset, which should cover most backward code compatibility issues. The settings and correction data under the Input/Output front-panel key (examples: Input Z Corr, Ext Amp Gain, etc.) are no longer part of any Mode, so they will not be preset by a Mode Preset. They are preset using Restore Input/Output Defaults, Restore System Defaults All. Note that because User Preset does a Recall State, and all of these settings are saved in State, they ARE recalled when using

	User Preset.
Initial S/W Revision	Prior to A.02.00

## How-To Preset

The table below shows all possible presets, their corresponding SCPI commands and front-panel access (key paths). Instrument settings depend on the current measurement context. Some settings are local to the current measurement, some are global (common) across all the measurements in the current mode, and some are global to all the available modes. In a similar way, restoring the settings to their preset state can be done within the different contexts.

Auto Couple - is a measurement local key. It sets all Auto/Man parameter couplings in the measurement to Auto. Any Auto/Man selection that is local to other measurements in the mode will not be affected.

Meas Preset - is a measurement local key. Meas Preset resets all the variables local to the current measurement except the persistent ones.

Mode Preset - resets all the current mode's measurement local and measurement global variables except the persistent ones.

Restore Mode Defaults - resets ALL the Mode variables (and all the Meas global and Meas local variables), including the persistent ones.

Type Of Preset	SCPI Command	Front Panel Access
Auto Couple	:COUPlE ALL	Auto Couple front-panel key
Meas Preset	:CONFIgure:<Measurement>	Meas Setup Menu
Mode Preset	:SYSTem:PRESet	Mode Preset (green key)
Restore Mode Defaults	:INSTrument:DEFault	Mode Setup Menu
Restore All Mode Defaults	:SYSTem:DEFault MODEs	System Menu; Restore System Default Menu
*RST	*RST	not possible (Mode Preset with Single)
Restore Input/Output Defaults	:SYSTem:DEFault INPut	System Menu; Restore System Default Menu
Restore Power On Defaults	:SYSTem:DEFault PON	System Menu; Restore System Default Menu
Restore Alignment Defaults	:SYSTem:DEFault ALIGn	System Menu; Restore System Default Menu
Restore Miscellaneous Defaults	:SYSTem:DEFault MISC	System Menu; Restore System Default Menu
Restore All System Defaults	:SYSTem:DEFault [ALL] :SYSTem:PRESet:PERSistent	System Menu; Restore System Default Menu
User Preset	:SYSTem:PRESet:USER	User Preset Menu
User Preset All Modes	:SYSTem:PRESet:USER:ALL	User Preset Menu

Power On Mode Preset	:SYSTem:PON:TYPE MODE	System Menu
Power On User Preset	:SYSTem:PON:TYPE USER	System Menu
Power On Last State	:SYSTem:PON:TYPE LAST	System Menu

### Preset Type (Remote Command Only)

As stated in the Backward Compatibility section, to be compatible with ESA/PSA the PRESet:TYPE command will be implemented as a no-op.

<b>Mode</b>	All
<b>Remote Command</b>	:SYSTem:PRESet:TYPE FACTory MODE USER :SYSTem:PRESet:TYPE?
<b>Example</b>	:SYST:PRESet:TYPE FACT
<b>Notes</b>	This command is supported for backward compatibility only. It is a no-op which does not change the behavior of any preset operation.
<b>Preset</b>	This is unaffected by Preset but is set to Mode on a "Restore System Defaults->All"
<b>State Saved</b>	No
<b>Initial S/W Revision</b>	Prior to A.02.00

## Mode Setup

See ["Mode Setup" on page 328](#)

## Peak Search

There is no 'Peak Search' supported in Spectrum Emission Mask so this front-panel key displays a blank menu when pressed.

---

Key Path	Front-panel key
Initial S/W Revision	Prior to A.02.00

---



Print

See "Print" on page 341

## Quick Save

The Quick Save front-panel key repeats the most recent save that was performed from the Save menu, with the following exceptions:

- Register saves are not remembered as Saves for the purpose of the Quick Save function
- If the current measurement does not support the last non-register save that was performed, an informational message is generated, “File type not supported for this measurement”

Quick Save repeats the last type of qualified save (that is, a save qualified by the above criteria) in the last save directory by creating a unique filename using the Auto File Naming algorithm described below.

If Quick Save is pressed after startup and before any qualified Save has been performed, the Quick Save function performs a Screen Image save using the current settings for Screen Image saves (current theme, current directory), which then becomes the “last save” for the purpose of subsequent Quick Saves.

The Auto File Naming feature automatically generates a file name for use when saving a file. The filename consists of a prefix and suffix separated by a dot, as is standard for the Windows® file system. A default prefix exists for each of the available file types:

Type	Default Prefix	Menu
State	State_	(Save/Recall)
Trace + State	State_	(Save/Recall)
Screen	Screen_	(Save/Recall)
Amplitude Corrections	Ampcor_	(Import/Export)
Traces	Trace_	(Import/Export)
Limit Lines	LLine_	(Import/Export)
Measurement Result	MeasR_	(Import/Export)
Capture Buffer	CapBuf_	(Import/Export)

A four digit number is appended to the prefix to create a unique file name. The numbering sequence starts at 0000 within each Mode for each file type and updates incrementally to 9999, then wraps to 0000 again. It remembers where it was through a Mode Preset and when leaving and returning to the Mode. It is reset by Restore Misc Defaults and Restore System Defaults and subsequent running of the instrument application. So, for example, the first auto file name generated for State files is State\_0000.state. The next is State\_0001, and so forth.

One of the key features of Auto File Name is that we guarantee that the Auto File Name will never conflict with an existing file. The algorithm looks for the next available number. If it gets to 9999, then it looks for holes. If it find no holes, that is no more numbers are available, it gives an error.

For example, if when we get to State\_0010.state there is already a State\_0010.state file in the current directory, it advances the counter to State\_0011.state to ensure that no conflict will exist (and then it verifies that State\_0011.state also does not exist in the current directory and advances again if it does, and so forth).

If you enter a file name for a given file type, then the prefix becomes the filename you entered instead of the default prefix, followed by an underscore. The last four letters (the suffix) are the 4-digit number.

For example, if you save a measurement results file as “fred.csv”, then the next auto file name chosen for a measurement results save will be fred\_0000.csv.

**NOTE** Although 0000 is used in the example above, the number that is used is actually the current number in the Meas Results sequence, that is, the number that would have been used if you had not entered your own file name.

**NOTE** If the filename you entered ends with \_dddd, where d=any number, making it look just like an auto file name, then the next auto file name picks up where you left off with the suffix being dddd + 1.

Key Path	Front-panel key
Notes	No remote command for this key specifically.
Initial S/W Revision	Prior to A.02.00

## Recall

The Recall menu lets you choose what you want to recall, and where you want to recall it from. Among the types of files you can recall are **States and Traces**. In addition, an Import (Data) option lets you recall a number of data types stored in CSV files (as used by Excel and other spreadsheet programs).

The default paths for Recall are data type dependent and are the same as for the Save key.

Key Path	Front-panel key
Notes	<p>No remote command for this key specifically, but the :MMEM:LOAD command is available for specific file types. An example is :MMEM:LOAD:STATe &lt;filename&gt;.</p> <p>If you try to recall a State file for a mode that is not licensed or not available in the instrument, an error message will occur and the state will not change.</p>
Backwards Compatibility Notes	<p>In legacy analyzers, it was possible to load a state without affecting the trace data, limit lines or correction data. Similarly (since User Preset is actually loading a state), it was possible to do a User Preset without affecting the trace data, limit lines or correction data.</p> <p>In the X-Series, “state” always includes all of this data; so whenever state is loaded, all of the traces, limit lines and corrections are affected. Although this differs from previous behavior, it is desirable behavior, and should not cause adverse issues for users.</p>
Backwards Compatibility Notes	<p>Recall for the X-Series supports backward compatibility in the sense that you can recall a state file from any X-Series model number and any version of X-Series software. This is only possible if part of the recalling process goes through a limiting step after recalling the mode settings, at least for settings that may vary with version number, model number, option and license differences. If you try to recall a state file onto an instrument with less capability than what was available on the instrument during the save, the recall will ignore the state it doesn't support and it will limit the recalled setting to what it allows.</p> <p>Example: if the saved state includes preamp ON, but the recalling instrument does not have a preamp; the preamp is limited to OFF. Conversely, if you save a state without a preamp, the preamp is OFF in the state file. When this saved file is recalled on an instrument with a licensed preamp, the preamp is changed to OFF. Another example is if the saved state has center frequency set to 20 GHz, but the instrument recalling the saved state is a different model and only supports 13.5 GHz. In this case, the center frequency is limited along with any other frequency based settings. Since the center frequency can't be preserved in this case, the recall limiting tries to at least preserve span to keep the measurement setup as intact as possible.</p> <p>It may be appropriate to issue a warning if the state is limited on the recall; warnings do not go out to SCPI so this would only affect the manual user.</p> <p>Note that there is no state file compatibility outside of the X-Series. For example, you cannot recall a state file from ESA or PSA.</p>
Initial S/W Revision	Prior to A.02.00

## State

The Recall State menu lets you choose a register or file from which to recall the state.

The content of a state file includes all of the settings and data required to return the analyzer as closely as possible to the Mode it was in, with the exact settings that were in place, when the save occurred. The Mode settings in each state file include the settings that are affected by Mode Preset, as well as the

additional settings affected by Restore Mode Defaults; all of the Mode’s settings. In addition, all of the settings of the Input/Output system are included, even though they are outside of the Mode’s state, because they are needed to restore the complete setup. Persistent System settings (for example, GPIB address) are not affected by either a Mode Preset or Restore Mode Defaults, nor are they included in a saved State file.

Since each state file is only for one Mode, the settings for other Modes are unaffected when it is loaded. Recall State will cause a mode switch if the state being recalled is not from the current active mode.

After the recall completes, the message "File <filename> recalled" or “Recalled State Register <register number>” is displayed.

For rapid recalls, the State menu lists 16 registers that you can choose from to recall. Pressing a Register key initiates the recall. You can also select a file from which to recall.

The default path for all State Files is:

My Documents\<<mode name>\state

where <mode name> is the parameter used to select the mode with the INST:SEL command (for example, SA for the Spectrum Analyzer).

See "[More Information](#)" on page 1158.

<b>Key Path</b>	Recall
<b>Mode</b>	All
<b>Remote Command</b>	:MMEMory:LOAD:STATe <filename>
<b>Example</b>	:MMEM:LOAD:STAT "myState.state" This recalls the file myState.state on the default path
<b>Example</b>	MMEM:LOAD:STAT "MyStateFile.state" This loads the state file data (on the default file directory path) into the instrument state.
<b>Notes</b>	<p>When you pick a file to recall, the analyzer first verifies that the file is recallable in the current instrument by checking the software version and model number of the instrument. If everything matches, a full recall proceeds by aborting the currently running measurement, clearing any pending operations, and then loading the State from the saved state file. You can open state files from any mode, so recalling a State file switches to the mode that was active when the save occurred. After switching to the mode of the saved state file, mode settings and data (if any for the mode) are loaded with values from the saved file. The saved measurement of the mode becomes the newly active measurement and the data relevant to the measurement (if there is any) is recalled.</p> <p>If there is a mismatch between file version or model number or instrument version or model number, the recall function tries to recall as much as possible and returns a warning message. It may limit settings that differ based on model number, licensing or version number.</p> <p>After recalling the state, the Recall State function does the following:</p> <ul style="list-style-type: none"> <li>• Makes the saved measurement for the mode the active measurement.</li> <li>• Clears the input and output buffers.</li> <li>• Status Byte is set to 0.</li> <li>• Executes a *CLS</li> </ul> <p>If the file specified is empty an error is generated. If the specified file does not exist, another error is generated. If there is a mismatch between the file and the proper file type, an error is generated. If</p>

	there is a mismatch between file version or model number or instrument version or model number, a warning is displayed. Then it returns to the State menu and File Open dialog goes away. After the Recall, the analyzer exits the Recall menu and returns to the previous menu.
<b>Backwards Compatibility SCPI</b>	:MMEMory:LOAD:STATe 1,<filename> For backwards compatibility, the above syntax is supported. The "1" is simply ignored.
Initial S/W Revision	Prior to A.02.00

## More Information

In measurements that support saving Traces, for example, Swept SA, the Trace data is saved along with the State in the State file. When recalling the State, the Trace data is recalled as well. Traces are recalled exactly as they were stored, including the writing mode and update and display modes. If a Trace was updating and visible when the State was saved, it will come back updating and visible, and its data will be rewritten right away. When you use State to save and recall traces, any trace whose data must be preserved should be placed in View or Blank mode before saving.

The following table describes the Trace Save and Recall possibilities:

You want to recall state and one trace's data, leaving other traces unaffected.	Save Trace+State from 1 trace. Make sure that no other traces are updating (they should all be in View or Blank mode) when the save is performed.	On Recall, specify the trace you want to load the one trace's data into. This trace will load in View. All other traces' data will be unaffected, although their trace mode will be as it was when the state save was performed.
You want to recall all traces	Save Trace+State from ALL traces.	On Recall, all traces will come back in View (or Blank if they were in Blank or Background when saved)
You want all traces to load exactly as they were when saved.	Save State	On recall, all traces' mode and data will be exactly as they were when saved. Any traces that were updating will have their data immediately overwritten.

## From File...

When you press "From File", the analyzer brings up a Windows dialog and a menu entitled "File Open." This menu allows you to navigate to the various fields in the Windows dialog without using a keyboard or mouse. The Tab and Arrow keys can also be used for dialog navigation.

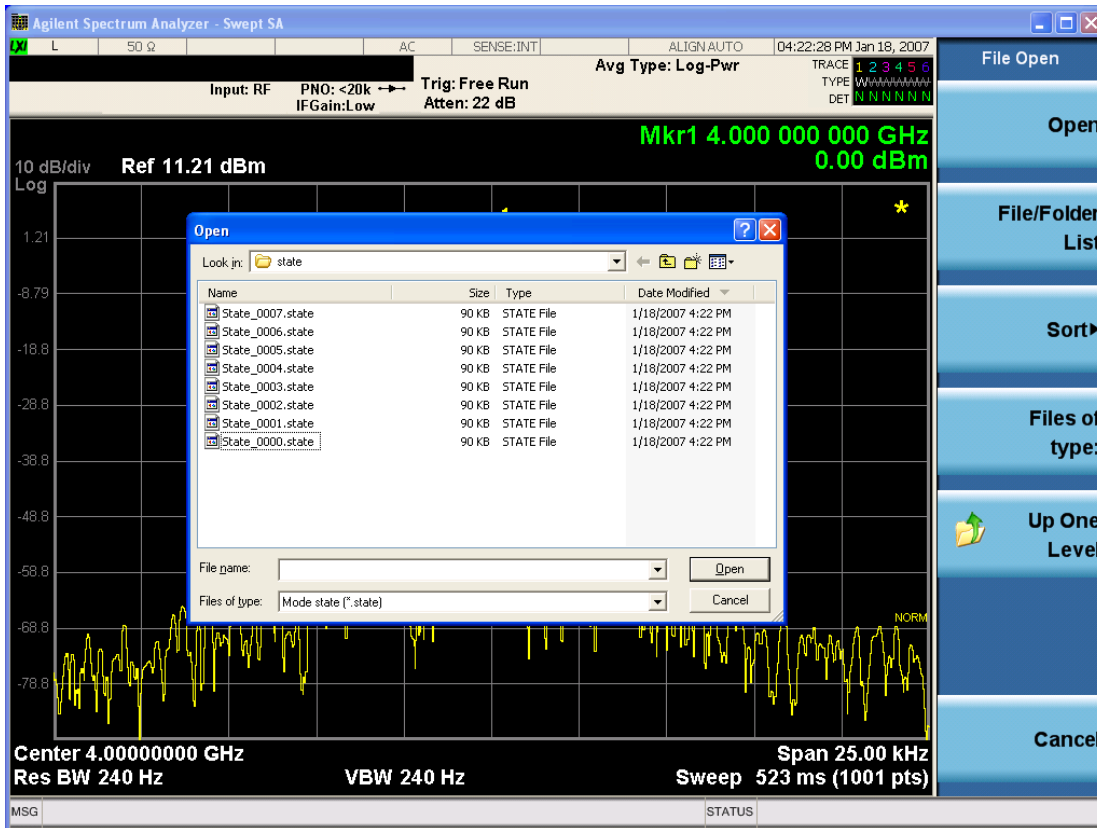

Listed below are the functions of the various fields in the dialog, and the corresponding softkeys:

#### Open

Performs the recall of the specified file. While the recall is being performed, the floppy icon appears briefly in the Meas bar.

#### File/Folder List

Enables you to navigate to the center of the dialog that contains the list of files and folders. Once here you can get information about the file and use the tab keys to navigate to the other fields in the dialog, such as Look In.

#### Look In

The Look In field shows the path from which the file will be recalled and allows you to change the path using the up and down arrow keys to navigate to other paths; the Enter key to open a directory; and the Backspace key to go back one directory. The **Look In field** first uses the last path from the Save As dialog **Save In:** path for that same file type. There is no softkey for directly navigating to the Look In field, but you can use the left tab to get here from the File/Folder List.

User specified paths are remembered when you leave and return to a Mode and are reset back to the default using Restore Mode Defaults.

#### Sort

Accesses a menu that enables you to sort the files within the File Open dialog. Only one sorting type can be selected at a time and the sorting happens immediately. The sorting types are By Date, By Name, By extension, and By Size.

#### Files of Type

This field shows the file suffix for the type of file you have selected to recall. For example, if you navigated here while recalling State, "Mode state (\*.state)" is in the field. If you navigated here while recalling Trace, ""Mode state (\*.trace)" is in the field. If you navigated here while importing a trace data file, "Trace Data (\*.csv)" is in the field. For some file types, there is more than one choice in the dropdown menu, which you can select by using the up and down arrow keys and Enter.

#### Up One Level

This key corresponds to the icon of a folder with the up arrow that is in the tool bar of the dialog. When pressed, it causes the file and folder list to navigate up one level in the directory structure. The Backspace key does the same thing.

#### Cancel

This key corresponds to the Cancel selection in the dialog. It causes the current **Open** request to be cancelled. The ESC key does the same thing.

Key Path	Recall, State
Notes	Brings up the Open dialog for recalling a State Save Type
Initial S/W Revision	Prior to A.02.00

### Edit Register Names

You may enter a custom name on any of the Register keys, to help you remember what you are using that state to save. To do this, press the Edit Register Names key, choose the register whose name you wish to edit, and then enter the desired label using the Alpha Editor or an external PC keyboard.

The maximum number of characters that can be added is 30. In most cases, 30 characters will fit on two lines of the key.

For more information and the SCPI command, see Edit Register Names under the Save, State function.

Key Path	Recall, State
Mode	All
Dependencies	N9060A-7FP or N9060B-2FP license required to edit the register names. When the feature is not licensed, sending the SCPI command generates an error, -221, "Settings conflict;Option not available"
Initial S/W Revision	A.11.00

### Register 1 thru Register 16

Selecting any one of these register keys causes the State of the mode from the specified Register to be recalled. Each of the register keys annotates whether it is empty or at what date and time it was last



modified. In addition, you can use the Edit Register Names key under Save, State to enter custom names for each register.

Registers are shared by all modes, so recalling from any one of the registers will cause a mode switch to the mode that was active when the save to the Register occurred.

Although these 16 registers are the only registers available from the front panel, there are 128 state registers available in the instrument. Registers 17–128 are only available from the SCPI interface, using the \*RCL command.

After the recall completes, the message "Register <register number> recalled" appears in the message bar. If you are in the Spectrum Analyzer Mode, and you are recalling a register that was saved in the Spectrum Analyzer Mode, then after the recall, you will still be in the Recall Register menu. If the Recall causes you to switch modes, then after the Recall, you will be in the Frequency menu.

If a requested register is empty an error is generated.

Key Path	Recall, State
<b>Example</b>	*RCL 1
Range	1–16 from front panel, 1–128 from SCPI
Readback	Date and time with seconds resolution are displayed on the key OR A custom name of up to 30 characters entered using the Save, State, Edit Register Names key OR “(empty)” if no prior save operation has been performed to this register.
Initial S/W Revision	Prior to A.02.00
Modified at S/W Revision	Prior to A.11.00

## Register 1 thru Register 16

Selecting any one of these register keys causes the State of the mode from the specified Register to be recalled. Each of the register keys annotates whether it is empty or at what date and time it was last modified. In addition, you can use the Edit Register Names key under Save, State to enter custom names for each register.

Registers are shared by all modes, so recalling from any one of the registers will cause a mode switch to the mode that was active when the save to the Register occurred.

Although these 16 registers are the only registers available from the front panel, there are 128 state registers available in the instrument. Registers 17–128 are only available from the SCPI interface, using the \*RCL command.

After the recall completes, the message "Register <register number> recalled" appears in the message bar. If you are in the Spectrum Analyzer Mode, and you are recalling a register that was saved in the Spectrum Analyzer Mode, then after the recall, you will still be in the Recall Register menu. If the Recall causes you to switch modes, then after the Recall, you will be in the Frequency menu.

If a requested register is empty an error is generated.

Key Path	Recall, State
<b>Example</b>	*RCL 1
Range	1-16 from front panel, 1-128 from SCPI
Readback	Date and time with seconds resolution are displayed on the key OR A custom name of up to 30 characters entered using the Save, State, Edit Register Names key OR “(empty)” if no prior save operation has been performed to this register.
Initial S/W Revision	Prior to A.02.00
Modified at S/W Revision	Prior to A.11.00

## Data (Import)

Importing a data file loads data that was previously saved from the current measurement or from other measurements and/or modes that produce compatible data files. The Import Menu only contains Data Types that are supported by the current measurement.

Since the commonly exported data files are in .csv format, the data can be edited by the user prior to importing. This allows you to export a data file, manipulate the data in Excel (the most common PC Application for manipulating .csv files) and then import it.

Importing Data loads measurement data from the specified file into the specified or default destination, depending on the data type selected. Selecting an Import Data menu key will not actually cause the importing to occur, since the analyzer still needs to know from where to get the data. Pressing the Open key in this menu brings up the Open dialog and Open menu that provides you with the options from where to recall the data. Once a filename has been selected or entered in the Open menu, the recall occurs as soon as the Open button is pressed.

Key Path	Recall
Mode	All
Notes	The menu is built from whatever data types are available for the mode. Some keys will be missing completely, so the key locations in the sub-menu will vary. No SCPI command directly controls the Data Type that this key controls. The Data Type is included in the MMEM:LOAD commands.
Dependencies	If a file type is not used by a certain measurement, it is grayed out for that measurement. The key for a file type will not show at all if there are no measurements in the Mode that support it.
Preset	Is not affected by Preset or shutdown, but is reset during Restore Mode Defaults
Readback	The data type that is currently selected
Initial S/W Revision	Prior to A.02.00

## Amplitude Correction

This key selects the Amplitude Corrections as the data type to be imported. When pressed a second time, it brings up the Select Menu, which lets you select the Correction into which the data will be imported.

Amplitude Corrections are fully discussed in the documentation of the Input/Output key, under the Corrections key.

A set of preloaded Corrections files can be found in the directory

/My Documents/ EMC Limits and Ampcor.

When the Amplitude Correction is an Antenna correction and the Antenna Unit in the file is not None, the Y Axis Unit setting will change to match the Antenna Unit in the file.

Key Path	Recall
Mode	SA EDGE GSM PN
Remote Command	:MMEMory:LOAD:CORRection 1 2 3 4 5 6 7 8, <filename>
Example	:MMEM:LOAD:CORR 2, "myAmpcor.csv" recalls the Amplitude Correction data from the file myAmpcor.csv in the current directory to the 2nd Amplitude Correction table, and turns on Correction 2. The default path is D:\User_My_Documents\Instrument\My Documents\amplitudeCorrections\
Dependencies	Only the first correction array (Correction 1) supports antenna units. This means that a correction file with an Antenna Unit can only be loaded into the Corrections 1 register. Consequently only for Correction 1 does the dropdown in the Recall dialog include.ant, and if an attempt is made to load a correction file into any other Correction register which DOES contain an antenna unit, a Mass Storage error is generated. Corrections are not supported by all Measurements. If in a Mode in which some Measurements support it, this key will be grayed out in measurements that do not. The key will not show at all if no measurements in the Mode support it. Errors are reported if the file is empty or missing, or if the file type does not match, or if there is a mismatch between the file type and the destination data type. If any of these occur during manual operation, the analyzer returns to the Import Data menu and the File Open dialog goes away. This key does not appear unless you have the proper option installed in your instrument. This command will generate an "Option not available" error unless you have the proper option installed in your instrument.
Couplings	When a correction file is loaded from mass storage, it is automatically turned on ( <b>Correction ON</b> ) and <b>ApplyCorrections</b> is set to On. This allows you to see its effect, thus confirming the load.
Readback	selected Correction
Backwards Compatibility SCPI	:MMEMory:LOAD:CORRection ANTenna   CABLe   OTHer   USER, <filename> For backwards compatibility, ANTenna maps to 1, CABLe maps to 2, OTHer maps to 3 and USER maps to 4
Initial S/W Revision	A.02.00

### Amplitude Correction

These keys let you select which Correction to import the data into. Once selected, the key returns back to the Import Data menu and the selected Correction number is annotated on the key. The next step is to select the Open key in the Import Data menu.

Antenna corrections are a particular kind of Amplitude Corrections – they are distinguished in the corrections file by having the Antenna Unit set to a value other than None. Only Correction 1 supports Antenna Units.

Key Path	Recall, Data, Amplitude Correction
Notes	auto return
Dependencies	Only Correction 1 may be used to load a Correction that contains an Antenna Unit other than None
Preset	Not part of Preset, but is reset to Correction 1 by Restore Input/Output Defaults; survives shutdown.
State Saved	The current Correction number is saved in instrument state
Initial S/W Revision	A.02.00

### Chan Table

Imports the channel table from a channel plan file. This function enables you to use your own defined channel tables by importing a modified channel table file.

Instead of creating a brand new channel plan file, you can generate a channel plan file to fit your needs using a saved channel plan file or the default channel plan file ChannelPlan.txt in the directory “My Documents\Digital Video\data”. The saved channel plan file is obtained by pressing Save, Data, Channel Table, and then Save As...

Note that while editing the channel plan file, you cannot change the channel plan name, such as NTSC\_B.VHF, NTSC\_B.UHF, otherwise your modifications on the corresponding channel plan will not work. You can add, remove, or modify the channel numbers and center frequencies in each channel plan. The value of Start Channel and Channel Count may also need to be changed.

File Location and Extension

**File location:** “My Documents\Digital Video\data”

**File type:** text file

**File extension:** .txt

**Example:**

File Location: My Documents\Digital Video\data

File Name: ChannelPlan\_0001.txt

Key Path	Recall, Data
Mode	DVB-T/H
Remote Command	MMEMoRY:LOAD:CHTable <string>
Example	MMEM:LOAD:CHT “ChannelPlan_0001.txt”
Initial S/W Revision	A.07.00

## Capture Buffer

Capture buffer functionality is available only in Mod Accuracy measurement. The captured data is raw data which is not processed.

Key Path	Recall, Data
Mode	DVB-T/H
Example	MMEM:LOAD:CAPT "MyCaptureData.bin" This loads the file of capture data (on the default file directory path) into the instrument.
Dependencies	Capture buffer data is only available for Mod Accuracy measurement. In other measurements, this key is grayed out.
Initial S/W Revision	Prior to A.01.70

## DVB-T2 Config

Imports DVB-T2 configuration from setting files (single PLP or multiple PLPs). This key is available only in DVB-T2 Mod Accuracy measurement and will be grayed out in other measurements.

If the configuration file to be recalled is created with previous instrument S/W revision A.10.52 or before (To check the instrument S/W revision, press System, Show, System on the instrument), it doesn't have Transmission Mode and Version parameters. Then you need to set up the DVB-T2 version and transmission mode manually by pressing Mode Setup, Radio Std, DVB-T2, Version 1.1.1, and toggling Transmission Mode to SISO to select the standard version and transmission mode of the signal under test.

All the modulation parameters can be set from the setting file. These parameters include Version, Transmission Mode, Guard Interval, FFT size, Carrier Mode, Pilot Pattern, L1 Modulation Format, Data Symbols, PAPR Type, PLP Number, SubSlices Number, SubSlices Interval, PLP Modulation Format, PLP Constellation Rotation, FEC Type, Time IL Length, FEC Block Num, PLP ID, PLP Start, PLP Type and PLP Code Rate.

File Location and Extension

**File location:** "My Documents\DVB\data\EVMT2\data"

**File type:** text file

**File extension:** .csv

**Example:**

File Location: My Documents\DVB\data\EVMT2\data

File Name: DVBT2Config\_0001.csv

Key Path	Recall, Data
Mode	DVB-T/H
<b>Remote Command</b>	MMEMory:LOAD:T2Config <string>

<b>Example</b>	MMEM:LOAD:T2C "DVBT2Config_0001.csv"
<b>Dependencies</b>	This key is grayed out in all other measurements except DVB-T2 Mod Accuracy measurement.
<b>Couplings</b>	Auto Detect (Meas, DVB-T2 ModAccuracy, Meas Setup) will be changed to OFF automatically when the DVB-T2 config file is loaded.
<b>Initial S/W Revision</b>	A.07.00

### Open...

When you press "Open", the analyzer brings up a Windows dialog and a menu entitled "File Open." This menu allows you to navigate to the various fields in the Windows dialog without using a keyboard or mouse. The Tab and Arrow keys can also be used for dialog navigation.

See "From File..." on page 2201 in Recall, State, for a full description of this dialog and menu.

<b>Key Path</b>	Recall, Data
<b>Notes</b>	The key location is mode-dependent and will vary. Brings up Open dialog for recalling a <mode specific> Save Type
<b>Initial S/W Revision</b>	Prior to A.02.00

## Restart

The Restart function restarts the current sweep, or measurement, or set of averaged/held sweeps or measurements. If you are Paused, pressing Restart does a Resume.

The Restart function is accessed in several ways:

- Pressing the Restart key
- Sending the remote command INIT:IMMEDIATE
- Sending the remote command INIT:RESTART

See "[More Information](#)" on page 1167

Key Path	Front-panel key
Remote Command	:INITiate[:IMMEDIATE] :INITiate:RESTART
Example	:INIT:IMM :INIT:REST
Notes	:INITiate:RESTART and :INITiate:IMMEDIATE perform exactly the same function.
Couplings	Resets average/hold count k. For the first sweep overwrites all active (update=on) traces with new current data. For application modes, it resets other parameters as required by the measurement.
Status Bits/OPC dependencies	This is an Overlapped command. The STATUS:OPERation register bits 0 through 8 are cleared. The STATUS:QUESTIONable register bit 9 (INTEgrity sum) is cleared. The SWEEPING bit is set. The MEASURING bit is set.
Backwards Compatibility Notes	For Spectrum Analysis mode in ESA and PSA, the Restart hardkey and the INITiate:RESTART command restart trace averages (displayed average count reset to 1) for a trace in Clear Write, but did not restart Max Hold and Min Hold. In the X-Series, the Restart hardkey and the INITiate:RESTART command restart not only Trace Average, but MaxHold and MinHold traces as well. For wireless comms modes in ESA and PSA, the Restart hardkey and the INITiate:RESTART command restart every measurement, which includes all traces and numeric results. There is no change to this operation.
Initial S/W Revision	Prior to A.02.00

### More Information

The **Restart** function first aborts the current sweep/measurement as quickly as possible. It then resets the sweep and trigger systems, sets up the measurement and initiates a new data measurement sequence with a new data acquisition (sweep) taken once the trigger condition is met.

If the analyzer is in the process of aligning when **Restart** is executed, the alignment finishes before the restart function is performed.

Even when set for Single operation, multiple sweeps may be taken when Restart is pressed (for example, when averaging/holding is on). Thus when we say that **Restart** "restarts a measurement," we may mean:

- It restarts the current sweep
- It restarts the current measurement
- It restarts the current set of sweeps if any trace is in Trace Average, Max Hold or Min Hold
- It restarts the current set of measurements if Averaging, or Max Hold, or Min Hold is on for the measurement
- depending on the current settings.

With **Average/Hold Number** (in **Meas Setup** menu) set to 1, or Averaging off, or no trace in Trace Average or Hold, a single sweep is equivalent to a single measurement. A single sweep is taken after the trigger condition is met; and the analyzer stops sweeping once that sweep has completed. However, with **Average/Hold Number** >1 and at least one trace set to **Trace Average, Max Hold, or Min Hold (SA Measurement)** or **Averaging on (most other measurements)**, multiple sweeps/data acquisitions are taken for a single measurement. The trigger condition must be met prior to each sweep. The sweep is stopped when the average count  $k$  equals the number  $N$  set for **Average/Hold Number**. A measurement average usually applies to all traces, marker results, and numeric results; but sometimes it only applies to the numeric results.

Once the full set of sweeps has been taken, the analyzer will go to idle state. To take one more sweep without resetting the average count, increment the average count by 1, by pressing the step up key while **Average/Hold Number** is the active function, or sending the remote command CALC:AVER:TCON UP.



## Save

The Save menu lets you choose what you want to save and where you want to save it. Among the types of files you can save are **States**, **Traces**, and **Screen Images**. In addition, an Export (Data) option lets you save a number of data types as CSV files for easy import into Excel and other spreadsheet programs.

Key Path	Front-panel key
Mode	All
Notes	No remote command for this key specifically, but the :MMEM:STORe command is available for specific file types. An example is :MMEM:STOR:STATe <filename>.
Initial S/W Revision	Prior to A.02.00

## State

The Save State menu lets you choose a register or file for saving the state.

The content of a state file includes all of the settings and data required to return the analyzer as closely as possible to the Mode it was in, with the exact settings which were in place, when the save occurred. The Mode settings in each state file include the settings that are affected by Mode Preset, as well as the additional settings affected by Restore Mode Defaults; all of the Mode's settings. In addition, all of the settings of the Input/Output system are included, even though they are outside of the Mode's state, because they are needed to restore the complete setup. Persistent System settings (for example, Verbose SCPI) are not affected by either Mode Preset or Restore Mode Defaults, nor are they included in a saved State file.

After the save completes, the message "File <filename> saved" or "State Register <register number> saved" is displayed.

For rapid saving, the State menu lists 16 registers to save to. Pressing a Register key initiates the save. You can also select a file to save to.

The default path for all State Files is:

My Documents\<<mode name>\state

where <mode name> is the parameter used to select the mode with the INST:SEL command (for example, SA for the Spectrum Analyzer).

Key Path	Save
Mode	All
Remote Command	:MMEMory:STORe:STATe <filename>
Example	MMEM:STOR:STATe "MyStateFile.state" This stores the current instrument state data in the file MyStateFile.state in the default directory.
Notes	Both single and double quotes are supported for any filename parameter over remote. After saving to a register, that register's menu key is updated with the date the time, unless a custom label has been entered for that key. After saving to a register, you remain in the Save State menu, so that you can see the Register key

update. After saving to a file, the analyzer automatically returns to the previous menu and any Save As dialog goes away.

**Backwards Compatibility SCPI** :MMEMory:STORe:STATe 1,<filename>

For backwards compatibility, the above syntax is supported. The "1" is simply ignored. The command is sequential.

Initial S/W Revision Prior to A.02.00

### To File . . .

When you press “To File”, the analyzer brings up a Windows dialog and a menu entitled “Save As.” This menu allows you to navigate to the various fields in the Windows dialog without using a keyboard or mouse. The Tab and Arrow keys can also be used for dialog navigation.

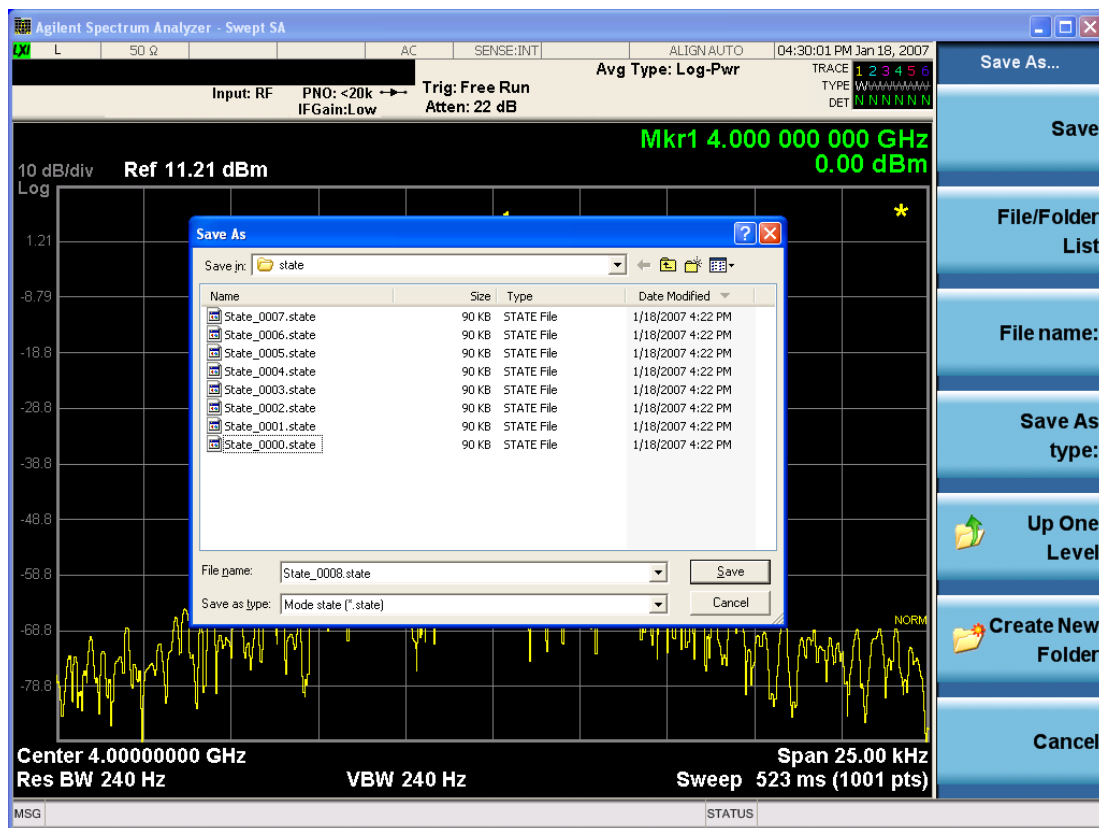

The Listed below

are the functions of the various fields in the dialog, and the corresponding softkeys:

#### Save

Performs the save to the specified file of the selected type. If the file already exists, a dialog will appear that allows you to replace the existing file by selecting OK, or you can Cancel the request. If you select OK, the file will be overwritten. Using the C: drive is strongly discouraged, since it runs the risk of being overwritten during an instrument software upgrade.

While the save is being performed, the floppy icon appears briefly in the Meas bar.

### File/Folder List

Enables you to navigate to the center of the dialog that contains the list of files and folders. Once here you can get information about the file and use the tab keys to navigate to the other fields in the dialog, such as Save In.

### Save In

The Save In field shows the path to which the file will be saved and allows you to change the path using the up and down arrow keys to navigate to other paths; the Enter key to open a directory; and the Backspace key to go back one directory. The **Save In field** defaults to the default path for this type of file and remembers the last path you used to save this type of file. There is no softkey for directly navigating to the Save In field but you can use left tab to get here from the File/Folder List.

User specified paths are remembered when you leave and return to a Mode and are reset back to the default using Restore Mode Defaults.

### File Name

The File Name field is initially loaded with an automatically generated filename specific to the appropriate Save Type. The automatically generated filename is guaranteed not to conflict with any filename currently in the directory. You may replace or modify this filename using the File Name key. See the ["Quick Save " on page 2197](#) documentation for more on the automatic file naming algorithm.

When you press the File Name key the analyzer displays the Alpha Editor. Use the knob to choose the letter to add and the front-panel Enter key to add the letter to the file name. The BK character moves you back and the FW character moves you forward in the filename. The Select key on the front panel generates a space character. When you are done entering the filename press the Done softkey. This returns back to the **File Open** dialog and menu, but does not cause the save to occur.

### Save As Type

This field shows the file suffix for the type of file you have selected to save. For example, if you navigated here while saving State, "Mode state (\*.state)" is in the field. If you navigated here from saving Trace, ""Mode state (\*.trace)" is in the field. If you navigated here while exporting a trace data file, "Trace Data (\*.csv)" is in the field. For some file types, there is more than one choice in the dropdown, which you can select by using the up and down arrow keys and Enter.

### Up One Level

This key corresponds to the icon of a folder with the up arrow that is in the tool bar of the dialog. When pressed, it causes the file and folder list to navigate up one level in the directory structure. The Backspace key does the same thing.

### Create New Folder

This key corresponds to the icon of a folder with the "\*" that is in the tool bar of the dialog. When pressed, a new folder is created in the current directory with the name **New Folder** and you can enter a new folder name using the Alpha Editor.

### Cancel

This key corresponds to the Cancel selection in the dialog. It causes the current **Save As** request to be cancelled. The ESC key does the same thing.

Key Path	Save, State
Mode	All
Notes	Brings up Save As dialog for saving a State Save Type
Initial S/W Revision	Prior to A.02.00

## Edit Register Names

You may enter a custom name on any of the Register keys, to help you remember what you are using that state to save. To do this, press the Edit Register Names key, choose the register whose name you wish to edit, and then enter the desired label using the Alpha Editor or an external PC keyboard.

The maximum number of characters that can be added is 30. In most cases, 30 characters will fit on two lines of the key.

See ["More Information" on page 1172](#)

Key Path	Save, State
Mode	All
<b>Remote Command</b>	:MMEMory:REGister:STATe:LABel <reg number>,"label" :MMEMory:REGister:STATe:LABel? <reg number>
<b>Example</b>	:MMEM:REG:STAT:LAB 1,"my label"
Notes	<reg number> is an integer from 1 to 16. If the SCPI specifies an invalid register number an error message is generated, -222,"Data out of range;Invalid register label number" "label" is a string from 0 to 30 characters in length. If a label exceeds 30 characters, an error message is generated, -150,"String data error;Label clipped to 30 characters" "label" of length 0 erases the custom label and restores the default (time and date) label. E.g.: :MMEM:REG:STAT:LAB 1,""
Dependencies	N9060A-7FP or N9060B-2FP license required to edit the register names. When the feature is not licensed, sending this command generates an error, -221,"Settings conflict;Option not available"
Preset	The names are unaffected by Preset or power cycle but are set to the default label (time and date) on a "Restore System Defaults->Misc"
Initial S/W Revision	A.11.00

## More Information

When you edit one of the register names, the time and date field will be replaced by the custom name.

If you delete all the characters in the custom name, it restores the default (time and date).

The register names are stored within the state files, but they are not part of the instrument state; that is, once you have edited a register name, loading a new state will not change that register name. Another consequence of this is that the names will be persistent through a power cycle. Also, if a named state file is transferred to another analyzer, it will bring its custom name along with it.

If you try to edit the name of an empty register, the analyzer will first save the state to have a file to put the name in. If you load a named state file into an analyzer with older firmware it will ignore the metadata.

The \*SAV and \*RCL commands will not be affected by the custom register names, nor will the MMEM commands.

### Register 1 thru Register 16

Selecting any one of these register menu keys causes the State of the currently active mode to be saved to the specified Register. The registers are provided for rapid saving and recalling, since you do not need to specify a filename or navigate to a file. Each of the register menu keys annotates whether it is empty or at what date and time it was last modified. In addition, you can use the Edit Register Names key to enter custom names for each register.

Although these 16 registers are the only registers available from the front panel, there are 128 state registers available in the instrument. Registers 17–128 are only available from the SCPI interface, using the \*SAV command.

There is one set of 128 state registers in the instrument, not one set for each Mode. When a state is saved, the Mode it was saved from is saved with it; then when it is recalled, the instrument switches to that Mode.

After the save completes, the corresponding register menu key annotation is updated with the date and time and the message "Register <register number> saved" is displayed.

Key Path	Save, State
Mode	All
<b>Example</b>	*SAV 1
Range	1–16 from front panel, 1–128 from SCPI
Readback	Date and time with seconds resolution are displayed on the key OR A custom name of up to 30 characters entered using the Edit Register Names key OR “(empty)” if no prior save operation has been performed to this register.
Initial S/W Revision	Prior to A.02.00
Modified at S/W Revision	A.11.00

### Register 1 thru Register 16

Selecting any one of these register menu keys causes the State of the currently active mode to be saved to the specified Register. The registers are provided for rapid saving and recalling, since you do not need to specify a filename or navigate to a file. Each of the register menu keys annotates whether it is empty or at what date and time it was last modified. In addition, you can use the Edit Register Names key to enter custom names for each register.

Although these 16 registers are the only registers available from the front panel, there are 128 state registers available in the instrument. Registers 17–128 are only available from the SCPI interface, using the \*SAV command.

There is one set of 128 state registers in the instrument, not one set for each Mode. When a state is saved, the Mode it was saved from is saved with it; then when it is recalled, the instrument switches to that Mode.

After the save completes, the corresponding register menu key annotation is updated with the date and time and the message "Register <register number> saved" is displayed.

Key Path	Save, State
Mode	All
Example	*SAV 1
Range	1-16 from front panel, 1-128 from SCPI
Readback	Date and time with seconds resolution are displayed on the key OR A custom name of up to 30 characters entered using the Edit Register Names key OR “(empty)” if no prior save operation has been performed to this register.
Initial S/W Revision	Prior to A.02.00
Modified at S/W Revision	A.11.00

## Data (Export)

Exporting a data file stores data from the current measurement to mass storage files. The Export Menu only contains data types that are supported by the current measurement.

Since the commonly exported data files are in .csv format, the data can be edited by you prior to importing. This allows you to export a data file, manipulate the data in Excel (the most common PC Application for manipulating .csv files) and then import it.

Selecting an Export Data menu key will not actually cause the exporting to occur, since the analyzer still needs to know where you wish to save the data. Pressing the Save As key in this menu brings up the Save As dialog and Save As menu that allows you to specify the destination file and directory. Once a filename has been selected or entered in the Open menu, the export will occur as soon as the Save key is pressed.

Key Path	Save
Mode	All
Notes	The menu is built from whatever data types are available for the mode. So the key locations in the sub menu will vary.  No SCPI command directly controls the Data Type that this key controls. The Data Type is included in the MMEM:STORe commands.
Dependencies	If a file type is not used by a certain measurement, that type is grayed out for that measurement. The key for a file type will not show at all if there are no measurements in the Mode that support it.
Preset	Is not affected by a Preset or shutdown, but is reset during Restore Mode Defaults
Readback	The data type that is currently selected
Initial S/W Revision	Prior to A.02.00

## Amplitude Correction

Pressing this key selects **Amplitude Corrections** as the data type to be exported. Pressing this key again brings up the Select Menu, which allows the user to select which **Amplitude Correction** to save.

Amplitude Corrections are fully discussed in the documentation of the Input/Output key, under the Corrections softkey.

See "[Correction Data File](#)" on page 1175

Key Path	Save
<b>Remote Command</b>	:MMEMory:STORe:CORRection 1 2 3 4 5 6, <filename>
<b>Example</b>	:MMEM:STOR:CORR 2 "myAmpcor.csv" saves Correction 2 to the file myAmpcor.csv on the current path. The default path is My Documents\amplitudeCorrections.
Notes	If the save is initiated via SCPI, and the file already exists, the file will be overwritten. Using the C: drive is strongly discouraged, since it runs the risk of being overwritten during an instrument software upgrade. Both single and double quotes are supported for any filename parameter over SCPI.
Dependencies	Corrections are not supported by all Measurements. If in a Mode in which some Measurements support it, this key will be grayed out in measurements that do not. The key will not show at all if no measurements in the Mode support it. This key will not appear unless you have the proper option installed in your instrument.
Readback	Selected Correction
<b>Backwards Compatibility SCPI</b>	:MMEMory:STORe:CORRection ANTenna   CABLe   OTHer   USER, <filename> For backwards compatibility, ANTenna maps to 1, CABLe maps to 2, OTHer maps to 3 and USER maps to 4
Initial S/W Revision	A.02.00

## Correction Data File

A Corrections Data File contains a copy of one of the analyzer correction tables. Corrections provide a way to adjust the trace display for predetermined gain curves (such as for cable loss).

Corrections files are text files in .csv (comma separated values) form, to make them importable into Excel or other spreadsheet programs. The format for Corrections files is as follows.

Line #	Type of field	Example	Notes
1	File type, must be "Amplitude Correction"	Amplitude Correction	May not be omitted
2	File Description (in quotes)	"Correction Factors for 11966E"	60 characters max; may be empty but may not be omitted. If exceeds 60 characters, error -233 Too much data reported
3	Comment (in quotes)	"Class B Radiated"	60 characters max; may be empty but

Line #	Type of field	Example	Notes
			may not be omitted. . If exceeds 60 characters, error -233 Too much data reported
4	Instrument Version, Model #	A.02.06,N9020A	May be empty but may not be omitted
5	Option List, File Format Version	K03 LFE EXM ,01	May be empty but may not be omitted
6	Freq Unit to be used for all frequency values in the file	Frequency Unit,MHz	assumed to be Hz if omitted
7	Antenna Unit	Antenna Unit,None	If omitted leaves the Antenna unit unchanged. The amplitude unit in the Antenna Unit field is a conversion factor that is used to adjust the Y Axis Units of the current mode, if the mode supports Antenna Units. For more details on antenna correction data, refer to the Input/Output,Corrections key description. Allowable values: dBuV/m, dBuA/m, dBG, dBpT, None
8	Freq Interpolation	Frequency Interpolation,Linear	if omitted leaves the Freq Interpolation unchanged. Allowable values: Linear, Logarithmic
9	Bias value in mA	Bias,0.00	If omitted leaves the Bias value unchanged (added as of A.08.50)
10	Bias State	Bias State,On	If omitted leaves the Bias State unchanged. Allowable values: On, Off (added as of A.08.50)
11	Overlap, two values, Freq1 and Freq2, separated by commas.	Overlap,33500,40000	Uses Freq Unit from line 6. Thus, in this example Freq1=33.5 GHz, Freq2= 40.0 GHz (see note below). If omitted leaves the overlap unchanged (added as of A.08.50)
12	DATA marker	DATA	Corrections data begins in the next line

Lines 2 through 5 can be empty but must appear in the file. Lines 6 through 11 are optional, the lines can be left out of the file altogether.

The Overlap row and the two Bias rows apply only to external mixing. Both are read-only, they are never written by the analyzer. The only way to insert or modify these rows is to edit the file with a text editor or a spreadsheet editor. These rows are intended for use by mixer manufacturers, as they allow the manufacturer to insert data about how the mixer corrections were generated and how they should be applied. The Bias rows allow you to specify whether to turn Bias on or off when the Correction is turned on and to specify a Bias value (turning off the Correction does not change the Bias, but turning it back on again sets it to the value specified in the file). The Overlap row allows you to specify an overlap region in which



two different corrections may be applied. It is expected that in the corrections data itself, there will be TWO corrections values exactly at Max Freq, otherwise Overlap is ignored. The way the overlap is processed is as follows: if at any given time the current analyzer Start Freq is greater than Freq 1 and lower than Freq 2, and the current Stop Freq is greater than Freq 2, extend the first correction point at or above Freq 2 down to Freq 1, rather than using the correction data between Freq1 and Freq2.

The Antenna Unit row can only be used in Correction register 1, because there can only be one setting for Antenna Unit at any given time. If a Correction whose Antenna Unit is set to anything but None is loaded into any Correction register but 1, an error is generated (Mass storage error; Can only load an Antenna Unit into Correction 1). When a correction file is saved from any Correction register but 1, Antenna Unit is always written as None.

Similarly, the Bias rows can only be used in Correction register 1, because there can only be one setting for Bias at any given time. If a Correction file with a Bias or Bias State row is loaded into any Correction register but 1, an error is generated: Mass storage error; Can only load Bias Settings into Correction 1

The data follows the DATA row, as comma separated X, Y pairs; one pair per line.

For example, suppose you have an Antenna to correct for on an N9020A version A.02.06 and the correction data is:

- 0 dB at 200 MHz
- 17 dB at 210 MHz
- 14.8 dB at 225 MHz

Then the file will look like:

- Amplitude Correction
- "Correction Factors for 11966E"
- "Class B Radiated"
- A.02.06,N9020A
- P13 EA3 UK6,01
- Frequency Unit,MHz
- Antenna Unit,dBuV/m
- Frequency Interpolation,Linear
- DATA
- 200.000000,0.00
- 210.000000,17.00
- 225.000000,14.80

The choices for the 1 of N fields in the metadata are as follows:

- Frequency Unit: Hz, kHz, MHz, GHz
- Antenna Unit: dBuv/m, dBuA/m, dBG, dBpT, None

- Frequency Interpolation: Logarithmic, Linear

### Amplitude Correction

These keys let you choose which Correction to save. Once selected, the key returns back to the Export Data menu and the selected Correction number is annotated on the key.

The next step in the Save process is to select the Save As key in the Export Data menu.

Key Path	Save, Data, Amplitude Correction
Preset	Not part of a Preset, but is reset to Correction 1 by Restore Input/Output Defaults. Survives a shutdown.
Readback	1
Initial S/W Revision	A.02.00

### Chan Table

Exports the current channel table to a channel table file.

The exported channel table file can be edited to meet your requirements, and then imported by pressing Recall, Data, Channel Table, and then Open...

Note that while editing the channel plan file, you can't change the channel plan name, such as NTSC\_B.VHF, NTSC\_B.UHF, otherwise your modifications on the corresponding channel plan will not work. You can add, remove, or modify the channel numbers and center frequencies in each channel plan. The value of Start Channel and Channel Count may also need to be changed.

File Location and Extension

**File location:** "My Documents\Digital Video\data"

**File type:** text file

**File extension:** .txt

**Example:**

File Location: My Documents\Digital Video\data

File Name: ChannelPlan\_0001.txt

Key Path	Save, Data
Mode	DVB-T/H
Remote Command	MMEMory:STORe:CHTable <string>
Example	MMEM:STOR:CHT "ChannelPlan_0001.txt"
Initial S/W Revision	A.07.00

### Measurement Results

Pressing this key selects Meas Results as the data type to be exported.

The Meas Results file contains information that describes the current state of the analyzer. It is detailed in ["Meas Results File Contents" on page 1179](#) below.

Key Path	Save, Data
Remote Command	:MMEMory:STORe:RESults <string>
Example	:MMEM:STOR:RES "MeasR_0000.csv"
Notes	<p>If the save is initiated via SCPI and the file already exists, the file will be overwritten.</p> <p>The SCPI command exports Spectrum Emission Mask measurement results to the file specified as the parameter in the current path. The default path is My Documents\<current mode&gt;\data\sem\results.<="" p=""> <p>Using the C: drive is strongly discouraged, since it runs the risk of being overwritten during an instrument software upgrade.</p> <p>The SCPI parameter is a quoted string that specifies the filename. Both single and double quotes are supported for any filename parameter over SCPI.</p> </current></p>
Dependencies	The current active measurement must be the Spectrum Emission Mask measurement to use this command.
Status Bits/OPC dependencies	Sequential – waits for the previous measurement to complete
Initial S/W Revision	Prior to A.02.00

### Meas Results File Contents

A Meas Results File contains measurement results with the following information.

- File ID string, which is "MeasResult"
- Measurement ID following Mode ID, which is "SA:SEM" for example.
- Firmware rev and model number
- Option string
- Automatic Trigger Time
- Automatic Trigger Time State
- Center Frequency
- ChanIntegBW
- ChannelDetector
- ChannelDetectorState
- ChanPwrRefAuto
- ChanResBW
- ChanResBWAuto
- ChanSpan
- ChanSweepTime

- ChanSweepTimeAuto
- ChanVbwRbwRatio
- ChanVbwRbwRatioAuto
- ChanVideoBW
- ChanVideoBWAuto
- Electrical Atten
- Electrical Atten Bypass
- Electrical Atten State
- External1 Trigger Delay
- External1 Trigger Delay State
- External1 Trigger Level
- External1 Trigger Slope
- External2 Trigger Delay
- External2 Trigger Delay State
- External2 Trigger Level
- External2 Trigger Slope
- FilterAlpha
- Internal Preamp
- Internal Preamp Band
- Line Trigger Delay
- Line Trigger Delay State
- Line Trigger Slope
- Mechanical Atten
- Mechanical Atten Auto
- OffsetDetector
- OffsetDetectorState
- OffsetLimitAbsStartBTS
- OffsetLimitAbsStartMS
- OffsetLimitAbsStopBTS
- OffsetLimitAbsStopMS
- OffsetLimitFailMaskBTS

- OffsetLimitFailMaskMS
- OffsetLimitRelStartBTS
- OffsetLimitRelStartMS
- OffsetLimitRelStopBTS
- OffsetLimitRelStopMS
- OffsetMeasBWBTS
- OffsetMeasBWMS
- OffsetResolutionBWAUTOBTS
- OffsetResolutionBWAUTOMS
- OffsetResolutionBWBTS
- OffsetResolutionBWMS
- OffsetSideBTS
- OffsetSideMS
- OffsetStartFrequencyBTS
- OffsetStartFrequencyMS
- OffsetStateBTS
- OffsetStateMS
- OffsetStopFrequencyBTS
- OffsetStopFrequencyMS
- OffsetSweepTimeAutoBTS
- OffsetSweepTimeAutoMS
- OffsetSweepTimeBTS
- OffsetSweepTimeMS
- OffsetVbwRbwRatioAutoBTS
- OffsetVbwRbwRatioAutoMS
- OffsetVbwRbwRatioBTS
- OffsetVbwRbwRatioMS
- OffsetVideoBWAUTOBTS
- OffsetVideoBWAUTOMS
- OffsetVideoBWBTS
- OffsetVideoBWMS

- PeakReference
- Periodic Timer Period
- Periodic Timer Sync Source
- Periodic Timer Trigger Delay
- Periodic Timer Trigger Delay State
- PowerReference
- PSDReference
- Radio Device
- RFBurst Trigger Delay
- RFBurst Trigger Delay State
- RFBurst Trigger Level Abs
- RFBurst Trigger Level Rel
- RFBurst Trigger Level Type
- RFBurst Trigger Slope
- RrcFilter
- SemAverageNumber
- SemAverageState
- TotalAtten
- Trigger Holdoff
- Trigger Holdoff State
- TriggerSource
- Video Trigger Delay
- Video Trigger Delay State
- Video Trigger Level
- Video Trigger Slope
- ViewSelection

The file contains these data followed by MeasResult1 to MeasResult12 that flag the start of the measurement results. Each line of Measurement Results consists of twelve comma separated values from MeasResult1 value to MeasResult12 value. MeasResult1 contains the same results as MEAS/READ/FETCH:SEMAsk1; MeasResult2, MEAS/READ/FETCH:SEMAsk2; MeasResult3, MEAS/READ/FETCH:SEMAsk3;... (continues in the same manner)

The exported file is in CSV format, with a.csv extension. The Meas Results file, when imported into Excel, shows the following data:

MeasResult		
SA:SEM		
A.10.53	N90	
	30A	
526 ALV ATP	1	
B1X B1Y B25		
B40 BBA CR3		
CRP DCF DDA		
DP2 DRD EA3		
EDP EMC EP1		
ERC ESC ESP		
EXM FSA LFE		
LNP MAT		
MPB NFE		
NUL P26 PFR		
PNC RTL RTS		
S40 SB1 SEC		
SM1 TVT YAS		
YAV		
Automatic Trigger Time	0.1	
Automatic Trigger Time State	FALS	E
Center Frequency	1.33	E+10
ChanIntegBW	384 000 0	384 000 0
ChannelDetector	Average	
ChannelDetectorState	TRUE	
ChanPwrRefAuto	TRUE	
ChanResBW	100 000	100 000
ChanResBWAuto	FALS E	FALS E
ChanSpan	500 000 0	500 000 0
ChanSweepTime	0.00 250 7	0.00 250 7

11 Spectrum Emission Mask Measurement  
Save

ChanSweepTimeAuto	TRUE	TRUE
ChanVbwRbwRatio	1	1
ChanVbwRbwRatioAuto	FALSE	FALSE
ChanVideoBW	100000	100000
ChanVideoBWAuto	TRUE	TRUE
Electrical Atten	0	
Electrical Atten Bypass	TRUE	
Electrical Atten State	FALSE	
External1 Trigger Delay	1.00E-06	
External1 Trigger Delay State	FALSE	
External1 Trigger Level	1.2	
External1 Trigger Slope	Positive	
External2 Trigger Delay	1.00E-06	
External2 Trigger Delay State	FALSE	
External2 Trigger Level	1.2	
External2 Trigger Slope	Positive	
FilterAlpha	0.22	
Internal Preamp	FALSE	
Internal Preamp Band	Low	
Line Trigger Delay	1.00E-06	
Line Trigger Delay State	FALSE	



Line Trigger Slope	Positive					
Mechanical Atten	10					
Mechanical Atten Auto	TRUE					
OffsetDetector	Peak					
OffsetDetectorState	TRUE					
OffsetLimitAbsStartBTS	-14	-14	-26	-13	-13	-13
OffsetLimitAbsStartMS	-14	-14	-26	-13	-13	-13
OffsetLimitAbsStopBTS	-14	-26	-26	-13	-13	-13
OffsetLimitAbsStopMS	-14	-26	-26	-13	-13	-13
OffsetLimitFailMaskBTS	ABSolute	ABSolute	ABSolute	ABSolute	ABSolute	ABSolute
OffsetLimitFailMaskMS	ABSolute	ABSolute	ABSolute	ABSolute	ABSolute	ABSolute
OffsetLimitRelStartBTS	-30	-30	-30	-30	-30	-30
OffsetLimitRelStartMS	-30	-30	-30	-30	-30	-30
OffsetLimitRelStopBTS	-30	-30	-30	-30	-30	-30
OffsetLimitRelStopMS	-30	-30	-30	-30	-30	-30
OffsetMeasBWBTS	1	1	1	1	1	1
OffsetMeasBWMMS	1	1	1	1	1	1
OffsetResolutionBWAUTOBTS	FALSE	FALSE	FALSE	FALSE	FALSE	FALSE
OffsetResolutionBWAUTOMS	FALSE	FALSE	FALSE	FALSE	FALSE	FALSE
OffsetResolutionBWBTS	30000	30000	30000	1000000	100000	100000
OffsetResolutionBWMMS	300	300	300	1000000	100	100

onBWMS	00	00	00		000 0	000 0
OffsetSideBTS	Both	Both	Both	Both	Both	Both
OffsetSideMS	Both	Both	Both	Both	Both	Both
OffsetStartFrequencyBTS	251 500 0	271 500 0	351 500 0	4000000	800 000 0	125 000 00
OffsetStartFrequencyMS	251 500 0	271 500 0	351 500 0	4000000	800 000 0	125 000 00
OffsetStateBTS	TRUE	TRUE	TRUE	TRUE	TRUE	FALSE
OffsetStateMS	TRUE	TRUE	TRUE	TRUE	TRUE	FALSE
OffsetStopFrequencyBTS	271 500 0	351 500 0	400 000 0	8000000	125 000 00	150 000 00
OffsetStopFrequencyMS	271 500 0	351 500 0	400 000 0	8000000	125 000 00	150 000 00
OffsetSweepTimeAutoBTS	TRUE	TRUE	TRUE	TRUE	TRUE	TRUE
OffsetSweepTimeAutoMS	TRUE	TRUE	TRUE	TRUE	TRUE	TRUE
OffsetSweepTimeBTS	0.01 733 3	0.06 932	0.04 202 7	0.002053	0.00 225 3	0.00 125 3
OffsetSweepTimeMS	0.01 733 3	0.06 932	0.04 202 7	0.002053	0.00 225 3	0.00 125 3
OffsetVbwRbwRatioAutoBTS	FALSE	FALSE	FALSE	FALSE	FALSE	FALSE
OffsetVbwRbwRatioAutoMS	FALSE	FALSE	FALSE	FALSE	FALSE	FALSE
OffsetVbwRbwRatioBTS	0.01	0.01	0.01	0.01	0.01	0.01
OffsetVbwRbwRatioMS	0.01	0.01	0.01	0.01	0.01	0.01
OffsetVideoBWAutoBTS	TRUE	TRUE	TRUE	TRUE	TRUE	TRUE
OffsetVideoBWAutoMS	TRUE	TRUE	TRUE	TRUE	TRUE	TRUE

OffsetVideoB WBTS	300	300	300	10000	100 00	100 00
OffsetVideoB WMS	300	300	300	10000	100 00	100 00
PeakReferenc e	- 82.9 957					
Periodic Timer Period	0.02					
Periodic Timer Sync Source	None					
Periodic Timer Trigger Delay	1.00 E-06					
Periodic Timer Trigger Delay State	FALS E					
PowerReferen ce	- 73.6 966					
PSDReferenc e	- 139. 54					
Radio Device	Bts					
RFBurst Trigger Delay	1.00 E-06					
RFBurst Trigger Delay State	FALS E					
RFBurst Trigger Level Abs	-20					
RFBurst Trigger Level Rel	-6					
RFBurst Trigger Level Type	Absol ute					
RFBurst Trigger Slope	Posit ive					
RrcFilter	FALS E					
SemAverageN umber	10					

SemAverageState	FALSE										
TotalAttenuation	10										
TriggerHoldoff	0.1										
TriggerHoldoffState	FALSE										
TriggerSource	Free										
VideoTriggerDelay	1.00										
VideoTriggerDelayState	E-06										
VideoTriggerLevel	-25										
VideoTriggerSlope	Positive										
VideoSelection	AbsPwrFreq										
MeasResult1	MeasResult2	MeasResult3	MeasResult4	MeasResult5	MeasResult6	MeasResult7	MeasResult8	MeasResult9	MeasResult10	MeasResult11	MeasResult12
-999	-78.89359	-13	999	-73.6966334099879	-999	-999	-999	-999	-999	-999	-999
-73.6966334099879	-78.95235	-13	999	-999	-999	-999	-999	-999	-999	-999	-999

### Capture Buffer

Capture buffer functionality is available only in Mod Accuracy measurement. The captured data is raw data which is not processed.

Key Path	Save, Data
Mode	DVB-T/H
Example	MMEM:STOR:CAPT "MyCaptureData.bin" This stores the capture data in the file MyCaptureData.bin in the default directory.
Dependencies	Capture buffer functionality is only available for Mod Accuracy measurement. In other measurements, this key is grayed out.
Initial S/W Revision	Prior to A.01.70

## DVB-T2 Config

Exports the current DVB-T2 configuration to a file (single PLP or multiple PLPs). This key is available only in DVB-T2 Mod Accuracy measurement and will be grayed out in other measurements.

You can view the exported file for the format of the DVB-T2 configuration files and create your own DVB-T2 configuration file by modifying the exported file.

File Location and Extension

**File location:** "My Documents\DVB\data\EVMT2\data"

**File type:** text file

**File extension:** .csv

**Example:**

File Location: My Documents\DVB\data\EVMT2\data

File Name: DVBT2Config\_0001.csv

Key Path	Save, Data
Mode	DVB-T/H
Remote Command	MMEMoRY:STORe:T2Config <string>
Example	MMEM:STOR:T2C "DVBT2Config_0001.csv"
Dependencies	This key is grayed out in all the other measurements except DVB-T2 Mod Accuracy measurement.
Initial S/W Revision	A.07.00

## Save As . . .

When you press "Save As", the analyzer brings up a Windows dialog and a menu entitled "**Save As.**" This menu allows you to navigate to the various fields in the Windows dialog without using a keyboard or mouse. The Tab and Arrow keys can also be used for dialog navigation.

See "[To File . . .](#)" on page 2213 in Save, State for a full description of this dialog and menu.

The default path for saving files is:

For all of the Trace Data Files:

My Documents\`<mode name>`\data\traces

For all of the Limit Data Files:

My Documents\`<mode name>`\data\limits

For all of the Measurement Results Data Files:

My Documents\`<mode name>`\data\`<measurement name>`\results

For all of the Capture Buffer Data Files:

My Documents\`<mode name>`\data\captureBuffer

Key Path	Save, Data
Mode	All
Notes	The key location is mode-dependent and will vary. Brings up the Save As dialog for saving a <mode specific> Save Type. The save is performed immediately and does not wait until the measurement is complete.
Initial S/W Revision	Prior to A.02.00

## Screen Image

Pressing Screen Image accesses a menu of functions that enable you to specify a format and location for the saved screen image. It brings up a menu that allows you to specify the color scheme of the Screen Image (Themes) or navigate to the Save As dialog to perform the actual save.

Screen Image files contain an exact representation of the analyzer display. They cannot be loaded back onto the analyzer, but they can be loaded into your PC for use in many popular applications.

The image to be saved is actually captured when the Save front panel key is pressed, and kept in temporary storage to be used if you ask for a Screen Image save. When the Screen Image key is pressed, a "thumbnail" of the captured image is displayed, as shown below:

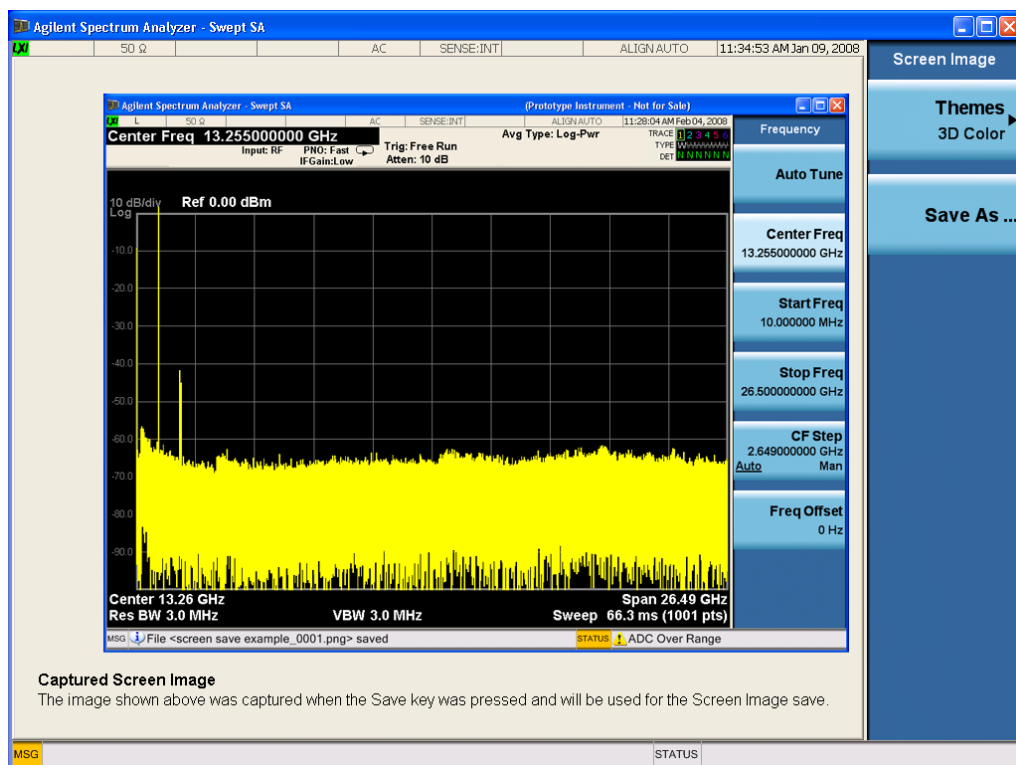

When you continue on into the Save As menu and complete the Screen Image save, the image depicted in the thumbnail is the one that gets saved, showing the menus that were on the screen before going into the Save menus. The save is performed immediately and does not wait until the measurement is complete.

After you have completed the save, the Quick Save front-panel key lets you quickly repeat the last save performed, using an auto-named file, with the current screen data.

**NOTE**

For versions previous to A.01.55, if you initiate a screen image save by navigating through the Save menus, the image that is saved will contain the Save menu softkeys, not the menus and the active function that were on the screen when you first pressed the Save front panel key.

Key Path	Save
Mode	All
Remote Command	:MMEMory:STORe:SCReem <filename>
Example	:MMEM:STOR:SCR "myScreen.png" This stores the current screen image in the file MyScreenFile.png in the default directory.
Initial S/W Revision	Prior to A.02.00

## Themes

Accesses a menu of functions that enable you to choose the theme to be used when saving the screen image.

The **Themes** option is the same as the **Themes** option under the **Display** and **Page Setup** dialogs. It allows you to choose between themes to be used when saving the screen image.

Key Path	Save, Screen Image
Remote Command	:MMEMory:STORe:SCReem:THEMe TDColor   TDMonochrome   FCOLOR   FMONochrome  :MMEMory:STORe:SCReem:THEMe?
Example	:MMEM:STOR:SCR:THEM TDM
Preset	3D Color; Is not part of Preset, but is reset by Restore Misc Defaults or Restore System Defaults All and survives subsequent running of the modes.
Readback	3D Color   3D Mono   Flat Color   Flat Mono
Backwards Compatibility Notes	In ESA and PSA we offer the choice of "Reverse Bitmap" or "Reverse Metafile" when saving screen images. This is much like the "Flat Color" theme available in X-Series. Also, if you selected Reverse Bitmap AND a black & white screen image, that would be much like "Flat Monochrome". In other words, each of the X-Series themes has a similar screen image type in ESA/PSA. But they are not identical.
Initial S/W Revision	Prior to A.02.00

## 3D Color

Selects a standard color theme with each object filled, shaded and colored as designed.

Key Path	Save, Screen Image, Themes
Example	MMEM:STOR:SCR:THEM TDC

Readback	3D Color
Initial S/W Revision	Prior to A.02.00

### 3D Monochrome

Selects a format that is like 3D color but shades of gray are used instead of colors.

Key Path	Save, Screen Image, Themes
<b>Example</b>	MMEM:STOR:SCR:THEM TDM
Readback	3D Mono
Initial S/W Revision	Prior to A.02.00

### Flat Color

Selects a format that is best when the screen is to be printed on an ink printer.

Key Path	Save, Screen Image, Themes
<b>Example</b>	MMEM:STOR:SCR:THEM FCOL
Readback	Flat Color
Initial S/W Revision	Prior to A.02.00

### Flat Monochrome

Selects a format that is like Flat Color. But only black is used (no colors, not even gray), and no fill.

Key Path	Save, Screen Image, Themes
<b>Example</b>	MMEM:STOR:SCR:THEM FMON
Readback	Flat Mono
Initial S/W Revision	Prior to A.02.00

### Save As...

When you press "Save As", the analyzer brings up a Windows dialog and a menu entitled "**Save As.**" This menu allows you to navigate to the various fields in the Windows dialog without using a keyboard or mouse. The Tab and Arrow keys can also be used for dialog navigation.

See "[To File . . .](#)" on page 2213 in Save, State for a full description of this dialog and menu.

The default path for Screen Images is

My Documents\<<mode name>\screen.



where <mode name> is the parameter used to select the mode with the INST:SEL command (for example, SA for the Spectrum Analyzer).

Key Path	Save, Screen Image
Notes	Brings up Save As dialog for saving a Screen Image Save Type
Initial S/W Revision	Prior to A.02.00

### Mass Storage Catalog (Remote Command Only)

Key path	SCPI Only
<b>Remote Command</b>	:MMEMory:CATalog? [<directory_name>]
Notes	<p>The string must be a valid logical path.</p> <p>Queries disk usage information (drive capacity, free space available) and obtains a list of files and directories in a specified directory in the following format: &lt;numeric_value&gt;,&lt;numeric_value&gt;,{&lt;file_entry&gt;}</p> <p>It returns two numeric parameters and as many strings as there are files and directories. The first parameter indicates the total amount of storage currently used in bytes. The second parameter indicates the total amount of storage available, also in bytes. The &lt;file_entry&gt; is a string. Each &lt;file_entry&gt; indicates the name, type, and size of one file in the directory list: &lt;file_name&gt;,&lt;file_type&gt;,&lt;file_size&gt;</p> <p>As the windows file system has an extension that indicates file type, &lt;file_type&gt; is always empty. &lt;file_size&gt; provides the size of the file in bytes. For directories, &lt;file_entry&gt; is surrounded by square brackets and both &lt;file_type&gt; and &lt;file_size&gt; are empty</p>
Initial S/W Revision	Prior to A.02.00

### Mass Storage Change Directory (Remote Command Only)

Key path	SCPI Only
<b>Remote Command</b>	:MMEMory:CDIRectory [<directory_name>] :MMEMory:CDIRectory?
Notes	<p>The string must be a valid logical path.</p> <p>Changes the default directory for a mass memory file system. The &lt;directory_name&gt; parameter is a string. If no parameter is specified, the directory is set to the *RST value.</p> <p>At *RST, this value is set to the default user data storage area, that is defined as System.Environment.SpecialFolder.Personal.</p> <p>Query returns full path of the default directory.</p>
Initial S/W Revision	Prior to A.02.00

## Mass Storage Copy (Remote Command Only)

Key path	SCPI Only
<b>Remote Command</b>	:MMEMory:COpy <string>,<string>[,<string>,<string>]
Notes	<p>The string must be a valid logical path.</p> <p>Copies an existing file to a new file or an existing directory to a new directory.</p> <p>Two forms of parameters are allowed. The first form has two parameters. In this form, the first parameter specifies the source, and the second parameter specifies the destination.</p> <p>The second form has four parameters. In this form, the first and third parameters specify the source. The second and fourth parameters specify the directories. The first pair of parameters specifies the source. The second pair specifies the destination. An error is generated if the source doesn't exist or the destination file already exists.</p> <p>This command will generate an "access denied" error if the destination is a restricted folder (e.g., C:\Windows) and the current user does not have Power User or Administrator privileges.</p>

## Mass Storage Device Copy (Remote Command Only)

This command transfers data to/from a file and a peripheral device.

Key path	SCPI Only
<b>Remote Command</b>	:MMEMory:COpy:DEvice <source_string>,<dest_string>
Notes	<p>The strings must be a valid logical path or a valid device keyword. If the dest_string is a device keyword, the data is copied from the source file to the device. If the source_string is a device keyword, the data is copied to the source file from the device.</p> <p>Valid device keywords are:</p> <p>SNS (smart noise source)</p> <p>An error is generated if the file or device is not found.</p>

## Mass Storage Delete (Remote Command Only)

Key path	SCPI Only
<b>Remote Command</b>	:MMEMory:DElete <file_name>[,<directory_name>]
Notes	<p>The string must be a valid logical path.</p> <p>Removes a file from the specified directory. The &lt;file_name&gt; parameter specifies the file name to be removed. This command will generate an "access denied" error if the file is in a restricted folder (e.g., C:\Windows) and the current user does not have Power User or Administrator privileges.</p>
Initial S/W Revision	Prior to A.02.00

## Mass Storage Data (Remote Command Only)

Creates a file containing the specified data OR queries the data from an existing file.

Key path	SCPI Only
<b>Remote Command</b>	:MMEMory:DATA <file_name>, <data> :MMEMory:DATA? <file_name>
Notes	The string must be a valid logical path. The command form is MMEMory:DATA <file_name>,<data>. It loads <data> into the file <file_name>. <data> is in 488.2 block format. <file_name> is string data. The query form is MMEMory:DATA? <file_name> with the response being the associated <data> in block format.
Initial S/W Revision	Prior to A.02.00

### Mass Storage Make Directory (Remote Command Only)

Key path	SCPI Only
<b>Remote Command</b>	:MMEMory:MDIRectory <directory_name>
Notes	The string must be a valid logical path. Creates a new directory. The <directory_name> parameter specifies the name to be created. This command will generate an “access denied” error if the new directory would be in a restricted folder (e.g., C:\Windows) and the current user does not have Power User or Administrator privileges.
Initial S/W Revision	Prior to A.02.00

### Mass Storage Move (Remote Command Only)

Key path	SCPI Only
<b>Remote Command</b>	:MMEMory:MOVE <string>,<string>[,<string>,<string>]
Notes	The string must be a valid logical path. Moves an existing file to a new file or an existing directory to a new directory. Two forms of parameters are allowed. The first form has two parameters. In this form, the first parameter specifies the source, and the second parameter specifies the destination. The second form has four parameters. In this form, the first and third parameters specify the source. The second and fourth parameters specify the directories. The first pair of parameters specifies the source. The second pair specifies the destination. An error is generated if the source doesn't exist or the destination file already exists. This command will generate an “access denied” error if the destination is a restricted folder (e.g., C:\Windows) and the current user does not have Power User or Administrator privileges.
Initial S/W Revision	Prior to A.02.00

## Mass Storage Remove Directory (Remote Command Only)

Key path	SCPI Only
<b>Remote Command</b>	:MMEMory:RDIRectory <directory_name>
Notes	<p>The string must be a valid logical path.</p> <p>Removes a directory. The &lt;directory_name&gt; parameter specifies the directory name to be removed. All files and directories under the specified directory shall also be removed.</p> <p>This command will generate an “access denied” error if the folder is a restricted folder (e.g., C:\Windows) or is in a restricted folder and the current user does not have Power User or Administrator privileges.</p>
Initial S/W Revision	Prior to A.02.00

## Single (Single Measurement/Sweep)

Sets the analyzer for Single measurement operation. The single/continuous state is Meas Global, so the setting will affect all the measurements. If you are Paused, pressing Single does a Resume.

See ["More Information" on page 1197](#)

Key Path	Front-panel key
Example	:INIT:CONT OFF
Notes	See Cont key description.
Backwards Compatibility Notes	<p>For Spectrum Analysis mode in ESA and PSA, the Single hardkey and the INITiate:IMM switched from continuous measurement to single measurement and restarted sweeps and averages (displayed average count reset to 1), but did not restart Max Hold and Min Hold. In the X-Series, the Single hardkey and the INITiate:IMM command initiate a sweep/ measurement/ average sequence/hold sequence including MaxHold and MinHold.</p> <p>For Spectrum Analysis mode in ESA and PSA, the Single hardkey restarted the sweep regardless of whether or not you were in an active sweep or sweep sequence. In the X-Series, Restart does this but Single only restarts the sweep or sweep sequence if you are in the idle state.</p> <p>INIT[:IMM] in ESA &amp; PSA Spectrum Analysis Mode does an implied ABORt. In some other PSA Modes, INIT[:IMM] is ignored if not in the idle state. . The X-Series follows the ESA/PSA SA Mode model, which may cause some Modes to have compatibility problems.</p>
Initial S/W Revision	Prior to A.02.00

### More Information

See ["Restart" on page 2210](#) for details on the INIT:IMMediate (Restart) function.

If you are already in single sweep, the INIT:CONT OFF command has no effect.

If you are already in Single Sweep, then pressing the Single key in the middle of a sweep does not restart the sweep or sequence. Similarly, pressing the Single key does not restart the sweep or sequence if the sweep is not in the idle state (for example, if you are taking a very slow sweep, or the analyzer is waiting for a trigger). Instead, it results in a message. "Already in Single, press Restart to initiate a new sweep or sequence". Even though pressing the Single key in the middle of a sweep does not restart the sweep, sending INIT:IMMediate does reset it.

To take one more sweep without resetting the average count, increment the average count by 1, by pressing the step up key while **Average/Hold Number** is the active function, or sending the remote command CALC:AVER:TCON UP.

## Source

There is no Source control functionality for this measurement. When this key is pressed, the screen either displays a blank menu, or the previously-selected menu remains unchanged.

---

Key Path	Front-panel key
----------	-----------------

---

## Span X Scale

Accesses a menu of functions that enable you to set the horizontal scale parameters.

Key Path	Front-panel key
Initial S/W Revision	A.11.00

### Ref Value

Sets the X reference value.

Key Path	SPAN X Scale
Mode	BASIC, PNOISE, WCDMA, C2K, GSM, WIMAXOFDMA, TDSCDMA, 1XEVDO, DVB, DTMB, ISDBT, CMMB, LTE, LTETDD, DCTV, WLAN, MSR, LTEAFDD, LTEATDD
<b>Remote Command</b>	:DISPlay:SEMask:VIEW[1]:WINDow[1]:TRACe:X[:SCALE]:RLEVel <freq> :DISPlay:SEMask:VIEW[1]:WINDow[1]:TRACe:X[:SCALE]:RLEVel?
<b>Example</b>	DISP:SEM:VIEW:WIND:TRAC:X:RLEV 10 DISP:SEM:VIEW:WIND:TRAC:X:RLEV?
Notes	You must be in the mode that includes SEM measurement to use this command. Use :INSTrument:SElect to set the mode.
Couplings	If Auto Scaling is set to On, this value is automatically determined by the measurement result. When you set this value manually, Auto Scaling automatically changes to Off.
Preset	1.0 GHz
State Saved	Saved in instrument state.
Min	-1000 GHz
Max	1000 GHz
Default Unit	Hz
Initial S/W Revision	A.11.00

### Scale/Div

Sets the horizontal scale.

Key Path	SPAN X Scale
Mode	BASIC, PNOISE, WCDMA, C2K, GSM, WIMAXOFDMA, TDSCDMA, 1XEVDO, DVB, DTMB, ISDBT, CMMB, LTE, LTETDD, DCTV, WLAN, MSR, LTEAFDD, LTEATDD
<b>Remote Command</b>	:DISPlay:SEMask:VIEW[1]:WINDow[1]:TRACe:X[:SCALE]:PDIVision <freq> :DISPlay:SEMask:VIEW[1]:WINDow[1]:TRACe:X[:SCALE]:PDIVision ?
<b>Example</b>	DISP:SEM:VIEW:WIND:TRAC:X:PDIV 500 DISP:SEM:VIEW:WIND:TRAC:X:PDIV?

Notes	You must be in a mode that includes the SEM measurement to use this command. Use INSTRUMENT:SElect to set the mode.
Couplings	If Auto Scaling is set to On, this value is automatically determined by the measurement result. When you set this value manually, Auto Scaling automatically changes to Off.
Preset	Automatically Calculated
State Saved	Yes Saved in instrument state.
Min	1 Hz
Max	10.0 GHz
Initial S/W Revision	A.11.00

## Ref Position

Sets the reference position for the X axis to Left, Center or Right.

Key Path	SPAN X Scale
Mode	BASIC, PNOISE, WCDMA, C2K, GSM, WIMAXOFDMA, TDSCDMA, 1XEVD0, DVB, DTMB, ISDBT, CMMB, LTE, LTETDD, DCTV, WLAN, MSR, LTEAFDD, LTEATDD
Remote Command	:DISPlay:SEMAsk:VIEW[1]:WINDow[1]:TRACe:X[:SCALe]:RPOSition LEFT   CENTER   RIGHT :DISPlay:SEMAsk:VIEW[1]:WINDow[1]:TRACe:X[:SCALe]:RPOSition?
Example	DISP:SEM:VIEW:WIND:TRAC:X:RPOS LEFT DISP:SEM:VIEW:WIND:TRAC:X:RPOS?
Notes	You must be in a mode that includes the SEM measurement to use this command. Use INSTRUMENT:SElect to set the mode.
Preset	CENTER
State Saved	Yes Saved in instrument state.
Range	Left Ctr Right
Initial S/W Revision	A.11.00

## Auto Scaling

Toggles the scale coupling function between On and Off.

Key Path	SPAN X Scale
Mode	BASIC, PNOISE, WCDMA, C2K, GSM, WIMAXOFDMA, TDSCDMA, 1XEVD0, DVB, DTMB, ISDBT, CMMB, LTE, LTETDD, DCTV, WLAN, MSR, LTEAFDD, LTEATDD
Remote Command	:DISPlay:SEMAsk:VIEW[1]:WINDow[1]:TRACe:X[:SCALe]:COUPlE 0   1   OFF   ON :DISPlay:SEMAsk:VIEW[1]:WINDow[1]:TRACe:X[:SCALe]:COUPlE?
Example	DISP:SEM:VIEW:WIND:TRAC:X:COUP ON



DISP:SEM:VIEW:WIND:TRAC:X:COUP?	
Notes	You must be in a mode that includes the SEM measurement to use this command. Use INSTRument:SElect to set the mode.
Couplings	When Auto Scaling is On and the Restart front-panel key is pressed, this function automatically determines the scale per division and reference values based on the measurement results. When you set a value to either Scale/Div or Ref Value manually, Auto Scaling automatically changes to Off.
Preset	1
State Saved	Yes Saved in instrument state.
Range	On Off
Initial S/W Revision	A.11.00

## Sweep/Control

Displays a menu that enables you to set up and control the sweep time, gate method, and source of the current measurement. See ["Sweep/Control" on page 2235](#) for more information.

Key Path	Front-panel key
Initial S/W Revision	Prior to A.02.00

### Pause

Pauses a measurement after the current data acquisition is complete. When Paused, the label on the key changes to Resume. Pressing the Resume key resumes the measurement at the point it was at when paused. See ["Pause/Resume" on page 2235](#) for more details.

Key Path	Sweep/Control
Initial S/W Revision	Prior to A.02.00

### Gate

Accesses a menu that enables you to control the gating function. The Gate functionality is used to view signals best viewed by qualifying them with other events.

Gate setup parameters are the same for all measurements – they do not change as you change measurements. Settings like these are called “Meas Global” and are unaffected by Meas Preset.

Note that Sweep Time autocoupling rules and annotation are changed by Gate being on.

Key Path	Sweep/Control
Scope	Meas Global
Readback	The state and method of Gate, as [Off, LO] or [On, Video]. Note that for measurements that only support gated LO, the method is nonetheless read back, but always as LO.
Initial S/W Revision	Prior to A.02.00

### Gate On/Off

Turns the gate function on and off.

When the Gate Function is on, the selected Gate Method is used along with the gate settings and the signal at the gate source to control the sweep and video system with the gate signal. Not all measurements allow every type of Gate Methods.

When Gate is on, the annunciation in the measurement bar reflects that it is on and what method is used, as seen in the following "Gate: LO" annunciator graphic.

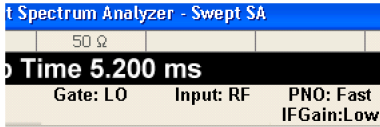

Key Path	Sweep/Control, Gate
Remote Command	[ :SENSe ] :SWEep:EGATe [ :STATe ] OFF ON 0 1 [ :SENSe ] :SWEep:EGATe [ :STATe ] ?
Example	SWE:EGAT ON SWE:EGAT?
Dependencies	<p>The function is unavailable (grayed out) and Off when:</p> <ul style="list-style-type: none"> <li>• Gate Method is LO or Video and FFT Sweep Type is manually selected.</li> <li>• Gate Method is FFT and Swept Sweep Type is manually selected.</li> <li>• Marker Count is ON.</li> </ul> <p>The following are unavailable whenever Gate is on:</p> <ul style="list-style-type: none"> <li>• FFT under Sweep Type when Method=LO or Video or Swept under Sweep Type when Method=FFT</li> <li>• Marker Count</li> </ul> <p>While Gate is on, the Auto Rules for Sweep Type are modified so that the choice agrees with the Gate Method: i.e., FFT for Method = FFT and Swept for Method = LO or Video.</p> <p>The Gate softkey and all SCPI under the [:SENSe]:SWEep:EGATe SCPI node are grayed out when Source Mode is Tracking with an external source. This is because the Gate circuitry is used to sync the external source. If the Tracking Source is turned on, the Gate is turned off.</p> <p>When in the ACP measurement:</p> <ul style="list-style-type: none"> <li>• When Meas Method is RBW or FAST, this function is unavailable and the key is grayed out.</li> <li>• Whenever Gate is on, Meas Method, RBW or FAST is unavailable and keys for those are grayed out.</li> <li>• When Gate is on, Offset Res BW and Offset Video BW are ignored (if you set these values) and the measurement works as if all Offset Res BW and all Offset Video BW are coupled with the Res BW and the Video BW under the BW menu. When Gate is on, the Offset BW key in the Offset/Limit menu is grayed out.</li> </ul>
Preset	Off LTETDD: On
State Saved	Saved in instrument state
Range	On Off
Backwards Compatibility SCPI	[ :SENSe ] :SWEep:TIME:GATE[:STATe] ESA compatibility
Backwards Compatibility Notes	In ESA, Trig Delay (On) and Gate (On) could not be active at the same time.. This dependency does not exist in PSA or in the X-Series.
Initial S/W Revision	Prior to A.02.00

## Gate View On/Off

Turning on Gate View in the Swept SA measurement provides a single-window gate view display..

Turning on Gate View in other measurements shows the split-screen Gate View. In these measurements, when the Gate View is on, the regular view of the current measurement traces and results are reduced vertically to about 70% of the regular height. The Zero Span window, showing the positions of the Gate, is shown between the Measurement Bar and the reduced measurement window. By reducing the height of the measurement window, some of the annotation on the Data Display may not fit and is not shown.

<b>Key Path</b>	Sweep/Control, Gate
<b>Remote Command</b>	[ :SENSe ] :SWEep:EGATe:VIEW ON OFF 1 0 [ :SENSe ] :SWEep:EGATe:VIEW?
<b>Example</b>	SWE:EGAT:VIEW ON turns on the gate view.
<b>Dependencies</b>	In the Swept SA measurement: In Gate View, the regular Sweep Time key is grayed out . When pressed, the grayed out key puts up the informational message "Use Gate View Sweep Time in the Gate menu." In the other measurements: When you turn Gate View on, the lower window takes on the current state of the instrument. Upon leaving Gate View, the instrument takes on the state of the lower window. When you turn Gate View on, the upper window Sweep Time is set to the gate view sweep time.
<b>Couplings</b>	These couplings apply to the Swept SA measurement: <ul style="list-style-type: none"> <li>• When Gate View is turned on, the instrument is set to Zero Span.</li> <li>• Gate View automatically turns off whenever a Span other than Zero is selected.</li> <li>• Gate View automatically turns off if you press the Last Span key while in Gate View, and the instrument returns to the Span it was in before entering Gate View (even if that is Zero Span).</li> <li>• When Gate View is turned on, the sweep time used is the gate view sweep time. This is set according to the rules in section "<a href="#">Gate View Setup</a>" on page 2043</li> <li>• When Gate View is turned off, Sweep Time is set to the normal Swept SA measurement sweep time.</li> <li>• If Gate View is on and Gate is off, then turning on Gate turns off Gate View.</li> </ul>
<b>Preset</b>	OFF
<b>State Saved</b>	Saved in instrument state
<b>Range</b>	On Off
<b>Initial S/W Revision</b>	Prior to A.02.00

A sample of the Gate View screen in the Swept SA measurement is shown in the following graphic :

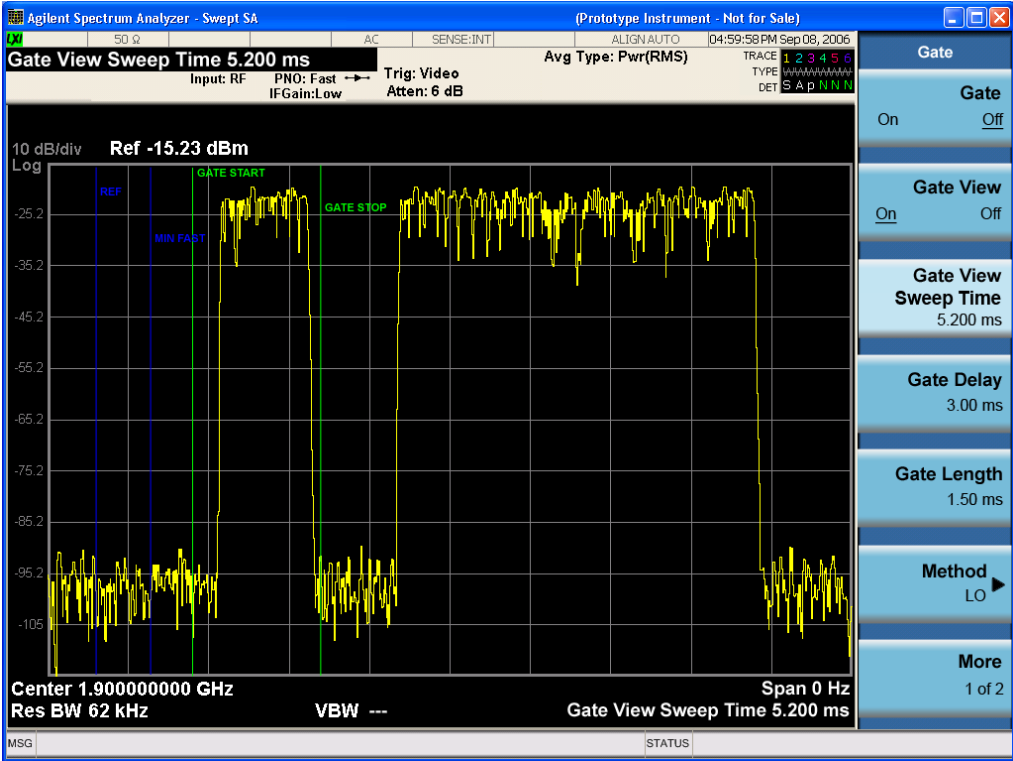

A sample of the Gate View screen in other measurements is shown in the following graphic. This example is for the ACP measurement:

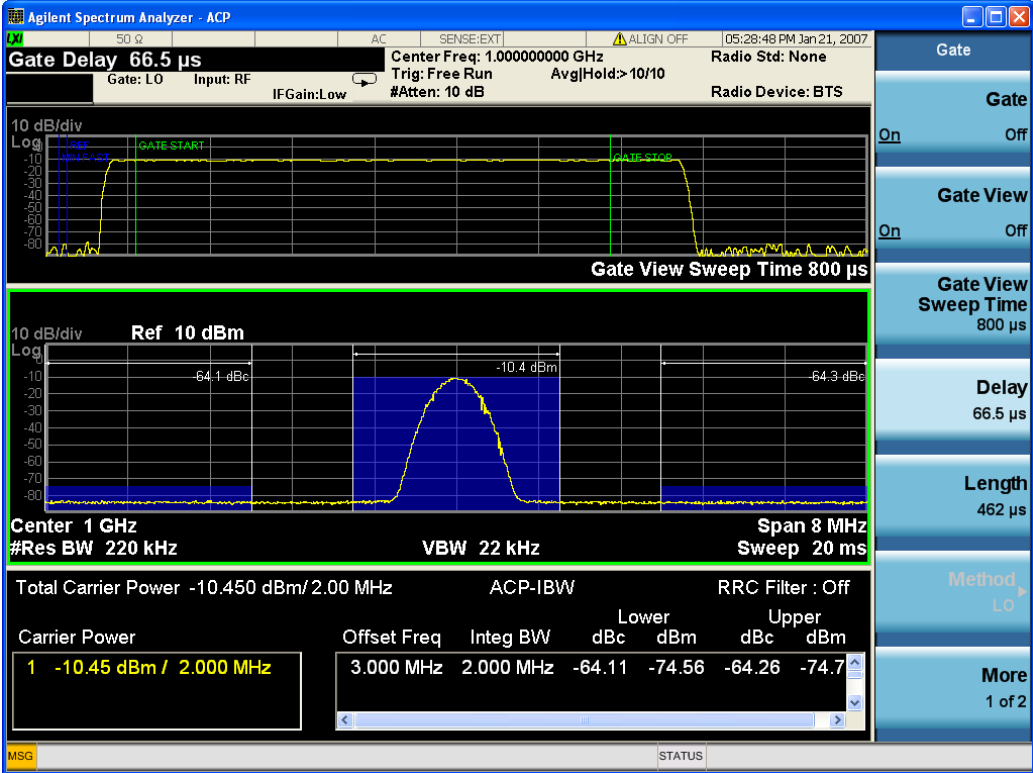

Turning Gate View off returns the analyzer to the Normal measurement view.

In the Swept SA, the normal measurement view is the single-window Swept SA view. When returning to this view, the Swept SA measurement returns to the Span it was in before entering **Gate View** (even if that is Zero Span).

The **Gate View** window is triggered from the Gate Source, with zero trigger delay. Also, when updating the **Gate View** window, the Gate itself must not operate. So it is internally shut off while the gate view window is being updated. For the Swept SA measurement, this means that the Gate is internally shut off whenever the gate view window is displayed. The measurement bar and softkeys continue to show the Trigger source for the main sweep window and give no indication that the Gate is shut off or that the Gate View window is triggered from the Gate Source.

When in **Gate View**, vertical lines are displayed in the Gate View window as follows:

- Green lines are displayed at the gate edges as follows: in Edge Gate, a line is shown for Delay and one for the end of the Gate period, defined by Length. In Level Gate a line is shown only for Delay. You can adjust the position of the green lines by adjusting the gate length and the gate delay. These lines update in the Gate View window as the active function changes, even if the window is not being updated. In Gated LO and Gated Video, these lines are positioned relative to the delay reference line (not relative to 0 time). In Gated FFT, their location is relative to the left edge of the screen.
- A blue line is displayed showing the delay reference, that is, the reference point for the Gate Delay within the Zero Span window. The blue line represents where (in time) the effective location of the gate start would be if the gate were programmed to zero delay.
- 
- The second blue line is labeled "MIN FAST" as shown in the figure above because it represents the minimum Gate Delay for fast Gated LO operation. This line is only displayed in Gated LO. You cannot scroll (knob) or decrement (down key) the Gate Delay to less than that represented by the position of this line, it can only be set below this position manually, although once there it can be moved freely with the knob while below the line.
- A yellow line in the Gated Video case only, is displayed at Blength, where Blength is the display point (bucket) length for the swept trace, which is given by the sweep time for that trace divided by number of Points – 1. So it is referenced to 0 time, not to the delay reference. This line is labeled NEXT PT (it is not shown in the figure above because the figure above is for Gated LO).
- The yellow line represents the edge of a display point (bucket). Normally in Gated Video, the bucket length must be selected so that it exceeds the off time of the burst. There is another way to use the analyzer in Gated Video measurements, and that is to set the bucket width much shorter than the off time of the burst. Then use the Max Hold trace function to fill in "missing" buckets more slowly. This allows you to see some of the patterns of the Gated Video results earlier, though seeing a completely filled-in spectrum later.

## Gate View Setup

Accesses a menu that enables you to setup parameters relevant to the Gate View

Key Path	Sweep/Control, Gate
Scope	Meas Global
Initial S/W Revision	A.10.00

## Gate View Sweep Time

Controls the sweep time in the Gate View window. To provide an optimal view of the gate signal, the analyzer initializes Gate View Sweep Time based on the current settings of Gate Delay and Gate Length.

Key Path	Sweep/Control, Gate, Gate View Setup
Remote Command	[ :SENSe ] :SWEep:EGATe:TIME <time> [ :SENSe ] :SWEep:EGATe:TIME?
Example	SWE:EGAT:TIME 500 ms
Dependencies	Gate View Sweep Time is initialized: <ul style="list-style-type: none"> <li>• On Preset (after initializing delay and length).</li> <li>• Every time the Gate Method is set/changed.</li> </ul> <p>Additionally, in the Swept SA measurement, whenever you do a Preset, or leave Gate View, the analyzer remembers the Gate Delay and Gate Length settings. Then, when returning to Gate View, if the current Gate Delay and/or Gate Length do not match the remembered values Gate View Sweep Time is re-initialized.</p> <ol style="list-style-type: none"> <li>1. Compute the location of the "gate stop" line, which you know is at time <math>t = t_{min} + GateDelay + GateLength</math>.</li> </ol>
Preset	519.3 $\mu$ s WiMAX OFDMA: 5 ms GSM/EDGE: 1 ms
State Saved	Saved in instrument state
Max	6000 s
Initial S/W Revision	Prior to A.02.00

## Gate View Start Time

Controls the time at the left edge of the Gate View.

Key Path	Sweep/Control, Gate, Gate View Setup
Remote Command	[ :SENSe ] :SWEep:EGATe:VIEW:STARt <time> [ :SENSe ] :SWEep:EGATe:VIEW:STARt?
Example	SWE:EGAT:VIEW:STAR 10ms
Notes	Units of time are required or no units; otherwise an invalid suffix error message will be generated. See error -131.
Preset	0 ms
State Saved	Saved in instrument state
Min	0
Max	500 ms
Initial S/W Revision	A.10.00

## Gate Delay

Controls the length of time from the time the gate condition goes True until the gate is turned on.

Key Path	Sweep/Control, Gate
Remote Command	[ :SENSe ] :SWEep:EGATe:DELay <time> [ :SENSe ] :SWEep:EGATe:DELay?
Example	SWE:EGAT:DELay 500ms SWE:EGAT:DELay?
Notes	Units of time are required or no units; otherwise an invalid suffix error message will be generated.
Preset	57.7 us WiMAX OFDMA: 71 us GSM/EDGE: 600 us WLAN: 500 us
State Saved	Saved in instrument state
Min	0.0 us
Max	100 s
Backwards Compatibility SCPI	[ :SENSe ] :SWEep:TIME:GATE:DELay ESA compatibility
Initial S/W Revision	Prior to A.02.00

## Gate Length

Controls the length of time that the gate is on after it opens.

Key Path	Sweep/Control, Gate
Remote Command	[ :SENSe ] :SWEep:EGATe:LENGth <time> [ :SENSe ] :SWEep:EGATe:LENGth?
Example	SWE:EGAT:LENG 1 SWE:EGAT:LENG?
Notes	Units of time are required or no units; otherwise an invalid suffix error message will be generated.
Dependencies	<p>Grayed out when Gate Method is set to FFT in which case the label changes to that shown below.</p>  <p>The key is also grayed out if Gate Control = Level.</p>
Preset	461.6 us



	WiMAX OFDMA: 50 us GSM/EDGE: 200 us WLAN: 1.54 ms
State Saved	Saved in instrument state
Min	100 ns
Max	5 s
<b>Backwards Compatibility SCPI</b>	[:SENSe]:SWEep:TIME:GATE:LENGth ESA compatibility
Initial S/W Revision	Prior to A.02.00

## Gate Source

The menus under the Gate Source key are the same as those under the Trigger key, with the exception that neither Free Run nor Video are available as Gate Source selections. However, a different SCPI command is used to select the Gate Source (see table below) because you may independently set the Gate Source and the Trigger Source.

Any changes to the settings in the setup menus under each Gate Source selection key (for example: Trigger Level, Trigger Delay, etc.) also affect the corresponding settings under the Trigger menu keys. The SCPI commands used for these are the same for Trigger and Gate, since there is only one setting which affects both Gate and Trigger. Example: to set the Trigger Level for External 1 you use the command :TRIG:EXT1:LEV regardless of whether you are using External 1 as a Trigger Source or a Gate Source.

Key Path	Sweep/Control, Gate
<b>Remote Command</b>	[:SENSe]:SWEep:EGATe:SOURce EXTernal1   EXTernal2   LINE   FRAME   RFBurst  [:SENSe]:SWEep:EGATe:SOURce?
Dependencies	In some models, there is no second External input. In these models, the External 2 key is blanked and the EXTernal2 parameter will generate a "Hardware missing; Not available for this model number" error.
Preset	EXTernal 1 GSM/EDGE, MSR: FRAME LTETDD: EXTernal 1When Direction is Downlink, FRAME when Direction is Uplink.
Backwards Compatibility Notes	In ESA, there is a single Gate input port. In PSA, the Gate Source may be taken from one of two specified input ports. In the X-Series, any Trigger Source can be a Gate Source.
Initial S/W Revision	Prior to A.02.00
Modified at S/W Revision	A.03.00, A.14.00

## Line

Pressing this key, when it is not selected, selects the line signal as the trigger. A new sweep/measurement will start synchronized with the next cycle of the line voltage. Pressing this key, when it is already selected, access the line trigger setup menu.

Key Path	Trigger
<b>Example</b>	TRIG:SOUR LINE Swept SA measurement TRIG:<meas>:SOUR LINE Measurements other than Swept SA
Dependencies	Line trigger is not available when operating from a "dc power source", for example, when the instrument is powered from batteries.
State Saved	Saved in instrument state
Status Bits/OPC dependencies	The Status Operation Register bit 5 "Waiting for Trigger" is set at the same time as the Sweeping or Measuring bit is set. It is cleared when the trigger actually occurs (that is, after the trigger event occurs and all the applicable trigger criteria have been met). A corresponding pop-up message ("Waiting for trigger") is generated if no trigger signal appears after approximately 2 sec. This message goes away when a trigger signal appears.
Initial S/W Revision	Prior to A.02.00

## Trig Slope

Controls the trigger polarity. It is set positive to trigger on a rising edge and negative to trigger on a falling edge.

Key Path	Trigger, Line
<b>Remote Command</b>	:TRIGger[:SEquence]:LINE:SLOPe POSitive NEGative :TRIGger[:SEquence]:LINE:SLOPe?
<b>Example</b>	TRIG:LINE:SLOP NEG
Preset	POSitive
State Saved	Saved in instrument state
Backwards Compatibility Notes	The legacy :TRIGger[:SEquence]:SLOPe command affects the slopes for the VID, LINE, EXT1, EXT2, and RFB triggers.
Initial S/W Revision	Prior to A.02.00

## External 1

Pressing this key, when it is not selected, selects an external input signal as the trigger. A new sweep/measurement will start when the external trigger condition is met using the external 1 input connector on the rear panel.

Pressing this key, when it is already selected, accesses the external 1 trigger setup menu.

Key Path	Trigger
<b>Example</b>	TRIG:SOUR EXT1 Swept SA measurement TRIG:<meas>:SOUR EXT1 Measurements other than Swept SA
Dependencies	Grayed out if in use by Point Trigger in the Source Setup menu. Forced to Free Run if already selected and Point Trigger is set to External 1.
State Saved	Saved in instrument state
Status Bits/OPC dependencies	The Status Operation Register bit 5 "Waiting for Trigger" is set at the same time as the Sweeping or Measuring bit is set. It is cleared when the trigger actually occurs (that is, after the trigger event occurs and all the applicable trigger criteria have been met). A corresponding pop-up message ("Waiting for trigger") is generated if no trigger signal appears after approximately 2 sec. This message goes away when a trigger signal appears.
Initial S/W Revision	Prior to A.02.00

### Trigger Level

Sets the value where the external 1 trigger input will trigger a new sweep/measurement.

Key Path	Trigger, External 1
<b>Remote Command</b>	:TRIGger[:SEquence]:EXTernal1:LEVel <level> :TRIGger[:SEquence]:EXTernal1:LEVel?
<b>Example</b>	TRIG:EXT1:LEV 0.4 V
Couplings	This same level is used for the Ext1 trigger source in the Trigger menu, for the Ext1 selection in the Periodic Timer sync source (in the Trigger menu and in the Gate Source menu), and also for the Ext1 selection in the Gate Source menu.
Preset	1.2 V
State Saved	Saved in instrument state
Min	-5 V
Max	5 V
Default Unit	V
<b>Backwards Compatibility SCPI</b>	:TRIGger[:SEquence]:EXTernal:LEVel For backward compatibility, the parameter EXTernal is mapped to EXTernal1
<b>Backwards Compatibility SCPI</b>	:TRIGger[:SEquence]:FRAME:EXTernal1:LEVel
Initial S/W Revision	Prior to A.02.00

### Trig Slope

Controls the trigger polarity. It is set positive to trigger on a rising edge and negative to trigger on a falling edge.

Key Path	Trigger, External 1
Remote Command	:TRIGger[:SEquence]:EXTernal1:SLOPe POSitive NEGative :TRIGger[:SEquence]:EXTernal1:SLOPe?
Example	TRIG:EXT1:SLOP NEG
Couplings	This same slope is used in the Ext1 selection for the trigger source in the Trigger menu and for the period timer sync source (in the Trigger menu and in the Gate Source menu).
Preset	POSitive
State Saved	Saved in instrument state
Backwards Compatibility SCPI	:TRIGger[:SEquence]:EXTernal:SLOPe For backward compatibility, the parameter EXTernal is mapped to EXTernal1
Backwards Compatibility SCPI	:TRIGger[:SEquence]:FRAMe:EXTernal1:SLOPe
Backwards Compatibility Notes	The legacy :TRIGger[:SEquence]:SLOPe command affects the slopes for the VID, LINE, EXT1, EXT2, and RFB triggers.
Initial S/W Revision	Prior to A.02.00

## External 2

Pressing this key, when it is not selected, selects an external input signal as the trigger. A new sweep/measurement will start when the external trigger condition is met using the external 2 input connector. The external trigger 2 input connector is on the rear panel.

Pressing this key, when it is already selected, accesses the external 2 trigger setup menu.

Key Path	Trigger
Example	TRIG:SOUR EXT2 Swept SA measurement TRIG:<meas>:SOUR EXT2 Measurements other than Swept SA
Dependencies	In some models, there is no second External input. In these models, the External 2 key is blanked and the EXTernal2 parameter will generate a "Hardware missing; Not available for this model number" message.  Grayed out if in use by Point Trigger in the Source Setup menu. Forced to Free Run if already selected and Point Trigger is set to External 2.
State Saved	Saved in instrument state
Status Bits/OPC dependencies	The Status Operation Register bit 5 "Waiting for Trigger" is set at the same time as the Sweeping or Measuring bit is set. It is cleared when the trigger actually occurs (that is, after the trigger event occurs and all the applicable trigger criteria have been met). A corresponding pop-up message ("Waiting for trigger") is generated if no trigger signal appears after approximately 2 sec. This message goes away when a trigger signal appears.
Initial S/W Revision	Prior to A.02.00
Modified at S/W Revision	A.03.00

## Trigger Level

Sets the value where the external 2 trigger input will trigger a new sweep/measurement.

Key Path	Trigger, External 2
<b>Remote Command</b>	:TRIGger[:SEquence]:EXTernal2:LEVel :TRIGger[:SEquence]:EXTernal2:LEVel?
<b>Example</b>	TRIG:EXT2:LEV 1.1 V
Couplings	This same level is used for the Ext2 trigger source in the Trigger menu, for the Ext2 selection in the Periodic Timer sync source (in the Trigger menu and in the Gate Source menu), and also for the Ext2 selection in the Gate Source menu.
Preset	1.2 V
State Saved	Saved in instrument state
Min	-5 V
Max	5 V
Default Unit	V
<b>Backwards Compatibility SCPI</b>	:TRIGger[:SEquence]:FRAMe:EXTernal2:LEVel
Initial S/W Revision	Prior to A.02.00

## Trig Slope

Controls the trigger polarity. It is set positive to trigger on a rising edge and negative to trigger on a falling edge.

Key Path	Trigger, External 2
<b>Remote Command</b>	:TRIGger[:SEquence]:EXTernal2:SLOPe POSitive NEGative :TRIGger[:SEquence]:EXTernal2:SLOPe?
<b>Example</b>	TRIG:EXT2:SLOP NEG
Couplings	This same slope is used in the Ext2 selection for the trigger source in the Trigger menu and for the period timer sync source (in the Trigger menu and in the Gate Source menu).
Preset	POSitive
State Saved	Saved in instrument state
<b>Backwards Compatibility SCPI</b>	:TRIGger[:SEquence]:FRAMe:EXTernal2:SLOPe
Backwards Compatibility Notes	The legacy :TRIGger[:SEquence]:SLOPe command affects the slopes for the VID, LINE, EXT1, EXT2, and RFB triggers.
Initial S/W Revision	Prior to A.02.00

## RF Burst

Pressing this key, when it is not selected, selects the RF Burst as the trigger. A new sweep/measurement will start when an RF burst envelope signal is identified from the signal at the RF Input connector. Pressing this key, when it is already selected, accesses the RF Burst trigger setup menu.

In some models, a variety of burst trigger circuitry is available, resulting in various available burst trigger bandwidths. The analyzer automatically chooses the appropriate trigger path based on the hardware configuration and other settings of the analyzer.

Key Path	Trigger
<b>Example</b>	TRIG:SOUR RFB Swept SA measurement TRIG:< meas>:SOUR RFB Measurements other than Swept SA
State Saved	Saved in instrument state
Status Bits/OPC dependencies	The Status Operation Register bit 5 "Waiting for Trigger" is set at the same time as the Sweeping or Measuring bit is set. It is cleared when the trigger actually occurs (that is, after the trigger event occurs and all the applicable trigger criteria have been met). A corresponding pop-up message ("Waiting for trigger") is generated if no trigger signal appears after approximately 2 sec. This message goes away when a trigger signal appears.
Backwards Compatibility Notes	The legacy command: :TRIGger[:SEQuence]:RFBurst:FSElectivity[:STATe] OFF ON 0 1 is not supported in the X-Series, as the hardware to do Frequency Selective burst triggers does not exist in X-Series.
Initial S/W Revision	Prior to A.02.00
Modified at S/W Revision	A.04.00

## Absolute Trigger Level

Sets the absolute trigger level for the RF burst envelope.

When using the External Mixing path, the Absolute Trigger Level is uncalibrated because the factory default was set to accommodate the expected IF levels for the RF path.

Key Path	Trigger, RF Burst
Scope	Meas Global
<b>Remote Command</b>	:TRIGger[:SEQuence]:RFBurst:LEVel:ABSolute <ampl> :TRIGger[:SEQuence]:RFBurst:LEVel:ABSolute?
<b>Example</b>	TRIG:RFB:LEV:ABS 10 dBm sets the trigger level of the RF burst envelope signal to the absolute level of 10 dBm
Notes	Sending this command does not switch the setting from relative to absolute; to switch it you need to send the :TRIGger[:SEQuence]:RFBurst:LEVel:TYPE command, below. Amplitude Corrections are not taken into account by the Absolute Trigger Level. For example, if you have given yourself effective gain with an amplitude correction factor, the Absolute Trigger will not fire until you have set the trigger level that far below the displayed signal level, rather than simply to

	the displayed signal level. This is only true for Amplitude Corrections, not External Gain or Ref Level Offset functions. If mode is Bluetooth, the default value is -50 dBm.
Couplings	This same level is used for the RF Burst trigger source in the Trigger menu, for the RF Burst selection in the Periodic Timer sync source (in the Trigger menu and in the Gate Source menu), and also for the RF Burst selection in the Gate Source menu
Preset	-20 dBm
State Saved	Saved in instrument state
Min	-200 dBm
Max	100 dBm
Default Unit	depends on the current selected Y-Axis unit
<b>Backwards Compatibility SCPI</b>	:TRIGger[:SEquence]:FRAMe:RFBurst:LEVel:ABSolute
Initial S/W Revision	Prior to A.02.00
Modified at S/W Revision	A.04.00

Key Path	Trigger, RF Burst
<b>Remote Command</b>	:TRIGger[:SEquence]:RFBurst:LEVel:TYPE ABSolute RELative :TRIGger[:SEquence]:RFBurst:LEVel:TYPE?
<b>Example</b>	TRIG:RFB:LEV:TYPE REL sets the trigger level type of the RF burst trigger to Relative.
Preset	ABSolute
State Saved	Saved in instrument state
Initial S/W Revision	Prior to A.02.00
Modified at S/W Revision	A.04.00

### Relative Trigger Level

Sets the relative trigger level for the RF burst envelope.

In some models, the relative burst trigger function is implemented in hardware. In other models, without the advanced triggering hardware required, the relative burst trigger function is implemented in software in some measurements, and is unavailable in other measurements.

When implemented in software, the relative RF Burst trigger function is implemented as follows:

1. The measurement starts with the absolute RF Burst trigger setting. If it cannot get a trigger with that level, auto trigger fires and the acquisition starts anyway. After the acquisition, the measurement searches for the peak in the acquired waveform and saves it.

2. Now, in the next cycle of the measurement, the measurement determines a new absolute RF Burst level based on the peak value from the first measurement and the Relative RF Burst Trigger Level (always 0 or negative dB) set by the user. The following formula is used:
  3. absolute RF Burst level = peak level of the previous acquisition + relative RF Burst level
  4. If the new absolute RF Burst level differs from the previous by more than 0.5 dB, the new level is sent to the hardware; otherwise it is not updated (to avoid slowing down the acquisition)
- Steps 2 and 3 repeat for subsequent measurements.

Key Path	Trigger, RF Burst
Scope	Meas Global
<b>Remote Command</b>	:TRIGger[:SEquence]:RFBurst:LEVel:RELative <rel_ampl> :TRIGger[:SEquence]:RFBurst:LEVel:RELative?
<b>Example</b>	TRIG:RFB:LEV:REL -10 dB sets the trigger level of the RF burst envelope signal to the relative level of -10 dB
Notes	Sending this command does not switch the setting from absolute to relative; to switch it you need to send the :TRIGger[:SEquence]:RFBurst:LEVel:TYPE command, above. The relative trigger level is not available in some measurements. In those measurements the RELative parameter, and the :TRIGger[:SEquence]:RFBurst:LEVel:TYPE command (above), will generate an error if sent.
Dependencies	This key is grayed out and Absolute Trigger Level selected if the required hardware is not present in your analyzer and the current measurement does not support Relative triggering.
Preset	-6 dB GSM: -25 dB
State Saved	Saved in instrument state
Min	-45 dB
Max	0 dB
Default Unit	dB or dBc
<b>Backwards Compatibility SCPI</b>	:TRIGger[:SEquence]:RFBurst:LEVel This legacy command is aliased to :TRIGger[:SEquence]:RFBurst:LEVel:RELative because the PSA had ONLY relative burst triggering
Initial S/W Revision	Prior to A.02.00
Modified at S/W Revision	A.04.00

### Trigger Slope

It is set positive to trigger on a rising edge and negative to trigger on a falling edge.

Key Path	Trigger, RF Burst
<b>Remote Command</b>	:TRIGger[:SEquence]:RFBurst:SLOPe POSitive NEGative :TRIGger[:SEquence]:RFBurst:SLOPe?



<b>Example</b>	TRIG:RFB:SLOP NEG
Couplings	This same slope is used in the RF Burst selection for the trigger source in the Trigger menu and for the period timer sync source (in the Trigger menu and in the Gate Source menu).
Preset	POSitive
State Saved	Saved in instrument state
<b>Backwards Compatibility SCPI</b>	:TRIGger[:SEQuence]:FRAMe:RFBurst:SLOPe
Backwards Compatibility Notes	The legacy :TRIGger[:SEQuence]:SLOPe command affects the slopes for the VID, LINE, EXT1, EXT2, and RFB triggers.
Initial S/W Revision	Prior to A.02.00

### Periodic Timer (Frame Trigger)

Pressing this key, when it is not selected, selects the internal periodic timer signal as the trigger. Triggering occurrences are set by the **Period** parameter, which is modified by the **Sync Source** and **Offset**. Pressing this key, when it is already selected, accesses the periodic timer trigger setup functions.

If you do not have a sync source selected (it is Off), then the internal timer will not be synchronized with any external timing events.

<b>Key Path</b>	<b>Trigger</b>
<b>Example</b>	TRIG:SOUR FRAM                      Swept SA measurement TRIG:<meas>:SOUR FRAM      Measurements other than Swept SA
State Saved	Saved in instrument state
Readback	[Sync: <value of Sync Source>], for example, [Sync: External 1]
Status Bits/OPC dependencies	The Status Operation Register bit 5 "Waiting for Trigger" is set at the same time as the Sweeping or Measuring bit is set. It is cleared when the trigger actually occurs (that is, after the trigger event occurs and all the applicable trigger criteria have been met). A corresponding pop-up message ("Waiting for trigger") is generated if no trigger signal appears after approximately 2 sec. This message goes away when a trigger signal appears.
Initial S/W Revision	Prior to A.02.00

### Periodic Timer Triggering:

This feature selects the internal periodic timer signal as the trigger. Trigger occurrences are set by the **Periodic Timer** parameter, which is modified by the **Sync Source** and **Offset**.

The figure below shows the action of the periodic timer trigger. Before reviewing the figure, we'll explain some uses for the periodic trigger.

A common application is measuring periodic burst RF signals for which a trigger signal is not easily available. For example, we might be measuring a TDMA radio which bursts every 20 ms. Let's assume that the 20 ms period is very consistent. Let's also assume that we do not have an external trigger source

available that is synchronized with the period, and that the signal-to-noise ratio of the signal is not high enough to provide a clean RF burst trigger at all of the analysis frequencies. For example, we might want to measure spurious transmissions at an offset from the carrier that is larger than the bandwidth of the RF burst trigger. In this application, we can set the Periodic Timer to a 20.00 ms period and adjust the offset from that timer to position our trigger just where we want it. If we find that the 20.00 ms is not exactly right, we can adjust the period slightly to minimize the drift between the period timer and the signal to be measured.

A second way to use this feature would be to use **Sync Source** temporarily, instead of **Offset**. In this case, we might tune to the signal in a narrow span and use the RF Burst trigger to synchronize the periodic timer. Then we would turn the sync source off so that it would not miss-trigger. Miss-triggering can occur when we are tuned so far away from the RF burst trigger that it is no longer reliable.

A third example would be to synchronize to a signal that has a reference time element of much longer period than the period of interest. In some CDMA applications, it is useful to look at signals with a short periodicity, by synchronizing that periodicity to the "even-second clock" edge that happens every two seconds. Thus, we could connect the even-second clock trigger to Ext1 and use then Ext1 as the sync source for the periodic timer.

The figure below illustrates this third example. The top trace represents the even-second clock. It causes the periodic timer to synchronize with the leading edge shown. The analyzer trigger occurs at a time delayed by the accumulated offset from the period trigger event. The periodic timer continues to run, and triggers continue to occur, with a periodicity determined by the analyzer time base. The timer output (labeled "late event") will drift away from its ideal time due to imperfect matching between the time base of the signal being measured and the time base of the analyzer, and also because of imperfect setting of the period parameter. But the synchronization is restored on the next even-second clock event. ("Accumulated offset" is described in the in the **Offset** function section.)

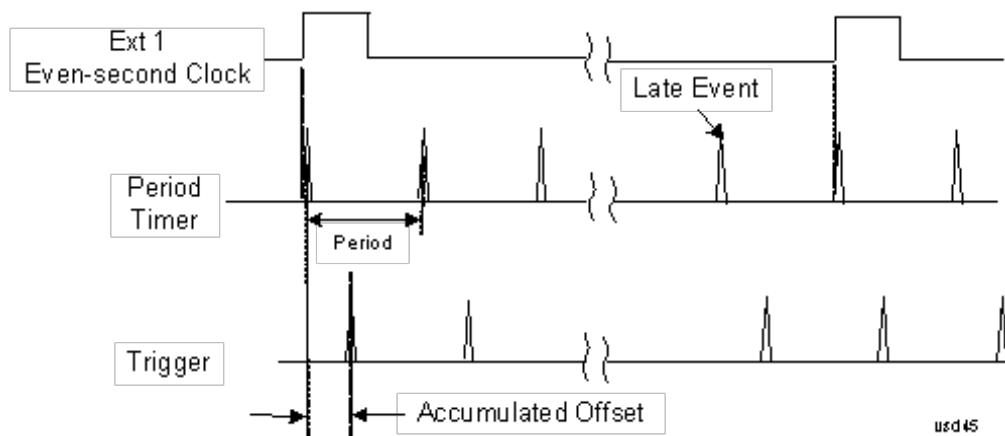

**Period**

Sets the period of the internal periodic timer clock. For digital communications signals, this is usually set to the frame period of your current input signal. In the case that sync source is not set to OFF, and the external sync source rate is changed for some reason, the periodic timer is synchronized at the every external synchronization pulse by resetting the internal state of the timer circuit.

<b>Key Path</b>	Trigger, Periodic Timer
<b>Remote Command</b>	:TRIGger[:SEquence]:FRAME:PERiod <time>

	:TRIGger[:SEquence]:FRAMe:PERiod?
<b>Example</b>	TRIG:FRAM:PER 100 ms
Dependencies	The invalid data indicator turns on when the period is changed, until the next sweep/measurement completes.
Couplings	The same period is used in the Gate Source selection of the period timer.
Preset	20 ms GSM: 4.615383
State Saved	Saved in instrument state
Min	100.000 ns
Max	559.0000 ms
Default Unit	S
Initial S/W Revision	Prior to A.02.00

### Offset

Adjusts the accumulated offset between the periodic timer events and the trigger event. Adjusting the accumulated offset is different than setting an offset, and requires explanation.

The periodic timer is usually not synchronized with any external events, so the timing of its output events has no absolute meaning. Since the timing relative to external events (RF signals) is important, you need to be able to adjust (offset) it. However, you have no direct way to see when the periodic timer events occur. All that you can see is the trigger timing. When you want to adjust the trigger timing, you will be changing the internal offset between the periodic timer events and the trigger event. Because the absolute value of that internal offset is unknown, we will just call that the accumulated offset. Whenever the Offset parameter is changed, you are changing that accumulated offset. You can reset the displayed offset using Reset Offset Display. Changing the display does not change the value of the accumulated offset, and you can still make additional changes to accumulated offset.

To avoid ambiguity, we define that an increase in the "offset" parameter, either from the knob or the SCPI adjust command, serves to delay the timing of the trigger event.

Key Path	Trigger, Periodic Timer
<b>Remote Command</b>	:TRIGger[:SEquence]:FRAMe:OFFSet <time> :TRIGger[:SEquence]:FRAMe:OFFSet?
<b>Example</b>	TRIG:FRAM:OFFS 1.2 ms
Notes	The front panel interface (for example, the knob), and this command, adjust the accumulated offset, which is shown on the active function display. However, the actual amount sent to the hardware each time the offset is updated is the delta value, that is, the current accumulated offset value minus the previous accumulated offset value. Note that the accumulated offset value is essentially arbitrary; it represents the accumulated offset from the last time the offset was zeroed (with the Reset Offset Display key).  Note that this command does not change the period of the trigger waveform. Note also that Offset is used only when the sync source is set to OFF, otherwise delay is used, see section "Trig Delay" on page 443.

	An increase in the "offset" parameter, either from the knob or the SCPI adjust command, serves to delay the timing of the trigger event.
Notes	When the SCPI command is sent the value shown on the key (and the Active Function, if this happens to be the active function) is updated with the new value. However, the actual amount sent to the hardware is the delta value, that is, the current accumulated offset value minus the previous accumulated offset value.  The SCPI query simply returns the value currently showing on the key.
Dependencies	The invalid data indicator turns on when the offset is changed, until the next sweep/measurement completes.
Couplings	The same offset is used in the Gate Source selection of the period timer.
Preset	0 s
State Saved	Saved in instrument state
Min	-10.000 s
Max	10.000 s
Default Unit	S
Initial S/W Revision	Prior to A.02.00

#### Offset Adjust (Remote Command Only)

This remote command does not work at all like the related front panel keys. This command lets you advance the phase of the frame trigger by the amount you specify.

It does not change the period of the trigger waveform. If the command is sent multiple times, it advances the phase of the frame trigger an additional amount each time it is sent. Negative numbers are permitted.

<b>Remote Command</b>	:TRIGger[:SEquence]:FRAMe:ADJust <time>
<b>Example</b>	TRIG:FRAM:ADJ 1.2 ms
Notes	Note also that Offset is used only when the sync source is set to OFF, otherwise delay is used, see section "Trig Delay" on page 443  An increase in the "offset" parameter, either from the knob or the SCPI adjust command, serves to delay the timing of the trigger event.
Notes	The front panel interface (for example, the knob) and the :TRIG:FRAM:OFFS command adjust the accumulated offset, which is shown on the active function display. However, the actual amount sent to the hardware is the delta value, that is, the current offset value minus the previous offset value.  When the SCPI command is sent the value shown on the key (and the Active Function, if this happens to be the active function) is updated by increasing it (or decreasing it if the value sent is negative) by the amount specified in the SCPI command.  This is a "command only" SCPI command, with no query.
Dependencies	The invalid data indicator turns on when the offset is changed, until the next sweep/measurement completes.
Couplings	The same offset is used in the Gate Source selection of the period timer.
Preset	0 s

State Saved	Saved in instrument state
Min	-10.000 s
Max	10.000 s
Default Unit	S
Initial S/W Revision	Prior to A.02.00

### Reset Offset Display

Resets the value of the periodic trigger offset display setting to 0.0 seconds. The current displayed trigger location may include an offset value defined with the Offset key. Pressing this key redefines the currently displayed trigger location as the new trigger point that is 0.0 s offset. The Offset key can then be used to add offset relative to this new timing.

Key Path	Trigger, Periodic Timer
<b>Remote Command</b>	:TRIGger[:SEquence]:FRAMe:OFFSet:DISPlay:RESet
<b>Example</b>	TRIG:FRAM:OFFS:DISP:RES
Initial S/W Revision	Prior to A.02.00

### Sync Source

Selects a signal source for you to synchronize your periodic timer trigger to, otherwise you are triggering at some arbitrary location in the frame. Synchronization reduces the precision requirements on the setting of the period.

For convenience you may adjust the level and slope of the selected sync source in a conditional branch setup menu accessed from the Sync Source menu. Note that these settings match those in the **Trigger** and **Gate Source** menus; that is, each trigger source has only one value of level and slope, regardless of which menu it is accessed from.

Key Path	Trigger, Periodic Timer
<b>Remote Command</b>	:TRIGger[:SEquence]:FRAMe:SYNC EXTernal1   EXTernal2   RFBurst   OFF :TRIGger[:SEquence]:FRAMe:SYNC?
<b>Example</b>	TRIG:FRAM:SYNC EXT2
Dependencies	In some models, there is no second External input. In these models, the External 2 key is blanked and the EXTernal2 parameter will generate a "Hardware missing; Not available for this model number" message.
Preset	Off GSM/EDGE, MSR,LTE,LTETDD: RFBurst
State Saved	Saved in instrument state
Readback	The current setting is read back to this key and it is also Readback to the previous Periodic Timer trigger key.

<b>Backwards Compatibility SCPI</b>	:TRIGger[:SEquence]:FRAMe:SYNC EXTernal
Initial S/W Revision	Prior to A.02.00
Modified at S/W Revision	A.03.00, A.14.00

### Off

Turns off the sync source for your periodic trigger. With the sync source off, the timing will drift unless the signal source frequency is locked to the analyzer frequency reference.

<b>Key Path</b>	Trigger, Periodic Timer, Sync Source
<b>Example</b>	TRIG:FRAM:SYNC OFF
Readback	Off
Initial S/W Revision	Prior to A.02.00

### External 1

Pressing this key, when it is not selected, selects an external input signal as the trigger. A new sweep/measurement will start when the external trigger condition is met using the external 1 input connector on the rear panel.

Pressing this key, when it is already selected, accesses the external 1 trigger setup menu.

<b>Key Path</b>	Trigger
<b>Example</b>	TRIG:SOUR EXT1 Swept SA measurement TRIG:<meas>:SOUR EXT1 Measurements other than Swept SA
<b>Dependencies</b>	Grayed out if in use by Point Trigger in the Source Setup menu. Forced to Free Run if already selected and Point Trigger is set to External 1.
<b>State Saved</b>	Saved in instrument state
<b>Status Bits/OPC dependencies</b>	The Status Operation Register bit 5 "Waiting for Trigger" is set at the same time as the Sweeping or Measuring bit is set. It is cleared when the trigger actually occurs (that is, after the trigger event occurs and all the applicable trigger criteria have been met). A corresponding pop-up message ("Waiting for trigger") is generated if no trigger signal appears after approximately 2 sec. This message goes away when a trigger signal appears.
Initial S/W Revision	Prior to A.02.00

### Trigger Level

Sets the value where the external 1 trigger input will trigger a new sweep/measurement.

Key Path	Trigger, External 1
<b>Remote Command</b>	:TRIGger[:SEquence]:EXTernal1:LEVel <level> :TRIGger[:SEquence]:EXTernal1:LEVel?
<b>Example</b>	TRIG:EXT1:LEV 0.4 V
Couplings	This same level is used for the Ext1 trigger source in the Trigger menu, for the Ext1 selection in the Periodic Timer sync source (in the Trigger menu and in the Gate Source menu), and also for the Ext1 selection in the Gate Source menu.
Preset	1.2 V
State Saved	Saved in instrument state
Min	-5 V
Max	5 V
Default Unit	V
<b>Backwards Compatibility SCPI</b>	:TRIGger[:SEquence]:EXTernal:LEVel For backward compatibility, the parameter EXTernal is mapped to EXTernal1
<b>Backwards Compatibility SCPI</b>	:TRIGger[:SEquence]:FRAMe:EXTernal1:LEVel
Initial S/W Revision	Prior to A.02.00

### Trig Slope

Controls the trigger polarity. It is set positive to trigger on a rising edge and negative to trigger on a falling edge.

Key Path	Trigger, External 1
<b>Remote Command</b>	:TRIGger[:SEquence]:EXTernal1:SLOPe POSitive NEGative :TRIGger[:SEquence]:EXTernal1:SLOPe?
<b>Example</b>	TRIG:EXT1:SLOP NEG
Couplings	This same slope is used in the Ext1 selection for the trigger source in the Trigger menu and for the period timer sync source (in the Trigger menu and in the Gate Source menu).
Preset	POSitive
State Saved	Saved in instrument state
<b>Backwards Compatibility SCPI</b>	:TRIGger[:SEquence]:EXTernal:SLOPe For backward compatibility, the parameter EXTernal is mapped to EXTernal1
<b>Backwards Compatibility SCPI</b>	:TRIGger[:SEquence]:FRAMe:EXTernal1:SLOPe
Backwards Compatibility Notes	The legacy :TRIGger[:SEquence]:SLOPe command affects the slopes for the VID, LINE, EXT1, EXT2, and RFB triggers.
Initial S/W Revision	Prior to A.02.00

## External 2

Pressing this key, when it is not selected, selects an external input signal as the trigger. A new sweep/measurement will start when the external trigger condition is met using the external 2 input connector. The external trigger 2 input connector is on the rear panel.

Pressing this key, when it is already selected, accesses the external 2 trigger setup menu.

Key Path	Trigger
<b>Example</b>	TRIG:SOUR EXT2 Swept SA measurement TRIG:<meas>:SOUR EXT2 Measurements other than Swept SA
Dependencies	In some models, there is no second External input. In these models, the External 2 key is blanked and the EXTERNAL2 parameter will generate a "Hardware missing; Not available for this model number" message. Grayed out if in use by Point Trigger in the Source Setup menu. Forced to Free Run if already selected and Point Trigger is set to External 2.
State Saved	Saved in instrument state
Status Bits/OPC dependencies	The Status Operation Register bit 5 "Waiting for Trigger" is set at the same time as the Sweeping or Measuring bit is set. It is cleared when the trigger actually occurs (that is, after the trigger event occurs and all the applicable trigger criteria have been met). A corresponding pop-up message ("Waiting for trigger") is generated if no trigger signal appears after approximately 2 sec. This message goes away when a trigger signal appears.
Initial S/W Revision	Prior to A.02.00
Modified at S/W Revision	A.03.00

## Trigger Level

Sets the value where the external 2 trigger input will trigger a new sweep/measurement.

Key Path	Trigger, External 2
<b>Remote Command</b>	:TRIGger[:SEquence]:EXTernal2:LEVel :TRIGger[:SEquence]:EXTernal2:LEVel?
<b>Example</b>	TRIG:EXT2:LEV 1.1 V
Couplings	This same level is used for the Ext2 trigger source in the Trigger menu, for the Ext2 selection in the Periodic Timer sync source (in the Trigger menu and in the Gate Source menu), and also for the Ext2 selection in the Gate Source menu.
Preset	1.2 V
State Saved	Saved in instrument state
Min	-5 V
Max	5 V
Default Unit	V
<b>Backwards Compatibility SCPI</b>	:TRIGger[:SEquence]:FRAME:EXTernal2:LEVel
Initial S/W Revision	Prior to A.02.00



## Trig Slope

Controls the trigger polarity. It is set positive to trigger on a rising edge and negative to trigger on a falling edge.

Key Path	Trigger, External 2
<b>Remote Command</b>	:TRIGger[:SEquence]:EXTernal2:SLOPe POSitive NEGative :TRIGger[:SEquence]:EXTernal2:SLOPe?
<b>Example</b>	TRIG:EXT2:SLOP NEG
Couplings	This same slope is used in the Ext2 selection for the trigger source in the Trigger menu and for the period timer sync source (in the Trigger menu and in the Gate Source menu).
Preset	POSitive
State Saved	Saved in instrument state
<b>Backwards Compatibility SCPI</b>	:TRIGger[:SEquence]:FRAMe:EXTernal2:SLOPe
Backwards Compatibility Notes	The legacy :TRIGger[:SEquence]:SLOPe command affects the slopes for the VID, LINE, EXT1, EXT2, and RFB triggers.
Initial S/W Revision	Prior to A.02.00

## RF Burst

Pressing this key, when it is not selected, selects the RF Burst as the trigger. A new sweep/measurement will start when an RF burst envelope signal is identified from the signal at the RF Input connector. Pressing this key, when it is already selected, accesses the RF Burst trigger setup menu.

In some models, a variety of burst trigger circuitry is available, resulting in various available burst trigger bandwidths. The analyzer automatically chooses the appropriate trigger path based on the hardware configuration and other settings of the analyzer.

Key Path	Trigger
<b>Example</b>	TRIG:SOUR RFB      Swept SA measurement TRIG:<meas>:SOUR RFB    Measurements other than Swept SA
State Saved	Saved in instrument state
Status Bits/OPC dependencies	The Status Operation Register bit 5 "Waiting for Trigger" is set at the same time as the Sweeping or Measuring bit is set. It is cleared when the trigger actually occurs (that is, after the trigger event occurs and all the applicable trigger criteria have been met). A corresponding pop-up message ("Waiting for trigger") is generated if no trigger signal appears after approximately 2 sec. This message goes away when a trigger signal appears.
Backwards Compatibility Notes	The legacy command: :TRIGger[:SEquence]:RFBurst:FSElectivity[:STATe] OFF ON 0 1 is not supported in the X-Series, as the hardware to do Frequency Selective burst triggers does not exist in X-Series.

Initial S/W Revision	Prior to A.02.00
Modified at S/W Revision	A.04.00

### Absolute Trigger Level

Sets the absolute trigger level for the RF burst envelope.

When using the External Mixing path, the Absolute Trigger Level is uncalibrated because the factory default was set to accommodate the expected IF levels for the RF path.

Key Path	Trigger, RF Burst
Scope	Meas Global
<b>Remote Command</b>	:TRIGger[:SEquence]:RFBurst:LEVel:ABSolute <ampl> :TRIGger[:SEquence]:RFBurst:LEVel:ABSolute?
<b>Example</b>	TRIG:RFB:LEV:ABS 10 dBm sets the trigger level of the RF burst envelope signal to the absolute level of 10 dBm
Notes	Sending this command does not switch the setting from relative to absolute; to switch it you need to send the :TRIGger[:SEquence]:RFBurst:LEVel:TYPE command, below.  Amplitude Corrections are not taken into account by the Absolute Trigger Level. For example, if you have given yourself effective gain with an amplitude correction factor, the Absolute Trigger will not fire until you have set the trigger level that far below the displayed signal level, rather than simply to the displayed signal level. This is only true for Amplitude Corrections, not External Gain or Ref Level Offset functions.  If mode is Bluetooth, the default value is -50 dBm.
Couplings	This same level is used for the RF Burst trigger source in the Trigger menu, for the RF Burst selection in the Periodic Timer sync source (in the Trigger menu and in the Gate Source menu), and also for the RF Burst selection in the Gate Source menu
Preset	-20 dBm
State Saved	Saved in instrument state
Min	-200 dBm
Max	100 dBm
Default Unit	depends on the current selected Y-Axis unit
<b>Backwards Compatibility SCPI</b>	:TRIGger[:SEquence]:FRAME:RFBurst:LEVel:ABSolute
Initial S/W Revision	Prior to A.02.00
Modified at S/W Revision	A.04.00

Key Path	Trigger, RF Burst
<b>Remote Command</b>	:TRIGger[:SEquence]:RFBurst:LEVel:TYPE ABSolute RELative :TRIGger[:SEquence]:RFBurst:LEVel:TYPE?

<b>Example</b>	TRIG:RFB:LEV:TYPE REL sets the trigger level type of the RF burst trigger to Relative.
Preset	ABSolute
State Saved	Saved in instrument state
Initial S/W Revision	Prior to A.02.00
Modified at S/W Revision	A.04.00

### Trigger Slope

It is set positive to trigger on a rising edge and negative to trigger on a falling edge.

Key Path	Trigger, RF Burst
<b>Remote Command</b>	:TRIGger[:SEQuence]:RFBurst:SLOPe POSitive NEGative :TRIGger[:SEQuence]:RFBurst:SLOPe?
<b>Example</b>	TRIG:RFB:SLOP NEG
Couplings	This same slope is used in the RF Burst selection for the trigger source in the Trigger menu and for the period timer sync source (in the Trigger menu and in the Gate Source menu).
Preset	POSitive
State Saved	Saved in instrument state
<b>Backwards Compatibility SCPI</b>	:TRIGger[:SEQuence]:FRAME:RFBurst:SLOPe
Backwards Compatibility Notes	The legacy :TRIGger[:SEQuence]:SLOPe command affects the slopes for the VID, LINE, EXT1, EXT2, and RFB triggers.
Initial S/W Revision	Prior to A.02.00

### Sync Holdoff

Sync Holdoff specifies the duration that the sync source signal must be kept false before the transition to true to be recognized as the sync timing. The periodic timer phase is aligned when the sync source signal becomes true, after the Holdoff time is satisfied.

A holdoff of 2 ms will work with most WiMAX signals, but there may be cases where the burst off duration is less than 1 ms and this value will need to be changed.

Key Path	Trigger, Periodic Timer
<b>Remote Command</b>	:TRIGger[:SEQuence]:FRAME:SYNC:HOLDoff <time> :TRIGger[:SEQuence]:FRAME:SYNC:HOLDoff? :TRIGger[:SEQuence]:FRAME:SYNC:HOLDoff:STATe OFF ON 0 1 :TRIGger[:SEQuence]:FRAME:SYNC:HOLDoff:STATe?
Preset	On, 1.000 ms

State Saved	Saved in instrument state
Min	0 ms
Max	+500 ms
Default Unit	s
Initial S/W Revision	Prior to A.02.00

## Control Edge/Level

Sets the method of controlling the gating function from the gating signal.

### Edge

In Edge triggering, the gate opens (after the Delay) on the selected edge (for example, positive) of the gate signal and closes on the alternate edge (for example, negative).

### Level

In Level triggering, the gate opens (after the Delay) when the gate signal has achieved a certain level and stays open as long as that level is maintained.

Key Path	Sweep/Control, Gate
Remote Command	[ :SENSe ] :SWEep:EGATe:CONTRol EDGE LEVe1 [ :SENSe ] :SWEep:EGATe:CONTRol?
Example	SWE:EGAT:CONT EDGE
Dependencies	If the Gate Method is FFT the Control key is grayed out and Edge is selected. If the Gate Source is TV, Frame or Line, the Control key is grayed out and Edge is selected.
Preset	EDGE
State Saved	Saved in instrument state
Backwards Compatibility SCPI	[ :SENSe ] :SWEep:TIME:GATE:TYPE ESA Compatibility
Initial S/W Revision	Prior to A.02.00

## Gate Holdoff

Lets you increase or decrease the wait time after a gate event ends before the analyzer will respond to the next gate signal.

After any Gate event finishes, the analyzer must wait for the sweep system to settle before it can respond to another Gate signal. The analyzer calculates a "wait time," taking into account a number of factors, including RBW and Phase Noise Optimization settings. The goal is to achieve the same accuracy when gated as in ungated operation. The figure below illustrates this concept:

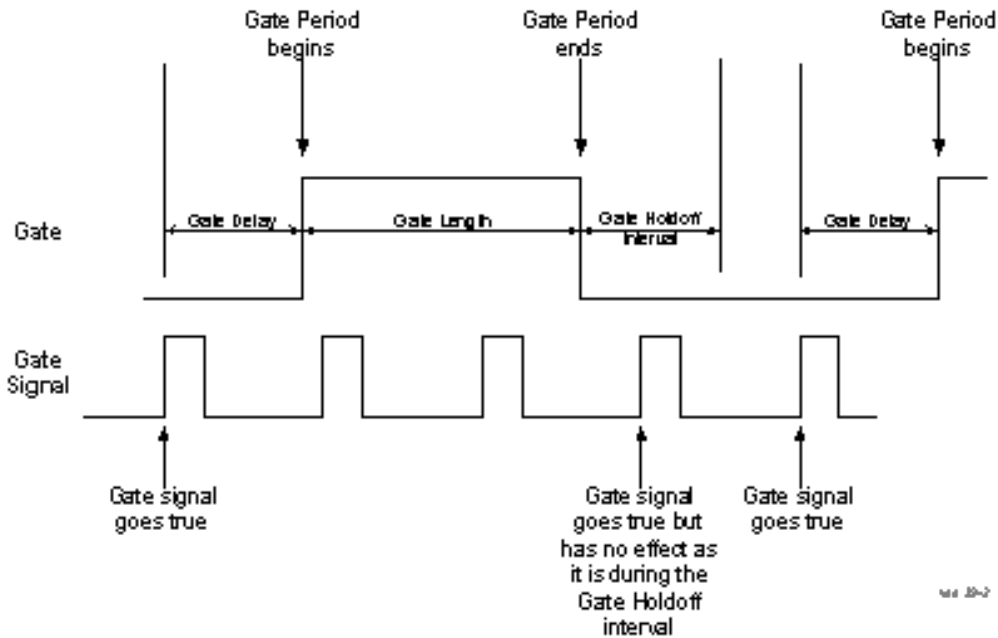

When Gate Holdoff is in Auto, the wait time calculated by the analyzer is used. When Gate Time is in Manual, the user may adjust the wait time, usually decreasing it in order to achieve greater speed, but at the risk of decreasing accuracy.

When the Method key is set to Video or FFT, the Gate Holdoff function has no effect.

In measurements that do not support Auto, the value shown when Auto is selected is “---” and the manually set holdoff is returned to a query.

Key Path	Sweep/Control, Gate
<b>Remote Command</b>	<pre>[ :SENSe ] :SWEep:EGATe:HOLDoff &lt;time&gt; [ :SENSe ] :SWEep:EGATe:HOLDoff? [ :SENSe ] :SWEep:EGATe:HOLDoff:AUTO OFF ON 0 1 [ :SENSe ] :SWEep:EGATe:HOLDoff:AUTO?</pre>
<b>Example</b>	<pre>SWE:EGAT:HOLD 0.0002 SWE:EGAT:HOLD? SWE:EGAT:HOLD:AUTO ON SWE:EGAT:HOLD:AUTO?</pre>
<b>Couplings</b>	<p>When Gate Holdoff is Auto, the Gate Holdoff key shows the value calculated by the analyzer for the wait time.</p> <p>Pressing the Gate Holdoff key while it is in Auto and not selected, causes the key to become selected and allows the user to adjust the value. If the value is adjusted, the setting changes to Man.</p> <p>Pressing the Gate Holdoff key, while it is in Auto and selected, does not change the value of Gate Holdoff, but causes the setting to change to Man. Now the user can adjust the value.</p> <p>Pressing the key while it is in Man and selected, cause the value to change back to Auto.</p> <p>Pressing the key while it is in Man and not selected, causes the key to become selected and allows the user to adjust the value.</p>

	When Method is set to Video or FFT, the Gate Holdoff function has no effect.
Preset	Auto Auto/On
State Saved	Saved in instrument state
Min	1 µsec
Max	1 sec
Initial S/W Revision	Prior to A.02.00

### Gate Delay Compensation

This function allows you to select an RBW-dependent value by which to adjust the gate delay, to compensate for changes in the delay caused by RBW effects.

You can select between uncompensated operation and two types of compensation, Delay Until RBW Settled and Compensate for RBW Group Delay.

See "[More Information](#)" on page 1231

Key Path	Sweep/Control, Gate
Scope	Meas Global
Remote Command	[ :SENSe ] :SWEep:EGATe:DElAy:COMPensation:TYPE OFF   SETTled   GDElAy [ :SENSe ] :SWEep:EGATe:DElAy:COMPensation:TYPE?
Example	SWE:EGAT:DEL:COMP:TYPE SETT SWE:EGAT:DEL:COMP:TYPE?
Notes	Although this function is Meas Global, there are some measurements that do not support this function. In those measurements the operation will be Uncompensated. Going into one of those measurements will not change the Meas Global selection; it will simply display the grayed-out menu key with "Uncompensated" showing as the selection. This is a non-forceful grayout, so the SCPI command is still accepted.  If Gate Delay Compensation is not supported at all within a particular mode, the key is not displayed, and if the SCPI command is sent while in a measurement within that mode, an "Undefined Header" message is generated.  Measurements that do not support this function include: Swept SA
Preset	TD-SCDMA mode: Compensate for RBW Group Delay All other modes: Delay Until RBW Settled
State Saved	Saved in instrument state
Range	Uncompensated Delay Until RBW Settled Compensate for RBW Group Delay
Readback text	Uncompensated Settled Group Delay
Initial S/W Revision	Prior to A.02.00
Modified at S/W Revision	A.11.0

## More Information

Selecting Uncompensated means that the actual gate delay is as you sets it.

Selecting Delay Until RBW Settled causes the gate delay to be increased above the user setting by an amount equal to  $3.06/\text{RBW}$ . This compensated delay causes the GATE START and GATE STOP lines on the display to move by the compensation amount, and the actual hardware gate delay to be increased by the same amount. All the other gate lines (for example, MIN FAST) are unaffected. If the RBW subsequently changes, the compensation is readjusted for the new RBW. The value shown on the Gate Delay key does NOT change.

Delay Until RBW Settled allows excellent measurements of gated signals, by allowing the IF to settle following any transient that affects the burst. Excellent measurements also require that the analysis region not extend into the region affected by the falling edge of the burst. Thus, excellent measurements can only be made over a width that declines with narrowing RBWs, which is achieved by decreasing the gate length below the user setting by an amount equal to  $2.53/\text{RBW}$ . Therefore, for general purpose compensation, you will still want to change the gate length with changes in RBW even if the gate delay is compensated. The compensated Gate Length is limited by the analyzer so that it will never go below 10% of the value shown on the Gate Length key, as otherwise the sweep times could get very long. Anytime the Gate Length and RBW values combine in such a way that this limiting takes place, a warning is displayed. For measurements which contain multiple sweeps with different RBW like SEM and SPUR, the smallest RBW is used for this limiting.

Selecting Compensate for RBW Group Delay causes the gate delay to be increased above the user setting by an amount equal to  $1.81/\text{RBW}$ . This compensated delay causes the GATE START, GATE STOP lines on the display to move by the compensation amount, and the actual hardware gate delay to be increased by the same amount. All the other gate lines (for example, MIN FAST) are unaffected. If the RBW subsequently changes, the compensation is readjusted for the new RBW. The value shown on the Gate Delay key does NOT change. Compensate for RBW Group Delay also includes gate length compensation; the gate length itself is adjusted as necessary to attempt to compensate for delay effects imposed by the RBW.

Compensate for RBW Group Delay is similar to Delay Until RBW Settled, but compensates for the group delay of the RBW filter, rather than the filter settling time. As the RBW gets narrow, this can allow the settling tail of the RBW to affect the beginning part of the gated measurement, and allow the beginning of the RBW settling transient to affect the end of the gated measurement. These two effects are symmetric because the RBW response is symmetric. Because the gate length is not automatically compensated, some users might find this compensation to be more intuitive than compensation for RBW settling.

## Min Fast Position Query (Remote Command Only)

This command queries the position of the MIN FAST line, relative to the delay reference (REF) line. See section "[Gate View On/Off](#)" on page 2040. If this query is sent while not in gate view, the MinFast calculation is performed based on the current values of the appropriate parameters and the result is returned. Knowing this value lets you set an optimal gate delay value for the current measurement setup.

<b>Remote Command</b>	[ :SENSe ] :SWEep:EGATe:MINFast?
<b>Example</b>	SWE:EGAT:MIN?
<b>Initial S/W Revision</b>	Prior to A.02.00

### Gate Preset (Remote Command Only)

Presets the time-gated spectrum analysis capability.

This command sets gate parameter values to the ESA preset values, as follows:

Gate trigger type = edge

Gate polarity = positive

Gate delay = 1 us

Gate length = 1 us

<b>Remote Command</b>	<code>[:SENSe]:SWEep:TIME:GATE:PRESet</code> ESA Compatibility
Initial S/W Revision	Prior to A.02.00

### Gate Level (Remote Command Only)

Sets the gate input transition point level for the external TRIGGER inputs on the front and rear panel. This is a legacy command for PSA compatibility. It is simply an alias to the equivalent trigger level command.

<b>Remote Command</b>	<code>[:SENSe]:SWEep:EGATE:EXTErnal[1] 2:LEVel &lt;voltage&gt;</code> <code>[:SENSe]:SWEep:EGATE:EXTErnal[1] 2:LEVel?</code>
Notes	This command is simply an alias to <code>:TRIGger[:SEQuence]:EXTErnal[1] 2:LEVel</code> For details refer
Initial S/W Revision	Prior to A.02.00

### Gate Polarity (Remote Command Only)

Sets the polarity for the gate signal. This setup is now done using the gate trigger's slope setting.

When Positive (Pos) is selected, a positive-going edge (Edge) or a high voltage (Level) will satisfy the gate condition, after the delay set with the Gate Delay key. When Negative (Neg) is selected, a negative-going edge (Edge) or a low voltage (Level) will satisfy the gate condition after the delay.

<b>Remote Command</b>	<code>[:SENSe]:SWEep:EGATE:POLarity</code> NEGative POSitive <code>[:SENSe]:SWEep:EGATE:POLarity?</code>
<b>Example</b>	<code>SWE:EGAT:POL</code> NEG <code>SWE:EGAT:POL?</code>
Preset	POSitive
State Saved	Saved in instrument state
<b>Backwards Compatibility SCPI</b>	<code>[:SENSe]:SWEep:TIME:GATE:POLarity</code> ESA compatibility
Initial S/W Revision	Prior to A.02.00



---

<b>Remote Command</b>	<code>[ :SENSe ] :SWEep :TIME :GATE :LEVel HIGH   LOW</code> <code>[ :SENSe ] :SWEep :TIME :GATE :LEVel ?</code> ESA compatibility
Preset	HIGH
Initial S/W Revision	Prior to A.02.00

---

## System

See ["System" on page 342](#)

## Trace/Detector

Accesses a menu of functions that enable you to control trace and detector for the current measurement.

Key Path	Front-panel key
Initial S/W Revision	Prior to A.02.00

### Trace Type

Allows you to select the type of trace for the current measurement. The menu contains a 1-of-N selection of the trace type (Clear Write, Average, Max Hold, Min Hold).

Key Path	Trace/Detector
Mode	SA, WCDMA, C2K, WIMAX OFDMA, TD-SCDMA, 1xEVDO, DTMB (CTTB), DVB-T/H, ISDB-T, CMMB, LTE, LTE-TDD, Digital Cable TV, WLAN, MSR, LTEAFDD, LTEATDD
Remote Command	:TRACe:SEMAsk:TYPE WRITe AVERAge MAXHold MINHold :TRACe:SEMAsk:TYPE?
Example	TRAC:SEM:TYPE MINH TRAC:SEM:TYPE?
Notes	WRITe = Clear Write AVERAge = Average MAXHold = Maximum Hold MINHold = Minimum Hold
Couplings	When Detector setting is "Auto" ([:SENSe]:SEMAsk:DETEctor:AUTO?), Detector ([:SENSe]:SEMAsk:DETEctor[:FUNCTion]?) switches aligning with the switch of this parameter: "NORMal" with WRITe (Clear Write), "AVERAge" with AVERAge, "POSitive (peak)" with MAXHold, and "NEGative (peak)" with MINHold.
Preset	AVERAge
State Saved	Saved in instrument state.
Range	WRITe AVERAge MAXHold MINHold
Initial S/W Revision	Prior to A.02.00
Modified at S/W Revision	A.02.00, A.03.00

### Chan Detector

Accesses a menu of functions that enable you to control the detectors for reference channel. The following choices are available:

- Auto—the detector selected depends on marker functions, trace functions, average type, and the trace averaging function.
- Normal—the detector determines the peak of the CW-like signals, and it yields alternating maximums and minimums of noise-like signals. This is also referred to as Rosenfell detection.

- Average—the detector determines the average of the signal within the sweep points. The averaging method depends upon the Average Type selection (voltage, power or log scales).
- Peak—the detector determines the maximum of the signal within the sweep points.
- Sample—the detector indicates the instantaneous level of the signal at the center of the sweep points represented by each display point.
- Negative Peak—the detector determines the minimum of the signal within the sweep points.

Key Path	Trace/Detector
Initial S/W Revision	Prior to A.02.00

### Chan Detector Auto

Sets the detector to the default detection mode for the reference channel. This mode is dependent upon the current reference channel conditions.

Key Path	Trace/Detector
Mode	SA, WCDMA, C2K, WIMAX OFDMA, TD-SCDMA, 1xEVDO, DTMB (CTTB), DVB-T/H, ISDB-T, CMMB, LTE, LTETDD, Digital Cable TV, WLAN, MSR, LTEAFDD, LTEATDD
Remote Command	<code>[ :SENSe ] :SEMAsk:DETEctor:CARRier:AUTO ON OFF 1 0</code> <code>[ :SENSe ] :SEMAsk:DETEctor:CARRier:AUTO?</code>
Example	<code>SEM:DET:CARR:AUTO OFF</code> <code>SEM:DET:CARR:AUTO?</code>
Notes	See Couplings in the Trace Type section. You must be in the mode that includes SEM measurement to use this command. Use <code>:INSTRument:SElect</code> to set the mode.
Preset	ON
State Saved	Saved in instrument state
Range	On Off
Initial S/W Revision	Prior to A.02.00
Modified at S/W Revision	A.02.00, A.03.00

### Chan Detector Selection

Selects the detector mode for the reference channel.

Key Path	Trace/Detector
Mode	SA, WCDMA, C2K, WIMAX OFDMA, TD-SCDMA, 1xEVDO, DTMB (CTTB), DVB-T/H, ISDB-T, CMMB, LTE, LTETDD, Digital Cable TV, WLAN, MSR, LTEAFDD, LTEATDD
Remote Command	<code>[ :SENSe ] :SEMAsk:DETEctor:CARRier[:FUNCTion] AVERAge   NEGAtive   NORMAl   POSitive   SAMPlE</code> <code>[ :SENSe ] :SEMAsk:DETEctor:CARRier[:FUNCTion]?</code>

<b>Example</b>	SEM:DET:CARR NEG SEM:DET:CARR?
<b>Notes</b>	When you manually select a detector (instead of selecting Auto), that detector is used regardless of other analyzer settings.  Note: This detector setting affects the reference channel. There is not a per trace detector. You must be in the mode that includes SEM measurement to use this command. Use :INSTrument:SElect to set the mode.
<b>Couplings</b>	See Couplings in the Trace Type section.
<b>Preset</b>	AVERage
<b>State Saved</b>	Saved in instrument state.
<b>Range</b>	Normal Average Peak Sample Negative Peak
<b>Initial S/W Revision</b>	Prior to A.02.00
<b>Modified at S/W Revision</b>	A.02.00, A.03.00

## Offset Detector

Accesses a menu of functions that enable you to control the detector for offsets. The following choices are available.

- Auto– the detector selected depends on marker functions, trace functions, average type, and the trace averaging function.
- Normal–the detector determines the peak of the CW-like signals, and it yields alternating maximums and minimums of noise-like signals. This is also referred to as Rosenfell detection.
- Average–the detector determines the average of the signal within the sweep points. The averaging method depends upon the Average Type selection (voltage, power or log scales).
- Peak–the detector determines the maximum of the signal within the sweep points.
- Sample–the detector indicates the instantaneous level of the signal at the center of the sweep points represented by each display point.
- Negative Peak–the detector determines the minimum of the signal within the sweep points.

<b>Key Path</b>	Trace/Detector
<b>Initial S/W Revision</b>	Prior to A.02.00

## Offset Detector Auto

Sets the detector to the default detection mode for the offsets. This mode is dependent upon the current signal conditions of the offsets.

<b>Key Path</b>	Trace/Detector
<b>Mode</b>	SA, WCDMA, C2K, WIMAX OFDMA, TD-SCDMA, 1xEVDO, DTMB (CTTB), DVB-T/H, ISDB-T, CMMB,

	LTE, LTE-TDD, Digital Cable TV, WLAN, MSR, LTEAFDD, LTEATDD
<b>Remote Command</b>	[ :SENSe ] :SEMAsk:DETEctor:OFFSet:AUTO ON OFF 1 0 [ :SENSe ] :SEMAsk:DETEctor:OFFSet:AUTO?
<b>Example</b>	SEM:DET:OFFS:AUTO OFF SEM:DET:OFFS:AUTO?
<b>Notes</b>	See Couplings in the Trace Type section. You must be in the mode that includes SEM measurement to use this command. Use :INSTRument:SELEct to set the mode.
<b>Preset</b>	ON
<b>State Saved</b>	Saved in instrument state.
<b>Range</b>	On Off
<b>Initial S/W Revision</b>	Prior to A.02.00
<b>Modified at S/W Revision</b>	A.02.00, A.03.00

## Offset Detector Selection

Selects the detector mode for the offsets.

<b>Key Path</b>	Trace/Detector
<b>Mode</b>	SA, WCDMA, C2K, WIMAX OFDMA, TD-SCDMA, 1xEVDO, DTMB (CTTB), DVB-T/H, ISDB-T, CMMB, LTE, LTE-TDD, Digital Cable TV, WLAN, MSR, LTEAFDD, LTEATDD
<b>Remote Command</b>	[ :SENSe ] :SEMAsk:DETEctor:OFFSet[:FUNction] AVERAge   NEGAtive   NORMAl   POSitive   SAMPLe [ :SENSe ] :SEMAsk:DETEctor:OFFSet[:FUNction]?
<b>Example</b>	SEM:DET:OFFS AVER SEM:DET:OFFS?
<b>Notes</b>	When you manually select a detector (instead of selecting Auto), that detector is used regardless of other analyzer settings. Note: This detector setting has effects all offsets. There is not a per trace detector. You must be in the mode that includes SEM measurement to use this command. Use :INSTRument:SELEct to set the mode.
<b>Couplings</b>	See Couplings in the Trace Type section.
<b>Preset</b>	POSitive
<b>State Saved</b>	Saved in instrument state.
<b>Range</b>	Normal Average Peak Sample Negative Peak
<b>Initial S/W Revision</b>	Prior to A.02.00
<b>Modified at S/W Revision</b>	A.02.00, A.03.00

## Trigger

See "Trigger" on page 412

### Free Run

See "Free Run " on page 419

### Video

See "Video (IF Envelope) " on page 420

### Trigger Level

See "Trigger Level " on page 420

### Trig Slope

See "Trig Slope " on page 421

### Trig Delay

See "Trig Delay " on page 422

### Line

See "Line " on page 2047

### Trig Slope

See "Trig Slope " on page 2047

### Trig Delay

See "Trig Delay " on page 424

### External 1

See "External 1 " on page 2059

### Trigger Level

See "Trigger Level " on page 2059

### Trig Slope

See "Trig Slope " on page 2060

### Trig Delay

See "Trig Delay " on page 427

### External 2

See "External 2 " on page 2061

### **Trigger Level**

See ["Trigger Level "](#) on page 2061

### **Trig Slope**

See ["Trig Slope "](#) on page 2062

### **Trig Delay**

See ["Trig Delay "](#) on page 429

### **RF Burst**

See ["RF Burst "](#) on page 2062

### **Absolute Trigger**

See ["Absolute Trigger Level"](#) on page 2063

### **Relative Trigger**

See ["Relative Trigger Level"](#) on page 2052

### **Trig Slope**

See ["Trigger Slope "](#) on page 2064

### **Trig Delay**

See ["Trig Delay "](#) on page 433

### **Periodic Timer**

See ["Periodic Timer \(Frame Trigger\) "](#) on page 2054

### **Period**

See ["Period "](#) on page 2055

### **Offset**

See ["Offset "](#) on page 2056

### **Reset Offset Display**

See ["Reset Offset Display "](#) on page 2058

### **Sync Source**

See ["Sync Source "](#) on page 2058

### **Off**

See ["Off "](#) on page 2059



### External 1

See "External 1 " on page 2059

#### Trigger Level

See "Trigger Level " on page 2059

#### Trig Slope

See "Trig Slope " on page 2060

### External 2

See "External 2 " on page 2061

#### Trigger Level

See "Trigger Level " on page 2061

#### Trig Slope

See "Trig Slope " on page 2062

### RF Burst

See "RF Burst " on page 2062

### Absolute Trigger

See "Absolute Trigger Level" on page 2063

#### Trig Slope

See "Trigger Slope " on page 2064

### Trig Delay

See "Trig Delay" on page 443

### Auto/Holdoff

See "Auto/Holdoff " on page 444

### Auto Trig

See "Auto Trig " on page 444

### Trig Holdoff

See "Trig Holdoff " on page 445

## User Preset

Accesses a menu that gives you the following three choices:

- User Preset – recalls a state previously saved using the Save User Preset function.
- User Preset All Modes – presets all of the modes in the analyzer
- Save User Preset– saves the current state for the current mode

Key Path	Front-panel key
Backwards Compatibility Notes	<p>User Preset is actually loading a state, and in legacy analyzers, it was possible to load a state without affecting the trace data, limit lines or correction data. Similarly it was possible to do a User Preset without affecting the trace data, limit lines or correction data.</p> <p>In the X-Series, “state” always includes all of this data; so whenever state is loaded, or User Preset is executed, all of the traces, limit lines and corrections are affected. Although this differs from previous behavior, it is desirable behavior, and should not cause adverse issues for users.</p> <p>On ESA and PSA, User Preset affected the entire instrument’s state. In the X-Series, User Preset only recalls the state for the active mode. There is a User Preset file for each mode. User Preset can never cause a mode switch as it can in legacy analyzers. If you want to recall all modes to their user preset file state, you will need to do a User Preset after mode switching into each mode.</p> <p>User Preset recalls mode state which can now include data like traces; whereas on ESA and PSA, User Preset did not affect data.</p>
Initial S/W Revision	Prior to A.02.00

## User Preset

User Preset sets the state of the currently active mode back to the state that was previously saved for this mode using the Save User Preset menu key or the SCPI command, SYST:PRES:USER:SAV. It not only recalls the Mode Preset settings, but it also recalls all of the mode persistent settings, and the Input/Output system setting that existed at the time Save User Preset was executed.

If a Save User Preset has not been done at any time, User Preset recalls the default user preset file for the currently active mode. The default user preset files are created if, at power-on, a mode detects there is no user preset file. There will never be a scenario when there is no user preset file to restore. For each mode, the default user preset state is the same state that would be saved if a Save User Preset is performed in each mode right after doing a Restore Mode Default and after a Restore Input/Output Defaults.

The User Preset function does the following:

- Aborts the currently running measurement.
- Sets the mode State to the values defined by Save User Preset.
- Makes the saved measurement for the currently running mode the active measurement.
- Brings up the saved menu for the power-on mode.
- Clears the input and output buffers.
- Sets the Status Byte to 0.

Key Path	User Preset
<b>Remote Command</b>	:SYSTem:PRESet:USER
<b>Example</b>	:SYST:PRES:USER:SAVE:SYST:PRES:USER
Notes	:SYST:PRES:USER:SAVE is used to save the current state as the user preset state. Clears all pending OPC bits. The Status Byte is set to 0. Pressing the User Preset front-panel key while already in the User Preset menu will cause the User Preset to get executed
Couplings	A user preset will cause the currently running measurement to be aborted and cause the saved measurement to be active. Recalling a User Preset file has the same issues that recalling a Save State file has. Some settings may need to be limited and therefore re-coupled, since the capabilities of the mode may have changes when the User Preset file was last saved.
Initial S/W Revision	Prior to A.02.00

## User Preset All Modes

Recalls all of the User Preset files for each mode, switches to the power-on mode, and activates the saved measurement from the power-on mode User Preset file.

**NOTE**

When the instrument is secured, all of the user preset files are converted back to their default user preset files.

The User Preset function does the following:

- Aborts the currently running measurement.
- Switches the Mode to the power-on mode.
- Restores the User Preset files for each mode.
- Makes the saved measurement for the power-on mode the active measurement.
- Brings up the saved menu for the power-on mode.
- Clears the input and output buffers.
- Sets the Status Byte to 0.

Key Path	User Preset
<b>Remote Command</b>	:SYSTem:PRESet:USER:ALL
<b>Example</b>	:SYST:PRES:USER:SAVE:SYST:PRES:USER:ALL
Notes	Clears all pending OPC bits. The Status Byte is set to 0. :SYST:PRES:USER:SAVE is used to save the current state as the user preset state.
Couplings	A user preset will cause the currently running measurement to be aborted, cause a mode switch to the power-on mode, and cause the saved measurement to be active in the power-on mode. Recalling a User Preset file has the same issues that recalling a Save State file has. Some settings may need to be limited and therefore re-coupled, since the capabilities of the mode may have changes when the User Preset file was last saved.
Initial S/W Revision	Prior to A.02.00

## Save User Preset

Saves the currently active mode and its State. You can recall this User Preset file by pressing the User Preset menu key or sending the SYST:PRES:USER remote command. This same state is also saved by the Save State function.

Key Path	User Preset
Remote Command	:SYSTem:PRESet:USER:SAVE
Example	:SYST:PRES:USER:SAVE
Notes	:SYST:PRES:SAVE creates the same file as if the user requested a *SAV or a MMEM:STOR:STAT, except User Preset Save does not allow the user to specify the filename or the location of the file.
Initial S/W Revision	Prior to A.02.00

## View/Display

Accesses a menu of functions that enable you to control the instrument display.

The following keys select how the results are displayed:

- **Abs Pwr Freq**—displays the absolute power levels in dBm and the corresponding frequencies in the text window.
- **Rel Pwr Freq**—displays the relative power levels in dBc and the corresponding frequencies in the text window.
- **Integrated Power**—displays the absolute and relative power levels integrated throughout the bandwidths between the start and stop frequencies in the text window.
- **Carrier Info**—displays the carrier configuration information with measure powers. (Only available in MSR and LTE-Advanced FDD/TDD)

["View Selection by Name \(Remote Command Only\)" on page 1245](#)

["Views Selection by Number \(Remote Command only\)" on page 1246](#)

### View Selection by Name (Remote Command Only)

Key Path	View/Display
Mode	SA, WCDMA, C2K, WIMAX OFDMA, TD-SCDMA, 1xEVDO, DTMB (CTTB), DVB-T/H, ISDB-T, CMMB, LTE, LTE-TDD, Digital Cable TV, WLAN, MSR, LTEAFDD, LTEATDD
Remote Command	:DISPlay:SEMask:VIEW[:SElect] APFReq   RPFReq   IPOWer   CINformation :DISPlay:SEMask:VIEW[:SElect]?
Example	DISP:SEM:VIEW IPOW DISP:SEM:VIEW?
Notes	You must be in the mode that includes SEM measurement to use this command. Use :INSTrument:SElect to set the mode.
Dependencies	In the SA mode, when "Radio Standard" is set to WLAN, IPOWer is not available and the key is grayed out. CINformation is available only in MSR and LTE-Advanced FDD/TDD mode, otherwise the key is blank.
Preset	SA, , WCDMA, , C2K, , TD-SCDMA, , 1xEVDO, , DTMB (CTTB), , DVB-T/H, , ISDB-T, , CMMB, , LTE, , LTE-TDD, , Digital Cable TV, , MSR, , LTEAFDD, , LTEATDD: APFReq WIMAX OFDMA, WLAN: RPFReq
State Saved	Saved in instrument state.
Range	Abs Pwr & Freq  Rel Pwr & Freq Integrated Power Carrier Info
Initial S/W Revision	Prior to A.02.00
Modified at S/W Revision	A.02.00, A.03.00, A.10.00

### Views Selection by Number (Remote Command only)

The following numerical selections determine how the results are displayed:

1. displays the absolute power levels in dBm and the corresponding frequencies in the text window.
2. displays the relative power levels in dBc and the corresponding frequencies in the text window.
3. displays the absolute and relative power levels integrated throughout the bandwidths between the start and stop frequencies in the text window.
4. displays the carrier info table. (Only available in MSR and LTE-Advanced FDD/TDD)

<b>Mode</b>	SA, WCDMA, C2K, WIMAX OFDMA, TD-SCDMA, 1xEVDO, DTMB (CTTB), DVB-T/H, ISDB-T, CMMB, LTE, LTE-TDD, Digital Cable TV, WLAN, MSR, LTEAFDD, LTEATDD
<b>Remote Command</b>	:DISPlay:SEMask:VIEW:NSElect <integer> :DISPlay:SEMask:VIEW:NSElect?
<b>Example</b>	DISP:SEM:VIEW:NSEL 2 DISP:SEM:VIEW:NSEL?
<b>Notes</b>	In the SA mode, when "Radio Standard" is set to WLAN, Option 3 is not available. Option 4 is available only in MSR and LTE-Advanced FDD/TDD mode. You must be in the mode that includes SEM measurement to use this command. Use :INSTrument:SElect to set the mode.
<b>Preset</b>	SA, , WCDMA, , C2K, , TD-SCDMA, , 1xEVDO, , DTMB (CTTB), , DVB-T/H, , ISDB-T, , CMMB, , LTE, , LTE-TDD, , Digital Cable TV, , MSR, , LTEAFDD, , LTEATDD: 1 WIMAX OFDMA, WLAN: 2
<b>State Saved</b>	Saved in instrument state.
<b>Min</b>	1
<b>Max</b>	MSR, LTEAFDD, LTEATDD: 4 Other modes: 3
<b>Initial S/W Revision</b>	Prior to A.02.00
<b>Modified at S/W Revision</b>	A.02.00, A.03.00, A.10.00

<b>Key Path</b>	Front-panel key
<b>Initial S/W Revision</b>	Prior to A.02.00

### Display

The Display menu is common to most measurements, and is used for configuring items on the display. Some Display menu settings apply to all the measurements in a mode, and some only to the current measurement. Those under the System Display Settings key apply to all measurements in all modes.

<b>Key Path</b>	Display
-----------------	---------

---

Key Path	View/Display
Initial S/W Revision	Prior to A.02.00

---

## Annotation

Turns on and off various parts of the display annotation. The annotation is divided up into four categories:

1. Meas Bar: This is the measurement bar at the top of the screen. It does not include the settings panel or the Active Function. Turning off the Meas Bar turns off the settings panel and the Active Function. When the Meas Bar is off, the graticule area expands to fill the area formerly occupied by the Meas Bar.
2. Screen Annotation: this is the annotation and annunciation around the graticule, including any annotation on lines (such as the display line, the threshold line, etc.) This does NOT include the marker number or the N dB result. When off, the graticule expands to fill the entire graticule area.
3. Trace annotation: these are the labels on the traces, showing their detector (or their math mode).
4. Active Function annotation: this is the active function display in the meas bar, and all of the active function values displayed on softkeys.

See the figure below. Each type of annotation can be turned on and off individually.

11 Spectrum Emission Mask Measurement  
View/Display

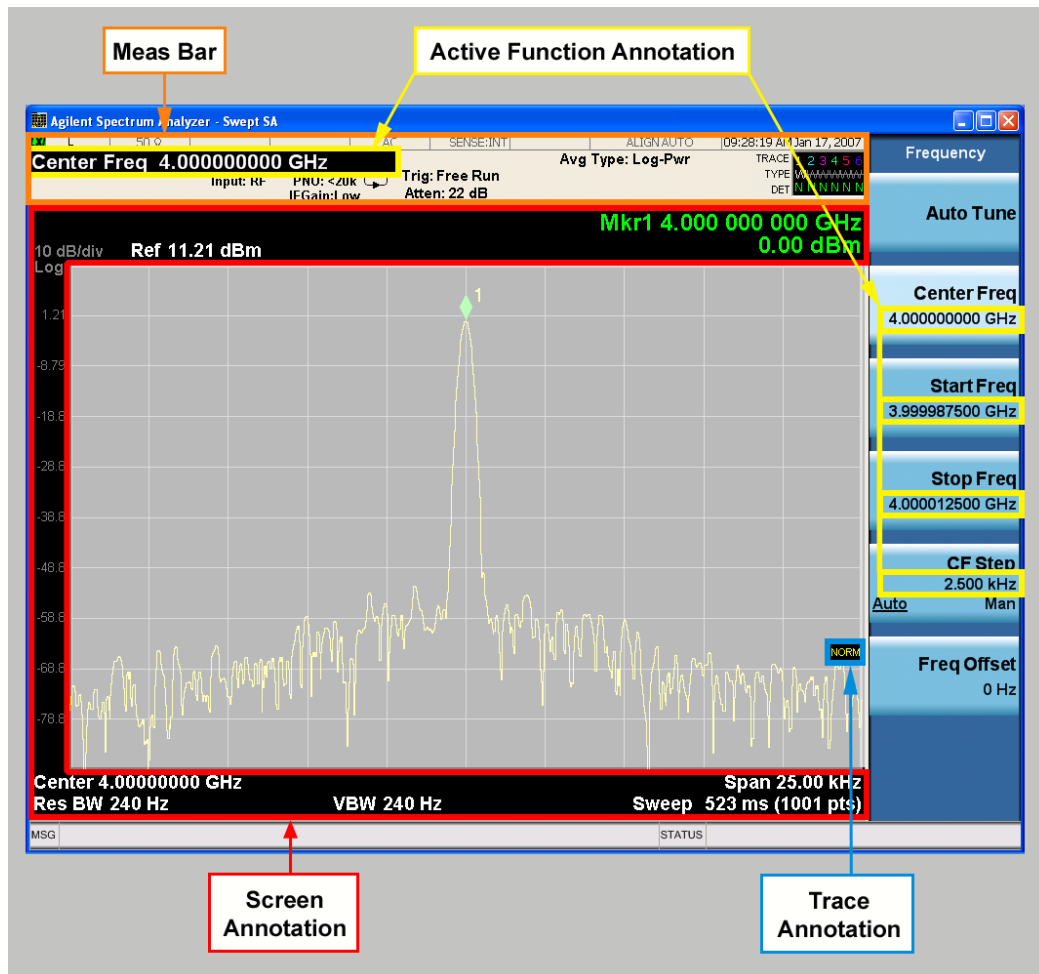

Key Path	View/Display, Display
Initial S/W Revision	Prior to A.02.00

Meas Bar On/Off

This function turns the Measurement Bar on and off, including the settings panel. When off, the graticule area expands to fill the area formerly occupied by the Measurement Bar.

Key Path	View/Display, Display, Annotation
Remote Command	:DISPlay:ANNOtation:MBAR[:STATe] OFF ON 0 1 :DISPlay:ANNOtation:MBAR[:STATe]?
Example	DISP:ANN:MBAR OFF
Dependencies	Grayed out and forced to OFF when System Display Settings, Annotation is set to Off.
Preset	On This should remain Off through a Preset when System DisplaySettings, Annotation is set to Off.
State Saved	Saved in instrument state.
Initial S/W Revision	Prior to A.02.00



## Screen

This controls the display of the annunciation and annotation around the graticule, including any annotation on lines (such as the display line, the threshold line, etc.) and the y-axis annotation. This does NOT include marker annotation (or the N dB result). When off, the graticule expands to fill the entire graticule area, leaving only the 1.5% gap above the graticule as described in the Trace/Detector chapter.

Key Path	View/Display, Display, Annotation
Remote Command	:DISPlay:ANNotation:SCReen[:STATe] OFF ON 0 1 :DISPlay:ANNotation:SCReen[:STATe]?
Example	DISP:ANN:SCR OFF
Dependencies	Grayed-out and forced to OFF when System Display Settings, Annotation is set to Off.
Preset	On This should remain Off through a Preset when System DisplaySettings, Annotation is set to Off
State Saved	Saved in instrument state.
Initial S/W Revision	Prior to A.02.00

## Active Function Values On/Off

Turns on and off the active function display in the Meas Bar, and all of the active function values displayed on the softkeys.

Note that all of the softkeys that have active functions have these numeric values blanked when this function is on. This is a security feature..

11 Spectrum Emission Mask Measurement  
View/Display

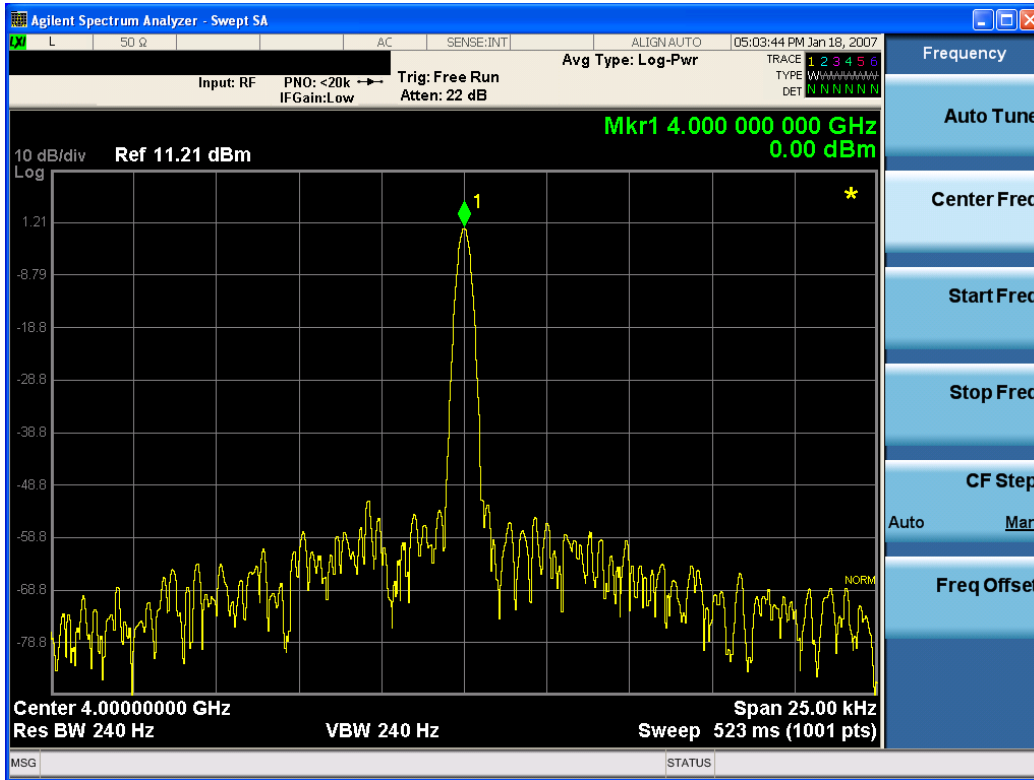

Key Path	View/Display, Display, Annotation
Remote Command	:DISPlay:ACTivefunc[:STATE] ON OFF 1 0 :DISPlay:ACTivefunc[:STATE]?
Example	DISP:ACT OFF
Dependencies	Grayed out and forced to OFF when System Display Settings, Annotation is set to Off.
Preset	On This should remain Off through a Preset when System DisplaySettings, Annotation is set to Off
State Saved	Saved in instrument state.
Initial S/W Revision	Prior to A.02.00

Title

Displays menu keys that enable you to change or clear a title on your display.

Key Path	View/Display, Display
Initial S/W Revision	Prior to A.02.00

Change Title

Writes a title into the "measurement name" field in the banner, for example, "Swept SA".

Press Change Title to enter a new title through the alpha editor. Press Enter or Return to complete the entry. Press ESC to cancel the entry and preserve your existing title.

The display title will replace the measurement name. It remains for this measurement until you press Change Title again, or you recall a state, or a Preset is performed. A title can also be cleared by pressing Title, Clear Title.

**NOTE**

Notice the inclusion of the <measurement> parameter in the command below. Because each measurement remembers the Display Title, the command must be qualified with the measurement name. For the Swept SA measurement this is not the case; no <measurement> parameter is used when changing the Display Title for the Swept SA measurement.

Key Path	View/Display, Display, Title
Mode	All
<b>Remote Command</b>	:DISPlay:<measurement>:ANNotation:TITLe:DATA <string> :DISPlay:<measurement>:ANNotation:TITLe:DATA?
<b>Example</b>	DISP:ANN:TITL:DATA "This Is My Title" This example is for the Swept SA measurement in the Spectrum Analyzer mode. The SANalyzer <measurement> name is not used. DISP:ACP:ANN:TITL:DATA "This Is My Title" This example is for Measurements other than Swept SA. Both set the title to: This Is My Title
Notes	Pressing this key cancels any active function. When a title is edited the previous title remains intact (it is not cleared) and the cursor goes at the end so that characters can be added or BKSP can be used to go back over previous characters.
Preset	No title (measurement name instead)
State Saved	Saved in instrument state.
Initial S/W Revision	Prior to A.02.00

**Clear Title**

Clears a title from the front-panel display. Once cleared, the title cannot be retrieved. After the title is cleared, the current Measurement Name replaces it in the title bar.

Key Path	View/Display, Display, Title
<b>Example</b>	The following commands clear the title and restore the measurement's original title: DISP:ANN:TITL:DATA "" This example is for the Swept SA measurement in the Spectrum Analyzer mode. The SANalyzer <measurement> name is not used. DISP:ACP:ANN:TITL:DATA "" This example is for ACP; in measurements other than Swept SA the measurement name is required.
Notes	Uses the :DISPlay:<measurement>:ANNotation:TITLe:DATA <string> command with an empty string (in the Swept SA, the <measurement> is omitted).
Preset	Performed on Preset.
Initial S/W Revision	Prior to A.02.00

## Graticule

Pressing Graticule turns the display graticule On or Off. It also turns the graticule y-axis annotation on and off.

Key Path	View/Display, Display
Remote Command	:DISPlay:WINDow[1]:TRACe:GRATicule:GRID[:STATe] OFF ON 0 1 :DISPlay:WINDow[1]:TRACe:GRATicule:GRID[:STATe]?
Example	DISP:WIND:TRAC:GRAT:GRID OFF
Notes	The graticule is the set of horizontal and vertical lines that make up the grid/divisions for the x-axis and y-axis.
Preset	On
State Saved	Saved in instrument state
Initial S/W Revision	Prior to A.02.00

## System Display Settings

These settings are "Mode Global" – they affect all modes and measurements and are reset only by Restore Misc Defaults or Restore System Defaults under System.

Key Path	View/Display, Display
Initial S/W Revision	Prior to A.02.00

## Annotation Local Settings

This is a Mode Global override of the meas local annotation settings. When it is All Off, it forces ScreenAnnotation, Meas Bar, Trace, and Active Function Values settings to be OFF for all measurements in all modes. This provides the security based "annotation off" function of previous analyzers; hence it uses the legacy SCPI command.

When it is All Off, the Screen, Meas Bar, Trace, and Active Function Values keys under the Display, Annotation menu are grayed out and forced to Off. When Local Settings is selected, you are able to set the local annotation settings on a measurement by measurement basis.

Key Path	View/Display, Display, System Display Settings
Remote Command	:DISPlay:WINDow[1]:ANNotation[:ALL] OFF ON 0 1 :DISPlay:WINDow[1]:ANNotation[:ALL]?
Example	:DISP:WIND:ANN OFF
Preset	On (Set by Restore Misc Defaults)
State Saved	Not saved in instrument state.
Backwards Compatibility Notes	The WINDow parameter and optional subopcode is included for backwards compatibility but ignored – all windows are equally affected.
Initial S/W Revision	Prior to A.02.00

## Themes

Accesses a menu of functions that enable you to choose the theme to be used when saving the screen image.

The **Themes** option is the same as the **Themes** option under the **Display** and **Page Setup** dialogs. It allows you to choose between themes to be used when saving the screen image.

<b>Key Path</b>	Save, Screen Image
<b>Remote Command</b>	:MMEMory:STORe:SCReen:THEMe TDColor   TDMonochrome   FCOLor   FMONochrome  :MMEMory:STORe:SCReen:THEMe?
<b>Example</b>	:MMEM:STOR:SCR:THEM TDM
<b>Preset</b>	3D Color; Is not part of Preset, but is reset by Restore Misc Defaults or Restore System Defaults All and survives subsequent running of the modes.
<b>Readback</b>	3D Color   3D Mono   Flat Color   Flat Mono
<b>Backwards Compatibility Notes</b>	In ESA and PSA we offer the choice of "Reverse Bitmap" or "Reverse Metafile" when saving screen images. This is much like the "Flat Color" theme available in X-Series. Also, if you selected Reverse Bitmap AND a black & white screen image, that would be much like "Flat Monochrome". In other words, each of the X-Series themes has a similar screen image type in ESA/PSA. But they are not identical.
<b>Initial S/W Revision</b>	Prior to A.02.00

### 3D Color

Selects a standard color theme with each object filled, shaded and colored as designed.

<b>Key Path</b>	Save, Screen Image, Themes
<b>Example</b>	MMEM:STOR:SCR:THEM TDC
<b>Readback</b>	3D Color
<b>Initial S/W Revision</b>	Prior to A.02.00

### 3D Monochrome

Selects a format that is like 3D color but shades of gray are used instead of colors.

<b>Key Path</b>	Save, Screen Image, Themes
<b>Example</b>	MMEM:STOR:SCR:THEM TDM
<b>Readback</b>	3D Mono
<b>Initial S/W Revision</b>	Prior to A.02.00

### Flat Color

Selects a format that is best when the screen is to be printed on an ink printer.

Key Path	Save, Screen Image, Themes
<b>Example</b>	MMEM:STOR:SCR:THEM FCOL
Readback	Flat Color
Initial S/W Revision	Prior to A.02.00

### Flat Monochrome

Selects a format that is like Flat Color. But only black is used (no colors, not even gray), and no fill.

Key Path	Save, Screen Image, Themes
<b>Example</b>	MMEM:STOR:SCR:THEM FMON
Readback	Flat Mono
Initial S/W Revision	Prior to A.02.00

### Backlight

Accesses the display backlight on/off keys. This setting may interact with settings under the Windows "Power" menu.

When the backlight is off, pressing ESC, TAB, SPACE, ENTER, UP, DOWN, LEFT, RIGHT, DEL, BKSP, CTRL, or ALT turns the backlight on without affecting the application. Pressing any other key will turn backlight on and could potentially perform the action as well.

Key Path	View/Display, Display, System Display Settings
<b>Remote Command</b>	:DISPlay:BACKlight ON OFF :DISPlay:BACKlight?
Preset	ON (Set by Restore Misc Defaults)
Initial S/W Revision	Prior to A.02.00

### Backlight Intensity

An active function used to set the backlight intensity. It goes from 0 to 100 where 100 is full on and 0 is off. This value is independent of the values set under the Backlight on/off key.

Key Path	View/Display, Display, System Display Settings
<b>Remote Command</b>	:DISPlay:BACKlight:INTensity <integer> :DISPlay:BACKlight:INTensity?
<b>Example</b>	DISP:BACK:INT 50

Preset	100 (Set by Restore Misc Defaults)
Min	0
Max	100
Initial S/W Revision	Prior to A.02.00

## Abs Pwr Freq

Sets the display to the Absolute Peak Power and Frequency view. The views differ depending on the setting of the measurement type (Meas Type) under the Measurement Setup menu.

"Abs Peak Pwr & Freq (Total Pwr Ref)" on page 1255

"Abs Peak Pwr & Freq (PSD Ref)" on page 1257

"Abs Peak Pwr & Freq (Spectrum Pk Ref)" on page 1259

### Abs Peak Pwr & Freq (Total Pwr Ref)

This view consists of the following two windows:

"Trace Window" on page 1257

"Results Window " on page 1257

11 Spectrum Emission Mask Measurement  
View/Display

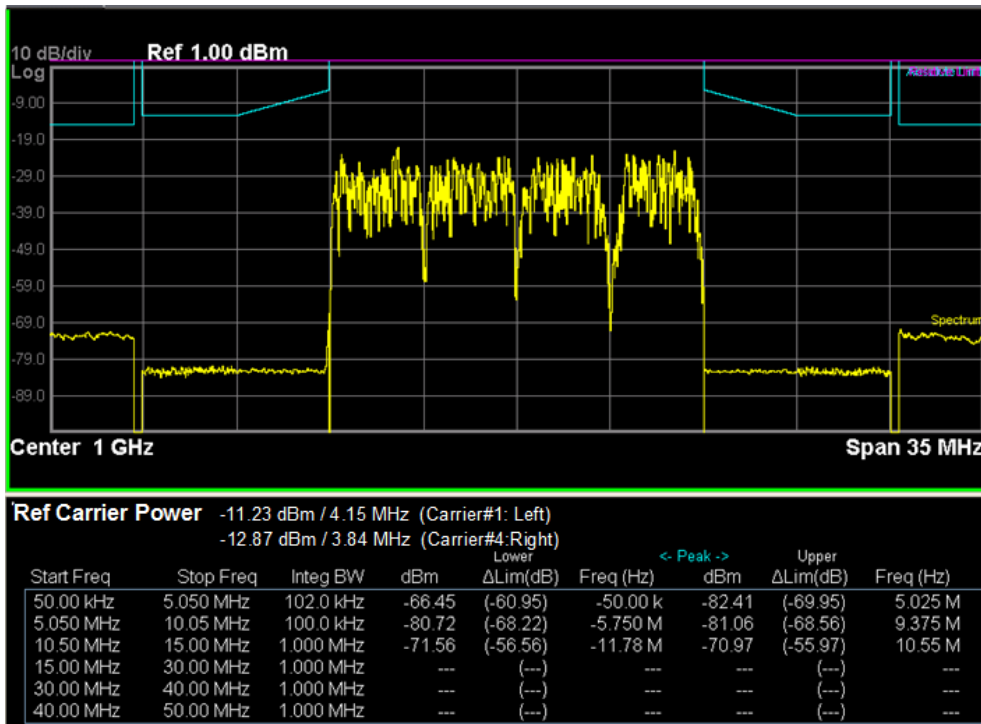
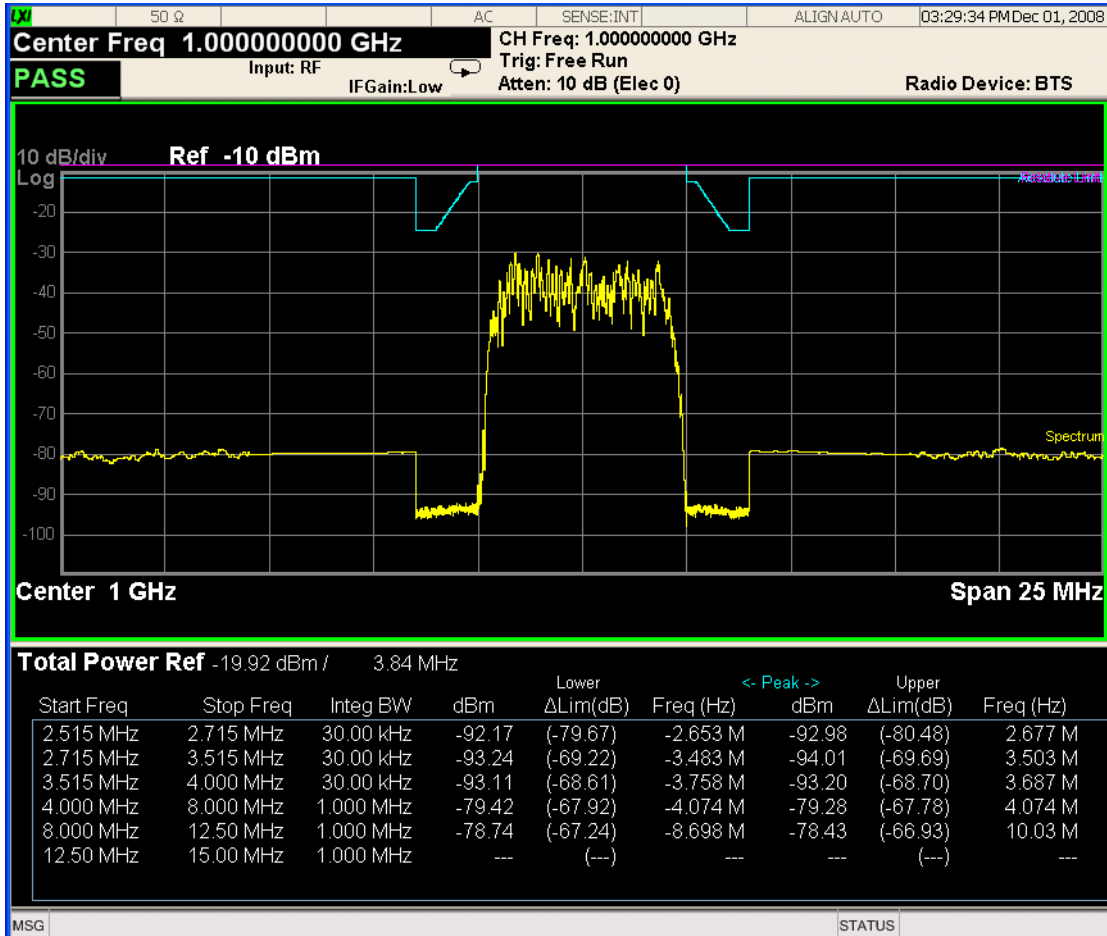



## Trace Window

Corresponding Trace	yellow - Combined trace from carrier and each offset
---------------------	--

## Results Window

Name	Corresponding Results
Total Pwr Ref	n=1 2nd element Absolute power at the reference area. Channel Integration Bandwidth
Start (Hz)	Start frequency for offset
Stop (Hz)	Stop frequency for offset
Meas BW (Hz)	Measurement bandwidth for offset
Lower Peak (dBm)	Absolute peak power on minimum margin point of the negative offset
Lower $\Delta$ lim (dB)	Minimum margin from limit line which is decided by Fail Mask setting on the negative offset
Lower Freq (Hz)	Frequency on minimum margin point of the negative offset
Upper Peak (dBm)	Absolute peak power on minimum margin point of the positive offset
Upper $\Delta$ lim (dB)	Minimum margin from limit line which is decided by Fail Mask setting on the positive offset
Upper Freq (Hz)	Frequency on minimum margin point of the positive offset

## Abs Peak Pwr & Freq (PSD Ref)

This view consists of the following two windows:

"Trace Window" on page 1259

"Results Window " on page 1259

11 Spectrum Emission Mask Measurement  
View/Display

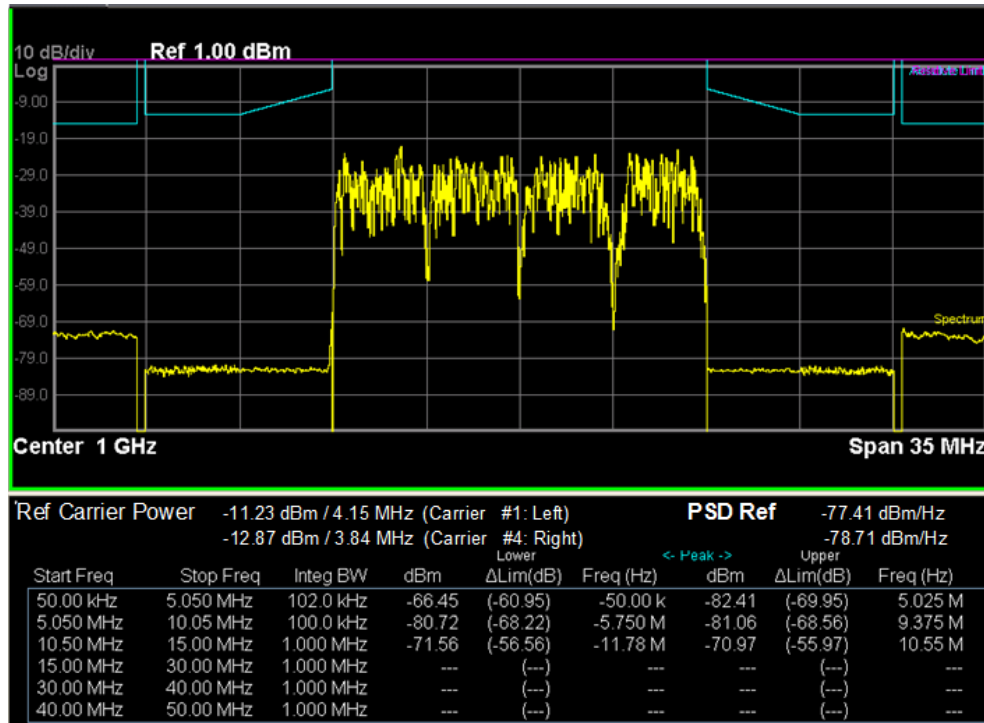
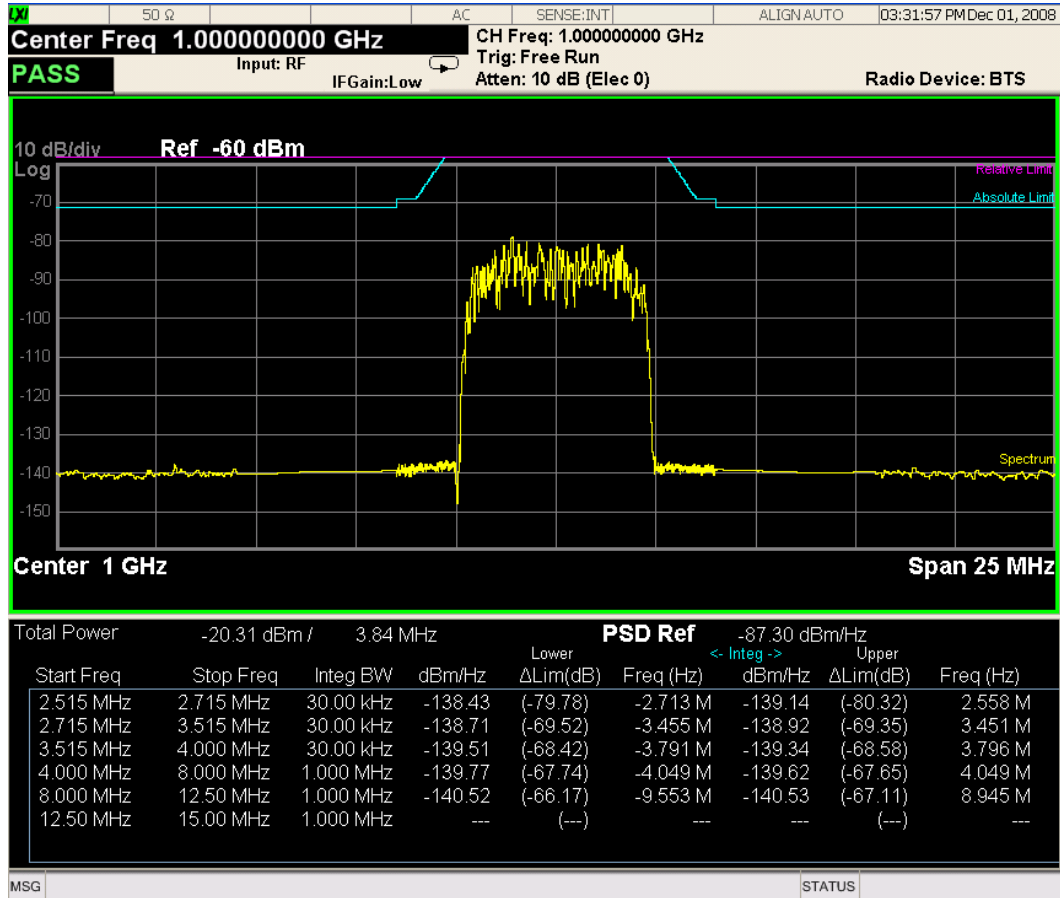

## Trace Window

Corresponding Trace	yellow - Combined trace from carrier and each offset
---------------------	--

## Results Window

Name	Corresponding Results
Total Pwr	n=1 2nd element Absolute power at the reference area.
	Channel Integration Bandwidth
PSD Ref	n=5 1st element Power spectral density reference at the reference area
Start (Hz)	Start frequency for offset
Stop (Hz)	Stop frequency for offset
Meas BW (Hz)	Measurement bandwidth for offset
Lower (dBm/Hz)	Absolute power spectrum density of the negative offset
Lower $\Delta$ lim (dB)	Minimum margin from limit line which is decided by Fail Mask setting on the negative offset
Lower Freq (Hz)	Frequency on minimum margin point of the negative offset
Upper (dBm/Hz)	Absolute power spectrum density of the positive offset
Upper $\Delta$ lim (dB)	Minimum margin from limit line which is decided by Fail Mask setting on the positive offset
Upper Freq (Hz)	Frequency on minimum margin point of the positive offset

## Abs Peak Pwr & Freq (Spectrum Pk Ref)

This view consists of the following two windows:

"Trace Window" on page 1259

"Results Window " on page 1259

11 Spectrum Emission Mask Measurement  
View/Display

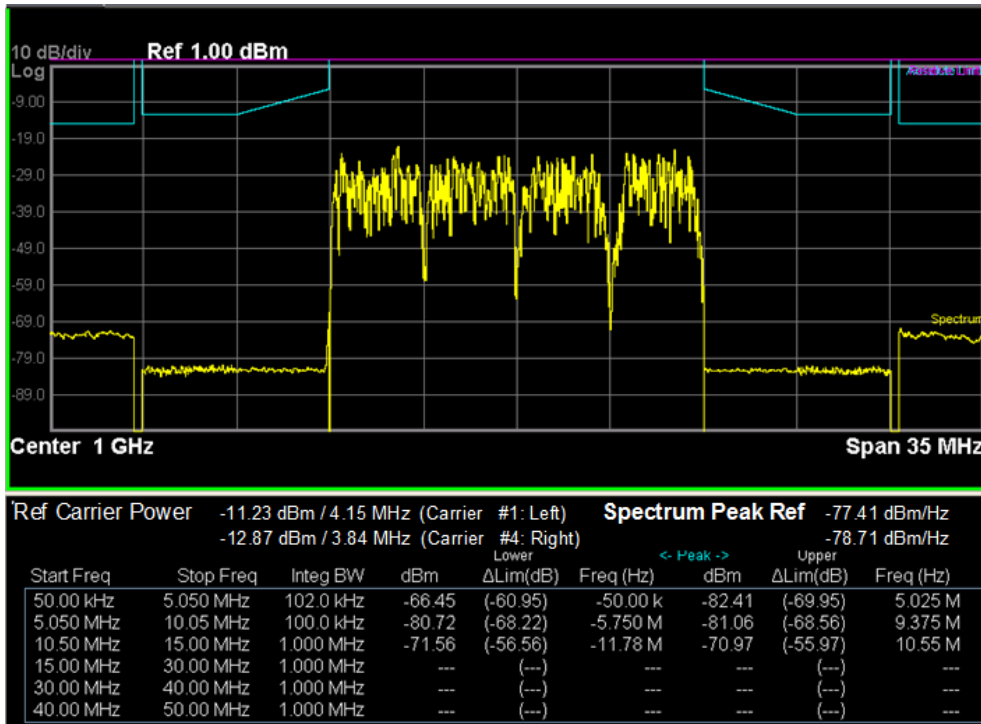
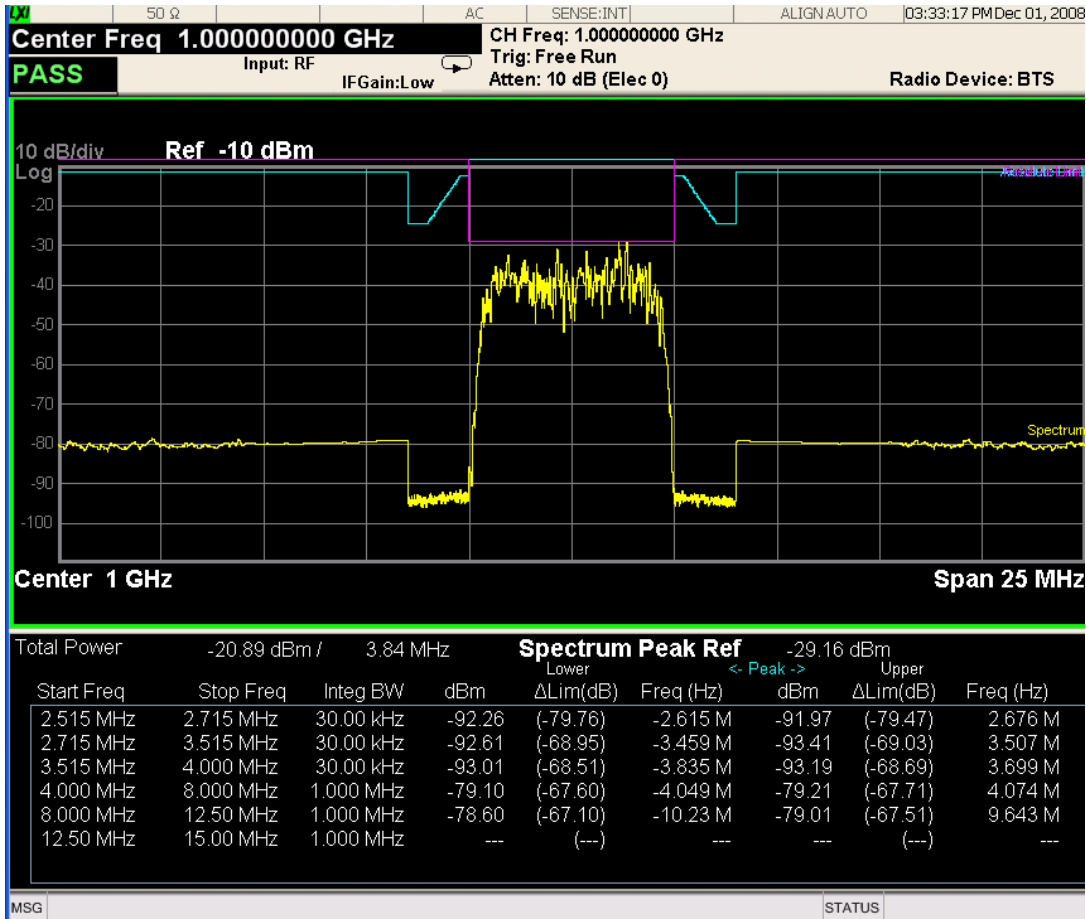

## Trace Window

Corresponding Trace	yellow - Combined trace from carrier and each offset
---------------------	--

## Results Window

Name	Corresponding Results
Total Pwr	Absolute power at the reference area. Channel Integration Bandwidth
Spectrum Peak Ref	n=5 1st element Spectrum peak power reference at the reference area
Start (Hz)	Start frequency for offset
Stop (Hz)	Stop frequency for offset
Meas BW (Hz)	Measurement bandwidth for offset
Lower(dBm)	Absolute peak power on minimum margin point of the negative offset
Lower $\Delta$ lim (dB)	Minimum margin from limit line which is decided by Fail Mask setting on the negative offset
Lower Freq (Hz)	Frequency on minimum margin point of the negative offset
Upper (dBm)	Absolute peak power on minimum margin point of the positive offset
Upper $\Delta$ lim (dB)	Minimum margin from limit line which is decided by Fail Mask setting on the positive offset
Upper Freq (Hz)	Frequency on minimum margin point of the positive offset

Key Path	View/Display
Initial S/W Revision	Prior to A.02.00

## Rel Pwr Freq

Sets the display to the Relative Peak Power and Frequency view. The views differ depending on the setting of the measurement type (Meas Type) under the Measurement Setup menu.

"Rel Peak Pwr & Freq (Total Pwr Ref)" on page 1261

"Rel Peak Pwr & Freq (PSD Ref)" on page 1263

"Rel Peak Pwr & Freq (Spectrum Pk Ref)" on page 1264

## Rel Peak Pwr & Freq (Total Pwr Ref)

This view consists of the following two windows:

"Trace Window" on page 1262

"Results Window" on page 1262

11 Spectrum Emission Mask Measurement  
View/Display

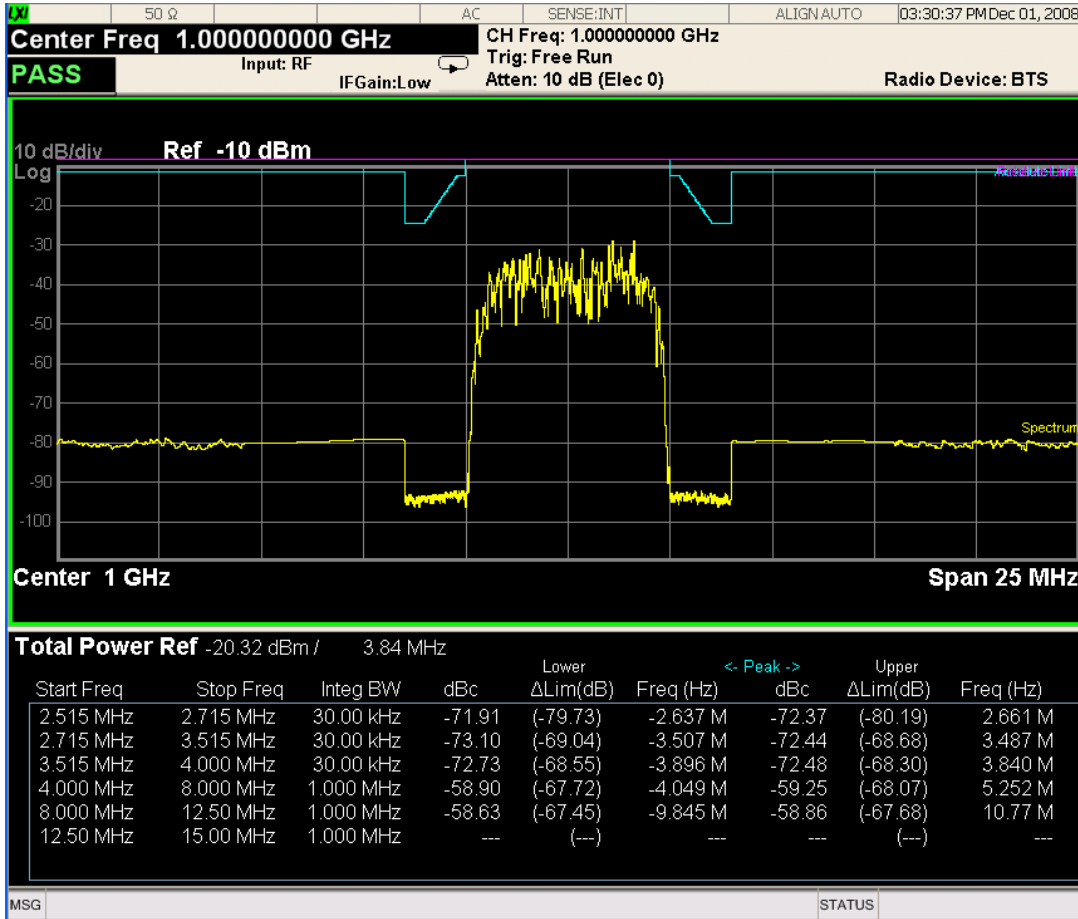

Trace Window

Corresponding Trace	yellow - Combined trace from carrier and each offset
---------------------	--

Results Window

Name	Corresponding Results
Total Pwr Ref	n=1 2nd element Absolute power at the reference area.
	Channel Integration Bandwidth
Start (Hz)	Start frequency for offset
Stop (Hz)	Stop frequency for offset
Meas BW (Hz)	Measurement bandwidth for offset
Lower Peak (dBc)	Relative peak power on minimum margin point of the negative offset
Lower ΔLim (dB)	Minimum margin from limit line which is decided by Fail Mask setting on the negative offset

Name	Corresponding Results
Lower Freq (Hz)	Frequency on minimum margin point of the negative offset
Upper Peak (dBc)	Relative peak power on minimum margin point of the positive offset
Upper ΔLim (dB)	Minimum margin from limit line which is decided by Fail Mask setting on the positive offset
Upper Freq (Hz)	Frequency on minimum margin point of the positive offset

### Rel Peak Pwr & Freq (PSD Ref)

This view consists of the following two windows:

"Trace Window" on page 1263

"Results Window" on page 1264

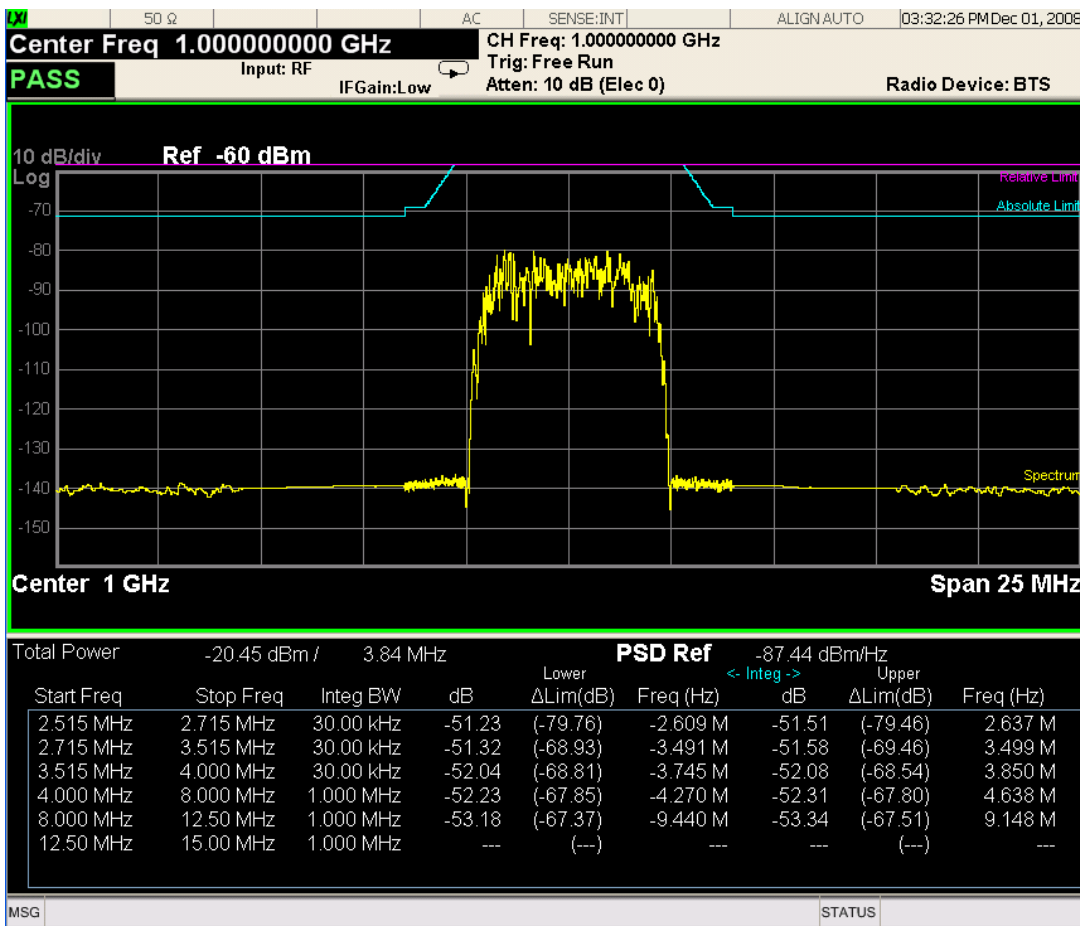

### Trace Window

Corresponding Trace	yellow - Combined trace from carrier and each offset
---------------------	--

## Results Window

Name	Corresponding Results
Total Pwr	n=1 2nd element Absolute power at the reference area.
	Channel Integration Bandwidth
PSD Ref	n=5 1st element Power spectral density reference at the reference area
Start (Hz)	Start frequency for offset
Stop (Hz)	Stop frequency for offset
Meas BW (Hz)	Measurement bandwidth for offset
Lower (dB)	Relative power spectrum density of the negative offset
Lower $\Delta$ Lim (dB)	Minimum margin from limit line which is decided by Fail Mask setting on the negative offset
Lower Freq (Hz)	Frequency on minimum margin point of the negative offset
Upper (dB)	Relative power spectrum density of the positive offset
Upper $\Delta$ Lim (dB)	Minimum margin from limit line which is decided by Fail Mask setting on the positive offset
Upper Freq (Hz)	Frequency on minimum margin point of the positive offset

### Rel Peak Pwr & Freq (Spectrum Pk Ref)

This view consists of the following two windows:

"Trace Window" on page 1262

"Results Window" on page 1262



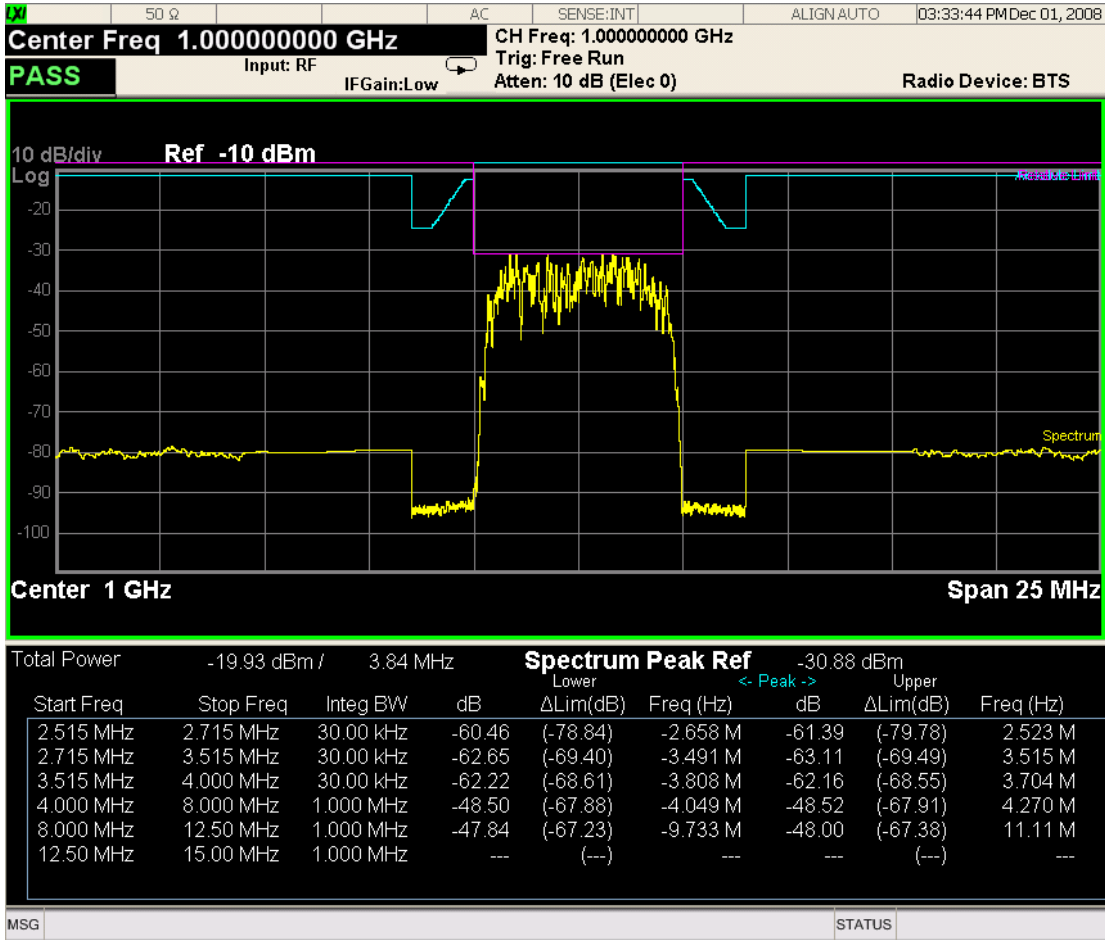

Trace Window

Corresponding Trace	yellow - Combined trace from carrier and each offset
---------------------	--

Results Window

Name	Corresponding Results
Total Pwr	Absolute power at the reference area. Channel Integration Bandwidth
Spectrum Peak Ref	n=5 1st element Spectrum peak power reference at the reference area
Start (Hz)	Start frequency for offset
Stop (Hz)	Stop frequency for offset
Meas BW (Hz)	Measurement bandwidth for offset
Lower Peak (dB)	Relative peak power on minimum margin point of the negative offset
Lower ΔLim (dB)	Minimum margin from limit line which is decided by Fail Mask setting

Name	Corresponding Results
	on the negative offset
Lower Freq (Hz)	Frequency on minimum margin point of the negative offset
Upper Peak (dB)	Relative peak power on minimum margin point of the positive offset
Upper $\Delta$ Lim (dB)	Minimum margin from limit line which is decided by Fail Mask setting on the positive offset
Upper Freq (Hz)	Frequency on minimum margin point of the positive offset

Key Path	View/Display
Initial S/W Revision	Prior to A.02.00

## Integrated Power

Sets the display to the Integrated Power view. The views differ depending on the setting of the measurement type (Meas Type) under the Measurement Setup menu.

"Integrated Power (Total Pwr Ref)" on page 1266

"Integrated Power (PSD Ref)" on page 1269

"Integrated Power (Spectrum Pk Ref)" on page 1272

### Integrated Power (Total Pwr Ref)

"Trace Window" on page 1268

"Results Window" on page 1268

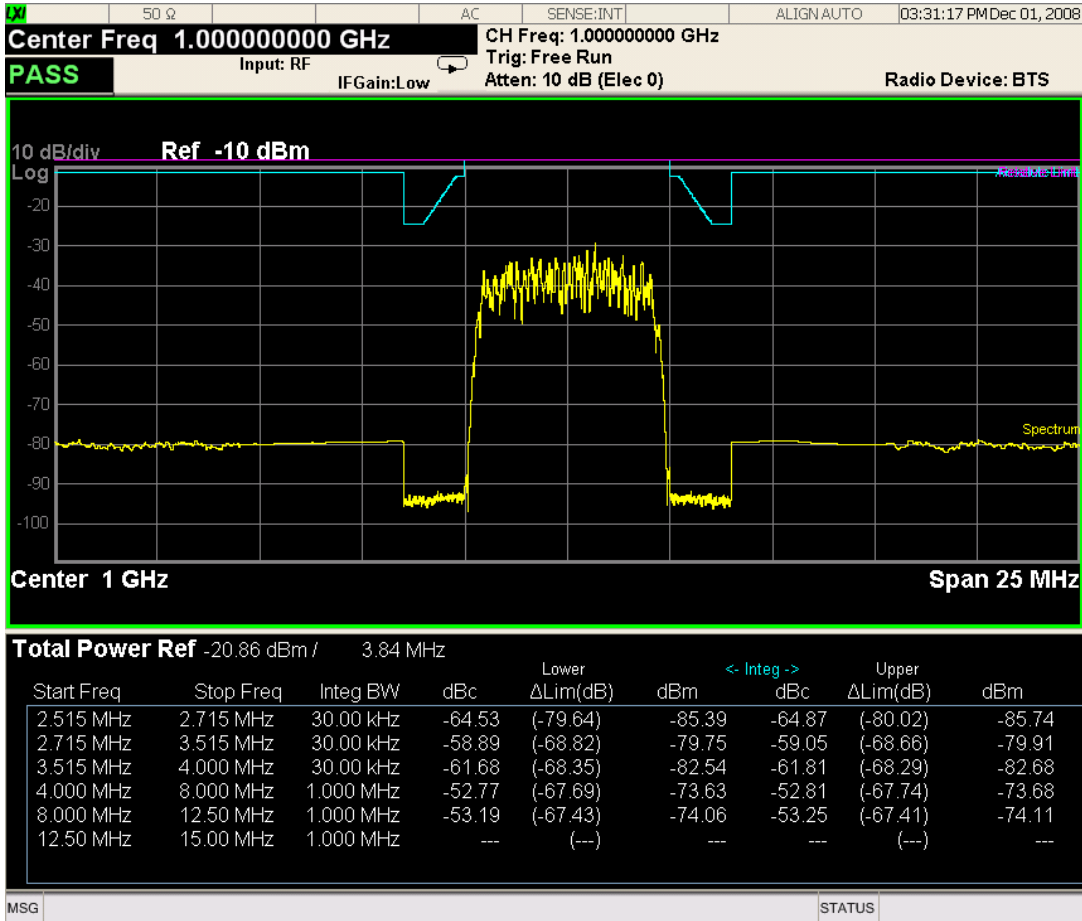

For WLAN 802.11 ac (80 + 80 MHz), power readouts of both of the carriers are displayed in the lower result window.

11 Spectrum Emission Mask Measurement  
View/Display

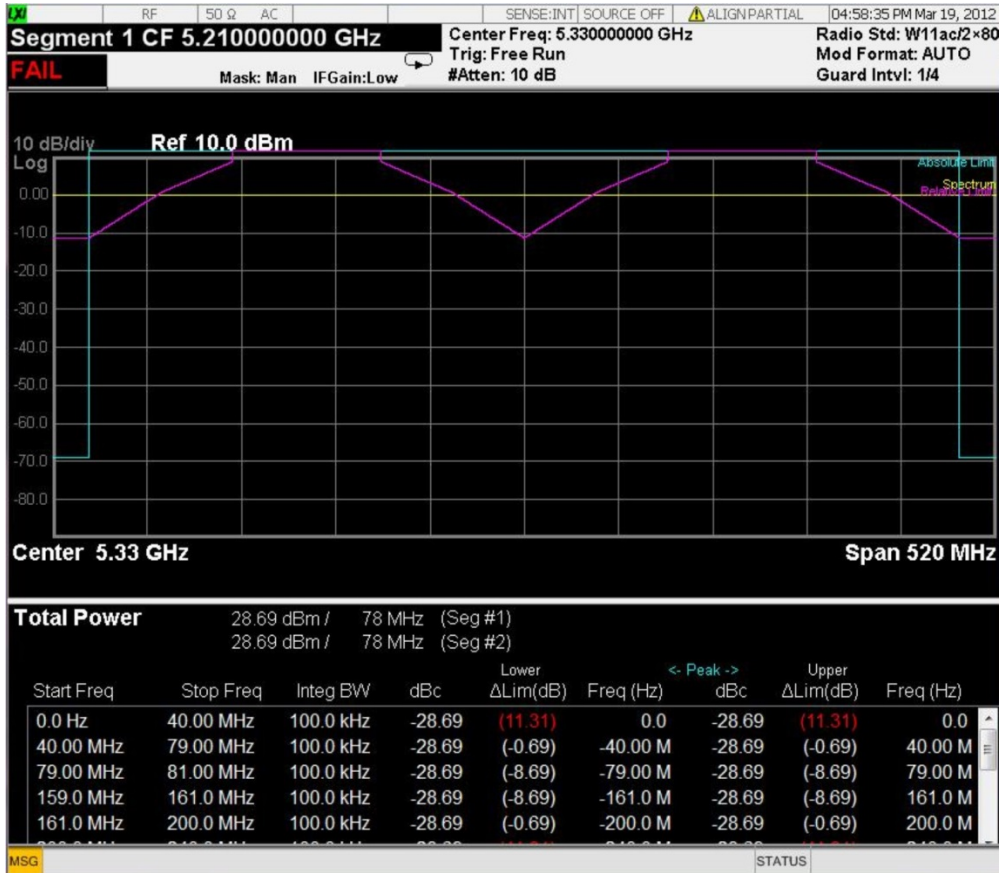

Trace Window

Corresponding Trace                      yellow - Combined trace from carrier and each offset

Results Window

Name	Corresponding Results
Total Pwr Ref	n=1 2nd element Absolute power at the reference area.
	Channel Integration Bandwidth
Start (Hz)	Start frequency for offset
Stop (Hz)	Stop frequency for offset
Meas BW (Hz)	Measurement bandwidth for offset
Lower Integ (dBc)	Relative integrated power on the negative offset
Lower ΔLim (dB)	Minimum margin from limit line which is decided by Fail Mask setting on the negative offset
Lower Integ (dBm)	Absolute integrated power on the negative offset

Name	Corresponding Results
Upper Integ (dBc)	Relative integrated power on the positive offset
Upper ΔLim (dB)	Minimum margin from limit line which is decided by Fail Mask setting on the positive offset
Upper Integ (dBm)	Absolute integrated power on the positive offset

Integrated Power (PSD Ref)

"Trace Window" on page 1271

"Results Window" on page 1271

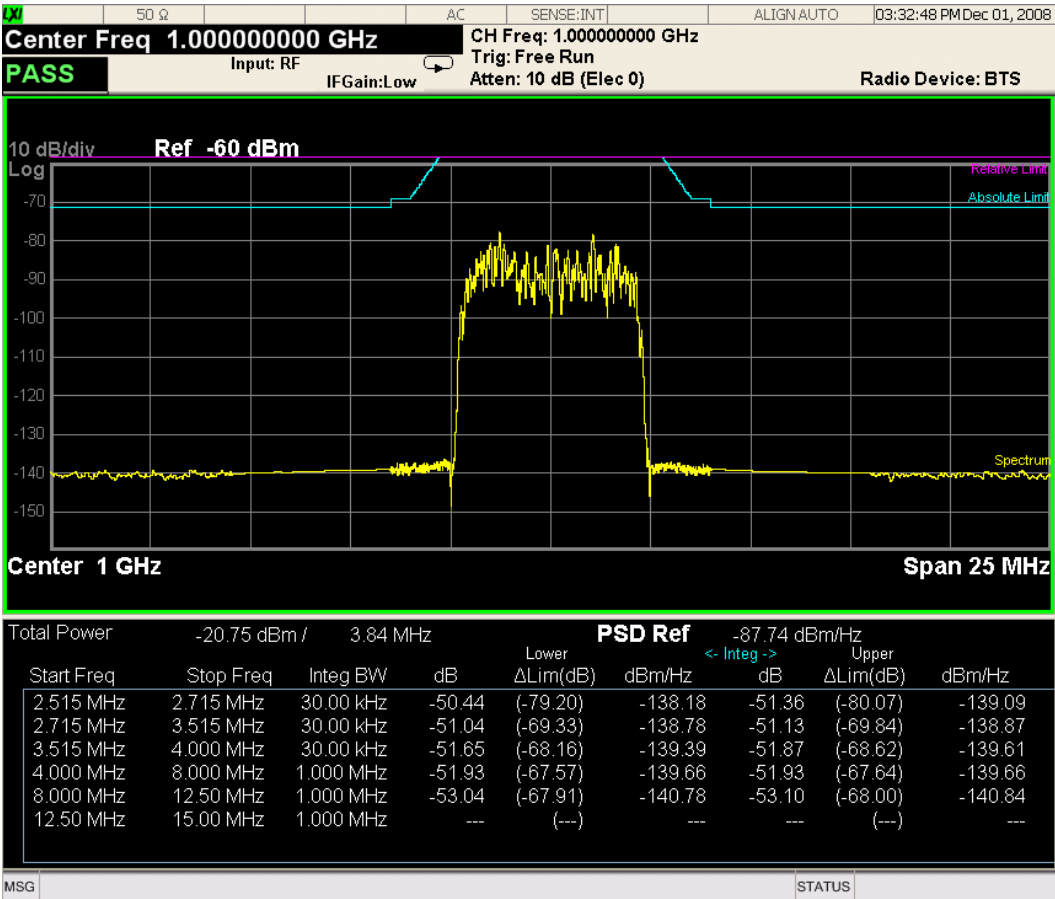

# 11 Spectrum Emission Mask Measurement View/Display



For WLAN 802.11ac (80 + 80 MHz), power readouts of both of the carriers are displayed in the lower result window.

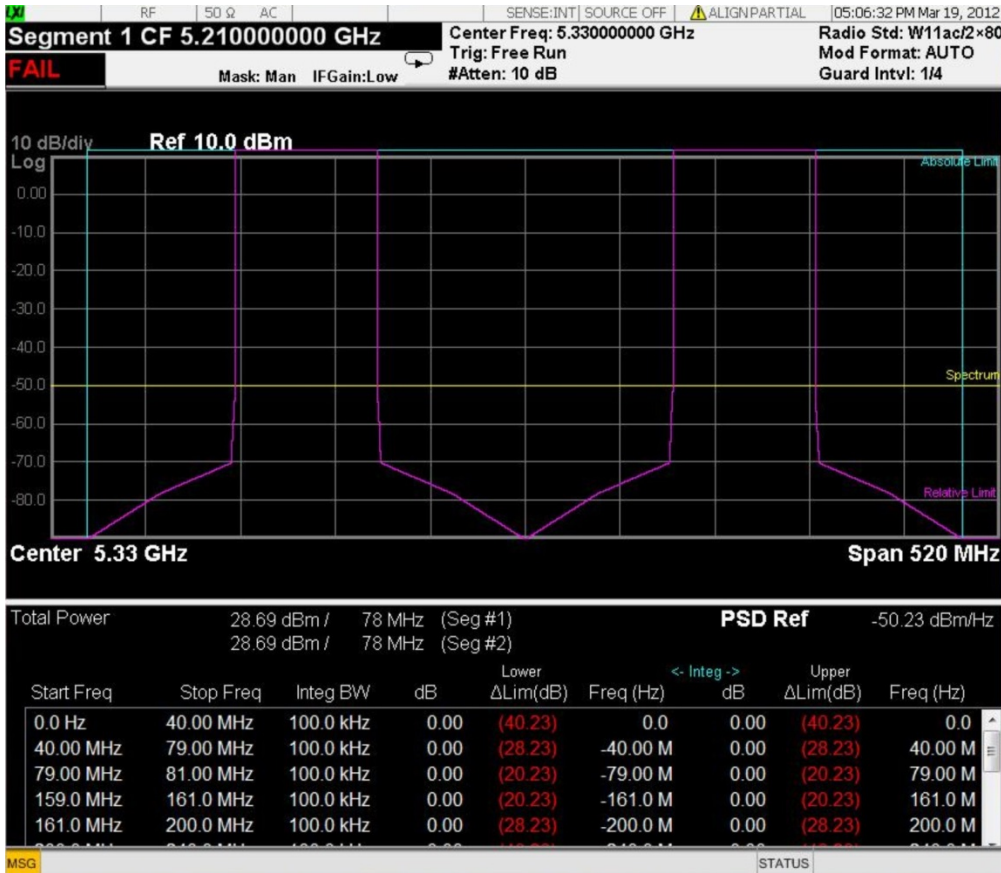

### Trace Window

Corresponding Trace      yellow - Combined trace from carrier and each offset

### Results Window

Name	Corresponding Results
Total Pwr	n=1 2nd element Absolute power at the reference area.
PSD Ref	n=5 1st element Power spectral density reference at the reference area
Start (Hz)	Start frequency for offset
Stop (Hz)	Stop frequency for offset
Meas BW (Hz)	Measurement bandwidth for offset
Lower (dB)	Relative power spectrum density of the negative offset
Lower ΔLim (dB)	Minimum margin from limit line which is decided by Fail Mask setting on the negative offset

Name	Corresponding Results
Lower (dBm/Hz)	Absolute power spectrum density of the negative offset
Upper (dB)	Relative power spectrum density of the positive offset
Upper ΔLim (dB)	Minimum margin from limit line which is decided by Fail Mask setting on the positive offset
Upper (dBm/Hz)	Absolute power spectrum density of the negative offset

**Integrated Power (Spectrum Pk Ref)**

"Trace Window" on page 1268

"Results Window" on page 1268

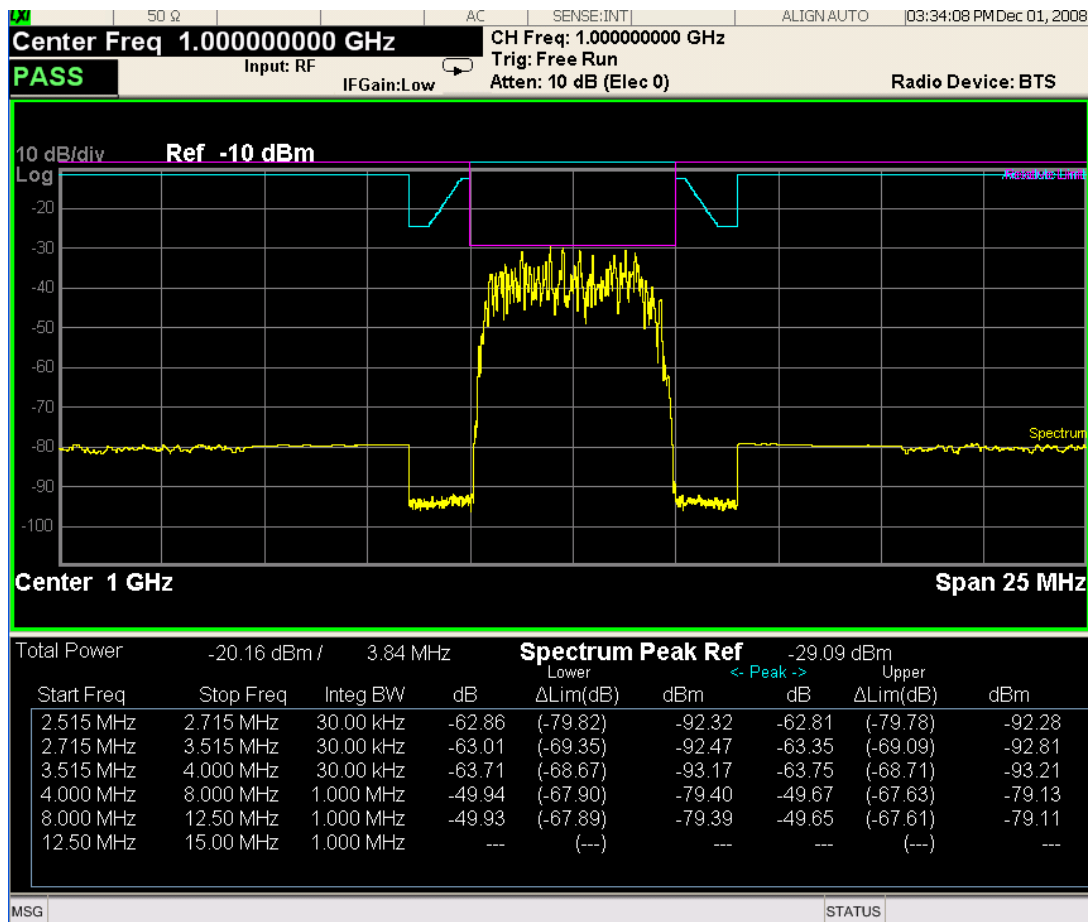

For WLAN 802.11ac (80 + 80 MHz), power readouts of both of the carriers are displayed in the lower result window.



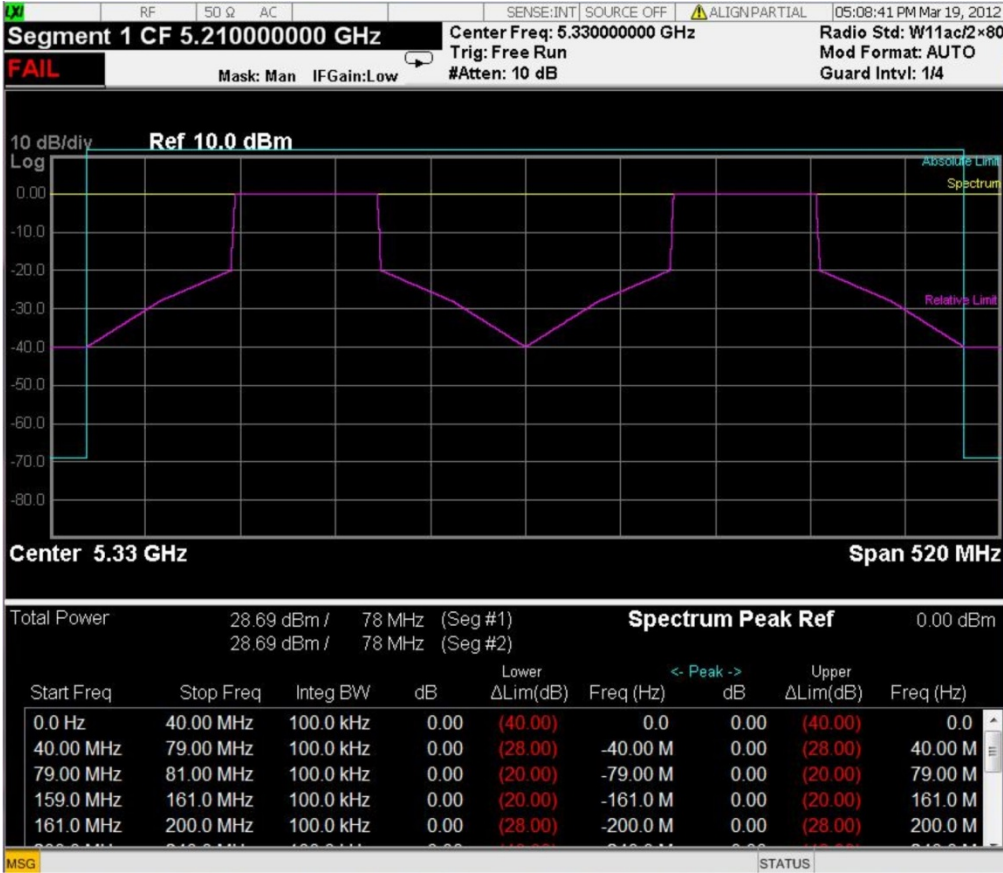

Trace Window

Corresponding Trace                      yellow - Combined trace from carrier and each offset

Results Window

Name	Corresponding Results
Total Pwr	Absolute power at the reference area. Channel Integration Bandwidth
Spectrum Peak Ref	n=5 1st element Peak power at the reference area
Start (Hz)	Start frequency for offset
Stop (Hz)	Stop frequency for offset
Meas BW (Hz)	Measurement bandwidth for offset
Lower Peak (dB)	Relative peak power on minimum margin point of the negative offset
Lower Δlim (dB)	Minimum margin from limit line which is decided by Fail Mask setting on the negative offset

Name	Corresponding Results
Lower Peak (dBm)	Absolute peak power on minimum margin point of the negative offset
Upper Peak (dB)	Relative peak power on minimum margin point of the positive offset
Upper $\Delta$ lim (dB)	Minimum margin from limit line which is decided by Fail Mask setting on the positive offset
Upper Peak (dBm)	Absolute peak power on minimum margin point of the positive offset

Key Path	View/Display
Initial S/W Revision	Prior to A.02.00

## Limit Lines

Toggles the limit lines display function for the spectrum emission mask measurements On and Off.

Key Path	View/Display
Mode	SA, WCDMA, C2K, WIMAX OFDMA, TD-SCDMA, 1xEVDO, DTMB (CTTB), DVB-T/H, ISDB-T, CMMB, LTE, LTE-TDD, Digital Cable TV, WLAN, MSR, LTEAFDD, LTEATDD
<b>Remote Command</b>	:CALCulate:SEMask:LLINe:STATe ON OFF 1 0 :CALCulate:SEMask:LLINe:STATe?
<b>Example</b>	CALC:SEM:LLIN:STAT OFF CALC:SEM:LLIN:STAT?
Notes	You must be in the mode that includes SEM measurement to use this command. Use :INSTrument:SElect to set the mode.
Preset	ON
State Saved	Saved in instrument state.
Range	On Off
Initial S/W Revision	Prior to A.02.00
Modified at S/W Revision	A.02.00, A.03.00

## 12 Mod Accuracy Measurement

The Modulation Accuracy measurement measures the modulation accuracy of DVB-T/H signals. Various parameters that measure the quality of modulation are reported. For more details, see ["Amplitude \(AMPTD\) Y Scale" on page 1282](#).

This topic contains the following sections:

["Measurement Commands for Mod Accuracy " on page 1276](#)

["Remote Command Results for Mod Accuracy Measurement" on page 1277](#)

## Measurement Commands for Mod Accuracy

The general functionality of CONFigure, FETCh, INITiate, MEASure, and READ are described in this section.

CONFigure:EVM

CONFigure:EVM:NDEFault

FETCh:EVM[n]?

INITiate:EVM

MEASure:EVM[n]?

READ:EVM[n]?

For more measurement related commands, see the SENSE subsystem and the section ["Remote Measurement Functions" on page 2165](#).

## Remote Command Results for Mod Accuracy Measurement

For each result, the following heading is used to represent its format and precision.

#.Result Name (type of number) [unit] <explanation>

Types of numbers include double, float and integer.

Index: n	Results Returned
0	<p>I/Q Capture Data Trace (float) [volt] &lt;2 * duration of an OFDM symbol * sample rate * num of demodulated symbols&gt;</p> <p>Returns unprocessed I/Q trace data of Capture Interval, as a series of trace point values, in volts. The I values are the even-indexed values, listed first in each pair. The Q values are the odd-indexed values.</p> <p>The sample rate is 15 MHz in this measurement.</p> <p>If no data is captured, one NaN will be returned.</p>
1 (or not specified)	<p>Returns 54 comma-separated scalar results, in the following order:</p> <ol style="list-style-type: none"> <li>1. RMS EVM (Average) (double) [% rms] Averaged RMS EVM (in average cycle) in certain symbols.</li> <li>2. Peak EVM (double) [% pk] Peak RMS EVM value in certain symbols.</li> <li>3. Position of Peak EVM – Sub-carrier Number (int) [NA] Sub-carrier number corresponding to the position of peak RMS EVM.</li> <li>4. RMS MER (Average) (double) [dB rms] Averaged RMS MER (in average cycle) in certain symbols.</li> <li>5. Peak MER (double) [dB pk] Peak RMS MER value in certain symbols.</li> <li>6. Position of Peak MER – Sub-carrier Number (int) [NA] Sub-carrier number corresponding to the position of peak RMS MER.</li> <li>7. RMS Mag Error (Average) (double) [% rms] Averaged RMS magnitude error (in average cycle) in certain symbols.</li> <li>8. Peak Mag Error (double) [% pk] Peak magnitude error in certain symbols.</li> <li>9. Position of Peak Mag Error – Sub-carrier Number (int) [NA] Sub-carrier number corresponding to the position of peak magnitude error.</li> <li>10. RMS Phase Error (Average) (double) [° rms] Averaged RMS phase error (in average cycle) in certain symbols.</li> <li>11. Peak Phase Error (double) [°] Peak phase error in certain symbols.</li> <li>12. Position of Peak Phase Error – Sub-carrier Number (int) [NA] Sub-carrier number corresponding to the position of peak phase error.</li> <li>13. Freq Err (Average) (double) [Hz] Averaged frequency error (in average cycle) in certain symbols.</li> <li>14. Phase Jitter (Average) (double) [rad rms]</li> </ol>

Index: n	Results Returned
	Averaged RMS phase jitter (in average cycle) in certain symbols.
15.	Quad Err (Average) (double) [deg] Averaged quadrature error (in average cycle) in certain symbols.
16.	Amptd Imbalance (Average) (double) [%] Averaged amplitude imbalance (in average cycle) of I and Q signal in percentage.
17.	RMS SNR (Average) (double) [dB rms] Averaged RMS SNR (in average cycle) in certain symbols.
18.	Carrier Suppression (Average) (double) [dB] Averaged carrier suppression (in average cycle).
19.	TPS power ratio (Average) (double) [dB] Averaged TPS power ratio (in average cycle) in certain symbols.
20.	Data power ratio (Average) (double) [dB] Averaged Data power ratio (in average cycle) in certain symbols.
21.	BER before Viterbi (HP) (exponential) BER before Viterbi of the high priority stream.
22.	Error count before Viterbi (HP) (exponential) Error count before Viterbi of the high priority stream.
23.	Total count before Viterbi (HP) (exponential) Total count before Viterbi of the high priority stream.
24.	BER before Viterbi (exponential) BER before Viterbi of the low priority stream.
25.	Error count before Viterbi (exponential) Error count before Viterbi of the low priority stream.
26.	Total count before Viterbi (exponential) Total count before Viterbi of the low priority stream.
27.	BER before RS (HP) (exponential) BER before RS of the high priority stream.
28.	Error count before RS (HP) (exponential) Error count before RS of the high priority stream.
29.	Total count before RS (HP) (exponential) Total count before RS of the high priority stream.
30.	BER before RS (exponential) BER before RS of the low priority stream.
31.	Error count before RS (exponential) Error count before RS of the low priority stream.
32.	Total count before RS (exponential) Total count before RS of the low priority stream.
33.	Error count after RS (HP) (exponential) Error count after RS of the high priority stream.
34.	Error count after RS (exponential)

Index: n	Results Returned
	Error count after RS of the low priority stream.
35.	RMS Data EVM (Average) (double) [% rms] Averaged RMS EVM (in average cycle) of data carriers in certain symbols.
36.	RMS Pilot EVM (Average) (double) [% rms] Averaged RMS EVM (in average cycle) of pilot carriers in certain symbols.
37.	RMS TPS EVM (Average) (double) [% rms] Averaged RMS EVM (in average cycle) of TPS carriers in certain symbols.
38.	RMS Data MER (Average) (double) [dB rms] Averaged RMS MER (in average cycle) of data carriers in certain symbols.
39.	RMS Pilot MER (Average) (double) [dB rms] Averaged RMS MER (in average cycle) of pilot carriers in certain symbols.
40.	RMS TPS MER (Average) (double) [dB rms] Averaged RMS MER (in average cycle) of TPS carriers in certain symbols.
41.	Tx Power (Average) (double) [dBm rms] Average Tx power.
42.	MER Monitor Total Points (int) [NA] Total MER points during monitor time.
43.	MER Monitor Failed Points (int) [NA] Failed MER points during monitor time.
44.	Total count after RS (HP) (exponential) Total count after RS of the high priority stream.
45.	BER after RS (HP) (exponential) BER after RS of the high priority stream.
46.	Total count after RS (exponential) Total count after RS of the low priority stream.
47.	BER after RS (exponential) BER after RS of the low priority stream.
48.	Packet error count (HP) (exponential) Packet error count of the high priority stream.
49.	Total packet count (HP) (exponential) Total packet count of the high priority stream.
50.	Packet error rate (HP) (exponential) Packet error rate of the high priority stream.
51.	Packet error count (exponential) Packet error count of the low priority stream.
52.	Total packet count (exponential) Total packet count of the low priority stream.
53.	Packet error rate (exponential) Packet error rate of the low priority stream.
54.	Clock Err (Average) (double) [Hz]

Index: n	Results Returned
	Averaged (in average cycle) clock error of the current symbols.
2	I/Q Measured Polar Data Trace (float) [volt] <2 * number of carriers * number of symbols> Returns normalized I/Q trace data of captured symbols, as a series of trace point values, in volts. The I values are the even-indexed values, listed first in each pair. The Q values are the odd-indexed values.
3	MER vs. Sub-carrier (double) [dB] <1705/3409/6817> Returns MER vs. Sub-carrier data, as a series of comma-separated trace points. The result is a series of floating point numbers. There are 1705 sub-carriers in 2k mode, 6817 sub-carriers in 8k mode and 3409 sub-carriers in 4k mode.
4	Spectrum (double) [dB] <2048/4096/8192> Returns Spectrum data, as a series of comma-separated trace points. The result is a series of floating point numbers. There are 2048 frequency points in 2k mode, 8192 in 8k mode and 4096 in 4k mode.
5	Amptd vs. Sub-carrier (double) [dB] <1705/3409/6817> Returns amplitude vs. sub-carrier data, as a series of comma-separated trace points. The result is a series of floating point numbers. There are 1705 sub-carriers in 2k mode, 6817 sub-carriers in 8k mode and 3409 sub-carriers in 4k mode.
6	Phase vs. Sub-carrier (double) [°] <1705/3409/6817> Returns phase vs. sub-carrier data, as a series of comma-separated trace points. The result is a series of floating point numbers. There are 1705 sub-carriers in 2k mode, 6817 sub-carriers in 8k mode and 3409 sub-carriers in 4k mode.
7	Group Delay vs. Sub-carrier (double) [us] <1704/3408/6816> Returns group delay vs. sub-carrier data, as a series of comma-separated trace points. The result is a series of floating point numbers. There are 1704 sub-carriers in 2k mode, 6816 sub-carriers in 8k mode and 3408 sub-carrers in 4k mode.
8	Amptd vs. Time (double) [dB] <512/1024/2048> Returns amplitude vs. time data, as a series of comma-separated trace points. The result is a series of floating point numbers. There are 512 time points in 2k mode, 2048 points in 8k mode and 1024 points in 4k mode.
9	TPS Decoding (bit) [NA] <68> Returns the TPS original bits. There are 68 bits in the original TPS bits. For 2k/8k mode, 31 information bits are in use. For 4k mode, 33 information bits are in use. Note that the result is active only when the Decoding key under Meas Setup panel is turned on.
10	MER vs. Time (double) [dB] < 0 ~ Display Points > Returns MER results displayed on MER monitor view during the monitor time, as a series of comma-separated trace points.
11	EVM vs. Sub-carrier (double) [%] <1705/3409/6817> Returns EVM vs. Sub-carrier data, as a series of comma-separated trace points. The result is a series of floating point numbers. There are 1705 sub-carriers in 2k mode, 6817 sub-carriers in 8k mode and 3409 sub-carriers in 4k mode.



## Mod Accuracy Measurement Description

Mod Accuracy Measurement provides the properties and methods for measuring the modulation errors in DVB-T/H. This measurement covers the following results:

- Constellation graphic for configurable sub-carrier ranges
- EVM/MER vs. Subcarrier/Frequency, Magnitude error, Phase error
- Frequency Error, Quadrature Error, Amplitude Imbalance, SNR, Carrier Suppression
- Channel Frequency Response
- Channel Impulse Response
- TPS decoding results
- BER results
- MER monitor results

---

Key Path	Meas
Initial S/W Revision	A.02.00

---

## Amplitude (AMPTD) Y Scale

The AMPTD Y Scale key accesses a menu allowing you to set the desired vertical scale and associated settings. It specifies Amplitude Y Scale settings when MER/EVM vs. Sub-carrier/Frequency window, Spectrum window, Amptd vs. Sub-carrier window, Phase vs. Sub-carrier window, Group Delay vs. Sub-carrier window, Amptd vs. Time window, or MER vs. Time window is active.

Key Path	Front-panel key
Initial S/W Revision	A.02.00

### Ref Value

This key allows you to set the displayed Y reference value. The key is active in MER/EVM vs. Sub-carrier/Frequency Window, Spectrum Window, Amptd vs. Sub-carrier Window, Phase vs. Sub-carrier Window, Group Delay vs. Sub-carrier Window, Amptd vs. Time Window, and MER vs. Time Window.

Key Path	AMPTD Y Scale
Initial S/W Revision	A.02.00

### Y Ref Value (I/Q Error View – MER/EVM vs. Sub-carrier/ Frequency Window)

This key sets the reference value in the MER/EVM vs. Sub-carrier/Frequency window. The displayed value will be updated according to the Scale Type (AMPTD Y Scale, More) as follows:

"Y Ref Value (Scale Type is MER)" on page 1282

"Y Ref Value (Scale Type is EVM)" on page 1283

### Y Ref Value (Scale Type is MER)

If the scale type is set to MER, Y Ref Value is displayed and set in dB.

Key Path	AMPTD Y Scale
Mode	DVB-T/H
Remote Command	:DISPlay:EVM:VIEW2:WINDow[1]:TRACe:Y[:SCALE] [:MER]:RLEVel <real> :DISPlay:EVM:VIEW2:WINDow[1]:TRACe:Y[:SCALE] [:MER]:RLEVel?
Example	DISP:EVM:VIEW2:WIND:TRAC:Y:RLEV 0.0 DISP:EVM:VIEW2:WIND:TRAC:Y:RLEV?
Notes	SCPI Remarks: VIEW2: I/Q Error View WINDow[1]: MER/EVM vs. Sub-carrier/Frequency Window on I/Q Error View
Dependencies	If Auto Scaling is set to On, this value is automatically determined by the measurement result. When you set this value manually, Auto Scaling is automatically set to Off.
Preset	Value is automatically determined by the measurement result with Auto Scaling set to On. Result

	depends on signal source
State Saved	No
Min	-500.0
Max	500.0
Initial S/W Revision	A.02.00
Modified at S/W Revision	A.06.00

### Y Ref Value (Scale Type is EVM)

If the scale type is set to EVM, Y Ref Value is displayed and set in %.

Key Path	AMPTD Y Scale
Mode	DVB-T/H
<b>Remote Command</b>	:DISPlay:EVM:VIEW2:WINDow[1]:TRACe:Y[:SCALe]:EVM:RLEVel <real> :DISPlay:EVM:VIEW2:WINDow[1]:TRACe:Y[:SCALe]:EVM:RLEVel?
<b>Example</b>	DISP:EVM:VIEW2:WIND:TRAC:Y:EVM:RLEV 0.0 DISP:EVM:VIEW2:WIND:TRAC:Y:EVM:RLEV?
Notes	SCPI Remarks: VIEW2: I/Q Error View WINDow[1]: MER/EVM vs. Sub-carrier/Frequency Window on I/Q Error View
Dependencies	If Auto Scaling is set to On, this value is automatically determined by the measurement result. When you set this value manually, Auto Scaling is automatically set to Off.
Preset	Value is automatically determined by the measurement result with Auto Scaling set to On. Result depends on signal source
State Saved	No
Min	0.0
Max	500.0
Initial S/W Revision	A.06.00

### Y Ref Value (I/Q Error View – Spectrum Window)

This key sets the reference value in the Spectrum window.

Key Path	AMPTD Y Scale
Mode	DVB-T/H
<b>Remote Command</b>	:DISPlay:EVM:VIEW2:WINDow2:TRACe:Y[:SCALe]:RLEVel <real> :DISPlay:EVM:VIEW2:WINDow2:TRACe:Y[:SCALe]:RLEVel?
<b>Example</b>	DISP:EVM:VIEW2:WIND2:TRAC:Y:RLEV 0.0 DISP:EVM:VIEW2:WIND2:TRAC:Y:RLEV?

Notes	SCPI Remarks: VIEW2: I/Q Error View WINDow2: Spectrum Window on I/Q Error View
Dependencies	If Auto Scaling is set to On, this value is automatically determined by the measurement result. When you set this value manually, Auto Scaling is automatically set to Off.
Preset	Result depends on signal source
State Saved	No
Min	-150.0
Max	50.0
Initial S/W Revision	A.02.00

### Y Ref Value (Channel Frequency Response View – Amptd vs. Sub-carrier Window)

This key sets the reference value in the Amptd vs. Sub-carrier window.

Key Path	AMPTD Y Scale
Mode	DVB-T/H
<b>Remote Command</b>	:DISPlay:EVM:VIEW3:WINDow[1]:TRACe:Y[:SCALE]:RLEVel <real> :DISPlay:EVM:VIEW3:WINDow[1]:TRACe:Y[:SCALE]:RLEVel?
<b>Example</b>	DISP:EVM:VIEW3:WIND:TRAC:Y:RLEV 0.0 DISP:EVM:VIEW3:WIND:TRAC:Y:RLEV?
Notes	SCPI Remarks: VIEW3: Channel Frequency Response View WINDow[1]: Amptd vs. Sub-carrier Window
Dependencies	If Auto Scaling is set to On, this value is automatically determined by the measurement result. When you set this value manually, Auto Scaling is automatically set to Off.
Preset	Result depends on signal source
State Saved	No
Min	-100.0
Max	100.0
Initial S/W Revision	A.02.00

### Y Ref Value (Channel Frequency Response View – Phase vs. Sub-carrier Window)

This key sets the reference value in the Phase vs. Sub-carrier window.

Key Path	AMPTD Y Scale
Mode	DVB-T/H
<b>Remote Command</b>	:DISPlay:EVM:VIEW3:WINDow2:TRACe:Y[:SCALE]:RLEVel <real>

	:DISPlay:EVM:VIEW3:WINDow2:TRACe:Y[:SCALe]:RLEVel?
<b>Example</b>	DISP:EVM:VIEW3:WIND2:TRAC:Y:RLEV 0.0 DISP:EVM:VIEW3:WIND2:TRAC:Y:RLEV?
Notes	SCPI Remarks: VIEW3: Channel Frequency Response View WINDow2: Phase vs. Sub-carrier Window
Dependencies	If Auto Scaling is set to On, this value is automatically determined by the measurement result. When you set this value manually, Auto Scaling is automatically set to Off.
Preset	Result depends on signal source
State Saved	No
Min	-180.0
Max	180.0
Initial S/W Revision	A.02.00

### Y Ref Value (Channel Frequency Response View – Group Delay vs. Sub-carrier Window)

This key sets the reference value in the Group Delay vs. Sub-carrier window.

Key Path	AMPTD Y Scale
Mode	DVB-T/H
<b>Remote Command</b>	:DISPlay:EVM:VIEW3:WINDow3:TRACe:Y[:SCALe]:RLEVel <real> :DISPlay:EVM:VIEW3:WINDow3:TRACe:Y[:SCALe]:RLEVel?
<b>Example</b>	DISP:EVM:VIEW3:WIND3:TRAC:Y:RLEV 0.0 DISP:EVM:VIEW3:WIND3:TRAC:Y:RLEV?
Notes	SCPI Remarks: VIEW3: Channel Frequency Response View WINDow3: Group Delay vs. Sub-carrier Window
Dependencies	If Auto Scaling is set to On, this value is automatically determined by the measurement result. When you set this value manually, Auto Scaling is automatically set to Off.
Preset	Result depends on signal source
State Saved	No
Min	-5.0e6
Max	5.0e6
Initial S/W Revision	A.02.00

### Y Ref Value (Channel Impulse Response View – Amptd vs. Time Window)

This key sets the reference value in the Amptd vs. Time window.

Key Path	AMPTD Y Scale
Mode	DVB-T/H
<b>Remote Command</b>	:DISPlay:EVM:VIEW4:WINDow[1]:TRACe:Y[:SCALE]:RLEVel <real> :DISPlay:EVM:VIEW4:WINDow[1]:TRACe:Y[:SCALE]:RLEVel?
<b>Example</b>	DISP:EVM:VIEW4:WIND:TRAC:Y:RLEV 0.0 DISP:EVM:VIEW4:WIND:TRAC:Y:RLEV?
Notes	SCPI Remarks: VIEW4: Channel Impulse Response View WINDow[1]: Amptd vs. Time Window
Dependencies	If Auto Scaling is set to On, this value is automatically determined by the measurement result. When you set this value manually, Auto Scaling is automatically set to Off.
Preset	Result depends on signal source
State Saved	No
Min	-500.0
Max	100.0
Initial S/W Revision	A.02.00

### Y Ref Value (MER Monitor View – MER vs. Time Window)

This key sets the reference value in the MER vs. Time window.

Key Path	AMPTD Y Scale
Mode	DVB-T/H
<b>Remote Command</b>	:DISPlay:EVM:VIEW5:WINDow[1]:TRACe:Y[:SCALE]:RLEVel <real> :DISPlay:EVM:VIEW5:WINDow[1]:TRACe:Y[:SCALE]:RLEVel?
<b>Example</b>	DISP:EVM:VIEW5:WIND:TRAC:Y:RLEV 0.0 DISP:EVM:VIEW5:WIND:TRAC:Y:RLEV?
Notes	SCPI Remarks: VIEW5:MER Monitor View WINDow[1]: MER vs. Time Window
Dependencies	If Auto Scaling is set to On, this value is automatically determined by the measurement result. When you set this value manually, Auto Scaling is automatically set to Off.
Preset	60
State Saved	No
Min	-200.0
Max	100.0
Initial S/W Revision	A.06.00

## Attenuation

This menu controls the attenuator functions and interactions between the attenuation system components.

There are two attenuator configurations in the X-Series. One is a dual attenuator configuration consisting of a mechanical attenuator and an optional electronic attenuator. The other configuration uses a single attenuator with combined mechanical and electronic sections that controls all the attenuation functions. Different models in the X-Series come with different configurations.

See ["Dual Attenuator Configurations:" on page 1287](#)

See ["Single Attenuator Configuration:" on page 1288](#)

Most Attenuation settings are the same for all measurements – they do not change as you change measurements. Settings like these are called “Meas Global” and are unaffected by Meas Preset.

Key Path	AMPTD Y Scale
Scope	Meas Global
Dependencies	In measurements that support the I/Q inputs, this key is unavailable when I/Q is the selected input, and is replaced by the Range key in that case.
Readback Line	Contains a summary in [ ] brackets of the current total attenuation. See the descriptions of the , " <a href="#">(Mech) Atten</a> " on page 2102, and " <a href="#">Enable Elec Atten</a> " on page 2104 keys for more detail on the contributors to the total attenuation.  Note that when "Pre-Adjust for Min Clip" is on, this value can change at the start of every measurement.
Initial S/W Revision	Prior to A.02.00
Modified at S/W Revision	A.03.00

### Dual Attenuator Configurations:

Configuration 1: Mechanical attenuator + optional electronic attenuator

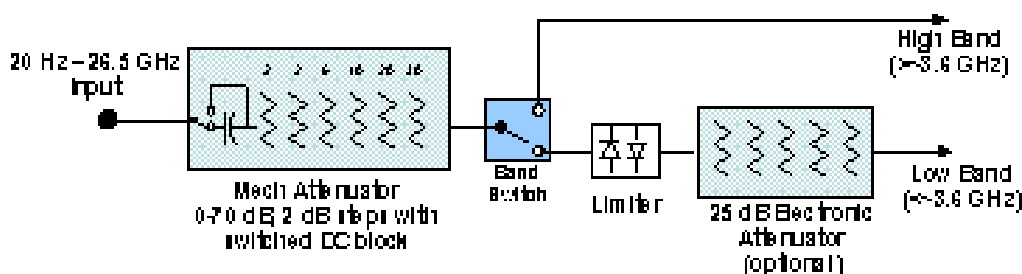

Configuration 2: Mechanical attenuator, no optional electronic attenuator

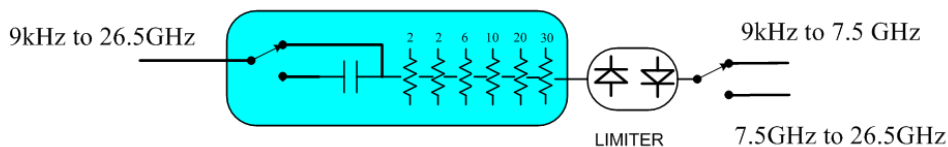

(note that Configuration 2 is not strictly speaking a dual-section attenuator, since there is no electronic section available. However, it behaves exactly like Configuration 1 without the Electronic Attenuator option EA3, therefore for the sake of this document it is grouped into the “Dual Attenuator” configuration)

### Single Attenuator Configuration:

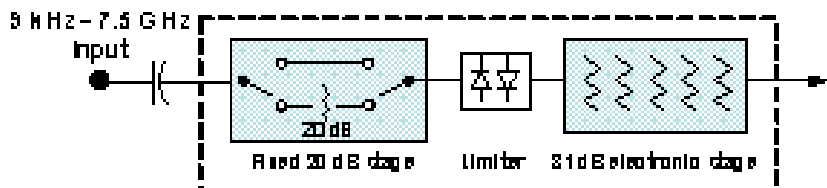

You can tell which attenuator configuration you have by pressing the Attenuation key, which (in most Modes) opens the Attenuation menu. If the first key in the Attenuation menu says Mech Atten you have the dual attenuator configuration. If the first key says Atten you have the single attenuator configuration.

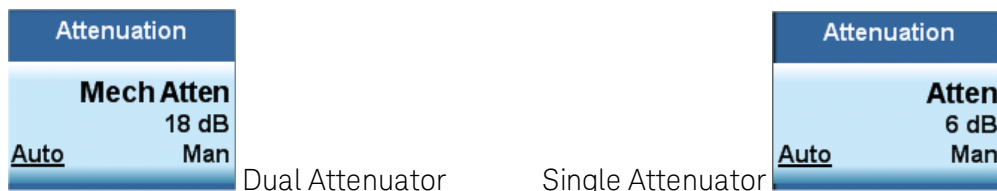

In the single attenuator configuration, you control the attenuation with a single control, as the fixed stage has only two states. In the dual attenuator configuration, both stages have significant range so you are given separate control of the mechanical and electronic attenuator stages.

When you have the dual attenuator configuration, you may still have only a single attenuator, because unless option EA3 (the Electronic Attenuator option) is available, and you purchase it, you will have only the mechanical attenuator.

### (Mech) Atten

This key is labeled Mech Atten in dual attenuator models and Atten in single attenuator models. In the dual attenuator configuration, this key only affects the mechanical attenuator.

This key lets you modify the attenuation applied to the RF input signal path. This value is normally auto coupled to the Ref Level, the Internal Preamp Gain, any External Gain that is entered, and the Max Mixer Level, as described in the table below.

See "[Attenuator Configurations and Auto/Man](#)" on page 1290

Key Path	AMPTD Y Scale, Attenuation
Remote Command	[ :SENSe ] :POWer [ :RF ] :ATTenuation <rel_amp1>



	<pre>[ :SENSe ] :POWer [ :RF ] :ATTenuation? [ :SENSe ] :POWer [ :RF ] :ATTenuation:AUTO OFF ON 0 1 [ :SENSe ] :POWer [ :RF ] :ATTenuation:AUTO?</pre>
<b>Example</b>	<p>POW:ATT 20</p> <p>Dual attenuator configuration: sets the mechanical attenuator to 20 dB</p> <p>Single attenuator mode: sets the main attenuation to 20 dB (see below for definition of “main” attenuation).</p> <p>If the attenuator was in Auto, it sets it to Manual.</p>
<b>Dependencies</b>	<p>Some measurements do not support the Auto setting of (Mech) Atten. In these measurements, the Auto/Man selection is not available, and the Auto/Man line on the key disappears.</p> <p>In dual attenuator configurations, when the electronic attenuator is enabled, the mechanical attenuator has no auto setting and the Auto/Man line on the key disappears. The state of Auto/Man is remembered and restored when the electronic attenuator is once again disabled. This is described in more detail in the <a href="#">"Enable Elec Atten" on page 2104</a> key description.</p> <p>See <a href="#">"Attenuator Configurations and Auto/Man" on page 1290</a> for more information on the Auto/Man functionality of Attenuation.</p>
<b>Couplings</b>	<p>When (Mech) Atten is in Auto, it uses the following algorithm to determine a value:</p> <p>If the USB Preamp is connected to USB, use 0 dB.</p> <p>Otherwise, <math>Atten = ReferenceLevel + PreAmpGain + ExternalGain - RefLevelOffset - MaxMixerLevel + IF\ Gain</math>.</p> <p>Limit this value to be between 6 dB and the Max value. No value below 6 dB can ever be chosen by Auto.</p> <p>The resulting value is rounded up to the largest value possible given the attenuation step setting. That is, 50.01 dB would change to 60 dB (for a 10 dB attenuation step).</p> <p>The “IF Gain” term in the equation above is either 0 dB or +10 dB, depending on the settings of FFT IF Gain, Swept IF Gain, max Ref Level and the Auto/Man setting of Mech Atten.</p> <p>In External Mixing and BBIQ, where the Attenuator is not in the signal path, the Attenuator setting changes as described above when (Mech) Atten is in Auto, but no changes are made to the actual attenuator hardware setting until the input is changed back to the RF Input.</p>
<b>Preset</b>	<p>The preset for Mech Attenuation is “Auto.”</p> <p>The Auto value of attenuation is:</p> <p>CXA, EXA, MXA and PXA: 10 dB</p>
<b>State Saved</b>	<p>Saved in instrument state</p>
<b>Min</b>	<p>0 dB</p> <p>The attenuation set by this key cannot be decreased below 6 dB with the knob or step keys. To get to a value below 6 dB it has to be directly entered from the keypad or via SCPI. This protects from adjusting the attenuation to a dangerously small value which can put the instrument at risk of damage to input circuitry. However, if the current mechanical attenuation is below 6 dB it can be increased with the knob and step keys, but not decreased.</p>
<b>Max</b>	<p>CXA N9000A–503/507: 50 dB</p> <p>CXA N9000A–513/526: 70dB</p>

	EXA: 60 dB MXA and PXA: 70 dB In the single attenuator configuration, the total of ATT and EATT cannot exceed 50 dB, so if the EATT is set to 24 dB first, the main attenuation cannot be greater than 26 dB and will be reduced accordingly; if the main attenuator is set to 40 dB first, EATT cannot be greater than 10 dB.
Initial S/W Revision	Prior to A.02.00
Modified at S/W Revision	A.03.00

### Attenuator Configurations and Auto/Man

As described in the Attenuation key description, there are two distinct attenuator configurations available in the X-Series, the single attenuator and dual attenuator configurations. In dual attenuator configurations, we have the mechanical attenuation and the electronic attenuation, and the current total attenuation is the sum of the electronic + mechanical attenuation. In single attenuator configurations, we refer to the attenuation set using the (Mech) Atten key (or POW:ATT SCPI) as the “main” attenuation; and the attenuation that is set by the SCPI command POW:EATT as the “soft” attenuation (the POW:EATT command is honored even in the single attenuator configuration, for compatibility purposes). Then the current total attenuation is the sum of the main + soft attenuation. See the Elec Atten key description for more on “soft” attenuation.

In the dual attenuator configuration, when the electronic attenuator is enabled, there is no Auto/Man functionality for the mechanical attenuator, and the third line of the key label (the Auto/Man line) disappears:

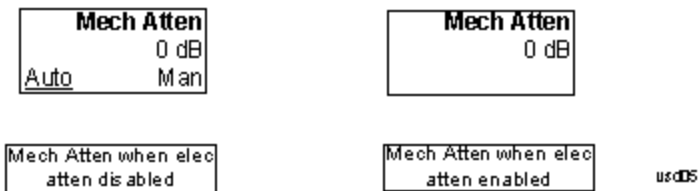

### Enable Elec Atten

Enables the Electronic Attenuator.

The electronic attenuator offers finer steps than the mechanical attenuator, has no acoustical noise, is faster, and is less subject to wear. These advantages primarily aid in remote operation and are negligible for front panel use. See ["Using the Electronic Attenuator: Pros and Cons" on page 1292](#) for a detailed discussion of the pros and cons of using the electronic attenuator.

For the single attenuator configuration, for SCPI backwards compatibility, the “soft” attenuation feature replaces the dual attenuator configuration’s electronic attenuator. All the same couplings and limitations apply. See ["Attenuator Configurations and Auto/Man" on page 2103](#)

See ["More Information" on page 1291](#)

Key Path	AMPTD Y Scale, Attenuation
Remote Command	[ :SENSe ] :POWer [ :RF ] :EATTenuation:STATe OFF ON 0 1

[:SENSe]:POWer[:RF]:EATTenuation:STATe?	
<b>Example</b>	POW:EATT:STAT ON
<b>Dependencies</b>	<p>This key only appears in Dual Attenuator models with an Electronic Attenuator installed. It does not appear in models with the Single Attenuator configuration, as in the single attenuator configuration there is no “electronic attenuator” there is only a single integrated attenuator (which has both a mechanical and electronic stage). However, in the single attenuator configuration, EATT SCPI commands are accepted for compatibility with other X-series instruments and set a “soft” attenuation as described in <a href="#">"Attenuator Configurations and Auto/Man" on page 2103</a>.</p> <p>The electronic attenuator (and the “soft” attenuation function provided in single attenuator configurations) is unavailable above 3.6 GHz. Therefore, if the Stop Frequency of the analyzer is &gt; 3.6 GHz then the Enable Elec Atten key will be OFF and grayed out.</p> <p>If the Internal Preamp is on, meaning it is set to Low Band or Full, the electronic attenuator (and the “soft” attenuation function provided in single attenuator configurations) is unavailable. In this case the Enable Elec Atten key will be OFF and grayed out.</p> <p>If either of the above is true, if the SCPI command is sent, an error indicating that the electronic attenuator is unavailable will be sent.</p> <p>If the electronic/soft Attenuator is enabled, then the Stop Freq of the analyzer is limited to 3.6 GHz and the Internal Preamp is unavailable.</p> <p>The SCPI-only “soft” electronic attenuation for the single-attenuator configuration is not available in all measurements; in particular, it is not available in the Swept SA measurement.</p>
<b>Couplings</b>	Enabling and disabling the Electronic Attenuator affects the setting of the Mechanical Attenuator (in dual attenuator configurations). This is described in more detail below this table.
<b>Preset</b>	OFF for Swept SA measurement; ON for all other measurements that support the electronic attenuator
<b>State Saved</b>	Saved in instrument state
<b>Initial S/W Revision</b>	Prior to A.02.00
<b>Modified at S/W Revision</b>	A.03.00

## More Information

### Mechanical Attenuator Transition Rules

When the Electronic Attenuator is enabled, the Mechanical Attenuator transitions to a state that has no Auto function. Below are the rules for transitioning the Mechanical Attenuator. NOTE that the information below ONLY applies to the dual attenuator configurations, and ONLY when the Electronic Attenuator is installed:

#### When the Electronic Attenuation is enabled from a disabled state:

- The Mechanical Attenuator is initialized to 10 dB (this is its optimal performance setting). You can then set it as desired with SCPI, numeric keypad, step keys, or knob, and it behaves as it normally would in manual mode
- The Auto/Man state of (Mech) Atten is saved
- The Auto/Man line on the (Mech) Atten key disappears and the auto rules are disabled

- The Electronic Attenuator is set to 10 dB less than the previous value of the Mechanical Attenuator, within the limitation that it must stay within the range of 0 to 24 dB of attenuation.

#### Examples in the dual attenuator configuration:

- Mech Atten at 20 dB. Elec Atten enabled, Mech Atten set to 10 dB, and Elec Atten set to 10 dB. New total attenuation equals the value before Elec Atten enabled.
- Mech Atten at 0 dB. Elec Atten enabled, Mech Atten set to 10 dB, and Elec Atten set to 0 dB. New total attenuation does not equal the value before Elec Atten enabled.
- Mech Atten at 40 dB. Elec Atten enabled, Mech Atten set to 10 dB, and Elec Atten set to 24 dB. New total attenuation does not equal the value before Elec Atten enabled.

#### When the Electronic Attenuation is disabled from an enabled state:

- The Elec Atten key is grayed out
- The Auto/Man state of (Mech) Atten is restored
- If now in Auto, (Mech) Atten recouples
- If now in Man, (Mech) Atten is set to the value of total attenuation that existed before the Elec Atten was disabled. The resulting value is rounded up to the smallest value possible given the (Mech) Atten Step setting - (That is, 57 dB changes to 58 dB when (Mech) Atten Step is 2 dB.)

#### Using the Electronic Attenuator: Pros and Cons

The electronic attenuator offers finer steps than the mechanical attenuator, has no acoustical noise, is faster, and is less subject to wear.

The “finer steps” advantage of the electronic attenuator is beneficial in optimizing the alignment of the analyzer dynamic range to the signal power in the front panel as well as remote use. Thus, you can achieve improved relative signal measurement accuracy. Compared to a mechanical attenuator with 2 dB steps, the 1 dB resolution of the electronic attenuator only gives better resolution when the odd-decibel steps are used. Those odd-decibel steps are less accurately calibrated than the even-decibel steps, so one tradeoff for this superior relative accuracy is reduced absolute amplitude accuracy.

Another disadvantage of the electronic attenuator is that the spectrum analyzer loses its “Auto” setting, making operation less convenient.

Also, the relationship between the dynamic range specifications (TOI, SHI, compression and noise) and instrument performance are less well-known with the electrical attenuator. With the mechanical attenuator, TOI, SHI and compression threshold levels increase dB-for-dB with increasing attenuation, and the noise floor does as well. With the electronic attenuator, there is an excess attenuation of about 1 to 3 dB between 0 and 3.6 GHz, making the effective TOI, SHI, and so forth, less well known. Excess attenuation is the actual attenuation relative to stated attenuation. Excess attenuation is accounted for in the analyzer calibration

#### Elec Atten

Controls the Electronic Attenuator in dual attenuator configurations. This key does not appear in single attenuator configurations, as the control of both the mechanical and electronic stages of the single attenuator is integrated into the single Atten key.

Key Path	AMPTD Y Scale, Attenuation
Remote Command	[ :SENSe ] :POWer [ :RF ] :EATTenuation <rel_ampl> [ :SENSe ] :POWer [ :RF ] :EATTenuation?
Notes	Electronic Attenuation's specification is defined only when Mechanical Attenuation is 6 dB.
Dependencies	This key only appears in Dual Attenuator models with an Electronic Attenuator installed. It does not appear in models with the Single Attenuator configuration, as in the single attenuator configuration there is no "electronic attenuator" there is only a single integrated attenuator (which has both a mechanical and electronic stage). However, in the single attenuator configuration, EATT SCPI commands are accepted for compatibility with other X-series instruments and set a "soft" attenuation as described in <a href="#">"Attenuator Configurations and Auto/Man" on page 2103</a> . The "soft" attenuation is treated as an addition to the "main" attenuation value set by the Atten softkey or the POW:ATT SCPI command and affects the total attenuation displayed on the Attenuation key and the Meas Bar.  When Enable Elec Atten is off or grayed out, the Elec Atten key is grayed out.
Preset	0 dB
State Saved	Saved in instrument state
Min	0 dB
Max	Dual attenuator configuration: 24 dB  Single attenuator configuration: the total of ATT and EATT cannot exceed 50 dB, so if the EATT is set to 24 dB first, the main attenuation cannot be greater than 26 dB and will be reduced accordingly; if the main attenuator is set to 40 dB first, EATT cannot be greater than 10 dB
Initial S/W Revision	Prior to A.02.00
Modified at S/W Revision	A.03.00

## Adjust Atten for Min Clip

Sets the combination of mechanical and electronic attenuation and gain based on the current measured signal level so that clipping will be at a minimum.

This is an "immediate action" function, that is, it executes once, when the key is pressed.

This key is grayed out in measurements that do not support this functionality. The spectrum analyzer measurement, Swept SA, does not support this functionality.

Key Path	AMPTD Y Scale, Attenuation
Remote Command	[ :SENSe ] :POWer [ :RF ] :RANGe:OPTimize IMMEDIATE
Initial S/W Revision	Prior to A.02.00
Modified at S/W Revision	A.03.00

## Pre-Adjust for Min Clip

If this function is on, it does the adjustment described under ["Adjust Atten for Min Clip" on page 2107](#) each time a measurement restarts. Therefore, in Continuous measurement mode, it only executes before the

first measurement.

In dual attenuator models, you can set Elec+Mech Atten, in which case both attenuators participate in the autoranging, or Elec Atten Only, in which case the mechanical attenuator does not participate in the autoranging. This latter case results in less wear on the mechanical attenuator and is usually faster.

This key is grayed out in measurements that do not support this functionality. The spectrum analyzer measurement, Swept SA, does not support this functionality.

<b>Key Path</b>	AMPTD Y Scale, Attenuation
<b>Remote Command</b>	<code>[ :SENSe ] :POWeR [ :RF ] :RANGe:OPTimize:ATTenuation OFF   ELECtrical   COMBined</code>  <code>[ :SENSe ] :POWeR [ :RF ] :RANGe:OPTimize:ATTenuation?</code>
<b>Notes</b>	The SCPI parameter ELECtrical sets this function to On in single attenuator models. The SCPI parameter COMBined is mapped to ELECtrical in single attenuator models; if you send COMBined, it sets the function to On and returns ELEC to a query.
<b>Dependencies</b>	This key only appears in Dual Attenuator models with an Electronic Attenuator installed. In instruments with Dual Attenuator model, when Enable Elec Atten is off or grayed out, the Pre-Adjust for Min Clip key is grayed out.
<b>Preset</b>	OFF for Swept SA measurement; ON for all other measurements that support Pre-Adjust for Min Clip
<b>State Saved</b>	Saved in instrument state
<b>Range</b>	Dual attenuator models: Off   Elec Atten Only   Mech + Elec Atten Single attenuator models: Off   On
<b>Initial S/W Revision</b>	Prior to A.02.00
<b>Modified at S/W Revision</b>	A.03.00

<b>Remote Command</b>	<code>[ :SENSe ] :POWeR [ :RF ] :RANGe:AUTO ON OFF 1 0</code>  <code>[ :SENSe ] :POWeR [ :RF ] :RANGe:AUTO?</code>
<b>Notes</b>	ON aliases to "Elec Atten Only" (:POW:RANG:OPT:ATT ELEC) OFF aliases to "Off" (:POW:RANG:OPT:ATT OFF) The query :POW:RANG:AUTO? returns true if :POW:RANG:OPT:ATT is not "Off"
<b>Initial S/W Revision</b>	Prior to A.02.00

## Off

Turns Pre-Adjust for Min Clip off. This is the default setting.

This key is grayed out in measurements that do not support this functionality. The spectrum analyzer measurement, Swept SA, does not support this functionality.

Key Path	AMPTD Y Scale, Attenuation, Pre-Adjust for Min Clip
Example	:POW:RANGe:OPT:ATT OFF
Initial S/W Revision	Prior to A.02.00

### Elec Atten Only

Selects only the electric attenuator to participate in auto ranging. This offers less wear on the mechanical attenuator and is usually faster.

This key is grayed out in measurements that do not support this functionality. The spectrum analyzer measurement, Swept SA, does not support this functionality.

Key Path	AMPTD Y Scale, Attenuation, Pre-Adjust for Min Clip
Example	:POW:RANGe:OPT:ATT ELEC
Initial S/W Revision	Prior to A.02.00

### Mech + Elec Atten

In dual attenuator models, this selects both attenuators participate in the autoranging.

This key is grayed out in measurements that do not support this functionality. The spectrum analyzer measurement, Swept SA, does not support this functionality.

Key Path	AMPTD Y Scale, Attenuation, Pre-Adjust for Min Clip
Example	:POW:RANGe:OPT:ATT COMB
Initial S/W Revision	Prior to A.02.00

### (Mech) Atten Step

This controls the step size used when making adjustments to the input attenuation.

This key is labeled Mech Atten Step in dual attenuator models and Atten Step in single attenuator models. In the dual attenuator configuration, this key only affects the step size of the mechanical attenuator.

Key Path	AMPTD Y Scale, Attenuation
<b>Remote Command</b>	[ :SENSe ] :POWer [ :RF ] :ATTenuation:STEP [ :INCRement ] 10 dB   2 dB [ :SENSe ] :POWer [ :RF ] :ATTenuation:STEP [ :INCRement ] ?
<b>Example</b>	POW:ATT:STEP 2
Notes	Note this feature works like a 1-N choice from the front panel, but it takes a specific value (in dB) when used remotely. The only valid values are 2 and 10.
Dependencies	Blanked in CXA and EXA if option FSA (2 dB steps) is not present. If blanked, attempts to set it via SCPI will yield an error.

Couplings	When the attenuation step size changes, the current mechanical attenuation value is adjusted (if necessary) to be quantized to the new step size. That is, if step is set to 10 dB, mech atten is increased if necessary so it is a multiple of 10 dB
Preset	PXA and MXA: 2 dB EXA and CXA: 10 dB (2 dB with option FSA)
State Saved	Saved in instrument state
Initial S/W Revision	Prior to A.02.00
Modified at S/W Revision	A.03.00

## Scale/Div

This key allows you to set Y Scale/Div. The key is active in MER/EVM vs. Sub-carrier/Frequency Window, Spectrum Window, Amptd vs. Sub-carrier Window, Phase vs. Sub-carrier Window, Group Delay vs. Sub-carrier Window, Amptd vs. Time Window, and MER vs. Time Window.

Key Path	AMPTD Y Scale
Initial S/W Revision	A.02.00

## Y Scale/Div (I/Q Error View – MER/EVM vs. Sub-carrier/ Frequency Window)

This key sets the sensitivity of the measurement result in the MER/EVM vs. Sub-carrier/Freq window. The displayed value will be updated according to the Scale Type (AMPTD Y Scale, More) as follows:

"Y Scale/Div (Scale Type is MER)" on page 1296

"Y Scale/Div (Scale Type is EVM)" on page 1297

## Y Scale/Div (Scale Type is MER)

If the scale type is set to MER, Y Scale/Div is displayed and set in dB.

Key Path	AMPTD Y Scale
Mode	DVB-T/H
Remote Command	:DISPlay:EVM:VIEW2:WINDow[1]:TRACe:Y[:SCALE][:MER]:PDIVision <real> :DISPlay:EVM:VIEW2:WINDow[1]:TRACe:Y[:SCALE][:MER]:PDIVision?
Example	DISP:EVM:VIEW2:WIND:TRAC:Y:PDIV 10.0 DISP:EVM:VIEW2:WIND:TRAC:Y:PDIV?
Notes	SCPI Remarks: VIEW2: I/Q Error View WINDow[1]: MER/EVM vs. Sub-carrier/Frequency Window on I/Q Error View
Dependencies	If Auto Scaling is set to On, this value is automatically determined by the measurement result. When you set this value manually, Auto Scaling is automatically set to Off.



Preset	Value is automatically determined by the measurement result with Auto Scaling set to On. Result depends on signal source
State Saved	No
Min	0.1
Max	40.0
Initial S/W Revision	A.02.00
Modified at S/W Revision	A.06.00

### Y Scale/Div (Scale Type is EVM)

If the scale type is set to EVM, Y Scale/Div is displayed and set in %.

Key Path	AMPTD Y Scale
Mode	DVB-T/H
<b>Remote Command</b>	:DISPlay:EVM:VIEW2:WINDow[1]:TRACe:Y[:SCALe]:EVM:PDIVision <real> :DISPlay:EVM:VIEW2:WINDow[1]:TRACe:Y[:SCALe]:EVM:PDIVision?
<b>Example</b>	DISP:EVM:VIEW2:WIND:TRAC:Y:EVM:PDIV 10.0 DISP:EVM:VIEW2:WIND:TRAC:Y:EVM:PDIV?
Notes	SCPI Remarks: VIEW2: I/Q Error View WINDow[1]: MER/EVM vs. Sub-carrier/Frequency Window on I/Q Error View
Dependencies	If Auto Scaling is set to On, this value is automatically determined by the measurement result. When you set this value manually, Auto Scaling is automatically set to Off.
Preset	Value is automatically determined by the measurement result with Auto Scaling set to On. Result depends on signal source
State Saved	No
Min	0.01
Max	50.0
Initial S/W Revision	A.06.00

### Y Scale/Div (I/Q Error View – Spectrum Window)

This key sets the sensitivity of the measurement result in the Spectrum window.

Key Path	AMPTD Y Scale
Mode	DVB-T/H
<b>Remote Command</b>	:DISPlay:EVM:VIEW2:WINDow2:TRACe:Y[:SCALe]:PDIVision <real> :DISPlay:EVM:VIEW2:WINDow2:TRACe:Y[:SCALe]:PDIVision?
<b>Example</b>	DISP:EVM:VIEW2:WIND2:TRAC:Y:PDIV 10.0

	DISP:EVM:VIEW2:WIND2:TRAC:Y:PDIV?
Notes	SCPI Remarks: VIEW2: I/Q Error View WINDow2: Spectrum Window on I/Q Error View
Dependencies	If Auto Scaling is set to On, this value is automatically determined by the measurement result. When you set this value manually, Auto Scaling is automatically set to Off.
Preset	Result depends on signal source
State Saved	No
Min	0.1
Max	40.0
Initial S/W Revision	A.02.00

### Y Scale/Div (Channel Frequency Response View – Amptd vs. Sub-carrier Window)

This key sets the sensitivity of the measurement result in the Amptd vs. Sub-carrier window.

Key Path	AMPTD Y Scale
Mode	DVB-T/H
Remote Command	:DISPlay:EVM:VIEW3:WINDow[1]:TRACe:Y[:SCALE]:PDIVision <real> :DISPlay:EVM:VIEW3:WINDow[1]:TRACe:Y[:SCALE]:PDIVision?
Example	DISP:EVM:VIEW3:WIND:TRAC:Y:PDIV 10.0 DISP:EVM:VIEW3:WIND:TRAC:Y:PDIV?
Notes	SCPI Remarks: VIEW2: Channel Frequency Response View WINDow[1]: Amptd vs. Sub-carrier Window
Dependencies	If Auto Scaling is set to On, this value is automatically determined by the measurement result. When you set this value manually, Auto Scaling is automatically set to Off.
Preset	Result depends on signal source
State Saved	No
Min	0.1
Max	40.0
Initial S/W Revision	A.02.00

### Y Scale/Div (Channel Frequency Response View – Phase vs. Sub-carrier Window)

This key sets the sensitivity of the measurement result in the Phase vs. Sub-carrier window.

Key Path	AMPTD Y Scale
----------	---------------

Mode	DVB-T/H
<b>Remote Command</b>	:DISPlay:EVM:VIEW3:WINDow2:TRACe:Y[:SCALe]:PDIVision <real> :DISPlay:EVM:VIEW3:WINDow2:TRACe:Y[:SCALe]:PDIVision?
<b>Example</b>	DISP:EVM:VIEW3:WIND2:TRAC:Y:PDIV 36.0 DISP:EVM:VIEW3:WIND2:TRAC:Y:PDIV?
Notes	SCPI Remarks: VIEW3: Channel Frequency Response View WINDow2: Phase vs. Sub-carrier Window
Dependencies	If Auto Scaling is set to On, this value is automatically determined by the measurement result. When you set this value manually, Auto Scaling is automatically set to Off.
Preset	Result depends on signal source
State Saved	No
Min	0.001
Max	50.0
Initial S/W Revision	A.02.00

### Y Scale/Div (Channel Frequency Response View – Group Delay vs. Sub-carrier Window)

This key sets the sensitivity of the measurement result in the Group Delay vs. Sub-carrier window.

Key Path	AMPTD Y Scale
Mode	DVB-T/H
<b>Remote Command</b>	:DISPlay:EVM:VIEW3:WINDow3:TRACe:Y[:SCALe]:PDIVision <real> :DISPlay:EVM:VIEW3:WINDow3:TRACe:Y[:SCALe]:PDIVision?
<b>Example</b>	DISP:EVM:VIEW3:WIND3:TRAC:Y:PDIV 1.0 DISP:EVM:VIEW3:WIND3:TRAC:Y:PDIV?
Notes	SCPI Remarks: VIEW3: Channel Frequency Response View WINDow3: Group Delay vs. Sub-carrier Window
Dependencies	If Auto Scaling is set to On, this value is automatically determined by the measurement result. When you set this value manually, Auto Scaling is automatically set to Off.
Preset	Result depends on signal source
State Saved	No
Min	0.01
Max	1.0e6
Initial S/W Revision	A.02.00

### Y Scale/Div (Channel Impulse Response View – Amptd vs. Time Window)

This key sets the sensitivity of the measurement result in the Amptd vs. Time window.

Key Path	AMPTD Y Scale
Mode	DVB-T/H
Remote Command	:DISPlay:EVM:VIEW4:WINDow[1]:TRACe:Y[:SCALE]:PDIVision <real> :DISPlay:EVM:VIEW4:WINDow[1]:TRACe:Y[:SCALE]:PDIVision?
Example	DISP:EVM:VIEW4:WIND:TRAC:Y:PDIV 10.0 DISP:EVM:VIEW4:WIND:TRAC:Y:PDIV?
Notes	SCPI Remarks: VIEW4: Channel Impulse Response View WINDow[1]: Amptd vs. Time Window
Dependencies	If Auto Scaling is set to On, this value is automatically determined by the measurement result. When you set this value manually, Auto Scaling is automatically set to Off.
Preset	Result depends on signal source
State Saved	No
Min	0.1
Max	40.0
Initial S/W Revision	A.02.00

### Y Scale/Div (MER Monitor View – MER vs. Time Window)

This key sets the sensitivity of the measurement result in the MER vs. Time window.

Key Path	AMPTD Y Scale
Mode	DVB-T/H
Remote Command	:DISPlay:EVM:VIEW5:WINDow[1]:TRACe:Y[:SCALE]:PDIVision <real> :DISPlay:EVM:VIEW5:WINDow[1]:TRACe:Y[:SCALE]:PDIVision?
Example	DISP:EVM:VIEW5:WIND:TRAC:Y:PDIV 10.0 DISP:EVM:VIEW5:WIND:TRAC:Y:PDIV?
Notes	SCPI Remarks: VIEW5: MER Monitor View WINDow[1]: MER vs. Time Window
Dependencies	If Auto Scaling is set to On, this value is automatically determined by the measurement result. When you set this value manually, Auto Scaling is automatically set to Off.
Preset	5
State Saved	No
Min	0.1
Max	40.0
Initial S/W Revision	A.06.00

## Presel Center

When this key is pressed, the centering of the preselector filter is adjusted to optimize the amplitude accuracy at the frequency of the selected marker. If the selected marker is not on when Presel Center is pressed, the analyzer will turn on the selected marker, perform a peak search, and then perform centering on the marker's center frequency. If the selected marker is already on and between the start and stop frequencies of the analyzer, the analyzer performs the preselector calibration on that marker's frequency. If the selected marker is already on, but outside the frequency range between Start Freq and Stop Freq, the analyzer will first perform a peak search, and then perform centering on the marker's center frequency.

The value displayed on the Presel Adjust key will change to reflect the new preselector tuning (see Presel Adjust).

A number of considerations should be observed to ensure proper operation. See "[Proper Preselector Operation](#)" on page 1302.

Key Path	AMPTD Y Scale
Remote Command	[ :SENSe ] :POWer [ :RF ] :PCENter
Example	POW:PCEN
Notes	Note that the rules outlined above under the key description apply for the remote command as well as the key. The result of the command is dependent on marker position, and so forth. Any message shown by the key press is also shown in response to the remote command.
Dependencies	<ul style="list-style-type: none"> <li>• Grayed out if the microwave preselector is off. )</li> <li>• If the selected marker's frequency is below Band 1, advisory message 0.5001 is generated and no action is taken.</li> <li>• Grayed out if entirely in Band 0.</li> <li>• Blank in models that do not include a preselector, such as option 503. If the SCPI is sent in these instruments, it is accepted without error, and the query always returns 0.</li> <li>• Grayed out in the Spectrogram View.</li> </ul>
Couplings	<p>The active marker position determines where the centering will be attempted.</p> <p>If the analyzer is in a measurement such as averaging when centering is initiated, the act of centering the preselector will restart averaging but the first average trace will not be taken until the centering is completed.</p>
Status Bits/OPC dependencies	<p>When centering the preselector, *OPC will not return true until the process is complete and a subsequent measurement has completed, nor will results be returned to a READ or MEASure command.</p> <p>The Measuring bit should remain set while this command is operating and should not go false until the subsequent sweep/measurement has completed.</p>
Initial S/W Revision	Prior to A.02.00
Modified at S/W Revision	A.03.00

## Proper Preselector Operation

A number of considerations should be observed to ensure proper operation:

1. If the selected marker is off, the analyzer will turn on a marker, perform a peak search, and adjust the preselector using the selected marker's frequency. It uses the "highest peak" peak search method unqualified by threshold or excursion, so that there is no chance of a 'no peak found' error. It continues with that peak, even if it is the peak of just noise. Therefore, for this operation to work properly, there should be a signal on screen in a preselected range for the peak search to find.
2. If the selected marker is already on, the analyzer will attempt the centering at that marker's frequency. There is no preselector for signals below about 3.6 GHz, therefore if the marker is on a signal below 3.6 GHz, no centering will be attempted and an advisory message generated
3. In some models, the preselector can be bypassed. If it is bypassed, no centering will be attempted in that range and a message will be generated.

## Preselector Adjust

Allows you to manually adjust the preselector filter frequency to optimize its response to the signal of interest. This function is only available when **"Presel Center" on page 2111** is available.

For general purpose signal analysis, using Presel Center is recommended. Centering the filter minimizes the impact of long-term preselector drift. Presel Adjust can be used instead to manually optimize the preselector. One application of manual optimization would be to peak the preselector response, which both optimizes the signal-to-noise ratio and minimizes amplitude variations due to small (short-term) preselector drifting.

<b>Key Path</b>	AMPTD Y Scale
<b>Scope</b>	Meas Global
<b>Remote Command</b>	[ :SENSe ] :POWer [ :RF ] :PADJust <freq> [ :SENSe ] :POWer [ :RF ] :PADJust?
<b>Example</b>	POW:PADJ 100KHz POW:PADJ?
<b>Notes</b>	The value on the key reads out to 0.1 MHz resolution.
<b>Dependencies</b>	<ul style="list-style-type: none"> <li>• Grayed out if microwave preselector is off. )</li> <li>• Grayed out if entirely in Band 0.</li> <li>• Blank in models that do not include a preselector, such as option 503. If the SCPI is sent in these instruments, it is accepted without error, and the query always returns 0.</li> <li>• Grayed out in the Spectrogram View.</li> </ul>
<b>Preset</b>	0 MHz
<b>State Saved</b>	The Presel Adjust value set by Presel Center, or by manually adjusting Presel Adjust, is not saved in instrument state, and does not survive a Preset or power cycle.
<b>Min</b>	-500 MHz
<b>Max</b>	500 MHz

Default Unit	Hz
<b>Backwards Compatibility SCPI</b>	<code>[:SENSe]:POWer[:RF]:MW:PADJust</code> <code>[:SENSe]:POWer[:RF]:MMW:PADJust</code> PSA had multiple preselectors, but the X-Series has only one. These commands simply alias to <code>[:SENSe]:POWer[:RF]:PADJust</code>
Initial S/W Revision	Prior to A.02.00
Modified at S/W Revision	A.03.00

<b>Remote Command</b>	<code>[:SENSe]:POWer[:RF]:PADJust:PRESelector MWAVE   MMWave   EXTERNAL</code> <code>[:SENSe]:POWer[:RF]:PADJust:PRESelector?</code>
Notes	PSA had multiple preselectors, and you could select which preselector to adjust. Since the X-Series has only one mm/uW preselector, the preselector selection softkey is no longer available. However, to provide backward compatibility, we accept the legacy remote commands. The command form has no effect, the query always returns MWAVE
Initial S/W Revision	Prior to A.02.00

## μW Path Control

The μW Path Control functions include the μW Preselector Bypass (Option MPB) and Low Noise Path (Option LNP) controls in the High Band path circuits.

When the μW Preselector is bypassed, the user has better flatness, but will be subject to spurs from out of band interfering signals. When the Low Noise Path is enabled, the analyzer automatically switches around certain circuitry in the high frequency bands which can contribute to noise, when it is appropriate based on other analyzer settings.

For most applications, the preset state is Standard Path, which gives the best remote-control throughput, minimizes acoustic noise from switching and minimizes the risk of wear out in the hardware switches. For applications that utilize the wideband IF paths, the preset state is the μW Preselector Bypass path, if option MPB is present. This is because, when using a wideband IF such as the 140 MHz IF, the μW Preselector's bandwidth can be narrower than the available IF bandwidth, causing degraded amplitude flatness and phase linearity, so it is desirable to bypass the preselector in the default case.

Users may choose Low Noise Path Enable. It gives a lower noise floor, especially in the 21–26.5 GHz region, though without improving many measures of dynamic range, and without giving the best possible noise floor. The preamp, if purchased and used, gives better noise floor than does the Low Noise Path, however its compression threshold and third-order intercept are much poorer than that of the non-preamp Low Noise Path. There are some applications, typically for signals around –30 dBm, for which the third-order dynamic range of the standard path is good enough, but the noise floor is not low enough even with 0 dB input attenuation. When the third-order dynamic range of the preamp path is too little and the noise floor of the standard path is too high, the Low Noise Path can provide the best dynamic range.

Key Path	AMPTD Y Scale
Mode	SA, BASIC, PNOISE, VSA , LTE, LTETDD
Scope	Meas Global
<b>Remote Command</b>	[ :SENSe ] :POWer [ :RF ] :MW:PATH STD LNPath MPBypass FULL [ :SENSe ] :POWer [ :RF ] :MW:PATH?
<b>Example</b>	:POW:MW:PATH LNP Enables the Low Noise path
Notes	If a Presel Center is performed, the analyzer will momentarily switch to the Standard Path, regardless of the setting of $\mu$ W Path Control  The DC Block will always be switched in when the low noise path is switched in, to protect succeeding circuitry from DC. Note that this does not mean “when the low noise path is enabled” but when, based on the Low Noise Path rules, the path is actually switched in. This can happen when the selection is Low Noise Path Enable . In the case where the DC Block is switched in the analyzer is now AC coupled. However, if the user has selected DC coupling, the UI will still behave as though it were DC coupled, including all annunciation, warnings, status bits, and responses to SCPI queries. This is because, based on other settings, the analyzer could switch out the low noise path at any time and hence go back to being DC coupled.  Alignment switching ignores the settings in this menu, and restores them when finished.
Dependencies	Unavailable in BBIQ and External Mixing
Preset	All modes other than IQ Analyzer mode and VXA: STD IQ Analyzer, VXA and WLAN mode: MPB option present and licensed: MPB MPB option not present and licensed: STD
State Saved	Save in instrument state
Readback	Value selected in the submenu
Initial S/W Revision	A.04.00
Modified at S/W Revision	A.10.00

## Standard Path

This path gives the best remote-control throughput, minimizes acoustic noise from switching and minimizes the risk of wear in the hardware switches, particularly in remote test scenarios where both low band and high band setups will follow in rapid succession.

In this path, the bypass of the low band/high band switch and microwave preamp is never activated, which can cause some noise degradation but preserves the life of the bypass switch.

Key Path	AMPTD Y Scale, $\mu$ W Path Control
<b>Example</b>	:POW:MW:PATH STD
Readback Text	Standard Path
Initial S/W Revision	A.04.00



## Low Noise Path Enable

You may choose Low Noise Path Enable, which gives a lower noise floor under some circumstances, particularly when operating in the 21–26.5 GHz region. With the Low Noise Path enabled, the low band/high band switch and microwave preamp are bypassed whenever all of the following are true:

- The analyzer is not in the Low Band, meaning:
- the start frequency is above 3.5 GHz and
- the stop frequency is above 3.6 GHz.
- the internal preamp is not installed or (if installed) is set to Off or Low Band

Note that this means that, when any part of a sweep is done in Low Band, the Low Noise Path is not used, whether or not the Low Noise Path Enable is selected in the user interface. Also, if the preamp is turned on, the Low Noise Path is not used, whether or not the Low Noise Path Enable is selected in the user interface. The only time the Low Noise Path is used is when Low Noise Path Enable is selected, the sweep is completely in High Band (> 3.6 GHz) and no preamp is in use.

See "[More Information](#)" on page 1305

Key Path	AMPTD Y Scale, $\mu$ W Path Control
Measurement	Swept SA
<b>Example</b>	:POW:MW:PATH LNP
Notes	For measurements that use IQ acquisition, the low noise path is used when the Center Frequency is in High Band (> 3.6 GHz) and no preamp is in use. In other words, the rules above are modified to use only the center frequency to qualify which path to switch in. This is not the case for FFT's in the Swept SA measurement; they use the same rules as swept measurements.
Dependencies	Key is blanked if current mode does not support it. Key is grayed out if mode supports it but current measurement does not support it. Unless Option LNP is present and licensed, key is blank and if SCPI command sent, error -241, "Hardware missing; Option not installed" is generated.
Readback Text	Low Noise Path Enable
Initial S/W Revision	A.04.00

## More Information

The user should understand that the Low Noise Path, while giving improved DANL, has the disadvantage of decreased TOI performance and decreased gain compression performance relative to the standard path.

The user should also understand that the bypass switch is a mechanical switch and has finite life, so if the Low Noise Path is enabled, it is possible to cause frequent cycling of this switch by frequently changing analyzer settings such that the above conditions hold true only some of the time. A user making tests of this nature should consider opting for the Standard Path, which will never throw the bypass switch, at the expense of some degraded noise performance.

The low noise path is useful for situations where the signal level is so low that the analyzer performance is dominated by noise even with 0 dB attenuation, but still high enough that the preamp option would have excessive third-order intermodulation or compression. The preamp, if purchased and used, gives better noise floor than does the “Low Noise Path.” However, its compression threshold and third-order intercept are much poorer than that of the non-preamp path. There are some applications, typically for signals around -30 dBm, for which the third-order dynamic range of the standard path is good enough, but the noise floor is not low enough even with 0 dB input attenuation. When the third-order dynamic range of the preamp path is too little and the noise floor of the standard path is too high, the Low Noise Path can provide the best dynamic range

The graph below illustrates the concept. It shows, in red, the performance of an analyzer at different attenuation settings, both with the preamp on and off, in a measurement that is affected by both analyzer noise and analyzer TOI. The green shows the best available dynamic range, offset by 0.5 dB for clarity. The blue shows how the best available dynamic range improves for moderate signal levels with the low noise path switched in. In this illustration, the preamp improves the noise floor by 15 dB while degrading the third-order intercept by 30 dB, and the low noise path reduces loss by 8 dB. The attenuator step size is 2 dB.

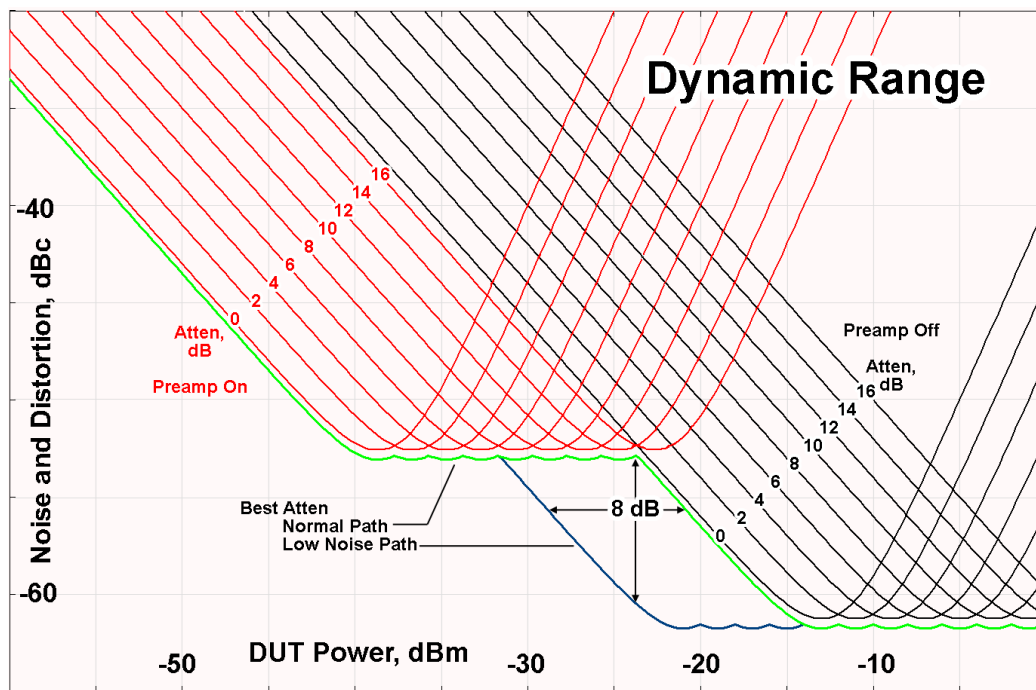

There are other times where selecting the low noise path improves performance, too. Compression-limited measurements such as finding the nulls in a pulsed-RF spectrum can profit from the low noise path in a way similar to the TOI-limited measurement illustrated. Accuracy can be improved when the low noise path allows the optimum attenuation to increase from a small amount like 0, 2 or 4 dB to a larger amount, giving better return loss at the analyzer input. Harmonic measurements, such as second and third harmonic levels, are much improved using the low noise path because of the superiority of that path for harmonic (though not intermodulation) distortion performance.

## μW Preselector Bypass

This key toggles the preselector bypass switch for band 1 and higher. When the microwave preselect is on, the signal path is preselected. When the microwave preselector is off, the signal path is not preselected. The preselected path is the normal path for the analyzer.

The preselector is a tunable bandpass filter which prevents signals away from the frequency of interest from combining in the mixer to generate in-band spurious signals (images). The consequences of using a preselector filter are its limited bandwidth, the amplitude and phase ripple in its passband, and any amplitude and phase instability due to center frequency drift.

Option MPB or pre-selector bypass provides an unpreselected input mixer path for certain X-Series signal analyzers with frequency ranges above 3.6 GHz. This signal path allows a wider bandwidth and less amplitude variability, which is an advantage when doing modulation analysis and broadband signal analysis. The disadvantage is that, without the preselector, image signals will be displayed. Another disadvantage of bypassing the preselector is increased LO emission levels at the front panel input port.

Image responses are separated from the real signal by twice the 1st IF. For IF Paths of 10 MHz and 25 MHz, the 1st IF is 322.5 MHz, so the image response and the real signal will be separated by 645 MHz. The 1st IF will be different for other IF Path settings. When viewing a real signal and its corresponding image response in internal mixing, the image response will be to the left of the real signal.

Also, the image response and the real signal typically have the same amplitude and exhibit the same shape factor.

However, if Option FS1, Fast Sweep Capability, is enabled, the image response in the Swept SA measurement will appear lower in amplitude and have a much wider shape factor compared to the real signal.

Key Path	AMPTD Y Scale, μW Path Control
Example	:POW:MW:PATH MPB
Dependencies	Key is blanked if current mode does not support it. Key is grayed out if mode supports it but current measurement does not support it. Key is blank unless Option MPB is present and licensed. If SCPI command sent when MPB not present, error -241, "Hardware missing; Option not installed" is generated.
Readback Text	μW Preselector Bypass
Initial S/W Revision	A.04.00

Remote Command	[ :SENSe ] :POWer [ :RF ] :MW:PRESelector [ :STATe ] ON OFF 0 1 [ :SENSe ] :POWer [ :RF ] :MW:PRESelector [ :STATe ] ?
Example	:POW:MW:PRES OFF Bypasses the microwave preselector
Notes	The ON parameter sets the STD path (:POW:MW:PATH STD) The OFF parameter sets path MPB (:POW:MW:PATH MPB)
Preset	ON

## Scale Type

Sets Y Scale Type. This key is visible only when the current window is MER/EVM vs. Sub-carrier/ Frequency window. If it is set to MER, the Y scale displays the MER value. If it is set to EVM, the Y scale displays the EVM value.

Key Path	AMPTD Y Scale, More
Mode	DVB-T/H
Remote Command	:DISPlay:EVM:VIEW2:WINDow[1]:TRACe:Y[:SCALE]:TYPE MER EVM :DISPlay:EVM:VIEW2:WINDow[1]:TRACe:Y[:SCALE]:TYPE?
Example	DISP:EVM:VIEW2:WIND:TRAC:Y:TYPE MER DISP:EVM:VIEW2:WIND:TRAC:Y:TYPE?
Preset	MER
State Saved	No
Range	MER   EVM
Initial S/W Revision	A.06.00

## Internal Preamp

Accesses a menu of keys that control the internal preamps. Turning on the preamp gives a better noise figure, but a poorer TOI to noise floor dynamic range. You can optimize this setting for your particular measurement.

The instrument takes the preamp gain into account as it sweeps. If you sweep outside of the range of the preamp the instrument will also account for that. The displayed result will always reflect the correct gain.

For some measurements, when the preamp is on and any part of the displayed frequency range is below the lowest frequency for which the preamp has specifications, a warning condition message appears in the status line. For example, for a preamp with a 9 kHz lowest specified frequency: "Preamp: Accy unspec'd below 9 kHz".

Key Path	AMPTD Y Scale
Scope	Meas Global
Remote Command	[:SENSe]:POWer[:RF]:GAIN[:STATe] OFF ON 0 1 [:SENSe]:POWer[:RF]:GAIN[:STATe]?
Dependencies	Preamp is not available on all hardware platforms. If the preamp is not present or is unlicensed, the key is not shown. The preamp is not available when the electronic/soft attenuator is enabled.
Couplings	The act of connecting the U7227A USB Preamplifier to one of the analyzer's USB ports will cause the Internal Preamp to be switched on. When this happens an informational message will be generated: "Internal Preamp turned on for optimal operation with USB Preamp." Note that if the Internal Preamp was already on, there will be no change to the setting, but if it was Off it will be switched On, to Full Range.

Note that this same action occurs when the SA mode is selected while the USB Preamp is connected to one of the analyzer's USB ports, if it is the first time that the SA mode has run since powerup, or if the last time the SA mode was running the USB Preamp was NOT connected. Subsequently disconnecting the USB Preamp from USB does not change the Internal Preamp setting nor restore the previous setting.

Preset	OFF
State Saved	Saved in instrument state
Initial S/W Revision	Prior to A.02.00
Modified at S/W Revision	A.14.00

Key Path	AMPTD Y Scale, Internal Preamp
Scope	Meas Global
<b>Remote Command</b>	[ :SENSe ] :POWer [ :RF ] :GAIN:BAND LOW   FULL [ :SENSe ] :POWer [ :RF ] :GAIN:BAND?
Dependencies	Preamp is not available on all hardware platforms. If the preamp is not present or is unlicensed, the key is not shown. If a POW:GAIN:BAND FULL command is sent when a low band preamp is available, the preamp band parameter is to LOW instead of FULL, and an "Option not installed" message is generated.
Preset	LOW
State Saved	Saved in instrument state
Initial S/W Revision	Prior to A.02.00

## Off

Turns the internal preamp off

Key Path	AMPTD Y Scale, Internal Preamp
<b>Example</b>	:POW:GAIN OFF
Readback	Off
Initial S/W Revision	Prior to A.02.00

## Low Band

Sets the internal preamp to use only the low band.

The frequency range of the installed (optional) low-band preamp is displayed in square brackets on the Low Band key label.

Key Path	AMPTD Y Scale, Internal Preamp
<b>Example</b>	:POW:GAIN ON

	:POW:GAIN:BAND LOW
Readback	Low Band
Initial S/W Revision	Prior to A.02.00

## Full Range

Sets the internal preamp to use its full range. The low band (0–3.6 GHz or 0–3GHz, depending on the model) is supplied by the low band preamp and the frequencies above low band are supplied by the high band preamp.

The frequency range of the installed (optional) preamp is displayed in square brackets on the Full Range key label. If the high band option is not installed the Full Range key does not appear.

Key Path	AMPTD Y Scale, Internal Preamp
<b>Example</b>	:POW:GAIN ON :POW:GAIN:BAND FULL
Readback	Full Range
Initial S/W Revision	Prior to A.02.00

## Range

This key is only available when I/Q is the selected input. It replaces the Attenuation key in that case.

Each input channel (I and Q) has four internal gain ranges. The maximum allowed voltage in each gain range is slightly more than the nominal value, so the break point between ranges is a couple of millivolts higher than the nominal (setting a peak voltage of 0.502 mV will still map to the 0.5 V Peak range).

Gain Setting	Volts RMS	Volts Peak	Volts Peak - Peak	<b>dBm (50Ω)</b>	Break Point
0 dB	0.7071	1.0	2.0	10	n/a
6 dB	0.3536	0.5	1.0	4	0.502 V Peak
12 dB	0.1768	0.25	0.5	-2	0.252 V Peak
18 dB	0.0884	0.125	0.25	-8	0.127 V Peak

Key Path	AMPTD Y Scale
Notes	Visible only when the selected input is I/Q.
State Saved	No
Readback Text	When Range is Auto, "[Auto]" When Range is Man and I & Q are the same, "[<range value>]" When Range is Man and I & Q are different: "[: <I range value>"]

	Q: <Q range value>]" See I Range and Q Range for the <range value> enumeration definition.
Initial S/W Revision	Prior to A.02.00

## Range Auto/Man

The Auto setting for Range causes the range to be set based on the Y Scale settings. When Range is "Auto", the I & Q Range are set based on the top of the Y Scale when the Y scale is in dB units (for example, power), or to the max(abs(top), abs(bottom)) when the Y scale reference is not at the top of the screen.

Not all measurements support Range Auto/Man. If Auto is not supported in the current measurement, this key is grayed out and shows "Man" and MAN is returned to a SCPI query, but this does NOT change the Auto/Man setting for Range. When you go to a measurement that supports Auto, it goes back to Auto if it was previously in Auto mode.

Key Path	AMPTD Y Scale, Range
Scope	Meas Global
Remote Command	[ :SENSe ] :VOLTage:IQ:RANGe:AUTO OFF ON 0 1 [ :SENSe ] :VOLTage:IQ:RANGe:AUTO?
Example	Put the I Range and Q Range in manual. VOLT:IQ:RANG:AUTO OFF
Dependencies	If Auto is not supported, sending the SCPI command will generate an error.
Couplings	When in Auto, both I Range and Q Range are set to the same value, computed as follows: Maximum absolute value is computed for the Y Scale. The top and bottom of the graph are computed based on Ref Value, Scale/Div, and Ref Position. Formula: YMax = max(abs(top), abs(bottom)). The I Range and Q Range are then set to YMax.
Preset	ON
State Saved	Saved in instrument state
Range	Auto   Man
Initial S/W Revision	Prior to A.02.00

Remote Command	[ :SENSe ] :POWer:IQ:RANGe:AUTO OFF ON 0 1 [ :SENSe ] :POWer:IQ:RANGe:AUTO?
Example	Put the I Range and Q Range in manual. POW:IQ:RANG:AUTO OFF
Notes	The POW:IQ:RANG:AUTO is an alternate form of the VOLT:IQ:RANG:AUTO command. This is to maintain consistency with I Range and Q Range, which support both the POWER and VOLTage forms of the command.
Preset	ON
Range	Auto   Man
Initial S/W Revision	Prior to A.02.00

## I Range

This is the internal gain range for the I channel when Input Path is I Only or I and I/Q, and it is used for both the I and Q channels when the Input Path is I+jQ. See "[I/Q Gain Ranges](#)" on page 2127.

Key Path	AMPTD Y Scale, Range
Remote Command	<code>[ :SENSe]:VOLTage:IQ[:I]:RANGe[:UPPer] &lt;voltage&gt;</code> <code>[ :SENSe]:VOLTage:IQ[:I]:RANGe[:UPPer]?</code>
Example	Set the I Range to 0.5 V Peak <code>VOLT:IQ:RANG 0.5 V</code>
Notes	The numeric entries are mapped to the smallest gain range whose break point is greater than or equal to the value, or 1 V Peak if the value is greater than 1 V.
Couplings	When Q Same as I is On, the I Range value will be copied to the Q Range. Changing the value will also set Range = Man.
Preset	1 V Peak
State Saved	Saved in instrument state
Range	1 V Peak   0.5 V Peak   0.25 V Peak   0.125 V Peak
Min	0.125 V
Max	1 V
Initial S/W Revision	Prior to A.02.00

Remote Command	<code>[ :SENSe]:POWer:IQ[:I]:RANGe[:UPPer] &lt;ampl&gt;</code> <code>[ :SENSe]:POWer:IQ[:I]:RANGe[:UPPer]?</code>
Example	Set the I Range to 0.5 V Peak when Reference Z is 50Ω, and to 1.0 V Peak when Reference Z is 75Ω. <code>POW:IQ:RANG 4 dBm</code>
Notes	The POWer form of the command is provided for convenience. It maps to the same underlying gain range parameter as the VOLTage form of the command. The Reference Z (not the I channel Input Z) is used to convert the power to peak voltage, which is then used to set the I Range as with the VOLTage form of the command. The power values of the 4 range states (1V Peak, 0.5V Peak, 0.25V Peak, and 0.125V Peak) will vary with Reference Z. Here are some examples: 50Ω: 10, 4, -2, -8 75Ω: 8.2, 2.2, -3.8, -9.8 600Ω: -0.8, -6.8, -12.8, -18.9
Preset	10.0 dBm
Range	-20 dBm to 10 dBm
Min	-20 dBm
Max	10 dBm
Initial S/W Revision	Prior to A.02.00



### 1 V Peak

Set the channel gain state to 1 Volt Peak.

Key Path	AMPTD Y Scale, I Range   Q Range
Initial S/W Revision	Prior to A.02.00

### 0.5 V Peak

Set the channel gain state to 0.5 Volt Peak.

Key Path	AMPTD Y Scale, I Range   Q Range
Initial S/W Revision	Prior to A.02.00

### 0.25 V Peak

Set the channel gain state to 0.25 Volt Peak.

Key Path	AMPTD Y Scale, I Range   Q Range
Initial S/W Revision	Prior to A.02.00

### 0.125 V Peak

Set the channel gain state to 0.125 Volt Peak.

Key Path	AMPTD Y Scale, I Range   Q Range
Initial S/W Revision	Prior to A.02.00

### Q Range Value

This is the internal gain range for the Q channel. See "[I/Q Gain Ranges](#)" on page 2127. The Q Range only applies to Input Path Q Only and Ind I/Q. For input I+jQ the I Range determines both I and Q channel range settings.

Key Path	AMPTD Y Scale, Range
<b>Remote Command</b>	[ :SENSe ] :VOLTage:IQ:Q:RANGe[:UPPer] <voltage> [ :SENSe ] :VOLTage:IQ:Q:RANGe[:UPPer] ?
<b>Example</b>	Set the Q Range to 0.5 V Peak VOLT:IQ:Q:RANG 0.5 V
<b>Notes</b>	The numeric entries are mapped to the smallest gain range whose break point is greater than or

	equal to the value, or 1 V Peak if the value is greater than 1 V. The Q Range is only used for Input Path Q Only and Ind I/Q. For input I+jQ the I Range determines both I and Q channel range settings.
Couplings	When Q Same as I is On, the I Range value will be copied to the Q Range and the range value keys are disabled. Changing the value will also set Range = Man.
Preset	1 V Peak
State Saved	Saved in instrument state
Range	1 V Peak   0.5 V Peak   0.25 V Peak   0.125 V Peak
Min	0.125 V
Max	1 V
Initial S/W Revision	Prior to A.02.00

<b>Remote Command</b>	<code>[ :SENSe ] :POWer:IQ:Q:RANGe[:UPPer] &lt;ampl&gt;</code> <code>[ :SENSe ] :POWer:IQ:Q:RANGe[:UPPer] ?</code>
<b>Example</b>	Will set the Q Range to 0.5 V Peak when Reference Z is 50Ω, and to 1.0 V Peak when Reference Z is 75Ω. <code>POW:IQ:Q:RANG 4 dBm</code>
<b>Notes</b>	The POWER form of the command is provided for convenience. It maps to the same underlying gain range parameter as the VOLTage form of the command. The Reference Z (not the Q channel Input Z) is used to convert the power to peak voltage, which is then used to set the Q Range as with the VOLTage form of the command. The power values of the 4 range states (1V Peak, 0.5V Peak, 0.25V Peak, and 0.125V Peak) will vary with Reference Z. Here are some examples: 50Ω: 10, 4, -2, -8 75Ω: 8.2, 2.2, -3.8, -9.8 600Ω: -0.8, -6.8, -12.8, -18.9
Preset	10.0 dBm
Range	-20 dBm to 10 dBm
Min	-20 dBm
Max	10 dBm
Initial S/W Revision	Prior to A.02.00

### Q Same as I

Many, but not all, usages require the I and Q channels to have an identical setup. To simplify channel setup, the Q Same as I will cause the Q channel range to be mirrored from the I channel. That way you only need to set up one channel (the I channel). The I channel values are copied to the Q channel, so at the time Q Same as I is Off, the I and Q channel setups will be identical.

Key Path	AMPTD Y Scale, Range, Q Range
Remote Command	[ :SENSE ] :VOLTage   P OWer : IQ :MIRRed OFF   ON   0   1 [ :SENSe ] :VOLTage   P OWer : IQ :MIRRed?
Example	Turn off the mirroring of I Range to Q Range. VOLT:IQ:MIRR OFF POW:IQ:MIRR OFF
Couplings	When On, the I Range value is mirrored (copied) to the Q Range.
Preset	On
State Saved	Saved in instrument state.
Range	On   Off
Readback Text	"Q Same as I" when On, otherwise none.
Initial S/W Revision	Prior to A.02.00

### 1 V Peak

Set the channel gain state to 1 Volt Peak.

Key Path	AMPTD Y Scale, I Range   Q Range
Initial S/W Revision	Prior to A.02.00

### 0.5 V Peak

Set the channel gain state to 0.5 Volt Peak.

Key Path	AMPTD Y Scale, I Range   Q Range
Initial S/W Revision	Prior to A.02.00

### 0.25 V Peak

Set the channel gain state to 0.25 Volt Peak.

Key Path	AMPTD Y Scale, I Range   Q Range
Initial S/W Revision	Prior to A.02.00

### 0.125 V Peak

Set the channel gain state to 0.125 Volt Peak.

Key Path	AMPTD Y Scale, I Range   Q Range
Initial S/W Revision	Prior to A.02.00

## I/Q Gain Ranges

See the following sections:

["1 V Peak" on page 2127](#)

["0.5 V Peak" on page 2128](#)

["0.25 V Peak" on page 2128](#)

["0.125 V Peak" on page 2128](#)

### 1 V Peak

Set the channel gain state to 1 Volt Peak.

Key Path	AMPTD Y Scale, I Range   Q Range
Initial S/W Revision	Prior to A.02.00

### 0.5 V Peak

Set the channel gain state to 0.5 Volt Peak.

Key Path	AMPTD Y Scale, I Range   Q Range
Initial S/W Revision	Prior to A.02.00

### 0.25 V Peak

Set the channel gain state to 0.25 Volt Peak.

Key Path	AMPTD Y Scale, I Range   Q Range
Initial S/W Revision	Prior to A.02.00

### 0.125 V Peak

Set the channel gain state to 0.125 Volt Peak.

Key Path	AMPTD Y Scale, I Range   Q Range
Initial S/W Revision	Prior to A.02.00

## Ref Position

This key allows you to set the displayed reference position to Top, Ctr (center), or Bot (bottom). The key is active in MER/EVM vs. Sub-carrier/Frequency Window, Spectrum Window, Amptd vs. Sub-carrier Window,

Phase vs. Sub-carrier Window, Group Delay vs. Sub-carrier Window, Amptd vs. Time Window, and MER vs. Time Window.

Key Path	AMPTD Y Scale
Initial S/W Revision	A.02.00

### Y Ref Position (I/Q Error View – MER/EVM vs. Sub-carrier/Frequency Window)

This key sets the Y-axis reference position in the MER/EVM vs. Sub-carrier/Frequency window.

Key Path	AMPTD Y Scale, More
Mode	DVB-T/H
<b>Remote Command</b>	:DISPlay:EVM:VIEW2:WINDow[1]:TRACe:Y[:SCALe]:RPOSition TOP   CENTer   BOTTom :DISPlay:EVM:VIEW2:WINDow[1]:TRACe:Y[:SCALe]:RPOSition?
<b>Example</b>	DISP:EVM:VIEW2:WIND:TRAC:Y:RPOS TOP DISP:EVM:VIEW2:WIND:TRAC:Y:RPOS?
Notes	SCPI Remarks: VIEW2: I/Q Error View WINDow[1]: MER/EVM vs. Sub-carrier/Frequency Window on I/Q Error View
Preset	TOP
State Saved	No
Range	Top   Ctr   Bot
Initial S/W Revision	A.02.00

### Y Ref Position (I/Q Error View – Spectrum Window)

This key sets the Y-axis reference position in the Spectrum window.

Key Path	AMPTD Y Scale, More
Mode	DVB-T/H
<b>Remote Command</b>	:DISPlay:EVM:VIEW2:WINDow2:TRACe:Y[:SCALe]:RPOSition TOP   CENTer   BOTTom :DISPlay:EVM:VIEW2:WINDow2:TRACe:Y[:SCALe]:RPOSition?
<b>Example</b>	DISP:EVM:VIEW2:WIND2:TRAC:Y:RPOS TOP DISP:EVM:VIEW2:WIND2:TRAC:Y:RPOS?
Notes	SCPI Remarks: VIEW2: I/Q Error View WINDow2: Spectrum Window on I/Q Error View
Preset	TOP

State Saved	No
Range	Top   Ctr   Bot
Initial S/W Revision	A.02.00

### Y Ref Position (Channel Frequency Response View – Amptd vs. Sub-carrier Window)

This key sets the Y-axis reference position in the Amptd vs. Sub-carrier window.

Key Path	AMPTD Y Scale, More
Mode	DVB-T/H
<b>Remote Command</b>	:DISPlay:EVM:VIEW3:WINDow[1]:TRACe:Y[:SCALe]:RPOSition TOP   CENTer   BOTTOm  :DISPlay:EVM:VIEW3:WINDow[1]:TRACe:Y[:SCALe]:RPOSition?
<b>Example</b>	DISP:EVM:VIEW3:WIND:TRAC:Y:RPOS TOP DISP:EVM:VIEW3:WIND:TRAC:Y:RPOS?
Notes	SCPI Remarks: VIEW3: Channel Frequency Response View WINDow[1]: Amptd vs. Sub-carrier Window
Preset	TOP
State Saved	No
Range	Top   Ctr   Bot
Initial S/W Revision	A.02.00

### Y Ref Position (Channel Frequency Response View – Phase vs. Sub-carrier Window)

This key sets the Y-axis reference position in the Phase vs. Sub-carrier window.

Key Path	AMPTD Y Scale, More
Mode	DVB-T/H
<b>Remote Command</b>	:DISPlay:EVM:VIEW3:WINDow2:TRACe:Y[:SCALe]:RPOSition TOP   CENTer   BOTTOm  :DISPlay:EVM:VIEW3:WINDow2:TRACe:Y[:SCALe]:RPOSition?
<b>Example</b>	DISP:EVM:VIEW3:WIND2:TRAC:Y:RPOS CENT DISP:EVM:VIEW3:WIND2:TRAC:Y:RPOS?
Notes	SCPI Remarks: VIEW3: Channel Frequency Response View WINDow2: Phase vs. Sub-carrier Window
Preset	CENT
State Saved	No

Range	Top   Ctr   Bot
Initial S/W Revision	A.02.00

### Y Ref Position (Channel Frequency Response View –Group Delay vs. Sub-carrier Window)

This key sets the Y-axis reference position in the Group Delay vs. Sub-carrier window.

Key Path	AMPTD Y Scale, More
Mode	DVB-T/H
<b>Remote Command</b>	:DISPlay:EVM:VIEW3:WINDow3:TRACe:Y[:SCALe]:RPOSition TOP   CENTer   BOTTom  :DISPlay:EVM:VIEW3:WINDow3:TRACe:Y[:SCALe]:RPOSition?
<b>Example</b>	DISP:EVM:VIEW3:WIND3:TRAC:Y:RPOS CENT DISP:EVM:VIEW3:WIND3:TRAC:Y:RPOS?
Notes	SCPI Remarks: VIEW3: Channel Frequency Response View WINDow3: Group Delay vs. Sub-carrier Window
Preset	CENT
State Saved	No
Range	Top   Ctr   Bot
Initial S/W Revision	A.02.00

### Y Ref Position (Channel Impulse Response View – Amptd vs. Time Window)

This key sets the Y-axis reference position in the Amptd vs. Time window.

Key Path	AMPTD Y Scale, More
Mode	DVB-T/H
<b>Remote Command</b>	:DISPlay:EVM:VIEW4:WINDow[1]:TRACe:Y[:SCALe]:RPOSition TOP   CENTer   BOTTom  :DISPlay:EVM:VIEW4:WINDow[1]:TRACe:Y[:SCALe]:RPOSition?
<b>Example</b>	DISP:EVM:VIEW4:WIND:TRAC:Y:RPOS TOP DISP:EVM:VIEW4:WIND:TRAC:Y:RPOS?
Notes	SCPI Remarks: VIEW4: Channel Impulse Response View WINDow[1]: Amptd vs. Time Window
Preset	TOP
State Saved	No
Range	Top   Ctr   Bot
Initial S/W Revision	A.02.00

### Y Ref Position (MER Monitor View – MER vs. Time Window)

This key sets the Y-axis reference position in the MER vs. Time window.

Key Path	AMPTD Y Scale, More
Mode	DVB-T/H
Remote Command	:DISPlay:EVM:VIEW5:WINDow[1]:TRACe:Y[:SCALE]:RPOSition TOP   CENTER   BOTTom :DISPlay:EVM:VIEW5:WINDow[1]:TRACe:Y[:SCALE]:RPOSition?
Example	DISP:EVM:VIEW5:WIND:TRAC:Y:RPOS TOP DISP:EVM:VIEW5:WIND:TRAC:Y:RPOS?
Notes	SCPI Remarks: VIEW5: MER Monitor View WINDow[1]: MER vs. Time Window
Preset	TOP
State Saved	No
Range	Top   Ctr   Bot
Initial S/W Revision	A.06.00

### Auto Scaling

This key allows you to toggle the scale coupling function between On and Off. The key is active in MER/EVM vs. Sub-carrier/Frequency Window, Spectrum Window, Amptd vs. Sub-carrier Window, Phase vs. Sub-carrier Window, Group Delay vs. Sub-carrier Window, Amptd vs. Time Window, and MER vs. Time Window.

Key Path	AMPTD Y Scale
Initial S/W Revision	A.02.00

### Y Auto Scaling (I/Q Error View – MER/EVM vs. Sub-carrier/Frequency Window)

When Auto Scaling is On, the scale per division and the reference values are automatically adjusted in the MER/EVM vs. Sub-carrier/Frequency window.

Key Path	AMPTD Y Scale, More
Mode	DVB-T/H
Remote Command	:DISPlay:EVM:VIEW2:WINDow[1]:TRACe:Y[:SCALE]:COUPle OFF   ON   0   1 :DISPlay:EVM:VIEW2:WINDow[1]:TRACe:Y[:SCALE]:COUPle?
Example	DISP:EVM:VIEW2:WIND:TRAC:Y:COUP OFF DISP:EVM:VIEW2:WIND:TRAC:Y:COUP?



Notes	SCPI Remarks: VIEW2: I/Q Error View WINDow[1]: MER/EVM vs. Sub-carrier/Frequency Window on I/Q Error View
Dependencies	When this parameter is set to On, it will activate the scale coupling function that automatically determines scale per division and reference values based on the measurement results. When you set a value to either Scale/Div or Ref Value manually, Auto Scaling is automatically set to Off.
Preset	ON
State Saved	No
Range	On   Off
Initial S/W Revision	A.02.00

### Y Auto Scaling (I/Q Error View – Spectrum Window)

When Auto Scaling is On, the scale per division and the reference values are automatically adjusted in the Spectrum window.

Key Path	AMPTD Y Scale, More
Mode	DVB-T/H
<b>Remote Command</b>	:DISPlay:EVM:VIEW2:WINDow2:TRACe:Y[:SCALe]:COUPle OFF ON 0 1 :DISPlay:EVM:VIEW2:WINDow2:TRACe:Y[:SCALe]:COUPle?
<b>Example</b>	DISP:EVM:VIEW2:WIND2:TRAC:Y:COUP OFF DISP:EVM:VIEW2:WIND2:TRAC:Y:COUP?
Notes	SCPI Remarks: VIEW2: I/Q Error View WINDow2: Spectrum Window on I/Q Error View
Dependencies	When this parameter is set to On, it will activate the scale coupling function that automatically determines scale per division and reference values based on the measurement results. When you set a value to either Scale/Div or Ref Value manually, Auto Scaling is automatically set to Off.
Preset	ON
State Saved	No
Range	On   Off
Initial S/W Revision	A.02.00

### Y Auto Scaling (Channel Frequency Response View – Amptd vs. Sub-carrier Window)

When Auto Scaling is On, the scale per division and the references value are automatically adjusted in the Amptd vs. Sub-carrier window.

Key Path	AMPTD Y Scale, More
----------	---------------------

Mode	DVB-T/H
<b>Remote Command</b>	:DISPlay:EVM:VIEW3:WINDow[1]:TRACe:Y[:SCALE]:COUPle OFF   ON   0   1 :DISPlay:EVM:VIEW3:WINDow[1]:TRACe:Y[:SCALE]:COUPle?
<b>Example</b>	DISP:EVM:VIEW3:WIND:TRAC:Y:COUP OFF DISP:EVM:VIEW3:WIND:TRAC:Y:COUP?
Notes	SCPI Remarks: VIEW3: Channel Frequency Response View WINDow[1]: Amptd vs. Sub-carrier Window
Dependencies	When this parameter is set to On, it will activate the scale coupling function that automatically determines scale per division and reference values based on the measurement results. When you set a value to either Scale/Div or Ref Value manually, Auto Scaling is automatically set to Off.
Preset	ON
State Saved	No
Range	On   Off
Initial S/W Revision	A.02.00

### Y Auto Scaling (Channel Frequency Response View – Phase vs. Sub-carrier Window)

When Auto Scaling is On, the scale per division and the references value are automatically adjusted in the Phase vs. Sub-carrier window.

Key Path	AMPTD Y Scale, More
Mode	DVB-T/H
<b>Remote Command</b>	:DISPlay:EVM:VIEW3:WINDow2:TRACe:Y[:SCALE]:COUPle OFF ON 0 1 :DISPlay:EVM:VIEW3:WINDow2:TRACe:Y[:SCALE]:COUPle?
<b>Example</b>	DISP:EVM:VIEW3:WIND2:TRAC:Y:COUP OFF DISP:EVM:VIEW3:WIND2:TRAC:Y:COUP?
Notes	SCPI Remarks: VIEW3: Channel Frequency Response View WINDow2: Phase vs. Sub-carrier Window
Dependencies	When this parameter is set to On, it will activate the scale coupling function that automatically determines scale per division and reference values based on the measurement results. When you set a value to either Scale/Div or Ref Value manually, Auto Scaling is automatically set to Off.
Preset	ON
State Saved	No
Range	On   Off
Initial S/W Revision	A.02.00

### Y Auto Scaling (Channel Frequency Response View – Group Delay vs. Sub-carrier Window)

When Auto Scaling is On, the scale per division and the reference values are automatically adjusted in the Group Delay vs. Sub-carrier window.

Key Path	AMPTD Y Scale, More
Mode	DVB-T/H
<b>Remote Command</b>	:DISPlay:EVM:VIEW3:WINDow3:TRACe:Y[:SCALe]:COUPle OFF ON 0 1 :DISPlay:EVM:VIEW3:WINDow3:TRACe:Y[:SCALe]:COUPle?
<b>Example</b>	DISP:EVM:VIEW3:WIND3:TRAC:Y:COUP OFF DISP:EVM:VIEW3:WIND3:TRAC:Y:COUP?
Notes	SCPI Remarks: VIEW3: Channel Frequency Response View WINDow3: Group Delay vs. Sub-carrier Window
Dependencies	When this parameter is set to On, it will activate the scale coupling function that automatically determines scale per division and reference values based on the measurement results. When you set a value to either Scale/Div or Ref Value manually, Auto Scaling is automatically set to Off.
Preset	ON
State Saved	No
Range	On   Off
Initial S/W Revision	A.02.00

### Y Auto Scaling (Channel Impulse Response View – Amptd vs. Time Window)

When Auto Scaling is On, the scale per division and the reference values are automatically adjusted in the Amptd vs. Time window.

Key Path	AMPTD Y Scale, More
Mode	DVB-T/H
<b>Remote Command</b>	:DISPlay:EVM:VIEW4:WINDow[1]:TRACe:Y[:SCALe]:COUPle OFF   ON   0   1 :DISPlay:EVM:VIEW4:WINDow[1]:TRACe:Y[:SCALe]:COUPle?
<b>Example</b>	DISP:EVM:VIEW4:WIND:TRAC:Y:COUP OFF DISP:EVM:VIEW4:WIND:TRAC:Y:COUP?
Notes	SCPI Remarks: VIEW4: Channel Impulse Response View WINDow[1]: Amptd vs. Time Window
Dependencies	When this parameter is set to On, it will activate the scale coupling function that automatically determines scale per division and reference values based on the measurement results. When you set a value to either Scale/Div or Ref Value manually, Auto Scaling is automatically set to Off.
Preset	ON
State Saved	No

Range	On   Off
Initial S/W Revision	A.02.00

### Y Auto Scaling (MER Monitor View – MER vs. Time Window)

When Auto Scaling is On, the scale per division and the reference values are automatically adjusted in the MER vs. Time window.

Key Path	AMPTD Y Scale, More
Mode	DVB-T/H
<b>Remote Command</b>	:DISPlay:EVM:VIEW5:WINDow[1]:TRACe:Y[:SCALE]:COUPle OFF   ON   0   1 :DISPlay:EVM:VIEW5:WINDow[1]:TRACe:Y[:SCALE]:COUPle?
<b>Example</b>	DISP:EVM:VIEW5:WIND:TRAC:Y:COUP OFF DISP:EVM:VIEW5:WIND:TRAC:Y:COUP?
Notes	SCPI Remarks: VIEW5: MER Monitor View WINDow[1]: MER vs. Time Window
Dependencies	When this parameter is set to On, it will activate the scale coupling function that automatically determines scale per division and reference values based on the measurement results. When you set a value to either Scale/Div or Ref Value manually, Auto Scaling is automatically set to Off.
Preset	OFF
State Saved	No
Range	On   Off
Initial S/W Revision	A.06.00

## Auto Couple

The Auto Couple feature provides a quick and convenient way to automatically couple multiple instrument settings. This helps ensure accurate measurements and optimum dynamic range. When the Auto Couple feature is activated, either from the front panel or remotely, all parameters of the current measurement that have an Auto/Manual mode are set to Auto mode and all measurement settings dependent on (or coupled to) the Auto/Man parameters are automatically adjusted for optimal performance.

However, the Auto Couple key actions are confined to the current measurement only. It does not affect other measurements in the mode, and it does not affect markers, marker functions, or trace or display attributes.

See "[More Information](#)" on page 1325

Key Path	Front-panel key
Remote Command	:COUPle ALL NONE
Example	:COUP ALL
Notes	:COUPle ALL puts all Auto/Man parameters in Auto mode (equivalent to pressing the Auto Couple key). :COUPLE NONE puts all Auto/Man parameters in manual mode. It decouples all the coupled instrument parameters and is not recommended for making measurements.
Initial S/W Revision	Prior to A.02.00

### More Information

There are two types of functions that have Auto/Manual modes.

#### Auto/Man Active Function keys

An Auto/Man toggle key controls the binary state associated with an instrument parameter by toggling between Auto (where the parameter is automatically coupled to the other parameters it is dependent upon) and Man (where the parameter is controlled independent of the other parameters), as well as making the parameter the active function. The current mode is indicated on the softkey with either Auto or Man underlined as illustrated below.



#### Auto/Man 1-of-N keys

An Auto/Man 1-of-N key allows you to manually pick from a list of parameter values, or place the function in Auto, in which case the value is automatically selected (and indicated) as shown below. If in Auto, Auto is underlined on the calling key. If in manual operation, manual is indicated on the calling key. But the calling key does not actually toggle the function, it simply opens the menu.

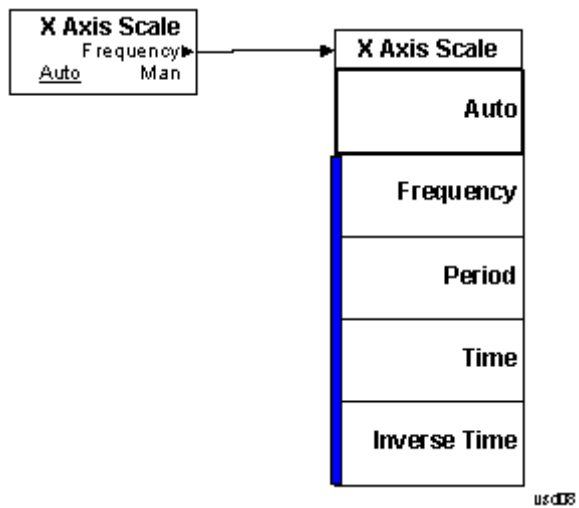

## BW

There is no BW functionality for this measurement.

---

Key Path	Front-panel key
Initial S/W Revision	A.02.00

---

## Cont (Continuous Measurement/Sweep)

Sets the analyzer for Continuous measurement operation. The single/continuous state is Meas Global so the setting will affect all measurements. If you are Paused, pressing Cont does a Resume.

<b>Key Path</b>	Front-panel key
<b>Remote Command</b>	:INITiate:CONTinuous OFF ON 0 1 :INITiate:CONTinuous?
<b>Example</b>	:INIT:CONT 0 puts analyzer in Single measurement operation. :INIT:CONT 1 puts analyzer in Continuous measurement operation
<b>Preset</b>	ON (Note that SYST:PRESet sets INIT:CONT to ON but *RST sets INIT:CONT to OFF)
<b>State Saved</b>	Saved in instrument state
<b>Backwards Compatibility Notes</b>	For Spectrum Analysis mode in ESA and PSA, there is no Cont hardkey, instead there is a Sweep Single/Cont key. In these analyzers, switching the Sweep Single/Cont key from Single to Cont restarts averages (displayed average count reset to 1), but does not restart Max Hold and Min Hold. The X-Series has Single and Cont keys in place of the SweepSingleCont key. In the X-Series, if in single measurement, the Cont key (and INIT:CONT ON ) switches to continuous measurement, but never restarts a measurement and never resets a sweep.
<b>Initial S/W Revision</b>	Prior to A.02.00

In Swept SA Measurement (Spectrum Analysis Mode):

The analyzer takes repetitive sweeps, averages, measurements, etc., when in Continuous mode. When the average count reaches the Average/Hold Number the count stops incrementing, but the analyzer keeps sweeping. See the Trace/Detector section for the averaging formula used both before and after the Average/Hold Number is reached. The trigger condition must be met prior to each sweep. The type of trace processing for multiple sweeps, is set under the Trace/Detector key, with choices of Trace Average, Max Hold, or Min Hold.

In Other Measurements/Modes:

With Avg/Hold Num (in the Meas Setup menu) set to Off or set to On with a value of 1, a sweep is taken after the trigger condition is met; and the analyzer continues to take new sweeps after the current sweep has completed and the trigger condition is again met. However, with Avg/Hold Num set to On with a value >1, multiple sweeps (data acquisitions) are taken for the measurement. The trigger condition must be met prior to each sweep. The sweep is not stopped when the average count k equals the number N set for Avg/Hold Num is reached, but the number k stops incrementing. A measurement average usually applies to all traces, marker results, and numeric results. But sometimes it only applies to the numeric results.

If the analyzer is in Single measurement, pressing the Cont key does not change k and does not cause the sweep to be reset; the only action is to put the analyzer into Continuous measurement operation.

If it is already in continuous sweep:

the INIT:CONT 1 command has no effect



the INIT:CONT 0 command will place the analyzer in Single Sweep but will have no effect on the current sequence until  $k = N$ , at which point the current sequence will stop and the instrument will go to the idle state.

## File

See "File" on page 336

## FREQ Channel

The key accesses a menu allowing you to set Frequency parameters for the current measurement. All measurements in DVB-T/H mode have the same menu structure under FREQ/Channel menu.

Key Path	Front-panel key
Initial S/W Revision	A.02.00

### Channel

Sets the analyzer to a frequency that corresponds to the Channel Number. If the Center Freq value entered does not exactly correlate with the Channel, the displayed value will be “---”.

Key Path	FREQ Channel
Mode	DVB-T/H
<b>Remote Command</b>	<code>[ :SENSe ] :FREQuency:CHANnel:NUMBer &lt;integer&gt;</code> <code>[ :SENSe ] :FREQuency:CHANnel:NUMBer?</code>
<b>Example</b>	FREQ:CHAN:NUMB 21 FREQ:CHAN:NUMB?
Dependencies	If your analyzer has multiple inputs and the selected input is BBIQ, this key will be grayed out and the displaying value will be “---”.
Couplings	Channel is coupled with Center Freq. A certain Channel corresponds to a certain value of Center Freq. If the Center Freq value entered does not exactly correlate with a Channel, the displaying value will be “---”, and the returned value of the SCPI command “FREQ:CHAN:NUMB?” is “-999”.
Preset	21
State Saved	Saved in instrument state.
Min	Depends on the selected channel table
Max	Depends on the selected channel table
Initial S/W Revision	A.02.00

### Center Freq

Sets the center frequency. If your analyzer has multiple inputs (RF and IQ), the displayed value will be updated according to the selected input. SCPI commands are available to directly set the center frequency for a specific input. This key is coupled with Channel when the selected input is RF.

See also:

["RF Center Freq" on page 1333](#)

["IQ Center Freq" on page 1333](#)

Key Path	FREQ Channel
Mode	DVB-T/H
<b>Remote Command</b>	[ :SENSe ] :FREQuency:CENTer <freq> [ :SENSe ] :FREQuency:CENTer?
<b>Example</b>	FREQ:CENT 1.0MHZ FREQ:CENT?
Couplings	Center Freq is coupled with Channel. A certain value of center frequency corresponds to a certain Channel. If the Channel changes, the Center Frequency will be changed to the frequency which is the center of the channel.
Preset	474.00MHz
State Saved	Saved in instrument state.
Min	-79.999995 MHz
Max	Hardware Dependent, for details, see <a href="#">"Maximum Frequency in X - Series Signal Analyzers" on page 1332.</a>
Initial S/W Revision	A.02.00

### Maximum Frequency in X - Series Signal Analyzers

The following table lists the maximum frequency in different X - Series signal analyzers.

Model numbers: N9020A, N9030A

Freq Option	Stop Freq after Mode Preset	Max Freq (can't tune above)
503	3.6 GHz	3.7 GHz
508	8.4 GHz	8.5 GHz
513	13.6 GHz	13.8 GHz
526	26.5 GHz	27.0 GHz
543 (N9030A only)	43 GHz	
544 (N9030A only)	44 GHz	44.5 GHz
550 (N9030A only)	50 GHz	51 GHz

Model number: N9010A

Freq Option	Stop Freq after Mode Preset	Max Freq (can't tune above)
503	3.6 GHz	3.7 GHz
507	7.0 GHz	7.1 GHz

513	13.6 GHz	13.8 GHz
526	26.5 GHz	27.0 GHz
532	32.0 GHz	32.5 GHz
544	44.0 GHz	44.5 GHz

Model number: N9000A

Freq Option	Stop Freq after Mode Preset	Max Freq (can't tune above)
503	3.0 GHz	3.08 GHz
507	7.5 GHz	7.58 GHz

## RF Center Freq

SCPI command to specify the RF Center Frequency. This will always access the RF value, even when the selected input is not RF.

Key Path	FREQ Channel
Mode	DVB-T/H
Remote Command	<code>[ :SENSe ] :FREQuency:RF:CENTer &lt;freq&gt;</code> <code>[ :SENSe ] :FREQuency:RF:CENTer?</code>
Example	FREQ:RF:CENT 1.0MHZ FREQ:RF:CENT?
Couplings	Center Freq is coupled with Channel. A certain value of center frequency corresponds to a certain Channel. If the Channel changes, the Center Frequency will be changed to the frequency which is the center of the channel.
Preset	474.00MHz
State Saved	Saved in instrument state.
Min	-79.999995 MHz
Max	Hardware Dependent, for details, see <a href="#">"Maximum Frequency in X - Series Signal Analyzers" on page 1332.</a>
Initial S/W Revision	A.02.00

## IQ Center Freq

SCPI command to specify the I/Q Center Frequency. This will always access the I/Q value, even when the selected input is not I/Q.

Key Path	FREQ Channel
Mode	DVB-T/H
<b>Remote Command</b>	[ :SENSe ] :FREQuency:IQ:CENTer <freq> [ :SENSe ] :FREQuency:IQ:CENTer?
<b>Example</b>	FREQ:IQ:CENT 1.0MHZ FREQ:IQ:CENT?
Preset	0 Hz
State Saved	Saved in instrument state.
Min	-39.999995 MHz
Max	39.999995 MHz
Initial S/W Revision	A.02.00

### Chan Step

Chan Step changes the step size for the Channel Number.

Key Path	FREQ Channel
Mode	DVB-T/H
<b>Remote Command</b>	[ :SENSe ] :FREQuency:CHANnel:STEP <integer> [ :SENSe ] :FREQuency:CHANnel:STEP?
<b>Example</b>	FREQ:CHAN:STEP 1 FREQ:CHAN:STEP?
Dependencies	If your analyzer has multiple inputs and the selected input is BBIQ, this key will be grayed out.
Preset	1
State Saved	Saved in instrument state.
Min	1
Max	Depends on the selected channel table
Initial S/W Revision	A.02.00

### CF Step

CF Step sets the step size for center frequency. If CF Step State is manual, you can set this value manually. Once CF Step State is changed to auto, CF Step changes to the value of Channel BW automatically.

Key Path	FREQ Channel
Mode	DVB-T/H
<b>Remote Command</b>	[ :SENSe ] :FREQuency:CENTer:STEP [ :INCRement ] <freq> [ :SENSe ] :FREQuency:CENTer:STEP [ :INCRement ] ?

	<code>[ :SENSe ] :FREQuency:CENTer:STEP:AUTO ON OFF 1 0</code>
	<code>[ :SENSe ] :FREQuency:CENTer:STEP:AUTO?</code>
<b>Example</b>	<code>FREQ:CENT:STEP 100KHZ</code> <code>FREQ:CENT:STEP?</code> <code>FREQ:CENT:STEP:AUTO OFF</code> <code>FREQ:CENT:STEP:AUTO?</code>
<b>Couplings</b>	CF Step is coupled to Channel BW (Mode Setup) when CF Step State is 'Auto'.
<b>Preset</b>	8.00MHz ON
<b>State Saved</b>	Saved in instrument state.
<b>Min</b>	1.0 kHz
<b>Max</b>	1 GHz
<b>Initial S/W Revision</b>	A.02.00

## Chan Table

Allows you to choose the appropriate TV standard: NTSC-M, NTSC-J, NTSC-Brazil, PAL-M, PAL-B/G, PAL-D/K, or PAL-I.

<b>Key Path</b>	FREQ Channel
<b>Mode</b>	DVB-T/H
<b>Remote Command</b>	<code>[ :SENSe ] :FREQuency:CHANnel:TABLE[:SElect] MNTSc   JNTSc   BNTSc   MPAL</code> <code>  IPAL   BPAL   DPAL</code> <code>[ :SENSe ] :FREQuency:CHANnel:TABLE[:SElect] ?</code>
<b>Example</b>	<code>FREQ:CHAN:TABL BPAL</code> <code>FREQ:CHAN:TABL?</code>
<b>Dependencies</b>	If your analyzer has multiple inputs and the selected input is BBIQ, this key will be grayed out.
<b>Couplings</b>	Couple with Channel. Setting Chan Table sets the range of Channel to the value corresponding to that Chan Table.
<b>Preset</b>	BPAL
<b>State Saved</b>	Saved in instrument state.
<b>Range</b>	NTSC-M   NTSC-J   NTSC-Brazil   PAL-M   PAL-I   PAL-B/G   PAL-D/K
<b>Initial S/W Revision</b>	A.02.00

## NTSC-M

If the current TV standard is NTSC-M, you can choose the appropriate channel plans in NTSC-M standard: Standard Cable (STD), Broadcast Channel (AIR), HRC Cable (HRC) or IRC Cable (IRC).

Key Path	FREQ Channel, Chan Table
Mode	DVB-T/H
<b>Remote Command</b>	[ :SENSE ] :FREQuency:CHANnel:TABLE:MNTSc [ :SElect ] STD   AIR   HRC   IRC [ :SENSe ] :FREQuency:CHANnel:TABLE:MNTSc [ :SElect ] ?
<b>Example</b>	FREQ:CHAN:TABL:MNTS STD FREQ:CHAN:TABL:MNTS?
Preset	STD
State Saved	Saved in instrument state.
Range	STD   AIR   HRC   IRC
Initial S/W Revision	A.02.00

### NTSC-J

If the current TV standard is NTSC-J, you can choose the appropriate channel plans in NTSC-J standard: Japan Standard Cable (Cable), apan Broadcast channels (AIR), or Japan Digital Cable (Cable Digital).

Key Path	FREQ Channel, Chan Table
Mode	DVB-T/H
<b>Remote Command</b>	[ :SENSE ] :FREQuency:CHANnel:TABLE:JNTSc [ :SElect ] CBL   AIR   DCBL [ :SENSe ] :FREQuency:CHANnel:TABLE:JNTSc [ :SElect ] ?
<b>Example</b>	FREQ:CHAN:TABL:JNTS AIR FREQ:CHAN:TABL:JNTS?
Preset	AIR
State Saved	Saved in instrument state.
Range	Cable AIR Cable Digital
Initial S/W Revision	A.02.00
Modified at S/W Revision	A.08.00

### NTSC-Brazil

If the current TV standard is NTSC-Brazil, you can choose the appropriate channel plans in NTSC-Brazil standard: NTSC-Brazil VHF or NTSC-Brazil UHF. Please refer to Appendix A for more detailed information.

Key Path	FREQ Channel, Chan Table
Mode	DVB-T/H
<b>Remote Command</b>	[ :SENSE ] :FREQuency:CHANnel:TABLE:BNTSc [ :SElect ] VHF   UHF [ :SENSe ] :FREQuency:CHANnel:TABLE:BNTSc [ :SElect ] ?
<b>Example</b>	FREQ:CHAN:TABL:BNTS VHF FREQ:CHAN:TABL:BNTS?



Preset	UHF
State Saved	Saved in instrument state.
Range	VHF UHF
Initial S/W Revision	A.06.00

## PAL-M

If the current TV standard is PAL-M, you can choose the appropriate channel plans in PAL-M standard: Standard Cable (STD), Broadcast Channel (AIR), HRC Cable (HRC) or IRC Cable (IRC).

Key Path	FREQ Channel, Chan Table
Mode	DVB-T/H
<b>Remote Command</b>	[ :SENSe ] :FREQuency:CHANnel:TABLE:MPAL[ :SElect ] STD   AIR   HRC   IRC [ :SENSe ] :FREQuency:CHANnel:TABLE:MPAL[ :SElect ] ?
<b>Example</b>	FREQ:CHAN:TABL:MPAL STD FREQ:CHAN:TABL:MPAL?
Preset	STD
State Saved	Saved in instrument state.
Range	STD   AIR   HRC   IRC
Initial S/W Revision	A.02.00

## PAL-I

If the current TV standard is PAL-I, you can choose the appropriate channel plans in PAL-I standard: HRC Cable (HRC), VHF channels (VHF) or UHF channels (UHF).

Key Path	FREQ Channel, Chan Table
Mode	DVB-T/H
<b>Remote Command</b>	[ :SENSe ] :FREQuency:CHANnel:TABLE:IPAL[ :SElect ] VHF UHF HRC [ :SENSe ] :FREQuency:CHANnel:TABLE:IPAL[ :SElect ] ?
<b>Example</b>	FREQ:CHAN:TABL:IPAL HRC FREQ:CHAN:TABL:IPAL?
Preset	HRC
State Saved	Saved in instrument state.
Range	VHF   UHF   HRC
Initial S/W Revision	A.02.00

## PAL-B/G

If the current TV standard is PAL-B/G, you can choose the appropriate channel plans in PAL-B/G standard: HRC Cable (HRC), VHF channels (VHF), UHF channels (UHF), S channels PAL-B/G Standard (S), S channels PAL-B/G Cable (S-Cable) or CENELEC channels (CENELEC).

<b>Key Path</b>	FREQ Channel, Chan Table
<b>Mode</b>	DVB-T/H
<b>Remote Command</b>	[ :SENSE ] :FREQuency:CHANnel:TABLE:BPAL [ :SElect ] VHF   UHF   HRC   S   SCBL   CEN  [ :SENSe ] :FREQuency:CHANnel:TABLE:BPAL [ :SElect ] ?
<b>Example</b>	FREQ:CHAN:TABL:BPAL HRC FREQ:CHAN:TABL:BPAL?
<b>Preset</b>	UHF
<b>State Saved</b>	Saved in instrument state.
<b>Range</b>	VHF   UHF   HRC   S   S-Cable   CENELEC
<b>Initial S/W Revision</b>	A.02.00

## PAL-D/K

If the current TV standard is PAL-D/K, you can choose the appropriate channel plans in PAL-D/K standard: China Broadcast Channels (DS) or China Standard Cable (Z).

<b>Key Path</b>	FREQ Channel, Chan Table
<b>Mode</b>	DVB-T/H
<b>Remote Command</b>	[ :SENSE ] :FREQuency:CHANnel:TABLE:DPAL [ :SElect ] DS   Z  [ :SENSe ] :FREQuency:CHANnel:TABLE:DPAL [ :SElect ] ?
<b>Example</b>	FREQ:CHAN:TABL:DPAL DS FREQ:CHAN:TABL:DPAL?
<b>Preset</b>	DS
<b>State Saved</b>	Saved in instrument state.
<b>Range</b>	DS   Z
<b>Initial S/W Revision</b>	A.02.00

## Input/Output

See "Input/Output" on page 204

## Marker

Accesses a menu that enables you to select, set up and control the markers for the current measurement.

Key Path	Front-panel key
Initial S/W Revision	A.02.00

### Select Marker

Accesses a menu that enables you to select, set up and control the markers for the current measurement.

Key Path	Marker
Initial S/W Revision	A.02.00

### Marker Type

Sets the marker control mode. If the selected marker is Off, pressing Marker sets it to Normal and places it at the center or left of the screen on the trace of the selected window. At the same time, reference value of the selected marker appears on the Active Function area.

Active Function Display:

Marker X-axis value

Default Active Function: the active function for the selected marker's current control mode. If the current control mode is Off, there is no active function and the active function is turned off.

The marker X-axis value entered in the active function area displays the marker value to its full entered precision.

Key Path	Marker
Mode	DVB-T/H
Remote Command	:CALCulate:EVM:MARKer[1] 2 ...12:MODE POSITION DELTA OFF :CALCulate:EVM:MARKer[1] 2 ...12:MODE?
Example	CALC:EVM:MARK:MODE POS CALC:EVM:MARK:MODE?
Notes	Restrictions Information: If the selected marker is <b>Off</b> , pressing Marker sets it to <b>Normal</b> and places it at the center or left of the screen on the trace of the selected window. At the same time, <b>Marker X-axis Value</b> appears on the Active Function area. <b>Default Active Function:</b> the active function for the selected marker's current control mode. If the current control mode is <b>Off</b> , there is no active function and the active function is turned off. <b>Active Function Display:</b> Marker X-axis value The marker X-axis value entered in the active function area will display the marker value to its full

	entered precision. SCPI Remarks: NORMal is changed to POSition in the new SA.
Preset	OFF
State Saved	Saved in instrument state.
Range	Normal   Delta   Off
Initial S/W Revision	A.02.00

## Properties

Accesses a menu that enables you to select a relative marker and marker trace.

Key Path	Marker
Initial S/W Revision	A.02.00

## Select Marker

Accesses a menu that enables you to select, set up and control the markers for the current measurement.

Key Path	Marker
Initial S/W Revision	A.02.00

## Relative To

Selects the marker the selected marker will be relative to (its reference marker).

Key Path	Marker, Properties
Mode	DVB-T/H
<b>Remote Command</b>	:CALCulate:EVM:MARKer [1]   2   ... 12:REFerence <integer> :CALCulate:EVM:MARKer [1]   2   ... 12:REFerence?
<b>Example</b>	CALC:EVM:MARK:REF 4 CALC:EVM:MARK:REF?
Notes	SCPI Remarks: When queried a single value will be returned (the specified marker numbers relative marker). A marker cannot be relative to itself so that choice is grayed out, and if sent from SCPI generates error -221: "Settings conflict; marker cannot be relative to itself."
Preset	2 3 4 5 6 7 8 9 10 11 12 1
State Saved	Saved in instrument state.
Min	1

Max	12
Initial S/W Revision	A.02.00

## Marker Trace

Assigns the specified marker to the designated trace.

In the DVB-T/H Modulation Accuracy measurement, there are eight named traces. If the marker is not Off, you can move the marker from the trace it was on to the selected trace using Marker Trace panel. The marker will retain its relative horizontal position in the new window.

If the marker is Off, it stays off, but it is now associated with the specified trace.

The query returns the name of the trace on which the marker is currently placed.

Key Path	Marker, Properties
Mode	DVB-T/H
Remote Command	:CALCulate:EVM:MARKer[1] 2 ...12:TRACe POLar   MVCarrier   SPECTrum   AVCarrier   PVCCarrier   GDVCarrier   AVTime   MVTime :CALCulate:EVM:MARKer[1] 2 ...12:TRACe?
Example	CALC:EVM:MARK:TRACE MVC CALC:EVM:MARK:TRACE?
Preset	MVC
State Saved	Saved in instrument state.
Range	Polar Trace   MER/EVM vs. Carr/Freq   Spectrum   Amptd vs. Carr   Phase vs. Carr   GD vs. Carr   Amptd vs. Time   MER vs. Time
Initial S/W Revision	A.02.00
Modified at S/W Revision	A.06.00

## Couple Markers

Toggles the state of the markers coupling between on and off. When this function is active (On), moving any marker causes an “equal X-axis movement” of every other marker that is not set to Off. “Equal X-axis movement” means that the differences between the coupled markers’ X-axis value (in the fundamental x-axis units of the trace that marker is on) are preserved and the X-axis value of each marker is moved (in the same fundamental x-axis units).

This can result in markers going off-screen.

Key Path	Marker, More
Mode	DVB-T/H
Remote Command	:CALCulate:EVM:MARKer:COUPlE[:STATe] OFF ON 0 1 :CALCulate:EVM:MARKer:COUPlE[:STATe]?

<b>Example</b>	CALC:EVM:MARK:COUP ON CALC:EVM:MARK:COUP?
Preset	OFF
State Saved	Saved in instrument state.
Range	On   Off
Initial S/W Revision	A.02.00

## All Markers Off

Turns off all markers.

Key Path	Marker, More
Mode	DVB-T/H
<b>Remote Command</b>	:CALCulate:EVM:MARKer:AOff
<b>Example</b>	CALC:EVM:MARK:AOff
Initial S/W Revision	A.02.00

## Marker X-axis Value (Remote Command only)

Sets the marker X-axis value in the current marker X-axis Scale unit. It has no effect if the marker type is Off, but is the SCPI equivalent of entering an X value if the marker type is Normal or Delta.

Mode	DVB-T/H
<b>Remote Command</b>	:CALCulate:EVM:MARKer[1] 2 ...12:X <real> :CALCulate:EVM:MARKer[1] 2 ...12:X?
<b>Example</b>	CALC:EVM:MARK3:X 0.0 CALC:EVM:MARK3:X?
Notes	Restrictions Information: The marker X-axis value has no unit suffix. For capture time data trace, the unit is second. The query returns the marker's absolute X-axis value if the control mode is <b>Normal</b> , or the offset from the marker's reference marker if the control mode is <b>Delta</b> . The query is returned without unit suffix. Depending on the trace, the SCPI Command/Query will support/return a sub-carrier value, a frequency value or a time value.
Preset	After a preset, all Markers are turned OFF, so Marker X-axis Value query will return a not a number (NAN).
State Saved	No
Min	-9.9E+37
Max	9.9E+37
Initial S/W Revision	A.02.00

### Marker X-axis Position (Remote Command only)

Sets the marker X position in trace points. It has no effect if the marker type is Off, but is the SCPI equivalent of entering a value if the marker type is Normal or Delta - except in trace points rather than X-axis Scale units. The entered value is immediately translated into the current X-axis Scale units for setting the value of the marker.

Mode	DVB-T/H
<b>Remote Command</b>	:CALCulate:EVM:MARKer[1] 2 ...12:X:POSition <real> :CALCulate:EVM:MARKer[1] 2 ...12:X:POSition?
<b>Example</b>	CALC:EVM:MARK10:X:POS 0 CALC:EVM:MARK10:X:POS?
Preset	After a preset, all Markers are turned OFF, so Marker X-axis Value query will return a not a number (NAN).
State Saved	No
Min	-9.9E+37
Max	9.9E+37
Initial S/W Revision	A.02.00

### Marker Y-axis Value (Remote Command only)

Queries the marker Y-axis value in the current marker Y-axis unit.

Mode	DVB-T/H
<b>Remote Command</b>	:CALCulate:EVM:MARKer[1] 2 ...12:Y?
<b>Example</b>	CALC:EVM:MARK11:Y?
Preset	Result depends on markers setup and signal source
State Saved	No
Initial S/W Revision	A.02.00



## Marker Function

There are no Marker Function operations supported in the Modulation Accuracy measurement. The front-panel key displays a blank menu when pressed.

---

Key Path	Front-panel key
Initial S/W Revision	A.02.00

---

## Marker To

There is no Marker To function supported in the Modulation Accuracy measurement. The front-panel key will display a blank menu when pressed.

---

Key Path	Front-panel key
Initial S/W Revision	A.02.00

---

## Meas

The information in this section is common to all measurements. For key and remote command information for a specific measurement, refer to the section that describes the measurement of interest.

Measurements available under the Meas key are specific to the current Mode.

When viewing Help for measurements, note the following:

**NOTE**

Operation for some keys differs between measurements. The information displayed in Help pertains to the current measurement. To see how a key operates in a different measurement, exit Help (press the Cancel Esc key), select the measurement, then reenter Help (press the Help key) and press that key.

---

Key Path	Front-panel key
Initial S/W Revision	Prior to A.02.00

---

### Remote Measurement Functions

This section contains the following topics:

"Measurement Group of Commands" on page 2166

"Current Measurement Query (Remote Command Only)" on page 2168

"Limit Test Current Results (Remote Command Only)" on page 2168

"Data Query (Remote Command Only)" on page 2168

"Calculate/Compress Trace Data Query (Remote Command Only)" on page 2169

"Calculate Peaks of Trace Data (Remote Command Only)" on page 2174

Hardware-Accelerated Fast Power Measurement (Remote Command Only)

"Format Data: Numeric Data (Remote Command Only)" on page 2175

"Format Data: Byte Order (Remote Command Only)" on page 2176

---

Initial S/W Revision	Prior to A.02.00
----------------------	------------------

---

## Measurement Group of Commands

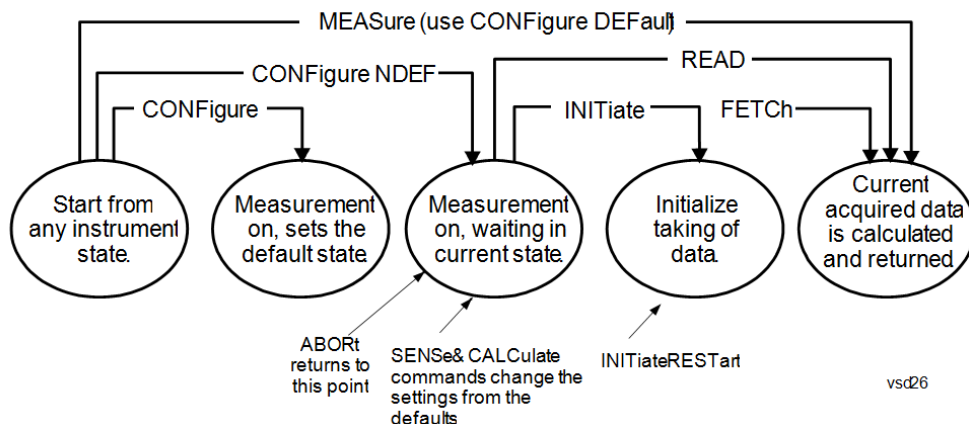

---

### Measure Commands:

:MEASure:<measurement>[n]?

This is a fast single-command way to make a measurement using the factory default instrument settings. These are the settings and units that conform to the Mode Setup settings (e.g. radio standard) that you have currently selected.

- Stops the current measurement (if any) and sets up the instrument for the specified measurement using the factory defaults
- Initiates the data acquisition for the measurement
- Blocks other SCPI communication, waiting until the measurement is complete before returning results.
- If the function does averaging, it is turned on and the number of averages is set to 10.
- After the data is valid it returns the scalar results, or the trace data, for the specified measurement. The type of data returned may be defined by an [n] value that is sent with the command.
- The scalar measurement results will be returned if the optional [n] value is not included, or is set to 1. If the [n] value is set to a value other than 1, the selected trace data results will be returned. See each command for details of what types of scalar results or trace data results are available.
- ASCII is the default format for the data output. (Older versions of Spectrum Analysis and Phase Noise mode measurements only use ASCII.) The binary data formats should be used for handling large blocks of data since they are smaller and faster than the ASCII format. Refer to the FORMat:DATA command for more information.

If you need to change some of the measurement parameters from the factory default settings you can set up the measurement with the CONFIgure command. Use the commands in the SENSe:<measurement> and CALCulate:<measurement> subsystems to change the settings. Then you can use the READ? command to initiate the measurement and query the results.

If you need to repeatedly make a given measurement with settings other than the factory defaults, you can use the commands in the SENSe:<measurement> and CALCulate:<measurement> subsystems to set up the measurement. Then use the READ? command to initiate the measurement and query results.

Measurement settings persist if you initiate a different measurement and then return to a previous one. Use READ:<measurement>? if you want to use those persistent settings. If you want to go back to the default settings, use MEASure:<measurement>?.

---

### Configure Commands:

:CONFIgure:<measurement>

This command stops the current measurement (if any) and sets up the instrument for the specified measurement using

---

---

the factory default instrument settings. It does not initiate the taking of measurement data unless INIT:CONTInuous is ON. If you change any measurement settings after using the CONFigure command, the READ command can be used to initiate a measurement without changing the settings back to their defaults.

In the Swept SA measurement in Spectrum Analyzer mode the CONFigure command also turns the averaging function on and sets the number of averages to 10 for all measurements.

:CONFigure: <measurement>: NDEFault stops the current measurement and changes to the specified measurement. It does not change the settings to the defaults. It does not initiate the taking of measurement data unless INIT:CONTInuous is ON.

The CONFigure? query returns the current measurement name.

The CONFigure:CATalog? query returns a quoted string of all licensed measurement names in the current mode. For example, "SAN, CHP, OBW, ACP, PST, TXP, SPUR, SEM, LIST".

---

#### Fetch Commands:

:FETCh:<measurement>[n]?

This command puts selected data from the most recent measurement into the output buffer. Use FETCh if you have already made a good measurement and you want to return several types of data (different [n] values, for example, both scalars and trace data) from a single measurement. FETCh saves you the time of re-making the measurement. You can only FETCh results from the measurement that is currently active, it will not change to a different measurement. An error message is reported if a measurement other than the current one is specified.

If you need to get new measurement data, use the READ command, which is equivalent to an INITiate followed by a FETCh.

The scalar measurement results will be returned if the optional [n] value is not included, or is set to 1. If the [n] value is set to a value other than 1, the selected trace data results will be returned. See each command for details of what types of scalar results or trace data results are available. The binary data formats should be used for handling large blocks of data since they are smaller and transfer faster than the ASCII format. (FORMat:DATA)

FETCh may be used to return results other than those specified with the original READ or MEASure command that you sent.

---

#### INITiate Commands:

:INITiate:<measurement>

This command is not available for measurements in all the instrument modes:

- Initiates a trigger cycle for the specified measurement, but does not output any data. You must then use the FETCh<meas> command to return data. If a measurement other than the current one is specified, the instrument will switch to that measurement and then initiate it.
- For example, suppose you have previously initiated the ACP measurement, but now you are running the channel power measurement. If you send INIT:ACP? it will change from channel power to ACP and will initiate an ACP measurement.
- Does not change any of the measurement settings. For example, if you have previously started the ACP measurement and you send INIT:ACP? it will initiate a new ACP measurement using the same instrument settings as the last time ACP was run.
- If your selected measurement is currently active (in the idle state) it triggers the measurement, assuming the trigger conditions are met. Then it completes one trigger cycle. Depending upon the measurement and the number of averages, there may be multiple data acquisitions, with multiple trigger events, for one full trigger cycle. It also holds off additional commands on GPIB until the acquisition is complete.

---

#### READ Commands:

:READ:<measurement>[n]?

- Does not preset the measurement to the factory default settings. For example, if you have previously initiated the ACP
-

---

measurement and you send READ:ACP? it will initiate a new measurement using the same instrument settings.

- Initiates the measurement and puts valid data into the output buffer. If a measurement other than the current one is specified, the instrument will switch to that measurement before it initiates the measurement and returns results.
  - For example, suppose you have previously initiated the ACP measurement, but now you are running the channel power measurement. Then you send READ:ACP? It will change from channel power back to ACP and, using the previous ACP settings, will initiate the measurement and return results.
  - Blocks other SCPI communication, waiting until the measurement is complete before returning the results
  - If the optional [n] value is not included, or is set to 1, the scalar measurement results will be returned. If the [n] value is set to a value other than 1, the selected trace data results will be returned. See each command for details of what types of scalar results or trace data results are available. The binary data formats should be used when handling large blocks of data since they are smaller and faster than the ASCII format. (FORMat:DATA)
- 

---

Initial S/W Revision	Prior to A.02.00
----------------------	------------------

---

### Current Measurement Query (Remote Command Only)

This command returns the name of the measurement that is currently running.

---

<b>Remote Command</b>	:CONFigure?
-----------------------	-------------

<b>Example</b>	CONF?
----------------	-------

Initial S/W Revision	Prior to A.02.00
----------------------	------------------

---

### Limit Test Current Results (Remote Command Only)

Queries the status of the current measurement limit testing. It returns a 0 if the measured results pass when compared with the current limits. It returns a 1 if the measured results fail any limit tests.

---

<b>Remote Command</b>	:CALCulate:CLIMits:FAIL?
-----------------------	--------------------------

<b>Example</b>	CALC:CLIM:FAIL? queries the current measurement to see if it fails the defined limits. Returns a 0 or 1: 0 it passes, 1 it fails.
----------------	--

Initial S/W Revision	Prior to A.02.00
----------------------	------------------

---

### Data Query (Remote Command Only)

Returns the designated measurement data for the currently selected measurement and subopcode.

n = any valid subopcode for the current measurement. See the measurement command results table for your current measurement, for information about what data is returned for the subopcodes.

This command uses the data setting specified by the FORMat:BORDER and FORMat:DATA commands and can return real or ASCII data. (See the format command descriptions under Input/Output in the Analyzer Setup section.)

<b>Remote Command</b>	:CALCulate:DATA[n]?
<b>Notes</b>	The return trace depends on the measurement. In CALCulate:<meas>:DATA[n], n is any valid subopcode for the current measurement. It returns the same data as the FETCH:<measurement>? query where <measurement> is the current measurement.
<b>Initial S/W Revision</b>	Prior to A.02.00

### Calculate/Compress Trace Data Query (Remote Command Only)

Returns compressed data for the currently selected measurement and sub-opcode [n].

n = any valid sub-opcode for that measurement. See the MEASure:<measurement>? command description of your specific measurement for information on the data that can be returned.

The data is returned in the current Y Axis Unit of the analyzer. The command is used with a sub-opcode <n> (default=1) to specify the trace. With trace queries, it is best if the analyzer is not sweeping during the query. Therefore, it is generally advisable to be in Single Sweep, or Update=Off.

This command is used to compress or decimate a long trace to extract and return only the desired data. A typical example would be to acquire N frames of GSM data and return the mean power of the first burst in each frame. The command can also be used to identify the best curve fit for the data.

<b>Remote Command</b>	:CALCulate:DATA<n>:COMPRESS? BLOCK   CFIT   MAXimum   MINimum   MEAN   DMEan   RMS   RMSCubed   SAMPLE   SDEVIation   PPHase [,<soffset> [,<length>[,<roffset>[,<rlimit>]]]]
<b>Example</b>	To query the mean power of a set of GSM bursts: Supply a signal that is a set of GSM bursts. Select the IQ Waveform measurement (in IQ Analyzer Mode). Set the sweep time to acquire at least one burst. Set the triggers such that acquisition happens at a known position relative to a burst. Then query the mean burst levels using, CALC:DATA2:COMP? MEAN, 24e-6, 526e-6 (These parameter values correspond to GSM signals, where 526e-6 is the length of the burst in the slot and you just want 1 burst.)
<b>Notes</b>	The command supports 5 parameters. Note that the last 4 (<soffset>, <length>, <roffset>, <rlimit>) are optional. But these optional parameters must be entered in the specified order. For example, if you want to specify <length>, then you must also specify <soffset>. See details below for a definition of each of these parameters.  This command uses the data in the format specified by FORMat:DATA, returning either binary or ASCII data.
<b>Initial S/W Revision</b>	Prior to A.02.00

- BLOCK or block data - returns all the data points from the region of the trace data that you specify. For example, it could be used to return the data points of an input signal over several timeslots, excluding the portions of the trace data that you do not want. (This is x,y pairs for trace data and I,Q pairs for complex data.)

- CFIT or curve fit - applies curve fitting routines to the data. <soffset> and <length> are required to define the data that you want. <roffset> is an optional parameter for the desired order of the curve equation. The query will return the following values: the x-offset (in seconds) and the curve coefficients ((order + 1) values).

MIN, MAX, MEAN, DME, RMS, RMSC, SAMP, SDEV and PPH return one data value for each specified region (or <length>) of trace data, for as many regions as possible until you run out of trace data (using <roffset> to specify regions). Or they return the number of regions you specify (using <rlimit>) ignoring any data beyond that.

- MINimum - returns the minimum data point (y value) for the specified region(s) of trace data. For I/Q trace data, the minimum magnitude of the I/Q pairs is returned.
- MAXimum - returns the maximum data point (y value) for the specified region(s) of trace data. For I/Q trace data, the maximum magnitude of the I/Q pairs is returned.
- MEAN - returns a single value that is the arithmetic mean of the data point values (in dB/ dBm) for the specified region(s) of trace data. For I/Q trace data, the mean of the magnitudes of the I/Q pairs is returned. See the following equations.

**NOTE** If the original trace data is in dB, this function returns the arithmetic mean of those log values, not log of the mean power which is a more useful value. The mean of the log is the better measurement technique when measuring CW signals in the presence of noise. The mean of the power, expressed in dB, is useful in power measurements such as Channel Power. To achieve the mean of the power, use the RMS option.

Equation 1

Mean Value of Data Points for Specified Region(s)

$$\text{MEAN} = \frac{1}{n} \sum_{X_i \in \text{region}(s)} X_i$$

where  $X_i$  is a data point value, and  $n$  is the number of data points in the specified region(s).

Equation 2

Mean Value of I/Q Data Pairs for Specified Region(s)

$$\text{MEAN} = \frac{1}{n} \sum_{X_i \in \text{region}(s)} |X_i|$$

where  $|X_i|$  is the magnitude of an I/Q pair, and  $n$  is the number of I/Q pairs in the specified region(s).

- DMEan - returns a single value that is the mean power (in dB/ dBm) of the data point values for the specified region(s) of trace data. See the following equation:

Equation 3

DMEan Value of Data Points for Specified Region(s)



$$\text{DME} = 10 \times \log_{10} \left( \frac{1}{n} \sum_{X_i \in \text{region}(s)} 10^{\frac{X_i}{10}} \right)$$

- RMS - returns a single value that is the average power on a root-mean-squared voltage scale (arithmetic rms) of the data point values for the specified region(s) of trace data. See the following equation.

**NOTE** For I/Q trace data, the rms of the magnitudes of the I/Q pairs is returned. See the following equation. This function is very useful for I/Q trace data. However, if the original trace data is in dB, this function returns the rms of the log values which is not usually needed.

Equation 4

RMS Value of Data Points for Specified Region(s)

$$\text{RMS} = \sqrt{\frac{1}{n} \sum_{X_i \in \text{region}(s)} X_i^2}$$

where  $X_i$  is a data point value, and  $n$  is the number of data points in the specified region(s).

Equation 5

RMS Value of I/Q Data Pairs for Specified Region(s)

$$\text{RMS} = \sqrt{\frac{1}{n} \sum_{X_i \in \text{region}(s)} X_i X_i^*}$$

where  $X_i$  is the complex value representation of an I/Q pair,  $X_i^*$  its conjugate complex number, and  $n$  is the number of I/Q pairs in the specified region(s).

Once you have the rms value for a region of trace data (linear or I/Q), you may want to calculate the mean power. You must convert this rms value (peak volts) to power in dBm:

$$10 \times \log[10 \times (\text{rms value})^2]$$

- SAMPLe - returns the first data value (x,y pair) for the specified region(s) of trace data. For I/Q trace data, the first I/Q pair is returned.
- SDEVIation - returns a single value that is the arithmetic standard deviation for the data point values for the specified region(s) of trace data. See the following equation.
- For I/Q trace data, the standard deviation of the magnitudes of the I/Q pairs is returned. See the following equation.

Equation 6

Standard Deviation of Data Point Values for Specified Region(s)

$$\text{SDEV} = \sqrt{\frac{1}{n} \sum_{X_i \in \text{region}(s)} (X_i - \bar{X})^2}$$

where  $X_i$  is a data point value,  $\bar{X}$  is the arithmetic mean of the data point values for the specified region (s), and  $n$  is the number of data points in the specified region(s).

$$\text{SDEV} = \sqrt{\frac{1}{n} \sum_{X_i \in \text{region}(s)} (|X_i| - \bar{X})^2}$$

where  $|X_i|$  is the magnitude of an I/Q pair,  $\bar{X}$  is the mean of the magnitudes for the specified region(s), and  $n$  is the number of data points in the specified region(s).

- PPHase - returns the x,y pairs of both rms power (dBm) and arithmetic mean phase (radian) for every specified region and frequency offset (Hz). The number of pairs is defined by the specified number of regions. This parameter can be used for I/Q vector ( $n=0$ ) in Waveform (time domain) measurement and all parameters are specified by data point in PPHase.

The rms power of the specified region may be expressed as:

$$\text{Power} = 10 \times \log [10 \times (\text{RMS I/Q value})] + 10.$$

The RMS I/Q value (peak volts) is:

$$\sqrt{\frac{1}{n} \sum_{X_i \in \text{region}} X_i X_i^*}$$

where  $X_i$  is the complex value representation of an I/Q pair,  $X_i^*$  its conjugate complex number, and  $n$  is the number of I/Q pairs in the specified region.

The arithmetic mean phase of the specified region may be expressed as:

$$\frac{1}{n} \sum_{Y_i \in \text{region}} Y_i$$

where  $Y_i$  is the unwrapped phase of I/Q pair with applying frequency correction and  $n$  is the number of I/Q pairs in the specified region.

The frequency correction is made by the frequency offset calculated by the arithmetic mean of every specified region's frequency offset. Each frequency offset is calculated by the least square method against the unwrapped phase of I/Q pair.

Sample Trace Data - Constant Envelope

(See below for explanation of variables.)

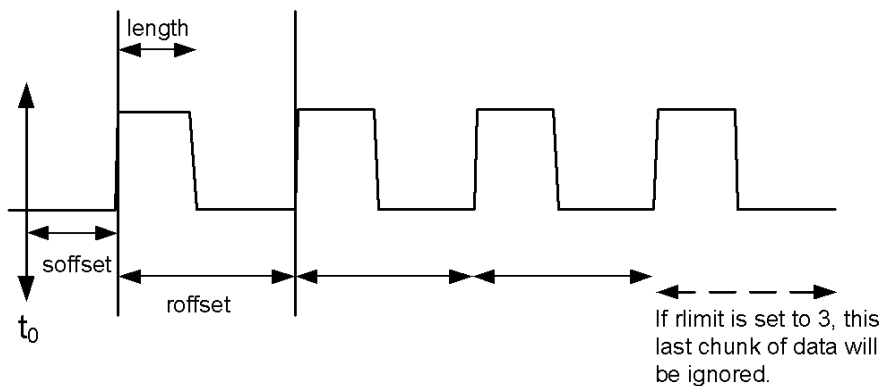

### Sample Trace Data - Not Constant Envelope

(See below for explanation of variables.)

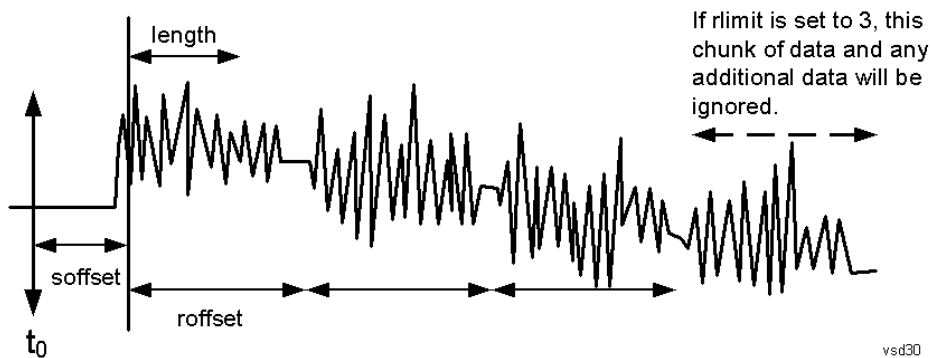

<soffset> - start offset is an optional real number. (It is in seconds for time-domain traces, and is a dimensionless index 0 to Npoints - 1, for frequency-domain traces). It specifies the amount of data at the beginning of the trace that will be ignored before the decimation process starts. It is the time or frequency change from the start of the trace to the point where you want to start using the data. The default value is zero.

<length> - is an optional real number. (It is in seconds for time-domain traces, and is a dimensionless index 0 to Npoints - 1, for frequency-domain traces). It defines how much data will be compressed into one value. This parameter has a default value equal to the current trace length.

<roffset> - repeat offset is an optional real number. (It is in seconds for time-domain traces, and is a dimensionless index 0 to Npoints - 1, for frequency-domain traces). It defines the beginning of the next field of trace elements to be compressed. This is relative to the beginning of the previous field. This parameter has a default value equal to the <length> variable. Note that this parameter is used for a completely different purpose when curve fitting (see CFIT above).

<rlimit> - repeat limit is an optional integer. It specifies the number of data items that you want returned. It will ignore any additional items beyond that number. You can use the Start offset and the Repeat limit to pick out exactly what part of the data you want to use. The default value is all the data.

## Calculate Peaks of Trace Data (Remote Command Only)

Returns a list of all the peaks for the currently selected measurement and sub-opcode [n]. The peaks must meet the requirements of the peak threshold and excursion values.

n = any valid sub-opcode for the current measurement. See the MEASure:<measurement> command description of your specific measurement for information on the data that can be returned.

The command can only be used with specific sub-opcodes with measurement results that are trace data. Both real and complex traces can be searched, but complex traces are converted to magnitude in dBm. In many measurements the sub-opcode n=0, is the raw trace data which cannot be searched for peaks. And Sub-opcode n=1, is often calculated results values which also cannot be searched for peaks.

This command uses the data setting specified by the FORMat:BORDER and FORMat:DATA commands and can return real or ASCII data. If the format is set to INT,32, it returns REAL,32 data.

The command has four types of parameters:

- Threshold (in dBm)
- Excursion (in dB)
- Sorting order (amplitude, frequency, time)
- Optional in some measurements: Display line use (all, > display line, < display line)

---

<b>Remote Command</b>	<p>For Swept SA measurement:</p> <pre>:CALCulate:DATA[1] 2 ... 6:PEAKs? &lt;threshold&gt;,&lt;excursion&gt;[,AMPLitude   FREQuency   TIME[,ALL   GTDLine   LTDLine]]</pre> <p>For most other measurements:</p> <pre>:CALCulate:DATA[1] 2 ... 6:PEAKs? &lt;threshold&gt;,&lt;excursion&gt;[,AMPLitude   FREQuency   TIME]</pre>
-----------------------	--

---

<b>Example</b>	<p>Example for Swept SA measurement in Spectrum Analyzer Mode:</p> <p>CALC:DATA4:PEAK? -40, 10, FREQ, GTDL This will identify the peaks of trace 4 that are above -40 dBm, with excursions of at least 10 dB. The peaks are returned in order of increasing frequency, starting with the lowest frequency. Only the peaks that are above the display line are returned.</p> <p>Query Results 1:</p> <p>With FORMat:DATA REAL, 32 selected, it returns a list of floating-point numbers. The first value in the list is the number of peak points that are in the following list. A peak point consists of two values: a peak amplitude followed by its corresponding frequency (or time).</p> <p>If no peaks are found the peak list will consist of only the number of peaks, (0).</p>
----------------	---

---

<b>Notes</b>	<p>&lt;n&gt; - is the trace that will be used</p> <p>&lt;threshold&gt; - is the level below which trace data peaks are ignored. Note that the threshold value is required and is always used as a peak criterion. To effectively disable the threshold criterion for this command, provide a substantially low threshold value such as -200 dBm. Also note that the threshold value used in this command is independent of and has no effect on the threshold value stored under the Peak Criteria menu.</p> <p>&lt;excursion&gt; - is the minimum amplitude variation (rise and fall) required for a signal to be identified as peak. Note that the excursion value is required and is always used as a peak criterion. To effectively disable the excursion criterion for this command, provide the minimum value of 0.0 dB. Also note that the excursion value used in this command is independent of and has no effect on the</p>
--------------	---

---

excursion value stored under the Peak Criteria menu.

Values must be provided for threshold and excursion. The sorting and display line parameters are optional (defaults are AMPLitude and ALL).

Note that there is always a Y-axis value for the display line, regardless of whether the display line state is on or off. It is the current Y-axis value of the display line which is used by this command to determine whether a peak should be reported

Sorting order:

AMPLitude - lists the peaks in order of descending amplitude, with the highest peak first (default if optional parameter not sent)

FREQUency - lists the peaks in order of occurrence, left to right across the x-axis.

TIME - lists the peaks in order of occurrence, left to right across the x-axis.

Peaks vs. Display Line:

ALL - lists all of the peaks found (default if optional parameter not sent).

GTDLine (greater than display line) - lists all of the peaks found above the display line.

LTDLine (less than display line) - lists all of the peaks found below the display line.

---

Initial S/W Revision      Prior to A.02.00

---

### Format Data: Numeric Data (Remote Command Only)

This command specifies the format of the trace data input and output. It specifies the formats used for trace data during data transfer across any remote port. It affects only the data format for setting and querying trace data for the :TRACe[:DATA], TRACe[:DATA]?, :CALCulate:DATA[n]? and FETCh:SANalyzer [n]? commands and queries.

---

**Remote Command**      :FORMat[:TRACe][:DATA] ASCii|INTeger,32|REAL,32 |REAL,64  
:FORMat[:TRACe][:DATA]?

---

**Notes**      The query response is:  
ASCii: ASC,8  
REAL,32: REAL,32  
REAL,64: REAL,64  
INTeger,32: INT,32

When the numeric data format is REAL or ASCii, data is output in the current Y Axis unit. When the data format is INTeger, data is output in units of m dBm (.001 dBm).

The INT,32 format returns binary 32-bit integer values in internal units (m dBm), in a definite length block.

---

**Dependencies**      Sending a data format spec with an invalid number (for example, INT,48) generates no error. The analyzer simply uses the default (8 for ASCii, 32 for INTeger, 32 for REAL).

Sending data to the analyzer which does not conform to the current FORMat specified, results in an error. Sending ASCII data when a definite block is expected generates message -161 "Invalid Block Data" and sending a definite block when ASCII data is expected generates message -121 "Invalid Character in Number".

---

**Preset**      ASCii

---

**Backwards Compatibility Notes**      Note that the INT,32 format is only applicable to the command, TRACe:DATA. This preserves backwards compatibility for the Swept SA measurement. For all other commands/queries which honor FORMat:DATA, if INT,32 is sent the analyzer will behave as though it were set to REAL,32.

---

Initial S/W Revision      Prior to A.02.00

---

The specs for each output type follow:

AScii - Amplitude values are in ASCII, in the current Y Axis Unit, one ASCII character per digit, values separated by commas, each value in the form:

SX.YYYYYEsZZ

Where:

S = sign (+ or -)

X = one digit to left of decimal point

Y = 5 digits to right of decimal point

E = E, exponent header

s = sign of exponent (+ or -)

ZZ = two digit exponent

REAL,32 - Binary 32-bit real values in the current Y Axis Unit, in a definite length block.

REAL,64 - Binary 64-bit real values in the current Y Axis Unit, in a definite length block.

### Format Data: Byte Order (Remote Command Only)

This command selects the binary data byte order for data transfer and other queries. It controls whether binary data is transferred in normal or swapped mode. This command affects only the byte order for setting and querying trace data for the :TRACe[:DATA], TRACe[:DATA]? , :CALCulate:DATA[n]? and FETCh:SANalyzer[n]? commands and queries.

By definition any command that says it uses FORMat:DATA uses any format supported by FORMat:DATA.

The NORMal order is a byte sequence that begins with the most significant byte (MSB) first, and ends with the least significant byte (LSB) last in the sequence: 1|2|3|4. SWAPped order is when the byte sequence begins with the LSB first, and ends with the MSB last in the sequence: 4|3|2|1.

---

**Remote Command** :FORMat:BORDER NORMal | SWAPped

:FORMat:BORDER?

---

**Preset** NORMal

---

**Initial S/W Revision** Prior to A.02.00

---

## Meas Setup

This key displays the measurement setup menu for the Modulation Accuracy measurement when the Modulation Accuracy measurement is selected in the Meas menu.

Key Path	Front-panel key
Initial S/W Revision	A.02.00

### Avg/Hold Num

This key sets the number of measurements to be averaged. After the specified number (average counts) have been averaged, the averaging mode (termination control) setting determines the averaging action.

Key Path	Meas Setup
Mode	DVB-T/H
<b>Remote Command</b>	[:SENSe]:EVM:AVERage:COUNT <integer> [:SENSe]:EVM:AVERage:COUNT? [:SENSe]:EVM:AVERage[:STATe] OFF ON 0 1 [:SENSe]:EVM:AVERage[:STATe]?
<b>Example</b>	EVM:AVER:COUN 100 EVM:AVER:COUN? EVM:AVER OFF EVM:AVER?
Preset	10 OFF
State Saved	Saved in instrument state.
Min	1
Max	10000
Initial S/W Revision	A.02.00

### Avg Mode

This key selects the type of termination control used for the averaging function. This determines the averaging action after the specified number of data acquisitions (average count) is reached. You can select between the Exp (exponential) and Repeat averaging modes. This selection only affects the averaging result after the number of N averages is reached. You can use the Avg/Hold Num key to set N.

KEY: Exponential averaging SCPI: EXPonential	When Measure is set at Cont, data acquisitions will continue indefinitely. After N averages, exponential averaging is used with a weighting factor of N (the displayed average count stops at N). Exponential averaging weights new data more than old data, which allows tracking of slow-changing signals.
---	--

<b>KEY:</b> Repeat averaging <b>SCPI:</b> REPeat	When Measure is set at Cont, data acquisitions will continue indefinitely. After N averages is reached, all previous result data is cleared and the average count is set back to 1. This is equivalent to being in Measure Single and pressing the Restart key when the Single measurement finishes.
---	--

<b>Key Path</b>	Meas Setup
<b>Mode</b>	DVB-T/H
<b>Remote Command</b>	[ :SENSe ] :EVM:AVERage:TCONtrol EXPonential REPeat [ :SENSe ] :EVM:AVERage:TCONtrol?
<b>Example</b>	EVM:AVER:TCON EXP EVM:AVER:TCON?
<b>Preset</b>	EXPonential
<b>State Saved</b>	Saved in instrument state.
<b>Range</b>	Exp   Repeat
<b>Initial S/W Revision</b>	A.02.00

### Auto Detect

This key is used for auto-demodulation. It means that modulation parameters will be auto-detected from the input signal instead of manually set by you.

These parameters include FFT size, Modulation Format, Alpha, Guard Interval, Hierarchical state, Inner Interleaver, HP Code Rate, and LP Code Rate.

This is a "one-time" function, that is, it executes once, when the key is pressed.

<b>Key Path</b>	Meas Setup
<b>Mode</b>	DVB-T/H
<b>Remote Command</b>	[ :SENSe ] :EVM:DETect
<b>Example</b>	EVM:DET
<b>Initial S/W Revision</b>	A.02.00

### Demod

Specifies the demodulation parameters.

<b>Key Path</b>	Meas Setup
<b>Initial S/W Revision</b>	A.02.00
<b>Modified at S/W Revision</b>	A.07.00



## Guard Interval

Sets the value of guard interval. The available selections include 1/4, 1/8, 1/16, and 1/32.

In DVB-T/H standard, guard interval is a cyclic continuation of the useful OFDM symbol time domain samples. The guard interval is inserted before the OFDM block and is used to prevent the useful OFDM symbol from the interference of the previous symbol.

Key Path	Meas Setup, Demod
Mode	DVB-T/H
Remote Command	[ :SENSe ] :EVM:GINTerval:RATio R1BY4 R1BY8 R1BY16 R1BY32 [ :SENSe ] :EVM:GINTerval:RATio?
Example	EVM:GINT:RAT R1BY4 EVM:GINT:RAT?
Preset	R1BY4
State Saved	Saved in instrument state.
Range	1/4 1/8 1/16 1/32
Backwards Compatibility SCPI	[ :SENSe ] :RADio:STANdard:GINTerval:RATio
Initial S/W Revision	A.02.00
Modified at S/W Revision	A.07.00

## FFT Size

Sets the number of subcarriers in one OFDM symbol. The available selections are 2K mode (1705 carriers), 4K mode (3409 carriers), and 8K mode (6817 carriers). Note that the 4K mode is available only for DVB-H standard.

Key Path	Meas Setup, Demod
Mode	DVB-T/H
Remote Command	[ :SENSe ] :EVM:NFFT N2K N4K N8K [ :SENSe ] :EVM:NFFT?
Example	EVM:NFFT N2K EVM:NFFT?
Notes	OFDM Modulation: the sequence of blocks is modulated according to the OFDM technique, using 2048, 4096, or 8192 carriers (2K, 4K, 8K mode, respectively). Increasing the number of carriers does not modify the payload bit rate, which remains constant.
Dependencies	If the Radio Std is DVBT, the 4K key is grayed out and there are only two selections, 2K and 8K. If Inner Interleaver (Meas Setup, Decode) is In-depth, the 8K key is grayed out. If 8K is selected, the In-depth key (Meas Setup, Decode, Inner Interleaver) will be grayed out.
Couplings	FFT Size is coupled to Radio Std (Mode Setup) in the following way: If the FFT Size is 4K, the FFT Size will be changed to 2K automatically when the Radio Std is changed from DVBH to DVBT (4K is only for DVBH).

Preset	N2K
State Saved	Saved in instrument state.
Range	2K 4K 8K
<b>Backwards Compatibility SCPI</b>	[ :SENSe ] :RADio:STANdard:NFFT
Initial S/W Revision	A.02.00
Modified at S/W Revision	A.07.00

## Hierarchical

Sets whether to use hierarchical transmission or not. Hierarchical transmission is used only when the modulation format is 16QAM or 64QAM.

Key Path	Meas Setup, Demod
Mode	DVB-T/H
<b>Remote Command</b>	[ :SENSe ] :EVM:HIERarchical [ :STATe ] OFF   ON   0   1 [ :SENSe ] :EVM:HIERarchical [ :STATe ] ?
<b>Example</b>	EVM:HIER OFF EVM:HIER?
Notes	For the SCPI command, transmission is hierarchical with SCPI State=ON transmission is Non-hierarchical with SCPI State=OFF
Dependencies	If Hierarchical is set to Off, the Alpha = 2 (Meas Setup, Demod, Alpha), Alpha = 4, LP Code Rate (Meas Setup, Decode), LP Before Viterbi (Meas Setup, Decode, BER Count Type), and LP Before RS keys are all grayed out, and if Hierarchical is ON the QPSK key (Meas Setup, Demod, Modulation Format) will be grayed out.
Couplings	If Hierarchical state is changed from On to Off and BER Count Type (Meas Setup, Decode) is about LP (Low Priority), the value will change to HP Before Viterbi automatically.
Preset	OFF
State Saved	Saved in instrument state.
Range	On   Off
<b>Backwards Compatibility SCPI</b>	[ :SENSe ] :RADio:STANdard:HIERarchical [ :STATe ]
Initial S/W Revision	A.02.00
Modified at S/W Revision	A.07.00

## Modulation Format

Sets modulation format. The available selections include QPSK, 16QAM, and 64QAM.

Key Path	Meas Setup, Demod
Mode	DVB-T/H
<b>Remote Command</b>	[ :SENSe ] :EVM:MODulation QPSK QAM16 QAM64 [ :SENSe ] :EVM:MODulation?
<b>Example</b>	EVM:MOD QPSK EVM:MOD?
Dependencies	If Hierarchical (Meas Setup, Demod) is ON, the QPSK key is grayed out.
Couplings	Modulation Format is coupled to Hierarchical (Meas Setup, Demod) in the following way: If Hierarchical is changed from OFF to ON and the current value of Modulation Format is QPSK, then the value of Modulation Format will be changed to 16QAM.
Preset	QPSK
State Saved	Saved in instrument state.
Range	QPSK 16QAM 64QAM
<b>Backwards Compatibility SCPI</b>	[ :SENSe ] :RADio:STANdard:MODulation
Initial S/W Revision	A.02.00
Modified at S/W Revision	A.07.00

## Alpha

Sets the value of alpha. The available selections include 1, 2, and 4.

Alpha describes the exact proportions of the constellations. It is the minimum distance between two constellation points carrying different HP-bit (High Priority - bit) values divided by the minimum distance between any two constellation points. For QPSK modulation, the value of Alpha can be only 1.

Key Path	Meas Setup, Demod
Mode	DVB-T/H
<b>Remote Command</b>	[ :SENSe ] :EVM:ALPHA ONE TWO FOUR [ :SENSe ] :EVM:ALPHA?
<b>Example</b>	EVM:ALPH ONE EVM:ALPH?
Dependencies	If Hierarchical is OFF, the Alpha = 2 and Alpha = 4 keys are grayed out. The only selection is Alpha = 1.
Couplings	Alpha is coupled to Hierarchical (Meas Setup, Demod) in the following way: If Hierarchical is changed from ON to OFF, the value of Alpha will automatically change to 1.
Preset	ONE
State Saved	Saved in instrument state.
Range	Alpha = 1 Alpha = 2 Alpha = 4
<b>Backwards</b>	[ :SENSe ] :RADio:STANdard:ALPHA

<b>Compatibility SCPI</b>	
Initial S/W Revision	A.02.00
Modified at S/W Revision	A.07.00

## Decode

Allows you to specify the decoding settings for Mod Accuracy measurement.

Key Path	Meas Setup
Initial S/W Revision	A.07.00

## Decoding

This key is used to switch between normal demodulation and TPS/BER decoding.

The capture length will be much longer when the Decoding key is turned on. As a result, the calculating speed will slow down.

Key Path	Meas Setup, Decode
Mode	DVB-T/H
<b>Remote Command</b>	[ :SENSe ] :EVM:DECoding:STATe OFF   ON   0   1 [ :SENSe ] :EVM:DECoding:STATe?
<b>Example</b>	EVM:DEC:STAT OFF EVM:DEC:STAT?
Couplings	The Decoding key is coupled with the current view in the following way: If Decoding is OFF, and the TPS Decoding or BER Results view is selected, the value of Decoding will be changed to ON automatically. If the current TPS Decoding or BER Results view is changed to another, the value of Decoding changes back to OFF unless the value of Decoding has been manually changed.
Preset	OFF
State Saved	Saved in instrument state.
Range	On   Off
Initial S/W Revision	A.02.00
Modified at S/W Revision	A.07.00

## Inner Interleaver

Sets the type of Inner Interleaver that is being used. In-depth interleaver can be used only in DVB-H standard, so In-depth key is grayed out when the radio standard is DVB-T.

Key Path	Meas Setup, Decode
Mode	DVB-T/H
<b>Remote Command</b>	<code>[ :SENSe ] :EVM :IINTerleaver NATive   IDEPth</code> <code>[ :SENSe ] :EVM :IINTerleaver ?</code>
<b>Example</b>	EVM:IINT NAT EVM:IINT?
Dependencies	If the value of FFT Size (Mode Setup, Radio Std, Common Setup) is 8K or the Radio Std is DVBT, the In-depth key is grayed out. If inner interleaver is set to In-depth, the 8K key (Mode Setup, Demod, FFT Size) will be grayed out.
Couplings	Inner Interleaver is coupled to Radio Std (Mode Setup) in the following way: If the Radio Std is changed from DVBH to DVBT, the value of Inner Interleaver will automatically be changed to Native.
Preset	NAT
State Saved	Saved in instrument state.
Range	Native   In-depth
<b>Backwards Compatibility SCPI</b>	<code>[ :SENSe ] :RADio :STANdard :IINTerleaver</code>
Initial S/W Revision	A.02.00
Modified at S/W Revision	A.07.00

## HP (High Priority) Code Rate

Sets the value for HP Code Rate.

Key Path	Meas Setup, Decode
Mode	DVB
<b>Remote Command</b>	<code>[ :SENSe ] :EVM :CRATe :HPRatio R1BY2   R2BY3   R3BY4   R5BY6   R7BY8</code> <code>[ :SENSe ] :EVM :CRATe :HPRatio ?</code>
<b>Example</b>	EVM:CRAT:HPR R1BY2 EVM:CRAT:HPR?
Preset	R1BY2
State Saved	Saved in instrument state.
Range	1/2   2/3   3/4   5/6   7/8
<b>Backwards Compatibility SCPI</b>	<code>[ :SENSe ] :RADio :STANdard :CRATe :HPRatio</code>
Initial S/W Revision	A.02.00
Modified at S/W Revision	A.07.00

## LP (Low Priority) Code Rate

Sets the value for LP Code Rate.

Key Path	Meas Setup, Decode
Mode	DVB
<b>Remote Command</b>	[ :SENSe ] :EVM:CRATe:LPRatio R1BY2   R2BY3   R3BY4   R5BY6   R7BY8 [ :SENSe ] :EVM:CRATe:LPRatio?
<b>Example</b>	EVM:CRAT:LPR R1BY2 EVM:CRAT:LPR?
Dependencies	If Hierarchical (Mode Setup, Radio Std, DVB-T/DVB-H) state of the current Radio Std is OFF, this key is grayed out.
Preset	R1BY2
State Saved	Saved in instrument state.
Range	1/2   2/3   3/4   5/6   7/8
<b>Backwards Compatibility SCPI</b>	[ :SENSe ] :RADio:STANdard:CRATe:LPRatio
Initial S/W Revision	A.02.00
Modified at S/W Revision	A.07.00

## BER Count Type

Sets BER Count Type. The selections include HP Before Viterbi, HP Before RS (After Viterbi), LP Before Viterbi, and LP Before RS (After Viterbi).

This key is only available when Decoding (Meas Setup, Decode) is on. It is used together with BER Bit Count (Meas Setup, Decode) to control the stop time of BER Calculation.

There are two types of BER: BER before Viterbi, BER before RS (BER after Viterbi). You can choose which BER using this key. When the total bit count of the selected BER exceeds BER Bit Count for the first time, the calculation of BER will stop.

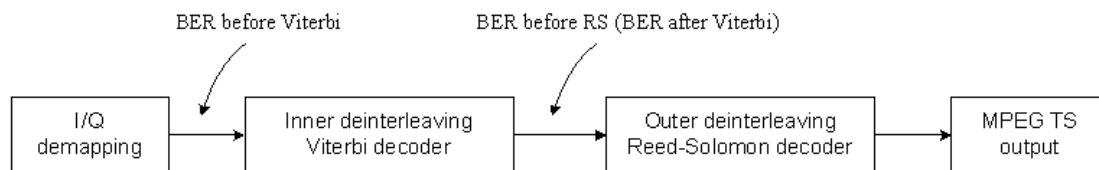

**NOTE**

RS stands for Reed-Solomon.

Key Path	Meas Setup, Decode
Mode	DVB-T/H
<b>Remote Command</b>	[ :SENSe ] :EVM:BERCount:TYPE HBViterbi   HBRS   LBViterbi   LBRS [ :SENSe ] :EVM:BERCount:TYPE?

<b>Example</b>	EVM:BERC:TYPE HBV EVM:BERC:TYPE?
Dependencies	If Decoding (Meas Setup, Decode) is set to off, this key is grayed out.
Couplings	BER Count Type is coupled to Hierarchical (Mode Setup, Radio Std, DVB-T/DVB-H) of the current Radio Std in the following way: If the Hierarchical state of the current Radio Std is changed from On to Off and the BER Count Type is about LP (Low Priority), the value will automatically change to HP Before Viterbi.
Preset	HBViterbi
State Saved	Saved in instrument state.
Range	HP Before Viterbi   HP Before RS (After Viterbi)   LP Before Viterbi   LP Before RS (After Viterbi)
Initial S/W Revision	A.03.00
Modified at S/W Revision	A.07.00

### HP Before Viterbi

Selects the total bit count at the Before Viterbi (High Priority stream) point as the signal to stop BER calculation.

Key Path	Meas Setup, Decode, BER Count Type
Mode	DVB-T/H
<b>Example</b>	EVM:BERC:TYPE HBV
Readback Text	HP Before Viterbi
Initial S/W Revision	A.03.00
Modified at S/W Revision	A.07.00

### HP Before RS

Selects the total bit count at the Before RS (High Priority stream) point as the signal to stop BER calculation.

Key Path	Meas Setup, Decode, BER Count Type
Mode	DVB-T/H
<b>Example</b>	EVM:BERC:TYPE HBRS
Readback Text	HP Before RS
Initial S/W Revision	A.03.00
Modified at S/W Revision	A.07.00

### LP Before Viterbi

Selects the total bit count at the Before Viterbi (Low Priority stream) point as the signal to stop BER calculation.

Key Path	Meas Setup, Decode, BER Count Type
Mode	DVB-T/H
<b>Example</b>	EVM:BERC:TYPE LBV
Dependencies	If Hierarchical (Mode Setup, Radio Std, DVB-T/DVB-H) of the current Radio Std is Off, this key will be grayed out.
Readback Text	LP Before Viterbi
Initial S/W Revision	A.03.00
Modified at S/W Revision	A.07.00

### LP Before RS

Selects the total bit count at the Before RS (Low Priority stream) point as the signal to stop BER calculation.

Key Path	Meas Setup, Decode, BER Count Type
Mode	DVB-T/H
<b>Example</b>	EVM:BERC:TYPE LBRS
Dependencies	If Hierarchical (Mode Setup, Radio Std, DVB-T/DVB-H) of the current Radio Std is Off, this key will be grayed out.
Readback Text	LP Before RS
Initial S/W Revision	A.03.00
Modified at S/W Revision	A.07.00

### BER Bit Count

Sets BER Bit Count. It is used together with BER Count Type (Meas Setup, Decode) to control the stop time of BER Calculation. When the total bit count of the specified BER count type (set under BER Count Type panel) exceeds the value of BER Bit Count for the first time, the calculation of BER will stop.

Key Path	Meas Setup, Decode
Mode	DVB-T/H
<b>Remote Command</b>	[ :SENSe ] :EVM:BERCount:BITS <real> [ :SENSe ] :EVM:BERCount:BITS?
<b>Example</b>	EVM:BERC:BITS 1.0e8 EVM:BERC:BITS?
Dependencies	If Decoding (Meas Setup, Decode) is set to off, this key is grayed out.



Preset	1.0e8
State Saved	Saved in instrument state.
Min	1
Max	1.0e25
Initial S/W Revision	A.03.00
Modified at S/W Revision	A.07.00

## Payload

Sets the type of payload for the signal under test. There are two kinds of payload: data packet and null TS packet. Null TS packet is defined as the four byte sequence 0x47, 0x1F, 0xFF, 0x10, followed by 184 zero bytes (0x00).

The BER calculation methods are different for signals with different payload type.

Key Path	Meas Setup, Decode
Mode	DVB-T/H
<b>Remote Command</b>	[ :SENSe ] :EVM:PAYLoad DATA NULL [ :SENSe ] :EVM:PAYLoad?
<b>Example</b>	EVM:PAYL DATA EVM:PAYL?
Preset	DATA
State Saved	Saved in instrument state.
Range	NullPacket   Data
Initial S/W Revision	A.02.00
Modified at S/W Revision	A.07.00

## Advanced

This key allows you to specify advanced settings for Mod Accuracy measurement.

Key Path	Meas Setup
Initial S/W Revision	A.02.00

## EVM Ref Calc Mode

Toggles between using RMS value and using Max value while calculating EVM.

If EVM Ref Calc Mode is selected as Max, EVM will be calculated using formula (a) which is defined in ETSI TR 101 290. If EVM Ref is selected as RMS, EVM will be calculated using formula (b).

$$EVM = \frac{\sqrt{\frac{1}{N} \sum_{j=1}^N (\delta I_j^2 + \delta Q_j^2)}}{S_{\max}} \times 100\% \quad (a)$$

$$EVM = \frac{\sqrt{\frac{1}{N} \sum_{j=1}^N (I_j^2 + Q_j^2)}}{S_{\text{rms}}} \times 100\% \quad (b)$$

$S_{\max}$  is the magnitude of the vector to the outermost state of the constellation.  $S_{\text{rms}}$  is calculated in the

following way:  $S_{\text{rms}} = \sqrt{\frac{1}{N} \sum_{j=1}^N (I_j^2 + Q_j^2)}$ . The definition of the other parameters in the formula is illustrated in the following figure.

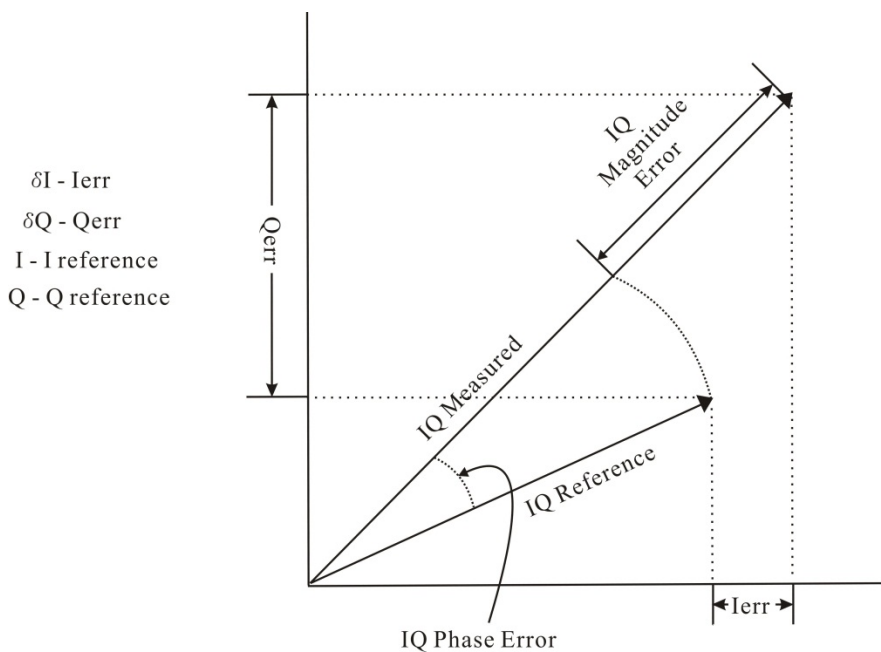

Key Path	Meas Setup, Advanced
Mode	DVB-T/H
Remote Command	[ :SENSe ] :EVM:CMODe RMS MAXimum [ :SENSe ] :EVM:CMODe?
Example	EVM:CMOD MAX EVM:CMOD?
Preset	MAX
State Saved	Saved in instrument state.
Range	RMS   Max
Initial S/W Revision	A.02.00

## I/Q Mismatch

This key is used to set the type of I/Q mismatch estimation.

I/Q mismatch includes amplitude imbalance and quadrature error. There are two kinds of estimation methods.

Key Path	Meas Setup, Advanced
Mode	DVB-T/H
Remote Command	[ :SENSe ] :EVM:IQMismatch STD FAST [ :SENSe ] :EVM:IQMismatch?
Example	EVM:IQM STD EVM:IQM?
Notes	Std: uses the formula in the standard to calculate AI and QE, providing results only in 2K mode. Fast: uses Agilent internal algorithm to calculate AI and QE, providing results in 2K, 4K and 8K mode.
Preset	FAST
State Saved	Saved in instrument state.
Range	Std   Fast
Initial S/W Revision	A.02.00

## Spectrum

This key sets whether to use normal spectrum or use inverted spectrum.

The Spectrum key is used when your signal's spectrum is inverted. In terms of the IQ complex components, to invert a spectrum in freq domain equals to conjugate the complex I/Q symbols in time domain.

$$(I + jQ)^* = I - jQ$$

This can often occur, for example, if you are measuring at an IF frequency, and the Q component of your baseband signal is inverted, or the I and Q signals are inadvertently swapped. When you set the spectrum key to Inverted, the analysis software will conjugate the complex baseband signal before demodulating, ensuring correct demodulation of the inverted signal.

Key Path	Meas Setup, Advanced
Mode	DVB-T/H
Remote Command	[ :SENSe ] :EVM:SPECTrum NORMal INVert [ :SENSe ] :EVM:SPECTrum?
Example	EVM:SPEC NORM EVM:SPEC?
Preset	NORMal
State Saved	Saved in instrument state.

Range	Normal   Invert
Initial S/W Revision	A.02.00

## Equalization

This key turns the equalization on and off.

Equalization is used to compensate for the distortions caused by the channel effects.

Key Path	Meas Setup, Advanced, More
Mode	DVB-T/H
<b>Remote Command</b>	[ :SENSe ] :EVM:EQualization:STATe OFF ON 0 1 [ :SENSe ] :EVM:EQualization:STATe?
<b>Example</b>	EVM:EQ:STAT ON EVM:EQ:STAT?
Preset	OFF
State Saved	Saved in instrument state.
Range	On   Off
Initial S/W Revision	A.02.00

## Clock Rate

Sets the clock rate either automatically based on channel bandwidth or manually by your input value.

Key Path	Meas Setup, Advanced
Mode	DVB-T/H
<b>Remote Command</b>	[ :SENSe ] :EVM:CLKRate <freq> [ :SENSe ] :EVM:CLKRate? [ :SENSe ] :EVM:CLKRate:AUTO ON OFF 1 0 [ :SENSe ] :EVM:CLKRate:AUTO?
<b>Example</b>	EVM:CLKR 9.142857e6 EVM:CLKR? EVM:CLKR:AUTO OFF EVM:CLKR:AUTO?
Couplings	The value of Clock Rate in Auto is coupled to Channel BW (Mode Setup) as follows: 9.142857 MHz in 8 MHz Channel BW 8.000000 MHz in 7 MHz Channel BW 6.857142 MHz in 6 MHz Channel BW 5.714285 MHz in 5 MHz Channel BW The value of Clock Rate State will be changed to Auto automatically when Channel BW (Mode Setup)

	is changed.
Preset	9.142857 MHz ON
State Saved	Saved in instrument state.
Min	8 MHz in 8 MHz Channel BW 7 MHz in 7 MHz Channel BW 6 MHz in 6 MHz Channel BW 5 MHz in 5 MHz Channel BW
Max	11 MHz in 8 MHz Channel BW 9 MHz in 7 MHz Channel BW 8 MHz in 6 MHz Channel BW 7 MHz in 5 MHz Channel BW
Initial S/W Revision	A.02.00

## Demodulation Symbols

Determines the capture length. More symbols provide a more accurate result, but require a longer processing time. You may use the preset value for most cases.

Key Path	Meas Setup, Advanced
Mode	DVB-T/H
<b>Remote Command</b>	<code>[ :SENSe ] :EVM:DSYMBOLs &lt;integer&gt;</code> <code>[ :SENSe ] :EVM:DSYMBOLs?</code>
<b>Example</b>	EVM:DSYM 4 EVM:DSYM?
Preset	4
State Saved	Saved in instrument state.
Min	4
Max	50
Initial S/W Revision	A.02.00

## Out of Band Filtering

Chooses whether to use the out of band filter.

The filter is used to eliminate the impact of out of band signal.

Key Path	Meas Setup, Advanced, More
Mode	DVB-T/H
<b>Remote Command</b>	<code>[ :SENSe ] :EVM:OBFiltering OFF ON 0 1</code>

	<code>[ :SENSe ] :EVM:OBFiltering?</code>
<b>Example</b>	EVM:OBF OFF EVM:OBF?
Preset	OFF
State Saved	Saved in instrument state.
Range	On   Off
Initial S/W Revision	A.02.00

## IF Gain

Enables you to control an internally switched IF amplifier with approximately 10 dB of gain. This amplifier takes full advantage of the RF dynamic range of the analyzer. When it is turned on without overloading the analyzer, the dynamic range is always better with it on than off. The IF Gain key can be used to set the IF Gain function to Auto, or to On (the extra 10 dB), or Off. These settings affect sensitivity and IF overloads.

This only applies to the RF input. It does not apply to baseband I/Q input.

Key Path	Meas Setup, Advanced, More
Initial S/W Revision	A.10.01

## IF Gain Auto

Activates the auto rules for IF Gain.

Key Path	Meas Setup, Advanced, More, IF Gain
Mode	DVB-T/H
<b>Remote Command</b>	<code>[ :SENSe ] :EVM:IF:GAIN:AUTO [ :STATe ] OFF   ON   0   1</code> <code>[ :SENSe ] :EVM:IF:GAIN:AUTO [ :STATe ] ?</code>
<b>Example</b>	EVM:IF:GAIN:AUTO ON EVM:IF:GAIN:AUTO?
Notes	This only applies to the RF input. It does not apply to baseband I/Q input.
Couplings	When either Auto Attenuation is active (for example, with electrical attenuator), or the Optimize Mechanical Attenuator range is requested, the IF Gain setting is changed according to the following rules.  'auto' sets IF Gain to 'High Gain' under any of the following conditions: a)The input attenuator is set to 0 dB, or, b)The preamp is turned on, or, c)The Max Mixer Level is -20 dBm or lower. For other settings, 'auto' sets IF Gain to 'Low Gain'.
Preset	ON

State Saved	Saved in instrument state.
Range	Off On
Initial S/W Revision	A.10.01

### IF Gain State

Selects the range of IF gain.

Key Path	Meas Setup, Advanced, More, IF Gain
Mode	DVB-T/H
Remote Command	[ :SENSe ] :EVM:IF:GAIN [ :STATe ] ON OFF 1 0 [ :SENSe ] :EVM:IF:GAIN [ :STATe ] ?
Example	EVM:IF:GAIN ON EVM:IF:GAIN?
Notes	This only applies to the RF input. It does not apply to baseband I/Q input. where ON = high gain OFF = low gain
Couplings	When either the auto attenuation works (for example, with the electrical attenuator) or optimize mechanical attenuator range is requested, the IF Gain setting is changed according to the following rule.  'Auto' sets IF Gain to 'High Gain' under any of the following conditions: the input attenuator is set to 0 dB, the preamp is turned on (total attenuation is less or equal than 2 dB), or the Max Mixer Level is -20 dBm or lower. For other settings, 'Auto" sets IF Gain to 'Low Gain'.
Preset	Auto and Low Gain
State Saved	Saved in instrument state.
Range	Low Gain (Best for Large Signals)   High Gain (Best Noise Level)
Readback Text	Low Gain   High Gain
Initial S/W Revision	A.10.01

### FFT Start Position

Sets the start position of FFT.

FFT Start Position means which part of GI (Guard Interval) are included in FFT. There are 9 values from 0/8 GI to 8/8 GI. As shown below, 0/8 GI means no CP is included in FFT and 8/8 GI means the entire GI is included in FFT.

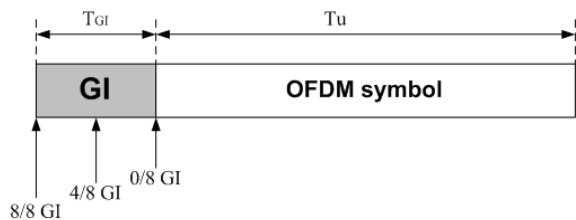

For a signal with pre-echo or delay waves, ISI (Inter-Symbol Interference) can be eliminated by adjusting FFT Start Position.

Choose appropriate FFT Start Position according to your channel delay profile to remove the effect of interferences. Together with Equalization (Meas Setup, Advanced), MER and Channel Impulse Response results can be improved.

Key Path	Meas Setup, Advanced, More
Mode	DVB-T/H
Remote Command	<code>[[:SENSE]:EVM:FFTStart GI08   GI18   GI28   GI38   GI48   GI58   GI68   GI78   GI88</code> <code>[[:SENSE]:EVM:FFTStart?</code>
Example	<code>EVM:FFTS GI18</code> <code>EVM:FFTS?</code>
Preset	GI48
State Saved	Saved in instrument state.
Range	0/8 GI 1/8 GI 2/8 GI 3/8 GI 4/8 GI 5/8 GI 6/8 GI 7/8 GI 8/8 GI
Initial S/W Revision	A.10.01

### PhNoise Opt

The Phase Noise Optimization setting affects the phase noise distribution on the analyzer's LO.

Key Path	Meas Setup, Advanced
Mode	CMMB
Remote Command	<code>[[:SENSE]:EVM:FREQuency:SYNThesis[:STATe] 1 2 3</code> <code>[[:SENSE]:EVM:FREQuency:SYNThesis[:STATe]?</code>
Example	<code>EVM:FREQ:SYNT 1</code> <code>EVM:FREQ:SYNT?</code>
Notes	Parameter: 1: Best Close-in $\Phi$ Noise, optimizes phase noise for small frequency offsets from the carrier. 2: Best Wide-offset $\Phi$ Noise, optimizes phase noise for wide frequency offsets from the carrier. 3: Fast Tuning, optimizes LO for tuning speed The actual behavior varies somewhat depending on model number and option; you always get fast tuning by choosing #3, but in some models, the “Fast Tuning” choice is identical to the “Best Close-In” choice. Specifically:



	<ul style="list-style-type: none"> <li>• Models with option EP1 (for example PXA), have a two-loop local oscillator, which switches to a single loop for fast tuning</li> <li>• Models with option EP2 (available, for example, for MXA), use a different loop bandwidth for the fast-tuning choice, which is a compromise between tuning speed and phase noise, giving good tuning speed at all offsets, although not as good as for Close-In; this is useful when you have to look across a wide range of spans</li> </ul> <p>In all other cases, Fast Tuning is the same as Best Close-In.</p>
Dependencies	Does not appear in all models. The key is blank in those models, but the SCPI command is accepted for compatibility (although no action is taken).
Preset	Default value is different depend on hardware configuration. Models with option EP2 (available, for example, for MXA), default value is 3; For other cases, default value is 2.
State Saved	Saved in instrument state.
Readback Text	Close-in Wide-offset Fast Tuning
Initial S/W Revision	A.13.01

## MER Monitor

Specifies MER monitor settings for Mod Accuracy measurement.

If Monitor (Meas Setup, More, MER Monitor) is toggled to On, MER Monitor process will start no matter whether the current view is MER Monitor view. The detailed procedure is as follows:

If the current view is MER Monitor view, refer to ["MER Monitor" on page 1489](#) for more information.

If the current view is NOT in MER Monitor view, the following actions will be performed. During this process, any other operations, which cause the measurement to restart, will restart the MER monitor process.

### 1. Record raw data

If the Limit Line (Meas Setup, MER Monitor) is turned on and the current MER result is smaller than the limit, raw data will be saved to "D:\userdata\DVB-TH\rawdata", which can be used by the Capture Buffer of X-Series Signal Analyzer for further research.

The recording file name is "dataIndex\_HourMinuteSecond.bin" (Index is the sequence number of the files saved in one monitoring process.), such as "data2\_155636.bin".

The maximum number of files that can be saved is controlled by Max Raw Data Files Saved(Meas Setup, MER Monitor). If the failed points exceed this number, raw data will no longer be saved. A message (File Number exceeds MaxRawDataFileSaved. Raw Data are not saved) will be displayed after the MER result in the Log file.

### 2. Log file

Date time, MER results and the rawdata file path (if MER is below the limit) will be saved in a log file named "MER\_log\_DVB\_TH.txt" in "D:\userdata\DVB-TH".

The format of this file is listed below.

-----

Starting Time: 9/8/2009 15:55:41

MER Limit: 35.0 dB

Monitor Time: 0.1 hour

MER Unit: dB

9/8/2009 15:55:41 39.5200086295896

9/8/2009 15:55:41 38.6605823043697

... ..  
 9/8/2009 15:56:36 34.0759440002693 D:\userdata\DVB-TH\rawdata\data2\_155636.bin... ..  
 ...9/8/2009 15:59:56 34.4563081204352 File Number exceeds MaxRawDataFileSaved. Raw Data are  
 not saved.

Total Time: 0 d 0 h 6 m 0 s

Total Points: 2236

Failed Points: 6

Failed Percentage (%): 0.268336314847942

---

Key Path	Meas Setup, More
Initial S/W Revision	A.06.00

---

## Monitor

Starts or stops MER Monitor.

---

Key Path	Meas Setup, More, MER Monitor
Mode	DVB-T/H
Remote Command	[ :SENSe ] :EVM:MERMonitor:STATe OFF ON 0 1 [ :SENSe ] :EVM:MERMonitor:STATe?
Example	EVM:MERM:STAT OFF EVM:MERM:STAT?
Couplings	This key is coupled with the current view in the following way: If Monitor is OFF and MER Monitor view is selected, the value of Monitor will be changed to ON automatically. If the current MER Monitor view is changed to another, the value of Monitor changes back to OFF unless the value of Monitor has been manually changed.
Preset	OFF
State Saved	Saved in instrument state.
Range	On   Off
Initial S/W Revision	A.06.00

---

## Display Points

Sets the maximum number of points displayed on the MER Monitor trace in MER Monitor view.

If the actual points exceed this number (2000 for example), only the most recent 2000 points are displayed on the graph. That is to say, if the number of points reaches 2001 when the maximum number of displayed points has been set to 2000, point 1 will be discarded.

Key Path	Meas Setup, More, MER Monitor
Mode	DVB-T/H
<b>Remote Command</b>	<code>[ :SENSe ] :EVM:MERMonitor:DPOints &lt;integer&gt;</code> <code>[ :SENSe ] :EVM:MERMonitor:DPOints?</code>
<b>Example</b>	<code>EVM:MERM:DPO 2000</code> <code>EVM:MERM:DPO?</code>
Preset	2000
State Saved	Saved in instrument state.
Min	10
Max	20000
Initial S/W Revision	A.06.00

## Limit Line

If Limit Line is set to on, a green line will display on MER Monitor view. Once the measured MER is below this Limit Line, the raw data will be saved to "D:\userdata\DVB-TH\rawdata" for future research.

If Limit Line is set to off, raw data will not be saved.

Refer to "[MER Monitor](#)" on page 1489 for more information.

Key Path	Meas Setup, More, MER Monitor
Mode	DVB-T/H
<b>Remote Command</b>	<code>[ :SENSe ] :EVM:MERMonitor:LIMit &lt;rel_ampl&gt;</code> <code>[ :SENSe ] :EVM:MERMonitor:LIMit?</code> <code>[ :SENSe ] :EVM:MERMonitor:LIMit:STATe OFF ON 0 1</code> <code>[ :SENSe ] :EVM:MERMonitor:LIMit:STATe?</code>
<b>Example</b>	<code>EVM:MERM:LIM 32.0</code> <code>EVM:MERM:LIM?</code> <code>EVM:MERM:LIM:STAT ON</code> <code>EVM:MERM:LIM:STAT?</code>
Preset	32.0 ON

State Saved	Saved in instrument state.
Min	0.0
Max	60.0
Initial S/W Revision	A.06.00

### Max Raw Data Files Saved

Sets the maximum number of raw data files that can be saved when the current MER is lower than Limit Line (Meas Setup, MER Monitor).

If the failed points exceed this number, raw data will not be saved anymore. A message (File Number exceeds MaxRawDataFileSaved. Raw Data are not saved) will be placed after the MER result in the Log file.

Refer to ["MER Monitor" on page 1489](#) for more information.

Key Path	Meas Setup, More, MER Monitor
Mode	DVB-T/H
Remote Command	[ :SENSe ] :EVM:MERMonitor:RDFiles:MAX <integer> [ :SENSe ] :EVM:MERMonitor:RDFiles:MAX?
Example	EVM:MERM:RDF:MAX 5 EVM:MERM:RDF:MAX?
Preset	5
State Saved	Saved in instrument state.
Min	0
Max	20
Initial S/W Revision	A.06.00

### Delete All MER Log and Data Files

Deletes all MER log and raw data files saved on the disk "D:\userdata\DVB-TH\" without any criteria. It is easy for you to delete useless data files without going to that path on the disk.

It is a "one-time" function, that is, it executes once, when the key is pressed. There will be a pop-up message for you to decide whether to delete these files or not.

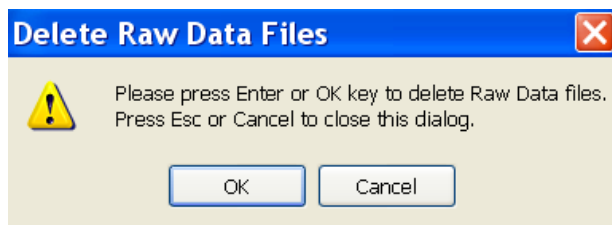

Key Path	Meas Setup, More, MER Monitor
Mode	DVB-T/H
<b>Remote Command</b>	[ :SENSe ] :EVM:MERMonitor:FILEs:DELeTe
<b>Example</b>	EVM:MERM:FIL:DEL
Initial S/W Revision	A.06.00

## Meas Preset

This key restores all the measurement settings to their defaults.

This will set the measure setup parameters (for the currently selected measurement only), to the factory defaults.

Key Path	Meas Setup, More
Mode	DVB-T/H
<b>Remote Command</b>	:CONFigure:EVM
<b>Example</b>	CONF:EVM
Couplings	Selecting measurement preset will restore all measurement parameters to their default values for the current measurement.
Initial S/W Revision	A.02.00

12 Mod Accuracy Measurement  
Mode

Mode

See "[Mode](#)" on page 298

## Mode Preset

Returns the active mode to a known state.

Mode Preset does the following for the currently active mode:

- Aborts the currently running measurement.
- Brings up the default menu for the mode, with no active function.
- Sets measurement Global settings to their preset values for the active mode only.
- Activates the default measurement.
- Brings up the default menu for the mode.
- Clears the input and output buffers.
- Sets Status Byte to 0.

Mode Preset does not:

- Cause a mode switch
- Affect mode persistent settings
- Affect system settings

See "[How-To Preset](#)" on page 1384 for more information.

Key Path	Front-panel key
<b>Remote Command</b>	:SYSTem:PRESet
<b>Example</b>	:SYST:PRES
Notes	*RST is preferred over :SYST:PRES for remote operation. *RST does a Mode Preset, as done by the :SYST:PRES command, and it sets the measurement mode to Single measurement rather than Continuous for optimal remote control throughput. Clears all pending OPC bits. The Status Byte is set to 0.
Couplings	A Mode Preset aborts the currently running measurement, activates the default measurement, and gets the mode to a consistent state with all of the default couplings set.
Backwards Compatibility Notes	In the X-Series, the legacy "Factory Preset" has been replaced with Mode Preset, which only presets the currently active mode, not the entire instrument. In the X-Series, the way to preset the entire instrument is by using System, Restore System Defaults All, which behaves essentially the same way as restore System Defaults does on ESA and PSA. There is also no "Preset Type" as there is on the PSA. There is a green Mode Preset front-panel key that does a Mode Preset and a white-with-green-letters User Preset front-panel key that does a User Preset. The old PRESet:TYPE command is ignored (without generating an error), and SYST:PRES without a parameter does a Mode Preset, which should cover most backward code compatibility issues. The settings and correction data under the Input/Output front-panel key (examples: Input Z Corr, Ext Amp Gain, etc.) are no longer part of any Mode, so they will not be preset by a Mode Preset. They are preset using Restore Input/Output Defaults, Restore System Defaults All. Note that because User Preset does a Recall State, and all of these settings are saved in State, they ARE recalled when using

	User Preset.
Initial S/W Revision	Prior to A.02.00

## How-To Preset

The table below shows all possible presets, their corresponding SCPI commands and front-panel access (key paths). Instrument settings depend on the current measurement context. Some settings are local to the current measurement, some are global (common) across all the measurements in the current mode, and some are global to all the available modes. In a similar way, restoring the settings to their preset state can be done within the different contexts.

Auto Couple - is a measurement local key. It sets all Auto/Man parameter couplings in the measurement to Auto. Any Auto/Man selection that is local to other measurements in the mode will not be affected.

Meas Preset - is a measurement local key. Meas Preset resets all the variables local to the current measurement except the persistent ones.

Mode Preset - resets all the current mode's measurement local and measurement global variables except the persistent ones.

Restore Mode Defaults - resets ALL the Mode variables (and all the Meas global and Meas local variables), including the persistent ones.

Type Of Preset	SCPI Command	Front Panel Access
Auto Couple	:COUPle ALL	Auto Couple front-panel key
Meas Preset	:CONFigure:<Measurement>	Meas Setup Menu
Mode Preset	:SYSTem:PRESet	Mode Preset (green key)
Restore Mode Defaults	:INSTrument:DEFault	Mode Setup Menu
Restore All Mode Defaults	:SYSTem:DEFault MODes	System Menu; Restore System Default Menu
*RST	*RST	not possible (Mode Preset with Single)
Restore Input/Output Defaults	:SYSTem:DEFault INPUt	System Menu; Restore System Default Menu
Restore Power On Defaults	:SYSTem:DEFault PON	System Menu; Restore System Default Menu
Restore Alignment Defaults	:SYSTem:DEFault ALIGN	System Menu; Restore System Default Menu
Restore Miscellaneous Defaults	:SYSTem:DEFault MISC	System Menu; Restore System Default Menu
Restore All System Defaults	:SYSTem:DEFault [ALL] :SYSTem:PRESet:PERsistent	System Menu; Restore System Default Menu
User Preset	:SYSTem:PRESet:USER	User Preset Menu
User Preset All Modes	:SYSTem:PRESet:USER:ALL	User Preset Menu



Power On Mode Preset	:SYSTem:PON:TYPE MODE	System Menu
Power On User Preset	:SYSTem:PON:TYPE USER	System Menu
Power On Last State	:SYSTem:PON:TYPE LAST	System Menu

### Preset Type (Remote Command Only)

As stated in the Backward Compatibility section, to be compatible with ESA/PSA the PRESet:TYPE command will be implemented as a no-op.

Mode	All
<b>Remote Command</b>	:SYSTem:PRESet:TYPE FACTory MODE USER :SYSTem:PRESet:TYPE?
<b>Example</b>	:SYST:PRESet:TYPE FACT
Notes	This command is supported for backward compatibility only. It is a no-op which does not change the behavior of any preset operation.
Preset	This is unaffected by Preset but is set to Mode on a "Restore System Defaults->All"
State Saved	No
Initial S/W Revision	Prior to A.02.00

## Mode Setup

See "[Mode Setup](#)" on page 328

## Peak Search

Accesses a menu that enables you to control the peak search function and places a marker on the trace point with the maximum y-axis value for that marker's trace.

Key Path	Front-panel key
Mode	DVB-T/H
<b>Remote Command</b>	:CALCulate:EVM:MARKer [1]   2   . . . 12:MAXimum
<b>Example</b>	CALC:EVM:MARK2:MAX
Initial S/W Revision	A.02.00

### Next Peak

Moves the selected marker to the peak that has the next highest amplitude less than the marker's current value.

Key Path	Peak Search
Mode	DVB-T/H
<b>Remote Command</b>	:CALCulate:EVM:MARKer [1]   2   . . . 12:MAXimum:NEXT
<b>Example</b>	CALC:EVM:MARK2:MAX:NEXT
Initial S/W Revision	A.02.00

### Next Pk Right

Moves the selected marker to the next peak to the right of the current marker.

Key Path	Peak Search
Mode	DVB-T/H
<b>Remote Command</b>	:CALCulate:EVM:MARKer [1]   2   . . . 12:MAXimum:RIGHT
<b>Example</b>	CALC:EVM:MARK2:MAX:RIGH
Initial S/W Revision	A.02.00

### Next Pk Left

Moves the selected marker to the next peak to the left of the current marker.

Key Path	Peak Search
Mode	DVB-T/H
<b>Remote Command</b>	:CALCulate:EVM:MARKer [1]   2   . . . 12:MAXimum:LEFT
<b>Example</b>	CALC:EVM:MARK2:MAX:LEFT
Initial S/W Revision	A.02.00

## Marker Delta

Sets the control mode for the selected marker to Delta mode.

Key Path	Peak Search
Initial S/W Revision	A.02.00

## Peak Criteria

This key is visible only when the current view is Channel Impulse Response.

Pressing this key opens the Peak Criteria menu and allows you to adjust the 'Pk Threshold' and 'Pk Excursion' parameters used for peak table.

For a signal to be identified as a peak it must meet certain criteria. If either the peak excursion or peak threshold functions are on, then the signal must satisfy those criteria before being identified as a peak.

**NOTE** The criteria only affect the peaks in Peak Table. It will not affect 'Peak Search', 'Next Peak', etc.

Key Path	Peak Search, More
Initial S/W Revision	A.06.00

## Pk Excursion

This key is visible only when the current view is Channel Impulse Response.

Turns the peak excursion requirement on/off and sets the excursion value. The value defines the minimum amplitude variation (rise and fall) required for a signal to be identified as peak.

When both Pk Excursion and Pk Threshold are on, a signal must rise above the Pk Threshold value by at least the Peak Excursion value and then fall back from its local maximum by at least the Peak Excursion value to be considered a peak.

**NOTE** In the event that a sequence of trace points with precisely the same values represents the maximum, the leftmost point is found.

Key Path	Peak Search, More, Peak Criteria
Mode	DVB-T/H
Remote Command	:CALCulate:EVM:MARKer:PEAK:EXCursion <rel_ampl> :CALCulate:EVM:MARKer:PEAK:EXCursion? :CALCulate:EVM:MARKer:PEAK:EXCursion:STATE OFF ON 0 1 :CALCulate:EVM:MARKer:PEAK:EXCursion:STATE?
Example	CALC:EVM:MARK:PEAK:EXC 6.00 CALC:EVM:MARK:PEAK:EXC?

	CALC:EVM:MARK:PEAK:EXC:STAT ON CALC:EVM:MARK:PEAK:EXC:STAT?
Preset	6.00 ON
State Saved	Saved in instrument state.
Min	0.00
Max	100.00
Initial S/W Revision	A.06.00

## Pk Threshold

This key is visible only when the current view is Channel Impulse Response.

Turns the peak threshold requirement on/off and sets the threshold value. The peak threshold value defines the minimum signal level (or min threshold) that the peak identification algorithm uses to recognize a peak.

When both Pk Excursion and Pk Threshold are on, a signal must rise above the Pk Threshold value by at least the Peak Excursion value and then fall back from its local maximum by at least the Peak Excursion value to be considered a peak.

For example, if a threshold value of -90 dB is selected, the peak search algorithm will only consider signals with amplitude greater than the -90 dB threshold. If a threshold value of -90 dB is selected, and Peak Excursion is On and set to 6 dB, the peak search algorithm will only consider signals with amplitude greater than the -90 dB threshold which rise 6 dB above the threshold and then fall back to the threshold.

Key Path	Peak Search, More, Peak Criteria
Mode	DVB-T/H
<b>Remote Command</b>	:CALCulate:EVM:MARKer:PEAK:THReshold <real> :CALCulate:EVM:MARKer:PEAK:THReshold? :CALCulate:EVM:MARKer:PEAK:THReshold:STATe OFF ON 0 1 :CALCulate:EVM:MARKer:PEAK:THReshold:STATe?
<b>Example</b>	CALC:EVM:MARK:PEAK:THR -90.00 CALC:EVM:MARK:PEAK:THR? CALC:EVM:MARK:PEAK:THR:STAT ON CALC:EVM:MARK:PEAK:THR:STAT?
Couplings	If Peak Threshold is set to Off, turning on Peak Threshold line will turn on Peak Threshold. If Peak Threshold Line is set to On, turning off Peak Threshold will turn off Peak Threshold Line.
Preset	-90.00 ON
State Saved	Saved in instrument state.
Min	-200.00

---

Max	0.00
Initial S/W Revision	A.06.00

---

### Pk Threshold Line

This key is visible only when the current view is Channel Impulse Response view.

Turns the peak threshold line on or off. Preset state is off. No equivalent SCPI command.

See "[More Information](#)" on page 1390.

---

Key Path	Peak Search, More, Peak Criteria
Mode	DVB-T/H
Couplings	If Peak Threshold is set to Off, turning on Peak Threshold line will turn on Peak Threshold. If Peak Threshold Line is set to On, turning off Peak Threshold will turn off Peak Threshold Line.
Initial S/W Revision	A.06.00

---

### More Information

The Peak Threshold line is green and has the value of the peak threshold (for example, “-60.00 dB”) written above its right side. If Peak Excursion is ON, it shows on the left side as a region above the Peak Threshold line. As with all such lines (Peak Limit Line) it is drawn on top of all traces.

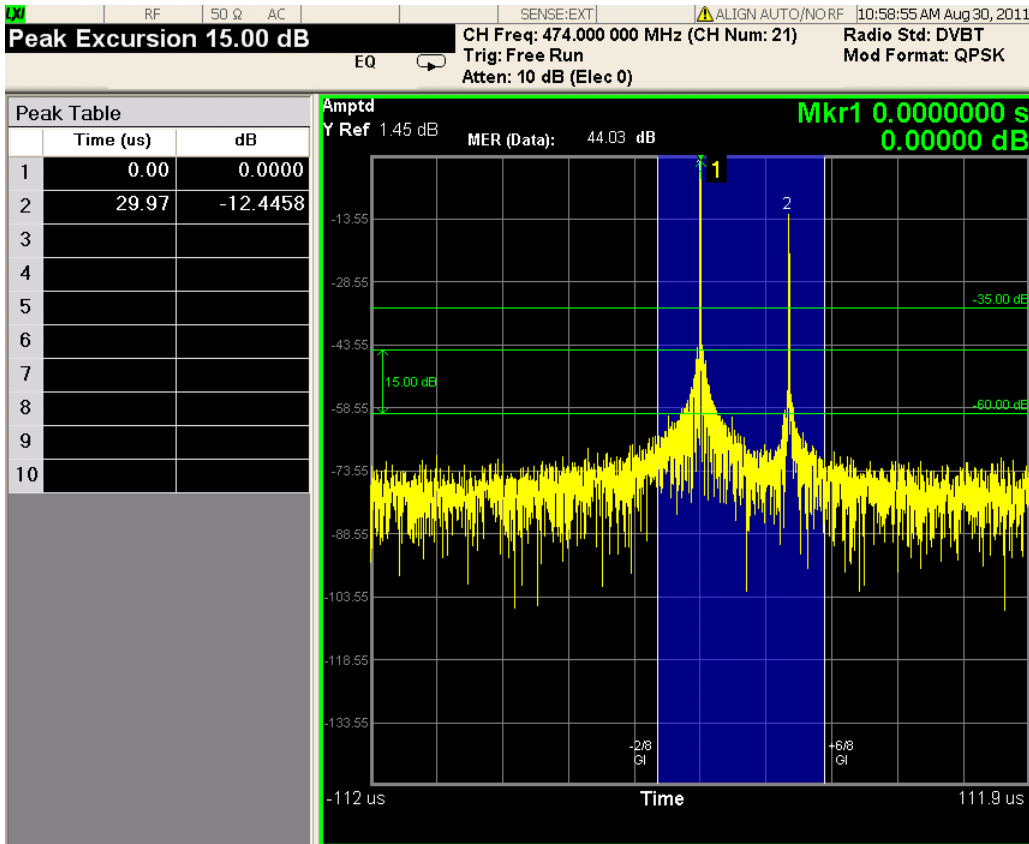

This function is automatically set to OFF whenever Peak Threshold is set to OFF. Manually turning it ON automatically turns on Pk Threshold.

The green line above PK Threshold line and the double arrow-headed line with xx dB on the right indicate the PK Excursion. You can see this information only if both Pk Threshold Line (Peak Search, More, Peak Criteria) and Peak Excursion (Peak Search, More, Peak Criteria) are toggled to On.

### Peak Table

This key is visible only when the current view is Channel Impulse Response.

Key Path	Peak Search, More
Initial S/W Revision	A.06.00

The Peak Table provides a list of up to 10 signal peaks from the Amplitude vs. Time trace. If there are more than 10 signals which meet the peak search criteria, only the 10 highest peaks are listed.

The list of peaks in the Peak Table can be ordered either by ascending time (absolute value, delay) or by descending amplitude. In either case, the entire trace is first evaluated and the 10 highest peaks are selected for inclusion in the list. After the peaks are selected, they are then sorted and displayed according to the Peak Sort setting.

When Peak Table is turned on, a new window is created along the left side of the display to accommodate the table. Each entry in the table contains the peak index (1–10), the x-axis value, and the y-axis value. Each peak index number is also displayed on the trace immediately above the corresponding peak.

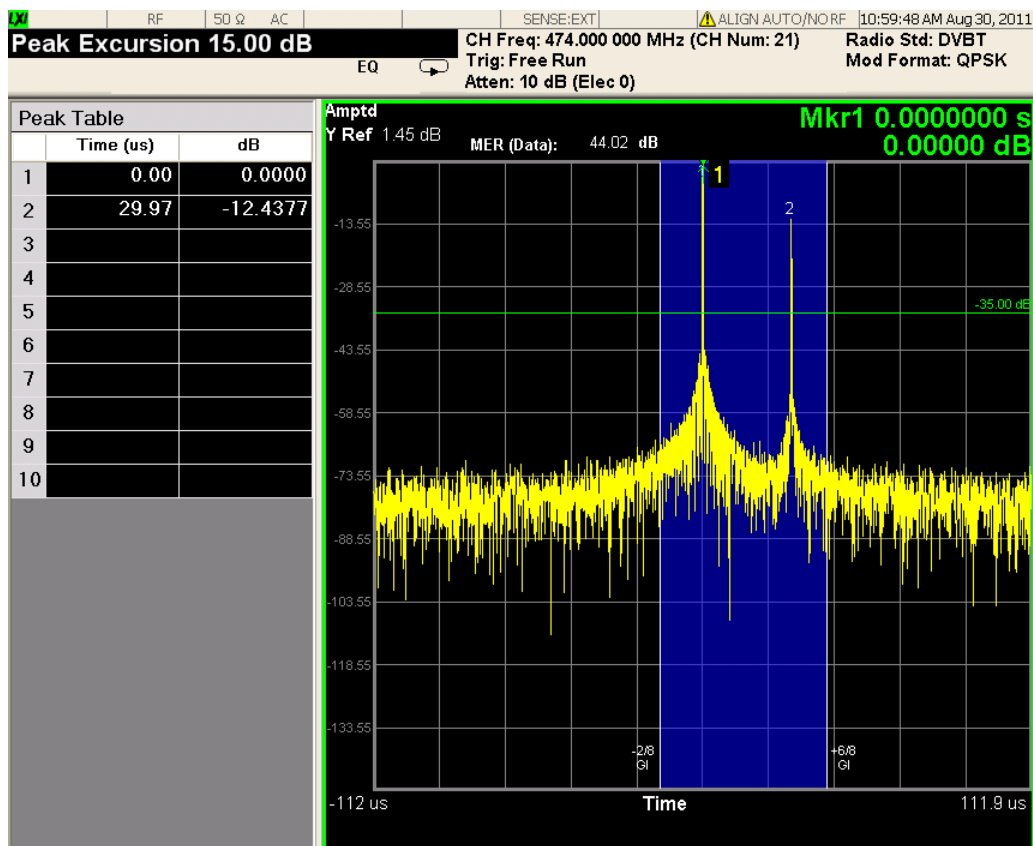

### Peak Table

This key is visible only when the current view is Channel Impulse Response.

Turns Peak Table on/off. When turned on, the display is split into a measurement window and a peak table display window.

Key Path	Peak Search, More, Peak Table
Mode	DVB-T/H
Remote Command	:CALCulate:EVM:MARKer:PEAK:TABLE:STATE OFF ON 0 1 :CALCulate:EVM:MARKer:PEAK:TABLE:STATE?
Example	CALC:EVM:MARK:PEAK:TABL:STAT OFF CALC:EVM:MARK:PEAK:TABL:STAT?
Preset	ON
State Saved	Saved in instrument state.
Range	On   Off
Initial S/W Revision	A.06.00



## Peak Sort

This key is visible only when the current view is Channel Impulse Response.

Sets the peak table sorting routine to list the peaks in order of descending amplitude or ascending time (absolute value).

Key Path	Peak Search, More, Peak Table
Mode	DVB
Remote Command	:CALCulate:EVM:MARKer:PEAK:SORT TIME AMPLitude :CALCulate:EVM:MARKer:PEAK:SORT?
Example	CALC:EVM:MARK:PEAK:SORT AMPLitude CALC:EVM:MARK:PEAK:SORT?
Preset	AMPLitude
State Saved	Saved in instrument state.
Range	Time   Amptd
Initial S/W Revision	A.06.00

## Peak Limit

This key is visible only when the current view is Channel Impulse Response.

If Peak Limit is set to on, a green line will display on Channel Impulse Response view. Only the peaks above Peak Limit will be displayed in the Peak Table.

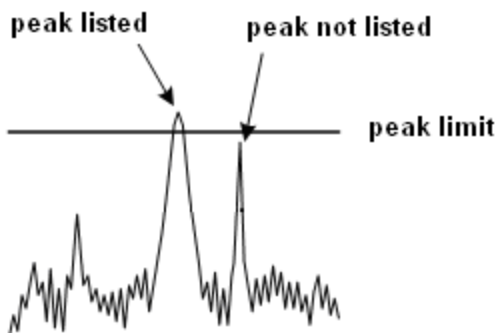

Key Path	Peak Search, More, Peak Table
Mode	DVB-T/H
Remote Command	:CALCulate:EVM:MARKer:PEAK:LIMit <real> :CALCulate:EVM:MARKer:PEAK:LIMit? :CALCulate:EVM:MARKer:PEAK:LIMit:STATE OFF ON 0 1 :CALCulate:EVM:MARKer:PEAK:LIMit:STATE?
Example	CALC:EVM:MARK:PEAK:LIM -35.0 CALC:EVM:MARK:PEAK:LIM?

	CALC:EVM:MARK:PEAK:LIM:STAT OFF CALC:EVM:MARK:PEAK:LIM:STAT?
Preset	-35.00 ON
State Saved	Saved in instrument state.
Min	-1000.00
Max	500.00
Initial S/W Revision	A.06.00

### Pk-Pk Search

Finds and displays the amplitude and frequency (or time, if in zero span) differences between the highest and lowest y-axis value.

Key Path	Peak Search, More
Mode	DVB-T/H
<b>Remote Command</b>	:CALCulate:EVM:MARKer[1] 2 ...12:PTPeak
<b>Example</b>	CALC:EVM:MARK:PTP
Notes	Restrictions Information: Turns on the Marker $\Delta$ active function.
Couplings	This key is not available (key is grayed out) when Coupled Markers is on.
Initial S/W Revision	A.02.00

### Min Search

Moves the selected marker to the minimum y-axis value on the current trace.

Key Path	Peak Search, More
Mode	DVB-T/H
<b>Remote Command</b>	:CALCulate:EVM:MARKer[1] 2 ...12:MINimum
<b>Example</b>	CALC:EVM:MARK:MIN
Initial S/W Revision	A.02.00

Print

See "Print" on page 341

## Quick Save

The Quick Save front-panel key repeats the most recent save that was performed from the Save menu, with the following exceptions:

- Register saves are not remembered as Saves for the purpose of the Quick Save function
- If the current measurement does not support the last non-register save that was performed, an informational message is generated, “File type not supported for this measurement”

Quick Save repeats the last type of qualified save (that is, a save qualified by the above criteria) in the last save directory by creating a unique filename using the Auto File Naming algorithm described below.

If Quick Save is pressed after startup and before any qualified Save has been performed, the Quick Save function performs a Screen Image save using the current settings for Screen Image saves (current theme, current directory), which then becomes the “last save” for the purpose of subsequent Quick Saves.

The Auto File Naming feature automatically generates a file name for use when saving a file. The filename consists of a prefix and suffix separated by a dot, as is standard for the Windows® file system. A default prefix exists for each of the available file types:

Type	Default Prefix	Menu
State	State_	(Save/Recall)
Trace + State	State_	(Save/Recall)
Screen	Screen_	(Save/Recall)
Amplitude Corrections	Ampcor_	(Import/Export)
Traces	Trace_	(Import/Export)
Limit Lines	LLine_	(Import/Export)
Measurement Result	MeasR_	(Import/Export)
Capture Buffer	CapBuf_	(Import/Export)

A four digit number is appended to the prefix to create a unique file name. The numbering sequence starts at 0000 within each Mode for each file type and updates incrementally to 9999, then wraps to 0000 again. It remembers where it was through a Mode Preset and when leaving and returning to the Mode. It is reset by Restore Misc Defaults and Restore System Defaults and subsequent running of the instrument application. So, for example, the first auto file name generated for State files is State\_0000.state. The next is State\_0001, and so forth.

One of the key features of Auto File Name is that we guarantee that the Auto File Name will never conflict with an existing file. The algorithm looks for the next available number. If it gets to 9999, then it looks for holes. If it find no holes, that is no more numbers are available, it gives an error.

For example, if when we get to State\_0010.state there is already a State\_0010.state file in the current directory, it advances the counter to State\_0011.state to ensure that no conflict will exist (and then it verifies that State\_0011.state also does not exist in the current directory and advances again if it does, and so forth).

If you enter a file name for a given file type, then the prefix becomes the filename you entered instead of the default prefix, followed by an underscore. The last four letters (the suffix) are the 4-digit number.

For example, if you save a measurement results file as “fred.csv”, then the next auto file name chosen for a measurement results save will be fred\_0000.csv.

**NOTE** Although 0000 is used in the example above, the number that is used is actually the current number in the Meas Results sequence, that is, the number that would have been used if you had not entered your own file name.

**NOTE** If the filename you entered ends with \_dddd, where d=any number, making it look just like an auto file name, then the next auto file name picks up where you left off with the suffix being dddd + 1.

Key Path	Front-panel key
Notes	No remote command for this key specifically.
Initial S/W Revision	Prior to A.02.00

## Recall

The Recall menu lets you choose what you want to recall, and where you want to recall it from. Among the types of files you can recall are **States and Traces**. In addition, an Import (Data) option lets you recall a number of data types stored in CSV files (as used by Excel and other spreadsheet programs).

The default paths for Recall are data type dependent and are the same as for the Save key.

Key Path	Front-panel key
Notes	<p>No remote command for this key specifically, but the :MMEM:LOAD command is available for specific file types. An example is :MMEM:LOAD:STATe &lt;filename&gt;.</p> <p>If you try to recall a State file for a mode that is not licensed or not available in the instrument, an error message will occur and the state will not change.</p>
Backwards Compatibility Notes	<p>In legacy analyzers, it was possible to load a state without affecting the trace data, limit lines or correction data. Similarly (since User Preset is actually loading a state), it was possible to do a User Preset without affecting the trace data, limit lines or correction data.</p> <p>In the X-Series, “state” always includes all of this data; so whenever state is loaded, all of the traces, limit lines and corrections are affected. Although this differs from previous behavior, it is desirable behavior, and should not cause adverse issues for users.</p>
Backwards Compatibility Notes	<p>Recall for the X-Series supports backward compatibility in the sense that you can recall a state file from any X-Series model number and any version of X-Series software. This is only possible if part of the recalling process goes through a limiting step after recalling the mode settings, at least for settings that may vary with version number, model number, option and license differences. If you try to recall a state file onto an instrument with less capability than what was available on the instrument during the save, the recall will ignore the state it doesn't support and it will limit the recalled setting to what it allows.</p> <p>Example: if the saved state includes preamp ON, but the recalling instrument does not have a preamp; the preamp is limited to OFF. Conversely, if you save a state without a preamp, the preamp is OFF in the state file. When this saved file is recalled on an instrument with a licensed preamp, the preamp is changed to OFF. Another example is if the saved state has center frequency set to 20 GHz, but the instrument recalling the saved state is a different model and only supports 13.5 GHz. In this case, the center frequency is limited along with any other frequency based settings. Since the center frequency can't be preserved in this case, the recall limiting tries to at least preserve span to keep the measurement setup as intact as possible.</p> <p>It may be appropriate to issue a warning if the state is limited on the recall; warnings do not go out to SCPI so this would only affect the manual user.</p> <p>Note that there is no state file compatibility outside of the X-Series. For example, you cannot recall a state file from ESA or PSA.</p>
Initial S/W Revision	Prior to A.02.00

## State

The Recall State menu lets you choose a register or file from which to recall the state.

The content of a state file includes all of the settings and data required to return the analyzer as closely as possible to the Mode it was in, with the exact settings that were in place, when the save occurred. The Mode settings in each state file include the settings that are affected by Mode Preset, as well as the

additional settings affected by Restore Mode Defaults; all of the Mode’s settings. In addition, all of the settings of the Input/Output system are included, even though they are outside of the Mode’s state, because they are needed to restore the complete setup. Persistent System settings (for example, GPIB address) are not affected by either a Mode Preset or Restore Mode Defaults, nor are they included in a saved State file.

Since each state file is only for one Mode, the settings for other Modes are unaffected when it is loaded. Recall State will cause a mode switch if the state being recalled is not from the current active mode.

After the recall completes, the message "File <filename> recalled" or “Recalled State Register <register number>” is displayed.

For rapid recalls, the State menu lists 16 registers that you can choose from to recall. Pressing a Register key initiates the recall. You can also select a file from which to recall.

The default path for all State Files is:

My Documents\<<mode name>\state

where <mode name> is the parameter used to select the mode with the INST:SEL command (for example, SA for the Spectrum Analyzer).

See "[More Information](#)" on page 1400.

<b>Key Path</b>	Recall
<b>Mode</b>	All
<b>Remote Command</b>	:MMEMory:LOAD:STATe <filename>
<b>Example</b>	:MMEM:LOAD:STAT "myState.state" This recalls the file myState.state on the default path
<b>Example</b>	MMEM:LOAD:STAT "MyStateFile.state" This loads the state file data (on the default file directory path) into the instrument state.
<b>Notes</b>	<p>When you pick a file to recall, the analyzer first verifies that the file is recallable in the current instrument by checking the software version and model number of the instrument. If everything matches, a full recall proceeds by aborting the currently running measurement, clearing any pending operations, and then loading the State from the saved state file. You can open state files from any mode, so recalling a State file switches to the mode that was active when the save occurred. After switching to the mode of the saved state file, mode settings and data (if any for the mode) are loaded with values from the saved file. The saved measurement of the mode becomes the newly active measurement and the data relevant to the measurement (if there is any) is recalled.</p> <p>If there is a mismatch between file version or model number or instrument version or model number, the recall function tries to recall as much as possible and returns a warning message. It may limit settings that differ based on model number, licensing or version number.</p> <p>After recalling the state, the Recall State function does the following:</p> <ul style="list-style-type: none"> <li>• Makes the saved measurement for the mode the active measurement.</li> <li>• Clears the input and output buffers.</li> <li>• Status Byte is set to 0.</li> <li>• Executes a *CLS</li> </ul> <p>If the file specified is empty an error is generated. If the specified file does not exist, another error is generated. If there is a mismatch between the file and the proper file type, an error is generated. If</p>

	there is a mismatch between file version or model number or instrument version or model number, a warning is displayed. Then it returns to the State menu and File Open dialog goes away. After the Recall, the analyzer exits the Recall menu and returns to the previous menu.
<b>Backwards Compatibility SCPI</b>	:MMEMory:LOAD:STATe 1,<filename> For backwards compatibility, the above syntax is supported. The "1" is simply ignored.
Initial S/W Revision	Prior to A.02.00

### More Information

In measurements that support saving Traces, for example, Swept SA, the Trace data is saved along with the State in the State file. When recalling the State, the Trace data is recalled as well. Traces are recalled exactly as they were stored, including the writing mode and update and display modes. If a Trace was updating and visible when the State was saved, it will come back updating and visible, and its data will be rewritten right away. When you use State to save and recall traces, any trace whose data must be preserved should be placed in View or Blank mode before saving.

The following table describes the Trace Save and Recall possibilities:

You want to recall state and one trace's data, leaving other traces unaffected.	Save Trace+State from 1 trace. Make sure that no other traces are updating (they should all be in View or Blank mode) when the save is performed.	On Recall, specify the trace you want to load the one trace's data into. This trace will load in View. All other traces' data will be unaffected, although their trace mode will be as it was when the state save was performed.
You want to recall all traces	Save Trace+State from ALL traces.	On Recall, all traces will come back in View (or Blank if they were in Blank or Background when saved)
You want all traces to load exactly as they were when saved.	Save State	On recall, all traces' mode and data will be exactly as they were when saved. Any traces that were updating will have their data immediately overwritten.

### From File...

When you press "From File", the analyzer brings up a Windows dialog and a menu entitled "File Open." This menu allows you to navigate to the various fields in the Windows dialog without using a keyboard or mouse. The Tab and Arrow keys can also be used for dialog navigation.



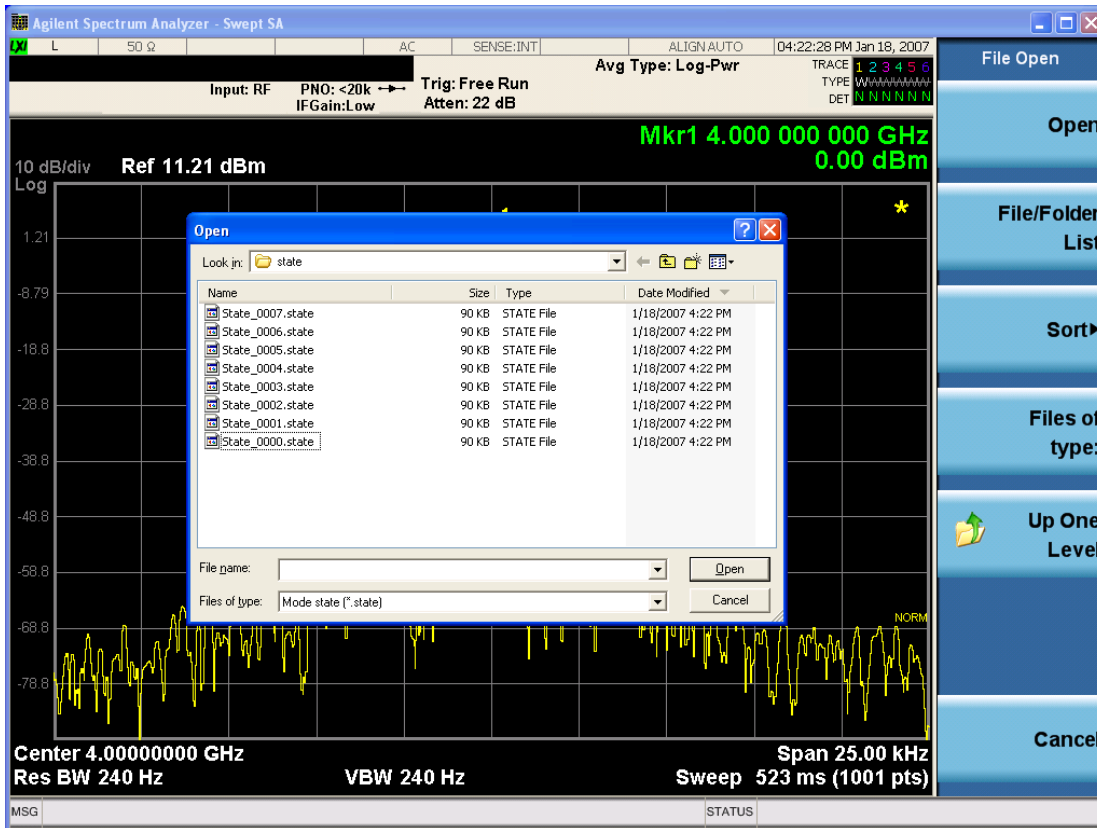

Listed below are the functions of the various fields in the dialog, and the corresponding softkeys:

#### Open

Performs the recall of the specified file. While the recall is being performed, the floppy icon appears briefly in the Meas bar.

#### File/Folder List

Enables you to navigate to the center of the dialog that contains the list of files and folders. Once here you can get information about the file and use the tab keys to navigate to the other fields in the dialog, such as Look In.

#### Look In

The Look In field shows the path from which the file will be recalled and allows you to change the path using the up and down arrow keys to navigate to other paths; the Enter key to open a directory; and the Backspace key to go back one directory. The **Look In field** first uses the last path from the Save As dialog **Save In:** path for that same file type. There is no softkey for directly navigating to the Look In field, but you can use the left tab to get here from the File/Folder List.

User specified paths are remembered when you leave and return to a Mode and are reset back to the default using Restore Mode Defaults.

#### Sort

Accesses a menu that enables you to sort the files within the File Open dialog. Only one sorting type can be selected at a time and the sorting happens immediately. The sorting types are By Date, By Name, By extension, and By Size.

#### Files of Type

This field shows the file suffix for the type of file you have selected to recall. For example, if you navigated here while recalling State, "Mode state (\*.state)" is in the field. If you navigated here while recalling Trace, ""Mode state (\*.trace)" is in the field. If you navigated here while importing a trace data file, "Trace Data (\*.csv)" is in the field. For some file types, there is more than one choice in the dropdown menu, which you can select by using the up and down arrow keys and Enter.

#### Up One Level

This key corresponds to the icon of a folder with the up arrow that is in the tool bar of the dialog. When pressed, it causes the file and folder list to navigate up one level in the directory structure. The Backspace key does the same thing.

#### Cancel

This key corresponds to the Cancel selection in the dialog. It causes the current **Open** request to be cancelled. The ESC key does the same thing.

Key Path	Recall, State
Notes	Brings up the Open dialog for recalling a State Save Type
Initial S/W Revision	Prior to A.02.00

### Edit Register Names

You may enter a custom name on any of the Register keys, to help you remember what you are using that state to save. To do this, press the Edit Register Names key, choose the register whose name you wish to edit, and then enter the desired label using the Alpha Editor or an external PC keyboard.

The maximum number of characters that can be added is 30. In most cases, 30 characters will fit on two lines of the key.

For more information and the SCPI command, see Edit Register Names under the Save, State function.

Key Path	Recall, State
Mode	All
Dependencies	N9060A-7FP or N9060B-2FP license required to edit the register names. When the feature is not licensed, sending the SCPI command generates an error, -221, "Settings conflict;Option not available"
Initial S/W Revision	A.11.00

### Register 1 thru Register 16

Selecting any one of these register keys causes the State of the mode from the specified Register to be recalled. Each of the register keys annotates whether it is empty or at what date and time it was last

modified. In addition, you can use the Edit Register Names key under Save, State to enter custom names for each register.

Registers are shared by all modes, so recalling from any one of the registers will cause a mode switch to the mode that was active when the save to the Register occurred.

Although these 16 registers are the only registers available from the front panel, there are 128 state registers available in the instrument. Registers 17–128 are only available from the SCPI interface, using the \*RCL command.

After the recall completes, the message "Register <register number> recalled" appears in the message bar. If you are in the Spectrum Analyzer Mode, and you are recalling a register that was saved in the Spectrum Analyzer Mode, then after the recall, you will still be in the Recall Register menu. If the Recall causes you to switch modes, then after the Recall, you will be in the Frequency menu.

If a requested register is empty an error is generated.

Key Path	Recall, State
<b>Example</b>	*RCL 1
Range	1–16 from front panel, 1–128 from SCPI
Readback	Date and time with seconds resolution are displayed on the key OR A custom name of up to 30 characters entered using the Save, State, Edit Register Names key OR “(empty)” if no prior save operation has been performed to this register.
Initial S/W Revision	Prior to A.02.00
Modified at S/W Revision	Prior to A.11.00

## Register 1 thru Register 16

Selecting any one of these register keys causes the State of the mode from the specified Register to be recalled. Each of the register keys annotates whether it is empty or at what date and time it was last modified. In addition, you can use the Edit Register Names key under Save, State to enter custom names for each register.

Registers are shared by all modes, so recalling from any one of the registers will cause a mode switch to the mode that was active when the save to the Register occurred.

Although these 16 registers are the only registers available from the front panel, there are 128 state registers available in the instrument. Registers 17–128 are only available from the SCPI interface, using the \*RCL command.

After the recall completes, the message "Register <register number> recalled" appears in the message bar. If you are in the Spectrum Analyzer Mode, and you are recalling a register that was saved in the Spectrum Analyzer Mode, then after the recall, you will still be in the Recall Register menu. If the Recall causes you to switch modes, then after the Recall, you will be in the Frequency menu.

If a requested register is empty an error is generated.

Key Path	Recall, State
<b>Example</b>	*RCL 1
Range	1-16 from front panel, 1-128 from SCPI
Readback	Date and time with seconds resolution are displayed on the key OR A custom name of up to 30 characters entered using the Save, State,Edit Register Names key OR “(empty)” if no prior save operation has been performed to this register.
Initial S/W Revision	Prior to A.02.00
Modified at S/W Revision	Prior to A.11.00

## Data (Import)

Importing a data file loads data that was previously saved from the current measurement or from other measurements and/or modes that produce compatible data files. The Import Menu only contains Data Types that are supported by the current measurement.

Since the commonly exported data files are in .csv format, the data can be edited by the user prior to importing. This allows you to export a data file, manipulate the data in Excel (the most common PC Application for manipulating .csv files) and then import it.

Importing Data loads measurement data from the specified file into the specified or default destination, depending on the data type selected. Selecting an Import Data menu key will not actually cause the importing to occur, since the analyzer still needs to know from where to get the data. Pressing the Open key in this menu brings up the Open dialog and Open menu that provides you with the options from where to recall the data. Once a filename has been selected or entered in the Open menu, the recall occurs as soon as the Open button is pressed.

Key Path	Recall
Mode	All
Notes	The menu is built from whatever data types are available for the mode. Some keys will be missing completely, so the key locations in the sub-menu will vary. No SCPI command directly controls the Data Type that this key controls. The Data Type is included in the MMEM:LOAD commands.
Dependencies	If a file type is not used by a certain measurement, it is grayed out for that measurement. The key for a file type will not show at all if there are no measurements in the Mode that support it.
Preset	Is not affected by Preset or shutdown, but is reset during Restore Mode Defaults
Readback	The data type that is currently selected
Initial S/W Revision	Prior to A.02.00

## Amplitude Correction

This key selects the Amplitude Corrections as the data type to be imported. When pressed a second time, it brings up the Select Menu, which lets you select the Correction into which the data will be imported.

Amplitude Corrections are fully discussed in the documentation of the Input/Output key, under the Corrections key.

A set of preloaded Corrections files can be found in the directory

/My Documents/ EMC Limits and Ampcor.

When the Amplitude Correction is an Antenna correction and the Antenna Unit in the file is not None, the Y Axis Unit setting will change to match the Antenna Unit in the file.

Key Path	Recall
Mode	SA EDGE GSM PN
Remote Command	:MMEMory:LOAD:CORRection 1 2 3 4 5 6 7 8, <filename>
Example	:MMEM:LOAD:CORR 2, "myAmpcor.csv" recalls the Amplitude Correction data from the file myAmpcor.csv in the current directory to the 2nd Amplitude Correction table, and turns on Correction 2. The default path is D:\User_My_Documents\Instrument\My Documents\amplitudeCorrections\
Dependencies	<p>Only the first correction array (Correction 1) supports antenna units. This means that a correction file with an Antenna Unit can only be loaded into the Corrections 1 register. Consequently only for Correction 1 does the dropdown in the Recall dialog include.ant, and if an attempt is made to load a correction file into any other Correction register which DOES contain an antenna unit, a Mass Storage error is generated.</p> <p>Corrections are not supported by all Measurements. If in a Mode in which some Measurements support it, this key will be grayed out in measurements that do not. The key will not show at all if no measurements in the Mode support it.</p> <p>Errors are reported if the file is empty or missing, or if the file type does not match, or if there is a mismatch between the file type and the destination data type. If any of these occur during manual operation, the analyzer returns to the Import Data menu and the File Open dialog goes away.</p> <p>This key does not appear unless you have the proper option installed in your instrument.</p> <p>This command will generate an "Option not available" error unless you have the proper option installed in your instrument.</p>
Couplings	When a correction file is loaded from mass storage, it is automatically turned on ( <b>Correction ON</b> ) and <b>ApplyCorrections</b> is set to On. This allows you to see its effect, thus confirming the load.
Readback	selected Correction
Backwards Compatibility SCPI	:MMEMory:LOAD:CORRection ANTenna   CABLe   OTHer   USER, <filename> For backwards compatibility, ANTenna maps to 1, CABLe maps to 2, OTHer maps to 3 and USER maps to 4
Initial S/W Revision	A.02.00

## Amplitude Correction

These keys let you select which Correction to import the data into. Once selected, the key returns back to the Import Data menu and the selected Correction number is annotated on the key. The next step is to select the Open key in the Import Data menu.

Antenna corrections are a particular kind of Amplitude Corrections – they are distinguished in the corrections file by having the Antenna Unit set to a value other than None. Only Correction 1 supports Antenna Units.

Key Path	Recall, Data, Amplitude Correction
Notes	auto return
Dependencies	Only Correction 1 may be used to load a Correction that contains an Antenna Unit other than None
Preset	Not part of Preset, but is reset to Correction 1 by Restore Input/Output Defaults; survives shutdown.
State Saved	The current Correction number is saved in instrument state
Initial S/W Revision	A.02.00

## Chan Table

Imports the channel table from a channel plan file. This function enables you to use your own defined channel tables by importing a modified channel table file.

Instead of creating a brand new channel plan file, you can generate a channel plan file to fit your needs using a saved channel plan file or the default channel plan file ChannelPlan.txt in the directory “My Documents\Digital Video\data\”. The saved channel plan file is obtained by pressing Save, Data, Channel Table, and then Save As...

Note that while editing the channel plan file, you cannot change the channel plan name, such as NTSC\_B.VHF, NTSC\_B.UHF, otherwise your modifications on the corresponding channel plan will not work. You can add, remove, or modify the channel numbers and center frequencies in each channel plan. The value of Start Channel and Channel Count may also need to be changed.

File Location and Extension

**File location:** “My Documents\Digital Video\data”

**File type:** text file

**File extension:** .txt

**Example:**

File Location: My Documents\Digital Video\data

File Name: ChannelPlan\_0001.txt

Key Path	Recall, Data
Mode	DVB-T/H
Remote Command	MMEMory:LOAD:CHTable <string>
Example	MMEM:LOAD:CHT “ChannelPlan_0001.txt”
Initial S/W Revision	A.07.00

## Capture Buffer

Capture buffer functionality is available only in Mod Accuracy measurement. The captured data is raw data which is not processed.

Key Path	Recall, Data
Mode	DVB-T/H
Example	MMEM:LOAD:CAPT "MyCaptureData.bin" This loads the file of capture data (on the default file directory path) into the instrument.
Dependencies	Capture buffer data is only available for Mod Accuracy measurement. In other measurements, this key is grayed out.
Initial S/W Revision	Prior to A.01.70

## DVB-T2 Config

Imports DVB-T2 configuration from setting files (single PLP or multiple PLPs). This key is available only in DVB-T2 Mod Accuracy measurement and will be grayed out in other measurements.

If the configuration file to be recalled is created with previous instrument S/W revision A.10.52 or before (To check the instrument S/W revision, press System, Show, System on the instrument), it doesn't have Transmission Mode and Version parameters. Then you need to set up the DVB-T2 version and transmission mode manually by pressing Mode Setup, Radio Std, DVB-T2, Version 1.1.1, and toggling Transmission Mode to SISO to select the standard version and transmission mode of the signal under test.

All the modulation parameters can be set from the setting file. These parameters include Version, Transmission Mode, Guard Interval, FFT size, Carrier Mode, Pilot Pattern, L1 Modulation Format, Data Symbols, PAPR Type, PLP Number, SubSlices Number, SubSlices Interval, PLP Modulation Format, PLP Constellation Rotation, FEC Type, Time IL Length, FEC Block Num, PLP ID, PLP Start, PLP Type and PLP Code Rate.

File Location and Extension

**File location:** "My Documents\DVB\data\EVMT2\data"

**File type:** text file

**File extension:** .csv

**Example:**

File Location: My Documents\DVB\data\EVMT2\data

File Name: DVBT2Config\_0001.csv

Key Path	Recall, Data
Mode	DVB-T/H
Remote Command	MMEMory:LOAD:T2Config <string>

<b>Example</b>	MMEM:LOAD:T2C "DVBT2Config_0001.csv"
<b>Dependencies</b>	This key is grayed out in all other measurements except DVB-T2 Mod Accuracy measurement.
<b>Couplings</b>	Auto Detect (Meas, DVB-T2 ModAccuracy, Meas Setup) will be changed to OFF automatically when the DVB-T2 config file is loaded.
<b>Initial S/W Revision</b>	A.07.00

## Open...

When you press "Open", the analyzer brings up a Windows dialog and a menu entitled "File Open." This menu allows you to navigate to the various fields in the Windows dialog without using a keyboard or mouse. The Tab and Arrow keys can also be used for dialog navigation.

See "[From File...](#)" on page 2201 in Recall, State, for a full description of this dialog and menu.

<b>Key Path</b>	Recall, Data
<b>Notes</b>	The key location is mode-dependent and will vary. Brings up Open dialog for recalling a <mode specific> Save Type
<b>Initial S/W Revision</b>	Prior to A.02.00



## Restart

The Restart function restarts the current sweep, or measurement, or set of averaged/held sweeps or measurements. If you are Paused, pressing Restart does a Resume.

The Restart function is accessed in several ways:

- Pressing the Restart key
- Sending the remote command INIT:IMMEDIATE
- Sending the remote command INIT:RESTART

See "[More Information](#)" on page 1409

Key Path	Front-panel key
Remote Command	:INITiate[:IMMEDIATE] :INITiate:RESTART
Example	:INIT:IMM :INIT:REST
Notes	:INITiate:RESTART and :INITiate:IMMEDIATE perform exactly the same function.
Couplings	Resets average/hold count k. For the first sweep overwrites all active (update=on) traces with new current data. For application modes, it resets other parameters as required by the measurement.
Status Bits/OPC dependencies	This is an Overlapped command. The STATUS:OPERation register bits 0 through 8 are cleared. The STATUS:QUESTIONable register bit 9 (INTEgrity sum) is cleared. The SWEEPING bit is set. The MEASURING bit is set.
Backwards Compatibility Notes	For Spectrum Analysis mode in ESA and PSA, the Restart hardkey and the INITiate:RESTART command restart trace averages (displayed average count reset to 1) for a trace in Clear Write, but did not restart Max Hold and Min Hold. In the X-Series, the Restart hardkey and the INITiate:RESTART command restart not only Trace Average, but MaxHold and MinHold traces as well. For wireless comms modes in ESA and PSA, the Restart hardkey and the INITiate:RESTART command restart every measurement, which includes all traces and numeric results. There is no change to this operation.
Initial S/W Revision	Prior to A.02.00

### More Information

The **Restart** function first aborts the current sweep/measurement as quickly as possible. It then resets the sweep and trigger systems, sets up the measurement and initiates a new data measurement sequence with a new data acquisition (sweep) taken once the trigger condition is met.

If the analyzer is in the process of aligning when **Restart** is executed, the alignment finishes before the restart function is performed.

Even when set for Single operation, multiple sweeps may be taken when Restart is pressed (for example, when averaging/holding is on). Thus when we say that **Restart** "restarts a measurement," we may mean:

- It restarts the current sweep
- It restarts the current measurement
- It restarts the current set of sweeps if any trace is in Trace Average, Max Hold or Min Hold
- It restarts the current set of measurements if Averaging, or Max Hold, or Min Hold is on for the measurement
- depending on the current settings.

With **Average/Hold Number** (in **Meas Setup** menu) set to 1, or Averaging off, or no trace in Trace Average or Hold, a single sweep is equivalent to a single measurement. A single sweep is taken after the trigger condition is met; and the analyzer stops sweeping once that sweep has completed. However, with **Average/Hold Number** >1 and at least one trace set to **Trace Average, Max Hold, or Min Hold (SA Measurement)** or **Averaging on (most other measurements)**, multiple sweeps/data acquisitions are taken for a single measurement. The trigger condition must be met prior to each sweep. The sweep is stopped when the average count  $k$  equals the number  $N$  set for **Average/Hold Number**. A measurement average usually applies to all traces, marker results, and numeric results; but sometimes it only applies to the numeric results.

Once the full set of sweeps has been taken, the analyzer will go to idle state. To take one more sweep without resetting the average count, increment the average count by 1, by pressing the step up key while **Average/Hold Number** is the active function, or sending the remote command `CALC:AVER:TCON UP`.

## Save

The Save menu lets you choose what you want to save and where you want to save it. Among the types of files you can save are **States**, **Traces**, and **Screen Images**. In addition, an Export (Data) option lets you save a number of data types as CSV files for easy import into Excel and other spreadsheet programs.

Key Path	Front-panel key
Mode	All
Notes	No remote command for this key specifically, but the :MMEM:STORe command is available for specific file types. An example is :MMEM:STOR:STATe <filename>.
Initial S/W Revision	Prior to A.02.00

## State

The Save State menu lets you choose a register or file for saving the state.

The content of a state file includes all of the settings and data required to return the analyzer as closely as possible to the Mode it was in, with the exact settings which were in place, when the save occurred. The Mode settings in each state file include the settings that are affected by Mode Preset, as well as the additional settings affected by Restore Mode Defaults; all of the Mode's settings. In addition, all of the settings of the Input/Output system are included, even though they are outside of the Mode's state, because they are needed to restore the complete setup. Persistent System settings (for example, Verbose SCPI) are not affected by either Mode Preset or Restore Mode Defaults, nor are they included in a saved State file.

After the save completes, the message "File <filename> saved" or "State Register <register number> saved" is displayed.

For rapid saving, the State menu lists 16 registers to save to. Pressing a Register key initiates the save. You can also select a file to save to.

The default path for all State Files is:

My Documents\<<mode name>\state

where <mode name> is the parameter used to select the mode with the INST:SEL command (for example, SA for the Spectrum Analyzer).

Key Path	Save
Mode	All
Remote Command	:MMEMory:STORe:STATe <filename>
Example	MMEM:STOR:STATe "MyStateFile.state" This stores the current instrument state data in the file MyStateFile.state in the default directory.
Notes	Both single and double quotes are supported for any filename parameter over remote. After saving to a register, that register's menu key is updated with the date the time, unless a custom label has been entered for that key. After saving to a register, you remain in the Save State menu, so that you can see the Register key

update. After saving to a file, the analyzer automatically returns to the previous menu and any Save As dialog goes away.

**Backwards Compatibility SCPI** :MMEMory:STORe:STATe 1,<filename>

For backwards compatibility, the above syntax is supported. The "1" is simply ignored. The command is sequential.

Initial S/W Revision Prior to A.02.00

### To File . . .

When you press “To File”, the analyzer brings up a Windows dialog and a menu entitled “Save As.” This menu allows you to navigate to the various fields in the Windows dialog without using a keyboard or mouse. The Tab and Arrow keys can also be used for dialog navigation.

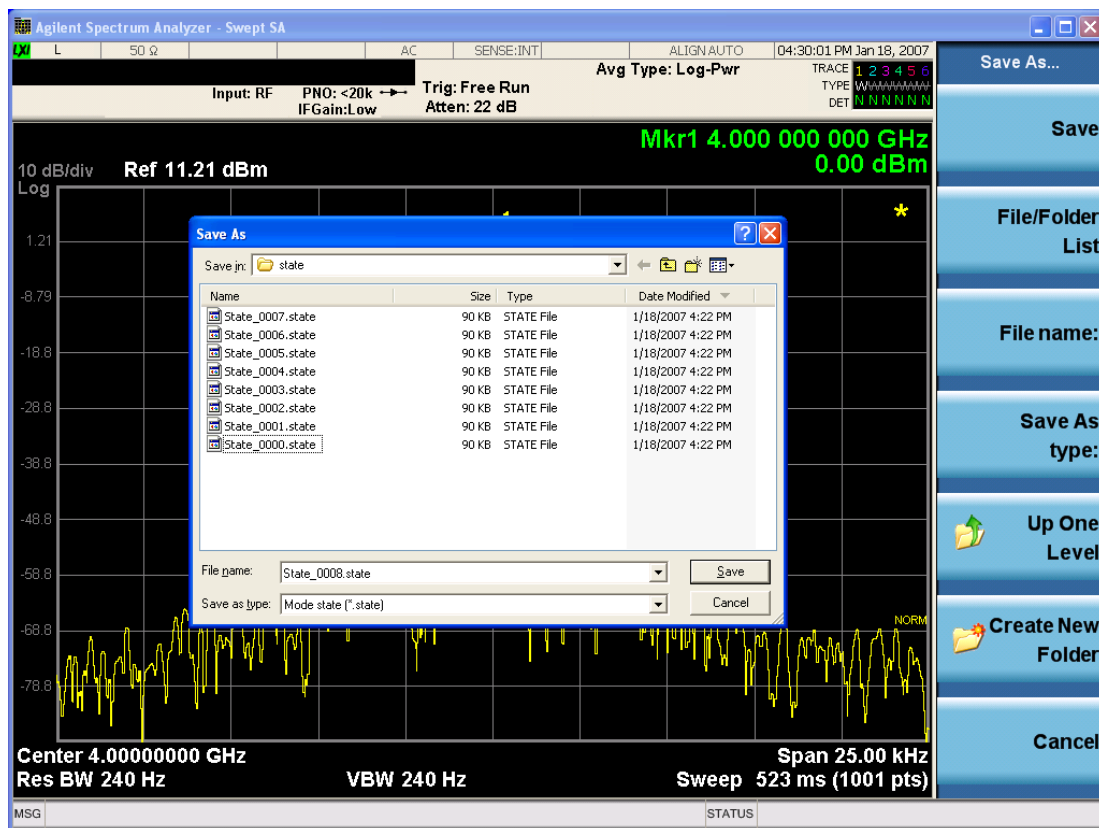

The Listed below

are the functions of the various fields in the dialog, and the corresponding softkeys:

### Save

Performs the save to the specified file of the selected type. If the file already exists, a dialog will appear that allows you to replace the existing file by selecting OK, or you can Cancel the request. If you select OK, the file will be overwritten. Using the C: drive is strongly discouraged, since it runs the risk of being overwritten during an instrument software upgrade.

While the save is being performed, the floppy icon appears briefly in the Meas bar.

## File/Folder List

Enables you to navigate to the center of the dialog that contains the list of files and folders. Once here you can get information about the file and use the tab keys to navigate to the other fields in the dialog, such as Save In.

## Save In

The Save In field shows the path to which the file will be saved and allows you to change the path using the up and down arrow keys to navigate to other paths; the Enter key to open a directory; and the Backspace key to go back one directory. The **Save In field** defaults to the default path for this type of file and remembers the last path you used to save this type of file. There is no softkey for directly navigating to the Save In field but you can use left tab to get here from the File/Folder List.

User specified paths are remembered when you leave and return to a Mode and are reset back to the default using Restore Mode Defaults.

## File Name

The File Name field is initially loaded with an automatically generated filename specific to the appropriate Save Type. The automatically generated filename is guaranteed not to conflict with any filename currently in the directory. You may replace or modify this filename using the File Name key. See the ["Quick Save " on page 2197](#) documentation for more on the automatic file naming algorithm.

When you press the File Name key the analyzer displays the Alpha Editor. Use the knob to choose the letter to add and the front-panel Enter key to add the letter to the file name. The BK character moves you back and the FW character moves you forward in the filename. The Select key on the front panel generates a space character. When you are done entering the filename press the Done softkey. This returns back to the **File Open** dialog and menu, but does not cause the save to occur.

## Save As Type

This field shows the file suffix for the type of file you have selected to save. For example, if you navigated here while saving State, "Mode state (\*.state)" is in the field. If you navigated here from saving Trace, ""Mode state (\*.trace)" is in the field. If you navigated here while exporting a trace data file, "Trace Data (\*.csv)" is in the field. For some file types, there is more than one choice in the dropdown, which you can select by using the up and down arrow keys and Enter.

## Up One Level

This key corresponds to the icon of a folder with the up arrow that is in the tool bar of the dialog. When pressed, it causes the file and folder list to navigate up one level in the directory structure. The Backspace key does the same thing.

## Create New Folder

This key corresponds to the icon of a folder with the "\*" that is in the tool bar of the dialog. When pressed, a new folder is created in the current directory with the name **New Folder** and you can enter a new folder name using the Alpha Editor.

## Cancel

This key corresponds to the Cancel selection in the dialog. It causes the current **Save As** request to be cancelled. The ESC key does the same thing.

Key Path	Save, State
Mode	All
Notes	Brings up Save As dialog for saving a State Save Type
Initial S/W Revision	Prior to A.02.00

## Edit Register Names

You may enter a custom name on any of the Register keys, to help you remember what you are using that state to save. To do this, press the Edit Register Names key, choose the register whose name you wish to edit, and then enter the desired label using the Alpha Editor or an external PC keyboard.

The maximum number of characters that can be added is 30. In most cases, 30 characters will fit on two lines of the key.

See ["More Information" on page 1414](#)

Key Path	Save, State
Mode	All
<b>Remote Command</b>	:MMEMory:REGister:STATe:LABel <reg number>,"label" :MMEMory:REGister:STATe:LABel? <reg number>
<b>Example</b>	:MMEM:REG:STAT:LAB 1,"my label"
Notes	<reg number> is an integer from 1 to 16. If the SCPI specifies an invalid register number an error message is generated, -222,"Data out of range;Invalid register label number" "label" is a string from 0 to 30 characters in length. If a label exceeds 30 characters, an error message is generated, -150,"String data error;Label clipped to 30 characters" "label" of length 0 erases the custom label and restores the default (time and date) label. E.g.: :MMEM:REG:STAT:LAB 1,""
Dependencies	N9060A-7FP or N9060B-2FP license required to edit the register names. When the feature is not licensed, sending this command generates an error, -221,"Settings conflict;Option not available"
Preset	The names are unaffected by Preset or power cycle but are set to the default label (time and date) on a "Restore System Defaults->Misc"
Initial S/W Revision	A.11.00

## More Information

When you edit one of the register names, the time and date field will be replaced by the custom name.

If you delete all the characters in the custom name, it restores the default (time and date).

The register names are stored within the state files, but they are not part of the instrument state; that is, once you have edited a register name, loading a new state will not change that register name. Another consequence of this is that the names will be persistent through a power cycle. Also, if a named state file is transferred to another analyzer, it will bring its custom name along with it.

If you try to edit the name of an empty register, the analyzer will first save the state to have a file to put the name in. If you load a named state file into an analyzer with older firmware it will ignore the metadata.

The \*SAV and \*RCL commands will not be affected by the custom register names, nor will the MMEM commands.

### Register 1 thru Register 16

Selecting any one of these register menu keys causes the State of the currently active mode to be saved to the specified Register. The registers are provided for rapid saving and recalling, since you do not need to specify a filename or navigate to a file. Each of the register menu keys annotates whether it is empty or at what date and time it was last modified. In addition, you can use the Edit Register Names key to enter custom names for each register.

Although these 16 registers are the only registers available from the front panel, there are 128 state registers available in the instrument. Registers 17–128 are only available from the SCPI interface, using the \*SAV command.

There is one set of 128 state registers in the instrument, not one set for each Mode. When a state is saved, the Mode it was saved from is saved with it; then when it is recalled, the instrument switches to that Mode.

After the save completes, the corresponding register menu key annotation is updated with the date and time and the message "Register <register number> saved" is displayed.

Key Path	Save, State
Mode	All
<b>Example</b>	*SAV 1
Range	1–16 from front panel, 1–128 from SCPI
Readback	Date and time with seconds resolution are displayed on the key OR A custom name of up to 30 characters entered using the Edit Register Names key OR “(empty)” if no prior save operation has been performed to this register.
Initial S/W Revision	Prior to A.02.00
Modified at S/W Revision	A.11.00

### Register 1 thru Register 16

Selecting any one of these register menu keys causes the State of the currently active mode to be saved to the specified Register. The registers are provided for rapid saving and recalling, since you do not need to specify a filename or navigate to a file. Each of the register menu keys annotates whether it is empty or at what date and time it was last modified. In addition, you can use the Edit Register Names key to enter custom names for each register.

Although these 16 registers are the only registers available from the front panel, there are 128 state registers available in the instrument. Registers 17–128 are only available from the SCPI interface, using the \*SAV command.

There is one set of 128 state registers in the instrument, not one set for each Mode. When a state is saved, the Mode it was saved from is saved with it; then when it is recalled, the instrument switches to that Mode.

After the save completes, the corresponding register menu key annotation is updated with the date and time and the message "Register <register number> saved" is displayed.

Key Path	Save, State
Mode	All
Example	*SAV 1
Range	1-16 from front panel, 1-128 from SCPI
Readback	Date and time with seconds resolution are displayed on the key OR A custom name of up to 30 characters entered using the Edit Register Names key OR "(empty)" if no prior save operation has been performed to this register.
Initial S/W Revision	Prior to A.02.00
Modified at S/W Revision	A.11.00

## Data (Export)

Exporting a data file stores data from the current measurement to mass storage files. The Export Menu only contains data types that are supported by the current measurement.

Since the commonly exported data files are in .csv format, the data can be edited by you prior to importing. This allows you to export a data file, manipulate the data in Excel (the most common PC Application for manipulating .csv files) and then import it.

Selecting an Export Data menu key will not actually cause the exporting to occur, since the analyzer still needs to know where you wish to save the data. Pressing the Save As key in this menu brings up the Save As dialog and Save As menu that allows you to specify the destination file and directory. Once a filename has been selected or entered in the Open menu, the export will occur as soon as the Save key is pressed.

Key Path	Save
Mode	All
Notes	The menu is built from whatever data types are available for the mode. So the key locations in the sub menu will vary. No SCPI command directly controls the Data Type that this key controls. The Data Type is included in the MMEM:STORe commands.
Dependencies	If a file type is not used by a certain measurement, that type is grayed out for that measurement. The key for a file type will not show at all if there are no measurements in the Mode that support it.
Preset	Is not affected by a Preset or shutdown, but is reset during Restore Mode Defaults
Readback	The data type that is currently selected
Initial S/W Revision	Prior to A.02.00



## Amplitude Correction

Pressing this key selects **Amplitude Corrections** as the data type to be exported. Pressing this key again brings up the Select Menu, which allows the user to select which **Amplitude Correction** to save.

Amplitude Corrections are fully discussed in the documentation of the Input/Output key, under the Corrections softkey.

See "[Correction Data File](#)" on page 1417

Key Path	Save
<b>Remote Command</b>	:MMEMory:STORe:CORRection 1 2 3 4 5 6, <filename>
<b>Example</b>	:MMEM:STOR:CORR 2 "myAmpcor.csv" saves Correction 2 to the file myAmpcor.csv on the current path. The default path is My Documents\amplitudeCorrections.
Notes	If the save is initiated via SCPI, and the file already exists, the file will be overwritten. Using the C: drive is strongly discouraged, since it runs the risk of being overwritten during an instrument software upgrade. Both single and double quotes are supported for any filename parameter over SCPI.
Dependencies	Corrections are not supported by all Measurements. If in a Mode in which some Measurements support it, this key will be grayed out in measurements that do not. The key will not show at all if no measurements in the Mode support it. This key will not appear unless you have the proper option installed in your instrument.
Readback	Selected Correction
<b>Backwards Compatibility SCPI</b>	:MMEMory:STORe:CORRection ANTenna   CABLe   OTHer   USER, <filename> For backwards compatibility, ANTenna maps to 1, CABLe maps to 2, OTHer maps to 3 and USER maps to 4
Initial S/W Revision	A.02.00

## Correction Data File

A Corrections Data File contains a copy of one of the analyzer correction tables. Corrections provide a way to adjust the trace display for predetermined gain curves (such as for cable loss).

Corrections files are text files in .csv (comma separated values) form, to make them importable into Excel or other spreadsheet programs. The format for Corrections files is as follows.

Line #	Type of field	Example	Notes
1	File type, must be "Amplitude Correction"	Amplitude Correction	May not be omitted
2	File Description (in quotes)	"Correction Factors for 11966E"	60 characters max; may be empty but may not be omitted. If exceeds 60 characters, error -233 Too much data reported
3	Comment (in quotes)	"Class B Radiated"	60 characters max; may be empty but

Line #	Type of field	Example	Notes
			may not be omitted. . If exceeds 60 characters, error -233 Too much data reported
4	Instrument Version, Model #	A.02.06,N9020A	May be empty but may not be omitted
5	Option List, File Format Version	K03 LFE EXM ,01	May be empty but may not be omitted
6	Freq Unit to be used for all frequency values in the file	Frequency Unit,MHz	assumed to be Hz if omitted
7	Antenna Unit	Antenna Unit,None	If omitted leaves the Antenna unit unchanged. The amplitude unit in the Antenna Unit field is a conversion factor that is used to adjust the Y Axis Units of the current mode, if the mode supports Antenna Units. For more details on antenna correction data, refer to the Input/Output,Corrections key description. Allowable values: dBuV/m, dBuA/m, dBG, dBpT, None
8	Freq Interpolation	Frequency Interpolation,Linear	if omitted leaves the Freq Interpolation unchanged. Allowable values: Linear, Logarithmic
9	Bias value in mA	Bias,0.00	If omitted leaves the Bias value unchanged (added as of A.08.50)
10	Bias State	Bias State,On	If omitted leaves the Bias State unchanged. Allowable values: On, Off (added as of A.08.50)
11	Overlap, two values, Freq1 and Freq2, separated by commas.	Overlap,33500,40000	Uses Freq Unit from line 6. Thus, in this example Freq1=33.5 GHz, Freq2= 40.0 GHz (see note below). If omitted leaves the overlap unchanged (added as of A.08.50)
12	DATA marker	DATA	Corrections data begins in the next line

Lines 2 through 5 can be empty but must appear in the file. Lines 6 through 11 are optional, the lines can be left out of the file altogether.

The Overlap row and the two Bias rows apply only to external mixing. Both are read-only, they are never written by the analyzer. The only way to insert or modify these rows is to edit the file with a text editor or a spreadsheet editor. These rows are intended for use by mixer manufacturers, as they allow the manufacturer to insert data about how the mixer corrections were generated and how they should be applied. The Bias rows allow you to specify whether to turn Bias on or off when the Correction is turned on and to specify a Bias value (turning off the Correction does not change the Bias, but turning it back on again sets it to the value specified in the file). The Overlap row allows you to specify an overlap region in which

two different corrections may be applied. It is expected that in the corrections data itself, there will be TWO corrections values exactly at Max Freq, otherwise Overlap is ignored. The way the overlap is processed is as follows: if at any given time the current analyzer Start Freq is greater than Freq 1 and lower than Freq 2, and the current Stop Freq is greater than Freq 2, extend the first correction point at or above Freq 2 down to Freq 1, rather than using the correction data between Freq1 and Freq2.

The Antenna Unit row can only be used in Correction register 1, because there can only be one setting for Antenna Unit at any given time. If a Correction whose Antenna Unit is set to anything but None is loaded into any Correction register but 1, an error is generated (Mass storage error; Can only load an Antenna Unit into Correction 1). When a correction file is saved from any Correction register but 1, Antenna Unit is always written as None.

Similarly, the Bias rows can only be used in Correction register 1, because there can only be one setting for Bias at any given time. If a Correction file with a Bias or Bias State row is loaded into any Correction register but 1, an error is generated: Mass storage error; Can only load Bias Settings into Correction 1

The data follows the DATA row, as comma separated X, Y pairs; one pair per line.

For example, suppose you have an Antenna to correct for on an N9020A version A.02.06 and the correction data is:

- 0 dB at 200 MHz
- 17 dB at 210 MHz
- 14.8 dB at 225 MHz

Then the file will look like:

- Amplitude Correction
- "Correction Factors for 11966E"
- "Class B Radiated"
- A.02.06,N9020A
- P13 EA3 UK6,01
- Frequency Unit,MHz
- Antenna Unit,dBuV/m
- Frequency Interpolation,Linear
- DATA
- 200.000000,0.00
- 210.000000,17.00
- 225.000000,14.80

The choices for the 1 of N fields in the metadata are as follows:

- Frequency Unit: Hz, kHz, MHz, GHz
- Antenna Unit: dBuv/m, dBuA/m, dBG, dBpT, None

- Frequency Interpolation: Logarithmic, Linear

### Amplitude Correction

These keys let you choose which Correction to save. Once selected, the key returns back to the Export Data menu and the selected Correction number is annotated on the key.

The next step in the Save process is to select the Save As key in the Export Data menu.

Key Path	Save, Data, Amplitude Correction
Preset	Not part of a Preset, but is reset to Correction 1 by Restore Input/Output Defaults. Survives a shutdown.
Readback	1
Initial S/W Revision	A.02.00

### Chan Table

Exports the current channel table to a channel table file.

The exported channel table file can be edited to meet your requirements, and then imported by pressing Recall, Data, Channel Table, and then Open...

Note that while editing the channel plan file, you can't change the channel plan name, such as NTSC\_B.VHF, NTSC\_B.UHF, otherwise your modifications on the corresponding channel plan will not work. You can add, remove, or modify the channel numbers and center frequencies in each channel plan. The value of Start Channel and Channel Count may also need to be changed.

File Location and Extension

**File location:** "My Documents\Digital Video\data"

**File type:** text file

**File extension:** .txt

**Example:**

File Location: My Documents\Digital Video\data

File Name: ChannelPlan\_0001.txt

Key Path	Save, Data
Mode	DVB-T/H
Remote Command	MMEMory:STORe:CHTable <string>
Example	MMEM:STOR:CHT "ChannelPlan_0001.txt"
Initial S/W Revision	A.07.00

## Measurement Results

Different types of results are available for each particular measurement. The results that are available are documented under the individual measurements. These measurement results are the same as the results that are returned when using the MEASure:<measurement> command (usually for sub-opcode 1).

Key Path	Save, Data
Mode	DVB-T/H
Example	MMEM:STOR:RES "MyResultsFile.xml" This stores the measurement results data in the file MyResultsFile.xml in the default directory.
Initial S/W Revision	Prior to A.01.70

## Capture Buffer

Capture buffer functionality is available only in Mod Accuracy measurement. The captured data is raw data which is not processed.

Key Path	Save, Data
Mode	DVB-T/H
Example	MMEM:STOR:CAPT "MyCaptureData.bin" This stores the capture data in the file MyCaptureData.bin in the default directory.
Dependencies	Capture buffer functionality is only available for Mod Accuracy measurement. In other measurements, this key is grayed out.
Initial S/W Revision	Prior to A.01.70

## DVB-T2 Config

Exports the current DVB-T2 configuration to a file (single PLP or multiple PLPs). This key is available only in DVB-T2 Mod Accuracy measurement and will be grayed out in other measurements.

You can view the exported file for the format of the DVB-T2 configuration files and create your own DVB-T2 configuration file by modifying the exported file.

File Location and Extension

**File location:** "My Documents\DVB\data\EVMT2\data"

**File type:** text file

**File extension:** .csv

**Example:**

File Location: My Documents\DVB\data\EVMT2\data

File Name: DVBT2Config\_0001.csv

Key Path	Save, Data
----------	------------

Mode	DVB-T/H
Remote Command	MMEMoRY:STORe:T2Config <string>
Example	MMEM:STOR:T2C "DVBT2Config_0001.csv"
Dependencies	This key is grayed out in all the other measurements except DVB-T2 Mod Accuracy measurement.
Initial S/W Revision	A.07.00

## Save As . . .

When you press "Save As", the analyzer brings up a Windows dialog and a menu entitled "**Save As.**" This menu allows you to navigate to the various fields in the Windows dialog without using a keyboard or mouse. The Tab and Arrow keys can also be used for dialog navigation.

See "[To File . . .](#)" on page 2213 in Save, State for a full description of this dialog and menu.

The default path for saving files is:

For all of the Trace Data Files:

My Documents\<<mode name>\data\traces

For all of the Limit Data Files:

My Documents\<<mode name>\data\limits

For all of the Measurement Results Data Files:

My Documents\<<mode name>\data\<<measurement name>\results

For all of the Capture Buffer Data Files:

My Documents\<<mode name>\data\captureBuffer

Key Path	Save, Data
Mode	All
Notes	The key location is mode-dependent and will vary. Brings up the Save As dialog for saving a <mode specific> Save Type. The save is performed immediately and does not wait until the measurement is complete.
Initial S/W Revision	Prior to A.02.00

## Screen Image

Pressing Screen Image accesses a menu of functions that enable you to specify a format and location for the saved screen image. It brings up a menu that allows you to specify the color scheme of the Screen Image (Themes) or navigate to the Save As dialog to perform the actual save.

Screen Image files contain an exact representation of the analyzer display. They cannot be loaded back onto the analyzer, but they can be loaded into your PC for use in many popular applications.

The image to be saved is actually captured when the Save front panel key is pressed, and kept in temporary storage to be used if you ask for a Screen Image save. When the Screen Image key is pressed, a "thumbnail" of the captured image is displayed, as shown below:

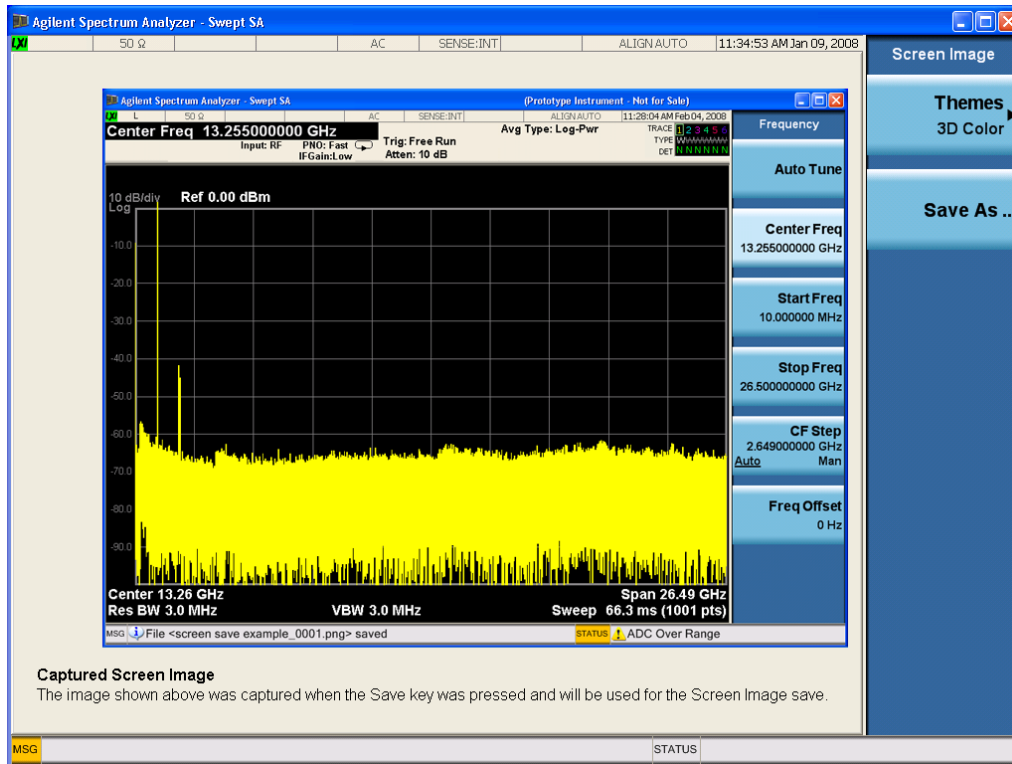

When you continue on into the Save As menu and complete the Screen Image save, the image depicted in the thumbnail is the one that gets saved, showing the menus that were on the screen before going into the Save menu. The save is performed immediately and does not wait until the measurement is complete.

After you have completed the save, the Quick Save front-panel key lets you quickly repeat the last save performed, using an auto-named file, with the current screen data.

**NOTE**

For versions previous to A.01.55, if you initiate a screen image save by navigating through the Save menus, the image that is saved will contain the Save menu softkeys, not the menus and the active function that were on the screen when you first pressed the Save front panel key.

Key Path	Save
Mode	All
Remote Command	:MMEMory:STORe:SCReen <filename>
Example	:MMEM:STOR:SCR "myScreen.png" This stores the current screen image in the file MyScreenFile.png in the default directory.
Initial S/W Revision	Prior to A.02.00

## Themes

Accesses a menu of functions that enable you to choose the theme to be used when saving the screen image.

The **Themes** option is the same as the **Themes** option under the **Display** and **Page Setup** dialogs. It allows you to choose between themes to be used when saving the screen image.

<b>Key Path</b>	Save, Screen Image
<b>Remote Command</b>	:MMEMory:STORe:SCReen:THEMe TDColor   TDMonochrome   FCOLor   FMONochrome  :MMEMory:STORe:SCReen:THEMe?
<b>Example</b>	:MMEM:STOR:SCR:THEM TDM
<b>Preset</b>	3D Color; Is not part of Preset, but is reset by Restore Misc Defaults or Restore System Defaults All and survives subsequent running of the modes.
<b>Readback</b>	3D Color   3D Mono   Flat Color   Flat Mono
<b>Backwards Compatibility Notes</b>	In ESA and PSA we offer the choice of "Reverse Bitmap" or "Reverse Metafile" when saving screen images. This is much like the "Flat Color" theme available in X-Series. Also, if you selected Reverse Bitmap AND a black & white screen image, that would be much like "Flat Monochrome". In other words, each of the X-Series themes has a similar screen image type in ESA/PSA. But they are not identical.
<b>Initial S/W Revision</b>	Prior to A.02.00

## 3D Color

Selects a standard color theme with each object filled, shaded and colored as designed.

<b>Key Path</b>	Save, Screen Image, Themes
<b>Example</b>	MMEM:STOR:SCR:THEM TDC
<b>Readback</b>	3D Color
<b>Initial S/W Revision</b>	Prior to A.02.00

## 3D Monochrome

Selects a format that is like 3D color but shades of gray are used instead of colors.

<b>Key Path</b>	Save, Screen Image, Themes
<b>Example</b>	MMEM:STOR:SCR:THEM TDM
<b>Readback</b>	3D Mono
<b>Initial S/W Revision</b>	Prior to A.02.00

## Flat Color

Selects a format that is best when the screen is to be printed on an ink printer.



Key Path	Save, Screen Image, Themes
<b>Example</b>	MMEM:STOR:SCR:THEM FCOL
Readback	Flat Color
Initial S/W Revision	Prior to A.02.00

### Flat Monochrome

Selects a format that is like Flat Color. But only black is used (no colors, not even gray), and no fill.

Key Path	Save, Screen Image, Themes
<b>Example</b>	MMEM:STOR:SCR:THEM FMON
Readback	Flat Mono
Initial S/W Revision	Prior to A.02.00

### Save As...

When you press "Save As", the analyzer brings up a Windows dialog and a menu entitled "**Save As.**" This menu allows you to navigate to the various fields in the Windows dialog without using a keyboard or mouse. The Tab and Arrow keys can also be used for dialog navigation.

See "[To File . . .](#)" on page 2213 in Save, State for a full description of this dialog and menu.

The default path for Screen Images is

My Documents\`<mode name>`\screen.

where `<mode name>` is the parameter used to select the mode with the INST:SEL command (for example, SA for the Spectrum Analyzer).

Key Path	Save, Screen Image
Notes	Brings up Save As dialog for saving a Screen Image Save Type
Initial S/W Revision	Prior to A.02.00

### Mass Storage Catalog (Remote Command Only)

Key path	SCPI Only
<b>Remote Command</b>	:MMEMory:CATalog? [ <code>&lt;directory_name&gt;</code> ]
Notes	<p>The string must be a valid logical path.</p> <p>Queries disk usage information (drive capacity, free space available) and obtains a list of files and directories in a specified directory in the following format:</p> <p><code>&lt;numeric_value&gt;,&lt;numeric_value&gt;,{&lt;file_entry&gt;}</code></p> <p>It returns two numeric parameters and as many strings as there are files and directories. The first</p>

parameter indicates the total amount of storage currently used in bytes. The second parameter indicates the total amount of storage available, also in bytes. The <file\_entry> is a string. Each <file\_entry> indicates the name, type, and size of one file in the directory list:

<file\_name>,<file\_type>,<file\_size>

As the windows file system has an extension that indicates file type, <file\_type> is always empty. <file\_size> provides the size of the file in bytes. For directories, <file\_entry> is surrounded by square brackets and both <file\_type> and <file\_size> are empty

---

Initial S/W Revision      Prior to A.02.00

---

## Mass Storage Change Directory (Remote Command Only)

---

Key path                      SCPI Only

**Remote Command**        :MMEMory:CDIRectory [<directory\_name>]  
                                 :MMEMory:CDIRectory?

**Notes**                      The string must be a valid logical path.  
  
Changes the default directory for a mass memory file system. The <directory\_name> parameter is a string. If no parameter is specified, the directory is set to the \*RST value.  
  
At \*RST, this value is set to the default user data storage area, that is defined as System.Environment.SpecialFolder.Personal.  
  
Query returns full path of the default directory.

---

Initial S/W Revision      Prior to A.02.00

---

## Mass Storage Copy (Remote Command Only)

---

Key path                      SCPI Only

**Remote Command**        :MMEMory:COPY <string>,<string>[,<string>,<string>]

**Notes**                      The string must be a valid logical path.  
  
Copies an existing file to a new file or an existing directory to a new directory.  
  
Two forms of parameters are allowed. The first form has two parameters. In this form, the first parameter specifies the source, and the second parameter specifies the destination.  
  
The second form has four parameters. In this form, the first and third parameters specify the source. The second and fourth parameters specify the directories. The first pair of parameters specifies the source. The second pair specifies the destination. An error is generated if the source doesn't exist or the destination file already exists.  
  
This command will generate an "access denied" error if the destination is a restricted folder (e.g., C:\Windows) and the current user does not have Power User or Administrator privileges.

## Mass Storage Device Copy (Remote Command Only)

This command transfers data to/from a file and a peripheral device.

Key path	SCPI Only
<b>Remote Command</b>	:MMEMory:COpy:DEvice <source_string>,<dest_string>
Notes	The strings must be a valid logical path or a valid device keyword. If the dest_string is a device keyword, the data is copied from the source file to the device. If the source_string is a device keyword, the data is copied to the source file from the device.  Valid device keywords are: SNS (smart noise source)  An error is generated if the file or device is not found.

### Mass Storage Delete (Remote Command Only)

Key path	SCPI Only
<b>Remote Command</b>	:MMEMory:DElete <file_name>[,<directory_name>]
Notes	The string must be a valid logical path.  Removes a file from the specified directory. The <file_name> parameter specifies the file name to be removed. This command will generate an “access denied” error if the file is in a restricted folder (e.g., C:\Windows) and the current user does not have Power User or Administrator privileges.
Initial S/W Revision	Prior to A.02.00

### Mass Storage Data (Remote Command Only)

Creates a file containing the specified data OR queries the data from an existing file.

Key path	SCPI Only
<b>Remote Command</b>	:MMEMory:DATA <file_name>, <data>  :MMEMory:DATA? <file_name>
Notes	The string must be a valid logical path.  The command form is MMEMory:DATA <file_name>,<data>. It loads <data> into the file <file_name>. <data> is in 488.2 block format. <file_name> is string data.  The query form is MMEMory:DATA? <file_name> with the response being the associated <data> in block format.
Initial S/W Revision	Prior to A.02.00

### Mass Storage Make Directory (Remote Command Only)

Key path	SCPI Only
<b>Remote Command</b>	:MMEMory:MDIRectory <directory_name>
Notes	The string must be a valid logical path.  Creates a new directory. The <directory_name> parameter specifies the name to be created.

---

	This command will generate an “access denied” error if the new directory would be in a restricted folder (e.g., C:\Windows) and the current user does not have Power User or Administrator privileges.
Initial S/W Revision	Prior to A.02.00

---

### Mass Storage Move (Remote Command Only)

---

Key path	SCPI Only
<b>Remote Command</b>	:MMEMory:MOVE <string>,<string>[,<string>,<string>]
Notes	<p>The string must be a valid logical path.</p> <p>Moves an existing file to a new file or an existing directory to a new directory.</p> <p>Two forms of parameters are allowed. The first form has two parameters. In this form, the first parameter specifies the source, and the second parameter specifies the destination.</p> <p>The second form has four parameters. In this form, the first and third parameters specify the source. The second and fourth parameters specify the directories. The first pair of parameters specifies the source. The second pair specifies the destination. An error is generated if the source doesn't exist or the destination file already exists.</p> <p>This command will generate an “access denied” error if the destination is a restricted folder (e.g., C:\Windows) and the current user does not have Power User or Administrator privileges.</p>
Initial S/W Revision	Prior to A.02.00

---

### Mass Storage Remove Directory (Remote Command Only)

---

Key path	SCPI Only
<b>Remote Command</b>	:MMEMory:RDIRECTory <directory_name>
Notes	<p>The string must be a valid logical path.</p> <p>Removes a directory. The &lt;directory_name&gt; parameter specifies the directory name to be removed. All files and directories under the specified directory shall also be removed.</p> <p>This command will generate an “access denied” error if the folder is a restricted folder (e.g., C:\Windows) or is in a restricted folder and the current user does not have Power User or Administrator privileges.</p>
Initial S/W Revision	Prior to A.02.00

---

## Single (Single Measurement/Sweep)

Sets the analyzer for Single measurement operation. The single/continuous state is Meas Global, so the setting will affect all the measurements. If you are Paused, pressing Single does a Resume.

See ["More Information" on page 1429](#)

Key Path	Front-panel key
Example	:INIT:CONT OFF
Notes	See Cont key description.
Backwards Compatibility Notes	<p>For Spectrum Analysis mode in ESA and PSA, the Single hardkey and the INITiate:IMM switched from continuous measurement to single measurement and restarted sweeps and averages (displayed average count reset to 1), but did not restart Max Hold and Min Hold. In the X-Series, the Single hardkey and the INITiate:IMM command initiate a sweep/ measurement/ average sequence/hold sequence including MaxHold and MinHold.</p> <p>For Spectrum Analysis mode in ESA and PSA, the Single hardkey restarted the sweep regardless of whether or not you were in an active sweep or sweep sequence. In the X-Series, Restart does this but Single only restarts the sweep or sweep sequence if you are in the idle state.</p> <p>INIT[:IMM] in ESA &amp; PSA Spectrum Analysis Mode does an implied ABORT. In some other PSA Modes, INIT[:IMM] is ignored if not in the idle state. . The X-Series follows the ESA/PSA SA Mode model, which may cause some Modes to have compatibility problems.</p>
Initial S/W Revision	Prior to A.02.00

### More Information

See ["Restart" on page 2210](#) for details on the INIT:IMMEDIATE (Restart) function.

If you are already in single sweep, the INIT:CONT OFF command has no effect.

If you are already in Single Sweep, then pressing the Single key in the middle of a sweep does not restart the sweep or sequence. Similarly, pressing the Single key does not restart the sweep or sequence if the sweep is not in the idle state (for example, if you are taking a very slow sweep, or the analyzer is waiting for a trigger). Instead, it results in a message. "Already in Single, press Restart to initiate a new sweep or sequence". Even though pressing the Single key in the middle of a sweep does not restart the sweep, sending INIT:IMMEDIATE does reset it.

To take one more sweep without resetting the average count, increment the average count by 1, by pressing the step up key while **Average/Hold Number** is the active function, or sending the remote command CALC:AVER:TCON UP.

## Source

There is no Source control functionality for this measurement. When this key is pressed, the screen either displays a blank menu, or the previously-selected menu remains unchanged.

---

Key Path	Front-panel key
----------	-----------------

---

## SPAN X Scale

The SPAN X Scale key accesses the menu to set the desired horizontal scale and associated settings of the window.

It specifies the SPAN X Scale settings when MER/EVM vs. Sub-carrier/Frequency window, Spectrum window, Amptd vs. Sub-carrier window, phase vs. Sub-carrier window, group delay vs. Sub-carrier window, Amptd vs. Time Window, or MER vs. Time Window is active.

Key Path	Front-panel key
Initial S/W Revision	A.02.00

### Ref Value

This key allows you to set the X reference value. The key is active in MER/EVM vs. Sub-carrier/Frequency Window, Spectrum Window, Amptd vs. Sub-carrier Window, Phase vs. Sub-carrier Window, Group Delay vs. Sub-carrier Window, Amptd vs. Time Window, and MER vs. Time Window.

Key Path	Span X Scale
Initial S/W Revision	A.02.00

### X Ref Value (I/Q Error View – MER/EVM vs. Sub-carrier/Frequency Window)

This key sets the reference value on the horizontal axis in the MER/EVM vs. Sub-carrier/Frequency window. The displayed value will be updated according to the Scale Type (Span X Scale) as follows:

"X Ref Value (Scale Type is Carrier)" on page 1431

"X Ref Value (Scale Type is Freq)" on page 1432

### X Ref Value (Scale Type is Carrier)

If the scale type is set to Carrier, X Ref Value is displayed and set in subcarr.

Key Path	Span X Scale
Mode	DVB-T/H
Remote Command	:DISPlay:EVM:VIEW2:WINDow[1]:TRACe:X[:SCALE][:CARRier]:RLEVel <real> :DISPlay:EVM:VIEW2:WINDow[1]:TRACe:X[:SCALE][:CARRier]:RLEVel?
Example	DISP:EVM:VIEW2:WIND:TRAC:X:RLEV 0.0 DISP:EVM:VIEW2:WIND:TRAC:X:RLEV?
Notes	SCPI Remarks: VIEW2: I/Q Error View WINDow[1]: MER/EVM vs. Sub-carrier/Frequency Window on I/Q Error View
Dependencies	If Auto Scaling is set to On, this value is automatically determined by the measurement result. When you set this value manually, Auto Scaling is automatically set to Off.

Preset	Value is automatically determined by the measurement result with Auto Scaling set to On.
State Saved	No
Min	0.0
Max	7000.0
Initial S/W Revision	A.02.00
Modified at S/W Revision	A.06.00

### X Ref Value (Scale Type is Freq)

If the scale type is set to Freq, X Ref Value is displayed and set in Hz.

Key Path	Span X Scale
Mode	DVB-T/H
<b>Remote Command</b>	:DISPlay:EVM:VIEW2:WINDow[1]:TRACe:X[:SCALe]:FREQuency:RLEVel <real> :DISPlay:EVM:VIEW2:WINDow[1]:TRACe:X[:SCALe]:FREQuency:RLEVel?
<b>Example</b>	DISP:EVM:VIEW2:WIND:TRAC:X:FREQ:RLEV 0.0 DISP:EVM:VIEW2:WIND:TRAC:X:FREQ:RLEV?
Notes	SCPI Remarks: VIEW2: I/Q Error View WINDow[1]: MER/EVM vs. Sub-carrier/Frequency Window on I/Q Error View
Dependencies	If Auto Scaling is set to On, this value is automatically determined by the measurement result. When you set this value manually, Auto Scaling is automatically set to Off.
Preset	Value is automatically determined by the measurement result with Auto Scaling set to On.
State Saved	No
Min	0.0
Max	3.0e9 Hz
Initial S/W Revision	A.06.00

### X Ref Value (I/Q Error View – Spectrum Window)

This key sets the frequency reference value on the horizontal axis in the Spectrum window.

Key Path	Span X Scale
Mode	DVB-T/H
<b>Remote Command</b>	:DISPlay:EVM:VIEW2:WINDow2:TRACe:X[:SCALe]:RLEVel <real> :DISPlay:EVM:VIEW2:WINDow2:TRACe:X[:SCALe]:RLEVel?
<b>Example</b>	DISP:EVM:VIEW2:WIND2:TRAC:X:RLEV 470.00 DISP:EVM:VIEW2:WIND2:TRAC:X:RLEV?
Notes	SCPI Remarks:



	VIEW2: I/Q Error View WINDow2: Spectrum Window on I/Q Error View
Dependencies	If Auto Scaling is set to On, this value is automatically determined by the measurement result. When you set this value manually, Auto Scaling is automatically set to Off.
Preset	Result depends on current FFT size, Channel BW and Center Frequency.
State Saved	No
Min	0 Hz
Max	3.0e9 Hz
Initial S/W Revision	A.02.00

### X Ref Value (Channel Frequency Response View – Amptd vs. Sub-carrier Window)

This key sets the sub-carrier reference value on the horizontal axis in the Amptd vs. Sub-carrier window.

Key Path	Span X Scale
Mode	DVB-T/H
<b>Remote Command</b>	:DISPlay:EVM:VIEW3:WINDow[1]:TRACe:X[:SCALe]:RLEVel <real> :DISPlay:EVM:VIEW3:WINDow[1]:TRACe:X[:SCALe]:RLEVel?
<b>Example</b>	DISP:EVM:VIEW3:WIND:TRAC:X:RLEV 0.0 DISP:EVM:VIEW3:WIND:TRAC:X:RLEV?
Notes	SCPI Remarks: VIEW3: Channel Frequency Response View WINDow[1]: Amptd vs. Sub-carrier Window
Dependencies	If Auto Scaling is set to On, this value is automatically determined by the measurement result. When you set this value manually, Auto Scaling is automatically set to Off.
Preset	0.0
State Saved	No
Min	0.0
Max	7000.0
Initial S/W Revision	A.02.00

### X Ref Value (Channel Frequency Response View – Phase vs. Sub-carrier Window)

This key sets the sub-carrier reference value on the horizontal axis in the Phase vs. Sub-carrier window.

Key Path	Span X Scale
Mode	DVB-T/H
<b>Remote Command</b>	:DISPlay:EVM:VIEW3:WINDow2:TRACe:X[:SCALe]:RLEVel <real> :DISPlay:EVM:VIEW3:WINDow2:TRACe:X[:SCALe]:RLEVel?

<b>Example</b>	DISP:EVM:VIEW3:WIND2:TRAC:X:RLEV 0.0 DISP:EVM:VIEW3:WIND2:TRAC:X:RLEV?
Notes	SCPI Remarks: VIEW3: Channel Frequency Response View WINDow2: Phase vs. Sub-carrier Window
Dependencies	If Auto Scaling is set to On, this value is automatically determined by the measurement result. When you set this value manually, Auto Scaling is automatically set to Off.
Preset	0.0
State Saved	No
Min	0.0
Max	7000.0
Initial S/W Revision	A.02.00

### X Ref Value (Channel Frequency Response View –Group Delay vs. Sub-carrier Window)

This key sets the sub-carrier reference value on the horizontal axis in the Group Delay vs. Sub-carrier window.

Key Path	Span X Scale
Mode	DVB-T/H
<b>Remote Command</b>	:DISPlay:EVM:VIEW3:WINDow3:TRACe:X[:SCALE]:RLEVel <real> :DISPlay:EVM:VIEW3:WINDow3:TRACe:X[:SCALE]:RLEVel?
<b>Example</b>	DISP:EVM:VIEW3:WIND3:TRAC:X:RLEV 0.0 DISP:EVM:VIEW3:WIND3:TRAC:X:RLEV?
Notes	SCPI Remarks: VIEW3: Channel Frequency Response View WINDow3: Group Delay vs. Sub-carrier Window
Dependencies	If Auto Scaling is set to On, this value is automatically determined by the measurement result. When you set this value manually, Auto Scaling is automatically set to Off.
Preset	0.0
State Saved	No
Min	0.0
Max	7000.0
Initial S/W Revision	A.02.00

### X Ref Value (Channel Impulse Response View – Amptd vs. Time Window)

This key sets the reference value on the horizontal axis in the Amptd vs. Time window. The displayed value will be updated according to the Scale Type (Span X Scale) as follows:

"X Ref Value (Scale Type is Time)" on page 1435

"X Ref Value (Scale Type is Distance)" on page 1435

### X Ref Value (Scale Type is Time)

If the scale type is set to Time, X Ref Value is displayed and set in time.

Key Path	Span X Scale
Mode	DVB-T/H
Remote Command	:DISPlay:EVM:VIEW4:WINDow[1]:TRACe:X[:SCALe][:TIME]:RLEVel <real> :DISPlay:EVM:VIEW4:WINDow[1]:TRACe:X[:SCALe][:TIME]:RLEVel?
Example	DISP:EVM:VIEW4:WIND:TRAC:X:RLEV 0.0 DISP:EVM:VIEW4:WIND:TRAC:X:RLEV?
Notes	SCPI Remarks: VIEW4: Channel Impulse Response View WINDow[1]: Amptd vs. Time Window
Dependencies	If Auto Scaling is set to On, this value is automatically determined by the measurement result. When you set this value manually, Auto Scaling is automatically set to Off.
Preset	0.00 s
State Saved	No
Min	-20.0 s
Max	20.0 s
Initial S/W Revision	A.02.00

### X Ref Value (Scale Type is Distance)

If the scale type is set to Distance, X Ref Value is displayed and set in distance.

Key Path	Span X Scale
Mode	DVB-T/H
Remote Command	:DISPlay:EVM:VIEW4:WINDow[1]:TRACe:X[:SCALe]:DISTance:RLEVel <real> :DISPlay:EVM:VIEW4:WINDow[1]:TRACe:X[:SCALe]:DISTance:RLEVel?
Example	DISP:EVM:VIEW4:WIND:TRAC:X:DIST:RLEV 0.0 DISP:EVM:VIEW4:WIND:TRAC:X:DIST:RLEV?
Notes	SCPI Remarks: VIEW4: Channel Impulse Response View WINDow[1]: Amptd vs. Time Window
Dependencies	If Auto Scaling is set to On, this value is automatically determined by the measurement result. When you set this value manually, Auto Scaling is automatically set to Off.
Preset	0.0 m
State Saved	No

Min	-6.0e9 m
Max	6.0e9 m
Initial S/W Revision	A.02.00

### X Ref Value (MER Monitor View – MER vs. Time Window)

This key sets the reference value on the horizontal axis in the MER vs. Time window.

Key Path	Span X Scale
Mode	DVB-T/H
Remote Command	:DISPlay:EVM:VIEW5:WINDow[1]:TRACe:X[:SCALE]:RLEVel <real> :DISPlay:EVM:VIEW5:WINDow[1]:TRACe:X[:SCALE]:RLEVel?
Example	DISP:EVM:VIEW5:WIND:TRAC:X:RLEV 0.0 DISP:EVM:VIEW5:WIND:TRAC:X:RLEV?
Notes	SCPI Remarks: VIEW5: MER Monitor View WINDow[1]: MER vs. Time Window
Dependencies	If Auto Scaling is set to On, this value is automatically determined by the measurement result. When you set this value manually, Auto Scaling is automatically set to Off.
Preset	0.0
State Saved	No
Min	0.0
Max	5000.0
Initial S/W Revision	A.06.00

### Scale/Div

This key allows you to set the X Scale/Div. The key is active in MER/EVM vs. Sub-carrier/Frequency Window, Spectrum Window, Amptd vs. Sub-carrier Window, Phase vs. Sub-carrier Window, Group Delay vs. Sub-carrier Window, Amptd vs. Time Window, and MER vs. Time Window.

Key Path	Span X Scale
Initial S/W Revision	A.02.00

### X Scale/Div (I/Q Error View – MER/EVM vs. Sub-carrier/ Frequency Window)

This key sets the value per division on the horizontal scale in the MER/EVM vs. Sub-carrier/Frequency window. The displayed value will be updated according to the Scale Type (Span X Scale) as follows:

"X Scale/Div (Scale Type is Carrier)" on page 1437

"X Scale/Div (Scale Type is Freq)" on page 1437

### X Scale/Div (Scale Type is Carrier)

If the scale type is set to Carrier, X Scale/Div is displayed and set in subcarr.

Key Path	Span X Scale
Mode	DVB-T/H
Remote Command	:DISPlay:EVM:VIEW2:WINDow[1]:TRACe:X[:SCALe][:CARRier]:PDIVision <real> :DISPlay:EVM:VIEW2:WINDow[1]:TRACe:X[:SCALe][:CARRier]:PDIVision?
Example	DISP:EVM:VIEW2:WIND:TRAC:X:PDIV 84.0 DISP:EVM:VIEW2:WIND:TRAC:X:PDIV?
Notes	SCPI Remarks: VIEW2: I/Q Error View WINDow[1]: MER/EVM vs. Sub-carrier/Frequency Window on I/Q Error View
Dependencies	If Auto Scaling is set to On, this value is automatically determined by the measurement result. When you set this value manually, Auto Scaling is automatically set to Off.
Preset	Value is automatically determined by the measurement result with Auto Scaling set to On. Result depends on current FFT size.
State Saved	No
Min	1.0
Max	700.0
Initial S/W Revision	A.02.00
Modified at S/W Revision	A.06.00

### X Scale/Div (Scale Type is Freq)

If the scale type is set to Freq, X Scale/Div is displayed and set in Hz.

Key Path	Span X Scale
Mode	DVB-T/H
Remote Command	:DISPlay:EVM:VIEW2:WINDow[1]:TRACe:X[:SCALe]:FREQUency:PDIVision <real> :DISPlay:EVM:VIEW2:WINDow[1]:TRACe:X[:SCALe]:FREQUency:PDIVision?
Example	DISP:EVM:VIEW2:WIND:TRAC:X:FREQ:PDIV 84.0 DISP:EVM:VIEW2:WIND:TRAC:X:FREQ:PDIV?
Notes	SCPI Remarks: VIEW2: I/Q Error View WINDow[1]: MER/EVM vs. Sub-carrier/Frequency Window on I/Q Error View
Dependencies	If Auto Scaling is set to On, this value is automatically determined by the measurement result. When you set this value manually, Auto Scaling is automatically set to Off.
Preset	Value is automatically determined by the measurement result with Auto Scaling set to On. Result depends on current FFT size.

State Saved	No
Min	1.0 Hz
Max	500.0e6 Hz
Initial S/W Revision	A.06.00

### X Scale/Div (I/Q Error View – Spectrum Window)

This key sets the frequency value per division on the horizontal scale in the Spectrum window.

Key Path	Span X Scale
Mode	DVB-T/H
Remote Command	:DISPlay:EVM:VIEW2:WINDow2:TRACe:X[:SCALe]:PDIVision <real> :DISPlay:EVM:VIEW2:WINDow2:TRACe:X[:SCALe]:PDIVision?
Example	DISP:EVM:VIEW2:WIND2:TRAC:X:PDIV 1.0 DISP:EVM:VIEW2:WIND2:TRAC:X:PDIV?
Notes	SCPI Remarks: VIEW2: I/Q Error View WINDow2: Spectrum Window on I/Q Error View
Dependencies	If Auto Scaling is set to On, this value is automatically determined by the measurement result. When you set this value manually, Auto Scaling is automatically set to Off.
Preset	Result depends on current FFT size, Channel BW and Center Frequency.
State Saved	No
Min	1 Hz
Max	5.0e8 Hz
Initial S/W Revision	A.02.00

### X Scale/Div (Channel Frequency Response View – Amptd vs. Sub-carrier Window)

This key sets the sub-carrier value per division on the horizontal scale in the Amptd vs. Sub-carrier window.

Key Path	Span X Scale
Mode	DVB-T/H
Remote Command	:DISPlay:EVM:VIEW3:WINDow[1]:TRACe:X[:SCALe]:PDIVision <real> :DISPlay:EVM:VIEW3:WINDow[1]:TRACe:X[:SCALe]:PDIVision?
Example	DISP:EVM:VIEW3:WIND:TRAC:X:PDIV 84.0 DISP:EVM:VIEW3:WIND:TRAC:X:PDIV?
Notes	SCPI Remarks: VIEW3: Channel Frequency Response View WINDow[1]: Amptd vs. Sub-carrier Window

Dependencies	If Auto Scaling is set to On, this value is automatically determined by the measurement result. When you set this value manually, Auto Scaling is automatically set to Off.
Preset	Result depends on current FFT size.
State Saved	No
Min	1.0
Max	700.0
Initial S/W Revision	A.02.00

### X Scale/Div (Channel Frequency Response View – Phase vs. Sub-carrier Window)

This key sets the sub-carrier value per division on the horizontal scale in the Phase vs. Sub-carrier window.

Key Path	Span X Scale
Mode	DVB-T/H
<b>Remote Command</b>	:DISPlay:EVM:VIEW3:WINDow2:TRACe:X[:SCALE]:PDIVision <real> :DISPlay:EVM:VIEW3:WINDow2:TRACe:X[:SCALE]:PDIVision?
<b>Example</b>	DISP:EVM:VIEW3:WIND2:TRAC:X:PDIV 84.0 DISP:EVM:VIEW3:WIND2:TRAC:X:PDIV?
Notes	SCPI Remarks: VIEW3: Channel Frequency Response View WINDow2: Phase vs. Sub-carrier Window
Dependencies	If Auto Scaling is set to On, this value is automatically determined by the measurement result. When you set this value manually, Auto Scaling is automatically set to Off.
Preset	Result depends on current FFT size.
State Saved	No
Min	1.0
Max	700.0
Initial S/W Revision	A.02.00

### X Scale/Div (Channel Frequency Response View –Group Delay vs. Sub-carrier Window)

This key sets the sub-carrier value per division on the horizontal scale in the Group Delay vs. Sub-carrier window.

Key Path	Span X Scale
Mode	DVB-T/H
<b>Remote Command</b>	:DISPlay:EVM:VIEW3:WINDow3:TRACe:X[:SCALE]:PDIVision <real> :DISPlay:EVM:VIEW3:WINDow3:TRACe:X[:SCALE]:PDIVision?
<b>Example</b>	DISP:EVM:VIEW3:WIND3:TRAC:X:PDIV 84.0

	DISP:EVM:VIEW3:WIND3:TRAC:X:PDIV?
Notes	SCPI Remarks: VIEW3: Channel Frequency Response View WINDow3: Group Delay vs. Sub-carrier Window
Dependencies	If Auto Scaling is set to On, this value is automatically determined by the measurement result. When you set this value manually, Auto Scaling is automatically set to Off.
Preset	Result depends on current FFT size.
State Saved	No
Min	1.0
Max	700.0
Initial S/W Revision	A.02.00

### X Scale/Div (Channel Impulse Response View – Amptd vs. Time Window)

This key sets the value per division on the horizontal scale in the Amptd vs. Time window. The displayed value will be updated according to the Scale Type (Span X Scale) as follows:

"X Scale/Div (Scale Type is Time)" on page 1440

"X Scale/Div (Scale Type is Distance)" on page 1441

### X Scale/Div (Scale Type is Time)

If the scale type is set to Time, X Scale/Div is displayed and set in time.

Key Path	Span X Scale
Mode	DVB-T/H
Remote Command	:DISPlay:EVM:VIEW4:WINDow[1]:TRACe:X[:SCALE][:TIME]:PDIVision <real> :DISPlay:EVM:VIEW4:WINDow[1]:TRACe:X[:SCALE][:TIME]:PDIVision?
Example	DISP:EVM:VIEW4:WIND:TRAC:X:PDIV 1.0 DISP:EVM:VIEW4:WIND:TRAC:X:PDIV?
Notes	SCPI Remarks: VIEW4: Channel Impulse Response View WINDow[1]: Amptd vs. Time Window
Dependencies	If Auto Scaling is set to On, this value is automatically determined by the measurement result. When you set this value manually, Auto Scaling is automatically set to Off.
Preset	Result depends on current FFT size and Channel BW.
State Saved	No
Min	5.0e-8 s
Max	1.0 s
Initial S/W Revision	A.02.00



### X Scale/Div (Scale Type is Distance)

If the scale type is set to Distance, X Scale/Div is displayed and set in distance.

Key Path	Span X Scale
Mode	DVB-T/H
Remote Command	:DISPlay:EVM:VIEW4:WINDow[1]:TRACe:X[:SCALe]:DISTance:PDIVision <real> :DISPlay:EVM:VIEW4:WINDow[1]:TRACe:X[:SCALe]:DISTance:PDIVision?
Example	DISP:EVM:VIEW4:WIND:TRAC:X:DIST:PDIV 3000.0 DISP:EVM:VIEW4:WIND:TRAC:X:DIST:PDIV?
Notes	SCPI Remarks: VIEW4: Channel Impulse Response View WINDow[1]: Amptd vs. Time Window
Dependencies	If Auto Scaling is set to On, this value is automatically determined by the measurement result. When you set this value manually, Auto Scaling is automatically set to Off.
Preset	Result depends on current FFT size and Channel BW.
State Saved	No
Min	15.0 m
Max	3.0e8 m
Initial S/W Revision	A.02.00

### X Scale/Div (MER Monitor View – MER vs. Time Window)

This key sets the sub-carrier value per division on the horizontal scale in the MER vs. Time window.

Key Path	Span X Scale
Mode	DVB-T/H
Remote Command	:DISPlay:EVM:VIEW5:WINDow[1]:TRACe:X[:SCALe]:PDIVision <real> :DISPlay:EVM:VIEW5:WINDow[1]:TRACe:X[:SCALe]:PDIVision?
Example	DISP:EVM:VIEW5:WIND:TRAC:X:PDIV 1.0 DISP:EVM:VIEW5:WIND:TRAC:X:PDIV?
Notes	SCPI Remarks: VIEW5: MER Monitor View WINDow[1]: MER vs. Time Window
Dependencies	If Auto Scaling is set to On, this value is automatically determined by the measurement result. When you set this value manually, Auto Scaling is automatically set to Off.
Preset	Value is automatically determined by the measurement settings with Auto Scaling set to On. Result depends on current Display Points.
State Saved	No
Min	1.0
Max	1000.0
Initial S/W Revision	A.06.00

## Ref Position

This key allows you to set the displayed reference position to Left, Ctr (center), or Right. The key is active in MER/EVM vs. Sub-carrier/Frequency Window, Spectrum Window, Amptd vs. Sub-carrier Window, Phase vs. Sub-carrier Window, Group Delay vs. Sub-carrier Window, Amptd vs. Time Window, and MER vs. Time Window.

Key Path	Span X Scale
Initial S/W Revision	A.02.00

## X Ref Position (I/Q Error View – MER/EVM vs. Sub-carrier/Frequency Window)

This key sets the X-axis reference position in the MER/EVM vs. Sub-carrier/Frequency window.

Key Path	Span X Scale
Mode	DVB-T/H
<b>Remote Command</b>	:DISPlay:EVM:VIEW2:WINDow[1]:TRACe:X[:SCALE]:RPOSition LEFT   CENTer   RIGHT  :DISPlay:EVM:VIEW2:WINDow[1]:TRACe:X[:SCALE]:RPOSition?
<b>Example</b>	DISP:EVM:VIEW2:WIND:TRAC:X:RPOS CENT DISP:EVM:VIEW2:WIND:TRAC:X:RPOS?
Notes	SCPI Remarks: VIEW2: I/Q Error View WINDow[1]: MER/EVM vs. Sub-carrier/Frequency Window on I/Q Error View
Preset	LEFT
State Saved	No
Range	Left   Ctr   Right
Initial S/W Revision	A.02.00

## X Ref Position (I/Q Error View – Spectrum Window)

This key sets the X-axis reference position in the Spectrum window.

Key Path	Span X Scale
Mode	DVB-T/H
<b>Remote Command</b>	:DISPlay:EVM:VIEW2:WINDow2:TRACe:X[:SCALE]:RPOSition LEFT   CENTer   RIGHT  :DISPlay:EVM:VIEW2:WINDow2:TRACe:X[:SCALE]:RPOSition?
<b>Example</b>	DISP:EVM:VIEW2:WIND2:TRAC:X:RPOS CENT DISP:EVM:VIEW2:WIND2:TRAC:X:RPOS?

Notes	SCPI Remarks: VIEW2: I/Q Error View WINDow2: Spectrum Window on I/Q Error View
Preset	CENT
State Saved	No
Range	Left   Ctr   Right
Initial S/W Revision	A.02.00

### X Ref Position (Channel Frequency Response View – Amptd vs. Sub-carrier Window)

This key sets the X-axis reference position in the Amptd vs. Sub-carrier window.

Key Path	Span X Scale
Mode	DVB-T/H
<b>Remote Command</b>	:DISPlay:EVM:VIEW3:WINDow[1]:TRACe:X[:SCALe]:RPOSition LEFT   CENTer   RIGHT  :DISPlay:EVM:VIEW3:WINDow[1]:TRACe:X[:SCALe]:RPOSition?
<b>Example</b>	DISP:EVM:VIEW3:WIND:TRAC:X:RPOS CENT DISP:EVM:VIEW3:WIND:TRAC:X:RPOS?
Notes	SCPI Remarks: VIEW3: Channel Frequency Response View WINDow[1]: Amptd vs. Sub-carrier Window
Preset	LEFT
State Saved	No
Range	Left   Ctr   Right
Initial S/W Revision	A.02.00

### X Ref Position (Channel Frequency Response View – Phase vs. Sub-carrier Window)

This key sets the X-axis reference position in the Phase vs. Sub-carrier window.

Key Path	Span X Scale
Mode	DVB-T/H
<b>Remote Command</b>	:DISPlay:EVM:VIEW3:WINDow2:TRACe:X[:SCALe]:RPOSition LEFT   CENTer   RIGHT  :DISPlay:EVM:VIEW3:WINDow2:TRACe:X[:SCALe]:RPOSition?
<b>Example</b>	DISP:EVM:VIEW3:WIND2:TRAC:X:RPOS CENT DISP:EVM:VIEW3:WIND2:TRAC:X:RPOS?
Notes	SCPI Remarks:

	VIEW3: Channel Frequency Response View WINDow2: Phase vs. Sub-carrier Window
Preset	LEFT
State Saved	No
Range	Left   Ctr   Right
Initial S/W Revision	A.02.00

### X Ref Position (Channel Frequency Response View – Group Delay vs. Sub-carrier Window)

This key sets the X-axis reference position in the Group Delay vs. Sub-carrier window.

Key Path	Span X Scale
Mode	DVB-T/H
<b>Remote Command</b>	:DISPlay:EVM:VIEW3:WINDow3:TRACe:X[:SCALE]:RPOSition LEFT   CENTer   RIGHT  :DISPlay:EVM:VIEW3:WINDow3:TRACe:X[:SCALE]:RPOSition?
<b>Example</b>	DISP:EVM:VIEW3:WIND3:TRAC:X:RPOS CENT DISP:EVM:VIEW3:WIND3:TRAC:X:RPOS?
Notes	SCPI Remarks: VIEW3: Channel Frequency Response View WINDow3: Group Delay vs. Sub-carrier Window
Preset	LEFT
State Saved	No
Range	Left   Ctr   Right
Initial S/W Revision	A.02.00

### X Ref Position (Channel Impulse Response View – Amptd vs. Time Window)

This key sets the X-axis reference position in the Amptd vs. Time window.

Key Path	Span X Scale
Mode	DVB-T/H
<b>Remote Command</b>	:DISPlay:EVM:VIEW4:WINDow[1]:TRACe:X[:SCALE]:RPOSition LEFT   CENTer   RIGHT  :DISPlay:EVM:VIEW4:WINDow[1]:TRACe:X[:SCALE]:RPOSition?
<b>Example</b>	DISP:EVM:VIEW4:WIND:TRAC:X:RPOS CENT DISP:EVM:VIEW4:WIND:TRAC:X:RPOS?
Notes	SCPI Remarks: VIEW4: Channel Impulse Response View

	WINDow[1]: Amptd vs. Time Window
Preset	CENT
State Saved	No
Range	Left   Ctr   Right
Initial S/W Revision	A.02.00

### X Ref Position (MER Monitor View – MER vs. Time Window)

This key sets the X-axis reference position in the MER vs. Time window.

Key Path	Span X Scale
Mode	DVB-T/H
<b>Remote Command</b>	:DISPlay:EVM:VIEW5:WINDow[1]:TRACe:X[:SCALe]:RPOSition LEFT   CENTer   RIGHT :DISPlay:EVM:VIEW5:WINDow[1]:TRACe:X[:SCALe]:RPOSition?
<b>Example</b>	DISP:EVM:VIEW5:WIND:TRAC:X:RPOS CENT DISP:EVM:VIEW5:WIND:TRAC:X:RPOS?
Notes	SCPI Remarks: VIEW5: MER Monitor View WINDow[1]: MER vs. Time Window
Preset	LEFT
State Saved	No
Range	Left   Ctr   Right
Initial S/W Revision	A.06.00

### Auto Scaling

This key allows you to toggle the scale coupling function between On and Off. The key is active in MER/EVM vs. Sub-carrier/Frequency Window, Spectrum Window, Amptd vs. Sub-carrier Window, Phase vs. Sub-carrier Window, Group Delay vs. Sub-carrier Window, Amptd vs. Time Window, and MER vs. Time Window.

Key Path	Span X Scale
Initial S/W Revision	A.02.00

### X Auto Scaling (I/Q Error View – MER/EVM vs. Sub-carrier/Frequency Window)

When Auto Scaling is On, the scale per division and the reference values are automatically adjusted in the MER/EVM vs. Sub-carrier/Frequency window.

Key Path	Span X Scale
Mode	DVB-T/H
Remote Command	:DISPlay:EVM:VIEW2:WINDow[1]:TRACe:X[:SCALe]:COUPle OFF   ON   0   1 :DISPlay:EVM:VIEW2:WINDow[1]:TRACe:X[:SCALe]:COUPle?
Example	DISP:EVM:VIEW2:WIND:TRAC:X:COUP ON DISP:EVM:VIEW2:WIND:TRAC:X:COUP?
Notes	SCPI Remarks: VIEW2: I/Q Error View WINDow[1]: MER/EVM vs. Sub-carrier/Frequency Window on I/Q Error View
Dependencies	When this parameter is set to On, it will activate the scale coupling function that automatically determines scale per division and reference values based on the measurement results. When you set a value to either Scale/Div or Ref Value manually, Auto Scaling is automatically set to Off.
Preset	ON
State Saved	No
Range	On   Off
Initial S/W Revision	A.02.00

### X Auto Scaling (I/Q Error View – Spectrum Window)

When Auto Scaling is On, the scale per division and the reference values are automatically adjusted in the Spectrum window.

Key Path	Span X Scale
Mode	DVB-T/H
Remote Command	:DISPlay:EVM:VIEW2:WINDow2:TRACe:X[:SCALe]:COUPle OFF ON 0 1 :DISPlay:EVM:VIEW2:WINDow2:TRACe:X[:SCALe]:COUPle?
Example	DISP:EVM:VIEW2:WIND2:TRAC:X:COUP ON DISP:EVM:VIEW2:WIND2:TRAC:X:COUP?
Notes	SCPI Remarks: VIEW2: I/Q Error View WINDow2: Spectrum Window on I/Q Error View
Dependencies	When this parameter is set to On, it will activate the scale coupling function that automatically determines scale per division and reference values based on the measurement results. When you set a value to either Scale/Div or Ref Value manually, Auto Scaling is automatically set to Off.
Preset	ON
State Saved	No
Range	On   Off
Initial S/W Revision	A.02.00

### X Auto Scaling (Channel Frequency Response View – Amptd vs. Sub-carrier Window)

When Auto Scaling is On, the scale per division and the reference values are automatically adjusted in the Amptd vs. Sub-carrier window.

Key Path	Span X Scale
Mode	DVB-T/H
<b>Remote Command</b>	:DISPlay:EVM:VIEW3:WINDow[1]:TRACe:X[:SCALe]:COUPle OFF   ON   0   1 :DISPlay:EVM:VIEW3:WINDow[1]:TRACe:X[:SCALe]:COUPle?
<b>Example</b>	DISP:EVM:VIEW3:WIND:TRAC:X:COUP ON DISP:EVM:VIEW3:WIND:TRAC:X:COUP?
Notes	SCPI Remarks: VIEW3: Channel Frequency Response View WINDow[1]: Amptd vs. Sub-carrier Window
Dependencies	When this parameter is set to On, it will activate the scale coupling function that automatically determines scale per division and reference values based on the measurement results. When you set a value to either Scale/Div or Ref Value manually, Auto Scaling is automatically set to Off.
Preset	ON
State Saved	No
Range	On   Off
Initial S/W Revision	A.02.00

### X Auto Scaling (Channel Frequency Response View – Phase vs. Sub-carrier Window)

When Auto Scaling is On, the scale per division and the reference values are automatically adjusted in the Phase vs. Sub-carrier window.

Key Path	Span X Scale
Mode	DVB-T/H
<b>Remote Command</b>	:DISPlay:EVM:VIEW3:WINDow2:TRACe:X[:SCALe]:COUPle OFF ON 0 1 :DISPlay:EVM:VIEW3:WINDow2:TRACe:X[:SCALe]:COUPle?
<b>Example</b>	DISP:EVM:VIEW3:WIND2:TRAC:X:COUP ON DISP:EVM:VIEW3:WIND2:TRAC:X:COUP?
Notes	SCPI Remarks: VIEW3: Channel Frequency Response View WINDow2: Phase vs. Sub-carrier Window
Dependencies	When this parameter is set to On, it will activate the scale coupling function that automatically determines scale per division and reference values based on the measurement results. When you set a value to either Scale/Div or Ref Value manually, Auto Scaling is automatically set to Off.
Preset	ON
State Saved	No

Range	On   Off
Initial S/W Revision	A.02.00

### X Auto Scaling (Channel Frequency Response View –Group Delay vs. Sub-carrier Window)

When Auto Scaling is On, the scale per division and the reference values are automatically adjusted in the Group Delay vs. Sub-carrier window.

Key Path	Span X Scale
Mode	DVB-T/H
<b>Remote Command</b>	:DISPlay:EVM:VIEW3:WINDow3:TRACe:X[:SCALe]:COUPle OFF ON 0 1 :DISPlay:EVM:VIEW3:WINDow3:TRACe:X[:SCALe]:COUPle?
<b>Example</b>	DISP:EVM:VIEW3:WIND3:TRAC:X:COUP ON DISP:EVM:VIEW3:WIND3:TRAC:X:COUP?
Notes	SCPI Remarks: VIEW3: Channel Frequency Response View WINDow3: Group Delay vs. Sub-carrier Window
Dependencies	When this parameter is set to On, it will activate the scale coupling function that automatically determines scale per division and reference values based on the measurement results. When you set a value to either Scale/Div or Ref Value manually, Auto Scaling is automatically set to Off.
Preset	ON
State Saved	No
Range	On   Off
Initial S/W Revision	A.02.00

### X Auto Scaling (Channel Impulse Response View – Amptd vs. Time Window)

When Auto Scaling is On, the scale per division and the reference values are automatically adjusted in the Amptd vs. Time window.

Key Path	Span X Scale
Mode	DVB-T/H
<b>Remote Command</b>	:DISPlay:EVM:VIEW4:WINDow[1]:TRACe:X[:SCALe]:COUPle OFF   ON   0   1 :DISPlay:EVM:VIEW4:WINDow[1]:TRACe:X[:SCALe]:COUPle?
<b>Example</b>	DISP:EVM:VIEW4:WIND:TRAC:X:COUP ON DISP:EVM:VIEW4:WIND:TRAC:X:COUP?
Notes	SCPI Remarks: VIEW4: Channel Impulse Response View WINDow[1]: Amptd vs. Time Window



Dependencies	When this parameter is set to On, it will activate the scale coupling function that automatically determines scale per division and reference values based on the measurement results. When you set a value to either Scale/Div or Ref Value manually, Auto Scaling is automatically set to Off.
Preset	ON
State Saved	No
Range	On   Off
Initial S/W Revision	A.02.00

### X Auto Scaling (MER Monitor MER vs. Time Window)

When Auto Scaling is On, the scale per division and the reference values are automatically adjusted in the MER vs. Time window.

Key Path	Span X Scale
Mode	DVB-T/H
<b>Remote Command</b>	:DISPlay:EVM:VIEW5:WINDow[1]:TRACe:X[:SCALe]:COUPle OFF   ON   0   1 :DISPlay:EVM:VIEW5:WINDow[1]:TRACe:X[:SCALe]:COUPle?
<b>Example</b>	DISP:EVM:VIEW5:WIND:TRAC:X:COUP ON DISP:EVM:VIEW5:WIND:TRAC:X:COUP?
Notes	SCPI Remarks: VIEW5: MER Monitor View WINDow[1]: MER vs. Time Window
Dependencies	When this parameter is set to On, it will activate the scale coupling function that automatically determines scale per division and reference values based on the measurement results. When you set a value to either Scale/Div or Ref Value manually, Auto Scaling is automatically set to Off.
Preset	ON
State Saved	No
Range	On   Off
Initial S/W Revision	A.06.00

### Scale Type

Sets X Scale Type. The key is active in MER/EVM vs. Sub-carrier/Frequency window and Amptd vs. Time window.

Key Path	Scale Type
Initial S/W Revision	A.06.00
Modified at S/W Revision	A.10.01

### Scale Type (MER/EVM vs. Sub-carrier/ Frequency window)

Sets X Scale Type for MER/EVM vs. Sub-carrier/ Frequency window. If it is set to Carrier, the X scale displays the carrier value. If it is set to Freq, the X scale displays the carrier frequency value.

Key Path	Span X Scale
Mode	DVB-T/H
<b>Remote Command</b>	:DISPlay:EVM:VIEW2:WINDow[1]:TRACe:X[:SCALE]:TYPE CARRier   FREQuency :DISPlay:EVM:VIEW2:WINDow[1]:TRACe:X[:SCALE]:TYPE?
<b>Example</b>	DISP:EVM:VIEW2:WIND:TRAC:X:TYPE CARR DISP:EVM:VIEW2:WIND:TRAC:X:TYPE?
Preset	CARRier
State Saved	No
Range	Carrier   Freq
Initial S/W Revision	A.06.00

### Scale Type (Amptd vs. Time window)

Sets X Scale Type for Amptd vs. Time window. If it is set to Carrier, the X scale displays the carrier value. If it is set to Freq, the X scale displays the carrier frequency value.

Distance =  $c \times \text{Time}$ , in which  $c$  ( $3 \times 10^8$ ) is the speed of light.

Key Path	Span X Scale
Mode	DVB-T/H
<b>Remote Command</b>	:DISPlay:EVM:VIEW4:WINDow[1]:TRACe:X[:SCALE]:TYPE TIME   DISTance :DISPlay:EVM:VIEW4:WINDow[1]:TRACe:X[:SCALE]:TYPE?
<b>Example</b>	DISP:EVM:VIEW4:WIND:TRAC:X:TYPE TIME DISP:EVM:VIEW4:WIND:TRAC:X:TYPE?
Preset	TIME
State Saved	No
Range	Time   Distance
Initial S/W Revision	A.06.00

## Sweep/Control

Accesses a menu that enables you to configure the Sweep and Control functions of the analyzer, such as Sweep Time and Gating.

Key Path	Front-panel key
Initial S/W Revision	Prior to A.02.00

### Pause/Resume

Pauses a measurement after the current data acquisition is complete.

When Paused, the label on the key changes to Resume. Pressing Resume un-pauses the measurement. When you are Paused, pressing Restart, Single or Cont does a Resume.

Key Path	Sweep/Control
<b>Remote Command</b>	:INITiate:PAUSE
Dependencies	Grayed out in Measurements that do not support Pausing. Blanked in Modes that do not support Pausing.
Initial S/W Revision	Prior to A.02.00

Key Path	Sweep/Control
<b>Remote Command</b>	:INITiate:RESume
Dependencies	Grayed out in Measurements that do not support Pausing. Blanked in Modes that do not support Pausing.
Initial S/W Revision	Prior to A.02.00

### Abort (Remote Command Only)

This command is used to stop the current measurement. It aborts the current measurement as quickly as possible, resets the sweep and trigger systems, and puts the measurement into an "idle" state. If the analyzer is in the process of aligning when ABORT is sent, the alignment finishes before the abort function is performed. So ABORT does not abort an alignment.

If the analyzer is set for Continuous measurement, it sets up the measurement and initiates a new data measurement sequence with a new data acquisition (sweep) taken once the trigger condition is met.

If the analyzer is set for Single measurement, it remains in the "idle" state until an :INIT:IMM command is received.

<b>Remote Command</b>	:ABORt
<b>Example</b>	:ABOR

---

Notes	If :INITiate:CONTInuous is ON, then a new continuous measurement will start immediately, with sweep (data acquisition) occurring once the trigger condition has been met. If :INITiate:CONTInuous is OFF, then :INITiate:IMMEDIATE is used to start a single measurement; with sweep (data acquisition) occurring once the trigger condition has been met.
Dependencies	For continuous measurement, ABORt is equivalent to the Restart key. Not all measurements support the abort command.
Status Bits/OPC dependencies	The STATus:OPERation register bits 0 through 8 are cleared. The STATus:QUEStionable register bit 9 (INTegrity sum) is cleared. Since all the bits that feed into OPC are cleared by the ABORt, the ABORt will cause the *OPC query to return true.
Initial S/W Revision	Prior to A.02.00

---

## System

See "System" on page 342

## Trace/Detector

Displays menu keys that let you normalize trace data.

This function is only available in the Channel Frequency Response view. In other views, there is no Trace/Detector functions.

Key Path	Front-panel key
Initial S/W Revision	A.02.00

### Normalize

Displays menu keys that let you normalize trace data.

Key Path	Trace/Detector
Dependencies	This key is only available in the Channel Frequency Response view, and it's blank in other views.
Readback	[On] or [Off]
Initial S/W Revision	A.10.01

### Normalize On/Off

Normalize (On) activates the normalize function. On each sweep, the normalized trace is subtracted from Trace 1 and the result is added to the normalized reference level. This arithmetic assumes all values are in decibel units.

Key Path	Trace/Detector, Normalize
<b>Remote Command</b>	:CALCulate:EVM:NTData[:STATe] OFF ON 0 1 :CALCulate:EVM:NTData[:STATe]?
<b>Example</b>	:CALC:EVM:NTD ON :CALC:EVM:NTD?
Dependencies	If Normalize (On) is pressed before Store Ref, an error message "Execution Error; Store ref trace before turning on Normalize" is generated. Normalize remains off in this case.
Preset	OFF
State Saved	Saved in Instrument State.
Initial S/W Revision	A.10.01

### Store Ref

Copies trace 1 into reference trace. Store Ref must be pressed before pressing Normalize (On).

Key Path	Trace/Detector, Normalize
----------	---------------------------

<b>Remote Command</b>	TRACe:EVM:RTRace:STORe[:IMMediate]
<b>Example</b>	TRAC:EVM:RTR:STOR
<b>Dependencies</b>	If Normalize (On) is pressed before Store Ref, an error message “Execution Error; Store ref trace before turning on Normalize” is generated. Normalize remains off in this case.
<b>Initial S/W Revision</b>	A.10.01

## Show Ref Trace

Views or blanks the reference trace on the display.

<b>Key Path</b>	Trace/Detector, Normalize
<b>Remote Command</b>	TRACe:EVM:RTRace:DISPlay OFF ON 0 1 TRACe:EVM:RTRace:DISPlay?
<b>Example</b>	TRAC:EVM:RTR:DISP ON
<b>State Saved</b>	Saved in instrument state.
<b>Initial S/W Revision</b>	A.10.01

## Norm Ref Lvl

Sets the level (in dB) of the normalized reference.

<b>Key Path</b>	Trace/Detector, Normalize
<b>Remote Command</b>	:DISPlay:EVM:VIEW3:WINDow[1]:TRACe:Y[:SCALe]:NRLevel <real> :DISPlay:EVM:VIEW3:WINDow[1]:TRACe:Y[:SCALe]:NRLevel?
<b>Example</b>	DISP:EVM:VIEW3:WIND:TRAC:Y:NRL 10.0dB DISP:EVM:VIEW3:WIND:TRAC:Y:NRL?
<b>Preset</b>	0 dB
<b>State Saved</b>	Saved in instrument state.
<b>Min</b>	-327.6 dB
<b>Max</b>	327.6 dB
<b>Initial S/W Revision</b>	A.10.01

## Norm Ref Posn

Offsets the displayed trace without affecting the instrument gain or attenuation settings. This allows the displayed trace to be moved without decreasing measurement accuracy. The normalized reference position is indicated with a right arrow on the left side of the display and a left arrow on the right side of the display, just inside the graticule. See picture below:

12 Mod Accuracy Measurement  
Trace/Detector

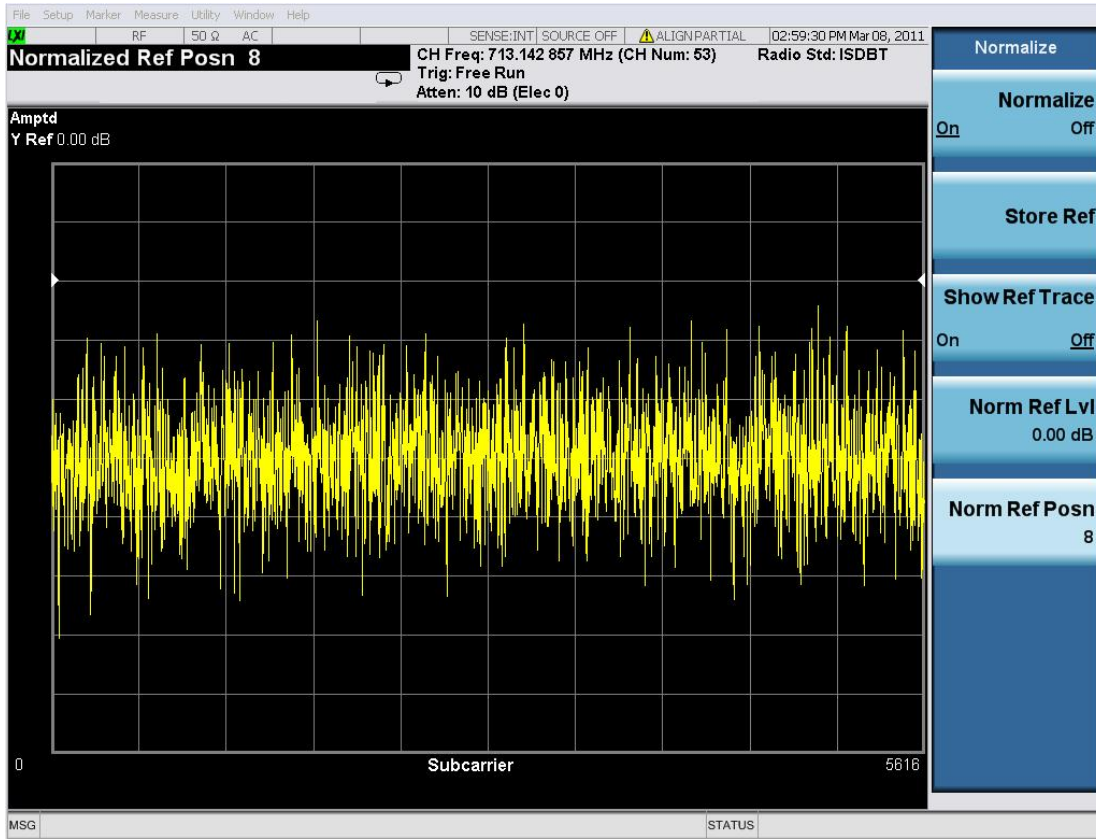

Key Path	Trace/Detector, Normalize
Remote Command	:DISPlay:EVM:VIEW3:WINDow[1]:TRACe:Y[:SCALE]:NRPosition <integer> :DISPlay:EVM:VIEW3:WINDow[1]:TRACe:Y[:SCALE]:NRPosition?
Example	DISP:EVM:VIEW3:WIND:TRAC:Y:NRP 5 DISP:EVM:VIEW3:WIND:TRAC:Y:NRP?
Notes	The top and bottom graticule lines correspond to 10 and 0, respectively.
Preset	10
State Saved	Saved in Instrument State.
Min	0
Max	10
Initial S/W Revision	A.10.01



## Trigger

See ["Trigger" on page 412](#)

### Free Run

See ["Free Run " on page 419](#)

### External 1

See ["External 1 " on page 2059](#)

### Trigger Level

See ["Trigger Level " on page 2059](#)

### Trig Slope

See ["Trig Slope " on page 2060](#)

### Trig Delay

See ["Trig Delay " on page 427](#)

### External 2

See ["External 2 " on page 2061](#)

### Trigger Level

See ["Trigger Level " on page 2061](#)

### Trig Slope

See ["Trig Slope " on page 2062](#)

### Trig Delay

See ["Trig Delay " on page 429](#)

### RF Burst

See ["RF Burst " on page 2062](#)

### Absolute Trigger

See ["Absolute Trigger Level" on page 2063](#)

### Relative Trigger

See ["Relative Trigger Level" on page 2052](#)

### Trig Slope

See ["Trigger Slope " on page 2064](#)

### Trig Delay

See "Trig Delay " on page 433

### Auto/Holdoff

See "Auto/Holdoff " on page 444

### Auto Trig

See "Auto Trig " on page 444

### Trig Holdoff

See "Trig Holdoff " on page 445

### Baseband I/Q

See \_\_\_ on page X

### I/Q Mag

See \_\_\_ on page X

### Trigger Level

See \_\_\_ on page X

### Trig Slope

See \_\_\_ on page X

### Trig Delay

See \_\_\_ on page X

### I

See \_\_\_ on page X

### Trigger Level

See \_\_\_ on page X

### Trig Slope

See \_\_\_ on page X

### Trig Delay

See \_\_\_ on page X

### Q

See \_\_\_ on page X

**Trigger Level**

See \_\_\_ on page X

**Trig Slope**

See \_\_\_ on page X

**Trig Delay**

See \_\_\_ on page X

**Input I**

See \_\_\_ on page X

**Trigger Level**

See \_\_\_ on page X

**Trig Slope**

See \_\_\_ on page X

**Trig Delay**

See \_\_\_ on page X

**Input Q**

See \_\_\_ on page X

**Trigger Level**

See \_\_\_ on page X

**Trig Slope**

See \_\_\_ on page X

**Trig Delay**

See \_\_\_ on page X

**Aux Channel Center Freq**

See \_\_\_ on page X

**Trigger Level**

See \_\_\_ on page X

**Trig Slope**

See \_\_\_ on page X

**Trig Delay**

See \_\_\_ on page X

12 Mod Accuracy Measurement  
Trigger

**Trigger Center Freq**

See \_\_\_ on page X

**Trigger BW**

See \_\_\_ on page X

## User Preset

Accesses a menu that gives you the following three choices:

- User Preset – recalls a state previously saved using the Save User Preset function.
- User Preset All Modes – presets all of the modes in the analyzer
- Save User Preset– saves the current state for the current mode

Key Path	Front-panel key
Backwards Compatibility Notes	<p>User Preset is actually loading a state, and in legacy analyzers, it was possible to load a state without affecting the trace data, limit lines or correction data. Similarly it was possible to do a User Preset without affecting the trace data, limit lines or correction data.</p> <p>In the X-Series, “state” always includes all of this data; so whenever state is loaded, or User Preset is executed, all of the traces, limit lines and corrections are affected. Although this differs from previous behavior, it is desirable behavior, and should not cause adverse issues for users.</p> <p>On ESA and PSA, User Preset affected the entire instrument’s state. In the X-Series, User Preset only recalls the state for the active mode. There is a User Preset file for each mode. User Preset can never cause a mode switch as it can in legacy analyzers. If you want to recall all modes to their user preset file state, you will need to do a User Preset after mode switching into each mode.</p> <p>User Preset recalls mode state which can now include data like traces; whereas on ESA and PSA, User Preset did not affect data.</p>
Initial S/W Revision	Prior to A.02.00

## User Preset

User Preset sets the state of the currently active mode back to the state that was previously saved for this mode using the Save User Preset menu key or the SCPI command, SYST:PRES:USER:SAV. It not only recalls the Mode Preset settings, but it also recalls all of the mode persistent settings, and the Input/Output system setting that existed at the time Save User Preset was executed.

If a Save User Preset has not been done at any time, User Preset recalls the default user preset file for the currently active mode. The default user preset files are created if, at power-on, a mode detects there is no user preset file. There will never be a scenario when there is no user preset file to restore. For each mode, the default user preset state is the same state that would be saved if a Save User Preset is performed in each mode right after doing a Restore Mode Default and after a Restore Input/Output Defaults.

The User Preset function does the following:

- Aborts the currently running measurement.
- Sets the mode State to the values defined by Save User Preset.
- Makes the saved measurement for the currently running mode the active measurement.
- Brings up the saved menu for the power-on mode.
- Clears the input and output buffers.
- Sets the Status Byte to 0.

Key Path	User Preset
Remote Command	:SYSTem:PRESet:USER
Example	:SYST:PRES:USER:SAVE:SYST:PRES:USER
Notes	:SYST:PRES:USER:SAVE is used to save the current state as the user preset state. Clears all pending OPC bits. The Status Byte is set to 0. Pressing the User Preset front-panel key while already in the User Preset menu will cause the User Preset to get executed
Couplings	A user preset will cause the currently running measurement to be aborted and cause the saved measurement to be active. Recalling a User Preset file has the same issues that recalling a Save State file has. Some settings may need to be limited and therefore re-coupled, since the capabilities of the mode may have changes when the User Preset file was last saved.
Initial S/W Revision	Prior to A.02.00

### User Preset All Modes

Recalls all of the User Preset files for each mode, switches to the power-on mode, and activates the saved measurement from the power-on mode User Preset file.

**NOTE**

When the instrument is secured, all of the user preset files are converted back to their default user preset files.

The User Preset function does the following:

- Aborts the currently running measurement.
- Switches the Mode to the power-on mode.
- Restores the User Preset files for each mode.
- Makes the saved measurement for the power-on mode the active measurement.
- Brings up the saved menu for the power-on mode.
- Clears the input and output buffers.
- Sets the Status Byte to 0.

Key Path	User Preset
Remote Command	:SYSTem:PRESet:USER:ALL
Example	:SYST:PRES:USER:SAVE:SYST:PRES:USER:ALL
Notes	Clears all pending OPC bits. The Status Byte is set to 0. :SYST:PRES:USER:SAVE is used to save the current state as the user preset state.
Couplings	A user preset will cause the currently running measurement to be aborted, cause a mode switch to the power-on mode, and cause the saved measurement to be active in the power-on mode. Recalling a User Preset file has the same issues that recalling a Save State file has. Some settings may need to be limited and therefore re-coupled, since the capabilities of the mode may have changes when the User Preset file was last saved.
Initial S/W Revision	Prior to A.02.00

## Save User Preset

Saves the currently active mode and its State. You can recall this User Preset file by pressing the User Preset menu key or sending the SYST:PRES:USER remote command. This same state is also saved by the Save State function.

Key Path	User Preset
<b>Remote Command</b>	:SYSTem:PRESet:USER:SAVE
<b>Example</b>	:SYST:PRES:USER:SAVE
Notes	:SYST:PRES:SAVE creates the same file as if the user requested a *SAV or a MMEM:STOR:STAT, except User Preset Save does not allow the user to specify the filename or the location of the file.
Initial S/W Revision	Prior to A.02.00

## View/Display

The View/Display key opens the View/Display menu for current measurement. The views that are available are specific to the current measurement selected under the Meas key.

The DVB-T/H Modulation Accuracy measurement consists of eight views. The default view is I/Q Measured Polar Graph (left/right). For the selection of each view, refer to ["View Selection" on page 1464](#).

NO.	View	NO. of Windows	Window No.	Window
1	VIEW[1] I/Q Measured Polar Graph	Dual (Horizontal)	WINDow[1]	Result Metrics
			WINDow2	I/Q Measured Polar Graph
2	VIEW2 I/Q Error	Quad	WINDow[1]	MER/EVM vs. Sub-carrier/Frequency
			WINDow2	Spectrum
			WINDow3	I/Q Mismatch Polar Graph
			WINDow4	Result Metrics
3	VIEW3 Channel Frequency Response	Triple (Vertical)	WINDow[1]	Amptd vs. Sub-carrier
			WINDow2	Phase vs. Sub-carrier
			WINDow3	Group Delay vs. Sub-carrier
4	VIEW4 Channel Impulse Response	Single	WINDow[1]	Amptd vs. Time
5	VIEW5 TPS Decoding	Single	WINDow[1]	TPS original bits and decoded information
6	VIEW6 BER Results	Single	WINDow[1]	BER Results
7	VIEW7 MER Monitor	Single	WINDow[1]	MER Monitor
8	VIEW8 Result Metrics	Single	WINDow[1]	Result Metrics Summary

### View Selection

Allows you to select the desired measurement view from the following selections:

1 I/Q Measured Polar Graph.

2 I/Q Error (quad view). Provides a combination view of MER/EVM vs. Sub-carrier/Frequency graph, Spectrum graph, I/Q Mismatch Polar Graph, and the result metrics.

3 Channel Frequency Response (triple view). Provides a combination view of Amptd vs. Sub-carrier graph, Phase vs. Sub-carrier graph and Group Delay vs. Sub-carrier graph.



4Channel Impulse Response.

5TPS Decoding.

6BER Results.

7MER Monitor.

8Result Metrics.

Key Path	View/Display
Mode	DVB-T/H
Remote Command	:DISPlay:EVM:VIEW[:SElect] POLar   IQERror   FREQuency   IMPulse   TPS   BER   MERMonitor   NRESults :DISPlay:EVM:VIEW[:SElect]?
Example	DISP:EVM:VIEW POL DISP:EVM:VIEW?
Preset	POLar
State Saved	Saved in instrument state.
Range	I/Q Measured Polar Graph   I/Q Error (Quad View)   Channel Frequency Response   Channel Impulse Response   TPS Decoding   BER Results   MER Monitor   Result Metrics
Initial S/W Revision	A.02.00

Key Path	Front-panel key
Initial S/W Revision	A.02.00

## Display

The Display menu is common to most measurements, and is used for configuring items on the display. Some Display menu settings apply to all the measurements in a mode, and some only to the current measurement. Those under the System Display Settings key apply to all measurements in all modes.

Key Path	Display
Key Path	View/Display
Initial S/W Revision	Prior to A.02.00

## Annotation

Turns on and off various parts of the display annotation. The annotation is divided up into four categories:

1. Meas Bar: This is the measurement bar at the top of the screen. It does not include the settings panel or the Active Function. Turning off the Meas Bar turns off the settings panel and the Active Function. When the Meas Bar is off, the graticule area expands to fill the area formerly occupied by the Meas Bar.

2. Screen Annotation: this is the annotation and annunciation around the graticule, including any annotation on lines (such as the display line, the threshold line, etc.) This does NOT include the marker number or the N dB result. When off, the graticule expands to fill the entire graticule area.
3. Trace annotation: these are the labels on the traces, showing their detector (or their math mode).
4. Active Function annotation: this is the active function display in the meas bar, and all of the active function values displayed on softkeys.

See the figure below. Each type of annotation can be turned on and off individually.

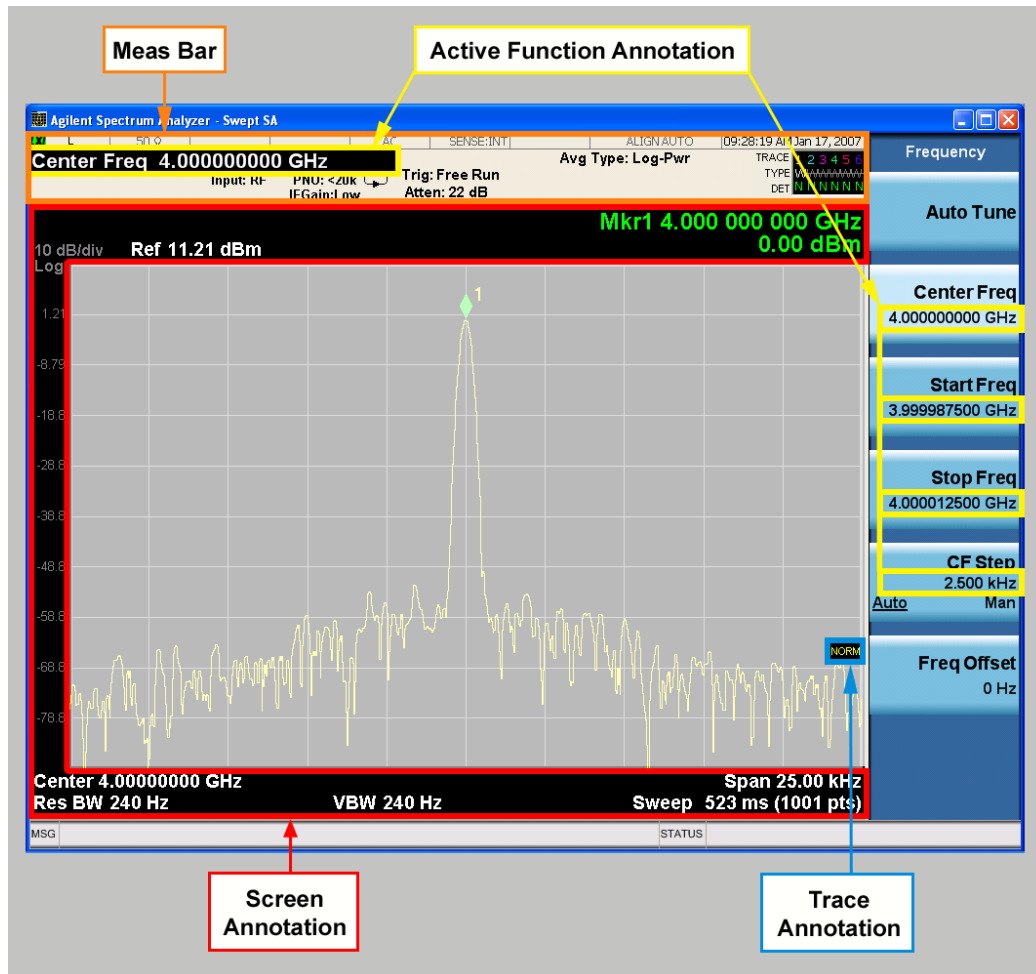

Key Path	View/Display, Display
Initial S/W Revision	Prior to A.02.00

### Meas Bar On/Off

This function turns the Measurement Bar on and off, including the settings panel. When off, the graticule area expands to fill the area formerly occupied by the Measurement Bar.

Key Path	View/Display, Display, Annotation
<b>Remote Command</b>	:DISPlay:ANNotation:MBAR[:STATe] OFF ON 0 1 :DISPlay:ANNotation:MBAR[:STATe]?
<b>Example</b>	DISP:ANN:MBAR OFF
Dependencies	Grayed out and forced to OFF when System Display Settings, Annotation is set to Off.
Preset	On This should remain Off through a Preset when System DisplaySettings, Annotation is set to Off.
State Saved	Saved in instrument state.
Initial S/W Revision	Prior to A.02.00

### Screen

This controls the display of the annunciation and annotation around the graticule, including any annotation on lines (such as the display line, the threshold line, etc.) and the y-axis annotation. This does NOT include marker annotation (or the N dB result). When off, the graticule expands to fill the entire graticule area, leaving only the 1.5% gap above the graticule as described in the Trace/Detector chapter.

Key Path	View/Display, Display, Annotation
<b>Remote Command</b>	:DISPlay:ANNotation:SCReen[:STATe] OFF ON 0 1 :DISPlay:ANNotation:SCReen[:STATe]?
<b>Example</b>	DISP:ANN:SCR OFF
Dependencies	Grayed-out and forced to OFF when System Display Settings, Annotation is set to Off.
Preset	On This should remain Off through a Preset when System DisplaySettings, Annotation is set to Off
State Saved	Saved in instrument state.
Initial S/W Revision	Prior to A.02.00

### Active Function Values On/Off

Turns on and off the active function display in the Meas Bar, and all of the active function values displayed on the softkeys.

Note that all of the softkeys that have active functions have these numeric values blanked when this function is on. This is a security feature..

12 Mod Accuracy Measurement  
View/Display

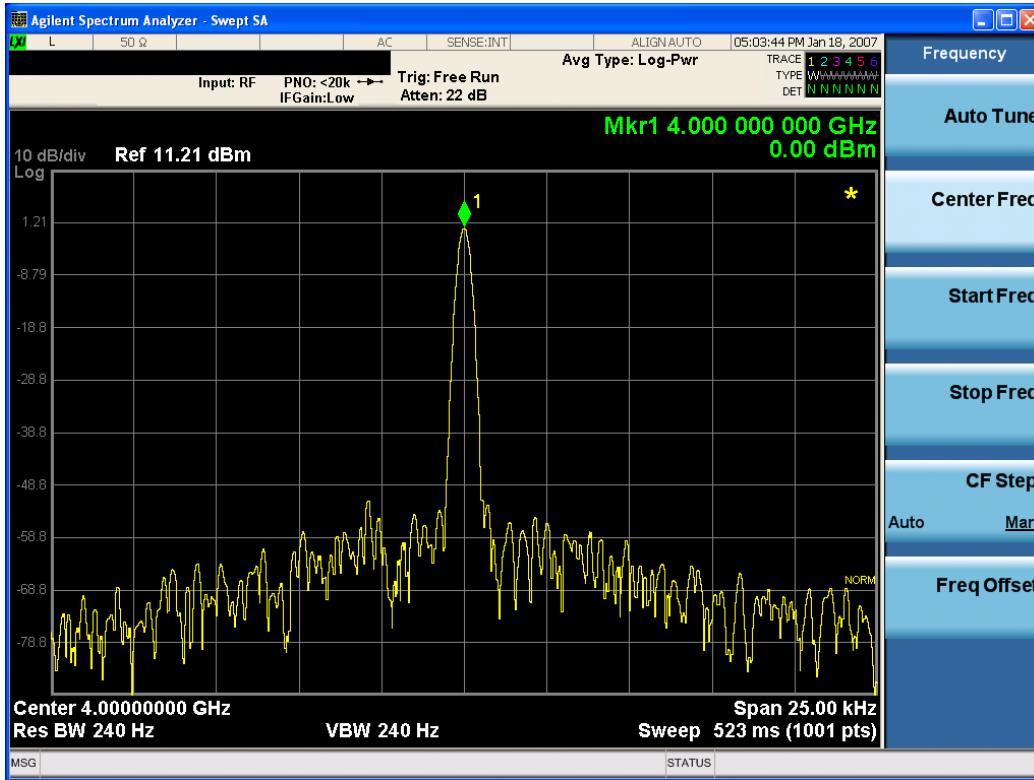

Key Path	View/Display, Display, Annotation
Remote Command	:DISPlay:ACTivefunc[:STATE] ON OFF 1 0 :DISPlay:ACTivefunc[:STATE] ?
Example	DISP:ACT OFF
Dependencies	Grayed out and forced to OFF when System Display Settings, Annotation is set to Off.
Preset	On This should remain Off through a Preset when System DisplaySettings, Annotation is set to Off
State Saved	Saved in instrument state.
Initial S/W Revision	Prior to A.02.00

### Title

Displays menu keys that enable you to change or clear a title on your display.

Key Path	View/Display, Display
Initial S/W Revision	Prior to A.02.00

### Change Title

Writes a title into the "measurement name" field in the banner, for example, "Swept SA".

Press Change Title to enter a new title through the alpha editor. Press Enter or Return to complete the entry. Press ESC to cancel the entry and preserve your existing title.

The display title will replace the measurement name. It remains for this measurement until you press Change Title again, or you recall a state, or a Preset is performed. A title can also be cleared by pressing Title, Clear Title.

**NOTE**

Notice the inclusion of the <measurement> parameter in the command below. Because each measurement remembers the Display Title, the command must be qualified with the measurement name. For the Swept SA measurement this is not the case; no <measurement> parameter is used when changing the Display Title for the Swept SA measurement.

Key Path	View/Display, Display, Title
Mode	All
<b>Remote Command</b>	:DISPlay:<measurement>:ANNotation:TITLe:DATA <string> :DISPlay:<measurement>:ANNotation:TITLe:DATA?
<b>Example</b>	DISP:ANN:TITL:DATA "This Is My Title" This example is for the Swept SA measurement in the Spectrum Analyzer mode. The SANalyzer <measurement> name is not used. DISP:ACP:ANN:TITL:DATA "This Is My Title" This example is for Measurements other than Swept SA. Both set the title to: This Is My Title
Notes	Pressing this key cancels any active function. When a title is edited the previous title remains intact (it is not cleared) and the cursor goes at the end so that characters can be added or BKSP can be used to go back over previous characters.
Preset	No title (measurement name instead)
State Saved	Saved in instrument state.
Initial S/W Revision	Prior to A.02.00

### Clear Title

Clears a title from the front-panel display. Once cleared, the title cannot be retrieved. After the title is cleared, the current Measurement Name replaces it in the title bar.

Key Path	View/Display, Display, Title
<b>Example</b>	The following commands clear the title and restore the measurement's original title: DISP:ANN:TITL:DATA "" This example is for the Swept SA measurement in the Spectrum Analyzer mode. The SANalyzer <measurement> name is not used. DISP:ACP:ANN:TITL:DATA "" This example is for ACP; in measurements other than Swept SA the measurement name is required.
Notes	Uses the :DISPlay:<measurement>:ANNotation:TITLe:DATA <string> command with an empty string (in the Swept SA, the <measurement> is omitted).
Preset	Performed on Preset.
Initial S/W Revision	Prior to A.02.00

## Graticule

Pressing Graticule turns the display graticule On or Off. It also turns the graticule y-axis annotation on and off.

Key Path	View/Display, Display
Remote Command	:DISPlay:WINDow[1]:TRACe:GRATicule:GRID[:STATe] OFF ON 0 1 :DISPlay:WINDow[1]:TRACe:GRATicule:GRID[:STATe]?
Example	DISP:WIND:TRAC:GRAT:GRID OFF
Notes	The graticule is the set of horizontal and vertical lines that make up the grid/divisions for the x-axis and y-axis.
Preset	On
State Saved	Saved in instrument state
Initial S/W Revision	Prior to A.02.00

## System Display Settings

These settings are "Mode Global" – they affect all modes and measurements and are reset only by Restore Misc Defaults or Restore System Defaults under System.

Key Path	View/Display, Display
Initial S/W Revision	Prior to A.02.00

## Annotation Local Settings

This is a Mode Global override of the meas local annotation settings. When it is All Off, it forces ScreenAnnotation, Meas Bar, Trace, and Active Function Values settings to be OFF for all measurements in all modes. This provides the security based "annotation off" function of previous analyzers; hence it uses the legacy SCPI command.

When it is All Off, the Screen, Meas Bar, Trace, and Active Function Values keys under the Display, Annotation menu are grayed out and forced to Off. When Local Settings is selected, you are able to set the local annotation settings on a measurement by measurement basis.

Key Path	View/Display, Display, System Display Settings
Remote Command	:DISPlay:WINDow[1]:ANNotation[:ALL] OFF ON 0 1 :DISPlay:WINDow[1]:ANNotation[:ALL]?
Example	:DISP:WIND:ANN OFF
Preset	On (Set by Restore Misc Defaults)
State Saved	Not saved in instrument state.
Backwards Compatibility Notes	The WINDow parameter and optional subopcode is included for backwards compatibility but ignored – all windows are equally affected.
Initial S/W Revision	Prior to A.02.00

## Themes

Accesses a menu of functions that enable you to choose the theme to be used when saving the screen image.

The **Themes** option is the same as the **Themes** option under the **Display** and **Page Setup** dialogs. It allows you to choose between themes to be used when saving the screen image.

<b>Key Path</b>	Save, Screen Image
<b>Remote Command</b>	:MMEMory:STORe:SCReen:THEMe TDColor   TDMonochrome   FCOLor   FMONochrome  :MMEMory:STORe:SCReen:THEMe?
<b>Example</b>	:MMEM:STOR:SCR:THEM TDM
<b>Preset</b>	3D Color; Is not part of Preset, but is reset by Restore Misc Defaults or Restore System Defaults All and survives subsequent running of the modes.
<b>Readback</b>	3D Color   3D Mono   Flat Color   Flat Mono
<b>Backwards Compatibility Notes</b>	In ESA and PSA we offer the choice of "Reverse Bitmap" or "Reverse Metafile" when saving screen images. This is much like the "Flat Color" theme available in X-Series. Also, if you selected Reverse Bitmap AND a black & white screen image, that would be much like "Flat Monochrome". In other words, each of the X-Series themes has a similar screen image type in ESA/PSA. But they are not identical.
<b>Initial S/W Revision</b>	Prior to A.02.00

### 3D Color

Selects a standard color theme with each object filled, shaded and colored as designed.

<b>Key Path</b>	Save, Screen Image, Themes
<b>Example</b>	MMEM:STOR:SCR:THEM TDC
<b>Readback</b>	3D Color
<b>Initial S/W Revision</b>	Prior to A.02.00

### 3D Monochrome

Selects a format that is like 3D color but shades of gray are used instead of colors.

<b>Key Path</b>	Save, Screen Image, Themes
<b>Example</b>	MMEM:STOR:SCR:THEM TDM
<b>Readback</b>	3D Mono
<b>Initial S/W Revision</b>	Prior to A.02.00

### Flat Color

Selects a format that is best when the screen is to be printed on an ink printer.

Key Path	Save, Screen Image, Themes
<b>Example</b>	MMEM:STOR:SCR:THEM FCOL
Readback	Flat Color
Initial S/W Revision	Prior to A.02.00

### Flat Monochrome

Selects a format that is like Flat Color. But only black is used (no colors, not even gray), and no fill.

Key Path	Save, Screen Image, Themes
<b>Example</b>	MMEM:STOR:SCR:THEM FMON
Readback	Flat Mono
Initial S/W Revision	Prior to A.02.00

### Backlight

Accesses the display backlight on/off keys. This setting may interact with settings under the Windows "Power" menu.

When the backlight is off, pressing ESC, TAB, SPACE, ENTER, UP, DOWN, LEFT, RIGHT, DEL, BKSP, CTRL, or ALT turns the backlight on without affecting the application. Pressing any other key will turn backlight on and could potentially perform the action as well.

Key Path	View/Display, Display, System Display Settings
<b>Remote Command</b>	:DISPlay:BACKlight ON OFF :DISPlay:BACKlight?
Preset	ON (Set by Restore Misc Defaults)
Initial S/W Revision	Prior to A.02.00

### Backlight Intensity

An active function used to set the backlight intensity. It goes from 0 to 100 where 100 is full on and 0 is off. This value is independent of the values set under the Backlight on/off key.

Key Path	View/Display, Display, System Display Settings
<b>Remote Command</b>	:DISPlay:BACKlight:INTensity <integer> :DISPlay:BACKlight:INTensity?
<b>Example</b>	DISP:BACK:INT 50



Preset	100 (Set by Restore Misc Defaults)
Min	0
Max	100
Initial S/W Revision	Prior to A.02.00

### I/Q Measured Polar Graph

Selects the Polar Graph view, and modifies the display settings of polar graph.

There are two windows, "Result Metrics Window" on page 1473 (left) and "I/Q Measured Polar Graph Window" on page 1474 (right).

**NOTE** In Polar Graph window, the blue points are data points, the white points are TPS points and the green points are pilot points.

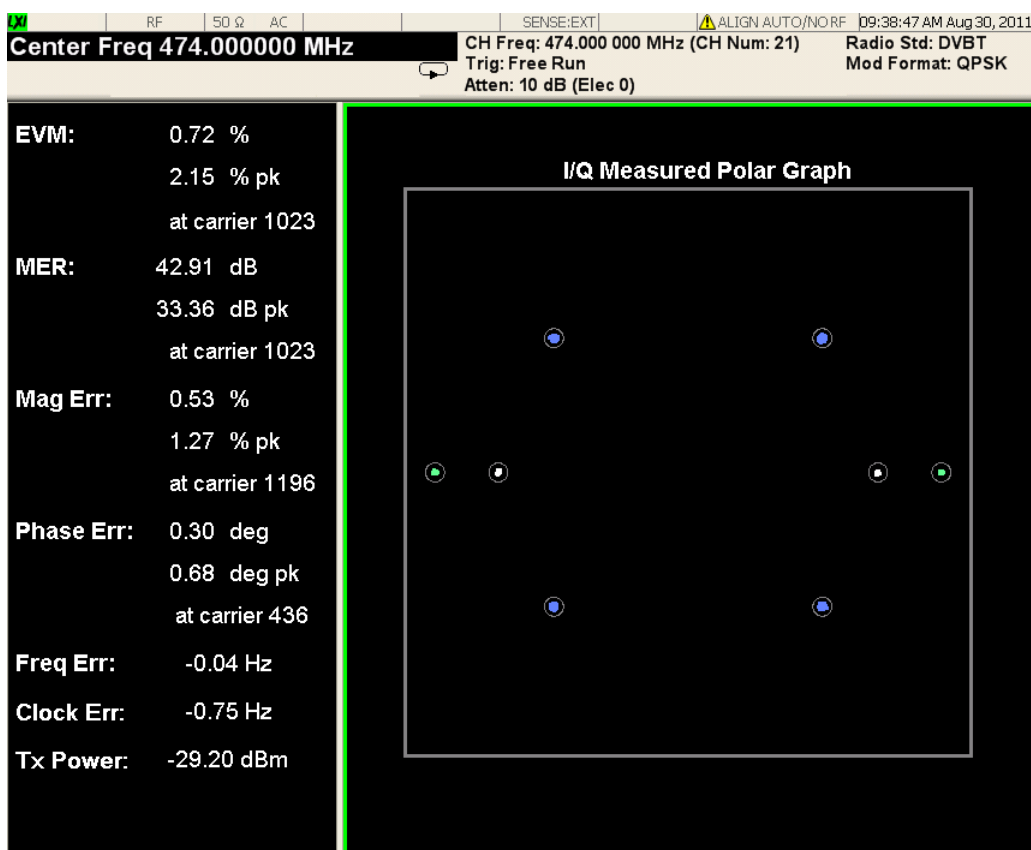

Figure 5 - 1 I/Q Measured Polar Graph View of Modulation Accuracy Measurement

### Result Metrics Window

Modulation Accuracy Result Metrics are listed in the following table.

Name	Corresponding Results	Format
RMS EVM	n=1 1st RMS EVM of the current symbols	99.99 % rms
Peak EVM	n=1 2nd Peak EVM of the current symbols	99.99 % pk
Peak EVM Position	n=1 3rd Sub-carrier number corresponding to the position of peak EVM is returned	at carrier (999)
RMS MER	n=1 4th RMS MER of the current symbols	99.99 dB rms
Peak MER	n=1 5th Peak MER of the current symbols	99.99 dB pk
Peak MER Position	n=1 6th Sub-carrier number corresponding to the position of peak MER is returned	at carrier (999)
RMS Mag Err	n=1 7th RMS magnitude error of the current symbols	99.99 % rms
Peak Mag Err	n=1 8th Peak magnitude error of the current symbols	99.99 % pk
Peak Mag Err Position	n=1 9th Sub-carrier number corresponding to the position of peak magnitude error is returned	at carrier (999)
RMS Phase Err	n=1 10th RMS phase error of the current symbols	99.99 deg rms
Peak Phase Err	n=1 11th Peak phase error of the current symbols	99.99 deg pk
Peak Phase Err Position	n=1 12th Sub-carrier number corresponding to the position of peak phase error is returned	at carrier (999)
Freq Err	n=1 13th Frequency error of the current symbols	99.99 Hz

### I/Q Measured Polar Graph Window

This window provides IQ polar graph.

Name	Corresponding Trace	Format
Constellation	The I/Q polar trace of measured input data. The length displayed is defined by I/Q Points.(n=2)	Constellation

Key Path	View/Display
<b>Example</b>	:DISPlay:EVM:VIEW POLar :DISPlay:EVM:VIEW?
Initial S/W Revision	A.02.00

## Start Carrier

Sets the start carrier number. The constellation points between the start carrier and the stop carrier will be displayed on I/Q Measured Polar Graph view.

You can view the constellation points only for pilot, TPS or data points by setting the start carrier number and stop carrier number.

Key Path	View/Display, I/Q Measured Polar Graph
Mode	DVB-T/H
<b>Remote Command</b>	:DISPlay:EVM:CARRier:STARt <integer> :DISPlay:EVM:CARRier:STARt?
<b>Example</b>	DISP:EVM:CARR:STAR 0 DISP:EVM:CARR:STAR?
Notes	Meaning of the numeric values: Number of start carrier on I/Q Measured Polar Graph.
Preset	0
State Saved	Saved in instrument state.
Min	0
Max	1704 in 2K mode, 3408 in 4K mode, 6816 in 8K mode.
Initial S/W Revision	A.02.00

## Stop Carrier

Sets the stop carrier number. The constellation points between the start carrier and the stop carrier will be displayed on I/Q Measured polar graph.

You can view the constellation points of only pilot, TPS or data points by setting the start carrier number and stop carrier number.

Key Path	View/Display, I/Q Measured Polar Graph
Mode	DVB-T/H
<b>Remote Command</b>	:DISPlay:EVM:CARRier:STOP <integer> :DISPlay:EVM:CARRier:STOP?
<b>Example</b>	DISP:EVM:CARR:STOP 1704 DISP:EVM:CARR:STOP?

Notes	Meaning of the numeric values: Number of stop carrier on I/Q Measured Polar Graph.
Couplings	The current value of this key is coupled with the value of FFT Size (Mode Setup, Demod) and the value of Start Carrier Number in the following way. When the value of FFT size is changed, the current value of this key will be changed to its max value. When the value of Start Carrier Number is set beyond the current value of this key, the value of Stop Carrier Number will be changed to its max value.
Preset	Max
State Saved	Saved in instrument state.
Min	Start Carrier
Max	1704 in 2K mode, 3408 in 4K mode, 6816 in 8K mode.
Initial S/W Revision	A.02.00

## I/Q Error

Selects the I/Q Error view.

There are four windows in this view:

- 1 "[MER/EVM vs. Sub-carrier/Frequency Window](#)" on page 1477 (top left)
- 2 "[Spectrum Window](#)" on page 1479 (top right)
- 3 "[I/Q Mismatch Polar Graph Window](#)" on page 1480 (bottom left)
- 4 "[Result Metrics Window](#)" on page 1480 (bottom right)

The Reference Value, Units per Division and Reference Position of X or Y-axis in the trace graph can be adjusted by selecting SPAN X Scale or AMPTD Y Scale.

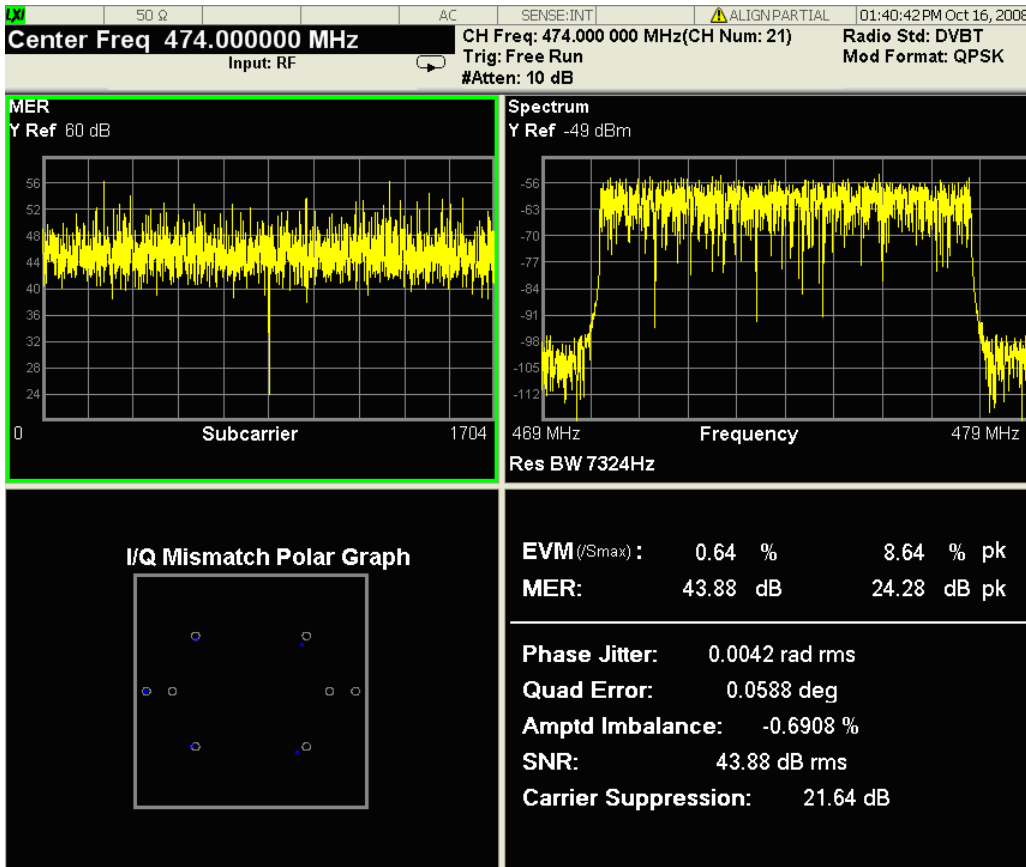

Figure 5 - 2 I/Q Error View of Modulation Accuracy Measurement

### MER/EVM vs. Sub-carrier/Frequency Window

This window provides MER/EVM vs. Sub-carrier/Frequency results. It comprises the MER/EVM value of each sub-carrier/frequency point in order to present a panorama of MER/EVM results. There are 1705 points in 2K mode, 3409 points in 4K mode and 6817 points in 8K mode.

<b>Marker Trace</b>	Yes
<b>Corresponding Trace</b>	MER/EVM vs. Sub-carrier/Frequency trace (n=3)

The top left window can be changed by Y Scale Type (AMPTD Y Scale) and X Scale Type (Span X Scale).

If Y Scale Type is set to MER and X Scale Type is set to Carrier,

12 Mod Accuracy Measurement  
View/Display

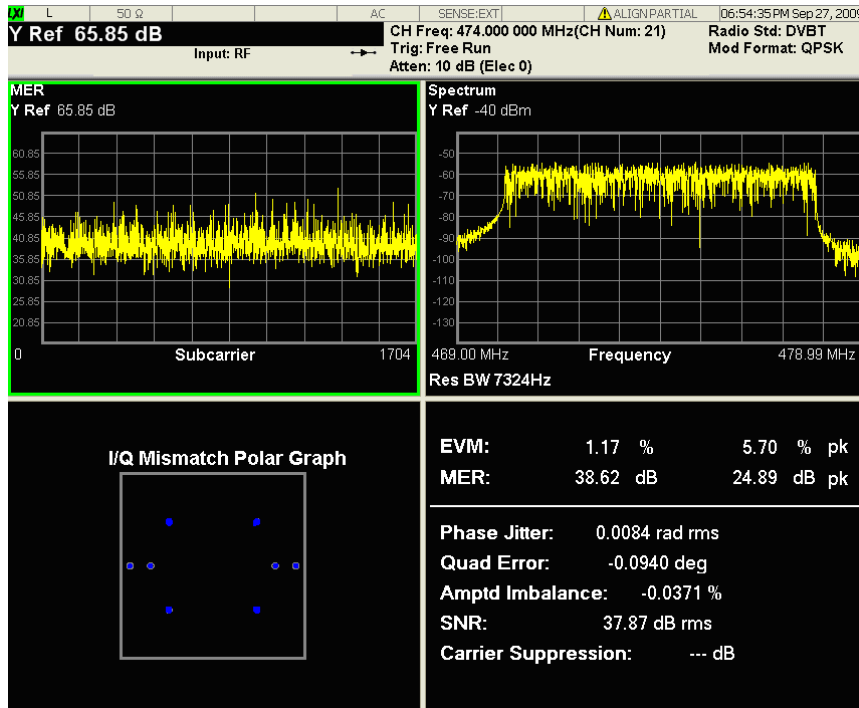

If Y Scale Type is set to EVM and X Scale Type is set to Carrier,

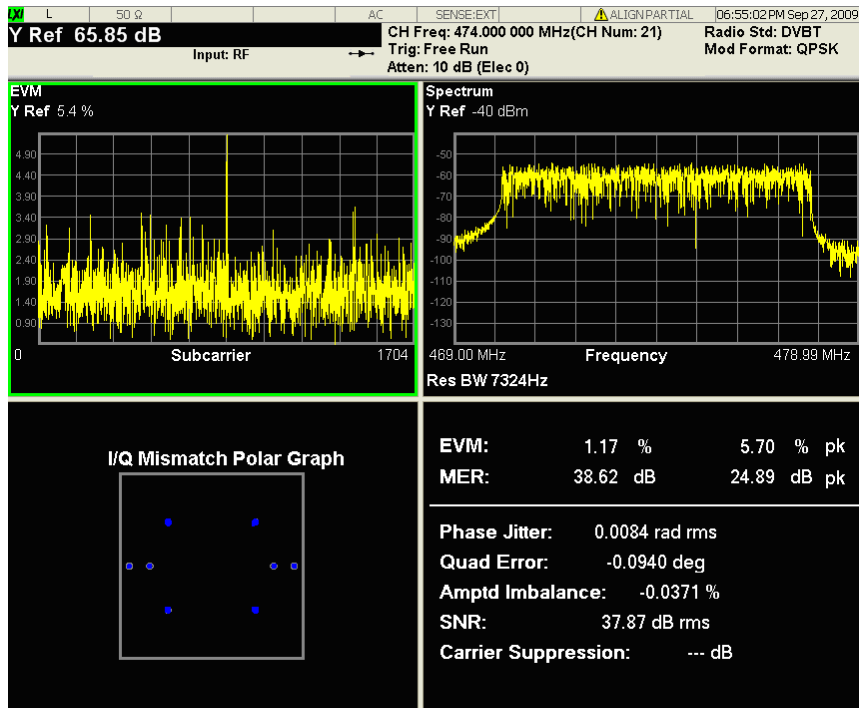

If Y Scale Type is set to MER and X Scale Type is set to Freq,

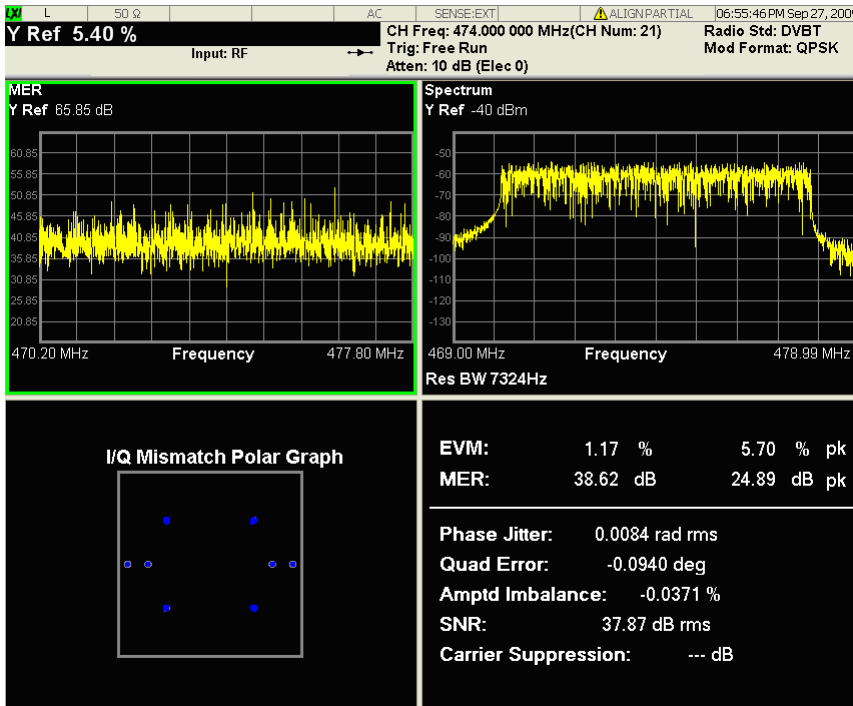

If Y Scale Type is set to EVM and X Scale Type is set to Freq,

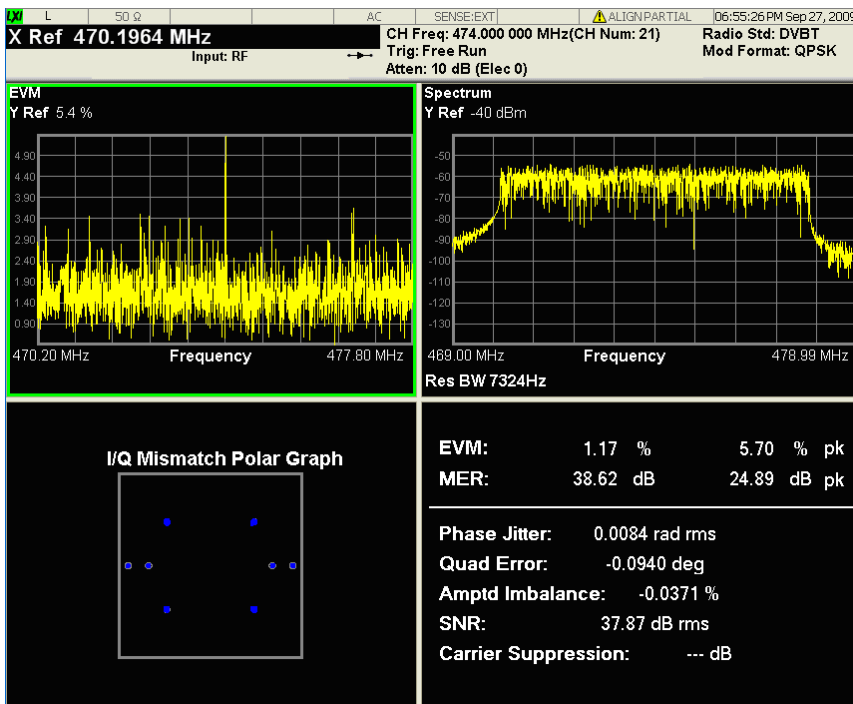

### Spectrum Window

This window provides Spectrum results. This spectrum graph is obtained using FFT rather than sweeping.

<b>Marker Trace</b>	Yes
<b>Corresponding Trace</b>	Spectrum trace (n=4)

### I/Q Mismatch Polar Graph Window

This window provides I/Q Mismatch Polar Graph. It is composed of the constellation points using in the estimation of AI & QE.

<b>Marker Trace</b>	Yes
<b>Corresponding Trace</b>	I/Q Mismatch Polar Graph

### Result Metrics Window

This window provides Modulation Accuracy result metrics.

<b>Name</b>	<b>Corresponding Results</b>	<b>Format</b>
RMS EVM	n=1 1st RMS EVM of the current symbols	99.99 %
Peak EVM	n=1 2nd Peak EVM of the current symbols	99.99 %
RMS MER	n=1 4th RMS MER of the current symbols	99.99 dB
Peak MER	n=1 5th Peak MER of the current symbols	99.99 dB
RMS Phase Jitter	n=1 14th RMS phase jitter of the current symbols	99.9999 rad rms
Quad Err	n=1 15th Quadrature error of the current symbols	99.9999 deg
Amptd Imbalance	n=1 16th Amplitude imbalance of the current symbols	99.9999 %
RMS SNR	n=1 17th RMS SNR of the current symbols	99.99 dB rms
Carrier Suppression	n=1 18th Carrier suppression of the current symbols	99.99 dB

<b>Key Path</b>	View/Display
<b>Example</b>	:DISPlay:EVM:VIEW IQERror :DISPlay:EVM:VIEW?
<b>Initial S/W Revision</b>	A.02.00



## Channel Frequency Response

Selects the channel frequency response view.

There are three windows in this view:

- 1 "Amplitude vs. Sub-carrier Window" on page 1481 (Top)
- 2 "Phase vs. Sub-carrier Window" on page 1482 (Center)
- 3 "Group delay vs. Sub-carrier Window" on page 1482 (Bottom)

The Reference Value, Units per Division and Reference Position of X or Y-axis in the trace graph can be adjusted by selecting SPAN X Scale or AMPTD Y Scale.

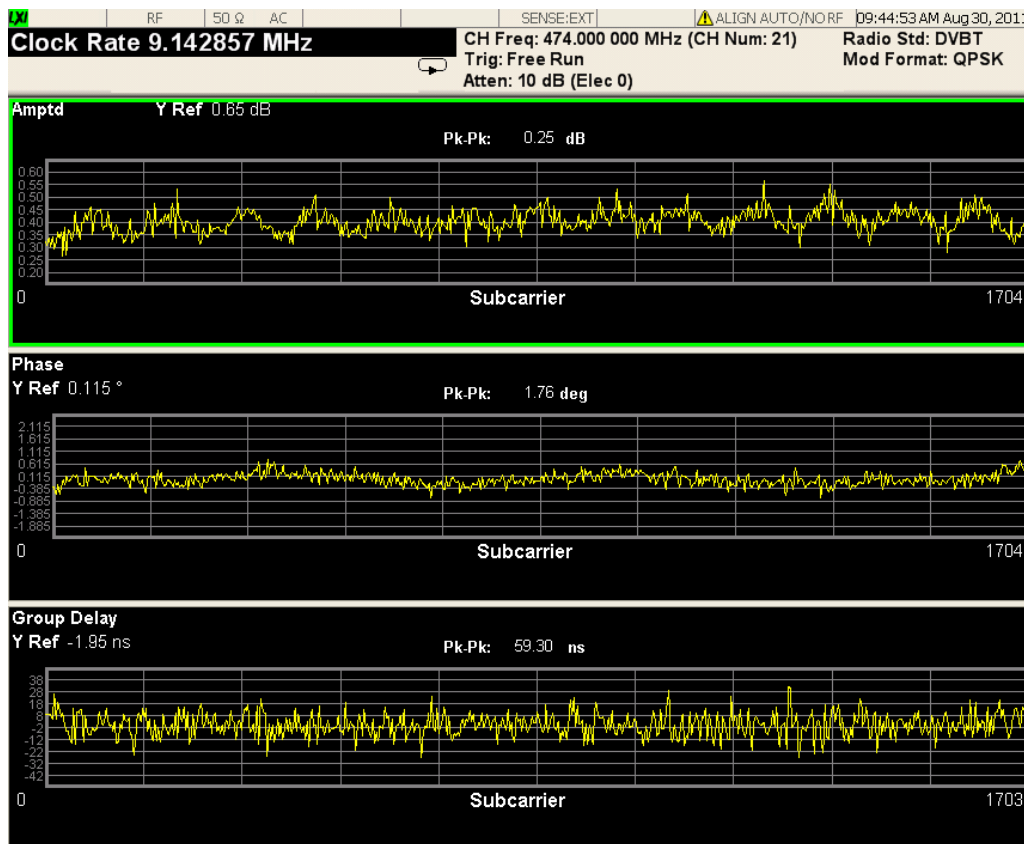

Figure 5 - 3 Channel Frequency Response View of Modulation Accuracy Measurement

### Amplitude vs. Sub-carrier Window

This window provides amplitude vs. sub-carrier results.

<b>Marker Trace</b>	Yes
<b>Corresponding Trace</b>	Amplitude vs. Sub-carrier trace (n=5).

## Phase vs. Sub-carrier Window

This window provides phase vs. sub-carrier results.

<b>Marker Trace</b>	Yes
<b>Corresponding Trace</b>	Phase vs. Sub-carrier trace (n=6).

## Group delay vs. Sub-carrier Window

This window provides group delay vs. sub-carrier results.

<b>Marker Trace</b>	Yes
<b>Corresponding Trace</b>	Group delay vs. Sub-carrier trace (n=7).

<b>Key Path</b>	View/Display
<b>Example</b>	:DISPlay:EVM:VIEW FREQuency :DISPlay:EVM:VIEW?
<b>Initial S/W Revision</b>	A.02.00

## Group Delay Aperture

Sets the value of group delay aperture which can affect the accuracy of the group delay measurement. Larger group delay aperture improves the accuracy of the measured group delay, increases the smoothing of the group delay trace, but decreases resolution.

Group delay aperture is defined as a percentage of the current frequency span. When group delay is calculated for a given point, the aperture is centered at that point. For example, the group delay for the 100 Hz may be calculated by measuring the phase change between 90 and 110 Hz.

<b>Key Path</b>	View/Display, Channel Frequency Response
<b>Mode</b>	DVB-T/H
<b>Remote Command</b>	:DISPlay:EVM:GDELay:APERture <real> :DISPlay:EVM:GDELay:APERture?
<b>Example</b>	DISP:EVM:GDEL:APER 10.0 DISP:EVM:GDEL:APER?
<b>Preset</b>	1.0
<b>State Saved</b>	No
<b>Min</b>	0.1
<b>Max</b>	50.0
<b>Backwards Compatibility SCPI</b>	:DISPlay:EVM:GD:APERture <real> :DISPlay:EVM:GD:APERture?
<b>Initial S/W Revision</b>	A.11.00

## Channel Impulse Response

Selects the channel impulse response view.

There are two windows, Peak Table (left) and "Amplitude vs. time window" on page 1483 (right). For more information about peak table, refer to "Peak Table" on page 1391.

The blue bar displayed on the Amplitude vs. time window is the GI range bar. For more information, refer to "GI Range Bar" on page 1484.

## Amplitude vs. time window

<b>Marker Trace</b>	Yes
<b>Corresponding Trace</b>	Amplitude vs. Time trace (n=8).

The Reference Value, Units per Division and Reference Position of X or Y-axis in this graph can be adjusted by selecting SPAN X Scale or AMPTD Y Scale. The X axis can be set to display the delay or the distance of the paths in the channel delay profile using the Scale Type key under SPAN X Scale panel.

If X Scale type is set to Time,

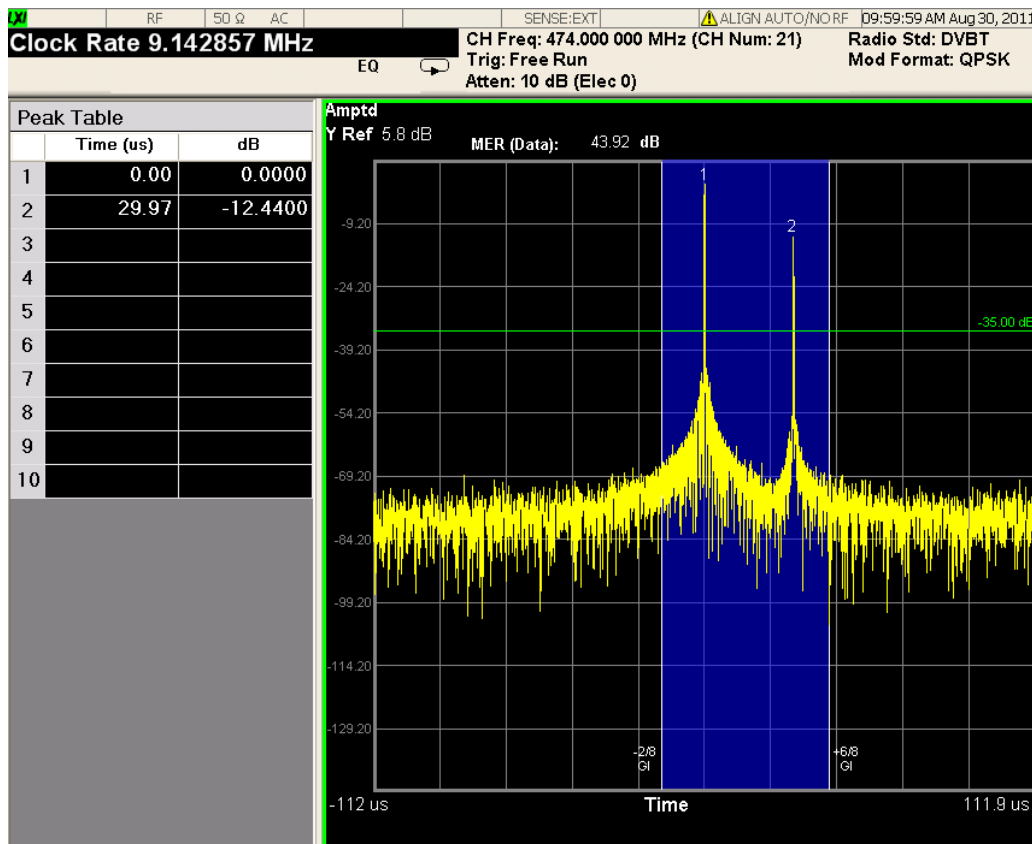

If X Scale Type is set to Distance,

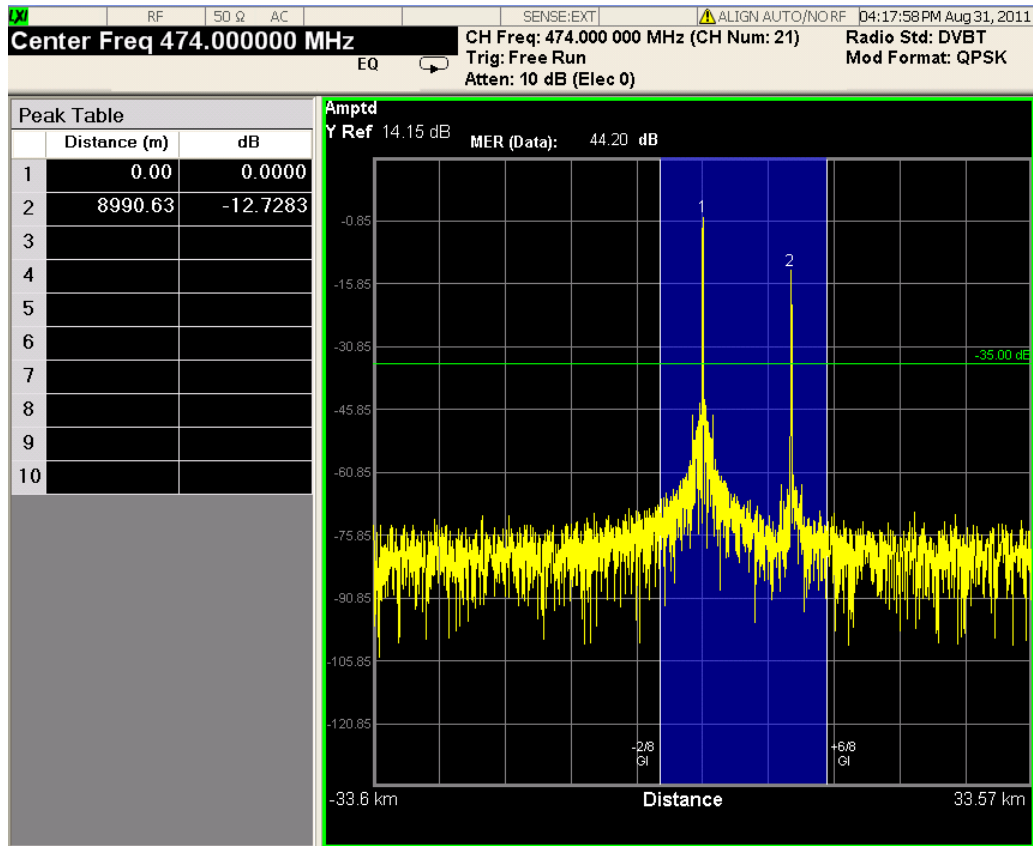

Figure 5 - 4 Channel Impulse Response View of Modulation Accuracy Measurement

Key Path	View/Display
Example	:DISPlay:EVM:VIEW IMPulse :DISPlay:EVM:VIEW?
Initial S/W Revision	A.02.00

### GI Range Bar

Turns the bar On and Off. If the value is On, there will be a bar with the range of GI displayed on Channel Impulse Response view.

The position of the GI range bar can be changed by the FFT Start Position (Meas Setup, Advanced, More). If all the paths are displayed within the GI range, that means there is no ISI (inter symbol interference) under the current settings.

Key Path	View/Display, Channel Impulse Response
Mode	DVB-T/H
Remote Command	:DISPlay:EVM:GIRBar [:STATe] OFF ON 0 1 :DISPlay:EVM:GIRBar [:STATe] ?

<b>Example</b>	DISP:EVM:GIRB OFF DISP:EVM:GIRB?
Preset	ON
State Saved	Saved in instrument state.
Range	On   Off
Initial S/W Revision	A.06.00

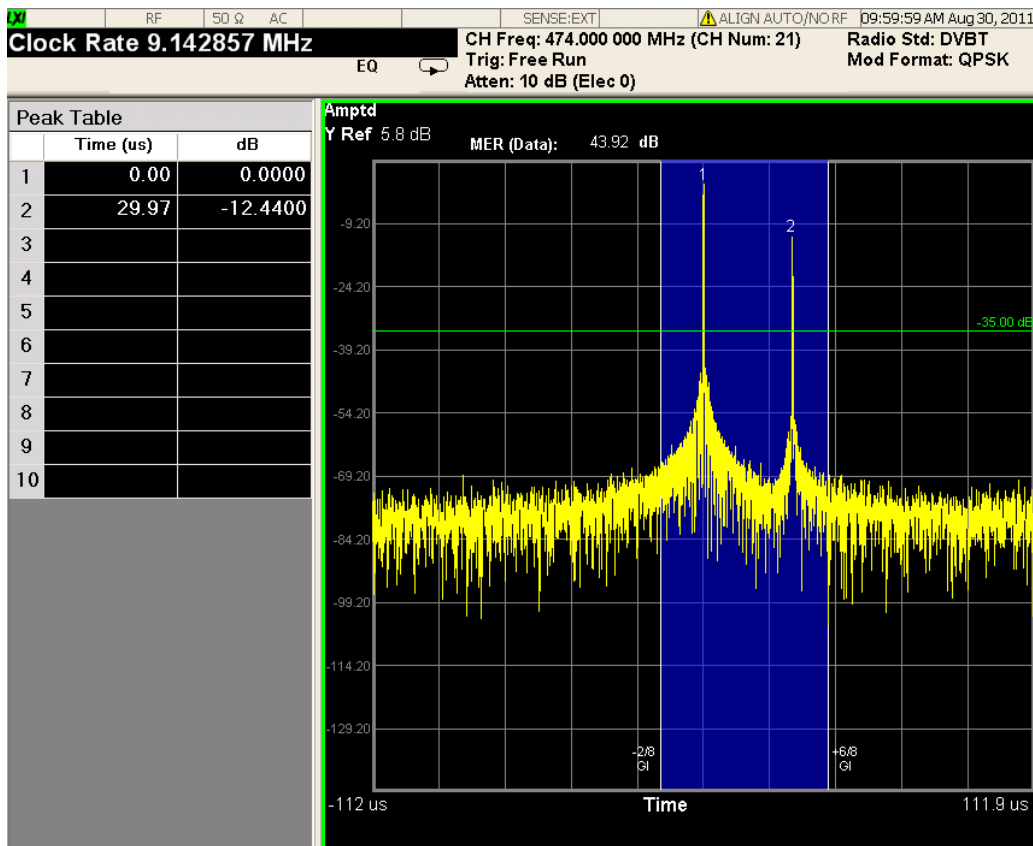

## TPS Decoding

Selects the TPS decoding view.

There is one window, TPS original bits and decoded information window, which shows the original TPS bits and the decoded information.

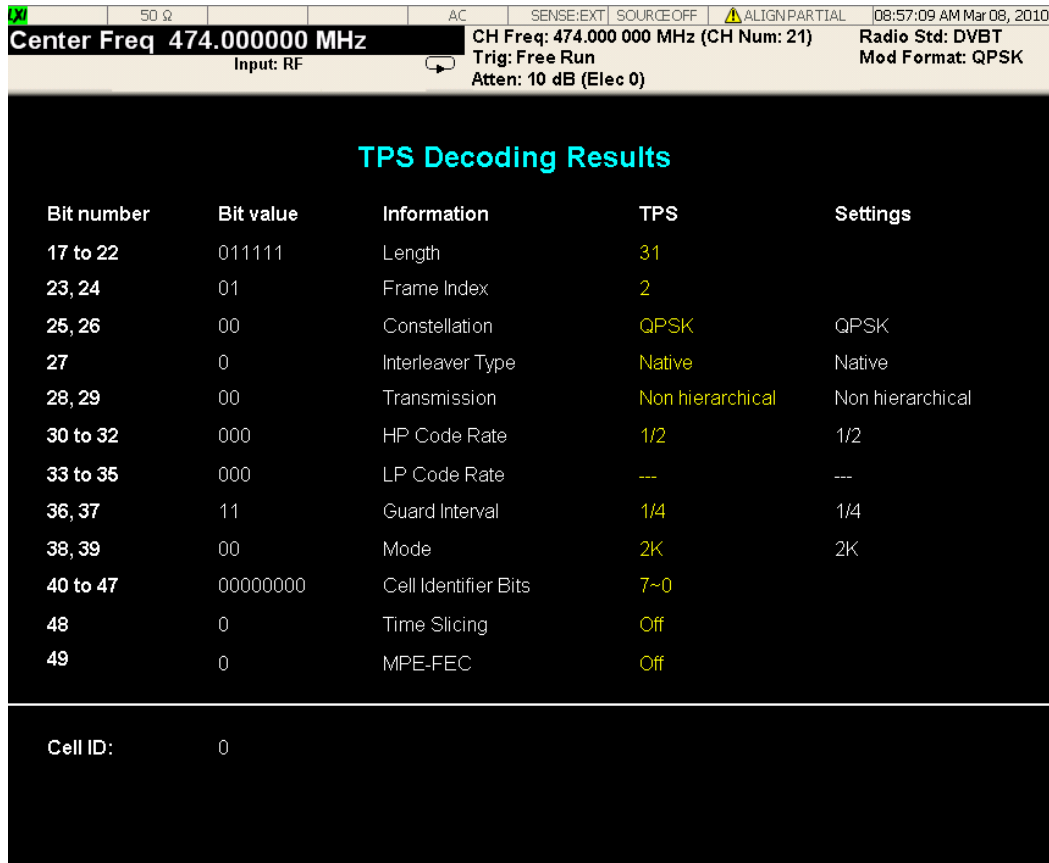

Figure 5 - 5 TPS Decoding View of Modulation Accuracy Measurement

Key Path	View/Display
<b>Example</b>	:DISPlay:EVM:VIEW TPS :DISPlay:EVM:VIEW?
Initial S/W Revision	A.02.00

## BER Results

Selects the BER results view.

There is one window, which shows the summary of BER results. It is displayed in the following way:

BER (Error Count / Total count).

HP stands for “High Priority” while LP stands for “Low Priority”.

For non-hierarchical transmission mode, there is only one set of results for each kind of BER which is displayed in HP field. For hierarchical, there are two sets of results for each kind of BER which are displayed separately in HP and LP field.

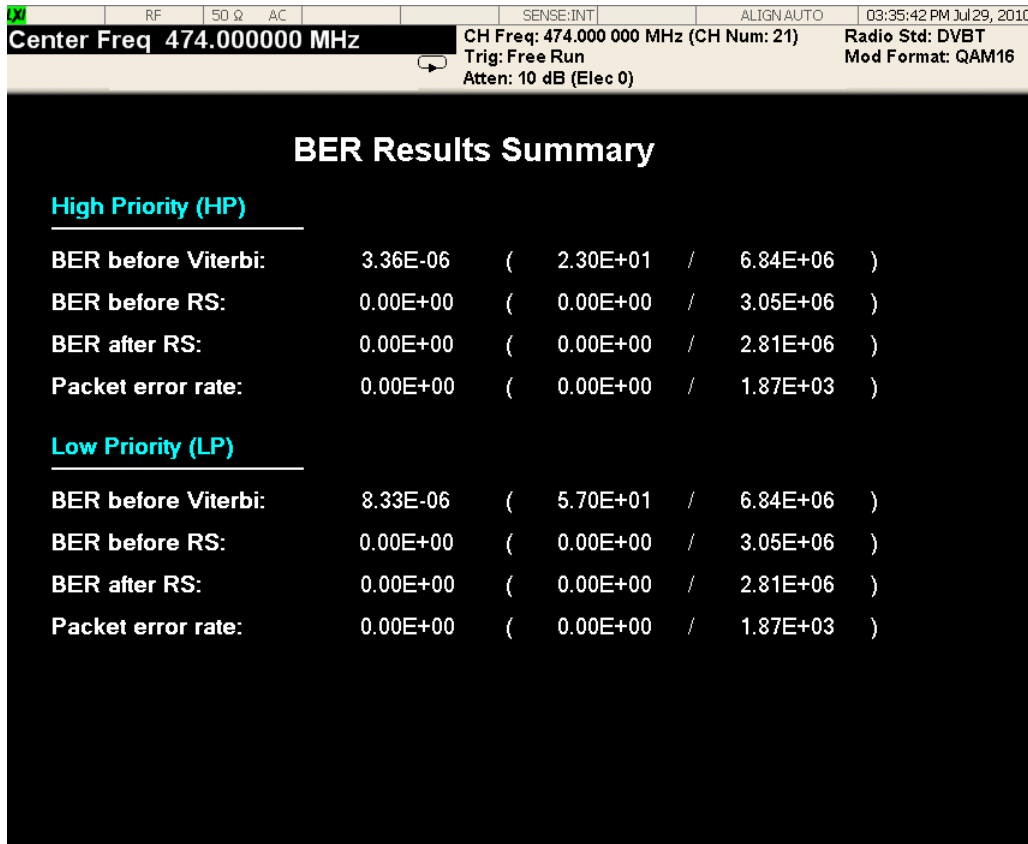

Figure 5 - 6 BER Results View of Modulation Accuracy Measurement

### BER Results Window

This window shows the BER results.

There are two methods to calculate BER related results. One is “In Service” (using data packet) and the other is “Out of Service” (using Null TS packet).

Name	Corresponding Results	Format
BER before Viterbi(HP)	n=1 21st BER before Viterbi of the high priority stream	9.99E9
Error count before Viterbi (HP)	n=1 22nd Error count before Viterbi of the high priority stream	9.99E9
Total count before Viterbi (HP)	n=1 23rd Total count before Viterbi of the high priority stream	9.99E9
BER before Viterbi	n=1 24th BER before Viterbi of the low priority stream	9.99E9
Error count	n=1 25th	9.99E9

Name	Corresponding Results	Format
before Viterbi	Error count before Viterbi of the low priority stream	
Total count before Viterbi	n=1 26th Total count before Viterbi of the low priority stream	9.99E9
BER before RS (HP)	n=1 27th BER before RS of the high priority stream	9.99E9
Error count before RS(HP)	n=1 28th Error count before RS of the high priority stream	9.99E9
Total count before RS(HP)	n=1 29th Total count before RS of the high priority stream	9.99E9
BER before RS	n=1 30th BER before RS of the low priority stream	9.99E9
Error count before RS	n=1 31st Error count before RS of the low priority stream	9.99E9
Total count before RS	n=1 32nd Total count before RS of the low priority stream	9.99E9
Error count after RS(HP)	n=1 33rd Error count after RS of the high priority stream	9.99E9
Error count after RS	n=1 34th Error count after RS of the low priority stream	9.99E9
Total count after RS (HP)	n=1 44th Total count after RS of the high priority stream.	9.99E9
BER after RS (HP)	n=1 45th BER after RS of the high priority stream.	9.99E9
Total count after RS	n=1 46th Total count after RS of the low priority stream.	9.99E9
BER after RS	n=1 47th BER after RS of the low priority stream.	9.99E9
Packet error count (HP)	n=1 48th Packet error count of the high priority stream.	9.99E9
Total packet count (HP)	n=1 49th Total packet count of the high priority stream.	9.99E9
Packet error rate (HP)	n=1 50th Packet error rate of the high priority stream.	9.99E9
Packet error count	n=1 51st Packet error count of the low priority stream.	9.99E9
Total packet count	n=1 52nd Total packet count of the low priority stream.	9.99E9
Packet error rate	n=1 53rd Packet error rate of the low priority stream.	9.99E9



Key Path	View/Display
<b>Example</b>	:DISPlay:EVM:VIEW BER :DISPlay:EVM:VIEW?
Initial S/W Revision	A.02.00

## MER Monitor

Selects the MER Monitor view.

MER monitor is used to monitor the MER performance for a specific period of time, which can be up to several hours or several days. All the setup parameters are under Meas Setup, More, MER Monitor panel.

### 1. Display

The MER results are displayed on the graph sequentially. The maximum number of the displayed points are controlled by the Display Points (Meas Setup, MER Monitor). If the actual points exceed this value (2000 for example), only the most recent 2000 points are displayed on the graph. That is to say, if the number of points reaches 2001 when the maximum number of displayed points has been set to 2000, point 1 will be discarded.

There is a green line displayed on the graph if the Limit Line (Meas Setup, MER Monitor) is turned on.

When the Monitor Time (Meas Setup, MER Monitor) is arrived, there will be a message displayed on the MSG line

### 2. Record raw data

If Limit Line (Meas Setup, MER Monitor) is turned on and the current MER result is smaller than the limit, raw data will be saved to "D:\userdata\DVB-TH\rawdata", which can be used by Capture Buffer of X-Series Signal Analyzer for further research directly.

The recording file name is "dataIndex\_HourMinuteSecond.bin" (Index is the sequence number of the files saved in one monitoring process.), such as "data2\_155636.bin".

The maximum number of files that can be saved is controlled by Max Raw Data Files Saved (Meas Setup, MER Monitor). If the failed points exceed this number, raw data will no longer be saved. A message (File Number exceeds MaxRawDataFileSaved. Raw Data are not saved) will be displayed after the MER result in the Log file.

### 3. Log file

Date time, MER results and the rawdata file path (if MER is below the limit) will be saved in a log file named "MER\_log\_DVB\_TH.txt" in "D:\userdata\DVB-TH."

The format of this file is listed below.

```
-----
Starting Time:   9/8/2009 15:55:41
MER Limit:   35.0 dB
Monitor Time:   0.1 hour
MER Unit:   dB
```

9/8/2009 15:55:41 39.5200086295896  
9/8/2009 15:55:41 38.6605823043697

.....

9/8/2009 15:56:36 34.0759440002693 D:\userdata\DVB-TH\rawdata\data2\_155636.bin  
... ..9/8/2009 15:59:56 34.4563081204352 File Number exceeds MaxRawDataFileSaved. Raw  
Data are not saved.

.....

Total Time: 0 d 0 h 6 m 0 s

Total Points: 2236

Failed Points: 6

Failed Percentage (%): 0.268336314847942

-----

There is one window, "Amplitude vs. time window" on page 1483, which shows the MER vs. time results.

### MER vs. time window

<b>Marker Trace</b>	Yes
<b>Corresponding Trace</b>	MER vs. Time trace

The Reference Value, Units per Division and Reference Position of X or Y-axis in this graph can be adjusted by setting SPAN X Scale or AMPTD Y Scale.

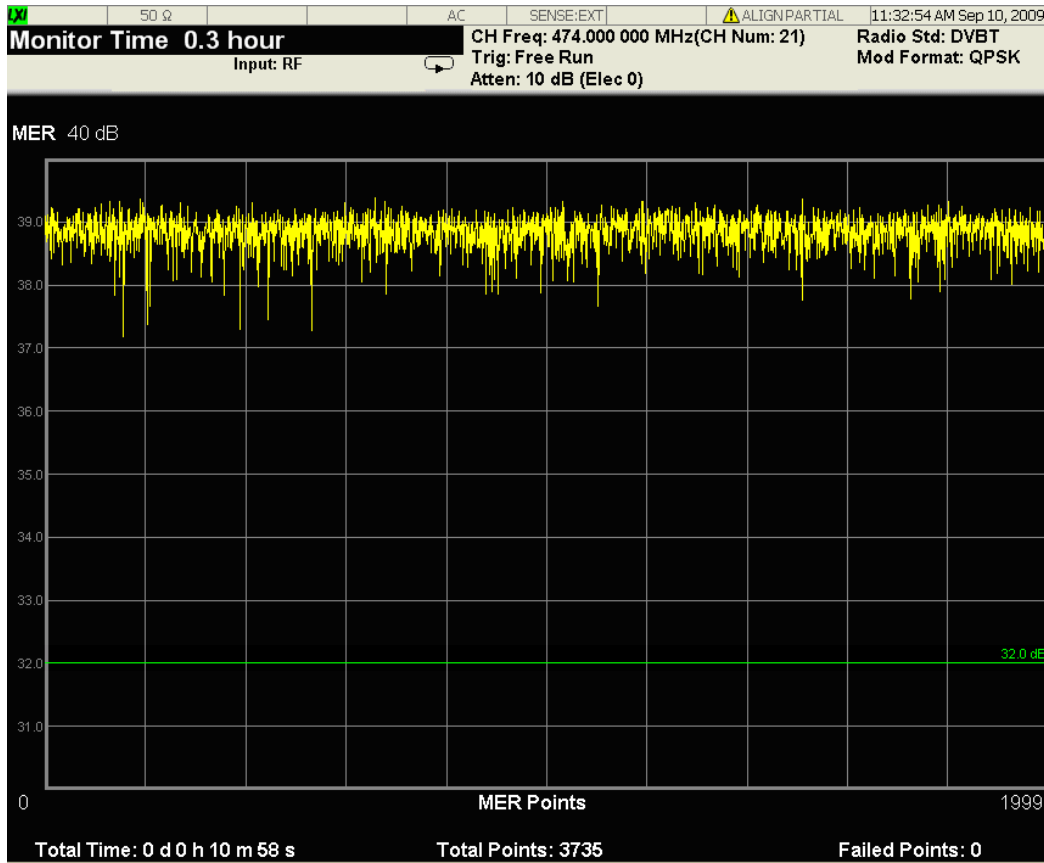

Key Path	View/Display
Example	:DISPlay:EVM:VIEW MERMonitor :DISPlay:EVM:VIEW?
Initial S/W Revision	A.06.00

## Result Metrics

Selects the result metrics view.

There is one window, "[Result Metrics Summary Window](#)" on page 1492, which shows the summary of modulation accuracy result metrics.

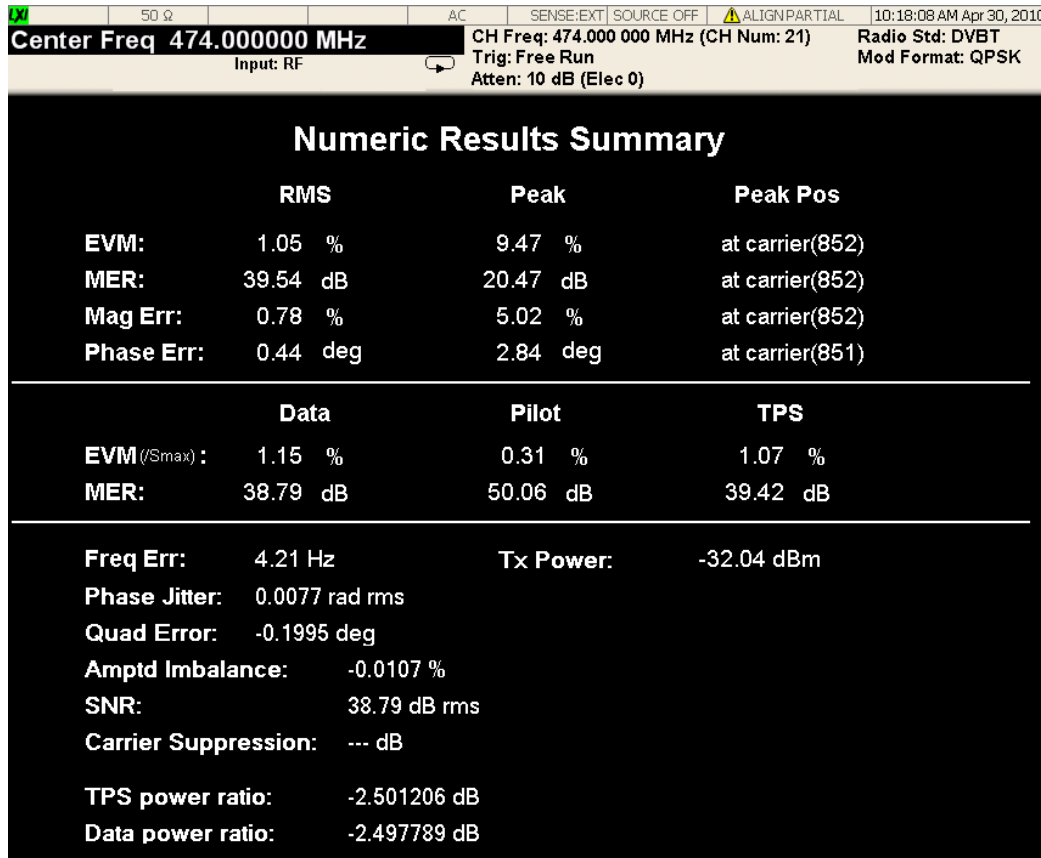

Figure 5 - 7 Result Metrics View of Modulation Accuracy Measurement

### Result Metrics Summary Window

This window shows the results summary.

Name	Corresponding Results	Format
RMS EVM	n=1 1st RMS EVM of the current symbols	99.99 %
Peak EVM	n=1 2nd Peak EVM of the current symbols	99.99 %
Peak EVM Position	n=1 3rd Sub-carrier number corresponding to the position of peak EVM is returned	at carrier (999)
RMS MER	n=1, 4th RMS MER of the current symbols	99.99 dB
Peak MER	n=1 5th Peak MER of the current symbols	99.99 dB
Peak MER Position	n=1 6th Sub-carrier number corresponding to the position of peak MER is returned	at carrier (999)

Name	Corresponding Results	Format
RMS Mag Err	n=1 7th RMS magnitude error of the current symbols	99.99 %
Peak Mag Err	n=1 8th Peak magnitude error of the current symbols	99.99 %
Peak Mag Err Position	n=1 9th Sub-carrier number corresponding to the position of peak magnitude error is returned	at carrier (999)
RMS Phase Err	n=1 10th RMS phase error of the current symbols	99.99 deg
Peak Phase Err	n=1 11th Peak phase error of the current symbols	99.99 deg
Peak Phase Err Position	n=1 12th Sub-carrier number corresponding to the position of peak phase error is returned	at carrier (999)
Freq Err	n=1 13th Frequency error of the current symbols	99.99 Hz
RMS Phase Jitter	n=1 14th RMS phase jitter of the current symbols	99.9999 rad rms
Quad Err	n=1 15th Quadrature error of the current symbols	99.9999 deg
Amptd Imbalance	n=1 16th Amplitude imbalance of the current symbols	99.9999%
RMS SNR	n=1 17th RMS SNR of the current symbols	99.99 dB rms
Carrier Suppression	n=1 18th Carrier suppression of the current symbols	99.99 dB
TPS power ratio	n=1 19th TPS power ratio of the current symbols	99.999999 dB
Data power ratio	n=1 20th Data power ratio of the current symbols	99.999999 dB
RMS Data EVM	n=1 35th RMS EVM of data carriers in certain symbols	99.99 %
RMS Pilot EVM	n=1 36th RMS EVM of pilot carriers in certain symbols	99.99 %
RMS TPS EVM	n=1 37th RMS EVM of TPS carriers in certain symbols	99.99 %
RMS Data MER	n=1 38th RMS MER of data carriers in certain symbols	99.99 dB

Name	Corresponding Results	Format
RMS Pilot MER	n=1 39th RMS MER of pilot carriers in certain symbols	99.99 dB
RMS TPS MER	n=1 40th RMS MER of TPS carriers in certain symbols	99.99 dB
Tx Power	n=1 41st Tx power	99.99 dBm

Key Path	View/Display
<b>Example</b>	:DISPlay:EVM:VIEW NRESults :DISPlay:EVM:VIEW?
Initial S/W Revision	A.02.00

### View Selection by number (Remote Command SCPI only)

Selects the desired measurement view by number.

Key Path	SCPI only
Mode	DVB-T/H
<b>Remote Command</b>	:DISPlay:EVM:VIEW:NSElect <integer> :DISPlay:EVM:VIEW:NSElect?
<b>Example</b>	DISP:EVM:VIEW:NSEL 0 DISP:EVM:VIEW:NSEL?
Notes	Meaning of the numeric values: 0: I/Q Measured Polar Graph View 1: I/Q Error View 2: Channel Frequency Response View 3: Channel Impulse Response View 4: TPS Decoding View 5. BER Results View 6. MER Monitor View 7. Result Metrics View
Preset	0
State Saved	Saved in instrument state.
Min	0
Max	7
Initial S/W Revision	A.02.00

## 13 DVB-T2 Mod Accuracy Measurement

The DVB-T2 Modulation Accuracy measurement measures the modulation accuracy of DVB-T2 signals. Various parameters that measure the quality of modulation are reported. For more details, see ["DVB-T2 Mod Accuracy Measurement Description "](#) on page 1503.

This topic contains the following sections:

["Measurement Commands for DVB-T2 Mod Accuracy "](#) on page 1496

["Remote Command Results for DVB-T2 Mod Accuracy Measurement"](#) on page 1497

## Measurement Commands for DVB-T2 Mod Accuracy

The general functionality of CONFigure, FETCh, INITiate, MEASure, and READ are described at this section.

CONFigure:EVMtwo

CONFigure:EVMtwo:NDEFault

FETCh:EVMtwo[n]?

INITiate:EVMtwo

MEASure:EVMtwo[n]?

READ:EVMtwo[n]?

For more measurement related commands, see the SENSE subsystem and the section "[Remote Measurement Functions](#)" on page 2165.



## Remote Command Results for DVB-T2 Mod Accuracy Measurement

For each result, the following heading is used to represent its format and precision.

#.Result Name (type of number) [unit] <explanation>

Types of numbers include double, float and integer.

Index: n	Results Returned
0	<p>I/Q Capture Data Trace (float) [volt] &lt;2 * (duration of P1 + duration of P2 + duration of data symbol * num of data symbols) * sample rate&gt;</p> <p>Returns unprocessed I/Q trace data of Capture Interval, as a series of trace point values, in volts. The I values are listed first in each pair, using the 0 through even-indexed values. The Q values are the odd-indexed values. The sample rate is 15 MHz in this measurement.</p> <p>If no data is captured, one NaN will be returned.</p>
1 (or not specified)	<p>Returns the following 49 comma-separated scalar results, in the following order:</p> <ol style="list-style-type: none"> <li>1. EVM (Average) (double) [%] Averaged EVM (in average cycle) in certain symbols.</li> <li>2. Peak EVM (double) [% pk] Peak EVM value in certain symbols.</li> <li>3. Position of Peak EVM – Sub-carrier Number (int) [NA] Sub-carrier number corresponding to the position of peak EVM is returned.</li> <li>4. MER (Average) (double) [dB] Averaged MER (in average cycle) in certain symbols.</li> <li>5. Peak MER (double) [dB pk] Peak MER value in certain symbols.</li> <li>6. Position of Peak MER – Sub-carrier Number (int) [NA] Sub-carrier number corresponding to the position of peak MER is returned.</li> <li>7. Mag Error (Average) (double) [%] Averaged magnitude error (in average cycle) in certain symbols.</li> <li>8. Peak Mag Error (double) [% pk] Peak magnitude error in certain symbols.</li> <li>9. Position of Peak Mag Error – Sub-carrier Number (int) [NA] Sub-carrier number corresponding to the position of peak magnitude error is returned.</li> <li>10. Phase Error (Average) (double) [°] Averaged phase error (in average cycle) in certain symbols.</li> <li>11. Peak Phase Error (double) [°] Peak phase error in certain symbols.</li> <li>12. Position of Peak Phase Error – Sub-carrier Number (int) [NA] Sub-carrier number corresponding to the position of peak phase error is returned.</li> <li>13. Freq Err (Average) (double) [Hz] Averaged frequency error (in average cycle) in certain symbols.</li> <li>14. Quad Err (Average) (double) [deg]</li> </ol>

Index: n	Results Returned
	Averaged quadrature error (in average cycle) in certain symbols.
15.	Amptd Imbalance (Average) (double) [dB] Averaged (in average cycle) amplitude imbalance of I and Q signal in dB.
16.	Data MER (Average) (double) [dB] Averaged MER (in average cycle) of data carriers in certain symbols.
17.	L1-pre MER (Average) (double) [dB] Averaged MER (in average cycle) of L1-pre carriers in certain symbols.
18.	L1-post MER (Average) (double) [dB] Averaged MER (in average cycle) of L1-post carriers in certain symbols.
19.	P2 Pilot MER (Average) (double) [dB] Averaged MER (in average cycle) of P2 pilot carriers in certain symbols.
20.	Continued Pilot MER (Average) (double) [dB] Averaged MER (in average cycle) of continued pilot carriers in certain symbols.
21.	Scattered Pilot MER (Average) (double) [dB] Averaged MER (in average cycle) of scattered pilot carriers in certain symbols.
22.	Frame-closing Pilot MER (Average) (double) [dB] Averaged MER (in average cycle) of frame-closing pilot carriers in certain symbols. “---“ is returned when there are no frame-closing pilot symbols in the current signal.
23.	Data EVM (Average) (double) [%] Averaged EVM (in average cycle) of data carriers in certain symbols.
24.	L1-pre EVM (Average) (double) [%] Averaged EVM (in average cycle) of L1-pre carriers in certain symbols.
25.	L1-post EVM (Average) (double) [%] Averaged EVM (in average cycle) of L1-post carriers in certain symbols.
26.	P2 Pilot EVM (Average) (double) [%] Averaged EVM (in average cycle) of P2 pilot carriers in certain symbols.
27.	Continued Pilot EVM (Average) (double) [%] Averaged EVM (in average cycle) of continued pilot carriers in certain symbols.
28.	Scattered Pilot EVM (Average) (double) [%] Averaged EVM (in average cycle) of scattered pilot carriers in certain symbols.
29.	Frame-closing Pilot EVM (Average) (double) [%] Averaged EVM (in average cycle) of frame-closing pilot carriers in certain symbols. “---“ is returned when there are no frame-closing pilot symbols in the current signal.
30.	Tx Power (Average) (double) [dBm] Averaged transmitted signal power.
31.	Timing Skew (Average) (double) [us] Averaged (in average cycle) timing skew of the current symbols.
32.	Trigger Difference (Average) (double) [us] Averaged (in average cycle) Trigger Difference of the current symbols.
33.	Clock Err (Average) (double) [Hz]

Index: n	Results Returned
	<p>Averaged (in average cycle) clock error of the current symbols.</p> <p>34. BER before LDPC (exponential) [NA] BER before LDPC.</p> <p>35. Error count before LDPC (exponential) [NA] Error count before LDPC.</p> <p>36. Total count before LDPC (exponential) [NA] Total count before LDPC.</p> <p>37. BER before BCH (exponential) [NA] BER before BCH.</p> <p>38. Error count before BCH (exponential) [NA] Error count before BCH.</p> <p>39. Total count before BCH (exponential) [NA] Total count before BCH.</p> <p>40. BER after BCH (exponential) [NA] BER after BCH.</p> <p>41. Error count after BCH (exponential) [NA] Error count after BCH.</p> <p>42. Total count after BCH (exponential) [NA] Total count after BCH.</p> <p>43. Packet error rate (exponential) [NA] Packet error rate.</p> <p>44. Packet error count (exponential) [NA] Error packet count.</p> <p>45. Total packet count (exponential) [NA] Total packet count.</p> <p>46. Average LDPC Iteration Number (double) [NA] Averaged LDPC iteration number.</p> <p>47. Current LDPC Iteration Number (double) [NA] Current LDPC iteration number.</p> <p>48. Max LDPC Iteration Number (double) [NA] Max LDPC iteration number.</p> <p>49. Min LDPC Iteration Number (double) [NA] Min LDPC iteration number.</p>
2	<p>I/Q Measured Polar Data Trace (float) [volt] &lt;2 * number of carriers * 5&gt; Returns normalized I/Q trace data of captured symbols, as a series of trace point values, in volts. The I values are listed first in each pair, using the 0 through even-indexed values. The Q values are the odd-indexed values.</p>
3	<p>MER vs. Sub-carrier (double) [dB] &lt;853/1705/3409/6817(6913)/13633(13921)/27265(27841)&gt; Returns MER vs. Sub-carrier data, as a series of comma-separated trace points. The result is a series of floating point numbers. There are 853 sub-carriers in 1K mode, 1705 sub-carriers in 2K mode, 3409 sub-carriers in 4k mode, 6817</p>

Index: n	Results Returned
	(normal carrier mode) / 6913 (extended carrier mode) sub-carriers in 8K mode, 13633 (normal carrier mode) / 13921 (extended carrier mode) sub-carriers in 16K mode and 27265 (normal carrier mode) / 27841 (extended carrier mode) sub-carriers in 32K mode.
4	<p>EVM vs. Sub-carrier (double) [%] &lt;853/1705/3409/6817(6913)/13633(13921)/27265(27841)&gt;</p> <p>Returns EVM vs. Sub-carrier data, as a series of comma-separated trace points. The result is a series of floating point numbers.</p> <p>There are 853 sub-carriers in 1K mode, 1705 sub-carriers in 2K mode, 3409 sub-carriers in 4k mode, 6817 (normal carrier mode) / 6913 (extended carrier mode) sub-carriers in 8K mode, 13633 (normal carrier mode) / 13921 (extended carrier mode) sub-carriers in 16K mode and 27265 (normal carrier mode) / 27841 (extended carrier mode) sub-carriers in 32K mode.</p>
5	<p>Amptd vs. Sub-carrier (double) [dB] &lt;853/1705/3409/6817(6913)/13633(13921)/27265(27841)&gt;</p> <p>Returns amplitude vs. sub-carrier data, as a series of comma-separated trace points. The result is a series of floating point numbers.</p> <p>There are 853 sub-carriers in 1K mode, 1705 sub-carriers in 2K mode, 3409 sub-carriers in 4k mode, 6817 (normal carrier mode) / 6913 (extended carrier mode) sub-carriers in 8K mode, 13633 (normal carrier mode) / 13921 (extended carrier mode) sub-carriers in 16K mode and 27265 (normal carrier mode) / 27841 (extended carrier mode) sub-carriers in 32K mode.</p>
6	<p>Phase vs. Sub-carrier (double) [°] &lt;853/1705/3409/6817(6913)/13633(13921)/27265(27841)&gt;</p> <p>Returns phase vs. sub-carrier data, as a series of comma-separated trace points. The result is a series of floating point numbers.</p> <p>There are 853 sub-carriers in 1K mode, 1705 sub-carriers in 2K mode, 3409 sub-carriers in 4k mode, 6817 (normal carrier mode) / 6913 (extended carrier mode) sub-carriers in 8K mode, 13633 (normal carrier mode) / 13921 (extended carrier mode) sub-carriers in 16K mode and 27265 (normal carrier mode) / 27841 (extended carrier mode) sub-carriers in 32K mode.</p>
7	<p>Group Delay vs. Sub-carrier (double) [us] &lt;852/1704/3408/6816(6912)/13632(13920)/27264(27840)&gt;</p> <p>Returns group delay vs. sub-carrier data, as a series of comma-separated trace points. The result is a series of floating point numbers.</p> <p>There are 852 sub-carriers in 1K mode, 1704 sub-carriers in 2K mode, 3408 sub-carriers in 4k mode, 6816 (normal carrier mode) / 6912 (extended carrier mode) sub-carriers in 8K mode, 13632 (normal carrier mode) / 13920 (extended carrier mode) sub-carriers in 16K mode and 27264 (normal carrier mode) / 27840 (extended carrier mode) sub-carriers in 32K mode.</p>
8	<p>Amptd vs. Time (double) [dB] &lt;1024/2048/4096/8192/16384/32768&gt;</p> <p>Returns amplitude vs. time data, as a series of comma-separated trace points. The result is a series of floating point numbers.</p> <p>There are 1024 points in 1k mode, 2048 points in 2K mode, 4096 points in 4K mode, 8192 points in 8K mode, 16384 points in 16K mode and 32768 points in 32K mode.</p>
9	<p>MER vs. Time (double) [dB] &lt; 0 ~ Display Points - 1 &gt;</p> <p>Returns MER results displayed on MER monitor view during the monitor time, as a series of comma-separated trace points.</p>
10	<p>Data EVM vs. PLP (Average) (double) [%] &lt;PLP Number&gt;</p> <p>Averaged data EVM (in average cycle) vs. PLP.</p>
11	<p>Data MER vs. PLP (Average) (double) [dB] &lt;PLP Number&gt;</p> <p>Averaged data MER (in average cycle) vs. PLP.</p>

Index: n	Results Returned
12	Data Mag Error vs. PLP (Average) (double) [%] <PLP Number> Averaged data magnitude error (in average cycle) vs. PLP.
13	Data Phase Error vs. PLP (Average) (double) [°] <PLP Number> Averaged data phase error (in average cycle) vs. PLP.
14	Peak Data EVM vs. PLP (double) [% pk] <PLP Number> Peak data EVM vs. PLP.
15	Peak Data MER vs. PLP (double) [dB pk] <PLP Number> Peak data MER of vs. PLP.
16	Peak Data Mag Error vs. PLP (double) [% pk] <PLP Number> Peak data magnitude error vs. PLP.
17	Peak Data Phase Error vs. PLP (double) [° pk] <PLP Number> Peak data phase error vs. PLP.
18	Accumulated Data MER vs. PLP (double) [dB] <PLP Number> Averaged data MER (calculated using the MER results of a certain PLP in the frames that contains the PLP) vs. PLP.
19	Accumulated Peak Data MER vs. PLP (double) [dB] <PLP Number> The peak data MER value (the peak MER of a certain PLP in the frames that contain this PLP) vs. PLP.
20	Accumulated Frame Number vs. PLP (int) <PLP Number> The number of frames that contain the PLP.
21	L1-pre Signalling Bits (float) All L1-pre signalling bits.
22	L1-post Signalling Bits (float) All L1-post signalling bits.
23	Reference Amptd vs. Sub-carrier (double) [dB] Returns reference amplitude vs. sub-carrier data, as a series of comma-separated trace points. The result is a series of floating point numbers.
24	Current Amptd vs. Sub-carrier (double) [dB] Returns current amplitude vs. sub-carrier data, as a series of comma-separated trace points. The result is a series of floating point numbers.
25	Reference Amptd vs. Sub-carrier of Tx2 when using Tx1+Tx2 as MISO Test Setup (double) [dB] Returns reference Tx2 amplitude vs. sub-carrier data when using Tx1+Tx2 as MISO Test Setup, as a series of comma-separated trace points. The result is a series of floating point numbers.
26	Current Amptd vs. Sub-carrier of Tx2 when using Tx1+Tx2 as MISO Test Setup (double) [dB] Returns current Tx2 amplitude vs. sub-carrier data when using Tx1+Tx2 as MISO Test Setup, as a series of comma-separated trace points. The result is a series of floating point numbers.
27	Amptd vs. Sub-carrier of Tx2 when using Tx1+Tx2 as MISO Test Setup (double) [dB] <853/1705/3409/6817 (6913)/13633(13921)/27265(27841)> Returns Tx2 amplitude vs. sub-carrier data when using Tx1+Tx2 as MISO Test Setup, as a series of comma-separated trace points. The result is a series of floating point numbers.

Index: n	Results Returned
	<p>There are 853 sub-carriers in 1K mode, 1705 sub-carriers in 2K mode, 3409 sub-carriers in 4k mode, 6817 (normal carrier mode) / 6913 (extended carrier mode) sub-carriers in 8K mode, 13633 (normal carrier mode) / 13921 (extended carrier mode) sub-carriers in 16K mode and 27265 (normal carrier mode) / 27841 (extended carrier mode) sub-carriers in 32K mode.</p>
28	<p>Phase vs. Sub-carrier of Tx2 when using Tx1+Tx2 as MISO Test Setup (double) [°] &lt;853/1705/3409/6817 (6913)/13633(13921)/27265(27841)&gt;</p> <p>Returns Tx2 phase vs. sub-carrier data when using Tx1+Tx2 as MISO Test Setup, as a series of comma-separated trace points. The result is a series of floating point numbers.</p> <p>There are 853 sub-carriers in 1K mode, 1705 sub-carriers in 2K mode, 3409 sub-carriers in 4k mode, 6817 (normal carrier mode) / 6913 (extended carrier mode) sub-carriers in 8K mode, 13633 (normal carrier mode) / 13921 (extended carrier mode) sub-carriers in 16K mode and 27265 (normal carrier mode) / 27841 (extended carrier mode) sub-carriers in 32K mode.</p>
29	<p>Group Delay vs. Sub-carrier of Tx2 when using Tx1+Tx2 as MISO Test Setup (double) [us] &lt;852/1704/3408/6816(6912)/13632(13920)/27264(27840)&gt;</p> <p>Returns Tx2 group delay vs. sub-carrier data when using Tx1+Tx2 as MISO Test Setup, as a series of comma-separated trace points. The result is a series of floating point numbers.</p> <p>There are 852 sub-carriers in 1K mode, 1704 sub-carriers in 2K mode, 3408 sub-carriers in 4k mode, 6816 (normal carrier mode) / 6912 (extended carrier mode) sub-carriers in 8K mode, 13632 (normal carrier mode) / 13920 (extended carrier mode) sub-carriers in 16K mode and 27264 (normal carrier mode) / 27840 (extended carrier mode) sub-carriers in 32K mode.</p>
30	<p>Amptd vs. Time of Tx2 when using Tx1+Tx2 as MISO Test Setup (double) [dB] &lt;1024/2048/4096/8192/16384/32768&gt;</p> <p>Returns Tx2 amplitude vs. time data when using Tx1+Tx2 as MISO Test Setup, as a series of comma-separated trace points. The result is a series of floating point numbers.</p> <p>There are 1024 points in 1k mode, 2048 points in 2K mode, 4096 points in 4K mode, 8192 points in 8K mode, 16384 points in 16K mode and 32768 points in 32K mode.</p>

## DVB-T2 Mod Accuracy Measurement Description

DVB-T2 Mod Accuracy measurement provides the properties and methods for measuring the modulation errors of DVB-T2 signals in DVB-T/H with T2 mode. This measurement covers the following results:

- Constellation graphic on specified sub-carrier ranges or PLP
- MER, EVM of overall carriers, Data carriers, P2 Pilot carriers, L1-pre carriers, L1-post carriers, Continual Pilot carriers, Scattered Pilot carriers and Frame Closing (FC) carriers
- Mag Error, Phase Error, Frequency Error
- Quadrature Error, Amplitude Imbalance
- Channel Frequency Response and Channel Impulse Response
- L1 Signalling information
- MER Monitor results

Key Path	Meas
Initial S/W Revision	A.07.00

## Amplitude (AMPTD) Y Scale

The AMPLITUDE Y Scale key accesses a menu allowing you to set the desired vertical scale and associated settings. It specifies AMPLITUDE Y Scale settings when MER/EVM vs. Sub-carrier/Frequency window, Amptd vs. Sub-carrier window, Phase vs. Sub-carrier window, Group Delay vs. Sub-carrier window, Amptd vs. Time window, or MER vs. Time window is active.

Key Path	Front-panel key
Initial S/W Revision	A.07.00

### Ref Value

This key allows you to set the displayed Y reference value. The key is active in MER/EVM vs. Sub-carrier/Frequency window, Amptd vs. Sub-carrier window, Phase vs. Sub-carrier window, Group Delay vs. Sub-carrier window, Amptd vs. Time window, and MER vs. Time window.

Key Path	AMPTD Y Scale
Initial S/W Revision	A.07.00

### Y Ref Value (I/Q Error View – MER/EVM vs. Sub-carrier/ Frequency Window)

This key sets the reference value in the MER/EVM vs. Sub-carrier/Frequency window. The displayed value will be updated according to Scale Type (AMPTD Y Scale, More).

"Y Ref Value (Scale Type is MER)" on page 1504

"Y Ref Value (Scale Type is EVM)" on page 1505

### Y Ref Value (Scale Type is MER)

If the scale type is set to MER, Y Ref Value is displayed and set in dB.

Key Path	AMPTD Y Scale
Mode	DVB-T/H
Remote Command	:DISPlay:EVMTtwo:VIEW2:WINDow[1]:TRACe:Y[:SCALE] [:MER]:RLEVel <real> :DISPlay:EVMTtwo:VIEW2:WINDow[1]:TRACe:Y[:SCALE] [:MER]:RLEVel?
Example	DISP:EVMT:VIEW2:WIND:TRAC:Y:RLEV 0.0 DISP:EVMT:VIEW2:WIND:TRAC:Y:RLEV?
Notes	SCPI Remarks: VIEW2: I/Q Error View WINDow[1]: MER/EVM vs. Sub-carrier/Frequency Window on I/Q Error View
Dependencies	If Auto Scaling is set to On, this value is automatically determined by the measurement result. When you set this value manually, Auto Scaling is automatically set to Off.
Preset	Value is automatically determined by the measurement result with Auto Scaling set to On. Result



	depends on signal source.
State Saved	No
Min	-500.0
Max	500.0
Initial S/W Revision	A.07.00

### Y Ref Value (Scale Type is EVM)

If the scale type is set to EVM, Y Ref Value is displayed and set in %.

Key Path	AMPTD Y Scale
Mode	DVB-T/H
<b>Remote Command</b>	:DISPlay:EVMTtwo:VIEW2:WINDow[1]:TRACe:Y[:SCALe]:EVM:RLEVel <real> :DISPlay:EVMTtwo:VIEW2:WINDow[1]:TRACe:Y[:SCALe]:EVM:RLEVel?
<b>Example</b>	DISP:EVMT:VIEW2:WIND:TRAC:Y:EVM:RLEV 0.0 DISP:EVMT:VIEW2:WIND:TRAC:Y:EVM:RLEV?
Notes	SCPI Remarks: VIEW2: I/Q Error View WINDow[1]: MER/EVM vs. Sub-carrier/Frequency Window on I/Q Error View
Dependencies	If Auto Scaling is set to On, this value is automatically determined by the measurement result. When you set this value manually, Auto Scaling is automatically set to Off.
Preset	Value is automatically determined by the measurement result with Auto Scaling set to On. Result depends on signal source.
State Saved	No
Min	0.0
Max	500.0
Initial S/W Revision	A.07.00

### Y Ref Value (Channel Frequency Response View – Amptd vs. Sub-carrier Window)

This key sets the reference value in the Amptd vs. Sub-carrier window.

Key Path	AMPTD Y Scale
Mode	DVB-T/H
<b>Remote Command</b>	:DISPlay:EVMTtwo:VIEW3:WINDow[1]:TRACe:Y[:SCALe]:RLEVel <real> :DISPlay:EVMTtwo:VIEW3:WINDow[1]:TRACe:Y[:SCALe]:RLEVel?
<b>Example</b>	DISP:EVMT:VIEW3:WIND:TRAC:Y:RLEV 0.0 DISP:EVMT:VIEW3:WIND:TRAC:Y:RLEV?
Notes	SCPI Remarks:

	VIEW3: Channel Frequency Response View WINDow[1]: Amptd vs. Sub-carrier Window
Dependencies	If Auto Scaling is set to On, this value is automatically determined by the measurement result. When you set this value manually, Auto Scaling is automatically set to Off.
Preset	Value is automatically determined by the measurement result with Auto Scaling set to On. Result depends on signal source.
State Saved	No
Min	-100.0
Max	100.0
Initial S/W Revision	A.07.00

### Y Ref Value (Channel Frequency Response View – Phase vs. Sub-carrier Window)

This key sets the reference value in the Phase vs. Sub-carrier window.

Key Path	AMPTD Y Scale
Mode	DVB-T/H
<b>Remote Command</b>	:DISPlay:EVMTtwo:VIEW3:WINDow2:TRACe:Y[:SCALE]:RLEVel <real> :DISPlay:EVMTtwo:VIEW3:WINDow2:TRACe:Y[:SCALE]:RLEVel?
<b>Example</b>	DISP:EVMT:VIEW3:WIND2:TRAC:Y:RLEV 0.0 DISP:EVMT:VIEW3:WIND2:TRAC:Y:RLEV?
Notes	SCPI Remarks: VIEW3: Channel Frequency Response View WINDow2: Phase vs. Sub-carrier Window
Dependencies	If Auto Scaling is set to On, this value is automatically determined by the measurement result. When you set this value manually, Auto Scaling is automatically set to Off.
Preset	Value is automatically determined by the measurement result with Auto Scaling set to On. Result depends on signal source.
State Saved	No
Min	-180.0
Max	180.0
Initial S/W Revision	A.07.00

### Y Ref Value (Channel Frequency Response View – Group Delay vs. Sub-carrier Window)

This key sets the reference value in the Group Delay vs. Sub-carrier window.

Key Path	AMPTD Y Scale
Mode	DVB-T/H

<b>Remote Command</b>	:DISPlay:EVMTtwo:VIEW3:WINDow3:TRACe:Y[:SCALe]:RLEVel <real> :DISPlay:EVMTtwo:VIEW3:WINDow3:TRACe:Y[:SCALe]:RLEVel?
<b>Example</b>	DISP:EVMT:VIEW3:WIND3:TRAC:Y:RLEV 0.0 DISP:EVMT:VIEW3:WIND3:TRAC:Y:RLEV?
<b>Notes</b>	SCPI Remarks: VIEW3: Channel Frequency Response View WINDow3: Group Delay vs. Sub-carrier Window
<b>Dependencies</b>	If Auto Scaling is set to On, this value is automatically determined by the measurement result. When you set this value manually, Auto Scaling is automatically set to Off.
<b>Preset</b>	Value is automatically determined by the measurement result with Auto Scaling set to On. Result depends on signal source.
<b>State Saved</b>	No
<b>Min</b>	-5.0e6
<b>Max</b>	5.0e6
<b>Initial S/W Revision</b>	A.07.00

### Y Ref Value (Channel Impulse Response View – Amptd vs. Time Window)

This key sets the reference value in the Amptd vs. Time window.

<b>Key Path</b>	AMPTD Y Scale
<b>Mode</b>	DVB-T/H
<b>Remote Command</b>	:DISPlay:EVMTtwo:VIEW4:WINDow[1]:TRACe:Y[:SCALe]:RLEVel <real> :DISPlay:EVMTtwo:VIEW4:WINDow[1]:TRACe:Y[:SCALe]:RLEVel?
<b>Example</b>	DISP:EVMT:VIEW4:WIND:TRAC:Y:RLEV 0.0 DISP:EVMT:VIEW4:WIND:TRAC:Y:RLEV?
<b>Notes</b>	SCPI Remarks: VIEW4: Channel Impulse Response View WINDow[1]: Amptd vs. Time Window
<b>Dependencies</b>	If Auto Scaling is set to On, this value is automatically determined by the measurement result. When you set this value manually, Auto Scaling is automatically set to Off.
<b>Preset</b>	Value is automatically determined by the measurement result with Auto Scaling set to On. Result depends on signal source.
<b>State Saved</b>	No
<b>Min</b>	-500.0
<b>Max</b>	100.0
<b>Initial S/W Revision</b>	A.07.00

## Y Ref Value (MER Monitor View – MER vs. Time Window)

This key sets the reference value in the MER vs. Time window.

Key Path	AMPTD Y Scale
Mode	DVB-T/H
Remote Command	:DISPlay:EVMTtwo:VIEW5:WINDow[1]:TRACe:Y[:SCALE]:RLEVel <real> :DISPlay:EVMTtwo:VIEW5:WINDow[1]:TRACe:Y[:SCALE]:RLEVel?
Example	DISP:EVMT:VIEW5:WIND:TRAC:Y:RLEV 0.0 DISP:EVMT:VIEW5:WIND:TRAC:Y:RLEV?
Notes	SCPI Remarks: VIEW5:MER Monitor View WINDow[1]: MER vs. Time Window
Dependencies	If Auto Scaling is set to On, this value is automatically determined by the measurement result. When you set this value manually, Auto Scaling is automatically set to Off.
Preset	Value is automatically determined by the measurement result with Auto Scaling set to On. Result depends on signal source.
State Saved	No
Min	-200.0
Max	100.0
Initial S/W Revision	A.07.00

## Attenuation

This menu controls the attenuator functions and interactions between the attenuation system components.

There are two attenuator configurations in the X-Series. One is a dual attenuator configuration consisting of a mechanical attenuator and an optional electronic attenuator. The other configuration uses a single attenuator with combined mechanical and electronic sections that controls all the attenuation functions. Different models in the X-Series come with different configurations.

See "[Dual Attenuator Configurations:](#)" on page 1509

See "[Single Attenuator Configuration:](#)" on page 1509

Most Attenuation settings are the same for all measurements – they do not change as you change measurements. Settings like these are called “Meas Global” and are unaffected by Meas Preset.

Key Path	AMPTD Y Scale
Scope	Meas Global
Dependencies	In measurements that support the I/Q inputs, this key is unavailable when I/Q is the selected input, and is replaced by the Range key in that case.
Readback Line	Contains a summary in [ ] brackets of the current total attenuation. See the descriptions of the , "

(Mech) Atten " on page 2102, and "Enable Elec Atten" on page 2104 keys for more detail on the contributors to the total attenuation.

Note that when "Pre-Adjust for Min Clip" is on, this value can change at the start of every measurement.

Initial S/W Revision Prior to A.02.00

Modified at S/W Revision A.03.00

### Dual Attenuator Configurations:

Configuration 1: Mechanical attenuator + optional electronic attenuator

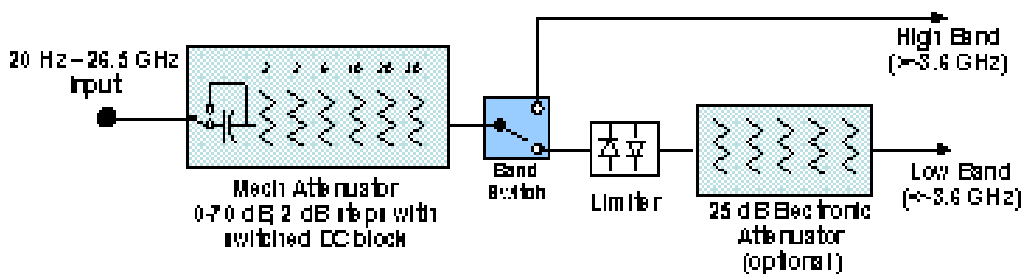

Configuration 2: Mechanical attenuator, no optional electronic attenuator

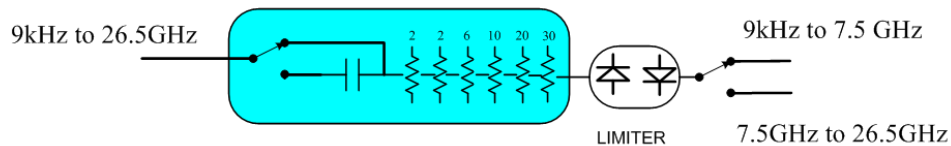

(note that Configuration 2 is not strictly speaking a dual-section attenuator, since there is no electronic section available. However, it behaves exactly like Configuration 1 without the Electronic Attenuator option EA3, therefore for the sake of this document it is grouped into the "Dual Attenuator" configuration)

### Single Attenuator Configuration:

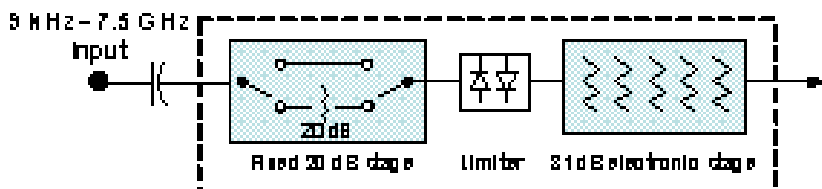

You can tell which attenuator configuration you have by pressing the Attenuation key, which (in most Modes) opens the Attenuation menu. If the first key in the Attenuation menu says Mech Atten you have the dual attenuator configuration. If the first key says Atten you have the single attenuator configuration.

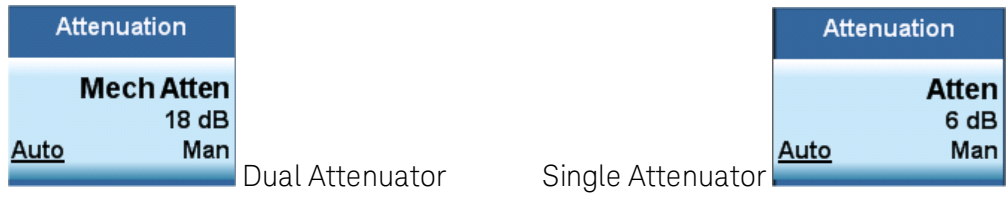

In the single attenuator configuration, you control the attenuation with a single control, as the fixed stage has only two states. In the dual attenuator configuration, both stages have significant range so you are given separate control of the mechanical and electronic attenuator stages.

When you have the dual attenuator configuration, you may still have only a single attenuator, because unless option EA3 (the Electronic Attenuator option) is available, and you purchase it, you will have only the mechanical attenuator.

**(Mech) Atten**

This key is labeled Mech Atten in dual attenuator models and Atten in single attenuator models. In the dual attenuator configuration, this key only affects the mechanical attenuator.

This key lets you modify the attenuation applied to the RF input signal path. This value is normally auto coupled to the Ref Level, the Internal Preamp Gain, any External Gain that is entered, and the Max Mixer Level, as described in the table below.

See "[Attenuator Configurations and Auto/Man](#)" on page 1511

<b>Key Path</b>	AMPTD Y Scale, Attenuation
<b>Remote Command</b>	<pre>[ :SENSe]:POWer[:RF]:ATTenuation &lt;rel_ampl&gt; [:SENSe]:POWer[:RF]:ATTenuation? [:SENSe]:POWer[:RF]:ATTenuation:AUTO OFF ON 0 1 [:SENSe]:POWer[:RF]:ATTenuation:AUTO?</pre>
<b>Example</b>	<p>POW:ATT 20</p> <p>Dual attenuator configuration: sets the mechanical attenuator to 20 dB</p> <p>Single attenuator mode: sets the main attenuation to 20 dB (see below for definition of “main” attenuation).</p> <p>If the attenuator was in Auto, it sets it to Manual.</p>
<b>Dependencies</b>	<p>Some measurements do not support the Auto setting of (Mech) Atten. In these measurements, the Auto/Man selection is not available, and the Auto/Man line on the key disappears.</p> <p>In dual attenuator configurations, when the electronic attenuator is enabled, the mechanical attenuator has no auto setting and the Auto/Man line on the key disappears. The state of Auto/Man is remembered and restored when the electronic attenuator is once again disabled. This is described in more detail in the "<a href="#">Enable Elec Atten</a>" on page 2104 key description.</p> <p>See "<a href="#">Attenuator Configurations and Auto/Man</a>" on page 1511 for more information on the Auto/Man functionality of Attenuation.</p>
<b>Couplings</b>	<p>When (Mech) Atten is in Auto, it uses the following algorithm to determine a value:</p> <p>If the USB Preamp is connected to USB, use 0 dB.</p> <p>Otherwise, Atten = ReferenceLevel + PreAmpGain + ExternalGain – RefLevelOffset - MaxMixerLevel</p>

	<p>+ IF Gain.</p> <p>Limit this value to be between 6 dB and the Max value. No value below 6 dB can ever be chosen by Auto.</p> <p>The resulting value is rounded up to the largest value possible given the attenuation step setting. That is, 50.01 dB would change to 60 dB (for a 10 dB attenuation step).</p> <p>The “IF Gain” term in the equation above is either 0 dB or +10 dB, depending on the settings of FFT IF Gain, Swept IF Gain, max Ref Level and the Auto/Man setting of Mech Atten.</p> <p>In External Mixing and BBIQ, where the Attenuator is not in the signal path, the Attenuator setting changes as described above when (Mech) Atten is in Auto, but no changes are made to the actual attenuator hardware setting until the input is changed back to the RF Input.</p>
Preset	<p>The preset for Mech Attenuation is “Auto.”</p> <p>The Auto value of attenuation is: CXA, EXA, MXA and PXA: 10 dB</p>
State Saved	Saved in instrument state
Min	<p>0 dB</p> <p>The attenuation set by this key cannot be decreased below 6 dB with the knob or step keys. To get to a value below 6 dB it has to be directly entered from the keypad or via SCPI. This protects from adjusting the attenuation to a dangerously small value which can put the instrument at risk of damage to input circuitry. However, if the current mechanical attenuation is below 6 dB it can be increased with the knob and step keys, but not decreased.</p>
Max	<p>CXA N9000A-503/507: 50 dB CXA N9000A-513/526: 70dB EXA: 60 dB MXA and PXA: 70 dB</p> <p>In the single attenuator configuration, the total of ATT and EATT cannot exceed 50 dB, so if the EATT is set to 24 dB first, the main attenuation cannot be greater than 26 dB and will be reduced accordingly; if the main attenuator is set to 40 dB first, EATT cannot be greater than 10 dB.</p>
Initial S/W Revision	Prior to A.02.00
Modified at S/W Revision	A.03.00

### Attenuator Configurations and Auto/Man

As described in the Attenuation key description, there are two distinct attenuator configurations available in the X-Series, the single attenuator and dual attenuator configurations. In dual attenuator configurations, we have the mechanical attenuation and the electronic attenuation, and the current total attenuation is the sum of the electronic + mechanical attenuation. In single attenuator configurations, we refer to the attenuation set using the (Mech) Atten key (or POW:ATT SCPI) as the “main” attenuation; and the attenuation that is set by the SCPI command POW:EATT as the “soft” attenuation (the POW:EATT command is honored even in the single attenuator configuration, for compatibility purposes). Then the current total attenuation is the sum of the main + soft attenuation. See the Elec Atten key description for more on “soft” attenuation.

In the dual attenuator configuration, when the electronic attenuator is enabled, there is no Auto/Man functionality for the mechanical attenuator, and the third line of the key label (the Auto/Man line) disappears:

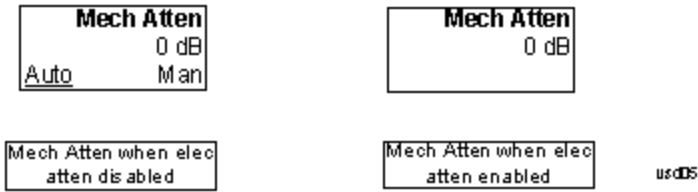

### Enable Elec Atten

Enables the Electronic Attenuator.

The electronic attenuator offers finer steps than the mechanical attenuator, has no acoustical noise, is faster, and is less subject to wear. These advantages primarily aid in remote operation and are negligible for front panel use. See ["Using the Electronic Attenuator: Pros and Cons" on page 1514](#) for a detailed discussion of the pros and cons of using the electronic attenuator.

For the single attenuator configuration, for SCPI backwards compatibility, the “soft” attenuation feature replaces the dual attenuator configuration’s electronic attenuator. All the same couplings and limitations apply. See ["Attenuator Configurations and Auto/Man" on page 2103](#)

See ["More Information" on page 1513](#)

<b>Key Path</b>	AMPTD Y Scale, Attenuation
<b>Remote Command</b>	[ :SENSe ] :POWer [ :RF ] :EATTenuation :STATe OFF   ON   0   1 [ :SENSe ] :POWer [ :RF ] :EATTenuation :STATe ?
<b>Example</b>	POW:EATT:STAT ON
<b>Dependencies</b>	<p>This key only appears in Dual Attenuator models with an Electronic Attenuator installed. It does not appear in models with the Single Attenuator configuration, as in the single attenuator configuration there is no “electronic attenuator” there is only a single integrated attenuator (which has both a mechanical and electronic stage). However, in the single attenuator configuration, EATT SCPI commands are accepted for compatibility with other X-series instruments and set a “soft” attenuation as described in <a href="#">"Attenuator Configurations and Auto/Man" on page 2103</a>.</p> <p>The electronic attenuator (and the “soft” attenuation function provided in single attenuator configurations) is unavailable above 3.6 GHz. Therefore, if the Stop Frequency of the analyzer is &gt; 3.6 GHz then the Enable Elec Atten key will be OFF and grayed out.</p> <p>If the Internal Preamp is on, meaning it is set to Low Band or Full, the electronic attenuator (and the “soft” attenuation function provided in single attenuator configurations) is unavailable. In this case the Enable Elec Atten key will be OFF and grayed out.</p> <p>If either of the above is true, if the SCPI command is sent, an error indicating that the electronic attenuator is unavailable will be sent.</p> <p>If the electronic/soft Attenuator is enabled, then the Stop Freq of the analyzer is limited to 3.6 GHz and the Internal Preamp is unavailable.</p> <p>The SCPI-only “soft” electronic attenuation for the single-attenuator configuration is not available in all measurements; in particular, it is not available in the Swept SA measurement.</p>
<b>Couplings</b>	Enabling and disabling the Electronic Attenuator affects the setting of the Mechanical Attenuator (in



	dual attenuator configurations). This is described in more detail below this table.
Preset	OFF for Swept SA measurement; ON for all other measurements that support the electronic attenuator
State Saved	Saved in instrument state
Initial S/W Revision	Prior to A.02.00
Modified at S/W Revision	A.03.00

## More Information

### Mechanical Attenuator Transition Rules

When the Electronic Attenuator is enabled, the Mechanical Attenuator transitions to a state that has no Auto function. Below are the rules for transitioning the Mechanical Attenuator. NOTE that the information below ONLY applies to the dual attenuator configurations, and ONLY when the Electronic Attenuator is installed:

#### When the Electronic Attenuation is enabled from a disabled state:

- The Mechanical Attenuator is initialized to 10 dB (this is its optimal performance setting). You can then set it as desired with SCPI, numeric keypad, step keys, or knob, and it behaves as it normally would in manual mode
- The Auto/Man state of (Mech) Atten is saved
- The Auto/Man line on the (Mech) Atten key disappears and the auto rules are disabled
- The Electronic Attenuator is set to 10 dB less than the previous value of the Mechanical Attenuator, within the limitation that it must stay within the range of 0 to 24 dB of attenuation.

#### Examples in the dual attenuator configuration:

- Mech Atten at 20 dB. Elec Atten enabled, Mech Atten set to 10 dB, and Elec Atten set to 10 dB. New total attenuation equals the value before Elec Atten enabled.
- Mech Atten at 0 dB. Elec Atten enabled, Mech Atten set to 10 dB, and Elec Atten set to 0 dB. New total attenuation does not equal the value before Elec Atten enabled.
- Mech Atten at 40 dB. Elec Atten enabled, Mech Atten set to 10 dB, and Elec Atten set to 24 dB. New total attenuation does not equal the value before Elec Atten enabled.

#### When the Electronic Attenuation is disabled from an enabled state:

- The Elec Atten key is grayed out
- The Auto/Man state of (Mech) Atten is restored
- If now in Auto, (Mech) Atten recouples
- If now in Man, (Mech) Atten is set to the value of total attenuation that existed before the Elec Atten was disabled. The resulting value is rounded up to the smallest value possible given the (Mech) Atten Step setting - (That is, 57 dB changes to 58 dB when (Mech) Atten Step is 2 dB.)

## Using the Electronic Attenuator: Pros and Cons

The electronic attenuator offers finer steps than the mechanical attenuator, has no acoustical noise, is faster, and is less subject to wear.

The “finer steps” advantage of the electronic attenuator is beneficial in optimizing the alignment of the analyzer dynamic range to the signal power in the front panel as well as remote use. Thus, you can achieve improved relative signal measurement accuracy. Compared to a mechanical attenuator with 2 dB steps, the 1 dB resolution of the electronic attenuator only gives better resolution when the odd-decibel steps are used. Those odd-decibel steps are less accurately calibrated than the even-decibel steps, so one tradeoff for this superior relative accuracy is reduced absolute amplitude accuracy.

Another disadvantage of the electronic attenuator is that the spectrum analyzer loses its “Auto” setting, making operation less convenient.

Also, the relationship between the dynamic range specifications (TOI, SHI, compression and noise) and instrument performance are less well-known with the electrical attenuator. With the mechanical attenuator, TOI, SHI and compression threshold levels increase dB-for-dB with increasing attenuation, and the noise floor does as well. With the electronic attenuator, there is an excess attenuation of about 1 to 3 dB between 0 and 3.6 GHz, making the effective TOI, SHI, and so forth, less well known. Excess attenuation is the actual attenuation relative to stated attenuation. Excess attenuation is accounted for in the analyzer calibration

## Elec Atten

Controls the Electronic Attenuator in dual attenuator configurations. This key does not appear in single attenuator configurations, as the control of both the mechanical and electronic stages of the single attenuator is integrated into the single Atten key.

Key Path	AMPTD Y Scale, Attenuation
Remote Command	[ :SENSe ] :POWer [ :RF ] :EATTenuation <rel_amp1> [ :SENSe ] :POWer [ :RF ] :EATTenuation?
Notes	Electronic Attenuation's specification is defined only when Mechanical Attenuation is 6 dB.
Dependencies	This key only appears in Dual Attenuator models with an Electronic Attenuator installed. It does not appear in models with the Single Attenuator configuration, as in the single attenuator configuration there is no “electronic attenuator” there is only a single integrated attenuator (which has both a mechanical and electronic stage). However, in the single attenuator configuration, EATT SCPI commands are accepted for compatibility with other X-series instruments and set a “soft” attenuation as described in <a href="#">"Attenuator Configurations and Auto/Man" on page 2103</a> . The “soft” attenuation is treated as an addition to the “main” attenuation value set by the Atten softkey or the POW:ATT SCPI command and affects the total attenuation displayed on the Attenuation key and the Meas Bar.  When Enable Elec Atten is off or grayed out, the Elec Atten key is grayed out.
Preset	0 dB
State Saved	Saved in instrument state
Min	0 dB
Max	Dual attenuator configuration: 24 dB Single attenuator configuration: the total of ATT and EATT cannot exceed 50 dB, so if the EATT is set to 24 dB first, the main attenuation cannot be greater than 26 dB and will be reduced accordingly; if

	the main attenuator is set to 40 dB first, EATT cannot be greater than 10 dB
Initial S/W Revision	Prior to A.02.00
Modified at S/W Revision	A.03.00

## Adjust Atten for Min Clip

Sets the combination of mechanical and electronic attenuation and gain based on the current measured signal level so that clipping will be at a minimum.

This is an "immediate action" function, that is, it executes once, when the key is pressed.

This key is grayed out in measurements that do not support this functionality. The spectrum analyzer measurement, Swept SA, does not support this functionality.

Key Path	AMPTD Y Scale, Attenuation
Remote Command	<code>[ :SENSe ] :POWer [ :RF ] :RANGe :OPTimize IMMEDIATE</code>
Initial S/W Revision	Prior to A.02.00
Modified at S/W Revision	A.03.00

## Pre-Adjust for Min Clip

If this function is on, it does the adjustment described under "[Adjust Atten for Min Clip](#)" on page 2107 each time a measurement restarts. Therefore, in Continuous measurement mode, it only executes before the first measurement.

In dual attenuator models, you can set Elec+Mech Atten, in which case both attenuators participate in the autoranging, or Elec Atten Only, in which case the mechanical attenuator does not participate in the autoranging. This latter case results in less wear on the mechanical attenuator and is usually faster.

This key is grayed out in measurements that do not support this functionality. The spectrum analyzer measurement, Swept SA, does not support this functionality.

Key Path	AMPTD Y Scale, Attenuation
Remote Command	<code>[ :SENSe ] :POWer [ :RF ] :RANGe :OPTimize :ATTenuation OFF   ELECTrical   COMBined</code> <code>[ :SENSe ] :POWer [ :RF ] :RANGe :OPTimize :ATTenuation?</code>
Notes	The SCPI parameter ELECTrical sets this function to On in single attenuator models. The SCPI parameter COMBined is mapped to ELECTrical in single attenuator models; if you send COMBined, it sets the function to On and returns ELEC to a query.
Dependencies	This key only appears in Dual Attenuator models with an Electronic Attenuator installed. In instruments with Dual Attenuator model, when Enable Elec Atten is off or grayed out, the Pre-Adjust for Min Clip key is grayed out.
Preset	OFF for Swept SA measurement; ON for all other measurements that support Pre-Adjust for Min Clip

State Saved	Saved in instrument state
Range	Dual attenuator models: Off   Elec Atten Only   Mech + Elec Atten Single attenuator models: Off   On
Initial S/W Revision	Prior to A.02.00
Modified at S/W Revision	A.03.00

<b>Remote Command</b>	<code>[ :SENSe ] :POWer [ :RF ] :RANGe :AUTO ON OFF 1 0</code> <code>[ :SENSe ] :POWer [ :RF ] :RANGe :AUTO?</code>
Notes	ON aliases to "Elec Atten Only" (:POW:RANG:OPT:ATT ELEC) OFF aliases to "Off" (:POW:RANG:OPT:ATT OFF) The query :POW:RANG:AUTO? returns true if :POW:RANG:OPT:ATT is not "Off"
Initial S/W Revision	Prior to A.02.00

## Off

Turns Pre-Adjust for Min Clip off. This is the default setting.

This key is grayed out in measurements that do not support this functionality. The spectrum analyzer measurement, Swept SA, does not support this functionality.

Key Path	AMPTD Y Scale, Attenuation, Pre-Adjust for Min Clip
Example	:POW:RANG:OPT:ATT OFF
Initial S/W Revision	Prior to A.02.00

## Elec Atten Only

Selects only the electric attenuator to participate in auto ranging. This offers less wear on the mechanical attenuator and is usually faster.

This key is grayed out in measurements that do not support this functionality. The spectrum analyzer measurement, Swept SA, does not support this functionality.

Key Path	AMPTD Y Scale, Attenuation, Pre-Adjust for Min Clip
Example	:POW:RANG:OPT:ATT ELEC
Initial S/W Revision	Prior to A.02.00

## Mech + Elec Atten

In dual attenuator models, this selects both attenuators participate in the autoranging.

This key is grayed out in measurements that do not support this functionality. The spectrum analyzer measurement, Swept SA, does not support this functionality.

Key Path	AMPTD Y Scale, Attenuation, Pre-Adjust for Min Clip
Example	:POW:RANGe:OPT:ATT COMB
Initial S/W Revision	Prior to A.02.00

### (Mech) Atten Step

This controls the step size used when making adjustments to the input attenuation.

This key is labeled Mech Atten Step in dual attenuator models and Atten Step in single attenuator models. In the dual attenuator configuration, this key only affects the step size of the mechanical attenuator.

Key Path	AMPTD Y Scale, Attenuation
<b>Remote Command</b>	[ :SENSe ] :POWer [ :RF ] :ATTenuation :STEP [ :INCRement ] 10 dB   2 dB [ :SENSe ] :POWer [ :RF ] :ATTenuation :STEP [ :INCRement ] ?
<b>Example</b>	POW:ATT:STEP 2
Notes	Note this feature works like a 1-N choice from the front panel, but it takes a specific value (in dB) when used remotely. The only valid values are 2 and 10.
Dependencies	Blanked in CXA and EXA if option FSA (2 dB steps) is not present. If blanked, attempts to set it via SCPI will yield an error.
Couplings	When the attenuation step size changes, the current mechanical attenuation value is adjusted (if necessary) to be quantized to the new step size. That is, if step is set to 10 dB, mech atten is increased if necessary so it is a multiple of 10 dB
Preset	PXA and MXA: 2 dB EXA and CXA: 10 dB (2 dB with option FSA)
State Saved	Saved in instrument state
Initial S/W Revision	Prior to A.02.00
Modified at S/W Revision	A.03.00

### Scale/Div

This key allows you to set Y Scale/Div. The key is active in MER/EVM vs. Sub-carrier/Frequency window, Amptd vs. Sub-carrier window, Phase vs. Sub-carrier window, Group Delay vs. Sub-carrier window, Amptd vs. Time window, and MER vs. Time window.

Key Path	AMPTD Y Scale
Initial S/W Revision	A.07.00

## Y Scale/Div (I/Q Error View – MER/EVM vs. Sub-carrier/ Frequency Window)

This key sets the sensitivity of the measurement result in the MER/EVM vs. Sub-carrier/Freq window. The displayed value will be updated according to Scale Type (AMPTD Y Scale, More).

"Y Scale/Div (Scale Type is MER)" on page 1518

"Y Scale/Div (Scale Type is EVM)" on page 1518

### Y Scale/Div (Scale Type is MER)

If the scale type is set to MER, Y Scale/Div is displayed and set in dB.

Key Path	AMPTD Y Scale
Mode	DVB-T/H
Remote Command	:DISPlay:EVMTtwo:VIEW2:WINDow[1]:TRACe:Y[:SCALe][:MER]:PDIVision <real> :DISPlay:EVMTtwo:VIEW2:WINDow[1]:TRACe:Y[:SCALe][:MER]:PDIVision?
Example	DISP:EVMT:VIEW2:WIND:TRAC:Y:PDIV 10.0 DISP:EVMT:VIEW2:WIND:TRAC:Y:PDIV?
Notes	SCPI Remarks: VIEW2: I/Q Error View WINDow[1]: MER/EVM vs. Sub-carrier/Frequency Window on I/Q Error View
Dependencies	If Auto Scaling is set to On, this value is automatically determined by the measurement result. When you set this value manually, Auto Scaling is automatically set to Off.
Preset	Value is automatically determined by the measurement result with Auto Scaling set to On. Result depends on signal source
State Saved	No
Min	0.1
Max	40.0
Initial S/W Revision	A.07.00

### Y Scale/Div (Scale Type is EVM)

If the scale type is set to EVM, Y Scale/Div is displayed and set in %.

Key Path	AMPTD Y Scale
Mode	DVB-T/H
Remote Command	:DISPlay:EVMTtwo:VIEW2:WINDow[1]:TRACe:Y[:SCALe]:EVM:PDIVision <real> :DISPlay:EVMTtwo:VIEW2:WINDow[1]:TRACe:Y[:SCALe]:EVM:PDIVision?
Example	DISP:EVMT:VIEW2:WIND:TRAC:Y:EVM:PDIV 10.0 DISP:EVMT:VIEW2:WIND:TRAC:Y:EVM:PDIV?
Notes	SCPI Remarks: VIEW2: I/Q Error View WINDow[1]: MER/EVM vs. Sub-carrier/Frequency Window on I/Q Error View

Dependencies	If Auto Scaling is set to On, this value is automatically determined by the measurement result. When you set this value manually, Auto Scaling is automatically set to Off.
Preset	Value is automatically determined by the measurement result with Auto Scaling set to On. Result depends on signal source.
State Saved	No
Min	0.01
Max	50.0
Initial S/W Revision	A.07.00

### Y Scale/Div (Channel Frequency Response View – Amptd vs. Sub-carrier Window)

This key sets the sensitivity of the measurement result in the Amptd vs. Sub-carrier window.

Key Path	AMPTD Y Scale
Mode	DVB-T/H
<b>Remote Command</b>	:DISPlay:EVMTtwo:VIEW3:WINDow[1]:TRACe:Y[:SCALe]:PDIVision <real> :DISPlay:EVMTtwo:VIEW3:WINDow[1]:TRACe:Y[:SCALe]:PDIVision?
<b>Example</b>	DISP:EVMT:VIEW3:WIND:TRAC:Y:PDIV 10.0 DISP:EVMT:VIEW3:WIND:TRAC:Y:PDIV?
Notes	SCPI Remarks: VIEW2: Channel Frequency Response View WINDow[1]: Amptd vs. Sub-carrier Window
Dependencies	If Auto Scaling is set to On, this value is automatically determined by the measurement result. When you set this value manually, Auto Scaling is automatically set to Off.
Preset	Value is automatically determined by the measurement result with Auto Scaling set to On. Result depends on signal source.
State Saved	No
Min	0.1
Max	40.0
Initial S/W Revision	A.07.00

### Y Scale/Div (Channel Frequency Response View – Phase vs. Sub-carrier Window)

This key sets the sensitivity of the measurement result in the Phase vs. Sub-carrier window.

Key Path	AMPTD Y Scale
Mode	DVB-T/H
<b>Remote Command</b>	:DISPlay:EVMTtwo:VIEW3:WINDow2:TRACe:Y[:SCALe]:PDIVision <real> :DISPlay:EVMTtwo:VIEW3:WINDow2:TRACe:Y[:SCALe]:PDIVision?

<b>Example</b>	DISP:EVMT:VIEW3:WIND2:TRAC:Y:PDIV 36.0 DISP:EVMT:VIEW3:WIND2:TRAC:Y:PDIV?
Notes	SCPI Remarks: VIEW3: Channel Frequency Response View WINDow2: Phase vs. Sub-carrier Window
Dependencies	If Auto Scaling is set to On, this value is automatically determined by the measurement result. When you set this value manually, Auto Scaling is automatically set to Off.
Preset	Value is automatically determined by the measurement result with Auto Scaling set to On. Result depends on signal source.
State Saved	No
Min	0.001
Max	50.0
Initial S/W Revision	A.07.00

### Y Scale/Div (Channel Frequency Response View – Group Delay vs. Sub-carrier Window)

This key sets the sensitivity of the measurement result in the Group Delay vs. Sub-carrier window.

Key Path	AMPTD Y Scale
Mode	DVB-T/H
<b>Remote Command</b>	:DISPlay:EVMTtwo:VIEW3:WINDow3:TRACe:Y[:SCALE]:PDIVision <real> :DISPlay:EVMTtwo:VIEW3:WINDow3:TRACe:Y[:SCALE]:PDIVision?
<b>Example</b>	DISP:EVMT:VIEW3:WIND3:TRAC:Y:PDIV 1.0 DISP:EVMT:VIEW3:WIND3:TRAC:Y:PDIV?
Notes	SCPI Remarks: VIEW3: Channel Frequency Response View WINDow3: Group Delay vs. Sub-carrier Window
Dependencies	If Auto Scaling is set to On, this value is automatically determined by the measurement result. When you set this value manually, Auto Scaling is automatically set to Off.
Preset	Value is automatically determined by the measurement result with Auto Scaling set to On. Result depends on signal source.
State Saved	No
Min	0.01
Max	1.0e6
Initial S/W Revision	A.07.00

### Y Scale/Div (Channel Impulse Response View – Amptd vs. Time Window)

This key sets the sensitivity of the measurement result in the Amptd vs. Time window.



Key Path	AMPTD Y Scale
Mode	DVB-T/H
<b>Remote Command</b>	:DISPlay:EVMTtwo:VIEW4:WINDow[1]:TRACe:Y[:SCALe]:PDIVision <real> :DISPlay:EVMTtwo:VIEW4:WINDow[1]:TRACe:Y[:SCALe]:PDIVision?
<b>Example</b>	DISP:EVMT:VIEW4:WIND:TRAC:Y:PDIV 10.0 DISP:EVMT:VIEW4:WIND:TRAC:Y:PDIV?
Notes	SCPI Remarks: VIEW4: Channel Impulse Response View WINDow[1]: Amptd vs. Time Window
Dependencies	If Auto Scaling is set to On, this value is automatically determined by the measurement result. When you set this value manually, Auto Scaling is automatically set to Off.
Preset	Value is automatically determined by the measurement result with Auto Scaling set to On. Result depends on signal source.
State Saved	No
Min	0.1
Max	40.0
Initial S/W Revision	A.07.00

### Y Scale/Div (MER Monitor View – MER vs. Time Window)

This key sets the sensitivity of the measurement result in the MER vs. Time window.

Key Path	AMPTD Y Scale
Mode	DVB-T/H
<b>Remote Command</b>	:DISPlay:EVMTtwo:VIEW5:WINDow[1]:TRACe:Y[:SCALe]:PDIVision <real> :DISPlay:EVMTtwo:VIEW5:WINDow[1]:TRACe:Y[:SCALe]:PDIVision?
<b>Example</b>	DISP:EVMT:VIEW5:WIND:TRAC:Y:PDIV 10.0 DISP:EVMT:VIEW5:WIND:TRAC:Y:PDIV?
Notes	SCPI Remarks: VIEW5: MER Monitor View WINDow[1]: MER vs. Time Window
Dependencies	If Auto Scaling is set to On, this value is automatically determined by the measurement result. When you set this value manually, Auto Scaling is automatically set to Off.
Preset	Value is automatically determined by the measurement result with Auto Scaling set to On. Result depends on signal source.
State Saved	No
Min	0.1
Max	40.0
Initial S/W Revision	A.07.00

## Presel Center

When this key is pressed, the centering of the preselector filter is adjusted to optimize the amplitude accuracy at the frequency of the selected marker. If the selected marker is not on when Presel Center is pressed, the analyzer will turn on the selected marker, perform a peak search, and then perform centering on the marker's center frequency. If the selected marker is already on and between the start and stop frequencies of the analyzer, the analyzer performs the preselector calibration on that marker's frequency. If the selected marker is already on, but outside the frequency range between Start Freq and Stop Freq, the analyzer will first perform a peak search, and then perform centering on the marker's center frequency.

The value displayed on the Presel Adjust key will change to reflect the new preselector tuning (see Presel Adjust).

A number of considerations should be observed to ensure proper operation. See ["Proper Preselector Operation" on page 1523](#).

<b>Key Path</b>	AMPTD Y Scale
<b>Remote Command</b>	[ :SENSe ] :POWer [ :RF ] :PCENter
<b>Example</b>	POW:PCEN
<b>Notes</b>	Note that the rules outlined above under the key description apply for the remote command as well as the key. The result of the command is dependent on marker position, and so forth. Any message shown by the key press is also shown in response to the remote command.
<b>Dependencies</b>	<ul style="list-style-type: none"> <li>• Grayed out if the microwave preselector is off. )</li> <li>• If the selected marker's frequency is below Band 1, advisory message 0.5001 is generated and no action is taken.</li> <li>• Grayed out if entirely in Band 0.</li> <li>• Blank in models that do not include a preselector, such as option 503. If the SCPI is sent in these instruments, it is accepted without error, and the query always returns 0.</li> <li>• Grayed out in the Spectrogram View.</li> </ul>
<b>Couplings</b>	<p>The active marker position determines where the centering will be attempted.</p> <p>If the analyzer is in a measurement such as averaging when centering is initiated, the act of centering the preselector will restart averaging but the first average trace will not be taken until the centering is completed.</p>
<b>Status Bits/OPC dependencies</b>	<p>When centering the preselector, *OPC will not return true until the process is complete and a subsequent measurement has completed, nor will results be returned to a READ or MEASure command.</p> <p>The Measuring bit should remain set while this command is operating and should not go false until the subsequent sweep/measurement has completed.</p>
<b>Initial S/W Revision</b>	Prior to A.02.00
<b>Modified at S/W Revision</b>	A.03.00

## Proper Preselector Operation

A number of considerations should be observed to ensure proper operation:

1. If the selected marker is off, the analyzer will turn on a marker, perform a peak search, and adjust the preselector using the selected marker's frequency. It uses the "highest peak" peak search method unqualified by threshold or excursion, so that there is no chance of a 'no peak found' error. It continues with that peak, even if it is the peak of just noise. Therefore, for this operation to work properly, there should be a signal on screen in a preselected range for the peak search to find.
2. If the selected marker is already on, the analyzer will attempt the centering at that marker's frequency. There is no preselector for signals below about 3.6 GHz, therefore if the marker is on a signal below 3.6 GHz, no centering will be attempted and an advisory message generated
3. In some models, the preselector can be bypassed. If it is bypassed, no centering will be attempted in that range and a message will be generated.

## Preselector Adjust

Allows you to manually adjust the preselector filter frequency to optimize its response to the signal of interest. This function is only available when "Presel Center" on page 2111 is available.

For general purpose signal analysis, using Presel Center is recommended. Centering the filter minimizes the impact of long-term preselector drift. Presel Adjust can be used instead to manually optimize the preselector. One application of manual optimization would be to peak the preselector response, which both optimizes the signal-to-noise ratio and minimizes amplitude variations due to small (short-term) preselector drifting.

<b>Key Path</b>	AMPTD Y Scale
<b>Scope</b>	Meas Global
<b>Remote Command</b>	[ :SENSe ] :POWer [ :RF ] :PADJust <freq> [ :SENSe ] :POWer [ :RF ] :PADJust?
<b>Example</b>	POW:PADJ 100KHz POW:PADJ?
<b>Notes</b>	The value on the key reads out to 0.1 MHz resolution.
<b>Dependencies</b>	<ul style="list-style-type: none"> <li>• Grayed out if microwave preselector is off. )</li> <li>• Grayed out if entirely in Band 0.</li> <li>• Blank in models that do not include a preselector, such as option 503. If the SCPI is sent in these instruments, it is accepted without error, and the query always returns 0.</li> <li>• Grayed out in the Spectrogram View.</li> </ul>
<b>Preset</b>	0 MHz
<b>State Saved</b>	The Presel Adjust value set by Presel Center, or by manually adjusting Presel Adjust, is not saved in instrument state, and does not survive a Preset or power cycle.
<b>Min</b>	-500 MHz
<b>Max</b>	500 MHz

Default Unit	Hz
<b>Backwards Compatibility SCPI</b>	<code>[:SENSe]:POWer[:RF]:MW:PADJust</code> <code>[:SENSe]:POWer[:RF]:MMW:PADJust</code> PSA had multiple preselectors, but the X-Series has only one. These commands simply alias to <code>[:SENSe]:POWer[:RF]:PADJust</code>
Initial S/W Revision	Prior to A.02.00
Modified at S/W Revision	A.03.00

<b>Remote Command</b>	<code>[:SENSe]:POWer[:RF]:PADJust:PRESelector MWAVE   MMWave   EXTERNAL</code> <code>[:SENSe]:POWer[:RF]:PADJust:PRESelector?</code>
Notes	PSA had multiple preselectors, and you could select which preselector to adjust. Since the X-Series has only one mm/uW preselector, the preselector selection softkey is no longer available. However, to provide backward compatibility, we accept the legacy remote commands. The command form has no effect, the query always returns MWAVE
Initial S/W Revision	Prior to A.02.00

## μW Path Control

The μW Path Control functions include the μW Preselector Bypass (Option MPB) and Low Noise Path (Option LNP) controls in the High Band path circuits.

When the μW Preselector is bypassed, the user has better flatness, but will be subject to spurs from out of band interfering signals. When the Low Noise Path is enabled, the analyzer automatically switches around certain circuitry in the high frequency bands which can contribute to noise, when it is appropriate based on other analyzer settings.

For most applications, the preset state is Standard Path, which gives the best remote-control throughput, minimizes acoustic noise from switching and minimizes the risk of wear out in the hardware switches. For applications that utilize the wideband IF paths, the preset state is the μW Preselector Bypass path, if option MPB is present. This is because, when using a wideband IF such as the 140 MHz IF, the μW Preselector's bandwidth can be narrower than the available IF bandwidth, causing degraded amplitude flatness and phase linearity, so it is desirable to bypass the preselector in the default case.

Users may choose Low Noise Path Enable. It gives a lower noise floor, especially in the 21–26.5 GHz region, though without improving many measures of dynamic range, and without giving the best possible noise floor. The preamp, if purchased and used, gives better noise floor than does the Low Noise Path, however its compression threshold and third-order intercept are much poorer than that of the non-preamp Low Noise Path. There are some applications, typically for signals around –30 dBm, for which the third-order dynamic range of the standard path is good enough, but the noise floor is not low enough even with 0 dB input attenuation. When the third-order dynamic range of the preamp path is too little and the noise floor of the standard path is too high, the Low Noise Path can provide the best dynamic range.

Key Path	AMPTD Y Scale
Mode	SA, BASIC, PNOISE, VSA , LTE, LTETDD
Scope	Meas Global
<b>Remote Command</b>	[ :SENSe] :POWer [ :RF] :MW:PATH STD LNPath MPBypass FULL [ :SENSe] :POWer [ :RF] :MW:PATH?
<b>Example</b>	:POW:MW:PATH LNP Enables the Low Noise path
Notes	If a Presel Center is performed, the analyzer will momentarily switch to the Standard Path, regardless of the setting of $\mu$ W Path Control  The DC Block will always be switched in when the low noise path is switched in, to protect succeeding circuitry from DC. Note that this does not mean “when the low noise path is enabled” but when, based on the Low Noise Path rules, the path is actually switched in. This can happen when the selection is Low Noise Path Enable . In the case where the DC Block is switched in the analyzer is now AC coupled. However, if the user has selected DC coupling, the UI will still behave as though it were DC coupled, including all annunciation, warnings, status bits, and responses to SCPI queries. This is because, based on other settings, the analyzer could switch out the low noise path at any time and hence go back to being DC coupled.  Alignment switching ignores the settings in this menu, and restores them when finished.
Dependencies	Unavailable in BBIQ and External Mixing
Preset	All modes other than IQ Analyzer mode and VXA: STD IQ Analyzer, VXA and WLAN mode: MPB option present and licensed: MPB MPB option not present and licensed: STD
State Saved	Save in instrument state
Readback	Value selected in the submenu
Initial S/W Revision	A.04.00
Modified at S/W Revision	A.10.00

## Standard Path

This path gives the best remote-control throughput, minimizes acoustic noise from switching and minimizes the risk of wear in the hardware switches, particularly in remote test scenarios where both low band and high band setups will follow in rapid succession.

In this path, the bypass of the low band/high band switch and microwave preamp is never activated, which can cause some noise degradation but preserves the life of the bypass switch.

Key Path	AMPTD Y Scale, $\mu$ W Path Control
<b>Example</b>	:POW:MW:PATH STD
Readback Text	Standard Path
Initial S/W Revision	A.04.00

## Low Noise Path Enable

You may choose Low Noise Path Enable, which gives a lower noise floor under some circumstances, particularly when operating in the 21–26.5 GHz region. With the Low Noise Path enabled, the low band/high band switch and microwave preamp are bypassed whenever all of the following are true:

- The analyzer is not in the Low Band, meaning:
- the start frequency is above 3.5 GHz and
- the stop frequency is above 3.6 GHz.
- the internal preamp is not installed or (if installed) is set to Off or Low Band

Note that this means that, when any part of a sweep is done in Low Band, the Low Noise Path is not used, whether or not the Low Noise Path Enable is selected in the user interface. Also, if the preamp is turned on, the Low Noise Path is not used, whether or not the Low Noise Path Enable is selected in the user interface. The only time the Low Noise Path is used is when Low Noise Path Enable is selected, the sweep is completely in High Band (> 3.6 GHz) and no preamp is in use.

See "[More Information](#)" on page 1526

Key Path	AMPTD Y Scale, $\mu$ W Path Control
Measurement	Swept SA
<b>Example</b>	:POW:MW:PATH LNP
Notes	<p>For measurements that use IQ acquisition, the low noise path is used when the Center Frequency is in High Band (&gt; 3.6 GHz) and no preamp is in use.</p> <p>In other words, the rules above are modified to use only the center frequency to qualify which path to switch in.</p> <p>This is not the case for FFT's in the Swept SA measurement; they use the same rules as swept measurements.</p>
Dependencies	<p>Key is blanked if current mode does not support it.</p> <p>Key is grayed out if mode supports it but current measurement does not support it.</p> <p>Unless Option LNP is present and licensed, key is blank and if SCPI command sent, error -241, "Hardware missing; Option not installed" is generated.</p>
Readback Text	Low Noise Path Enable
Initial S/W Revision	A.04.00

## More Information

The user should understand that the Low Noise Path, while giving improved DANL, has the disadvantage of decreased TOI performance and decreased gain compression performance relative to the standard path.

The user should also understand that the bypass switch is a mechanical switch and has finite life, so if the Low Noise Path is enabled, it is possible to cause frequent cycling of this switch by frequently changing analyzer settings such that the above conditions hold true only some of the time. A user making tests of this nature should consider opting for the Standard Path, which will never throw the bypass switch, at the expense of some degraded noise performance.

The low noise path is useful for situations where the signal level is so low that the analyzer performance is dominated by noise even with 0 dB attenuation, but still high enough that the preamp option would have excessive third-order intermodulation or compression. The preamp, if purchased and used, gives better noise floor than does the “Low Noise Path.” However, its compression threshold and third-order intercept are much poorer than that of the non-preamp path. There are some applications, typically for signals around -30 dBm, for which the third-order dynamic range of the standard path is good enough, but the noise floor is not low enough even with 0 dB input attenuation. When the third-order dynamic range of the preamp path is too little and the noise floor of the standard path is too high, the Low Noise Path can provide the best dynamic range

The graph below illustrates the concept. It shows, in red, the performance of an analyzer at different attenuation settings, both with the preamp on and off, in a measurement that is affected by both analyzer noise and analyzer TOI. The green shows the best available dynamic range, offset by 0.5 dB for clarity. The blue shows how the best available dynamic range improves for moderate signal levels with the low noise path switched in. In this illustration, the preamp improves the noise floor by 15 dB while degrading the third-order intercept by 30 dB, and the low noise path reduces loss by 8 dB. The attenuator step size is 2 dB.

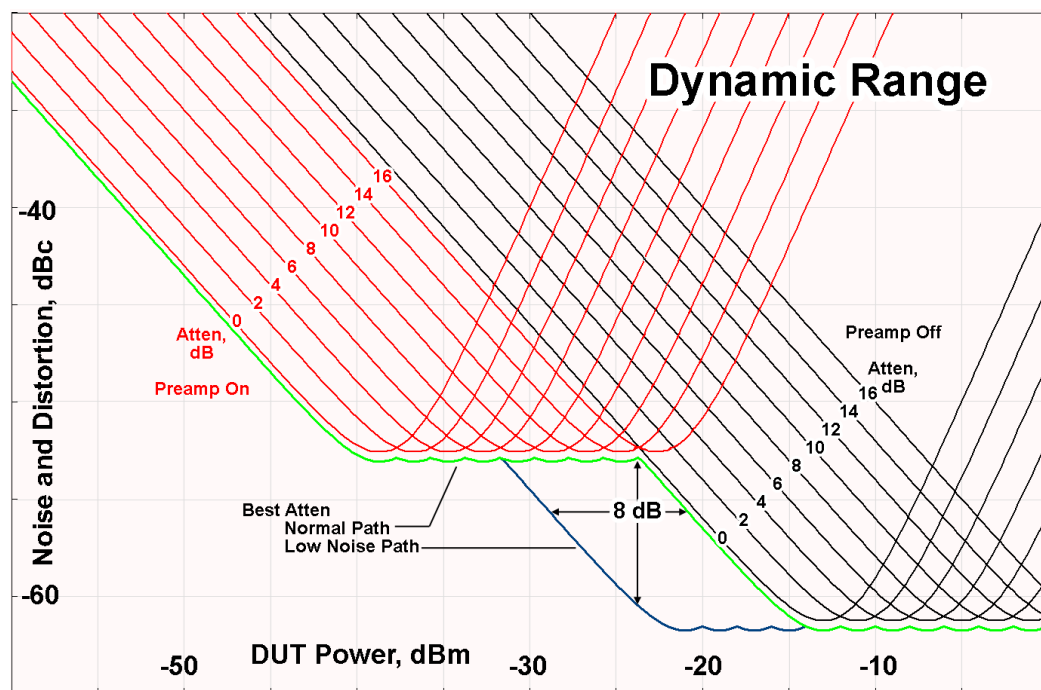

There are other times where selecting the low noise path improves performance, too. Compression-limited measurements such as finding the nulls in a pulsed-RF spectrum can profit from the low noise path in a way similar to the TOI-limited measurement illustrated. Accuracy can be improved when the low noise path allows the optimum attenuation to increase from a small amount like 0, 2 or 4 dB to a larger amount, giving better return loss at the analyzer input. Harmonic measurements, such as second and third harmonic levels, are much improved using the low noise path because of the superiority of that path for harmonic (though not intermodulation) distortion performance.

## μW Preselector Bypass

This key toggles the preselector bypass switch for band 1 and higher. When the microwave preselector is on, the signal path is preselected. When the microwave preselector is off, the signal path is not preselected. The preselected path is the normal path for the analyzer.

The preselector is a tunable bandpass filter which prevents signals away from the frequency of interest from combining in the mixer to generate in-band spurious signals (images). The consequences of using a preselector filter are its limited bandwidth, the amplitude and phase ripple in its passband, and any amplitude and phase instability due to center frequency drift.

Option MPB or pre-selector bypass provides an unpreselected input mixer path for certain X-Series signal analyzers with frequency ranges above 3.6 GHz. This signal path allows a wider bandwidth and less amplitude variability, which is an advantage when doing modulation analysis and broadband signal analysis. The disadvantage is that, without the preselector, image signals will be displayed. Another disadvantage of bypassing the preselector is increased LO emission levels at the front panel input port.

Image responses are separated from the real signal by twice the 1st IF. For IF Paths of 10 MHz and 25 MHz, the 1st IF is 322.5 MHz, so the image response and the real signal will be separated by 645 MHz. The 1st IF will be different for other IF Path settings. When viewing a real signal and its corresponding image response in internal mixing, the image response will be to the left of the real signal.

Also, the image response and the real signal typically have the same amplitude and exhibit the same shape factor.

However, if Option FS1, Fast Sweep Capability, is enabled, the image response in the Swept SA measurement will appear lower in amplitude and have a much wider shape factor compared to the real signal.

Key Path	AMPTD Y Scale, μW Path Control
Example	:POW:MW:PATH MPB
Dependencies	Key is blanked if current mode does not support it. Key is grayed out if mode supports it but current measurement does not support it. Key is blank unless Option MPB is present and licensed. If SCPI command sent when MPB not present, error -241, "Hardware missing; Option not installed" is generated.
Readback Text	μW Preselector Bypass
Initial S/W Revision	A.04.00

Remote Command	<code>[ :SENSe ] :POWer [ :RF ] :MW:PRESelector [ :STATe ] ON   OFF   0   1</code> <code>[ :SENSe ] :POWer [ :RF ] :MW:PRESelector [ :STATe ] ?</code>
Example	:POW:MW:PRES OFF Bypasses the microwave preselector
Notes	The ON parameter sets the STD path (:POW:MW:PATH STD) The OFF parameter sets path MPB (:POW:MW:PATH MPB)
Preset	ON



## Scale Type

Sets Y Scale Type. This key is visible only when the current window is MER/EVM vs. Sub-carrier/ Frequency window. If it is set to MER, the Y scale displays the MER value. If it is set to EVM, the Y scale displays the EVM value.

Key Path	AMPTD Y Scale, More
Mode	DVB-T/H
Remote Command	:DISPlay:EVMTtwo:VIEW2:WINDow[1]:TRACe:Y[:SCALe]:TYPE MER   EVM :DISPlay:EVMTtwo:VIEW2:WINDow[1]:TRACe:Y[:SCALe]:TYPE?
Example	DISP:EVMT:VIEW2:WIND:TRAC:Y:TYPE MER DISP:EVMT:VIEW2:WIND:TRAC:Y:TYPE?
Preset	MER
State Saved	No
Range	MER   EVM
Initial S/W Revision	A.07.00

## Internal Preamp

Accesses a menu of keys that control the internal preamps. Turning on the preamp gives a better noise figure, but a poorer TOI to noise floor dynamic range. You can optimize this setting for your particular measurement.

The instrument takes the preamp gain into account as it sweeps. If you sweep outside of the range of the preamp the instrument will also account for that. The displayed result will always reflect the correct gain.

For some measurements, when the preamp is on and any part of the displayed frequency range is below the lowest frequency for which the preamp has specifications, a warning condition message appears in the status line. For example ,for a preamp with a 9 kHz lowest specified frequency: "Preamp: Accy unspec'd below 9 kHz".

Key Path	AMPTD Y Scale
Scope	Meas Global
Remote Command	[:SENSe]:POWer[:RF]:GAIN[:STATe] OFF ON 0 1 [:SENSe]:POWer[:RF]:GAIN[:STATe]?
Dependencies	Preamp is not available on all hardware platforms. If the preamp is not present or is unlicensed, the key is not shown. The preamp is not available when the electronic/soft attenuator is enabled.
Couplings	The act of connecting the U7227A USB Preamplifier to one of the analyzer's USB ports will cause the Internal Preamp to be switched on. When this happens an informational message will be generated: "Internal Preamp turned on for optimal operation with USB Preamp." Note that if the Internal Preamp was already on, there will be no change to the setting, but if it was Off it will be switched On, to Full Range.

---

	Note that this same action occurs when the SA mode is selected while the USB Preamp is connected to one of the analyzer's USB ports, if it is the first time that the SA mode has run since powerup, or if the last time the SA mode was running the USB Preamp was NOT connected. Subsequently disconnecting the USB Preamp from USB does not change the Internal Preamp setting nor restore the previous setting.
Preset	OFF
State Saved	Saved in instrument state
Initial S/W Revision	Prior to A.02.00
Modified at S/W Revision	A.14.00

---

Key Path	AMPTD Y Scale, Internal Preamp
Scope	Meas Global
<b>Remote Command</b>	[ :SENSe ] :POWer [ :RF ] :GAIN:BAND LOW FULL [ :SENSe ] :POWer [ :RF ] :GAIN:BAND?
Dependencies	Preamp is not available on all hardware platforms. If the preamp is not present or is unlicensed, the key is not shown. If a POW:GAIN:BAND FULL command is sent when a low band preamp is available, the preamp band parameter is to LOW instead of FULL, and an "Option not installed" message is generated.
Preset	LOW
State Saved	Saved in instrument state
Initial S/W Revision	Prior to A.02.00

---

## Off

Turns the internal preamp off

Key Path	AMPTD Y Scale, Internal Preamp
<b>Example</b>	:POW:GAIN OFF
Readback	Off
Initial S/W Revision	Prior to A.02.00

---

## Low Band

Sets the internal preamp to use only the low band.

The frequency range of the installed (optional) low-band preamp is displayed in square brackets on the Low Band key label.

Key Path	AMPTD Y Scale, Internal Preamp
<b>Example</b>	:POW:GAIN ON

---

	:POW:GAIN:BAND LOW
Readback	Low Band
Initial S/W Revision	Prior to A.02.00

## Full Range

Sets the internal preamp to use its full range. The low band (0–3.6 GHz or 0–3GHz, depending on the model) is supplied by the low band preamp and the frequencies above low band are supplied by the high band preamp.

The frequency range of the installed (optional) preamp is displayed in square brackets on the Full Range key label. If the high band option is not installed the Full Range key does not appear.

Key Path	AMPTD Y Scale, Internal Preamp
<b>Example</b>	:POW:GAIN ON :POW:GAIN:BAND FULL
Readback	Full Range
Initial S/W Revision	Prior to A.02.00

## Range

This key is only available when I/Q is the selected input. It replaces the Attenuation key in that case.

Each input channel (I and Q) has four internal gain ranges. The maximum allowed voltage in each gain range is slightly more than the nominal value, so the break point between ranges is a couple of millivolts higher than the nominal (setting a peak voltage of 0.502 mV will still map to the 0.5 V Peak range).

Gain Setting	Volts RMS	Volts Peak	Volts Peak - Peak	dBm (50Ω)	Break Point
0 dB	0.7071	1.0	2.0	10	n/a
6 dB	0.3536	0.5	1.0	4	0.502 V Peak
12 dB	0.1768	0.25	0.5	-2	0.252 V Peak
18 dB	0.0884	0.125	0.25	-8	0.127 V Peak

Key Path	AMPTD Y Scale
Notes	Visible only when the selected input is I/Q.
State Saved	No
Readback Text	When Range is Auto, "[Auto]" When Range is Man and I & Q are the same, "[<range value>]" When Range is Man and I & Q are different: "[I: <I range value>]"

	Q: <Q range value>]" See I Range and Q Range for the <range value> enumeration definition.
Initial S/W Revision	Prior to A.02.00

## Range Auto/Man

The Auto setting for Range causes the range to be set based on the Y Scale settings. When Range is "Auto", the I & Q Range are set based on the top of the Y Scale when the Y scale is in dB units (for example, power), or to the max(abs(top), abs(bottom)) when the Y scale reference is not at the top of the screen.

Not all measurements support Range Auto/Man. If Auto is not supported in the current measurement, this key is grayed out and shows "Man" and MAN is returned to a SCPI query, but this does NOT change the Auto/Man setting for Range. When you go to a measurement that supports Auto, it goes back to Auto if it was previously in Auto mode.

Key Path	AMPTD Y Scale, Range
Scope	Meas Global
Remote Command	[ :SENSe ] :VOLTage :IQ :RANGe :AUTO OFF   ON   0   1 [ :SENSe ] :VOLTage :IQ :RANGe :AUTO ?
Example	Put the I Range and Q Range in manual. VOLT:IQ:RANG:AUTO OFF
Dependencies	If Auto is not supported, sending the SCPI command will generate an error.
Couplings	When in Auto, both I Range and Q Range are set to the same value, computed as follows: Maximum absolute value is computed for the Y Scale. The top and bottom of the graph are computed based on Ref Value, Scale/Div, and Ref Position. Formula: YMax = max(abs(top), abs(bottom)). The I Range and Q Range are then set to YMax.
Preset	ON
State Saved	Saved in instrument state
Range	Auto   Man
Initial S/W Revision	Prior to A.02.00

Remote Command	[ :SENSe ] :POWer :IQ :RANGe :AUTO OFF   ON   0   1 [ :SENSe ] :POWer :IQ :RANGe :AUTO ?
Example	Put the I Range and Q Range in manual. POW:IQ:RANG:AUTO OFF
Notes	The POW:IQ:RANG:AUTO is an alternate form of the VOLT:IQ:RANG:AUTO command. This is to maintain consistency with I Range and Q Range, which support both the POWer and VOLTage forms of the command.
Preset	ON
Range	Auto   Man
Initial S/W Revision	Prior to A.02.00

## I Range

This is the internal gain range for the I channel when Input Path is I Only or I and I/Q, and it is used for both the I and Q channels when the Input Path is I+jQ. See "[I/Q Gain Ranges](#)" on page 2127.

Key Path	AMPTD Y Scale, Range
<b>Remote Command</b>	<code>[ :SENSe ] :VOLTage:IQ[:I]:RANGe[:UPPer] &lt;voltage&gt;</code> <code>[ :SENSe ] :VOLTage:IQ[:I]:RANGe[:UPPer] ?</code>
<b>Example</b>	Set the I Range to 0.5 V Peak <code>VOLT:IQ:RANG 0.5 V</code>
Notes	The numeric entries are mapped to the smallest gain range whose break point is greater than or equal to the value, or 1 V Peak if the value is greater than 1 V.
Couplings	When Q Same as I is On, the I Range value will be copied to the Q Range. Changing the value will also set Range = Man.
Preset	1 V Peak
State Saved	Saved in instrument state
Range	1 V Peak   0.5 V Peak   0.25 V Peak   0.125 V Peak
Min	0.125 V
Max	1 V
Initial S/W Revision	Prior to A.02.00

<b>Remote Command</b>	<code>[ :SENSe ] :POWer:IQ[:I]:RANGe[:UPPer] &lt;ampl&gt;</code> <code>[ :SENSe ] :POWer:IQ[:I]:RANGe[:UPPer] ?</code>
<b>Example</b>	Set the I Range to 0.5 V Peak when Reference Z is 50Ω, and to 1.0 V Peak when Reference Z is 75Ω. <code>POW:IQ:RANG 4 dBm</code>
Notes	The POWER form of the command is provided for convenience. It maps to the same underlying gain range parameter as the VOLTage form of the command. The Reference Z (not the I channel Input Z) is used to convert the power to peak voltage, which is then used to set the I Range as with the VOLTage form of the command. The power values of the 4 range states (1V Peak, 0.5V Peak, 0.25V Peak, and 0.125V Peak) will vary with Reference Z. Here are some examples: 50Ω: 10, 4, -2, -8 75Ω: 8.2, 2.2, -3.8, -9.8 600Ω: -0.8, -6.8, -12.8, -18.9
Preset	10.0 dBm
Range	-20 dBm to 10 dBm
Min	-20 dBm
Max	10 dBm
Initial S/W Revision	Prior to A.02.00

### 1 V Peak

Set the channel gain state to 1 Volt Peak.

Key Path	AMPTD Y Scale, I Range   Q Range
Initial S/W Revision	Prior to A.02.00

### 0.5 V Peak

Set the channel gain state to 0.5 Volt Peak.

Key Path	AMPTD Y Scale, I Range   Q Range
Initial S/W Revision	Prior to A.02.00

### 0.25 V Peak

Set the channel gain state to 0.25 Volt Peak.

Key Path	AMPTD Y Scale, I Range   Q Range
Initial S/W Revision	Prior to A.02.00

### 0.125 V Peak

Set the channel gain state to 0.125 Volt Peak.

Key Path	AMPTD Y Scale, I Range   Q Range
Initial S/W Revision	Prior to A.02.00

### Q Range Value

This is the internal gain range for the Q channel. See "[I/Q Gain Ranges](#)" on page 2127. The Q Range only applies to Input Path Q Only and Ind I/Q. For input I+jQ the I Range determines both I and Q channel range settings.

Key Path	AMPTD Y Scale, Range
Remote Command	<code>[ :SENSe ] :VOLTage:IQ:Q:RANGe[:UPPer] &lt;voltage&gt;</code> <code>[ :SENSe ] :VOLTage:IQ:Q:RANGe[:UPPer] ?</code>
Example	Set the Q Range to 0.5 V Peak <code>VOLT:IQ:Q:RANG 0.5 V</code>
Notes	The numeric entries are mapped to the smallest gain range whose break point is greater than or

	equal to the value, or 1 V Peak if the value is greater than 1 V. The Q Range is only used for Input Path Q Only and Ind I/Q. For input I+jQ the I Range determines both I and Q channel range settings.
Couplings	When Q Same as I is On, the I Range value will be copied to the Q Range and the range value keys are disabled. Changing the value will also set Range = Man.
Preset	1 V Peak
State Saved	Saved in instrument state
Range	1 V Peak   0.5 V Peak   0.25 V Peak   0.125 V Peak
Min	0.125 V
Max	1 V
Initial S/W Revision	Prior to A.02.00

<b>Remote Command</b>	<code>[ :SENSe ] :POWer :IQ :Q :RANGe [ :UPPer ] &lt;amp;l&gt;</code> <code>[ :SENSe ] :POWer :IQ :Q :RANGe [ :UPPer ] ?</code>
<b>Example</b>	Will set the Q Range to 0.5 V Peak when Reference Z is 50Ω, and to 1.0 V Peak when Reference Z is 75Ω. <code>POW:IQ:Q:RANG 4 dBm</code>
<b>Notes</b>	The POWER form of the command is provided for convenience. It maps to the same underlying gain range parameter as the VOLTage form of the command. The Reference Z (not the Q channel Input Z) is used to convert the power to peak voltage, which is then used to set the Q Range as with the VOLTage form of the command. The power values of the 4 range states (1V Peak, 0.5V Peak, 0.25V Peak, and 0.125V Peak) will vary with Reference Z. Here are some examples: 50Ω: 10, 4, -2, -8 75Ω: 8.2, 2.2, -3.8, -9.8 600Ω: -0.8, -6.8, -12.8, -18.9
Preset	10.0 dBm
Range	-20 dBm to 10 dBm
Min	-20 dBm
Max	10 dBm
Initial S/W Revision	Prior to A.02.00

### Q Same as I

Many, but not all, usages require the I and Q channels to have an identical setup. To simplify channel setup, the Q Same as I will cause the Q channel range to be mirrored from the I channel. That way you only need to set up one channel (the I channel). The I channel values are copied to the Q channel, so at the time Q Same as I is Off, the I and Q channel setups will be identical.

Key Path	AMPTD Y Scale, Range, Q Range
Remote Command	[ :SENSe ] :VOLTage   POWer :IQ :MIRRored OFF   ON   0   1 [ :SENSe ] :VOLTage   POWer :IQ :MIRRored ?
Example	Turn off the mirroring of I Range to Q Range. VOLT:IQ:MIRR OFF POW:IQ:MIRR OFF
Couplings	When On, the I Range value is mirrored (copied) to the Q Range.
Preset	On
State Saved	Saved in instrument state.
Range	On   Off
Readback Text	"Q Same as I" when On, otherwise none.
Initial S/W Revision	Prior to A.02.00

### 1 V Peak

Set the channel gain state to 1 Volt Peak.

Key Path	AMPTD Y Scale, I Range   Q Range
Initial S/W Revision	Prior to A.02.00

### 0.5 V Peak

Set the channel gain state to 0.5 Volt Peak.

Key Path	AMPTD Y Scale, I Range   Q Range
Initial S/W Revision	Prior to A.02.00

### 0.25 V Peak

Set the channel gain state to 0.25 Volt Peak.

Key Path	AMPTD Y Scale, I Range   Q Range
Initial S/W Revision	Prior to A.02.00

### 0.125 V Peak

Set the channel gain state to 0.125 Volt Peak.

Key Path	AMPTD Y Scale, I Range   Q Range
Initial S/W Revision	Prior to A.02.00



## I/Q Gain Ranges

See the following sections:

["1 V Peak" on page 2127](#)

["0.5 V Peak" on page 2128](#)

["0.25 V Peak" on page 2128](#)

["0.125 V Peak" on page 2128](#)

### 1 V Peak

Set the channel gain state to 1 Volt Peak.

Key Path	AMPTD Y Scale, I Range   Q Range
Initial S/W Revision	Prior to A.02.00

### 0.5 V Peak

Set the channel gain state to 0.5 Volt Peak.

Key Path	AMPTD Y Scale, I Range   Q Range
Initial S/W Revision	Prior to A.02.00

### 0.25 V Peak

Set the channel gain state to 0.25 Volt Peak.

Key Path	AMPTD Y Scale, I Range   Q Range
Initial S/W Revision	Prior to A.02.00

### 0.125 V Peak

Set the channel gain state to 0.125 Volt Peak.

Key Path	AMPTD Y Scale, I Range   Q Range
Initial S/W Revision	Prior to A.02.00

## Ref Position

This key allows you to set the displayed reference position to either Top, Ctr (center), or Bot (bottom). The key is active in MER/EVM vs. Sub-carrier/Frequency window, Amptd vs. Sub-carrier window, Phase vs.

Sub-carrier window, Group Delay vs. Sub-carrier window, Amptd vs. Time window, and MER vs. Time window.

Key Path	AMPTD Y Scale
Initial S/W Revision	A.07.00

### Y Ref Position (I/Q Error View – MER/EVM vs. Sub-carrier/Frequency Window)

This key sets the Y-axis reference position in the MER/EVM vs. Sub-carrier/Frequency window.

Key Path	AMPTD Y Scale, More
Mode	DVB-T/H
<b>Remote Command</b>	:DISPlay:EVMTtwo:VIEW2:WINDow[1]:TRACe:Y[:SCALE]:RPOSition TOP   CENTer   BOTTom  :DISPlay:EVMTtwo:VIEW2:WINDow[1]:TRACe:Y[:SCALE]:RPOSition?
<b>Example</b>	DISP:EVMT:VIEW2:WIND:TRAC:Y:RPOS TOP DISP:EVMT:VIEW2:WIND:TRAC:Y:RPOS?
Notes	SCPI Remarks: VIEW2: I/Q Error View WINDow[1]: MER/EVM vs. Sub-carrier/Frequency Window on I/Q Error View
Preset	TOP
State Saved	No
Range	Top   Ctr   Bot
Initial S/W Revision	A.07.00

### Y Ref Position (Channel Frequency Response View – Amptd vs. Sub-carrier Window)

This key sets the Y-axis reference position in the Amptd vs. Sub-carrier window.

Key Path	AMPTD Y Scale, More
Mode	DVB-T/H
<b>Remote Command</b>	:DISPlay:EVMTtwo:VIEW3:WINDow[1]:TRACe:Y[:SCALE]:RPOSition TOP   CENTer   BOTTom  :DISPlay:EVMTtwo:VIEW3:WINDow[1]:TRACe:Y[:SCALE]:RPOSition?
<b>Example</b>	DISP:EVMT:VIEW3:WIND:TRAC:Y:RPOS TOP DISP:EVMT:VIEW3:WIND:TRAC:Y:RPOS?
Notes	SCPI Remarks: VIEW3: Channel Frequency Response View WINDow[1]: Amptd vs. Sub-carrier Window
Preset	TOP

State Saved	No
Range	Top   Ctr   Bot
Initial S/W Revision	A.07.00

### Y Ref Position (Channel Frequency Response View – Phase vs. Sub-carrier Window)

This key sets the Y-axis reference position in the Phase vs. Sub-carrier window.

Key Path	AMPTD Y Scale, More
Mode	DVB-T/H
Remote Command	:DISPlay:EVMTtwo:VIEW3:WINDow2:TRACe:Y[:SCALE]:RPOSition TOP   CENTer   BOTTom :DISPlay:EVMTtwo:VIEW3:WINDow2:TRACe:Y[:SCALE]:RPOSition?
Example	DISP:EVMT:VIEW3:WIND2:TRAC:Y:RPOS CENT DISP:EVMT:VIEW3:WIND2:TRAC:Y:RPOS?
Notes	SCPI Remarks: VIEW3: Channel Frequency Response View WINDow2: Phase vs. Sub-carrier Window
Preset	CENT
State Saved	No
Range	Top   Ctr   Bot
Initial S/W Revision	A.07.00

### Y Ref Position (Channel Frequency Response View –Group Delay vs. Sub-carrier Window)

This key sets the Y-axis reference position in the Group Delay vs. Sub-carrier window.

Key Path	AMPTD Y Scale, More
Mode	DVB-T/H
Remote Command	:DISPlay:EVMTtwo:VIEW3:WINDow3:TRACe:Y[:SCALE]:RPOSition TOP   CENTer   BOTTom :DISPlay:EVMTtwo:VIEW3:WINDow3:TRACe:Y[:SCALE]:RPOSition?
Example	DISP:EVMT:VIEW3:WIND3:TRAC:Y:RPOS CENT DISP:EVMT:VIEW3:WIND3:TRAC:Y:RPOS?
Notes	SCPI Remarks: VIEW3: Channel Frequency Response View WINDow3: Group Delay vs. Sub-carrier Window
Preset	CENT
State Saved	No

Range	Top   Ctr   Bot
Initial S/W Revision	A.07.00

### Y Ref Position (Channel Impulse Response View – Amptd vs. Time Window)

This key sets the Y-axis reference position in the Amptd vs. Time window.

Key Path	AMPTD Y Scale, More
Mode	DVB-T/H
<b>Remote Command</b>	:DISPlay:EVMTtwo:VIEW4:WINDow[1]:TRACe:Y[:SCALe]:RPOSition TOP   CENTer   BOTTom  :DISPlay:EVMTtwo:VIEW4:WINDow[1]:TRACe:Y[:SCALe]:RPOSition?
<b>Example</b>	DISP:EVMT:VIEW4:WIND:TRAC:Y:RPOS TOP DISP:EVMT:VIEW4:WIND:TRAC:Y:RPOS?
Notes	SCPI Remarks: VIEW4: Channel Impulse Response View WINDow[1]: Amptd vs. Time Window
Preset	TOP
State Saved	No
Range	Top   Ctr   Bot
Initial S/W Revision	A.07.00

### Y Ref Position (MER Monitor View – MER vs. Time Window)

This key sets the Y-axis reference position in the MER vs. Time window.

Key Path	AMPTD Y Scale, More
Mode	DVB-T/H
<b>Remote Command</b>	:DISPlay:EVMTtwo:VIEW5:WINDow[1]:TRACe:Y[:SCALe]:RPOSition TOP   CENTer   BOTTom  :DISPlay:EVMTtwo:VIEW5:WINDow[1]:TRACe:Y[:SCALe]:RPOSition?
<b>Example</b>	DISP:EVMT:VIEW5:WIND:TRAC:Y:RPOS TOP DISP:EVMT:VIEW5:WIND:TRAC:Y:RPOS?
Notes	SCPI Remarks: VIEW5: MER Monitor View WINDow[1]: MER vs. Time Window
Preset	TOP
State Saved	No
Range	Top   Ctr   Bot
Initial S/W Revision	A.07.00

## Auto Scaling

This key allows you to toggle the scale coupling function between On and Off. The key is active in MER/EVM vs. Sub-carrier/Frequency window, Amptd vs. Sub-carrier window, Phase vs. Sub-carrier window, Group Delay vs. Sub-carrier window, Amptd vs. Time window, and MER vs. Time window.

Key Path	AMPTD Y Scale
Initial S/W Revision	A.07.00

## Y Auto Scaling (I/Q Error View – MER/EVM vs. Sub-carrier/Frequency Window)

When Auto Scaling is On, the scale per division and reference values are automatically adjusted in the MER/EVM vs. Sub-carrier/Frequency window.

Key Path	AMPTD Y Scale, More
Mode	DVB-T/H
Remote Command	:DISPlay:EVMTtwo:VIEW2:WINDow[1]:TRACe:Y[:SCALe]:COUPle OFF   ON   0   1 :DISPlay:EVMTtwo:VIEW2:WINDow[1]:TRACe:Y[:SCALe]:COUPle?
Example	DISP:EVMT:VIEW2:WIND:TRAC:Y:COUP OFF DISP:EVMT:VIEW2:WIND:TRAC:Y:COUP?
Notes	SCPI Remarks: VIEW2: I/Q Error View WINDow[1]: MER/EVM vs. Sub-carrier/Frequency Window on I/Q Error View
Dependencies	When this parameter is set to On, it will activate the scale coupling function that automatically determines scale per division and reference values based on the measurement results. When you set a value to either Scale/Div or Ref Value manually, Auto Scaling is automatically set to Off.
Preset	ON
State Saved	No
Range	On   Off
Initial S/W Revision	A.07.00

## Y Auto Scaling (Channel Frequency Response View – Amptd vs. Sub-carrier Window)

When Auto Scaling is On, the scale per division and reference values are automatically adjusted in the Amptd vs. Sub-carrier window.

Key Path	AMPTD Y Scale, More
Mode	DVB-T/H
Remote Command	:DISPlay:EVMTtwo:VIEW3:WINDow[1]:TRACe:Y[:SCALe]:COUPle OFF   ON   0   1

	:DISPlay:EVMTtwo:VIEW3:WINDow[1]:TRACe:Y[:SCALe]:COUPle?
<b>Example</b>	DISP:EVMT:VIEW3:WIND:TRAC:Y:COUP OFF DISP:EVMT:VIEW3:WIND:TRAC:Y:COUP?
<b>Notes</b>	SCPI Remarks: VIEW3: Channel Frequency Response View WINDow[1]: Amptd vs. Sub-carrier Window
<b>Dependencies</b>	When this parameter is set to On, it will activate the scale coupling function that automatically determines scale per division and reference values based on the measurement results. When you set a value to either Scale/Div or Ref Value manually, Auto Scaling is automatically set to Off.
<b>Preset</b>	ON
<b>State Saved</b>	No
<b>Range</b>	On   Off
<b>Initial S/W Revision</b>	A.07.00

### Y Auto Scaling (Channel Frequency Response View – Phase vs. Sub-carrier Window)

When Auto Scaling is On, the scale per division and reference values are automatically adjusted in the Phase vs. Sub-carrier window.

<b>Key Path</b>	AMPTD Y Scale, More
<b>Mode</b>	DVB-T/H
<b>Remote Command</b>	:DISPlay:EVMTtwo:VIEW3:WINDow2:TRACe:Y[:SCALe]:COUPle OFF   ON   0   1 :DISPlay:EVMTtwo:VIEW3:WINDow2:TRACe:Y[:SCALe]:COUPle?
<b>Example</b>	DISP:EVMT:VIEW3:WIND2:TRAC:Y:COUP OFF DISP:EVMT:VIEW3:WIND2:TRAC:Y:COUP?
<b>Notes</b>	SCPI Remarks: VIEW3: Channel Frequency Response View WINDow2: Phase vs. Sub-carrier Window
<b>Dependencies</b>	When this parameter is set to On, it will activate the scale coupling function that automatically determines scale per division and reference values based on the measurement results. When you set a value to either Scale/Div or Ref Value manually, Auto Scaling is automatically set to Off.
<b>Preset</b>	ON
<b>State Saved</b>	No
<b>Range</b>	On   Off
<b>Initial S/W Revision</b>	A.07.00

### Y Auto Scaling (Channel Frequency Response View –Group Delay vs. Sub-carrier Window)

When Auto Scaling is On, the scale per division and reference values are automatically adjusted in the Group Delay vs. Sub-carrier window.

Key Path	AMPTD Y Scale, More
Mode	DVB-T/H
Remote Command	:DISPlay:EVMTtwo:VIEW3:WINDow3:TRACe:Y[:SCALe]:COUPle OFF   ON   0   1 :DISPlay:EVMTtwo:VIEW3:WINDow3:TRACe:Y[:SCALe]:COUPle?
Example	DISP:EVMT:VIEW3:WIND3:TRAC:Y:COUP OFF DISP:EVMT:VIEW3:WIND3:TRAC:Y:COUP?
Notes	SCPI Remarks: VIEW3: Channel Frequency Response View WINDow3: Group Delay vs. Sub-carrier Window
Dependencies	When this parameter is set to On, it will activate the scale coupling function that automatically determines scale per division and reference values based on the measurement results. When you set a value to either Scale/Div or Ref Value manually, Auto Scaling is automatically set to Off.
Preset	ON
State Saved	No
Range	On   Off
Initial S/W Revision	A.07.00

### Y Auto Scaling (Channel Impulse Response View – Amptd vs. Time Window)

When Auto Scaling is On, the scale per division and reference values are automatically adjusted in the Amptd vs. Time window.

Key Path	AMPTD Y Scale, More
Mode	DVB-T/H
Remote Command	:DISPlay:EVMTtwo:VIEW4:WINDow[1]:TRACe:Y[:SCALe]:COUPle OFF   ON   0   1 :DISPlay:EVMTtwo:VIEW4:WINDow[1]:TRACe:Y[:SCALe]:COUPle?
Example	DISP:EVMT:VIEW4:WIND:TRAC:Y:COUP OFF DISP:EVMT:VIEW4:WIND:TRAC:Y:COUP?
Notes	SCPI Remarks: VIEW4: Channel Impulse Response View WINDow[1]: Amptd vs. Time Window
Dependencies	When this parameter is set to On, it will activate the scale coupling function that automatically determines scale per division and reference values based on the measurement results. When you set a value to either Scale/Div or Ref Value manually, Auto Scaling is automatically set to Off.
Preset	ON
State Saved	No
Range	On   Off
Initial S/W Revision	A.07.00

### Y Auto Scaling (MER Monitor View – MER vs. Time Window)

When Auto Scaling is On, the scale per division and reference values are automatically adjusted in the MER vs. Time window.

<b>Key Path</b>	AMPTD Y Scale, More
<b>Mode</b>	DVB-T/H
<b>Remote Command</b>	:DISPlay:EVMTtwo:VIEW5:WINDow[1]:TRACe:Y[:SCALe]:COUPle OFF   ON   0   1 :DISPlay:EVMTtwo:VIEW5:WINDow[1]:TRACe:Y[:SCALe]:COUPle?
<b>Example</b>	DISP:EVMT:VIEW5:WIND:TRAC:Y:COUP OFF DISP:EVMT:VIEW5:WIND:TRAC:Y:COUP?
<b>Notes</b>	SCPI Remarks: VIEW5: MER Monitor View WINDow[1]: MER vs. Time Window
<b>Dependencies</b>	When this parameter is set to On, it will activate the scale coupling function that automatically determines scale per division and reference values based on the measurement results. When you set a value to either Scale/Div or Ref Value manually, Auto Scaling is automatically set to Off.
<b>Preset</b>	OFF
<b>State Saved</b>	No
<b>Range</b>	On   Off
<b>Initial S/W Revision</b>	A.07.00



## Auto Couple

The Auto Couple feature provides a quick and convenient way to automatically couple multiple instrument settings. This helps ensure accurate measurements and optimum dynamic range. When the Auto Couple feature is activated, either from the front panel or remotely, all parameters of the current measurement that have an Auto/Manual mode are set to Auto mode and all measurement settings dependent on (or coupled to) the Auto/Man parameters are automatically adjusted for optimal performance.

However, the Auto Couple key actions are confined to the current measurement only. It does not affect other measurements in the mode, and it does not affect markers, marker functions, or trace or display attributes.

See "[More Information](#)" on page 1545

Key Path	Front-panel key
Remote Command	:COUPle ALL NONE
Example	:COUP ALL
Notes	:COUPle ALL puts all Auto/Man parameters in Auto mode (equivalent to pressing the Auto Couple key). :COUPLE NONE puts all Auto/Man parameters in manual mode. It decouples all the coupled instrument parameters and is not recommended for making measurements.
Initial S/W Revision	Prior to A.02.00

### More Information

There are two types of functions that have Auto/Manual modes.

#### Auto/Man Active Function keys

An Auto/Man toggle key controls the binary state associated with an instrument parameter by toggling between Auto (where the parameter is automatically coupled to the other parameters it is dependent upon) and Man (where the parameter is controlled independent of the other parameters), as well as making the parameter the active function. The current mode is indicated on the softkey with either Auto or Man underlined as illustrated below.



#### Auto/Man 1-of-N keys

An Auto/Man 1-of-N key allows you to manually pick from a list of parameter values, or place the function in Auto, in which case the value is automatically selected (and indicated) as shown below. If in Auto, Auto is underlined on the calling key. If in manual operation, manual is indicated on the calling key. But the calling key does not actually toggle the function, it simply opens the menu.

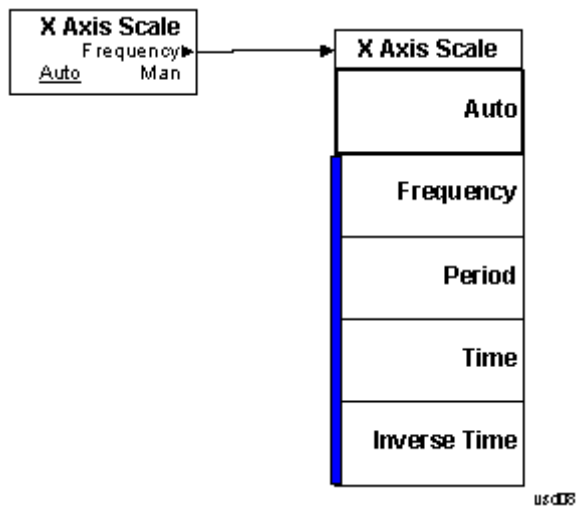

## BW

There is no BW functionality for this measurement.

---

Key Path	Front-panel key
Initial S/W Revision	A.07.00

---

## Cont (Continuous Measurement/Sweep)

Sets the analyzer for Continuous measurement operation. The single/continuous state is Meas Global so the setting will affect all measurements. If you are Paused, pressing Cont does a Resume.

<b>Key Path</b>	Front-panel key
<b>Remote Command</b>	:INITiate:CONTinuous OFF ON 0 1 :INITiate:CONTinuous?
<b>Example</b>	:INIT:CONT 0 puts analyzer in Single measurement operation. :INIT:CONT 1 puts analyzer in Continuous measurement operation
<b>Preset</b>	ON (Note that SYST:PRESet sets INIT:CONT to ON but *RST sets INIT:CONT to OFF)
<b>State Saved</b>	Saved in instrument state
<b>Backwards Compatibility Notes</b>	For Spectrum Analysis mode in ESA and PSA, there is no Cont hardkey, instead there is a Sweep Single/Cont key. In these analyzers, switching the Sweep Single/Cont key from Single to Cont restarts averages (displayed average count reset to 1), but does not restart Max Hold and Min Hold. The X-Series has Single and Cont keys in place of the SweepSingleCont key. In the X-Series, if in single measurement, the Cont key (and INIT:CONT ON ) switches to continuous measurement, but never restarts a measurement and never resets a sweep.
<b>Initial S/W Revision</b>	Prior to A.02.00

In Swept SA Measurement (Spectrum Analysis Mode):

The analyzer takes repetitive sweeps, averages, measurements, etc., when in Continuous mode. When the average count reaches the Average/Hold Number the count stops incrementing, but the analyzer keeps sweeping. See the Trace/Detector section for the averaging formula used both before and after the Average/Hold Number is reached. The trigger condition must be met prior to each sweep. The type of trace processing for multiple sweeps, is set under the Trace/Detector key, with choices of Trace Average, Max Hold, or Min Hold.

In Other Measurements/Modes:

With Avg/Hold Num (in the Meas Setup menu) set to Off or set to On with a value of 1, a sweep is taken after the trigger condition is met; and the analyzer continues to take new sweeps after the current sweep has completed and the trigger condition is again met. However, with Avg/Hold Num set to On with a value >1, multiple sweeps (data acquisitions) are taken for the measurement. The trigger condition must be met prior to each sweep. The sweep is not stopped when the average count k equals the number N set for Avg/Hold Num is reached, but the number k stops incrementing. A measurement average usually applies to all traces, marker results, and numeric results. But sometimes it only applies to the numeric results.

If the analyzer is in Single measurement, pressing the Cont key does not change k and does not cause the sweep to be reset; the only action is to put the analyzer into Continuous measurement operation.

If it is already in continuous sweep:

the INIT:CONT 1 command has no effect

the INIT:CONT 0 command will place the analyzer in Single Sweep but will have no effect on the current sequence until  $k = N$ , at which point the current sequence will stop and the instrument will go to the idle state.

13 DVB-T2 Mod Accuracy Measurement  
File

File

See "File" on page 336

## FREQ Channel

The key accesses a menu allowing you to set Frequency parameters for the current measurement. All measurements in DVB-T/H mode have the same menu structure under FREQ/Channel menu.

Key Path	Front-panel key
Initial S/W Revision	A.02.00

### Channel

Sets the analyzer to a frequency that corresponds to the Channel Number. If the Center Freq value entered does not exactly correlate with the Channel, the displayed value will be “---”.

Key Path	FREQ Channel
Mode	DVB-T/H
<b>Remote Command</b>	<code>[ :SENSe ] :FREQuency:CHANnel:NUMBer &lt;integer&gt;</code> <code>[ :SENSe ] :FREQuency:CHANnel:NUMBer?</code>
<b>Example</b>	FREQ:CHAN:NUMB 21 FREQ:CHAN:NUMB?
Dependencies	If your analyzer has multiple inputs and the selected input is BBIQ, this key will be grayed out and the displaying value will be “---”.
Couplings	Channel is coupled with Center Freq. A certain Channel corresponds to a certain value of Center Freq. If the Center Freq value entered does not exactly correlate with a Channel, the displaying value will be “---”, and the returned value of the SCPI command “FREQ:CHAN:NUMB?” is “-999”.
Preset	21
State Saved	Saved in instrument state.
Min	Depends on the selected channel table
Max	Depends on the selected channel table
Initial S/W Revision	A.02.00

### Center Freq

Sets the center frequency. If your analyzer has multiple inputs (RF and IQ), the displayed value will be updated according to the selected input. SCPI commands are available to directly set the center frequency for a specific input. This key is coupled with Channel when the selected input is RF.

See also:

["RF Center Freq" on page 1553](#)

["IQ Center Freq" on page 1553](#)

Key Path	FREQ Channel
Mode	DVB-T/H
<b>Remote Command</b>	[ :SENSe ] :FREQuency:CENTer <freq> [ :SENSe ] :FREQuency:CENTer?
<b>Example</b>	FREQ:CENT 1.0MHZ FREQ:CENT?
Couplings	Center Freq is coupled with Channel. A certain value of center frequency corresponds to a certain Channel. If the Channel changes, the Center Frequency will be changed to the frequency which is the center of the channel.
Preset	474.00MHz
State Saved	Saved in instrument state.
Min	-79.999995 MHz
Max	Hardware Dependent, for details, see <a href="#">"Maximum Frequency in X - Series Signal Analyzers" on page 1552.</a>
Initial S/W Revision	A.02.00

### Maximum Frequency in X - Series Signal Analyzers

The following table lists the maximum frequency in different X – Series signal analyzers.

Model numbers: N9020A, N9030A

Freq Option	Stop Freq after Mode Preset	Max Freq (can't tune above)
503	3.6 GHz	3.7 GHz
508	8.4 GHz	8.5 GHz
513	13.6 GHz	13.8 GHz
526	26.5 GHz	27.0 GHz
543 (N9030A only)	43 GHz	
544 (N9030A only)	44 GHz	44.5 GHz
550 (N9030A only)	50 GHz	51 GHz

Model number: N9010A

Freq Option	Stop Freq after Mode Preset	Max Freq (can't tune above)
503	3.6 GHz	3.7 GHz
507	7.0 GHz	7.1 GHz



513	13.6 GHz	13.8 GHz
526	26.5 GHz	27.0 GHz
532	32.0 GHz	32.5 GHz
544	44.0 GHz	44.5 GHz

Model number: N9000A

Freq Option	Stop Freq after Mode Preset	Max Freq (can't tune above)
503	3.0 GHz	3.08 GHz
507	7.5 GHz	7.58 GHz

## RF Center Freq

SCPI command to specify the RF Center Frequency. This will always access the RF value, even when the selected input is not RF.

Key Path	FREQ Channel
Mode	DVB-T/H
Remote Command	<code>[ :SENSe ] :FREQuency:RF:CENTer &lt;freq&gt;</code> <code>[ :SENSe ] :FREQuency:RF:CENTer?</code>
Example	FREQ:RF:CENT 1.0MHZ FREQ:RF:CENT?
Couplings	Center Freq is coupled with Channel. A certain value of center frequency corresponds to a certain Channel. If the Channel changes, the Center Frequency will be changed to the frequency which is the center of the channel.
Preset	474.00MHz
State Saved	Saved in instrument state.
Min	-79.999995 MHz
Max	Hardware Dependent, for details, see <a href="#">"Maximum Frequency in X - Series Signal Analyzers" on page 1552.</a>
Initial S/W Revision	A.02.00

## IQ Center Freq

SCPI command to specify the I/Q Center Frequency. This will always access the I/Q value, even when the selected input is not I/Q.

Key Path	FREQ Channel
Mode	DVB-T/H
<b>Remote Command</b>	[ :SENSe ] :FREQuency:IQ:CENTer <freq> [ :SENSe ] :FREQuency:IQ:CENTer?
<b>Example</b>	FREQ:IQ:CENT 1.0MHZ FREQ:IQ:CENT?
Preset	0 Hz
State Saved	Saved in instrument state.
Min	-39.999995 MHz
Max	39.999995 MHz
Initial S/W Revision	A.02.00

### Chan Step

Chan Step changes the step size for the Channel Number.

Key Path	FREQ Channel
Mode	DVB-T/H
<b>Remote Command</b>	[ :SENSe ] :FREQuency:CHANnel:STEP <integer> [ :SENSe ] :FREQuency:CHANnel:STEP?
<b>Example</b>	FREQ:CHAN:STEP 1 FREQ:CHAN:STEP?
Dependencies	If your analyzer has multiple inputs and the selected input is BBIQ, this key will be grayed out.
Preset	1
State Saved	Saved in instrument state.
Min	1
Max	Depends on the selected channel table
Initial S/W Revision	A.02.00

### CF Step

CF Step sets the step size for center frequency. If CF Step State is manual, you can set this value manually. Once CF Step State is changed to auto, CF Step changes to the value of Channel BW automatically.

Key Path	FREQ Channel
Mode	DVB-T/H
<b>Remote Command</b>	[ :SENSe ] :FREQuency:CENTer:STEP [ :INCRement ] <freq> [ :SENSe ] :FREQuency:CENTer:STEP [ :INCRement ] ?

	<code>[ :SENSe ] :FREQuency:CENTer:STEP:AUTO ON OFF 1 0</code>
	<code>[ :SENSe ] :FREQuency:CENTer:STEP:AUTO?</code>
<b>Example</b>	FREQ:CENT:STEP 100KHZ FREQ:CENT:STEP? FREQ:CENT:STEP:AUTO OFF FREQ:CENT:STEP:AUTO?
Couplings	CF Step is coupled to Channel BW (Mode Setup) when CF Step State is 'Auto'.
Preset	8.00MHz ON
State Saved	Saved in instrument state.
Min	1.0 kHz
Max	1 GHz
Initial S/W Revision	A.02.00

## Chan Table

Allows you to choose the appropriate TV standard: NTSC-M, NTSC-J, NTSC-Brazil, PAL-M, PAL-B/G, PAL-D/K, or PAL-I.

Key Path	FREQ Channel
Mode	DVB-T/H
<b>Remote Command</b>	<code>[ :SENSe ] :FREQuency:CHANnel:TABLE[:SElect] MNTSc   JNTSc   BNTSc   MPAL   IPAL   BPAL   DPAL</code> <code>[ :SENSe ] :FREQuency:CHANnel:TABLE[:SElect] ?</code>
<b>Example</b>	FREQ:CHAN:TABL BPAL FREQ:CHAN:TABL?
Dependencies	If your analyzer has multiple inputs and the selected input is BBIQ, this key will be grayed out.
Couplings	Couple with Channel. Setting Chan Table sets the range of Channel to the value corresponding to that Chan Table.
Preset	BPAL
State Saved	Saved in instrument state.
Range	NTSC-M   NTSC-J   NTSC-Brazil   PAL-M   PAL-I   PAL-B/G   PAL-D/K
Initial S/W Revision	A.02.00

## NTSC-M

If the current TV standard is NTSC-M, you can choose the appropriate channel plans in NTSC-M standard: Standard Cable (STD), Broadcast Channel (AIR), HRC Cable (HRC) or IRC Cable (IRC).

Key Path	FREQ Channel, Chan Table
Mode	DVB-T/H
<b>Remote Command</b>	[ :SENSE ] :FREQuency:CHANnel:TABLE:MNTSc [ :SElect ] STD   AIR   HRC   IRC [ :SENSe ] :FREQuency:CHANnel:TABLE:MNTSc [ :SElect ] ?
<b>Example</b>	FREQ:CHAN:TABL:MNTS STD FREQ:CHAN:TABL:MNTS?
Preset	STD
State Saved	Saved in instrument state.
Range	STD   AIR   HRC   IRC
Initial S/W Revision	A.02.00

### NTSC-J

If the current TV standard is NTSC-J, you can choose the appropriate channel plans in NTSC-J standard: Japan Standard Cable (Cable), apan Broadcast channels (AIR), or Japan Digital Cable (Cable Digital).

Key Path	FREQ Channel, Chan Table
Mode	DVB-T/H
<b>Remote Command</b>	[ :SENSE ] :FREQuency:CHANnel:TABLE:JNTSc [ :SElect ] CBL   AIR   DCBL [ :SENSe ] :FREQuency:CHANnel:TABLE:JNTSc [ :SElect ] ?
<b>Example</b>	FREQ:CHAN:TABL:JNTS AIR FREQ:CHAN:TABL:JNTS?
Preset	AIR
State Saved	Saved in instrument state.
Range	Cable AIR Cable Digital
Initial S/W Revision	A.02.00
Modified at S/W Revision	A.08.00

### NTSC-Brazil

If the current TV standard is NTSC-Brazil, you can choose the appropriate channel plans in NTSC-Brazil standard: NTSC-Brazil VHF or NTSC-Brazil UHF. Please refer to Appendix A for more detailed information.

Key Path	FREQ Channel, Chan Table
Mode	DVB-T/H
<b>Remote Command</b>	[ :SENSE ] :FREQuency:CHANnel:TABLE:BNTSc [ :SElect ] VHF   UHF [ :SENSe ] :FREQuency:CHANnel:TABLE:BNTSc [ :SElect ] ?
<b>Example</b>	FREQ:CHAN:TABL:BNTS VHF FREQ:CHAN:TABL:BNTS?

Preset	UHF
State Saved	Saved in instrument state.
Range	VHF UHF
Initial S/W Revision	A.06.00

## PAL-M

If the current TV standard is PAL-M, you can choose the appropriate channel plans in PAL-M standard: Standard Cable (STD), Broadcast Channel (AIR), HRC Cable (HRC) or IRC Cable (IRC).

Key Path	FREQ Channel, Chan Table
Mode	DVB-T/H
<b>Remote Command</b>	[ :SENSe ] :FREQuency:CHANnel:TABLE:MPAL[ :SElect ] STD   AIR   HRC   IRC [ :SENSe ] :FREQuency:CHANnel:TABLE:MPAL[ :SElect ] ?
<b>Example</b>	FREQ:CHAN:TABL:MPAL STD FREQ:CHAN:TABL:MPAL?
Preset	STD
State Saved	Saved in instrument state.
Range	STD   AIR   HRC   IRC
Initial S/W Revision	A.02.00

## PAL-I

If the current TV standard is PAL-I, you can choose the appropriate channel plans in PAL-I standard: HRC Cable (HRC), VHF channels (VHF) or UHF channels (UHF).

Key Path	FREQ Channel, Chan Table
Mode	DVB-T/H
<b>Remote Command</b>	[ :SENSe ] :FREQuency:CHANnel:TABLE:IPAL[ :SElect ] VHF UHF HRC [ :SENSe ] :FREQuency:CHANnel:TABLE:IPAL[ :SElect ] ?
<b>Example</b>	FREQ:CHAN:TABL:IPAL HRC FREQ:CHAN:TABL:IPAL?
Preset	HRC
State Saved	Saved in instrument state.
Range	VHF   UHF   HRC
Initial S/W Revision	A.02.00

### PAL-B/G

If the current TV standard is PAL-B/G, you can choose the appropriate channel plans in PAL-B/G standard: HRC Cable (HRC), VHF channels (VHF), UHF channels (UHF), S channels PAL-B/G Standard (S), S channels PAL-B/G Cable (S-Cable) or CENELEC channels (CENELEC).

<b>Key Path</b>	FREQ Channel, Chan Table
<b>Mode</b>	DVB-T/H
<b>Remote Command</b>	[ :SENSE ] :FREQuency:CHANnel:TABLE:BPAL [ :SElect ] VHF   UHF   HRC   S   SCBL   CEN  [ :SENSe ] :FREQuency:CHANnel:TABLE:BPAL [ :SElect ] ?
<b>Example</b>	FREQ:CHAN:TABL:BPAL HRC FREQ:CHAN:TABL:BPAL?
<b>Preset</b>	UHF
<b>State Saved</b>	Saved in instrument state.
<b>Range</b>	VHF   UHF   HRC   S   S-Cable   CENELEC
<b>Initial S/W Revision</b>	A.02.00

### PAL-D/K

If the current TV standard is PAL-D/K, you can choose the appropriate channel plans in PAL-D/K standard: China Broadcast Channels (DS) or China Standard Cable (Z).

<b>Key Path</b>	FREQ Channel, Chan Table
<b>Mode</b>	DVB-T/H
<b>Remote Command</b>	[ :SENSE ] :FREQuency:CHANnel:TABLE:DPAL [ :SElect ] DS   Z  [ :SENSe ] :FREQuency:CHANnel:TABLE:DPAL [ :SElect ] ?
<b>Example</b>	FREQ:CHAN:TABL:DPAL DS FREQ:CHAN:TABL:DPAL?
<b>Preset</b>	DS
<b>State Saved</b>	Saved in instrument state.
<b>Range</b>	DS   Z
<b>Initial S/W Revision</b>	A.02.00

## Input/Output

See "Input/Output" on page 204

## Marker

Accesses a menu that enables you to select, set up, and control the markers for the current measurement.

Key Path	Front-panel key
Initial S/W Revision	A.07.00

### Select Marker

Accesses a menu that enables you to select, set up, and control the markers for the current measurement.

Key Path	Marker
Initial S/W Revision	A.07.00

### Marker Type

Sets the Marker Control mode. If the selected marker is Off, pressing Marker sets it to Normal and places it at the center or left of the screen on the trace of the selected window. At the same time, reference value of the selected marker appears on the Active Function area.

Active Function Display:

Marker X-axis value

Default Active Function: the active function for the selected marker's current control mode. If the current control mode is Off, there is no active function and the active function is turned off.

The marker X-axis value entered in the active function area displays the marker value to its full entered precision.

Key Path	Marker
Mode	DVB-T/H
Remote Command	:CALCulate:EVMTtwo:MARKer[1] 2 ...12:MODE POSITION DELta OFF :CALCulate:EVMTtwo:MARKer[1] 2 ...12:MODE?
Example	CALC:EVMT:MARK:MODE POS CALC:EVMT:MARK:MODE?
Notes	Restrictions Information: If the selected marker is Off, pressing Marker sets it to Normal and places it at the center or left of the screen on the trace of the selected window. At the same time, Marker X-axis Value appears on the Active Function area. <b>Default Active Function:</b> the active function for the selected marker's current control mode. If the current control mode is Off, there is no active function and the active function is turned off. <b>Active Function Display:</b> Marker X-axis value The marker X-axis value entered in the active function area will display the marker value to its full



	entered precision. SCPI Remarks: NORMal is changed to POSition in the new SA.
Preset	OFF
State Saved	Saved in instrument state.
Range	Normal   Delta   Off
Initial S/W Revision	A.07.00

## Properties

Accesses a menu that enables you to select a relative marker and marker trace.

Key Path	Marker
Initial S/W Revision	A.07.00

## Select Marker

Accesses a menu that enables you to select, set up, and control the markers for the current measurement.

Key Path	Marker
Initial S/W Revision	A.07.00

## Relative To

Selects the marker the selected marker will be relative to (its reference marker).

Key Path	Marker, Properties
Mode	DVB-T/H
Remote Command	:CALCulate:EVMTtwo:MARKer [1]   2   ...12:REFerence <integer> :CALCulate:EVMTtwo:MARKer [1]   2   ...12:REFerence?
Example	CALC:EVMT:MARK:REF 4 CALC:EVMT:MARK:REF?
Notes	SCPI Remarks: When queried a single value will be returned (the specified marker numbers relative marker). A marker cannot be relative to itself so that choice is grayed out, and sending from SCPI generates error -221: "Settings conflict; marker cannot be relative to itself."
Preset	2 3 4 5 6 7 8 9 10 11 12 1
State Saved	Saved in instrument state.
Min	1

Max	12
Initial S/W Revision	A.07.00

## Marker Trace

Assigns the specified marker to the designated trace.

In the DVB-T2 Modulation Accuracy measurement, there are 11 named traces. If the marker is not Off, you can move the marker from the trace it was on to the selected trace using Marker Trace panel. The marker will retain its relative horizontal positions in the new window.

If the marker is Off, it stays off, but it is now associated with the specified trace.

The query returns the name of the trace on which the marker is currently placed.

Key Path	Marker, Properties
Mode	DVB-T/H
Remote Command	:CALCulate:EVMTtwo:MARKer[1] 2 ...12:TRACe POLar   MVCarrier   AVCcarrier   A2VCarrier   PVCcarrier   P2VCarrier   GDVCarrier   GD2VCarrier   AVTime   A2VTime   MVTime :CALCulate:EVMTtwo:MARKer[1] 2 ...12:TRACe?
Example	CALC:EVMT:MARK:TRACE MVC CALC:EVMT:MARK:TRACE?
Preset	MVC
State Saved	Saved in instrument state.
Range	Polar Trace   MER/EVM vs. Carr/Freq   Amptd vs. Carr Tx1   Amptd vs. Carr Tx2   Phase vs. Carr Tx1   Phase vs. Carr Tx2   GD vs. Carr Tx1   GD vs. Carr Tx2   Amptd vs. Time Tx1   Amptd vs. Time Tx2   MER vs. Time
Initial S/W Revision	A.07.00

## Couple Markers

Toggles the state of the markers coupling between on and off. When this function is active (On), moving any marker causes an “equal X-axis movement” of every other marker that is not set to Off. By “equal X-axis movement”, it means that the difference between each marker’s X-axis value (in the fundamental x-axis units of the trace that marker is on) and the X-axis value of the marker being moved (in the same fundamental x-axis units) is preserved.

This can result in markers going off-screen.

Key Path	Marker, More
Mode	DVB-T/H
Remote Command	:CALCulate:EVMTtwo:MARKer:COUple[:STATE] OFF ON 0 1 :CALCulate:EVMTtwo:MARKer:COUple[:STATE]?

<b>Example</b>	CALC:EVMT:MARK:COUP ON CALC:EVMT:MARK:COUP?
Preset	OFF
State Saved	Saved in instrument state.
Range	On   Off
Initial S/W Revision	A.07.00

## All Markers Off

Turns off all markers.

Key Path	Marker, More
Mode	DVB-T/H
<b>Remote Command</b>	:CALCulate:EVMTtwo:MARKer:AOFF
<b>Example</b>	CALC:EVMT:MARK:AOFF
Initial S/W Revision	A.07.00

## Marker X-axis Value (Remote Command only)

Sets the marker X-axis value in the current marker X-axis Scale unit. It has no effect if the marker type is Off, but is the SCPI equivalent of entering an X value if the marker type is Normal or Delta.

Mode	DVB-T/H
<b>Remote Command</b>	:CALCulate:EVMTtwo:MARKer[1] 2 ...12:X <real> :CALCulate:EVMTtwo:MARKer[1] 2 ...12:X?
<b>Example</b>	CALC:EVMT:MARK3:X 0.0 CALC:EVMT:MARK3:X?
Notes	Restrictions Information: The marker X-axis value has no unit suffix. For capture time data trace, the unit is second. The query returns the marker's absolute X-axis value if the control mode is Normal, or the offset from the marker's reference marker if the control mode is Delta. The query is returned without unit suffix. Depending on the trace, the SCPI Command/Query will support/return a sub-carrier value, a frequency value or a time value.
Preset	After a preset, all Markers are turned OFF, so Marker X-axis Value query will return a not a number (NAN).
State Saved	No
Min	-9.9E+37
Max	9.9E+37
Initial S/W Revision	A.07.00

### Marker X-axis Position (Remote Command only)

Sets the marker X position in trace points. It has no effect if the marker type is Off, but is the SCPI equivalent of entering a value if the marker type is Normal or Delta - except in trace points rather than X-axis Scale units. The entered value is immediately translated into the current X-axis Scale units for setting the value of the marker.

Mode	DVB-T/H
<b>Remote Command</b>	:CALCulate:EVMTtwo:MARKer[1] 2 ...12:X:POStion <real> :CALCulate:EVMTtwo:MARKer[1] 2 ...12:X:POStion?
<b>Example</b>	CALC:EVMT:MARK10:X:POS 0 CALC:EVMT:MARK10:X:POS?
Preset	After a preset, all Markers are turned OFF, so Marker X-axis Value query will return a not a number (NAN).
State Saved	No
Min	-9.9E+37
Max	9.9E+37
Initial S/W Revision	A.07.00

### Marker Y-axis Value (Remote Command only)

Queries the marker Y-axis value in the current marker Y-axis unit.

Mode	DVB-T/H
<b>Remote Command</b>	:CALCulate:EVMTtwo:MARKer[1] 2 ...12:Y?
<b>Example</b>	CALC:EVMT:MARK11:Y?
Preset	Result depends on markers setup and signal source
State Saved	No
Initial S/W Revision	A.07.00

## Marker Function

There are no Marker Function operations supported in the Modulation Accuracy measurement. The front-panel key displays a blank menu when pressed.

---

Key Path	Front-panel key
Initial S/W Revision	A.07.00

---

## Marker To

There is no Marker To operations supported in the Modulation Accuracy measurement. The front-panel key will display a blank menu when pressed.

---

Key Path	Front-panel key
Initial S/W Revision	A.07.00

---

## Meas

The information in this section is common to all measurements. For key and remote command information for a specific measurement, refer to the section that describes the measurement of interest.

Measurements available under the Meas key are specific to the current Mode.

When viewing Help for measurements, note the following:

**NOTE**

Operation for some keys differs between measurements. The information displayed in Help pertains to the current measurement. To see how a key operates in a different measurement, exit Help (press the Cancel Esc key), select the measurement, then reenter Help (press the Help key) and press that key.

---

Key Path	Front-panel key
Initial S/W Revision	Prior to A.02.00

---

### Remote Measurement Functions

This section contains the following topics:

"Measurement Group of Commands" on page 2166

"Current Measurement Query (Remote Command Only)" on page 2168

"Limit Test Current Results (Remote Command Only)" on page 2168

"Data Query (Remote Command Only)" on page 2168

"Calculate/Compress Trace Data Query (Remote Command Only)" on page 2169

"Calculate Peaks of Trace Data (Remote Command Only)" on page 2174

Hardware-Accelerated Fast Power Measurement (Remote Command Only)

"Format Data: Numeric Data (Remote Command Only)" on page 2175

"Format Data: Byte Order (Remote Command Only)" on page 2176

---

Initial S/W Revision	Prior to A.02.00
----------------------	------------------

---

## Measurement Group of Commands

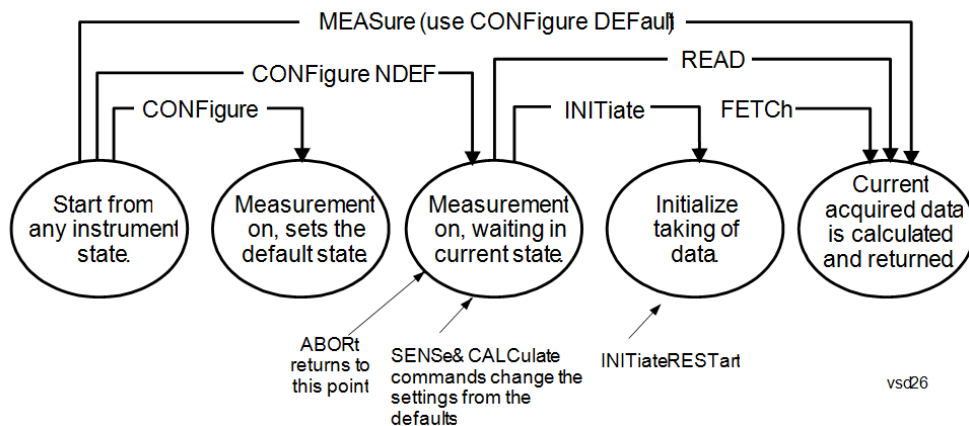

---

### Measure Commands:

:MEASure:<measurement>[n]?

This is a fast single-command way to make a measurement using the factory default instrument settings. These are the settings and units that conform to the Mode Setup settings (e.g. radio standard) that you have currently selected.

- Stops the current measurement (if any) and sets up the instrument for the specified measurement using the factory defaults
- Initiates the data acquisition for the measurement
- Blocks other SCPI communication, waiting until the measurement is complete before returning results.
- If the function does averaging, it is turned on and the number of averages is set to 10.
- After the data is valid it returns the scalar results, or the trace data, for the specified measurement. The type of data returned may be defined by an [n] value that is sent with the command.
- The scalar measurement results will be returned if the optional [n] value is not included, or is set to 1. If the [n] value is set to a value other than 1, the selected trace data results will be returned. See each command for details of what types of scalar results or trace data results are available.
- ASCII is the default format for the data output. (Older versions of Spectrum Analysis and Phase Noise mode measurements only use ASCII.) The binary data formats should be used for handling large blocks of data since they are smaller and faster than the ASCII format. Refer to the FORMat:DATA command for more information.

If you need to change some of the measurement parameters from the factory default settings you can set up the measurement with the CONFIgure command. Use the commands in the SENSE:<measurement> and CALCulate:<measurement> subsystems to change the settings. Then you can use the READ? command to initiate the measurement and query the results.

If you need to repeatedly make a given measurement with settings other than the factory defaults, you can use the commands in the SENSE:<measurement> and CALCulate:<measurement> subsystems to set up the measurement. Then use the READ? command to initiate the measurement and query results.

Measurement settings persist if you initiate a different measurement and then return to a previous one. Use READ:<measurement>? if you want to use those persistent settings. If you want to go back to the default settings, use MEASure:<measurement>?.

---

### Configure Commands:

:CONFIgure:<measurement>

This command stops the current measurement (if any) and sets up the instrument for the specified measurement using

---



---

the factory default instrument settings. It does not initiate the taking of measurement data unless INIT:CONTInuous is ON. If you change any measurement settings after using the CONFigure command, the READ command can be used to initiate a measurement without changing the settings back to their defaults.

In the Swept SA measurement in Spectrum Analyzer mode the CONFigure command also turns the averaging function on and sets the number of averages to 10 for all measurements.

:CONFigure: <measurement>: NDEFault stops the current measurement and changes to the specified measurement. It does not change the settings to the defaults. It does not initiate the taking of measurement data unless INIT:CONTInuous is ON.

The CONFigure? query returns the current measurement name.

The CONFigure:CATalog? query returns a quoted string of all licensed measurement names in the current mode. For example, "SAN, CHP, OBW, ACP, PST, TXP, SPUR, SEM, LIST".

---

#### Fetch Commands:

---

:FETCh:<measurement>[n]?

This command puts selected data from the most recent measurement into the output buffer. Use FETCh if you have already made a good measurement and you want to return several types of data (different [n] values, for example, both scalars and trace data) from a single measurement. FETCh saves you the time of re-making the measurement. You can only FETCh results from the measurement that is currently active, it will not change to a different measurement. An error message is reported if a measurement other than the current one is specified.

If you need to get new measurement data, use the READ command, which is equivalent to an INITiate followed by a FETCh.

The scalar measurement results will be returned if the optional [n] value is not included, or is set to 1. If the [n] value is set to a value other than 1, the selected trace data results will be returned. See each command for details of what types of scalar results or trace data results are available. The binary data formats should be used for handling large blocks of data since they are smaller and transfer faster than the ASCII format. (FORMat:DATA)

FETCh may be used to return results other than those specified with the original READ or MEASure command that you sent.

---

#### INITiate Commands:

---

:INITiate:<measurement>

This command is not available for measurements in all the instrument modes:

- Initiates a trigger cycle for the specified measurement, but does not output any data. You must then use the FETCh<meas> command to return data. If a measurement other than the current one is specified, the instrument will switch to that measurement and then initiate it.
  - For example, suppose you have previously initiated the ACP measurement, but now you are running the channel power measurement. If you send INIT:ACP? it will change from channel power to ACP and will initiate an ACP measurement.
  - Does not change any of the measurement settings. For example, if you have previously started the ACP measurement and you send INIT:ACP? it will initiate a new ACP measurement using the same instrument settings as the last time ACP was run.
  - If your selected measurement is currently active (in the idle state) it triggers the measurement, assuming the trigger conditions are met. Then it completes one trigger cycle. Depending upon the measurement and the number of averages, there may be multiple data acquisitions, with multiple trigger events, for one full trigger cycle. It also holds off additional commands on GPIB until the acquisition is complete.
- 

#### READ Commands:

---

:READ:<measurement>[n]?

- Does not preset the measurement to the factory default settings. For example, if you have previously initiated the ACP
-

---

measurement and you send READ:ACP? it will initiate a new measurement using the same instrument settings.

- Initiates the measurement and puts valid data into the output buffer. If a measurement other than the current one is specified, the instrument will switch to that measurement before it initiates the measurement and returns results.
  - For example, suppose you have previously initiated the ACP measurement, but now you are running the channel power measurement. Then you send READ:ACP? It will change from channel power back to ACP and, using the previous ACP settings, will initiate the measurement and return results.
  - Blocks other SCPI communication, waiting until the measurement is complete before returning the results
  - If the optional [n] value is not included, or is set to 1, the scalar measurement results will be returned. If the [n] value is set to a value other than 1, the selected trace data results will be returned. See each command for details of what types of scalar results or trace data results are available. The binary data formats should be used when handling large blocks of data since they are smaller and faster than the ASCII format. (FORMat:DATA)
- 

---

Initial S/W Revision	Prior to A.02.00
----------------------	------------------

---

### Current Measurement Query (Remote Command Only)

This command returns the name of the measurement that is currently running.

---

<b>Remote Command</b>	:CONFigure?
-----------------------	-------------

<b>Example</b>	CONF?
----------------	-------

Initial S/W Revision	Prior to A.02.00
----------------------	------------------

---

### Limit Test Current Results (Remote Command Only)

Queries the status of the current measurement limit testing. It returns a 0 if the measured results pass when compared with the current limits. It returns a 1 if the measured results fail any limit tests.

---

<b>Remote Command</b>	:CALCulate:CLIMits:FAIL?
-----------------------	--------------------------

<b>Example</b>	CALC:CLIM:FAIL? queries the current measurement to see if it fails the defined limits. Returns a 0 or 1: 0 it passes, 1 it fails.
----------------	--

Initial S/W Revision	Prior to A.02.00
----------------------	------------------

---

### Data Query (Remote Command Only)

Returns the designated measurement data for the currently selected measurement and subopcode.

n = any valid subopcode for the current measurement. See the measurement command results table for your current measurement, for information about what data is returned for the subopcodes.

This command uses the data setting specified by the FORMat:BORDER and FORMat:DATA commands and can return real or ASCII data. (See the format command descriptions under Input/Output in the Analyzer Setup section.)

<b>Remote Command</b>	:CALCulate:DATA[n]?
<b>Notes</b>	The return trace depends on the measurement. In CALCulate:<meas>:DATA[n], n is any valid subopcode for the current measurement. It returns the same data as the FETCH:<measurement>? query where <measurement> is the current measurement.
<b>Initial S/W Revision</b>	Prior to A.02.00

### Calculate/Compress Trace Data Query (Remote Command Only)

Returns compressed data for the currently selected measurement and sub-opcode [n].

n = any valid sub-opcode for that measurement. See the MEASure:<measurement>? command description of your specific measurement for information on the data that can be returned.

The data is returned in the current Y Axis Unit of the analyzer. The command is used with a sub-opcode <n> (default=1) to specify the trace. With trace queries, it is best if the analyzer is not sweeping during the query. Therefore, it is generally advisable to be in Single Sweep, or Update=Off.

This command is used to compress or decimate a long trace to extract and return only the desired data. A typical example would be to acquire N frames of GSM data and return the mean power of the first burst in each frame. The command can also be used to identify the best curve fit for the data.

<b>Remote Command</b>	:CALCulate:DATA<n>:COMPRESS? BLOCK   CFIT   MAXimum   MINimum   MEAN   DMEan   RMS   RMSCubed   SAMPLE   SDEVIation   PPHase [,<soffset> [,<length>[,<roffset>[,<rlimit>]]]]
<b>Example</b>	To query the mean power of a set of GSM bursts: Supply a signal that is a set of GSM bursts. Select the IQ Waveform measurement (in IQ Analyzer Mode). Set the sweep time to acquire at least one burst. Set the triggers such that acquisition happens at a known position relative to a burst. Then query the mean burst levels using, CALC:DATA2:COMP? MEAN, 24e-6, 526e-6 (These parameter values correspond to GSM signals, where 526e-6 is the length of the burst in the slot and you just want 1 burst.)
<b>Notes</b>	The command supports 5 parameters. Note that the last 4 (<soffset>, <length>, <roffset>, <rlimit>) are optional. But these optional parameters must be entered in the specified order. For example, if you want to specify <length>, then you must also specify <soffset>. See details below for a definition of each of these parameters. This command uses the data in the format specified by FORMat:DATA, returning either binary or ASCII data.
<b>Initial S/W Revision</b>	Prior to A.02.00

- BLOCK or block data - returns all the data points from the region of the trace data that you specify. For example, it could be used to return the data points of an input signal over several timeslots, excluding the portions of the trace data that you do not want. (This is x,y pairs for trace data and I,Q pairs for complex data.)

- CFIT or curve fit - applies curve fitting routines to the data. <soffset> and <length> are required to define the data that you want. <roffset> is an optional parameter for the desired order of the curve equation. The query will return the following values: the x-offset (in seconds) and the curve coefficients ((order + 1) values).

MIN, MAX, MEAN, DME, RMS, RMSC, SAMP, SDEV and PPH return one data value for each specified region (or <length>) of trace data, for as many regions as possible until you run out of trace data (using <roffset> to specify regions). Or they return the number of regions you specify (using <rlimit>) ignoring any data beyond that.

- MINimum - returns the minimum data point (y value) for the specified region(s) of trace data. For I/Q trace data, the minimum magnitude of the I/Q pairs is returned.
- MAXimum - returns the maximum data point (y value) for the specified region(s) of trace data. For I/Q trace data, the maximum magnitude of the I/Q pairs is returned.
- MEAN - returns a single value that is the arithmetic mean of the data point values (in dB/ dBm) for the specified region(s) of trace data. For I/Q trace data, the mean of the magnitudes of the I/Q pairs is returned. See the following equations.

- 

**NOTE**

If the original trace data is in dB, this function returns the arithmetic mean of those log values, not log of the mean power which is a more useful value. The mean of the log is the better measurement technique when measuring CW signals in the presence of noise. The mean of the power, expressed in dB, is useful in power measurements such as Channel Power. To achieve the mean of the power, use the RMS option.

Equation 1

Mean Value of Data Points for Specified Region(s)

$$MEAN = \frac{1}{n} \sum_{X_i \in \text{region}(s)} X_i$$

where  $X_i$  is a data point value, and  $n$  is the number of data points in the specified region(s).

Equation 2

Mean Value of I/Q Data Pairs for Specified Region(s)

$$MEAN = \frac{1}{n} \sum_{X_i \in \text{region}(s)} |X_i|$$

where  $|X_i|$  is the magnitude of an I/Q pair, and  $n$  is the number of I/Q pairs in the specified region(s).

- DMEan - returns a single value that is the mean power (in dB/ dBm) of the data point values for the specified region(s) of trace data. See the following equation:

Equation 3

DMEan Value of Data Points for Specified Region(s)

$$\text{DME} = 10 \times \log_{10} \left( \frac{1}{n} \sum_{X_i \in \text{region}(s)} 10^{\frac{X_i}{10}} \right)$$

- RMS - returns a single value that is the average power on a root-mean-squared voltage scale (arithmetic rms) of the data point values for the specified region(s) of trace data. See the following equation.

**NOTE**

For I/Q trace data, the rms of the magnitudes of the I/Q pairs is returned. See the following equation. This function is very useful for I/Q trace data. However, if the original trace data is in dB, this function returns the rms of the log values which is not usually needed.

Equation 4

RMS Value of Data Points for Specified Region(s)

$$\text{RMS} = \sqrt{\frac{1}{n} \sum_{X_i \in \text{region}(s)} X_i^2}$$

where  $X_i$  is a data point value, and  $n$  is the number of data points in the specified region(s).

Equation 5

RMS Value of I/Q Data Pairs for Specified Region(s)

$$\text{RMS} = \sqrt{\frac{1}{n} \sum_{X_i \in \text{region}(s)} X_i X_i^*}$$

where  $X_i$  is the complex value representation of an I/Q pair,  $X_i^*$  its conjugate complex number, and  $n$  is the number of I/Q pairs in the specified region(s).

Once you have the rms value for a region of trace data (linear or I/Q), you may want to calculate the mean power. You must convert this rms value (peak volts) to power in dBm:

$$10 \times \log[10 \times (\text{rms value})^2]$$

- SAMPLe - returns the first data value (x,y pair) for the specified region(s) of trace data. For I/Q trace data, the first I/Q pair is returned.
- SDEViation - returns a single value that is the arithmetic standard deviation for the data point values for the specified region(s) of trace data. See the following equation.
- For I/Q trace data, the standard deviation of the magnitudes of the I/Q pairs is returned. See the following equation.

Equation 6

Standard Deviation of Data Point Values for Specified Region(s)

$$\text{SDEV} = \sqrt{\frac{1}{n} \sum_{X_i \in \text{region}(s)} (X_i - \bar{X})^2}$$

where  $X_i$  is a data point value,  $\bar{X}$  is the arithmetic mean of the data point values for the specified region (s), and  $n$  is the number of data points in the specified region(s).

$$\text{SDEV} = \sqrt{\frac{1}{n} \sum_{X_i \in \text{region}(s)} (|X_i| - \bar{X})^2}$$

where  $|X_i|$  is the magnitude of an I/Q pair,  $\bar{X}$  is the mean of the magnitudes for the specified region(s), and  $n$  is the number of data points in the specified region(s).

- PPHase - returns the x,y pairs of both rms power (dBm) and arithmetic mean phase (radian) for every specified region and frequency offset (Hz). The number of pairs is defined by the specified number of regions. This parameter can be used for I/Q vector ( $n=0$ ) in Waveform (time domain) measurement and all parameters are specified by data point in PPHase.

The rms power of the specified region may be expressed as:

$$\text{Power} = 10 \times \log [10 \times (\text{RMS I/Q value})] + 10.$$

The RMS I/Q value (peak volts) is:

$$\sqrt{\frac{1}{n} \sum_{X_i \in \text{region}} X_i X_i^*}$$

where  $X_i$  is the complex value representation of an I/Q pair,  $X_i^*$  its conjugate complex number, and  $n$  is the number of I/Q pairs in the specified region.

The arithmetic mean phase of the specified region may be expressed as:

$$\frac{1}{n} \sum_{Y_i \in \text{region}} Y_i$$

where  $Y_i$  is the unwrapped phase of I/Q pair with applying frequency correction and  $n$  is the number of I/Q pairs in the specified region.

The frequency correction is made by the frequency offset calculated by the arithmetic mean of every specified region's frequency offset. Each frequency offset is calculated by the least square method against the unwrapped phase of I/Q pair.

Sample Trace Data - Constant Envelope

(See below for explanation of variables.)

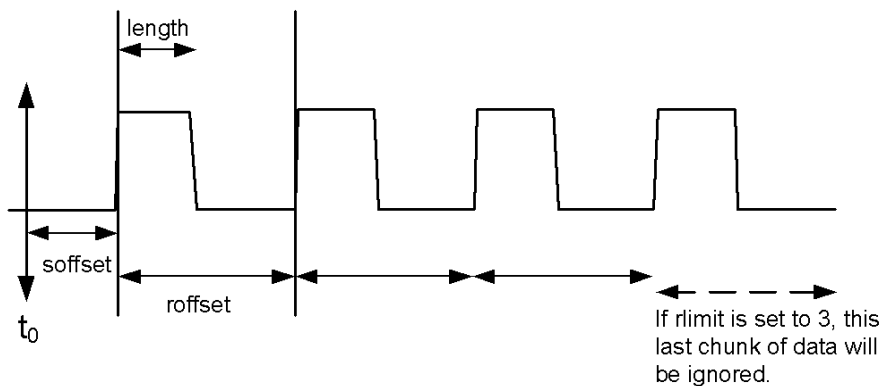

### Sample Trace Data - Not Constant Envelope

(See below for explanation of variables.)

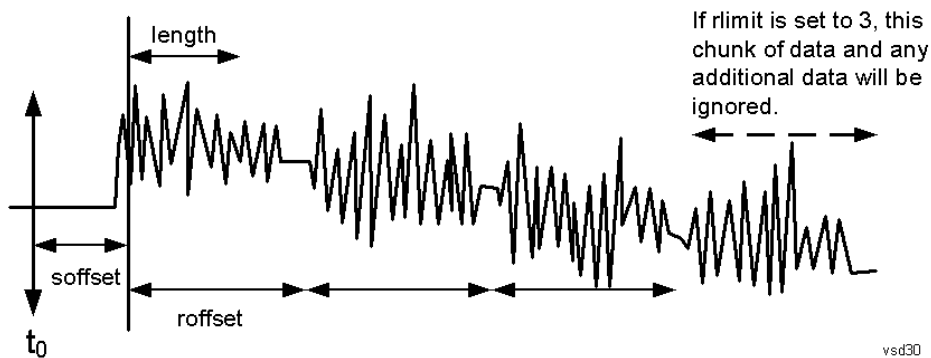

<soffset> - start offset is an optional real number. (It is in seconds for time-domain traces, and is a dimensionless index 0 to Npoints - 1, for frequency-domain traces). It specifies the amount of data at the beginning of the trace that will be ignored before the decimation process starts. It is the time or frequency change from the start of the trace to the point where you want to start using the data. The default value is zero.

<length> - is an optional real number. (It is in seconds for time-domain traces, and is a dimensionless index 0 to Npoints - 1, for frequency-domain traces). It defines how much data will be compressed into one value. This parameter has a default value equal to the current trace length.

<roffset> - repeat offset is an optional real number. (It is in seconds for time-domain traces, and is a dimensionless index 0 to Npoints - 1, for frequency-domain traces). It defines the beginning of the next field of trace elements to be compressed. This is relative to the beginning of the previous field. This parameter has a default value equal to the <length> variable. Note that this parameter is used for a completely different purpose when curve fitting (see CFIT above).

<rlimit> - repeat limit is an optional integer. It specifies the number of data items that you want returned. It will ignore any additional items beyond that number. You can use the Start offset and the Repeat limit to pick out exactly what part of the data you want to use. The default value is all the data.

## Calculate Peaks of Trace Data (Remote Command Only)

Returns a list of all the peaks for the currently selected measurement and sub-opcode [n]. The peaks must meet the requirements of the peak threshold and excursion values.

n = any valid sub-opcode for the current measurement. See the MEASure:<measurement> command description of your specific measurement for information on the data that can be returned.

The command can only be used with specific sub-opcodes with measurement results that are trace data. Both real and complex traces can be searched, but complex traces are converted to magnitude in dBm. In many measurements the sub-opcode n=0, is the raw trace data which cannot be searched for peaks. And Sub-opcode n=1, is often calculated results values which also cannot be searched for peaks.

This command uses the data setting specified by the FORMat:BORDER and FORMat:DATA commands and can return real or ASCII data. If the format is set to INT,32, it returns REAL,32 data.

The command has four types of parameters:

- Threshold (in dBm)
- Excursion (in dB)
- Sorting order (amplitude, frequency, time)
- Optional in some measurements: Display line use (all, > display line, < display line)

---

<b>Remote Command</b>	<p>For Swept SA measurement:</p> <pre>:CALCulate:DATA[1] 2 ... 6:PEAKs? &lt;threshold&gt;,&lt;excursion&gt;[,AMPLitude   FREQuency   TIME[,ALL   GTDLine   LTDLine]]</pre> <p>For most other measurements:</p> <pre>:CALCulate:DATA[1] 2 ... 6:PEAKs? &lt;threshold&gt;,&lt;excursion&gt;[,AMPLitude   FREQuency   TIME]</pre>
-----------------------	--

---

<b>Example</b>	<p>Example for Swept SA measurement in Spectrum Analyzer Mode:</p> <p>CALC:DATA4:PEAK? -40, 10, FREQ, GTDL This will identify the peaks of trace 4 that are above -40 dBm, with excursions of at least 10 dB. The peaks are returned in order of increasing frequency, starting with the lowest frequency. Only the peaks that are above the display line are returned.</p> <p>Query Results 1:</p> <p>With FORMat:DATA REAL, 32 selected, it returns a list of floating-point numbers. The first value in the list is the number of peak points that are in the following list. A peak point consists of two values: a peak amplitude followed by its corresponding frequency (or time).</p> <p>If no peaks are found the peak list will consist of only the number of peaks, (0).</p>
----------------	---

---

<b>Notes</b>	<p>&lt;n&gt; - is the trace that will be used</p> <p>&lt;threshold&gt; - is the level below which trace data peaks are ignored. Note that the threshold value is required and is always used as a peak criterion. To effectively disable the threshold criterion for this command, provide a substantially low threshold value such as -200 dBm. Also note that the threshold value used in this command is independent of and has no effect on the threshold value stored under the Peak Criteria menu.</p> <p>&lt;excursion&gt; - is the minimum amplitude variation (rise and fall) required for a signal to be identified as peak. Note that the excursion value is required and is always used as a peak criterion. To effectively disable the excursion criterion for this command, provide the minimum value of 0.0 dB. Also note that the excursion value used in this command is independent of and has no effect on the</p>
--------------	---

---



excursion value stored under the Peak Criteria menu.

Values must be provided for threshold and excursion. The sorting and display line parameters are optional (defaults are AMPLitude and ALL).

Note that there is always a Y-axis value for the display line, regardless of whether the display line state is on or off. It is the current Y-axis value of the display line which is used by this command to determine whether a peak should be reported

Sorting order:

AMPLitude - lists the peaks in order of descending amplitude, with the highest peak first (default if optional parameter not sent)

FREQUency - lists the peaks in order of occurrence, left to right across the x-axis.

TIME - lists the peaks in order of occurrence, left to right across the x-axis.

Peaks vs. Display Line:

ALL - lists all of the peaks found (default if optional parameter not sent).

GTDLine (greater than display line) - lists all of the peaks found above the display line.

LTDLine (less than display line) - lists all of the peaks found below the display line.

---

Initial S/W Revision      Prior to A.02.00

---

### Format Data: Numeric Data (Remote Command Only)

This command specifies the format of the trace data input and output. It specifies the formats used for trace data during data transfer across any remote port. It affects only the data format for setting and querying trace data for the :TRACe[:DATA], TRACe[:DATA]?, :CALCulate:DATA[n]? and FETCh:SANalyzer[n]? commands and queries.

---

**Remote Command**      :FORMat[:TRACe] [:DATA] ASCii|INTeger,32|REAL,32 |REAL,64  
:FORMat[:TRACe] [:DATA] ?

---

**Notes**      The query response is:  
ASCii: ASC,8  
REAL,32: REAL,32  
REAL,64: REAL,64  
INTeger,32: INT,32

When the numeric data format is REAL or ASCii, data is output in the current Y Axis unit. When the data format is INTeger, data is output in units of m dBm (.001 dBm).

The INT,32 format returns binary 32-bit integer values in internal units (m dBm), in a definite length block.

---

**Dependencies**      Sending a data format spec with an invalid number (for example, INT,48) generates no error. The analyzer simply uses the default (8 for ASCii, 32 for INTeger, 32 for REAL).

Sending data to the analyzer which does not conform to the current FORMat specified, results in an error. Sending ASCII data when a definite block is expected generates message -161 "Invalid Block Data" and sending a definite block when ASCII data is expected generates message -121 "Invalid Character in Number".

---

**Preset**      ASCii

---

**Backwards Compatibility Notes**      Note that the INT,32 format is only applicable to the command, TRACe:DATA. This preserves backwards compatibility for the Swept SA measurement. For all other commands/queries which honor FORMat:DATA, if INT,32 is sent the analyzer will behave as though it were set to REAL,32.

---

Initial S/W Revision      Prior to A.02.00

---

The specs for each output type follow:

AScii - Amplitude values are in ASCII, in the current Y Axis Unit, one ASCII character per digit, values separated by commas, each value in the form:

SX.YYYYYEsZZ

Where:

S = sign (+ or -)

X = one digit to left of decimal point

Y = 5 digits to right of decimal point

E = E, exponent header

s = sign of exponent (+ or -)

ZZ = two digit exponent

REAL,32 - Binary 32-bit real values in the current Y Axis Unit, in a definite length block.

REAL,64 - Binary 64-bit real values in the current Y Axis Unit, in a definite length block.

### Format Data: Byte Order (Remote Command Only)

This command selects the binary data byte order for data transfer and other queries. It controls whether binary data is transferred in normal or swapped mode. This command affects only the byte order for setting and querying trace data for the :TRACe[:DATA], TRACe[:DATA]? , :CALCulate:DATA[n]? and FETCh:SANalyzer[n]? commands and queries.

By definition any command that says it uses FORMat:DATA uses any format supported by FORMat:DATA.

The NORMal order is a byte sequence that begins with the most significant byte (MSB) first, and ends with the least significant byte (LSB) last in the sequence: 1|2|3|4. SWAPped order is when the byte sequence begins with the LSB first, and ends with the MSB last in the sequence: 4|3|2|1.

<b>Remote Command</b>	:FORMat:BORDER NORMal   SWAPped :FORMat:BORDER?
<b>Preset</b>	NORMal
<b>Initial S/W Revision</b>	Prior to A.02.00

## Meas Setup

This key displays the measurement setup menu that allows you to set demodulation and measurement parameters for the DVB-T2 Mod Accuracy measurement.

Key Path	Front-panel key
Initial S/W Revision	A.07.00

### Avg/Hold Num

This key sets the number that will be averaged. After the specified number (average counts) have been averaged, the averaging mode (termination control) setting determines the averaging action.

Key Path	Meas Setup
Mode	DVB-T/H
<b>Remote Command</b>	[:SENSe]:EVMttwo:AVERage:COUNT <integer> [:SENSe]:EVMttwo:AVERage:COUNT? [:SENSe]:EVMttwo:AVERage[:STATe] OFF ON 0 1 [:SENSe]:EVMttwo:AVERage[:STATe]?
<b>Example</b>	EVMT:AVER:COUN 100 EVMT:AVER:COUN? EVMT:AVER OFF EVMT:AVER?
Preset	10 OFF
State Saved	Saved in instrument state.
Min	1
Max	10000
Initial S/W Revision	A.07.00

### Avg Mode

This key selects the type of termination control used for the averaging function. This determines the averaging action after the specified number of data acquisitions (average count) is reached. You can select between the Exp (exponential) and Repeat averaging modes. This selection only affects the averaging result after the number of N averages is reached. You can use the Avg/Hold Num key to set N.

KEY: Exponential averaging SCPI: EXPonential	When Measure is set to Cont, data acquisitions will continue indefinitely. After N averages, exponential averaging is used with a weighting factor of N (the displayed average count stops at N). Exponential averaging weights new data more than old data, which allows tracking of slow-changing signals.
---	--

KEY: Repeat averaging SCPI: REPeat	When Measure is set to Cont, data acquisitions will continue indefinitely. After N averages is reached, all previous result data is cleared and the average count is set back to 1. This is equivalent to being in Measure Single and pressing the Restart key when the Single measurement finishes.
---------------------------------------	--

Key Path	Meas Setup
Mode	DVB-T/H
Remote Command	[ :SENSe ] :EVMtTwo:AVERage:TCONtrol EXPonential   REPeat [ :SENSe ] :EVMtTwo:AVERage:TCONtrol ?
Example	EVMt:AVER:TCON EXP EVMt:AVER:TCON ?
Preset	EXPonential
State Saved	Saved in instrument state.
Range	Exp   Repeat
Initial S/W Revision	A.07.00

### Auto Detect

This key is used for auto-demodulation. If it is set to On, modulation parameters will be auto-detected from the input signal instead of manually set by you. The information in the L1 signalling window will also be detected.

These auto-detected modulation parameters include Version, Transmission Mode, Guard Interval, FFT Size, Carrier Mode, Pilot Pattern, PAPR Type, Data Symbols, L1 Modulation Format, PLP Modulation Format, PLP Rotation, PLP FEC Type, PLP Time IL Length, PLP Code Rate, and the number of FEC Blocks in the associated PLP.

Make sure that Channel BW (Mode Setup) is set correctly to ensure Auto Detect works well.

Besides auto detect, the modulation parameters can also be configured manually. The ways to setup these parameters are different for different signals under test, as follows:

- If the signal under test contains a single PLP, the demodulation parameters can be set using keys under Meas Setup -> Demod panel.
- If the signal under test contains multiple PLPs, the demodulation parameters can be configured by importing the PLP configuration file containing demodulation parameters. For more information about PLP configuration files, refer to "DVB-T2 Config" on page 2208.

Key Path	Meas Setup
Mode	DVB-T/H

<b>Remote Command</b>	<code>[ :SENSe ] :EVMtTwo:DETECT:STATe OFF ON 0 1</code> <code>[ :SENSe ] :EVMtTwo:DETECT:STATe?</code>
<b>Example</b>	EVMT:DET:STAT OFF EVMT:DET:STAT?
<b>Dependencies</b>	If Auto Detect is on, the following keys will be grayed out: Version (Mode Setup, Radio Std, DVB-T2), Transmission Mode (Mode Setup, Radio Std, DVB-T2), Demod (Meas Setup) Code Rate (Meas Setup, More, Decode)
<b>Preset</b>	Mode Preset parameter
<b>State Saved</b>	Saved in instrument state.
<b>Range</b>	On   Off
<b>Initial S/W Revision</b>	A.07.00

## Demod

Specifies the demodulation parameters. This key is available only when Auto Detect is off.

<b>Key Path</b>	Meas Setup
<b>Dependencies</b>	This key is grayed out when Auto Detect (Meas Setup) is set to On.
<b>Initial S/W Revision</b>	A.07.00

## Guard Interval

Sets the value of guard interval. The available selections include 1/4, 19/128, 1/8, 19/256, 1/16, 1/32, and 1/128.

Guard interval is a cyclic continuation of the useful OFDM symbol time domain samples and is inserted before it. The guard interval is used to prevent the useful OFDM symbol from the interference of the previous symbol.

<b>Key Path</b>	Meas Setup, Demod
<b>Mode</b>	DVB-T/H
<b>Remote Command</b>	<code>[ :SENSe ] :EVMtTwo:GINterval:RATio R1BY4   R19BY128   R1BY8   R19BY256   R1BY16   R1BY32   R1BY128</code> <code>[ :SENSe ] :EVMtTwo:GINterval:RATio?</code>
<b>Example</b>	EVMT:GINT:RAT R1BY4 EVMT:GINT:RAT?
<b>Dependencies</b>	If the value is 1/128, 1/32, 19/256, or 19/128, the 1K key under FFT Size panel (Meas Setup, Demod) is grayed out. If the value is 1/128, 19/256, or 19/128, the 2K and 4K keys under FFT Size panel are grayed out.

	If the value is 1/4, the 32K key of FFT Size panel is grayed out.
Preset	R1BY4
State Saved	Saved in instrument state.
Range	1/4 19/128 1/8 19/256 1/16 1/32 1/128
Initial S/W Revision	A.07.00

## FFT Size

Sets the number of subcarriers in one OFDM symbol. The available selections include 1K (853 carriers), 2K (1705 carriers), 4K (3409 carriers), 8K (6817 carriers – normal carrier mode, 6913 carriers – extended carrier mode), 16K (13633 carriers – normal carrier mode, 13921 carriers – extended carrier mode), and 32K (27265 carriers – normal carrier mode, 27841 carriers – extended carrier mode).

Key Path	Meas Setup, Demod
Mode	DVB-T/H
Remote Command	[ :SENSe ] :EVMtwo:NFFT N1K N2K N4K N8K N16K N32K [ :SENSe ] :EVMtwo:NFFT?
Example	EVMT:NFFT N2K EVMT:NFFT?
Dependencies	If Carrier Mode (Meas Setup, Demod) is Extended, the 1K, 2K, and 4K keys are grayed out. If Guard Interval (Meas Setup, Demod) is 1/128, 1/32, 19/256, or 19/128, the 1K key is grayed out. If Guard Interval is 1/128, 19/256, or 19/128, the 2K and 4K keys are grayed out. If Guard Interval is 1/4, the 32K key is grayed out.
Couplings	FFT Size is coupled to Carrier Mode (Meas Setup, Demod) in the following way: If Carrier Mode is changed from Normal to Extended and FFT Size is 1K, 2K, or 4K, FFT Size will be automatically changed to 8K. FFT Size is coupled to Guard Interval (Meas Setup, Demod) in the following way: If Guard Interval is changed to 1/128 or 19/256, or 19/128 and FFT Size is 1/2/4K, FFT Size will be automatically changed to 8K. If Guard Interval is changed to 1/32 and FFT Size is 1K, FFT Size will be automatically changed to 8K. If Guard Interval is changed to 1/4 and FFT Size is 32K, FFT Size will be automatically changed to 2K.
Preset	Result depend on signal source
State Saved	Saved in instrument state.
Range	1K 2K 4K 8K 16K 32K
Initial S/W Revision	A.07.00

## Carrier Mode

Sets which carrier mode is used, normal or extended.

Key Path	Meas Setup, Demod
Mode	DVB-T/H
Remote Command	[ :SENSe]:EVMTwo:CARRier NORMal EXTended [ :SENSe]:EVMTwo:CARRier?
Example	EVMT:CARR NORM EVMT:CARR?
Dependencies	If extended carrier mode is used, the 1K, 2K, and 4K (Meas Setup, Demod, FFT Size) keys are grayed out.
Couplings	FFT Size (Meas Setup, Demod) is coupled to Carrier Mode in the following way: If Carrier Mode is changed from Normal to Extended and FFT Size is 1K, 2K, or 4K, FFT Size will be automatically changed to 8K.
Preset	NORMal
State Saved	Saved in instrument state.
Range	Normal   Extended
Initial S/W Revision	A.07.00

## Pilot Pattern

Sets the scattered pilot pattern used for the data OFDM symbols. There are eight options from PP1 to PP8. The allowed combination of scattered pilot patterns, FFT Size (Meas Setup, Demod), and Guard Interval (Meas Setup, Demod) are listed in the following table. “NA” indicates that the corresponding combination of FFT Size and Guard Interval are not allowed.

FFT Size	Guard Interval						
	1/12 8	1/3 2	1/1 6	19/25 6	1/ 8	19/12 8	1/ 4
32 K	PP7	PP4 PP6	PP2 PP8 PP4	PP2 PP8 PP4	PP 2 PP 8	PP2 PP8	NA
16 K	PP7	PP7 PP4 PP6	PP2 PP8 PP4 PP5	PP2 PP8 PP4 PP5	PP 2 PP 3 PP 8	PP2 PP3 PP8	PP 1 PP 8
8K	PP7	PP7 PP4	PP8 PP4 PP5	PP8 PP4 PP5	PP 2 PP 3 PP 8	PP2 PP3 PP8	PP 1 PP 8

4K, 2K	NA	PP7 PP4	PP4 PP5	NA	PP 2 PP 3	NA	PP 1
1K	NA	NA	PP4 PP5	NA	PP 2 PP 3	NA	PP 1

Key Path	Meas Setup, Demod
Mode	DVB-T/H
Remote Command	[ :SENSe ] :EVMTwo:PPILot PP1 PP2 PP3 PP4 PP5 PP6 PP7 PP8 [ :SENSe ] :EVMTwo:PPILot?
Example	EVMT:PPIL PP1 EVMT:PPIL?
Dependencies	If the selections are not available with the certain combinations of FFT Size and Guard Interval described in the table at the front of this section, the selections are grayed out.
Couplings	If FFT Size and Guard Interval are changed to some combination in which the current pilot pattern is not allowed according to the above table, the pilot pattern will change to the smallest one in the available scattered pilot group automatically. For example, the current selection is PP1 while FFT Size is 16K and GI is 1/4. If GI changes to 1/16, the selection will change to PP2 automatically.
Preset	PP1
State Saved	Saved in instrument state.
Range	PP1 PP2 PP3 PP4 PP5 PP6 PP7 PP8
Initial S/W Revision	A.07.00

## L1 Modulation Format

Sets the modulation format for L1-post signalling data block. The available options include BPSK, QPSK, 16QAM, and 64QAM.

Key Path	Meas Setup, Demod
Mode	DVB-T/H
Remote Command	[ :SENSe ] :EVMTwo:L1Modulation BPSK QPSK QAM16 QAM64 [ :SENSe ] :EVMTwo:L1Modulation?
Example	EVMT:L1M QPSK EVMT:L1M?
Preset	QPSK



State Saved	Saved in instrument state.
Range	BPSK QPSK 16QAM 64QAM
Initial S/W Revision	A.07.00

## Data Symbols

Sets the number of data OFDM symbols per T2-frame, excluding P1 and P2.

Key Path	Meas Setup, Demod
Mode	DVB-T/H
<b>Remote Command</b>	[ :SENSe ] :EVMTtwo:DSYMBOLS <integer> [ :SENSe ] :EVMTtwo:DSYMBOLS?
<b>Example</b>	EVMT:DSYM 7 EVMT:DSYM?
Preset	7
State Saved	Saved in instrument state.
Min	3
Max	2082
Initial S/W Revision	A.07.00

## PAPR Type

Sets what kind of PAPR (Peak to Average Power Ratio) reduction is used, if any.

Key Path	Meas Setup, Demod
Mode	DVB-T/H
<b>Remote Command</b>	[ :SENSe ] :EVMTtwo:PAPR OFF   ACE   TR   ACETr   L1P2TR   L1ACE   L1TR   L1AT [ :SENSe ] :EVMTtwo:PAPR?
<b>Example</b>	EVMT:PAPR OFF EVMT:PAPR?
Dependencies	If Constellation Rotation (Meas Setup, Demod, PLP) is On, the ACE and ACE_TR keys are grayed out. If Version (Mode Setup, Radio Std, DVB-T2) is 1.1.1, L1-ACE & P2-TR, L1ACE & ACE, L1-ACE & TR, and L1-ACE & ACE_TR will be grayed out. If Version is 1.2.1, No PAPR, ACE, TR, and ACE_TR will be grayed out.
Couplings	If Constellation Rotation (Meas Setup, Demod, PLP) is changed to On and the current selection is ACE or ACE_TR, the value will be changed to No PAPR automatically. If Version (Mode Setup, Radio Std, DVB-T2) is changed to 1.1.1, and the current selection is L1-ACE & P2-TR, or L1ACE & ACE, or L1-ACE & TR, or L1-ACE & ACE_TR, the value will be changed to No PAPR automatically. If Version is changed to 1.2.1, and the current selection is No PAPR, or ACE, or

	TR, or ACE_TR, the value will be changed to L1-ACE & P2-TR automatically.
Preset	OFF
State Saved	Saved in instrument state.
Range	No PAPR   ACE   TR   ACE_TR   L1-ACE & P2-TR   L1-ACE & ACE   L1-ACE & TR   L1-ACE & ACE_TR
Initial S/W Revision	A.07.00
Modified at S/W Revision	A.10.01

## PLP

Specifies PLP parameters.

Key Path	Meas Setup, Demod
Initial S/W Revision	A.07.00

## PLP Number

Sets the number of PLP in use.

Key Path	Meas Setup, Demod, PLP
Mode	DVB-T/H
<b>Remote Command</b>	[ :SENSe ] :EVMtTwo:PLP:NUMBer <integer> [ :SENSe ] :EVMtTwo:PLP:NUMBer?
<b>Example</b>	EVMT:PLP:NUMB 1 EVMT:PLP:NUMB?
Dependencies	If the PLP Number is greater than 1, all other keys under the PLP panel are grayed out.
Preset	1
State Saved	Saved in instrument state.
Min	1
Max	256
Initial S/W Revision	A.07.00

## Modulation Format

Sets the modulation format used by the associated PLP. The available options include QPSK, 16QAM, 64QAM, and 256QAM.

Key Path	Meas Setup, Demod, PLP
Mode	DVB-T/H
<b>Remote Command</b>	[ :SENSe ] :EVMtTwo:PLP:MODulation QPSK QAM16 QAM64 QAM256

	<code>[ :SENSe ] :EVMtTwo:PLP:MODulation?</code>
<b>Example</b>	EVMT:PLP:MOD QPSK EVMT:PLP:MOD?
Dependencies	If the PLP Number is greater than 1, all other keys under the PLP panel are grayed out.
Preset	QPSK
State Saved	Saved in instrument state.
Range	QPSK 16QAM 64QAM 256QAM
Initial S/W Revision	A.07.00

### Constellation Rotation

Sets whether constellation rotation is used or not in the associated PLP.

Key Path	Meas Setup, Demod, PLP
Mode	DVB-T/H
<b>Remote Command</b>	<code>[ :SENSe ] :EVMtTwo:PLP:ROTation OFF ON 0 1</code> <code>[ :SENSe ] :EVMtTwo:PLP:ROTation?</code>
<b>Example</b>	EVMT:PLP:ROT OFF EVMT:PLP:ROT?
Dependencies	If Constellation Rotation is On, the ACE and ACE_TR keys (Meas Setup, Demod, PAPR Type) are grayed out. If the PLP Number is greater than 1, all other keys under the PLP panel are grayed out.
Couplings	If Constellation Rotation is changed to On and the current value of PAPR Type (Meas Setup, Demod) is ACE or ACE_TR, this value will change to No PAPR automatically.
Preset	OFF
State Saved	Saved in instrument state.
Range	On   Off
Initial S/W Revision	A.07.00

### FEC Type

Sets the FEC type used by the associated PLP. The available options include Normal and Short.

Key Path	Meas Setup, Demod, PLP
Mode	DVB-T/H
<b>Remote Command</b>	<code>[ :SENSe ] :EVMtTwo:PLP:FECType SHORt NORMal</code> <code>[ :SENSe ] :EVMtTwo:PLP:FECType?</code>
<b>Example</b>	EVMT:PLP:FECT SHOR EVMT:PLP:FECT?

Dependencies	If the PLP Number is greater than 1, all other keys under the PLP panel are grayed out.
Preset	SHORT
State Saved	Saved in instrument state.
Range	Normal   Short
Initial S/W Revision	A.07.00

### Time IL Length

Sets the number of TI-blocks (Time Interleaver) per Interleaving Frame.

Note that interleaving frame mapped to more than one T2-frame is not supported.

If time interleaving is not used for the associated PLP, this value shall be set to 0.

Key Path	Meas Setup, Demod, PLP
Mode	DVB-T/H
<b>Remote Command</b>	[ :SENSe ] :EVMTwo:PLP:TILLength <integer> [ :SENSe ] :EVMTwo:PLP:TILLength?
<b>Example</b>	EVMT:PLP:TILL 1 EVMT:PLP:TILL?
Dependencies	If the PLP Number is greater than 1, all other keys under the PLP panel are grayed out.
Preset	1
State Saved	Saved in instrument state.
Min	0
Max	255
Initial S/W Revision	A.07.00

### FEC Block Num

Sets the number of FEC blocks contained in the current PLP.

Key Path	Meas Setup, Demod, PLP
Mode	DVB-T/H
<b>Remote Command</b>	[ :SENSe ] :EVMTwo:PLP:FECBlock <integer> [ :SENSe ] :EVMTwo:PLP:FECBlock?
<b>Example</b>	EVMT:PLP:FECB 1 EVMT:PLP:FECB?
Dependencies	If the PLP Number is greater than 1, all other keys under the PLP panel are grayed out.
Preset	2

State Saved	Saved in instrument state.
Min	1
Max	1023
Initial S/W Revision	A.07.00

## Sync Frame Now

Synchronizes the trigger to the start of a T2 frame. When it is pressed, the instrument will synchronize its internal period trigger to the start of T2 frame, and set the period of the trigger to the length of the T2 frame.

The trigger here refers to the periodic timer (Trigger, Periodic Timer).

To use the internal periodic timer, first choose the periodic timer (Trigger, More 1 of 2, Periodic Timer). Then press Sync Frame Now to calculate the difference between the periodic trigger and the start of the T2 frame. This difference will be used to adjust the internal periodic timer to the frame start. After that, the signal can be demodulated.

Key Path	Meas Setup
Mode	DVB-T/H
Remote Command	[ :SENSe ] :EVMTtwo :SFRame [ :IMMediate ]
Example	EVMT:SFR
Initial S/W Revision	A.07.00

## Advanced

This key allows you to specify advanced settings for DVB-T2 Mod Accuracy measurement.

Key Path	Meas Setup
Initial S/W Revision	A.07.00

## Spectrum

This key sets whether to use normal spectrum or use inverted spectrum.

The Spectrum key is used when your signal's spectrum is inverted. In terms of the IQ complex components, to invert a spectrum in freq domain equals to conjugate the complex I/Q symbols in time domain.

$$(I + jQ)^* = I - jQ$$

This can often occur, for example, if you are measuring at an IF frequency, and the Q component of your baseband signal is inverted, or the I and Q signals are inadvertently swapped. When you set the spectrum

key to Inverted, the analysis software will conjugate the complex baseband signal before demodulating, ensuring correct demodulation of the inverted signal.

Key Path	Meas Setup, Advanced
Mode	DVB-T/H
<b>Remote Command</b>	<code>[ :SENSe]:EVMTwo:SPECTrum NORMal INVert</code> <code>[ :SENSe]:EVMTwo:SPECTrum?</code>
<b>Example</b>	EVMT:SPEC NORM EVMT:SPEC?
Preset	NORMal
State Saved	Saved in instrument state.
Range	Normal   Invert
Initial S/W Revision	A.07.00

## Equalization

This key turns the equalization on and off.

Equalization is used to compensate for the distortions caused by the channel effects.

Key Path	Meas Setup, Advanced
Mode	DVB-T/H
<b>Remote Command</b>	<code>[ :SENSe]:EVMTwo:EQUalization:STATe OFF ON 0 1</code> <code>[ :SENSe]:EVMTwo:EQUalization:STATe?</code>
<b>Example</b>	EVMT:EQU:STAT ON EVMT:EQU:STAT?
Preset	OFF
State Saved	Saved in instrument state.
Range	On   Off
Initial S/W Revision	A.07.00

## Clock Rate

Sets the clock rate either automatically based on channel bandwidth or manually.

Key Path	Meas Setup, Advanced
Mode	DVB-T/H
<b>Remote Command</b>	<code>[ :SENSe]:EVMTwo:CLKRate &lt;freq&gt;</code> <code>[ :SENSe]:EVMTwo:CLKRate?</code> <code>[ :SENSe]:EVMTwo:CLKRate:AUTO ON OFF 1 0</code>

	<code>[ :SENSe ] :EVMtTwo:CLKRate:AUTO?</code>
<b>Example</b>	<p>EVMT:CLKR 9.142857e6  EVMT:CLKR?  EVMT:CLKR:AUTO OFF  EVMT:CLKR:AUTO?</p>
<b>Couplings</b>	<p>The value of Clock Rate in Auto is coupled to Channel BW (Mode Setup) as follows:  11.42857 MHz in 10MHz Channel BW  9.142857 MHz in 8 MHz Channel BW  8.000000 MHz in 7 MHz Channel BW  6.857142 MHz in 6 MHz Channel BW  5.714285 MHz in 5 MHz Channel BW  1.845070 MHz in 1.7 MHz Channel BW</p> <p>The value of Clock Rate State will be changed to Auto automatically when Channel BW (Mode Setup) is changed.</p>
<b>Preset</b>	<p>9.142857 MHz  ON</p>
<b>State Saved</b>	Saved in instrument state.
<b>Min</b>	<p>10 MHz in 10 MHz Channel BW  8 MHz in 8 MHz Channel BW  7 MHz in 7 MHz Channel BW  6 MHz in 6 MHz Channel BW  5 MHz in 5 MHz Channel BW  1 MHz in 1.7 MHz Channel BW</p>
<b>Max</b>	<p>13 MHz in 10 MHz Channel BW  11 MHz in 8 MHz Channel BW  9 MHz in 7 MHz Channel BW  8 MHz in 6 MHz Channel BW  7 MHz in 5 MHz Channel BW  3 MHz in 1.7 MHz Channel BW</p>
<b>Initial S/W Revision</b>	A.07.00

## Out of Band Filtering

Chooses whether to use the out of band filter.

The filter is used to eliminate the impact of out of band signals. Its bandwidth is system bandwidth (1.7/5/6/7/8/10 MHz).

<b>Key Path</b>	Meas Setup, Advanced
<b>Mode</b>	DVB-T/H
<b>Remote Command</b>	<code>[ :SENSe ] :EVMtTwo:OBFiltering OFF ON 0 1</code>

	<code>[ :SENSe ] :EVMTtwo :OBFiltering?</code>
<b>Example</b>	EVMT:OBF OFF EVMT:OBF?
Preset	OFF
State Saved	Saved in instrument state.
Range	On   Off
Initial S/W Revision	A.07.00

### FFT Start Position

Sets the start position of FFT.

FFT Start Position means how many parts of GI (Guard Interval) are included in FFT. There are 9 values from 0/8 GI to 8/8 GI. As shown below, 0/8 GI means no CP is included in FFT and 8/8 GI means the entire GI is included in FFT.

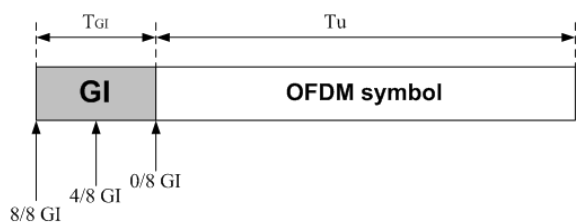

For a signal with pre-echo or delay waves, ISI (Inter-Symbol Interference) can be eliminated by adjusting FFT Start Position.

Choose appropriate FFT Start Position according to your channel delay profile to remove the effect of interferences. Together with Equalization (Meas Setup, Advanced), MER and Channel Impulse Response results can be improved.

<b>Key Path</b>	Meas Setup, Advanced
<b>Mode</b>	DVB-T/H
<b>Remote Command</b>	<code>[ :SENSe ] :EVMTtwo :FFTStart GI08   GI18   GI28   GI38   GI48   GI58   GI68   GI78   GI88</code> <code>[ :SENSe ] :EVMTtwo :FFTStart?</code>
<b>Example</b>	EVMT:FFTS GI18 EVMT:FFTS?
Preset	GI48
State Saved	Saved in instrument state.
Range	0/8 GI   1/8 GI   2/8 GI   3/8 GI   4/8 GI   5/8 GI   6/8 GI   7/8 GI   8/8 GI
Initial S/W Revision	A.10.01



## MISO Test Setup

Sets to use Tx1 Only, Tx2 Only or Tx1+Tx2 when doing MISO test.

Key Path	Meas Setup, Advanced
Mode	DVB-T/H
<b>Remote Command</b>	[ :SENSe ] :EVMtTwo:MISO:TSETup TX1   TX2   TX1TX2 [ :SENSe ] :EVMtTwo:MISO:TSETup?
<b>Example</b>	EVMT:MISO:TSET TX1TX2 EVMT:MISO:TSET?
Dependencies	If Transmission Mode (Mode Setup, Radio Std, DVB-T2) is SISO, this key is grayed out. If Transmission Mode (Mode Setup, Radio Std, DVB-T2) is MISO and this key is set to Tx1 + Tx2, Pilot (View/Display, I/Q Measured Polar Graph, Display Type) will be grayed out.
Preset	TX1TX2
State Saved	Saved in instrument state.
Range	Tx1 Only Tx2 Only Tx1 + Tx2
Initial S/W Revision	A.11.00

## Frame Tracking

Chooses whether to use frame tracking or not.

This key is used to track and compensate the difference between periodic timer and the start of a T2 frame.

It is available only when Periodic Timer (Trigger, More) is selected.

Key Path	Meas Setup, Advanced
Mode	DVB-T/H
<b>Remote Command</b>	[ :SENSe ] :EVMtTwo:FTRacking OFF   ON   0   1 [ :SENSe ] :EVMtTwo:FTRacking?
<b>Example</b>	EVMT:FTR ON EVMT:FTR?
Dependencies	If the current trigger is not Periodic Timer, this key will be grayed out.
Preset	ON
State Saved	Saved in instrument state.
Range	On   Off
Initial S/W Revision	A.07.00

## IF Gain

Enables you to control an internally switched IF amplifier with approximately 10 dB of gain. This amplifier takes full advantage of the RF dynamic range of the analyzer. When it is turned on without overloading the

analyzer, the dynamic range is always better with it on than off. The IF Gain key can be used to set the IF Gain function to Auto, or to On (the extra 10 dB), or Off. These settings affect sensitivity and IF overloads.

This only applies to the RF input. It does not apply to baseband I/Q input.

Key Path	Meas Setup, Advanced
Initial S/W Revision	A.10.01

### IF Gain Auto

Activates the auto rules for IF Gain.

Key Path	Meas Setup, Advanced, IF Gain
Mode	DVB-T/H
Remote Command	[ :SENSe ] :EVMtTwo :IF :GAIN :AUTO [ :STATe ] OFF   ON   0   1 [ :SENSe ] :EVMtTwo :IF :GAIN :AUTO [ :STATe ] ?
Example	EVMT:IF:GAIN:AUTO ON EVMT:IF:GAIN:AUTO?
Notes	This only applies to the RF input. It does not apply to baseband I/Q input.
Couplings	When either Auto Attenuation is active (for example, with electrical attenuator), or the Optimize Mechanical Attenuator range is requested, the IF Gain setting is changed according to the following rules. "Auto" sets IF Gain to "High Gain" under any of the following conditions: a)The input attenuator is set to 0 dB, or, b)The preamp is turned on, or, c)The Max Mixer Level is -20 dBm or lower. For other settings, "Auto" sets IF Gain to "Low Gain".
Preset	ON
State Saved	Saved in instrument state.
Range	Off On
Initial S/W Revision	A.10.01

### IF Gain State

Selects the range of IF gain.

Key Path	Meas Setup, Advanced, IF Gain
Mode	DVB-T/H
Remote Command	[ :SENSe ] :EVMtTwo :IF :GAIN [ :STATe ] ON   OFF   1   0 [ :SENSe ] :EVMtTwo :IF :GAIN [ :STATe ] ?
Example	EVMT:IF:GAIN ON EVMT:IF:GAIN?

Notes	This only applies to the RF input. It does not apply to baseband I/Q input. where ON = high gain OFF = low gain
Couplings	When either the auto attenuation works (for example, with the electrical attenuator) or optimize mechanical attenuator range is requested, the IF Gain setting is changed according to the following rule. “Auto” sets IF Gain to “High Gain” under any of the following conditions: the input attenuator is set to 0 dB, the preamp is turned on (total attenuation is less or equal than 2 dB), or the Max Mixer Level is -20 dBm or lower. For other settings, “Auto” sets IF Gain to “Low Gain”.
Preset	Auto and Low Gain
State Saved	Saved in instrument state.
Range	Low Gain (Best for Large Signals)   High Gain (Best Noise Level)
Readback Text	Low Gain   High Gain
Initial S/W Revision	A.10.01

## PhNoise Opt

The Phase Noise Optimization setting affects the phase noise distribution on the analyzer's LO.

Key Path	Meas Setup, Advanced
Mode	DVB-T/H
Remote Command	<code>[ :SENSe]: EVMTtwo:FREQuency:SYNThesis[:STATe] 1 2 3</code> <code>[ :SENSe]: EVMTtwo:FREQuency:SYNThesis[:STATe]?</code>
Example	EVMT:FREQ:SYNT 1 EVMT:FREQ:SYNT?
Notes	Parameter: 1: Best Close-in $\Phi$ Noise, optimizes phase noise for small frequency offsets from the carrier. 2: Best Wide-offset $\Phi$ Noise, optimizes phase noise for wide frequency offsets from the carrier. 3: Fast Tuning, optimizes LO for tuning speed The actual behavior varies somewhat depending on model number and option; you always get fast tuning by choosing #3, but in some models, the “Fast Tuning” choice is identical to the “Best Close-In” choice. Specifically: <ul style="list-style-type: none"> <li>• Models with option EP1 (for example PXA), have a two-loop local oscillator, which switches to a single loop for fast tuning</li> <li>• Models with option EP2 (available, for example, for MXA), use a different loop bandwidth for the fast-tuning choice, which is a compromise between tuning speed and phase noise, giving good tuning speed at all offsets, although not as good as for Close-In; this is useful when you have to look across a wide range of spans</li> </ul> In all other cases, Fast Tuning is the same as Best Close-In.
Dependencies	Does not appear in all models. The key is blank in those models, but the SCPI command is accepted for compatibility (although no action is taken).
Preset	Default value is different depend on hardware configuration.

	Models with option EP2 (available, for example, for MXA), default value is 3; For other cases, default value is 2.
State Saved	Saved in instrument state.
Readback Text	Close-in Wide-offset Fast Tuning
Initial S/W Revision	A.13.01

## MER Monitor

Specifies MER monitor settings for the DVB-T2 Mod Accuracy measurement.

If Monitor (Meas Setup, MER Monitor) is toggled to On, MER Monitor process will start no matter whether the current view is MER Monitor view. The detailed procedures are as follows:

If the current view is MER Monitor view, refer to ["MER Monitor" on page 1720](#) for more information.

If the current view is NOT MER Monitor view, the following actions will be performed. During this process, any other operations, which cause the measurement to restart, will restart the MER monitor process.

### 1. Record raw data

If Limit Line (Meas Setup, MER Monitor) is turned on and the current MER result is smaller than the limit, the raw IQ data will be saved to "D:\userdata\DVB-TH\rawdata", which can be used by the capture buffer of X-Series Signal Analyzer for further research directly.

The recording file name is "dataIndex\_HourMinuteSecond.bin" (Index is the sequence number of the files saved in one monitoring process.), such as "data2\_155636.bin".

The maximum number of files that can be saved is controlled by Max Raw Data Files Saved (Meas Setup, MER Monitor). If the failed points exceed this number, raw data will not be saved anymore. A message (File Number exceeds MaxRawDataFileSaved. Raw Data are not saved) will appear after the MER result in the Log file.

### 2. Log file

Date time, MER results and the rawdata file path (if MER is below the limit) will be saved in a log file named "MER\_log\_DVB\_TH.txt" in "D:\userdata\DVB-TH".

The format of this file is listed below.

```

-----
Starting Time:   9/8/2009 15:55:41
MER Limit:     35.0 dB
Monitor Time:   0.1 hour
MER Unit:      dB
9/8/2009 15:55:41    39.5200086295896
9/8/2009 15:55:41    38.6605823043697
... ..
9/8/2009 15:56:36    34.0759440002693 D:\userdata\DVB-TH\rawdata\data2_155636.bin... ..

```

...9/8/2009 15:59:56 34.4563081204352 File Number exceeds MaxRawDataFileSaved. Raw Data are not saved.

.....

Total Time: 0 d 0 h 6 m 0 s

Total Points: 2236

Failed Points: 6

Failed Percentage (%): 0.268336314847942

-----

Key Path	Meas Setup, More
Initial S/W Revision	A.07.00

## Monitor

Starts or stops MER Monitor.

Key Path	Meas Setup, More, MER Monitor
Mode	DVB-T/H
<b>Remote Command</b>	[ :SENSe ] :EVMTtwo:MERMonitor:STATe OFF ON 0 1 [ :SENSe ] :EVMTtwo:MERMonitor:STATe?
<b>Example</b>	EVMT:MERM:STAT OFF EVMT:MERM:STAT?
Preset	OFF
State Saved	Saved in instrument state.
Range	On   Off
Initial S/W Revision	A.07.00

## Monitor Time

Sets the total monitor time for MER monitor. If Monitor time is set to 1 hour, MER Monitor will stop after an hour.

Key Path	Meas Setup, More, MER Monitor
Mode	DVB-T/H
<b>Remote Command</b>	[ :SENSe ] :EVMTtwo:MERMonitor:TIME <real> [ :SENSe ] :EVMTtwo:MERMonitor:TIME?
<b>Example</b>	EVMT:MERM:TIME 1.0 EVMT:MERM:TIME?

Preset	1.0
State Saved	Saved in instrument state.
Min	0.1
Max	240.0
Initial S/W Revision	A.07.00

## Display Points

Sets the maximum number of points displayed on the MER Monitor trace.

If the actual points exceed this number (2000 for example), only the most recent 2000 points are displayed on the graph. That is to say, if the number of points reaches 2001 when the maximum number of displayed points has been set to 2000, point 1 will be discarded.

Key Path	Meas Setup, More, MER Monitor
Mode	DVB-T/H
<b>Remote Command</b>	<code>[ :SENSe]:EVMttwo:MERMonitor:DPOints &lt;integer&gt;</code> <code>[ :SENSe]:EVMttwo:MERMonitor:DPOints?</code>
<b>Example</b>	<code>EVMT:MERM:DPO 2000</code> <code>EVMT:MERM:DPO?</code>
Preset	2000
State Saved	Saved in instrument state.
Min	10
Max	20000
Initial S/W Revision	A.07.00

## Limit Line

If Limit Line is set to on, a blue line will display on MER Monitor view. Once the measured MER is under this Limit Line, the corresponding raw data will be saved to "D:\userdata\DVB-T2\rawdata" for future research.

If Limit Line is set to off, raw data will not be saved.

Refer to ["MER Monitor" on page 1720](#) for more information.

Key Path	Meas Setup, More, MER Monitor
Mode	DVB-T/H
<b>Remote Command</b>	<code>[ :SENSe]:EVMttwo:MERMonitor:LIMit &lt;real&gt;</code> <code>[ :SENSe]:EVMttwo:MERMonitor:LIMit?</code> <code>[ :SENSe]:EVMttwo:MERMonitor:LIMit:STATE OFF ON 0 1</code> <code>[ :SENSe]:EVMttwo:MERMonitor:LIMit:STATE?</code>

<b>Example</b>	EVMT:MERM:LIM 32.0 EVMT:MERM:LIM? EVMT:MERM:LIM:STAT ON EVMT:MERM:LIM:STAT?
Preset	32.0 ON
State Saved	Saved in instrument state.
Min	0.0
Max	60.0
Initial S/W Revision	A.07.00

### Max Raw Data Files Saved

Sets the maximum number of raw data files that can be saved when the current MER is lower than the Limit Line (Meas Setup, MER Monitor).

If the failed points exceed this number, raw data will no longer be saved. A message (File Number exceeds MaxRawDataFileSaved. Raw Data are not saved) will be displayed after the MER result in the Log file.

Refer to ["MER Monitor" on page 1720](#) for more information.

Key Path	Meas Setup, More, MER Monitor
Mode	DVB-T/H
<b>Remote Command</b>	[ :SENSe ] :EVMTtwo:MERMMonitor:RDFiles:MAX <integer> [ :SENSe ] :EVMTtwo:MERMMonitor:RDFiles:MAX?
<b>Example</b>	EVMT:MERM:RDF:MAX 5 EVMT:MERM:RDF:MAX?
Preset	5
State Saved	Saved in instrument state.
Min	0
Max	20
Initial S/W Revision	A.07.00

### Delete All MER Log and Data Files

Deletes all MER log and raw data files saved on the disk "D:\userdata\DVB-T2\rawdata" without any criteria. It is easy for you to delete useless data files without going to that path on the disk.

This is a "one-time" function, that is, it executes once, when the key is pressed. There will be a pop-up message for you to decide whether to delete these files or not.

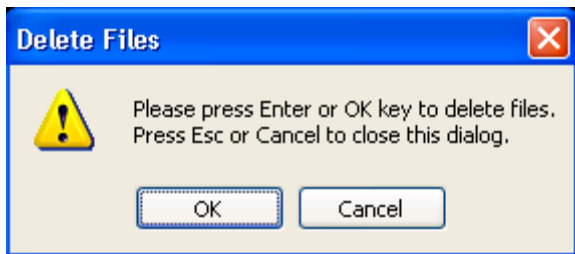

Key Path	Meas Setup, More, MER Monitor
Mode	DVB-T/H
<b>Remote Command</b>	[ :SENSe] :EVMtTwo:MERMonitor:FILEs:DELeTe
<b>Example</b>	EVMT:MERM:FIL:DEL
Initial S/W Revision	A.07.00

### Decode

Allows you to specify the decoding settings for DVB-T2 Mod Accuracy measurement.

Key Path	Meas Setup. More
Initial S/W Revision	A.11.00

### Decoding

Sets whether to do BER decoding or not.

Key Path	Meas Setup, More, Decode
Mode	DVB-T/H
<b>Remote Command</b>	[ :SENSe] :EVMtTwo:DECoding:STATe OFF ON 0 1 [ :SENSe] :EVMtTwo:DECoding:STATe?
<b>Example</b>	EVMT:DEC:STAT OFF EVMT:DEC:STAT?
Couplings	The Decoding key is coupled with the current view in the following way: If Decoding is OFF, and BER Results view is selected, the value of Decoding will be changed to ON automatically. If the current view is changed from BER Results view to another view, the value of Decoding changes back to OFF unless the value of Decoding has been manually changed.
Preset	OFF
State Saved	Saved in instrument state.
Range	On   Off
Initial S/W Revision	A.11.00



## PLP ID

Sets to calculate the BER of which PLP.

Key Path	Meas Setup, More, Decode
Mode	DVB-T/H
<b>Remote Command</b>	[ :SENSe ] :EVMttwo:BERPlpid <integer> [ :SENSe ] :EVMttwo:BERPlpid?
<b>Example</b>	EVMT:BERP 0 EVMT:BERP?
Dependencies	If Decoding (Meas Setup, More, Decode) is Off, this key is grayed out.
Preset	0
State Saved	Saved in instrument state.
Min	0
Max	255
Initial S/W Revision	A.11.00

## Code Rate

Sets the value for code Rate.

Key Path	Meas Setup, More, Decode
Mode	DVB
<b>Remote Command</b>	[ :SENSe ] :EVMttwo:CRATe R1BY2   R3BY5   R2BY3   R3BY4   R4BY5   R5BY6 [ :SENSe ] :EVMttwo:CRATe?
<b>Example</b>	EVMT:CRAT R1BY2 EVMT:CRAT?
Dependencies	If Decoding (Meas Setup, More, Decode) is Off, this key is grayed out. If Auto Detect (Meas Setup) is On, this key is grayed out and the used code rate is auto detected from L1.
Preset	R1BY2
State Saved	Saved in instrument state.
Range	1/2   3/5   2/3   3/4   4/5   5/6
Initial S/W Revision	A.11.00

## BER Count Type

Sets BER Count Type. The selections include Before LDPC and Before BCH.

This key is only available when Decoding (Meas Setup, Decode) is on. It is used together with BER Bit Count (Meas Setup, Decode) to control the stop time of BER Calculation.

When the total bit count of the selected BER exceeds BER Bit Count for the first time, the calculation of BER will stop.

Key Path	Meas Setup, More, Decode
Mode	DVB-T/H
<b>Remote Command</b>	[ :SENSe ] :EVMtTwo:BERCount:TYPE BLDPC BBCH [ :SENSe ] :EVMtTwo:BERCount:TYPE?
<b>Example</b>	EVMT:BERC:TYPE BLDP EVMT:BERC:TYPE?
Dependencies	If Decoding (Meas Setup, More, Decode) is Off, this key is grayed out.
Preset	BLDPC
State Saved	Saved in instrument state.
Range	Before LDPC   Before BCH   After BCH
Initial S/W Revision	A.11.00

### Before LDPC

Selects the total bit count at the Before LDPC point as the signal to stop BER calculation.

Key Path	Meas Setup, More, Decode, BER Count Type
Mode	DVB-T/H
<b>Example</b>	EVMT:BERC:TYPE BLDP
Readback Text	Before LDPC
Initial S/W Revision	A.11.00

### Before BCH

Selects the total bit count at the Before BCH point as the signal to stop BER calculation.

Key Path	Meas Setup, More, Decode, BER Count Type
Mode	DVB-T/H
<b>Example</b>	EVMT:BERC:TYPE BBCH
Readback Text	Before BCH
Initial S/W Revision	A.11.00

### BER Bit Count

Sets BER Bit Count. It is used together with BER Count Type (Meas Setup, Decode) to control the stop time of BER Calculation. When the total bit count of the specified BER count type (set under BER Count Type panel) exceeds the value of BER Bit Count for the first time, the calculation of BER will stop.

Key Path	Meas Setup, More, Decode
Mode	DVB-T/H
<b>Remote Command</b>	<code>[ :SENSe ] :EVMTtwo :BERCount :BITS &lt;real&gt;</code> <code>[ :SENSe ] :EVMTtwo :BERCount :BITS ?</code>
<b>Example</b>	EVMT:BERC:BITS 1.0e12 EVMT:BERC:BITS?
Dependencies	If Decoding (Meas Setup, More, Decode) is Off, this key is grayed out.
Preset	1.0e12
State Saved	Saved in instrument state.
Min	1
Max	1.0e+25
Initial S/W Revision	A.11.00

## Meas Preset

This key restores all the measurement settings to their defaults.

This will set the measure setup parameters (for the currently selected measurement only), to the factory defaults.

Key Path	Meas Setup, More
Mode	DVB-T/H
<b>Remote Command</b>	<code>:CONFigure:EVMTtwo</code>
<b>Example</b>	CONF:EVMT
Couplings	Selecting measurement preset will restore all measurement parameters to their default values for the current measurement.
Initial S/W Revision	A.07.00

## Mode

See ["Mode" on page 298](#)

## Mode Preset

Returns the active mode to a known state.

Mode Preset does the following for the currently active mode:

- Aborts the currently running measurement.
- Brings up the default menu for the mode, with no active function.
- Sets measurement Global settings to their preset values for the active mode only.
- Activates the default measurement.
- Brings up the default menu for the mode.
- Clears the input and output buffers.
- Sets Status Byte to 0.

Mode Preset does not:

- Cause a mode switch
- Affect mode persistent settings
- Affect system settings

See "[How-To Preset](#)" on page 1606 for more information.

Key Path	Front-panel key
<b>Remote Command</b>	:SYSTem:PRESet
<b>Example</b>	:SYST:PRES
Notes	*RST is preferred over :SYST:PRES for remote operation. *RST does a Mode Preset, as done by the :SYST:PRES command, and it sets the measurement mode to Single measurement rather than Continuous for optimal remote control throughput. Clears all pending OPC bits. The Status Byte is set to 0.
Couplings	A Mode Preset aborts the currently running measurement, activates the default measurement, and gets the mode to a consistent state with all of the default couplings set.
Backwards Compatibility Notes	In the X-Series, the legacy "Factory Preset" has been replaced with Mode Preset, which only presets the currently active mode, not the entire instrument. In the X-Series, the way to preset the entire instrument is by using System, Restore System Defaults All, which behaves essentially the same way as restore System Defaults does on ESA and PSA. There is also no "Preset Type" as there is on the PSA. There is a green Mode Preset front-panel key that does a Mode Preset and a white-with-green-letters User Preset front-panel key that does a User Preset. The old PRESet:TYPE command is ignored (without generating an error), and SYST:PRES without a parameter does a Mode Preset, which should cover most backward code compatibility issues. The settings and correction data under the Input/Output front-panel key (examples: Input Z Corr, Ext Amp Gain, etc.) are no longer part of any Mode, so they will not be preset by a Mode Preset. They are preset using Restore Input/Output Defaults, Restore System Defaults All. Note that because User Preset does a Recall State, and all of these settings are saved in State, they ARE recalled when using

	User Preset.
Initial S/W Revision	Prior to A.02.00

## How-To Preset

The table below shows all possible presets, their corresponding SCPI commands and front-panel access (key paths). Instrument settings depend on the current measurement context. Some settings are local to the current measurement, some are global (common) across all the measurements in the current mode, and some are global to all the available modes. In a similar way, restoring the settings to their preset state can be done within the different contexts.

Auto Couple - is a measurement local key. It sets all Auto/Man parameter couplings in the measurement to Auto. Any Auto/Man selection that is local to other measurements in the mode will not be affected.

Meas Preset - is a measurement local key. Meas Preset resets all the variables local to the current measurement except the persistent ones.

Mode Preset - resets all the current mode's measurement local and measurement global variables except the persistent ones.

Restore Mode Defaults - resets ALL the Mode variables (and all the Meas global and Meas local variables), including the persistent ones.

Type Of Preset	SCPI Command	Front Panel Access
Auto Couple	:COUPle ALL	Auto Couple front-panel key
Meas Preset	:CONFigure:<Measurement>	Meas Setup Menu
Mode Preset	:SYSTem:PRESet	Mode Preset (green key)
Restore Mode Defaults	:INSTrument:DEFault	Mode Setup Menu
Restore All Mode Defaults	:SYSTem:DEFault MODes	System Menu; Restore System Default Menu
*RST	*RST	not possible (Mode Preset with Single)
Restore Input/Output Defaults	:SYSTem:DEFault INPUt	System Menu; Restore System Default Menu
Restore Power On Defaults	:SYSTem:DEFault PON	System Menu; Restore System Default Menu
Restore Alignment Defaults	:SYSTem:DEFault ALIGN	System Menu; Restore System Default Menu
Restore Miscellaneous Defaults	:SYSTem:DEFault MISC	System Menu; Restore System Default Menu
Restore All System Defaults	:SYSTem:DEFault [ALL] :SYSTem:PRESet:PERsistent	System Menu; Restore System Default Menu
User Preset	:SYSTem:PRESet:USER	User Preset Menu
User Preset All Modes	:SYSTem:PRESet:USER:ALL	User Preset Menu

Power On Mode Preset	:SYSTem:PON:TYPE MODE	System Menu
Power On User Preset	:SYSTem:PON:TYPE USER	System Menu
Power On Last State	:SYSTem:PON:TYPE LAST	System Menu

### Preset Type (Remote Command Only)

As stated in the Backward Compatibility section, to be compatible with ESA/PSA the PRESet:TYPE command will be implemented as a no-op.

Mode	All
<b>Remote Command</b>	:SYSTem:PRESet:TYPE FACTory MODE USER :SYSTem:PRESet:TYPE?
<b>Example</b>	:SYST:PRESet:TYPE FACT
Notes	This command is supported for backward compatibility only. It is a no-op which does not change the behavior of any preset operation.
Preset	This is unaffected by Preset but is set to Mode on a "Restore System Defaults->All"
State Saved	No
Initial S/W Revision	Prior to A.02.00

## Mode Setup

See "[Mode Setup](#)" on page 328



## Peak Search

Accesses a menu that enables you to control the peak search function and places a marker on the trace point with the highest peak.

Key Path	Front-panel key
Mode	DVB-T/H
<b>Remote Command</b>	:CALCulate:EVMTtwo:MARKer[1] 2 ...12:MAXimum
<b>Example</b>	CALC:EVMT:MARK2:MAX
Initial S/W Revision	A.07.00

### Next Peak

Moves the selected marker to the peak that has the next highest amplitude less than the marker's current value.

Key Path	Peak Search
Mode	DVB-T/H
<b>Remote Command</b>	:CALCulate:EVMTtwo:MARKer[1] 2 ...12:MAXimum:NEXT
<b>Example</b>	CALC:EVMT:MARK2:MAX:NEXT
Initial S/W Revision	A.07.00

### Next Pk Right

Moves the selected marker to the next peak to the right of the current marker.

Key Path	Peak Search
Mode	DVB-T/H
<b>Remote Command</b>	:CALCulate:EVMTtwo:MARKer[1] 2 ...12:MAXimum:RIGHT
<b>Example</b>	CALC:EVMT:MARK2:MAX:RIGH
Initial S/W Revision	A.07.00

### Next Pk Left

Moves the selected marker to the next peak to the left of the current marker.

Key Path	Peak Search
Mode	DVB-T/H
<b>Remote Command</b>	:CALCulate:EVMTtwo:MARKer[1] 2 ...12:MAXimum:LEFT
<b>Example</b>	CALC:EVMT:MARK2:MAX:LEFT
Initial S/W Revision	A.07.00

## Marker Delta

Sets the control mode for the selected marker to Delta mode.

Key Path	Peak Search
Initial S/W Revision	A.07.00

## Peak Criteria

This key is visible only when the current view is Channel Impulse Response.

Key Path	Peak Search, More
Initial S/W Revision	A.07.00

Pressing this key opens the Peak Criteria menu and allows you to adjust the Pk Threshold and Pk Excursion parameters used for peak table.

For a signal to be identified as a peak it must meet certain criteria. If either the peak excursion or peak threshold functions are on, then the signal must satisfy those criteria before being identified as a peak.

**NOTE** The criteria only affect the peaks in Peak Table. It will not affect Peak Search, Next Peak, etc.

## Pk Excursion

This key is visible only when the current view is Channel Impulse Response.

Turns the peak excursion requirement on/off and sets the excursion value. The value defines the minimum amplitude variation (rise and fall) required for a signal to be identified as peak.

When both Pk Excursion and Pk Threshold are on, a signal must rise above the Pk Threshold value by at least the Peak Excursion value and then fall back from its local maximum by at least the Peak Excursion value to be considered a peak.

**NOTE** In the event that a sequence of trace points with precisely the same values represents the maximum, the leftmost point is found.

Key Path	Peak Search, More, Peak Criteria
Mode	DVB-T/H
Remote Command	:CALCulate:EVMTtwo:MARKer:PEAK:EXCursion <rel_ampl> :CALCulate:EVMTtwo:MARKer:PEAK:EXCursion? :CALCulate:EVMTtwo:MARKer:PEAK:EXCursion:STATE OFF ON 0 1 :CALCulate:EVMTtwo:MARKer:PEAK:EXCursion:STATE?
Example	CALC:EVMT:MARK:PEAK:EXC 6.00 CALC:EVMT:MARK:PEAK:EXC?

	CALC:EVMT:MARK:PEAK:EXC:STAT ON CALC:EVMT:MARK:PEAK:EXC:STAT?
Preset	6.00 ON
State Saved	Saved in instrument state.
Min	0.00
Max	100.00
Initial S/W Revision	A.07.00

## Pk Threshold

This key is visible only when the current view is Channel Impulse Response.

Turns the peak threshold requirement on/off and sets the threshold value. The peak threshold value defines the minimum signal level (or min threshold) that the peak identification algorithm uses to recognize a peak.

When both Pk Excursion and Pk Threshold are on, a signal must rise above the Pk Threshold value by at least the Peak Excursion value and then fall back from its local maximum by at least the Peak Excursion value to be considered a peak.

For example, if a threshold value of -90 dB is selected, the peak search algorithm will only consider signals with amplitude greater than the -90 dB threshold. If a threshold value of -90 dB is selected, and Peak Excursion is On and set to 6 dB, the peak search algorithm will only consider signals with amplitude greater than the -90 dB threshold which rise 6 dB above the threshold and then fall back to the threshold.

Key Path	Peak Search, More, Peak Criteria
Mode	DVB-T/H
<b>Remote Command</b>	:CALCulate:EVMTtwo:MARKer:PEAK:THReshold <real> :CALCulate:EVMTtwo:MARKer:PEAK:THReshold? :CALCulate:EVMTtwo:MARKer:PEAK:THReshold:STATe OFF ON 0 1 :CALCulate:EVMTtwo:MARKer:PEAK:THReshold:STATe?
<b>Example</b>	CALC:EVMT:MARK:PEAK:THR -90.00 CALC:EVMT:MARK:PEAK:THR? CALC:EVMT:MARK:PEAK:THR:STAT ON CALC:EVMT:MARK:PEAK:THR:STAT?
Couplings	If Peak Threshold is Off and the Peak Threshold line is turned on, it should turn on Peak Threshold. If Peak Threshold Line is On and the Peak Threshold is turned off, it should turn off Peak Threshold Line.
Preset	-90.00 ON
State Saved	Saved in instrument state.

Min	-200.00
Max	0.00
Initial S/W Revision	A.07.00

## Pk Threshold Line

This key is visible only when the current view is Channel Impulse Response.

Turns the peak threshold line on or off. Preset state is off. No equivalent SCPI command.

See "[More Information](#)" on page 1612.

Key Path	Peak Search, More, Peak Criteria
Mode	DVB-T/H
Couplings	If Peak Threshold is Off and the Peak Threshold line is turned on, it should turn on Peak Threshold. If Peak Threshold Line is On and the Peak Threshold is turned off, it should turn off Peak Threshold Line.
Initial S/W Revision	A.07.00

## More Information

The Peak Threshold line is green and has the value of the peak threshold (for example, “-60.00 dB”) written above its right side. If Peak Excursion is ON, it shows on the left side as a region above the Peak Threshold line. As with all such lines (Peak Limit Line) it is drawn on top of all traces.

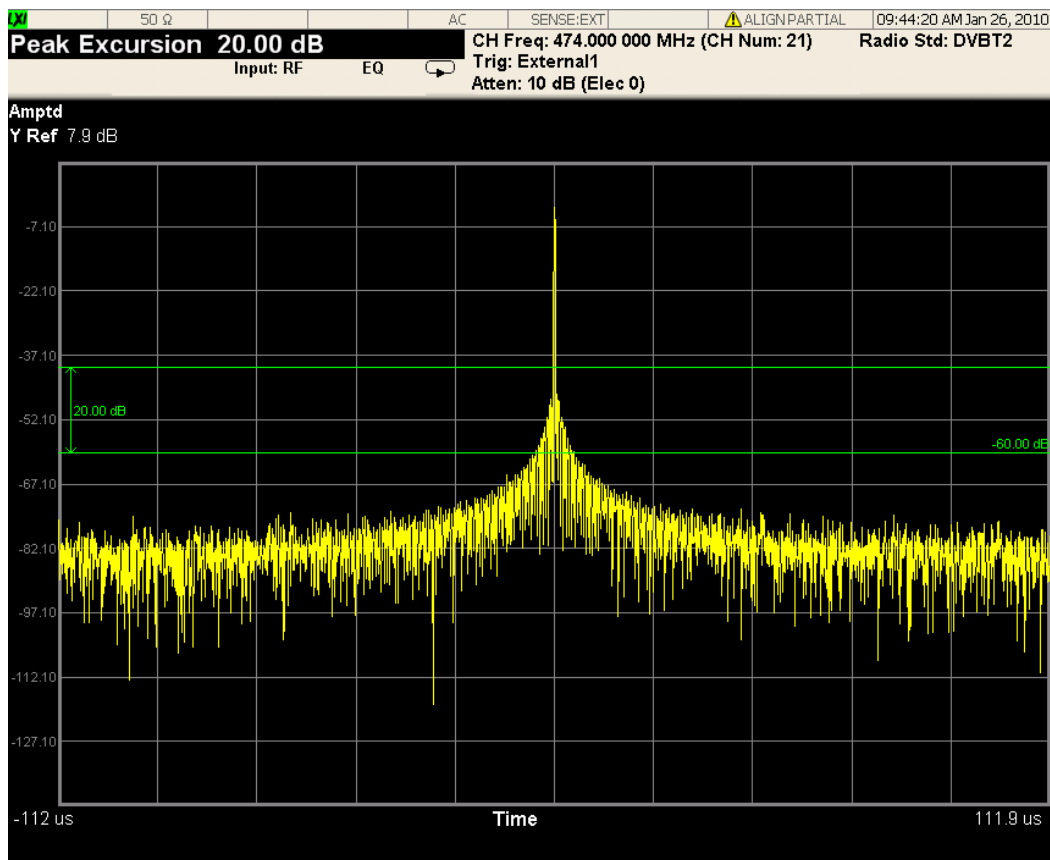

This function is automatically set to OFF whenever Peak Threshold is set to OFF. Manually turning it ON automatically turns on Pk Threshold.

The Peak Excursion part is on whenever the Pk Threshold part is on, unless Peak Excursion is OFF.

### Peak Table

This key is visible only when the current view is Channel Impulse Response.

Key Path	Peak Search, More
Initial S/W Revision	A.07.00

The Peak Table provides a displayed list of up to 10 signal peaks from the Amplitude vs. Time trace. If there are more than 10 signals which meet the peak search criteria, only the 10 highest peaks are listed.

The list of peaks in the Peak Table can be ordered either by ascending time (absolute value, delay) or by descending amplitude. In either case, the entire trace is first evaluated and the 10 highest peaks are selected for inclusion in the list. After the peaks are selected, they are then sorted and displayed according to the Peak Sort setting.

When Peak Table is turned on, a new window is created along the left side of the display to accommodate the table. Each entry in the table contains the peak index (1–10), the x-axis value, and the y-axis value. Each peak index number is also displayed on the trace immediately above the corresponding peak.

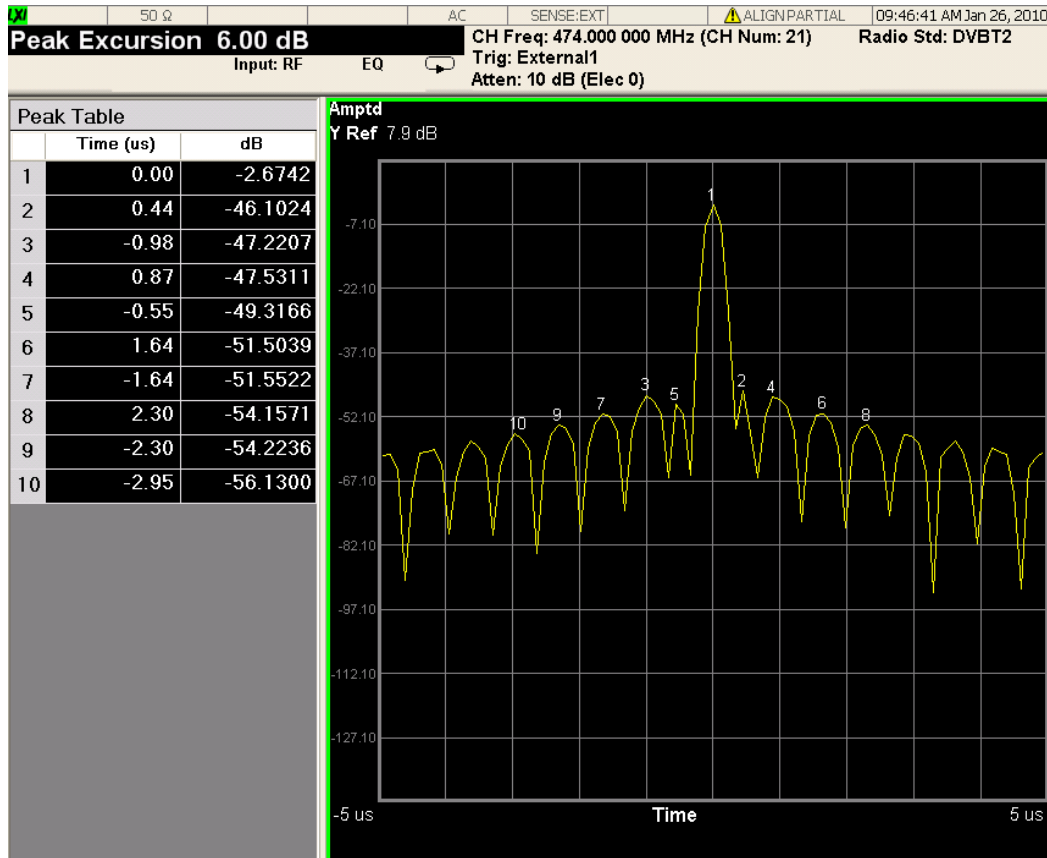

### Peak Table

This key is visible only when the current view is Channel Impulse Response.

Turns Peak Table on/off. When turned on, the display is split into a measurement window and a peak table display window.

<b>Key Path</b>	Peak Search, More, Peak Table
<b>Mode</b>	DVB-T/H
<b>Remote Command</b>	:CALCulate:EVMTtwo:MARKer:PEAK:TABLE:STATE OFF ON 0 1 :CALCulate:EVMTtwo:MARKer:PEAK:TABLE:STATE?
<b>Example</b>	CALC:EVMT:MARK:PEAK:TABL:STAT ON CALC:EVMT:MARK:PEAK:TABL:STAT?
<b>Preset</b>	ON
<b>State Saved</b>	Saved in instrument state.
<b>Range</b>	On   Off
<b>Initial S/W Revision</b>	A.07.00

## Peak Sort

This key is visible only when the current view is Channel Impulse Response.

Sets the peak table sorting routine to list the peaks in order of descending amplitude or ascending time (absolute value).

Key Path	Peak Search, More, Peak Table
Mode	DVB-T/H
Remote Command	:CALCulate:EVMTtwo:MARKer:PEAK:SORT TIME AMPLitude :CALCulate:EVMTtwo:MARKer:PEAK:SORT?
Example	CALC:EVMT:MARK:PEAK:SORT AMPLitude CALC:EVMT:MARK:PEAK:SORT?
Preset	AMPLitude
State Saved	Saved in instrument state.
Range	Time   Amptd
Initial S/W Revision	A.07.00

## Peak Limit

This key is visible only when the current view is Channel Impulse Response.

If Peak Limit is set to on, a green line will display on Channel Impulse Response view. Only the peaks above Peak Limit will be displayed in Peak Table.

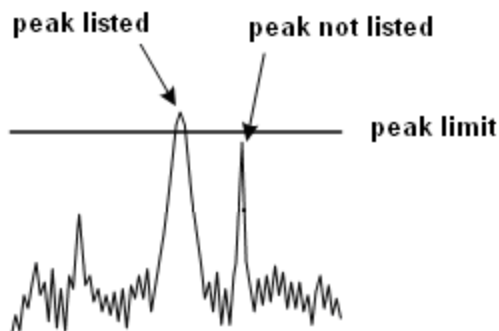

Key Path	Peak Search, More, Peak Table
Mode	DVB-T/H
Remote Command	:CALCulate:EVMTtwo:MARKer:PEAK:LIMit <real> :CALCulate:EVMTtwo:MARKer:PEAK:LIMit? :CALCulate:EVMTtwo:MARKer:PEAK:LIMit:STATE OFF ON 0 1 :CALCulate:EVMTtwo:MARKer:PEAK:LIMit:STATE?
Example	CALC:EVMT:MARK:PEAK:LIM -25.0 CALC:EVMT:MARK:PEAK:LIM?

	CALC:EVMT:MARK:PEAK:LIM:STAT ON CALC:EVMT:MARK:PEAK:LIM:STAT?
Preset	-35.00 ON
State Saved	Saved in instrument state.
Min	-1000.00
Max	500.00
Initial S/W Revision	A.07.00

### Pk-Pk Search

Finds and displays the amplitude and frequency (or time, if in zero span) differences between the highest and lowest y-axis value.

Key Path	Peak Search, More
Mode	DVB-T/H
<b>Remote Command</b>	:CALCulate:EVMTtwo:MARKer[1] 2 ...12:PTPeak
<b>Example</b>	CALC:EVMT:MARK:PTP
Notes	Restrictions Information: Turns on the Marker $\Delta$ active function.
Couplings	This key is not available (key is grayed out) when Couple Markers (Marker, More) is on.
Initial S/W Revision	A.07.00

### Min Search

Moves the selected marker to the minimum y-axis value on the current trace.

Key Path	Peak Search, More
Mode	DVB-T/H
<b>Remote Command</b>	:CALCulate:EVMTtwo:MARKer[1] 2 ...12:MINimum
<b>Example</b>	CALC:EVMT:MARK:MIN
Initial S/W Revision	A.07.00



Print

See "Print" on page 341

## Quick Save

The Quick Save front-panel key repeats the most recent save that was performed from the Save menu, with the following exceptions:

- Register saves are not remembered as Saves for the purpose of the Quick Save function
- If the current measurement does not support the last non-register save that was performed, an informational message is generated, “File type not supported for this measurement”

Quick Save repeats the last type of qualified save (that is, a save qualified by the above criteria) in the last save directory by creating a unique filename using the Auto File Naming algorithm described below.

If Quick Save is pressed after startup and before any qualified Save has been performed, the Quick Save function performs a Screen Image save using the current settings for Screen Image saves (current theme, current directory), which then becomes the “last save” for the purpose of subsequent Quick Saves.

The Auto File Naming feature automatically generates a file name for use when saving a file. The filename consists of a prefix and suffix separated by a dot, as is standard for the Windows® file system. A default prefix exists for each of the available file types:

Type	Default Prefix	Menu
State	State_	(Save/Recall)
Trace + State	State_	(Save/Recall)
Screen	Screen_	(Save/Recall)
Amplitude Corrections	Ampcor_	(Import/Export)
Traces	Trace_	(Import/Export)
Limit Lines	LLine_	(Import/Export)
Measurement Result	MeasR_	(Import/Export)
Capture Buffer	CapBuf_	(Import/Export)

A four digit number is appended to the prefix to create a unique file name. The numbering sequence starts at 0000 within each Mode for each file type and updates incrementally to 9999, then wraps to 0000 again. It remembers where it was through a Mode Preset and when leaving and returning to the Mode. It is reset by Restore Misc Defaults and Restore System Defaults and subsequent running of the instrument application. So, for example, the first auto file name generated for State files is State\_0000.state. The next is State\_0001, and so forth.

One of the key features of Auto File Name is that we guarantee that the Auto File Name will never conflict with an existing file. The algorithm looks for the next available number. If it gets to 9999, then it looks for holes. If it find no holes, that is no more numbers are available, it gives an error.

For example, if when we get to State\_0010.state there is already a State\_0010.state file in the current directory, it advances the counter to State\_0011.state to ensure that no conflict will exist (and then it verifies that State\_0011.state also does not exist in the current directory and advances again if it does, and so forth).

If you enter a file name for a given file type, then the prefix becomes the filename you entered instead of the default prefix, followed by an underscore. The last four letters (the suffix) are the 4-digit number.

For example, if you save a measurement results file as “fred.csv”, then the next auto file name chosen for a measurement results save will be fred\_0000.csv.

**NOTE**

Although 0000 is used in the example above, the number that is used is actually the current number in the Meas Results sequence, that is, the number that would have been used if you had not entered your own file name.

---

**NOTE**

If the filename you entered ends with \_dddd, where d=any number, making it look just like an auto file name, then the next auto file name picks up where you left off with the suffix being dddd + 1.

---

Key Path	Front-panel key
Notes	No remote command for this key specifically.
Initial S/W Revision	Prior to A.02.00

---

## Recall

The Recall menu lets you choose what you want to recall, and where you want to recall it from. Among the types of files you can recall are **States and Traces**. In addition, an Import (Data) option lets you recall a number of data types stored in CSV files (as used by Excel and other spreadsheet programs).

The default paths for Recall are data type dependent and are the same as for the Save key.

Key Path	Front-panel key
Notes	<p>No remote command for this key specifically, but the :MMEM:LOAD command is available for specific file types. An example is :MMEM:LOAD:STATe &lt;filename&gt;.</p> <p>If you try to recall a State file for a mode that is not licensed or not available in the instrument, an error message will occur and the state will not change.</p>
Backwards Compatibility Notes	<p>In legacy analyzers, it was possible to load a state without affecting the trace data, limit lines or correction data. Similarly (since User Preset is actually loading a state), it was possible to do a User Preset without affecting the trace data, limit lines or correction data.</p> <p>In the X-Series, "state" always includes all of this data; so whenever state is loaded, all of the traces, limit lines and corrections are affected. Although this differs from previous behavior, it is desirable behavior, and should not cause adverse issues for users.</p>
Backwards Compatibility Notes	<p>Recall for the X-Series supports backward compatibility in the sense that you can recall a state file from any X-Series model number and any version of X-Series software. This is only possible if part of the recalling process goes through a limiting step after recalling the mode settings, at least for settings that may vary with version number, model number, option and license differences. If you try to recall a state file onto an instrument with less capability than what was available on the instrument during the save, the recall will ignore the state it doesn't support and it will limit the recalled setting to what it allows.</p> <p>Example: if the saved state includes preamp ON, but the recalling instrument does not have a preamp; the preamp is limited to OFF. Conversely, if you save a state without a preamp, the preamp is OFF in the state file. When this saved file is recalled on an instrument with a licensed preamp, the preamp is changed to OFF. Another example is if the saved state has center frequency set to 20 GHz, but the instrument recalling the saved state is a different model and only supports 13.5 GHz. In this case, the center frequency is limited along with any other frequency based settings. Since the center frequency can't be preserved in this case, the recall limiting tries to at least preserve span to keep the measurement setup as intact as possible.</p> <p>It may be appropriate to issue a warning if the state is limited on the recall; warnings do not go out to SCPI so this would only affect the manual user.</p> <p>Note that there is no state file compatibility outside of the X-Series. For example, you cannot recall a state file from ESA or PSA.</p>
Initial S/W Revision	Prior to A.02.00

## State

The Recall State menu lets you choose a register or file from which to recall the state.

The content of a state file includes all of the settings and data required to return the analyzer as closely as possible to the Mode it was in, with the exact settings that were in place, when the save occurred. The Mode settings in each state file include the settings that are affected by Mode Preset, as well as the

additional settings affected by Restore Mode Defaults; all of the Mode’s settings. In addition, all of the settings of the Input/Output system are included, even though they are outside of the Mode’s state, because they are needed to restore the complete setup. Persistent System settings (for example, GPIB address) are not affected by either a Mode Preset or Restore Mode Defaults, nor are they included in a saved State file.

Since each state file is only for one Mode, the settings for other Modes are unaffected when it is loaded. Recall State will cause a mode switch if the state being recalled is not from the current active mode.

After the recall completes, the message "File <filename> recalled" or “Recalled State Register <register number>” is displayed.

For rapid recalls, the State menu lists 16 registers that you can choose from to recall. Pressing a Register key initiates the recall. You can also select a file from which to recall.

The default path for all State Files is:

My Documents\<<mode name>\state

where <mode name> is the parameter used to select the mode with the INST:SEL command (for example, SA for the Spectrum Analyzer).

See "[More Information](#)" on page 1622.

<b>Key Path</b>	Recall
<b>Mode</b>	All
<b>Remote Command</b>	:MMEMory:LOAD:STATe <filename>
<b>Example</b>	:MMEM:LOAD:STAT "myState.state" This recalls the file myState.state on the default path
<b>Example</b>	MMEM:LOAD:STAT "MyStateFile.state" This loads the state file data (on the default file directory path) into the instrument state.
<b>Notes</b>	<p>When you pick a file to recall, the analyzer first verifies that the file is recallable in the current instrument by checking the software version and model number of the instrument. If everything matches, a full recall proceeds by aborting the currently running measurement, clearing any pending operations, and then loading the State from the saved state file. You can open state files from any mode, so recalling a State file switches to the mode that was active when the save occurred. After switching to the mode of the saved state file, mode settings and data (if any for the mode) are loaded with values from the saved file. The saved measurement of the mode becomes the newly active measurement and the data relevant to the measurement (if there is any) is recalled.</p> <p>If there is a mismatch between file version or model number or instrument version or model number, the recall function tries to recall as much as possible and returns a warning message. It may limit settings that differ based on model number, licensing or version number.</p> <p>After recalling the state, the Recall State function does the following:</p> <ul style="list-style-type: none"> <li>• Makes the saved measurement for the mode the active measurement.</li> <li>• Clears the input and output buffers.</li> <li>• Status Byte is set to 0.</li> <li>• Executes a *CLS</li> </ul> <p>If the file specified is empty an error is generated. If the specified file does not exist, another error is generated. If there is a mismatch between the file and the proper file type, an error is generated. If</p>

---

	there is a mismatch between file version or model number or instrument version or model number, a warning is displayed. Then it returns to the State menu and File Open dialog goes away. After the Recall, the analyzer exits the Recall menu and returns to the previous menu.
<b>Backwards Compatibility SCPI</b>	:MMEMory:LOAD:STATe 1,<filename> For backwards compatibility, the above syntax is supported. The "1" is simply ignored.
Initial S/W Revision	Prior to A.02.00

---

### More Information

In measurements that support saving Traces, for example, Swept SA, the Trace data is saved along with the State in the State file. When recalling the State, the Trace data is recalled as well. Traces are recalled exactly as they were stored, including the writing mode and update and display modes. If a Trace was updating and visible when the State was saved, it will come back updating and visible, and its data will be rewritten right away. When you use State to save and recall traces, any trace whose data must be preserved should be placed in View or Blank mode before saving.

The following table describes the Trace Save and Recall possibilities:

You want to recall state and one trace's data, leaving other traces unaffected.	Save Trace+State from 1 trace. Make sure that no other traces are updating (they should all be in View or Blank mode) when the save is performed.	On Recall, specify the trace you want to load the one trace's data into. This trace will load in View. All other traces' data will be unaffected, although their trace mode will be as it was when the state save was performed.
You want to recall all traces	Save Trace+State from ALL traces.	On Recall, all traces will come back in View (or Blank if they were in Blank or Background when saved)
You want all traces to load exactly as they were when saved.	Save State	On recall, all traces' mode and data will be exactly as they were when saved. Any traces that were updating will have their data immediately overwritten.

### From File...

When you press "From File", the analyzer brings up a Windows dialog and a menu entitled "File Open." This menu allows you to navigate to the various fields in the Windows dialog without using a keyboard or mouse. The Tab and Arrow keys can also be used for dialog navigation.

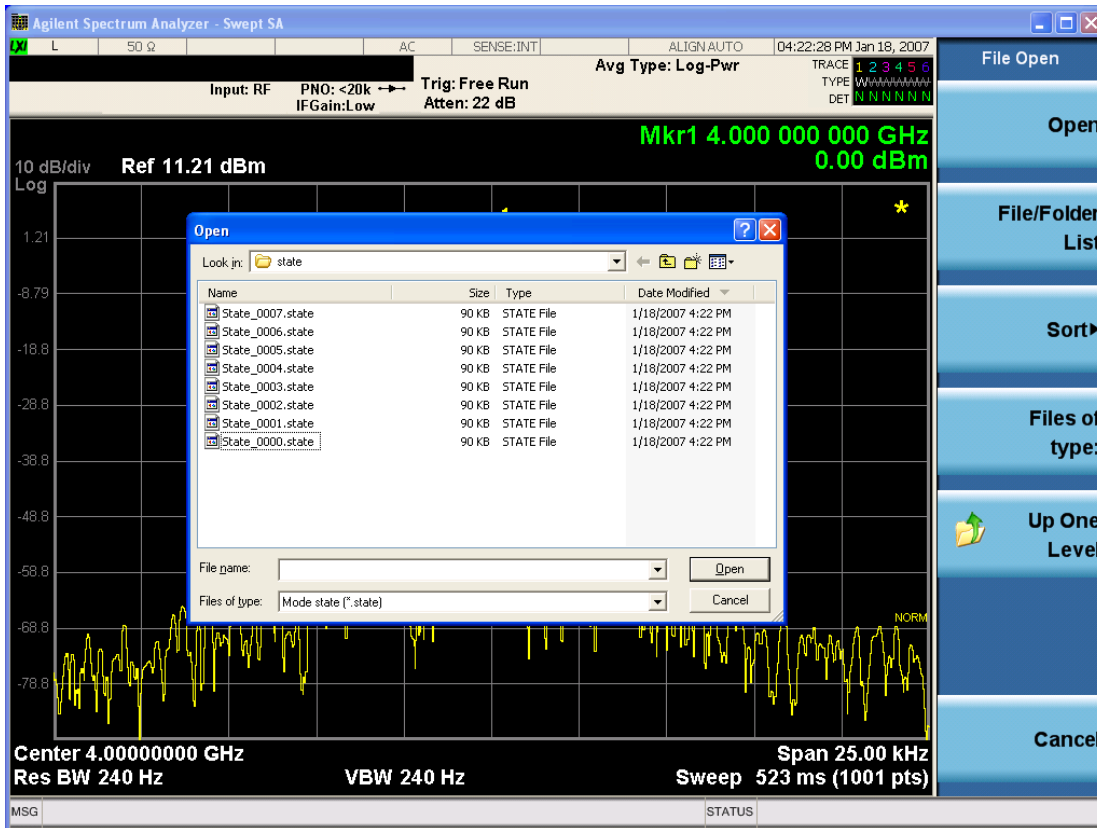

Listed below are the functions of the various fields in the dialog, and the corresponding softkeys:

#### Open

Performs the recall of the specified file. While the recall is being performed, the floppy icon appears briefly in the Meas bar.

#### File/Folder List

Enables you to navigate to the center of the dialog that contains the list of files and folders. Once here you can get information about the file and use the tab keys to navigate to the other fields in the dialog, such as Look In.

#### Look In

The Look In field shows the path from which the file will be recalled and allows you to change the path using the up and down arrow keys to navigate to other paths; the Enter key to open a directory; and the Backspace key to go back one directory. The **Look In field** first uses the last path from the Save As dialog **Save In:** path for that same file type. There is no softkey for directly navigating to the Look In field, but you can use the left tab to get here from the File/Folder List.

User specified paths are remembered when you leave and return to a Mode and are reset back to the default using Restore Mode Defaults.

#### Sort

Accesses a menu that enables you to sort the files within the File Open dialog. Only one sorting type can be selected at a time and the sorting happens immediately. The sorting types are By Date, By Name, By extension, and By Size.

#### Files of Type

This field shows the file suffix for the type of file you have selected to recall. For example, if you navigated here while recalling State, "Mode state (\*.state)" is in the field. If you navigated here while recalling Trace, ""Mode state (\*.trace)" is in the field. If you navigated here while importing a trace data file, "Trace Data (\*.csv)" is in the field. For some file types, there is more than one choice in the dropdown menu, which you can select by using the up and down arrow keys and Enter.

#### Up One Level

This key corresponds to the icon of a folder with the up arrow that is in the tool bar of the dialog. When pressed, it causes the file and folder list to navigate up one level in the directory structure. The Backspace key does the same thing.

#### Cancel

This key corresponds to the Cancel selection in the dialog. It causes the current **Open** request to be cancelled. The ESC key does the same thing.

Key Path	Recall, State
Notes	Brings up the Open dialog for recalling a State Save Type
Initial S/W Revision	Prior to A.02.00

### Edit Register Names

You may enter a custom name on any of the Register keys, to help you remember what you are using that state to save. To do this, press the Edit Register Names key, choose the register whose name you wish to edit, and then enter the desired label using the Alpha Editor or an external PC keyboard.

The maximum number of characters that can be added is 30. In most cases, 30 characters will fit on two lines of the key.

For more information and the SCPI command, see Edit Register Names under the Save, State function.

Key Path	Recall, State
Mode	All
Dependencies	N9060A-7FP or N9060B-2FP license required to edit the register names. When the feature is not licensed, sending the SCPI command generates an error, -221, "Settings conflict;Option not available"
Initial S/W Revision	A.11.00

### Register 1 thru Register 16

Selecting any one of these register keys causes the State of the mode from the specified Register to be recalled. Each of the register keys annotates whether it is empty or at what date and time it was last



modified. In addition, you can use the Edit Register Names key under Save, State to enter custom names for each register.

Registers are shared by all modes, so recalling from any one of the registers will cause a mode switch to the mode that was active when the save to the Register occurred.

Although these 16 registers are the only registers available from the front panel, there are 128 state registers available in the instrument. Registers 17–128 are only available from the SCPI interface, using the \*RCL command.

After the recall completes, the message "Register <register number> recalled" appears in the message bar. If you are in the Spectrum Analyzer Mode, and you are recalling a register that was saved in the Spectrum Analyzer Mode, then after the recall, you will still be in the Recall Register menu. If the Recall causes you to switch modes, then after the Recall, you will be in the Frequency menu.

If a requested register is empty an error is generated.

Key Path	Recall, State
<b>Example</b>	*RCL 1
Range	1–16 from front panel, 1–128 from SCPI
Readback	Date and time with seconds resolution are displayed on the key OR A custom name of up to 30 characters entered using the Save, State, Edit Register Names key OR “(empty)” if no prior save operation has been performed to this register.
Initial S/W Revision	Prior to A.02.00
Modified at S/W Revision	Prior to A.11.00

## Register 1 thru Register 16

Selecting any one of these register keys causes the State of the mode from the specified Register to be recalled. Each of the register keys annotates whether it is empty or at what date and time it was last modified. In addition, you can use the Edit Register Names key under Save, State to enter custom names for each register.

Registers are shared by all modes, so recalling from any one of the registers will cause a mode switch to the mode that was active when the save to the Register occurred.

Although these 16 registers are the only registers available from the front panel, there are 128 state registers available in the instrument. Registers 17–128 are only available from the SCPI interface, using the \*RCL command.

After the recall completes, the message "Register <register number> recalled" appears in the message bar. If you are in the Spectrum Analyzer Mode, and you are recalling a register that was saved in the Spectrum Analyzer Mode, then after the recall, you will still be in the Recall Register menu. If the Recall causes you to switch modes, then after the Recall, you will be in the Frequency menu.

If a requested register is empty an error is generated.

Key Path	Recall, State
<b>Example</b>	*RCL 1
Range	1-16 from front panel, 1-128 from SCPI
Readback	Date and time with seconds resolution are displayed on the key OR A custom name of up to 30 characters entered using the Save, State,Edit Register Names key OR “(empty)” if no prior save operation has been performed to this register.
Initial S/W Revision	Prior to A.02.00
Modified at S/W Revision	Prior to A.11.00

## Data (Import)

Importing a data file loads data that was previously saved from the current measurement or from other measurements and/or modes that produce compatible data files. The Import Menu only contains Data Types that are supported by the current measurement.

Since the commonly exported data files are in .csv format, the data can be edited by the user prior to importing. This allows you to export a data file, manipulate the data in Excel (the most common PC Application for manipulating .csv files) and then import it.

Importing Data loads measurement data from the specified file into the specified or default destination, depending on the data type selected. Selecting an Import Data menu key will not actually cause the importing to occur, since the analyzer still needs to know from where to get the data. Pressing the Open key in this menu brings up the Open dialog and Open menu that provides you with the options from where to recall the data. Once a filename has been selected or entered in the Open menu, the recall occurs as soon as the Open button is pressed.

Key Path	Recall
Mode	All
Notes	The menu is built from whatever data types are available for the mode. Some keys will be missing completely, so the key locations in the sub-menu will vary. No SCPI command directly controls the Data Type that this key controls. The Data Type is included in the MMEM:LOAD commands.
Dependencies	If a file type is not used by a certain measurement, it is grayed out for that measurement. The key for a file type will not show at all if there are no measurements in the Mode that support it.
Preset	Is not affected by Preset or shutdown, but is reset during Restore Mode Defaults
Readback	The data type that is currently selected
Initial S/W Revision	Prior to A.02.00

## Amplitude Correction

This key selects the Amplitude Corrections as the data type to be imported. When pressed a second time, it brings up the Select Menu, which lets you select the Correction into which the data will be imported.

Amplitude Corrections are fully discussed in the documentation of the Input/Output key, under the Corrections key.

A set of preloaded Corrections files can be found in the directory

/My Documents/ EMC Limits and Ampcor.

When the Amplitude Correction is an Antenna correction and the Antenna Unit in the file is not None, the Y Axis Unit setting will change to match the Antenna Unit in the file.

Key Path	Recall
Mode	SA EDGE GSM PN
Remote Command	:MMEMory:LOAD:CORRection 1 2 3 4 5 6 7 8, <filename>
Example	:MMEM:LOAD:CORR 2, "myAmpcor.csv" recalls the Amplitude Correction data from the file myAmpcor.csv in the current directory to the 2nd Amplitude Correction table, and turns on Correction 2. The default path is D:\User_My_Documents\Instrument\My Documents\amplitudeCorrections\
Dependencies	Only the first correction array (Correction 1) supports antenna units. This means that a correction file with an Antenna Unit can only be loaded into the Corrections 1 register. Consequently only for Correction 1 does the dropdown in the Recall dialog include.ant, and if an attempt is made to load a correction file into any other Correction register which DOES contain an antenna unit, a Mass Storage error is generated. Corrections are not supported by all Measurements. If in a Mode in which some Measurements support it, this key will be grayed out in measurements that do not. The key will not show at all if no measurements in the Mode support it. Errors are reported if the file is empty or missing, or if the file type does not match, or if there is a mismatch between the file type and the destination data type. If any of these occur during manual operation, the analyzer returns to the Import Data menu and the File Open dialog goes away. This key does not appear unless you have the proper option installed in your instrument. This command will generate an "Option not available" error unless you have the proper option installed in your instrument.
Couplings	When a correction file is loaded from mass storage, it is automatically turned on ( <b>Correction ON</b> ) and <b>ApplyCorrections</b> is set to On. This allows you to see its effect, thus confirming the load.
Readback	selected Correction
Backwards Compatibility SCPI	:MMEMory:LOAD:CORRection ANTenna   CABLe   OTHer   USER, <filename> For backwards compatibility, ANTenna maps to 1, CABLe maps to 2, OTHer maps to 3 and USER maps to 4
Initial S/W Revision	A.02.00

## Amplitude Correction

These keys let you select which Correction to import the data into. Once selected, the key returns back to the Import Data menu and the selected Correction number is annotated on the key. The next step is to select the Open key in the Import Data menu.

Antenna corrections are a particular kind of Amplitude Corrections – they are distinguished in the corrections file by having the Antenna Unit set to a value other than None. Only Correction 1 supports Antenna Units.

Key Path	Recall, Data, Amplitude Correction
Notes	auto return
Dependencies	Only Correction 1 may be used to load a Correction that contains an Antenna Unit other than None
Preset	Not part of Preset, but is reset to Correction 1 by Restore Input/Output Defaults; survives shutdown.
State Saved	The current Correction number is saved in instrument state
Initial S/W Revision	A.02.00

## Chan Table

Imports the channel table from a channel plan file. This function enables you to use your own defined channel tables by importing a modified channel table file.

Instead of creating a brand new channel plan file, you can generate a channel plan file to fit your needs using a saved channel plan file or the default channel plan file ChannelPlan.txt in the directory “My Documents\Digital Video\data\”. The saved channel plan file is obtained by pressing Save, Data, Channel Table, and then Save As...

Note that while editing the channel plan file, you cannot change the channel plan name, such as NTSC\_B.VHF, NTSC\_B.UHF, otherwise your modifications on the corresponding channel plan will not work. You can add, remove, or modify the channel numbers and center frequencies in each channel plan. The value of Start Channel and Channel Count may also need to be changed.

File Location and Extension

**File location:** “My Documents\Digital Video\data”

**File type:** text file

**File extension:** .txt

**Example:**

File Location: My Documents\Digital Video\data

File Name: ChannelPlan\_0001.txt

Key Path	Recall, Data
Mode	DVB-T/H
Remote Command	MMEMory:LOAD:CHTable <string>
Example	MMEM:LOAD:CHT “ChannelPlan_0001.txt”
Initial S/W Revision	A.07.00

## Capture Buffer

Capture buffer functionality is available only in Mod Accuracy measurement. The captured data is raw data which is not processed.

Key Path	Recall, Data
Mode	DVB-T/H
Example	MMEM:LOAD:CAPT "MyCaptureData.bin" This loads the file of capture data (on the default file directory path) into the instrument.
Dependencies	Capture buffer data is only available for Mod Accuracy measurement. In other measurements, this key is grayed out.
Initial S/W Revision	Prior to A.01.70

## DVB-T2 Config

Imports DVB-T2 configuration from setting files (single PLP or multiple PLPs). This key is available only in DVB-T2 Mod Accuracy measurement and will be grayed out in other measurements.

If the configuration file to be recalled is created with previous instrument S/W revision A.10.52 or before (To check the instrument S/W revision, press System, Show, System on the instrument), it doesn't have Transmission Mode and Version parameters. Then you need to set up the DVB-T2 version and transmission mode manually by pressing Mode Setup, Radio Std, DVB-T2, Version 1.1.1, and toggling Transmission Mode to SISO to select the standard version and transmission mode of the signal under test.

All the modulation parameters can be set from the setting file. These parameters include Version, Transmission Mode, Guard Interval, FFT size, Carrier Mode, Pilot Pattern, L1 Modulation Format, Data Symbols, PAPR Type, PLP Number, SubSlices Number, SubSlices Interval, PLP Modulation Format, PLP Constellation Rotation, FEC Type, Time IL Length, FEC Block Num, PLP ID, PLP Start, PLP Type and PLP Code Rate.

File Location and Extension

**File location:** "My Documents\DVB\data\EVMT2\data"

**File type:** text file

**File extension:** .csv

**Example:**

File Location: My Documents\DVB\data\EVMT2\data

File Name: DVBT2Config\_0001.csv

Key Path	Recall, Data
Mode	DVB-T/H
<b>Remote Command</b>	MMEMory:LOAD:T2Config <string>

<b>Example</b>	MMEM:LOAD:T2C "DVBT2Config_0001.csv"
<b>Dependencies</b>	This key is grayed out in all other measurements except DVB-T2 Mod Accuracy measurement.
<b>Couplings</b>	Auto Detect (Meas, DVB-T2 ModAccuracy, Meas Setup) will be changed to OFF automatically when the DVB-T2 config file is loaded.
<b>Initial S/W Revision</b>	A.07.00

## Open...

When you press "Open", the analyzer brings up a Windows dialog and a menu entitled "File Open." This menu allows you to navigate to the various fields in the Windows dialog without using a keyboard or mouse. The Tab and Arrow keys can also be used for dialog navigation.

See "[From File...](#)" on page 2201 in Recall, State, for a full description of this dialog and menu.

<b>Key Path</b>	Recall, Data
<b>Notes</b>	The key location is mode-dependent and will vary. Brings up Open dialog for recalling a <mode specific> Save Type
<b>Initial S/W Revision</b>	Prior to A.02.00

## Restart

The Restart function restarts the current sweep, or measurement, or set of averaged/held sweeps or measurements. If you are Paused, pressing Restart does a Resume.

The Restart function is accessed in several ways:

- Pressing the Restart key
- Sending the remote command INIT:IMMEDIATE
- Sending the remote command INIT:RESTART

See "[More Information](#)" on page 1631

Key Path	Front-panel key
Remote Command	:INITiate[:IMMEDIATE] :INITiate:RESTART
Example	:INIT:IMM :INIT:REST
Notes	:INITiate:RESTART and :INITiate:IMMEDIATE perform exactly the same function.
Couplings	Resets average/hold count k. For the first sweep overwrites all active (update=on) traces with new current data. For application modes, it resets other parameters as required by the measurement.
Status Bits/OPC dependencies	This is an Overlapped command. The STATUS:OPERation register bits 0 through 8 are cleared. The STATUS:QUESTIONable register bit 9 (INTEgrity sum) is cleared. The SWEEPING bit is set. The MEASURING bit is set.
Backwards Compatibility Notes	For Spectrum Analysis mode in ESA and PSA, the Restart hardkey and the INITiate:RESTART command restart trace averages (displayed average count reset to 1) for a trace in Clear Write, but did not restart Max Hold and Min Hold. In the X-Series, the Restart hardkey and the INITiate:RESTART command restart not only Trace Average, but MaxHold and MinHold traces as well. For wireless comms modes in ESA and PSA, the Restart hardkey and the INITiate:RESTART command restart every measurement, which includes all traces and numeric results. There is no change to this operation.
Initial S/W Revision	Prior to A.02.00

### More Information

The **Restart** function first aborts the current sweep/measurement as quickly as possible. It then resets the sweep and trigger systems, sets up the measurement and initiates a new data measurement sequence with a new data acquisition (sweep) taken once the trigger condition is met.

If the analyzer is in the process of aligning when **Restart** is executed, the alignment finishes before the restart function is performed.

Even when set for Single operation, multiple sweeps may be taken when Restart is pressed (for example, when averaging/holding is on). Thus when we say that **Restart** "restarts a measurement," we may mean:

- It restarts the current sweep
- It restarts the current measurement
- It restarts the current set of sweeps if any trace is in Trace Average, Max Hold or Min Hold
- It restarts the current set of measurements if Averaging, or Max Hold, or Min Hold is on for the measurement
- depending on the current settings.

With **Average/Hold Number** (in **Meas Setup** menu) set to 1, or Averaging off, or no trace in Trace Average or Hold, a single sweep is equivalent to a single measurement. A single sweep is taken after the trigger condition is met; and the analyzer stops sweeping once that sweep has completed. However, with **Average/Hold Number** >1 and at least one trace set to **Trace Average, Max Hold, or Min Hold (SA Measurement)** or **Averaging on (most other measurements)**, multiple sweeps/data acquisitions are taken for a single measurement. The trigger condition must be met prior to each sweep. The sweep is stopped when the average count  $k$  equals the number  $N$  set for **Average/Hold Number**. A measurement average usually applies to all traces, marker results, and numeric results; but sometimes it only applies to the numeric results.

Once the full set of sweeps has been taken, the analyzer will go to idle state. To take one more sweep without resetting the average count, increment the average count by 1, by pressing the step up key while **Average/Hold Number** is the active function, or sending the remote command CALC:AVER:TCON UP.



## Save

The Save menu lets you choose what you want to save and where you want to save it. Among the types of files you can save are **States**, **Traces**, and **Screen Images**. In addition, an Export (Data) option lets you save a number of data types as CSV files for easy import into Excel and other spreadsheet programs.

Key Path	Front-panel key
Mode	All
Notes	No remote command for this key specifically, but the :MMEM:STORe command is available for specific file types. An example is :MMEM:STOR:STATe <filename>.
Initial S/W Revision	Prior to A.02.00

## State

The Save State menu lets you choose a register or file for saving the state.

The content of a state file includes all of the settings and data required to return the analyzer as closely as possible to the Mode it was in, with the exact settings which were in place, when the save occurred. The Mode settings in each state file include the settings that are affected by Mode Preset, as well as the additional settings affected by Restore Mode Defaults; all of the Mode's settings. In addition, all of the settings of the Input/Output system are included, even though they are outside of the Mode's state, because they are needed to restore the complete setup. Persistent System settings (for example, Verbose SCPI) are not affected by either Mode Preset or Restore Mode Defaults, nor are they included in a saved State file.

After the save completes, the message "File <filename> saved" or "State Register <register number> saved" is displayed.

For rapid saving, the State menu lists 16 registers to save to. Pressing a Register key initiates the save. You can also select a file to save to.

The default path for all State Files is:

My Documents\<>mode name>\state

where <mode name> is the parameter used to select the mode with the INST:SEL command (for example, SA for the Spectrum Analyzer).

Key Path	Save
Mode	All
Remote Command	:MMEMory:STORe:STATe <filename>
Example	MMEM:STOR:STATe "MyStateFile.state" This stores the current instrument state data in the file MyStateFile.state in the default directory.
Notes	Both single and double quotes are supported for any filename parameter over remote. After saving to a register, that register's menu key is updated with the date the time, unless a custom label has been entered for that key. After saving to a register, you remain in the Save State menu, so that you can see the Register key

	update. After saving to a file, the analyzer automatically returns to the previous menu and any Save As dialog goes away.
<b>Backwards Compatibility SCPI</b>	:MMEMory:STORe:STATe 1,<filename> For backwards compatibility, the above syntax is supported. The "1" is simply ignored. The command is sequential.
Initial S/W Revision	Prior to A.02.00

### To File . . .

When you press “To File”, the analyzer brings up a Windows dialog and a menu entitled “Save As.” This menu allows you to navigate to the various fields in the Windows dialog without using a keyboard or mouse. The Tab and Arrow keys can also be used for dialog navigation.

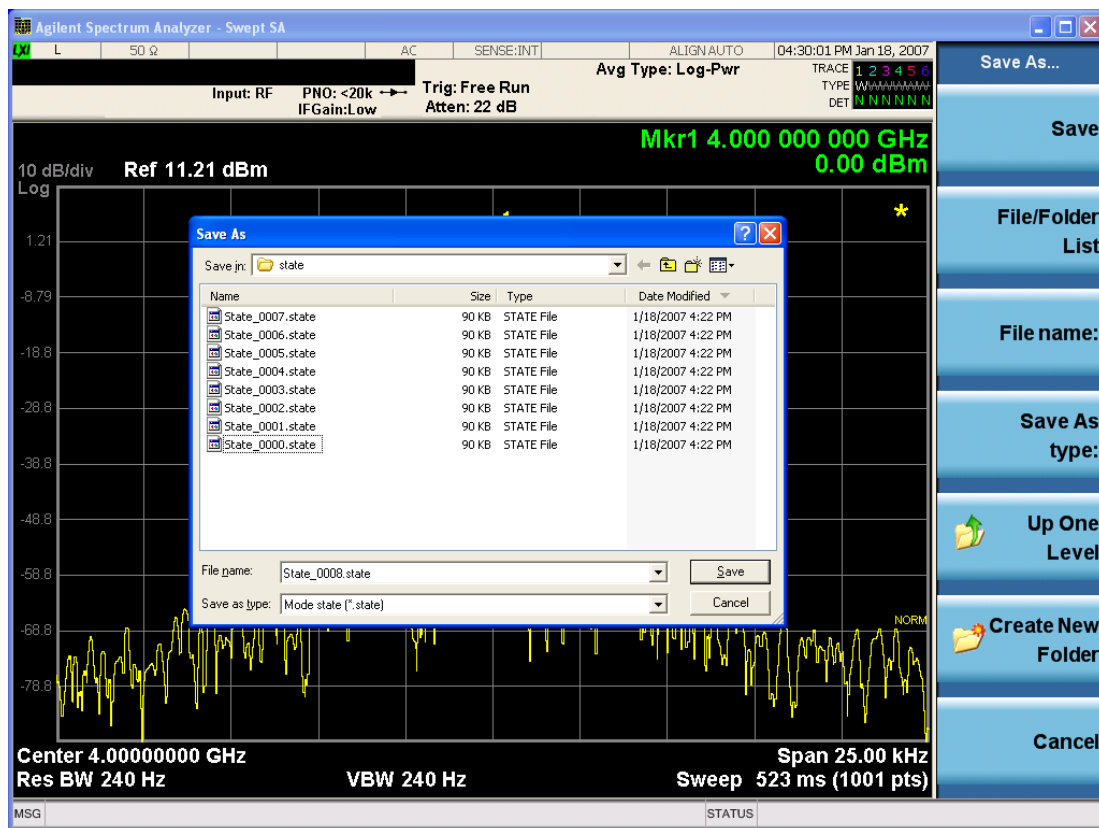

The Listed below

are the functions of the various fields in the dialog, and the corresponding softkeys:

#### Save

Performs the save to the specified file of the selected type. If the file already exists, a dialog will appear that allows you to replace the existing file by selecting OK, or you can Cancel the request. If you select OK, the file will be overwritten. Using the C: drive is strongly discouraged, since it runs the risk of being overwritten during an instrument software upgrade.

While the save is being performed, the floppy icon appears briefly in the Meas bar.

### File/Folder List

Enables you to navigate to the center of the dialog that contains the list of files and folders. Once here you can get information about the file and use the tab keys to navigate to the other fields in the dialog, such as Save In.

### Save In

The Save In field shows the path to which the file will be saved and allows you to change the path using the up and down arrow keys to navigate to other paths; the Enter key to open a directory; and the Backspace key to go back one directory. The **Save In field** defaults to the default path for this type of file and remembers the last path you used to save this type of file. There is no softkey for directly navigating to the Save In field but you can use left tab to get here from the File/Folder List.

User specified paths are remembered when you leave and return to a Mode and are reset back to the default using Restore Mode Defaults.

### File Name

The File Name field is initially loaded with an automatically generated filename specific to the appropriate Save Type. The automatically generated filename is guaranteed not to conflict with any filename currently in the directory. You may replace or modify this filename using the File Name key. See the ["Quick Save " on page 2197](#) documentation for more on the automatic file naming algorithm.

When you press the File Name key the analyzer displays the Alpha Editor. Use the knob to choose the letter to add and the front-panel Enter key to add the letter to the file name. The BK character moves you back and the FW character moves you forward in the filename. The Select key on the front panel generates a space character. When you are done entering the filename press the Done softkey. This returns back to the **File Open** dialog and menu, but does not cause the save to occur.

### Save As Type

This field shows the file suffix for the type of file you have selected to save. For example, if you navigated here while saving State, "Mode state (\*.state)" is in the field. If you navigated here from saving Trace, ""Mode state (\*.trace)" is in the field. If you navigated here while exporting a trace data file, "Trace Data (\*.csv)" is in the field. For some file types, there is more than one choice in the dropdown, which you can select by using the up and down arrow keys and Enter.

### Up One Level

This key corresponds to the icon of a folder with the up arrow that is in the tool bar of the dialog. When pressed, it causes the file and folder list to navigate up one level in the directory structure. The Backspace key does the same thing.

### Create New Folder

This key corresponds to the icon of a folder with the "\*" that is in the tool bar of the dialog. When pressed, a new folder is created in the current directory with the name **New Folder** and you can enter a new folder name using the Alpha Editor.

### Cancel

This key corresponds to the Cancel selection in the dialog. It causes the current **Save As** request to be cancelled. The ESC key does the same thing.

Key Path	Save, State
Mode	All
Notes	Brings up Save As dialog for saving a State Save Type
Initial S/W Revision	Prior to A.02.00

## Edit Register Names

You may enter a custom name on any of the Register keys, to help you remember what you are using that state to save. To do this, press the Edit Register Names key, choose the register whose name you wish to edit, and then enter the desired label using the Alpha Editor or an external PC keyboard.

The maximum number of characters that can be added is 30. In most cases, 30 characters will fit on two lines of the key.

See ["More Information" on page 1636](#)

Key Path	Save, State
Mode	All
<b>Remote Command</b>	:MMEMory:REGister:STATe:LABel <reg number>,"label" :MMEMory:REGister:STATe:LABel? <reg number>
<b>Example</b>	:MMEM:REG:STAT:LAB 1,"my label"
Notes	<reg number> is an integer from 1 to 16. If the SCPI specifies an invalid register number an error message is generated, -222,"Data out of range;Invalid register label number" "label" is a string from 0 to 30 characters in length. If a label exceeds 30 characters, an error message is generated, -150,"String data error;Label clipped to 30 characters" "label" of length 0 erases the custom label and restores the default (time and date) label. E.g.: :MMEM:REG:STAT:LAB 1,""
Dependencies	N9060A-7FP or N9060B-2FP license required to edit the register names. When the feature is not licensed, sending this command generates an error, -221,"Settings conflict;Option not available"
Preset	The names are unaffected by Preset or power cycle but are set to the default label (time and date) on a "Restore System Defaults->Misc"
Initial S/W Revision	A.11.00

## More Information

When you edit one of the register names, the time and date field will be replaced by the custom name.

If you delete all the characters in the custom name, it restores the default (time and date).

The register names are stored within the state files, but they are not part of the instrument state; that is, once you have edited a register name, loading a new state will not change that register name. Another consequence of this is that the names will be persistent through a power cycle. Also, if a named state file is transferred to another analyzer, it will bring its custom name along with it.

If you try to edit the name of an empty register, the analyzer will first save the state to have a file to put the name in. If you load a named state file into an analyzer with older firmware it will ignore the metadata.

The \*SAV and \*RCL commands will not be affected by the custom register names, nor will the MMEM commands.

### Register 1 thru Register 16

Selecting any one of these register menu keys causes the State of the currently active mode to be saved to the specified Register. The registers are provided for rapid saving and recalling, since you do not need to specify a filename or navigate to a file. Each of the register menu keys annotates whether it is empty or at what date and time it was last modified. In addition, you can use the Edit Register Names key to enter custom names for each register.

Although these 16 registers are the only registers available from the front panel, there are 128 state registers available in the instrument. Registers 17–128 are only available from the SCPI interface, using the \*SAV command.

There is one set of 128 state registers in the instrument, not one set for each Mode. When a state is saved, the Mode it was saved from is saved with it; then when it is recalled, the instrument switches to that Mode.

After the save completes, the corresponding register menu key annotation is updated with the date and time and the message "Register <register number> saved" is displayed.

Key Path	Save, State
Mode	All
<b>Example</b>	*SAV 1
Range	1–16 from front panel, 1–128 from SCPI
Readback	Date and time with seconds resolution are displayed on the key OR A custom name of up to 30 characters entered using the Edit Register Names key OR “(empty)” if no prior save operation has been performed to this register.
Initial S/W Revision	Prior to A.02.00
Modified at S/W Revision	A.11.00

### Register 1 thru Register 16

Selecting any one of these register menu keys causes the State of the currently active mode to be saved to the specified Register. The registers are provided for rapid saving and recalling, since you do not need to specify a filename or navigate to a file. Each of the register menu keys annotates whether it is empty or at what date and time it was last modified. In addition, you can use the Edit Register Names key to enter custom names for each register.

Although these 16 registers are the only registers available from the front panel, there are 128 state registers available in the instrument. Registers 17–128 are only available from the SCPI interface, using the \*SAV command.

There is one set of 128 state registers in the instrument, not one set for each Mode. When a state is saved, the Mode it was saved from is saved with it; then when it is recalled, the instrument switches to that Mode.

After the save completes, the corresponding register menu key annotation is updated with the date and time and the message "Register <register number> saved" is displayed.

Key Path	Save, State
Mode	All
Example	*SAV 1
Range	1-16 from front panel, 1-128 from SCPI
Readback	Date and time with seconds resolution are displayed on the key OR A custom name of up to 30 characters entered using the Edit Register Names key OR "(empty)" if no prior save operation has been performed to this register.
Initial S/W Revision	Prior to A.02.00
Modified at S/W Revision	A.11.00

## Data (Export)

Exporting a data file stores data from the current measurement to mass storage files. The Export Menu only contains data types that are supported by the current measurement.

Since the commonly exported data files are in .csv format, the data can be edited by you prior to importing. This allows you to export a data file, manipulate the data in Excel (the most common PC Application for manipulating .csv files) and then import it.

Selecting an Export Data menu key will not actually cause the exporting to occur, since the analyzer still needs to know where you wish to save the data. Pressing the Save As key in this menu brings up the Save As dialog and Save As menu that allows you to specify the destination file and directory. Once a filename has been selected or entered in the Open menu, the export will occur as soon as the Save key is pressed.

Key Path	Save
Mode	All
Notes	The menu is built from whatever data types are available for the mode. So the key locations in the sub menu will vary. No SCPI command directly controls the Data Type that this key controls. The Data Type is included in the MMEM:STORe commands.
Dependencies	If a file type is not used by a certain measurement, that type is grayed out for that measurement. The key for a file type will not show at all if there are no measurements in the Mode that support it.
Preset	Is not affected by a Preset or shutdown, but is reset during Restore Mode Defaults
Readback	The data type that is currently selected
Initial S/W Revision	Prior to A.02.00

## Amplitude Correction

Pressing this key selects **Amplitude Corrections** as the data type to be exported. Pressing this key again brings up the Select Menu, which allows the user to select which **Amplitude Correction** to save.

Amplitude Corrections are fully discussed in the documentation of the Input/Output key, under the Corrections softkey.

See "[Correction Data File](#)" on page 1639

Key Path	Save
<b>Remote Command</b>	:MMEMory:STORe:CORRection 1 2 3 4 5 6, <filename>
<b>Example</b>	:MMEM:STOR:CORR 2 "myAmpcor.csv" saves Correction 2 to the file myAmpcor.csv on the current path. The default path is My Documents\amplitudeCorrections.
Notes	If the save is initiated via SCPI, and the file already exists, the file will be overwritten. Using the C: drive is strongly discouraged, since it runs the risk of being overwritten during an instrument software upgrade. Both single and double quotes are supported for any filename parameter over SCPI.
Dependencies	Corrections are not supported by all Measurements. If in a Mode in which some Measurements support it, this key will be grayed out in measurements that do not. The key will not show at all if no measurements in the Mode support it. This key will not appear unless you have the proper option installed in your instrument.
Readback	Selected Correction
<b>Backwards Compatibility SCPI</b>	:MMEMory:STORe:CORRection ANTenna   CABLe   OTHer   USER, <filename> For backwards compatibility, ANTenna maps to 1, CABLe maps to 2, OTHer maps to 3 and USER maps to 4
Initial S/W Revision	A.02.00

## Correction Data File

A Corrections Data File contains a copy of one of the analyzer correction tables. Corrections provide a way to adjust the trace display for predetermined gain curves (such as for cable loss).

Corrections files are text files in .csv (comma separated values) form, to make them importable into Excel or other spreadsheet programs. The format for Corrections files is as follows.

Line #	Type of field	Example	Notes
1	File type, must be "Amplitude Correction"	Amplitude Correction	May not be omitted
2	File Description (in quotes)	"Correction Factors for 11966E"	60 characters max; may be empty but may not be omitted. If exceeds 60 characters, error -233 Too much data reported
3	Comment (in quotes)	"Class B Radiated"	60 characters max; may be empty but

Line #	Type of field	Example	Notes
			may not be omitted. . If exceeds 60 characters, error -233 Too much data reported
4	Instrument Version, Model #	A.02.06,N9020A	May be empty but may not be omitted
5	Option List, File Format Version	K03 LFE EXM ,01	May be empty but may not be omitted
6	Freq Unit to be used for all frequency values in the file	Frequency Unit,MHz	assumed to be Hz if omitted
7	Antenna Unit	Antenna Unit,None	If omitted leaves the Antenna unit unchanged. The amplitude unit in the Antenna Unit field is a conversion factor that is used to adjust the Y Axis Units of the current mode, if the mode supports Antenna Units. For more details on antenna correction data, refer to the Input/Output,Corrections key description. Allowable values: dBuV/m, dBuA/m, dBG, dBpT, None
8	Freq Interpolation	Frequency Interpolation,Linear	if omitted leaves the Freq Interpolation unchanged. Allowable values: Linear, Logarithmic
9	Bias value in mA	Bias,0.00	If omitted leaves the Bias value unchanged (added as of A.08.50)
10	Bias State	Bias State,On	If omitted leaves the Bias State unchanged. Allowable values: On, Off (added as of A.08.50)
11	Overlap, two values, Freq1 and Freq2, separated by commas.	Overlap,33500,40000	Uses Freq Unit from line 6. Thus, in this example Freq1=33.5 GHz, Freq2= 40.0 GHz (see note below). If omitted leaves the overlap unchanged (added as of A.08.50)
12	DATA marker	DATA	Corrections data begins in the next line

Lines 2 through 5 can be empty but must appear in the file. Lines 6 through 11 are optional, the lines can be left out of the file altogether.

The Overlap row and the two Bias rows apply only to external mixing. Both are read-only, they are never written by the analyzer. The only way to insert or modify these rows is to edit the file with a text editor or a spreadsheet editor. These rows are intended for use by mixer manufacturers, as they allow the manufacturer to insert data about how the mixer corrections were generated and how they should be applied. The Bias rows allow you to specify whether to turn Bias on or off when the Correction is turned on and to specify a Bias value (turning off the Correction does not change the Bias, but turning it back on again sets it to the value specified in the file). The Overlap row allows you to specify an overlap region in which



two different corrections may be applied. It is expected that in the corrections data itself, there will be TWO corrections values exactly at Max Freq, otherwise Overlap is ignored. The way the overlap is processed is as follows: if at any given time the current analyzer Start Freq is greater than Freq 1 and lower than Freq 2, and the current Stop Freq is greater than Freq 2, extend the first correction point at or above Freq 2 down to Freq 1, rather than using the correction data between Freq1 and Freq2.

The Antenna Unit row can only be used in Correction register 1, because there can only be one setting for Antenna Unit at any given time. If a Correction whose Antenna Unit is set to anything but None is loaded into any Correction register but 1, an error is generated (Mass storage error; Can only load an Antenna Unit into Correction 1). When a correction file is saved from any Correction register but 1, Antenna Unit is always written as None.

Similarly, the Bias rows can only be used in Correction register 1, because there can only be one setting for Bias at any given time. If a Correction file with a Bias or Bias State row is loaded into any Correction register but 1, an error is generated: Mass storage error; Can only load Bias Settings into Correction 1

The data follows the DATA row, as comma separated X, Y pairs; one pair per line.

For example, suppose you have an Antenna to correct for on an N9020A version A.02.06 and the correction data is:

- 0 dB at 200 MHz
- 17 dB at 210 MHz
- 14.8 dB at 225 MHz

Then the file will look like:

- Amplitude Correction
- "Correction Factors for 11966E"
- "Class B Radiated"
- A.02.06,N9020A
- P13 EA3 UK6,01
- Frequency Unit,MHz
- Antenna Unit,dBuV/m
- Frequency Interpolation,Linear
- DATA
- 200.000000,0.00
- 210.000000,17.00
- 225.000000,14.80

The choices for the 1 of N fields in the metadata are as follows:

- Frequency Unit: Hz, kHz, MHz, GHz
- Antenna Unit: dBuv/m, dBuA/m, dBG, dBpT, None

- Frequency Interpolation: Logarithmic, Linear

### Amplitude Correction

These keys let you choose which Correction to save. Once selected, the key returns back to the Export Data menu and the selected Correction number is annotated on the key.

The next step in the Save process is to select the Save As key in the Export Data menu.

Key Path	Save, Data, Amplitude Correction
Preset	Not part of a Preset, but is reset to Correction 1 by Restore Input/Output Defaults. Survives a shutdown.
Readback	1
Initial S/W Revision	A.02.00

### Chan Table

Exports the current channel table to a channel table file.

The exported channel table file can be edited to meet your requirements, and then imported by pressing Recall, Data, Channel Table, and then Open...

Note that while editing the channel plan file, you can't change the channel plan name, such as NTSC\_B.VHF, NTSC\_B.UHF, otherwise your modifications on the corresponding channel plan will not work. You can add, remove, or modify the channel numbers and center frequencies in each channel plan. The value of Start Channel and Channel Count may also need to be changed.

File Location and Extension

**File location:** "My Documents\Digital Video\data"

**File type:** text file

**File extension:** .txt

**Example:**

File Location: My Documents\Digital Video\data

File Name: ChannelPlan\_0001.txt

Key Path	Save, Data
Mode	DVB-T/H
Remote Command	MMEMory:STORe:CHTable <string>
Example	MMEM:STOR:CHT "ChannelPlan_0001.txt"
Initial S/W Revision	A.07.00

## Measurement Results

Different types of results are available for each particular measurement. The results that are available are documented under the individual measurements. These measurement results are the same as the results that are returned when using the MEASure:<measurement> command (usually for sub-opcode 1).

Key Path	Save, Data
Mode	DVB-T/H
Example	MMEM:STOR:RES "MyResultsFile.xml" This stores the measurement results data in the file MyResultsFile.xml in the default directory.
Initial S/W Revision	Prior to A.01.70

## Capture Buffer

Capture buffer functionality is available only in Mod Accuracy measurement. The captured data is raw data which is not processed.

Key Path	Save, Data
Mode	DVB-T/H
Example	MMEM:STOR:CAPT "MyCaptureData.bin" This stores the capture data in the file MyCaptureData.bin in the default directory.
Dependencies	Capture buffer functionality is only available for Mod Accuracy measurement. In other measurements, this key is grayed out.
Initial S/W Revision	Prior to A.01.70

## DVB-T2 Config

Exports the current DVB-T2 configuration to a file (single PLP or multiple PLPs). This key is available only in DVB-T2 Mod Accuracy measurement and will be grayed out in other measurements.

You can view the exported file for the format of the DVB-T2 configuration files and create your own DVB-T2 configuration file by modifying the exported file.

File Location and Extension

**File location:** "My Documents\DVB\data\EVMT2\data"

**File type:** text file

**File extension:** .csv

**Example:**

File Location: My Documents\DVB\data\EVMT2\data

File Name: DVBT2Config\_0001.csv

Key Path	Save, Data
----------	------------

Mode	DVB-T/H
Remote Command	MMEMory:STORe:T2Config <string>
Example	MMEM:STOR:T2C "DVBT2Config_0001.csv"
Dependencies	This key is grayed out in all the other measurements except DVB-T2 Mod Accuracy measurement.
Initial S/W Revision	A.07.00

### Save As . . .

When you press "Save As", the analyzer brings up a Windows dialog and a menu entitled "**Save As.**" This menu allows you to navigate to the various fields in the Windows dialog without using a keyboard or mouse. The Tab and Arrow keys can also be used for dialog navigation.

See "[To File . . .](#)" on page 2213 in Save, State for a full description of this dialog and menu.

The default path for saving files is:

For all of the Trace Data Files:

My Documents\<<mode name>\data\traces

For all of the Limit Data Files:

My Documents\<<mode name>\data\limits

For all of the Measurement Results Data Files:

My Documents\<<mode name>\data\<<measurement name>\results

For all of the Capture Buffer Data Files:

My Documents\<<mode name>\data\captureBuffer

Key Path	Save, Data
Mode	All
Notes	The key location is mode-dependent and will vary. Brings up the Save As dialog for saving a <mode specific> Save Type. The save is performed immediately and does not wait until the measurement is complete.
Initial S/W Revision	Prior to A.02.00

### Screen Image

Pressing Screen Image accesses a menu of functions that enable you to specify a format and location for the saved screen image. It brings up a menu that allows you to specify the color scheme of the Screen Image (Themes) or navigate to the Save As dialog to perform the actual save.

Screen Image files contain an exact representation of the analyzer display. They cannot be loaded back onto the analyzer, but they can be loaded into your PC for use in many popular applications.

The image to be saved is actually captured when the Save front panel key is pressed, and kept in temporary storage to be used if you ask for a Screen Image save. When the Screen Image key is pressed, a "thumbnail" of the captured image is displayed, as shown below:

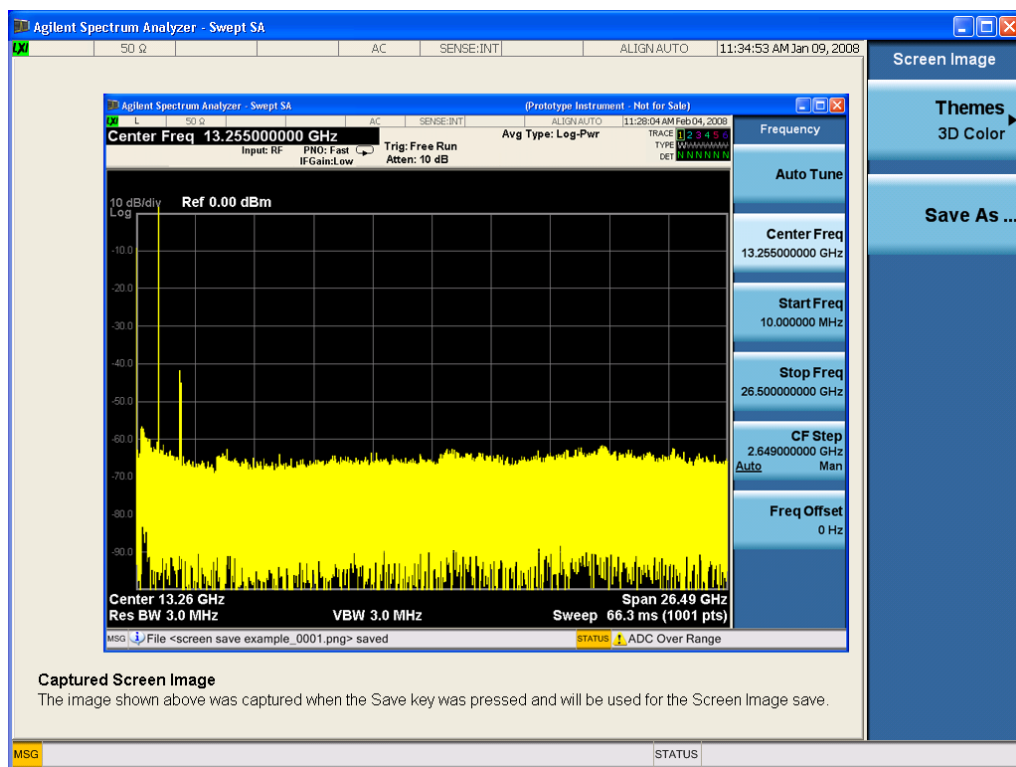

When you continue on into the Save As menu and complete the Screen Image save, the image depicted in the thumbnail is the one that gets saved, showing the menus that were on the screen before going into the Save menu. The save is performed immediately and does not wait until the measurement is complete.

After you have completed the save, the Quick Save front-panel key lets you quickly repeat the last save performed, using an auto-named file, with the current screen data.

**NOTE**

For versions previous to A.01.55, if you initiate a screen image save by navigating through the Save menus, the image that is saved will contain the Save menu softkeys, not the menus and the active function that were on the screen when you first pressed the Save front panel key.

Key Path	Save
Mode	All
Remote Command	:MMEMory:STORe:SCReen <filename>
Example	:MMEM:STOR:SCR "myScreen.png" This stores the current screen image in the file MyScreenFile.png in the default directory.
Initial S/W Revision	Prior to A.02.00

## Themes

Accesses a menu of functions that enable you to choose the theme to be used when saving the screen image.

The **Themes** option is the same as the **Themes** option under the **Display** and **Page Setup** dialogs. It allows you to choose between themes to be used when saving the screen image.

<b>Key Path</b>	Save, Screen Image
<b>Remote Command</b>	:MMEMory:STORe:SCReen:THEMe TDColor   TDMonochrome   FCOLor   FMONochrome  :MMEMory:STORe:SCReen:THEMe?
<b>Example</b>	:MMEM:STOR:SCR:THEM TDM
<b>Preset</b>	3D Color; Is not part of Preset, but is reset by Restore Misc Defaults or Restore System Defaults All and survives subsequent running of the modes.
<b>Readback</b>	3D Color   3D Mono   Flat Color   Flat Mono
<b>Backwards Compatibility Notes</b>	In ESA and PSA we offer the choice of "Reverse Bitmap" or "Reverse Metafile" when saving screen images. This is much like the "Flat Color" theme available in X-Series. Also, if you selected Reverse Bitmap AND a black & white screen image, that would be much like "Flat Monochrome". In other words, each of the X-Series themes has a similar screen image type in ESA/PSA. But they are not identical.
<b>Initial S/W Revision</b>	Prior to A.02.00

### 3D Color

Selects a standard color theme with each object filled, shaded and colored as designed.

<b>Key Path</b>	Save, Screen Image, Themes
<b>Example</b>	MMEM:STOR:SCR:THEM TDC
<b>Readback</b>	3D Color
<b>Initial S/W Revision</b>	Prior to A.02.00

### 3D Monochrome

Selects a format that is like 3D color but shades of gray are used instead of colors.

<b>Key Path</b>	Save, Screen Image, Themes
<b>Example</b>	MMEM:STOR:SCR:THEM TDM
<b>Readback</b>	3D Mono
<b>Initial S/W Revision</b>	Prior to A.02.00

### Flat Color

Selects a format that is best when the screen is to be printed on an ink printer.

Key Path	Save, Screen Image, Themes
<b>Example</b>	MMEM:STOR:SCR:THEM FCOL
Readback	Flat Color
Initial S/W Revision	Prior to A.02.00

### Flat Monochrome

Selects a format that is like Flat Color. But only black is used (no colors, not even gray), and no fill.

Key Path	Save, Screen Image, Themes
<b>Example</b>	MMEM:STOR:SCR:THEM FMON
Readback	Flat Mono
Initial S/W Revision	Prior to A.02.00

### Save As...

When you press "Save As", the analyzer brings up a Windows dialog and a menu entitled "**Save As.**" This menu allows you to navigate to the various fields in the Windows dialog without using a keyboard or mouse. The Tab and Arrow keys can also be used for dialog navigation.

See "[To File . . .](#)" on page 2213 in Save, State for a full description of this dialog and menu.

The default path for Screen Images is

My Documents\`<mode name>`\screen.

where `<mode name>` is the parameter used to select the mode with the INST:SEL command (for example, SA for the Spectrum Analyzer).

Key Path	Save, Screen Image
Notes	Brings up Save As dialog for saving a Screen Image Save Type
Initial S/W Revision	Prior to A.02.00

### Mass Storage Catalog (Remote Command Only)

Key path	SCPI Only
<b>Remote Command</b>	:MMEMory:CATalog? [ <code>&lt;directory_name&gt;</code> ]
Notes	<p>The string must be a valid logical path.</p> <p>Queries disk usage information (drive capacity, free space available) and obtains a list of files and directories in a specified directory in the following format:</p> <p><code>&lt;numeric_value&gt;,&lt;numeric_value&gt;,{&lt;file_entry&gt;}</code></p> <p>It returns two numeric parameters and as many strings as there are files and directories. The first</p>

parameter indicates the total amount of storage currently used in bytes. The second parameter indicates the total amount of storage available, also in bytes. The <file\_entry> is a string. Each <file\_entry> indicates the name, type, and size of one file in the directory list:

<file\_name>,<file\_type>,<file\_size>

As the windows file system has an extension that indicates file type, <file\_type> is always empty. <file\_size> provides the size of the file in bytes. For directories, <file\_entry> is surrounded by square brackets and both <file\_type> and <file\_size> are empty

---

Initial S/W Revision      Prior to A.02.00

---

### Mass Storage Change Directory (Remote Command Only)

---

Key path                    SCPI Only

**Remote Command**        :MMEMory:CDIRectory [<directory\_name>]  
                               :MMEMory:CDIRectory?

**Notes**                    The string must be a valid logical path.  
 Changes the default directory for a mass memory file system. The <directory\_name> parameter is a string. If no parameter is specified, the directory is set to the \*RST value.  
 At \*RST, this value is set to the default user data storage area, that is defined as System.Environment.SpecialFolder.Personal.  
 Query returns full path of the default directory.

---

Initial S/W Revision      Prior to A.02.00

---

### Mass Storage Copy (Remote Command Only)

---

Key path                    SCPI Only

**Remote Command**        :MMEMory:COPY <string>,<string>[,<string>,<string>]

**Notes**                    The string must be a valid logical path.  
 Copies an existing file to a new file or an existing directory to a new directory.  
 Two forms of parameters are allowed. The first form has two parameters. In this form, the first parameter specifies the source, and the second parameter specifies the destination.  
 The second form has four parameters. In this form, the first and third parameters specify the source. The second and fourth parameters specify the directories. The first pair of parameters specifies the source. The second pair specifies the destination. An error is generated if the source doesn't exist or the destination file already exists.  
 This command will generate an "access denied" error if the destination is a restricted folder (e.g., C:\Windows) and the current user does not have Power User or Administrator privileges.

### Mass Storage Device Copy (Remote Command Only)

This command transfers data to/from a file and a peripheral device.



Key path	SCPI Only
<b>Remote Command</b>	:MMEMory:COpy:DEvice <source_string>,<dest_string>
Notes	The strings must be a valid logical path or a valid device keyword. If the dest_string is a device keyword, the data is copied from the source file to the device. If the source_string is a device keyword, the data is copied to the source file from the device.  Valid device keywords are: SNS (smart noise source)  An error is generated if the file or device is not found.

### Mass Storage Delete (Remote Command Only)

Key path	SCPI Only
<b>Remote Command</b>	:MMEMory:DElete <file_name>[,<directory_name>]
Notes	The string must be a valid logical path.  Removes a file from the specified directory. The <file_name> parameter specifies the file name to be removed. This command will generate an “access denied” error if the file is in a restricted folder (e.g., C:\Windows) and the current user does not have Power User or Administrator privileges.
Initial S/W Revision	Prior to A.02.00

### Mass Storage Data (Remote Command Only)

Creates a file containing the specified data OR queries the data from an existing file.

Key path	SCPI Only
<b>Remote Command</b>	:MMEMory:DATA <file_name>, <data>  :MMEMory:DATA? <file_name>
Notes	The string must be a valid logical path.  The command form is MMEMory:DATA <file_name>,<data>. It loads <data> into the file <file_name>. <data> is in 488.2 block format. <file_name> is string data.  The query form is MMEMory:DATA? <file_name> with the response being the associated <data> in block format.
Initial S/W Revision	Prior to A.02.00

### Mass Storage Make Directory (Remote Command Only)

Key path	SCPI Only
<b>Remote Command</b>	:MMEMory:MDIRectory <directory_name>
Notes	The string must be a valid logical path.  Creates a new directory. The <directory_name> parameter specifies the name to be created.

---

	This command will generate an “access denied” error if the new directory would be in a restricted folder (e.g., C:\Windows) and the current user does not have Power User or Administrator privileges.
Initial S/W Revision	Prior to A.02.00

---

### Mass Storage Move (Remote Command Only)

---

Key path	SCPI Only
<b>Remote Command</b>	:MMEMory:MOVE <string>,<string>[,<string>,<string>]
Notes	<p>The string must be a valid logical path.</p> <p>Moves an existing file to a new file or an existing directory to a new directory.</p> <p>Two forms of parameters are allowed. The first form has two parameters. In this form, the first parameter specifies the source, and the second parameter specifies the destination.</p> <p>The second form has four parameters. In this form, the first and third parameters specify the source. The second and fourth parameters specify the directories. The first pair of parameters specifies the source. The second pair specifies the destination. An error is generated if the source doesn't exist or the destination file already exists.</p> <p>This command will generate an “access denied” error if the destination is a restricted folder (e.g., C:\Windows) and the current user does not have Power User or Administrator privileges.</p>
Initial S/W Revision	Prior to A.02.00

---

### Mass Storage Remove Directory (Remote Command Only)

---

Key path	SCPI Only
<b>Remote Command</b>	:MMEMory:RDIRECTory <directory_name>
Notes	<p>The string must be a valid logical path.</p> <p>Removes a directory. The &lt;directory_name&gt; parameter specifies the directory name to be removed. All files and directories under the specified directory shall also be removed.</p> <p>This command will generate an “access denied” error if the folder is a restricted folder (e.g., C:\Windows) or is in a restricted folder and the current user does not have Power User or Administrator privileges.</p>
Initial S/W Revision	Prior to A.02.00

---

## Single (Single Measurement/Sweep)

Sets the analyzer for Single measurement operation. The single/continuous state is Meas Global, so the setting will affect all the measurements. If you are Paused, pressing Single does a Resume.

See ["More Information" on page 1651](#)

Key Path	Front-panel key
Example	:INIT:CONT OFF
Notes	See Cont key description.
Backwards Compatibility Notes	<p>For Spectrum Analysis mode in ESA and PSA, the Single hardkey and the INITiate:IMM switched from continuous measurement to single measurement and restarted sweeps and averages (displayed average count reset to 1), but did not restart Max Hold and Min Hold. In the X-Series, the Single hardkey and the INITiate:IMM command initiate a sweep/ measurement/ average sequence/hold sequence including MaxHold and MinHold.</p> <p>For Spectrum Analysis mode in ESA and PSA, the Single hardkey restarted the sweep regardless of whether or not you were in an active sweep or sweep sequence. In the X-Series, Restart does this but Single only restarts the sweep or sweep sequence if you are in the idle state.</p> <p>INIT[:IMM] in ESA &amp; PSA Spectrum Analysis Mode does an implied ABORT. In some other PSA Modes, INIT[:IMM] is ignored if not in the idle state. . The X-Series follows the ESA/PSA SA Mode model, which may cause some Modes to have compatibility problems.</p>
Initial S/W Revision	Prior to A.02.00

### More Information

See ["Restart" on page 2210](#) for details on the INIT:IMMediate (Restart) function.

If you are already in single sweep, the INIT:CONT OFF command has no effect.

If you are already in Single Sweep, then pressing the Single key in the middle of a sweep does not restart the sweep or sequence. Similarly, pressing the Single key does not restart the sweep or sequence if the sweep is not in the idle state (for example, if you are taking a very slow sweep, or the analyzer is waiting for a trigger). Instead, it results in a message. "Already in Single, press Restart to initiate a new sweep or sequence". Even though pressing the Single key in the middle of a sweep does not restart the sweep, sending INIT:IMMediate does reset it.

To take one more sweep without resetting the average count, increment the average count by 1, by pressing the step up key while **Average/Hold Number** is the active function, or sending the remote command CALC:AVER:TCON UP.

## Source

There is no Source control functionality for this measurement. When this key is pressed, the screen either displays a blank menu, or the previously-selected menu remains unchanged.

---

Key Path	Front-panel key
----------	-----------------

---

## SPAN X Scale

The SPAN X Scale key accesses the menu to set the desired horizontal scale and associated settings of the window.

It specifies SPAN X Scale settings when MER/EVM vs. Sub-carrier/Frequency window, Amptd vs. Sub-carrier window, phase vs. Sub-carrier window, group delay vs. Sub-carrier window, Amptd vs. Time Window, or MER vs. Time Window is active.

Key Path	Front-panel key
Initial S/W Revision	A.07.00

### Ref Value

This key allows you to set the displayed X reference value. The key is active in MER/EVM vs. Sub-carrier/Frequency Window, Amptd vs. Sub-carrier Window, Phase vs. Sub-carrier Window, Group Delay vs. Sub-carrier Window, Amptd vs. Time Window, and MER vs. Time Window.

Key Path	Span X Scale
Initial S/W Revision	A.07.00

### X Ref Value (I/Q Error View – MER/EVM vs. Sub-carrier/Frequency Window)

This key sets the sub-carrier reference value on the horizontal axis in the MER/EVM vs. Sub-carrier/Frequency window. The displayed value will be updated according to Scale Type (Span X Scale).

["X Ref Value \(Scale Type is Carrier\)" on page 1653](#)

["X Ref Value \(Scale Type is Freq\)" on page 1654](#)

### X Ref Value (Scale Type is Carrier)

If the scale type is set to Carrier, X Ref Value is displayed and set in sub-carrier.

Key Path	Span X Scale
Mode	DVB-T/H
Remote Command	:DISPlay:EVMTtwo:VIEW2:WINDow[1]:TRACe:X[:SCALE][:CARRier]:RLEVel <real>  :DISPlay:EVMTtwo:VIEW2:WINDow[1]:TRACe:X[:SCALE][:CARRier]:RLEVel?
Example	DISP:EVMT:VIEW2:WIND:TRAC:X:RLEV 0.0 DISP:EVMT:VIEW2:WIND:TRAC:X:RLEV?
Notes	SCPI Remarks: VIEW2: I/Q Error View WINDow[1]: MER/EVM vs. Sub-carrier/Frequency Window on I/Q Error View
Dependencies	If Auto Scaling is set to On, this value is automatically determined by the measurement result. When

	you set this value manually, Auto Scaling is automatically set to Off.
Preset	Value is automatically determined by the measurement result with Auto Scaling set to On.
State Saved	No
Min	0.0
Max	40000.0
Initial S/W Revision	A.07.00

### X Ref Value (Scale Type is Freq)

If the scale type is set to Freq, X Ref Value is displayed and set in frequency.

Key Path	Span X Scale
Mode	DVB-T/H
Remote Command	:DISPlay:EVMTtwo:VIEW2:WINDow[1]:TRACe:X[:SCALE]:FREQuency:RLEVel <real>  :DISPlay:EVMTtwo:VIEW2:WINDow[1]:TRACe:X[:SCALE]:FREQuency:RLEVel?
Example	DISP:EVMT:VIEW2:WIND:TRAC:X:FREQ:RLEV 0.0 DISP:EVMT:VIEW2:WIND:TRAC:X:FREQ:RLEV?
Notes	SCPI Remarks: VIEW2: I/Q Error View WINDow[1]: MER/EVM vs. Sub-carrier/Frequency Window on I/Q Error View
Dependencies	If Auto Scaling is set to On, this value is automatically determined by the measurement result. When you set this value manually, Auto Scaling is automatically set to Off.
Preset	Value is automatically determined by the measurement result with Auto Scaling set to On.
State Saved	No
Min	0.0
Max	3.0e9 Hz
Initial S/W Revision	A.07.00

### X Ref Value (Channel Frequency Response View – Amptd vs. Sub-carrier Window)

This key sets the sub-carrier reference value on the horizontal axis in the Amptd vs. Sub-carrier window.

Key Path	Span X Scale
Mode	DVB-T/H
Remote Command	:DISPlay:EVMTtwo:VIEW3:WINDow[1]:TRACe:X[:SCALE]:RLEVel <real>  :DISPlay:EVMTtwo:VIEW3:WINDow[1]:TRACe:X[:SCALE]:RLEVel?
Example	DISP:EVMT:VIEW3:WIND:TRAC:X:RLEV 0.0 DISP:EVMT:VIEW3:WIND:TRAC:X:RLEV?

Notes	SCPI Remarks: VIEW3: Channel Frequency Response View WINDow[1]: Amptd vs. Sub-carrier Window
Dependencies	If Auto Scaling is set to On, this value is automatically determined by the measurement result. When you set this value manually, Auto Scaling is automatically set to Off.
Preset	0.0
State Saved	No
Min	0.0
Max	40000.0
Initial S/W Revision	A.07.00

### X Ref Value (Channel Frequency Response View – Phase vs. Sub-carrier Window)

This key sets the sub-carrier reference value on the horizontal axis in the Phase vs. Sub-carrier window.

Key Path	Span X Scale
Mode	DVB-T/H
<b>Remote Command</b>	:DISPlay:EVMTtwo:VIEW3:WINDow2:TRACe:X[:SCALe]:RLEVel <real> :DISPlay:EVMTtwo:VIEW3:WINDow2:TRACe:X[:SCALe]:RLEVel?
<b>Example</b>	DISP:EVMT:VIEW3:WIND2:TRAC:X:RLEV 0.0 DISP:EVMT:VIEW3:WIND2:TRAC:X:RLEV?
Notes	SCPI Remarks: VIEW3: Channel Frequency Response View WINDow2: Phase vs. Sub-carrier Window
Dependencies	If Auto Scaling is set to On, this value is automatically determined by the measurement result. When you set this value manually, Auto Scaling is automatically set to Off.
Preset	0.0
State Saved	No
Min	0.0
Max	40000.0
Initial S/W Revision	A.07.00

### X Ref Value (Channel Frequency Response View –Group Delay vs. Sub-carrier Window)

This key sets the sub-carrier reference value on the horizontal axis in the Group Delay vs. Sub-carrier window.

Key Path	Span X Scale
Mode	DVB-T/H

<b>Remote Command</b>	:DISPlay:EVMTtwo:VIEW3:WINDow3:TRACe:X[:SCALE]:RLEVel <real> :DISPlay:EVMTtwo:VIEW3:WINDow3:TRACe:X[:SCALE]:RLEVel?
<b>Example</b>	DISP:EVMT:VIEW3:WIND3:TRAC:X:RLEV 0.0 DISP:EVMT:VIEW3:WIND3:TRAC:X:RLEV?
<b>Notes</b>	SCPI Remarks: VIEW3: Channel Frequency Response View WINDow3: Group Delay vs. Sub-carrier Window
<b>Dependencies</b>	If Auto Scaling is set to On, this value is automatically determined by the measurement result. When you set this value manually, Auto Scaling is automatically set to Off.
<b>Preset</b>	0.0
<b>State Saved</b>	No
<b>Min</b>	0.0
<b>Max</b>	40000.0
<b>Initial S/W Revision</b>	A.07.00

### X Ref Value (Channel Impulse Response View – Amptd vs. Time Window)

This key sets the reference value on the horizontal axis in the Amptd vs. Time window. The displayed value will be updated according to Scale Type (Span X Scale).

["X Ref Value \(Scale Type is Time\)" on page 1656](#)

["X Ref Value \(Scale Type is Distance\)" on page 1657](#)

### X Ref Value (Scale Type is Time)

If the scale type is set to Time, X Ref Value is displayed and set in time.

<b>Key Path</b>	Span X Scale
<b>Mode</b>	DVB-T/H
<b>Remote Command</b>	:DISPlay:EVMTtwo:VIEW4:WINDow[1]:TRACe:X[:SCALE][:TIME]:RLEVel <real> :DISPlay:EVMTtwo:VIEW4:WINDow[1]:TRACe:X[:SCALE][:TIME]:RLEVel?
<b>Example</b>	DISP:EVMT:VIEW4:WIND:TRAC:X:RLEV 0.0 DISP:EVMT:VIEW4:WIND:TRAC:X:RLEV?
<b>Notes</b>	SCPI Remarks: VIEW4: Channel Impulse Response View WINDow[1]: Amptd vs. Time Window
<b>Dependencies</b>	If Auto Scaling is set to On, this value is automatically determined by the measurement result. When you set this value manually, Auto Scaling is automatically set to Off.
<b>Preset</b>	0.00 s
<b>State Saved</b>	No



Min	-20.0 s
Max	20.0 s
Initial S/W Revision	A.07.00

### X Ref Value (Scale Type is Distance)

If the scale type is set to Distance, X Ref Value is displayed and set in distance.

Key Path	Span X Scale
Mode	DVB-T/H
Remote Command	:DISPlay:EVMTtwo:VIEW4:WINDow[1]:TRACe:X[:SCALe]:DISTance:RLEVel <real> :DISPlay:EVMTtwo:VIEW4:WINDow[1]:TRACe:X[:SCALe]:DISTance:RLEVel?
Example	DISP:EVMT:VIEW4:WIND:TRAC:X:DIST:RLEV 0.0 DISP:EVMT:VIEW4:WIND:TRAC:X:DIST:RLEV?
Notes	SCPI Remarks: VIEW4: Channel Impulse Response View WINDow[1]: Amptd vs. Time Window
Dependencies	If Auto Scaling is set to On, this value is automatically determined by the measurement result. When you set this value manually, Auto Scaling is automatically set to Off.
Preset	0.0 m
State Saved	No
Min	-6.0e9 m
Max	6.0e9 m
Initial S/W Revision	A.07.00

### X Ref Value (MER Monitor View – MER vs. Time Window)

This key sets the reference value on the horizontal axis in the MER vs. Time window.

Key Path	Span X Scale
Mode	DVB-T/H
Remote Command	:DISPlay:EVMTtwo:VIEW5:WINDow[1]:TRACe:X[:SCALe]:RLEVel <real> :DISPlay:EVMTtwo:VIEW5:WINDow[1]:TRACe:X[:SCALe]:RLEVel?
Example	DISP:EVMT:VIEW5:WIND:TRAC:X:RLEV 0.0 DISP:EVMT:VIEW5:WIND:TRAC:X:RLEV?
Notes	SCPI Remarks: VIEW5: MER Monitor View WINDow[1]: MER vs. Time Window
Dependencies	If Auto Scaling is set to On, this value is automatically determined by the measurement result. When

	you set this value manually, Auto Scaling is automatically set to Off.
Preset	0.0
State Saved	No
Min	0.0
Max	5000.0
Initial S/W Revision	A.07.00

### Scale/Div

This key allows you to set the X Scale/Div. The key is active in MER/EVM vs. Sub-carrier/Frequency window, Amptd vs. Sub-carrier window, Phase vs. Sub-carrier window, Group Delay vs. Sub-carrier window, Amptd vs. Time window, and MER vs. Time window.

Key Path	Span X Scale
Initial S/W Revision	A.07.00

### X Scale/Div (I/Q Error View – MER/EVM vs. Sub-carrier/ Frequency Window)

This key sets the value per division on the horizontal scale. The displayed value will be updated according to Scale Type (Span X Scale).

"X Scale/Div (Scale Type is Carrier)" on page 1658

"X Scale/Div (Scale Type is Freq)" on page 1659

### X Scale/Div (Scale Type is Carrier)

If the scale type is set to Carrier, the X Scale/Div is displayed and set in sub-carrier.

Key Path	Span X Scale
Mode	DVB-T/H
Remote Command	:DISPlay:EVMTtwo:VIEW2:WINDow[1]:TRACe:X[:SCALE][:CARRier]:PDIVision <real>  :DISPlay:EVMTtwo:VIEW2:WINDow[1]:TRACe:X[:SCALE][:CARRier]:PDIVision?
Example	DISP:EVMT:VIEW2:WIND:TRAC:X:PDIV 84.0 DISP:EVMT:VIEW2:WIND:TRAC:X:PDIV?
Notes	SCPI Remarks: VIEW2: I/Q Error View WINDow[1]: MER/EVM vs. Sub-carrier/Frequency Window on I/Q Error View
Dependencies	If Auto Scaling is set to On, this value is automatically determined by the measurement result. When you set this value manually, Auto Scaling is automatically set to Off.
Preset	Value is automatically determined by the measurement result with Auto Scaling set to On. Result depends on current FFT size.

State Saved	No
Min	1.0
Max	4000.0
Initial S/W Revision	A.07.00

### X Scale/Div (Scale Type is Freq)

If the scale type is set to Freq, X Scale/Div is displayed and set in frequency.

Key Path	Span X Scale
Mode	DVB-T/H
<b>Remote Command</b>	:DISPlay:EVMTtwo:VIEW2:WINDow[1]:TRACe:X[:SCALE]:FREQuency:PDIVision <real> :DISPlay:EVMTtwo:VIEW2:WINDow[1]:TRACe:X[:SCALE]:FREQuency:PDIVision?
<b>Example</b>	DISP:EVMT:VIEW2:WIND:TRAC:X:FREQ:PDIV 84.0 DISP:EVMT:VIEW2:WIND:TRAC:X:FREQ:PDIV?
Notes	SCPI Remarks: VIEW2: I/Q Error View WINDow[1]: MER/EVM vs. Sub-carrier/Frequency Window on I/Q Error View
Dependencies	If Auto Scaling is set to On, this value is automatically determined by the measurement result. When you set this value manually, Auto Scaling is automatically set to Off.
Preset	Value is automatically determined by the measurement result with Auto Scaling set to On. Result depends on current FFT size.
State Saved	No
Min	1.0 Hz
Max	500.0e6 Hz
Initial S/W Revision	A.07.00

### X Scale/Div (Channel Frequency Response View – Amptd vs. Sub-carrier Window)

This key sets the horizontal scale by changing the sub-carrier value per division in the Amptd vs. Sub-carrier window.

Key Path	Span X Scale
Mode	DVB-T/H
<b>Remote Command</b>	:DISPlay:EVMTtwo:VIEW3:WINDow[1]:TRACe:X[:SCALE]:PDIVision <real> :DISPlay:EVMTtwo:VIEW3:WINDow[1]:TRACe:X[:SCALE]:PDIVision?
<b>Example</b>	DISP:EVMT:VIEW3:WIND:TRAC:X:PDIV 84.0 DISP:EVMT:VIEW3:WIND:TRAC:X:PDIV?
Notes	SCPI Remarks:

	VIEW3: Channel Frequency Response View WINDow[1]: Amptd vs. Sub-carrier Window
Dependencies	If Auto Scaling is set to On, this value is automatically determined by the measurement result. When you set this value manually, Auto Scaling is automatically set to Off.
Preset	Value is automatically determined by the measurement settings with Auto Scaling set to On. Result depends on current FFT size.
State Saved	No
Min	1.0
Max	4000.0
Initial S/W Revision	A.07.00

### X Scale/Div (Channel Frequency Response View – Phase vs. Sub-carrier Window)

This key sets the horizontal scale by changing the sub-carrier value per division in the Phase vs. Sub-carrier window.

Key Path	Span X Scale
Mode	DVB-T/H
Remote Command	:DISPlay:EVMTtwo:VIEW3:WINDow2:TRACe:X[:SCALE]:PDIVision <real> :DISPlay:EVMTtwo:VIEW3:WINDow2:TRACe:X[:SCALE]:PDIVision?
Example	DISP:EVMT:VIEW3:WIND2:TRAC:X:PDIV 84.0 DISP:EVMT:VIEW3:WIND2:TRAC:X:PDIV?
Notes	SCPI Remarks: VIEW3: Channel Frequency Response View WINDow2: Phase vs. Sub-carrier Window
Dependencies	If Auto Scaling is set to On, this value is automatically determined by the measurement result. When you set this value manually, Auto Scaling is automatically set to Off.
Preset	Value is automatically determined by the measurement settings with Auto Scaling set to On. Result depends on current FFT size.
State Saved	No
Min	1.0
Max	4000.0
Initial S/W Revision	A.07.00

### X Scale/Div (Channel Frequency Response View –Group Delay vs. Sub-carrier Window)

This key sets the horizontal scale by changing the sub-carrier value per division in the Group Delay vs. Sub-carrier window.

Key Path	Span X Scale
Mode	DVB-T/H
<b>Remote Command</b>	:DISPlay:EVMTtwo:VIEW3:WINDow3:TRACe:X[:SCALE]:PDIVision <real> :DISPlay:EVMTtwo:VIEW3:WINDow3:TRACe:X[:SCALE]:PDIVision?
<b>Example</b>	DISP:EVMT:VIEW3:WIND3:TRAC:X:PDIV 84.0 DISP:EVMT:VIEW3:WIND3:TRAC:X:PDIV?
Notes	SCPI Remarks: VIEW3: Channel Frequency Response View WINDow3: Group Delay vs. Sub-carrier Window
Dependencies	If Auto Scaling is set to On, this value is automatically determined by the measurement result. When you set this value manually, Auto Scaling is automatically set to Off.
Preset	Value is automatically determined by the measurement settings with Auto Scaling set to On. Result depends on current FFT size.
State Saved	No
Min	1.0
Max	4000.0
Initial S/W Revision	A.07.00

### X Scale/Div (Channel Impulse Response View – Amptd vs. Time Window)

This key sets the horizontal scale by changing the value per division in the Amptd vs. Time window. The displayed value will be updated according to Scale Type (Span X Scale).

**"X Scale/Div (Scale Type is Time)" on page 1661**

**"X Scale/Div (Scale Type is Distance)" on page 1662**

### X Scale/Div (Scale Type is Time)

If the scale type is set to Time, the X Scale/Div is displayed and set in time.

Key Path	Span X Scale
Mode	DVB-T/H
<b>Remote Command</b>	:DISPlay:EVMTtwo:VIEW4:WINDow[1]:TRACe:X[:SCALE][:TIME]:PDIVision <real> :DISPlay:EVMTtwo:VIEW4:WINDow[1]:TRACe:X[:SCALE][:TIME]:PDIVision?
<b>Example</b>	DISP:EVMT:VIEW4:WIND:TRAC:X:PDIV 1.0 DISP:EVMT:VIEW4:WIND:TRAC:X:PDIV?
Notes	SCPI Remarks: VIEW4: Channel Impulse Response View WINDow[1]: Amptd vs. Time Window
Dependencies	If Auto Scaling is set to On, this value is automatically determined by the measurement result. When

	you set this value manually, Auto Scaling is automatically set to Off.
Preset	Value is automatically determined by the measurement settings with Auto Scaling set to On. Result depends on current FFT size and Channel BW.
State Saved	No
Min	5.0e-8 s
Max	1.0 s
Initial S/W Revision	A.07.00

### X Scale/Div (Scale Type is Distance)

If the scale type is set to Distance, the X Scale/Div is displayed and set in distance.

Key Path	Span X Scale
Mode	DVB-T/H
Remote Command	:DISPlay:EVMTtwo:VIEW4:WINDow[1]:TRACe:X[:SCALE]:DISTance:PDIVision <real>  :DISPlay:EVMTtwo:VIEW4:WINDow[1]:TRACe:X[:SCALE]:DISTance:PDIVision?
Example	DISP:EVMT:VIEW4:WIND:TRAC:X:DIST:PDIV 15.0 DISP:EVMT:VIEW4:WIND:TRAC:X:DIST:PDIV?
Notes	SCPI Remarks: VIEW4: Channel Impulse Response View WINDow[1]: Amptd vs. Time Window
Dependencies	If Auto Scaling is set to On, this value is automatically determined by the measurement result. When you set this value manually, Auto Scaling is automatically set to Off.
Preset	Value is automatically determined by the measurement settings with Auto Scaling set to On. Result depends on current FFT size and Channel BW.
State Saved	No
Min	15.0 m
Max	3.0e8 m
Initial S/W Revision	A.07.00

### X Scale/Div (MER Monitor View – MER vs. Time Window)

This key sets the horizontal scale by changing the value per division in the MER vs. Time window.

Key Path	Span X Scale
Mode	DVB-T/H
Remote Command	:DISPlay:EVMTtwo:VIEW5:WINDow[1]:TRACe:X[:SCALE]:PDIVision <real>  :DISPlay:EVMTtwo:VIEW5:WINDow[1]:TRACe:X[:SCALE]:PDIVision?
Example	DISP:EVMT:VIEW5:WIND:TRAC:X:PDIV 1.0

	DISP:EVMT:VIEW5:WIND:TRAC:X:PDIV?
Notes	SCPI Remarks: VIEW5: MER Monitor View WINDow[1]: MER vs. Time Window
Dependencies	If Auto Scaling is set to On, this value is automatically determined by the measurement result. When you set this value manually, Auto Scaling is automatically set to Off.
Preset	Value is automatically determined by the measurement settings with Auto Scaling set to On. Result depends on current Display Points.
State Saved	No
Min	1.0
Max	1000.0
Initial S/W Revision	A.07.00

## Ref Position

This key allows you to set the displayed reference position to Left, Ctr (center), or Right. The key is active in MER/EVM vs. Sub-carrier/Frequency window, Amptd vs. Sub-carrier window, Phase vs. Sub-carrier window, Group Delay vs. Sub-carrier window, Amptd vs. Time window, and MER vs. Time window.

Key Path	Span X Scale
Initial S/W Revision	A.07.00

## X Ref Position (I/Q Error View – MER/EVM vs. Sub-carrier/Frequency Window)

This key sets the X-axis reference position in the MER/EVM vs. Sub-carrier/Frequency window.

Key Path	Span X Scale
Mode	DVB-T/H
<b>Remote Command</b>	:DISPlay:EVMTtwo:VIEW2:WINDow[1]:TRACe:X[:SCALe]:RPOSition LEFT   CENTER   RIGHT  :DISPlay:EVMTtwo:VIEW2:WINDow[1]:TRACe:X[:SCALe]:RPOSition?
<b>Example</b>	DISP:EVMT:VIEW2:WIND:TRAC:X:RPOS CENT DISP:EVMT:VIEW2:WIND:TRAC:X:RPOS?
Notes	SCPI Remarks: VIEW2: I/Q Error View WINDow[1]: MER/EVM vs. Sub-carrier/Frequency Window on I/Q Error View
Preset	LEFT
State Saved	No
Range	Left   Ctr   Right
Initial S/W Revision	A.07.00

### X Ref Position (Channel Frequency Response View – Amptd vs. Sub-carrier Window)

This key sets the X-axis reference position in the Amptd vs. Sub-carrier window.

Key Path	Span X Scale
Mode	DVB-T/H
Remote Command	:DISPlay:EVMTtwo:VIEW3:WINDow[1]:TRACe:X[:SCALe]:RPOSition LEFT   CENTer   RIGHT  :DISPlay:EVMTtwo:VIEW3:WINDow[1]:TRACe:X[:SCALe]:RPOSition?
Example	DISP:EVMT:VIEW3:WIND:TRAC:X:RPOS CENT DISP:EVMT:VIEW3:WIND:TRAC:X:RPOS?
Notes	SCPI Remarks: VIEW3: Channel Frequency Response View WINDow[1]: Amptd vs. Sub-carrier Window
Preset	LEFT
State Saved	No
Range	Left   Ctr   Right
Initial S/W Revision	A.07.00

### X Ref Position (Channel Frequency Response View – Phase vs. Sub-carrier Window)

This key sets the X-axis reference position in the Phase vs. Sub-carrier window.

Key Path	Span X Scale
Mode	DVB-T/H
Remote Command	:DISPlay:EVMTtwo:VIEW3:WINDow2:TRACe:X[:SCALe]:RPOSition LEFT   CENTer   RIGHT  :DISPlay:EVMTtwo:VIEW3:WINDow2:TRACe:X[:SCALe]:RPOSition?
Example	DISP:EVMT:VIEW3:WIND2:TRAC:X:RPOS CENT DISP:EVMT:VIEW3:WIND2:TRAC:X:RPOS?
Notes	SCPI Remarks: VIEW3: Channel Frequency Response View WINDow2: Phase vs. Sub-carrier Window
Preset	LEFT
State Saved	No
Range	Left   Ctr   Right
Initial S/W Revision	A.07.00



### X Ref Position (Channel Frequency Response View – Group Delay vs. Sub-carrier Window)

This key sets the X-axis reference position in the Group Delay vs. Sub-carrier window.

Key Path	Span X Scale
Mode	DVB-T/H
<b>Remote Command</b>	:DISPlay:EVMTtwo:VIEW3:WINDow3:TRACe:X[:SCALe]:RPOSition LEFT   CENTer   RIGHT  :DISPlay:EVMTtwo:VIEW3:WINDow3:TRACe:X[:SCALe]:RPOSition?
<b>Example</b>	DISP:EVMT:VIEW3:WIND3:TRAC:X:RPOS CENT DISP:EVMT:VIEW3:WIND3:TRAC:X:RPOS?
Notes	SCPI Remarks: VIEW3: Channel Frequency Response View WINDow3: Group Delay vs. Sub-carrier Window
Preset	LEFT
State Saved	No
Range	Left   Ctr   Right
Initial S/W Revision	A.07.00

### X Ref Position (Channel Impulse Response View – Amptd vs. Time Window)

This key sets the X-axis reference position in the Amptd vs. Time window.

Key Path	Span X Scale
Mode	DVB-T/H
<b>Remote Command</b>	:DISPlay:EVMTtwo:VIEW4:WINDow[1]:TRACe:X[:SCALe]:RPOSition LEFT   CENTer   RIGHT  :DISPlay:EVMTtwo:VIEW4:WINDow[1]:TRACe:X[:SCALe]:RPOSition?
<b>Example</b>	DISP:EVMT:VIEW4:WIND:TRAC:X:RPOS CENT DISP:EVMT:VIEW4:WIND:TRAC:X:RPOS?
Notes	SCPI Remarks: VIEW4: Channel Impulse Response View WINDow[1]: Amptd vs. Time Window
Preset	CENT
State Saved	No
Range	Left   Ctr   Right
Initial S/W Revision	A.07.00

### X Ref Position (MER Monitor View – MER vs. Time Window)

This key sets the X-axis reference position in the MER vs. Time window.

Key Path	Span X Scale
Mode	DVB-T/H
Remote Command	:DISPlay:EVMTtwo:VIEW5:WINDow[1]:TRACe:X[:SCALe]:RPOSition LEFT   CENTER   RIGHT :DISPlay:EVMTtwo:VIEW5:WINDow[1]:TRACe:X[:SCALe]:RPOSition?
Example	DISP:EVMT:VIEW5:WIND:TRAC:X:RPOS CENT DISP:EVMT:VIEW5:WIND:TRAC:X:RPOS?
Notes	SCPI Remarks: VIEW5: MER Monitor View WINDow[1]: MER vs. Time Window
Preset	LEFT
State Saved	No
Range	Left   Ctr   Right
Initial S/W Revision	A.07.00

### Auto Scaling

This key allows you to toggle the scale coupling function between On and Off. The key is active in MER/EVM vs. Sub-carrier/Frequency window, Amptd vs. Sub-carrier window, Phase vs. Sub-carrier window, Group Delay vs. Sub-carrier window, Amptd vs. Time window, and MER vs. Time window.

Key Path	Span X Scale
Initial S/W Revision	A.07.00

### X Auto Scaling (I/Q Error View – MER/EVM vs. Sub-carrier/Frequency Window)

When Auto Scaling is On, the scale per division and reference values are automatically adjusted in the MER/EVM vs. Sub-carrier/Frequency window.

Key Path	Span X Scale
Mode	DVB-T/H
Remote Command	:DISPlay:EVMTtwo:VIEW2:WINDow[1]:TRACe:X[:SCALe]:COUPlE OFF   ON   0   1 :DISPlay:EVMTtwo:VIEW2:WINDow[1]:TRACe:X[:SCALe]:COUPlE?
Example	DISP:EVMT:VIEW2:WIND:TRAC:X:COUP ON DISP:EVMT:VIEW2:WIND:TRAC:X:COUP?
Notes	SCPI Remarks: VIEW2: I/Q Error View WINDow[1]: MER/EVM vs. Sub-carrier/Frequency Window on I/Q Error View
Dependencies	When this parameter is set to On, it will activate the scale coupling function that automatically

	determines scale per division and reference values based on the measurement results. When you set a value to either Scale/Div or Ref Value manually, Auto Scaling is automatically set to Off.
Preset	ON
State Saved	No
Range	On   Off
Initial S/W Revision	A.07.00

### X Auto Scaling (Channel Frequency Response View – Amptd vs. Sub-carrier Window)

When Auto Scaling is On, the scale per division and reference values are automatically adjusted in the Amptd vs. Sub-carrier window.

Key Path	Span X Scale
Mode	DVB-T/H
Remote Command	:DISPlay:EVMTtwo:VIEW3:WINDow[1]:TRACe:X[:SCALe]:COUPle OFF   ON   0   1 :DISPlay:EVMTtwo:VIEW3:WINDow[1]:TRACe:X[:SCALe]:COUPle?
Example	DISP:EVMT:VIEW3:WIND:TRAC:X:COUP ON DISP:EVMT:VIEW3:WIND:TRAC:X:COUP?
Notes	SCPI Remarks: VIEW3: Channel Frequency Response View WINDow[1]: Amptd vs. Sub-carrier Window
Dependencies	When this parameter is set to On, it will activate the scale coupling function that automatically determines scale per division and reference values based on the measurement results. When you set a value to either Scale/Div or Ref Value manually, Auto Scaling is automatically set to Off.
Preset	ON
State Saved	No
Range	On   Off
Initial S/W Revision	A.07.00

### X Auto Scaling (Channel Frequency Response View – Phase vs. Sub-carrier Window)

When Auto Scaling is On, the scale per division and reference values are automatically adjusted in the Phase vs. Sub-carrier window.

Key Path	Span X Scale
Mode	DVB-T/H
Remote Command	:DISPlay:EVMTtwo:VIEW3:WINDow2:TRACe:X[:SCALe]:COUPle OFF   ON   0   1 :DISPlay:EVMTtwo:VIEW3:WINDow2:TRACe:X[:SCALe]:COUPle?
Example	DISP:EVMT:VIEW3:WIND2:TRAC:X:COUP ON

	DISP:EVMT:VIEW3:WIND2:TRAC:X:COUP?
Notes	SCPI Remarks: VIEW3: Channel Frequency Response View WINDow2: Phase vs. Sub-carrier Window
Dependencies	When this parameter is set to On, it will activate the scale coupling function that automatically determines scale per division and reference values based on the measurement results. When you set a value to either Scale/Div or Ref Value manually, Auto Scaling is automatically set to Off.
Preset	ON
State Saved	No
Range	On   Off
Initial S/W Revision	A.07.00

### X Auto Scaling (Channel Frequency Response View –Group Delay vs. Sub-carrier Window)

When Auto Scaling is On, the scale per division and reference values are automatically adjusted in the Group Delay vs. Sub-carrier window.

Key Path	Span X Scale
Mode	DVB-T/H
Remote Command	:DISPlay:EVMTtwo:VIEW3:WINDow3:TRACe:X[:SCALE]:COUPle OFF   ON   0   1 :DISPlay:EVMTtwo:VIEW3:WINDow3:TRACe:X[:SCALE]:COUPle?
Example	DISP:EVMT:VIEW3:WIND3:TRAC:X:COUP ON DISP:EVMT:VIEW3:WIND3:TRAC:X:COUP?
Notes	SCPI Remarks: VIEW3: Channel Frequency Response View WINDow3: Group Delay vs. Sub-carrier Window
Dependencies	When this parameter is set to On, it will activate the scale coupling function that automatically determines scale per division and reference values based on the measurement results. When you set a value to either Scale/Div or Ref Value manually, Auto Scaling is automatically set to Off.
Preset	ON
State Saved	No
Range	On   Off
Initial S/W Revision	A.07.00

### X Auto Scaling (Channel Impulse Response View – Amptd vs. Time Window)

When Auto Scaling is On, the scale per division and reference values are automatically adjusted in the Amptd vs. Time window.

Key Path	Span X Scale
Mode	DVB-T/H
Remote Command	:DISPlay:EVMTtwo:VIEW4:WINDow[1]:TRACe:X[:SCALe]:COUPle OFF   ON   0   1 :DISPlay:EVMTtwo:VIEW4:WINDow[1]:TRACe:X[:SCALe]:COUPle?
Example	DISP:EVMT:VIEW4:WIND:TRAC:X:COUP ON DISP:EVMT:VIEW4:WIND:TRAC:X:COUP?
Notes	SCPI Remarks: VIEW4: Channel Impulse Response View WINDow[1]: Amptd vs. Time Window
Dependencies	When this parameter is set to On, it will activate the scale coupling function that automatically determines scale per division and reference values based on the measurement results. When you set a value to either Scale/Div or Ref Value manually, Auto Scaling is automatically set to Off.
Preset	ON
State Saved	No
Range	On   Off
Initial S/W Revision	A.07.00

### X Auto Scaling (MER Monitor MER vs. Time Window)

When Auto Scaling is On, the scale per division and reference values are automatically adjusted in the MER vs. Time window.

Key Path	Span X Scale
Mode	DVB-T/H
Remote Command	:DISPlay:EVMTtwo:VIEW5:WINDow[1]:TRACe:X[:SCALe]:COUPle OFF   ON   0   1 :DISPlay:EVMTtwo:VIEW5:WINDow[1]:TRACe:X[:SCALe]:COUPle?
Example	DISP:EVMT:VIEW5:WIND:TRAC:X:COUP ON DISP:EVMT:VIEW5:WIND:TRAC:X:COUP?
Notes	SCPI Remarks: VIEW5: MER Monitor View WINDow[1]: MER vs. Time Window
Dependencies	When this parameter is set to On, it will activate the scale coupling function that automatically determines scale per division and reference values based on the measurement results. When you set a value to either Scale/Div or Ref Value manually, Auto Scaling is automatically set to Off.
Preset	ON
State Saved	No
Range	On   Off
Initial S/W Revision	A.07.00

## Scale Type

Sets X Scale Type. The key is active in MER/EVM vs. Sub-carrier/Frequency window and Amptd vs. Time window.

Key Path	Scale Type
Initial S/W Revision	A.06.00
Modified at S/W Revision	A.10.01

### Scale Type (MER/EVM vs. Sub-carrier/Frequency window)

Sets X Scale Type for MER/EVM vs. Sub-carrier/ Frequency window. If it is set to Carrier, the X scale displays the carrier value. If it is set to Freq, the X scale displays the carrier frequency value.

Key Path	Span X Scale
Mode	DVB-T/H
<b>Remote Command</b>	:DISPlay:EVMTtwo:VIEW2:WINDow[1]:TRACe:X[:SCALE]:TYPE CARRier   FREQuency  :DISPlay:EVMTtwo:VIEW2:WINDow[1]:TRACe:X[:SCALE]:TYPE?
<b>Example</b>	DISP:EVMT:VIEW2:WIND:TRAC:X:TYPE CARR DISP:EVMT:VIEW2:WIND:TRAC:X:TYPE?
Preset	CARRier
State Saved	No
Range	Carrier   Freq
Initial S/W Revision	A.07.00

### Scale Type (Amptd vs. Time window)

Sets X Scale Type for Amptd vs. Time window. If it is set to Time, the X scale displays the time value. If it is set to Distance, the X scale displays the distance value.

Distance =  $c \times$  Time, in which  $c$  ( $3 \times 10^8$ ) is the speed of light.

Key Path	Span X Scale
Mode	DVB-T/H
<b>Remote Command</b>	:DISPlay:EVMTtwo:VIEW4:WINDow[1]:TRACe:X[:SCALE]:TYPE TIME   DISTance :DISPlay:EVMTtwo:VIEW4:WINDow[1]:TRACe:X[:SCALE]:TYPE?
<b>Example</b>	DISP:EVMT:VIEW4:WIND:TRAC:X:TYPE TIME DISP:EVMT:VIEW4:WIND:TRAC:X:TYPE?
Preset	TIME
State Saved	No

---

Range	Time   Distance
Initial S/W Revision	A.07.00

---

## Sweep/Control

Accesses a menu that enables you to configure the Sweep and Control functions of the analyzer, such as Sweep Time and Gating.

Key Path	Front-panel key
Initial S/W Revision	Prior to A.02.00

### Pause/Resume

Pauses a measurement after the current data acquisition is complete.

When Paused, the label on the key changes to Resume. Pressing Resume un-pauses the measurement. When you are Paused, pressing Restart, Single or Cont does a Resume.

Key Path	Sweep/Control
<b>Remote Command</b>	:INITiate:PAUSE
Dependencies	Grayed out in Measurements that do not support Pausing. Blanked in Modes that do not support Pausing.
Initial S/W Revision	Prior to A.02.00

Key Path	Sweep/Control
<b>Remote Command</b>	:INITiate:RESume
Dependencies	Grayed out in Measurements that do not support Pausing. Blanked in Modes that do not support Pausing.
Initial S/W Revision	Prior to A.02.00

### Abort (Remote Command Only)

This command is used to stop the current measurement. It aborts the current measurement as quickly as possible, resets the sweep and trigger systems, and puts the measurement into an "idle" state. If the analyzer is in the process of aligning when ABORT is sent, the alignment finishes before the abort function is performed. So ABORT does not abort an alignment.

If the analyzer is set for Continuous measurement, it sets up the measurement and initiates a new data measurement sequence with a new data acquisition (sweep) taken once the trigger condition is met.

If the analyzer is set for Single measurement, it remains in the "idle" state until an :INIT:IMM command is received.

<b>Remote Command</b>	:ABORT
<b>Example</b>	:ABOR



Notes	<p>If :INITiate:CONTInuous is ON, then a new continuous measurement will start immediately; with sweep (data acquisition) occurring once the trigger condition has been met.</p> <p>If :INITiate:CONTInuous is OFF, then :INITiate:IMMEDIATE is used to start a single measurement; with sweep (data acquisition) occurring once the trigger condition has been met.</p>
Dependencies	<p>For continuous measurement, ABORt is equivalent to the Restart key.</p> <p>Not all measurements support the abort command.</p>
Status Bits/OPC dependencies	<p>The STATus:OPERation register bits 0 through 8 are cleared.</p> <p>The STATus:QUEStionable register bit 9 (INTEgrity sum) is cleared.</p> <p>Since all the bits that feed into OPC are cleared by the ABORt, the ABORt will cause the *OPC query to return true.</p>
Initial S/W Revision	<p>Prior to A.02.00</p>

## System

See ["System" on page 342](#)

## Trace/Detector

Displays menu keys that let you normalize trace data.

This function is only available in the Channel Frequency Response view. In other views, there is no Trace/Detector functions.

Key Path	Front-panel key
Initial S/W Revision	A.07.00

## Normalize

Displays menu keys that let you normalize trace data.

Key Path	Trace/Detector
Dependencies	This key is only available in the Channel Frequency Response view, and it's blank in other views.
Readback	[On] or [Off]
Initial S/W Revision	A.10.01

## Normalize On/Off

Normalize (On) activates the normalize function. On each sweep, the normalized trace is subtracted from Trace 1 and the result is added to the normalized reference level. This arithmetic assumes all values are in decibel units.

Key Path	Trace/Detector, Normalize
<b>Remote Command</b>	:CALCulate:EVMTtwo:NTData[:STATE] OFF ON 0 1 :CALCulate:EVMTtwo:NTData[:STATE]?
<b>Example</b>	:CALC:EVMT:NTD ON :CALC:EVMT:NTD?
Dependencies	If Normalize (On) is pressed before Store Ref, an error message "Execution Error; Store ref trace before turning on Normalize" is generated. Normalize remains off in this case.
Preset	OFF
State Saved	Saved in Instrument State.
Initial S/W Revision	A.10.01

## Store Ref

Copies trace 1 into reference trace. Store Ref must be pressed before pressing Normalize (On).

Key Path	Trace/Detector, Normalize
----------	---------------------------

<b>Remote Command</b>	TRACe:EVMTtwo:RTRace:STORe[:IMMediate]
<b>Example</b>	TRAC:EVMT:RTR:STOR
<b>Dependencies</b>	If Normalize (On) is pressed before Store Ref, an error message “Execution Error; Store ref trace before turning on Normalize” is generated. Normalize remains off in this case.
<b>Initial S/W Revision</b>	A.10.01

## Show Ref Trace

Views or blanks the reference trace on the display.

<b>Key Path</b>	Trace/Detector, Normalize
<b>Remote Command</b>	TRACe:EVMTtwo:RTRace:DISPlay OFF ON 0 1 TRACe:EVMTtwo:RTRace:DISPlay?
<b>Example</b>	TRAC:EVMT:RTR:DISP ON
<b>State Saved</b>	Saved in instrument state.
<b>Initial S/W Revision</b>	A.10.01

## Norm Ref Lvl

Sets the level (in dB) of the normalized reference.

<b>Key Path</b>	Trace/Detector, Normalize
<b>Remote Command</b>	:DISPlay:EVMTtwo:VIEW3:WINDow[1]:TRACe:Y[:SCALE]:NRLevel <real> :DISPlay:EVMTtwo:VIEW3:WINDow[1]:TRACe:Y[:SCALE]:NRLevel?
<b>Example</b>	DISP:EVMT:VIEW3:WIND:TRAC:Y:NRL 10.0dB DISP:EVMT:VIEW3:WIND:TRAC:Y:NRL?
<b>Preset</b>	0 dB
<b>State Saved</b>	Saved in instrument state.
<b>Min</b>	-327.6 dB
<b>Max</b>	327.6 dB
<b>Initial S/W Revision</b>	A.10.01

## Norm Ref Posn

Offsets the displayed trace without affecting the instrument gain or attenuation settings. This allows the displayed trace to be moved without decreasing measurement accuracy. The normalized reference position is indicated with a right arrow on the left side of the display and a left arrow on the right side of the display, just inside the graticule. See picture below:

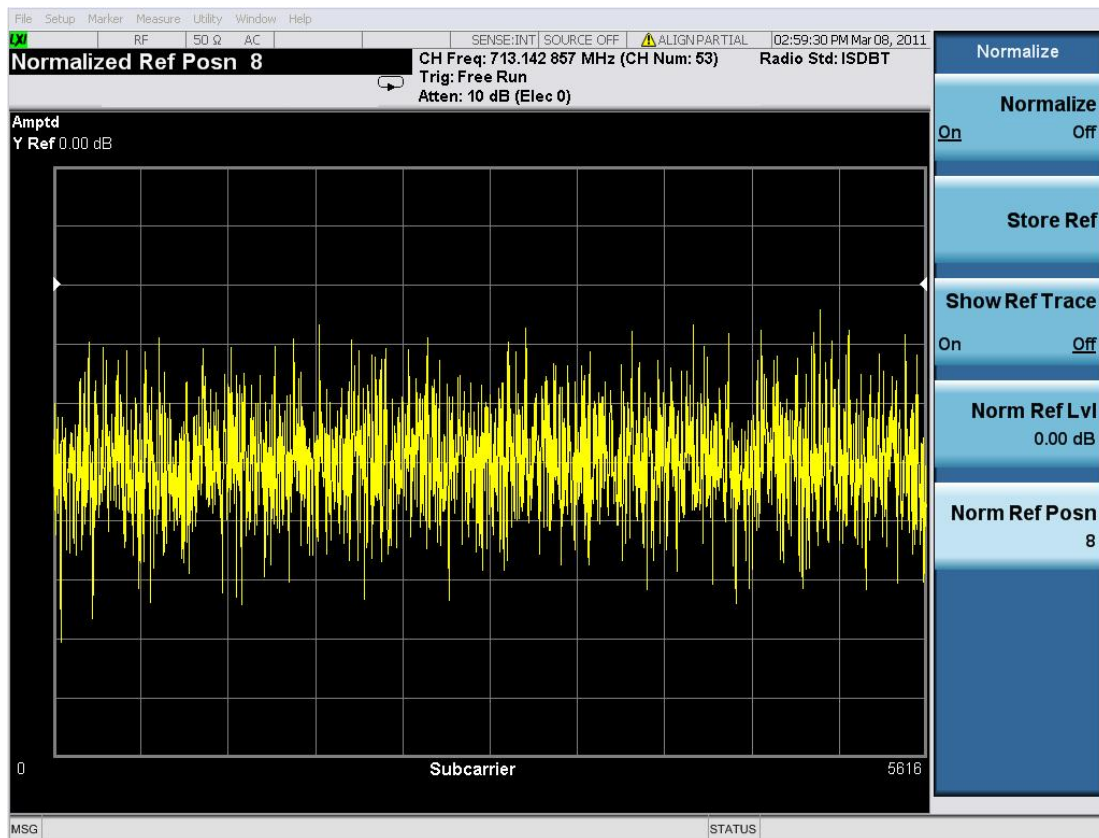

Key Path	Trace/Detector, Normalize
Remote Command	:DISPlay:EVMTtwo:VIEW3:WINDow[1]:TRACe:Y[:SCALE]:NRPosition <integer> :DISPlay:EVMTtwo:VIEW3:WINDow[1]:TRACe:Y[:SCALE]:NRPosition?
Example	DISP:EVMT:VIEW3:WIND:TRAC:Y:NRP 5 DISP:EVMT:VIEW3:WIND:TRAC:Y:NRP?
Notes	The top and bottom graticule lines correspond to 10 and 0, respectively.
Preset	10
State Saved	Saved in Instrument State.
Min	0
Max	10
Initial S/W Revision	A.10.01

## Trigger

See ["Trigger" on page 412](#)

### Free Run

See ["Free Run " on page 419](#)

### External 1

See ["External 1 " on page 2059](#)

### Trigger Level

See ["Trigger Level " on page 2059](#)

### Trig Slope

See ["Trig Slope " on page 2060](#)

### Trig Delay

See ["Trig Delay " on page 427](#)

### External 2

See ["External 2 " on page 2061](#)

### Trigger Level

See ["Trigger Level " on page 2061](#)

### Trig Slope

See ["Trig Slope " on page 2062](#)

### Trig Delay

See ["Trig Delay " on page 429](#)

### RF Burst

See ["RF Burst " on page 2062](#)

### Absolute Trigger

See ["Absolute Trigger Level" on page 2063](#)

### Relative Trigger

See ["Relative Trigger Level" on page 2052](#)

### Trig Slope

See ["Trigger Slope " on page 2064](#)

## Trig Delay

See "Trig Delay " on page 433

## Periodic Timer

See "Periodic Timer (Frame Trigger) " on page 2054

## Period

See "Period " on page 2055

## Offset

See "Offset " on page 2056

## Offset Adjust (Remote Command Only)

See "Offset Adjust (Remote Command Only)" on page 2057

## Reset Offset Display

See "Reset Offset Display " on page 2058

## Sync Source

See "Sync Source " on page 2058

## Off

See "Off " on page 2059

## External 1

See "External 1 " on page 2059

## Trigger Level

See "Trigger Level " on page 2059

## Trig Slope

See "Trig Slope " on page 2060

## External 2

See "External 2 " on page 2061

## Trigger Level

See "Trigger Level " on page 2061

## Trig Slope

See "Trig Slope " on page 2062

## RF Burst

See "RF Burst " on page 2062

### **Absolute Trigger**

See ["Absolute Trigger Level" on page 2063](#)

### **Trig Slope**

See ["Trigger Slope " on page 2064](#)

### **Trig Delay**

See ["Trig Delay" on page 443](#)

### **Auto/Holdoff**

See ["Auto/Holdoff " on page 444](#)

### **Auto Trig**

See ["Auto Trig " on page 444](#)

### **Trig Holdoff**

See ["Trig Holdoff " on page 445](#)

### **Baseband I/Q**

See [\\_\\_\\_ on page X](#)

### **I/Q Mag**

See [\\_\\_\\_ on page X](#)

### **Trigger Level**

See [\\_\\_\\_ on page X](#)

### **Trig Slope**

See [\\_\\_\\_ on page X](#)

### **Trig Delay**

See [\\_\\_\\_ on page X](#)

### **I**

See [\\_\\_\\_ on page X](#)

### **Trigger Level**

See [\\_\\_\\_ on page X](#)

### **Trig Slope**

See [\\_\\_\\_ on page X](#)



**Trig Delay**

See \_\_\_ on page X

**Q**

See \_\_\_ on page X

**Trigger Level**

See \_\_\_ on page X

**Trig Slope**

See \_\_\_ on page X

**Trig Delay**

See \_\_\_ on page X

**Input I**

See \_\_\_ on page X

**Trigger Level**

See \_\_\_ on page X

**Trig Slope**

See \_\_\_ on page X

**Trig Delay**

See \_\_\_ on page X

**Input Q**

See \_\_\_ on page X

**Trigger Level**

See \_\_\_ on page X

**Trig Slope**

See \_\_\_ on page X

**Trig Delay**

See \_\_\_ on page X

**Aux Channel Center Freq**

See \_\_\_ on page X

**Trigger Level**

See \_\_\_ on page X

**Trig Slope**

See \_\_\_ on page X

**Trig Delay**

See \_\_\_ on page X

**Trigger Center Freq**

See \_\_\_ on page X

**Trigger BW**

See \_\_\_ on page X

## User Preset

Accesses a menu that gives you the following three choices:

- User Preset – recalls a state previously saved using the Save User Preset function.
- User Preset All Modes – presets all of the modes in the analyzer
- Save User Preset– saves the current state for the current mode

Key Path	Front-panel key
Backwards Compatibility Notes	<p>User Preset is actually loading a state, and in legacy analyzers, it was possible to load a state without affecting the trace data, limit lines or correction data. Similarly it was possible to do a User Preset without affecting the trace data, limit lines or correction data.</p> <p>In the X-Series, “state” always includes all of this data; so whenever state is loaded, or User Preset is executed, all of the traces, limit lines and corrections are affected. Although this differs from previous behavior, it is desirable behavior, and should not cause adverse issues for users.</p> <p>On ESA and PSA, User Preset affected the entire instrument’s state. In the X-Series, User Preset only recalls the state for the active mode. There is a User Preset file for each mode. User Preset can never cause a mode switch as it can in legacy analyzers. If you want to recall all modes to their user preset file state, you will need to do a User Preset after mode switching into each mode.</p> <p>User Preset recalls mode state which can now include data like traces; whereas on ESA and PSA, User Preset did not affect data.</p>
Initial S/W Revision	Prior to A.02.00

## User Preset

User Preset sets the state of the currently active mode back to the state that was previously saved for this mode using the Save User Preset menu key or the SCPI command, SYST:PRES:USER:SAV. It not only recalls the Mode Preset settings, but it also recalls all of the mode persistent settings, and the Input/Output system setting that existed at the time Save User Preset was executed.

If a Save User Preset has not been done at any time, User Preset recalls the default user preset file for the currently active mode. The default user preset files are created if, at power-on, a mode detects there is no user preset file. There will never be a scenario when there is no user preset file to restore. For each mode, the default user preset state is the same state that would be saved if a Save User Preset is performed in each mode right after doing a Restore Mode Default and after a Restore Input/Output Defaults.

The User Preset function does the following:

- Aborts the currently running measurement.
- Sets the mode State to the values defined by Save User Preset.
- Makes the saved measurement for the currently running mode the active measurement.
- Brings up the saved menu for the power-on mode.
- Clears the input and output buffers.
- Sets the Status Byte to 0.

Key Path	User Preset
Remote Command	:SYSTem:PRESet:USER
Example	:SYST:PRES:USER:SAVE:SYST:PRES:USER
Notes	:SYST:PRES:USER:SAVE is used to save the current state as the user preset state. Clears all pending OPC bits. The Status Byte is set to 0. Pressing the User Preset front-panel key while already in the User Preset menu will cause the User Preset to get executed
Couplings	A user preset will cause the currently running measurement to be aborted and cause the saved measurement to be active. Recalling a User Preset file has the same issues that recalling a Save State file has. Some settings may need to be limited and therefore re-coupled, since the capabilities of the mode may have changes when the User Preset file was last saved.
Initial S/W Revision	Prior to A.02.00

### User Preset All Modes

Recalls all of the User Preset files for each mode, switches to the power-on mode, and activates the saved measurement from the power-on mode User Preset file.

**NOTE**

When the instrument is secured, all of the user preset files are converted back to their default user preset files.

The User Preset function does the following:

- Aborts the currently running measurement.
- Switches the Mode to the power-on mode.
- Restores the User Preset files for each mode.
- Makes the saved measurement for the power-on mode the active measurement.
- Brings up the saved menu for the power-on mode.
- Clears the input and output buffers.
- Sets the Status Byte to 0.

Key Path	User Preset
Remote Command	:SYSTem:PRESet:USER:ALL
Example	:SYST:PRES:USER:SAVE:SYST:PRES:USER:ALL
Notes	Clears all pending OPC bits. The Status Byte is set to 0. :SYST:PRES:USER:SAVE is used to save the current state as the user preset state.
Couplings	A user preset will cause the currently running measurement to be aborted, cause a mode switch to the power-on mode, and cause the saved measurement to be active in the power-on mode. Recalling a User Preset file has the same issues that recalling a Save State file has. Some settings may need to be limited and therefore re-coupled, since the capabilities of the mode may have changes when the User Preset file was last saved.
Initial S/W Revision	Prior to A.02.00

## Save User Preset

Saves the currently active mode and its State. You can recall this User Preset file by pressing the User Preset menu key or sending the SYST:PRES:USER remote command. This same state is also saved by the Save State function.

Key Path	User Preset
<b>Remote Command</b>	:SYSTem:PRESet:USER:SAVE
<b>Example</b>	:SYST:PRES:USER:SAVE
Notes	:SYST:PRES:SAVE creates the same file as if the user requested a *SAV or a MMEM:STOR:STAT, except User Preset Save does not allow the user to specify the filename or the location of the file.
Initial S/W Revision	Prior to A.02.00

## View/Display

The View/Display key opens the View/Display menu for the current measurement. The views that are available are specific to the current measurement selected under the Meas key.

The DVB-T2 Modulation Accuracy measurement consists of nine views. The default view is I/Q Measured Polar Graph (left/right). For the selection of each view, refer to "[View Selection](#)" on page 1686.

NO.	View	NO. of Windows	Window No.	Window
1	VIEW[1] I/Q Measured Polar Graph	Dual (Horizontal)	WINDow[1]	Result Metrics
			WINDow2	I/Q Measured Polar Graph
2	VIEW2 I/Q Error	Quad	WINDow[1]	MER/EVM vs. Sub-carrier/Frequency
			WINDow2	L1 Signalling
			WINDow3	I/Q Measured Polar Graph
			WINDow4	Result Metrics
3	VIEW3 Channel Frequency Response	Triple (Vertical)	WINDow[1]	Amptd vs. Sub-carrier
			WINDow2	Phase vs. Sub-carrier
			WINDow3	Group Delay vs. Sub-carrier
4	VIEW4 Channel Impulse Response	Single	WINDow[1]	Amptd vs. Time
5	VIEW5 MER Monitor	Single	WINDow[1]	MER Monitor
6	VIEW6 L1 Signalling	Single	WINDow[1]	L1 Signalling
7	VIEW7 Result Metrics	Single	WINDow[1]	Result Metrics Summary
8	VIEW8 MER vs. PLP	Single	WINDow[1]	MER vs. PLP
9	VIEW9 BER Results	Single	WINDow[1]	BER Results

### View Selection

Allows you to select the desired measurement view from the following selections:

1I/Q Measured Polar Graph

2I/Q Error (quad view). Provides a combination view of MER/EVM vs. Sub-carrier/Frequency graph, L1 Signalling graph, I/Q Measured Polar Graph, and the result metrics.

3Channel Frequency Response (triple view). Provides a combination view of Amptd vs. Sub-carrier graph, Phase vs. Sub-carrier graph and Group Delay vs. Sub-carrier graph.

4Channel Impulse Response

5L1 Signalling

6MER Monitor

7Result Metrics

8MER vs. PLP

9BER Results

Key Path	View/Display
Mode	DVB-T/H
Remote Command	:DISPlay:EVMTtwo:VIEW[:SElect] POLar   IQError   FREquency   IMPulse   SIGNalling   MERMonitor   NResults   MERPlp   BER  :DISPlay:EVMTtwo:VIEW[:SElect]?
Example	DISP:EVMT:VIEW POL DISP:EVMT:VIEW?
Preset	POLar
State Saved	Saved in instrument state.
Range	I/Q Measured Polar Graph   I/Q Error (Quad View)   Channel Frequency Response   Channel Impulse Response   L1 Signalling   MER Monitor   Result Metrics   MER vs. PLP   BER Results
Initial S/W Revision	A.07.00
Modified at S/W Revision	A.08.00

Key Path	Front-panel key
Initial S/W Revision	A.07.00
Modified at S/W Revision	A.11.00

## Display

The Display menu is common to most measurements, and is used for configuring items on the display. Some Display menu settings apply to all the measurements in a mode, and some only to the current measurement. Those under the System Display Settings key apply to all measurements in all modes.

Key Path	Display
Key Path	View/Display
Initial S/W Revision	Prior to A.02.00

### Annotation

Turns on and off various parts of the display annotation. The annotation is divided up into four categories:

1. Meas Bar: This is the measurement bar at the top of the screen. It does not include the settings panel or the Active Function. Turning off the Meas Bar turns off the settings panel and the Active Function. When the Meas Bar is off, the graticule area expands to fill the area formerly occupied by the Meas Bar.
2. Screen Annotation: this is the annotation and annunciation around the graticule, including any annotation on lines (such as the display line, the threshold line, etc.) This does NOT include the marker number or the N dB result. When off, the graticule expands to fill the entire graticule area.
3. Trace annotation: these are the labels on the traces, showing their detector (or their math mode).
4. Active Function annotation: this is the active function display in the meas bar, and all of the active function values displayed on softkeys.

See the figure below. Each type of annotation can be turned on and off individually.

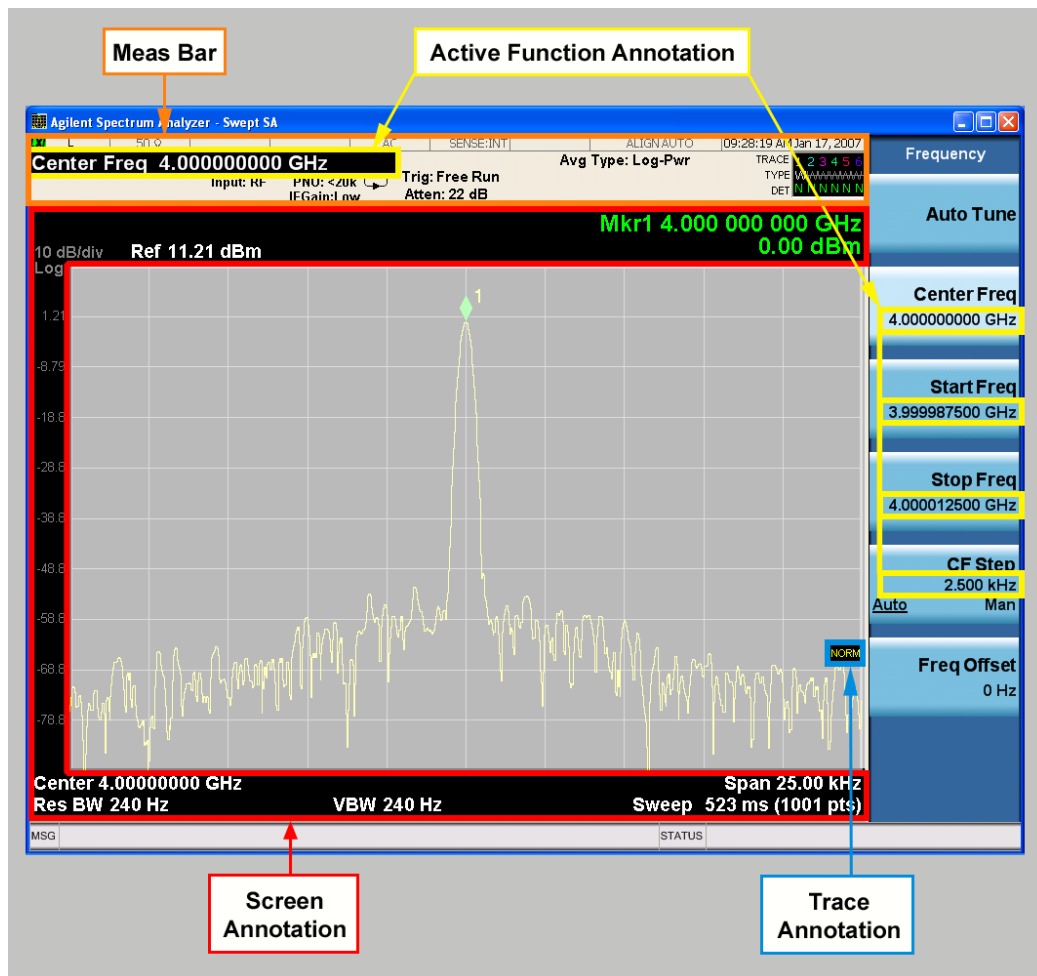

Key Path	View/Display, Display
Initial S/W Revision	Prior to A.02.00



## Meas Bar On/Off

This function turns the Measurement Bar on and off, including the settings panel. When off, the graticule area expands to fill the area formerly occupied by the Measurement Bar.

Key Path	View/Display, Display, Annotation
Remote Command	:DISPlay:ANNotation:MBAR[:STATe] OFF ON 0 1 :DISPlay:ANNotation:MBAR[:STATe]?
Example	DISP:ANN:MBAR OFF
Dependencies	Grayed out and forced to OFF when System Display Settings, Annotation is set to Off.
Preset	On This should remain Off through a Preset when System DisplaySettings, Annotation is set to Off.
State Saved	Saved in instrument state.
Initial S/W Revision	Prior to A.02.00

## Screen

This controls the display of the annunciation and annotation around the graticule, including any annotation on lines (such as the display line, the threshold line, etc.) and the y-axis annotation. This does NOT include marker annotation (or the N dB result). When off, the graticule expands to fill the entire graticule area, leaving only the 1.5% gap above the graticule as described in the Trace/Detector chapter.

Key Path	View/Display, Display, Annotation
Remote Command	:DISPlay:ANNotation:SCReen[:STATe] OFF ON 0 1 :DISPlay:ANNotation:SCReen[:STATe]?
Example	DISP:ANN:SCR OFF
Dependencies	Grayed-out and forced to OFF when System Display Settings, Annotation is set to Off.
Preset	On This should remain Off through a Preset when System DisplaySettings, Annotation is set to Off
State Saved	Saved in instrument state.
Initial S/W Revision	Prior to A.02.00

## Active Function Values On/Off

Turns on and off the active function display in the Meas Bar, and all of the active function values displayed on the softkeys.

Note that all of the softkeys that have active functions have these numeric values blanked when this function is on. This is a security feature..

13 DVB-T2 Mod Accuracy Measurement  
View/Display

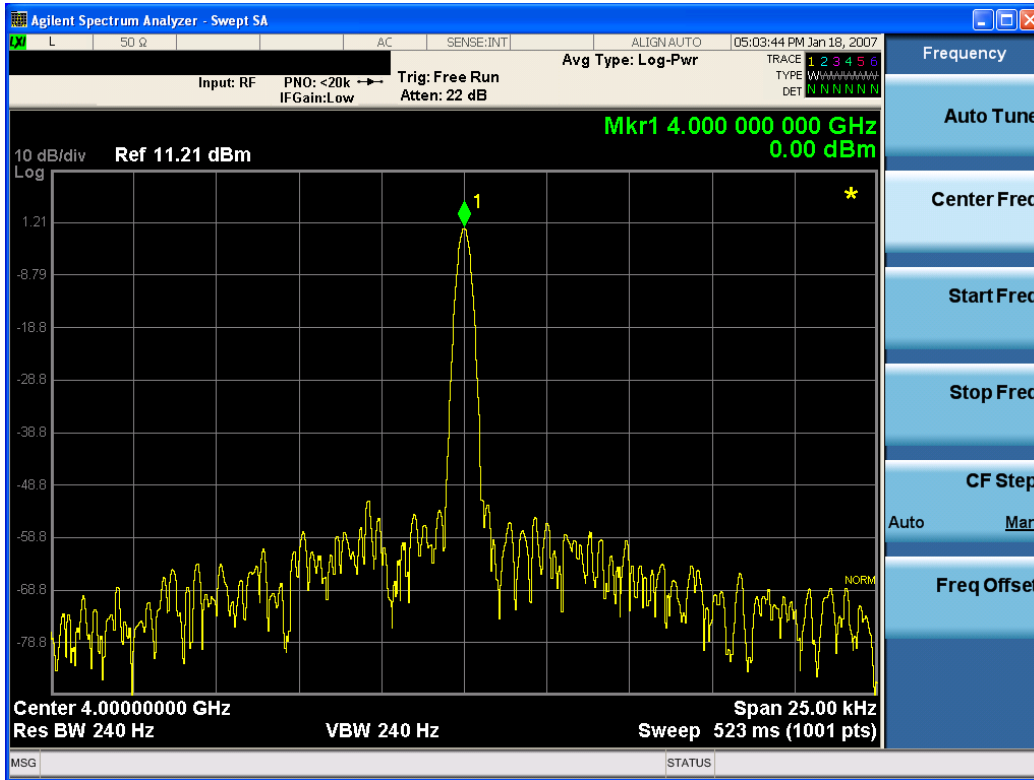

Key Path	View/Display, Display, Annotation
Remote Command	:DISPlay:ACTivefunc[:STATE] ON OFF 1 0 :DISPlay:ACTivefunc[:STATE] ?
Example	DISP:ACT OFF
Dependencies	Grayed out and forced to OFF when System Display Settings, Annotation is set to Off.
Preset	On This should remain Off through a Preset when System DisplaySettings, Annotation is set to Off
State Saved	Saved in instrument state.
Initial S/W Revision	Prior to A.02.00

Title

Displays menu keys that enable you to change or clear a title on your display.

Key Path	View/Display, Display
Initial S/W Revision	Prior to A.02.00

Change Title

Writes a title into the "measurement name" field in the banner, for example, "Swept SA".

Press Change Title to enter a new title through the alpha editor. Press Enter or Return to complete the entry. Press ESC to cancel the entry and preserve your existing title.

The display title will replace the measurement name. It remains for this measurement until you press Change Title again, or you recall a state, or a Preset is performed. A title can also be cleared by pressing Title, Clear Title.

**NOTE**

Notice the inclusion of the <measurement> parameter in the command below. Because each measurement remembers the Display Title, the command must be qualified with the measurement name. For the Swept SA measurement this is not the case; no <measurement> parameter is used when changing the Display Title for the Swept SA measurement.

Key Path	View/Display, Display, Title
Mode	All
<b>Remote Command</b>	:DISPlay:<measurement>:ANNotation:TITLe:DATA <string> :DISPlay:<measurement>:ANNotation:TITLe:DATA?
<b>Example</b>	DISP:ANN:TITL:DATA "This Is My Title" This example is for the Swept SA measurement in the Spectrum Analyzer mode. The SANalyzer <measurement> name is not used. DISP:ACP:ANN:TITL:DATA "This Is My Title" This example is for Measurements other than Swept SA. Both set the title to: This Is My Title
Notes	Pressing this key cancels any active function. When a title is edited the previous title remains intact (it is not cleared) and the cursor goes at the end so that characters can be added or BKSP can be used to go back over previous characters.
Preset	No title (measurement name instead)
State Saved	Saved in instrument state.
Initial S/W Revision	Prior to A.02.00

### Clear Title

Clears a title from the front-panel display. Once cleared, the title cannot be retrieved. After the title is cleared, the current Measurement Name replaces it in the title bar.

Key Path	View/Display, Display, Title
<b>Example</b>	The following commands clear the title and restore the measurement's original title: DISP:ANN:TITL:DATA "" This example is for the Swept SA measurement in the Spectrum Analyzer mode. The SANalyzer <measurement> name is not used. DISP:ACP:ANN:TITL:DATA "" This example is for ACP; in measurements other than Swept SA the measurement name is required.
Notes	Uses the :DISPlay:<measurement>:ANNotation:TITLe:DATA <string> command with an empty string (in the Swept SA, the <measurement> is omitted).
Preset	Performed on Preset.
Initial S/W Revision	Prior to A.02.00

## Graticule

Pressing Graticule turns the display graticule On or Off. It also turns the graticule y-axis annotation on and off.

Key Path	View/Display, Display
Remote Command	:DISPlay:WINDow[1]:TRACe:GRATicule:GRID[:STATe] OFF ON 0 1 :DISPlay:WINDow[1]:TRACe:GRATicule:GRID[:STATe]?
Example	DISP:WIND:TRAC:GRAT:GRID OFF
Notes	The graticule is the set of horizontal and vertical lines that make up the grid/divisions for the x-axis and y-axis.
Preset	On
State Saved	Saved in instrument state
Initial S/W Revision	Prior to A.02.00

## System Display Settings

These settings are "Mode Global" – they affect all modes and measurements and are reset only by Restore Misc Defaults or Restore System Defaults under System.

Key Path	View/Display, Display
Initial S/W Revision	Prior to A.02.00

## Annotation Local Settings

This is a Mode Global override of the meas local annotation settings. When it is All Off, it forces ScreenAnnotation, Meas Bar, Trace, and Active Function Values settings to be OFF for all measurements in all modes. This provides the security based "annotation off" function of previous analyzers; hence it uses the legacy SCPI command.

When it is All Off, the Screen, Meas Bar, Trace, and Active Function Values keys under the Display, Annotation menu are grayed out and forced to Off. When Local Settings is selected, you are able to set the local annotation settings on a measurement by measurement basis.

Key Path	View/Display, Display, System Display Settings
Remote Command	:DISPlay:WINDow[1]:ANNotation[:ALL] OFF ON 0 1 :DISPlay:WINDow[1]:ANNotation[:ALL]?
Example	:DISP:WIND:ANN OFF
Preset	On (Set by Restore Misc Defaults)
State Saved	Not saved in instrument state.
Backwards Compatibility Notes	The WINDow parameter and optional subopcode is included for backwards compatibility but ignored – all windows are equally affected.
Initial S/W Revision	Prior to A.02.00

## Themes

Accesses a menu of functions that enable you to choose the theme to be used when saving the screen image.

The **Themes** option is the same as the **Themes** option under the **Display** and **Page Setup** dialogs. It allows you to choose between themes to be used when saving the screen image.

<b>Key Path</b>	Save, Screen Image
<b>Remote Command</b>	:MMEMory:STORe:SCReen:THEMe TDColor   TDMonochrome   FCOlor   FMONochrome  :MMEMory:STORe:SCReen:THEMe?
<b>Example</b>	:MMEM:STOR:SCR:THEM TDM
<b>Preset</b>	3D Color; Is not part of Preset, but is reset by Restore Misc Defaults or Restore System Defaults All and survives subsequent running of the modes.
<b>Readback</b>	3D Color   3D Mono   Flat Color   Flat Mono
<b>Backwards Compatibility Notes</b>	In ESA and PSA we offer the choice of "Reverse Bitmap" or "Reverse Metafile" when saving screen images. This is much like the "Flat Color" theme available in X-Series. Also, if you selected Reverse Bitmap AND a black & white screen image, that would be much like "Flat Monochrome". In other words, each of the X-Series themes has a similar screen image type in ESA/PSA. But they are not identical.
<b>Initial S/W Revision</b>	Prior to A.02.00

### 3D Color

Selects a standard color theme with each object filled, shaded and colored as designed.

<b>Key Path</b>	Save, Screen Image, Themes
<b>Example</b>	MMEM:STOR:SCR:THEM TDC
<b>Readback</b>	3D Color
<b>Initial S/W Revision</b>	Prior to A.02.00

### 3D Monochrome

Selects a format that is like 3D color but shades of gray are used instead of colors.

<b>Key Path</b>	Save, Screen Image, Themes
<b>Example</b>	MMEM:STOR:SCR:THEM TDM
<b>Readback</b>	3D Mono
<b>Initial S/W Revision</b>	Prior to A.02.00

### Flat Color

Selects a format that is best when the screen is to be printed on an ink printer.

Key Path	Save, Screen Image, Themes
<b>Example</b>	MMEM:STOR:SCR:THEM FCOL
Readback	Flat Color
Initial S/W Revision	Prior to A.02.00

### Flat Monochrome

Selects a format that is like Flat Color. But only black is used (no colors, not even gray), and no fill.

Key Path	Save, Screen Image, Themes
<b>Example</b>	MMEM:STOR:SCR:THEM FMON
Readback	Flat Mono
Initial S/W Revision	Prior to A.02.00

### Backlight

Accesses the display backlight on/off keys. This setting may interact with settings under the Windows "Power" menu.

When the backlight is off, pressing ESC, TAB, SPACE, ENTER, UP, DOWN, LEFT, RIGHT, DEL, BKSP, CTRL, or ALT turns the backlight on without affecting the application. Pressing any other key will turn backlight on and could potentially perform the action as well.

Key Path	View/Display, Display, System Display Settings
<b>Remote Command</b>	:DISPlay:BACKlight ON OFF :DISPlay:BACKlight?
Preset	ON (Set by Restore Misc Defaults)
Initial S/W Revision	Prior to A.02.00

### Backlight Intensity

An active function used to set the backlight intensity. It goes from 0 to 100 where 100 is full on and 0 is off. This value is independent of the values set under the Backlight on/off key.

Key Path	View/Display, Display, System Display Settings
<b>Remote Command</b>	:DISPlay:BACKlight:INTensity <integer> :DISPlay:BACKlight:INTensity?
<b>Example</b>	DISP:BACK:INT 50

Preset	100 (Set by Restore Misc Defaults)
Min	0
Max	100
Initial S/W Revision	Prior to A.02.00

## I/Q Measured Polar Graph

Selects the Polar Graph view, and modifies the display settings of polar graph.

There are two windows, "[Result Metrics Window](#)" on page 1697(left) and "[I/Q Measured Polar Graph Window](#)" on page 1698 (right).

### NOTE

In Polar Graph window, the blue points (■) are data points, the green points (■) are L1-pre points, the hot pink points (■) are L1-post points, the white points (■) are P2 pilot points, the sky blue points (■) are continued pilot points, the green yellow points (■) are scattered pilot points and the purple points (■) are frame-closing pilot points.

In the I/Q Measured Polar Graph Window, only the constellation points of the current PLP ID will be displayed.

If Transmission Mode (Mode Setup, Radio Std, DVB-T2) is MISO and MISO Test Seup (Meas Setup, Advanced) is Tx1+Tx2, only Data EVM/MER, Freq Err, Clock Err and Tx Power will be given. Others will be displayed as "---".

13 DVB-T2 Mod Accuracy Measurement  
View/Display

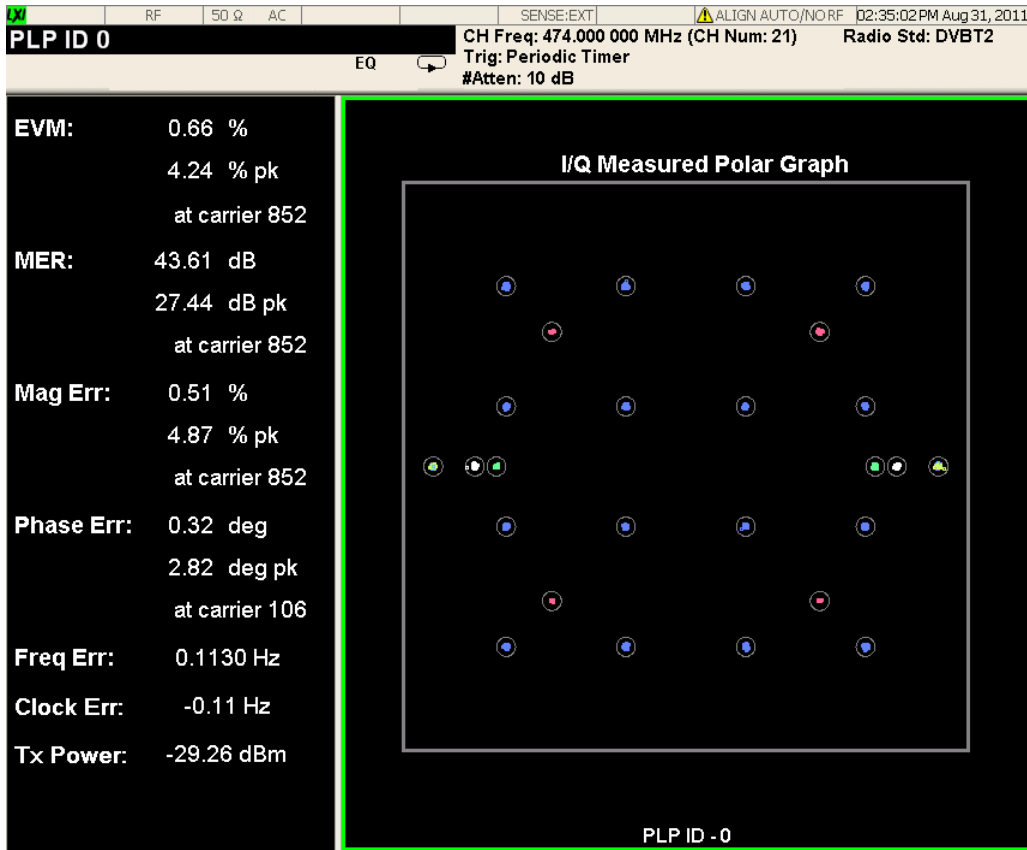

Rotated constellation



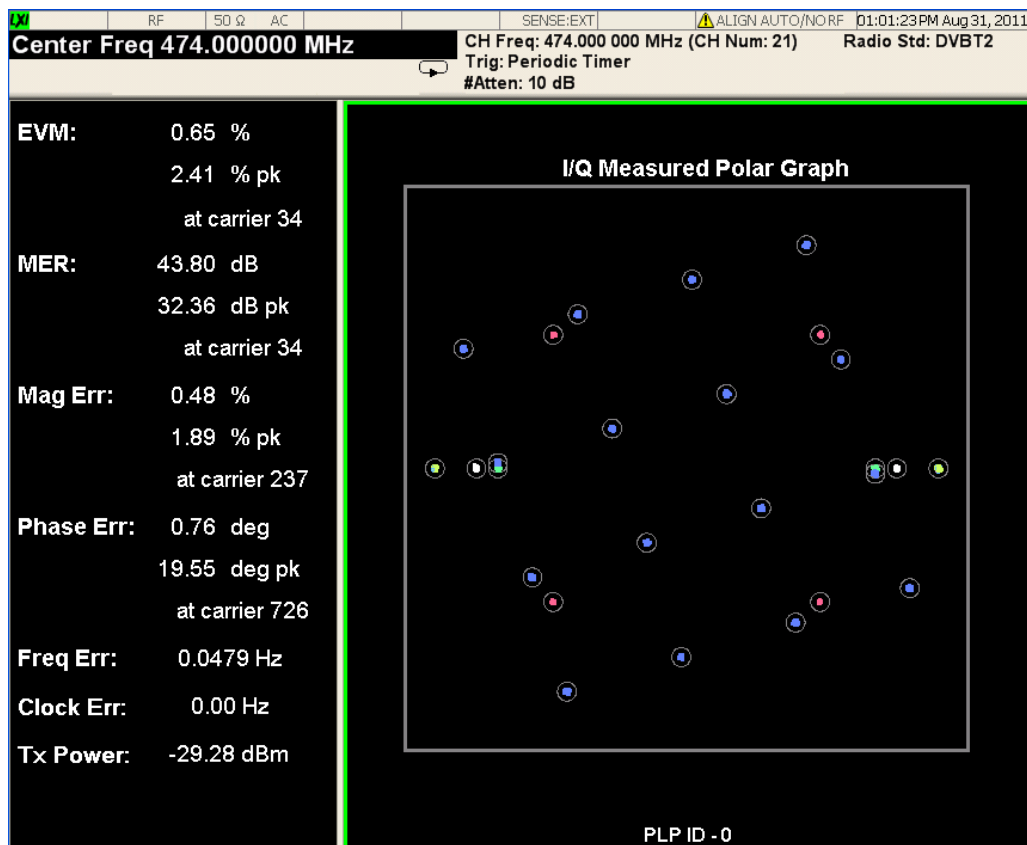

Figure 5 - 1 I/Q Measured Polar Graph View of Modulation Accuracy Measurement

### Result Metrics Window

Modulation Accuracy Result Metrics are listed in the following table.

Name	Corresponding Results	Format
EVM	n=1 1st EVM of the current symbols	99.99 %
Peak EVM	n=1 2nd Peak EVM of the current symbols	99.99 % pk
Peak EVM Position	n=1 3rd Sub-carrier number corresponding to the position of peak EVM is returned	at carrier (999)
MER	n=1 4th MER of the current symbols	99.99 dB
Peak MER	n=1 5th Peak MER of the current symbols	99.99 dB pk
Peak MER Position	n=1 6th Sub-carrier number corresponding to the position of peak MER is returned	at carrier (999)

Name	Corresponding Results	Format
Mag Err	n=1 7th Magnitude error of the current symbols	99.99 %
Peak Mag Err	n=1 8th Peak magnitude error of the current symbols	99.99 % pk
Peak Mag Err Position	n=1 9th Sub-carrier number corresponding to the position of peak magnitude error is returned	at carrier (999)
Phase Err	n=1 10th Phase error of the current symbols	99.99 deg
Peak Phase Err	n=1 11th Peak phase error of the current symbols	99.99 deg pk
Peak Phase Err Position	n=1 12th Sub-carrier number corresponding to the position of peak phase error is returned	at carrier (999)
Freq Err	n=1 13th Frequency error of the current symbols	99.99 Hz

## I/Q Measured Polar Graph Window

This window provides IQ polar graph.

Name	Corresponding Trace	Format
Constellation	The I/Q polar trace of measured input data. The length displayed is defined by I/Q Points.(n=2)	Constellation
Key Path	View/Display	
Example	:DISPlay:EVMtwo:VIEW POLar :DISPlay:EVMtwo:VIEW?	
Initial S/W Revision	A.07.00	

## Start Carrier

Sets the start carrier number. The constellation points between the start carrier and the stop carrier will be displayed in the I/Q Measured polar graph.

You can view the constellation points of certain carriers.

Key Path	View/Display, I/Q Measured Polar Graph
----------	--

Mode	DVB-T/H
<b>Remote Command</b>	:DISPlay:EVMTtwo:CARRier:STARt <integer> :DISPlay:EVMTtwo:CARRier:STARt?
<b>Example</b>	DISP:EVMT:CARR:STAR 0 DISP:EVMT:CARR:STAR?
Notes	Meaning of the numeric values: Number of the start carrier on I/Q Measured Polar Graph.
Dependencies	This key is grayed out if the current constellation is rotated.
Preset	0
State Saved	Saved in instrument state.
Min	0
Max	852 in 1K mode, 1704 in 2K mode, 3408 in 4K mode, 6816 (normal carrier mode) / 6912 (extended carrier mode) in 8K mode, 13632 (normal carrier mode) / 13920 (extended carrier mode) in 16K mode and 27264 (normal) / 27840 (extended carrier mode) in 32K mode.
Initial S/W Revision	A.07.00

## Stop Carrier

Sets the stop carrier number. The constellation points between the start carrier and the stop carrier will be displayed in the I/Q Measured polar graph.

You can view the constellation points of certain carriers.

Key Path	View/Display, I/Q Measured Polar Graph
Mode	DVB-T/H
<b>Remote Command</b>	:DISPlay:EVMTtwo:CARRier:STOP <integer> :DISPlay:EVMTtwo:CARRier:STOP?
<b>Example</b>	DISP:EVMT:CARR:STOP 1704 DISP:EVMT:CARR:STOP?
Notes	Meaning of the numeric values: Number of the stop carrier on I/Q Measured Polar Graph.
Dependencies	This key is grayed out if the current constellation is rotated.
Couplings	The current value of this key is coupled with the value of FFT Size (Mode Setup, Demod) and the value of Start Carrier Number in the following way. When the value of FFT size changes, the current value of this key will be changed to its max value corresponding to the FFT Size. When the value of the Start Carrier Number jumps beyond the current value of this key, the value of the Stop Carrier number will be changed to its max value.
Preset	Max
State Saved	Saved in instrument state.
Min	Start Carrier

Max	852 in 1K mode, 1704 in 2K mode, 3408 in 4K mode, 6816 (normal carrier mode) / 6912 (extended carrier mode) in 8K mode, 13632 (normal carrier mode) / 13920 (extended carrier mode) in 16K mode and 27264 (normal) / 27840 (extended carrier mode) in 32K mode.
Initial S/W Revision	A.07.00

## PLP ID

Sets PLP ID. The constellation points of the selected PLP will be displayed on I/Q Measured polar graph window.

Key Path	View/Display, I/Q Measured Polar Graph
Mode	DVB-T/H
<b>Remote Command</b>	:DISPlay:EVMTtwo:IDPLp <integer> :DISPlay:EVMTtwo:IDPLp?
<b>Example</b>	DISP:EVMT:IDPL 0 DISP:EVMT:IDPL?
Preset	0
State Saved	Saved in instrument state.
Min	0
Max	255
Initial S/W Revision	A.07.00

## Display Type

Sets the Display Type. The constellation points of the selected type will be displayed on I/Q Measured polar graph window.

Key Path	View/Display, I/Q Measured Polar Graph
Initial S/W Revision	A.08.00

## Data

Toggles the state of Data constellation points. Data constellation points will be displayed on the graph if the state is ON.

Key Path	View/Display, I/Q Measured Polar Graph, Display Type
Mode	DVB-T/H
<b>Remote Command</b>	:DISPlay:EVMTtwo:DTYPe:DATA[:STATe] OFF ON 0 1 :DISPlay:EVMTtwo:DTYPe:DATA[:STATe]?
<b>Example</b>	DISP:EVMT:DTYP:DATA ON

	DISP:EVMt:DTYP:DATA?
Preset	ON
State Saved	Saved in instrument state.
Range	On   Off
Initial S/W Revision	A.08.00

### Pilot

Toggles the state of pilot constellation points. Pilot constellation points will be displayed on the graph if the state is ON.

Key Path	View/Display, I/Q Measured Polar Graph, Display Type
Mode	DVB-T/H
<b>Remote Command</b>	:DISPlay:EVMttwo:DTYPe:PILot[:STATe] OFF ON 0 1 :DISPlay:EVMttwo:DTYPe:PILot[:STATe]?
<b>Example</b>	DISP:EVMt:DTYP:PIL ON DISP:EVMt:DTYP:PIL?
Dependencies	If Transmission Mode (Mode Setup, Radio Std, DVB-T2) is MISO and MISO Test Setup (Meas Setup, Advanced) is Tx1 + Tx2, this key is grayed out.
Preset	ON
State Saved	Saved in instrument state.
Range	On   Off
Initial S/W Revision	A.08.00

### L1-pre

Toggles the state of L1-pre constellation points. L1-pre constellation points will be displayed on the graph if the state is ON.

Key Path	View/Display, I/Q Measured Polar Graph, Display Type
Mode	DVB-T/H
<b>Remote Command</b>	:DISPlay:EVMttwo:DTYPe:L1Signalling:PRE[:STATe] OFF ON 0 1 :DISPlay:EVMttwo:DTYPe:L1Signalling:PRE[:STATe]?
<b>Example</b>	DISP:EVMt:DTYP:L1S:PRE ON DISP:EVMt:DTYP:L1S:PRE?
Preset	ON
State Saved	Saved in instrument state.
Range	On   Off
Initial S/W Revision	A.08.00

## L1-post

Toggles the state of L1-post constellation points. L1-post constellation points will be displayed on the graph if the state is ON.

Key Path	View/Display, I/Q Measured Polar Graph, Display Type
Mode	DVB-T/H
Remote Command	:DISPlay:EVMTtwo:DTYPe:L1Signalling:POST[:STATe] OFF ON 0 1 :DISPlay:EVMTtwo:DTYPe:L1Signalling:POST[:STATe]?
Example	DISP:EVMT:DTYP:L1S:POST ON DISP:EVMT:DTYP:L1S:POST?
Preset	ON
State Saved	Saved in instrument state.
Range	On   Off
Initial S/W Revision	A.08.00

## I/Q Error

Selects the I/Q Error view.

There are four windows in this view:

- 1 "MER/EVM vs. Sub-carrier/Frequency Window" on page 1703 (top left)
- 2 "L1 Signalling Window" on page 1707 (top right)
- 3 "I/Q Measured Polar Graph Window" on page 1708 (bottom left)
- 4 "Result Metrics Window" on page 1708 (bottom right)

The Reference Value, Units per Division and Reference Position of the X or Y-axis in the trace graph can be adjusted by selecting SPAN X Scale or AMPTD Y Scale.

In the I/Q Measured Polar Graph Window and Result Metrics Window, only the constellation points and results of the current PLP ID will be displayed.

### NOTE

If Constellation Rotation is used in that PLP under test, the peak values for EVM, MER, Mag Err, and Phase Err in Result Metrics window will be displayed as "---".

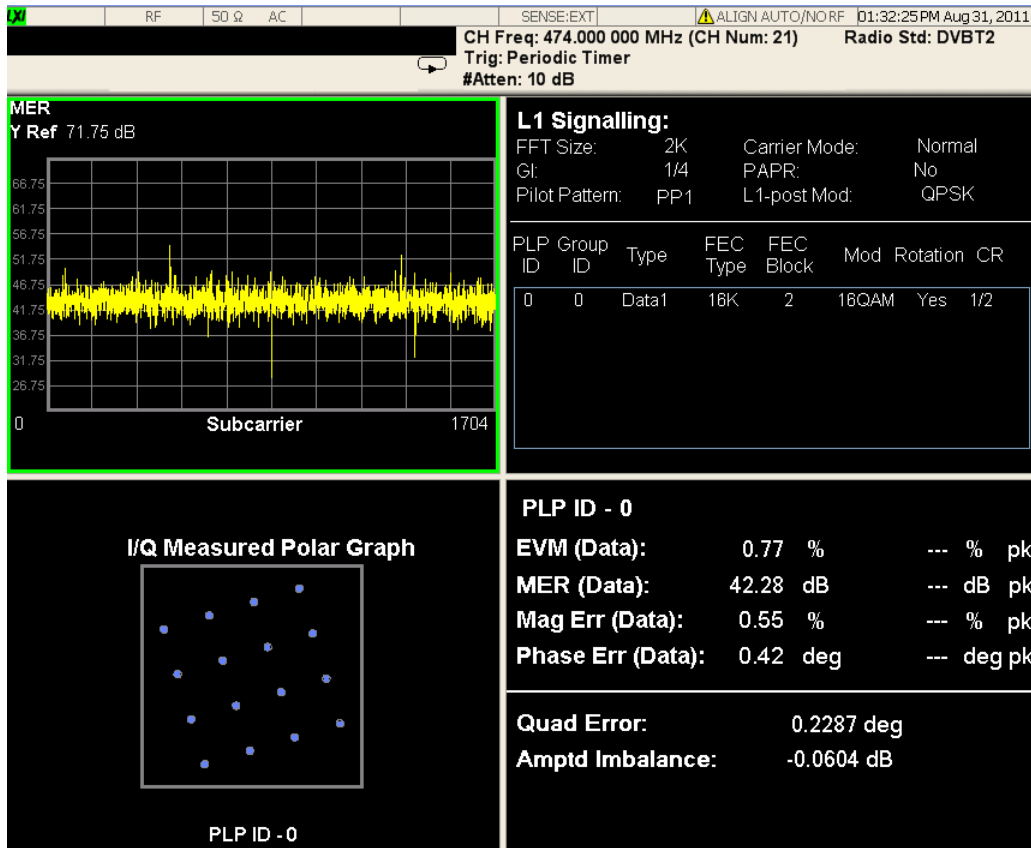

Figure 5 - 2 I/Q Error View of Modulation Accuracy Measurement

### MER/EVM vs. Sub-carrier/Frequency Window

This window provides MER/EVM vs. Sub-carrier/Frequency results. It comprises the MER/EVM value of each sub-carrier/frequency point in order to give the users a panorama of MER/EVM results. There are 853 sub-carriers in 1K mode, 1705 sub-carriers in 2K mode, 3409 in 4k mode, 6817 (normal carrier mode) / 6913 (extended carrier mode) in 8K mode, 13633 (normal carrier mode) / 13921 (extended carrier mode) in 16K mode and 27265 (normal carrier mode) / 27841 (extended carrier mode) in 32K mode.

<b>Marker Trace</b>	Yes
<b>Corresponding Trace</b>	MER/EVM vs. Sub-carrier/Frequency trace (n=3)

The top left window will be changed by Y Scale Type and X Scale Type.

If Y Scale Type is MER and X Scale Type is Carrier,

13 DVB-T2 Mod Accuracy Measurement  
View/Display

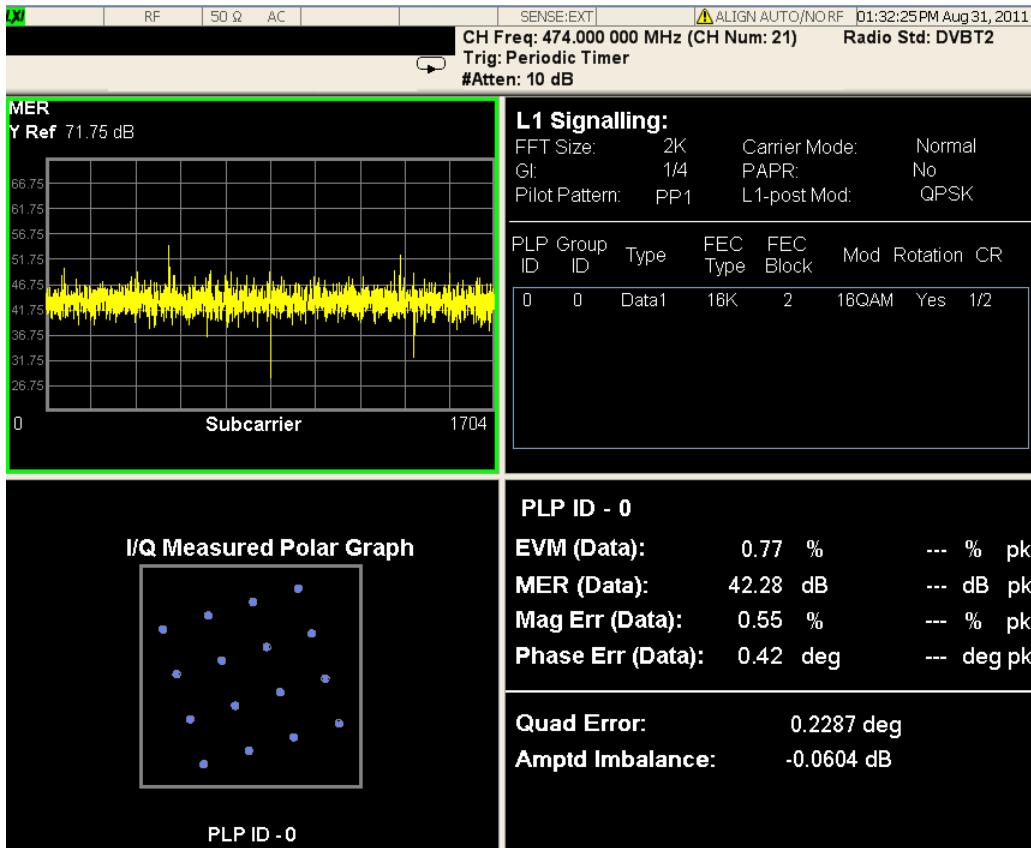

If Y Scale Type is EVM and X Scale Type is Carrier,



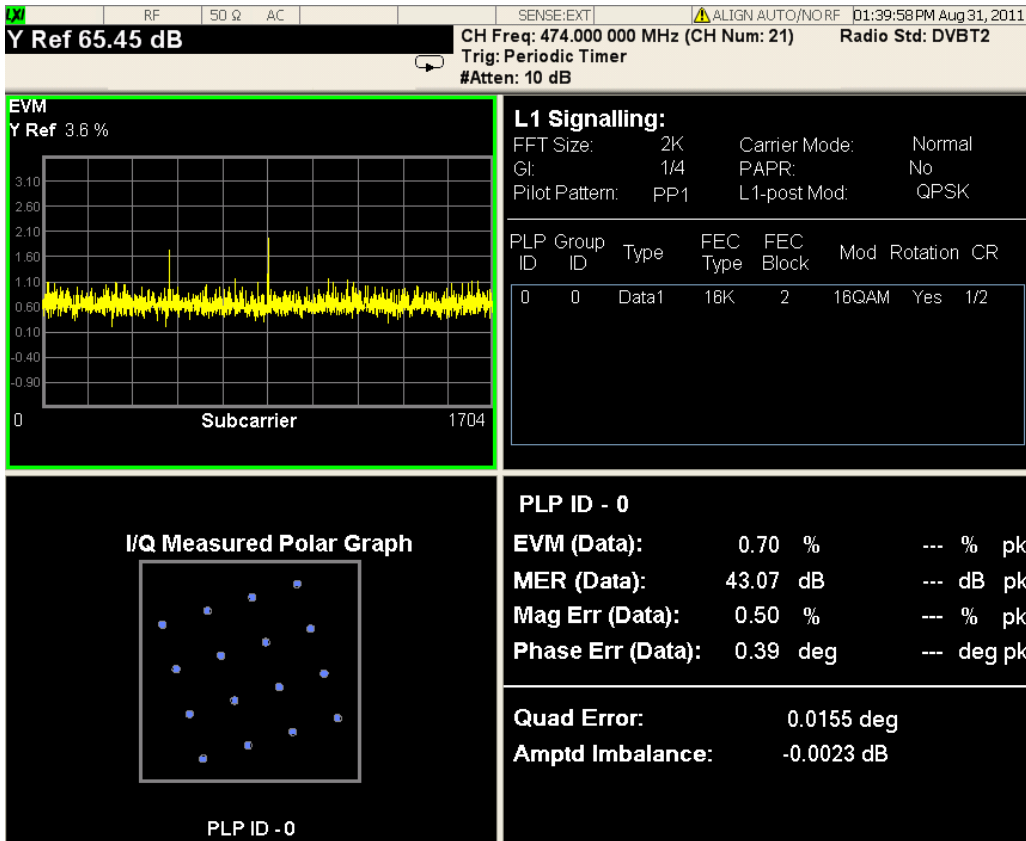

If Y Scale Type is MER and X Scale Type is Freq,

13 DVB-T2 Mod Accuracy Measurement  
View/Display

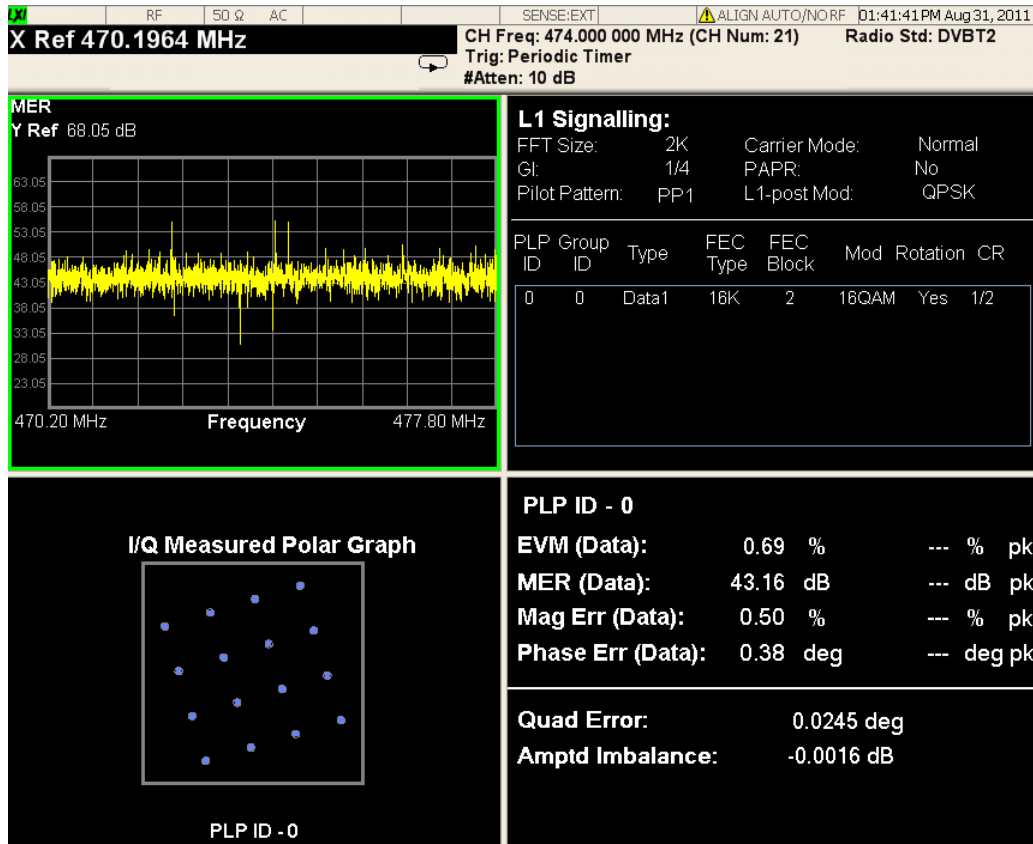

If Y Scale Type is EVM and X Scale Type is Freq,

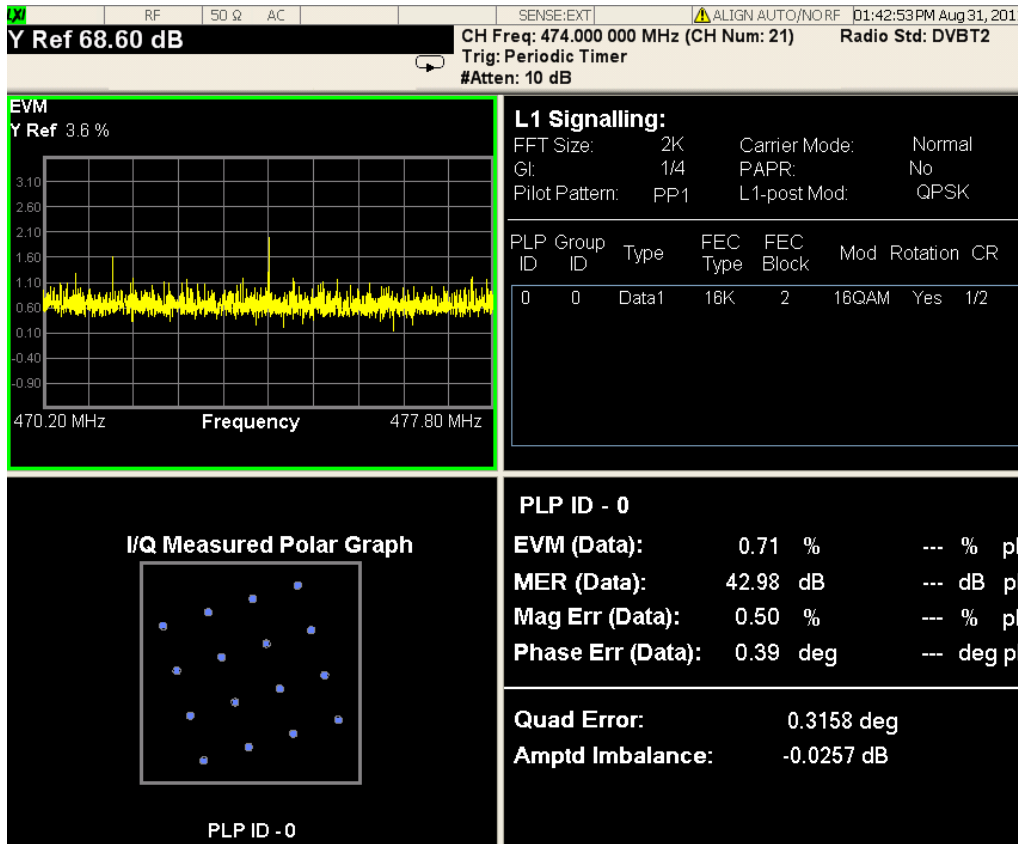

## L1 Signalling Window

This window provides L1 Signalling graph.

Name	Corresponding Results	Format
FFT Size	FFT size	1K, 2K, 4K, 8K, 16K, 32K
GI	Guard interval of the current super-frame	1/4, 19/128, 1/8, 19/256, 1/16, 1/32, 1/128
Pilot Pattern	Scattered pilot pattern used for the data OFDM symbols	PP1, PP2, PP3, PP4, PP5, PP6, PP7, PP8
Carrier Mode	Carrier mode	Normal, Extended
PAPR	PAPR	No, TR
L1-post Mod	Modulation format of L1-post signalling data block	BPSK, QPSK, 16QAM, 64QAM
Network ID	The current DVB-T2 network ID.	99999
T2 Sys ID	T2 system ID within the DVB-T2 network.	99999
Cell ID	Geographic cell ID in a DVB-T2 network.	99999
PLP	PLP type	Common, Data

Name	Corresponding Results	Format
Type		
FEC Block	Number of FEC blocks	9999
FEC Type	FEC type	16K LDPC, 64K LDPC
Mod	Modulation format for corresponding PLCH	BPSK, QPSK, 16QAM
Rotation	RS code rate for corresponding PLCH	(240, 240), (240, 224), (240,192), (240, 176)
CR	LDPC code rate for corresponding PLCH	$\frac{1}{2}$ , $\frac{3}{4}$

### I/Q Measured Polar Graph Window

This window provides Polar Graph.

Name	Corresponding Trace	Format
Constellation	The I/Q polar trace of measured input data. The length displayed is defined by I/Q Points.(n=2)	Constellation

### Result Metrics Window

This window provides Modulation Accuracy result metrics.

Name	Corresponding Results	Format
Data EVM vs. PLP	n=10 Averaged data EVM (in average cycle) vs. PLP	99.99 %
Data MER vs. PLP	n=11 Averaged data MER (in average cycle) vs. PLP	99.99 dB
Data Mag Error vs. PLP	n=1 2 Averaged data magnitude error (in average cycle) vs. PLP	99.99 %
Data Phase Error vs. PLP	n=13 Averaged data phase error (in average cycle) vs. PLP	99.99 deg
Peak Data EVM vs. PLP	n=14 Peak data EVM vs. PLP	99.99 % pk
Peak Data MER vs. PLP	n=15 Peak data MER of vs. PLP	99.99 dB pk
Peak Data Mag Error	n=16 Peak data magnitude error vs. PLP	99.99 % pk
Peak Data Phase Error vs. PLP	n=17 Peak data phase error vs. PLP	99.99 deg pk

Name	Corresponding Results	Format
Quad Err	n=1 14th Quadrature error of the current symbols	99.9999 deg
Amptd Imbalance	n=1 15th Amplitude imbalance of the current symbols	99.9999 %

Key Path	View/Display
<b>Example</b>	:DISPlay:EVMTtwo:VIEW IQERror :DISPlay:EVMTtwo:VIEW?
Initial S/W Revision	A.07.00

## PLP ID

Sets the PLP ID to measure. The I/Q Measured Polar Graph window and Result Metrics window of this view display the constellation graph and measurement results for the specified PLP.

Key Path	View/Display, I/Q Error
Mode	DVB-T/H
<b>Remote Command</b>	:DISPlay:EVMTtwo:IDPLp <integer> :DISPlay:EVMTtwo:IDPLp?
<b>Example</b>	DISP:EVMT:IDPL 0 DISP:EVMT:IDPL?
Preset	0
State Saved	Saved in instrument state.
Min	0
Max	255
Initial S/W Revision	A.07.00

## Scroll

Scrolls the display of the L1 Signalling window.

Key Path	View/Display, I/Q Error
Initial S/W Revision	A.07.00

## Prev Page

Moves the display one page back to the previous page of the L1 Signalling window.

---

Key Path	View/Display, I/Q Error, Scroll
Mode	DVB-T/H
Initial S/W Revision	A.07.00

---

### Next Page

Moves the display one page forward to the next page of the L1 Signalling window.

---

Key Path	View/Display, I/Q Error, Scroll
Mode	DVB-T/H
Initial S/W Revision	A.07.00

---

### Scroll Up

Moves one line upward from the current line of the L1 Signalling window.

Pressing the up arrow hard key has the same effect as this function, if no active function is shown. If an active function is shown, the up arrow hard key controls the active function, but has no effect on line movement.

---

Key Path	View/Display, I/Q Error, Scroll
Mode	DVB-T/H
Initial S/W Revision	A.07.00

---

### Scroll Down

Moves one line downward from the current line of the L1 Signalling window.

Pressing the down arrow hard key has the same effect as this function, if no active function is shown. If an active function is shown, the down arrow hard key controls the active function, but has no effect on line movement.

---

Key Path	View/Display, I/Q Error, Scroll
Mode	DVB-T/H
Initial S/W Revision	A.07.00

---

### First Page

Moves the display to the first page of the L1 Signalling window.

---

Key Path	View/Display, I/Q Error, Scroll
----------	---------------------------------

---

Mode	DVB-T/H
Initial S/W Revision	A.07.00

### Last Page

Moves the display to the last page of the L1 Signalling window.

Key Path	View/Display, I/Q Error, Scroll
Mode	DVB-T/H
Initial S/W Revision	A.07.00

### Channel Frequency Response

Selects the channel frequency response view.

There are three windows in this view:

- 1 "Amplitude vs. Sub-carrier Window" on page 1712 (Top)
- 2 "Phase vs. Sub-carrier Window" on page 1712 (Center)
- 3 "Group delay vs. Sub-carrier Window" on page 1712 (Bottom)

The Reference Value, Units per Division and Reference Position of X or Y-axis in the trace graph can be adjusted by selecting SPAN X Scale or AMPTD Y Scale.

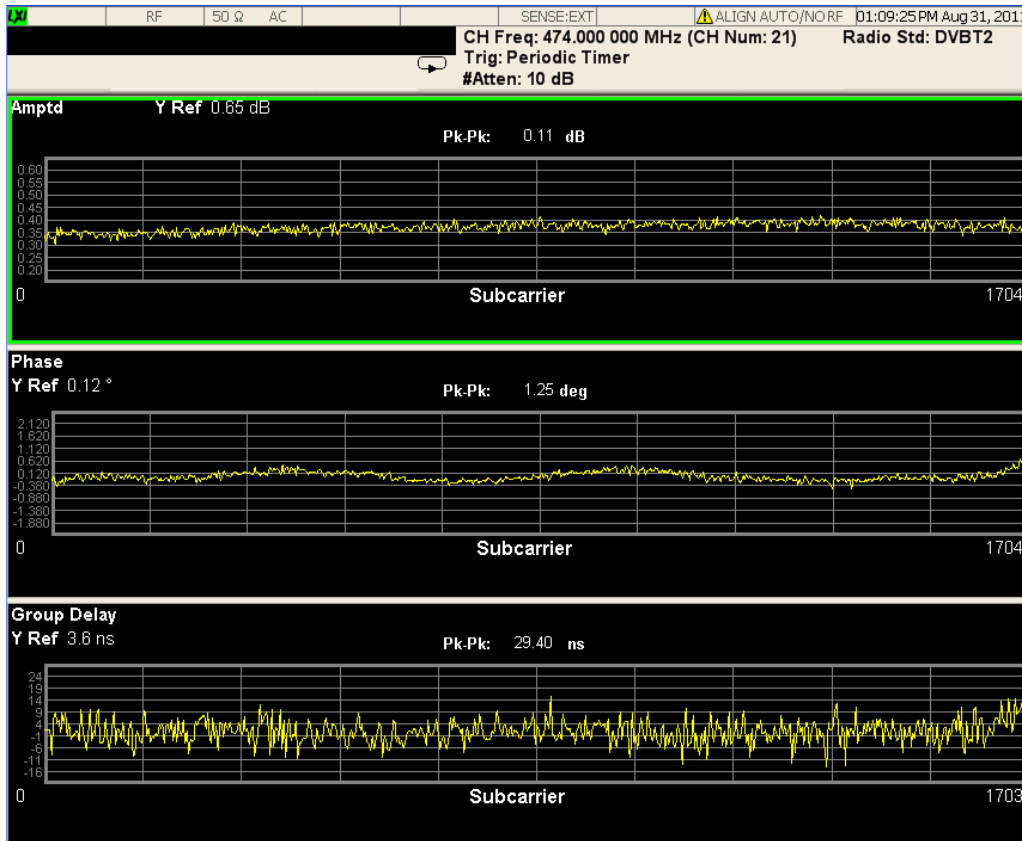

Figure 5 - 3 Channel Frequency Response View of Modulation Accuracy Measurement

### Amplitude vs. Sub-carrier Window

This window provides amplitude vs. sub-carrier results.

<b>Marker Trace</b>	Yes
<b>Corresponding Trace</b>	Amplitude vs. Sub-carrier trace (n=5).

### Phase vs. Sub-carrier Window

This window provides phase vs. sub-carrier results.

<b>Marker Trace</b>	Yes
<b>Corresponding Trace</b>	Phase vs. Sub-carrier trace (n=6).

### Group delay vs. Sub-carrier Window

This window provides group delay vs. sub-carrier results.

<b>Marker Trace</b>	Yes
<b>Corresponding Trace</b>	Group delay vs. Sub-carrier trace (n=7).



Key Path	View/Display
<b>Example</b>	:DISPlay:EVMTtwo:VIEW FREQuency :DISPlay:EVMTtwo:VIEW?
Initial S/W Revision	A.07.00

## MISO Display

Sets to display the trace of Tx1 or Tx2 or both Tx1 and Tx2. The key is available only when using Tx1 + Tx2 as MISO Test Setup (Meas Setup, Advanced).

Key Path	View/Display, Channel Frequency Response
Mode	DVB-T/H
<b>Remote Command</b>	:DISPlay:EVMTtwo:MISO:TYPE TX1 TX2 TX1TX2 :DISPlay:EVMTtwo:MISO:TYPE?
<b>Example</b>	DISP:EVMT:MISO:TYPE TX1TX2 DISP:EVMT:MISO:TYPE?
Dependencies	This key is grayed out unless Transmission Mode (Mode Setup, Radio Std, DVB-T2) is MISO and MISO Test Setup (Meas Setup, Advanced) is Tx1 + Tx2.
Preset	TX1TX2
State Saved	Saved in instrument state.
Range	Tx1 Only Tx2 Only Tx1 + Tx2
Initial S/W Revision	A.11.00

## Group Delay Aperture

Sets the value of group delay aperture which can affect the accuracy of the group delay measurement. Larger group delay aperture improves the accuracy of the measured group delay, increases the smoothing of the group delay trace, but decreases resolution.

Group delay aperture is defined as a percentage of the current frequency span. When group delay is calculated for a given point, the aperture is centered at that point. For example, the group delay for the 100 Hz may be calculated by measuring the phase change between 90 and 110 Hz.

Key Path	View/Display, Channel Frequency Response
Mode	DVB-T/H
<b>Remote Command</b>	:DISPlay:EVMTtwo:GDELaY:APERture <real> :DISPlay:EVMTtwo:GDELaY:APERture?
<b>Example</b>	DISP:EVMT:GDEL:APER 10.0 DISP:EVMT:GDEL:APER?

Preset	1.0
State Saved	No
Min	0.1
Max	50.0
<b>Backwards Compatibility SCPI</b>	:DISPlay:EVMTwo:GD:APERture <real>
	:DISPlay:EVMTwo:GD:APERture?
Initial S/W Revision	A.11.00

## Channel Impulse Response

Selects the channel impulse response view.

There is one window, "[Amplitude vs. time window](#)" on page 1714, which shows the amplitude vs. time results.

### Amplitude vs. time window

<b>Marker Trace</b>	Yes
<b>Corresponding Trace</b>	Amplitude vs. Time trace (n=8).

The Reference Value, Units per Division and Reference Position of X or Y-axis in this graph can be adjusted by selecting SPAN X Scale or AMPTD Y Scale. The X axis can be set to display the delay or the distance of the paths in the channel delay profile using the Scale Type key under SPAN X Scale panel.

If X Scale type is set to Time,

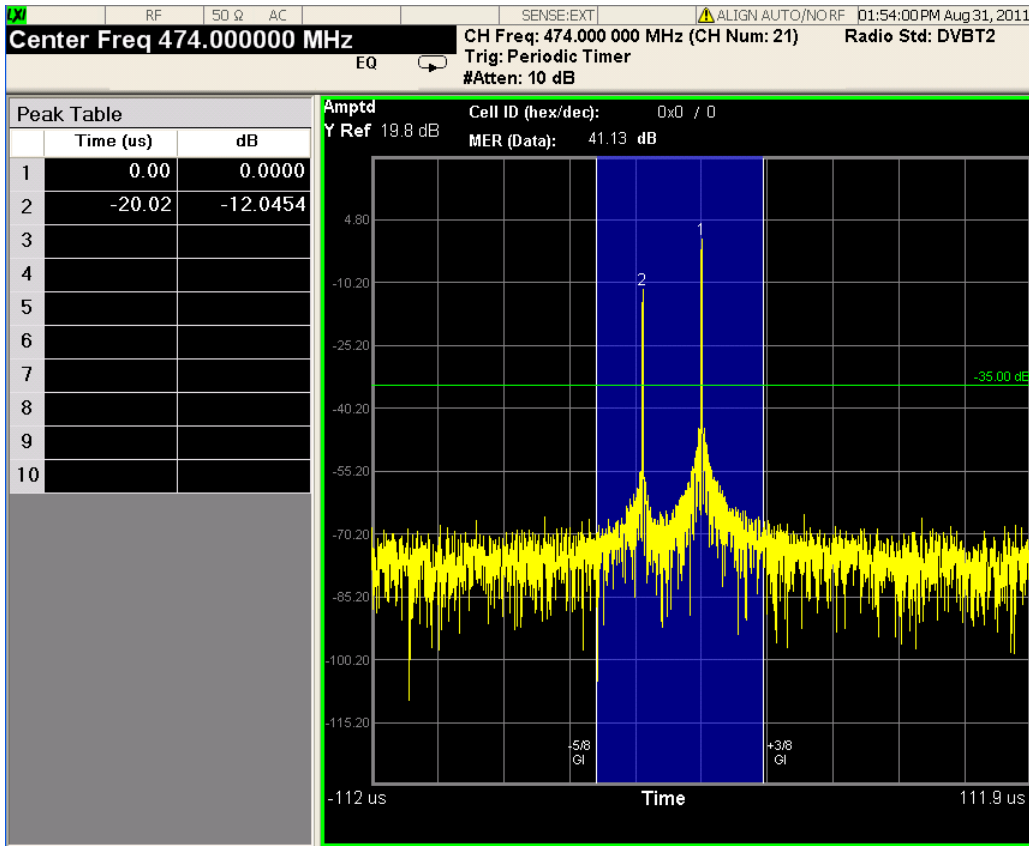

If X Scale Type is set to Distance,

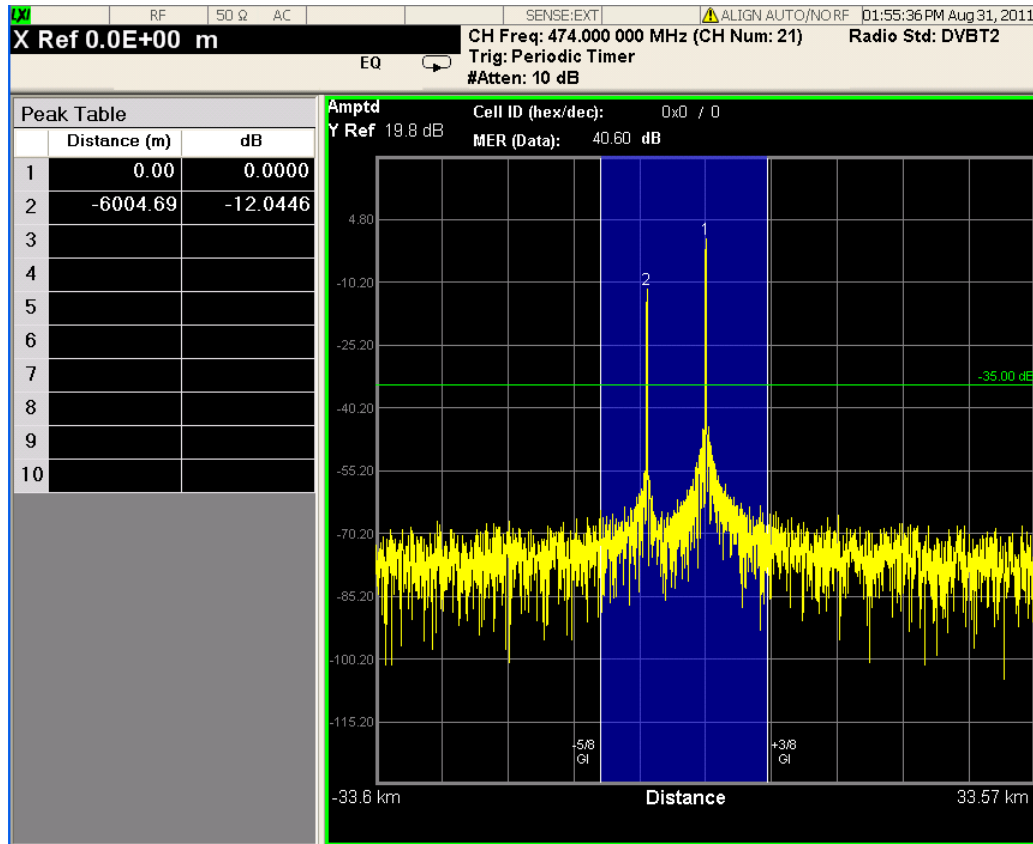

Figure 5 - 4 Channel Impulse Response View of Modulation Accuracy Measurement

Key Path	View/Display
Example	:DISPlay:EVMTtwo:VIEW IMPulse :DISPlay:EVMTtwo:VIEW?
Initial S/W Revision	A.07.00

### MISO Display

Sets to display the trace of Tx1 or Tx2 or both Tx1 and Tx2. The key is available only when using Tx1 + Tx2 as MISO Test Setup (Meas Setup, Advanced).

Key Path	View/Display, Channel Impulse Response
Mode	DVB-T/H
Remote Command	:DISPlay:EVMTtwo:MISO:TYPE TX1   TX2   TX1TX2 :DISPlay:EVMTtwo:MISO:TYPE?
Example	DISP:EVMT:MISO:TYPE TX1 TX2 DISP:EVMT:MISO:TYPE?
Dependencies	This key is grayed out unless Transmission Mode (Mode Setup, Radio Std, DVB-T2) is MISO and MISO Test Setup (Meas Setup, Advanced) is Tx1 + Tx2.

Preset	TX1TX2
State Saved	Saved in instrument state.
Range	Tx1 Only Tx2 Only Tx1 + Tx2
Initial S/W Revision	A.11.00

## GI Range Bar

Turns the bar On and Off. If the value is On, there will be a bar with the range of GI (Guard Interval) displayed on Channel Impulse Response view.

The position of the GI range bar can be changed by the FFT Start Position (Meas Setup, Advanced, More). If all the paths are displayed within the GI range, that means there is no ISI (inter symbol interference) under the current settings.

Key Path	View/Display, Channel Impulse Response
Mode	DVB-T/H
<b>Remote Command</b>	:DISPlay:EVMTtwo:GIRBar[:STATE] OFF ON 0 1 :DISPlay:EVMTtwo:GIRBar[:STATE]?
<b>Example</b>	DISP:EVMT:GIRB ON DISP:EVMT:GIRB?
Dependencies	The start position of the GI bar depends on FFT Start Position (Meas Setup, Advanced).
Preset	ON
State Saved	Saved in instrument state.
Range	On   Off
Initial S/W Revision	A.07.00
Modified at S/W Revision	A.10.01

## L1 Signalling

Selects the L1 Signalling view.

There is one window, L1 Signalling information window, which shows the decoded information.

RF 50 Ω AC
SENSE:INT SOURCE OFF ALIGN OFF
09:15:25 AM Apr 22, 2011

**Center Freq 474.000000 MHz**
CH Freq: 474.000 000 MHz (CH Num: 21) Radio Std: DVBT2  
Trig: Periodic Timer  
Atten: 10 dB (Elec 0)

**L1 Signalling**
Version: v1.1.1

**P1 Signalling**  
 P2 Type: SISO      FFT Size: 8K (1/32, 1/16, 1/8, 1/4)      Preambles: Not mixed

**L1-pre Signalling**  

Tx Input: TS	PAPR: No PAPR	Network ID: 12421
Carrier Mode: Normal	L1-post Mod: 64QAM	System ID: 32769
P2 Type: SISO	L1-post CR: 1/2	Cell ID (hex/dec): 0x0/0
FFT Size: 8K	L1-post FEC: LDPC 16K	Data Symbols: 238
Preambles: Not mixed	Pilot Pattern: PP7	L1-post Extension: No
GI: 1/32	T2 Frames: 2	Rf Num: 1

**L1-post Signalling**  
 Sub Slices: 1      PLP Number: 9      Sub Slice Interval: 756000

**PLP Info**

ID	Group ID	Type	Payload	FEC Type	FEC Block	Mod Format	Rot	CR	TIL Len	TIL Type	PLP Start
000	000	Common	TS	64K	8	QPSK	Yes	3/5	3	0	0
001	001	Data1	TS	64K	10	16QAM	Yes	3/5	3	0	259200
002	001	Data1	TS	64K	10	16QAM	No	3/5	3	0	421200
003	001	Data1	TS	64K	10	64QAM	Yes	3/5	3	0	583200
004	001	Data1	TS	64K	10	64QAM	No	3/5	3	0	691200
005	002	Data2	TS	64K	20	64QAM	Yes	3/5	3	0	799200
006	002	Data2	TS	64K	20	64QAM	No	3/5	3	0	1015200
007	002	Data2	TS	64K	20	256QAM	Yes	3/5	3	0	1231200
008	002	Data2	TS	64K	20	256QAM	No	3/5	3	0	1393200

<b>Key Path</b>	View/Display
<b>Example</b>	:DISPlay:EVM:VIEW SIGNalling :DISPlay:EVM:VIEW?
<b>Initial S/W Revision</b>	A.07.00

### Prev Page

Moves the display one page back to the previous page of the L1 Signalling window.

<b>Key Path</b>	View/Display, L1 Signalling
<b>Mode</b>	DVB-T/H
<b>Initial S/W Revision</b>	A.07.00

### Next Page

Moves the display one page forward to the next page of the L1 Signalling window.

Key Path	View/Display, L1 Signalling
Mode	DVB-T/H
Initial S/W Revision	A.07.00

## Scroll Up

Moves one line upward from the current line of the L1 Signalling window.

Pressing the up arrow hard key has the same effect as this function, if no active function is shown. If an active function is shown, the up arrow hard key controls the active function, but has no effect on line movement.

Key Path	View/Display, L1 Signalling
Mode	DVB-T/H
Initial S/W Revision	A.07.00

## Scroll Down

Moves one line downward from the current line of the L1 Signalling window.

Pressing the down arrow hard key has the same effect as this function, if no active function is shown. If an active function is shown, the down arrow hard key controls the active function, but has no effect on line movement.

Key Path	View/Display, L1 Signalling
Mode	DVB-T/H
Initial S/W Revision	A.07.00

## First Page

Moves the display to the first page of the L1 Signalling window.

Key Path	View/Display, L1 Signalling
Mode	DVB-T/H
Initial S/W Revision	A.07.00

## Last Page

Moves the display to the last page of the L1 Signalling window.

Key Path	View/Display, L1 Signalling
----------	-----------------------------

Mode	DVB-T/H
Initial S/W Revision	A.07.00

## MER Monitor

Selects the MER Monitor view.

MER Monitor is used to monitor the MER performance for a specific period of time, which can be several hours or several days. All the setup parameters are under Meas Setup, MER Monitor panel.

### 1. Display

The MER results are displayed on the graph sequentially. The maximum number of the displayed points is controlled by Display Points (Meas Setup, MER Monitor). If the actual points exceed this number (2000 for example), only the most recent 2000 points are displayed on the graph. That is to say, if the number of points reaches 2001 when the maximum number of displayed points has been set to 2000, point 1 will be discarded.

There is a blue line displayed on the graph if the Limit Line (Meas Setup, MER Monitor) is turned on.

When the set of Monitor Time arrives, there will be a message "MER Monitor Completed!" displayed on the MSG line

### 2. Record raw data

If the Limit Line (Meas Setup, MER Monitor) is turned on and the current MER result is smaller than the limit, raw data will be saved to "D:\userdata\DVB-T2\rawdata" which can be used by the X-Series Signal Analyzer for further research. The format is "sampleInterval I Q I Q ...."

SampleInterval is  $1.0 / \text{Sample Frequency}$ .

The recording file name is "MER\_DVB\_T2\_failed\_recording\_Index\_Hour-Minute-Second.txt" (Index is the sequence number of the files saved in one monitoring process.), such as "MER\_DVB\_T2\_failed\_recording\_2\_15-56-36.txt".

The maximum number of files saved is controlled by Max Raw Data Files Saved (Meas Setup, MER Monitor). If the failed points exceed this number, raw data will no longer be saved. A message (File Number exceeds MaxRawDataFileSaved. Raw Data are not saved) will be displayed after the MER result in the Log file.

### 3. Log file

Date time, the MER result and the rawdata file path (if MER is below the limit) will be saved as a log file named "MER\_log\_DVB\_T2.txt" in "D:\userdata\DVB-T2."

The format of this file is listed below.

```
9/8/2009 15:56:36    34.0759440002693 D:\userdata\DVB-T2\rawdata\MER_DVB_T2_failed_
recording_2_15-56-36.txt
```

```
9/8/2009 15:59:56    34.4563081204352 File Number exceeds MaxRawDataFileSaved. Raw Data are
not saved.
```

There is one window, "[MER vs. Time window](#)" on page 1721, which shows the MER vs. time results.



## MER vs. Time window

<b>Marker Trace</b>	Yes
<b>Corresponding Trace</b>	MER vs. Time trace

The Reference Value, Units per Division and Reference Position of the X or Y-axis in this graph can be adjusted by selecting SPAN X Scale or AMPTD Y Scale.

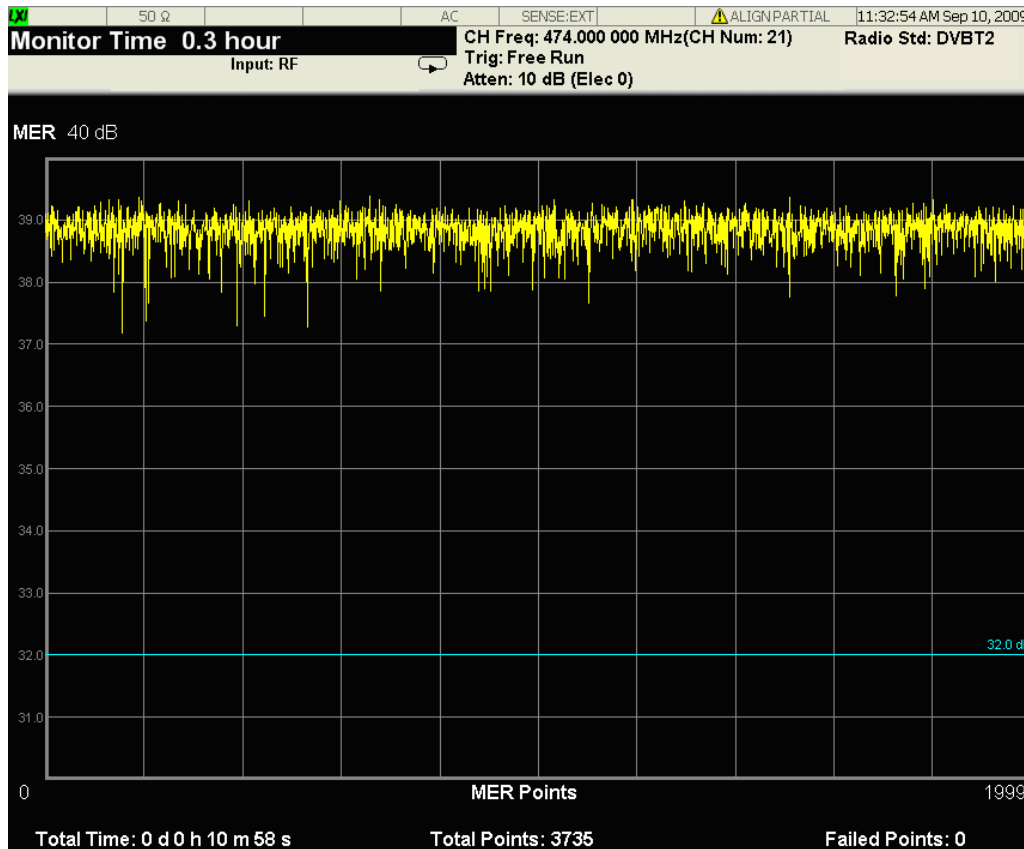

<b>Key Path</b>	View/Display
<b>Example</b>	:DISPlay:EVMtwo:VIEW MERMonitor :DISPlay:EVMtwo:VIEW?
<b>Initial S/W Revision</b>	A.07.00

## MER vs. PLP

Selects the MER vs. PLP view.

There is one window, MER vs. PLP result window, which shows the MER results of each PLP.

Some PLPs are not transmitted in every frame. “Frames with this PLP” shows the frame number which has the certain PLP. Avg MER (dB) is averaged using the MER results of the certain PLP in the frames that contain this PLP. Peak MER (dB) is the peak MER value of the certain PLP in the frames that contains this PLP.



Name	Corresponding Results	Format
Accumulated Data MER vs. PLP	n=18 Averaged data MER (using the MER result of certain PLP in the frames contained this PLP) vs. PLP in certain symbols	99.99
Accumulated Peak Data MER vs. PLP	n=19 The peak data MER value (peak MER of certain PLP in the frames contained this PLP) vs. PLP in certain symbols	99.99
Accumulated Frame Number	n=20 Frame number that contained certain PLP	999

Key Path	View/Display
Example	:DISPlay:EVM:VIEW MERPlp :DISPlay:EVM:VIEW?
Initial S/W Revision	A.08.00

## Prev Page

Moves the display one page back to the previous page of the MER vs. PLP window.

Key Path	View/Display, More, MER vs. PLP
Mode	DVB-T/H
Initial S/W Revision	A.08.00

## Next Page

Moves the display one page forward to the next page of the MER vs. PLP window.

Key Path	View/Display, More, MER vs. PLP
Mode	DVB-T/H
Initial S/W Revision	A.08.00

## Scroll Up

Moves one line upward from the current line of the MER vs. PLP window.

Pressing the up arrow hard key has the same effect as this function, if no active function is shown. If an active function is shown, the up arrow hard key controls the active function, but has no effect on line movement.

Key Path	View/Display, More, MER vs. PLP
Mode	DVB-T/H
Initial S/W Revision	A.08.00

## Scroll Down

Moves one line downward from the current line of the MER vs. PLP window.

Pressing the down arrow hard key has the same effect as this function, if no active function is shown. If an active function is shown, the down arrow hard key controls the active function, but has no effect on line movement.

Key Path	View/Display, More, MER vs. PLP
Mode	DVB-T/H
Initial S/W Revision	A.08.00

### First Page

Moves the display to the first page of the MER vs. PLP window.

Key Path	View/Display, More, MER vs. PLP
Mode	DVB-T/H
Initial S/W Revision	A.08.00

### Last Page

Moves the display to the last page of the MER vs. PLP window.

Key Path	View/Display, More, MER vs. PLP
Mode	DVB-T/H
Initial S/W Revision	A.08.00

### Result Metrics

Selects the result metrics view.

There is one window, "[Result Metrics Summary Window](#)" on page 1725, which shows the summary of modulation accuracy result metrics.

The EVM and MER results for P2 pilot will be displayed as "---" when the FFT size is 16K/32K and Equalization (Meas Setup, Advanced) is Off.

The EVM and MER results for FC pilot will be displayed as "---" when the combination of FFT size, GI, and pilot pattern used in the current signal is not included in the following table.

FFT Size	Guard Interval						
	1/12 8	1/3 2	1/1 6	19/25 6	1/ 8	19/12 8	1/ 4
32K		PP6	PP4	PP4	PP2	PP2	NA
16K		PP7 PP6	PP4 PP5	PP4 PP5	PP2 PP3 PP3	PP2 PP3	PP1
8K		PP7	PP4 PP5	PP4 PP5	PP2 PP3 PP3	PP2 PP3	PP1
4K, 2K	NA	PP7	PP4 PP5	NA	PP2 PP	NA	PP1

3							
1K	NA	NA	PP4	NA	PP	NA	PP
			PP5		2		1
					PP		
					3		

If Transmission Mode (Mode Setup, Radio Std, DVB-T2) is MISO and MISO Test Seup (Meas Setup, Advanced) is Tx1+Tx2, overall EVM/MER/Mag Err/Phase Err, Pilot EVM/MER, Quad Error, Amptd Imbalance and Timing Skew will be displayed as “---”.

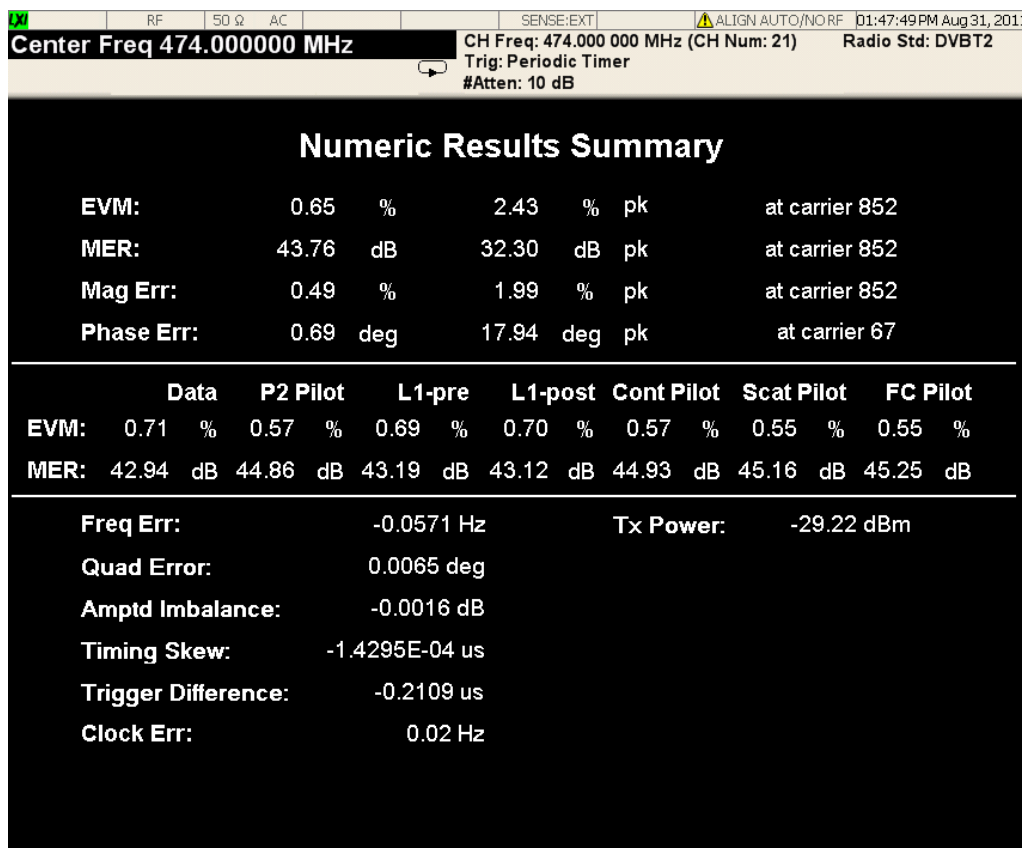

Figure 5 - 5 Result Metrics View of Modulation Accuracy Measurement

### Result Metrics Summary Window

This window shows the results summary.

Name	Corresponding Results	Format
EVM	n=1 1st EVM of the current symbols	99.99 %
Peak EVM	n=1 2nd Peak EVM of the current symbols	99.99 %

Name	Corresponding Results	Format
Peak EVM Position	n=1 3rd Sub-carrier number corresponding to the position of peak EVM is returned	at carrier (999)
MER	n=1, 4th MER of the current symbols	99.99 dB
Peak MER	n=1 5th Peak MER of the current symbols	99.99 dB
Peak MER Position	n=1 6th Sub-carrier number corresponding to the position of peak MER is returned	at carrier (999)
Mag Err	n=1 7th Magnitude error of the current symbols	99.99 %
Peak Mag Err	n=1 8th Peak magnitude error of the current symbols	99.99 %
Peak Mag Err Position	n=1 9th Sub-carrier number corresponding to the position of peak magnitude error is returned	at carrier (999)
Phase Err	n=1 10th Phase error of the current symbols	99.99 deg
Peak Phase Err	n=1 11th Peak phase error of the current symbols	99.99 deg
Peak Phase Err Position	n=1 12th Sub-carrier number corresponding to the position of peak phase error is returned	at carrier (999)
Freq Err	n=1 13th Frequency error of the current symbols	99.99 Hz
Quad Err	n=1 14th Quadrature error of the current symbols	99.9999 deg
Amptd Imbalance	n=1 15th Amplitude imbalance of the current symbols	99.9999%
Data MER	n=1 16th MER of data carriers in certain symbols	99.99 dB
L1-pre MER	n=1 17th MER of L1-pre carriers in certain symbols	99.99 dB
L1-post MER	n=1 18th MER of L1-post carriers in certain symbols	99.99 dB
P2 Pilot MER	n=1 19th MER of P2 pilot carriers in certain symbols	99.99 dB
Continued Pilot	n=1 20th	99.99 dB

Name	Corresponding Results	Format
MER	MER of continued pilot carriers in certain symbols	
Scattered Pilot MER	n=1 21st MER of scattered pilot carriers in certain symbols	99.99 dB
Frame-closing Pilot MER	n=1 22nd MER of frame-closing pilot carriers in certain symbols	99.99 dB
Data EVM	n=1 23rd EVM of data carriers in certain symbols	99.99 %
L1-pre EVM	n=1 24th EVM of L1-pre carriers in certain symbols	99.99 %
L1-post EVM	n=1 25th EVM of L1-post carriers in certain symbols	99.99 %
P2 Pilot EVM	n=1 26th EVM of P2 pilot carriers in certain symbols	99.99 %
Continued Pilot EVM	n=1 27th EVM of continued pilot carriers in certain symbols	99.99 %
Scattered Pilot EVM	n=1 28th EVM of scattered pilot carriers in certain symbols	99.99 %
Frame-closing Pilot EVM	n=1 29th EVM of frame-closing pilot carriers in certain symbols	99.99 %
Tx Power	n=1 30th Signal power.	99.99 dB
Timing Skew	n=1 31st Timing skew of the current symbols	9.9999E9 us
Trigger Difference	n=1 32nd Trigger Difference in the current symbols	99.9999 us
Clock Err	n=1 33rd Clock error in the current symbols	99.99 Hz

Key Path	View/Display
Example	:DISPlay:EVMtwo:VIEW NRESults :DISPlay:EVMtwo:VIEW?
Initial S/W Revision	A.07.00

## BER Results

Selects the BER results view.

There is one window, which shows the summary of BER results.

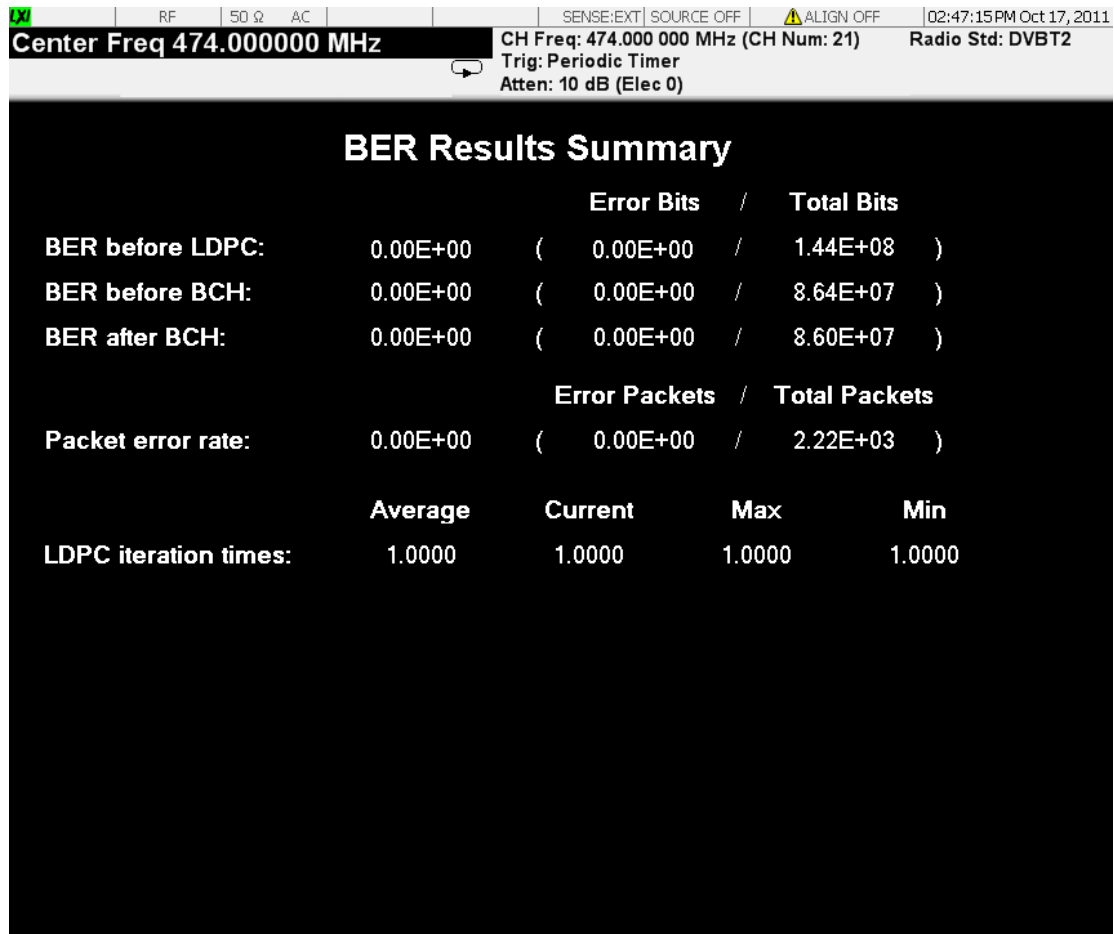

### BER Results Window

This window shows the BER results.

Name	Corresponding Results	Format
BER before LDPC	n=1 34th BER before LDPC	9.99E9
Error count before LDPC	n=1 35th Error count before LDPC	9.99E9
Total count before LDPC	n=1 36th Total count before LDPC	9.99E9
BER before BCH	n=1 37th BER before BCH	9.99E9
Error count before BCH	n=1 38th Error count before BCH	9.99E9
Total count before BCH	n=1 39th Total count before BCH	9.99E9
BER after BCH	n=1 40th	9.99E9



Name	Corresponding Results	Format
	BER after BCH	
Error count after BCH	n=1 41st Error count after BCH	9.99E9
Total count after BCH	n=1 42nd Total count after BCH	9.99E9
Packet error rate	n=1 43th Packet error rate	9.99E9
Packet error count	n=1 44rd Packet error count	9.99E9
Total packet count	n=1 45th Total packet count	9.99E9
Average LDPC Iteration Number	n=1 46th Averaged LDPC iteration number	9.9999
Current LDPC Iteration Number	n=1 47th Current LDPC iteration number	9.9999
Max LDPC Iteration Number	n=1 48th Max LDPC iteration number	9.9999
Min LDPC Iteration Number	n=1 49th Min LDPC iteration number	9.9999

Key Path	View/Display
<b>Example</b>	:DISPlay:EVMTtwo:VIEW BER :DISPlay:EVMTtwo:VIEW?
Initial S/W Revision	A.11.00

### View Selection by number (Remote Command SCPI only)

Allows you to select the desired measurement view by number.

Key Path	SCPI only
Mode	DVB-T/H
<b>Remote Command</b>	:DISPlay:EVMTtwo:VIEW:NSElect <integer> :DISPlay:EVMTtwo:VIEW:NSElect?
<b>Example</b>	DISP:EVMT:VIEW:NSEL 0

---

	DISP:EVMT:VIEW:NSEL?
Notes	Meaning of the numeric values: 0: I/Q Measured Polar Graph View 1: I/Q Error View 2: Channel Frequency Response View 3: Channel Impulse Response View 4: L1 Signalling View 5. MER Monitor View 6. Result Metrics View 7. MER vs. PLP View 8. BER Results View
Preset	0
State Saved	Saved in instrument state.
Min	0
Max	8
Initial S/W Revision	A.07.00
Modified at S/W Revision	A.11.00

---

## 14 Spurious Emissions Measurement

The Spurious Emissions measurement identifies and determines the power level of spurious emissions in certain frequency bands. For measurement results and views, see ["View/Display" on page 1912](#).

This topic contains the following sections:

["Measurement Commands for Spurious Emissions" on page 1732](#)

["Remote Command Results for Spurious Emissions Measurement" on page 1733](#)

## Measurement Commands for Spurious Emissions

The following commands can be used to retrieve the measurement results:

`:CONFigure:SPURious`

`:CONFigure:SPURious:NDEFault`

`:INITiate:SPURious`

`:FETCh:SPURious [n]?`

`:READ:SPURious [n]?`

`:MEASure:SPURious [n]?`

For more measurement related commands, see the SENSE subsystem, and the section "[Remote Measurement Functions](#)" on page 2165.

## Remote Command Results for Spurious Emissions Measurement

The following table describes the results returned by the FETCh, MEASure, and READ queries listed above, according to the index value n. Note that the queries are not available when viewing the Range Table.

n	Return Value
1 (or not supplied)	Returns a variable-length (1+6*Spurs – up to 1201 entries) comma separated list containing detailed information in the following format: 1. Number of spurs in following list (Integer) 2.[Repeat the following for each spur] a.Spur # b.Range # Spur was located (Integer) c.Frequency of Spur (Hz, Float64) d.Amplitude of Spur (dBm, Float32) e.Absolute Limit (dBm, Float32) f.Pass or Fail (1 0, Boolean)
2 – 21	Returns a comma separated list of the trace data for the selected range (where range number = n – 1) using Detector 1. If selected range is not active SCPI_NAN is returned for each trace data element where SCPI_NAN = 9.91E37.
22	Returns the number of spurs found.
23 – 42	Returns a comma separated list of the trace data for the selected range (where range number = n – 22) using Detector 2. If selected range is not active or Detector 2 selection is off, SCPI_NAN is returned for each trace data element where SCPI_NAN = 9.91E37.
Key Path	Meas
Initial S/W Revision	Prior to A.02.00

## AMPTD Y Scale

AMPTD Y Scale opens a menu of functions that enable you to modify the Amplitude parameters.

Key Path	Front-panel key
Initial S/W Revision	Prior to A.02.00

### Ref Value

Sets the value for the absolute power reference. When Auto Scaling for the Y-axis is off, the measurement uses the current reference level settings. When Auto Scaling for the Y-axis is on, the analyzer will set the reference level such that the absolute limit will be positioned two divisions down from the top of the display.

Key Path	AMPTD Y Scale
Mode	SA, WCDMA, WIMAX OFDMA, TD-SCDMA,C2k, 1xEV-DO, DVB-T/H, LTE, LTETDD, WLAN, MSR, LTEAFDD, LTEATDD
Remote Command	:DISPlay:SPURious:VIEW[1]:WINDow[1]:TRACe:Y[:SCALE]:RLEVel < real> :DISPlay:SPURious:VIEW[1]:WINDow[1]:TRACe:Y[:SCALE]:RLEVel?
Example	DISP:SPUR:VIEW:WIND:TRAC:Y:RLEV -50 dBm DISP:SPUR:VIEW:WIND:TRAC:Y:RLEV?
Notes	You must be in the Spectrum Analysis mode, W-CDMA mode, cdma2000 mode, DVB-T/H mode, TD-SCDMA mode, LTE mode, LTETDD mode, WLAN mode, MSR, LTE-Advanced FDD/TDD mode or WiMAX mode to use this command. Use INSTRument:SElect to set the mode.
Couplings	When the Y Auto Scaling is off, the measurement uses the current reference level settings. When the Y Auto Scaling is on, the analyzer automatically sets the reference level such that the absolute limit is positioned two divisions down from the top of the display. This is the most useful setting when searching for spurs. The algorithm used for determining the ref level is Ref Level = Absolute Limit + (2 * Scale/Div). All other reference level settings are left as the current base instrument settings.
Preset	0.00 dBm
State Saved	Saved in instrument state.
Min	-250.0 dBm
Max	250.0 dBm
Initial S/W Revision	Prior to A.02.00
Modified at S/W Revision	A.03.00

### Attenuation

This menu controls the attenuator functions and interactions between the attenuation system components.

There are two attenuator configurations in the X-Series. One is a dual attenuator configuration consisting of a mechanical attenuator and an optional electronic attenuator. The other configuration uses a single

attenuator with combined mechanical and electronic sections that controls all the attenuation functions. Different models in the X-Series come with different configurations.

See ["Dual Attenuator Configurations:" on page 1735](#)

See ["Single Attenuator Configuration:" on page 1736](#)

Most Attenuation settings are the same for all measurements – they do not change as you change measurements. Settings like these are called “Meas Global” and are unaffected by Meas Preset.

Key Path	AMPTD Y Scale
Scope	Meas Global
Dependencies	In measurements that support the I/Q inputs, this key is unavailable when I/Q is the selected input, and is replaced by the Range key in that case.
Readback Line	Contains a summary in [ ] brackets of the current total attenuation. See the descriptions of the , " <a href="#">(Mech) Atten</a> " on page 2102, and " <a href="#">Enable Elec Atten</a> " on page 2104 keys for more detail on the contributors to the total attenuation.  Note that when "Pre-Adjust for Min Clip" is on, this value can change at the start of every measurement.
Initial S/W Revision	Prior to A.02.00
Modified at S/W Revision	A.03.00

### Dual Attenuator Configurations:

Configuration 1: Mechanical attenuator + optional electronic attenuator

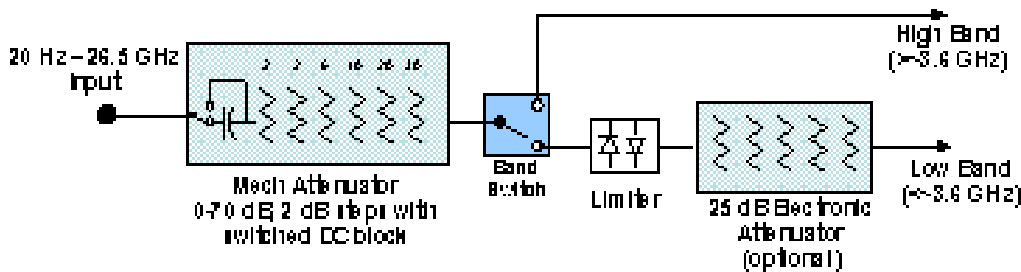

Configuration 2: Mechanical attenuator, no optional electronic attenuator

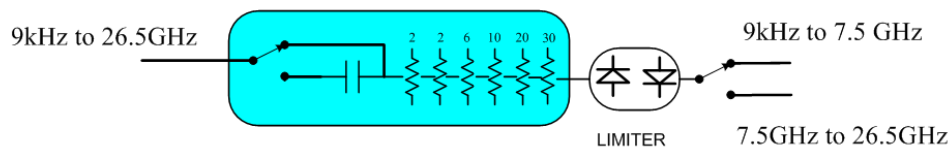

(note that Configuration 2 is not strictly speaking a dual-section attenuator, since there is no electronic section available. However, it behaves exactly like Configuration 1 without the Electronic Attenuator option EA3, therefore for the sake of this document it is grouped into the “Dual Attenuator” configuration)

### Single Attenuator Configuration:

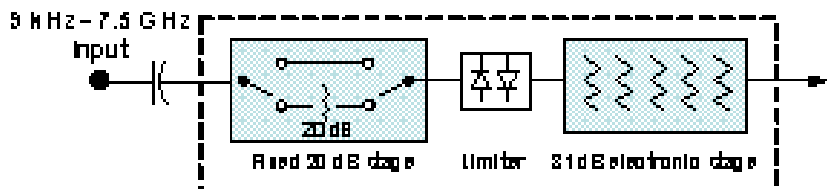

You can tell which attenuator configuration you have by pressing the Attenuation key, which (in most Modes) opens the Attenuation menu. If the first key in the Attenuation menu says Mech Atten you have the dual attenuator configuration. If the first key says Atten you have the single attenuator configuration.



In the single attenuator configuration, you control the attenuation with a single control, as the fixed stage has only two states. In the dual attenuator configuration, both stages have significant range so you are given separate control of the mechanical and electronic attenuator stages.

When you have the dual attenuator configuration, you may still have only a single attenuator, because unless option EA3 (the Electronic Attenuator option) is available, and you purchase it, you will have only the mechanical attenuator.

### (Mech) Atten

This key is labeled Mech Atten in dual attenuator models and Atten in single attenuator models. In the dual attenuator configuration, this key only affects the mechanical attenuator.

This key lets you modify the attenuation applied to the RF input signal path. This value is normally auto coupled to the Ref Level, the Internal Preamp Gain, any External Gain that is entered, and the Max Mixer Level, as described in the table below.

See ["Attenuator Configurations and Auto/Man" on page 1738](#)

Key Path	AMPTD Y Scale, Attenuation
<b>Remote Command</b>	<pre>[ :SENSe]:POWeR[:RF]:ATTenuation &lt;rel_ampl&gt; [:SENSe]:POWeR[:RF]:ATTenuation? [:SENSe]:POWeR[:RF]:ATTenuation:AUTO OFF ON 0 1 [:SENSe]:POWeR[:RF]:ATTenuation:AUTO?</pre>
<b>Example</b>	<p>POW:ATT 20</p> <p>Dual attenuator configuration: sets the mechanical attenuator to 20 dB</p> <p>Single attenuator mode: sets the main attenuation to 20 dB (see below for definition of “main” attenuation).</p> <p>If the attenuator was in Auto, it sets it to Manual.</p>
<b>Dependencies</b>	Some measurements do not support the Auto setting of (Mech) Atten. In these measurements, the



---

Auto/Man selection is not available, and the Auto/Man line on the key disappears.

In dual attenuator configurations, when the electronic attenuator is enabled, the mechanical attenuator has no auto setting and the Auto/Man line on the key disappears. The state of Auto/Man is remembered and restored when the electronic attenuator is once again disabled. This is described in more detail in the "[Enable Elec Atten](#)" on page 2104 key description.

See "[Attenuator Configurations and Auto/Man](#)" on page 1738 for more information on the Auto/Man functionality of Attenuation.

---

Couplings

When (Mech) Atten is in Auto, it uses the following algorithm to determine a value:

If the USB Preamp is connected to USB, use 0 dB.

Otherwise,  $Atten = ReferenceLevel + PreAmpGain + ExternalGain - RefLevelOffset - MaxMixerLevel + IF\ Gain$ .

Limit this value to be between 6 dB and the Max value. No value below 6 dB can ever be chosen by Auto.

The resulting value is rounded up to the largest value possible given the attenuation step setting. That is, 50.01 dB would change to 60 dB (for a 10 dB attenuation step).

The "IF Gain" term in the equation above is either 0 dB or +10 dB, depending on the settings of FFT IF Gain, Swept IF Gain, max Ref Level and the Auto/Man setting of Mech Atten.

In External Mixing and BBIQ, where the Attenuator is not in the signal path, the Attenuator setting changes as described above when (Mech) Atten is in Auto, but no changes are made to the actual attenuator hardware setting until the input is changed back to the RF Input.

---

Preset                      The preset for Mech Attenuation is "Auto."  
                                  The Auto value of attenuation is:  
                                  CXA, EXA, MXA and PXA: 10 dB

---

State Saved                Saved in instrument state

---

Min                            0 dB

The attenuation set by this key cannot be decreased below 6 dB with the knob or step keys. To get to a value below 6 dB it has to be directly entered from the keypad or via SCPI. This protects from adjusting the attenuation to a dangerously small value which can put the instrument at risk of damage to input circuitry. However, if the current mechanical attenuation is below 6 dB it can be increased with the knob and step keys, but not decreased.

---

Max                            CXA N9000A-503/507: 50 dB  
                                  CXA N9000A-513/526: 70dB  
                                  EXA: 60 dB  
                                  MXA and PXA: 70 dB

In the single attenuator configuration, the total of ATT and EATT cannot exceed 50 dB, so if the EATT is set to 24 dB first, the main attenuation cannot be greater than 26 dB and will be reduced accordingly; if the main attenuator is set to 40 dB first, EATT cannot be greater than 10 dB.

---

Initial S/W Revision      Prior to A.02.00

---

Modified at S/W Revision   A.03.00

---

### Attenuator Configurations and Auto/Man

As described in the Attenuation key description, there are two distinct attenuator configurations available in the X-Series, the single attenuator and dual attenuator configurations. In dual attenuator configurations, we have the mechanical attenuation and the electronic attenuation, and the current total attenuation is the sum of the electronic + mechanical attenuation. In single attenuator configurations, we refer to the attenuation set using the (Mech) Atten key (or POW:ATT SCPI) as the “main” attenuation; and the attenuation that is set by the SCPI command POW:EATT as the “soft” attenuation (the POW:EATT command is honored even in the single attenuator configuration, for compatibility purposes). Then the current total attenuation is the sum of the main + soft attenuation. See the Elec Atten key description for more on “soft” attenuation.

In the dual attenuator configuration, when the electronic attenuator is enabled, there is no Auto/Man functionality for the mechanical attenuator, and the third line of the key label (the Auto/Man line) disappears:

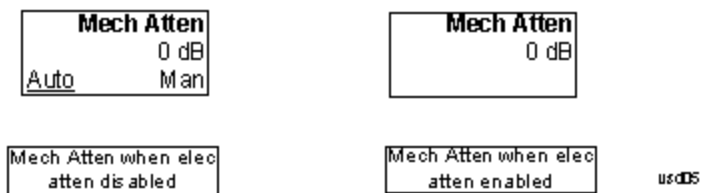

### Enable Elec Atten

Enables the Electronic Attenuator.

The electronic attenuator offers finer steps than the mechanical attenuator, has no acoustical noise, is faster, and is less subject to wear. These advantages primarily aid in remote operation and are negligible for front panel use. See ["Using the Electronic Attenuator: Pros and Cons" on page 1740](#) for a detailed discussion of the pros and cons of using the electronic attenuator.

For the single attenuator configuration, for SCPI backwards compatibility, the “soft” attenuation feature replaces the dual attenuator configuration’s electronic attenuator. All the same couplings and limitations apply. See ["Attenuator Configurations and Auto/Man" on page 2103](#)

See ["More Information" on page 1739](#)

<b>Key Path</b>	AMPTD Y Scale, Attenuation
<b>Remote Command</b>	[ :SENSe ] : POWer [ :RF ] : EATTenuation : STATE OFF   ON   0   1 [ :SENSe ] : POWer [ :RF ] : EATTenuation : STATE ?
<b>Example</b>	POW:EATT:STAT ON
<b>Dependencies</b>	This key only appears in Dual Attenuator models with an Electronic Attenuator installed. It does not appear in models with the Single Attenuator configuration, as in the single attenuator configuration there is no “electronic attenuator” there is only a single integrated attenuator (which has both a mechanical and electronic stage). However, in the single attenuator configuration, EATT SCPI commands are accepted for compatibility with other X-series instruments and set a “soft” attenuation as described in <a href="#">"Attenuator Configurations and Auto/Man" on page 2103</a> . The electronic attenuator (and the “soft” attenuation function provided in single attenuator configurations) is unavailable above 3.6 GHz. Therefore, if the Stop Frequency of the analyzer is > 3.6 GHz then the Enable Elec Atten key will be OFF and grayed out.

---

	<p>If the Internal Preamp is on, meaning it is set to Low Band or Full, the electronic attenuator (and the “soft” attenuation function provided in single attenuator configurations) is unavailable. In this case the Enable Elec Atten key will be OFF and grayed out.</p> <p>If either of the above is true, if the SCPI command is sent, an error indicating that the electronic attenuator is unavailable will be sent.</p> <p>If the electronic/soft Attenuator is enabled, then the Stop Freq of the analyzer is limited to 3.6 GHz and the Internal Preamp is unavailable.</p> <p>The SCPI-only “soft” electronic attenuation for the single-attenuator configuration is not available in all measurements; in particular, it is not available in the Swept SA measurement.</p>
Couplings	Enabling and disabling the Electronic Attenuator affects the setting of the Mechanical Attenuator (in dual attenuator configurations). This is described in more detail below this table.
Preset	OFF for Swept SA measurement; ON for all other measurements that support the electronic attenuator
State Saved	Saved in instrument state
Initial S/W Revision	Prior to A.02.00
Modified at S/W Revision	A.03.00

---

## More Information

### Mechanical Attenuator Transition Rules

When the Electronic Attenuator is enabled, the Mechanical Attenuator transitions to a state that has no Auto function. Below are the rules for transitioning the Mechanical Attenuator. NOTE that the information below ONLY applies to the dual attenuator configurations, and ONLY when the Electronic Attenuator is installed:

#### When the Electronic Attenuation is enabled from a disabled state:

- The Mechanical Attenuator is initialized to 10 dB (this is its optimal performance setting). You can then set it as desired with SCPI, numeric keypad, step keys, or knob, and it behaves as it normally would in manual mode
- The Auto/Man state of (Mech) Atten is saved
- The Auto/Man line on the (Mech) Atten key disappears and the auto rules are disabled
- The Electronic Attenuator is set to 10 dB less than the previous value of the Mechanical Attenuator, within the limitation that it must stay within the range of 0 to 24 dB of attenuation.

#### Examples in the dual attenuator configuration:

- Mech Atten at 20 dB. Elec Atten enabled, Mech Atten set to 10 dB, and Elec Atten set to 10 dB. New total attenuation equals the value before Elec Atten enabled.
- Mech Atten at 0 dB. Elec Atten enabled, Mech Atten set to 10 dB, and Elec Atten set to 0 dB. New total attenuation does not equal the value before Elec Atten enabled.
- Mech Atten at 40 dB. Elec Atten enabled, Mech Atten set to 10 dB, and Elec Atten set to 24 dB. New total attenuation does not equal the value before Elec Atten enabled.

**When the Electronic Attenuation is disabled from an enabled state:**

- The Elec Atten key is grayed out
- The Auto/Man state of (Mech) Atten is restored
- If now in Auto, (Mech) Atten recouples
- If now in Man, (Mech) Atten is set to the value of total attenuation that existed before the Elec Atten was disabled. The resulting value is rounded up to the smallest value possible given the (Mech) Atten Step setting - (That is, 57 dB changes to 58 dB when (Mech) Atten Step is 2 dB.)

**Using the Electronic Attenuator: Pros and Cons**

The electronic attenuator offers finer steps than the mechanical attenuator, has no acoustical noise, is faster, and is less subject to wear.

The “finer steps” advantage of the electronic attenuator is beneficial in optimizing the alignment of the analyzer dynamic range to the signal power in the front panel as well as remote use. Thus, you can achieve improved relative signal measurement accuracy. Compared to a mechanical attenuator with 2 dB steps, the 1 dB resolution of the electronic attenuator only gives better resolution when the odd-decibel steps are used. Those odd-decibel steps are less accurately calibrated than the even-decibel steps, so one tradeoff for this superior relative accuracy is reduced absolute amplitude accuracy.

Another disadvantage of the electronic attenuator is that the spectrum analyzer loses its “Auto” setting, making operation less convenient.

Also, the relationship between the dynamic range specifications (TOI, SHI, compression and noise) and instrument performance are less well-known with the electrical attenuator. With the mechanical attenuator, TOI, SHI and compression threshold levels increase dB-for-dB with increasing attenuation, and the noise floor does as well. With the electronic attenuator, there is an excess attenuation of about 1 to 3 dB between 0 and 3.6 GHz, making the effective TOI, SHI, and so forth, less well known. Excess attenuation is the actual attenuation relative to stated attenuation. Excess attenuation is accounted for in the analyzer calibration

**Elec Atten**

Controls the Electronic Attenuator in dual attenuator configurations. This key does not appear in single attenuator configurations, as the control of both the mechanical and electronic stages of the single attenuator is integrated into the single Atten key.

<b>Key Path</b>	AMPTD Y Scale, Attenuation
<b>Remote Command</b>	[ :SENSe ] :POWer [ :RF ] :EATTenuation <rel_ampl> [ :SENSe ] :POWer [ :RF ] :EATTenuation?
<b>Notes</b>	Electronic Attenuation’s specification is defined only when Mechanical Attenuation is 6 dB.
<b>Dependencies</b>	This key only appears in Dual Attenuator models with an Electronic Attenuator installed. It does not appear in models with the Single Attenuator configuration, as in the single attenuator configuration there is no “electronic attenuator” there is only a single integrated attenuator (which has both a mechanical and electronic stage). However, in the single attenuator configuration, EATT SCPI commands are accepted for compatibility with other X-series instruments and set a “soft” attenuation as described in <a href="#">"Attenuator Configurations and Auto/Man" on page 2103</a> . The “soft” attenuation is treated as an addition to the “main” attenuation value set by the Atten softkey or the

	POW:ATT SCPI command and affects the total attenuation displayed on the Attenuation key and the Meas Bar. When Enable Elec Atten is off or grayed out, the Elec Atten key is grayed out.
Preset	0 dB
State Saved	Saved in instrument state
Min	0 dB
Max	Dual attenuator configuration: 24 dB Single attenuator configuration: the total of ATT and EATT cannot exceed 50 dB, so if the EATT is set to 24 dB first, the main attenuation cannot be greater than 26 dB and will be reduced accordingly; if the main attenuator is set to 40 dB first, EATT cannot be greater than 10 dB
Initial S/W Revision	Prior to A.02.00
Modified at S/W Revision	A.03.00

### Adjust Atten for Min Clip

Sets the combination of mechanical and electronic attenuation and gain based on the current measured signal level so that clipping will be at a minimum.

This is an "immediate action" function, that is, it executes once, when the key is pressed.

This key is grayed out in measurements that do not support this functionality. The spectrum analyzer measurement, Swept SA, does not support this functionality.

Key Path	AMPTD Y Scale, Attenuation
Remote Command	<code>[ :SENSe ] :POWer [ :RF ] :RANGe:OPTimize IMMEDIATE</code>
Initial S/W Revision	Prior to A.02.00
Modified at S/W Revision	A.03.00

### Pre-Adjust for Min Clip

If this function is on, it does the adjustment described under "[Adjust Atten for Min Clip](#)" on page 2107 each time a measurement restarts. Therefore, in Continuous measurement mode, it only executes before the first measurement.

In dual attenuator models, you can set Elec+Mech Atten, in which case both attenuators participate in the autoranging, or Elec Atten Only, in which case the mechanical attenuator does not participate in the autoranging. This latter case results in less wear on the mechanical attenuator and is usually faster.

This key is grayed out in measurements that do not support this functionality. The spectrum analyzer measurement, Swept SA, does not support this functionality.

Key Path	AMPTD Y Scale, Attenuation
Remote Command	<code>[ :SENSe ] :POWer [ :RF ] :RANGe:OPTimize:ATTenuation OFF   ELECTRical   COMBined</code>

	<code>[ :SENSe ] :POWer [ :RF ] :RANGe:OPTimize:ATTenuation?</code>
Notes	The SCPI parameter ELECtrical sets this function to On in single attenuator models. The SCPI parameter COMBined is mapped to ELECtrical in single attenuator models; if you send COMBined, it sets the function to On and returns ELEC to a query.
Dependencies	This key only appears in Dual Attenuator models with an Electronic Attenuator installed. In instruments with Dual Attenuator model, when Enable Elec Atten is off or grayed out, the Pre-Adjust for Min Clip key is grayed out.
Preset	OFF for Swept SA measurement; ON for all other measurements that support Pre-Adjust for Min Clip
State Saved	Saved in instrument state
Range	Dual attenuator models: Off   Elec Atten Only   Mech + Elec Atten Single attenuator models: Off   On
Initial S/W Revision	Prior to A.02.00
Modified at S/W Revision	A.03.00

<b>Remote Command</b>	<code>[ :SENSe ] :POWer [ :RF ] :RANGe:AUTO ON OFF 1 0</code> <code>[ :SENSe ] :POWer [ :RF ] :RANGe:AUTO?</code>
Notes	ON aliases to "Elec Atten Only" (:POW:RANG:OPT:ATT ELEC) OFF aliases to "Off" (:POW:RANG:OPT:ATT OFF) The query :POW:RANG:AUTO? returns true if :POW:RANG:OPT:ATT is not "Off"
Initial S/W Revision	Prior to A.02.00

## Off

Turns Pre-Adjust for Min Clip off. This is the default setting.

This key is grayed out in measurements that do not support this functionality. The spectrum analyzer measurement, Swept SA, does not support this functionality.

Key Path	AMPTD Y Scale, Attenuation, Pre-Adjust for Min Clip
Example	:POW:RANGe:OPT:ATT OFF
Initial S/W Revision	Prior to A.02.00

## Elec Atten Only

Selects only the electric attenuator to participate in auto ranging. This offers less wear on the mechanical attenuator and is usually faster.

This key is grayed out in measurements that do not support this functionality. The spectrum analyzer measurement, Swept SA, does not support this functionality.

Key Path	AMPTD Y Scale, Attenuation, Pre-Adjust for Min Clip
Example	:POW:RANGe:OPT:ATT ELEC
Initial S/W Revision	Prior to A.02.00

### Mech + Elec Atten

In dual attenuator models, this selects both attenuators participate in the autoranging.

This key is grayed out in measurements that do not support this functionality. The spectrum analyzer measurement, Swept SA, does not support this functionality.

Key Path	AMPTD Y Scale, Attenuation, Pre-Adjust for Min Clip
Example	:POW:RANGe:OPT:ATT COMB
Initial S/W Revision	Prior to A.02.00

### (Mech) Atten Step

This controls the step size used when making adjustments to the input attenuation.

This key is labeled Mech Atten Step in dual attenuator models and Atten Step in single attenuator models. In the dual attenuator configuration, this key only affects the step size of the mechanical attenuator.

Key Path	AMPTD Y Scale, Attenuation
Remote Command	[[:SENSe]:POWer[:RF]:ATTenuation:STEP[:INCRement] 10 dB   2 dB [:SENSe]:POWer[:RF]:ATTenuation:STEP[:INCRement]?
Example	POW:ATT:STEP 2
Notes	Note this feature works like a 1-N choice from the front panel, but it takes a specific value (in dB) when used remotely. The only valid values are 2 and 10.
Dependencies	Blanked in CXA and EXA if option FSA (2 dB steps) is not present. If blanked, attempts to set it via SCPI will yield an error.
Couplings	When the attenuation step size changes, the current mechanical attenuation value is adjusted (if necessary) to be quantized to the new step size. That is, if step is set to 10 dB, mech atten is increased if necessary so it is a multiple of 10 dB
Preset	PXA and MXA: 2 dB EXA and CXA: 10 dB (2 dB with option FSA)
State Saved	Saved in instrument state
Initial S/W Revision	Prior to A.02.00
Modified at S/W Revision	A.03.00

## Scale/Div

Sets the units per division of the vertical scale in the logarithmic display. However, since the Auto Scaling is defaulted to On, this value is automatically determined by the measurement result. When you set a value manually, Auto Scaling automatically changes to Off.

<b>Key Path</b>	AMPTD Y Scale
<b>Mode</b>	SA, WCDMA, C2K, WIMAX OFDMA, TD-SCDMA, DVB-T/H, LTE, LTETDD, WLAN, MSR, LTEAFDD, LTEATDD
<b>Remote Command</b>	:DISPlay:SPURious:VIEW[1]:WINDow[1]:TRACe:Y[:SCALe]:PDIVision <rel_ ampl> :DISPlay:SPURious:VIEW[1]:WINDow[1]:TRACe:Y[:SCALe]:PDIVision?
<b>Example</b>	DISP:SPUR:VIEW:WIND:TRAC:Y:PDIV 10 dB DISP:SPUR:VIEW:WIND:TRAC:Y:PDIV?
<b>Notes</b>	You must be in the Spectrum Analysis mode, W-CDMA mode, cdma2000 mode, DVB-T/H mode, TD-SCDMA, LTE mode, LTE TDD mode, WLAN mode, MSR, LTE-Advanced FDD/TDD mode or WiMAX mode to use this command. Use INSTRument:SElect to set the mode.
<b>Couplings</b>	When Auto Scaling is On, this value is automatically determined by the measurement result. When you set a value manually, Auto Scaling automatically changes to Off.
<b>Preset</b>	10.00 dB
<b>State Saved</b>	Saved in instrument state.
<b>Range</b>	0.10 dB to 20.00 dB
<b>Min</b>	0.10 dB
<b>Max</b>	20.00 dB
<b>Initial S/W Revision</b>	Prior to A.02.00
<b>Modified at S/W Revision</b>	A.03.00

## Presel Center

When this key is pressed, the centering of the preselector filter is adjusted to optimize the amplitude accuracy at the frequency of the selected marker. If the selected marker is not on when Presel Center is pressed, the analyzer will turn on the selected marker, perform a peak search, and then perform centering on the marker's center frequency. If the selected marker is already on and between the start and stop frequencies of the analyzer, the analyzer performs the preselector calibration on that marker's frequency. If the selected marker is already on, but outside the frequency range between Start Freq and Stop Freq, the analyzer will first perform a peak search, and then perform centering on the marker's center frequency.

The value displayed on the Presel Adjust key will change to reflect the new preselector tuning (see Presel Adjust).

A number of considerations should be observed to ensure proper operation. See ["Proper Preselector Operation" on page 1745](#).

<b>Key Path</b>	AMPTD Y Scale
-----------------	---------------



<b>Remote Command</b>	<code>[ :SENSe ] :POWer [ :RF ] :PCENter</code>
<b>Example</b>	POW:PCEN
<b>Notes</b>	Note that the rules outlined above under the key description apply for the remote command as well as the key. The result of the command is dependent on marker position, and so forth. Any message shown by the key press is also shown in response to the remote command.
<b>Dependencies</b>	<ul style="list-style-type: none"> <li>• Grayed out if the microwave preselector is off. )</li> <li>• If the selected marker's frequency is below Band 1, advisory message 0.5001 is generated and no action is taken.</li> <li>• Grayed out if entirely in Band 0.</li> <li>• Blank in models that do not include a preselector, such as option 503. If the SCPI is sent in these instruments, it is accepted without error, and the query always returns 0.</li> <li>• Grayed out in the Spectrogram View.</li> </ul>
<b>Couplings</b>	<p>The active marker position determines where the centering will be attempted.</p> <p>If the analyzer is in a measurement such as averaging when centering is initiated, the act of centering the preselector will restart averaging but the first average trace will not be taken until the centering is completed.</p>
<b>Status Bits/OPC dependencies</b>	<p>When centering the preselector, *OPC will not return true until the process is complete and a subsequent measurement has completed, nor will results be returned to a READ or MEASure command.</p> <p>The Measuring bit should remain set while this command is operating and should not go false until the subsequent sweep/measurement has completed.</p>
<b>Initial S/W Revision</b>	Prior to A.02.00
<b>Modified at S/W Revision</b>	A.03.00

## Proper Preselector Operation

A number of considerations should be observed to ensure proper operation:

1. If the selected marker is off, the analyzer will turn on a marker, perform a peak search, and adjust the preselector using the selected marker's frequency. It uses the "highest peak" peak search method unqualified by threshold or excursion, so that there is no chance of a 'no peak found' error. It continues with that peak, even if it is the peak of just noise. Therefore, for this operation to work properly, there should be a signal on screen in a preselected range for the peak search to find.
2. If the selected marker is already on, the analyzer will attempt the centering at that marker's frequency. There is no preselector for signals below about 3.6 GHz, therefore if the marker is on a signal below 3.6 GHz, no centering will be attempted and an advisory message generated
3. In some models, the preselector can be bypassed. If it is bypassed, no centering will be attempted in that range and a message will be generated.

## Preselector Adjust

Allows you to manually adjust the preselector filter frequency to optimize its response to the signal of interest. This function is only available when "Presel Center" on page 2111 is available.

For general purpose signal analysis, using Presel Center is recommended. Centering the filter minimizes the impact of long-term preselector drift. Presel Adjust can be used instead to manually optimize the preselector. One application of manual optimization would be to peak the preselector response, which both optimizes the signal-to-noise ratio and minimizes amplitude variations due to small (short-term) preselector drifting.

Key Path	AMPTD Y Scale
Scope	Meas Global
Remote Command	<code>[ :SENSe ] :POWeR [ :RF ] :PADJust &lt;freq&gt;</code> <code>[ :SENSe ] :POWeR [ :RF ] :PADJust?</code>
Example	POW:PADJ 100KHz POW:PADJ?
Notes	The value on the key reads out to 0.1 MHz resolution.
Dependencies	<ul style="list-style-type: none"> <li>• Grayed out if microwave preselector is off. )</li> <li>• Grayed out if entirely in Band 0.</li> <li>• Blank in models that do not include a preselector, such as option 503. If the SCPI is sent in these instruments, it is accepted without error, and the query always returns 0.</li> <li>• Grayed out in the Spectrogram View.</li> </ul>
Preset	0 MHz
State Saved	The Presel Adjust value set by Presel Center, or by manually adjusting Presel Adjust, is not saved in instrument state, and does not survive a Preset or power cycle.
Min	-500 MHz
Max	500 MHz
Default Unit	Hz
Backwards Compatibility SCPI	<code>[ :SENSe ] :POWeR [ :RF ] :MW :PADJust</code> <code>[ :SENSe ] :POWeR [ :RF ] :MMW :PADJust</code> PSA had multiple preselectors, but the X-Series has only one. These commands simply alias to <code>[ :SENSe ] :POWeR [ :RF ] :PADJust</code>
Initial S/W Revision	Prior to A.02.00
Modified at S/W Revision	A.03.00

Remote Command	<code>[ :SENSe ] :POWeR [ :RF ] :PADJust :PRESelector MWAVE   MMWave   EXTeRnal</code> <code>[ :SENSe ] :POWeR [ :RF ] :PADJust :PRESelector?</code>
Notes	PSA had multiple preselectors, and you could select which preselector to adjust. Since the X-Series has only one mm/uW preselector, the preselector selection softkey is no longer available. However,

---

to provide backward compatibility, we accept the legacy remote commands.  
The command form has no effect, the query always returns MWAVE

---

Initial S/W Revision      Prior to A.02.00

---

## Y Axis Unit

Displays the menu keys that enable you to change the vertical (Y) axis amplitude unit. The analyzer retains the entered Y Axis Unit separately for both Log and Lin amplitude scale types. For example, if Scale Type has been set to Log, and you set Y Axis Unit to dBm, pressing Scale Type (Log) sets the Y Axis Unit to dBm. If Scale Type has been set to Lin and you set Y Axis Unit to V, pressing Scale Type (Lin) sets the Y Axis Unit to V. Pressing Scale Type (Log) again sets the Y axis unit back to dBm.

### NOTE

The units of current (A, dBmA, dBuA) are calculated based on 50 ohms input impedance.

All four of the EMI units (dB $\mu$ A/m, dB $\mu$ V/m, dBG, dBpT) are treated by the instrument exactly as though they were dBuV. The user must load an appropriate correction factor using Amplitude Corrections for accurate and meaningful results.

If a SCPI command is sent to the analyzer that uses one of the EMI units as a terminator, the analyzer treats it as though DBUV had been sent as the terminator.

---

Key Path	AMPTD Y Scale
Mode	SA
Scope	Meas Global
Remote Command	:UNIT:POWer DBM   DBMV   DBMA   V   W   A   DBUV   DBUA   DBPW   DBUVM   DBUAM   DBPT   DBG :UNIT:POWer?

**Example**      UNIT:POW dBmV  
UNIT:POW?

**Notes**      The Y axis unit has either logarithmic or linear characteristics. The set of units that is logarithmic consists of dBm, dBmV, dBmA, dB $\mu$ V, dB $\mu$ A, dB $\mu$ V/m, dB $\mu$ A/m, dBpT, and dBG. The set of units that are linear consists of V, W, and A. The chosen unit will determine how the reference level and all the amplitude-related outputs like trace data, marker data, etc. read out.

**Notes**      The settings of Y Axis Unit and Scale Type, affect how the data is read over the remote interface. When using the remote interface no unit is returned, so you must know what the Y axis unit is to interpret the results:  
Example 1, set the following:  
Scale Type (Log)  
Y Axis Unit, dBm  
Scale/Div, 1 dB  
Ref Level, 10 dBm  
This sets the top line to 10 dBm with each vertical division representing 1 dB. Thus, if a point on trace 1 is on the fifth graticule line from the top, it represents 5 dBm and will read out remotely as 5.  
Example 2, set the following:

---

	<p>Scale Type (Lin)          Y Axis Unit, Volts          Ref Level, 100 mV (10 mV/div)          This sets the top line to 100 mV and the bottom line to 0 V, so each vertical division represents 10 mV. Thus, if a point on trace 1 is on the fifth graticule line from the top, it represents 50 mV and will read out remotely as 50.</p>
Dependencies	<p>If an amplitude correction with an Antenna Unit other than None is applied and enabled, then that antenna unit is forced and the key with that unit is the only Y Axis Unit available. All other Y Axis Unit keys are grayed out.</p> <p>If an amplitude correction with an Antenna Unit other than None is applied and enabled, and you then turn off that correction or set Apply Corrections to No, the Y Axis Unit that existed before the Antenna Unit was applied is restored.</p>
Couplings	The analyzer retains the entered Y Axis Unit separately for both Log and Lin amplitude scale types
Preset	dBm for log scale, V for linear. The true 'preset' value is dBm, since at preset the Y Scale type is set to logarithmic.
State Saved	Saved in instrument state
Readback line	1-of-N selection
Initial S/W Revision	Prior to A.02.00
Modified at S/W Revision	A.02.00, A.04.00, A.11.00

### dBm

Sets the amplitude unit for the selected amplitude scale (log/lin) to dBm.

Key Path	AMPTD Y Scale, Y Axis Unit
<b>Example</b>	UNIT:POW DBM
Dependencies	Grayed out if an Amplitude Correction with an Antenna Unit is ON.
Readback	dBm
Initial S/W Revision	Prior to A.02.00
Modified at S/W Revision	A.02.00

### dBmV

Sets the amplitude unit for the selected amplitude scale (log/lin) to dBmV.

Key Path	AMPTD Y Scale, Y Axis Unit
<b>Example</b>	UNIT:POW DBMV
Dependencies	Grayed out if an Amplitude Correction with an Antenna Unit is ON.
Readback	dBmV
Initial S/W Revision	Prior to A.02.00
Modified at S/W Revision	A.02.00

## dBmA

Sets the amplitude unit for the selected amplitude scale (log/lin) to dBmA.

Key Path	AMPTD Y Scale, Y Axis Unit
<b>Example</b>	UNIT:POW DBMA
Dependencies	Grayed out if an Amplitude Correction with an Antenna Unit is ON.
Readback	dBmA
Initial S/W Revision	Prior to A.02.00
Modified at S/W Revision	A.02.00

## W

Sets the amplitude unit for the selected amplitude scale (log/lin) to watt.

Key Path	AMPTD Y Scale, Y Axis Unit
<b>Example</b>	UNIT:POW W
Dependencies	Grayed out if an Amplitude Correction with an Antenna Unit is ON.
Readback	W
Initial S/W Revision	Prior to A.02.00
Modified at S/W Revision	A.02.00

## V

Sets the amplitude unit for the selected amplitude scale (log/lin) to volt.

Key Path	AMPTD Y Scale, Y Axis Unit
<b>Example</b>	UNIT:POW V
Dependencies	Grayed out if an Amplitude Correction with an Antenna Unit is ON.
Readback	V
Initial S/W Revision	Prior to A.02.00
Modified at S/W Revision	A.02.00

## A

Sets the amplitude unit for the selected amplitude scale (log/lin) to Ampere.

Key Path	AMPTD Y Scale, Y Axis Unit
----------	----------------------------

<b>Example</b>	UNIT:POW A
Dependencies	Grayed out if an Amplitude Correction with an Antenna Unit is ON.
Readback	A
Initial S/W Revision	Prior to A.02.00
Modified at S/W Revision	A.02.00

### dB $\mu$ V

Sets the amplitude unit for the selected amplitude scale (log/lin) to dB $\mu$ V.

Key Path	AMPTD Y Scale, Y Axis Unit
<b>Example</b>	UNIT:POW DBUV
Dependencies	Grayed out if an Amplitude Correction with an Antenna Unit is ON.
Readback	dB $\mu$ V
Initial S/W Revision	Prior to A.02.00
Modified at S/W Revision	A.02.00

### dB $\mu$ A

Sets the amplitude unit for the selected amplitude scale (log/lin) to dB $\mu$ A.

**NOTE**

The unit dBuA can also appear as an Antenna Unit. This will be used by customers using current probes, because current probes are often supplied with conversion tables that provide the transducer factors. When dBuA is used as an Antenna Unit the normal conversion from power to amps for dBuA (based on the analyzer input impedance) is not done, but instead the conversion is based solely on the Correction that contains the transducer factors. This is what distinguishes dBuA as a normal unit from dBuA as an antenna unit. When querying the Y-Axis unit, you can query the Antenna Unit to distinguish between regular dBuA and the dBuA antenna unit. If :CORR:CSET:ANT? returns NOC (for No Conversion), you are using a normal Y Axis dBuA. If it returns UA you are using an Antenna Unit dBuA.

Key Path	AMPTD Y Scale, Y Axis Unit
<b>Example</b>	UNIT:POW DBUA
Dependencies	Grayed out if an Amplitude Correction with an Antenna Unit is ON.
Readback	dB $\mu$ A
Initial S/W Revision	Prior to A.02.00
Modified at S/W Revision	A.02.00

## dBpW

Sets the amplitude unit for the selected amplitude scale (log/lin) to dBpW.

Key Path	AMPTD Y Scale, Y Axis Unit
<b>Example</b>	UNIT:POW DBPW
Dependencies	Grayed out if an Amplitude Correction with an Antenna Unit is ON.
Readback	dB $\mu$ A
Initial S/W Revision	A.11.00

## Antenna Unit

When a Correction is turned on that uses an Antenna Unit, the Y Axis Unit changes to that Antenna Unit. All of the keys in the Y-Axis Unit menu are then greyed out, except the Antenna Unit key. The unit being used is shown on this key and is shown as selected in the submenu.

Key Path	AMPTD Y Scale, Y Axis Unit
Dependencies	Grayed out if no Amplitude Correction with an Antenna Unit is on.
Readback line	Currently selected unit
Initial S/W Revision	A.11.00

## dB $\mu$ V/m

Sets the amplitude unit for the selected amplitude scale (log/lin) to dB $\mu$ V/m. This is an antenna unit, and this key is grayed out unless a Correction with this Antenna Unit selected is ON. If this is the case, all of the other Antenna Units are grayed out.

Key Path	AMPTD Y Scale, Y Axis Unit, Antenna Unit
<b>Example</b>	UNIT:POW DBUVM
Dependencies	Grayed out if no Amplitude Correction with an Antenna Unit is on.
Readback	dB $\mu$ V/m
Initial S/W Revision	A.02.00

## dB $\mu$ A/m

Sets the amplitude unit for the selected amplitude scale (log/lin) to dB $\mu$ A/m. This is an antenna unit, and this key is grayed out unless a Correction with this Antenna Unit selected is ON. If this is the case, all of the other Antenna Units are grayed out.

Key Path	AMPTD Y Scale, Y Axis Unit, Antenna Unit
<b>Example</b>	UNIT:POW DBUAM
Dependencies	Grayed out if no Amplitude Correction with an Antenna Unit is on.

Readback	dB $\mu$ A/m
Initial S/W Revision	A.02.00

### dB $\mu$ A

Sets the amplitude unit for the selected amplitude scale (log/lin) to dB $\mu$ A. This is an antenna unit, and this key is grayed out unless a Correction with this Antenna Unit selected is ON. If this is the case, all of the other Antenna Units are grayed out.

Key Path	AMPTD Y Scale, Y Axis Unit, Antenna Unit
<b>Example</b>	UNIT:POW DBUAM
Dependencies	Grayed out if no Amplitude Correction with an Antenna Unit is on.
Readback	dB $\mu$ A
Initial S/W Revision	A.11.00

### dBpT

Sets the amplitude unit for the selected amplitude scale (log/lin) to dBpT. This is an antenna unit, and this key is grayed out unless a Correction with this Antenna Unit selected is ON. If this is the case, all of the other Antenna Units are grayed out.

Key Path	AMPTD Y Scale, Y Axis Unit, Antenna Unit
<b>Example</b>	UNIT:POW DBPT
Dependencies	Grayed out if no Amplitude Correction with an Antenna Unit is on.
Readback	dBpT
Initial S/W Revision	A.02.00

### DBG

Sets the amplitude unit for the selected amplitude scale (log/lin) to DBG. This is an antenna unit, and this key is grayed out unless a Correction with this Antenna Unit selected is ON. If this is the case, all of the other Antenna Units are grayed out.

Key Path	AMPTD Y Scale, Y Axis Unit, Antenna Unit
<b>Example</b>	UNIT:POW DBG
Dependencies	Grayed out if no Amplitude Correction with an Antenna Unit is on.
Readback	DBG
Initial S/W Revision	A.02.00



## None

This is selected if no Antenna Unit is currently on, however you cannot actually set this value, since it is always grayed out. The key is included simply to provide an indication on the Readback line of the Antenna Unit key when there is no Antenna Unit selected.

Key Path	AMPTD Y Scale, Y Axis Unit, Antenna Unit
Readback	"None"
Initial S/W Revision	A.11.00

## μW Path Control

The μW Path Control functions include the μW Preselector Bypass (Option MPB) and Low Noise Path (Option LNP) controls in the High Band path circuits.

When the μW Preselector is bypassed, the user has better flatness, but will be subject to spurs from out of band interfering signals. When the Low Noise Path is enabled, the analyzer automatically switches around certain circuitry in the high frequency bands which can contribute to noise, when it is appropriate based on other analyzer settings.

For most applications, the preset state is Standard Path, which gives the best remote-control throughput, minimizes acoustic noise from switching and minimizes the risk of wear out in the hardware switches. For applications that utilize the wideband IF paths, the preset state is the μW Preselector Bypass path, if option MPB is present. This is because, when using a wideband IF such as the 140 MHz IF, the μW Preselector's bandwidth can be narrower than the available IF bandwidth, causing degraded amplitude flatness and phase linearity, so it is desirable to bypass the preselector in the default case.

Users may choose Low Noise Path Enable. It gives a lower noise floor, especially in the 21–26.5 GHz region, though without improving many measures of dynamic range, and without giving the best possible noise floor. The preamp, if purchased and used, gives better noise floor than does the Low Noise Path, however its compression threshold and third-order intercept are much poorer than that of the non-preamp Low Noise Path. There are some applications, typically for signals around –30 dBm, for which the third-order dynamic range of the standard path is good enough, but the noise floor is not low enough even with 0 dB input attenuation. When the third-order dynamic range of the preamp path is too little and the noise floor of the standard path is too high, the Low Noise Path can provide the best dynamic range.

Key Path	AMPTD Y Scale
Mode	SA, BASIC, PNOISE, VSA , LTE, LTETDD
Scope	Meas Global
Remote Command	[ :SENSe] :POWer [ :RF] :MW:PATH STD LNPath MPBypass FULL [ :SENSe] :POWer [ :RF] :MW:PATH?
Example	:POW:MW:PATH LNP Enables the Low Noise path
Notes	If a Presel Center is performed, the analyzer will momentarily switch to the Standard Path, regardless of the setting of μW Path Control The DC Block will always be switched in when the low noise path is switched in, to protect succeeding circuitry from DC. Note that this does not mean "when the low noise path is enabled" but

	<p>when, based on the Low Noise Path rules, the path is actually switched in. This can happen when the selection is Low Noise Path Enable . In the case where the DC Block is switched in the analyzer is now AC coupled. However, if the user has selected DC coupling, the UI will still behave as though it were DC coupled, including all annunciation, warnings, status bits, and responses to SCPI queries. This is because, based on other settings, the analyzer could switch out the low noise path at any time and hence go back to being DC coupled.</p> <p>Alignment switching ignores the settings in this menu, and restores them when finished.</p>
Dependencies	Unavailable in BBIQ and External Mixing
Preset	<p>All modes other than IQ Analyzer mode and VXA: STD</p> <p>IQ Analyzer, VXA and WLAN mode:</p> <p>MPB option present and licensed: MPB</p> <p>MPB option not present and licensed: STD</p>
State Saved	Save in instrument state
Readback	Value selected in the submenu
Initial S/W Revision	A.04.00
Modified at S/W Revision	A.10.00

## Standard Path

This path gives the best remote-control throughput, minimizes acoustic noise from switching and minimizes the risk of wear in the hardware switches, particularly in remote test scenarios where both low band and high band setups will follow in rapid succession.

In this path, the bypass of the low band/high band switch and microwave preamp is never activated, which can cause some noise degradation but preserves the life of the bypass switch.

Key Path	AMPTD Y Scale, $\mu$ W Path Control
Example	:POW:MW:PATH STD
Readback Text	Standard Path
Initial S/W Revision	A.04.00

## Low Noise Path Enable

You may choose Low Noise Path Enable, which gives a lower noise floor under some circumstances, particularly when operating in the 21–26.5 GHz region. With the Low Noise Path enabled, the low band/high band switch and microwave preamp are bypassed whenever all of the following are true:

- The analyzer is not in the Low Band, meaning:
- the start frequency is above 3.5 GHz and
- the stop frequency is above 3.6 GHz.
- the internal preamp is not installed or (if installed) is set to Off or Low Band

Note that this means that, when any part of a sweep is done in Low Band, the Low Noise Path is not used, whether or not the Low Noise Path Enable is selected in the user interface. Also, if the preamp is turned on, the Low Noise Path is not used, whether or not the Low Noise Path Enable is selected in the user interface. The only time the Low Noise Path is used is when Low Noise Path Enable is selected, the sweep is completely in High Band (> 3.6 GHz) and no preamp is in use.

See "[More Information](#)" on page 1755

Key Path	AMPTD Y Scale, $\mu$ W Path Control
Measurement	Swept SA
Example	:POW:MW:PATH LNP
Notes	<p>For measurements that use IQ acquisition, the low noise path is used when the Center Frequency is in High Band (&gt; 3.6 GHz) and no preamp is in use.</p> <p>In other words, the rules above are modified to use only the center frequency to qualify which path to switch in.</p> <p>This is not the case for FFT's in the Swept SA measurement; they use the same rules as swept measurements.</p>
Dependencies	<p>Key is blanked if current mode does not support it.</p> <p>Key is grayed out if mode supports it but current measurement does not support it.</p> <p>Unless Option LNP is present and licensed, key is blank and if SCPI command sent, error -241, "Hardware missing; Option not installed" is generated.</p>
Readback Text	Low Noise Path Enable
Initial S/W Revision	A.04.00

## More Information

The user should understand that the Low Noise Path, while giving improved DANL, has the disadvantage of decreased TOI performance and decreased gain compression performance relative to the standard path.

The user should also understand that the bypass switch is a mechanical switch and has finite life, so if the Low Noise Path is enabled, it is possible to cause frequent cycling of this switch by frequently changing analyzer settings such that the above conditions hold true only some of the time. A user making tests of this nature should consider opting for the Standard Path, which will never throw the bypass switch, at the expense of some degraded noise performance.

The low noise path is useful for situations where the signal level is so low that the analyzer performance is dominated by noise even with 0 dB attenuation, but still high enough that the preamp option would have excessive third-order intermodulation or compression. The preamp, if purchased and used, gives better noise floor than does the "Low Noise Path." However, its compression threshold and third-order intercept are much poorer than that of the non-preamp path. There are some applications, typically for signals around -30 dBm, for which the third-order dynamic range of the standard path is good enough, but the noise floor is not low enough even with 0 dB input attenuation. When the third-order dynamic range of the preamp path is too little and the noise floor of the standard path is too high, the Low Noise Path can provide the best dynamic range

The graph below illustrates the concept. It shows, in red, the performance of an analyzer at different attenuation settings, both with the preamp on and off, in a measurement that is affected by both analyzer

noise and analyzer TOI. The green shows the best available dynamic range, offset by 0.5 dB for clarity. The blue shows how the best available dynamic range improves for moderate signal levels with the low noise path switched in. In this illustration, the preamp improves the noise floor by 15 dB while degrading the third-order intercept by 30 dB, and the low noise path reduces loss by 8 dB. The attenuator step size is 2 dB.

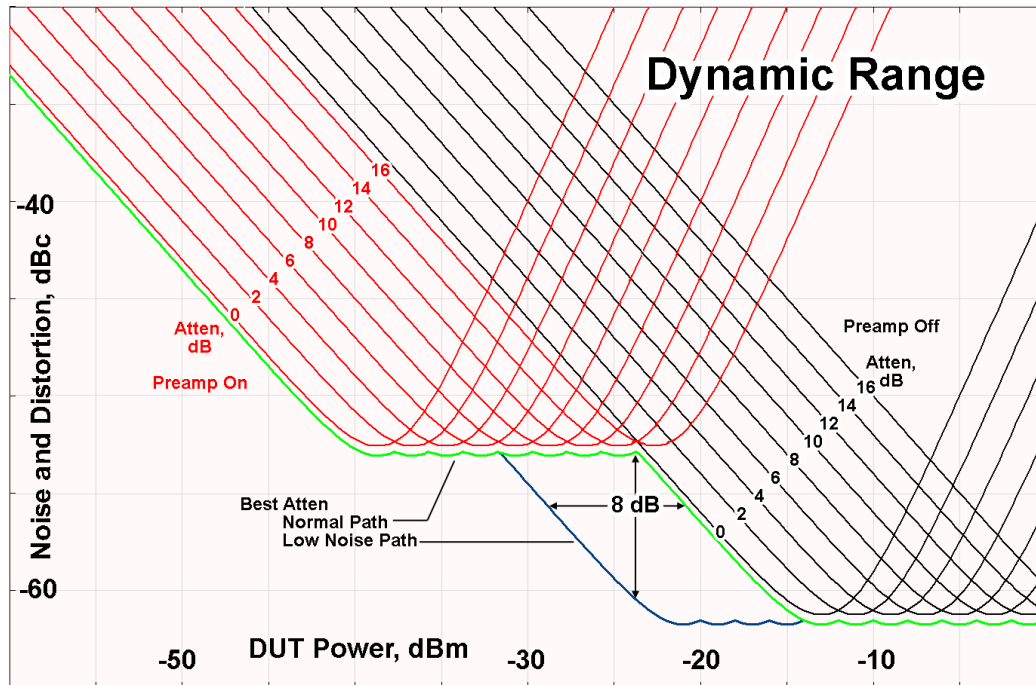

There are other times where selecting the low noise path improves performance, too. Compression-limited measurements such as finding the nulls in a pulsed-RF spectrum can profit from the low noise path in a way similar to the TOI-limited measurement illustrated. Accuracy can be improved when the low noise path allows the optimum attenuation to increase from a small amount like 0, 2 or 4 dB to a larger amount, giving better return loss at the analyzer input. Harmonic measurements, such as second and third harmonic levels, are much improved using the low noise path because of the superiority of that path for harmonic (though not intermodulation) distortion performance.

### μW Preselector Bypass

This key toggles the preselector bypass switch for band 1 and higher. When the microwave preselector is on, the signal path is preselected. When the microwave preselector is off, the signal path is not preselected. The preselected path is the normal path for the analyzer.

The preselector is a tunable bandpass filter which prevents signals away from the frequency of interest from combining in the mixer to generate in-band spurious signals (images). The consequences of using a preselector filter are its limited bandwidth, the amplitude and phase ripple in its passband, and any amplitude and phase instability due to center frequency drift.

Option MPB or pre-selector bypass provides an unpreselected input mixer path for certain X-Series signal analyzers with frequency ranges above 3.6 GHz. This signal path allows a wider bandwidth and less amplitude variability, which is an advantage when doing modulation analysis and broadband signal analysis. The disadvantage is that, without the preselector, image signals will be displayed. Another disadvantage of bypassing the preselector is increased LO emission levels at the front panel input port.

Image responses are separated from the real signal by twice the 1st IF. For IF Paths of 10 MHz and 25 MHz, the 1st IF is 322.5 MHz, so the image response and the real signal will be separated by 645 MHz. The 1st IF will be different for other IF Path settings. When viewing a real signal and its corresponding image response in internal mixing, the image response will be to the left of the real signal.

Also, the image response and the real signal typically have the same amplitude and exhibit the same shape factor.

However, if Option FS1, Fast Sweep Capability, is enabled, the image response in the Swept SA measurement will appear lower in amplitude and have a much wider shape factor compared to the real signal.

Key Path	AMPTD Y Scale, $\mu$ W Path Control
<b>Example</b>	:POW:MW:PATH MPB
Dependencies	Key is blanked if current mode does not support it. Key is grayed out if mode supports it but current measurement does not support it. Key is blank unless Option MPB is present and licensed. If SCPI command sent when MPB not present, error -241, "Hardware missing; Option not installed" is generated.
Readback Text	$\mu$ W Preselector Bypass
Initial S/W Revision	A.04.00

<b>Remote Command</b>	[ :SENSe ] :POWer [ :RF ] :MW:PRESelector [ :STATe ] ON OFF 0 1 [ :SENSe ] :POWer [ :RF ] :MW:PRESelector [ :STATe ] ?
<b>Example</b>	:POW:MW:PRES OFF Bypasses the microwave preselector
Notes	The ON parameter sets the STD path (:POW:MW:PATH STD) The OFF parameter sets path MPB (:POW:MW:PATH MPB)
Preset	ON

## Internal Preamp

Accesses a menu of keys that control the internal preamps. Turning on the preamp gives a better noise figure, but a poorer TOI to noise floor dynamic range. You can optimize this setting for your particular measurement.

The instrument takes the preamp gain into account as it sweeps. If you sweep outside of the range of the preamp the instrument will also account for that. The displayed result will always reflect the correct gain.

For some measurements, when the preamp is on and any part of the displayed frequency range is below the lowest frequency for which the preamp has specifications, a warning condition message appears in the status line. For example ,for a preamp with a 9 kHz lowest specified frequency: "Preamp: Accy unspec'd below 9 kHz".

Key Path	AMPTD Y Scale
----------	---------------

Scope	Meas Global
<b>Remote Command</b>	<code>[ :SENSe ] :POWeR [ :RF ] :GAIN [ :STATe ] OFF   ON   0   1</code> <code>[ :SENSe ] :POWeR [ :RF ] :GAIN [ :STATe ] ?</code>
Dependencies	Preamp is not available on all hardware platforms. If the preamp is not present or is unlicensed, the key is not shown. The preamp is not available when the electronic/soft attenuator is enabled.
Couplings	The act of connecting the U7227A USB Preamplifier to one of the analyzer's USB ports will cause the Internal Preamp to be switched on. When this happens an informational message will be generated: "Internal Preamp turned on for optimal operation with USB Preamp." Note that if the Internal Preamp was already on, there will be no change to the setting, but if it was Off it will be switched On, to Full Range. Note that this same action occurs when the SA mode is selected while the USB Preamp is connected to one of the analyzer's USB ports, if it is the first time that the SA mode has run since powerup, or if the last time the SA mode was running the USB Preamp was NOT connected. Subsequently disconnecting the USB Preamp from USB does not change the Internal Preamp setting nor restore the previous setting.
Preset	OFF
State Saved	Saved in instrument state
Initial S/W Revision	Prior to A.02.00
Modified at S/W Revision	A.14.00

Key Path	AMPTD Y Scale, Internal Preamp
Scope	Meas Global
<b>Remote Command</b>	<code>[ :SENSe ] :POWeR [ :RF ] :GAIN :BAND LOW   FULL</code> <code>[ :SENSe ] :POWeR [ :RF ] :GAIN :BAND ?</code>
Dependencies	Preamp is not available on all hardware platforms. If the preamp is not present or is unlicensed, the key is not shown. If a POW:GAIN:BAND FULL command is sent when a low band preamp is available, the preamp band parameter is to LOW instead of FULL, and an "Option not installed" message is generated.
Preset	LOW
State Saved	Saved in instrument state
Initial S/W Revision	Prior to A.02.00

## Off

Turns the internal preamp off

Key Path	AMPTD Y Scale, Internal Preamp
----------	--------------------------------

<b>Example</b>	:POW:GAIN OFF
Readback	Off
Initial S/W Revision	Prior to A.02.00

## Low Band

Sets the internal preamp to use only the low band.

The frequency range of the installed (optional) low-band preamp is displayed in square brackets on the Low Band key label.

Key Path	AMPTD Y Scale, Internal Preamp
<b>Example</b>	:POW:GAIN ON :POW:GAIN:BAND LOW
Readback	Low Band
Initial S/W Revision	Prior to A.02.00

## Full Range

Sets the internal preamp to use its full range. The low band (0–3.6 GHz or 0–3GHz, depending on the model) is supplied by the low band preamp and the frequencies above low band are supplied by the high band preamp.

The frequency range of the installed (optional) preamp is displayed in square brackets on the Full Range key label. If the high band option is not installed the Full Range key does not appear.

Key Path	AMPTD Y Scale, Internal Preamp
<b>Example</b>	:POW:GAIN ON :POW:GAIN:BAND FULL
Readback	Full Range
Initial S/W Revision	Prior to A.02.00

## Auto Scaling

Toggles the Auto Scaling function between On and Off.

Key Path	AMPTD Y Scale
Mode	SA, WCDMA, C2K, WIMAX OFDMA, TD-SCDMA, DVB-T/H, LTE, LTETDD, WLAN, MSR, LTEAFDD, LTEATDD
<b>Remote Command</b>	:DISPlay:SPURious:VIEW[1]:WINDow[1]:TRACe:Y[:SCALE]:COUPle 0   1   OFF   ON :DISPlay:SPURious:VIEW[1]:WINDow[1]:TRACe:Y[:SCALE]:COUPle?

<b>Example</b>	DISP:SPUR:VIEW:WIND:TRAC:Y:COUP OFF DISP:SPUR:VIEW:WIND:TRAC:Y:COUP?
<b>Couplings</b>	<p>When Auto Scaling is On and the Restart front-panel key is pressed, this function automatically determines the scale per division and reference values based on the measurement results.</p> <p>When you set a value to either Scale/Div or Ref Value manually, Auto Scaling automatically changes to Off.</p> <p>When the Y Auto Scaling is off, the measurement uses the current reference level settings. When the Y Auto Scaling is on, the analyzer automatically sets the reference level such that the absolute limit is positioned two divisions down from the top of the display. This is the most useful setting when searching for spurs. The algorithm used for determining the ref level is <math>\text{Ref Level} = \text{Absolute Limit} + (2 * \text{Scale/Div})</math>. All other reference level settings are left as the current base instrument settings.</p>
<b>Preset</b>	1
<b>State Saved</b>	Saved in instrument state.
<b>Range</b>	On Off
<b>Backwards Compatibility SCPI</b>	[ :SENSe ] : SPURious : POWer [ :RF ] : RANGe : AUTO
<b>Initial S/W Revision</b>	Prior to A.02.00
<b>Modified at S/W Revision</b>	A.03.00



## Auto Couple

The Auto Couple feature provides a quick and convenient way to automatically couple multiple instrument settings. This helps ensure accurate measurements and optimum dynamic range. When the Auto Couple feature is activated, either from the front panel or remotely, all parameters of the current measurement that have an Auto/Manual mode are set to Auto mode and all measurement settings dependent on (or coupled to) the Auto/Man parameters are automatically adjusted for optimal performance.

However, the Auto Couple key actions are confined to the current measurement only. It does not affect other measurements in the mode, and it does not affect markers, marker functions, or trace or display attributes.

See "[More Information](#)" on page 1761

Key Path	Front-panel key
Remote Command	:COUPle ALL NONE
Example	:COUP ALL
Notes	:COUPle ALL puts all Auto/Man parameters in Auto mode (equivalent to pressing the Auto Couple key). :COUPLE NONE puts all Auto/Man parameters in manual mode. It decouples all the coupled instrument parameters and is not recommended for making measurements.
Initial S/W Revision	Prior to A.02.00

### More Information

There are two types of functions that have Auto/Manual modes.

#### Auto/Man Active Function keys

An Auto/Man toggle key controls the binary state associated with an instrument parameter by toggling between Auto (where the parameter is automatically coupled to the other parameters it is dependent upon) and Man (where the parameter is controlled independent of the other parameters), as well as making the parameter the active function. The current mode is indicated on the softkey with either Auto or Man underlined as illustrated below.



#### Auto/Man 1-of-N keys

An Auto/Man 1-of-N key allows you to manually pick from a list of parameter values, or place the function in Auto, in which case the value is automatically selected (and indicated) as shown below. If in Auto, Auto is underlined on the calling key. If in manual operation, manual is indicated on the calling key. But the calling key does not actually toggle the function, it simply opens the menu.

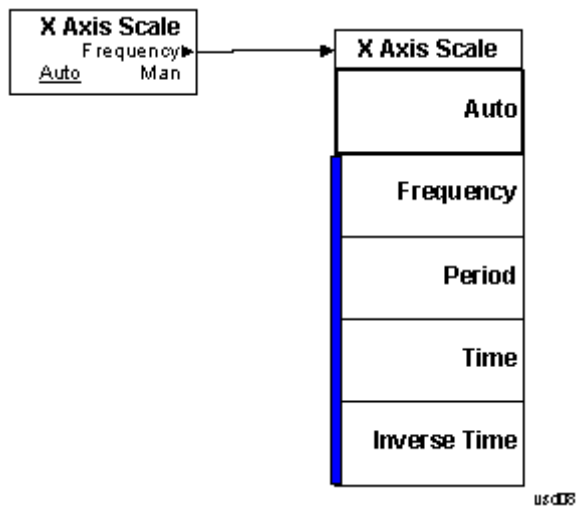

## BW

BW is unavailable in the Spurious Emissions measurement. When pressed, this key displays a blank menu.

Key Path	Front-panel key
Initial S/W Revision	Prior to A.02.00

## Cont (Continuous Measurement/Sweep)

Sets the analyzer for Continuous measurement operation. The single/continuous state is Meas Global so the setting will affect all measurements. If you are Paused, pressing Cont does a Resume.

<b>Key Path</b>	Front-panel key
<b>Remote Command</b>	:INITiate:CONTinuous OFF ON 0 1 :INITiate:CONTinuous?
<b>Example</b>	:INIT:CONT 0 puts analyzer in Single measurement operation. :INIT:CONT 1 puts analyzer in Continuous measurement operation
<b>Preset</b>	ON (Note that SYST:PRESet sets INIT:CONT to ON but *RST sets INIT:CONT to OFF)
<b>State Saved</b>	Saved in instrument state
<b>Backwards Compatibility Notes</b>	For Spectrum Analysis mode in ESA and PSA, there is no Cont hardkey, instead there is a Sweep Single/Cont key. In these analyzers, switching the Sweep Single/Cont key from Single to Cont restarts averages (displayed average count reset to 1), but does not restart Max Hold and Min Hold. The X-Series has Single and Cont keys in place of the SweepSingleCont key. In the X-Series, if in single measurement, the Cont key (and INIT:CONT ON ) switches to continuous measurement, but never restarts a measurement and never resets a sweep.
<b>Initial S/W Revision</b>	Prior to A.02.00

In Swept SA Measurement (Spectrum Analysis Mode):

The analyzer takes repetitive sweeps, averages, measurements, etc., when in Continuous mode. When the average count reaches the Average/Hold Number the count stops incrementing, but the analyzer keeps sweeping. See the Trace/Detector section for the averaging formula used both before and after the Average/Hold Number is reached. The trigger condition must be met prior to each sweep. The type of trace processing for multiple sweeps, is set under the Trace/Detector key, with choices of Trace Average, Max Hold, or Min Hold.

In Other Measurements/Modes:

With Avg/Hold Num (in the Meas Setup menu) set to Off or set to On with a value of 1, a sweep is taken after the trigger condition is met; and the analyzer continues to take new sweeps after the current sweep has completed and the trigger condition is again met. However, with Avg/Hold Num set to On with a value >1, multiple sweeps (data acquisitions) are taken for the measurement. The trigger condition must be met prior to each sweep. The sweep is not stopped when the average count k equals the number N set for Avg/Hold Num is reached, but the number k stops incrementing. A measurement average usually applies to all traces, marker results, and numeric results. But sometimes it only applies to the numeric results.

If the analyzer is in Single measurement, pressing the Cont key does not change k and does not cause the sweep to be reset; the only action is to put the analyzer into Continuous measurement operation.

If it is already in continuous sweep:

the INIT:CONT 1 command has no effect

the INIT:CONT 0 command will place the analyzer in Single Sweep but will have no effect on the current sequence until  $k = N$ , at which point the current sequence will stop and the instrument will go to the idle state.

14 Spurious Emissions Measurement  
File

File

See "File" on page 336

## FREQ Channel

The key accesses a menu allowing you to set Frequency parameters for the current measurement. All measurements in DVB-T/H mode have the same menu structure under FREQ/Channel menu.

Key Path	Front-panel key
Initial S/W Revision	A.02.00

### Channel

Sets the analyzer to a frequency that corresponds to the Channel Number. If the Center Freq value entered does not exactly correlate with the Channel, the displayed value will be "---".

Key Path	FREQ Channel
Mode	DVB-T/H
<b>Remote Command</b>	<code>[ :SENSe ] :FREQuency:CHANnel:NUMBer &lt;integer&gt;</code> <code>[ :SENSe ] :FREQuency:CHANnel:NUMBer?</code>
<b>Example</b>	FREQ:CHAN:NUMB 21 FREQ:CHAN:NUMB?
Dependencies	If your analyzer has multiple inputs and the selected input is BBIQ, this key will be grayed out and the displaying value will be "---".
Couplings	Channel is coupled with Center Freq. A certain Channel corresponds to a certain value of Center Freq. If the Center Freq value entered does not exactly correlate with a Channel, the displaying value will be "---", and the returned value of the SCPI command "FREQ:CHAN:NUMB?" is "-999".
Preset	21
State Saved	Saved in instrument state.
Min	Depends on the selected channel table
Max	Depends on the selected channel table
Initial S/W Revision	A.02.00

### Center Freq

Sets the center frequency. If your analyzer has multiple inputs (RF and IQ), the displayed value will be updated according to the selected input. SCPI commands are available to directly set the center frequency for a specific input. This key is coupled with Channel when the selected input is RF.

See also:

["RF Center Freq" on page 1769](#)

["IQ Center Freq" on page 1769](#)

Key Path	FREQ Channel
Mode	DVB-T/H
<b>Remote Command</b>	[ :SENSe ] :FREQuency:CENTer <freq> [ :SENSe ] :FREQuency:CENTer?
<b>Example</b>	FREQ:CENT 1.0MHZ FREQ:CENT?
Couplings	Center Freq is coupled with Channel. A certain value of center frequency corresponds to a certain Channel. If the Channel changes, the Center Frequency will be changed to the frequency which is the center of the channel.
Preset	474.00MHz
State Saved	Saved in instrument state.
Min	-79.999995 MHz
Max	Hardware Dependent, for details, see <a href="#">"Maximum Frequency in X - Series Signal Analyzers" on page 1768.</a>
Initial S/W Revision	A.02.00

### Maximum Frequency in X - Series Signal Analyzers

The following table lists the maximum frequency in different X – Series signal analyzers.

Model numbers: N9020A, N9030A

Freq Option	Stop Freq after Mode Preset	Max Freq (can't tune above)
503	3.6 GHz	3.7 GHz
508	8.4 GHz	8.5 GHz
513	13.6 GHz	13.8 GHz
526	26.5 GHz	27.0 GHz
543 (N9030A only)	43 GHz	
544 (N9030A only)	44 GHz	44.5 GHz
550 (N9030A only)	50 GHz	51 GHz

Model number: N9010A

Freq Option	Stop Freq after Mode Preset	Max Freq (can't tune above)
503	3.6 GHz	3.7 GHz
507	7.0 GHz	7.1 GHz



513	13.6 GHz	13.8 GHz
526	26.5 GHz	27.0 GHz
532	32.0 GHz	32.5 GHz
544	44.0 GHz	44.5 GHz

Model number: N9000A

Freq Option	Stop Freq after Mode Preset	Max Freq (can't tune above)
503	3.0 GHz	3.08 GHz
507	7.5 GHz	7.58 GHz

## RF Center Freq

SCPI command to specify the RF Center Frequency. This will always access the RF value, even when the selected input is not RF.

Key Path	FREQ Channel
Mode	DVB-T/H
Remote Command	<code>[ :SENSe ] :FREQuency:RF:CENTer &lt;freq&gt;</code> <code>[ :SENSe ] :FREQuency:RF:CENTer?</code>
Example	FREQ:RF:CENT 1.0MHZ FREQ:RF:CENT?
Couplings	Center Freq is coupled with Channel. A certain value of center frequency corresponds to a certain Channel. If the Channel changes, the Center Frequency will be changed to the frequency which is the center of the channel.
Preset	474.00MHz
State Saved	Saved in instrument state.
Min	-79.999995 MHz
Max	Hardware Dependent, for details, see <a href="#">"Maximum Frequency in X - Series Signal Analyzers" on page 1768.</a>
Initial S/W Revision	A.02.00

## IQ Center Freq

SCPI command to specify the I/Q Center Frequency. This will always access the I/Q value, even when the selected input is not I/Q.

Key Path	FREQ Channel
Mode	DVB-T/H
<b>Remote Command</b>	<code>[ :SENSe ] :FREQuency:IQ:CENTer &lt;freq&gt;</code> <code>[ :SENSe ] :FREQuency:IQ:CENTer?</code>
<b>Example</b>	FREQ:IQ:CENT 1.0MHZ FREQ:IQ:CENT?
Preset	0 Hz
State Saved	Saved in instrument state.
Min	-39.999995 MHz
Max	39.999995 MHz
Initial S/W Revision	A.02.00

### Chan Step

Chan Step changes the step size for the Channel Number.

Key Path	FREQ Channel
Mode	DVB-T/H
<b>Remote Command</b>	<code>[ :SENSe ] :FREQuency:CHANnel:STEP &lt;integer&gt;</code> <code>[ :SENSe ] :FREQuency:CHANnel:STEP?</code>
<b>Example</b>	FREQ:CHAN:STEP 1 FREQ:CHAN:STEP?
Dependencies	If your analyzer has multiple inputs and the selected input is BBIQ, this key will be grayed out.
Preset	1
State Saved	Saved in instrument state.
Min	1
Max	Depends on the selected channel table
Initial S/W Revision	A.02.00

### CF Step

CF Step sets the step size for center frequency. If CF Step State is manual, you can set this value manually. Once CF Step State is changed to auto, CF Step changes to the value of Channel BW automatically.

Key Path	FREQ Channel
Mode	DVB-T/H
<b>Remote Command</b>	<code>[ :SENSe ] :FREQuency:CENTer:STEP [ :INCRement ] &lt;freq&gt;</code> <code>[ :SENSe ] :FREQuency:CENTer:STEP [ :INCRement ] ?</code>

	<code>[ :SENSe ] :FREQuency:CENTer:STEP:AUTO ON OFF 1 0</code>
	<code>[ :SENSe ] :FREQuency:CENTer:STEP:AUTO?</code>
<b>Example</b>	FREQ:CENT:STEP 100KHZ FREQ:CENT:STEP? FREQ:CENT:STEP:AUTO OFF FREQ:CENT:STEP:AUTO?
Couplings	CF Step is coupled to Channel BW (Mode Setup) when CF Step State is 'Auto'.
Preset	8.00MHz ON
State Saved	Saved in instrument state.
Min	1.0 kHz
Max	1 GHz
Initial S/W Revision	A.02.00

## Chan Table

Allows you to choose the appropriate TV standard: NTSC-M, NTSC-J, NTSC-Brazil, PAL-M, PAL-B/G, PAL-D/K, or PAL-I.

Key Path	FREQ Channel
Mode	DVB-T/H
<b>Remote Command</b>	<code>[ :SENSe ] :FREQuency:CHANnel:TABLE[:SElect] MNTSc   JNTSc   BNTSc   MPAL   IPAL   BPAL   DPAL</code> <code>[ :SENSe ] :FREQuency:CHANnel:TABLE[:SElect] ?</code>
<b>Example</b>	FREQ:CHAN:TABL BPAL FREQ:CHAN:TABL?
Dependencies	If your analyzer has multiple inputs and the selected input is BBIQ, this key will be grayed out.
Couplings	Couple with Channel. Setting Chan Table sets the range of Channel to the value corresponding to that Chan Table.
Preset	BPAL
State Saved	Saved in instrument state.
Range	NTSC-M   NTSC-J   NTSC-Brazil   PAL-M   PAL-I   PAL-B/G   PAL-D/K
Initial S/W Revision	A.02.00

## NTSC-M

If the current TV standard is NTSC-M, you can choose the appropriate channel plans in NTSC-M standard: Standard Cable (STD), Broadcast Channel (AIR), HRC Cable (HRC) or IRC Cable (IRC).

Key Path	FREQ Channel, Chan Table
Mode	DVB-T/H
<b>Remote Command</b>	[ :SENSe ] :FREQuency:CHANnel:TABLE:MNTSc [ :SElect ] STD   AIR   HRC   IRC [ :SENSe ] :FREQuency:CHANnel:TABLE:MNTSc [ :SElect ] ?
<b>Example</b>	FREQ:CHAN:TABL:MNTS STD FREQ:CHAN:TABL:MNTS?
Preset	STD
State Saved	Saved in instrument state.
Range	STD   AIR   HRC   IRC
Initial S/W Revision	A.02.00

### NTSC-J

If the current TV standard is NTSC-J, you can choose the appropriate channel plans in NTSC-J standard: Japan Standard Cable (Cable), apan Broadcast channels (AIR), or Japan Digital Cable (Cable Digital).

Key Path	FREQ Channel, Chan Table
Mode	DVB-T/H
<b>Remote Command</b>	[ :SENSe ] :FREQuency:CHANnel:TABLE:JNTSc [ :SElect ] CBL   AIR   DCBL [ :SENSe ] :FREQuency:CHANnel:TABLE:JNTSc [ :SElect ] ?
<b>Example</b>	FREQ:CHAN:TABL:JNTS AIR FREQ:CHAN:TABL:JNTS?
Preset	AIR
State Saved	Saved in instrument state.
Range	Cable AIR Cable Digital
Initial S/W Revision	A.02.00
Modified at S/W Revision	A.08.00

### NTSC-Brazil

If the current TV standard is NTSC-Brazil, you can choose the appropriate channel plans in NTSC-Brazil standard: NTSC-Brazil VHF or NTSC-Brazil UHF. Please refer to Appendix A for more detailed information.

Key Path	FREQ Channel, Chan Table
Mode	DVB-T/H
<b>Remote Command</b>	[ :SENSe ] :FREQuency:CHANnel:TABLE:BNTSc [ :SElect ] VHF   UHF [ :SENSe ] :FREQuency:CHANnel:TABLE:BNTSc [ :SElect ] ?
<b>Example</b>	FREQ:CHAN:TABL:BNTS VHF FREQ:CHAN:TABL:BNTS?

Preset	UHF
State Saved	Saved in instrument state.
Range	VHF UHF
Initial S/W Revision	A.06.00

## PAL-M

If the current TV standard is PAL-M, you can choose the appropriate channel plans in PAL-M standard: Standard Cable (STD), Broadcast Channel (AIR), HRC Cable (HRC) or IRC Cable (IRC).

Key Path	FREQ Channel, Chan Table
Mode	DVB-T/H
<b>Remote Command</b>	[ :SENSe ] :FREQuency:CHANnel:TABLE:MPAL[ :SElect ] STD   AIR   HRC   IRC [ :SENSe ] :FREQuency:CHANnel:TABLE:MPAL[ :SElect ] ?
<b>Example</b>	FREQ:CHAN:TABL:MPAL STD FREQ:CHAN:TABL:MPAL?
Preset	STD
State Saved	Saved in instrument state.
Range	STD   AIR   HRC   IRC
Initial S/W Revision	A.02.00

## PAL-I

If the current TV standard is PAL-I, you can choose the appropriate channel plans in PAL-I standard: HRC Cable (HRC), VHF channels (VHF) or UHF channels (UHF).

Key Path	FREQ Channel, Chan Table
Mode	DVB-T/H
<b>Remote Command</b>	[ :SENSe ] :FREQuency:CHANnel:TABLE:IPAL[ :SElect ] VHF UHF HRC [ :SENSe ] :FREQuency:CHANnel:TABLE:IPAL[ :SElect ] ?
<b>Example</b>	FREQ:CHAN:TABL:IPAL HRC FREQ:CHAN:TABL:IPAL?
Preset	HRC
State Saved	Saved in instrument state.
Range	VHF   UHF   HRC
Initial S/W Revision	A.02.00

### PAL-B/G

If the current TV standard is PAL-B/G, you can choose the appropriate channel plans in PAL-B/G standard: HRC Cable (HRC), VHF channels (VHF), UHF channels (UHF), S channels PAL-B/G Standard (S), S channels PAL-B/G Cable (S-Cable) or CENELEC channels (CENELEC).

<b>Key Path</b>	FREQ Channel, Chan Table
<b>Mode</b>	DVB-T/H
<b>Remote Command</b>	[ :SENSE ] :FREQuency:CHANnel:TABLE:BPAL [ :SElect ] VHF   UHF   HRC   S   SCBL   CEN  [ :SENSe ] :FREQuency:CHANnel:TABLE:BPAL [ :SElect ] ?
<b>Example</b>	FREQ:CHAN:TABL:BPAL HRC FREQ:CHAN:TABL:BPAL?
<b>Preset</b>	UHF
<b>State Saved</b>	Saved in instrument state.
<b>Range</b>	VHF   UHF   HRC   S   S-Cable   CENELEC
<b>Initial S/W Revision</b>	A.02.00

### PAL-D/K

If the current TV standard is PAL-D/K, you can choose the appropriate channel plans in PAL-D/K standard: China Broadcast Channels (DS) or China Standard Cable (Z).

<b>Key Path</b>	FREQ Channel, Chan Table
<b>Mode</b>	DVB-T/H
<b>Remote Command</b>	[ :SENSE ] :FREQuency:CHANnel:TABLE:DPAL [ :SElect ] DS   Z  [ :SENSe ] :FREQuency:CHANnel:TABLE:DPAL [ :SElect ] ?
<b>Example</b>	FREQ:CHAN:TABL:DPAL DS FREQ:CHAN:TABL:DPAL?
<b>Preset</b>	DS
<b>State Saved</b>	Saved in instrument state.
<b>Range</b>	DS   Z
<b>Initial S/W Revision</b>	A.02.00

## Input/Output

See "Input/Output" on page 204

## Marker

Displays the menu keys that enable you to select, set up and control the markers for the current measurement.

Key Path	Front-panel key
Initial S/W Revision	Prior to A.02.00

### Select Marker

Displays 12 markers available for selection.

Key Path	Marker
Initial S/W Revision	Prior to A.02.00

### Marker Type

Sets the marker control mode to Normal, Delta and Off. Normal enables you to activate the selected marker to read the power level and time. Delta enables you to read the differences in the power levels and time scales between the selected marker and the next marker. Off enables you to turn off the selected marker.

All interactions and dependencies detailed under the key description are enforced when the remote command is sent.

Key Path	Marker
Mode	SA, WCDMA, C2K, WIMAX OFDMA, TD-SCDMA, 1xEV-DO, DVB-T/H, LTE, LTE-TDD, WLAN, MSR, LTE-FDD, LTE-TDD
Remote Command	:CALCulate:SPURious:MARKer[1] 2 ... 12:MODE POSITION   DELTA   OFF :CALCulate:SPURious:MARKer[1] 2 ... 12:MODE?
Example	CALC:SPUR:MARK:MODE POS CALC:SPUR:MARK:MODE?

**Notes**

If the selected marker is Off, pressing Marker sets it to Normal and places it at the center of the screen on the trace determined by the Marker Trace rules. At the same time, Marker X Axis Value appears on the Active Function area.

**Default Active Function:** the active function for the selected marker's current control mode. If the current control mode is Off, there is no active function and the active function is turned off.

**Active Function Display:** the marker X axis value entered in the active function area will display the marker value to its full entered precision.

You must be in the cdma2000 mode, 1xEV-DO mode, TD-SCDMA mode, W-CDMA mode, DVB-T/H mode, GSM/EDGE mode, LTE mode, LTE TDD mode, WLAN mode, MSR, LTE-Advanced FDD/TDD mode or WiMAX mode to use this command. Use INSTRument:SElect to set the mode.



Preset	=OFF
State Saved	Saved in instrument state.
Range	Normal Delta Off
Initial S/W Revision	Prior to A.02.00
Modified at S/W Revision	A.03.00

## Properties

Accesses the Properties menu to set certain properties of the selected marker.

Key Path	Marker
Initial S/W Revision	Prior to A.02.00

## Select Marker

Displays 12 markers available for selection.

Key Path	Marker
Initial S/W Revision	Prior to A.02.00

## Relative To

Selects the marker the selected marker will be relative to (its reference marker).

Every marker has another marker to which it is relative. This marker is referred to as the "reference marker" for that marker. This attribute is set by the Marker, Properties, Relative To key. The marker must be a Delta marker to make this attribute relevant. If it is a Delta marker, the reference marker determines how the marker is controlled and how its value is displayed. A marker cannot be relative to itself.

Key Path	Marker, Properties
Mode	SA, WCDMA, C2K, WIMAX OFDMA, TD-SCDMA, 1xEV-DO, DVB-T/H, LTE, LTE-TDD, WLAN, MSR, LTEAFDD, LTEATDD
<b>Remote Command</b>	:CALCulate:SPURious:MARKer[1] 2 ... 12:REFerence <integer> :CALCulate:SPURious:MARKer[1] 2 ... 12:REFerence?
<b>Example</b>	CALC:SPUR:MARK3:REF 5 CALC:SPUR:MARK:REF?
Notes	A marker cannot be relative to itself so that choice is grayed out, and if sent from SCPI generates error -221: "Settings conflict; marker cannot be relative to itself." When queried a single value will be returned (the specified marker numbers relative marker). You must be in the Spectrum Analysis mode, GSM mode, LTE mode, LTE TDD mode, WLAN mode, MSR, LTE-Advanced FDD/TDD mode or WiMAX mode or TD-SCDMA mode to use this command.

	Use INSTRument:SElect to set the mode.
Preset	2 3 4 5 6 7 8 9 10 11 12 1
State Saved	Saved in instrument state.
Min	1
Max	12
Initial S/W Revision	Prior to A.02.00
Modified at S/W Revision	A.03.00

### Couple Markers

When this function is true, moving any marker causes an equal X Axis movement of every other marker which is not Off. By “equal X Axis movement” we mean that we preserve the difference between each marker’s X Axis value (in the fundamental x-axis units of the trace that marker is on) and the X Axis value of the marker being moved (in the same fundamental x-axis units).

Key Path	Marker
Mode	SA, WCDMA, C2K, WIMAX OFDMA, TD-SCDMA, 1xEV-DO, DVB-T/H, LTE, LTETDD, WLAN, MSR, LTEAFDD, LTEATDD
<b>Remote Command</b>	:CALCulate:SPURious:MARKer:COUPle[:STATe] ON OFF 1 0 :CALCulate:SPURious:MARKer:COUPle[:STATe]?
<b>Example</b>	CALC:SPUR:MARK:COUP ON CALC:SPUR:MARK:COUP?
Preset	OFF
State Saved	Saved in instrument state.
Range	On Off
Initial S/W Revision	Prior to A.02.00
Modified at S/W Revision	A.03.00

### All Markers Off

Turns off all markers.

Key Path	Marker
Mode	SA, WCDMA, C2K, WIMAX OFDMA, TD-SCDMA, 1xEV-DO, DVB-T/H, LTE, LTETDD, WLAN, MSR, LTEAFDD, LTEATDD
<b>Remote Command</b>	:CALCulate:SPURious:MARKer:AOFF
<b>Example</b>	CALC:SPUR:MARK:AOFF
Initial S/W Revision	Prior to A.02.00
Modified at S/W Revision	A.03.00

### Marker X Axis Value (Remote Command only)

Sets the Marker X Axis value in the current marker X Axis Scale unit. It has no effect if the control mode is Off, but is the SCPI equivalent of entering an X value if the control mode is Normal or Delta.

Mode	SA, WCDMA, C2K, WIMAX OFDMA, TD-SCDMA, DVB-T/H, LTE, LTETDD, WLAN, MSR, LTEAFDD, LTEATDD
<b>Remote Command</b>	:CALCulate:SPURious:MARKer[1] 2 ... 12:X <freq> :CALCulate:SPURious:MARKer[1] 2 ... 12:X?
<b>Example</b>	CALC:SPUR:MARK2:X 25 kHz CALC:SPUR:MARK3:X?
Notes	If no suffix is sent it will use the fundamental units for the current marker X Axis Scale. If a suffix is sent that does not match the current marker X Axis Scale unit, an error "Invalid suffix" will be generated.  The query returns the absolute X Axis marker value if the control mode is Normal, or the offset from the reference marker if the control mode is Delta. The query is returned in the fundamental units for the current marker X Axis scale: Hz for Frequency and Inverse Time, seconds for Period and Time. If the marker is Off, the response is not a number.
Preset	1 GHz
State Saved	No
Min	-9.9E+37
Max	9.9E+37
Initial S/W Revision	Prior to A.02.00
Modified at S/W Revision	A.03.00

### Marker X Axis Position (Remote Command only)

Sets the Marker X position in trace points. It has no effect if the control mode is Off, but is the SCPI equivalent of entering a value if the control mode is Normal or Delta - except in trace points rather than X Axis Scale units. The entered value is immediately translated into the current X Axis Scale units for setting the value of the marker.

Mode	SA, WCDMA, C2K, WIMAX OFDMA, TD-SCDMA, 1xEV-DO, DVB-T/H, LTE, LTETDD, WLAN, MSR, LTEAFDD, LTEATDD
<b>Remote Command</b>	:CALCulate:SPURious:MARKer[1] 2 ... 12:X:POSition <integer> :CALCulate:SPURious:MARKer[1] 2 ... 12:X:POSition?
<b>Example</b>	CALC:SPUR:MARK10:X:POS 300 CALC:SPUR:MARK10:X:POS?
Notes	The query returns the absolute X Axis marker value in trace points if the control mode is Normal, or the offset from the reference marker in trace points if the control mode is Delta. The value is returned as a real number, not an integer, corresponding to the translation from X Axis Scale units to trace points . If the marker is Off the response is not a number.
Preset	300

State Saved	No
Min	-9.9E+37
Max	9.9E+37
Initial S/W Revision	Prior to A.02.00
Modified at S/W Revision	A.03.00

### Marker Y Axis Value (Remote Command only)

Returns the marker Y Axis value in the current marker Y Axis unit.

Mode	SA, WCDMA, C2K, WIMAX OFDMA, TD-SCDMA, 1xEV-DO, DVB-T/H, LTE, LTE-TDD, WLAN, MSR, LTEAFDD, LTEATDD
<b>Remote Command</b>	:CALCulate:SPURious:MARKer[1 2 ... 12]:Y?
<b>Example</b>	CALC:SPUR:MARK11:Y?
Notes	If no suffix is sent, it will use the current Y Axis unit. If a suffix is sent that does not have units of absolute amplitude, an error "Invalid suffix" will be generated.
Preset	Depends on Y axis range of selected Trace.
State Saved	No
Initial S/W Revision	Prior to A.02.00
Modified at S/W Revision	A.03.00

## Marker Function

There are no 'Marker Functions' supported in Spurious Emissions so this front-panel key displays a blank menu when pressed.

---

Key Path	Front-panel key
Initial S/W Revision	Prior to A.02.00

---

## Marker To

There is no 'Marker To' functionality supported in Spurious Emissions, so this front-panel key displays a blank menu when pressed.

---

Key Path	Front-panel key
Initial S/W Revision	Prior to A.02.00

---

## Meas

The information in this section is common to all measurements. For key and remote command information for a specific measurement, refer to the section that describes the measurement of interest.

Measurements available under the Meas key are specific to the current Mode.

When viewing Help for measurements, note the following:

**NOTE**

Operation for some keys differs between measurements. The information displayed in Help pertains to the current measurement. To see how a key operates in a different measurement, exit Help (press the Cancel Esc key), select the measurement, then reenter Help (press the Help key) and press that key.

---

Key Path	Front-panel key
Initial S/W Revision	Prior to A.02.00

---

### Remote Measurement Functions

This section contains the following topics:

"Measurement Group of Commands" on page 2166

"Current Measurement Query (Remote Command Only)" on page 2168

"Limit Test Current Results (Remote Command Only)" on page 2168

"Data Query (Remote Command Only)" on page 2168

"Calculate/Compress Trace Data Query (Remote Command Only)" on page 2169

"Calculate Peaks of Trace Data (Remote Command Only)" on page 2174

Hardware-Accelerated Fast Power Measurement (Remote Command Only)

"Format Data: Numeric Data (Remote Command Only)" on page 2175

"Format Data: Byte Order (Remote Command Only)" on page 2176

---

Initial S/W Revision	Prior to A.02.00
----------------------	------------------

---

## Measurement Group of Commands

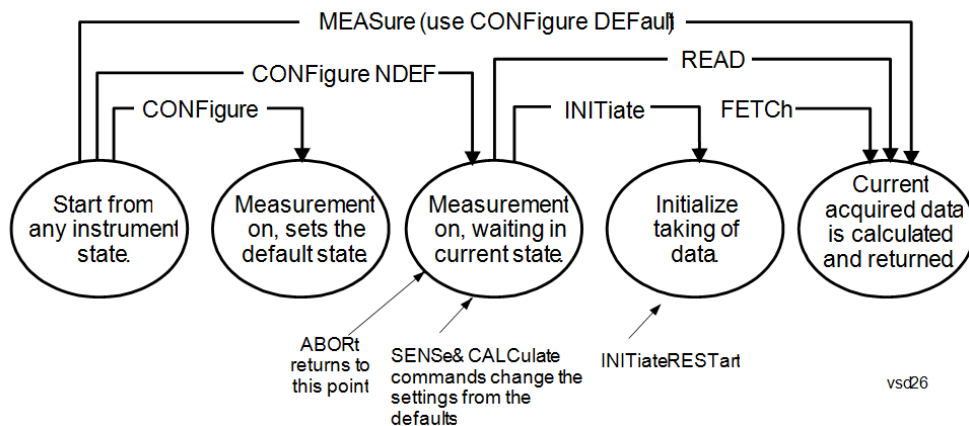

---

### Measure Commands:

:MEASure:<measurement>[n]?

This is a fast single-command way to make a measurement using the factory default instrument settings. These are the settings and units that conform to the Mode Setup settings (e.g. radio standard) that you have currently selected.

- Stops the current measurement (if any) and sets up the instrument for the specified measurement using the factory defaults
- Initiates the data acquisition for the measurement
- Blocks other SCPI communication, waiting until the measurement is complete before returning results.
- If the function does averaging, it is turned on and the number of averages is set to 10.
- After the data is valid it returns the scalar results, or the trace data, for the specified measurement. The type of data returned may be defined by an [n] value that is sent with the command.
- The scalar measurement results will be returned if the optional [n] value is not included, or is set to 1. If the [n] value is set to a value other than 1, the selected trace data results will be returned. See each command for details of what types of scalar results or trace data results are available.
- ASCII is the default format for the data output. (Older versions of Spectrum Analysis and Phase Noise mode measurements only use ASCII.) The binary data formats should be used for handling large blocks of data since they are smaller and faster than the ASCII format. Refer to the FORMat:DATA command for more information.

If you need to change some of the measurement parameters from the factory default settings you can set up the measurement with the CONFIgure command. Use the commands in the SENSe:<measurement> and CALCulate:<measurement> subsystems to change the settings. Then you can use the READ? command to initiate the measurement and query the results.

If you need to repeatedly make a given measurement with settings other than the factory defaults, you can use the commands in the SENSe:<measurement> and CALCulate:<measurement> subsystems to set up the measurement. Then use the READ? command to initiate the measurement and query results.

Measurement settings persist if you initiate a different measurement and then return to a previous one. Use READ:<measurement>? if you want to use those persistent settings. If you want to go back to the default settings, use MEASure:<measurement>?.

---

### Configure Commands:

:CONFIgure:<measurement>

This command stops the current measurement (if any) and sets up the instrument for the specified measurement using

---



---

the factory default instrument settings. It does not initiate the taking of measurement data unless INIT:CONTInuous is ON. If you change any measurement settings after using the CONFigure command, the READ command can be used to initiate a measurement without changing the settings back to their defaults.

In the Swept SA measurement in Spectrum Analyzer mode the CONFigure command also turns the averaging function on and sets the number of averages to 10 for all measurements.

:CONFigure: <measurement>: NDEFault stops the current measurement and changes to the specified measurement. It does not change the settings to the defaults. It does not initiate the taking of measurement data unless INIT:CONTInuous is ON.

The CONFigure? query returns the current measurement name.

The CONFigure:CATalog? query returns a quoted string of all licensed measurement names in the current mode. For example, "SAN, CHP, OBW, ACP, PST, TXP, SPUR, SEM, LIST".

---

#### Fetch Commands:

:FETCh:<measurement>[n]?

This command puts selected data from the most recent measurement into the output buffer. Use FETCh if you have already made a good measurement and you want to return several types of data (different [n] values, for example, both scalars and trace data) from a single measurement. FETCh saves you the time of re-making the measurement. You can only FETCh results from the measurement that is currently active, it will not change to a different measurement. An error message is reported if a measurement other than the current one is specified.

If you need to get new measurement data, use the READ command, which is equivalent to an INITiate followed by a FETCh.

The scalar measurement results will be returned if the optional [n] value is not included, or is set to 1. If the [n] value is set to a value other than 1, the selected trace data results will be returned. See each command for details of what types of scalar results or trace data results are available. The binary data formats should be used for handling large blocks of data since they are smaller and transfer faster than the ASCII format. (FORMat:DATA)

FETCh may be used to return results other than those specified with the original READ or MEASure command that you sent.

---

#### INITiate Commands:

:INITiate:<measurement>

This command is not available for measurements in all the instrument modes:

- Initiates a trigger cycle for the specified measurement, but does not output any data. You must then use the FETCh<meas> command to return data. If a measurement other than the current one is specified, the instrument will switch to that measurement and then initiate it.
- For example, suppose you have previously initiated the ACP measurement, but now you are running the channel power measurement. If you send INIT:ACP? it will change from channel power to ACP and will initiate an ACP measurement.
- Does not change any of the measurement settings. For example, if you have previously started the ACP measurement and you send INIT:ACP? it will initiate a new ACP measurement using the same instrument settings as the last time ACP was run.
- If your selected measurement is currently active (in the idle state) it triggers the measurement, assuming the trigger conditions are met. Then it completes one trigger cycle. Depending upon the measurement and the number of averages, there may be multiple data acquisitions, with multiple trigger events, for one full trigger cycle. It also holds off additional commands on GPIB until the acquisition is complete.

---

#### READ Commands:

:READ:<measurement>[n]?

- Does not preset the measurement to the factory default settings. For example, if you have previously initiated the ACP
-

---

measurement and you send READ:ACP? it will initiate a new measurement using the same instrument settings.

- Initiates the measurement and puts valid data into the output buffer. If a measurement other than the current one is specified, the instrument will switch to that measurement before it initiates the measurement and returns results.
  - For example, suppose you have previously initiated the ACP measurement, but now you are running the channel power measurement. Then you send READ:ACP? It will change from channel power back to ACP and, using the previous ACP settings, will initiate the measurement and return results.
  - Blocks other SCPI communication, waiting until the measurement is complete before returning the results
  - If the optional [n] value is not included, or is set to 1, the scalar measurement results will be returned. If the [n] value is set to a value other than 1, the selected trace data results will be returned. See each command for details of what types of scalar results or trace data results are available. The binary data formats should be used when handling large blocks of data since they are smaller and faster than the ASCII format. (FORMat:DATA)
- 

---

Initial S/W Revision	Prior to A.02.00
----------------------	------------------

---

### Current Measurement Query (Remote Command Only)

This command returns the name of the measurement that is currently running.

---

<b>Remote Command</b>	:CONFigure?
-----------------------	-------------

<b>Example</b>	CONF?
----------------	-------

Initial S/W Revision	Prior to A.02.00
----------------------	------------------

---

### Limit Test Current Results (Remote Command Only)

Queries the status of the current measurement limit testing. It returns a 0 if the measured results pass when compared with the current limits. It returns a 1 if the measured results fail any limit tests.

---

<b>Remote Command</b>	:CALCulate:CLIMits:FAIL?
-----------------------	--------------------------

<b>Example</b>	CALC:CLIM:FAIL? queries the current measurement to see if it fails the defined limits. Returns a 0 or 1: 0 it passes, 1 it fails.
----------------	--

Initial S/W Revision	Prior to A.02.00
----------------------	------------------

---

### Data Query (Remote Command Only)

Returns the designated measurement data for the currently selected measurement and subopcode.

n = any valid subopcode for the current measurement. See the measurement command results table for your current measurement, for information about what data is returned for the subopcodes.

This command uses the data setting specified by the FORMat:BORDER and FORMat:DATA commands and can return real or ASCII data. (See the format command descriptions under Input/Output in the Analyzer Setup section.)

<b>Remote Command</b>	:CALCulate:DATA[n]?
<b>Notes</b>	The return trace depends on the measurement. In CALCulate:<meas>:DATA[n], n is any valid subopcode for the current measurement. It returns the same data as the FETCH:<measurement>? query where <measurement> is the current measurement.
<b>Initial S/W Revision</b>	Prior to A.02.00

### Calculate/Compress Trace Data Query (Remote Command Only)

Returns compressed data for the currently selected measurement and sub-opcode [n].

n = any valid sub-opcode for that measurement. See the MEASure:<measurement>? command description of your specific measurement for information on the data that can be returned.

The data is returned in the current Y Axis Unit of the analyzer. The command is used with a sub-opcode <n> (default=1) to specify the trace. With trace queries, it is best if the analyzer is not sweeping during the query. Therefore, it is generally advisable to be in Single Sweep, or Update=Off.

This command is used to compress or decimate a long trace to extract and return only the desired data. A typical example would be to acquire N frames of GSM data and return the mean power of the first burst in each frame. The command can also be used to identify the best curve fit for the data.

<b>Remote Command</b>	:CALCulate:DATA<n>:COMPRESS? BLOCK   CFIT   MAXimum   MINimum   MEAN   DMEan   RMS   RMSCubed   SAMPLE   SDEVIation   PPHase [,<soffset> [,<length>[,<roffset>[,<rlimit>]]]]
<b>Example</b>	To query the mean power of a set of GSM bursts: Supply a signal that is a set of GSM bursts. Select the IQ Waveform measurement (in IQ Analyzer Mode). Set the sweep time to acquire at least one burst. Set the triggers such that acquisition happens at a known position relative to a burst. Then query the mean burst levels using, CALC:DATA2:COMP? MEAN, 24e-6, 526e-6 (These parameter values correspond to GSM signals, where 526e-6 is the length of the burst in the slot and you just want 1 burst.)
<b>Notes</b>	The command supports 5 parameters. Note that the last 4 (<soffset>, <length>, <roffset>, <rlimit>) are optional. But these optional parameters must be entered in the specified order. For example, if you want to specify <length>, then you must also specify <soffset>. See details below for a definition of each of these parameters. This command uses the data in the format specified by FORMat:DATA, returning either binary or ASCII data.
<b>Initial S/W Revision</b>	Prior to A.02.00

- BLOCK or block data - returns all the data points from the region of the trace data that you specify. For example, it could be used to return the data points of an input signal over several timeslots, excluding the portions of the trace data that you do not want. (This is x,y pairs for trace data and I,Q pairs for complex data.)

- CFIT or curve fit - applies curve fitting routines to the data. <soffset> and <length> are required to define the data that you want. <roffset> is an optional parameter for the desired order of the curve equation. The query will return the following values: the x-offset (in seconds) and the curve coefficients ((order + 1) values).

MIN, MAX, MEAN, DME, RMS, RMSC, SAMP, SDEV and PPH return one data value for each specified region (or <length>) of trace data, for as many regions as possible until you run out of trace data (using <roffset> to specify regions). Or they return the number of regions you specify (using <rlimit>) ignoring any data beyond that.

- MINimum - returns the minimum data point (y value) for the specified region(s) of trace data. For I/Q trace data, the minimum magnitude of the I/Q pairs is returned.
- MAXimum - returns the maximum data point (y value) for the specified region(s) of trace data. For I/Q trace data, the maximum magnitude of the I/Q pairs is returned.
- MEAN - returns a single value that is the arithmetic mean of the data point values (in dB/ dBm) for the specified region(s) of trace data. For I/Q trace data, the mean of the magnitudes of the I/Q pairs is returned. See the following equations.

•

**NOTE**

If the original trace data is in dB, this function returns the arithmetic mean of those log values, not log of the mean power which is a more useful value. The mean of the log is the better measurement technique when measuring CW signals in the presence of noise. The mean of the power, expressed in dB, is useful in power measurements such as Channel Power. To achieve the mean of the power, use the RMS option.

Equation 1

Mean Value of Data Points for Specified Region(s)

$$MEAN = \frac{1}{n} \sum_{X_i \in \text{region}(s)} X_i$$

where  $X_i$  is a data point value, and  $n$  is the number of data points in the specified region(s).

Equation 2

Mean Value of I/Q Data Pairs for Specified Region(s)

$$MEAN = \frac{1}{n} \sum_{X_i \in \text{region}(s)} |X_i|$$

where  $|X_i|$  is the magnitude of an I/Q pair, and  $n$  is the number of I/Q pairs in the specified region(s).

- DMEan - returns a single value that is the mean power (in dB/ dBm) of the data point values for the specified region(s) of trace data. See the following equation:

Equation 3

DMEan Value of Data Points for Specified Region(s)

$$\text{DME} = 10 \times \log_{10} \left( \frac{1}{n} \sum_{X_i \in \text{region}(s)} 10^{\frac{X_i}{10}} \right)$$

- RMS - returns a single value that is the average power on a root-mean-squared voltage scale (arithmetic rms) of the data point values for the specified region(s) of trace data. See the following equation.

**NOTE** For I/Q trace data, the rms of the magnitudes of the I/Q pairs is returned. See the following equation. This function is very useful for I/Q trace data. However, if the original trace data is in dB, this function returns the rms of the log values which is not usually needed.

Equation 4

RMS Value of Data Points for Specified Region(s)

$$\text{RMS} = \sqrt{\frac{1}{n} \sum_{X_i \in \text{region}(s)} X_i^2}$$

where  $X_i$  is a data point value, and  $n$  is the number of data points in the specified region(s).

Equation 5

RMS Value of I/Q Data Pairs for Specified Region(s)

$$\text{RMS} = \sqrt{\frac{1}{n} \sum_{X_i \in \text{region}(s)} X_i X_i^*}$$

where  $X_i$  is the complex value representation of an I/Q pair,  $X_i^*$  its conjugate complex number, and  $n$  is the number of I/Q pairs in the specified region(s).

Once you have the rms value for a region of trace data (linear or I/Q), you may want to calculate the mean power. You must convert this rms value (peak volts) to power in dBm:

$$10 \times \log[10 \times (\text{rms value})^2]$$

- SAMPLe - returns the first data value (x,y pair) for the specified region(s) of trace data. For I/Q trace data, the first I/Q pair is returned.
- SDEViation - returns a single value that is the arithmetic standard deviation for the data point values for the specified region(s) of trace data. See the following equation.
- For I/Q trace data, the standard deviation of the magnitudes of the I/Q pairs is returned. See the following equation.

Equation 6

Standard Deviation of Data Point Values for Specified Region(s)

$$\text{SDEV} = \sqrt{\frac{1}{n} \sum_{X_i \in \text{region}(s)} (X_i - \bar{X})^2}$$

where  $X_i$  is a data point value,  $\bar{X}$  is the arithmetic mean of the data point values for the specified region (s), and  $n$  is the number of data points in the specified region(s).

$$\text{SDEV} = \sqrt{\frac{1}{n} \sum_{X_i \in \text{region}(s)} (|X_i| - \bar{X})^2}$$

where  $|X_i|$  is the magnitude of an I/Q pair,  $\bar{X}$  is the mean of the magnitudes for the specified region(s), and  $n$  is the number of data points in the specified region(s).

- PPHase - returns the x,y pairs of both rms power (dBm) and arithmetic mean phase (radian) for every specified region and frequency offset (Hz). The number of pairs is defined by the specified number of regions. This parameter can be used for I/Q vector ( $n=0$ ) in Waveform (time domain) measurement and all parameters are specified by data point in PPHase.

The rms power of the specified region may be expressed as:

$$\text{Power} = 10 \times \log [10 \times (\text{RMS I/Q value})] + 10.$$

The RMS I/Q value (peak volts) is:

$$\sqrt{\frac{1}{n} \sum_{X_i \in \text{region}} X_i X_i^*}$$

where  $X_i$  is the complex value representation of an I/Q pair,  $X_i^*$  its conjugate complex number, and  $n$  is the number of I/Q pairs in the specified region.

The arithmetic mean phase of the specified region may be expressed as:

$$\frac{1}{n} \sum_{Y_i \in \text{region}} Y_i$$

where  $Y_i$  is the unwrapped phase of I/Q pair with applying frequency correction and  $n$  is the number of I/Q pairs in the specified region.

The frequency correction is made by the frequency offset calculated by the arithmetic mean of every specified region's frequency offset. Each frequency offset is calculated by the least square method against the unwrapped phase of I/Q pair.

Sample Trace Data - Constant Envelope

(See below for explanation of variables.)

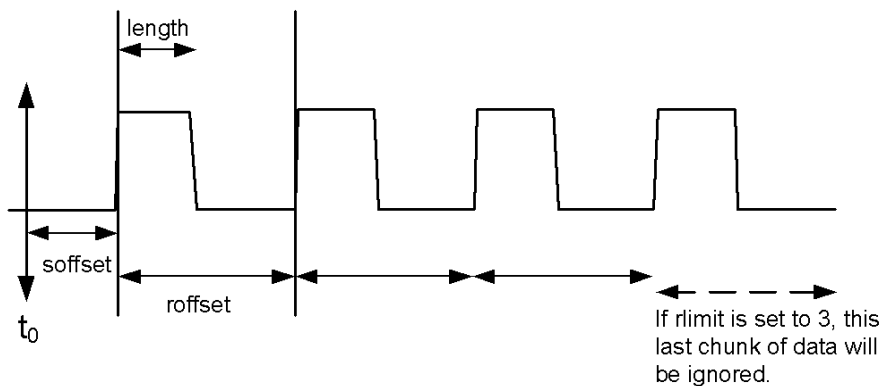

### Sample Trace Data - Not Constant Envelope

(See below for explanation of variables.)

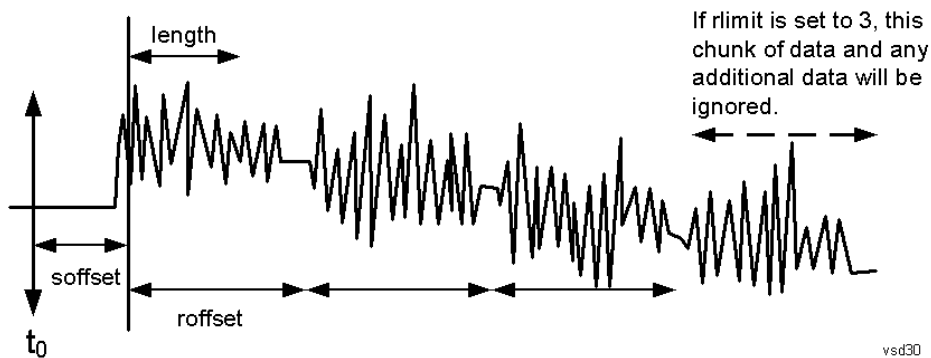

<soffset> - start offset is an optional real number. (It is in seconds for time-domain traces, and is a dimensionless index 0 to Npoints - 1, for frequency-domain traces). It specifies the amount of data at the beginning of the trace that will be ignored before the decimation process starts. It is the time or frequency change from the start of the trace to the point where you want to start using the data. The default value is zero.

<length> - is an optional real number. (It is in seconds for time-domain traces, and is a dimensionless index 0 to Npoints - 1, for frequency-domain traces). It defines how much data will be compressed into one value. This parameter has a default value equal to the current trace length.

<roffset> - repeat offset is an optional real number. (It is in seconds for time-domain traces, and is a dimensionless index 0 to Npoints - 1, for frequency-domain traces). It defines the beginning of the next field of trace elements to be compressed. This is relative to the beginning of the previous field. This parameter has a default value equal to the <length> variable. Note that this parameter is used for a completely different purpose when curve fitting (see CFIT above).

<rlimit> - repeat limit is an optional integer. It specifies the number of data items that you want returned. It will ignore any additional items beyond that number. You can use the Start offset and the Repeat limit to pick out exactly what part of the data you want to use. The default value is all the data.

## Calculate Peaks of Trace Data (Remote Command Only)

Returns a list of all the peaks for the currently selected measurement and sub-opcode [n]. The peaks must meet the requirements of the peak threshold and excursion values.

n = any valid sub-opcode for the current measurement. See the MEASure:<measurement> command description of your specific measurement for information on the data that can be returned.

The command can only be used with specific sub-opcodes with measurement results that are trace data. Both real and complex traces can be searched, but complex traces are converted to magnitude in dBm. In many measurements the sub-opcode n=0, is the raw trace data which cannot be searched for peaks. And Sub-opcode n=1, is often calculated results values which also cannot be searched for peaks.

This command uses the data setting specified by the FORMat:BORDER and FORMat:DATA commands and can return real or ASCII data. If the format is set to INT,32, it returns REAL,32 data.

The command has four types of parameters:

- Threshold (in dBm)
- Excursion (in dB)
- Sorting order (amplitude, frequency, time)
- Optional in some measurements: Display line use (all, > display line, < display line)

---

<b>Remote Command</b>	<p>For Swept SA measurement:</p> <pre>:CALCulate:DATA[1] 2 ... 6:PEAKs? &lt;threshold&gt;,&lt;excursion&gt;[,AMPLitude   FREQuency   TIME[,ALL   GTDLine   LTDLine]]</pre> <p>For most other measurements:</p> <pre>:CALCulate:DATA[1] 2 ... 6:PEAKs? &lt;threshold&gt;,&lt;excursion&gt;[,AMPLitude   FREQuency   TIME]</pre>
-----------------------	--

---

<b>Example</b>	<p>Example for Swept SA measurement in Spectrum Analyzer Mode:</p> <p>CALC:DATA4:PEAK? -40, 10, FREQ, GTDL This will identify the peaks of trace 4 that are above -40 dBm, with excursions of at least 10 dB. The peaks are returned in order of increasing frequency, starting with the lowest frequency. Only the peaks that are above the display line are returned.</p> <p>Query Results 1:</p> <p>With FORMat:DATA REAL, 32 selected, it returns a list of floating-point numbers. The first value in the list is the number of peak points that are in the following list. A peak point consists of two values: a peak amplitude followed by its corresponding frequency (or time).</p> <p>If no peaks are found the peak list will consist of only the number of peaks, (0).</p>
----------------	---

---

<b>Notes</b>	<p>&lt;n&gt; - is the trace that will be used</p> <p>&lt;threshold&gt; - is the level below which trace data peaks are ignored. Note that the threshold value is required and is always used as a peak criterion. To effectively disable the threshold criterion for this command, provide a substantially low threshold value such as -200 dBm. Also note that the threshold value used in this command is independent of and has no effect on the threshold value stored under the Peak Criteria menu.</p> <p>&lt;excursion&gt; - is the minimum amplitude variation (rise and fall) required for a signal to be identified as peak. Note that the excursion value is required and is always used as a peak criterion. To effectively disable the excursion criterion for this command, provide the minimum value of 0.0 dB. Also note that the excursion value used in this command is independent of and has no effect on the</p>
--------------	---

---



excursion value stored under the Peak Criteria menu.

Values must be provided for threshold and excursion. The sorting and display line parameters are optional (defaults are AMPLitude and ALL).

Note that there is always a Y-axis value for the display line, regardless of whether the display line state is on or off. It is the current Y-axis value of the display line which is used by this command to determine whether a peak should be reported

Sorting order:

AMPLitude - lists the peaks in order of descending amplitude, with the highest peak first (default if optional parameter not sent)

FREQUency - lists the peaks in order of occurrence, left to right across the x-axis.

TIME - lists the peaks in order of occurrence, left to right across the x-axis.

Peaks vs. Display Line:

ALL - lists all of the peaks found (default if optional parameter not sent).

GTDLine (greater than display line) - lists all of the peaks found above the display line.

LTDLine (less than display line) - lists all of the peaks found below the display line.

---

Initial S/W Revision      Prior to A.02.00

---

### Format Data: Numeric Data (Remote Command Only)

This command specifies the format of the trace data input and output. It specifies the formats used for trace data during data transfer across any remote port. It affects only the data format for setting and querying trace data for the :TRACe[:DATA], TRACe[:DATA]?, :CALCulate:DATA[n]? and FETCh:SANalyzer [n]? commands and queries.

---

**Remote Command**      :FORMat[:TRACe] [:DATA] ASCii|INTeger,32|REAL,32 |REAL,64  
:FORMat[:TRACe] [:DATA]?

---

**Notes**      The query response is:  
ASCii: ASC,8  
REAL,32: REAL,32  
REAL,64: REAL,64  
INTeger,32: INT,32

When the numeric data format is REAL or ASCii, data is output in the current Y Axis unit. When the data format is INTeger, data is output in units of m dBm (.001 dBm).

The INT,32 format returns binary 32-bit integer values in internal units (m dBm), in a definite length block.

---

**Dependencies**      Sending a data format spec with an invalid number (for example, INT,48) generates no error. The analyzer simply uses the default (8 for ASCii, 32 for INTeger, 32 for REAL).

Sending data to the analyzer which does not conform to the current FORMat specified, results in an error. Sending ASCII data when a definite block is expected generates message -161 "Invalid Block Data" and sending a definite block when ASCII data is expected generates message -121 "Invalid Character in Number".

---

**Preset**      ASCii

---

**Backwards Compatibility Notes**      Note that the INT,32 format is only applicable to the command, TRACe:DATA. This preserves backwards compatibility for the Swept SA measurement. For all other commands/queries which honor FORMat:DATA, if INT,32 is sent the analyzer will behave as though it were set to REAL,32.

---

Initial S/W Revision      Prior to A.02.00

---

The specs for each output type follow:

ASCIi - Amplitude values are in ASCII, in the current Y Axis Unit, one ASCII character per digit, values separated by commas, each value in the form:

SX.YYYYYEsZZ

Where:

S = sign (+ or -)

X = one digit to left of decimal point

Y = 5 digits to right of decimal point

E = E, exponent header

s = sign of exponent (+ or -)

ZZ = two digit exponent

REAL,32 - Binary 32-bit real values in the current Y Axis Unit, in a definite length block.

REAL,64 - Binary 64-bit real values in the current Y Axis Unit, in a definite length block.

### Format Data: Byte Order (Remote Command Only)

This command selects the binary data byte order for data transfer and other queries. It controls whether binary data is transferred in normal or swapped mode. This command affects only the byte order for setting and querying trace data for the :TRACe[:DATA], TRACe[:DATA]? , :CALCulate:DATA[n]? and FETCh:SANalyzer[n]? commands and queries.

By definition any command that says it uses FORMat:DATA uses any format supported by FORMat:DATA.

The NORMal order is a byte sequence that begins with the most significant byte (MSB) first, and ends with the least significant byte (LSB) last in the sequence: 1|2|3|4. SWAPped order is when the byte sequence begins with the LSB first, and ends with the MSB last in the sequence: 4|3|2|1.

---

**Remote Command** :FORMat:BORDER NORMal | SWAPped

:FORMat:BORDER?

---

**Preset** NORMal

---

**Initial S/W Revision** Prior to A.02.00

---

## Meas Setup

Displays the measurement setup menu for the currently selected measurement.

Key Path	Front-panel key
Initial S/W Revision	Prior to A.02.00

### Avg/Hold Num

Specifies the number of measurement averages used to calculate the measurement result. The average is displayed at the end of each sweep.

Average State allows you to turn averaging on or off.

Key Path	Meas Setup
Mode	SA, WCDMA, C2K, WIMAX OFDMA, CDMA1xEVDO, TD-SCDMA, DVB-T/H, LTE, LTE-TDD, WLAN, MSR, LTEAFDD, LTEATDD
<b>Remote Command</b>	[:SENSe]:SPURious:AVERage:COUNT <integer> [:SENSe]:SPURious:AVERage:COUNT? [:SENSe]:SPURious:AVERage[:STATE] ON OFF 1 0 [:SENSe]:SPURious:AVERage[:STATE]?
<b>Example</b>	SPUR:AVER:COUN 2500 SPUR:AVER:COUN? SPUR:AVER ON SPUR:AVER?
Notes	You must be in the Spectrum Analysis mode, W-CDMA mode, cdma2000 mode, DVB-T/H mode, TD-SCDMA mode, LTE mode, LTE TDD mode, WLAN mode, MSR, LTE-Advanced FDD/TDD mode or WiMAX mode to use this command. Use INSTRument:SElect to set the mode.
Preset	10 OFF
State Saved	Saved in instrument state.
Min	1
Max	10000
Initial S/W Revision	Prior to A.02.00
Modified at S/W Revision	A.03.00

### Avg Mode

Enables you to set the averaging mode.

- When set to Exponential (Exp) the measurement averaging continues using the specified number of averages to compute each averaged value. The average will be displayed at the end of each sweep.

- When set to Repeat, the measurement resets the average counter each time the specified number of averages is reached.

Key Path	Meas Setup
Mode	SA, WCDMA, WIMAX OFDMA, TD-SCDMA, DVB-T/H, LTE, LTETDD, WLAN, MSR, LTEAFDD, LTEATDD
Remote Command	[ :SENSE ] :SPURious:AVErage:TCONtrol EXPonential   REPEAT [ :SENSE ] :SPURious:AVErage:TCONtrol?
Example	SPUR:AVER:TCON REP SPUR:AVER:TCON?
Notes	You must be in the cdma2000 mode, TD-SCDMA mode, W-CDMA mode, DVB-T/H mode, GSM/EDGE mode, LTE mode, LTE TDD mode, WLAN mode, MSR, LTE-Advanced FDD/TDD mode or WiMAX mode to use this command. Use INSTRument:SElect to set the mode.
Preset	EXPonential
State Saved	Saved in instrument state.
Range	Exp Repeat
Initial S/W Revision	Prior to A.02.00
Modified at S/W Revision	A.03.00

### CH Mean Power (DVB-T/H only)

Set the mean power of the signal channel. The enter value is used to calculate the limit parameter which is different according as the different mean power of the transmitter. This key only shows up in the DVB-T/H.

Category A (mean power < 25W)

Freq Range	Limit	RBW	Note
9kHz~174MHz	-36dBm	100kHz	Required by EN302-296 Chapter 4.2.1 for DVB-T transmitter.
174MHz~400MHz	-82dBm	4kHz	
400MHz~790MHz	-36dBm	100kHz	
790MHz~862MHz	-76dBm	4kHz	
862MHz~1GHz	-36dBm	100kHz	
> 1GHz	-30dBm	100kHz	

Category B (25W < mean power <= 1000W)

Freq Range	Limit	RBW	Note
9kHz~174MHz	-36dBm	100kHz	Required by EN302-296 Chapter 4.2.1 for DVB-T transmitter.
174MHz~400MHz	-126dBc	4kHz	
400MHz~790MHz	-36dBm	100kHz	
790MHz~862MHz	-120dBc	4kHz	
862MHz~1GHz	-36dBm	100kHz	
> 1GHz	-30dBm	100kHz	

Category C (mean power > 1000W)

Freq Range	Limit	RBW	Note
9kHz~174MHz	-36dBm	100kHz	Required by EN302-296 Chapter 4.2.1 for DVB-T transmitter.
174MHz~400MHz	-66dBm	4kHz	
400MHz~790MHz	-36dBm	100kHz	
790MHz~862MHz	-60dBm	4kHz	
862MHz~1GHz	-36dBm	100kHz	
> 1GHz	-30dBm	100kHz	

Key Path	Meas Setup
Mode	DVB-T/H
Remote Command	[ :SENSe ] :SPURious :CARRier :POWer <real> [ :SENSe ] :SPURious :CARRier :POWer?
Example	SPUR:CARR:POW -30.00 dBm SPUR:CARR:POW?
Couplings	When the mean power of the signal channel is between 25 watt and 1000 watt, the measurement uses the current enter value as the reference to calculate the limit parameters.
Preset	-30.00 dBm
State Saved	Saved in instrument state.
Min	-250.0 dBm
Max	250.0 dBm
Initial S/W Revision	A.02.00

## Range Table

Enables you to set range parameters.

To change a parameter, select the appropriate menu softkey and enter the value using the numeric keypad or the knob. The analyzer settings will be updated with the new parameter values.

When the current view is the Range Table view, the selected range is highlighted and displayed in the Range Table automatically. With the normal window arrangement, up to five ranges are displayed. In the zoom mode, all 20 ranges can be displayed.

In the Range Table window, there are three tables corresponding to each page of the Range Table menu. When the Range Table key is pressed, the table of the first menu page is displayed.

The Displayed table is changed by changing the Range Table menu page. It can also be changed by a remote command. When the Range Table is changed by the command, the menu page changes accordingly if the Range Table menu is displayed.

Key Path	Meas Setup
Initial S/W Revision	Prior to A.02.00

### Range

Changing the range updates the values on the other menu keys so that they reflect the settings for the selected range. If Range is turned on, it will be used as part of the measurement. If it is off, it will be excluded. A range is made up of the next fifteen parameters. This parameter can send up to 20 values. The location in the list sent corresponds to the range the value is associated with. Missing values are not permitted; that is, if you want to change values 2 and 6 you must send all values up to 6. Subsequent values will remain as they were. The query for this parameter always returns 20 values.

Key Path	Meas Setup, Range Table
Mode	SA, WCDMA, C2K, 1xEV-DO, WIMAX OFDMA, TD-SCDMA, DVB-T/H, LTE, LTE-TDD, MSR, LTE-FDD, LTE-TDD
Remote Command	<pre>:DISPlay:SPURious:VIEW:RANGe[:SElect] &lt;integer&gt; :DISPlay:SPURious:VIEW:RANGe[:SElect]?  [:SENSe]:SPURious[:RANGe][:LIST]:STATe ON   OFF   1   0, ON   OFF   1   0, ON   OFF   1   0, ON   OFF   1   0, ON   OFF   1   0, ON   OFF   1   0, ON   OFF   1   0, ON   OFF   1   0, ON   OFF   1   0, ON   OFF   1   0, ON   OFF   1   0, ON   OFF   1   0, ON   OFF   1   0, ON   OFF   1   0, ON   OFF   1   0, ON   OFF   1   0, ON   OFF   1   0 [:SENSe]:SPURious[:RANGe][:LIST]:STATe?</pre>
Example	<pre>DISP:SPUR:VIEW:RANG 2 DISP:SPUR:VIEW:RANG? SPUR:STAT ON SPUR:STAT?</pre>
Notes	You must be in cdma2000 mode, TD-SCDMA mode, W-CDMA mode, DVB-T/H mode, GSM/EDGE mode, LTE mode, LTE TDD mode, MSR, LTE-Advanced FDD/TDD mode or WiMAX mode to use this command. Use INSTRument:SElect to set the mode.
Preset	<pre>1 SA, WIMAX OFDMA:ON, ON, ON, ON, ON, OFF, OFF, OFF, OFF, OFF, OFF, OFF, OFF, OFF, OFF, OFF, OFF, OFF, OFF, OFF, OFF WCDMA:ON, ON, ON, ON, ON, ON, ON, ON, OFF, OFF, OFF, OFF, OFF, OFF, OFF, OFF, OFF, OFF, OFF, OFF, OFF, OFF</pre>

	OFF, OFF C2k, 1xEV-DO: ON, ON, ON, ON, OFF, OFF, OFF, OFF, OFF, OFF, OFF, OFF, OFF, OFF, OFF, OFF, OFF, OFF, OFF, OFF, TD-SCDMA: ON, ON, ON, ON, OFF, OFF, OFF, OFF, OFF, OFF, OFF, OFF, OFF, OFF, OFF, OFF, OFF, OFF, OFF, OFF, OFF, OFF DVB-T/H: ON, ON, ON, ON, ON, ON, OFF, OFF, OFF, OFF, OFF, OFF, OFF, OFF, OFF, OFF, OFF, OFF, OFF, OFF, OFF, OFF LTE, MSR, LTEAFDD: ON, ON, ON, ON, ON, ON, ON, OFF, OFF, OFF, OFF, OFF, OFF, OFF, OFF, OFF, OFF, OFF, OFF, OFF, OFF LTETDD, LT LTEATDD: OFF, OFF, ON, ON, ON, ON, ON, OFF, OFF, OFF, OFF, OFF, OFF, OFF, OFF, OFF, OFF, OFF, OFF, OFF, OFF
State Saved	Not saved in State
Min	1
Max	20
Initial S/W Revision	Prior to A.02.00
Modified at S/W Revision	A.03.00, A.10.00

## Start Freq

Sets the start frequency of the analyzer. This parameter can send up to 20 values. The location where the start frequency occurs in the list sent to the measurement corresponds to the range the value is associated with.

Missing values are not permitted. If you want to change values 2 and 6 you must send all values up to 6. Subsequent values will remain as they were. The query for this parameter always returns 20 values.

Key Path	Meas Setup, Range Table
Mode	SA, WCDMA, C2K, WIMAX OFDMA, TD-SCDMA, 1xEV-DO, DVB-T/H, LTE, LTETDD, WLAN
Remote Command	<pre>[ :SENSe] :SPURious [ :RANGe] [ :LIST] :FREQuency:STARt &lt;freq&gt;, &lt;freq&gt;  [ :SENSe] :SPURious [ :RANGe] [ :LIST] :FREQuency:STARt?</pre>
Example	<pre>SPUR:FREQ:STAR 9 kHz, 150 kHz, 30 MHz, 1GHz, 1.5 GHz, 1.5 GHz, 1.5 GHz, 1.5 GHz, 1.5 GHz, 1.5 GHz, 1.5 GHz, 1.5 GHz, 1.5 GHz, 1.5 GHz, 1.5 GHz, 1.5 GHz, 1.5 GHz, 1.5 GHz, 1.5 GHz, 1.5 GHz, 1.5 GHz SPUR:FREQ:STAR?</pre>
Notes	You must be in cdma2000 mode, TD-SCDMA mode, W-CDMA mode, DVB-T/H, GSM/EDGE mode, LTE mode, LTE TDD mode, WLAN mode, MSR or WiMAX mode to use this command. Use INSTRUMENT:SELEct to set the mode.
Preset	<pre>SA, WIMAX OFDMA:+1.92000000E+009, +1.89350000E+009, +2.10000000E+009, +2.17500000E+009, +8.00000000E+008, +1.50000000E+009, +1.50000000E+009, +1.50000000E+009, +1.50000000E+009, +1.50000000E+009, +1.50000000E+009, +1.50000000E+009, +1.50000000E+009, +1.50000000E+009, +1.50000000E+009, +1.50000000E+009, +1.50000000E+009, +1.50000000E+009, +1.50000000E+009,</pre>

	+1.50000000E+009 WCDMA:9kHz, 150kHz, 30MHz, 1GHz, 2.1GHz, 2.1GHz, 2.1774GHz, 2.18GHz, 1.5GHz, 1.5GHz, 1.5GHz, 1.5GHz, 1.5GHz, 1.5GHz, 1.5GHz, 1.5GHz, 1.5GHz, 1.5GHz, 1.5GHz, 1.5GHz C2K, 1xEV-DO: 9kHz, 150kHz, 30 MHz, 1GHz, 2.5GHz, 2.5GHz, 2.5GHz, 2.5 GHz, 2.5 GHz, 2.5 GHz, 2.5 GHz, 2.5 GHz, 2.5 GHz, 2.5 GHz, 2.5 GHz, 2.5 GHz, 2.5 GHz, 2.5 GHz TD-SCDMA: 9 kHz, 150 kHz, 30 MHz, 1GHz, 1.5 GHz, 1.5 GHz, 1.5 GHz, 1.5 GHz, 1.5 GHz, 1.5 GHz, 1.5 GHz, 1.5 GHz, 1.5 GHz, 1.5 GHz, 1.5 GHz, 1.5 GHz, 1.5 GHz, 1.5 GHz, 1.5 GHz, 1.5 GHz DVB-T/H: 9kHz, 174MHz, 400MHz, 790MHz, 862MHz, 1GHz, 1.5GHz, 1.5GHz, 1.5GHz, 1.5GHz, 1.5GHz, 1.5GHz, 1.5GHz, 1.5GHz, 1.5GHz, 1.5GHz, 1.5GHz, 1.5GHz LTE, MSR: 9 kHz, 150 kHz, 30 MHz, 1 GHz, 1.92GHz, 1.98 GHz, 2.18 GHz, 1.5 GHz, 1.5 GHz, 1.5 GHz, 1.5 GHz, 1.5 GHz, 1.5 GHz, 1.5 GHz, 1.5 GHz, 1.5 GHz, 1.5 GHz, 1.5 GHz, 1.5 GHz LTETDD: 9 kHz, 150 kHz, 30 MHz, 1 GHz, 1.90GHz, 2.01 GHz, 2.025 GHz, 1.5 GHz, 1.5 GHz, 1.5 GHz, 1.5 GHz, 1.5 GHz, 1.5 GHz, 1.5 GHz, 1.5 GHz, 1.5 GHz, 1.5 GHz, 1.5 GHz WLAN: 9 kHz, 150 kHz, 30 MHz, 1 GHz, 1.5 GHz, 1.5 GHz, 1.5 GHz, 1.5 GHz, 1.5 GHz, 1.5 GHz, 1.5 GHz, 1.5 GHz, 1.5 GHz, 1.5 GHz, 1.5 GHz, 1.5 GHz, 1.5 GHz, 1.5 GHz
State Saved	Saved in instrument state.
Min	-80 MHz
Max	Hardware Dependent: Option 503: 3699999990 Option 508: 8499999990 Option 513: 13799999990 Option 526: 26999999990
Initial S/W Revision	Prior to A.02.00
Modified at S/W Revision	A.03.00

## Stop Freq

Sets the stop frequency of the analyzer. This parameter can send up to 20 values.

The location of where the stop frequency occurs in the list sent to the measurement corresponds to the range the value is associated with.

Missing values are not permitted. If you want to change values 2 and 6 you must send all values up to 6. Subsequent values will remain as they were. The query for this parameter always returns 20 values.

Key Path	Meas Setup, Range Table
Mode	SA, WCDMA, C2K, WIMAX OFDMA, TD-SCDMA, 1xEV-DO, DVB-T/H, WLAN
Remote Command	[ :SENSe ] :SPURious [ :RANGe ] [ :LIST ] :FREQuency:STOP <freq>, <freq>, <freq>, <freq>, <freq>, <freq>, <freq>, <freq>, <freq>, <freq>, <freq>, <freq>, <freq>, <freq>, <freq>, <freq>, <freq>, <freq> [ :SENSe ] :SPURious [ :RANGe ] [ :LIST ] :FREQuency:STOP?



<b>Example</b>	SPUR:FREQ:STOP 150kHz, 30MHz, 1GHz, 2.1GHz, 2.1GHz, 2.1774GHz, 2.18GHz, 12.75GHz, 2.5GHz, 2.5GHz, 2.5GHz, 2.5GHz, 2.5GHz, 2.5GHz, 2.5GHz, 2.5GHz, 2.5GHz, 2.5GHz, 2.5GHz, 2.5GHz SPUR:FREQ:STOP?
<b>Notes</b>	You must be in cdma2000 mode, TD-SCDMA mode, W-CDMA mode, DVB-T/H, GSM/EDGE mode, LTE mode, LTE TDD mode, WLAN mode, MSR or WiMAX mode to use this command. Use INSTRUMENT:SElect to set the mode.
<b>Preset</b>	SA, WIMAX OFDMA:+1.98000000E+009, +1.91960000E+009, +2.10150000E+009, +2.18000000E+009, +1.00000000E+009, +2.50000000E+009, +2.50000000E+009, +2.50000000E+009, +2.50000000E+009, +2.50000000E+009, +2.50000000E+009, +2.50000000E+009, +2.50000000E+009, +2.50000000E+009, +2.50000000E+009, +2.50000000E+009, +2.50000000E+009, +2.50000000E+009 WCDMA:150kHz, 30MHz, 1GHz, 2.1GHz, 2.1GHz, 2.1774GHz, 2.18GHz, 12.75GHz, 2.5GHz, 2.5GHz, 2.5GHz, 2.5GHz, 2.5GHz, 2.5GHz, 2.5GHz, 2.5GHz, 2.5GHz, 2.5GHz, 2.5GHz C2K, 1xEV-DO: 150kHz, 30 MHz, 1GHz, 5GHz, 2.5GHz, 2.5GHz, 2.5GHz, 2.5 GHz, 2.5 GHz, 2.5 GHz, 2.5 GHz, 2.5 GHz, 2.5 GHz, 2.5 GHz, 2.5 GHz, 2.5 GHz, 2.5 GHz, 2.5 GHz, 2.5 GHz TD-SCDMA: 150kHz, 30 MHz, 1GHz, 12.75GHz, 2.5 GHz, 2.5 GHz, 2.5 GHz, 2.5 GHz, 2.5 GHz, 2.5 GHz, 2.5 GHz, 2.5 GHz, 2.5 GHz, 2.5 GHz, 2.5 GHz, 2.5 GHz DVB-T/H: 174MHz, 400MHz, 790MHz, 862MHz, 1GHz, 4.5GHz, 2.5GHz, 2.5GHz, 2.5GHz, 2.5GHz, 2.5GHz, 2.5GHz, 2.5GHz, 2.5GHz, 2.5GHz, 2.5GHz, 2.5GHz, 2.5GHz LTE, MSR: 150kHz, 30MHz, 1GHz, 1.92GHz, 1.98GHz, 2.1GHz, 12.75GHz, 2.5GHz, 2.5GHz, 2.5GHz, 2.5GHz, 2.5GHz, 2.5GHz, 2.5GHz, 2.5GHz, 2.5GHz, 2.5GHz, 2.5GHz, 2.5GHz LTETDD: 150kHz, 30MHz, 1GHz, 1.90GHz, 2.01GHz, 2.025GHz, 12.75GHz, 2.5GHz, 2.5GHz, 2.5GHz, 2.5GHz, 2.5GHz, 2.5GHz, 2.5GHz, 2.5GHz, 2.5GHz, 2.5GHz, 2.5GHz, 2.5GHz WLAN: 150 kHz, 30 MHz, 1 GHz, 12.75 GHz, 2.5 GHz, 2.5 GHz, 2.5 GHz, 2.5 GHz, 2.5 GHz, 2.5 GHz, 2.5 GHz, 2.5 GHz, 2.5 GHz, 2.5 GHz, 2.5 GHz, 2.5 GHz, 2.5 GHz, 2.5 GHz, 2.5 GHz
<b>State Saved</b>	Saved in instrument state.
<b>Min</b>	-79999990
<b>Max</b>	Hardware Dependent: Option 503: 3.7 GHz Option 508: 8.5 GHz Option 513: 13.8 GHz Option 526: 27.0 GHz
<b>Initial S/W Revision</b>	Prior to A.02.00
<b>Modified at S/W Revision</b>	A.03.00

## Res BW

Sets the resolution bandwidth of the analyzer. This parameter can send up to 20 values.

The location of where the resolution bandwidth occurs in the list sent to the measurement corresponds to the range the value is associated with.

Missing values are not permitted. In other words, if you want to change values 2 and 6 you must send all values up to 6. Subsequent values will remain as they were. The query for this parameter always returns 20 values.

<b>Key Path</b>	Meas Setup, Range Table
<b>Mode</b>	SA, WCDMA, C2K, WIMAX OFDMA, TD-SCDMA, 1xEV-DO, DVB-T/H, LTE, LTETDD, WLAN, MSR, LTEAFDD, LTEATDD
<b>Remote Command</b>	<pre>[ :SENSE ] : SPURious [ :RANGE ] [ :LIST ] : BANDwidth [ :RESolution ] &lt;freq&gt;, &lt;freq&gt;, &lt;freq&gt;, &lt;freq&gt;, &lt;freq&gt;, &lt;freq&gt;, &lt;freq&gt;, &lt;freq&gt;, &lt;freq&gt;, &lt;freq&gt;, &lt;freq&gt;, &lt;freq&gt;, &lt;freq&gt;, &lt;freq&gt;, &lt;freq&gt;, &lt;freq&gt;, &lt;freq&gt;, &lt;freq&gt;, &lt;freq&gt;, &lt;freq&gt;  [ :SENSE ] : SPURious [ :RANGE ] [ :LIST ] : BANDwidth [ :RESolution ] ?  [ :SENSE ] : SPURious [ :RANGE ] [ :LIST ] : BANDwidth [ :RESolution ] : AUTO OFF   ON   0   1, OFF   ON   0   1  [ :SENSE ] : SPURious [ :RANGE ] [ :LIST ] : BANDwidth [ :RESolution ] : AUTO?</pre>
<b>Example</b>	<pre>SPUR:BAND 1kHz, 10kHz, 100kHz, 1MHz, 1MHz, 1MHz, 1MHz, 3MHz, 3MHz, 3MHz, 3MHz, 3MHz, 3MHz, 3MHz, 3MHz, 3MHz, 3MHz, 3MHz, 3MHz, 3MHz, 3MHz SPUR:BAND? SPUR:BWID:AUTO ON, ON, ON, OFF, OFF, OFF, OFF, OFF, ON, ON, ON, ON, OFF, OFF, OFF, OFF, OFF, OFF, ON, ON SPUR:BWID:AUTO?</pre>
<b>Notes</b>	You must be in cdma2000 mode, TD-SCDMA mode, W-CDMA mode, DVB-T/H, GSM/EDGE mode, LTE mode, LTE TDD mode, WLAN mode, MSR, LTE-Advanced FDD/TDD mode or WiMAX mode to use this command. Use INSTRUMENT:SElect to set the mode.
<b>Presets</b>	<pre>SA, WIMAX OFDMA: 1.2MHz, 0.51MHz, 0.1MHz, 0.1MHz, 4MHz, 3MHz, 3MHz, 3MHz, 3MHz, 3MHz, 3MHz, 3MHz, 3MHz, 3MHz, 3MHz, 3MHz, 3MHz, 3MHz, 3MHz, 3MHz, 3MHz WCDMA: 1kHz, 10kHz, 100kHz, 1MHz, 1MHz, 1MHz, 1MHz, 1MHz, 3MHz, 3MHz, 3MHz, 3MHz, 3MHz, 3MHz, 3MHz, 3MHz, 3MHz, 3MHz, 3MHz, 3MHz C2k, 1xEV-DO: 1kHz, 10kHz, 100kHz, 1MHz, 1MHz, 1MHz, 1MHz, 3MHz, 3MHz, 3MHz, 3MHz, 3MHz, 3MHz, 3MHz, 3MHz, 3MHz, 3MHz, 3MHz, 3MHz TD-SCDMA: 1kHz, 10kHz, 100kHz, 1MHz, 3MHz, 3MHz, 3MHz, 3MHz, 3MHz, 3MHz, 3MHz, 3MHz, 3MHz, 3MHz, 3MHz, 3MHz, 3MHz, 3MHz, 3MHz DVB-T/H: 100kHz, 3.9kHz, 100kHz, 3.9kHz, 100kHz, 100kHz, 3MHz, 3MHz, 3MHz, 3MHz, 3MHz, 3MHz, 3MHz, 3MHz, 3MHz, 3MHz, 3MHz, 3MHz, 3MHz LTE, MSR, LTEAFDD: 1kHz, 10kHz, 100kHz, 1MHz, 100kHz, 1MHz, 1MHz, 3MHz, 3MHz, 3MHz, 3MHz, 3MHz, 3MHz, 3MHz, 3MHz, 3MHz, 3MHz, 3MHz, 3MHz, 3MHz LTETDD, LTEATDD: 1kHz, 10kHz, 100kHz, 1MHz, 1MHz, 1MHz, 1MHz, 3MHz, 3MHz, 3MHz, 3MHz, 3MHz, 3MHz, 3MHz, 3MHz, 3MHz, 3MHz, 3MHz, 3MHz WLAN: 1kHz, 10kHz, 100kHz, 1MHz, 3MHz, 3MHz, 3MHz, 3MHz, 3MHz, 3MHz, 3MHz, 3MHz, 3MHz, 3MHz, 3MHz, 3MHz, 3MHz, 3MHz, 3MHz, 3MHz, 3MHz</pre>



	<p>OFF   ON   0   1, OFF   ON   0   1, OFF   ON   0   1, OFF   ON   0   1, OFF   ON   0   1, OFF   ON   0   1, OFF   ON   0   1</p> <p>[ :SENSe ] :SPURious [ :RANGe ] [ :LIST ] :BANDwidth:VIDeo:AUTO?</p>
<b>Example</b>	<p>SPUR:BAND:VID 1kHz, 10kHz, 100kHz, 1MHz, 1MHz, 1MHz, 1MHz, 3MHz, 3MHz, 3MHz, 3MHz, 3MHz, 3MHz, 3MHz, 3MHz, 3MHz, 3MHz, 3MHz, 3MHz</p> <p>SPUR:BAND:VID?</p> <p>SPUR:BAND:VID:AUTO ON, ON, OFF, OFF, OFF, ON, ON, ON, OFF, OFF, OFF, OFF, OFF, OFF, ON, ON, ON, ON, ON</p> <p>SPUR:BAND:VID:AUTO?</p>
<b>Notes</b>	You must be in the cdma2000 mode, 1xEV-DO mode, TD-SCDMA mode, W-CDMA mode, DVB-TH mode, GSM/EDGE mode, LTE mode, LTE TDD mode, WLAN mode, MSR, LTE-Advanced FDD/TDD mode or WiMAX mode to use this command. Use INSTRUMENT:SElect to set the mode.
<b>Preset</b>	<p>SA, WCDMA, C2K, WIMAX OFDMA, TD-SCDMA, 1xEV-DO, DVB-T/H WLAN: Automatically calculated</p> <p>LTE, MSR, LTEATDD: 4.7kHz, 47kHz, 470kHz, 5MHz, 470kHz, 5MHz, 5MHz, 300kHz, ON</p> <p>DVB-T/H: OFF, OFF, OFF, OFF, OFF, OFF, OFF, ON, ON, ON, ON, ON, ON, ON, ON, ON, ON, ON, ON</p> <p>LTE, MSR, LTEAFDD: OFF, OFF, OFF, OFF, OFF, OFF, OFF, ON, ON, ON, ON, ON, ON, ON, ON, ON, ON, ON, ON</p> <p>LTETDD, LTEATDD: OFF, OFF, OFF, OFF, OFF, OFF, OFF, ON, ON, ON, ON, ON, ON, ON, ON, ON, ON, ON, ON</p>
<b>State Saved</b>	Saved in instrument state.
<b>Min</b>	1 Hz
<b>Max</b>	50 MHz
<b>Backwards Compatibility SCPI</b>	[ :SENSe ] :SPURious [ :RANGe ] [ :LIST ] :BWIDth:VIDeo
<b>Initial S/W Revision</b>	Prior to A.02.00
<b>Modified at S/W Revision</b>	A.03.00

### Filter Type

In addition to the Gaussian filter shape, there are certain special filter types, such as Flat Top, that are desirable under certain conditions. The Filter Type menu gives you control over these parameters.

<b>Key Path</b>	Meas Setup, Range Table
<b>Mode</b>	SA, WCDMA, C2K, WIMAX OFDMA, TD-SCDMA, 1xEV-DO, DVB-T/H, LTE, LTETDD, WLAN, MSR, LTEAFDD, LTEATDD
<b>Remote Command</b>	[ :SENSe ] :SPURious [ :RANGe ] [ :LIST ] :BANDwidth:SHAPE GAUSSian   FLATtop,



	CALC:SPUR:LIM:ABS:DATA?
Preset	SA, WIMAX OFDMA: -5.00000000E+001, -5.00000000E+001, -5.00000000E+001, - 5.00000000E+001, -5.00000000E+001, -5.00000000E+001, -5.00000000E+001, - 5.00000000E+001, -5.00000000E+001, -5.00000000E+001, -5.00000000E+001, - 5.00000000E+001, -5.00000000E+001, -5.00000000E+001, -5.00000000E+001, - 5.00000000E+001, -5.00000000E+001, -5.00000000E+001, -5.00000000E+001, - 5.00000000E+001 WCDMA: -36dBm, -36dBm, -36dBm, -30dBm, -25dBm, -15dBm, -25dBm, -30dBm, -50dBm, - 50dBm, -50dBm, -50dBm, -50dBm, -50dBm, -50dBm, -50dBm, -50dBm, -50dBm, - 50dBm C2K, 1xEV-DO: -13 dBm, -13dBm, -13 dBm, -13 dBm, -50 dBm, -50 dBm, -50 dBm, -50 dBm, -50 dBm, -50 dBm, -50 dBm, -50 dBm, -50 dBm, -50 dBm, -50 dBm, -50 dBm, -50 dBm, -50 dBm, -50 dBm, -50 dBm TD-SCDMA: -13 dBm, -13dBm, -13 dBm, -13 dBm, -50 dBm, -50 dBm, -50 dBm, -50 dBm, -50 dBm, -50 dBm, -50 dBm, -50 dBm, -50 dBm, -50 dBm, -50 dBm, -50 dBm, -50 dBm, -50 dBm, -50 dBm, -50 dBm DVB-T/H: -36dBm, -82dBm, -36dBm, -76dBm, -36dBm, -30dBm, -50dBm, -50dBm, -50dBm, -50dBm, - 50dBm, -50dBm, -50dBm, -50dBm, -50dBm, -50dBm, -50dBm, -50dBm, -50dBm, -50dBm LTE, MSR, LTEAFDD: -36dBm, -36dBm, -36dBm, -30dBm, -96dBm, -30dBm, -30dBm, -50dBm, -50dBm, -50dBm, -50dBm, -50dBm, -50dBm, -50dBm, -50dBm, -50dBm, -50dBm, -50dBm, -50dBm, -50dBm LTETDD, LTEATDD: -36dBm, -36dBm, -36dBm, -30dBm, -96dBm, -30dBm, -30dBm, -50dBm, - 50dBm, -50dBm, -50dBm, -50dBm, -50dBm, -50dBm, -50dBm, -50dBm, -50dBm, -50dBm, - 50dBm, -50dBm WLAN: -36dBm, -36dBm, -36dBm, -30dBm, -50dBm, -50dBm, -50dBm, -50dBm, -50dBm, -50dBm, - 50dBm, -50dBm, -50dBm, -50dBm, -50dBm, -50dBm, -50dBm, -50dBm, -50dBm, -50dBm
State Saved	Saved in instrument state.
Min	-150.0 dBm
Max	50.0 dBm
Initial S/W Revision	Prior to A.02.00
Modified at S/W Revision	A.03.00

### Abs Stop Limit

Abs Stop Limit is used to determine the limit above which spurs will report a failing. If Abs Stop Limit Mode is set to Auto, this is coupled to Abs Start Limit to make a flat limit line. If set to Man, Abs Start Limit and Abs Stop Limit can take different values to make a sloped limit line.

Abs Stop Limit Mode, when set to Couple, couples Abs Start Limit and Abs Stop Limit to make a flat limit line. If set to Man, Abs Start and Abs Stop can take different values to make a sloped limit line.

This parameter can send up to 20 values. The location in the list sent corresponds to the range of the associated value. Missing values are not permitted; that is, if you want to change values 2 and 6 you must send all values up to 6. Subsequent values will remain as they were. The query for this parameter always returns 20 values.

Key Path	Meas Setup, Range Table
Mode	SA, WCDMA, C2K, WIMAX OFDMA, TD-SCDMA, 1xEV-DO, DVB-T/H, LTE, LTETDD, WLAN, MSR, LTEAFDD, LTEATDD
Remote Command	<pre> :CALCulate:SPURious[:RANGe][:LIST]:LIMit:ABSolute[:UPPer]:DATA:STOP &lt;ampl&gt;, &lt;ampl&gt;  :CALCulate:SPURious[:RANGe][:LIST]:LIMit:ABSolute[:UPPer]:DATA:STOP?  :CALCulate:SPURious[:RANGe][:LIST]:LIMit:ABSolute [:UPPer]:DATA:STOP:AUTO OFF   ON   0   1, OFF   ON   0   1  :CALCulate:SPURious[:RANGe][:LIST]:LIMit:ABSolute [:UPPer]:DATA:STOP:AUTO? </pre>
Example	<pre> CALC:SPUR:LIM:ABS:DATA:STOP -25, -25, -25, -25, -25, -25, -25, -25, -25, -25, -25, -25, - 25, -25, -25, -25, -25, -25, -25 CALC:SPUR:LIM:ABS:DATA:STOP? CALC:SPUR:LIM:ABS:DATA:STOP:AUTO ON, ON, ON, ON, ON, ON, ON, ON, ON, ON, ON, ON, ON, ON, ON, ON, ON, ON, ON CALC:SPUR:LIM:ABS:DATA:STOP:AUTO? </pre>
Preset	<pre> SA, WIMAX OFDMA: -5.00000000E+001, -5.00000000E+001, -5.00000000E+001, - 5.00000000E+001, -5.00000000E+001, -5.00000000E+001, -5.00000000E+001, - 5.00000000E+001, -5.00000000E+001, -5.00000000E+001, -5.00000000E+001, - 5.00000000E+001, -5.00000000E+001, -5.00000000E+001, -5.00000000E+001, - 5.00000000E+001, -5.00000000E+001, -5.00000000E+001, -5.00000000E+001, - 5.00000000E+001  WCDMA: -36dBm, -36dBm, -36dBm, -30dBm, -25dBm, -15dBm, -25dBm, -30dBm, -50dBm, - 50dBm, -50dBm, -50dBm, -50dBm, -50dBm, -50dBm, -50dBm, -50dBm, -50dBm, - 50dBm  C2K, 1xEV-DO: -13 dBm, -13dBm, -13 dBm, -13 dBm, -50 dBm, -50 dBm, -50 dBm, -50 dBm, -50 dBm, -50 dBm, -50 dBm, -50 dBm, -50 dBm, -50 dBm, -50 dBm, -50 dBm, -50 dBm, -50 dBm, -50 dBm, -50 dBm  TD-SCDMA: -13 dBm, -13dBm, -13 dBm, -13 dBm, -50 dBm, -50 dBm, -50 dBm, -50 dBm, -50 dBm, -50 dBm, -50 dBm, -50 dBm, -50 dBm, -50 dBm, -50 dBm, -50 dBm, -50 dBm, -50 dBm, -50 dBm  DVB-T/H: -36dBm, -82dBm, -36dBm, -76dBm, -36dBm, -30dBm, -50dBm, -50dBm, -50dBm, -50dBm, - 50dBm, -50dBm, -50dBm, -50dBm, -50dBm, -50dBm, -50dBm, -50dBm, -50dBm, -50dBm </pre>

	LTE, MSR, LTEAFDD: -36dBm, -36dBm, -36dBm, -30dBm, -96dBm, -30dBm, -30dBm, -50dBm, -50dBm, -50dBm, -50dBm, -50dBm, -50dBm, -50dBm, -50dBm, -50dBm, -50dBm, -50dBm, -50dBm, -50dBm LTETDD, LTEATDD: -36dBm, -36dBm, -36dBm, -52dBm, -52dBm, -30dBm, -30dBm, -50dBm, -50dBm, -50dBm, -50dBm, -50dBm, -50dBm, -50dBm, -50dBm, -50dBm, -50dBm, -50dBm, -50dBm, -50dBm WLAN: -36dBm, -36dBm, -36dBm, -30dBm, -50dBm, -50dBm, -50dBm, -50dBm, -50dBm, -50dBm, -50dBm, -50dBm, -50dBm, -50dBm, -50dBm, -50dBm, -50dBm, -50dBm, -50dBm, -50dBm ON, ON, ON, ON, ON, ON, ON, ON, ON, ON, ON, ON, ON, ON, ON, ON, ON, ON, ON, ON
State Saved	Saved in instrument state.
Min	-150.0 dBm
Max	50.0 dBm
Initial S/W Revision	Prior to A.02.00
Modified at S/W Revision	A.03.00

### Peak Excursion

Sets the minimum amplitude variation of signals that can be identified as peaks. If a value of 6 dB is selected, peaks that rise and fall more than 6 dB above the peak threshold value are identified.

This parameter can send up to 20 values. The location in the list sent corresponds to the range of the associated value. Missing values are not permitted. If you want to change values 2 and 6 you must send all values up to 6. Subsequent values will remain as they were. The query for this parameter always returns 20 values.

Key Path	Meas Setup, Range Table
Mode	SA, WCDMA, C2K, WIMAX OFDMA, TD-SCDMA, 1xEV-DO, DVB-T/H, LTE, LTETDD, WLAN, MSR, LTEAFDD, LTEATDD
Remote Command	<pre>[ :SENSE ] : SPURious [ :RANGE ] [ :LIST ] : PEAK : EXCursion &lt;rel_ampl&gt;, &lt;rel_ampl&gt;, &lt;rel_ampl&gt;, &lt;rel_ampl&gt;, &lt;rel_ampl&gt;, &lt;rel_ampl&gt;, &lt;rel_ampl&gt;, &lt;rel_ampl&gt;, &lt;rel_ampl&gt;, &lt;rel_ampl&gt;, &lt;rel_ampl&gt;, &lt;rel_ampl&gt;, &lt;rel_ampl&gt;, &lt;rel_ampl&gt;, &lt;rel_ampl&gt;, &lt;rel_ampl&gt;, &lt;rel_ampl&gt;, &lt;rel_ampl&gt;, &lt;rel_ampl&gt;, &lt;rel_ampl&gt;</pre> <pre>[ :SENSE ] : SPURious [ :RANGE ] [ :LIST ] : PEAK : EXCursion?</pre>
Example	<pre>SPUR:PEAK:EXC 20, 20</pre> <pre>SPUR:PEAK:EXC?</pre>
Preset	<pre>+6.00000000E+000, +6.00000000E+000, +6.00000000E+000, +6.00000000E+000, +6.00000000E+000, +6.00000000E+000, +6.00000000E+000, +6.00000000E+000, +6.00000000E+000, +6.00000000E+000, +6.00000000E+000, +6.00000000E+000, +6.00000000E+000, +6.00000000E+000, +6.00000000E+000, +6.00000000E+000, +6.00000000E+000, +6.00000000E+000, +6.00000000E+000, +6.00000000E+000</pre>
State Saved	Saved in instrument state.
Min	0.0 dB



Max	100.0 dB
Initial S/W Revision	Prior to A.02.00
Modified at S/W Revision	A.03.00

## Pk Threshold

Sets the minimum amplitude of signals that can be identified as peaks. For example, if a value of -90 dBm is selected, only peaks that rise and fall more than the peak excursion value which are above -90 dBm are identified.

This parameter can send up to 20 values. The location in the list sent corresponds to the range of the associated value. Missing values are not permitted. If you want to change values 2 and 6 you must send all values up to 6. Subsequent values will remain as they were. The query for this parameter always returns 20 values.

Key Path	Meas Setup, Range Table
Mode	SA, WCDMA, C2K, WIMAX OFDMA, TD-SCDMA, 1xEV-DO, DVB-T/H, LTE, LTETDD, WLAN, MSR, LTEAFDD, LTEATDD
Remote Command	[:SENSe]:SPURious[:RANGe][:LIST]:PEAK:THReshold <real>, <real>, <real>, <real>, <real>, <real>, <real>, <real>, <real>, <real>, <real>, <real>, <real>, <real>, <real>, <real>, <real>, <real>  [:SENSe]:SPURious[:RANGe][:LIST]:PEAK:THReshold?
Example	SPUR:PEAK:THR 0,0,0 SPUR:PEAK:THR?
Preset	-9.00000000E+001, -9.00000000E+001, -9.00000000E+001, -9.00000000E+001, -9.00000000E+001, -9.00000000E+001, -9.00000000E+001, -9.00000000E+001, -9.00000000E+001, -9.00000000E+001, -9.00000000E+001, -9.00000000E+001, -9.00000000E+001, -9.00000000E+001, -9.00000000E+001, -9.00000000E+001, -9.00000000E+001
State Saved	Saved in instrument state.
Min	-200
Max	0
Initial S/W Revision	Prior to A.02.00
Modified at S/W Revision	A.03.00, A.07.00

## Attenuation

Defines attenuation value for each range.

- When Auto state is ON, attenuation value under AMPTD Y Scale is used.
- When Auto state is OFF, this value is used as mechanical attenuation value without electric attenuation.

Key Path	Meas Setup, Range Table
Mode	SA, WCDMA, C2K, WIMAX OFDMA, TD-SCDMA, 1xEV-DO, DVB-T/H, LTE, LTETDD, WLAN, MSR, LTEAFDD, LTEATDD
Remote Command	<pre>[:SENSe]:SPURious[:RANGe][:LIST]:ATTenuation &lt;rel_ampl&gt;, &lt;rel_ampl&gt;, &lt;rel_ampl&gt;, &lt;rel_ampl&gt;, &lt;rel_ampl&gt;, &lt;rel_ampl&gt;, &lt;rel_ampl&gt;, &lt;rel_ampl&gt;, &lt;rel_ampl&gt;, &lt;rel_ampl&gt;, &lt;rel_ampl&gt;, &lt;rel_ampl&gt;, &lt;rel_ampl&gt;, &lt;rel_ampl&gt;, &lt;rel_ampl&gt;, &lt;rel_ampl&gt;, &lt;rel_ampl&gt;, &lt;rel_ampl&gt;, &lt;rel_ampl&gt;, &lt;rel_ampl&gt;  [:SENSe]:SPURious[:RANGe][:LIST]:ATTenuation?  [:SENSe]:SPURious[:RANGe][:LIST]:ATTenuation:AUTO OFF   ON   0   1, OFF  [:SENSe]:SPURious[:RANGe][:LIST]:ATTenuation:AUTO?</pre>
Example	<pre>SPUR:ATT 10dB, 10dB, 10dB, 10dB, 10dB, 10dB, 10dB, 10dB, 10dB, 10dB, 10dB, 10dB, 10dB, 10dB, 10dB, 10dB, 10dB, 10dB, 10dB, 10dB SPUR:ATT? SPUR:ATT:AUTO 0, 0, 0, 0, 0, 0, 0, 0, 0, 0, 0, 0, 0, 0, 0, 0, 0, 0, 0, 0 SPUR:ATT:AUTO?</pre>
Notes	You must be in cdma2000 mode, 1xEV-DO mode, TD-SCDMA mode, W-CDMA mode, DVB-T/H, SA mode, LTE mode, LTE TDD mode, WLAN mode, MSR, LTE-Advanced FDD/TDD or WiMAX mode to use this command. Use INSTRUMENT:SElect to set the mode.
Couplings	“---“ is displayed as value when Auto state is ON, to indicate attenuation value under AMPTD Y Scale is being used.
Preset	<pre>10dB, 10dB ON, ON, ON, ON, ON, ON, ON, ON, ON, ON, ON, ON, ON, ON, ON, ON, ON, ON, ON, ON</pre>
State Saved	Saved in instrument state.
Min	0 dB
Max	70 dB
Initial S/W Revision	Prior to A.02.00
Modified at S/W Revision	A.03.00

## Detector 1

Sets the detector to be used by the trace for spur detection and limit line testing.

Key Path	Meas Setup, Range Table
Mode	SA, WCDMA, C2K, WIMAX OFDMA, TD-SCDMA, 1xEV-DO, DVB-T/H, LTE, LTETDD, WLAN, MSR, LTEAFDD, LTEATDD
Remote Command	[:SENSe]:SPURious[:RANGe][:LIST]:DETector[1][:FUNction] AVERage

	<p>NEGative   NORMal   POSitive   SAMPlE   RMS, AVERage   NEGative            NORMal   POSitive   SAMPlE   RMS, AVERage   NEGative   NORMal            POSitive   SAMPlE   RMS, AVERage   NEGative   NORMal   POSitive            SAMPlE   RMS, AVERage   NEGative   NORMal   POSitive   SAMPlE   RMS,          AVERage   NEGative   NORMal   POSitive   SAMPlE   RMS, AVERage            NEGative   NORMal   POSitive   SAMPlE   RMS, AVERage   NEGative            NORMal   POSitive   SAMPlE   RMS, AVERage   NEGative   NORMal            POSitive   SAMPlE   RMS, AVERage   NEGative   NORMal   POSitive            SAMPlE   RMS, AVERage   NEGative   NORMal   POSitive   SAMPlE   RMS,          AVERage   NEGative   NORMal   POSitive   SAMPlE   RMS, AVERage            NEGative   NORMal   POSitive   SAMPlE   RMS, AVERage   NEGative            NORMal   POSitive   SAMPlE   RMS, AVERage   NEGative   NORMal            POSitive   SAMPlE   RMS, AVERage   NEGative   NORMal   POSitive            SAMPlE   RMS, AVERage   NEGative   NORMal   POSitive   SAMPlE   RMS,          AVERage   NEGative   NORMal   POSitive   SAMPlE   RMS, AVERage            NEGative   NORMal   POSitive   SAMPlE   RMS, AVERage   NEGative            NORMal   POSitive   SAMPlE   RMS</p> <p>[[:SENSe]:SPURious[:RANGe]][:LIST]:DETEctor[1][:FUNction]?</p>
<b>Example</b>	<p>SPUR:DET NORM, NORM, NORM, NORM, NORM, NORM, NORM, NORM, NORM, NORM, NORM,          NORM, NORM, NORM, NORM, NORM, NORM, NORM, NORM, NORM, NORM,          SPUR:DET?</p>
<b>Notes</b>	<p>For backward compatibility, “NORMal” is available as a SCPI command parameter. However this is treated the same as “RMS” internally, so the query never returns “NORMal” as its results.</p>
<b>Preset</b>	<p>POS, POS, POS, POS, POS, POS, POS, POS, POS, POS, POS, POS, POS, POS, POS, POS,          POS, POS</p>
<b>State Saved</b>	<p>Saved in instrument state.</p>
<b>Range</b>	<p>Normal Average Peak Sample Negative Peak</p>
<b>Initial S/W Revision</b>	<p>Prior to A.02.00</p>
<b>Modified at S/W Revision</b>	<p>A.03.00</p>

## Detector 2

Sets the detector to be used by the trace for display purposes only.

<b>Key Path</b>	<p>Meas Setup, Range Table</p>
<b>Mode</b>	<p>SA, WCDMA, C2K, WIMAX OFDMA, TD-SCDMA, 1xEV-DO, DVB-T/H, LTE, LTEATDD, WLAN, MSR, LTEAFDD, LTEATDD</p>
<b>Remote Command</b>	<p>[[:SENSe]:SPURious[:RANGe]][:LIST]:DETEctor2[:FUNction] OFF   AVERage            NEGative   NORMal   POSitive   SAMPlE   RMS, OFF   AVERage   NEGative            NORMal   POSitive   SAMPlE   RMS, OFF   AVERage   NEGative   NORMal            POSitive   SAMPlE   RMS, OFF   AVERage   NEGative   NORMal   POSitive            SAMPlE   RMS, OFF   AVERage   NEGative   NORMal   POSitive   SAMPlE            RMS, OFF   AVERage   NEGative   NORMal   POSitive   SAMPlE   RMS, OFF            AVERage   NEGative   NORMal   POSitive   SAMPlE   RMS, OFF   AVERage            NEGative   NORMal   POSitive   SAMPlE   RMS, OFF   AVERage   NEGative            NORMal   POSitive   SAMPlE   RMS, OFF   AVERage   NEGative   NORMal            POSitive   SAMPlE   RMS, OFF   AVERage   NEGative   NORMal   POSitive            SAMPlE   RMS, OFF   AVERage   NEGative   NORMal   POSitive   SAMPlE  </p>

	<pre>RMS, OFF   AVERAge   NEGAtive   NORMAl   POSitive   SAMPlE   RMS, OFF   AVERAge   NEGAtive   NORMAl   POSitive   SAMPlE   RMS, OFF   AVERAge   NEGAtive   NORMAl   POSitive   SAMPlE   RMS, OFF   AVERAge   NEGAtive   NORMAl   POSitive   SAMPlE   RMS, OFF   AVERAge   NEGAtive   NORMAl   POSitive   SAMPlE   RMS, OFF   AVERAge   NEGAtive   NORMAl   POSitive   SAMPlE   RMS, OFF   AVERAge   NEGAtive   NORMAl   POSitive   SAMPlE   RMS, OFF   AVERAge   NEGAtive   NORMAl   POSitive   SAMPlE   RMS</pre> <pre>[[:SENSe]:SPURious[:RANGe][:LIST]:DETEctor2[:FUNction]?</pre>
<b>Example</b>	<pre>SPUR:DET2 AVER, AVER, AVER, AVER, AVER, AVER, AVER, AVER, AVER, AVER, AVER, AVER, AVER, AVER, AVER, AVER, AVER, AVER, AVER, AVER SPUR:DET2?</pre>
<b>Notes</b>	For backward compatibility, "NORMAl" is available as a SCPI command parameter. However this is treated same as "RMS" internally, so the query never returns "NORMAl" as its results.
<b>Preset</b>	OFF, OFF, OFF, OFF, OFF, OFF, OFF, OFF, OFF, OFF, OFF, OFF, OFF, OFF, OFF, OFF, OFF, OFF
<b>State Saved</b>	Saved in instrument state.
<b>Range</b>	Off  Normal Average Peak Sample Negative Peak
<b>Initial S/W Revision</b>	Prior to A.02.00
<b>Modified at S/W Revision</b>	A.03.00

## Sweep Time

Sets the sweep time mode of the analyzer. This can be Auto, where the analyzer determines the optimum setting, or Manual, where you determine the setting.

This parameter can send up to 20 values. The location in the list sent corresponds to the range of the associated value. Missing values are not permitted. If you want to change values 2 and 6 you must send all values up to 6. Subsequent values will remain as they were. The query for this parameter always returns 20 values.

<b>Key Path</b>	Meas Setup, Range Table
<b>Mode</b>	SA, WCDMA, C2K, WIMAX OFDMA, TD-SCDMA, 1xEV-DO, DVB-T/H, LTE, LTETDD, WLAN, MSR, LTEAFDD, LTEATDD
<b>Remote Command</b>	<pre>[[:SENSe]:SPURious[:RANGe][:LIST]:SWEep:TIME &lt;time&gt;, &lt;time&gt;, &lt;time&gt;, &lt;time&gt;, &lt;time&gt;, &lt;time&gt;, &lt;time&gt;, &lt;time&gt;, &lt;time&gt;, &lt;time&gt;, &lt;time&gt;, &lt;time&gt;, &lt;time&gt;, &lt;time&gt;, &lt;time&gt;, &lt;time&gt;, &lt;time&gt;, &lt;time&gt;, &lt;time&gt;, &lt;time&gt;</pre> <pre>[[:SENSe]:SPURious[:RANGe][:LIST]:SWEep:TIME?</pre> <pre>[[:SENSe]:SPURious[:RANGe][:LIST]:SWEep:TIME:AUTO OFF   ON   0   1, OFF   ON   0   1, OFF   ON   0   1, OFF   ON   0   1, OFF   ON   0   1, OFF   ON   0   1, OFF   ON   0   1, OFF   ON   0   1, OFF   ON   0   1, OFF   ON   0   1, OFF   ON   0   1, OFF   ON   0   1, OFF   ON   0   1, OFF   ON   0   1, OFF   ON   0   1, OFF   ON   0   1</pre> <pre>[[:SENSe]:SPURious[:RANGe][:LIST]:SWEep:TIME:AUTO?</pre>
<b>Example</b>	SPUR:SWE:TIME 10, 10, 10, 10, 10, 10, 10, 10, 10, 10, 10, 10, 10, 10, 10, 10, 10, 10, 10, 10

	<p>SPUR:SWE:TIME?</p> <p>SPUR:SWE:TIME:AUTO ON, ON</p> <p>SPUR:SWE:TIME:AUTO?</p>
Notes	You must be in cdma2000 mode, TD-SCDMA mode, W-CDMA mode, DVB-T/H, SA mode, LTE mode, LTE TDD mode, WLAN mode, MSR, LTE-Advanced FDD/TDD mode or WiMAX mode to use this command. Use INSTRument:SElect to set the mode.
Preset	Automatically calculated
State Saved	Saved in instrument state.
Min	1.0E-3
Max	2.0E+3
Initial S/W Revision	Prior to A.02.00
Modified at S/W Revision	A.03.00

## Points

Sets the number of points per sweep for the measurement. This parameter can send up to 20 values. The location in the list sent corresponds to the range of the associated value. Missing values are not permitted. If you want to change values 2 and 6 you must send all values up to 6. Subsequent values will remain as they were. The query for this parameter always returns 20 values.

The Points mode can be manual, where you determine the setting or auto, where the analyzer determines the number of trace points to ensure the sweep points resolution equals RBW/2. This is calculated using the following algorithm:

Points = (Stop Freq – Start Freq) / (ResBW / 2), with the computed values being clipped to a minimum of 601 and a maximum of 20001.

This parameter can send up to 20 values. The location in the list sent corresponds to the range the value is associated with. Missing values are not permitted; that is, if you want to change values 2 and 6 you must send all values up to 6. Subsequent values will remain as they were. The query for this parameter always returns 20 values.

Key Path	Meas Setup, Range Table
Mode	SA, WCDMA, C2K, WIMAX OFDMA, TD-SCDMA, 1xEV-DO, DVB-T/H, LTE, LTETDD, WLAN, MSR, LTEAFDD, LTEATDD
Remote Command	<pre>[ :SENSe ] :SPURious [ :RANGe ] [ :LIST ] :SWEep:POINTs &lt;integer&gt;  [ :SENSe ] :SPURious [ :RANGe ] [ :LIST ] :SWEep:POINTs?  [ :SENSe ] :SPURious [ :RANGe ] [ :LIST ] :SWEep:POINTs:AUTO OFF   ON   0   1, OFF   ON   0   1, OFF   ON   0   1, OFF   ON   0   1, OFF   ON   0   1, OFF   ON   0   1, OFF   ON   0   1, OFF   ON   0   1, OFF   ON   0   1, OFF   ON   0   1, OFF   ON   0   1, OFF   ON   0   1, OFF   ON   0   1, OFF   ON   0   1, OFF   ON   0   1, OFF   ON   0   1, OFF   ON   0   1, OFF   ON   0   1, OFF   ON   0   1, OFF   ON   0   1  [ :SENSe ] :SPURious [ :RANGe ] [ :LIST ] :SWEep:POINTs:AUTO?</pre>

<b>Example</b>	SPUR:SWE:POIN 1001,1001,1001 SPUR:SWE:POIN? SPUR:SWE:POIN:AUTO ON,ON,ON SPUR:SWE:POIN:AUTO?
Preset	SA, WIMAX OFDMA, DVB-T/H, WLAN: +601, +601, +601, +601, +601, +601, +601, +601, +601, +601, +601, +601, +601, +601, +601 WCDMA: 601, 2985, 9700, 1100, 601, 601, 601, 10570, 601, 601, 601, 601, 601, 601, 601, 601 C2K: 601, 601, 9970, 11750, , 601, 601, 601, 601, 601, 601, 601, 601, 601, 601, 601, 601, 601 CDMA1xEVDO: 601, 601, 9970, 11750, 601, 601, 601, 10570, 601, 601, 601, 601, 601, 601, 601 TD-SCDMA: 601, 5970, 19400, 20001, 601, 601, 601, 601, 601, 601, 601, 601, 601, 601, 601, 601 LTE, LTETDD, MSR, LTEAFDD, LTEATDD : Automatically calculated. WLAN: Automatically calculated. OFF, OFF, OFF, OFF, OFF, OFF, OFF, OFF, OFF, OFF, OFF, OFF, OFF, OFF, OFF, OFF, OFF, OFF, OFF LTE, LTETDD, WLAN, MSR, LTEAFDD, LTEATDD: ON, ON, ON, ON, ON, ON, ON, ON, ON, ON, ON, ON, ON, ON, ON, ON, ON, ON, ON
State Saved	Saved in instrument state.
Min	101
Max	20001
Initial S/W Revision	Prior to A.02.00
Modified at S/W Revision	A.03.00

### IF Gain

Sets the IF Gain function to Auto, On (the extra 10 dB) or Off. These settings affect sensitivity and IF overloads. A switched IF amplifier with approximately 10 dB of gain is available. This amplifier takes full advantage of the RF dynamic range of the analyzer. When it can be turned on without an overload, the dynamic range is always better with the amplifier on than off.

<b>Key Path</b>	Meas Setup, Range Table
Dependencies	The IF Gain keys (FFT IF Gain and Swept IF Gain) have no effect when the U7227A USB Preamplifier is connected. This is not annotated or reflected on any softkey; there are no keys grayed out nor any SCPI locked out. The analyzer simply behaves as though both FFT IF Gain and Swept IF Gain are set to Low regardless of the setting on the keys.
Initial S/W Revision	Prior to A.02.00

### IF Gain Auto

Activates the rules for auto IF Gain.



## Meas Type

Selects either Examine or Full measurement type. This parameter is coupled to the average mode. Therefore, if the examine measurement type is selected, the measurement sets the average mode to exponential. If the full measurement type is selected, the measurement sets the average mode to repeat. The behavior of each measurement type is described in the table below. When averaging is on, trace averaging is used as each active range is measured. Averaging is not used at any other time.

Type	Single	Continuous			
No Spurs Found	Spurs Found	No Spurs Found	Spurs Found		
<b>Examine</b>	All active ranges are measured. On completion the measurement is set to the idle state and the 'No Spurs' happening is displayed.	All active ranges are measured and the spurs found reported. On completion the measurement is set to the idle state and the trace containing the worst spur restored. The spur menu key is enabled. A marker is also added which is set to the frequency of the worst spur.	All active ranges are measured. On completion the SA remains set to last range checked with an active trace and the 'No Spurs' happening is displayed.	All active ranges are measured and the spurs found reported. On completion the SA is set to the range containing the worst spur found and continually sweeps this range. Note that the trace is continually updated but the metrics results aren't updated until restart to keep the initial results as references. Use marker readouts to refer the latest results. The spur menu key is enabled. A marker is also added which is set to the frequency of the worst spur.	
<b>Full</b>	All active ranges are measured. On completion measurement is set to idle state and the 'No Spurs' happening is displayed.	All active ranges are measured and spurs found reported. On completion the measurement is set to the idle state, displaying the trace of the last active range.	Measurement continually cycles through all active ranges.	All active ranges are measured and spurs found reported. On each cycle of the active ranges the spurs found are reset. This ensures any remote queries retrieve the trace data that matches the currently displayed results.	

<b>Key Path</b>	Meas Setup
<b>Mode</b>	SA, WCDMA, C2K, WIMAX OFDMA, TD-SCDMA, 1xEV-DO, DVB-T/H, LTE, LTEFDD, LTEATDD
<b>Remote Command</b>	[ :SENSe ] :SPURious:TYPE EXAMine FULL [ :SENSe ] :SPURious:TYPE?
<b>Example</b>	SPUR:TYPE FULL SPUR:TYPE?
<b>Preset</b>	EXAMine
<b>State Saved</b>	Saved in instrument state.
<b>Range</b>	Examine Full



Initial S/W Revision	Prior to A.02.00
Modified at S/W Revision	A.03.00

## Spur

Displays any spurs found. It is only enabled when the measurement type is set to examine and will turn on upon completion of a measurement. Once the Spur menu key has been enabled, you can view any spur. The measurement sets the analyzer to the range in which the currently selected spur was found. The range settings only changes if the spur selected is in a range which is different from the current range settings. A marker is used to identify the currently selected spur on the trace.

Key Path	Meas Setup
Mode	SA, WCDMA, C2K, WIMAX OFDMA, CDMA1xEVDO, TD-SCDMA, DVB-T/H, LTE, LTETDD, WLAN, MSR, LTEAFDD, LTEATDD
<b>Remote Command</b>	<code>[ :SENSe ] :SPURious:SPUR &lt;integer&gt;</code> <code>[ :SENSe ] :SPURious:SPUR?</code>
<b>Example</b>	SPUR:SPUR 55 SPUR:SPUR?
Preset	1
State Saved	No
Min	1
Max	200
Initial S/W Revision	Prior to A.02.00
Modified at S/W Revision	A.03.00

## Spurious Report Mode

Selects the spurious report mode.

- Select Limit Line Test (LIMTest) to report only spurs above the limit line. Any spurs reported will cause the measurement to fail. See Abs Start Limit for more information.
- Select All Spurs (ALL) to report all spurs detected by Peak Threshold and Peak Excursion.
- Select Minimum Margin (MMARgin) to report only the spur with the minimum margin from the limit line. For the spur above the limit, its margin is defined as the negative margin. If there are more than one spurs above the limit, only one spur with the largest negative margin is reported.

Key Path	Meas Setup
Mode	SA, WCDMA, C2K, WIMAX OFDMA, TD-SCDMA, 1xEV-DO, DVB-T/H, LTE, LTETDD, WLAN, MSR, LTEAFDD, LTEATDD
<b>Remote Command</b>	<code>[ :SENSe ] :SPURious:REPT:MODE ALL LIMTest MMARgin</code> <code>[ :SENSe ] :SPURious:REPT:MODE?</code>

<b>Example</b>	SPUR:REPT:MODE LIMT SPUR:REPT:MODE?
Dependencies	MMARgin is available only when option N9060A-7FP is installed.
Preset	ALL
State Saved	Saved in instrument state.
Range	All Spurs Limit Test Minimum Margin
Initial S/W Revision	Prior to A.02.00
Modified at S/W Revision	A.03.00, A.11.00

### Meas Preset

Restores all measurement parameters to their default values.

Key Path	Meas Setup
Mode	SA, WCDMA, C2K, WIMAX OFDMA, TD-SCDMA, 1xEV-DO, DVB-T/H, LTE, LTE-TDD, WLAN, MSR, LTEAFDD, LTEATDD
<b>Remote Command</b>	:CONFigure:SPURious
<b>Example</b>	CONF:SPUR
Initial S/W Revision	Prior to A.02.00
Modified at S/W Revision	A.03.00

### Fast Spurious Meas (Remote Command only)

This command is provided as the backward compatibility SCPI command of the Fast Spurious Measurement. Since this command is another representation of Spurious Report Mode, this command is coupled with the command.

When set to ON, only spurs above the limit line are reported. This is the same as Spurious Report Mode "LIMTest".

When set to OFF, all detected spurs are reported. This is the same as Spurious Report Mode "ALL."

Mode	SA, WCDMA, C2K, WIMAX OFDMA, TD-SCDMA, 1xEV-DO, DVB-T/H, WLAN, MSR, LTEAFDD, LTEATDD
<b>Remote Command</b>	[ :SENSe ] :SPURious :FSMeas ON OFF 1 0 [ :SENSe ] :SPURious :FSMeas?
<b>Example</b>	SPUR:FSM ON SPUR:FSM?
Couplings	If SPUR:REPT:MODE is ALL, this parameter is OFF. If SPUR:REPT:MODE is LIMTest, this parameter is ON.
Preset	OFF

---

State Saved	Saved in instrument state.
Initial S/W Revision	A.04.00

---

14 Spurious Emissions Measurement  
Mode

Mode

See "[Mode](#)" on page 298

## Mode Preset

Returns the active mode to a known state.

Mode Preset does the following for the currently active mode:

- Aborts the currently running measurement.
- Brings up the default menu for the mode, with no active function.
- Sets measurement Global settings to their preset values for the active mode only.
- Activates the default measurement.
- Brings up the default menu for the mode.
- Clears the input and output buffers.
- Sets Status Byte to 0.

Mode Preset does not:

- Cause a mode switch
- Affect mode persistent settings
- Affect system settings

See "[How-To Preset](#)" on page 1822 for more information.

Key Path	Front-panel key
<b>Remote Command</b>	:SYSTem:PRESet
<b>Example</b>	:SYST:PRES
Notes	*RST is preferred over :SYST:PRES for remote operation. *RST does a Mode Preset, as done by the :SYST:PRES command, and it sets the measurement mode to Single measurement rather than Continuous for optimal remote control throughput. Clears all pending OPC bits. The Status Byte is set to 0.
Couplings	A Mode Preset aborts the currently running measurement, activates the default measurement, and gets the mode to a consistent state with all of the default couplings set.
Backwards Compatibility Notes	In the X-Series, the legacy "Factory Preset" has been replaced with Mode Preset, which only presets the currently active mode, not the entire instrument. In the X-Series, the way to preset the entire instrument is by using System, Restore System Defaults All, which behaves essentially the same way as restore System Defaults does on ESA and PSA. There is also no "Preset Type" as there is on the PSA. There is a green Mode Preset front-panel key that does a Mode Preset and a white-with-green-letters User Preset front-panel key that does a User Preset. The old PRESet:TYPE command is ignored (without generating an error), and SYST:PRES without a parameter does a Mode Preset, which should cover most backward code compatibility issues. The settings and correction data under the Input/Output front-panel key (examples: Input Z Corr, Ext Amp Gain, etc.) are no longer part of any Mode, so they will not be preset by a Mode Preset. They are preset using Restore Input/Output Defaults, Restore System Defaults All. Note that because User Preset does a Recall State, and all of these settings are saved in State, they ARE recalled when using

	User Preset.
Initial S/W Revision	Prior to A.02.00

## How-To Preset

The table below shows all possible presets, their corresponding SCPI commands and front-panel access (key paths). Instrument settings depend on the current measurement context. Some settings are local to the current measurement, some are global (common) across all the measurements in the current mode, and some are global to all the available modes. In a similar way, restoring the settings to their preset state can be done within the different contexts.

Auto Couple - is a measurement local key. It sets all Auto/Man parameter couplings in the measurement to Auto. Any Auto/Man selection that is local to other measurements in the mode will not be affected.

Meas Preset - is a measurement local key. Meas Preset resets all the variables local to the current measurement except the persistent ones.

Mode Preset - resets all the current mode's measurement local and measurement global variables except the persistent ones.

Restore Mode Defaults - resets ALL the Mode variables (and all the Meas global and Meas local variables), including the persistent ones.

Type Of Preset	SCPI Command	Front Panel Access
Auto Couple	:COUPle ALL	Auto Couple front-panel key
Meas Preset	:CONFigure:<Measurement>	Meas Setup Menu
Mode Preset	:SYSTem:PRESet	Mode Preset (green key)
Restore Mode Defaults	:INSTrument:DEFault	Mode Setup Menu
Restore All Mode Defaults	:SYSTem:DEFault MODes	System Menu; Restore System Default Menu
*RST	*RST	not possible (Mode Preset with Single)
Restore Input/Output Defaults	:SYSTem:DEFault INPUt	System Menu; Restore System Default Menu
Restore Power On Defaults	:SYSTem:DEFault PON	System Menu; Restore System Default Menu
Restore Alignment Defaults	:SYSTem:DEFault ALIGN	System Menu; Restore System Default Menu
Restore Miscellaneous Defaults	:SYSTem:DEFault MISC	System Menu; Restore System Default Menu
Restore All System Defaults	:SYSTem:DEFault [ALL] :SYSTem:PRESet:PERsistent	System Menu; Restore System Default Menu
User Preset	:SYSTem:PRESet:USER	User Preset Menu
User Preset All Modes	:SYSTem:PRESet:USER:ALL	User Preset Menu

Power On Mode Preset	:SYSTem:PON:TYPE MODE	System Menu
Power On User Preset	:SYSTem:PON:TYPE USER	System Menu
Power On Last State	:SYSTem:PON:TYPE LAST	System Menu

### Preset Type (Remote Command Only)

As stated in the Backward Compatibility section, to be compatible with ESA/PSA the PRESet:TYPE command will be implemented as a no-op.

Mode	All
<b>Remote Command</b>	:SYSTem:PRESet:TYPE FACTory MODE USER :SYSTem:PRESet:TYPE?
<b>Example</b>	:SYST:PRESet:TYPE FACT
Notes	This command is supported for backward compatibility only. It is a no-op which does not change the behavior of any preset operation.
Preset	This is unaffected by Preset but is set to Mode on a "Restore System Defaults->All"
State Saved	No
Initial S/W Revision	Prior to A.02.00

## Mode Setup

See "[Mode Setup](#)" on page 328



## Peak Search

Performs a peak search and opens the Peak Search menu. The Peak Search functions allow you to define specific search criteria to determine which signals can be considered peaks, excluding unwanted signals from the search.

Places the selected marker on the trace point with the maximum y-axis value for that marker's trace.

Key Path	Front-panel key
Mode	SA, WCDMA, C2K, WIMAX OFDMA, 1xEV-DO, DVB-T/H, LTE, LTETDD, WLAN, MSR, LTEAFDD, LTEATDD
<b>Remote Command</b>	:CALCulate:SPURious:MARKer[1] 2 ... 12:MAXimum
<b>Example</b>	CALC:SPUR:MARK2:MAX
Initial S/W Revision	Prior to A.02.00
Modified at S/W Revision	A.03.00

## Next Peak

Moves the selected marker to the peak that has the next highest amplitude less than the current marker value.

Key Path	Peak Search
Mode	SA, WCDMA, C2K, WIMAX OFDMA, TD-SCDMA, 1xEV-DO, DVB-T/H, LTE, LTETDD, WLAN, MSR, LTEAFDD, LTEATDD
<b>Remote Command</b>	:CALCulate:SPURious:MARKer[1] 2 ... 12:MAXimum:NEXT
<b>Example</b>	CALC:SPUR:MARK2:MAX:NEXT
Initial S/W Revision	Prior to A.02.00
Modified at S/W Revision	A.03.00

## Next Pk Right

Moves the selected marker to the nearest peak to the right of the current marker which meets all enabled peak criteria.

Key Path	Peak Search
Mode	SA, WCDMA, C2K, WIMAX OFDMA, TD-SCDMA, 1xEV-DO, DVB-T/H, LTE, LTETDD, WLAN
<b>Remote Command</b>	:CALCulate:SPURious:MARKer[1] 2 ... 12:MAXimum:RIGHT
<b>Example</b>	CALC:SPUR:MARK2:MAX:RIGH
Initial S/W Revision	Prior to A.02.00
Modified at S/W Revision	A.03.00

### Next Pk Left

Moves the selected marker to the nearest peak to the left of the current marker which meets all enabled peak criteria.

Key Path	Peak Search
Mode	SA, WCDMA, C2K, WIMAX OFDMA, TD-SCDMA, 1xEV-DO, DVB-T/H, LTE, LTETDD, WLAN, MSR, LTEAFDD, LTEATDD
Remote Command	:CALCulate:SPURious:MARKer[1 2 ... 12:MAXimum:LEFT
Example	CALC:SPUR:MARK2:MAX:LEFT
Initial S/W Revision	Prior to A.02.00
Modified at S/W Revision	A.03.00

### Marker Delta

Performs the same function as the Delta 1-of-N selection key in the Marker menu. This sets the control mode for the selected marker to Delta mode. See the Marker section for the complete description of this function. The key is duplicated here in the Peak Search Menu to allow you to conveniently perform a peak search and change the control of the Marker mode to Delta without having to access two separate menus.

Key Path	Peak Search
Initial S/W Revision	Prior to A.02.00

### Pk-Pk Search

Finds and displays the amplitude and frequency (or time, if in zero span) differences between the highest and lowest y-axis value.

Key Path	Peak Search
Mode	SA, WCDMA, C2K, WIMAX OFDMA, TD-SCDMA, 1xEV-DO, DVB-T/H, LTE, LTETDD, WLAN, MSR, LTEAFDD, LTEATDD
Remote Command	:CALCulate:SPURious:MARKer[1 2 ... 12:PTPeak
Example	CALC:SPUR:MARK:PTP
Notes	Turns on the Marker $\Delta$
Dependencies	This key is not available (key is grayed-out) when Coupled Markers is on.
Initial S/W Revision	Prior to A.02.00
Modified at S/W Revision	A.03.00

### Min Search

Moves the selected marker to the minimum y-axis value on the current trace.

Key Path	Peak Search
Mode	SA, WCDMA, C2K, WIMAX OFDMA, TD-SCDMA, 1xEV-DO, DVB-T/H, LTE, LTETDD, WLAN, MSR, LTEAFDD, LTEATDD
<b>Remote Command</b>	:CALCulate:SPURious:MARKer[1] 2 ... 12:MINimum
<b>Example</b>	CALC:SPUR:MARK:MIN
Initial S/W Revision	Prior to A.02.00
Modified at S/W Revision	A.03.00

14 Spurious Emissions Measurement  
Print

Print

See ["Print" on page 341](#)

## Quick Save

The Quick Save front-panel key repeats the most recent save that was performed from the Save menu, with the following exceptions:

- Register saves are not remembered as Saves for the purpose of the Quick Save function
- If the current measurement does not support the last non-register save that was performed, an informational message is generated, “File type not supported for this measurement”

Quick Save repeats the last type of qualified save (that is, a save qualified by the above criteria) in the last save directory by creating a unique filename using the Auto File Naming algorithm described below.

If Quick Save is pressed after startup and before any qualified Save has been performed, the Quick Save function performs a Screen Image save using the current settings for Screen Image saves (current theme, current directory), which then becomes the “last save” for the purpose of subsequent Quick Saves.

The Auto File Naming feature automatically generates a file name for use when saving a file. The filename consists of a prefix and suffix separated by a dot, as is standard for the Windows® file system. A default prefix exists for each of the available file types:

Type	Default Prefix	Menu
State	State_	(Save/Recall)
Trace + State	State_	(Save/Recall)
Screen	Screen_	(Save/Recall)
Amplitude Corrections	Ampcor_	(Import/Export)
Traces	Trace_	(Import/Export)
Limit Lines	LLine_	(Import/Export)
Measurement Result	MeasR_	(Import/Export)
Capture Buffer	CapBuf_	(Import/Export)

A four digit number is appended to the prefix to create a unique file name. The numbering sequence starts at 0000 within each Mode for each file type and updates incrementally to 9999, then wraps to 0000 again. It remembers where it was through a Mode Preset and when leaving and returning to the Mode. It is reset by Restore Misc Defaults and Restore System Defaults and subsequent running of the instrument application. So, for example, the first auto file name generated for State files is State\_0000.state. The next is State\_0001, and so forth.

One of the key features of Auto File Name is that we guarantee that the Auto File Name will never conflict with an existing file. The algorithm looks for the next available number. If it gets to 9999, then it looks for holes. If it find no holes, that is no more numbers are available, it gives an error.

For example, if when we get to State\_0010.state there is already a State\_0010.state file in the current directory, it advances the counter to State\_0011.state to ensure that no conflict will exist (and then it verifies that State\_0011.state also does not exist in the current directory and advances again if it does, and so forth).

If you enter a file name for a given file type, then the prefix becomes the filename you entered instead of the default prefix, followed by an underscore. The last four letters (the suffix) are the 4-digit number.

For example, if you save a measurement results file as “fred.csv”, then the next auto file name chosen for a measurement results save will be fred\_0000.csv.

**NOTE**

Although 0000 is used in the example above, the number that is used is actually the current number in the Meas Results sequence, that is, the number that would have been used if you had not entered your own file name.

---

**NOTE**

If the filename you entered ends with \_dddd, where d=any number, making it look just like an auto file name, then the next auto file name picks up where you left off with the suffix being dddd + 1.

---

Key Path	Front-panel key
Notes	No remote command for this key specifically.
Initial S/W Revision	Prior to A.02.00

## Recall

The Recall menu lets you choose what you want to recall, and where you want to recall it from. Among the types of files you can recall are **States and Traces**. In addition, an Import (Data) option lets you recall a number of data types stored in CSV files (as used by Excel and other spreadsheet programs).

The default paths for Recall are data type dependent and are the same as for the Save key.

Key Path	Front-panel key
Notes	<p>No remote command for this key specifically, but the :MMEM:LOAD command is available for specific file types. An example is :MMEM:LOAD:STATe &lt;filename&gt;.</p> <p>If you try to recall a State file for a mode that is not licensed or not available in the instrument, an error message will occur and the state will not change.</p>
Backwards Compatibility Notes	<p>In legacy analyzers, it was possible to load a state without affecting the trace data, limit lines or correction data. Similarly (since User Preset is actually loading a state), it was possible to do a User Preset without affecting the trace data, limit lines or correction data.</p> <p>In the X-Series, “state” always includes all of this data; so whenever state is loaded, all of the traces, limit lines and corrections are affected. Although this differs from previous behavior, it is desirable behavior, and should not cause adverse issues for users.</p>
Backwards Compatibility Notes	<p>Recall for the X-Series supports backward compatibility in the sense that you can recall a state file from any X-Series model number and any version of X-Series software. This is only possible if part of the recalling process goes through a limiting step after recalling the mode settings, at least for settings that may vary with version number, model number, option and license differences. If you try to recall a state file onto an instrument with less capability than what was available on the instrument during the save, the recall will ignore the state it doesn't support and it will limit the recalled setting to what it allows.</p> <p>Example: if the saved state includes preamp ON, but the recalling instrument does not have a preamp; the preamp is limited to OFF. Conversely, if you save a state without a preamp, the preamp is OFF in the state file. When this saved file is recalled on an instrument with a licensed preamp, the preamp is changed to OFF. Another example is if the saved state has center frequency set to 20 GHz, but the instrument recalling the saved state is a different model and only supports 13.5 GHz. In this case, the center frequency is limited along with any other frequency based settings. Since the center frequency can't be preserved in this case, the recall limiting tries to at least preserve span to keep the measurement setup as intact as possible.</p> <p>It may be appropriate to issue a warning if the state is limited on the recall; warnings do not go out to SCPI so this would only affect the manual user.</p> <p>Note that there is no state file compatibility outside of the X-Series. For example, you cannot recall a state file from ESA or PSA.</p>
Initial S/W Revision	Prior to A.02.00

## State

The Recall State menu lets you choose a register or file from which to recall the state.

The content of a state file includes all of the settings and data required to return the analyzer as closely as possible to the Mode it was in, with the exact settings that were in place, when the save occurred. The Mode settings in each state file include the settings that are affected by Mode Preset, as well as the

additional settings affected by Restore Mode Defaults; all of the Mode’s settings. In addition, all of the settings of the Input/Output system are included, even though they are outside of the Mode’s state, because they are needed to restore the complete setup. Persistent System settings (for example, GPIB address) are not affected by either a Mode Preset or Restore Mode Defaults, nor are they included in a saved State file.

Since each state file is only for one Mode, the settings for other Modes are unaffected when it is loaded. Recall State will cause a mode switch if the state being recalled is not from the current active mode.

After the recall completes, the message "File <filename> recalled" or “Recalled State Register <register number>” is displayed.

For rapid recalls, the State menu lists 16 registers that you can choose from to recall. Pressing a Register key initiates the recall. You can also select a file from which to recall.

The default path for all State Files is:

My Documents\<mode name>\state

where <mode name> is the parameter used to select the mode with the INST:SEL command (for example, SA for the Spectrum Analyzer).

See "[More Information](#)" on page 1833.

<b>Key Path</b>	Recall
<b>Mode</b>	All
<b>Remote Command</b>	:MMEMory:LOAD:STATe <filename>
<b>Example</b>	:MMEM:LOAD:STAT "myState.state" This recalls the file myState.state on the default path
<b>Example</b>	MMEM:LOAD:STAT "MyStateFile.state" This loads the state file data (on the default file directory path) into the instrument state.
<b>Notes</b>	<p>When you pick a file to recall, the analyzer first verifies that the file is recallable in the current instrument by checking the software version and model number of the instrument. If everything matches, a full recall proceeds by aborting the currently running measurement, clearing any pending operations, and then loading the State from the saved state file. You can open state files from any mode, so recalling a State file switches to the mode that was active when the save occurred. After switching to the mode of the saved state file, mode settings and data (if any for the mode) are loaded with values from the saved file. The saved measurement of the mode becomes the newly active measurement and the data relevant to the measurement (if there is any) is recalled.</p> <p>If there is a mismatch between file version or model number or instrument version or model number, the recall function tries to recall as much as possible and returns a warning message. It may limit settings that differ based on model number, licensing or version number.</p> <p>After recalling the state, the Recall State function does the following:</p> <ul style="list-style-type: none"> <li>• Makes the saved measurement for the mode the active measurement.</li> <li>• Clears the input and output buffers.</li> <li>• Status Byte is set to 0.</li> <li>• Executes a *CLS</li> </ul> <p>If the file specified is empty an error is generated. If the specified file does not exist, another error is generated. If there is a mismatch between the file and the proper file type, an error is generated. If</p>



	there is a mismatch between file version or model number or instrument version or model number, a warning is displayed. Then it returns to the State menu and File Open dialog goes away. After the Recall, the analyzer exits the Recall menu and returns to the previous menu.
<b>Backwards Compatibility SCPI</b>	:MMEMory:LOAD:STATe 1,<filename> For backwards compatibility, the above syntax is supported. The "1" is simply ignored.
Initial S/W Revision	Prior to A.02.00

## More Information

In measurements that support saving Traces, for example, Swept SA, the Trace data is saved along with the State in the State file. When recalling the State, the Trace data is recalled as well. Traces are recalled exactly as they were stored, including the writing mode and update and display modes. If a Trace was updating and visible when the State was saved, it will come back updating and visible, and its data will be rewritten right away. When you use State to save and recall traces, any trace whose data must be preserved should be placed in View or Blank mode before saving.

The following table describes the Trace Save and Recall possibilities:

You want to recall state and one trace's data, leaving other traces unaffected.	Save Trace+State from 1 trace. Make sure that no other traces are updating (they should all be in View or Blank mode) when the save is performed.	On Recall, specify the trace you want to load the one trace's data into. This trace will load in View. All other traces' data will be unaffected, although their trace mode will be as it was when the state save was performed.
You want to recall all traces	Save Trace+State from ALL traces.	On Recall, all traces will come back in View (or Blank if they were in Blank or Background when saved)
You want all traces to load exactly as they were when saved.	Save State	On recall, all traces' mode and data will be exactly as they were when saved. Any traces that were updating will have their data immediately overwritten.

## From File...

When you press "From File", the analyzer brings up a Windows dialog and a menu entitled "File Open." This menu allows you to navigate to the various fields in the Windows dialog without using a keyboard or mouse. The Tab and Arrow keys can also be used for dialog navigation.

## 14 Spurious Emissions Measurement Recall

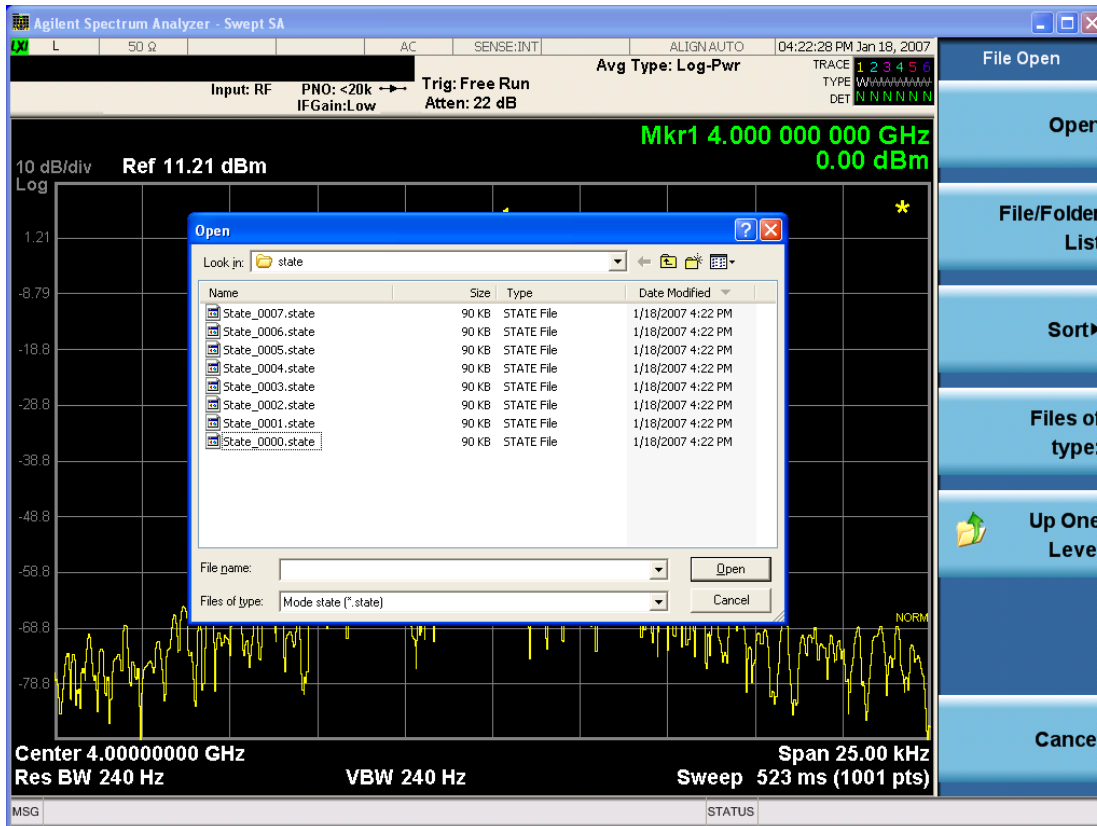

Listed below are the functions of the various fields in the dialog, and the corresponding softkeys:

### Open

Performs the recall of the specified file. While the recall is being performed, the floppy icon appears briefly in the Meas bar.

### File/Folder List

Enables you to navigate to the center of the dialog that contains the list of files and folders. Once here you can get information about the file and use the tab keys to navigate to the other fields in the dialog, such as Look In.

### Look In

The Look In field shows the path from which the file will be recalled and allows you to change the path using the up and down arrow keys to navigate to other paths; the Enter key to open a directory; and the Backspace key to go back one directory. The **Look In field** first uses the last path from the Save As dialog **Save In:** path for that same file type. There is no softkey for directly navigating to the Look In field, but you can use the left tab to get here from the File/Folder List.

User specified paths are remembered when you leave and return to a Mode and are reset back to the default using Restore Mode Defaults.

### Sort

Accesses a menu that enables you to sort the files within the File Open dialog. Only one sorting type can be selected at a time and the sorting happens immediately. The sorting types are By Date, By Name, By extension, and By Size.

#### Files of Type

This field shows the file suffix for the type of file you have selected to recall. For example, if you navigated here while recalling State, "Mode state (\*.state)" is in the field. If you navigated here while recalling Trace, ""Mode state (\*.trace)" is in the field. If you navigated here while importing a trace data file, "Trace Data (\*.csv)" is in the field. For some file types, there is more than one choice in the dropdown menu, which you can select by using the up and down arrow keys and Enter.

#### Up One Level

This key corresponds to the icon of a folder with the up arrow that is in the tool bar of the dialog. When pressed, it causes the file and folder list to navigate up one level in the directory structure. The Backspace key does the same thing.

#### Cancel

This key corresponds to the Cancel selection in the dialog. It causes the current **Open** request to be cancelled. The ESC key does the same thing.

Key Path	Recall, State
Notes	Brings up the Open dialog for recalling a State Save Type
Initial S/W Revision	Prior to A.02.00

### Edit Register Names

You may enter a custom name on any of the Register keys, to help you remember what you are using that state to save. To do this, press the Edit Register Names key, choose the register whose name you wish to edit, and then enter the desired label using the Alpha Editor or an external PC keyboard.

The maximum number of characters that can be added is 30. In most cases, 30 characters will fit on two lines of the key.

For more information and the SCPI command, see Edit Register Names under the Save, State function.

Key Path	Recall, State
Mode	All
Dependencies	N9060A-7FP or N9060B-2FP license required to edit the register names. When the feature is not licensed, sending the SCPI command generates an error, -221, "Settings conflict;Option not available"
Initial S/W Revision	A.11.00

### Register 1 thru Register 16

Selecting any one of these register keys causes the State of the mode from the specified Register to be recalled. Each of the register keys annotates whether it is empty or at what date and time it was last

modified. In addition, you can use the Edit Register Names key under Save, State to enter custom names for each register.

Registers are shared by all modes, so recalling from any one of the registers will cause a mode switch to the mode that was active when the save to the Register occurred.

Although these 16 registers are the only registers available from the front panel, there are 128 state registers available in the instrument. Registers 17–128 are only available from the SCPI interface, using the \*RCL command.

After the recall completes, the message "Register <register number> recalled" appears in the message bar. If you are in the Spectrum Analyzer Mode, and you are recalling a register that was saved in the Spectrum Analyzer Mode, then after the recall, you will still be in the Recall Register menu. If the Recall causes you to switch modes, then after the Recall, you will be in the Frequency menu.

If a requested register is empty an error is generated.

<b>Key Path</b>	Recall, State
<b>Example</b>	*RCL 1
<b>Range</b>	1–16 from front panel, 1–128 from SCPI
<b>Readback</b>	Date and time with seconds resolution are displayed on the key OR A custom name of up to 30 characters entered using the Save, State, Edit Register Names key OR “(empty)” if no prior save operation has been performed to this register.
<b>Initial S/W Revision</b>	Prior to A.02.00
<b>Modified at S/W Revision</b>	Prior to A.11.00

## Register 1 thru Register 16

Selecting any one of these register keys causes the State of the mode from the specified Register to be recalled. Each of the register keys annotates whether it is empty or at what date and time it was last modified. In addition, you can use the Edit Register Names key under Save, State to enter custom names for each register.

Registers are shared by all modes, so recalling from any one of the registers will cause a mode switch to the mode that was active when the save to the Register occurred.

Although these 16 registers are the only registers available from the front panel, there are 128 state registers available in the instrument. Registers 17–128 are only available from the SCPI interface, using the \*RCL command.

After the recall completes, the message "Register <register number> recalled" appears in the message bar. If you are in the Spectrum Analyzer Mode, and you are recalling a register that was saved in the Spectrum Analyzer Mode, then after the recall, you will still be in the Recall Register menu. If the Recall causes you to switch modes, then after the Recall, you will be in the Frequency menu.

If a requested register is empty an error is generated.

Key Path	Recall, State
<b>Example</b>	*RCL 1
Range	1-16 from front panel, 1-128 from SCPI
Readback	Date and time with seconds resolution are displayed on the key OR A custom name of up to 30 characters entered using the Save, State,Edit Register Names key OR “(empty)” if no prior save operation has been performed to this register.
Initial S/W Revision	Prior to A.02.00
Modified at S/W Revision	Prior to A.11.00

## Data (Import)

Importing a data file loads data that was previously saved from the current measurement or from other measurements and/or modes that produce compatible data files. The Import Menu only contains Data Types that are supported by the current measurement.

Since the commonly exported data files are in .csv format, the data can be edited by the user prior to importing. This allows you to export a data file, manipulate the data in Excel (the most common PC Application for manipulating .csv files) and then import it.

Importing Data loads measurement data from the specified file into the specified or default destination, depending on the data type selected. Selecting an Import Data menu key will not actually cause the importing to occur, since the analyzer still needs to know from where to get the data. Pressing the Open key in this menu brings up the Open dialog and Open menu that provides you with the options from where to recall the data. Once a filename has been selected or entered in the Open menu, the recall occurs as soon as the Open button is pressed.

Key Path	Recall
Mode	All
Notes	The menu is built from whatever data types are available for the mode. Some keys will be missing completely, so the key locations in the sub-menu will vary.  No SCPI command directly controls the Data Type that this key controls. The Data Type is included in the MMEM:LOAD commands.
Dependencies	If a file type is not used by a certain measurement, it is grayed out for that measurement. The key for a file type will not show at all if there are no measurements in the Mode that support it.
Preset	Is not affected by Preset or shutdown, but is reset during Restore Mode Defaults
Readback	The data type that is currently selected
Initial S/W Revision	Prior to A.02.00

## Amplitude Correction

This key selects the Amplitude Corrections as the data type to be imported. When pressed a second time, it brings up the Select Menu, which lets you select the Correction into which the data will be imported.

Amplitude Corrections are fully discussed in the documentation of the Input/Output key, under the Corrections key.

A set of preloaded Corrections files can be found in the directory

/My Documents/ EMC Limits and Ampcor.

When the Amplitude Correction is an Antenna correction and the Antenna Unit in the file is not None, the Y Axis Unit setting will change to match the Antenna Unit in the file.

Key Path	Recall
Mode	SA EDGE GSM PN
Remote Command	:MMEMory:LOAD:CORRection 1 2 3 4 5 6 7 8, <filename>
Example	:MMEM:LOAD:CORR 2, "myAmpcor.csv" recalls the Amplitude Correction data from the file myAmpcor.csv in the current directory to the 2nd Amplitude Correction table, and turns on Correction 2. The default path is D:\User_My_Documents\Instrument\My Documents\amplitudeCorrections\
Dependencies	<p>Only the first correction array (Correction 1) supports antenna units. This means that a correction file with an Antenna Unit can only be loaded into the Corrections 1 register. Consequently only for Correction 1 does the dropdown in the Recall dialog include.ant, and if an attempt is made to load a correction file into any other Correction register which DOES contain an antenna unit, a Mass Storage error is generated.</p> <p>Corrections are not supported by all Measurements. If in a Mode in which some Measurements support it, this key will be grayed out in measurements that do not. The key will not show at all if no measurements in the Mode support it.</p> <p>Errors are reported if the file is empty or missing, or if the file type does not match, or if there is a mismatch between the file type and the destination data type. If any of these occur during manual operation, the analyzer returns to the Import Data menu and the File Open dialog goes away.</p> <p>This key does not appear unless you have the proper option installed in your instrument.</p> <p>This command will generate an "Option not available" error unless you have the proper option installed in your instrument.</p>
Couplings	When a correction file is loaded from mass storage, it is automatically turned on ( <b>Correction ON</b> ) and <b>ApplyCorrections</b> is set to On. This allows you to see its effect, thus confirming the load.
Readback	selected Correction
Backwards Compatibility SCPI	:MMEMory:LOAD:CORRection ANTenna   CABLE   OTHer   USER, <filename> For backwards compatibility, ANTenna maps to 1, CABLE maps to 2, OTHer maps to 3 and USER maps to 4
Initial S/W Revision	A.02.00

## Amplitude Correction

These keys let you select which Correction to import the data into. Once selected, the key returns back to the Import Data menu and the selected Correction number is annotated on the key. The next step is to select the Open key in the Import Data menu.

Antenna corrections are a particular kind of Amplitude Corrections – they are distinguished in the corrections file by having the Antenna Unit set to a value other than None. Only Correction 1 supports Antenna Units.

Key Path	Recall, Data, Amplitude Correction
Notes	auto return
Dependencies	Only Correction 1 may be used to load a Correction that contains an Antenna Unit other than None
Preset	Not part of Preset, but is reset to Correction 1 by Restore Input/Output Defaults; survives shutdown.
State Saved	The current Correction number is saved in instrument state
Initial S/W Revision	A.02.00

## Chan Table

Imports the channel table from a channel plan file. This function enables you to use your own defined channel tables by importing a modified channel table file.

Instead of creating a brand new channel plan file, you can generate a channel plan file to fit your needs using a saved channel plan file or the default channel plan file ChannelPlan.txt in the directory “My Documents\Digital Video\data\”. The saved channel plan file is obtained by pressing Save, Data, Channel Table, and then Save As...

Note that while editing the channel plan file, you cannot change the channel plan name, such as NTSC\_B.VHF, NTSC\_B.UHF, otherwise your modifications on the corresponding channel plan will not work. You can add, remove, or modify the channel numbers and center frequencies in each channel plan. The value of Start Channel and Channel Count may also need to be changed.

File Location and Extension

**File location:** “My Documents\Digital Video\data”

**File type:** text file

**File extension:** .txt

**Example:**

File Location: My Documents\Digital Video\data

File Name: ChannelPlan\_0001.txt

Key Path	Recall, Data
Mode	DVB-T/H
<b>Remote Command</b>	MMEemory:LOAD:CHTable <string>
<b>Example</b>	MME:LOAD:CHT “ChannelPlan_0001.txt”
Initial S/W Revision	A.07.00

## Capture Buffer

Capture buffer functionality is available only in Mod Accuracy measurement. The captured data is raw data which is not processed.

Key Path	Recall, Data
Mode	DVB-T/H
Example	MMEM:LOAD:CAPT "MyCaptureData.bin" This loads the file of capture data (on the default file directory path) into the instrument.
Dependencies	Capture buffer data is only available for Mod Accuracy measurement. In other measurements, this key is grayed out.
Initial S/W Revision	Prior to A.01.70

## DVB-T2 Config

Imports DVB-T2 configuration from setting files (single PLP or multiple PLPs). This key is available only in DVB-T2 Mod Accuracy measurement and will be grayed out in other measurements.

If the configuration file to be recalled is created with previous instrument S/W revision A.10.52 or before (To check the instrument S/W revision, press System, Show, System on the instrument), it doesn't have Transmission Mode and Version parameters. Then you need to set up the DVB-T2 version and transmission mode manually by pressing Mode Setup, Radio Std, DVB-T2, Version 1.1.1, and toggling Transmission Mode to SISO to select the standard version and transmission mode of the signal under test.

All the modulation parameters can be set from the setting file. These parameters include Version, Transmission Mode, Guard Interval, FFT size, Carrier Mode, Pilot Pattern, L1 Modulation Format, Data Symbols, PAPR Type, PLP Number, SubSlices Number, SubSlices Interval, PLP Modulation Format, PLP Constellation Rotation, FEC Type, Time IL Length, FEC Block Num, PLP ID, PLP Start, PLP Type and PLP Code Rate.

File Location and Extension

**File location:** "My Documents\DVB\data\EVMT2\data"

**File type:** text file

**File extension:** .csv

**Example:**

File Location: My Documents\DVB\data\EVMT2\data

File Name: DVBT2Config\_0001.csv

Key Path	Recall, Data
Mode	DVB-T/H
Remote Command	MMEMory:LOAD:T2Config <string>



<b>Example</b>	MMEM:LOAD:T2C "DVBT2Config_0001.csv"
Dependencies	This key is grayed out in all other measurements except DVB-T2 Mod Accuracy measurement.
Couplings	Auto Detect (Meas, DVB-T2 ModAccuracy, Meas Setup) will be changed to OFF automatically when the DVB-T2 config file is loaded.
Initial S/W Revision	A.07.00

## Open...

When you press "Open", the analyzer brings up a Windows dialog and a menu entitled "**File Open.**" This menu allows you to navigate to the various fields in the Windows dialog without using a keyboard or mouse. The Tab and Arrow keys can also be used for dialog navigation.

See "[From File...](#)" on page 2201 in Recall, State, for a full description of this dialog and menu.

Key Path	Recall, Data
Notes	The key location is mode-dependent and will vary. Brings up Open dialog for recalling a <mode specific> Save Type
Initial S/W Revision	Prior to A.02.00

## Restart

The Restart function restarts the current sweep, or measurement, or set of averaged/held sweeps or measurements. If you are Paused, pressing Restart does a Resume.

The Restart function is accessed in several ways:

- Pressing the Restart key
- Sending the remote command INIT:IMMEDIATE
- Sending the remote command INIT:RESTART

See "[More Information](#)" on page 1842

Key Path	Front-panel key
Remote Command	:INITiate[:IMMEDIATE] :INITiate:RESTART
Example	:INIT:IMM :INIT:REST
Notes	:INITiate:RESTART and :INITiate:IMMEDIATE perform exactly the same function.
Couplings	Resets average/hold count k. For the first sweep overwrites all active (update=on) traces with new current data. For application modes, it resets other parameters as required by the measurement.
Status Bits/OPC dependencies	This is an Overlapped command. The STATus:OPERation register bits 0 through 8 are cleared. The STATus:QUESTionable register bit 9 (INTegrity sum) is cleared. The SWEEPING bit is set. The MEASURING bit is set.
Backwards Compatibility Notes	For Spectrum Analysis mode in ESA and PSA, the Restart hardkey and the INITiate:RESTART command restart trace averages (displayed average count reset to 1) for a trace in Clear Write, but did not restart Max Hold and Min Hold.  In the X-Series, the Restart hardkey and the INITiate:RESTART command restart not only Trace Average, but MaxHold and MinHold traces as well.  For wireless comms modes in ESA and PSA, the Restart hardkey and the INITiate:RESTART command restart every measurement, which includes all traces and numeric results. There is no change to this operation.
Initial S/W Revision	Prior to A.02.00

### More Information

The **Restart** function first aborts the current sweep/measurement as quickly as possible. It then resets the sweep and trigger systems, sets up the measurement and initiates a new data measurement sequence with a new data acquisition (sweep) taken once the trigger condition is met.

If the analyzer is in the process of aligning when **Restart** is executed, the alignment finishes before the restart function is performed.

Even when set for Single operation, multiple sweeps may be taken when Restart is pressed (for example, when averaging/holding is on). Thus when we say that **Restart** "restarts a measurement," we may mean:

- It restarts the current sweep
- It restarts the current measurement
- It restarts the current set of sweeps if any trace is in Trace Average, Max Hold or Min Hold
- It restarts the current set of measurements if Averaging, or Max Hold, or Min Hold is on for the measurement
- depending on the current settings.

With **Average/Hold Number** (in **Meas Setup** menu) set to 1, or Averaging off, or no trace in Trace Average or Hold, a single sweep is equivalent to a single measurement. A single sweep is taken after the trigger condition is met; and the analyzer stops sweeping once that sweep has completed. However, with **Average/Hold Number** >1 and at least one trace set to **Trace Average, Max Hold, or Min Hold (SA Measurement)** or **Averaging on (most other measurements)**, multiple sweeps/data acquisitions are taken for a single measurement. The trigger condition must be met prior to each sweep. The sweep is stopped when the average count  $k$  equals the number  $N$  set for **Average/Hold Number**. A measurement average usually applies to all traces, marker results, and numeric results; but sometimes it only applies to the numeric results.

Once the full set of sweeps has been taken, the analyzer will go to idle state. To take one more sweep without resetting the average count, increment the average count by 1, by pressing the step up key while **Average/Hold Number** is the active function, or sending the remote command `CALC:AVER:TCON UP`.

## Save

The Save menu lets you choose what you want to save and where you want to save it. Among the types of files you can save are **States**, **Traces**, and **Screen Images**. In addition, an Export (Data) option lets you save a number of data types as CSV files for easy import into Excel and other spreadsheet programs.

Key Path	Front-panel key
Mode	All
Notes	No remote command for this key specifically, but the :MMEM:STORe command is available for specific file types. An example is :MMEM:STOR:STATe <filename>.
Initial S/W Revision	Prior to A.02.00

## State

The Save State menu lets you choose a register or file for saving the state.

The content of a state file includes all of the settings and data required to return the analyzer as closely as possible to the Mode it was in, with the exact settings which were in place, when the save occurred. The Mode settings in each state file include the settings that are affected by Mode Preset, as well as the additional settings affected by Restore Mode Defaults; all of the Mode's settings. In addition, all of the settings of the Input/Output system are included, even though they are outside of the Mode's state, because they are needed to restore the complete setup. Persistent System settings (for example, Verbose SCPI) are not affected by either Mode Preset or Restore Mode Defaults, nor are they included in a saved State file.

After the save completes, the message "File <filename> saved" or "State Register <register number> saved" is displayed.

For rapid saving, the State menu lists 16 registers to save to. Pressing a Register key initiates the save. You can also select a file to save to.

The default path for all State Files is:

My Documents\<<mode name>\state

where <mode name> is the parameter used to select the mode with the INST:SEL command (for example, SA for the Spectrum Analyzer).

Key Path	Save
Mode	All
Remote Command	:MMEMory:STORe:STATe <filename>
Example	MMEM:STOR:STATe "MyStateFile.state" This stores the current instrument state data in the file MyStateFile.state in the default directory.
Notes	Both single and double quotes are supported for any filename parameter over remote. After saving to a register, that register's menu key is updated with the date the time, unless a custom label has been entered for that key. After saving to a register, you remain in the Save State menu, so that you can see the Register key

update. After saving to a file, the analyzer automatically returns to the previous menu and any Save As dialog goes away.

<b>Backwards Compatibility SCPI</b>	:MMEMory:STORe:STATe 1,<filename>
Initial S/W Revision	Prior to A.02.00

### To File . . .

When you press “To File”, the analyzer brings up a Windows dialog and a menu entitled “**Save As.**” This menu allows you to navigate to the various fields in the Windows dialog without using a keyboard or mouse. The Tab and Arrow keys can also be used for dialog navigation.

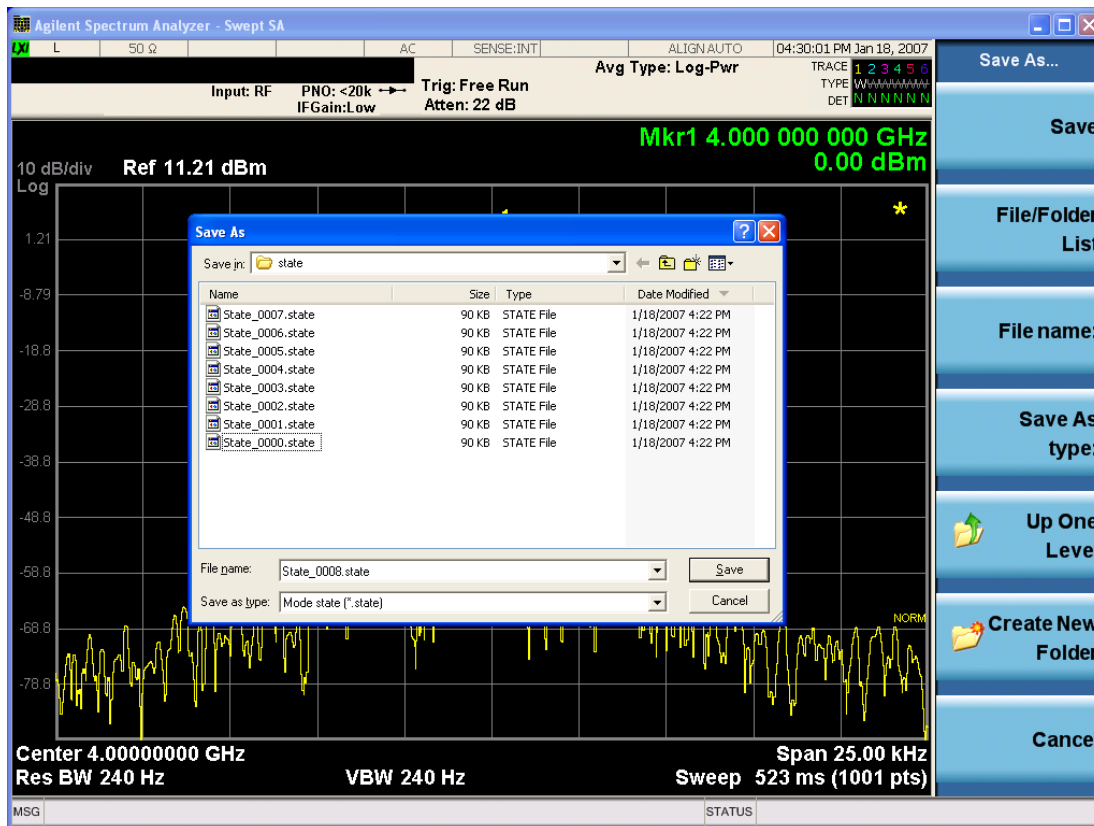

The Listed below

are the functions of the various fields in the dialog, and the corresponding softkeys:

#### Save

Performs the save to the specified file of the selected type. If the file already exists, a dialog will appear that allows you to replace the existing file by selecting OK, or you can Cancel the request. If you select OK, the file will be overwritten. Using the C: drive is strongly discouraged, since it runs the risk of being overwritten during an instrument software upgrade.

While the save is being performed, the floppy icon appears briefly in the Meas bar.

### File/Folder List

Enables you to navigate to the center of the dialog that contains the list of files and folders. Once here you can get information about the file and use the tab keys to navigate to the other fields in the dialog, such as Save In.

### Save In

The Save In field shows the path to which the file will be saved and allows you to change the path using the up and down arrow keys to navigate to other paths; the Enter key to open a directory; and the Backspace key to go back one directory. The **Save In field** defaults to the default path for this type of file and remembers the last path you used to save this type of file. There is no softkey for directly navigating to the Save In field but you can use left tab to get here from the File/Folder List.

User specified paths are remembered when you leave and return to a Mode and are reset back to the default using Restore Mode Defaults.

### File Name

The File Name field is initially loaded with an automatically generated filename specific to the appropriate Save Type. The automatically generated filename is guaranteed not to conflict with any filename currently in the directory. You may replace or modify this filename using the File Name key. See the ["Quick Save " on page 2197](#) documentation for more on the automatic file naming algorithm.

When you press the File Name key the analyzer displays the Alpha Editor. Use the knob to choose the letter to add and the front-panel Enter key to add the letter to the file name. The BK character moves you back and the FW character moves you forward in the filename. The Select key on the front panel generates a space character. When you are done entering the filename press the Done softkey. This returns back to the **File Open** dialog and menu, but does not cause the save to occur.

### Save As Type

This field shows the file suffix for the type of file you have selected to save. For example, if you navigated here while saving State, "Mode state (\*.state)" is in the field. If you navigated here from saving Trace, ""Mode state (\*.trace)" is in the field. If you navigated here while exporting a trace data file, "Trace Data (\*.csv)" is in the field. For some file types, there is more than one choice in the dropdown, which you can select by using the up and down arrow keys and Enter.

### Up One Level

This key corresponds to the icon of a folder with the up arrow that is in the tool bar of the dialog. When pressed, it causes the file and folder list to navigate up one level in the directory structure. The Backspace key does the same thing.

### Create New Folder

This key corresponds to the icon of a folder with the "\*" that is in the tool bar of the dialog. When pressed, a new folder is created in the current directory with the name **New Folder** and you can enter a new folder name using the Alpha Editor.

### Cancel

This key corresponds to the Cancel selection in the dialog. It causes the current **Save As** request to be cancelled. The ESC key does the same thing.

Key Path	Save, State
Mode	All
Notes	Brings up Save As dialog for saving a State Save Type
Initial S/W Revision	Prior to A.02.00

## Edit Register Names

You may enter a custom name on any of the Register keys, to help you remember what you are using that state to save. To do this, press the Edit Register Names key, choose the register whose name you wish to edit, and then enter the desired label using the Alpha Editor or an external PC keyboard.

The maximum number of characters that can be added is 30. In most cases, 30 characters will fit on two lines of the key.

See ["More Information" on page 1847](#)

Key Path	Save, State
Mode	All
<b>Remote Command</b>	:MMEMory:REGister:STATe:LABel <reg number>,"label" :MMEMory:REGister:STATe:LABel? <reg number>
<b>Example</b>	:MMEM:REG:STAT:LAB 1,"my label"
Notes	<reg number> is an integer from 1 to 16. If the SCPI specifies an invalid register number an error message is generated, -222,"Data out of range;Invalid register label number" "label" is a string from 0 to 30 characters in length. If a label exceeds 30 characters, an error message is generated, -150,"String data error;Label clipped to 30 characters" "label" of length 0 erases the custom label and restores the default (time and date) label. E.g.: :MMEM:REG:STAT:LAB 1,""
Dependencies	N9060A-7FP or N9060B-2FP license required to edit the register names. When the feature is not licensed, sending this command generates an error, -221,"Settings conflict;Option not available"
Preset	The names are unaffected by Preset or power cycle but are set to the default label (time and date) on a "Restore System Defaults->Misc"
Initial S/W Revision	A.11.00

## More Information

When you edit one of the register names, the time and date field will be replaced by the custom name.

If you delete all the characters in the custom name, it restores the default (time and date).

The register names are stored within the state files, but they are not part of the instrument state; that is, once you have edited a register name, loading a new state will not change that register name. Another consequence of this is that the names will be persistent through a power cycle. Also, if a named state file is transferred to another analyzer, it will bring its custom name along with it.

If you try to edit the name of an empty register, the analyzer will first save the state to have a file to put the name in. If you load a named state file into an analyzer with older firmware it will ignore the metadata.

The \*SAV and \*RCL commands will not be affected by the custom register names, nor will the MMEM commands.

### Register 1 thru Register 16

Selecting any one of these register menu keys causes the State of the currently active mode to be saved to the specified Register. The registers are provided for rapid saving and recalling, since you do not need to specify a filename or navigate to a file. Each of the register menu keys annotates whether it is empty or at what date and time it was last modified. In addition, you can use the Edit Register Names key to enter custom names for each register.

Although these 16 registers are the only registers available from the front panel, there are 128 state registers available in the instrument. Registers 17–128 are only available from the SCPI interface, using the \*SAV command.

There is one set of 128 state registers in the instrument, not one set for each Mode. When a state is saved, the Mode it was saved from is saved with it; then when it is recalled, the instrument switches to that Mode.

After the save completes, the corresponding register menu key annotation is updated with the date and time and the message "Register <register number> saved" is displayed.

Key Path	Save, State
Mode	All
Example	*SAV 1
Range	1–16 from front panel, 1–128 from SCPI
Readback	Date and time with seconds resolution are displayed on the key OR A custom name of up to 30 characters entered using the Edit Register Names key OR “(empty)” if no prior save operation has been performed to this register.
Initial S/W Revision	Prior to A.02.00
Modified at S/W Revision	A.11.00

### Register 1 thru Register 16

Selecting any one of these register menu keys causes the State of the currently active mode to be saved to the specified Register. The registers are provided for rapid saving and recalling, since you do not need to specify a filename or navigate to a file. Each of the register menu keys annotates whether it is empty or at what date and time it was last modified. In addition, you can use the Edit Register Names key to enter custom names for each register.

Although these 16 registers are the only registers available from the front panel, there are 128 state registers available in the instrument. Registers 17–128 are only available from the SCPI interface, using the \*SAV command.



There is one set of 128 state registers in the instrument, not one set for each Mode. When a state is saved, the Mode it was saved from is saved with it; then when it is recalled, the instrument switches to that Mode.

After the save completes, the corresponding register menu key annotation is updated with the date and time and the message "Register <register number> saved" is displayed.

Key Path	Save, State
Mode	All
Example	*SAV 1
Range	1-16 from front panel, 1-128 from SCPI
Readback	Date and time with seconds resolution are displayed on the key OR A custom name of up to 30 characters entered using the Edit Register Names key OR “(empty)” if no prior save operation has been performed to this register.
Initial S/W Revision	Prior to A.02.00
Modified at S/W Revision	A.11.00

## Data (Export)

Exporting a data file stores data from the current measurement to mass storage files. The Export Menu only contains data types that are supported by the current measurement.

Since the commonly exported data files are in .csv format, the data can be edited by you prior to importing. This allows you to export a data file, manipulate the data in Excel (the most common PC Application for manipulating .csv files) and then import it.

Selecting an Export Data menu key will not actually cause the exporting to occur, since the analyzer still needs to know where you wish to save the data. Pressing the Save As key in this menu brings up the Save As dialog and Save As menu that allows you to specify the destination file and directory. Once a filename has been selected or entered in the Open menu, the export will occur as soon as the Save key is pressed.

Key Path	Save
Mode	All
Notes	The menu is built from whatever data types are available for the mode. So the key locations in the sub menu will vary.  No SCPI command directly controls the Data Type that this key controls. The Data Type is included in the MMEM:STORe commands.
Dependencies	If a file type is not used by a certain measurement, that type is grayed out for that measurement. The key for a file type will not show at all if there are no measurements in the Mode that support it.
Preset	Is not affected by a Preset or shutdown, but is reset during Restore Mode Defaults
Readback	The data type that is currently selected
Initial S/W Revision	Prior to A.02.00

## Amplitude Correction

Pressing this key selects **Amplitude Corrections** as the data type to be exported. Pressing this key again brings up the Select Menu, which allows the user to select which **Amplitude Correction** to save.

Amplitude Corrections are fully discussed in the documentation of the Input/Output key, under the Corrections softkey.

See "[Correction Data File](#) " on page 1850

Key Path	Save
<b>Remote Command</b>	:MMEMory:STORe:CORRection 1 2 3 4 5 6, <filename>
<b>Example</b>	:MMEM:STOR:CORR 2 "myAmpcor.csv" saves Correction 2 to the file myAmpcor.csv on the current path. The default path is My Documents\amplitudeCorrections.
Notes	If the save is initiated via SCPI, and the file already exists, the file will be overwritten. Using the C: drive is strongly discouraged, since it runs the risk of being overwritten during an instrument software upgrade. Both single and double quotes are supported for any filename parameter over SCPI.
Dependencies	Corrections are not supported by all Measurements. If in a Mode in which some Measurements support it, this key will be grayed out in measurements that do not. The key will not show at all if no measurements in the Mode support it. This key will not appear unless you have the proper option installed in your instrument.
Readback	Selected Correction
<b>Backwards Compatibility SCPI</b>	:MMEMory:STORe:CORRection ANTenna   CABLe   OTHer   USER, <filename> For backwards compatibility, ANTenna maps to 1, CABLe maps to 2, OTHer maps to 3 and USER maps to 4
Initial S/W Revision	A.02.00

## Correction Data File

A Corrections Data File contains a copy of one of the analyzer correction tables. Corrections provide a way to adjust the trace display for predetermined gain curves (such as for cable loss).

Corrections files are text files in .csv (comma separated values) form, to make them importable into Excel or other spreadsheet programs. The format for Corrections files is as follows.

Line #	Type of field	Example	Notes
1	File type, must be "Amplitude Correction"	Amplitude Correction	May not be omitted
2	File Description (in quotes)	"Correction Factors for 11966E"	60 characters max; may be empty but may not be omitted. If exceeds 60 characters, error -233 Too much data reported
3	Comment (in quotes)	"Class B Radiated"	60 characters max; may be empty but

Line #	Type of field	Example	Notes
			may not be omitted. . If exceeds 60 characters, error -233 Too much data reported
4	Instrument Version, Model #	A.02.06,N9020A	May be empty but may not be omitted
5	Option List, File Format Version	K03 LFE EXM ,01	May be empty but may not be omitted
6	Freq Unit to be used for all frequency values in the file	Frequency Unit,MHz	assumed to be Hz if omitted
7	Antenna Unit	Antenna Unit,None	If omitted leaves the Antenna unit unchanged. The amplitude unit in the Antenna Unit field is a conversion factor that is used to adjust the Y Axis Units of the current mode, if the mode supports Antenna Units. For more details on antenna correction data, refer to the Input/Output,Corrections key description. Allowable values: dBuv/m, dBuA/m, dBG, dBpT, None
8	Freq Interpolation	Frequency Interpolation,Linear	if omitted leaves the Freq Interpolation unchanged. Allowable values: Linear, Logarithmic
9	Bias value in mA	Bias,0.00	If omitted leaves the Bias value unchanged (added as of A.08.50)
10	Bias State	Bias State,On	If omitted leaves the Bias State unchanged. Allowable values: On, Off (added as of A.08.50)
11	Overlap, two values, Freq1 and Freq2, separated by commas.	Overlap,33500,40000	Uses Freq Unit from line 6. Thus, in this example Freq1=33.5 GHz, Freq2= 40.0 GHz (see note below). If omitted leaves the overlap unchanged (added as of A.08.50)
12	DATA marker	DATA	Corrections data begins in the next line

Lines 2 through 5 can be empty but must appear in the file. Lines 6 through 11 are optional, the lines can be left out of the file altogether.

The Overlap row and the two Bias rows apply only to external mixing. Both are read-only, they are never written by the analyzer. The only way to insert or modify these rows is to edit the file with a text editor or a spreadsheet editor. These rows are intended for use by mixer manufacturers, as they allow the manufacturer to insert data about how the mixer corrections were generated and how they should be applied. The Bias rows allow you to specify whether to turn Bias on or off when the Correction is turned on and to specify a Bias value (turning off the Correction does not change the Bias, but turning it back on again sets it to the value specified in the file). The Overlap row allows you to specify an overlap region in which

two different corrections may be applied. It is expected that in the corrections data itself, there will be TWO corrections values exactly at Max Freq, otherwise Overlap is ignored. The way the overlap is processed is as follows: if at any given time the current analyzer Start Freq is greater than Freq 1 and lower than Freq 2, and the current Stop Freq is greater than Freq 2, extend the first correction point at or above Freq 2 down to Freq 1, rather than using the correction data between Freq1 and Freq2.

The Antenna Unit row can only be used in Correction register 1, because there can only be one setting for Antenna Unit at any given time. If a Correction whose Antenna Unit is set to anything but None is loaded into any Correction register but 1, an error is generated (Mass storage error; Can only load an Antenna Unit into Correction 1). When a correction file is saved from any Correction register but 1, Antenna Unit is always written as None.

Similarly, the Bias rows can only be used in Correction register 1, because there can only be one setting for Bias at any given time. If a Correction file with a Bias or Bias State row is loaded into any Correction register but 1, an error is generated: Mass storage error; Can only load Bias Settings into Correction 1

The data follows the DATA row, as comma separated X, Y pairs; one pair per line.

For example, suppose you have an Antenna to correct for on an N9020A version A.02.06 and the correction data is:

- 0 dB at 200 MHz
- 17 dB at 210 MHz
- 14.8 dB at 225 MHz

Then the file will look like:

- Amplitude Correction
- "Correction Factors for 11966E"
- "Class B Radiated"
- A.02.06,N9020A
- P13 EA3 UK6,01
- Frequency Unit,MHz
- Antenna Unit,dBuV/m
- Frequency Interpolation,Linear
- DATA
- 200.000000,0.00
- 210.000000,17.00
- 225.000000,14.80

The choices for the 1 of N fields in the metadata are as follows:

- Frequency Unit: Hz, kHz, MHz, GHz
- Antenna Unit: dBuV/m, dBuA/m, dBG, dBpT, None

- Frequency Interpolation: Logarithmic, Linear

### Amplitude Correction

These keys let you choose which Correction to save. Once selected, the key returns back to the Export Data menu and the selected Correction number is annotated on the key.

The next step in the Save process is to select the Save As key in the Export Data menu.

Key Path	Save, Data, Amplitude Correction
Preset	Not part of a Preset, but is reset to Correction 1 by Restore Input/Output Defaults. Survives a shutdown.
Readback	1
Initial S/W Revision	A.02.00

### Chan Table

Exports the current channel table to a channel table file.

The exported channel table file can be edited to meet your requirements, and then imported by pressing Recall, Data, Channel Table, and then Open...

Note that while editing the channel plan file, you can't change the channel plan name, such as NTSC\_B.VHF, NTSC\_B.UHF, otherwise your modifications on the corresponding channel plan will not work. You can add, remove, or modify the channel numbers and center frequencies in each channel plan. The value of Start Channel and Channel Count may also need to be changed.

File Location and Extension

**File location:** "My Documents\Digital Video\data"

**File type:** text file

**File extension:** .txt

**Example:**

File Location: My Documents\Digital Video\data

File Name: ChannelPlan\_0001.txt

Key Path	Save, Data
Mode	DVB-T/H
<b>Remote Command</b>	MMEMemory:STOR:CHTable <string>
<b>Example</b>	MMEM:STOR:CHT "ChannelPlan_0001.txt"
Initial S/W Revision	A.07.00

### Measurement Results

Pressing this key selects Meas Results as the data type to be exported.

The Meas Results file contains measurement result sets, plus information describing the current state of the analyzer, as detailed in ["Meas Results File Definition" on page 1854](#) and ["Meas Results File Example" on page 1856](#) below.

<b>Key Path</b>	Save, Data
<b>Remote Command</b>	:MMEMory:STORe:RESults <string>
<b>Example</b>	:MMEM:STOR:RES "MeasR_0000.csv"
<b>Notes</b>	<p>If the save is initiated via SCPI and the file already exists, the file will be overwritten.</p> <p>The SCPI command exports Spurious Emissions measurement results to the file specified as the parameter in the current path. The default path is My Documents\<current mode&gt;\data\spur\results.<="" p=""> <p>Using the C: drive is strongly discouraged, since it runs the risk of being overwritten during an instrument software upgrade.</p> <p>The SCPI parameter is a quoted string that specifies the filename. Both single and double quotes are supported for any filename parameter over SCPI.</p> </current></p>
<b>Dependencies</b>	The current active measurement must be the Spurious Emissions measurement to use this command.
<b>Status Bits/OPC dependencies</b>	Sequential – waits for the previous measurement to complete
<b>Initial S/W Revision</b>	Prior to A.02.00

### Meas Results File Definition

The content of a Meas Results File is defined in this section.

The first lines in the file consist of identification and instrument configuration details, as follows.

- File ID string, which is “MeasResult”
- Measurement ID following Mode ID, which is “SA:SPUR” for example.
- Firmware rev and model number
- Option string
- Abs Start Limit
- Abs Stop Limit
- Abs Stop Limit Mode
- Auto Scaling
- Auto Sweep Time Rules
- Automatic Trigger Time
- Automatic Trigger Time State
- Average Mode
- Average Number

- Average State
- Detector 1
- Detector 2
- Electrical Atten
- Electrical Atten State
- External Array Trigger Delay
- External Array Trigger Delay State
- External Array Trigger Level
- External Array Trigger Slope
- Filter Type
- IF Gain Auto
- IF Gain State
- Internal Preamp
- Internal Preamp Band
- Line Trigger Delay
- Line Trigger Delay State
- Line Trigger Slope
- Meas Type
- Mechanical Atten
- MechanicalAttenStepEnum
- Peak Excursn
- Periodic Timer Period
- Periodic Timer Sync Source
- Periodic Timer Trigger Delay
- Periodic Timer Trigger Delay State
- Pk Threshold
- Points
- Points Mode
- Range State
- Ref Value
- Res BW

- Res BW Mode
- RFBurst Trigger Delay
- RFBurst Trigger Delay State
- RFBurst Trigger Level Abs
- RFBurst Trigger Level Rel
- RFBurst Trigger Level Type
- RFBurst Trigger Slope
- Scale/Div
- Spurious Report Mode
- SpurRangeStartFrequencyArray
- SpurRangeStopFrequencyArray
- Sweep Time
- Sweep Time Mode
- Trigger Holdoff
- Trigger Holdoff State
- TriggerSource
- Video BW
- Video BW Mode

The data above is followed in the file by a line containing “MeasResult1” to “MeasResult42”. This line forms a header for each set of measurement results, which appear in subsequent lines. Each line of Measurement Results consists of 42 comma-separated values, from the MeasResult1 value to the MeasResult42 value.

The MeasResult1 set in the file corresponds to the data returned by MEAS/READ/FETCH:SPURious1; the MeasResult2 set corresponds to the data returned by MEAS/READ/FETCH:SPURious2, and so on.

The exported file is in CSV format, with a .csv extension.

### Meas Results File Example

When imported into Excel, a typical Meas Results file appears as shown in the example below.

NOTE: The following table omits the columns for MeasResult11 to MeasResult42, due to lack of space.

MeasResult	1	2	3	4	5	6	7	8	9	10
SA:SPUR										
A.10.53	N903 0A									
526 ALV ATP B1X	1									



B1Y B25 B40										
BBA CR3 CRP										
DCF DDA DP2										
DRD EA3 EDP										
EMC EP1 ERC										
ESC ESP EXM										
FSA LFE LNP MAT										
MPB NFE NUL										
P26 PFR PNC RTL										
RTS S40 SB1 SEC										
SM1 TVT YAS										
YAV										
Abs Start Limit	-50	-50	-50	-50	-50	-50	-50	-50	-50	-50
Abs Stop Limit	-50	-50	-50	-50	-50	-50	-50	-50	-50	-50
Abs Stop Limit Mode	TRUE	TRUE	TRUE	TRUE	TRUE	TRUE	TRUE	TRUE	TRUE	TRUE
Auto Scaling	TRUE									
Auto Sweep Time Rules	Norm									
Automatic Trigger Time	0.1									
Automatic Trigger Time State	FALSE									
Average Mode	Exponential									
Average Number	10									
Average State	FALSE									
Detector 1	Peak	Peak	Peak	Peak	Peak	Peak	Peak	Peak	Peak	Peak
Detector 2	Off	Off	Off	Off	Off	Off	Off	Off	Off	Off
Electrical Atten	0									
Electrical Atten State	FALSE									
External Array Trigger Delay	1.00 E-06	1.00 E-06								
External Array Trigger Delay State	FALSE	FALSE								
External Array Trigger Level	1.2	1.2								
External Array Trigger Slope	Positive	Positive								
Filter Type	Gaussian	Gaussian	Gaussian	Gaussian	Gaussian	Gaussian	Gaussian	Gaussian	Gaussian	Gaussian

IF Gain Auto	FALSE	FALSE	FALSE	FALSE	FALSE	FALSE	FALSE	FALSE	FALSE	FALSE
IF Gain State	FALSE	FALSE	FALSE	FALSE	FALSE	FALSE	FALSE	FALSE	FALSE	FALSE
Internal Preamp	FALSE									
Internal Preamp Band	Low									
Line Trigger Delay	1.00 E-06									
Line Trigger Delay State	FALSE									
Line Trigger Slope	Positive									
Meas Type	Examine									
Mechanical Atten	10									
MechanicalAtten StepEnum	S2dB									
Peak Excursn	6	6	6	6	6	6	6	6	6	6
Periodic Timer Period	0.02									
Periodic Timer Sync Source	None									
Periodic Timer Trigger Delay	1.00 E-06									
Periodic Timer Trigger Delay State	FALSE									
Pk Threshold	-90	-90	-90	-90	-90	-90	-90	-90	-90	-90
Points	601	601	601	601	601	601	601	601	601	601
Points Mode	FALSE	FALSE	FALSE	FALSE	FALSE	FALSE	FALSE	FALSE	FALSE	FALSE
Range State	TRUE	TRUE	TRUE	TRUE	TRUE	FALSE	FALSE	FALSE	FALSE	FALSE
Ref Value	0									
Res BW	1200 000	5100 00	1000 00	1000 00	4000 000	3000 000	3000 000	3000 000	30000 00	30000 00
Res BW Mode	FALSE	FALSE	FALSE	FALSE	FALSE	TRUE	TRUE	TRUE	TRUE	TRUE
RFBurst Trigger Delay	1.00 E-06									
RFBurst Trigger Delay State	FALSE									
RFBurst Trigger Level Abs	-20									
RFBurst Trigger	-6									

Level Rel										
RFBurst Trigger Level Type	Absolute									
RFBurst Trigger Slope	Positive									
Scale/Div	10									
Spurious Report Mode	All									
SpurRangeStartFrequencyArray	1.92E+09	1.89E+09	2.1E+09	2.18E+09	8E+08	1.5E+09	1.5E+09	1.5E+09	1.5E+09	1.5E+09
SpurRangeStopFrequencyArray	1.98E+09	1.92E+09	2.1E+09	2.18E+09	1E+09	2.5E+09	2.5E+09	2.5E+09	2.5E+09	2.5E+09
Sweep Time	0.001	0.001	0.0012	0.00396	0.001	0.001	0.001	0.001	0.001	0.001
Sweep Time Mode	TRUE	TRUE	TRUE	TRUE	TRUE	TRUE	TRUE	TRUE	TRUE	TRUE
Trigger Holdoff	0.1									
Trigger Holdoff State	FALSE									
TriggerSource	Free									
Video BW	120000	51000	10000	10000	390000	300000	300000	300000	300000	300000
Video BW Mode	TRUE	TRUE	TRUE	TRUE	TRUE	TRUE	TRUE	TRUE	TRUE	TRUE
MeasResult1	MeasResult2	MeasResult3	MeasResult4	MeasResult5	MeasResult6	MeasResult7	MeasResult8	MeasResult9	MeasResult10	MeasResult11
19	-80.27209	-80.87862	-90.94577	-89.27086	-76.77856	9.91E+37	9.91E+37	9.91E+37	9.91E+37	9.91E+37
1	-78.28497	-80.93996	-91.00485	-90.56063	-76.33968					

### Capture Buffer

Capture buffer functionality is available only in Mod Accuracy measurement. The captured data is raw data which is not processed.

Key Path	Save, Data
Mode	DVB-T/H
Example	MMEM:STOR:CAPT "MyCaptureData.bin" This stores the capture data in the file MyCaptureData.bin in the default directory.

Dependencies	Capture buffer functionality is only available for Mod Accuracy measurement. In other measurements, this key is grayed out.
Initial S/W Revision	Prior to A.01.70

## DVB-T2 Config

Exports the current DVB-T2 configuration to a file (single PLP or multiple PLPs). This key is available only in DVB-T2 Mod Accuracy measurement and will be grayed out in other measurements.

You can view the exported file for the format of the DVB-T2 configuration files and create your own DVB-T2 configuration file by modifying the exported file.

File Location and Extension

**File location:** "My Documents\DVB\data\EVMT2\data"

**File type:** text file

**File extension:** .csv

**Example:**

File Location: My Documents\DVB\data\EVMT2\data

File Name: DVBT2Config\_0001.csv

Key Path	Save, Data
Mode	DVB-T/H
Remote Command	MMEMory:STORe:T2Config <string>
Example	MMEM:STOR:T2C "DVBT2Config_0001.csv"
Dependencies	This key is grayed out in all the other measurements except DVB-T2 Mod Accuracy measurement.
Initial S/W Revision	A.07.00

## Save As . . .

When you press "Save As", the analyzer brings up a Windows dialog and a menu entitled "**Save As.**" This menu allows you to navigate to the various fields in the Windows dialog without using a keyboard or mouse. The Tab and Arrow keys can also be used for dialog navigation.

See "[To File . . .](#)" on page 2213 in Save, State for a full description of this dialog and menu.

The default path for saving files is:

For all of the Trace Data Files:

My Documents\<<mode name>\data\traces

For all of the Limit Data Files:

My Documents\<<mode name>\data\limits

For all of the Measurement Results Data Files:

My Documents\<<mode name>\data\<<measurement name>\results

For all of the Capture Buffer Data Files:

My Documents\<<mode name>\data\captureBuffer

Key Path	Save, Data
Mode	All
Notes	The key location is mode-dependent and will vary. Brings up the Save As dialog for saving a <mode specific> Save Type. The save is performed immediately and does not wait until the measurement is complete.
Initial S/W Revision	Prior to A.02.00

## Screen Image

Pressing Screen Image accesses a menu of functions that enable you to specify a format and location for the saved screen image. It brings up a menu that allows you to specify the color scheme of the Screen Image (Themes) or navigate to the Save As dialog to perform the actual save.

Screen Image files contain an exact representation of the analyzer display. They cannot be loaded back onto the analyzer, but they can be loaded into your PC for use in many popular applications.

The image to be saved is actually captured when the Save front panel key is pressed, and kept in temporary storage to be used if you ask for a Screen Image save. When the Screen Image key is pressed, a "thumbnail" of the captured image is displayed, as shown below:

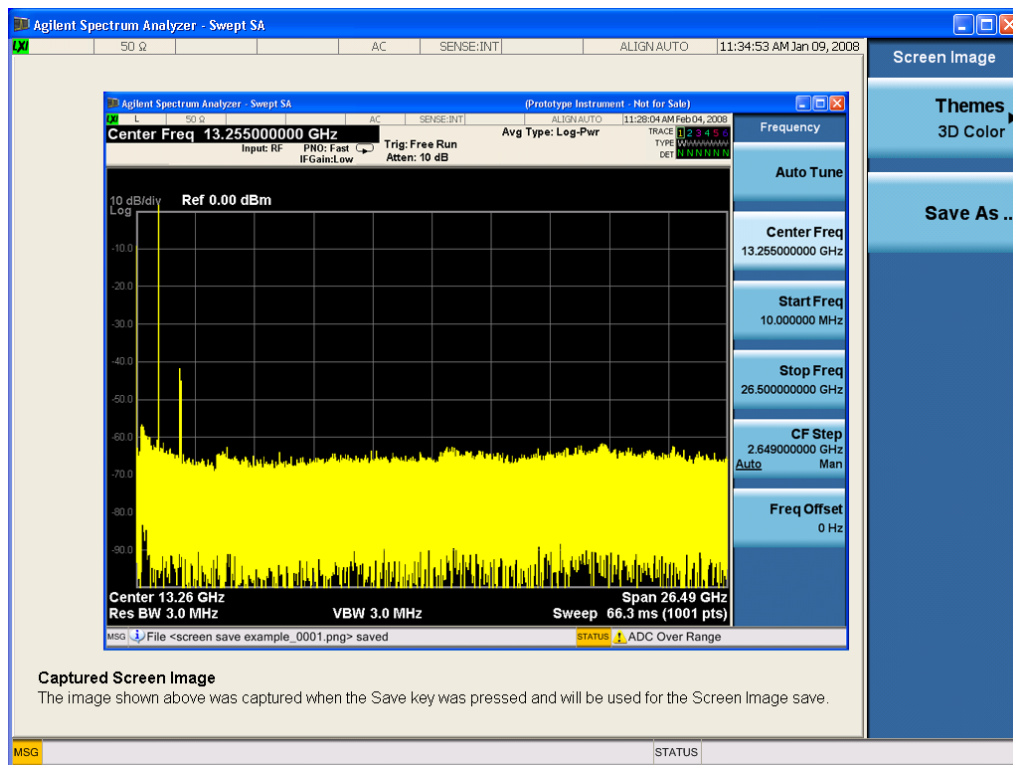

When you continue on into the Save As menu and complete the Screen Image save, the image depicted in the thumbnail is the one that gets saved, showing the menus that were on the screen before going into the Save menus. The save is performed immediately and does not wait until the measurement is complete.

After you have completed the save, the Quick Save front-panel key lets you quickly repeat the last save performed, using an auto-named file, with the current screen data.

**NOTE**

For versions previous to A.01.55, if you initiate a screen image save by navigating through the Save menus, the image that is saved will contain the Save menu softkeys, not the menus and the active function that were on the screen when you first pressed the Save front panel key.

Key Path	Save
Mode	All
Remote Command	:MMEMory:STORe:SCReen <filename>
Example	:MMEM:STOR:SCR "myScreen.png" This stores the current screen image in the file MyScreenFile.png in the default directory.
Initial S/W Revision	Prior to A.02.00

## Themes

Accesses a menu of functions that enable you to choose the theme to be used when saving the screen image.

The **Themes** option is the same as the **Themes** option under the **Display** and **Page Setup** dialogs. It allows you to choose between themes to be used when saving the screen image.

Key Path	Save, Screen Image
Remote Command	:MMEMory:STORe:SCReen:THEMe TDColor   TDMonochrome   FCOLor   FMONochrome  :MMEMory:STORe:SCReen:THEMe?
Example	:MMEM:STOR:SCR:THEM TDM
Preset	3D Color; Is not part of Preset, but is reset by Restore Misc Defaults or Restore System Defaults All and survives subsequent running of the modes.
Readback	3D Color   3D Mono   Flat Color   Flat Mono
Backwards Compatibility Notes	In ESA and PSA we offer the choice of "Reverse Bitmap" or "Reverse Metafile" when saving screen images. This is much like the "Flat Color" theme available in X-Series. Also, if you selected Reverse Bitmap AND a black & white screen image, that would be much like "Flat Monochrome". In other words, each of the X-Series themes has a similar screen image type in ESA/PSA. But they are not identical.
Initial S/W Revision	Prior to A.02.00

## 3D Color

Selects a standard color theme with each object filled, shaded and colored as designed.

Key Path	Save, Screen Image, Themes
<b>Example</b>	MMEM:STOR:SCR:THEM TDC
Readback	3D Color
Initial S/W Revision	Prior to A.02.00

### 3D Monochrome

Selects a format that is like 3D color but shades of gray are used instead of colors.

Key Path	Save, Screen Image, Themes
<b>Example</b>	MMEM:STOR:SCR:THEM TDM
Readback	3D Mono
Initial S/W Revision	Prior to A.02.00

### Flat Color

Selects a format that is best when the screen is to be printed on an ink printer.

Key Path	Save, Screen Image, Themes
<b>Example</b>	MMEM:STOR:SCR:THEM FCOL
Readback	Flat Color
Initial S/W Revision	Prior to A.02.00

### Flat Monochrome

Selects a format that is like Flat Color. But only black is used (no colors, not even gray), and no fill.

Key Path	Save, Screen Image, Themes
<b>Example</b>	MMEM:STOR:SCR:THEM FMON
Readback	Flat Mono
Initial S/W Revision	Prior to A.02.00

### Save As...

When you press "Save As", the analyzer brings up a Windows dialog and a menu entitled "**Save As.**" This menu allows you to navigate to the various fields in the Windows dialog without using a keyboard or mouse. The Tab and Arrow keys can also be used for dialog navigation.

See "[To File ...](#)" on page 2213 in Save, State for a full description of this dialog and menu.

The default path for Screen Images is

My Documents\`<mode name>`\screen.

where `<mode name>` is the parameter used to select the mode with the INST:SEL command (for example, SA for the Spectrum Analyzer).

Key Path	Save, Screen Image
Notes	Brings up Save As dialog for saving a Screen Image Save Type
Initial S/W Revision	Prior to A.02.00

### Mass Storage Catalog (Remote Command Only)

Key path	SCPI Only
<b>Remote Command</b>	:MMEMory:CATalog? [ <code>&lt;directory_name&gt;</code> ]
Notes	<p>The string must be a valid logical path.</p> <p>Queries disk usage information (drive capacity, free space available) and obtains a list of files and directories in a specified directory in the following format:  <code>&lt;numeric_value&gt;,&lt;numeric_value&gt;,{&lt;file_entry&gt;}</code></p> <p>It returns two numeric parameters and as many strings as there are files and directories. The first parameter indicates the total amount of storage currently used in bytes. The second parameter indicates the total amount of storage available, also in bytes. The <code>&lt;file_entry&gt;</code> is a string. Each <code>&lt;file_entry&gt;</code> indicates the name, type, and size of one file in the directory list:  <code>&lt;file_name&gt;,&lt;file_type&gt;,&lt;file_size&gt;</code></p> <p>As the windows file system has an extension that indicates file type, <code>&lt;file_type&gt;</code> is always empty. <code>&lt;file_size&gt;</code> provides the size of the file in bytes. For directories, <code>&lt;file_entry&gt;</code> is surrounded by square brackets and both <code>&lt;file_type&gt;</code> and <code>&lt;file_size&gt;</code> are empty</p>
Initial S/W Revision	Prior to A.02.00

### Mass Storage Change Directory (Remote Command Only)

Key path	SCPI Only
<b>Remote Command</b>	:MMEMory:CDIRectory [ <code>&lt;directory_name&gt;</code> ] :MMEMory:CDIRectory?
Notes	<p>The string must be a valid logical path.</p> <p>Changes the default directory for a mass memory file system. The <code>&lt;directory_name&gt;</code> parameter is a string. If no parameter is specified, the directory is set to the *RST value.</p> <p>At *RST, this value is set to the default user data storage area, that is defined as System.Environment.SpecialFolder.Personal.</p> <p>Query returns full path of the default directory.</p>
Initial S/W Revision	Prior to A.02.00



## Mass Storage Copy (Remote Command Only)

Key path	SCPI Only
<b>Remote Command</b>	:MMEMory:COpy <string>,<string>[,<string>,<string>]
Notes	<p>The string must be a valid logical path.</p> <p>Copies an existing file to a new file or an existing directory to a new directory.</p> <p>Two forms of parameters are allowed. The first form has two parameters. In this form, the first parameter specifies the source, and the second parameter specifies the destination.</p> <p>The second form has four parameters. In this form, the first and third parameters specify the source. The second and fourth parameters specify the directories. The first pair of parameters specifies the source. The second pair specifies the destination. An error is generated if the source doesn't exist or the destination file already exists.</p> <p>This command will generate an "access denied" error if the destination is a restricted folder (e.g., C:\Windows) and the current user does not have Power User or Administrator privileges.</p>

## Mass Storage Device Copy (Remote Command Only)

This command transfers data to/from a file and a peripheral device.

Key path	SCPI Only
<b>Remote Command</b>	:MMEMory:COpy:DEvice <source_string>,<dest_string>
Notes	<p>The strings must be a valid logical path or a valid device keyword. If the dest_string is a device keyword, the data is copied from the source file to the device. If the source_string is a device keyword, the data is copied to the source file from the device.</p> <p>Valid device keywords are:</p> <p>SNS (smart noise source)</p> <p>An error is generated if the file or device is not found.</p>

## Mass Storage Delete (Remote Command Only)

Key path	SCPI Only
<b>Remote Command</b>	:MMEMory:DElete <file_name>[,<directory_name>]
Notes	<p>The string must be a valid logical path.</p> <p>Removes a file from the specified directory. The &lt;file_name&gt; parameter specifies the file name to be removed. This command will generate an "access denied" error if the file is in a restricted folder (e.g., C:\Windows) and the current user does not have Power User or Administrator privileges.</p>
Initial S/W Revision	Prior to A.02.00

## Mass Storage Data (Remote Command Only)

Creates a file containing the specified data OR queries the data from an existing file.

Key path	SCPI Only
<b>Remote Command</b>	:MMEMory:DATA <file_name>, <data> :MMEMory:DATA? <file_name>
Notes	The string must be a valid logical path. The command form is MMEMory:DATA <file_name>,<data>. It loads <data> into the file <file_name>. <data> is in 488.2 block format. <file_name> is string data. The query form is MMEMory:DATA? <file_name> with the response being the associated <data> in block format.
Initial S/W Revision	Prior to A.02.00

### Mass Storage Make Directory (Remote Command Only)

Key path	SCPI Only
<b>Remote Command</b>	:MMEMory:MDIRectory <directory_name>
Notes	The string must be a valid logical path. Creates a new directory. The <directory_name> parameter specifies the name to be created. This command will generate an “access denied” error if the new directory would be in a restricted folder (e.g., C:\Windows) and the current user does not have Power User or Administrator privileges.
Initial S/W Revision	Prior to A.02.00

### Mass Storage Move (Remote Command Only)

Key path	SCPI Only
<b>Remote Command</b>	:MMEMory:MOVE <string>,<string>[,<string>,<string>]
Notes	The string must be a valid logical path. Moves an existing file to a new file or an existing directory to a new directory. Two forms of parameters are allowed. The first form has two parameters. In this form, the first parameter specifies the source, and the second parameter specifies the destination. The second form has four parameters. In this form, the first and third parameters specify the source. The second and fourth parameters specify the directories. The first pair of parameters specifies the source. The second pair specifies the destination. An error is generated if the source doesn't exist or the destination file already exists. This command will generate an “access denied” error if the destination is a restricted folder (e.g., C:\Windows) and the current user does not have Power User or Administrator privileges.
Initial S/W Revision	Prior to A.02.00

## Mass Storage Remove Directory (Remote Command Only)

Key path	SCPI Only
<b>Remote Command</b>	<code>:MMEMory:RDIrectory &lt;directory_name&gt;</code>
Notes	<p>The string must be a valid logical path.</p> <p>Removes a directory. The &lt;directory_name&gt; parameter specifies the directory name to be removed. All files and directories under the specified directory shall also be removed.</p> <p>This command will generate an “access denied” error if the folder is a restricted folder (e.g., C:\Windows) or is in a restricted folder and the current user does not have Power User or Administrator privileges.</p>
Initial S/W Revision	Prior to A.02.00

## Single (Single Measurement/Sweep)

Sets the analyzer for Single measurement operation. The single/continuous state is Meas Global, so the setting will affect all the measurements. If you are Paused, pressing Single does a Resume.

See ["More Information" on page 1868](#)

Key Path	Front-panel key
Example	:INIT:CONT OFF
Notes	See Cont key description.
Backwards Compatibility Notes	<p>For Spectrum Analysis mode in ESA and PSA, the Single hardkey and the INITiate:IMM switched from continuous measurement to single measurement and restarted sweeps and averages (displayed average count reset to 1), but did not restart Max Hold and Min Hold. In the X-Series, the Single hardkey and the INITiate:IMM command initiate a sweep/ measurement/ average sequence/hold sequence including MaxHold and MinHold.</p> <p>For Spectrum Analysis mode in ESA and PSA, the Single hardkey restarted the sweep regardless of whether or not you were in an active sweep or sweep sequence. In the X-Series, Restart does this but Single only restarts the sweep or sweep sequence if you are in the idle state.</p> <p>INIT[:IMM] in ESA &amp; PSA Spectrum Analysis Mode does an implied ABORT. In some other PSA Modes, INIT[:IMM] is ignored if not in the idle state. . The X-Series follows the ESA/PSA SA Mode model, which may cause some Modes to have compatibility problems.</p>
Initial S/W Revision	Prior to A.02.00

### More Information

See ["Restart" on page 2210](#) for details on the INIT:IMMEDIATE (Restart) function.

If you are already in single sweep, the INIT:CONT OFF command has no effect.

If you are already in Single Sweep, then pressing the Single key in the middle of a sweep does not restart the sweep or sequence. Similarly, pressing the Single key does not restart the sweep or sequence if the sweep is not in the idle state (for example, if you are taking a very slow sweep, or the analyzer is waiting for a trigger). Instead, it results in a message. "Already in Single, press Restart to initiate a new sweep or sequence". Even though pressing the Single key in the middle of a sweep does not restart the sweep, sending INIT:IMMEDIATE does reset it.

To take one more sweep without resetting the average count, increment the average count by 1, by pressing the step up key while **Average/Hold Number** is the active function, or sending the remote command CALC:AVER:TCON UP.

## Source

There is no Source control functionality for this measurement. When this key is pressed, the screen either displays a blank menu, or the previously-selected menu remains unchanged.

---

Key Path	Front-panel key
----------	-----------------

---

## Span X Scale

Span X Scale is unavailable in the Spurious Emissions measurement. When pressed, this key displays a blank menu.

---

Key Path	Front-panel key
Initial S/W Revision	Prior to A.02.00

---

## Sweep/Control

Accesses the Sweep/Control menu keys used to set up and control the sweep time and source.

Key Path	Front-panel key
Initial S/W Revision	Prior to A.02.00

### Sweep Setup

Sets the sweep functions that control the sweep state and time.

Key Path	Sweep/Control
Initial S/W Revision	Prior to A.02.00

### Auto Sweep Time Rules

Switches the analyzer between normal and accuracy sweep states. Setting Auto Sweep Time to Accy will result in slower sweep times, usually about three times as long, but better amplitude accuracy for CW signals. The instrument amplitude accuracy specifications only apply when Auto Sweep Time is set to Accy.

Additional amplitude errors which occur when Auto Sweep Time is set to Norm are usually well under 0.1 dB, though this is not guaranteed. Because of the faster sweep times and still low errors, Norm is the preferred setting of Auto Sweep Time. Auto Sweep Time is set to Norm on a Preset or Auto Couple. This means that in the Preset or Auto Coupled state, instrument amplitude accuracy specifications do not apply.

Key Path	Sweep/Control, Sweep Setup
Mode	SA, WCDMA, C2K, WIMAX OFDMA, TD-SCDMA, 1xEV-DO, DVB-T/H, LTE, LTETDD, WLAN, MSR, LTEAFDD, LTEATDD
Remote Command	[ :SENSe ] :SPURious :SWEep :TIME :AUTO :RULEs NORMal   ACCuracy [ :SENSe ] :SPURious :SWEep :TIME :AUTO :RULEs ?
Example	SPUR:SWE:TIME:AUTO:RUL ACC SPUR:SWE:TIME:AUTO:RUL ?
Notes	In Zero Span, this key is irrelevant and inaccessible (because the whole Sweep Setup menu is grayed out), however, Sweep Setup settings can be changed remotely with no error indication.
Preset	NORMal
State Saved	Saved in instrument state.
Range	Norm Accy
Initial S/W Revision	Prior to A.02.00
Modified at S/W Revision	A.03.00

## Sweep Type

Sets the sweep type of the spurious measurement to either Auto or Swept. When in Auto, the selections of swept type of ranges are governed by the Best Speed Sweep Type Rule, and FFT analysis might be chosen for some ranges if it speeds up the measurement.

Key Path	Sweep/Control, Sweep Setup
Mode	SA, WCDMA, C2K, WIMAX OFDMA, TD-SCDMA, 1xEV-DO, DVB-T/H, LTE, LTE-TDD, WLAN, MSR, LTEAFDD, LTEATDD
Remote Command	[ :SENSe ] : SPURious [ :RANGe ] : ALL : SWEep : TYPE : AUTO OFF   ON   0   1 [ :SENSe ] : SPURious [ :RANGe ] : ALL : SWEep : TYPE : AUTO ?
Example	SPUR:ALL:SWE:TYPE:AUTO 1 SPUR:ALL:SWE:TYPE:AUTO?
Dependencies	This parameter is available only when option N9060A-7FP is installed.
Preset	ON
State Saved	Saved in instrument state.
Range	Auto Swept
Initial S/W Revision	A.11.00

## Pause

Pauses a measurement after the current data acquisition is complete.

When paused, the label on the key changes to Resume. Pressing Resume resumes the measurement at the point it was at when paused.

See "[Pause/Resume](#)" on page 2235 for more information.

Key Path	Sweep/Control
Initial S/W Revision	Prior to A.02.00

## Gate

Accesses a menu that enables you to control the gating function. The Gate functionality is used to view signals best viewed by qualifying them with other events.

Gate setup parameters are the same for all measurements – they do not change as you change measurements. Settings like these are called “Meas Global” and are unaffected by Meas Preset.

Note that Sweep Time autocoupling rules and annotation are changed by Gate being on.

Key Path	Sweep/Control
Scope	Meas Global
Readback	



The state and method of Gate, as [Off, LO] or [On, Video]. Note that for measurements that only support gated LO, the method is nonetheless read back, but always as LO.

Initial S/W Revision      Prior to A.02.00

## Gate On/Off

Turns the gate function on and off.

When the Gate Function is on, the selected Gate Method is used along with the gate settings and the signal at the gate source to control the sweep and video system with the gate signal. Not all measurements allow every type of Gate Methods.

When Gate is on, the annunciation in the measurement bar reflects that it is on and what method is used, as seen in the following "Gate: LO" annunciator graphic.

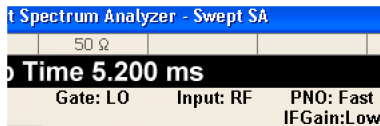

Key Path	Sweep/Control, Gate
Remote Command	[ :SENSe ] :SWEep:EGATe [ :STATe ] OFF   ON   0   1 [ :SENSe ] :SWEep:EGATe [ :STATe ] ?
Example	SWE:EGAT ON SWE:EGAT?

### Dependencies

The function is unavailable (grayed out) and Off when:

- Gate Method is LO or Video and FFT Sweep Type is manually selected.
- Gate Method is FFT and Swept Sweep Type is manually selected.
- Marker Count is ON.

The following are unavailable whenever Gate is on:

- FFT under Sweep Type when Method=LO or Video or Swept under Sweep Type when Method=FFT
- Marker Count

While Gate is on, the Auto Rules for Sweep Type are modified so that the choice agrees with the Gate Method: i.e., FFT for Method = FFT and Swept for Method = LO or Video.

The Gate softkey and all SCPI under the [:SENSe]:SWEep:EGATe SCPI node are grayed out when Source Mode is Tracking with an external source. This is because the Gate circuitry is used to sync the external source. If the Tracking Source is turned on, the Gate is turned off.

When in the ACP measurement:

- When Meas Method is RBW or FAST, this function is unavailable and the key is grayed out.
- Whenever Gate is on, Meas Method, RBW or FAST is unavailable and keys for those are grayed out.
- When Gate is on, Offset Res BW and Offset Video BW are ignored (if you set these values) and the

	measurement works as if all Offset Res BW and all Offset Video BW are coupled with the Res BW and the Video BW under the BW menu. When Gate is on, the Offset BW key in the Offset/Limit menu is grayed out.
Preset	Off LTETDD: On
State Saved	Saved in instrument state
Range	On Off
<b>Backwards Compatibility SCPI</b>	[[:SENSE]:SWEep:TIME:GATE[:STATe] ESA compatibility
Backwards Compatibility Notes	In ESA, Trig Delay (On) and Gate (On) could not be active at the same time.. This dependency does not exist in PSA or in the X-Series.
Initial S/W Revision	Prior to A.02.00

## Gate View On/Off

Turning on Gate View in the Swept SA measurement provides a single-window gate view display..

Turning on Gate View in other measurements shows the split-screen Gate View. In these measurements, when the Gate View is on, the regular view of the current measurement traces and results are reduced vertically to about 70% of the regular height. The Zero Span window, showing the positions of the Gate, is shown between the Measurement Bar and the reduced measurement window. By reducing the height of the measurement window, some of the annotation on the Data Display may not fit and is not shown.

Key Path	Sweep/Control, Gate
Remote Command	[[:SENSE]:SWEep:EGATe:VIEW ON OFF 1 0 [:SENSE]:SWEep:EGATe:VIEW?
Example	SWE:EGAT:VIEW ON turns on the gate view.
Dependencies	In the Swept SA measurement: In Gate View, the regular Sweep Time key is grayed out . When pressed, the grayed out key puts up the informational message "Use Gate View Sweep Time in the Gate menu." In the other measurements: When you turn Gate View on, the lower window takes on the current state of the instrument. Upon leaving Gate View, the instrument takes on the state of the lower window. When you turn Gate View on, the upper window Sweep Time is set to the gate view sweep time.
Couplings	These couplings apply to the Swept SA measurement: <ul style="list-style-type: none"> <li>• When Gate View is turned on, the instrument is set to Zero Span.</li> <li>• Gate View automatically turns off whenever a Span other than Zero is selected.</li> <li>• Gate View automatically turns off if you press the Last Span key while in Gate View, and the instrument returns to the Span it was in before entering Gate View (even if that is Zero Span).</li> <li>• When Gate View is turned on, the sweep time used is the gate view sweep time. This is set according to the rules in section "<a href="#">Gate View Setup</a>" on page 2043</li> <li>• When Gate View is turned off, Sweep Time is set to the normal Swept SA measurement sweep time.</li> </ul>

- If Gate View is on and Gate is off, then turning on Gate turns off Gate View.

Preset	OFF
State Saved	Saved in instrument state
Range	On Off
Initial S/W Revision	Prior to A.02.00

A sample of the Gate View screen in the Swept SA measurement is shown in the following graphic :

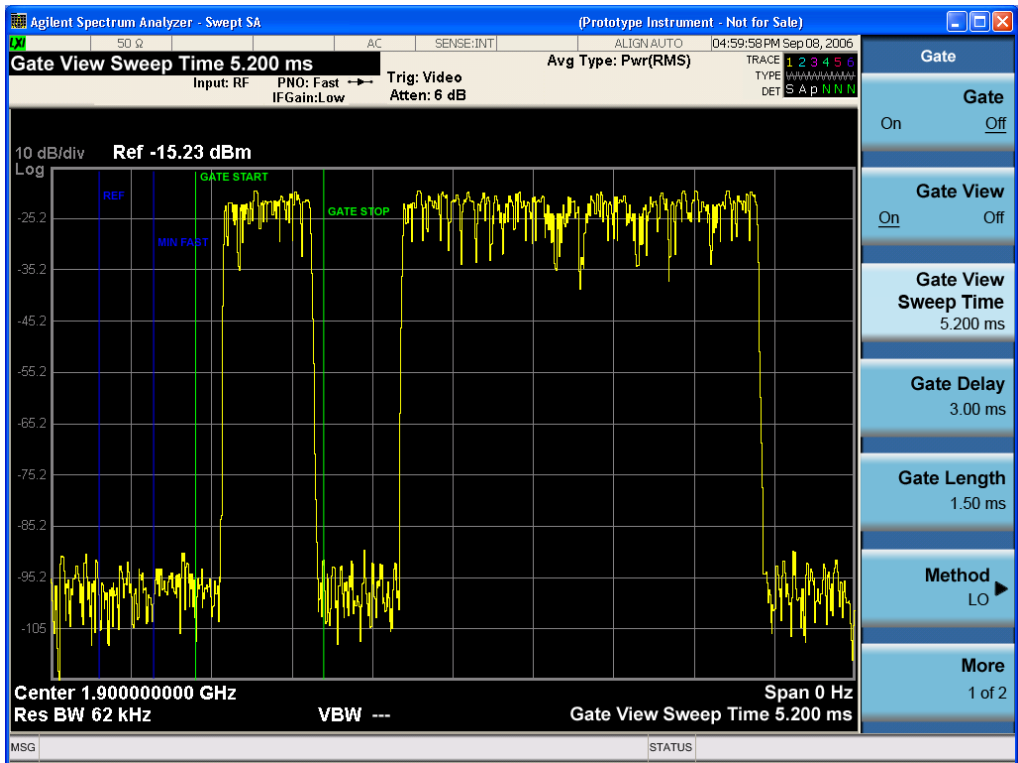

A sample of the Gate View screen in other measurements is shown in the following graphic . This example is for the ACP measurement:

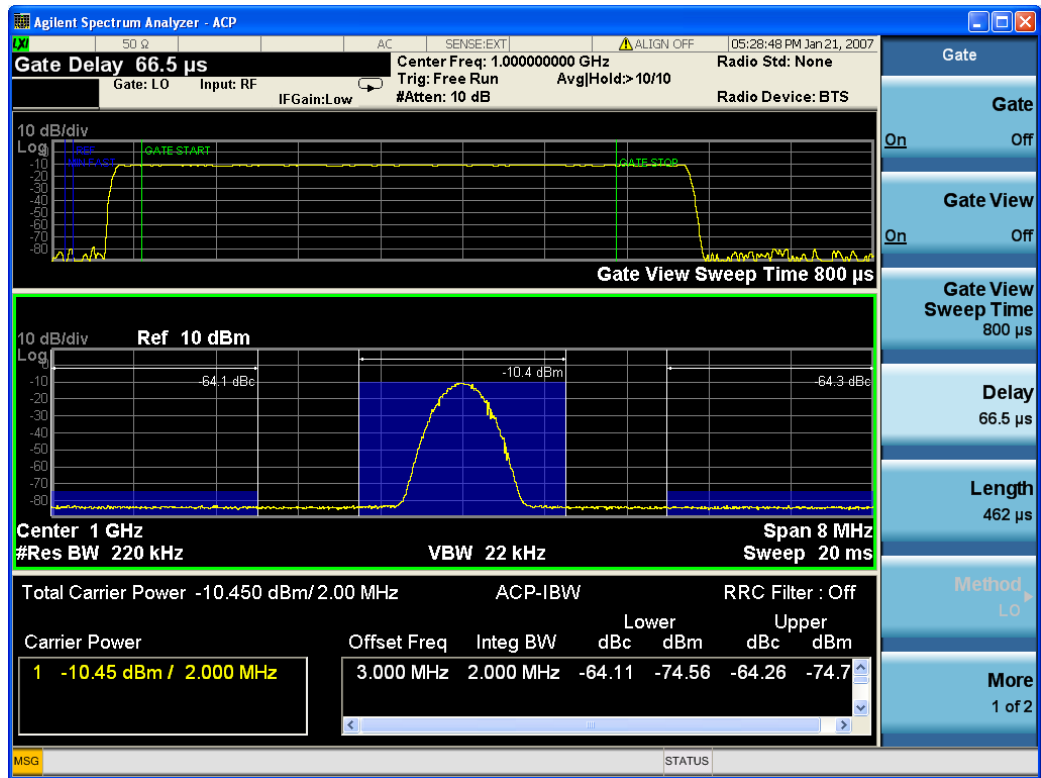

Turning Gate View off returns the analyzer to the Normal measurement view.

In the Swept SA, the normal measurement view is the single-window Swept SA view. When returning to this view, the Swept SA measurement returns to the Span it was in before entering Gate View (even if that is Zero Span).

The Gate View window is triggered from the Gate Source, with zero trigger delay. Also, when updating the Gate View window, the Gate itself must not operate. So it is internally shut off while the gate view window is being updated. For the Swept SA measurement, this means that the Gate is internally shut off whenever the gate view window is displayed. The measurement bar and softkeys continue to show the Trigger source for the main sweep window and give no indication that the Gate is shut off or that the Gate View window is triggered from the Gate Source.

When in Gate View, vertical lines are displayed in the Gate View window as follows:

- Green lines are displayed at the gate edges as follows: in Edge Gate, a line is shown for Delay and one for the end of the Gate period, defined by Length. In Level Gate a line is shown only for Delay. You can adjust the position of the green lines by adjusting the gate length and the gate delay. These lines update in the Gate View window as the active function changes, even if the window is not being updated. In Gated LO and Gated Video, these lines are positioned relative to the delay reference line (not relative to 0 time). In Gated FFT, their location is relative to the left edge of the screen.
- A blue line is displayed showing the delay reference, that is, the reference point for the Gate Delay within the Zero Span window. The blue line represents where (in time) the effective location of the gate start would be if the gate were programmed to zero delay.

- The second blue line is labeled "MIN FAST" as shown in the figure above because it represents the minimum Gate Delay for fast Gated LO operation. This line is only displayed in Gated LO. You cannot scroll (knob) or decrement (down key) the Gate Delay to less than that represented by the position of this line, it can only be set below this position manually, although once there it can be moved freely with the knob while below the line.
- A yellow line in the Gated Video case only, is displayed at  $Blength$ , where  $Blength$  is the display point (bucket) length for the swept trace, which is given by the sweep time for that trace divided by number of Points - 1. So it is referenced to 0 time, not to the delay reference. This line is labeled NEXT PT (it is not shown in the figure above because the figure above is for Gated LO).
- The yellow line represents the edge of a display point (bucket). Normally in Gated Video, the bucket length must be selected so that it exceeds the off time of the burst. There is another way to use the analyzer in Gated Video measurements, and that is to set the bucket width much shorter than the off time of the burst. Then use the Max Hold trace function to fill in "missing" buckets more slowly. This allows you to see some of the patterns of the Gated Video results earlier, though seeing a completely filled-in spectrum later.

## Gate View Setup

Accesses a menu that enables you to setup parameters relevant to the Gate View

Key Path	Sweep/Control, Gate
Scope	Meas Global
Initial S/W Revision	A.10.00

## Gate View Sweep Time

Controls the sweep time in the Gate View window. To provide an optimal view of the gate signal, the analyzer initializes Gate View Sweep Time based on the current settings of Gate Delay and Gate Length.

Key Path	Sweep/Control, Gate, Gate View Setup
<b>Remote Command</b>	[ :SENSe ] :SWEep:EGATe:TIME <time> [ :SENSe ] :SWEep:EGATe:TIME?
<b>Example</b>	SWE:EGAT:TIME 500 ms
Dependencies	Gate View Sweep Time is initialized: <ul style="list-style-type: none"> <li>• On Preset (after initializing delay and length).</li> <li>• Every time the Gate Method is set/changed.</li> </ul> <p>Additionally, in the Swept SA measurement, whenever you do a Preset, or leave Gate View, the analyzer remembers the Gate Delay and Gate Length settings. Then, when returning to Gate View, if the current Gate Delay and/or Gate Length do not match the remembered values Gate View Sweep Time is re-initialized.</p> <ol style="list-style-type: none"> <li>1. Compute the location of the "gate stop" line, which you know is at time <math>t = t_{min} + GateDelay + GateLength</math>.</li> </ol>
Preset	519.3 $\mu$ s

	WiMAX OFDMA: 5 ms GSM/EDGE: 1 ms
State Saved	Saved in instrument state
Max	6000 s
Initial S/W Revision	Prior to A.02.00

### Gate View Start Time

Controls the time at the left edge of the Gate View.

Key Path	Sweep/Control, Gate, Gate View Setup
Remote Command	[ :SENSe ] :SWEep:EGATe:VIEW:STARt <time> [ :SENSe ] :SWEep:EGATe:VIEW:STARt?
Example	SWE:EGAT:VIEW:STAR 10ms
Notes	Units of time are required or no units; otherwise an invalid suffix error message will be generated. See error -131.
Preset	0 ms
State Saved	Saved in instrument state
Min	0
Max	500 ms
Initial S/W Revision	A.10.00

### Gate Delay

Controls the length of time from the time the gate condition goes True until the gate is turned on.

Key Path	Sweep/Control, Gate
Remote Command	[ :SENSe ] :SWEep:EGATe:DELay <time> [ :SENSe ] :SWEep:EGATe:DELay?
Example	SWE:EGAT:DELay 500ms SWE:EGAT:DELay?
Notes	Units of time are required or no units; otherwise an invalid suffix error message will be generated.
Preset	57.7 us WiMAX OFDMA: 71 us GSM/EDGE: 600 us WLAN: 500 us
State Saved	Saved in instrument state

Min	0.0 us
Max	100 s
<b>Backwards Compatibility SCPI</b>	[:SENSe]:SWEep:TIME:GATE:DELay ESA compatibility
Initial S/W Revision	Prior to A.02.00

## Gate Length

Controls the length of time that the gate is on after it opens.

Key Path	Sweep/Control, Gate
<b>Remote Command</b>	[:SENSe]:SWEep:EGATe:LENGth <time> [:SENSe]:SWEep:EGATe:LENGth?
<b>Example</b>	SWE:EGAT:LENG 1 SWE:EGAT:LENG?
Notes	Units of time are required or no units; otherwise an invalid suffix error message will be generated.

### Dependencies

Grayed out when Gate Method is set to FFT in which case the label changes to that shown below.



The key is also grayed out if Gate Control = Level.

Preset	461.6 us WiMAX OFDMA: 50 us GSM/EDGE: 200 us WLAN: 1.54 ms
State Saved	Saved in instrument state
Min	100 ns
Max	5 s
<b>Backwards Compatibility SCPI</b>	[:SENSe]:SWEep:TIME:GATE:LENGth ESA compatibility
Initial S/W Revision	Prior to A.02.00

## Gate Source

The menus under the Gate Source key are the same as those under the Trigger key, with the exception that neither Free Run nor Video are available as Gate Source selections. However, a different SCPI command

is used to select the Gate Source (see table below) because you may independently set the Gate Source and the Trigger Source.

Any changes to the settings in the setup menus under each Gate Source selection key (for example: Trigger Level, Trigger Delay, etc.) also affect the corresponding settings under the Trigger menu keys. The SCPI commands used for these are the same for Trigger and Gate, since there is only one setting which affects both Gate and Trigger. Example: to set the Trigger Level for External 1 you use the command :TRIG:EXT1:LEV regardless of whether you are using External 1 as a Trigger Source or a Gate Source.

Key Path	Sweep/Control, Gate
Remote Command	[ :SENSe ] :SWEep:EGATe:SOURce EXTernal1   EXTernal2   LINE   FRAME   RFBurst  [ :SENSe ] :SWEep:EGATe:SOURce?
Dependencies	In some models, there is no second External input. In these models, the External 2 key is blanked and the EXTernal2 parameter will generate a "Hardware missing; Not available for this model number" error.
Preset	EXTernal 1 GSM/EDGE, MSR: FRAME LTETDD: EXTernal 1When Direction is Downlink, FRAME when Direction is Uplink.
Backwards Compatibility Notes	In ESA, there is a single Gate input port. In PSA, the Gate Source may be taken from one of two specified input ports. In the X-Series, any Trigger Source can be a Gate Source.
Initial S/W Revision	Prior to A.02.00
Modified at S/W Revision	A.03.00, A.14.00

## Line

Pressing this key, when it is not selected, selects the line signal as the trigger. A new sweep/measurement will start synchronized with the next cycle of the line voltage. Pressing this key, when it is already selected, access the line trigger setup menu.

Key Path	Trigger
Example	TRIG:SOUR LINE Swept SA measurement TRIG:<meas>:SOUR LINE Measurements other than Swept SA
Dependencies	Line trigger is not available when operating from a "dc power source", for example, when the instrument is powered from batteries.
State Saved	Saved in instrument state
Status Bits/OPC dependencies	The Status Operation Register bit 5 "Waiting for Trigger" is set at the same time as the Sweeping or Measuring bit is set. It is cleared when the trigger actually occurs (that is, after the trigger event occurs and all the applicable trigger criteria have been met). A corresponding pop-up message ("Waiting for trigger") is generated if no trigger signal appears after approximately 2 sec. This message goes away when a trigger signal appears.
Initial S/W Revision	Prior to A.02.00



## Trig Slope

Controls the trigger polarity. It is set positive to trigger on a rising edge and negative to trigger on a falling edge.

Key Path	Trigger, Line
<b>Remote Command</b>	:TRIGger[:SEquence]:LINE:SLOPe POSitive NEGative :TRIGger[:SEquence]:LINE:SLOPe?
<b>Example</b>	TRIG:LINE:SLOP NEG
Preset	POSitive
State Saved	Saved in instrument state
Backwards Compatibility Notes	The legacy :TRIGger[:SEquence]:SLOPe command affects the slopes for the VID, LINE, EXT1, EXT2, and RFB triggers.
Initial S/W Revision	Prior to A.02.00

## External 1

Pressing this key, when it is not selected, selects an external input signal as the trigger. A new sweep/measurement will start when the external trigger condition is met using the external 1 input connector on the rear panel.

Pressing this key, when it is already selected, accesses the external 1 trigger setup menu.

Key Path	Trigger
<b>Example</b>	TRIG:SOUR EXT1 Swept SA measurement TRIG:<meas>:SOUR EXT1 Measurements other than Swept SA
Dependencies	Grayed out if in use by Point Trigger in the Source Setup menu. Forced to Free Run if already selected and Point Trigger is set to External 1.
State Saved	Saved in instrument state
Status Bits/OPC dependencies	The Status Operation Register bit 5 "Waiting for Trigger" is set at the same time as the Sweeping or Measuring bit is set. It is cleared when the trigger actually occurs (that is, after the trigger event occurs and all the applicable trigger criteria have been met). A corresponding pop-up message ("Waiting for trigger") is generated if no trigger signal appears after approximately 2 sec. This message goes away when a trigger signal appears.
Initial S/W Revision	Prior to A.02.00

## Trigger Level

Sets the value where the external 1 trigger input will trigger a new sweep/measurement.

Key Path	Trigger, External 1
<b>Remote Command</b>	:TRIGger[:SEquence]:EXTernal1:LEVel <level>

	:TRIGger[:SEquence]:EXTernal:LEVel?
<b>Example</b>	TRIG:EXT1:LEV 0.4 V
Couplings	This same level is used for the Ext1 trigger source in the Trigger menu, for the Ext1 selection in the Periodic Timer sync source (in the Trigger menu and in the Gate Source menu), and also for the Ext1 selection in the Gate Source menu.
Preset	1.2 V
State Saved	Saved in instrument state
Min	-5 V
Max	5 V
Default Unit	V
<b>Backwards Compatibility SCPI</b>	:TRIGger[:SEquence]:EXTernal:LEVel
<b>Backwards Compatibility SCPI</b>	For backward compatibility, the parameter EXTernal is mapped to EXTernal1
<b>Backwards Compatibility SCPI</b>	:TRIGger[:SEquence]:FRAME:EXTernal1:LEVel
Initial S/W Revision	Prior to A.02.00

### Trig Slope

Controls the trigger polarity. It is set positive to trigger on a rising edge and negative to trigger on a falling edge.

Key Path	Trigger, External 1
<b>Remote Command</b>	:TRIGger[:SEquence]:EXTernal:SLOPe POSitive NEGative :TRIGger[:SEquence]:EXTernal:SLOPe?
<b>Example</b>	TRIG:EXT1:SLOP NEG
Couplings	This same slope is used in the Ext1 selection for the trigger source in the Trigger menu and for the period timer sync source (in the Trigger menu and in the Gate Source menu).
Preset	POSitive
State Saved	Saved in instrument state
<b>Backwards Compatibility SCPI</b>	:TRIGger[:SEquence]:EXTernal:SLOPe
<b>Backwards Compatibility SCPI</b>	For backward compatibility, the parameter EXTernal is mapped to EXTernal1
<b>Backwards Compatibility SCPI</b>	:TRIGger[:SEquence]:FRAME:EXTernal1:SLOPe
Backwards Compatibility Notes	The legacy :TRIGger[:SEquence]:SLOPe command affects the slopes for the VID, LINE, EXT1, EXT2, and RFB triggers.
Initial S/W Revision	Prior to A.02.00

## External 2

Pressing this key, when it is not selected, selects an external input signal as the trigger. A new sweep/measurement will start when the external trigger condition is met using the external 2 input connector. The external trigger 2 input connector is on the rear panel.

Pressing this key, when it is already selected, accesses the external 2 trigger setup menu.

Key Path	Trigger
<b>Example</b>	TRIG:SOUR EXT2 Swept SA measurement TRIG:<meas>:SOUR EXT2 Measurements other than Swept SA
Dependencies	In some models, there is no second External input. In these models, the External 2 key is blanked and the EXTernal2 parameter will generate a "Hardware missing; Not available for this model number" message. Grayed out if in use by Point Trigger in the Source Setup menu. Forced to Free Run if already selected and Point Trigger is set to External 2.
State Saved	Saved in instrument state
Status Bits/OPC dependencies	The Status Operation Register bit 5 "Waiting for Trigger" is set at the same time as the Sweeping or Measuring bit is set. It is cleared when the trigger actually occurs (that is, after the trigger event occurs and all the applicable trigger criteria have been met). A corresponding pop-up message ("Waiting for trigger") is generated if no trigger signal appears after approximately 2 sec. This message goes away when a trigger signal appears.
Initial S/W Revision	Prior to A.02.00
Modified at S/W Revision	A.03.00

## Trigger Level

Sets the value where the external 2 trigger input will trigger a new sweep/measurement.

Key Path	Trigger, External 2
<b>Remote Command</b>	:TRIGger[:SEquence]:EXTernal2:LEVel :TRIGger[:SEquence]:EXTernal2:LEVel?
<b>Example</b>	TRIG:EXT2:LEV 1.1 V
Couplings	This same level is used for the Ext2 trigger source in the Trigger menu, for the Ext2 selection in the Periodic Timer sync source (in the Trigger menu and in the Gate Source menu), and also for the Ext2 selection in the Gate Source menu.
Preset	1.2 V
State Saved	Saved in instrument state
Min	-5 V
Max	5 V
Default Unit	V
<b>Backwards Compatibility SCPI</b>	:TRIGger[:SEquence]:FRAMe:EXTernal2:LEVel
Initial S/W Revision	Prior to A.02.00

### Trig Slope

Controls the trigger polarity. It is set positive to trigger on a rising edge and negative to trigger on a falling edge.

<b>Key Path</b>	Trigger, External 2
<b>Remote Command</b>	:TRIGger[:SEquence]:EXTernal2:SLOPe POSitive NEGative :TRIGger[:SEquence]:EXTernal2:SLOPe?
<b>Example</b>	TRIG:EXT2:SLOP NEG
<b>Couplings</b>	This same slope is used in the Ext2 selection for the trigger source in the Trigger menu and for the period timer sync source (in the Trigger menu and in the Gate Source menu).
<b>Preset</b>	POSitive
<b>State Saved</b>	Saved in instrument state
<b>Backwards Compatibility SCPI</b>	:TRIGger[:SEquence]:FRAMe:EXTernal2:SLOPe
<b>Backwards Compatibility Notes</b>	The legacy :TRIGger[:SEquence]:SLOPe command affects the slopes for the VID, LINE, EXT1, EXT2, and RFB triggers.
<b>Initial S/W Revision</b>	Prior to A.02.00

### RF Burst

Pressing this key, when it is not selected, selects the RF Burst as the trigger. A new sweep/measurement will start when an RF burst envelope signal is identified from the signal at the RF Input connector. Pressing this key, when it is already selected, accesses the RF Burst trigger setup menu.

In some models, a variety of burst trigger circuitry is available, resulting in various available burst trigger bandwidths. The analyzer automatically chooses the appropriate trigger path based on the hardware configuration and other settings of the analyzer.

<b>Key Path</b>	Trigger
<b>Example</b>	TRIG:SOUR RFB                      Swept SA measurement TRIG:<meas>:SOUR RFB      Measurements other than Swept SA
<b>State Saved</b>	Saved in instrument state
<b>Status Bits/OPC dependencies</b>	The Status Operation Register bit 5 "Waiting for Trigger" is set at the same time as the Sweeping or Measuring bit is set. It is cleared when the trigger actually occurs (that is, after the trigger event occurs and all the applicable trigger criteria have been met). A corresponding pop-up message ("Waiting for trigger") is generated if no trigger signal appears after approximately 2 sec. This message goes away when a trigger signal appears.
<b>Backwards Compatibility Notes</b>	The legacy command: :TRIGger[:SEquence]:RFBurst:FSElectivity[:STATe] OFF ON 0 1 is not supported in the X-Series, as the hardware to do Frequency Selective burst triggers does not exist in X-Series.

Initial S/W Revision	Prior to A.02.00
Modified at S/W Revision	A.04.00

### Absolute Trigger Level

Sets the absolute trigger level for the RF burst envelope.

When using the External Mixing path, the Absolute Trigger Level is uncalibrated because the factory default was set to accommodate the expected IF levels for the RF path.

Key Path	Trigger, RF Burst
Scope	Meas Global
<b>Remote Command</b>	:TRIGger[:SEquence]:RFBurst:LEVel:ABSolute <ampl> :TRIGger[:SEquence]:RFBurst:LEVel:ABSolute?
<b>Example</b>	TRIG:RFB:LEV:ABS 10 dBm sets the trigger level of the RF burst envelope signal to the absolute level of 10 dBm
Notes	Sending this command does not switch the setting from relative to absolute; to switch it you need to send the :TRIGger[:SEquence]:RFBurst:LEVel:TYPE command, below.  Amplitude Corrections are not taken into account by the Absolute Trigger Level. For example, if you have given yourself effective gain with an amplitude correction factor, the Absolute Trigger will not fire until you have set the trigger level that far below the displayed signal level, rather than simply to the displayed signal level. This is only true for Amplitude Corrections, not External Gain or Ref Level Offset functions.  If mode is Bluetooth, the default value is -50 dBm.
Couplings	This same level is used for the RF Burst trigger source in the Trigger menu, for the RF Burst selection in the Periodic Timer sync source (in the Trigger menu and in the Gate Source menu), and also for the RF Burst selection in the Gate Source menu
Preset	-20 dBm
State Saved	Saved in instrument state
Min	-200 dBm
Max	100 dBm
Default Unit	depends on the current selected Y-Axis unit
<b>Backwards Compatibility SCPI</b>	:TRIGger[:SEquence]:FRAME:RFBurst:LEVel:ABSolute
Initial S/W Revision	Prior to A.02.00
Modified at S/W Revision	A.04.00

Key Path	Trigger, RF Burst
<b>Remote Command</b>	:TRIGger[:SEquence]:RFBurst:LEVel:TYPE ABSolute RELative :TRIGger[:SEquence]:RFBurst:LEVel:TYPE?

<b>Example</b>	TRIG:RFB:LEV:TYPE REL sets the trigger level type of the RF burst trigger to Relative.
Preset	ABSolute
State Saved	Saved in instrument state
Initial S/W Revision	Prior to A.02.00
Modified at S/W Revision	A.04.00

### Relative Trigger Level

Sets the relative trigger level for the RF burst envelope.

In some models, the relative burst trigger function is implemented in hardware. In other models, without the advanced triggering hardware required, the relative burst trigger function is implemented in software in some measurements, and is unavailable in other measurements.

When implemented in software, the relative RF Burst trigger function is implemented as follows:

1. The measurement starts with the absolute RF Burst trigger setting. If it cannot get a trigger with that level, auto trigger fires and the acquisition starts anyway. After the acquisition, the measurement searches for the peak in the acquired waveform and saves it.
2. Now, in the next cycle of the measurement, the measurement determines a new absolute RF Burst level based on the peak value from the first measurement and the Relative RF Burst Trigger Level (always 0 or negative dB) set by the user. The following formula is used:
3. absolute RF Burst level = peak level of the previous acquisition + relative RF Burst level
4. If the new absolute RF Burst level differs from the previous by more than 0.5 dB, the new level is sent to the hardware; otherwise it is not updated (to avoid slowing down the acquisition)

Steps 2 and 3 repeat for subsequent measurements.

<b>Key Path</b>	Trigger, RF Burst
<b>Scope</b>	Meas Global
<b>Remote Command</b>	:TRIGger[:SEquence]:RFBurst:LEVel:RELative <rel_amp1> :TRIGger[:SEquence]:RFBurst:LEVel:RELative?
<b>Example</b>	TRIG:RFB:LEV:REL -10 dB sets the trigger level of the RF burst envelope signal to the relative level of -10 dB
<b>Notes</b>	Sending this command does not switch the setting from absolute to relative; to switch it you need to send the :TRIGger[:SEquence]:RFBurst:LEVel:TYPE command, above. The relative trigger level is not available in some measurements. In those measurements the RELative parameter, and the :TRIGger[:SEquence]:RFBurst:LEVel:TYPE command (above), will generate an error if sent.
<b>Dependencies</b>	This key is grayed out and Absolute Trigger Level selected if the required hardware is not present in your analyzer and the current measurement does not support Relative triggering.
<b>Preset</b>	-6 dB

	GSM: -25 dB
State Saved	Saved in instrument state
Min	-45 dB
Max	0 dB
Default Unit	dB or dBc
<b>Backwards Compatibility SCPI</b>	:TRIGger[:SEquence]:RFBurst:LEVel
	This legacy command is aliased to :TRIGger[:SEquence]:RFBurst:LEVel:RELative because the PSA had ONLY relative burst triggering
Initial S/W Revision	Prior to A.02.00
Modified at S/W Revision	A.04.00

### Trigger Slope

It is set positive to trigger on a rising edge and negative to trigger on a falling edge.

Key Path	Trigger, RF Burst
<b>Remote Command</b>	:TRIGger[:SEquence]:RFBurst:SLOPe POSitive NEGative :TRIGger[:SEquence]:RFBurst:SLOPe?
<b>Example</b>	TRIG:RFB:SLOP NEG
Couplings	This same slope is used in the RF Burst selection for the trigger source in the Trigger menu and for the period timer sync source (in the Trigger menu and in the Gate Source menu).
Preset	POSitive
State Saved	Saved in instrument state
<b>Backwards Compatibility SCPI</b>	:TRIGger[:SEquence]:FRAMe:RFBurst:SLOPe
Backwards Compatibility Notes	The legacy :TRIGger[:SEquence]:SLOPe command affects the slopes for the VID, LINE, EXT1, EXT2, and RFB triggers.
Initial S/W Revision	Prior to A.02.00

### Periodic Timer (Frame Trigger)

Pressing this key, when it is not selected, selects the internal periodic timer signal as the trigger. Triggering occurrences are set by the **Period** parameter, which is modified by the **Sync Source** and **Offset**. Pressing this key, when it is already selected, accesses the periodic timer trigger setup functions.

If you do not have a sync source selected (it is Off), then the internal timer will not be synchronized with any external timing events.

Key Path	Trigger
<b>Example</b>	TRIG:SOUR FRAM      Swept SA measurement TRIG:<meas>:SOUR FRAM      Measurements other than Swept SA

State Saved	Saved in instrument state
Readback	[Sync: <value of Sync Source>], for example, [Sync: External 1]
Status Bits/OPC dependencies	The Status Operation Register bit 5 "Waiting for Trigger" is set at the same time as the Sweeping or Measuring bit is set. It is cleared when the trigger actually occurs (that is, after the trigger event occurs and all the applicable trigger criteria have been met). A corresponding pop-up message ("Waiting for trigger") is generated if no trigger signal appears after approximately 2 sec. This message goes away when a trigger signal appears.
Initial S/W Revision	Prior to A.02.00

Periodic Timer Triggering:

This feature selects the internal periodic timer signal as the trigger. Trigger occurrences are set by the **Periodic Timer** parameter, which is modified by the **Sync Source** and **Offset**.

The figure below shows the action of the periodic timer trigger. Before reviewing the figure, we'll explain some uses for the periodic trigger.

A common application is measuring periodic burst RF signals for which a trigger signal is not easily available. For example, we might be measuring a TDMA radio which bursts every 20 ms. Let's assume that the 20 ms period is very consistent. Let's also assume that we do not have an external trigger source available that is synchronized with the period, and that the signal-to-noise ratio of the signal is not high enough to provide a clean RF burst trigger at all of the analysis frequencies. For example, we might want to measure spurious transmissions at an offset from the carrier that is larger than the bandwidth of the RF burst trigger. In this application, we can set the Periodic Timer to a 20.00 ms period and adjust the offset from that timer to position our trigger just where we want it. If we find that the 20.00 ms is not exactly right, we can adjust the period slightly to minimize the drift between the period timer and the signal to be measured.

A second way to use this feature would be to use **Sync Source** temporarily, instead of **Offset**. In this case, we might tune to the signal in a narrow span and use the RF Burst trigger to synchronize the periodic timer. Then we would turn the sync source off so that it would not miss-trigger. Miss-triggering can occur when we are tuned so far away from the RF burst trigger that it is no longer reliable.

A third example would be to synchronize to a signal that has a reference time element of much longer period than the period of interest. In some CDMA applications, it is useful to look at signals with a short periodicity, by synchronizing that periodicity to the "even-second clock" edge that happens every two seconds. Thus, we could connect the even-second clock trigger to Ext1 and use then Ext1 as the sync source for the periodic timer.

The figure below illustrates this third example. The top trace represents the even-second clock. It causes the periodic timer to synchronize with the leading edge shown. The analyzer trigger occurs at a time delayed by the accumulated offset from the period trigger event. The periodic timer continues to run, and triggers continue to occur, with a periodicity determined by the analyzer time base. The timer output (labeled "late event") will drift away from its ideal time due to imperfect matching between the time base of the signal being measured and the time base of the analyzer, and also because of imperfect setting of the period parameter. But the synchronization is restored on the next even-second clock event. ("Accumulated offset" is described in the in the **Offset** function section.)



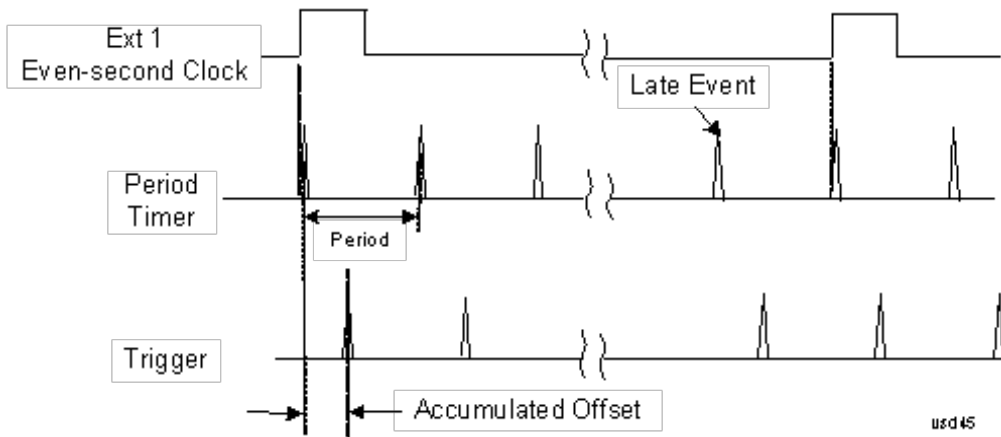

### Period

Sets the period of the internal periodic timer clock. For digital communications signals, this is usually set to the frame period of your current input signal. In the case that sync source is not set to OFF, and the external sync source rate is changed for some reason, the periodic timer is synchronized at the every external synchronization pulse by resetting the internal state of the timer circuit.

Key Path	Trigger, Periodic Timer
Remote Command	:TRIGger[:SEquence]:FRAMe:PERiod <time> :TRIGger[:SEquence]:FRAMe:PERiod?
Example	TRIG:FRAM:PER 100 ms
Dependencies	The invalid data indicator turns on when the period is changed, until the next sweep/measurement completes.
Couplings	The same period is used in the Gate Source selection of the period timer.
Preset	20 ms GSM: 4.615383
State Saved	Saved in instrument state
Min	100.000 ns
Max	559.0000 ms
Default Unit	S
Initial S/W Revision	Prior to A.02.00

### Offset

Adjusts the accumulated offset between the periodic timer events and the trigger event. Adjusting the accumulated offset is different than setting an offset, and requires explanation.

The periodic timer is usually not synchronized with any external events, so the timing of its output events has no absolute meaning. Since the timing relative to external events (RF signals) is important, you need to be able to adjust (offset) it. However, you have no direct way to see when the periodic timer events occur. All that you can see is the trigger timing. When you want to adjust the trigger timing, you will be changing the internal offset between the periodic timer events and the trigger event. Because the absolute value of

that internal offset is unknown, we will just call that the accumulated offset. Whenever the Offset parameter is changed, you are changing that accumulated offset. You can reset the displayed offset using Reset Offset Display. Changing the display does not change the value of the accumulated offset, and you can still make additional changes to accumulated offset.

To avoid ambiguity, we define that an increase in the "offset" parameter, either from the knob or the SCPI adjust command, serves to delay the timing of the trigger event.

<b>Key Path</b>	Trigger, Periodic Timer
<b>Remote Command</b>	:TRIGger[:SEquence]:FRAMe:OFFSet <time> :TRIGger[:SEquence]:FRAMe:OFFSet?
<b>Example</b>	TRIG:FRAM:OFFS 1.2 ms
<b>Notes</b>	<p>The front panel interface (for example, the knob), and this command, adjust the accumulated offset, which is shown on the active function display. However, the actual amount sent to the hardware each time the offset is updated is the delta value, that is, the current accumulated offset value minus the previous accumulated offset value. Note that the accumulated offset value is essentially arbitrary; it represents the accumulated offset from the last time the offset was zeroed (with the Reset Offset Display key).</p> <p>Note that this command does not change the period of the trigger waveform. Note also that Offset is used only when the sync source is set to OFF, otherwise delay is used, see section <a href="#">"Trig Delay" on page 443</a>.</p> <p>An increase in the "offset" parameter, either from the knob or the SCPI adjust command, serves to delay the timing of the trigger event.</p>
<b>Notes</b>	<p>When the SCPI command is sent the value shown on the key (and the Active Function, if this happens to be the active function) is updated with the new value. However, the actual amount sent to the hardware is the delta value, that is, the current accumulated offset value minus the previous accumulated offset value.</p> <p>The SCPI query simply returns the value currently showing on the key.</p>
<b>Dependencies</b>	The invalid data indicator turns on when the offset is changed, until the next sweep/measurement completes.
<b>Couplings</b>	The same offset is used in the Gate Source selection of the period timer.
<b>Preset</b>	0 s
<b>State Saved</b>	Saved in instrument state
<b>Min</b>	-10.000 s
<b>Max</b>	10.000 s
<b>Default Unit</b>	S
<b>Initial S/W Revision</b>	Prior to A.02.00

#### Offset Adjust (Remote Command Only)

This remote command does not work at all like the related front panel keys. This command lets you advance the phase of the frame trigger by the amount you specify.

It does not change the period of the trigger waveform. If the command is sent multiple times, it advances the phase of the frame trigger an additional amount each time it is sent. Negative numbers are permitted.

<b>Remote Command</b>	:TRIGger[:SEquence]:FRAMe:ADJust <time>
<b>Example</b>	TRIG:FRAM:ADJ 1.2 ms
<b>Notes</b>	Note also that Offset is used only when the sync source is set to OFF, otherwise delay is used, see section "Trig Delay" on page 443 An increase in the "offset" parameter, either from the knob or the SCPI adjust command, serves to delay the timing of the trigger event.
<b>Notes</b>	The front panel interface (for example, the knob) and the :TRIG:FRAM:OFFS command adjust the accumulated offset, which is shown on the active function display. However, the actual amount sent to the hardware is the delta value, that is, the current offset value minus the previous offset value. When the SCPI command is sent the value shown on the key (and the Active Function, if this happens to be the active function) is updated by increasing it (or decreasing it if the value sent is negative) by the amount specified in the SCPI command. This is a "command only" SCPI command, with no query.
<b>Dependencies</b>	The invalid data indicator turns on when the offset is changed, until the next sweep/measurement completes.
<b>Couplings</b>	The same offset is used in the Gate Source selection of the period timer.
<b>Preset</b>	0 s
<b>State Saved</b>	Saved in instrument state
<b>Min</b>	-10.000 s
<b>Max</b>	10.000 s
<b>Default Unit</b>	S
<b>Initial S/W Revision</b>	Prior to A.02.00

### Reset Offset Display

Resets the value of the periodic trigger offset display setting to 0.0 seconds. The current displayed trigger location may include an offset value defined with the Offset key. Pressing this key redefines the currently displayed trigger location as the new trigger point that is 0.0 s offset. The Offset key can then be used to add offset relative to this new timing.

<b>Key Path</b>	Trigger, Periodic Timer
<b>Remote Command</b>	:TRIGger[:SEquence]:FRAMe:OFFSet:DISPlay:RESet
<b>Example</b>	TRIG:FRAM:OFFS:DISP:RES
<b>Initial S/W Revision</b>	Prior to A.02.00

### Sync Source

Selects a signal source for you to synchronize your periodic timer trigger to, otherwise you are triggering at some arbitrary location in the frame. Synchronization reduces the precision requirements on the setting of the period.

For convenience you may adjust the level and slope of the selected sync source in a conditional branch setup menu accessed from the Sync Source menu. Note that these settings match those in the **Trigger** and **Gate Source** menus; that is, each trigger source has only one value of level and slope, regardless of which menu it is accessed from.

<b>Key Path</b>	Trigger, Periodic Timer
<b>Remote Command</b>	:TRIGger[:SEquence]:FRAMe:SYNC EXTernal1   EXTernal2   RFBurst   OFF :TRIGger[:SEquence]:FRAMe:SYNC?
<b>Example</b>	TRIG:FRAM:SYNC EXT2
<b>Dependencies</b>	In some models, there is no second External input. In these models, the External 2 key is blanked and the EXTERNAL2 parameter will generate a "Hardware missing; Not available for this model number" message.
<b>Preset</b>	Off GSM/EDGE, MSR,LTE,LTETDD: RFBurst
<b>State Saved</b>	Saved in instrument state
<b>Readback</b>	The current setting is read back to this key and it is also Readback to the previous Periodic Timer trigger key.
<b>Backwards Compatibility SCPI</b>	:TRIGger[:SEquence]:FRAMe:SYNC EXTernal For backward compatibility, the parameter EXTernal is mapped to EXTernal1
<b>Initial S/W Revision</b>	Prior to A.02.00
<b>Modified at S/W Revision</b>	A.03.00, A.14.00

### Off

Turns off the sync source for your periodic trigger. With the sync source off, the timing will drift unless the signal source frequency is locked to the analyzer frequency reference.

<b>Key Path</b>	Trigger, Periodic Timer, Sync Source
<b>Example</b>	TRIG:FRAM:SYNC OFF
<b>Readback</b>	Off
<b>Initial S/W Revision</b>	Prior to A.02.00

### External 1

Pressing this key, when it is not selected, selects an external input signal as the trigger. A new sweep/measurement will start when the external trigger condition is met using the external 1 input connector on the rear panel.

Pressing this key, when it is already selected, accesses the external 1 trigger setup menu.

<b>Key Path</b>	Trigger
<b>Example</b>	TRIG:SOUR EXT1 Swept SA measurement

	TRIG:<meas>:SOUR EXT1 Measurements other than Swept SA
Dependencies	Grayed out if in use by Point Trigger in the Source Setup menu. Forced to Free Run if already selected and Point Trigger is set to External 1.
State Saved	Saved in instrument state
Status Bits/OPC dependencies	The Status Operation Register bit 5 "Waiting for Trigger" is set at the same time as the Sweeping or Measuring bit is set. It is cleared when the trigger actually occurs (that is, after the trigger event occurs and all the applicable trigger criteria have been met). A corresponding pop-up message ("Waiting for trigger") is generated if no trigger signal appears after approximately 2 sec. This message goes away when a trigger signal appears.
Initial S/W Revision	Prior to A.02.00

### Trigger Level

Sets the value where the external 1 trigger input will trigger a new sweep/measurement.

Key Path	Trigger, External 1
<b>Remote Command</b>	:TRIGger[:SEquence]:EXTernal1:LEVel <level> :TRIGger[:SEquence]:EXTernal1:LEVel?
<b>Example</b>	TRIG:EXT1:LEV 0.4 V
Couplings	This same level is used for the Ext1 trigger source in the Trigger menu, for the Ext1 selection in the Periodic Timer sync source (in the Trigger menu and in the Gate Source menu), and also for the Ext1 selection in the Gate Source menu.
Preset	1.2 V
State Saved	Saved in instrument state
Min	-5 V
Max	5 V
Default Unit	V
<b>Backwards Compatibility SCPI</b>	:TRIGger[:SEquence]:EXTernal:LEVel For backward compatibility, the parameter EXTernal is mapped to EXTernal1
<b>Backwards Compatibility SCPI</b>	:TRIGger[:SEquence]:FRAMe:EXTernal1:LEVel
Initial S/W Revision	Prior to A.02.00

### Trig Slope

Controls the trigger polarity. It is set positive to trigger on a rising edge and negative to trigger on a falling edge.

Key Path	Trigger, External 1
<b>Remote Command</b>	:TRIGger[:SEquence]:EXTernal1:SLOPe POSitive NEGative

	:TRIGger[:SEquence]:EXTernal1:SLOPe?
<b>Example</b>	TRIG:EXT1:SLOP NEG
Couplings	This same slope is used in the Ext1 selection for the trigger source in the Trigger menu and for the period timer sync source (in the Trigger menu and in the Gate Source menu).
Preset	POSitive
State Saved	Saved in instrument state
<b>Backwards Compatibility SCPI</b>	:TRIGger[:SEquence]:EXTernal:SLOPe For backward compatibility, the parameter EXTernal is mapped to EXTernal1
<b>Backwards Compatibility SCPI</b>	:TRIGger[:SEquence]:FRAMe:EXTernal1:SLOPe
Backwards Compatibility Notes	The legacy :TRIGger[:SEquence]:SLOPe command affects the slopes for the VID, LINE, EXT1, EXT2, and RFB triggers.
Initial S/W Revision	Prior to A.02.00

### External 2

Pressing this key, when it is not selected, selects an external input signal as the trigger. A new sweep/measurement will start when the external trigger condition is met using the external 2 input connector. The external trigger 2 input connector is on the rear panel.

Pressing this key, when it is already selected, accesses the external 2 trigger setup menu.

Key Path	Trigger
<b>Example</b>	TRIG:SOUR EXT2 Swept SA measurement TRIG:<meas>:SOUR EXT2 Measurements other than Swept SA
Dependencies	In some models, there is no second External input. In these models, the External 2 key is blanked and the EXTernal2 parameter will generate a "Hardware missing; Not available for this model number" message.  Grayed out if in use by Point Trigger in the Source Setup menu.  Forced to Free Run if already selected and Point Trigger is set to External 2.
State Saved	Saved in instrument state
Status Bits/OPC dependencies	The Status Operation Register bit 5 "Waiting for Trigger" is set at the same time as the Sweeping or Measuring bit is set. It is cleared when the trigger actually occurs (that is, after the trigger event occurs and all the applicable trigger criteria have been met). A corresponding pop-up message ("Waiting for trigger") is generated if no trigger signal appears after approximately 2 sec. This message goes away when a trigger signal appears.
Initial S/W Revision	Prior to A.02.00
Modified at S/W Revision	A.03.00

### Trigger Level

Sets the value where the external 2 trigger input will trigger a new sweep/measurement.

Key Path	Trigger, External 2
<b>Remote Command</b>	:TRIGger[:SEquence]:EXTernal2:LEVel :TRIGger[:SEquence]:EXTernal2:LEVel?
<b>Example</b>	TRIG:EXT2:LEV 1.1 V
Couplings	This same level is used for the Ext2 trigger source in the Trigger menu, for the Ext2 selection in the Periodic Timer sync source (in the Trigger menu and in the Gate Source menu), and also for the Ext2 selection in the Gate Source menu.
Preset	1.2 V
State Saved	Saved in instrument state
Min	-5 V
Max	5 V
Default Unit	V
<b>Backwards Compatibility SCPI</b>	:TRIGger[:SEquence]:FRAMe:EXTernal2:LEVel
Initial S/W Revision	Prior to A.02.00

### Trig Slope

Controls the trigger polarity. It is set positive to trigger on a rising edge and negative to trigger on a falling edge.

Key Path	Trigger, External 2
<b>Remote Command</b>	:TRIGger[:SEquence]:EXTernal2:SLOPe POSitive NEGative :TRIGger[:SEquence]:EXTernal2:SLOPe?
<b>Example</b>	TRIG:EXT2:SLOP NEG
Couplings	This same slope is used in the Ext2 selection for the trigger source in the Trigger menu and for the period timer sync source (in the Trigger menu and in the Gate Source menu).
Preset	POSitive
State Saved	Saved in instrument state
<b>Backwards Compatibility SCPI</b>	:TRIGger[:SEquence]:FRAMe:EXTernal2:SLOPe
Backwards Compatibility Notes	The legacy :TRIGger[:SEquence]:SLOPe command affects the slopes for the VID, LINE, EXT1, EXT2, and RFB triggers.
Initial S/W Revision	Prior to A.02.00

### RF Burst

Pressing this key, when it is not selected, selects the RF Burst as the trigger. A new sweep/measurement will start when an RF burst envelope signal is identified from the signal at the RF Input connector. Pressing this key, when it is already selected, accesses the RF Burst trigger setup menu.

In some models, a variety of burst trigger circuitry is available, resulting in various available burst trigger bandwidths. The analyzer automatically chooses the appropriate trigger path based on the hardware configuration and other settings of the analyzer.

Key Path	Trigger
<b>Example</b>	TRIG:SOUR RFB Swept SA measurement TRIG:<meas>:SOUR RFB Measurements other than Swept SA
State Saved	Saved in instrument state
Status Bits/OPC dependencies	The Status Operation Register bit 5 "Waiting for Trigger" is set at the same time as the Sweeping or Measuring bit is set. It is cleared when the trigger actually occurs (that is, after the trigger event occurs and all the applicable trigger criteria have been met). A corresponding pop-up message ("Waiting for trigger") is generated if no trigger signal appears after approximately 2 sec. This message goes away when a trigger signal appears.
Backwards Compatibility Notes	The legacy command: :TRIGger[:SEquence]:RFBurst:FSElectivity[:STATe] OFF ON 0 1 is not supported in the X-Series, as the hardware to do Frequency Selective burst triggers does not exist in X-Series.
Initial S/W Revision	Prior to A.02.00
Modified at S/W Revision	A.04.00

### Absolute Trigger Level

Sets the absolute trigger level for the RF burst envelope.

When using the External Mixing path, the Absolute Trigger Level is uncalibrated because the factory default was set to accommodate the expected IF levels for the RF path.

Key Path	Trigger, RF Burst
Scope	Meas Global
<b>Remote Command</b>	:TRIGger[:SEquence]:RFBurst:LEVel:ABSolute <ampl> :TRIGger[:SEquence]:RFBurst:LEVel:ABSolute?
<b>Example</b>	TRIG:RFB:LEV:ABS 10 dBm sets the trigger level of the RF burst envelope signal to the absolute level of 10 dBm
Notes	Sending this command does not switch the setting from relative to absolute; to switch it you need to send the :TRIGger[:SEquence]:RFBurst:LEVel:TYPE command, below.  Amplitude Corrections are not taken into account by the Absolute Trigger Level. For example, if you have given yourself effective gain with an amplitude correction factor, the Absolute Trigger will not fire until you have set the trigger level that far below the displayed signal level, rather than simply to the displayed signal level. This is only true for Amplitude Corrections, not External Gain or Ref Level Offset functions.  If mode is Bluetooth, the default value is -50 dBm.
Couplings	This same level is used for the RF Burst trigger source in the Trigger menu, for the RF Burst selection in the Periodic Timer sync source (in the Trigger menu and in the Gate Source menu), and also for the



	RF Burst selection in the Gate Source menu
Preset	-20 dBm
State Saved	Saved in instrument state
Min	-200 dBm
Max	100 dBm
Default Unit	depends on the current selected Y-Axis unit
<b>Backwards Compatibility SCPI</b>	:TRIGger[:SEquence]:FRAMe:RFBurst:LEVel:ABSolute
Initial S/W Revision	Prior to A.02.00
Modified at S/W Revision	A.04.00

Key Path	Trigger, RF Burst
<b>Remote Command</b>	:TRIGger[:SEquence]:RFBurst:LEVel:TYPE ABSolute RELative :TRIGger[:SEquence]:RFBurst:LEVel:TYPE?
<b>Example</b>	TRIG:RFB:LEV:TYPE REL sets the trigger level type of the RF burst trigger to Relative.
Preset	ABSolute
State Saved	Saved in instrument state
Initial S/W Revision	Prior to A.02.00
Modified at S/W Revision	A.04.00

### Trigger Slope

It is set positive to trigger on a rising edge and negative to trigger on a falling edge.

Key Path	Trigger, RF Burst
<b>Remote Command</b>	:TRIGger[:SEquence]:RFBurst:SLOPe POSitive NEGative :TRIGger[:SEquence]:RFBurst:SLOPe?
<b>Example</b>	TRIG:RFB:SLOP NEG
Couplings	This same slope is used in the RF Burst selection for the trigger source in the Trigger menu and for the period timer sync source (in the Trigger menu and in the Gate Source menu).
Preset	POSitive
State Saved	Saved in instrument state
<b>Backwards Compatibility SCPI</b>	:TRIGger[:SEquence]:FRAMe:RFBurst:SLOPe
Backwards Compatibility Notes	The legacy :TRIGger[:SEquence]:SLOPe command affects the slopes for the VID, LINE, EXT1, EXT2, and RFB triggers.
Initial S/W Revision	Prior to A.02.00

### Sync Holdoff

Sync Holdoff specifies the duration that the sync source signal must be kept false before the transition to true to be recognized as the sync timing. The periodic timer phase is aligned when the sync source signal becomes true, after the Holdoff time is satisfied.

A holdoff of 2 ms will work with most WiMAX signals, but there may be cases where the burst off duration is less than 1 ms and this value will need to be changed.

Key Path	Trigger, Periodic Timer
Remote Command	:TRIGger[:SEquence]:FRAMe:SYNC:HOLDoff <time> :TRIGger[:SEquence]:FRAMe:SYNC:HOLDoff? :TRIGger[:SEquence]:FRAMe:SYNC:HOLDoff:STATe OFF ON 0 1 :TRIGger[:SEquence]:FRAMe:SYNC:HOLDoff:STATe?
Preset	On, 1.000 ms
State Saved	Saved in instrument state
Min	0 ms
Max	+500 ms
Default Unit	s
Initial S/W Revision	Prior to A.02.00

### Control Edge/Level

Sets the method of controlling the gating function from the gating signal.

#### Edge

In Edge triggering, the gate opens (after the Delay) on the selected edge (for example, positive) of the gate signal and closes on the alternate edge (for example, negative).

#### Level

In Level triggering, the gate opens (after the Delay) when the gate signal has achieved a certain level and stays open as long as that level is maintained.

Key Path	Sweep/Control, Gate
Remote Command	[:SENSe]:SWEep:EGATe:CONTRol EDGE LEVEl [:SENSe]:SWEep:EGATe:CONTRol?
Example	SWE:EGAT:CONT EDGE
Dependencies	If the Gate Method is FFT the Control key is grayed out and Edge is selected. If the Gate Source is TV, Frame or Line, the Control key is grayed out and Edge is selected.
Preset	EDGE
State Saved	Saved in instrument state
Backwards Compatibility SCPI	[:SENSe]:SWEep:TIME:GATE:TYPE ESA Compatibility
Initial S/W Revision	Prior to A.02.00

## Gate Holdoff

Lets you increase or decrease the wait time after a gate event ends before the analyzer will respond to the next gate signal.

After any Gate event finishes, the analyzer must wait for the sweep system to settle before it can respond to another Gate signal. The analyzer calculates a "wait time," taking into account a number of factors, including RBW and Phase Noise Optimization settings. The goal is to achieve the same accuracy when gated as in ungated operation. The figure below illustrates this concept:

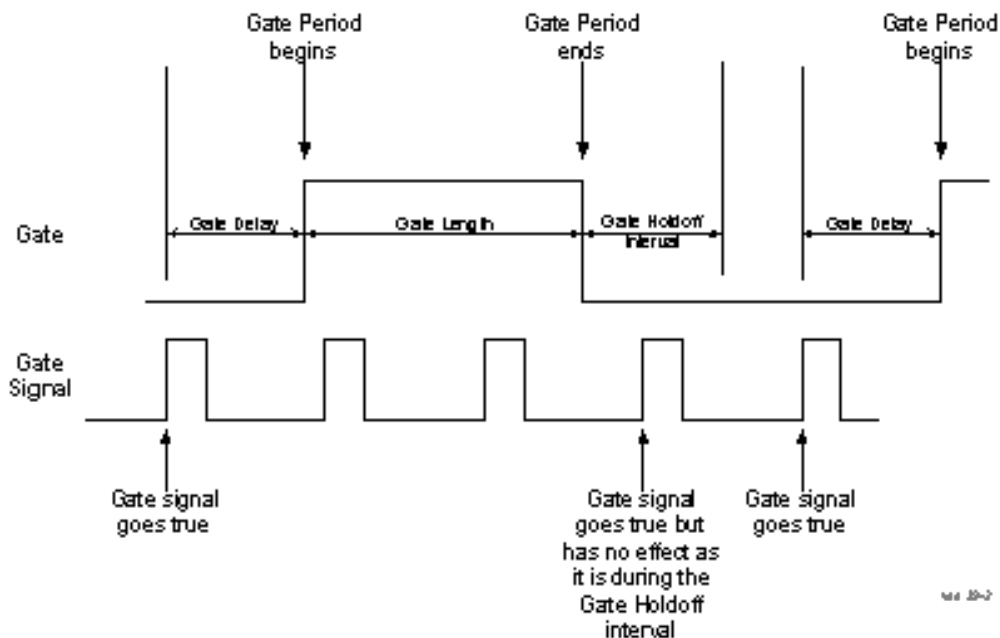

When Gate Holdoff is in Auto, the wait time calculated by the analyzer is used. When Gate Time is in Manual, the user may adjust the wait time, usually decreasing it in order to achieve greater speed, but at the risk of decreasing accuracy.

When the Method key is set to Video or FFT, the Gate Holdoff function has no effect.

In measurements that do not support Auto, the value shown when Auto is selected is "----" and the manually set holdoff is returned to a query.

Key Path	Sweep/Control, Gate
<b>Remote Command</b>	<pre>[ :SENSe ] :SWEep:EGATe:HOLDoff &lt;time&gt; [ :SENSe ] :SWEep:EGATe:HOLDoff? [ :SENSe ] :SWEep:EGATe:HOLDoff:AUTO OFF ON 0 1 [ :SENSe ] :SWEep:EGATe:HOLDoff:AUTO?</pre>
<b>Example</b>	<pre>SWE:EGAT:HOLD 0.0002 SWE:EGAT:HOLD? SWE:EGAT:HOLD:AUTO ON</pre>

SWE:EGAT:HOLD:AUTO?	
Couplings	<p>When Gate Holdoff is Auto, the Gate Holdoff key shows the value calculated by the analyzer for the wait time.</p> <p>Pressing the Gate Holdoff key while it is in Auto and not selected, causes the key to become selected and allows the user to adjust the value. If the value is adjusted, the setting changes to Man.</p> <p>Pressing the Gate Holdoff key, while it is in Auto and selected, does not change the value of Gate Holdoff, but causes the setting to change to Man. Now the user can adjust the value.</p> <p>Pressing the key while it is in Man and selected, cause the value to change back to Auto.</p> <p>Pressing the key while it is in Man and not selected, causes the key to become selected and allows the user to adjust the value.</p> <p>When Method is set to Video or FFT, the Gate Holdoff function has no effect.</p>
Preset	<p>Auto</p> <p>Auto/On</p>
State Saved	Saved in instrument state
Min	1 $\mu$ sec
Max	1 sec
Initial S/W Revision	Prior to A.02.00

## Gate Delay Compensation

This function allows you to select an RBW-dependent value by which to adjust the gate delay, to compensate for changes in the delay caused by RBW effects.

You can select between uncompensated operation and two types of compensation, Delay Until RBW Settled and Compensate for RBW Group Delay.

See ["More Information" on page 1901](#)

Key Path	Sweep/Control, Gate
Scope	Meas Global
Remote Command	<pre>[ :SENSe ] :SWEep:EGATe:DELAy:COMPensation:TYPE OFF   SETTled   GDELAy [ :SENSe ] :SWEep:EGATe:DELAy:COMPensation:TYPE?</pre>
Example	<pre>SWE:EGAT:DEL:COMP:TYPE SETT SWE:EGAT:DEL:COMP:TYPE?</pre>
Notes	<p>Although this function is Meas Global, there are some measurements that do not support this function. In those measurements the operation will be Uncompensated. Going into one of those measurements will not change the Meas Global selection; it will simply display the grayed-out menu key with “Uncompensated” showing as the selection. This is a non-forceful grayout, so the SCPI command is still accepted.</p> <p>If Gate Delay Compensation is not supported at all within a particular mode, the key is not displayed, and if the SCPI command is sent while in a measurement within that mode, an “Undefined Header” message is generated.</p> <p>Measurements that do not support this function include:</p>

Swept SA	
Preset	TD-SCDMA mode: Compensate for RBW Group Delay All other modes: Delay Until RBW Settled
State Saved	Saved in instrument state
Range	Uncompensated Delay Until RBW Settled Compensate for RBW Group Delay
Readback text	Uncompensated Settled Group Delay
Initial S/W Revision	Prior to A.02.00
Modified at S/W Revision	A.11.0

### More Information

Selecting Uncompensated means that the actual gate delay is as you sets it.

Selecting Delay Until RBW Settled causes the gate delay to be increased above the user setting by an amount equal to  $3.06/\text{RBW}$ . This compensated delay causes the GATE START and GATE STOP lines on the display to move by the compensation amount, and the actual hardware gate delay to be increased by the same amount. All the other gate lines (for example, MIN FAST) are unaffected. If the RBW subsequently changes, the compensation is readjusted for the new RBW. The value shown on the Gate Delay key does NOT change.

Delay Until RBW Settled allows excellent measurements of gated signals, by allowing the IF to settle following any transient that affects the burst. Excellent measurements also require that the analysis region not extend into the region affected by the falling edge of the burst. Thus, excellent measurements can only be made over a width that declines with narrowing RBWs, which is achieved by decreasing the gate length below the user setting by an amount equal to  $2.53/\text{RBW}$ . Therefore, for general purpose compensation, you will still want to change the gate length with changes in RBW even if the gate delay is compensated. The compensated Gate Length is limited by the analyzer so that it will never go below 10% of the value shown on the Gate Length key, as otherwise the sweep times could get very long. Anytime the Gate Length and RBW values combine in such a way that this limiting takes place, a warning is displayed. For measurements which contain multiple sweeps with different RBW like SEM and SPUR, the smallest RBW is used for this limiting.

Selecting Compensate for RBW Group Delay causes the gate delay to be increased above the user setting by an amount equal to  $1.81/\text{RBW}$ . This compensated delay causes the GATE START, GATE STOP lines on the display to move by the compensation amount, and the actual hardware gate delay to be increased by the same amount. All the other gate lines (for example, MIN FAST) are unaffected. If the RBW subsequently changes, the compensation is readjusted for the new RBW. The value shown on the Gate Delay key does NOT change. Compensate for RBW Group Delay also includes gate length compensation; the gate length itself is adjusted as necessary to attempt to compensate for delay effects imposed by the RBW.

Compensate for RBW Group Delay is similar to Delay Until RBW Settled, but compensates for the group delay of the RBW filter, rather than the filter settling time. As the RBW gets narrow, this can allow the settling tail of the RBW to affect the beginning part of the gated measurement, and allow the beginning of the RBW settling transient to affect the end of the gated measurement. These two effects are symmetric

because the RBW response is symmetric. Because the gate length is not automatically compensated, some users might find this compensation to be more intuitive than compensation for RBW settling.

### Min Fast Position Query (Remote Command Only)

This command queries the position of the MIN FAST line, relative to the delay reference (REF) line. See section "Gate View On/Off" on page 2040. If this query is sent while not in gate view, the MinFast calculation is performed based on the current values of the appropriate parameters and the result is returned. Knowing this value lets you set an optimal gate delay value for the current measurement setup.

<b>Remote Command</b>	<code>[ :SENSe ] :SWEep:EGATe:MINFast?</code>
<b>Example</b>	<code>SWE:EGAT:MIN?</code>
<b>Initial S/W Revision</b>	Prior to A.02.00

### Gate Preset (Remote Command Only)

Presets the time-gated spectrum analysis capability.

This command sets gate parameter values to the ESA preset values, as follows:

Gate trigger type = edge

Gate polarity = positive

Gate delay = 1 us

Gate length = 1 us

<b>Remote Command</b>	<code>[ :SENSe ] :SWEep:TIME:GATE:PRESet</code> ESA Compatibility
<b>Initial S/W Revision</b>	Prior to A.02.00

### Gate Level (Remote Command Only)

Sets the gate input transition point level for the external TRIGGER inputs on the front and rear panel. This is a legacy command for PSA compatibility. It is simply an alias to the equivalent trigger level command.

<b>Remote Command</b>	<code>[ :SENSe ] :SWEep:EGATe:EXTernal [ 1 ]   2 :LEVel &lt;voltage&gt;</code> <code>[ :SENSe ] :SWEep:EGATe:EXTernal [ 1 ]   2 :LEVel?</code>
<b>Notes</b>	This command is simply an alias to <code>:TRIGger[:SEQUence]:EXTernal[1]2:LEVel</code> For details refer
<b>Initial S/W Revision</b>	Prior to A.02.00

### Gate Polarity (Remote Command Only)

Sets the polarity for the gate signal. This setup is now done using the gate trigger's slope setting.

When Positive (Pos) is selected, a positive-going edge (Edge) or a high voltage (Level) will satisfy the gate condition, after the delay set with the Gate Delay key. When Negative (Neg) is selected, a negative-going edge (Edge) or a low voltage (Level) will satisfy the gate condition after the delay.

<b>Remote Command</b>	[ :SENSe ] :SWEep:EGATe:POLarity NEGative POSitive [ :SENSe ] :SWEep:EGATe:POLarity?
<b>Example</b>	SWE:EGAT:POL NEG SWE:EGAT:POL?
Preset	POSitive
State Saved	Saved in instrument state
<b>Backwards Compatibility SCPI</b>	[ :SENSe ] :SWEep:TIME:GATE:POLarity ESA compatibility
Initial S/W Revision	Prior to A.02.00

<b>Remote Command</b>	[ :SENSe ] :SWEep:TIME:GATE:LEVel HIGH LOW [ :SENSe ] :SWEep:TIME:GATE:LEVel? ESA compatibility
Preset	HIGH
Initial S/W Revision	Prior to A.02.00

## Gate

Accesses a menu that enables you to control the gating function.

The Gate functionality is used to view signals best viewed by qualifying them with other events. See "[Gate](#)" on page 2039 for more details.

Key Path	Sweep/Control
Initial S/W Revision	A.03.00

## System

See "[System](#)" on page 342



## Trace/Detector

Trace/Detector is unavailable in the Spurious Emissions measurement. When pressed, this key displays a blank menu.

---

Key Path	Front-panel key
Initial S/W Revision	Prior to A.02.00

---

## Trigger

See ["Trigger" on page 412](#)

### Free Run

See ["Free Run " on page 419](#)

### Video

See ["Video \(IF Envelope\) " on page 420](#)

### Trigger Level

See ["Trigger Level " on page 420](#)

### Trig Slope

See ["Trig Slope " on page 421](#)

### Trig Delay

See ["Trig Delay " on page 422](#)

### Line

See ["Line " on page 2047](#)

### Trig Slope

See ["Trig Slope " on page 2047](#)

### Trig Delay

See ["Trig Delay " on page 424](#)

### External 1

See ["External 1 " on page 2059](#)

### Trigger Level

See ["Trigger Level " on page 2059](#)

### Trig Slope

See ["Trig Slope " on page 2060](#)

### Trig Delay

See ["Trig Delay " on page 427](#)

### External 2

See ["External 2 " on page 2061](#)

## Trigger Level

See ["Trigger Level "](#) on page 2061

## Trig Slope

See ["Trig Slope "](#) on page 2062

## Trig Delay

See ["Trig Delay "](#) on page 429

## RF Burst

See ["RF Burst "](#) on page 2062

## Absolute Trigger

See ["Absolute Trigger Level"](#) on page 2063

## Relative Trigger

See ["Relative Trigger Level"](#) on page 2052

## Trig Slope

See ["Trigger Slope "](#) on page 2064

## Trig Delay

See ["Trig Delay "](#) on page 433

## Periodic Timer

See ["Periodic Timer \(Frame Trigger\) "](#) on page 2054

## Period

See ["Period "](#) on page 2055

## Offset

See ["Offset "](#) on page 2056

## Reset Offset Display

See ["Reset Offset Display "](#) on page 2058

## Sync Source

See ["Sync Source "](#) on page 2058

## Off

See ["Off "](#) on page 2059

### **External 1**

See "External 1 " on page 2059

#### **Trigger Level**

See "Trigger Level " on page 2059

#### **Trig Slope**

See "Trig Slope " on page 2060

### **External 2**

See "External 2 " on page 2061

#### **Trigger Level**

See "Trigger Level " on page 2061

#### **Trig Slope**

See "Trig Slope " on page 2062

### **RF Burst**

See "RF Burst " on page 2062

### **Absolute Trigger**

See "Absolute Trigger Level" on page 2063

#### **Trig Slope**

See "Trigger Slope " on page 2064

### **Trig Delay**

See "Trig Delay" on page 443

### **Auto/Holdoff**

See "Auto/Holdoff " on page 444

### **Auto Trig**

See "Auto Trig " on page 444

### **Trig Holdoff**

See "Trig Holdoff " on page 445

## User Preset

Accesses a menu that gives you the following three choices:

- User Preset – recalls a state previously saved using the Save User Preset function.
- User Preset All Modes – presets all of the modes in the analyzer
- Save User Preset– saves the current state for the current mode

Key Path	Front-panel key
Backwards Compatibility Notes	<p>User Preset is actually loading a state, and in legacy analyzers, it was possible to load a state without affecting the trace data, limit lines or correction data. Similarly it was possible to do a User Preset without affecting the trace data, limit lines or correction data.</p> <p>In the X-Series, “state” always includes all of this data; so whenever state is loaded, or User Preset is executed, all of the traces, limit lines and corrections are affected. Although this differs from previous behavior, it is desirable behavior, and should not cause adverse issues for users.</p> <p>On ESA and PSA, User Preset affected the entire instrument’s state. In the X-Series, User Preset only recalls the state for the active mode. There is a User Preset file for each mode. User Preset can never cause a mode switch as it can in legacy analyzers. If you want to recall all modes to their user preset file state, you will need to do a User Preset after mode switching into each mode.</p> <p>User Preset recalls mode state which can now include data like traces; whereas on ESA and PSA, User Preset did not affect data.</p>
Initial S/W Revision	Prior to A.02.00

## User Preset

User Preset sets the state of the currently active mode back to the state that was previously saved for this mode using the Save User Preset menu key or the SCPI command, SYST:PRES:USER:SAV. It not only recalls the Mode Preset settings, but it also recalls all of the mode persistent settings, and the Input/Output system setting that existed at the time Save User Preset was executed.

If a Save User Preset has not been done at any time, User Preset recalls the default user preset file for the currently active mode. The default user preset files are created if, at power-on, a mode detects there is no user preset file. There will never be a scenario when there is no user preset file to restore. For each mode, the default user preset state is the same state that would be saved if a Save User Preset is performed in each mode right after doing a Restore Mode Default and after a Restore Input/Output Defaults.

The User Preset function does the following:

- Aborts the currently running measurement.
- Sets the mode State to the values defined by Save User Preset.
- Makes the saved measurement for the currently running mode the active measurement.
- Brings up the saved menu for the power-on mode.
- Clears the input and output buffers.
- Sets the Status Byte to 0.

Key Path	User Preset
Remote Command	:SYSTem:PRESet:USER
Example	:SYST:PRES:USER:SAVE:SYST:PRES:USER
Notes	:SYST:PRES:USER:SAVE is used to save the current state as the user preset state. Clears all pending OPC bits. The Status Byte is set to 0. Pressing the User Preset front-panel key while already in the User Preset menu will cause the User Preset to get executed
Couplings	A user preset will cause the currently running measurement to be aborted and cause the saved measurement to be active. Recalling a User Preset file has the same issues that recalling a Save State file has. Some settings may need to be limited and therefore re-coupled, since the capabilities of the mode may have changes when the User Preset file was last saved.
Initial S/W Revision	Prior to A.02.00

### User Preset All Modes

Recalls all of the User Preset files for each mode, switches to the power-on mode, and activates the saved measurement from the power-on mode User Preset file.

**NOTE**

When the instrument is secured, all of the user preset files are converted back to their default user preset files.

The User Preset function does the following:

- Aborts the currently running measurement.
- Switches the Mode to the power-on mode.
- Restores the User Preset files for each mode.
- Makes the saved measurement for the power-on mode the active measurement.
- Brings up the saved menu for the power-on mode.
- Clears the input and output buffers.
- Sets the Status Byte to 0.

Key Path	User Preset
Remote Command	:SYSTem:PRESet:USER:ALL
Example	:SYST:PRES:USER:SAVE:SYST:PRES:USER:ALL
Notes	Clears all pending OPC bits. The Status Byte is set to 0. :SYST:PRES:USER:SAVE is used to save the current state as the user preset state.
Couplings	A user preset will cause the currently running measurement to be aborted, cause a mode switch to the power-on mode, and cause the saved measurement to be active in the power-on mode. Recalling a User Preset file has the same issues that recalling a Save State file has. Some settings may need to be limited and therefore re-coupled, since the capabilities of the mode may have changes when the User Preset file was last saved.
Initial S/W Revision	Prior to A.02.00

## Save User Preset

Saves the currently active mode and its State. You can recall this User Preset file by pressing the User Preset menu key or sending the SYST:PRES:USER remote command. This same state is also saved by the Save State function.

Key Path	User Preset
<b>Remote Command</b>	:SYSTem:PRESet:USER:SAVE
<b>Example</b>	:SYST:PRES:USER:SAVE
Notes	:SYST:PRES:SAVE creates the same file as if the user requested a *SAV or a MMEM:STOR:STAT, except User Preset Save does not allow the user to specify the filename or the location of the file.
Initial S/W Revision	Prior to A.02.00

## View/Display

Accesses a menu that includes keys that enables you to control the instrument display.

For details of available views, see [View Selection](#).

For details of remote commands associated with views, see [Range Table Selection \(SCPI only command\)](#).

Key Path	Front-panel key
Initial S/W Revision	Prior to A.02.00

## Display

The Display menu is common to most measurements, and is used for configuring items on the display. Some Display menu settings apply to all the measurements in a mode, and some only to the current measurement. Those under the System Display Settings key apply to all measurements in all modes.

Key Path	Display
Key Path	View/Display
Initial S/W Revision	Prior to A.02.00

## Annotation

Turns on and off various parts of the display annotation. The annotation is divided up into four categories:

1. Meas Bar: This is the measurement bar at the top of the screen. It does not include the settings panel or the Active Function. Turning off the Meas Bar turns off the settings panel and the Active Function. When the Meas Bar is off, the graticule area expands to fill the area formerly occupied by the Meas Bar.
2. Screen Annotation: this is the annotation and annunciation around the graticule, including any annotation on lines (such as the display line, the threshold line, etc.) This does NOT include the marker number or the N dB result. When off, the graticule expands to fill the entire graticule area.
3. Trace annotation: these are the labels on the traces, showing their detector (or their math mode).
4. Active Function annotation: this is the active function display in the meas bar, and all of the active function values displayed on softkeys.

See the figure below. Each type of annotation can be turned on and off individually.



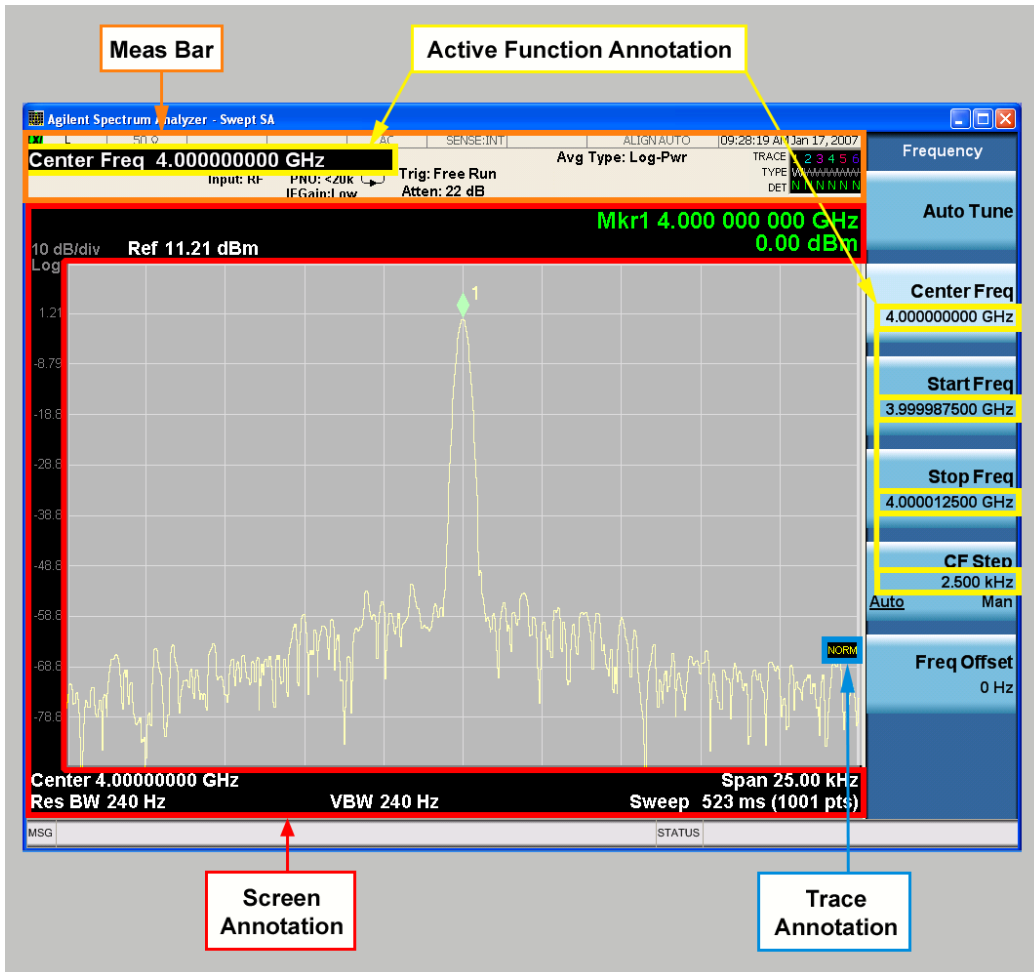

Key Path	View/Display, Display
Initial S/W Revision	Prior to A.02.00

### Meas Bar On/Off

This function turns the Measurement Bar on and off, including the settings panel. When off, the graticule area expands to fill the area formerly occupied by the Measurement Bar.

Key Path	View/Display, Display, Annotation
<b>Remote Command</b>	:DISPlay:ANNotation:MBAR[:STATE] OFF ON 0 1 :DISPlay:ANNotation:MBAR[:STATE]?
<b>Example</b>	DISP:ANN:MBAR OFF
Dependencies	Grayed out and forced to OFF when System Display Settings, Annotation is set to Off.
Preset	On This should remain Off through a Preset when System DisplaySettings, Annotation is set to Off.
State Saved	Saved in instrument state.
Initial S/W Revision	Prior to A.02.00

### Screen

This controls the display of the annunciation and annotation around the graticule, including any annotation on lines (such as the display line, the threshold line, etc.) and the y-axis annotation. This does NOT include marker annotation (or the N dB result). When off, the graticule expands to fill the entire graticule area, leaving only the 1.5% gap above the graticule as described in the Trace/Detector chapter.

<b>Key Path</b>	View/Display, Display, Annotation
<b>Remote Command</b>	:DISPlay:ANNotation:SCReen[:STATe] OFF ON 0 1 :DISPlay:ANNotation:SCReen[:STATe]?
<b>Example</b>	DISP:ANN:SCR OFF
<b>Dependencies</b>	Grayed-out and forced to OFF when System Display Settings, Annotation is set to Off.
<b>Preset</b>	On This should remain Off through a Preset when System DisplaySettings, Annotation is set to Off
<b>State Saved</b>	Saved in instrument state.
<b>Initial S/W Revision</b>	Prior to A.02.00

### Active Function Values On/Off

Turns on and off the active function display in the Meas Bar, and all of the active function values displayed on the softkeys.

Note that all of the softkeys that have active functions have these numeric values blanked when this function is on. This is a security feature..

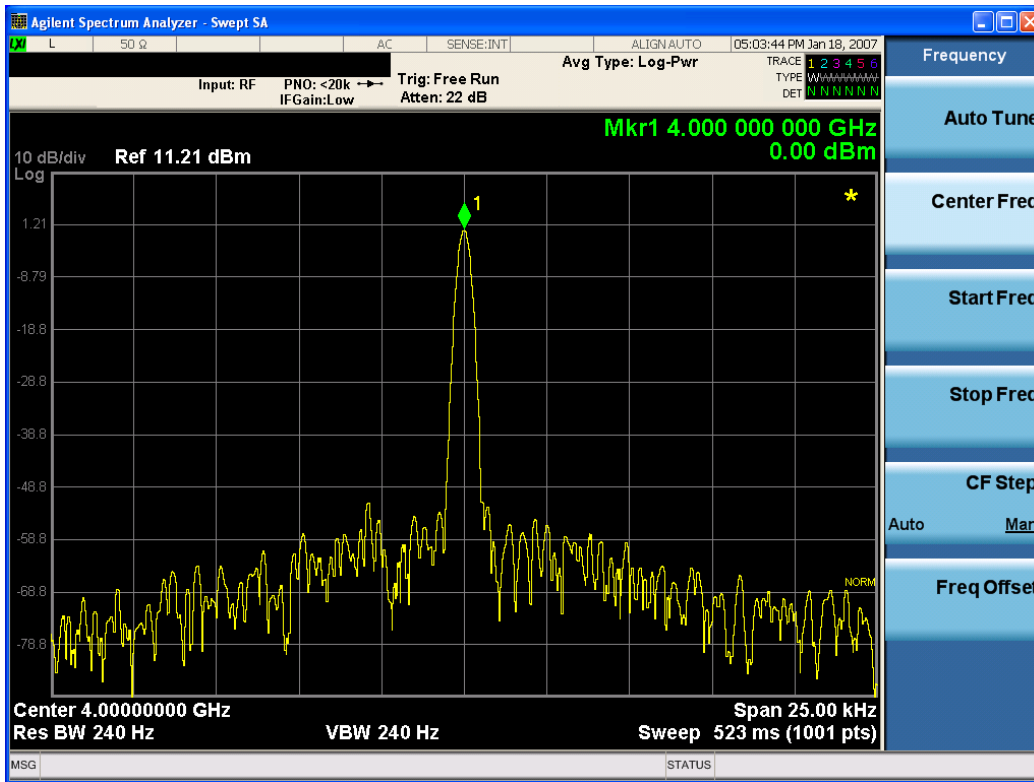

Key Path	View/Display, Display, Annotation
Remote Command	:DISPlay:ACTivefunc[:STATE] ON OFF 1 0 :DISPlay:ACTivefunc[:STATE]?
Example	DISP:ACT OFF
Dependencies	Grayed out and forced to OFF when System Display Settings, Annotation is set to Off.
Preset	On This should remain Off through a Preset when System DisplaySettings, Annotation is set to Off
State Saved	Saved in instrument state.
Initial S/W Revision	Prior to A.02.00

### Title

Displays menu keys that enable you to change or clear a title on your display.

Key Path	View/Display, Display
Initial S/W Revision	Prior to A.02.00

### Change Title

Writes a title into the "measurement name" field in the banner, for example, "Swept SA".

Press Change Title to enter a new title through the alpha editor. Press Enter or Return to complete the entry. Press ESC to cancel the entry and preserve your existing title.

The display title will replace the measurement name. It remains for this measurement until you press Change Title again, or you recall a state, or a Preset is performed. A title can also be cleared by pressing Title, Clear Title.

**NOTE**

Notice the inclusion of the <measurement> parameter in the command below. Because each measurement remembers the Display Title, the command must be qualified with the measurement name. For the Swept SA measurement this is not the case; no <measurement> parameter is used when changing the Display Title for the Swept SA measurement.

Key Path	View/Display, Display, Title
Mode	All
Remote Command	:DISPlay:<measurement>:ANNotation:TITLe:DATA <string> :DISPlay:<measurement>:ANNotation:TITLe:DATA?
Example	DISP:ANN:TITL:DATA "This Is My Title" This example is for the Swept SA measurement in the Spectrum Analyzer mode. The SANalyzer <measurement> name is not used. DISP:ACP:ANN:TITL:DATA "This Is My Title" This example is for Measurements other than Swept SA. Both set the title to: This Is My Title
Notes	Pressing this key cancels any active function. When a title is edited the previous title remains intact (it is not cleared) and the cursor goes at the end so that characters can be added or BKSP can be used to go back over previous characters.
Preset	No title (measurement name instead)
State Saved	Saved in instrument state.
Initial S/W Revision	Prior to A.02.00

**Clear Title**

Clears a title from the front-panel display. Once cleared, the title cannot be retrieved. After the title is cleared, the current Measurement Name replaces it in the title bar.

Key Path	View/Display, Display, Title
Example	The following commands clear the title and restore the measurement's original title: DISP:ANN:TITL:DATA "" This example is for the Swept SA measurement in the Spectrum Analyzer mode. The SANalyzer <measurement> name is not used. DISP:ACP:ANN:TITL:DATA "" This example is for ACP; in measurements other than Swept SA the measurement name is required.
Notes	Uses the :DISPlay:<measurement>:ANNotation:TITLe:DATA <string> command with an empty string (in the Swept SA, the <measurement> is omitted).
Preset	Performed on Preset.
Initial S/W Revision	Prior to A.02.00

## Graticule

Pressing Graticule turns the display graticule On or Off. It also turns the graticule y-axis annotation on and off.

Key Path	View/Display, Display
Remote Command	:DISPlay:WINDow[1]:TRACe:GRATicule:GRID[:STATe] OFF ON 0 1 :DISPlay:WINDow[1]:TRACe:GRATicule:GRID[:STATe]?
Example	DISP:WIND:TRAC:GRAT:GRID OFF
Notes	The graticule is the set of horizontal and vertical lines that make up the grid/divisions for the x-axis and y-axis.
Preset	On
State Saved	Saved in instrument state
Initial S/W Revision	Prior to A.02.00

## System Display Settings

These settings are "Mode Global" – they affect all modes and measurements and are reset only by Restore Misc Defaults or Restore System Defaults under System.

Key Path	View/Display, Display
Initial S/W Revision	Prior to A.02.00

## Annotation Local Settings

This is a Mode Global override of the meas local annotation settings. When it is All Off, it forces ScreenAnnotation, Meas Bar, Trace, and Active Function Values settings to be OFF for all measurements in all modes. This provides the security based "annotation off" function of previous analyzers; hence it uses the legacy SCPI command.

When it is All Off, the Screen, Meas Bar, Trace, and Active Function Values keys under the Display, Annotation menu are grayed out and forced to Off. When Local Settings is selected, you are able to set the local annotation settings on a measurement by measurement basis.

Key Path	View/Display, Display, System Display Settings
Remote Command	:DISPlay:WINDow[1]:ANNOtation[:ALL] OFF ON 0 1 :DISPlay:WINDow[1]:ANNOtation[:ALL]?
Example	:DISP:WIND:ANN OFF
Preset	On (Set by Restore Misc Defaults)
State Saved	Not saved in instrument state.
Backwards Compatibility Notes	The WINDow parameter and optional subopcode is included for backwards compatibility but ignored – all windows are equally affected.
Initial S/W Revision	Prior to A.02.00

## Themes

Accesses a menu of functions that enable you to choose the theme to be used when saving the screen image.

The **Themes** option is the same as the **Themes** option under the **Display** and **Page Setup** dialogs. It allows you to choose between themes to be used when saving the screen image.

<b>Key Path</b>	Save, Screen Image
<b>Remote Command</b>	:MMEMory:STORe:SCReen:THEMe TDColor   TDMonochrome   FCOLor   FMONochrome  :MMEMory:STORe:SCReen:THEMe?
<b>Example</b>	:MMEM:STOR:SCR:THEM TDM
<b>Preset</b>	3D Color; Is not part of Preset, but is reset by Restore Misc Defaults or Restore System Defaults All and survives subsequent running of the modes.
<b>Readback</b>	3D Color   3D Mono   Flat Color   Flat Mono
<b>Backwards Compatibility Notes</b>	In ESA and PSA we offer the choice of "Reverse Bitmap" or "Reverse Metafile" when saving screen images. This is much like the "Flat Color" theme available in X-Series. Also, if you selected Reverse Bitmap AND a black & white screen image, that would be much like "Flat Monochrome". In other words, each of the X-Series themes has a similar screen image type in ESA/PSA. But they are not identical.
<b>Initial S/W Revision</b>	Prior to A.02.00

### 3D Color

Selects a standard color theme with each object filled, shaded and colored as designed.

<b>Key Path</b>	Save, Screen Image, Themes
<b>Example</b>	MMEM:STOR:SCR:THEM TDC
<b>Readback</b>	3D Color
<b>Initial S/W Revision</b>	Prior to A.02.00

### 3D Monochrome

Selects a format that is like 3D color but shades of gray are used instead of colors.

<b>Key Path</b>	Save, Screen Image, Themes
<b>Example</b>	MMEM:STOR:SCR:THEM TDM
<b>Readback</b>	3D Mono
<b>Initial S/W Revision</b>	Prior to A.02.00

### Flat Color

Selects a format that is best when the screen is to be printed on an ink printer.

Key Path	Save, Screen Image, Themes
<b>Example</b>	MMEM:STOR:SCR:THEM FCOL
Readback	Flat Color
Initial S/W Revision	Prior to A.02.00

### Flat Monochrome

Selects a format that is like Flat Color. But only black is used (no colors, not even gray), and no fill.

Key Path	Save, Screen Image, Themes
<b>Example</b>	MMEM:STOR:SCR:THEM FMON
Readback	Flat Mono
Initial S/W Revision	Prior to A.02.00

### Backlight

Accesses the display backlight on/off keys. This setting may interact with settings under the Windows "Power" menu.

When the backlight is off, pressing ESC, TAB, SPACE, ENTER, UP, DOWN, LEFT, RIGHT, DEL, BKSP, CTRL, or ALT turns the backlight on without affecting the application. Pressing any other key will turn backlight on and could potentially perform the action as well.

Key Path	View/Display, Display, System Display Settings
<b>Remote Command</b>	:DISPlay:BACKlight ON OFF :DISPlay:BACKlight?
Preset	ON (Set by Restore Misc Defaults)
Initial S/W Revision	Prior to A.02.00

### Backlight Intensity

An active function used to set the backlight intensity. It goes from 0 to 100 where 100 is full on and 0 is off. This value is independent of the values set under the Backlight on/off key.

Key Path	View/Display, Display, System Display Settings
<b>Remote Command</b>	:DISPlay:BACKlight:INTensity <integer> :DISPlay:BACKlight:INTensity?
<b>Example</b>	DISP:BACK:INT 50

Preset	100 (Set by Restore Misc Defaults)
Min	0
Max	100
Initial S/W Revision	Prior to A.02.00

## View Selection

Selects the desired view. The following views are available:

- **"Graph + Metrics" on page 1920** – The lower window displays a list of spurs detected in a measurement cycle. The upper window displays a trace of the range that contains the currently selected spur.
- **"Range Table" on page 1921** – The lower window displays settings of ranges. The upper window displays a trace of the currently selected range.
- **"All Ranges" on page 1924** – The lower window displays a list of spurs detected in a measurement cycle. The upper window displays a merged trace of all the ranges.

Key Path	View/Display
Mode	SA, WCDMA, C2K, 1xEV-DO, WIMAX OFDMA, TD-SCDMA, DVB-T/H, LTE, LTE-TDD, MSR, LTE-FDD, LTE-TDD
Remote Command	:DISPlay:SPURious:VIEW[:SElect] RESult RANGE ALL :DISPlay:SPURious:VIEW[:SElect]?
Example	DISP:SPUR:VIEW RANG DISP:SPUR:VIEW?
Notes	You must be in cdma2000 mode, TD-SCDMA mode, W-CDMA mode, DVB-T/H mode, GSM/EDGE mode, LTE mode, LTE TDD mode, LTE-Advanced FDD/TDD mode, MSR or WiMAX mode to use this command. Use INSTRument:SElect to set the mode.
Preset	RESult
State Saved	No
Range	Graph + Metrics   Range Table   All Ranges
Initial S/W Revision	A.10.00
Modified at S/W Revision	A.11.00

## Graph + Metrics

Select Graph + Metrics to view measurement results.

- The lower window displays a list of spurs detected in a measurement cycle. The currently selected spur, which is highlighted, can be changed by the Spur softkey in the Meas Setup menu.
- The upper window displays a trace of the range that contains the currently selected spur.



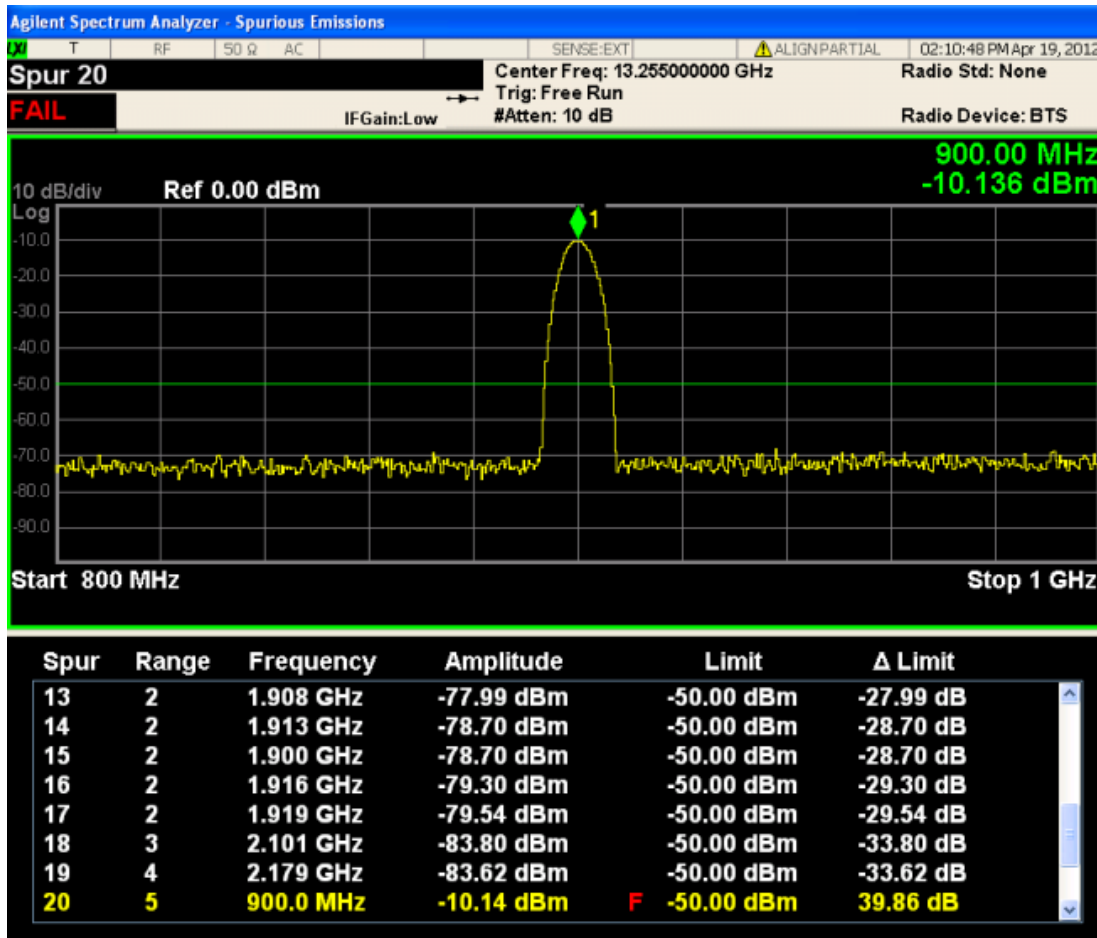

Result	Units	Min	Max
Spur	N/A	0	200
Range	N/A	1	20
Frequency	Hz	Analyzer Min	Analyzer Max
Amplitude	dBm	-150	50
Limit	dBm	-150	50

The spurs listed are within the current value of the Marker Peak Excursion setting of the absolute limit. All of the spurs listed passed. Any spur that has failed the absolute limit will have an 'F' beside it.

### Range Table

Select Range Table to view range settings.

- The upper window displays a trace of the range specified by the Range key under Range Table in Meas Setup.
- The lower window displays the range setting.

All enabled range may not be displayed with the normal window arrangement. Even in that case, the instrument always displays the highlighted line in the table. When you zoom the lower window, all 20 ranges can be displayed.

When the range state is OFF, “---” appears, to indicate the range is inactive.

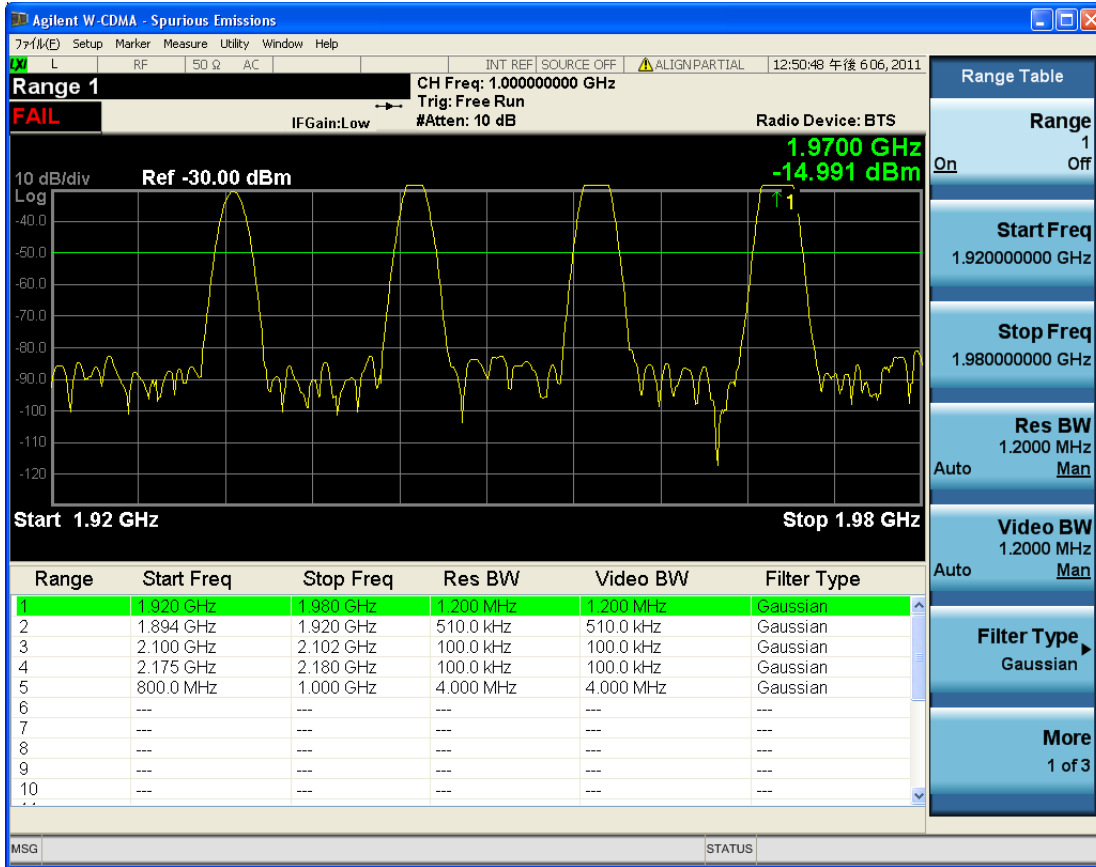

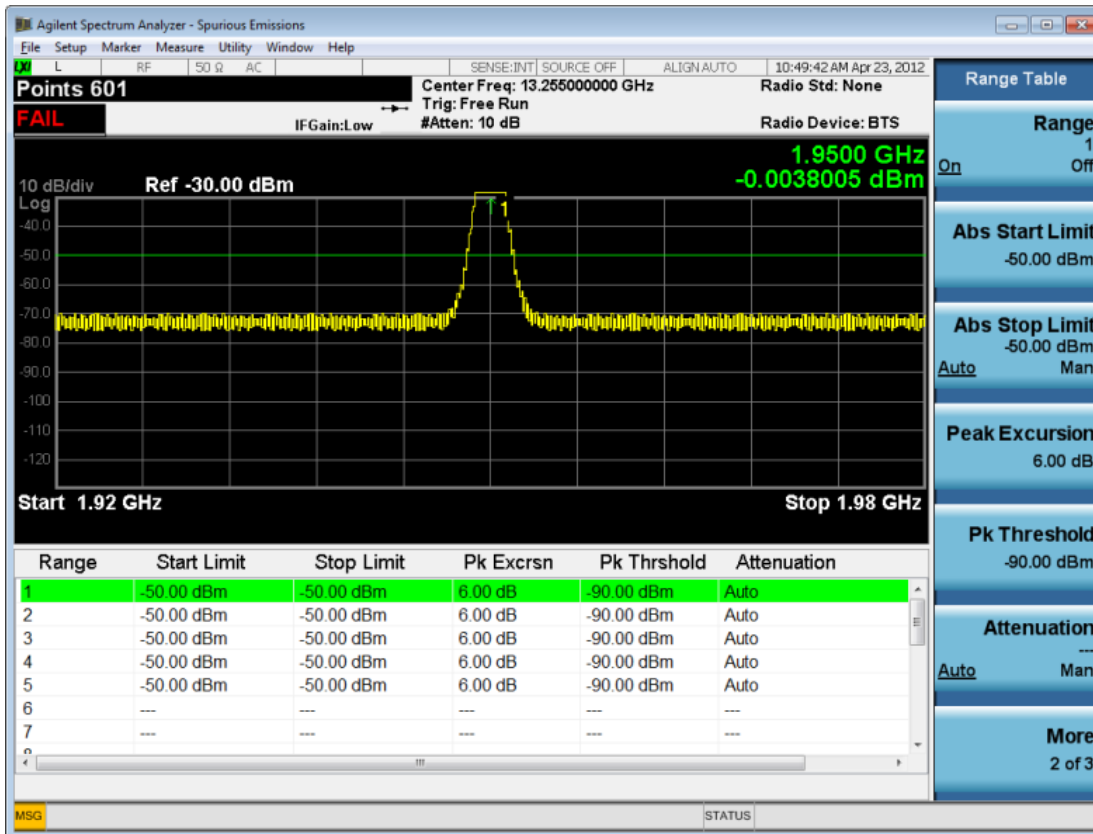

14 Spurious Emissions Measurement  
View/Display

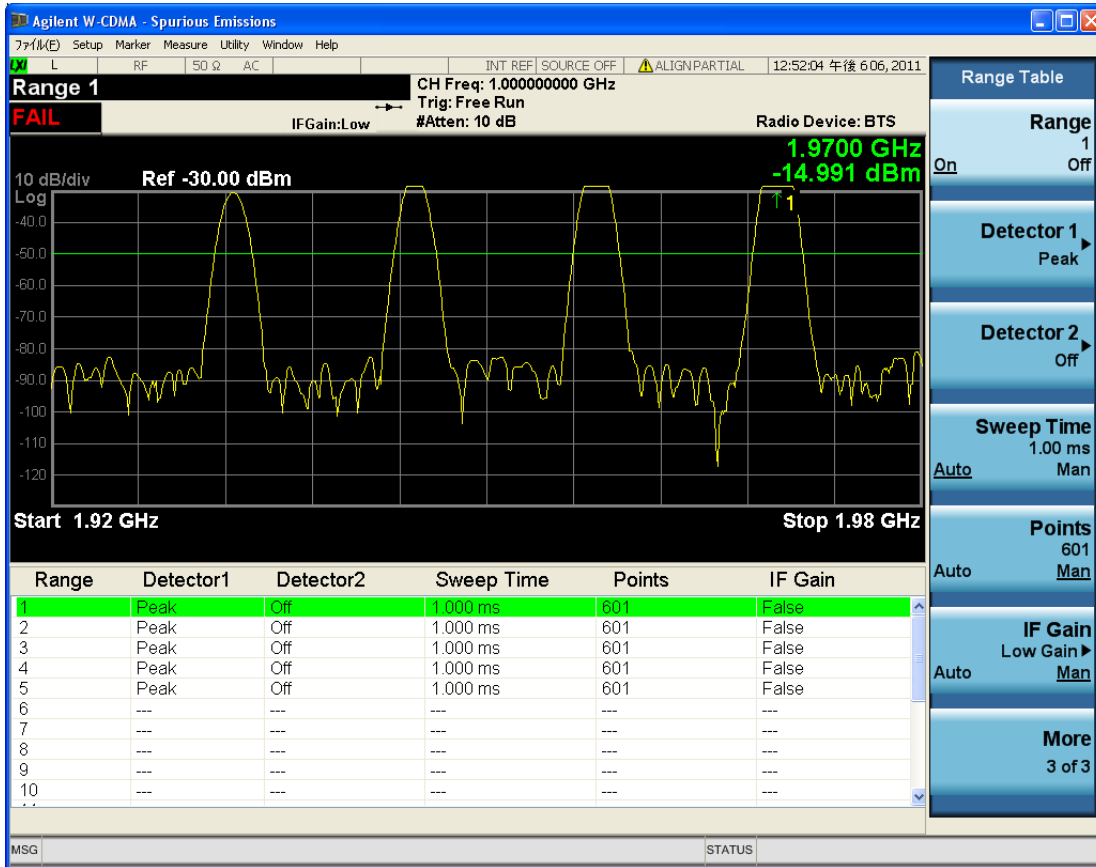

All Ranges

Select All Ranges to view measurement results for all the ranges.

- The upper window displays a merged trace of all the ranges.
- The lower window displays a list of spurs detected in a measurement cycle. The currently selected spur, which is highlighted, can be changed by the Spur softkey in the Meas Setup menu.

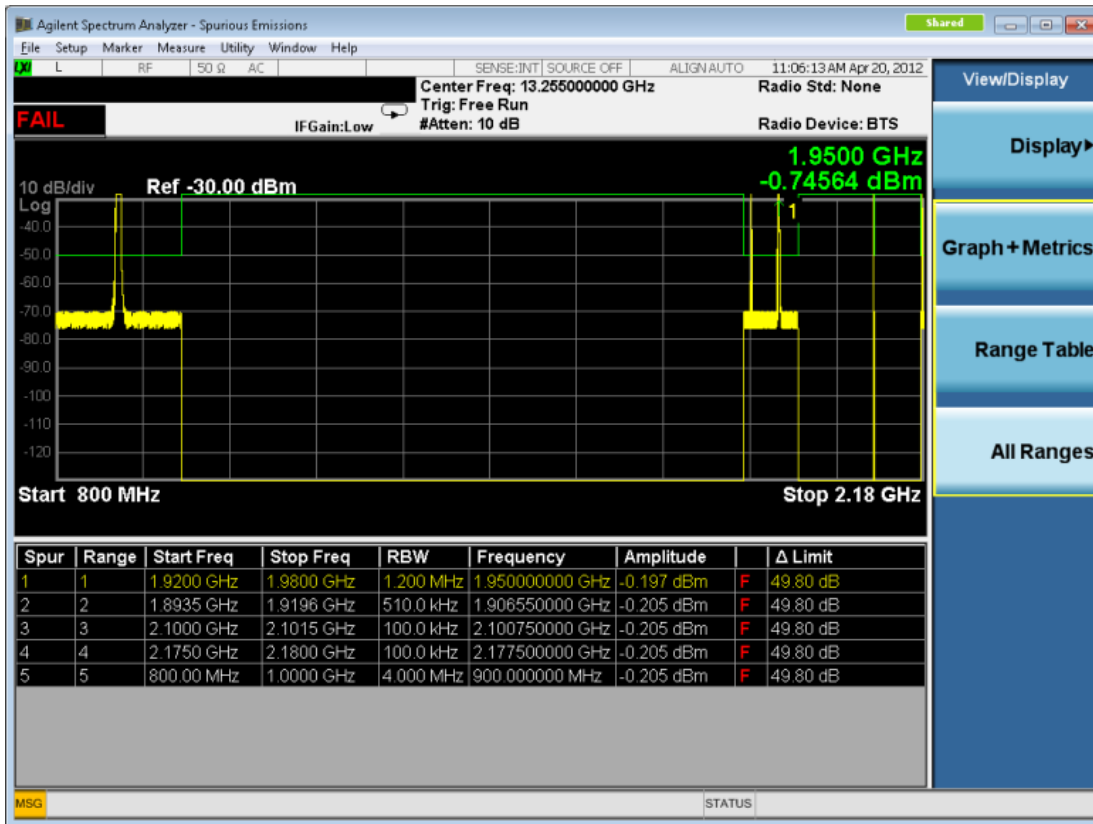

### Range Table Selection (SCPI only command)

Switches contents of Range Table. There are three tables in the Range Table window, corresponding to each page of the Range Table menu. If the Range Table menu is displayed, this command changes the page of the Range Table menu too. Pressing the Range Table softkey always changes the current Range Table to 1.

Key Path	SCPI only
Mode	SA, WCDMA, C2K, 1xEV-DO, WIMAX OFDMA, TD-SCDMA, DVB-T/H, LTE, LTETDD, WLAN, MSR, LTEAFDD, LTEATDD
Remote Command	:DISPlay:SPURious:VIEW:RANGe:TABLE <integer> :DISPlay:SPURious:VIEW:RANGe:TABLE?
Example	DISP:SPUR:VIEW:RANG:TABL 2 DISP:SPUR:VIEW:RANG:TABL?
Notes	You must be in cdma2000 mode, TD-SCDMA mode, W-CDMA mode, DVB-T/H mode, GSM/EDGE mode, LTE mode, LTE TDD mode, WLAN mode, LTE-Advanced FDD/TDD mode, MSR or WiMAX mode to use this command. Use INSTRument:SElect to set the mode.
Preset	1
State Saved	No
Min	1
Max	3
Initial S/W Revision	A.10.00



## 15 Monitor Spectrum Measurement

The monitor spectrum measurement is used as a quick, convenient means of looking at the entire spectrum. While the look and feel are similar to the Spectrum Analyzer mode, the functionality is greatly reduced for easy operation. The main purpose of the measurement is to show the spectrum. The default span should cover an appropriate frequency range of the application.

For measurement results and views, see ["View/Display" on page 2083](#).

This topic contains the following sections:

["Measurement Commands for Monitor Spectrum" on page 1928](#)

["Remote Command Results for Monitor Spectrum Measurement" on page 1929](#)

## Measurement Commands for Monitor Spectrum

The following commands can be used to retrieve the measurement results:

`:CONFigure:MONitor`

`:CONFigure:MONitor:NDEFault`

`:INITiate:MONitor`

`:FETCh:MONitor[n]?`

`:READ:MONitor[n]?`

`:MEASure:MONitor[n]?`

For more measurement related commands, see the SENSE subsystem, and the section "[Remote Measurement Functions](#)" on page 2165.



## Remote Command Results for Monitor Spectrum Measurement

The following table describes the results returned by the queries listed above, according to the index value  $n$ .

<b>n</b>	<b>Results Returned</b>
1 (or not specified)	Returns trace1 data with comma separated floating numbers
2	Returns trace2 data with comma separated floating numbers
3	Returns trace3 data with comma separated floating numbers

Key Path	Meas
Initial S/W Revision	Prior to A.02.00

## AMPTD Y Scale

Accesses a menu of functions that enable you to set the vertical scale parameters. These functions control how data on the vertical (Y) axis is displayed and control instrument settings that affect the vertical axis.

Key Path	Front-panel key
Initial S/W Revision	Prior to A.02.00

### Ref Value

Sets the absolute power reference value. However, since Auto Scaling defaults to On, this value is automatically determined by the measurement result. When you set a value manually, Auto Scaling automatically changes to Off.

Key Path	AMPTD Y Scale
Mode	All except SA and BASIC
Remote Command	:DISPlay:MONitor:VIEW[1]:WINDow[1]:TRACe:Y[:SCALe]:RLEVel <real> :DISPlay:MONitor:VIEW[1]:WINDow[1]:TRACe:Y[:SCALe]:RLEVel?
Example	DISP:MON:VIEW:WIND:TRAC:Y:RLEV 2.0 DISP:MON:VIEW:WIND:TRAC:Y:RLEV?
Couplings	When the Auto Scaling is On, this value is automatically determined by the measurement result. When you set a value manually, Auto Scaling automatically changes to Off.
Preset	10.00 dBm
State Saved	Saved in instrument state.
Min	-250.00 dBm
Max	250.00 dBm
Initial S/W Revision	Prior to A.02.00

### Attenuation

This menu controls the attenuator functions and interactions between the attenuation system components.

There are two attenuator configurations in the X-Series. One is a dual attenuator configuration consisting of a mechanical attenuator and an optional electronic attenuator. The other configuration uses a single attenuator with combined mechanical and electronic sections that controls all the attenuation functions. Different models in the X-Series come with different configurations.

See ["Dual Attenuator Configurations:" on page 1931](#)

See ["Single Attenuator Configuration:" on page 1931](#)

Most Attenuation settings are the same for all measurements – they do not change as you change measurements. Settings like these are called “Meas Global” and are unaffected by Meas Preset.

Key Path	AMPTD Y Scale
Scope	Meas Global
Dependencies	In measurements that support the I/Q inputs, this key is unavailable when I/Q is the selected input, and is replaced by the Range key in that case.
Readback Line	Contains a summary in [ ] brackets of the current total attenuation. See the descriptions of the , " <b>(Mech) Atten</b> " on page 2102, and " <b>Enable Elec Atten</b> " on page 2104 keys for more detail on the contributors to the total attenuation.  Note that when "Pre-Adjust for Min Clip" is on, this value can change at the start of every measurement.
Initial S/W Revision	Prior to A.02.00
Modified at S/W Revision	A.03.00

### Dual Attenuator Configurations:

Configuration 1: Mechanical attenuator + optional electronic attenuator

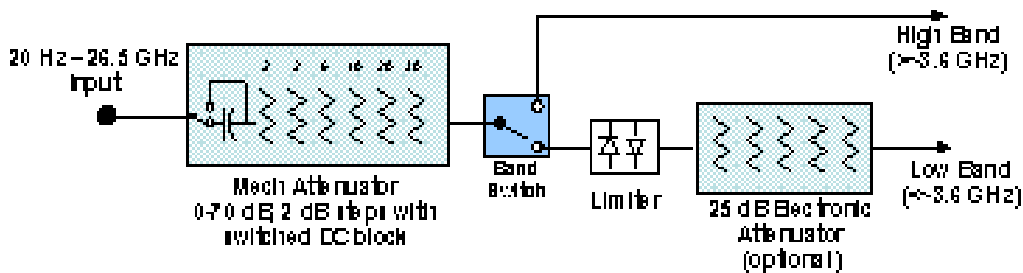

Configuration 2: Mechanical attenuator, no optional electronic attenuator

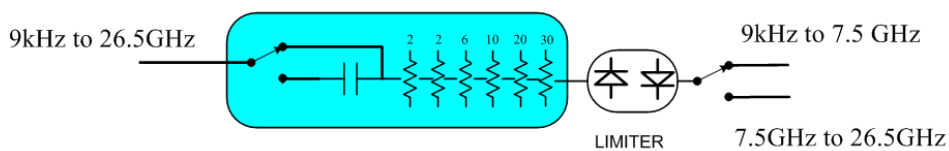

(note that Configuration 2 is not strictly speaking a dual-section attenuator, since there is no electronic section available. However, it behaves exactly like Configuration 1 without the Electronic Attenuator option EA3, therefore for the sake of this document it is grouped into the "Dual Attenuator" configuration)

### Single Attenuator Configuration:

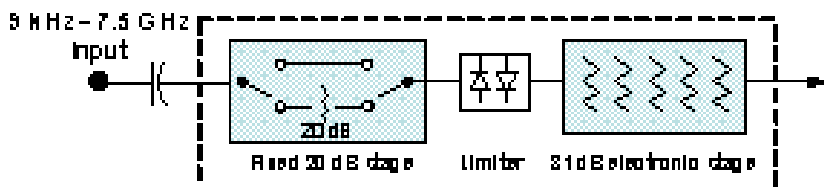

You can tell which attenuator configuration you have by pressing the Attenuation key, which (in most Modes) opens the Attenuation menu. If the first key in the Attenuation menu says Mech Atten you have the dual attenuator configuration. If the first key says Atten you have the single attenuator configuration.

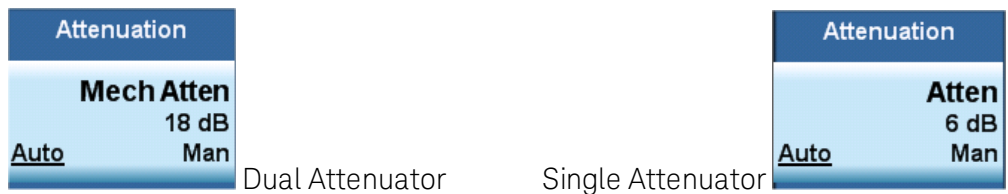

In the single attenuator configuration, you control the attenuation with a single control, as the fixed stage has only two states. In the dual attenuator configuration, both stages have significant range so you are given separate control of the mechanical and electronic attenuator stages.

When you have the dual attenuator configuration, you may still have only a single attenuator, because unless option EA3 (the Electronic Attenuator option) is available, and you purchase it, you will have only the mechanical attenuator.

### (Mech) Atten

This key is labeled Mech Atten in dual attenuator models and Atten in single attenuator models. In the dual attenuator configuration, this key only affects the mechanical attenuator.

This key lets you modify the attenuation applied to the RF input signal path. This value is normally auto coupled to the Ref Level, the Internal Preamp Gain, any External Gain that is entered, and the Max Mixer Level, as described in the table below.

See "[Attenuator Configurations and Auto/Man](#)" on page 1933

Key Path	AMPTD Y Scale, Attenuation
<b>Remote Command</b>	<pre>[ :SENSe] :POWer [:RF] :ATTenuation &lt;rel_amp1&gt; [ :SENSe] :POWer [:RF] :ATTenuation? [ :SENSe] :POWer [:RF] :ATTenuation:AUTO OFF ON 0 1 [ :SENSe] :POWer [:RF] :ATTenuation:AUTO?</pre>
<b>Example</b>	<p>POW:ATT 20</p> <p>Dual attenuator configuration: sets the mechanical attenuator to 20 dB</p> <p>Single attenuator mode: sets the main attenuation to 20 dB (see below for definition of "main" attenuation).</p> <p>If the attenuator was in Auto, it sets it to Manual.</p>
<b>Dependencies</b>	<p>Some measurements do not support the Auto setting of (Mech) Atten. In these measurements, the Auto/Man selection is not available, and the Auto/Man line on the key disappears.</p> <p>In dual attenuator configurations, when the electronic attenuator is enabled, the mechanical attenuator has no auto setting and the Auto/Man line on the key disappears. The state of Auto/Man is remembered and restored when the electronic attenuator is once again disabled. This is described in more detail in the "<a href="#">Enable Elec Atten</a>" on page 2104 key description.</p> <p>See "<a href="#">Attenuator Configurations and Auto/Man</a>" on page 1933 for more information on the Auto/Man functionality of Attenuation.</p>
<b>Couplings</b>	

---

	<p>When (Mech) Atten is in Auto, it uses the following algorithm to determine a value:          If the USB Preamp is connected to USB, use 0 dB.          Otherwise, Atten = ReferenceLevel + PreAmpGain + ExternalGain – RefLevelOffset - MaxMixerLevel + IF Gain.          Limit this value to be between 6 dB and the Max value. No value below 6 dB can ever be chosen by Auto.          The resulting value is rounded up to the largest value possible given the attenuation step setting. That is, 50.01 dB would change to 60 dB (for a 10 dB attenuation step).          The “IF Gain” term in the equation above is either 0 dB or +10 dB, depending on the settings of FFT IF Gain, Swept IF Gain, max Ref Level and the Auto/Man setting of Mech Atten.          In External Mixing and BBIQ, where the Attenuator is not in the signal path, the Attenuator setting changes as described above when (Mech) Atten is in Auto, but no changes are made to the actual attenuator hardware setting until the input is changed back to the RF Input.</p>
Preset	<p>The preset for Mech Attenuation is “Auto.”          The Auto value of attenuation is:          CXA, EXA, MXA and PXA: 10 dB</p>
State Saved	<p>Saved in instrument state</p>
Min	<p>0 dB          The attenuation set by this key cannot be decreased below 6 dB with the knob or step keys. To get to a value below 6 dB it has to be directly entered from the keypad or via SCPI. This protects from adjusting the attenuation to a dangerously small value which can put the instrument at risk of damage to input circuitry. However, if the current mechanical attenuation is below 6 dB it can be increased with the knob and step keys, but not decreased.</p>
Max	<p>CXA N9000A–503/507: 50 dB          CXA N9000A–513/526: 70dB          EXA: 60 dB          MXA and PXA: 70 dB          In the single attenuator configuration, the total of ATT and EATT cannot exceed 50 dB, so if the EATT is set to 24 dB first, the main attenuation cannot be greater than 26 dB and will be reduced accordingly; if the main attenuator is set to 40 dB first, EATT cannot be greater than 10 dB.</p>
Initial S/W Revision	<p>Prior to A.02.00</p>
Modified at S/W Revision	<p>A.03.00</p>

---

### Attenuator Configurations and Auto/Man

As described in the Attenuation key description, there are two distinct attenuator configurations available in the X-Series, the single attenuator and dual attenuator configurations. In dual attenuator configurations, we have the mechanical attenuation and the electronic attenuation, and the current total attenuation is the sum of the electronic + mechanical attenuation. In single attenuator configurations, we refer to the attenuation set using the (Mech) Atten key (or POW:ATT SCPI) as the “main” attenuation; and the attenuation that is set by the SCPI command POW:EATT as the “soft” attenuation (the POW:EATT command is honored even in the single attenuator configuration, for compatibility purposes). Then the

current total attenuation is the sum of the main + soft attenuation. See the Elec Atten key description for more on “soft” attenuation.

In the dual attenuator configuration, when the electronic attenuator is enabled, there is no Auto/Man functionality for the mechanical attenuator, and the third line of the key label (the Auto/Man line) disappears:

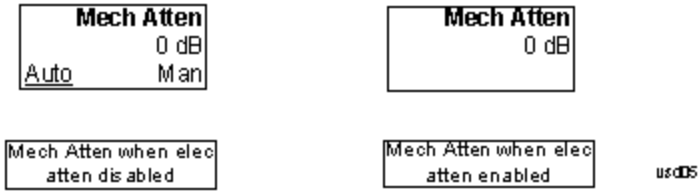

### Enable Elec Atten

Enables the Electronic Attenuator.

The electronic attenuator offers finer steps than the mechanical attenuator, has no acoustical noise, is faster, and is less subject to wear. These advantages primarily aid in remote operation and are negligible for front panel use. See ["Using the Electronic Attenuator: Pros and Cons" on page 1936](#) for a detailed discussion of the pros and cons of using the electronic attenuator.

For the single attenuator configuration, for SCPI backwards compatibility, the “soft” attenuation feature replaces the dual attenuator configuration’s electronic attenuator. All the same couplings and limitations apply. See ["Attenuator Configurations and Auto/Man" on page 2103](#)

See ["More Information" on page 1935](#)

<b>Key Path</b>	AMPTD Y Scale, Attenuation
<b>Remote Command</b>	[ :SENSE ] :POWER [ :RF ] :EATTenuation :STATe OFF   ON   0   1 [ :SENSE ] :POWER [ :RF ] :EATTenuation :STATe ?
<b>Example</b>	POW:EATT:STAT ON
<b>Dependencies</b>	<p>This key only appears in Dual Attenuator models with an Electronic Attenuator installed. It does not appear in models with the Single Attenuator configuration, as in the single attenuator configuration there is no “electronic attenuator” there is only a single integrated attenuator (which has both a mechanical and electronic stage). However, in the single attenuator configuration, EATT SCPI commands are accepted for compatibility with other X-series instruments and set a “soft” attenuation as described in <a href="#">"Attenuator Configurations and Auto/Man" on page 2103</a>.</p> <p>The electronic attenuator (and the “soft” attenuation function provided in single attenuator configurations) is unavailable above 3.6 GHz. Therefore, if the Stop Frequency of the analyzer is &gt; 3.6 GHz then the Enable Elec Atten key will be OFF and grayed out.</p> <p>If the Internal Preamp is on, meaning it is set to Low Band or Full, the electronic attenuator (and the “soft” attenuation function provided in single attenuator configurations) is unavailable. In this case the Enable Elec Atten key will be OFF and grayed out.</p> <p>If either of the above is true, if the SCPI command is sent, an error indicating that the electronic attenuator is unavailable will be sent.</p> <p>If the electronic/soft Attenuator is enabled, then the Stop Freq of the analyzer is limited to 3.6 GHz and the Internal Preamp is unavailable.</p> <p>The SCPI-only “soft” electronic attenuation for the single-attenuator configuration is not available in</p>

	all measurements; in particular, it is not available in the Swept SA measurement.
Couplings	Enabling and disabling the Electronic Attenuator affects the setting of the Mechanical Attenuator (in dual attenuator configurations). This is described in more detail below this table.
Preset	OFF for Swept SA measurement; ON for all other measurements that support the electronic attenuator
State Saved	Saved in instrument state
Initial S/W Revision	Prior to A.02.00
Modified at S/W Revision	A.03.00

## More Information

### Mechanical Attenuator Transition Rules

When the Electronic Attenuator is enabled, the Mechanical Attenuator transitions to a state that has no Auto function. Below are the rules for transitioning the Mechanical Attenuator. NOTE that the information below ONLY applies to the dual attenuator configurations, and ONLY when the Electronic Attenuator is installed:

#### When the Electronic Attenuation is enabled from a disabled state:

- The Mechanical Attenuator is initialized to 10 dB (this is its optimal performance setting). You can then set it as desired with SCPI, numeric keypad, step keys, or knob, and it behaves as it normally would in manual mode
- The Auto/Man state of (Mech) Atten is saved
- The Auto/Man line on the (Mech) Atten key disappears and the auto rules are disabled
- The Electronic Attenuator is set to 10 dB less than the previous value of the Mechanical Attenuator, within the limitation that it must stay within the range of 0 to 24 dB of attenuation.

#### Examples in the dual attenuator configuration:

- Mech Atten at 20 dB. Elec Atten enabled, Mech Atten set to 10 dB, and Elec Atten set to 10 dB. New total attenuation equals the value before Elec Atten enabled.
- Mech Atten at 0 dB. Elec Atten enabled, Mech Atten set to 10 dB, and Elec Atten set to 0 dB. New total attenuation does not equal the value before Elec Atten enabled.
- Mech Atten at 40 dB. Elec Atten enabled, Mech Atten set to 10 dB, and Elec Atten set to 24 dB. New total attenuation does not equal the value before Elec Atten enabled.

#### When the Electronic Attenuation is disabled from an enabled state:

- The Elec Atten key is grayed out
- The Auto/Man state of (Mech) Atten is restored
- If now in Auto, (Mech) Atten recouples

- If now in Man, (Mech) Atten is set to the value of total attenuation that existed before the Elec Atten was disabled. The resulting value is rounded up to the smallest value possible given the (Mech) Atten Step setting - (That is, 57 dB changes to 58 dB when (Mech) Atten Step is 2 dB.)

### Using the Electronic Attenuator: Pros and Cons

The electronic attenuator offers finer steps than the mechanical attenuator, has no acoustical noise, is faster, and is less subject to wear.

The “finer steps” advantage of the electronic attenuator is beneficial in optimizing the alignment of the analyzer dynamic range to the signal power in the front panel as well as remote use. Thus, you can achieve improved relative signal measurement accuracy. Compared to a mechanical attenuator with 2 dB steps, the 1 dB resolution of the electronic attenuator only gives better resolution when the odd-decibel steps are used. Those odd-decibel steps are less accurately calibrated than the even-decibel steps, so one tradeoff for this superior relative accuracy is reduced absolute amplitude accuracy.

Another disadvantage of the electronic attenuator is that the spectrum analyzer loses its “Auto” setting, making operation less convenient.

Also, the relationship between the dynamic range specifications (TOI, SHI, compression and noise) and instrument performance are less well-known with the electrical attenuator. With the mechanical attenuator, TOI, SHI and compression threshold levels increase dB-for-dB with increasing attenuation, and the noise floor does as well. With the electronic attenuator, there is an excess attenuation of about 1 to 3 dB between 0 and 3.6 GHz, making the effective TOI, SHI, and so forth, less well known. Excess attenuation is the actual attenuation relative to stated attenuation. Excess attenuation is accounted for in the analyzer calibration

### Elec Atten

Controls the Electronic Attenuator in dual attenuator configurations. This key does not appear in single attenuator configurations, as the control of both the mechanical and electronic stages of the single attenuator is integrated into the single Atten key.

Key Path	AMPTD Y Scale, Attenuation
Remote Command	<code>[ :SENSe ] :POWer [ :RF ] :EATTenuation &lt;rel_amp&gt;</code> <code>[ :SENSe ] :POWer [ :RF ] :EATTenuation?</code>
Notes	Electronic Attenuation's specification is defined only when Mechanical Attenuation is 6 dB.
Dependencies	This key only appears in Dual Attenuator models with an Electronic Attenuator installed. It does not appear in models with the Single Attenuator configuration, as in the single attenuator configuration there is no “electronic attenuator” there is only a single integrated attenuator (which has both a mechanical and electronic stage). However, in the single attenuator configuration, EATT SCPI commands are accepted for compatibility with other X-series instruments and set a “soft” attenuation as described in <a href="#">"Attenuator Configurations and Auto/Man" on page 2103</a> . The “soft” attenuation is treated as an addition to the “main” attenuation value set by the Atten softkey or the POW:ATT SCPI command and affects the total attenuation displayed on the Attenuation key and the Meas Bar.  When Enable Elec Atten is off or grayed out, the Elec Atten key is grayed out.
Preset	0 dB
State Saved	Saved in instrument state



Min	0 dB
Max	Dual attenuator configuration: 24 dB Single attenuator configuration: the total of ATT and EATT cannot exceed 50 dB, so if the EATT is set to 24 dB first, the main attenuation cannot be greater than 26 dB and will be reduced accordingly; if the main attenuator is set to 40 dB first, EATT cannot be greater than 10 dB
Initial S/W Revision	Prior to A.02.00
Modified at S/W Revision	A.03.00

## Adjust Atten for Min Clip

Sets the combination of mechanical and electronic attenuation and gain based on the current measured signal level so that clipping will be at a minimum.

This is an "immediate action" function, that is, it executes once, when the key is pressed.

This key is grayed out in measurements that do not support this functionality. The spectrum analyzer measurement, Swept SA, does not support this functionality.

Key Path	AMPTD Y Scale, Attenuation
<b>Remote Command</b>	<code>[ :SENSe ] :POWer [ :RF ] :RANGe:OPTimize IMMEDIATE</code>
Initial S/W Revision	Prior to A.02.00
Modified at S/W Revision	A.03.00

## Pre-Adjust for Min Clip

If this function is on, it does the adjustment described under "[Adjust Atten for Min Clip](#)" on page 2107 each time a measurement restarts. Therefore, in Continuous measurement mode, it only executes before the first measurement.

In dual attenuator models, you can set Elec+Mech Atten, in which case both attenuators participate in the autoranging, or Elec Atten Only, in which case the mechanical attenuator does not participate in the autoranging. This latter case results in less wear on the mechanical attenuator and is usually faster.

This key is grayed out in measurements that do not support this functionality. The spectrum analyzer measurement, Swept SA, does not support this functionality.

Key Path	AMPTD Y Scale, Attenuation
<b>Remote Command</b>	<code>[ :SENSe ] :POWer [ :RF ] :RANGe:OPTimize:ATTenuation OFF   ELECTrical   COMBined</code>  <code>[ :SENSe ] :POWer [ :RF ] :RANGe:OPTimize:ATTenuation?</code>
Notes	The SCPI parameter ELECTrical sets this function to On in single attenuator models. The SCPI parameter COMBined is mapped to ELECTrical in single attenuator models; if you send COMBined, it sets the function to On and returns ELEC to a query.
Dependencies	This key only appears in Dual Attenuator models with an Electronic Attenuator installed.

---

	In instruments with Dual Attenuator model, when Enable Elec Atten is off or grayed out, the Pre-Adjust for Min Clip key is grayed out.
Preset	OFF for Swept SA measurement; ON for all other measurements that support Pre-Adjust for Min Clip
State Saved	Saved in instrument state
Range	Dual attenuator models: Off   Elec Atten Only   Mech + Elec Atten Single attenuator models: Off   On
Initial S/W Revision	Prior to A.02.00
Modified at S/W Revision	A.03.00

---

<b>Remote Command</b>	<code>[ :SENSe ] :POWer [ :RF ] :RANGe :AUTO ON OFF 1 0</code> <code>[ :SENSe ] :POWer [ :RF ] :RANGe :AUTO?</code>
Notes	ON aliases to "Elec Atten Only" (:POW:RANG:OPT:ATT ELEC) OFF aliases to "Off" (:POW:RANG:OPT:ATT OFF) The query :POW:RANG:AUTO? returns true if :POW:RANG:OPT:ATT is not "Off"
Initial S/W Revision	Prior to A.02.00

---

## Off

Turns Pre-Adjust for Min Clip off. This is the default setting.

This key is grayed out in measurements that do not support this functionality. The spectrum analyzer measurement, Swept SA, does not support this functionality.

---

Key Path	AMPTD Y Scale, Attenuation, Pre-Adjust for Min Clip
Example	:POW:RANG:OPT:ATT OFF
Initial S/W Revision	Prior to A.02.00

---

## Elec Atten Only

Selects only the electric attenuator to participate in auto ranging. This offers less wear on the mechanical attenuator and is usually faster.

This key is grayed out in measurements that do not support this functionality. The spectrum analyzer measurement, Swept SA, does not support this functionality.

---

Key Path	AMPTD Y Scale, Attenuation, Pre-Adjust for Min Clip
Example	:POW:RANG:OPT:ATT ELEC
Initial S/W Revision	Prior to A.02.00

---

## Mech + Elec Atten

In dual attenuator models, this selects both attenuators participate in the autoranging.

This key is grayed out in measurements that do not support this functionality. The spectrum analyzer measurement, Swept SA, does not support this functionality.

Key Path	AMPTD Y Scale, Attenuation, Pre-Adjust for Min Clip
Example	:POW:RANGe:OPT:ATT COMB
Initial S/W Revision	Prior to A.02.00

## (Mech) Atten Step

This controls the step size used when making adjustments to the input attenuation.

This key is labeled Mech Atten Step in dual attenuator models and Atten Step in single attenuator models. In the dual attenuator configuration, this key only affects the step size of the mechanical attenuator.

Key Path	AMPTD Y Scale, Attenuation
<b>Remote Command</b>	<code>[ :SENSe ] :POWer [ :RF ] :ATTenuation :STEP [ :INCRement ] 10 dB   2 dB</code> <code>[ :SENSe ] :POWer [ :RF ] :ATTenuation :STEP [ :INCRement ] ?</code>
<b>Example</b>	POW:ATT:STEP 2
Notes	Note this feature works like a 1-N choice from the front panel, but it takes a specific value (in dB) when used remotely. The only valid values are 2 and 10.
Dependencies	Blanked in CXA and EXA if option FSA (2 dB steps) is not present. If blanked, attempts to set it via SCPI will yield an error.
Couplings	When the attenuation step size changes, the current mechanical attenuation value is adjusted (if necessary) to be quantized to the new step size. That is, if step is set to 10 dB, mech atten is increased if necessary so it is a multiple of 10 dB
Preset	PXA and MXA: 2 dB EXA and CXA: 10 dB (2 dB with option FSA)
State Saved	Saved in instrument state
Initial S/W Revision	Prior to A.02.00
Modified at S/W Revision	A.03.00

## Scale/Div

Sets the logarithmic units per vertical graticule division on the display. However, since the Auto Scaling defaults to On, this value is automatically determined by the measurement result. When you set a value manually, Auto Scaling automatically changes to Off.

Key Path	AMPTD Y Scale
Mode	All except SA and BASIC
Remote Command	:DISPlay:MONitor:VIEW[1]:WINDow[1]:TRACe:Y[:SCALe]:PDIVision <rel_ampl> :DISPlay:MONitor:VIEW[1]:WINDow[1]:TRACe:Y[:SCALe]:PDIVision?
Example	DISP:MON:VIEW:WIND:TRAC:Y:PDIV 5.0 dB DISP:MON:VIEW:WIND:TRAC:Y:PDIV?
Couplings	When the Auto Scaling is On, this value is automatically determined by the measurement result. When you set a value manually, Auto Scaling automatically changes to Off.
Preset	10.00 dB
State Saved	Saved in instrument state.
Min	0.10 dB
Max	20.00 dB
Initial S/W Revision	Prior to A.02.00

## Presel Center

When this key is pressed, the centering of the preselector filter is adjusted to optimize the amplitude accuracy at the frequency of the selected marker. If the selected marker is not on when Presel Center is pressed, the analyzer will turn on the selected marker, perform a peak search, and then perform centering on the marker's center frequency. If the selected marker is already on and between the start and stop frequencies of the analyzer, the analyzer performs the preselector calibration on that marker's frequency. If the selected marker is already on, but outside the frequency range between Start Freq and Stop Freq, the analyzer will first perform a peak search, and then perform centering on the marker's center frequency.

The value displayed on the Presel Adjust key will change to reflect the new preselector tuning (see Presel Adjust).

A number of considerations should be observed to ensure proper operation. See ["Proper Preselector Operation" on page 1941](#).

Key Path	AMPTD Y Scale
Remote Command	[:SENSe]:POWer[:RF]:PCENter
Example	POW:PCEN
Notes	Note that the rules outlined above under the key description apply for the remote command as well as the key. The result of the command is dependent on marker position, and so forth. Any message shown by the key press is also shown in response to the remote command.
Dependencies	<ul style="list-style-type: none"> <li>• Grayed out if the microwave preselector is off. )</li> <li>• If the selected marker's frequency is below Band 1, advisory message 0.5001 is generated and no action is taken.</li> <li>• Grayed out if entirely in Band 0.</li> <li>• Blank in models that do not include a preselector, such as option 503. If the SCPI is sent in these instruments, it is accepted without error, and the query always returns 0.</li> </ul>

- Grayed out in the Spectrogram View.

Couplings	The active marker position determines where the centering will be attempted. If the analyzer is in a measurement such as averaging when centering is initiated, the act of centering the preselector will restart averaging but the first average trace will not be taken until the centering is completed.
Status Bits/OPC dependencies	When centering the preselector, *OPC will not return true until the process is complete and a subsequent measurement has completed, nor will results be returned to a READ or MEASURE command. The Measuring bit should remain set while this command is operating and should not go false until the subsequent sweep/measurement has completed.
Initial S/W Revision	Prior to A.02.00
Modified at S/W Revision	A.03.00

## Proper Preselector Operation

A number of considerations should be observed to ensure proper operation:

1. If the selected marker is off, the analyzer will turn on a marker, perform a peak search, and adjust the preselector using the selected marker's frequency. It uses the "highest peak" peak search method unqualified by threshold or excursion, so that there is no chance of a 'no peak found' error. It continues with that peak, even if it is the peak of just noise. Therefore, for this operation to work properly, there should be a signal on screen in a preselected range for the peak search to find.
2. If the selected marker is already on, the analyzer will attempt the centering at that marker's frequency. There is no preselector for signals below about 3.6 GHz, therefore if the marker is on a signal below 3.6 GHz, no centering will be attempted and an advisory message generated
3. In some models, the preselector can be bypassed. If it is bypassed, no centering will be attempted in that range and a message will be generated.

## Preselector Adjust

Allows you to manually adjust the preselector filter frequency to optimize its response to the signal of interest. This function is only available when "Presel Center" on page 2111 is available.

For general purpose signal analysis, using Presel Center is recommended. Centering the filter minimizes the impact of long-term preselector drift. Presel Adjust can be used instead to manually optimize the preselector. One application of manual optimization would be to peak the preselector response, which both optimizes the signal-to-noise ratio and minimizes amplitude variations due to small (short-term) preselector drifting.

Key Path	AMPTD Y Scale
Scope	Meas Global
Remote Command	<code>[ :SENSe ] :POWER [ :RF ] :PADJust &lt;freq&gt;</code>

	<code>[ :SENSe ] :POWer [ :RF ] :PADJust?</code>
<b>Example</b>	POW:PADJ 100KHz POW:PADJ?
<b>Notes</b>	The value on the key reads out to 0.1 MHz resolution.
<b>Dependencies</b>	<ul style="list-style-type: none"> <li>• Grayed out if microwave preselector is off. )</li> <li>• Grayed out if entirely in Band 0.</li> <li>• Blank in models that do not include a preselector, such as option 503. If the SCPI is sent in these instruments, it is accepted without error, and the query always returns 0.</li> <li>• Grayed out in the Spectrogram View.</li> </ul>
<b>Preset</b>	0 MHz
<b>State Saved</b>	The Presel Adjust value set by Presel Center, or by manually adjusting Presel Adjust, is not saved in instrument state, and does not survive a Preset or power cycle.
<b>Min</b>	-500 MHz
<b>Max</b>	500 MHz
<b>Default Unit</b>	Hz
<b>Backwards Compatibility SCPI</b>	<code>[ :SENSe ] :POWer [ :RF ] :MW :PADJust</code> <code>[ :SENSe ] :POWer [ :RF ] :MMW :PADJust</code> PSA had multiple preselectors, but the X-Series has only one. These commands simply alias to <code>[ :SENSe ] :POWer [ :RF ] :PADJust</code>
<b>Initial S/W Revision</b>	Prior to A.02.00
<b>Modified at S/W Revision</b>	A.03.00

<b>Remote Command</b>	<code>[ :SENSe ] :POWer [ :RF ] :PADJust :PRESelector MWAVE   MMWave   EXTERNAL</code> <code>[ :SENSe ] :POWer [ :RF ] :PADJust :PRESelector?</code>
<b>Notes</b>	PSA had multiple preselectors, and you could select which preselector to adjust. Since the X-Series has only one mm/uW preselector, the preselector selection softkey is no longer available. However, to provide backward compatibility, we accept the legacy remote commands. The command form has no effect, the query always returns MWAVE
<b>Initial S/W Revision</b>	Prior to A.02.00

## µW Path Control

The µW Path Control functions include the µW Preselector Bypass (Option MPB) and Low Noise Path (Option LNP) controls in the High Band path circuits.

When the µW Preselector is bypassed, the user has better flatness, but will be subject to spurs from out of band interfering signals. When the Low Noise Path is enabled, the analyzer automatically switches around

certain circuitry in the high frequency bands which can contribute to noise, when it is appropriate based on other analyzer settings.

For most applications, the preset state is Standard Path, which gives the best remote-control throughput, minimizes acoustic noise from switching and minimizes the risk of wear out in the hardware switches. For applications that utilize the wideband IF paths, the preset state is the  $\mu$ W Preselector Bypass path, if option MPB is present. This is because, when using a wideband IF such as the 140 MHz IF, the  $\mu$ W Preselector's bandwidth can be narrower than the available IF bandwidth, causing degraded amplitude flatness and phase linearity, so it is desirable to bypass the preselector in the default case.

Users may choose Low Noise Path Enable. It gives a lower noise floor, especially in the 21–26.5 GHz region, though without improving many measures of dynamic range, and without giving the best possible noise floor. The preamp, if purchased and used, gives better noise floor than does the Low Noise Path, however its compression threshold and third-order intercept are much poorer than that of the non-preamp Low Noise Path. There are some applications, typically for signals around –30 dBm, for which the third-order dynamic range of the standard path is good enough, but the noise floor is not low enough even with 0 dB input attenuation. When the third-order dynamic range of the preamp path is too little and the noise floor of the standard path is too high, the Low Noise Path can provide the best dynamic range.

<b>Key Path</b>	AMPTD Y Scale
<b>Mode</b>	SA, BASIC, PNOISE, VSA , LTE, LTETDD
<b>Scope</b>	Meas Global
<b>Remote Command</b>	[ :SENSe ] :POWer [ :RF ] :MW:PATH STD LNPath MPBypass FULL [ :SENSe ] :POWer [ :RF ] :MW:PATH?
<b>Example</b>	:POW:MW:PATH LNP Enables the Low Noise path
<b>Notes</b>	If a Presel Center is performed, the analyzer will momentarily switch to the Standard Path, regardless of the setting of $\mu$ W Path Control  The DC Block will always be switched in when the low noise path is switched in, to protect succeeding circuitry from DC. Note that this does not mean “when the low noise path is enabled” but when, based on the Low Noise Path rules, the path is actually switched in. This can happen when the selection is Low Noise Path Enable . In the case where the DC Block is switched in the analyzer is now AC coupled. However, if the user has selected DC coupling, the UI will still behave as though it were DC coupled, including all annunciation, warnings, status bits, and responses to SCPI queries. This is because, based on other settings, the analyzer could switch out the low noise path at any time and hence go back to being DC coupled.  Alignment switching ignores the settings in this menu, and restores them when finished.
<b>Dependencies</b>	Unavailable in BBIQ and External Mixing
<b>Preset</b>	All modes other than IQ Analyzer mode and VXA: STD IQ Analyzer, VXA and WLAN mode: MPB option present and licensed: MPB MPB option not present and licensed: STD
<b>State Saved</b>	Save in instrument state
<b>Readback</b>	Value selected in the submenu
<b>Initial S/W Revision</b>	A.04.00
<b>Modified at S/W Revision</b>	A.10.00

## Standard Path

This path gives the best remote-control throughput, minimizes acoustic noise from switching and minimizes the risk of wear in the hardware switches, particularly in remote test scenarios where both low band and high band setups will follow in rapid succession.

In this path, the bypass of the low band/high band switch and microwave preamp is never activated, which can cause some noise degradation but preserves the life of the bypass switch.

Key Path	AMPTD Y Scale, $\mu$ W Path Control
<b>Example</b>	:POW:MW:PATH STD
Readback Text	Standard Path
Initial S/W Revision	A.04.00

## Low Noise Path Enable

You may choose Low Noise Path Enable, which gives a lower noise floor under some circumstances, particularly when operating in the 21–26.5 GHz region. With the Low Noise Path enabled, the low band/high band switch and microwave preamp are bypassed whenever all of the following are true:

- The analyzer is not in the Low Band, meaning:
- the start frequency is above 3.5 GHz and
- the stop frequency is above 3.6 GHz.
- the internal preamp is not installed or (if installed) is set to Off or Low Band

Note that this means that, when any part of a sweep is done in Low Band, the Low Noise Path is not used, whether or not the Low Noise Path Enable is selected in the user interface. Also, if the preamp is turned on, the Low Noise Path is not used, whether or not the Low Noise Path Enable is selected in the user interface. The only time the Low Noise Path is used is when Low Noise Path Enable is selected, the sweep is completely in High Band (> 3.6 GHz) and no preamp is in use.

See "[More Information](#)" on page 1945

Key Path	AMPTD Y Scale, $\mu$ W Path Control
Measurement	Swept SA
<b>Example</b>	:POW:MW:PATH LNP
Notes	For measurements that use IQ acquisition, the low noise path is used when the Center Frequency is in High Band (> 3.6 GHz) and no preamp is in use. In other words, the rules above are modified to use only the center frequency to qualify which path to switch in. This is not the case for FFT's in the Swept SA measurement; they use the same rules as swept measurements.
Dependencies	Key is blanked if current mode does not support it. Key is grayed out if mode supports it but current measurement does not support it. Unless Option LNP is present and licensed, key is blank and if SCPI command sent, error -241,



---

	"Hardware missing; Option not installed" is generated.
Readback Text	Low Noise Path Enable
Initial S/W Revision	A.04.00

---

### More Information

The user should understand that the Low Noise Path, while giving improved DANL, has the disadvantage of decreased TOI performance and decreased gain compression performance relative to the standard path.

The user should also understand that the bypass switch is a mechanical switch and has finite life, so if the Low Noise Path is enabled, it is possible to cause frequent cycling of this switch by frequently changing analyzer settings such that the above conditions hold true only some of the time. A user making tests of this nature should consider opting for the Standard Path, which will never throw the bypass switch, at the expense of some degraded noise performance.

The low noise path is useful for situations where the signal level is so low that the analyzer performance is dominated by noise even with 0 dB attenuation, but still high enough that the preamp option would have excessive third-order intermodulation or compression. The preamp, if purchased and used, gives better noise floor than does the "Low Noise Path." However, its compression threshold and third-order intercept are much poorer than that of the non-preamp path. There are some applications, typically for signals around -30 dBm, for which the third-order dynamic range of the standard path is good enough, but the noise floor is not low enough even with 0 dB input attenuation. When the third-order dynamic range of the preamp path is too little and the noise floor of the standard path is too high, the Low Noise Path can provide the best dynamic range

The graph below illustrates the concept. It shows, in red, the performance of an analyzer at different attenuation settings, both with the preamp on and off, in a measurement that is affected by both analyzer noise and analyzer TOI. The green shows the best available dynamic range, offset by 0.5 dB for clarity. The blue shows how the best available dynamic range improves for moderate signal levels with the low noise path switched in. In this illustration, the preamp improves the noise floor by 15 dB while degrading the third-order intercept by 30 dB, and the low noise path reduces loss by 8 dB. The attenuator step size is 2 dB.

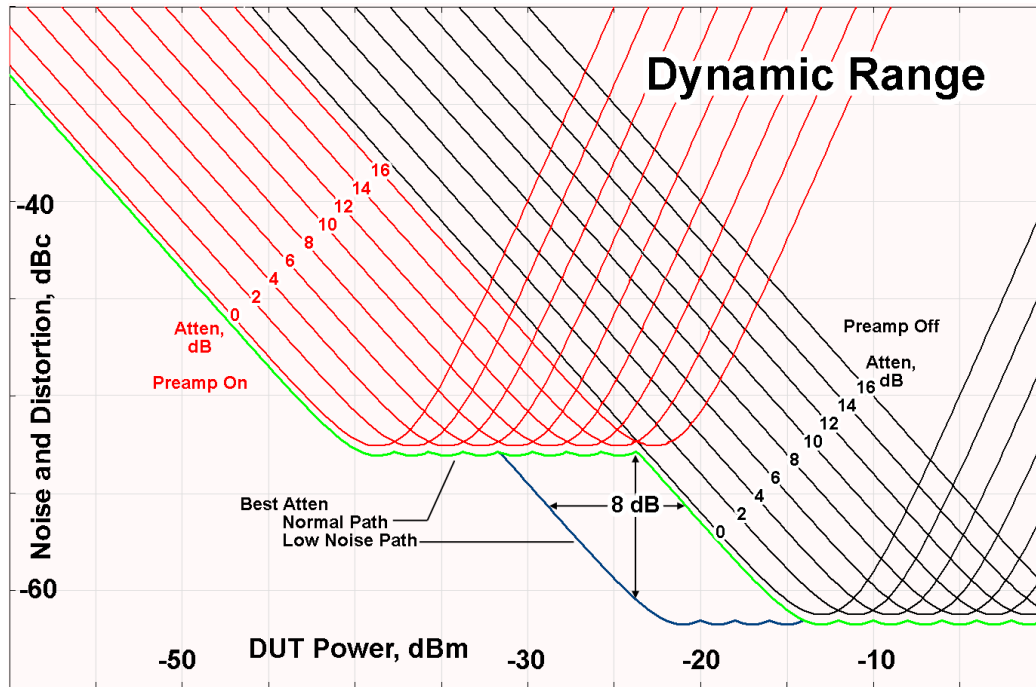

There are other times where selecting the low noise path improves performance, too. Compression-limited measurements such as finding the nulls in a pulsed-RF spectrum can profit from the low noise path in a way similar to the TOI-limited measurement illustrated. Accuracy can be improved when the low noise path allows the optimum attenuation to increase from a small amount like 0, 2 or 4 dB to a larger amount, giving better return loss at the analyzer input. Harmonic measurements, such as second and third harmonic levels, are much improved using the low noise path because of the superiority of that path for harmonic (though not intermodulation) distortion performance.

### µW Preselector Bypass

This key toggles the preselector bypass switch for band 1 and higher. When the microwave preselector is on, the signal path is preselected. When the microwave preselector is off, the signal path is not preselected. The preselected path is the normal path for the analyzer.

The preselector is a tunable bandpass filter which prevents signals away from the frequency of interest from combining in the mixer to generate in-band spurious signals (images). The consequences of using a preselector filter are its limited bandwidth, the amplitude and phase ripple in its passband, and any amplitude and phase instability due to center frequency drift.

Option MPB or pre-selector bypass provides an unpreselected input mixer path for certain X-Series signal analyzers with frequency ranges above 3.6 GHz. This signal path allows a wider bandwidth and less amplitude variability, which is an advantage when doing modulation analysis and broadband signal analysis. The disadvantage is that, without the preselector, image signals will be displayed. Another disadvantage of bypassing the preselector is increased LO emission levels at the front panel input port.

Image responses are separated from the real signal by twice the 1st IF. For IF Paths of 10 MHz and 25 MHz, the 1st IF is 322.5 MHz, so the image response and the real signal will be separated by 645 MHz. The 1st IF will be different for other IF Path settings. When viewing a real signal and its corresponding image response in internal mixing, the image response will be to the left of the real signal.

Also, the image response and the real signal typically have the same amplitude and exhibit the same shape factor.

However, if Option FS1, Fast Sweep Capability, is enabled, the image response in the Swept SA measurement will appear lower in amplitude and have a much wider shape factor compared to the real signal.

Key Path	AMPTD Y Scale, $\mu$ W Path Control
<b>Example</b>	:POW:MW:PATH MPB
Dependencies	Key is blanked if current mode does not support it. Key is grayed out if mode supports it but current measurement does not support it. Key is blank unless Option MPB is present and licensed. If SCPI command sent when MPB not present, error -241, "Hardware missing; Option not installed" is generated.
Readback Text	$\mu$ W Preselector Bypass
Initial S/W Revision	A.04.00

<b>Remote Command</b>	[ :SENSe ] :POWer [ :RF ] :MW :PRESelector [ :STATe ] ON   OFF   0   1 [ :SENSe ] :POWer [ :RF ] :MW :PRESelector [ :STATe ] ?
<b>Example</b>	:POW:MW:PRES OFF Bypasses the microwave preselector
Notes	The ON parameter sets the STD path (:POW:MW:PATH STD) The OFF parameter sets path MPB (:POW:MW:PATH MPB)
Preset	ON

## Internal Preamp

Accesses a menu of keys that control the internal preamps. Turning on the preamp gives a better noise figure, but a poorer TOI to noise floor dynamic range. You can optimize this setting for your particular measurement.

The instrument takes the preamp gain into account as it sweeps. If you sweep outside of the range of the preamp the instrument will also account for that. The displayed result will always reflect the correct gain.

For some measurements, when the preamp is on and any part of the displayed frequency range is below the lowest frequency for which the preamp has specifications, a warning condition message appears in the status line. For example ,for a preamp with a 9 kHz lowest specified frequency: "Preamp: Accy unspec'd below 9 kHz".

Key Path	AMPTD Y Scale
Scope	Meas Global
<b>Remote Command</b>	[ :SENSe ] :POWer [ :RF ] :GAIN [ :STATe ] OFF   ON   0   1 [ :SENSe ] :POWer [ :RF ] :GAIN [ :STATe ] ?
Dependencies	Preamp is not available on all hardware platforms. If the preamp is not present or is unlicensed, the

---

	key is not shown. The preamp is not available when the electronic/soft attenuator is enabled.
--	--

---

Couplings	The act of connecting the U7227A USB Preamplifier to one of the analyzer's USB ports will cause the Internal Preamp to be switched on. When this happens an informational message will be generated: "Internal Preamp turned on for optimal operation with USB Preamp." Note that if the Internal Preamp was already on, there will be no change to the setting, but if it was Off it will be switched On, to Full Range.  Note that this same action occurs when the SA mode is selected while the USB Preamp is connected to one of the analyzer's USB ports, if it is the first time that the SA mode has run since powerup, or if the last time the SA mode was running the USB Preamp was NOT connected.  Subsequently disconnecting the USB Preamp from USB does not change the Internal Preamp setting nor restore the previous setting.
Preset	OFF
State Saved	Saved in instrument state
Initial S/W Revision	Prior to A.02.00
Modified at S/W Revision	A.14.00

---

Key Path	AMPTD Y Scale, Internal Preamp
Scope	Meas Global
<b>Remote Command</b>	[ :SENSe ] :POWer [ :RF ] :GAIN:BAND LOW FULL [ :SENSe ] :POWer [ :RF ] :GAIN:BAND?
Dependencies	Preamp is not available on all hardware platforms. If the preamp is not present or is unlicensed, the key is not shown.  If a POW:GAIN:BAND FULL command is sent when a low band preamp is available, the preamp band parameter is to LOW instead of FULL, and an "Option not installed" message is generated.
Preset	LOW
State Saved	Saved in instrument state
Initial S/W Revision	Prior to A.02.00

---

## Off

Turns the internal preamp off

---

Key Path	AMPTD Y Scale, Internal Preamp
<b>Example</b>	:POW:GAIN OFF
Readback	Off
Initial S/W Revision	Prior to A.02.00

---

## Low Band

Sets the internal preamp to use only the low band.

The frequency range of the installed (optional) low-band preamp is displayed in square brackets on the Low Band key label.

Key Path	AMPTD Y Scale, Internal Preamp
<b>Example</b>	:POW:GAIN ON :POW:GAIN:BAND LOW
Readback	Low Band
Initial S/W Revision	Prior to A.02.00

## Full Range

Sets the internal preamp to use its full range. The low band (0–3.6 GHz or 0–3GHz, depending on the model) is supplied by the low band preamp and the frequencies above low band are supplied by the high band preamp.

The frequency range of the installed (optional) preamp is displayed in square brackets on the Full Range key label. If the high band option is not installed the Full Range key does not appear.

Key Path	AMPTD Y Scale, Internal Preamp
<b>Example</b>	:POW:GAIN ON :POW:GAIN:BAND FULL
Readback	Full Range
Initial S/W Revision	Prior to A.02.00

## Ref Position

Positions the reference level at the top, center or bottom of the Y Scale display. Changing the reference position does not change the reference level value.

Key Path	AMPTD Y Scale
Mode	All except SA and BASIC
<b>Remote Command</b>	:DISPlay:MONitor:VIEW[1]:WINDow[1]:TRACe:Y[:SCALe]:RPOSition TOP   CENTer   BOTTom  :DISPlay:MONitor:VIEW[1]:WINDow[1]:TRACe:Y[:SCALe]:RPOSition?
<b>Example</b>	DISP:MON:VIEW:WIND:TRAC:Y:RPOS CENT DISP:MON:VIEW:WIND:TRAC:Y:RPOS?
Preset	TOP
State Saved	Saved in instrument state.
Range	Top Ctr Bot
Initial S/W Revision	Prior to A.02.00

## Auto Scaling

Toggles the Auto Scaling function between On and Off.

<b>Key Path</b>	AMPTD Y Scale
<b>Mode</b>	All except SA and BASIC
<b>Remote Command</b>	:DISPlay:MONitor:VIEW[1]:WINDow[1]:TRACe:Y[:SCALe]:COUPle 0   1   OFF   ON  :DISPlay:MONitor:VIEW[1]:WINDow[1]:TRACe:Y[:SCALe]:COUPle?
<b>Example</b>	DISP:MON:VIEW:WIND:TRAC:Y:COUP ON DISP:MON:VIEW:WIND:TRAC:Y:COUP?
<b>Couplings</b>	When Auto Scaling is On, and the Restart front-panel key is pressed, this function automatically determines the scale per division and reference values based on the measurement results. When you set a value to either Scale/Div or Ref Value manually, Auto Scaling automatically changes to Off.
<b>Preset</b>	ON
<b>State Saved</b>	Saved in instrument state.
<b>Range</b>	On Off
<b>Initial S/W Revision</b>	Prior to A.02.00

## Auto Couple

The Auto Couple feature provides a quick and convenient way to automatically couple multiple instrument settings. This helps ensure accurate measurements and optimum dynamic range. When the Auto Couple feature is activated, either from the front panel or remotely, all parameters of the current measurement that have an Auto/Manual mode are set to Auto mode and all measurement settings dependent on (or coupled to) the Auto/Man parameters are automatically adjusted for optimal performance.

However, the Auto Couple key actions are confined to the current measurement only. It does not affect other measurements in the mode, and it does not affect markers, marker functions, or trace or display attributes.

See "[More Information](#)" on page 1951

Key Path	Front-panel key
Remote Command	:COUPle ALL NONE
Example	:COUP ALL
Notes	:COUPle ALL puts all Auto/Man parameters in Auto mode (equivalent to pressing the Auto Couple key). :COUPLE NONE puts all Auto/Man parameters in manual mode. It decouples all the coupled instrument parameters and is not recommended for making measurements.
Initial S/W Revision	Prior to A.02.00

### More Information

There are two types of functions that have Auto/Manual modes.

#### Auto/Man Active Function keys

An Auto/Man toggle key controls the binary state associated with an instrument parameter by toggling between Auto (where the parameter is automatically coupled to the other parameters it is dependent upon) and Man (where the parameter is controlled independent of the other parameters), as well as making the parameter the active function. The current mode is indicated on the softkey with either Auto or Man underlined as illustrated below.

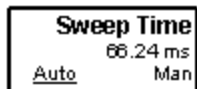

uscIT

#### Auto/Man 1-of-N keys

An Auto/Man 1-of-N key allows you to manually pick from a list of parameter values, or place the function in Auto, in which case the value is automatically selected (and indicated) as shown below. If in Auto, Auto is underlined on the calling key. If in manual operation, manual is indicated on the calling key. But the calling key does not actually toggle the function, it simply opens the menu.

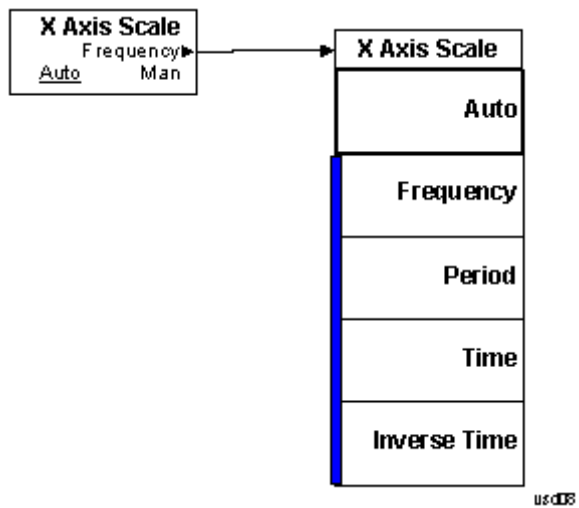



## BW

Accesses a menu that enables you to specify the resolution bandwidth functions that control the bandwidth and filter selection.

Key Path	Front-panel key
Initial S/W Revision	Prior to A.02.00

## Res BW

Sets the resolution bandwidth for the current measurement. If an unavailable bandwidth is entered with the numeric keypad, the closest available bandwidth is selected.

Key Path	BW
Mode	All except SA and BASIC
<b>Remote Command</b>	<pre>[ :SENSe]:MONitor:BANDwidth[:RESolution] &lt;freq&gt; [:SENSe]:MONitor:BANDwidth[:RESolution]? [:SENSe]:MONitor:BANDwidth[:RESolution]:AUTO OFF ON 0 1 [:SENSe]:MONitor:BANDwidth[:RESolution]:AUTO?</pre>
<b>Example</b>	<pre>MON:BAND 2.4 MHz MON:BAND? MON:BAND:AUTO ON MON:BAND:AUTO?</pre>
Preset	<pre>WCDMA: Automatically calculated WIMAX OFDMA: 100kHz C2K: Automatically calculated BLUETOOTH: Automatically calculated PN: Automatically calculated GSM/EDGE: Automatically calculated TD-SCDMA: Automatically calculated 1xEVDO: 30kHz DVB-T/H: 3.9kHz DTMB (CTTB): 3.9kHz ISDB-T: 3.9kHz CMMB: 3.9kHz LTE: 100 kHz LTETDD: 100 kHz Digital Cable TV: 3.9kHz WLAN: 100 kHz MSR: Automatically calculated LTEAFDD, LTEATDD: 100kHz</pre>

---

	WCDMA: ON
	WIMAX: OFF
	C2K: ON
	BLUETOOTH: ON
	PN: ON
	GSM/EDGE: ON
	TD-SCDMA: ON
	1xEVDO: ON
	DVB-T/H: OFF
	DTMB (CTTB): OFF
	ISDB-T: OFF
	CMMB: OFF
	LTE:OFF
	LTETDD: OFF
	Digital Cable TV: OFF
	WLAN: OFF
	MSR: ON
	LTEAFDD, LTEATDD: OFF
State Saved	Saved in instrument state.
Min	1.0 Hz
Max	8.0 MHz
<b>Backwards Compatibility SCPI</b>	<code>[[:SENSe]:MONitor:BWIDth[:RESolution]</code>
Initial S/W Revision	Prior to A.02.00
Modified at S/W Revision	A.02.00
Modified at S/W Revision	A.03.00

---

## Video BW

Changes the analyzer post-detection filter.

---

Key Path	BW
Mode	All except SA and BASIC
<b>Remote Command</b>	<code>[[:SENSe]:MONitor:BANDwidth:VIDeo &lt;bandwidth&gt;</code> <code>[[:SENSe]:MONitor:BANDwidth:VIDeo?</code> <code>[[:SENSe]:MONitor:BANDwidth:VIDeo:AUTO ON OFF 1 0</code> <code>[[:SENSe]:MONitor:BANDwidth:VIDeo:AUTO?</code>
<b>Example</b>	MON:BAND:VID 10 MHz MON:BAND:VID? MON:BAND:VID:AUTO OFF

---

	MON:BAND:VID:AUTO?
Preset	WCDMA: Automatically calculated WIMAX OFDMA: 1MHz C2K: Automatically calculated BLUETOOTH: Automatically calculated PN: Automatically calculated GSM/EDGE: Automatically calculated TD-SCDMA: Automatically calculated 1xEVDO: 300kHz DVB-T/H: 39kHz DTMB (CTTB): 39kHz ISDB-T: 39kHz CMMB: 39kHz LTE: 1 MHz LTETDD: 1 MHz Digital Cable TV: 39kHz WLAN: 1 MHz MSR: Automatically calculated LTEAFDD, LTEATDD:1 MHz WCDMA: ON WIMAX: OFF C2K: ON BLUETOOTH: ON PN: ON GSM/EDGE: ON TD-SCDMA: ON 1xEVDO: ON DVB-T/H: OFF DTMB (CTTB): OFF ISDB-T: OFF CMMB: OFF LTE:OFF LTETDD:OFF Digital Cable TV: OFF WLAN: OFF MSR: ON LTEAFDD, LTEATDD: OFF
State Saved	Saved in instrument state.
Min	1 Hz
Max	50 MHz

<b>Backwards Compatibility SCPI</b>	<code>[ :SENSe ] :MONitor :BWIDth :VIDeo</code>
Initial S/W Revision	Prior to A.02.00
Modified at S/W Revision	A.02.00
Modified at S/W Revision	A.03.00

### VBW:3dB RBW

Selects the ratio between the video bandwidth and the equivalent 3 dB resolution bandwidth to be used for setting the VBW when VBW is in Auto.

Key Path	BW
Mode	All except SA and BASIC
<b>Remote Command</b>	<code>[ :SENSe ] :MONitor :BANDwidth :VIDeo :RATio &lt;real&gt;</code> <code>[ :SENSe ] :MONitor :BANDwidth :VIDeo :RATio?</code> <code>[ :SENSe ] :MONitor :BANDwidth :VIDeo :RATio :AUTO OFF   ON   0   1</code> <code>[ :SENSe ] :MONitor :BANDwidth :VIDeo :RATio :AUTO?</code>
<b>Example</b>	MON:BAND:VID:RAT 2 MON:BAND:VID:RAT? MON:BAND:VID:RAT:AUTO 0 MON:BAND:VID:RAT:AUTO?
Preset	1 ON
State Saved	Saved in instrument state.
Min	0.00001
Max	3000000
<b>Backwards Compatibility SCPI</b>	<code>[ :SENSe ] :MONitor :BWIDth :VIDeo :RATio</code>
Initial S/W Revision	Prior to A.02.00

### Span:3dB RBW

Selects the ratio between span and resolution bandwidth.

The default setting is Auto with a Span:3 dB RBW ratio of 106:1. You can manually change this ratio by pressing the key, entering a new value, and pressing Enter.

Key Path	BW
Mode	All except SA and BASIC
<b>Remote Command</b>	<code>[ :SENSe ] :MONitor :FREQuency :SPAN :BANDwidth [ :RESolution ] :RATio &lt;integer&gt;</code>

---

```
[ :SENSe ] :MONitor:FREQuency:SPAN:BANDwidth[:RESolution]:RATio?
[ :SENSe ] :MONitor:FREQuency:SPAN:BANDwidth[:RESolution]:RATio:AUTO OFF |
ON | 0 | 1
[ :SENSe ] :MONitor:FREQuency:SPAN:BANDwidth[:RESolution]:RATio:AUTO?
```

---

**Example**

```
MON:FREQ:SPAN:BAND:RAT 200
MON:FREQ:SPAN:BAND:RAT?
MON:FREQ:SPAN:BAND:RAT:AUTO ON
MON:FREQ:SPAN:BAND:RAT:AUTO?
```

---

Preset 106  
ON

---

State Saved Saved in instrument state.

---

Min 2

---

Max 10000

---

**Backwards Compatibility SCPI** [ :SENSe ] :MONitor:FREQuency:SPAN:BWIDth[:RESolution]:RATio

---

Initial S/W Revision Prior to A.02.00

---

Modified at S/W Revision A.04.00

---

## Cont (Continuous Measurement/Sweep)

Sets the analyzer for Continuous measurement operation. The single/continuous state is Meas Global so the setting will affect all measurements. If you are Paused, pressing Cont does a Resume.

<b>Key Path</b>	Front-panel key
<b>Remote Command</b>	:INITiate:CONTinuous OFF ON 0 1 :INITiate:CONTinuous?
<b>Example</b>	:INIT:CONT 0 puts analyzer in Single measurement operation. :INIT:CONT 1 puts analyzer in Continuous measurement operation
<b>Preset</b>	ON (Note that SYST:PRESet sets INIT:CONT to ON but *RST sets INIT:CONT to OFF)
<b>State Saved</b>	Saved in instrument state
<b>Backwards Compatibility Notes</b>	For Spectrum Analysis mode in ESA and PSA, there is no Cont hardkey, instead there is a Sweep Single/Cont key. In these analyzers, switching the Sweep Single/Cont key from Single to Cont restarts averages (displayed average count reset to 1), but does not restart Max Hold and Min Hold. The X-Series has Single and Cont keys in place of the SweepSingleCont key. In the X-Series, if in single measurement, the Cont key (and INIT:CONT ON ) switches to continuous measurement, but never restarts a measurement and never resets a sweep.
<b>Initial S/W Revision</b>	Prior to A.02.00

In Swept SA Measurement (Spectrum Analysis Mode):

The analyzer takes repetitive sweeps, averages, measurements, etc., when in Continuous mode. When the average count reaches the Average/Hold Number the count stops incrementing, but the analyzer keeps sweeping. See the Trace/Detector section for the averaging formula used both before and after the Average/Hold Number is reached. The trigger condition must be met prior to each sweep. The type of trace processing for multiple sweeps, is set under the Trace/Detector key, with choices of Trace Average, Max Hold, or Min Hold.

In Other Measurements/Modes:

With Avg/Hold Num (in the Meas Setup menu) set to Off or set to On with a value of 1, a sweep is taken after the trigger condition is met; and the analyzer continues to take new sweeps after the current sweep has completed and the trigger condition is again met. However, with Avg/Hold Num set to On with a value >1, multiple sweeps (data acquisitions) are taken for the measurement. The trigger condition must be met prior to each sweep. The sweep is not stopped when the average count k equals the number N set for Avg/Hold Num is reached, but the number k stops incrementing. A measurement average usually applies to all traces, marker results, and numeric results. But sometimes it only applies to the numeric results.

If the analyzer is in Single measurement, pressing the Cont key does not change k and does not cause the sweep to be reset; the only action is to put the analyzer into Continuous measurement operation.

If it is already in continuous sweep:

the INIT:CONT 1 command has no effect

the INIT:CONT 0 command will place the analyzer in Single Sweep but will have no effect on the current sequence until  $k = N$ , at which point the current sequence will stop and the instrument will go to the idle state.

15 Monitor Spectrum Measurement  
File

File

See "File" on page 336



## FREQ Channel

The key accesses a menu allowing you to set Frequency parameters for the current measurement. All measurements in DVB-T/H mode have the same menu structure under FREQ/Channel menu.

Key Path	Front-panel key
Initial S/W Revision	A.02.00

### Channel

Sets the analyzer to a frequency that corresponds to the Channel Number. If the Center Freq value entered does not exactly correlate with the Channel, the displayed value will be “---”.

Key Path	FREQ Channel
Mode	DVB-T/H
<b>Remote Command</b>	<code>[ :SENSe ] :FREQuency:CHANnel:NUMBer &lt;integer&gt;</code> <code>[ :SENSe ] :FREQuency:CHANnel:NUMBer?</code>
<b>Example</b>	FREQ:CHAN:NUMB 21 FREQ:CHAN:NUMB?
Dependencies	If your analyzer has multiple inputs and the selected input is BBIQ, this key will be grayed out and the displaying value will be “---”.
Couplings	Channel is coupled with Center Freq. A certain Channel corresponds to a certain value of Center Freq. If the Center Freq value entered does not exactly correlate with a Channel, the displaying value will be “---”, and the returned value of the SCPI command “FREQ:CHAN:NUMB?” is “-999”.
Preset	21
State Saved	Saved in instrument state.
Min	Depends on the selected channel table
Max	Depends on the selected channel table
Initial S/W Revision	A.02.00

### Center Freq

Sets the center frequency. If your analyzer has multiple inputs (RF and IQ), the displayed value will be updated according to the selected input. SCPI commands are available to directly set the center frequency for a specific input. This key is coupled with Channel when the selected input is RF.

See also:

["RF Center Freq" on page 1963](#)

["IQ Center Freq" on page 1963](#)

Key Path	FREQ Channel
Mode	DVB-T/H
<b>Remote Command</b>	<code>[ :SENSe ] :FREQuency:CENTer &lt;freq&gt;</code> <code>[ :SENSe ] :FREQuency:CENTer?</code>
<b>Example</b>	FREQ:CENT 1.0MHZ FREQ:CENT?
Couplings	Center Freq is coupled with Channel. A certain value of center frequency corresponds to a certain Channel. If the Channel changes, the Center Frequency will be changed to the frequency which is the center of the channel.
Preset	474.00MHz
State Saved	Saved in instrument state.
Min	-79.999995 MHz
Max	Hardware Dependent, for details, see <a href="#">"Maximum Frequency in X - Series Signal Analyzers" on page 1962.</a>
Initial S/W Revision	A.02.00

### Maximum Frequency in X - Series Signal Analyzers

The following table lists the maximum frequency in different X - Series signal analyzers.

Model numbers: N9020A, N9030A

Freq Option	Stop Freq after Mode Preset	Max Freq (can't tune above)
503	3.6 GHz	3.7 GHz
508	8.4 GHz	8.5 GHz
513	13.6 GHz	13.8 GHz
526	26.5 GHz	27.0 GHz
543 (N9030A only)	43 GHz	
544 (N9030A only)	44 GHz	44.5 GHz
550 (N9030A only)	50 GHz	51 GHz

Model number: N9010A

Freq Option	Stop Freq after Mode Preset	Max Freq (can't tune above)
503	3.6 GHz	3.7 GHz
507	7.0 GHz	7.1 GHz

513	13.6 GHz	13.8 GHz
526	26.5 GHz	27.0 GHz
532	32.0 GHz	32.5 GHz
544	44.0 GHz	44.5 GHz

Model number: N9000A

Freq Option	Stop Freq after Mode Preset	Max Freq (can't tune above)
503	3.0 GHz	3.08 GHz
507	7.5 GHz	7.58 GHz

## RF Center Freq

SCPI command to specify the RF Center Frequency. This will always access the RF value, even when the selected input is not RF.

Key Path	FREQ Channel
Mode	DVB-T/H
Remote Command	<code>[ :SENSe ] :FREQuency:RF:CENTer &lt;freq&gt;</code> <code>[ :SENSe ] :FREQuency:RF:CENTer?</code>
Example	FREQ:RF:CENT 1.0MHZ FREQ:RF:CENT?
Couplings	Center Freq is coupled with Channel. A certain value of center frequency corresponds to a certain Channel. If the Channel changes, the Center Frequency will be changed to the frequency which is the center of the channel.
Preset	474.00MHz
State Saved	Saved in instrument state.
Min	-79.999995 MHz
Max	Hardware Dependent, for details, see <a href="#">"Maximum Frequency in X - Series Signal Analyzers" on page 1962.</a>
Initial S/W Revision	A.02.00

## IQ Center Freq

SCPI command to specify the I/Q Center Frequency. This will always access the I/Q value, even when the selected input is not I/Q.

Key Path	FREQ Channel
Mode	DVB-T/H
<b>Remote Command</b>	[ :SENSe ] :FREQuency:IQ:CENTer <freq> [ :SENSe ] :FREQuency:IQ:CENTer?
<b>Example</b>	FREQ:IQ:CENT 1.0MHZ FREQ:IQ:CENT?
Preset	0 Hz
State Saved	Saved in instrument state.
Min	-39.999995 MHz
Max	39.999995 MHz
Initial S/W Revision	A.02.00

### Chan Step

Chan Step changes the step size for the Channel Number.

Key Path	FREQ Channel
Mode	DVB-T/H
<b>Remote Command</b>	[ :SENSe ] :FREQuency:CHANnel:STEP <integer> [ :SENSe ] :FREQuency:CHANnel:STEP?
<b>Example</b>	FREQ:CHAN:STEP 1 FREQ:CHAN:STEP?
Dependencies	If your analyzer has multiple inputs and the selected input is BBIQ, this key will be grayed out.
Preset	1
State Saved	Saved in instrument state.
Min	1
Max	Depends on the selected channel table
Initial S/W Revision	A.02.00

### CF Step

CF Step sets the step size for center frequency. If CF Step State is manual, you can set this value manually. Once CF Step State is changed to auto, CF Step changes to the value of Channel BW automatically.

Key Path	FREQ Channel
Mode	DVB-T/H
<b>Remote Command</b>	[ :SENSe ] :FREQuency:CENTer:STEP [ :INCRement ] <freq> [ :SENSe ] :FREQuency:CENTer:STEP [ :INCRement ] ?

	<code>[ :SENSe ] :FREQuency:CENTer:STEP:AUTO ON OFF 1 0</code>
	<code>[ :SENSe ] :FREQuency:CENTer:STEP:AUTO?</code>
<b>Example</b>	FREQ:CENT:STEP 100KHZ FREQ:CENT:STEP? FREQ:CENT:STEP:AUTO OFF FREQ:CENT:STEP:AUTO?
Couplings	CF Step is coupled to Channel BW (Mode Setup) when CF Step State is 'Auto'.
Preset	8.00MHz ON
State Saved	Saved in instrument state.
Min	1.0 kHz
Max	1 GHz
Initial S/W Revision	A.02.00

## Chan Table

Allows you to choose the appropriate TV standard: NTSC-M, NTSC-J, NTSC-Brazil, PAL-M, PAL-B/G, PAL-D/K, or PAL-I.

Key Path	FREQ Channel
Mode	DVB-T/H
<b>Remote Command</b>	<code>[ :SENSe ] :FREQuency:CHANnel:TABLE[:SElect] MNTSc   JNTSc   BNTSc   MPAL   IPAL   BPAL   DPAL</code> <code>[ :SENSe ] :FREQuency:CHANnel:TABLE[:SElect] ?</code>
<b>Example</b>	FREQ:CHAN:TABL BPAL FREQ:CHAN:TABL?
Dependencies	If your analyzer has multiple inputs and the selected input is BBIQ, this key will be grayed out.
Couplings	Couple with Channel. Setting Chan Table sets the range of Channel to the value corresponding to that Chan Table.
Preset	BPAL
State Saved	Saved in instrument state.
Range	NTSC-M   NTSC-J   NTSC-Brazil   PAL-M   PAL-I   PAL-B/G   PAL-D/K
Initial S/W Revision	A.02.00

## NTSC-M

If the current TV standard is NTSC-M, you can choose the appropriate channel plans in NTSC-M standard: Standard Cable (STD), Broadcast Channel (AIR), HRC Cable (HRC) or IRC Cable (IRC).

Key Path	FREQ Channel, Chan Table
Mode	DVB-T/H
<b>Remote Command</b>	[ :SENSE ] :FREQuency:CHANnel:TABLE:MNTSc [ :SElect ] STD   AIR   HRC   IRC [ :SENSe ] :FREQuency:CHANnel:TABLE:MNTSc [ :SElect ] ?
<b>Example</b>	FREQ:CHAN:TABL:MNTS STD FREQ:CHAN:TABL:MNTS?
Preset	STD
State Saved	Saved in instrument state.
Range	STD   AIR   HRC   IRC
Initial S/W Revision	A.02.00

### NTSC-J

If the current TV standard is NTSC-J, you can choose the appropriate channel plans in NTSC-J standard: Japan Standard Cable (Cable), apan Broadcast channels (AIR), or Japan Digital Cable (Cable Digital).

Key Path	FREQ Channel, Chan Table
Mode	DVB-T/H
<b>Remote Command</b>	[ :SENSE ] :FREQuency:CHANnel:TABLE:JNTSc [ :SElect ] CBL   AIR   DCBL [ :SENSe ] :FREQuency:CHANnel:TABLE:JNTSc [ :SElect ] ?
<b>Example</b>	FREQ:CHAN:TABL:JNTS AIR FREQ:CHAN:TABL:JNTS?
Preset	AIR
State Saved	Saved in instrument state.
Range	Cable AIR Cable Digital
Initial S/W Revision	A.02.00
Modified at S/W Revision	A.08.00

### NTSC-Brazil

If the current TV standard is NTSC-Brazil, you can choose the appropriate channel plans in NTSC-Brazil standard: NTSC-Brazil VHF or NTSC-Brazil UHF. Please refer to Appendix A for more detailed information.

Key Path	FREQ Channel, Chan Table
Mode	DVB-T/H
<b>Remote Command</b>	[ :SENSE ] :FREQuency:CHANnel:TABLE:BNTSc [ :SElect ] VHF   UHF [ :SENSe ] :FREQuency:CHANnel:TABLE:BNTSc [ :SElect ] ?
<b>Example</b>	FREQ:CHAN:TABL:BNTS VHF FREQ:CHAN:TABL:BNTS?

Preset	UHF
State Saved	Saved in instrument state.
Range	VHF UHF
Initial S/W Revision	A.06.00

## PAL-M

If the current TV standard is PAL-M, you can choose the appropriate channel plans in PAL-M standard: Standard Cable (STD), Broadcast Channel (AIR), HRC Cable (HRC) or IRC Cable (IRC).

Key Path	FREQ Channel, Chan Table
Mode	DVB-T/H
<b>Remote Command</b>	[ :SENSe ] :FREQuency:CHANnel:TABLE:MPAL[ :SElect ] STD   AIR   HRC   IRC [ :SENSe ] :FREQuency:CHANnel:TABLE:MPAL[ :SElect ] ?
<b>Example</b>	FREQ:CHAN:TABL:MPAL STD FREQ:CHAN:TABL:MPAL?
Preset	STD
State Saved	Saved in instrument state.
Range	STD   AIR   HRC   IRC
Initial S/W Revision	A.02.00

## PAL-I

If the current TV standard is PAL-I, you can choose the appropriate channel plans in PAL-I standard: HRC Cable (HRC), VHF channels (VHF) or UHF channels (UHF).

Key Path	FREQ Channel, Chan Table
Mode	DVB-T/H
<b>Remote Command</b>	[ :SENSe ] :FREQuency:CHANnel:TABLE:IPAL[ :SElect ] VHF UHF HRC [ :SENSe ] :FREQuency:CHANnel:TABLE:IPAL[ :SElect ] ?
<b>Example</b>	FREQ:CHAN:TABL:IPAL HRC FREQ:CHAN:TABL:IPAL?
Preset	HRC
State Saved	Saved in instrument state.
Range	VHF   UHF   HRC
Initial S/W Revision	A.02.00

### PAL-B/G

If the current TV standard is PAL-B/G, you can choose the appropriate channel plans in PAL-B/G standard: HRC Cable (HRC), VHF channels (VHF), UHF channels (UHF), S channels PAL-B/G Standard (S), S channels PAL-B/G Cable (S-Cable) or CENELEC channels (CENELEC).

<b>Key Path</b>	FREQ Channel, Chan Table
<b>Mode</b>	DVB-T/H
<b>Remote Command</b>	[ :SENSE ] :FREQuency:CHANnel:TABLE:BPAL [ :SElect ] VHF   UHF   HRC   S   SCBL   CEN  [ :SENSE ] :FREQuency:CHANnel:TABLE:BPAL [ :SElect ] ?
<b>Example</b>	FREQ:CHAN:TABL:BPAL HRC FREQ:CHAN:TABL:BPAL?
<b>Preset</b>	UHF
<b>State Saved</b>	Saved in instrument state.
<b>Range</b>	VHF   UHF   HRC   S   S-Cable   CENELEC
<b>Initial S/W Revision</b>	A.02.00

### PAL-D/K

If the current TV standard is PAL-D/K, you can choose the appropriate channel plans in PAL-D/K standard: China Broadcast Channels (DS) or China Standard Cable (Z).

<b>Key Path</b>	FREQ Channel, Chan Table
<b>Mode</b>	DVB-T/H
<b>Remote Command</b>	[ :SENSE ] :FREQuency:CHANnel:TABLE:DPAL [ :SElect ] DS   Z  [ :SENSE ] :FREQuency:CHANnel:TABLE:DPAL [ :SElect ] ?
<b>Example</b>	FREQ:CHAN:TABL:DPAL DS FREQ:CHAN:TABL:DPAL?
<b>Preset</b>	DS
<b>State Saved</b>	Saved in instrument state.
<b>Range</b>	DS   Z
<b>Initial S/W Revision</b>	A.02.00



## Input/Output

See "Input/Output" on page 204

## Marker

Accesses a menu that enables you to select, set up and control the markers for the current measurement. For remote-only commands associated with Marker functionality, see:

- "Marker X Axis Value (Remote Command only)" on page 1973
- "Marker X Axis Position (Remote Command only)" on page 1973
- "Marker Y Axis Value (Remote Command only)" on page 1974

Key Path	Front-panel key
Initial S/W Revision	Prior to A.02.00

### Select Marker

Displays 12 markers available for selection.

Key Path	Marker
Initial S/W Revision	Prior to A.02.00

### Marker Type

Sets the marker control mode to Normal, Delta or Off. If the selected marker is Off, pressing Marker sets it to Normal and places a single marker at the center of the display. At the same time, Marker X Axis Value appears on the Active Function area.

Key Path	Marker
Mode	All except SA and BASIC
Remote Command	:CALCulate:MONitor:MARKer[1] 2 ... 12:MODE POSITION   DELTa   OFF :CALCulate:MONitor:MARKer[1] 2 ... 12:MODE?
Example	CALC:MON:MARK:MODE POS CALC:MON:MARK:MODE?
Notes	If the selected marker is Off, pressing Marker sets it to Normal and places it at the center of the screen on the trace determined by the Marker Trace rules. At the same time, Marker X Axis Value appears on the Active Function area.  Default Active Function: the active function for the selected marker's current control mode. If the current control mode is Off, there is no active function and the active function is turned off.  Active Function Display: the marker X axis value entered in the active function area displays the marker value to its full entered precision.
Preset	OFF
State Saved	Saved in instrument state.
Range	Normal Delta Off
Initial S/W Revision	Prior to A.02.00

## Properties

Accesses a menu that enables you to select the active marker, the reference marker and the trace for the current measurement.

Key Path	Marker
Initial S/W Revision	Prior to A.02.00

## Select Marker

Displays 12 markers available for selection.

Key Path	Marker
Initial S/W Revision	Prior to A.02.00

## Relative To

Selects the desired marker. The selected marker is relative to its reference marker.

Key Path	Marker, Properties
Mode	All except SA and BASIC
<b>Remote Command</b>	:CALCulate:MONitor:MARKer[1] 2 ... 12:REFerence <integer> :CALCulate:MONitor:MARKer[1] 2 ... 12:REFerence?
<b>Example</b>	CALC:MON:MARK2:REF 1 CALC:MON:MARK2:REF?
Notes	A marker cannot be relative to itself so that choice is grayed out, and if sent from SCPI generates error -221: "Settings conflict; marker cannot be relative to itself." When queried a single value is returned (the specified marker number's relative marker).
Preset	2 3 4 5 6 7 8 9 10 11 12 1
State Saved	Saved in instrument state.
Min	1
Max	12
Initial S/W Revision	Prior to A.02.00

## Marker Trace

Assigns the specified marker to the designated trace.

Key Path	Marker, Properties
Mode	All except SA and BASIC

<b>Remote Command</b>	:CALCulate:MONitor:MARKer[1] 2 ... 12:TRACe <integer> :CALCulate:MONitor:MARKer[1] 2 ... 12:TRACe?
<b>Example</b>	CALC:MON:MARK:TRAC 1 CALC:MON:MARK:TRAC?
Preset	1
State Saved	Saved in instrument state.
Min	1
Max	3
Initial S/W Revision	Prior to A.02.00

### Couple Markers

When this function is true, moving any marker causes an equal X Axis movement of every other marker that is not Off. By “equal X Axis movement” we mean that we preserve the difference between each marker’s X Axis value (in the fundamental x-axis units of the trace that marker is on) and the X Axis value of the marker being moved (in the same fundamental x-axis units).

<b>Key Path</b>	Marker
<b>Mode</b>	All except SA and BASIC
<b>Remote Command</b>	:CALCulate:MONitor:MARKer:COUPle[:STATe] ON OFF 1 0 :CALCulate:MONitor:MARKer:COUPle[:STATe]?
<b>Example</b>	CALC:MON:MARK:COUP ON CALC:MON:MARK:COUP?
Preset	OFF
State Saved	Saved in instrument state.
Range	On Off
Initial S/W Revision	Prior to A.02.00

### All Markers Off

Turns off all markers on the current measurement.

<b>Key Path</b>	Marker
<b>Mode</b>	All except SA and BASIC
<b>Remote Command</b>	:CALCulate:MONitor:MARKer:AOff
<b>Example</b>	CALC:MON:MARK:AOff
Initial S/W Revision	Prior to A.02.00

### Marker X Axis Value (Remote Command only)

Sets the marker X Axis value in the current marker X Axis Scale unit. It has no effect if the control mode is Off, but is the SCPI equivalent of entering an X value if the control mode is Normal or Delta.

Mode	All except SA and BASIC
Remote Command	:CALCulate:MONitor:MARKer[1] 2 ... 12:X <freq> :CALCulate:MONitor:MARKer[1] 2 ... 12:X?
Example	CALC:MON:MARK3:X 0 CALC:MON:MARK3:X?
Notes	If no suffix is sent, uses the fundamental units for the current marker X Axis Scale. If a suffix is sent that does not match the current marker X Axis Scale unit, an error "Invalid suffix" is generated. The query returns the marker's absolute X Axis value if the control mode is Normal, or the offset from the marker's reference marker if the control mode is Delta. The query is returned in the fundamental units for the current marker X Axis scale: Hz for Frequency and Inverse Time, seconds for Period and Time. If the marker is Off the response is not a number.
Preset	After a preset, all markers are turned OFF, so Marker X Axis Value query returns a not a number (NAN).
State Saved	No
Min	-9.9E+37
Max	9.9E+37
Initial S/W Revision	Prior to A.02.00

### Marker X Axis Position (Remote Command only)

Sets the marker X position in trace points. It has no effect if the control mode is Off, but is the SCPI equivalent of entering a value if the control mode is Normal or Delta – except in trace points rather than X Axis Scale units. The entered value is immediately translated into the current X Axis Scale units for setting the value of the marker.

Mode	All except SA and BASIC
Remote Command	:CALCulate:MONitor:MARKer[1] 2 ... 12:X:POSition <real> :CALCulate:MONitor:MARKer[1] 2 ... 12:X:POSition?
Example	CALC:MON:MARK:X:POS 0 CALC:MON:MARK:X:POS?
Notes	The query returns the marker's absolute X Axis value in trace points if the control mode is Normal, or the offset from the marker's reference marker in trace points if the control mode is Delta. The value is returned as a real number, not an integer, corresponding to the translation from X Axis Scale units to trace points. If the marker is Off the response is not a number.
Preset	After a preset, all markers are turned OFF, so Marker X Axis Value query returns a not a number (NAN).
State Saved	No
Min	-9.9E+37

---

Max	9.9E+37
Initial S/W Revision	Prior to A.02.00

---

### Marker Y Axis Value (Remote Command only)

Returns the marker Y Axis value in the current marker.

---

Mode	All except SA and BASIC
<b>Remote Command</b>	:CALCulate:MONitor:MARKer[1] 2 ... 12:Y?
<b>Example</b>	CALC:MON:MARK11:Y?
Preset	Result dependent on markers setup and signal source
<b>Backwards Compatibility SCPI</b>	:CALCulate:MONitor:MARKer[1] 2 ... 12:FUNCTion:RESult?
Initial S/W Revision	Prior to A.02.00

---

## Marker Function

Accesses special marker functions such as marker noise, and power in a specified bandwidth or time interval.

Key Path	Front-panel key
Initial S/W Revision	Prior to A.02.00

## Select Marker

Displays 12 markers available for selection.

Key Path	Marker
Initial S/W Revision	Prior to A.02.00

## Marker Function Type

Sets the marker control function type to one of the following:

NOISe	Marker Noise
BPOWer	Band/Interval Power
BDENsity	Band Interval Density
OFF	Marker Function Off

Key Path	Marker Function
Mode	All except SA and BASIC
<b>Remote Command</b>	:CALCulate:MONitor:MARKer[1] 2 ... 12:FUNCtion NOISe   BPOWer   BDENsity   OFF :CALCulate:MONitor:MARKer[1] 2 ... 12:FUNCtion?
<b>Example</b>	CALC:MON:MARK:FUNC NOISCALC:MON:MARK:FUNC?
Preset	OFF
State Saved	Saved in instrument state.
Range	Marker Noise Band/Interval Power Band Interval Density Marker Function Off
Initial S/W Revision	Prior to A.02.00

## Band Adjust

Accesses a menu that enables you to set the frequency span width and the left and right edge, or time values, for the band or interval of the selected marker.

Key Path	Marker Function
Initial S/W Revision	Prior to A.02.00

### Band/Interval Span for Frequency Domain

Sets the width of the frequency span for the selected marker.

Key Path	Marker Function
Mode	All except SA and BASIC
<b>Remote Command</b>	:CALCulate:MONitor:MARKer[1] 2 ... 12:FUNction:BAND:SPAN <freq> :CALCulate:MONitor:MARKer[1] 2 ... 12:FUNction:BAND:SPAN?
<b>Example</b>	CALC:MON:MARK12:FUNC:BAND:SPAN 20 MHz CALC:MON:MARK12:FUNC:BAND:SPAN?
Couplings	Changing the Band/Interval Span necessarily changes the Band/Interval Left and Band/Interval Right values.
Preset	Depends on X axis range of selected Trace.
State Saved	Saved in instrument state.
Min	-9.9E+37
Max	9.9E+37
Initial S/W Revision	Prior to A.02.00

### Band/Interval Left for Frequency Domain

Sets the left edge frequency or time value for the band of the selected marker.

Key Path	Marker Function
Mode	All except SA and BASIC
<b>Remote Command</b>	:CALCulate:MONitor:MARKer[1] 2 ... 12:FUNction:BAND:LEFT <freq> :CALCulate:MONitor:MARKer[1] 2 ... 12:FUNction:BAND:LEFT?
<b>Example</b>	CALC:MON:MARK12:FUNC:BAND:LEFT 20 GHz CALC:MON:MARK12:FUNC:BAND:LEFT?
Couplings	Changing the Band/Interval Left necessarily changes the Band/Interval Span value.
Preset	Depends on X axis range of selected Trace.
State Saved	Saved in instrument state.
Min	-9.9E+37
Max	9.9E+37
Initial S/W Revision	Prior to A.02.00



## Band/Interval Right for Frequency Domain

Sets the right edge frequency or time value for the band of the selected marker.

Key Path	Marker Function
Mode	All except SA and BASIC
<b>Remote Command</b>	:CALCulate:MONitor:MARKer[1] 2 ... 12:FUNCtion:BAND:RIGHT <freq> :CALCulate:MONitor:MARKer[1] 2 ... 12:FUNCtion:BAND:RIGHT?
<b>Example</b>	CALC:MON:MARK12:FUNC:BAND:RIGH 20 GHz CALC:MON:MARK12:FUNC:BAND:RIGH?
Couplings	Changing the Band/Interval Right necessarily changes the Band/Interval Span value.
Preset	Depends on X axis range of selected Trace.
State Saved	Saved in instrument state.
Min	-9.9E+37
Max	9.9E+37
Initial S/W Revision	Prior to A.02.00

## Marker To

There is no 'Marker To' functionality supported in Monitor Spectrum. The front-panel key displays a blank menu when pressed.

---

Key Path	Front-panel key
Initial S/W Revision	Prior to A.02.00

---

## Meas

The information in this section is common to all measurements. For key and remote command information for a specific measurement, refer to the section that describes the measurement of interest.

Measurements available under the Meas key are specific to the current Mode.

When viewing Help for measurements, note the following:

**NOTE**

Operation for some keys differs between measurements. The information displayed in Help pertains to the current measurement. To see how a key operates in a different measurement, exit Help (press the Cancel Esc key), select the measurement, then reenter Help (press the Help key) and press that key.

---

Key Path	Front-panel key
Initial S/W Revision	Prior to A.02.00

---

### Remote Measurement Functions

This section contains the following topics:

"Measurement Group of Commands" on page 2166

"Current Measurement Query (Remote Command Only)" on page 2168

"Limit Test Current Results (Remote Command Only)" on page 2168

"Data Query (Remote Command Only)" on page 2168

"Calculate/Compress Trace Data Query (Remote Command Only)" on page 2169

"Calculate Peaks of Trace Data (Remote Command Only)" on page 2174

Hardware-Accelerated Fast Power Measurement (Remote Command Only)

"Format Data: Numeric Data (Remote Command Only)" on page 2175

"Format Data: Byte Order (Remote Command Only)" on page 2176

---

Initial S/W Revision	Prior to A.02.00
----------------------	------------------

---

## Measurement Group of Commands

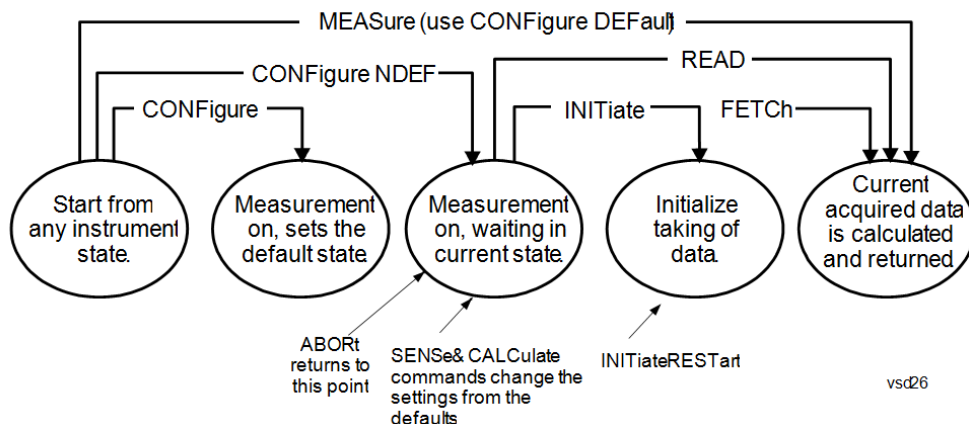

---

### Measure Commands:

:MEASure:<measurement>[n]?

This is a fast single-command way to make a measurement using the factory default instrument settings. These are the settings and units that conform to the Mode Setup settings (e.g. radio standard) that you have currently selected.

- Stops the current measurement (if any) and sets up the instrument for the specified measurement using the factory defaults
- Initiates the data acquisition for the measurement
- Blocks other SCPI communication, waiting until the measurement is complete before returning results.
- If the function does averaging, it is turned on and the number of averages is set to 10.
- After the data is valid it returns the scalar results, or the trace data, for the specified measurement. The type of data returned may be defined by an [n] value that is sent with the command.
- The scalar measurement results will be returned if the optional [n] value is not included, or is set to 1. If the [n] value is set to a value other than 1, the selected trace data results will be returned. See each command for details of what types of scalar results or trace data results are available.
- ASCII is the default format for the data output. (Older versions of Spectrum Analysis and Phase Noise mode measurements only use ASCII.) The binary data formats should be used for handling large blocks of data since they are smaller and faster than the ASCII format. Refer to the FORMat:DATA command for more information.

If you need to change some of the measurement parameters from the factory default settings you can set up the measurement with the CONFigure command. Use the commands in the SENSE:<measurement> and CALCulate:<measurement> subsystems to change the settings. Then you can use the READ? command to initiate the measurement and query the results.

If you need to repeatedly make a given measurement with settings other than the factory defaults, you can use the commands in the SENSE:<measurement> and CALCulate:<measurement> subsystems to set up the measurement. Then use the READ? command to initiate the measurement and query results.

Measurement settings persist if you initiate a different measurement and then return to a previous one. Use READ:<measurement>? if you want to use those persistent settings. If you want to go back to the default settings, use MEASure:<measurement>?.

---

### Configure Commands:

:CONFigure:<measurement>

This command stops the current measurement (if any) and sets up the instrument for the specified measurement using

---

---

the factory default instrument settings. It does not initiate the taking of measurement data unless INIT:CONTInuous is ON. If you change any measurement settings after using the CONFigure command, the READ command can be used to initiate a measurement without changing the settings back to their defaults.

In the Swept SA measurement in Spectrum Analyzer mode the CONFigure command also turns the averaging function on and sets the number of averages to 10 for all measurements.

:CONFigure: <measurement>: NDEFault stops the current measurement and changes to the specified measurement. It does not change the settings to the defaults. It does not initiate the taking of measurement data unless INIT:CONTInuous is ON.

The CONFigure? query returns the current measurement name.

The CONFigure:CATalog? query returns a quoted string of all licensed measurement names in the current mode. For example, "SAN, CHP, OBW, ACP, PST, TXP, SPUR, SEM, LIST".

---

#### Fetch Commands:

:FETCh:<measurement>[n]?

This command puts selected data from the most recent measurement into the output buffer. Use FETCh if you have already made a good measurement and you want to return several types of data (different [n] values, for example, both scalars and trace data) from a single measurement. FETCh saves you the time of re-making the measurement. You can only FETCh results from the measurement that is currently active, it will not change to a different measurement. An error message is reported if a measurement other than the current one is specified.

If you need to get new measurement data, use the READ command, which is equivalent to an INITiate followed by a FETCh.

The scalar measurement results will be returned if the optional [n] value is not included, or is set to 1. If the [n] value is set to a value other than 1, the selected trace data results will be returned. See each command for details of what types of scalar results or trace data results are available. The binary data formats should be used for handling large blocks of data since they are smaller and transfer faster than the ASCII format. (FORMat:DATA)

FETCh may be used to return results other than those specified with the original READ or MEASure command that you sent.

---

#### INITiate Commands:

:INITiate:<measurement>

This command is not available for measurements in all the instrument modes:

- Initiates a trigger cycle for the specified measurement, but does not output any data. You must then use the FETCh<meas> command to return data. If a measurement other than the current one is specified, the instrument will switch to that measurement and then initiate it.
- For example, suppose you have previously initiated the ACP measurement, but now you are running the channel power measurement. If you send INIT:ACP? it will change from channel power to ACP and will initiate an ACP measurement.
- Does not change any of the measurement settings. For example, if you have previously started the ACP measurement and you send INIT:ACP? it will initiate a new ACP measurement using the same instrument settings as the last time ACP was run.
- If your selected measurement is currently active (in the idle state) it triggers the measurement, assuming the trigger conditions are met. Then it completes one trigger cycle. Depending upon the measurement and the number of averages, there may be multiple data acquisitions, with multiple trigger events, for one full trigger cycle. It also holds off additional commands on GPIB until the acquisition is complete.

---

#### READ Commands:

:READ:<measurement>[n]?

- Does not preset the measurement to the factory default settings. For example, if you have previously initiated the ACP
-

---

measurement and you send READ:ACP? it will initiate a new measurement using the same instrument settings.

- Initiates the measurement and puts valid data into the output buffer. If a measurement other than the current one is specified, the instrument will switch to that measurement before it initiates the measurement and returns results.
  - For example, suppose you have previously initiated the ACP measurement, but now you are running the channel power measurement. Then you send READ:ACP? It will change from channel power back to ACP and, using the previous ACP settings, will initiate the measurement and return results.
  - Blocks other SCPI communication, waiting until the measurement is complete before returning the results
  - If the optional [n] value is not included, or is set to 1, the scalar measurement results will be returned. If the [n] value is set to a value other than 1, the selected trace data results will be returned. See each command for details of what types of scalar results or trace data results are available. The binary data formats should be used when handling large blocks of data since they are smaller and faster than the ASCII format. (FORMat:DATA)
- 

---

Initial S/W Revision	Prior to A.02.00
----------------------	------------------

---

### Current Measurement Query (Remote Command Only)

This command returns the name of the measurement that is currently running.

---

<b>Remote Command</b>	:CONFigure?
-----------------------	-------------

<b>Example</b>	CONF?
----------------	-------

Initial S/W Revision	Prior to A.02.00
----------------------	------------------

---

### Limit Test Current Results (Remote Command Only)

Queries the status of the current measurement limit testing. It returns a 0 if the measured results pass when compared with the current limits. It returns a 1 if the measured results fail any limit tests.

---

<b>Remote Command</b>	:CALCulate:CLIMits:FAIL?
-----------------------	--------------------------

<b>Example</b>	CALC:CLIM:FAIL? queries the current measurement to see if it fails the defined limits. Returns a 0 or 1: 0 it passes, 1 it fails.
----------------	--

Initial S/W Revision	Prior to A.02.00
----------------------	------------------

---

### Data Query (Remote Command Only)

Returns the designated measurement data for the currently selected measurement and subopcode.

n = any valid subopcode for the current measurement. See the measurement command results table for your current measurement, for information about what data is returned for the subopcodes.

This command uses the data setting specified by the FORMat:BORDER and FORMat:DATA commands and can return real or ASCII data. (See the format command descriptions under Input/Output in the Analyzer Setup section.)

<b>Remote Command</b>	:CALCulate:DATA[n]?
<b>Notes</b>	The return trace depends on the measurement. In CALCulate:<meas>:DATA[n], n is any valid subopcode for the current measurement. It returns the same data as the FETCH:<measurement>? query where <measurement> is the current measurement.
<b>Initial S/W Revision</b>	Prior to A.02.00

### Calculate/Compress Trace Data Query (Remote Command Only)

Returns compressed data for the currently selected measurement and sub-opcode [n].

n = any valid sub-opcode for that measurement. See the MEASure:<measurement>? command description of your specific measurement for information on the data that can be returned.

The data is returned in the current Y Axis Unit of the analyzer. The command is used with a sub-opcode <n> (default=1) to specify the trace. With trace queries, it is best if the analyzer is not sweeping during the query. Therefore, it is generally advisable to be in Single Sweep, or Update=Off.

This command is used to compress or decimate a long trace to extract and return only the desired data. A typical example would be to acquire N frames of GSM data and return the mean power of the first burst in each frame. The command can also be used to identify the best curve fit for the data.

<b>Remote Command</b>	:CALCulate:DATA<n>:COMPRESS? BLOCK   CFIT   MAXimum   MINimum   MEAN   DMEan   RMS   RMSCubed   SAMPLE   SDEVIation   PPHase [,<soffset> [,<length>[,<roffset>[,<rlimit>]]]]
<b>Example</b>	To query the mean power of a set of GSM bursts: Supply a signal that is a set of GSM bursts. Select the IQ Waveform measurement (in IQ Analyzer Mode). Set the sweep time to acquire at least one burst. Set the triggers such that acquisition happens at a known position relative to a burst. Then query the mean burst levels using, CALC:DATA2:COMP? MEAN, 24e-6, 526e-6 (These parameter values correspond to GSM signals, where 526e-6 is the length of the burst in the slot and you just want 1 burst.)
<b>Notes</b>	The command supports 5 parameters. Note that the last 4 (<soffset>, <length>, <roffset>, <rlimit>) are optional. But these optional parameters must be entered in the specified order. For example, if you want to specify <length>, then you must also specify <soffset>. See details below for a definition of each of these parameters. This command uses the data in the format specified by FORMat:DATA, returning either binary or ASCII data.
<b>Initial S/W Revision</b>	Prior to A.02.00

- BLOCK or block data - returns all the data points from the region of the trace data that you specify. For example, it could be used to return the data points of an input signal over several timeslots, excluding the portions of the trace data that you do not want. (This is x,y pairs for trace data and I,Q pairs for complex data.)

- CFIT or curve fit - applies curve fitting routines to the data. <soffset> and <length> are required to define the data that you want. <roffset> is an optional parameter for the desired order of the curve equation. The query will return the following values: the x-offset (in seconds) and the curve coefficients ((order + 1) values).

MIN, MAX, MEAN, DME, RMS, RMSC, SAMP, SDEV and PPH return one data value for each specified region (or <length>) of trace data, for as many regions as possible until you run out of trace data (using <roffset> to specify regions). Or they return the number of regions you specify (using <rlimit>) ignoring any data beyond that.

- MINimum - returns the minimum data point (y value) for the specified region(s) of trace data. For I/Q trace data, the minimum magnitude of the I/Q pairs is returned.
- MAXimum - returns the maximum data point (y value) for the specified region(s) of trace data. For I/Q trace data, the maximum magnitude of the I/Q pairs is returned.
- MEAN - returns a single value that is the arithmetic mean of the data point values (in dB/ dBm) for the specified region(s) of trace data. For I/Q trace data, the mean of the magnitudes of the I/Q pairs is returned. See the following equations.

•

**NOTE**

If the original trace data is in dB, this function returns the arithmetic mean of those log values, not log of the mean power which is a more useful value. The mean of the log is the better measurement technique when measuring CW signals in the presence of noise. The mean of the power, expressed in dB, is useful in power measurements such as Channel Power. To achieve the mean of the power, use the RMS option.

Equation 1

Mean Value of Data Points for Specified Region(s)

$$MEAN = \frac{1}{n} \sum_{X_i \in \text{region}(s)} X_i$$

where  $X_i$  is a data point value, and  $n$  is the number of data points in the specified region(s).

Equation 2

Mean Value of I/Q Data Pairs for Specified Region(s)

$$MEAN = \frac{1}{n} \sum_{X_i \in \text{region}(s)} |X_i|$$

where  $|X_i|$  is the magnitude of an I/Q pair, and  $n$  is the number of I/Q pairs in the specified region(s).

- DMEan - returns a single value that is the mean power (in dB/ dBm) of the data point values for the specified region(s) of trace data. See the following equation:

Equation 3

DMEan Value of Data Points for Specified Region(s)



$$\text{DME} = 10 \times \log_{10} \left( \frac{1}{n} \sum_{X_i \in \text{region}(s)} 10^{\frac{X_i}{10}} \right)$$

- RMS - returns a single value that is the average power on a root-mean-squared voltage scale (arithmetic rms) of the data point values for the specified region(s) of trace data. See the following equation.

**NOTE**

For I/Q trace data, the rms of the magnitudes of the I/Q pairs is returned. See the following equation. This function is very useful for I/Q trace data. However, if the original trace data is in dB, this function returns the rms of the log values which is not usually needed.

Equation 4

RMS Value of Data Points for Specified Region(s)

$$\text{RMS} = \sqrt{\frac{1}{n} \sum_{X_i \in \text{region}(s)} X_i^2}$$

where  $X_i$  is a data point value, and  $n$  is the number of data points in the specified region(s).

Equation 5

RMS Value of I/Q Data Pairs for Specified Region(s)

$$\text{RMS} = \sqrt{\frac{1}{n} \sum_{X_i \in \text{region}(s)} X_i X_i^*}$$

where  $X_i$  is the complex value representation of an I/Q pair,  $X_i^*$  its conjugate complex number, and  $n$  is the number of I/Q pairs in the specified region(s).

Once you have the rms value for a region of trace data (linear or I/Q), you may want to calculate the mean power. You must convert this rms value (peak volts) to power in dBm:

$$10 \times \log[10 \times (\text{rms value})^2]$$

- SAMPLe - returns the first data value (x,y pair) for the specified region(s) of trace data. For I/Q trace data, the first I/Q pair is returned.
- SDEViation - returns a single value that is the arithmetic standard deviation for the data point values for the specified region(s) of trace data. See the following equation.
- For I/Q trace data, the standard deviation of the magnitudes of the I/Q pairs is returned. See the following equation.

Equation 6

Standard Deviation of Data Point Values for Specified Region(s)

$$\text{SDEV} = \sqrt{\frac{1}{n} \sum_{X_i \in \text{region}(s)} (X_i - \bar{X})^2}$$

where  $X_i$  is a data point value,  $\bar{X}$  is the arithmetic mean of the data point values for the specified region (s), and  $n$  is the number of data points in the specified region(s).

$$\text{SDEV} = \sqrt{\frac{1}{n} \sum_{X_i \in \text{region}(s)} (|X_i| - \bar{X})^2}$$

where  $|X_i|$  is the magnitude of an I/Q pair,  $\bar{X}$  is the mean of the magnitudes for the specified region(s), and  $n$  is the number of data points in the specified region(s).

- PPHase - returns the x,y pairs of both rms power (dBm) and arithmetic mean phase (radian) for every specified region and frequency offset (Hz). The number of pairs is defined by the specified number of regions. This parameter can be used for I/Q vector ( $n=0$ ) in Waveform (time domain) measurement and all parameters are specified by data point in PPHase.

The rms power of the specified region may be expressed as:

$$\text{Power} = 10 \times \log [10 \times (\text{RMS I/Q value})] + 10.$$

The RMS I/Q value (peak volts) is:

$$\sqrt{\frac{1}{n} \sum_{X_i \in \text{region}} X_i X_i^*}$$

where  $X_i$  is the complex value representation of an I/Q pair,  $X_i^*$  its conjugate complex number, and  $n$  is the number of I/Q pairs in the specified region.

The arithmetic mean phase of the specified region may be expressed as:

$$\frac{1}{n} \sum_{Y_i \in \text{region}} Y_i$$

where  $Y_i$  is the unwrapped phase of I/Q pair with applying frequency correction and  $n$  is the number of I/Q pairs in the specified region.

The frequency correction is made by the frequency offset calculated by the arithmetic mean of every specified region's frequency offset. Each frequency offset is calculated by the least square method against the unwrapped phase of I/Q pair.

Sample Trace Data - Constant Envelope

(See below for explanation of variables.)

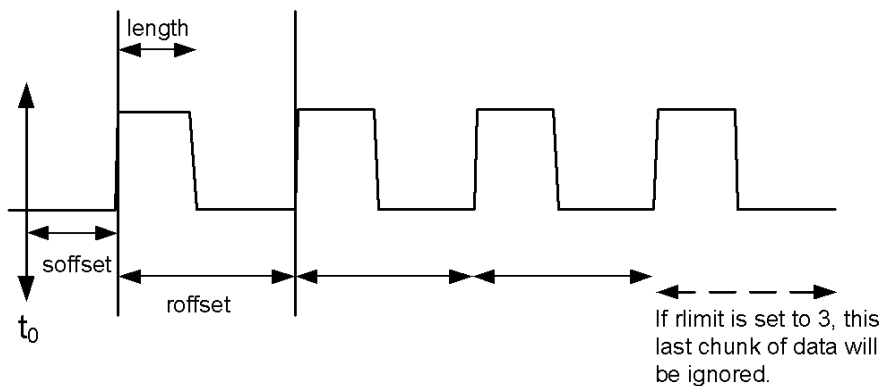

### Sample Trace Data - Not Constant Envelope

(See below for explanation of variables.)

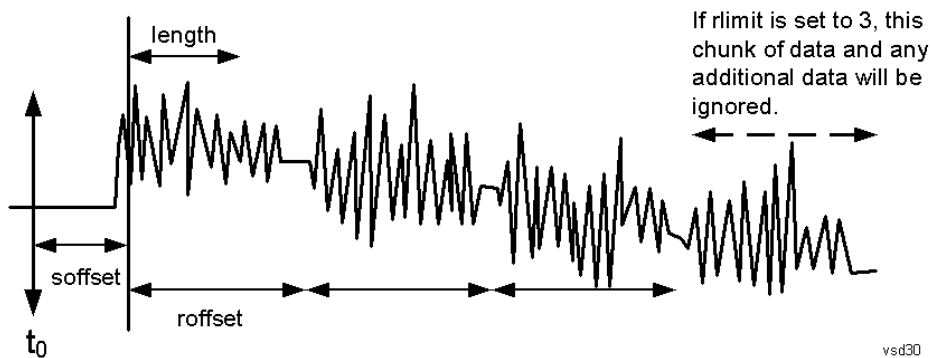

<soffset> - start offset is an optional real number. (It is in seconds for time-domain traces, and is a dimensionless index 0 to Npoints - 1, for frequency-domain traces). It specifies the amount of data at the beginning of the trace that will be ignored before the decimation process starts. It is the time or frequency change from the start of the trace to the point where you want to start using the data. The default value is zero.

<length> - is an optional real number. (It is in seconds for time-domain traces, and is a dimensionless index 0 to Npoints - 1, for frequency-domain traces). It defines how much data will be compressed into one value. This parameter has a default value equal to the current trace length.

<roffset> - repeat offset is an optional real number. (It is in seconds for time-domain traces, and is a dimensionless index 0 to Npoints - 1, for frequency-domain traces). It defines the beginning of the next field of trace elements to be compressed. This is relative to the beginning of the previous field. This parameter has a default value equal to the <length> variable. Note that this parameter is used for a completely different purpose when curve fitting (see CFIT above).

<rlimit> - repeat limit is an optional integer. It specifies the number of data items that you want returned. It will ignore any additional items beyond that number. You can use the Start offset and the Repeat limit to pick out exactly what part of the data you want to use. The default value is all the data.

## Calculate Peaks of Trace Data (Remote Command Only)

Returns a list of all the peaks for the currently selected measurement and sub-opcode [n]. The peaks must meet the requirements of the peak threshold and excursion values.

n = any valid sub-opcode for the current measurement. See the MEASure:<measurement> command description of your specific measurement for information on the data that can be returned.

The command can only be used with specific sub-opcodes with measurement results that are trace data. Both real and complex traces can be searched, but complex traces are converted to magnitude in dBm. In many measurements the sub-opcode n=0, is the raw trace data which cannot be searched for peaks. And Sub-opcode n=1, is often calculated results values which also cannot be searched for peaks.

This command uses the data setting specified by the FORMat:BORDER and FORMat:DATA commands and can return real or ASCII data. If the format is set to INT,32, it returns REAL,32 data.

The command has four types of parameters:

- Threshold (in dBm)
- Excursion (in dB)
- Sorting order (amplitude, frequency, time)
- Optional in some measurements: Display line use (all, > display line, < display line)

---

<b>Remote Command</b>	<p>For Swept SA measurement:</p> <pre>:CALCulate:DATA[1] 2 ... 6:PEAKs? &lt;threshold&gt;,&lt;excursion&gt;[,AMPLitude   FREQuency   TIME[,ALL   GTDLine   LTDLine]]</pre> <p>For most other measurements:</p> <pre>:CALCulate:DATA[1] 2 ... 6:PEAKs? &lt;threshold&gt;,&lt;excursion&gt;[,AMPLitude   FREQuency   TIME]</pre>
-----------------------	--

---

<b>Example</b>	<p>Example for Swept SA measurement in Spectrum Analyzer Mode:</p> <p>CALC:DATA4:PEAK? -40, 10, FREQ, GTDL This will identify the peaks of trace 4 that are above -40 dBm, with excursions of at least 10 dB. The peaks are returned in order of increasing frequency, starting with the lowest frequency. Only the peaks that are above the display line are returned.</p> <p>Query Results 1:</p> <p>With FORMat:DATA REAL, 32 selected, it returns a list of floating-point numbers. The first value in the list is the number of peak points that are in the following list. A peak point consists of two values: a peak amplitude followed by its corresponding frequency (or time).</p> <p>If no peaks are found the peak list will consist of only the number of peaks, (0).</p>
----------------	---

---

<b>Notes</b>	<p>&lt;n&gt; - is the trace that will be used</p> <p>&lt;threshold&gt; - is the level below which trace data peaks are ignored. Note that the threshold value is required and is always used as a peak criterion. To effectively disable the threshold criterion for this command, provide a substantially low threshold value such as -200 dBm. Also note that the threshold value used in this command is independent of and has no effect on the threshold value stored under the Peak Criteria menu.</p> <p>&lt;excursion&gt; - is the minimum amplitude variation (rise and fall) required for a signal to be identified as peak. Note that the excursion value is required and is always used as a peak criterion. To effectively disable the excursion criterion for this command, provide the minimum value of 0.0 dB. Also note that the excursion value used in this command is independent of and has no effect on the</p>
--------------	---

---

excursion value stored under the Peak Criteria menu.

Values must be provided for threshold and excursion. The sorting and display line parameters are optional (defaults are AMPLitude and ALL).

Note that there is always a Y-axis value for the display line, regardless of whether the display line state is on or off. It is the current Y-axis value of the display line which is used by this command to determine whether a peak should be reported

Sorting order:

AMPLitude - lists the peaks in order of descending amplitude, with the highest peak first (default if optional parameter not sent)

FREQUency - lists the peaks in order of occurrence, left to right across the x-axis.

TIME - lists the peaks in order of occurrence, left to right across the x-axis.

Peaks vs. Display Line:

ALL - lists all of the peaks found (default if optional parameter not sent).

GTDLine (greater than display line) - lists all of the peaks found above the display line.

LTDLine (less than display line) - lists all of the peaks found below the display line.

---

Initial S/W Revision      Prior to A.02.00

---

### Format Data: Numeric Data (Remote Command Only)

This command specifies the format of the trace data input and output. It specifies the formats used for trace data during data transfer across any remote port. It affects only the data format for setting and querying trace data for the :TRACe[:DATA], TRACe[:DATA]?, :CALCulate:DATA[n]? and FETCh:SANalyzer [n]? commands and queries.

---

**Remote Command**      :FORMat[:TRACe][:DATA] ASCii|INTeger,32|REAL,32 |REAL,64  
:FORMat[:TRACe][:DATA]?

---

**Notes**      The query response is:  
ASCii: ASC,8  
REAL,32: REAL,32  
REAL,64: REAL,64  
INTeger,32: INT,32

When the numeric data format is REAL or ASCii, data is output in the current Y Axis unit. When the data format is INTeger, data is output in units of m dBm (.001 dBm).

The INT,32 format returns binary 32-bit integer values in internal units (m dBm), in a definite length block.

---

**Dependencies**      Sending a data format spec with an invalid number (for example, INT,48) generates no error. The analyzer simply uses the default (8 for ASCii, 32 for INTeger, 32 for REAL).

Sending data to the analyzer which does not conform to the current FORMat specified, results in an error. Sending ASCII data when a definite block is expected generates message -161 "Invalid Block Data" and sending a definite block when ASCII data is expected generates message -121 "Invalid Character in Number".

---

**Preset**      ASCii

---

**Backwards Compatibility Notes**      Note that the INT,32 format is only applicable to the command, TRACe:DATA. This preserves backwards compatibility for the Swept SA measurement. For all other commands/queries which honor FORMat:DATA, if INT,32 is sent the analyzer will behave as though it were set to REAL,32.

---

Initial S/W Revision      Prior to A.02.00

---

The specs for each output type follow:

AScii - Amplitude values are in ASCII, in the current Y Axis Unit, one ASCII character per digit, values separated by commas, each value in the form:

SX.YYYYYEsZZ

Where:

S = sign (+ or -)

X = one digit to left of decimal point

Y = 5 digits to right of decimal point

E = E, exponent header

s = sign of exponent (+ or -)

ZZ = two digit exponent

REAL,32 - Binary 32-bit real values in the current Y Axis Unit, in a definite length block.

REAL,64 - Binary 64-bit real values in the current Y Axis Unit, in a definite length block.

### Format Data: Byte Order (Remote Command Only)

This command selects the binary data byte order for data transfer and other queries. It controls whether binary data is transferred in normal or swapped mode. This command affects only the byte order for setting and querying trace data for the :TRACe[:DATA], TRACe[:DATA]? , :CALCulate:DATA[n]? and FETCh:SANalyzer[n]? commands and queries.

By definition any command that says it uses FORMat:DATA uses any format supported by FORMat:DATA.

The NORMal order is a byte sequence that begins with the most significant byte (MSB) first, and ends with the least significant byte (LSB) last in the sequence: 1|2|3|4. SWAPped order is when the byte sequence begins with the LSB first, and ends with the MSB last in the sequence: 4|3|2|1.

---

<b>Remote Command</b>	:FORMat:BORDER NORMal   SWAPped
-----------------------	---------------------------------

	:FORMat:BORDER?
--	-----------------

---

<b>Preset</b>	NORMal
---------------	--------

---

<b>Initial S/W Revision</b>	Prior to A.02.00
-----------------------------	------------------

---

## Meas Setup

Displays the setup menu for the current measurement. The measurement setup parameters include the number of measurement averages used to calculate the measurement result and the averaging mode. The setup menu also includes the option to reset the measurement settings to their factory defaults.

Key Path	Front-panel key
Initial S/W Revision	Prior to A.02.00

### Avg/Hold Num

Specifies the number of measurement averages used when calculating the measurement result. The average is displayed at the end of each sweep.

After the specified number of average counts, the averaging mode (terminal control) setting determines the averaging action.

Key Path	Meas Setup
Mode	All except SA and BASIC
Remote Command	[:SENSe]:MONitor:AVERage:COUNT <integer> [:SENSe]:MONitor:AVERage:COUNT? [:SENSe]:MONitor:AVERage[:STATe] OFF ON 0 1 [:SENSe]:MONitor:AVERage[:STATe]?
Example	MON:AVER:COUN 25 MON:AVER:COUN? MON:AVER ON MON:AVER?
Preset	10 OFF
State Saved	Saved in instrument state.
Min	1
Max	1000
Initial S/W Revision	Prior to A.02.00

### Avg Mode

Toggles the average mode between exponential (Exp) and Repeat.

- **Exp**– continues measurement averaging, using the specified number of averages to compute each averaged value. The average is displayed at the end of each sweep.
- **Repeat**– causes the measurement to reset the average counter each time the specified number of averages is reached.

Key Path	Meas Setup
Mode	All except SA and BASIC
<b>Remote Command</b>	<code>[ :SENSe ] :MONitor :AVERage :TCONtrol EXPonential   REPEAT</code> <code>[ :SENSe ] :MONitor :AVERage :TCONtrol ?</code>
<b>Example</b>	MON:AVER:TCON EXP MON:AVER:TCON?
Preset	EXPonential
State Saved	Saved in instrument state.
Range	ExpRepeat
Initial S/W Revision	Prior to A.02.00

### Meas Preset

Restores all the measurement parameters to their default values.

Key Path	Meas Setup
Mode	All except SA and BASIC
<b>Remote Command</b>	<code>:CONFigure :MONitor</code>
<b>Example</b>	CONF:MON
Initial S/W Revision	Prior to A.02.00



## Mode

See "Mode" on page 298

## Mode Preset

Returns the active mode to a known state.

Mode Preset does the following for the currently active mode:

- Aborts the currently running measurement.
- Brings up the default menu for the mode, with no active function.
- Sets measurement Global settings to their preset values for the active mode only.
- Activates the default measurement.
- Brings up the default menu for the mode.
- Clears the input and output buffers.
- Sets Status Byte to 0.

Mode Preset does not:

- Cause a mode switch
- Affect mode persistent settings
- Affect system settings

See "[How-To Preset](#)" on page 1995 for more information.

<b>Key Path</b>	Front-panel key
<b>Remote Command</b>	:SYSTem:PRESet
<b>Example</b>	:SYST:PRES
<b>Notes</b>	*RST is preferred over :SYST:PRES for remote operation. *RST does a Mode Preset, as done by the :SYST:PRES command, and it sets the measurement mode to Single measurement rather than Continuous for optimal remote control throughput. Clears all pending OPC bits. The Status Byte is set to 0.
<b>Couplings</b>	A Mode Preset aborts the currently running measurement, activates the default measurement, and gets the mode to a consistent state with all of the default couplings set.
<b>Backwards Compatibility Notes</b>	In the X-Series, the legacy "Factory Preset" has been replaced with Mode Preset, which only presets the currently active mode, not the entire instrument. In the X-Series, the way to preset the entire instrument is by using System, Restore System Defaults All, which behaves essentially the same way as restore System Defaults does on ESA and PSA. There is also no "Preset Type" as there is on the PSA. There is a green Mode Preset front-panel key that does a Mode Preset and a white-with-green-letters User Preset front-panel key that does a User Preset. The old PRESet:TYPE command is ignored (without generating an error), and SYST:PRES without a parameter does a Mode Preset, which should cover most backward code compatibility issues. The settings and correction data under the Input/Output front-panel key (examples: Input Z Corr, Ext Amp Gain, etc.) are no longer part of any Mode, so they will not be preset by a Mode Preset. They are preset using Restore Input/Output Defaults, Restore System Defaults All. Note that because User Preset does a Recall State, and all of these settings are saved in State, they ARE recalled when using

	User Preset.
Initial S/W Revision	Prior to A.02.00

## How-To Preset

The table below shows all possible presets, their corresponding SCPI commands and front-panel access (key paths). Instrument settings depend on the current measurement context. Some settings are local to the current measurement, some are global (common) across all the measurements in the current mode, and some are global to all the available modes. In a similar way, restoring the settings to their preset state can be done within the different contexts.

Auto Couple - is a measurement local key. It sets all Auto/Man parameter couplings in the measurement to Auto. Any Auto/Man selection that is local to other measurements in the mode will not be affected.

Meas Preset - is a measurement local key. Meas Preset resets all the variables local to the current measurement except the persistent ones.

Mode Preset - resets all the current mode's measurement local and measurement global variables except the persistent ones.

Restore Mode Defaults - resets ALL the Mode variables (and all the Meas global and Meas local variables), including the persistent ones.

Type Of Preset	SCPI Command	Front Panel Access
Auto Couple	:COUPlE ALL	Auto Couple front-panel key
Meas Preset	:CONFIgure:<Measurement>	Meas Setup Menu
Mode Preset	:SYSTem:PRESet	Mode Preset (green key)
Restore Mode Defaults	:INSTrument:DEFault	Mode Setup Menu
Restore All Mode Defaults	:SYSTem:DEFault MODEs	System Menu; Restore System Default Menu
*RST	*RST	not possible (Mode Preset with Single)
Restore Input/Output Defaults	:SYSTem:DEFault INPut	System Menu; Restore System Default Menu
Restore Power On Defaults	:SYSTem:DEFault PON	System Menu; Restore System Default Menu
Restore Alignment Defaults	:SYSTem:DEFault ALIGn	System Menu; Restore System Default Menu
Restore Miscellaneous Defaults	:SYSTem:DEFault MISC	System Menu; Restore System Default Menu
Restore All System Defaults	:SYSTem:DEFault [ALL] :SYSTem:PRESet:PERSistent	System Menu; Restore System Default Menu
User Preset	:SYSTem:PRESet:USER	User Preset Menu
User Preset All Modes	:SYSTem:PRESet:USER:ALL	User Preset Menu

Power On Mode Preset	:SYSTem:PON:TYPE MODE	System Menu
Power On User Preset	:SYSTem:PON:TYPE USER	System Menu
Power On Last State	:SYSTem:PON:TYPE LAST	System Menu

### Preset Type (Remote Command Only)

As stated in the Backward Compatibility section, to be compatible with ESA/PSA the PRESet:TYPE command will be implemented as a no-op.

<b>Mode</b>	All
<b>Remote Command</b>	:SYSTem:PRESet:TYPE FACTory MODE USER :SYSTem:PRESet:TYPE?
<b>Example</b>	:SYST:PRESet:TYPE FACT
<b>Notes</b>	This command is supported for backward compatibility only. It is a no-op which does not change the behavior of any preset operation.
<b>Preset</b>	This is unaffected by Preset but is set to Mode on a "Restore System Defaults->All"
<b>State Saved</b>	No
<b>Initial S/W Revision</b>	Prior to A.02.00

## Mode Setup

See ["Mode Setup" on page 328](#)

## Peak Search

Places the selected marker on the trace point with the maximum y-axis value for that marker's trace. Pressing Peak Search with the selected marker off causes the selected marker to be set to Normal, then a peak search is immediately performed.

<b>Key Path</b>	Front-panel key
<b>Mode</b>	All except SA and BASIC
<b>Remote Command</b>	:CALCulate:MONitor:MARKer[1] 2 ... 12:MAXimum
<b>Example</b>	CALC:MON:MARK2:MAX
<b>Initial S/W Revision</b>	Prior to A.02.00

Print

See "Print" on page 341

## Quick Save

The Quick Save front-panel key repeats the most recent save that was performed from the Save menu, with the following exceptions:

- Register saves are not remembered as Saves for the purpose of the Quick Save function
- If the current measurement does not support the last non-register save that was performed, an informational message is generated, “File type not supported for this measurement”

Quick Save repeats the last type of qualified save (that is, a save qualified by the above criteria) in the last save directory by creating a unique filename using the Auto File Naming algorithm described below.

If Quick Save is pressed after startup and before any qualified Save has been performed, the Quick Save function performs a Screen Image save using the current settings for Screen Image saves (current theme, current directory), which then becomes the “last save” for the purpose of subsequent Quick Saves.

The Auto File Naming feature automatically generates a file name for use when saving a file. The filename consists of a prefix and suffix separated by a dot, as is standard for the Windows® file system. A default prefix exists for each of the available file types:

Type	Default Prefix	Menu
State	State_	(Save/Recall)
Trace + State	State_	(Save/Recall)
Screen	Screen_	(Save/Recall)
Amplitude Corrections	Ampcor_	(Import/Export)
Traces	Trace_	(Import/Export)
Limit Lines	LLine_	(Import/Export)
Measurement Result	MeasR_	(Import/Export)
Capture Buffer	CapBuf_	(Import/Export)

A four digit number is appended to the prefix to create a unique file name. The numbering sequence starts at 0000 within each Mode for each file type and updates incrementally to 9999, then wraps to 0000 again. It remembers where it was through a Mode Preset and when leaving and returning to the Mode. It is reset by Restore Misc Defaults and Restore System Defaults and subsequent running of the instrument application. So, for example, the first auto file name generated for State files is State\_0000.state. The next is State\_0001, and so forth.

One of the key features of Auto File Name is that we guarantee that the Auto File Name will never conflict with an existing file. The algorithm looks for the next available number. If it gets to 9999, then it looks for holes. If it find no holes, that is no more numbers are available, it gives an error.

For example, if when we get to State\_0010.state there is already a State\_0010.state file in the current directory, it advances the counter to State\_0011.state to ensure that no conflict will exist (and then it verifies that State\_0011.state also does not exist in the current directory and advances again if it does, and so forth).



If you enter a file name for a given file type, then the prefix becomes the filename you entered instead of the default prefix, followed by an underscore. The last four letters (the suffix) are the 4-digit number.

For example, if you save a measurement results file as “fred.csv”, then the next auto file name chosen for a measurement results save will be fred\_0000.csv.

**NOTE**

Although 0000 is used in the example above, the number that is used is actually the current number in the Meas Results sequence, that is, the number that would have been used if you had not entered your own file name.

**NOTE**

If the filename you entered ends with \_dddd, where d=any number, making it look just like an auto file name, then the next auto file name picks up where you left off with the suffix being dddd + 1.

Key Path	Front-panel key
Notes	No remote command for this key specifically.
Initial S/W Revision	Prior to A.02.00

## Recall

The Recall menu lets you choose what you want to recall, and where you want to recall it from. Among the types of files you can recall are **States and Traces**. In addition, an Import (Data) option lets you recall a number of data types stored in CSV files (as used by Excel and other spreadsheet programs).

The default paths for Recall are data type dependent and are the same as for the Save key.

Key Path	Front-panel key
Notes	<p>No remote command for this key specifically, but the :MMEM:LOAD command is available for specific file types. An example is :MMEM:LOAD:STATe &lt;filename&gt;.</p> <p>If you try to recall a State file for a mode that is not licensed or not available in the instrument, an error message will occur and the state will not change.</p>
Backwards Compatibility Notes	<p>In legacy analyzers, it was possible to load a state without affecting the trace data, limit lines or correction data. Similarly (since User Preset is actually loading a state), it was possible to do a User Preset without affecting the trace data, limit lines or correction data.</p> <p>In the X-Series, “state” always includes all of this data; so whenever state is loaded, all of the traces, limit lines and corrections are affected. Although this differs from previous behavior, it is desirable behavior, and should not cause adverse issues for users.</p>
Backwards Compatibility Notes	<p>Recall for the X-Series supports backward compatibility in the sense that you can recall a state file from any X-Series model number and any version of X-Series software. This is only possible if part of the recalling process goes through a limiting step after recalling the mode settings, at least for settings that may vary with version number, model number, option and license differences. If you try to recall a state file onto an instrument with less capability than what was available on the instrument during the save, the recall will ignore the state it doesn't support and it will limit the recalled setting to what it allows.</p> <p>Example: if the saved state includes preamp ON, but the recalling instrument does not have a preamp; the preamp is limited to OFF. Conversely, if you save a state without a preamp, the preamp is OFF in the state file. When this saved file is recalled on an instrument with a licensed preamp, the preamp is changed to OFF. Another example is if the saved state has center frequency set to 20 GHz, but the instrument recalling the saved state is a different model and only supports 13.5 GHz. In this case, the center frequency is limited along with any other frequency based settings. Since the center frequency can't be preserved in this case, the recall limiting tries to at least preserve span to keep the measurement setup as intact as possible.</p> <p>It may be appropriate to issue a warning if the state is limited on the recall; warnings do not go out to SCPI so this would only affect the manual user.</p> <p>Note that there is no state file compatibility outside of the X-Series. For example, you cannot recall a state file from ESA or PSA.</p>
Initial S/W Revision	Prior to A.02.00

## State

The Recall State menu lets you choose a register or file from which to recall the state.

The content of a state file includes all of the settings and data required to return the analyzer as closely as possible to the Mode it was in, with the exact settings that were in place, when the save occurred. The Mode settings in each state file include the settings that are affected by Mode Preset, as well as the

additional settings affected by Restore Mode Defaults; all of the Mode's settings. In addition, all of the settings of the Input/Output system are included, even though they are outside of the Mode's state, because they are needed to restore the complete setup. Persistent System settings (for example, GPIB address) are not affected by either a Mode Preset or Restore Mode Defaults, nor are they included in a saved State file.

Since each state file is only for one Mode, the settings for other Modes are unaffected when it is loaded. Recall State will cause a mode switch if the state being recalled is not from the current active mode.

After the recall completes, the message "File <filename> recalled" or "Recalled State Register <register number>" is displayed.

For rapid recalls, the State menu lists 16 registers that you can choose from to recall. Pressing a Register key initiates the recall. You can also select a file from which to recall.

The default path for all State Files is:

My Documents\<<mode name>\state

where <mode name> is the parameter used to select the mode with the INST:SEL command (for example, SA for the Spectrum Analyzer).

See "[More Information](#)" on page 2004.

<b>Key Path</b>	Recall
<b>Mode</b>	All
<b>Remote Command</b>	:MMEMory:LOAD:STATe <filename>
<b>Example</b>	:MMEM:LOAD:STAT "myState.state" This recalls the file myState.state on the default path
<b>Example</b>	MMEM:LOAD:STAT "MyStateFile.state" This loads the state file data (on the default file directory path) into the instrument state.
<b>Notes</b>	<p>When you pick a file to recall, the analyzer first verifies that the file is recallable in the current instrument by checking the software version and model number of the instrument. If everything matches, a full recall proceeds by aborting the currently running measurement, clearing any pending operations, and then loading the State from the saved state file. You can open state files from any mode, so recalling a State file switches to the mode that was active when the save occurred. After switching to the mode of the saved state file, mode settings and data (if any for the mode) are loaded with values from the saved file. The saved measurement of the mode becomes the newly active measurement and the data relevant to the measurement (if there is any) is recalled.</p> <p>If there is a mismatch between file version or model number or instrument version or model number, the recall function tries to recall as much as possible and returns a warning message. It may limit settings that differ based on model number, licensing or version number.</p> <p>After recalling the state, the Recall State function does the following:</p> <ul style="list-style-type: none"> <li>• Makes the saved measurement for the mode the active measurement.</li> <li>• Clears the input and output buffers.</li> <li>• Status Byte is set to 0.</li> <li>• Executes a *CLS</li> </ul> <p>If the file specified is empty an error is generated. If the specified file does not exist, another error is generated. If there is a mismatch between the file and the proper file type, an error is generated. If</p>

---

	there is a mismatch between file version or model number or instrument version or model number, a warning is displayed. Then it returns to the State menu and File Open dialog goes away. After the Recall, the analyzer exits the Recall menu and returns to the previous menu.
<b>Backwards Compatibility SCPI</b>	:MMEMory:LOAD:STATe 1,<filename> For backwards compatibility, the above syntax is supported. The "1" is simply ignored.
Initial S/W Revision	Prior to A.02.00

---

### More Information

In measurements that support saving Traces, for example, Swept SA, the Trace data is saved along with the State in the State file. When recalling the State, the Trace data is recalled as well. Traces are recalled exactly as they were stored, including the writing mode and update and display modes. If a Trace was updating and visible when the State was saved, it will come back updating and visible, and its data will be rewritten right away. When you use State to save and recall traces, any trace whose data must be preserved should be placed in View or Blank mode before saving.

The following table describes the Trace Save and Recall possibilities:

You want to recall state and one trace's data, leaving other traces unaffected.	Save Trace+State from 1 trace. Make sure that no other traces are updating (they should all be in View or Blank mode) when the save is performed.	On Recall, specify the trace you want to load the one trace's data into. This trace will load in View. All other traces' data will be unaffected, although their trace mode will be as it was when the state save was performed.
You want to recall all traces	Save Trace+State from ALL traces.	On Recall, all traces will come back in View (or Blank if they were in Blank or Background when saved)
You want all traces to load exactly as they were when saved.	Save State	On recall, all traces' mode and data will be exactly as they were when saved. Any traces that were updating will have their data immediately overwritten.

### From File...

When you press "From File", the analyzer brings up a Windows dialog and a menu entitled "File Open." This menu allows you to navigate to the various fields in the Windows dialog without using a keyboard or mouse. The Tab and Arrow keys can also be used for dialog navigation.

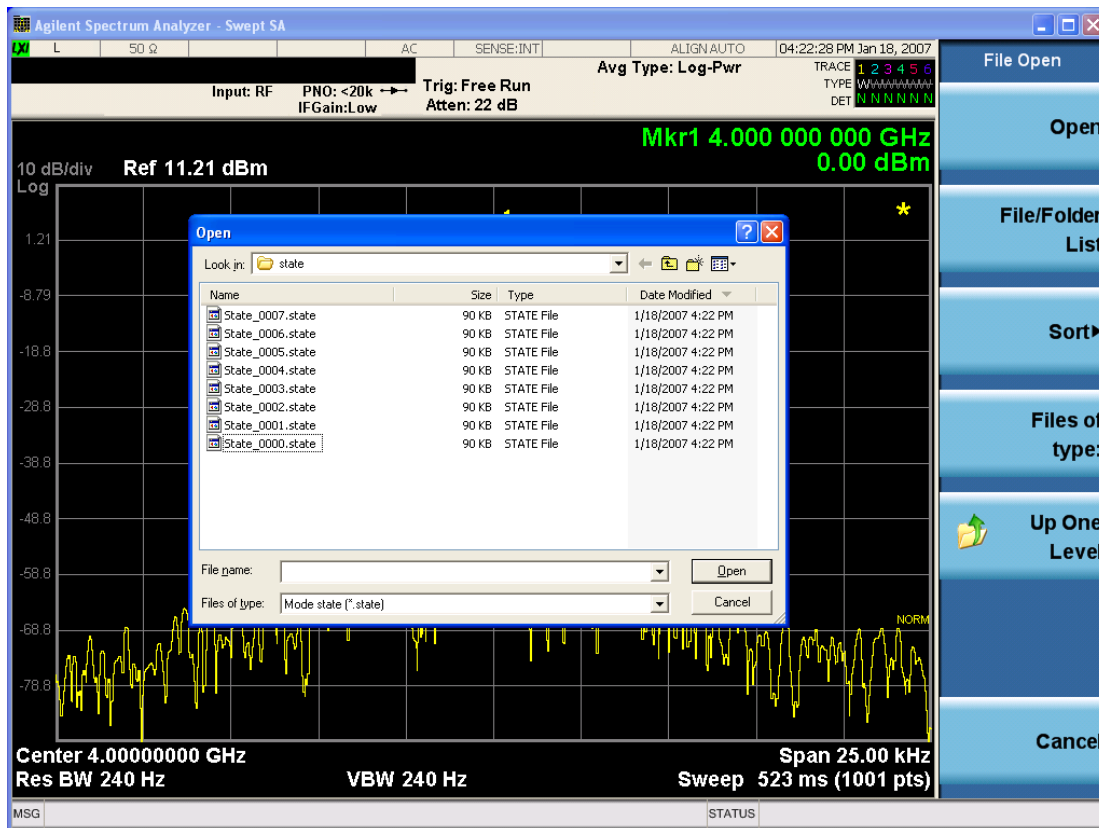

Listed below are the functions of the various fields in the dialog, and the corresponding softkeys:

#### Open

Performs the recall of the specified file. While the recall is being performed, the floppy icon appears briefly in the Meas bar.

#### File/Folder List

Enables you to navigate to the center of the dialog that contains the list of files and folders. Once here you can get information about the file and use the tab keys to navigate to the other fields in the dialog, such as Look In.

#### Look In

The Look In field shows the path from which the file will be recalled and allows you to change the path using the up and down arrow keys to navigate to other paths; the Enter key to open a directory; and the Backspace key to go back one directory. The **Look In field** first uses the last path from the Save As dialog **Save In:** path for that same file type. There is no softkey for directly navigating to the Look In field, but you can use the left tab to get here from the File/Folder List.

User specified paths are remembered when you leave and return to a Mode and are reset back to the default using Restore Mode Defaults.

#### Sort

Accesses a menu that enables you to sort the files within the File Open dialog. Only one sorting type can be selected at a time and the sorting happens immediately. The sorting types are By Date, By Name, By extension, and By Size.

#### Files of Type

This field shows the file suffix for the type of file you have selected to recall. For example, if you navigated here while recalling State, "Mode state (\*.state)" is in the field. If you navigated here while recalling Trace, ""Mode state (\*.trace)" is in the field. If you navigated here while importing a trace data file, "Trace Data (\*.csv)" is in the field. For some file types, there is more than one choice in the dropdown menu, which you can select by using the up and down arrow keys and Enter.

#### Up One Level

This key corresponds to the icon of a folder with the up arrow that is in the tool bar of the dialog. When pressed, it causes the file and folder list to navigate up one level in the directory structure. The Backspace key does the same thing.

#### Cancel

This key corresponds to the Cancel selection in the dialog. It causes the current **Open** request to be cancelled. The ESC key does the same thing.

Key Path	Recall, State
Notes	Brings up the Open dialog for recalling a State Save Type
Initial S/W Revision	Prior to A.02.00

### Edit Register Names

You may enter a custom name on any of the Register keys, to help you remember what you are using that state to save. To do this, press the Edit Register Names key, choose the register whose name you wish to edit, and then enter the desired label using the Alpha Editor or an external PC keyboard.

The maximum number of characters that can be added is 30. In most cases, 30 characters will fit on two lines of the key.

For more information and the SCPI command, see Edit Register Names under the Save, State function.

Key Path	Recall, State
Mode	All
Dependencies	N9060A-7FP or N9060B-2FP license required to edit the register names. When the feature is not licensed, sending the SCPI command generates an error, -221, "Settings conflict;Option not available"
Initial S/W Revision	A.11.00

### Register 1 thru Register 16

Selecting any one of these register keys causes the State of the mode from the specified Register to be recalled. Each of the register keys annotates whether it is empty or at what date and time it was last

modified. In addition, you can use the Edit Register Names key under Save, State to enter custom names for each register.

Registers are shared by all modes, so recalling from any one of the registers will cause a mode switch to the mode that was active when the save to the Register occurred.

Although these 16 registers are the only registers available from the front panel, there are 128 state registers available in the instrument. Registers 17–128 are only available from the SCPI interface, using the \*RCL command.

After the recall completes, the message "Register <register number> recalled" appears in the message bar. If you are in the Spectrum Analyzer Mode, and you are recalling a register that was saved in the Spectrum Analyzer Mode, then after the recall, you will still be in the Recall Register menu. If the Recall causes you to switch modes, then after the Recall, you will be in the Frequency menu.

If a requested register is empty an error is generated.

Key Path	Recall, State
<b>Example</b>	*RCL 1
Range	1–16 from front panel, 1–128 from SCPI
Readback	Date and time with seconds resolution are displayed on the key OR A custom name of up to 30 characters entered using the Save, State, Edit Register Names key OR “(empty)” if no prior save operation has been performed to this register.
Initial S/W Revision	Prior to A.02.00
Modified at S/W Revision	Prior to A.11.00

## Register 1 thru Register 16

Selecting any one of these register keys causes the State of the mode from the specified Register to be recalled. Each of the register keys annotates whether it is empty or at what date and time it was last modified. In addition, you can use the Edit Register Names key under Save, State to enter custom names for each register.

Registers are shared by all modes, so recalling from any one of the registers will cause a mode switch to the mode that was active when the save to the Register occurred.

Although these 16 registers are the only registers available from the front panel, there are 128 state registers available in the instrument. Registers 17–128 are only available from the SCPI interface, using the \*RCL command.

After the recall completes, the message "Register <register number> recalled" appears in the message bar. If you are in the Spectrum Analyzer Mode, and you are recalling a register that was saved in the Spectrum Analyzer Mode, then after the recall, you will still be in the Recall Register menu. If the Recall causes you to switch modes, then after the Recall, you will be in the Frequency menu.

If a requested register is empty an error is generated.

Key Path	Recall, State
<b>Example</b>	*RCL 1
Range	1-16 from front panel, 1-128 from SCPI
Readback	Date and time with seconds resolution are displayed on the key OR A custom name of up to 30 characters entered using the Save, State, Edit Register Names key OR “(empty)” if no prior save operation has been performed to this register.
Initial S/W Revision	Prior to A.02.00
Modified at S/W Revision	Prior to A.11.00

### Data (Import)

Importing a data file loads data that was previously saved from the current measurement or from other measurements and/or modes that produce compatible data files. The Import Menu only contains Data Types that are supported by the current measurement.

Since the commonly exported data files are in .csv format, the data can be edited by the user prior to importing. This allows you to export a data file, manipulate the data in Excel (the most common PC Application for manipulating .csv files) and then import it.

Importing Data loads measurement data from the specified file into the specified or default destination, depending on the data type selected. Selecting an Import Data menu key will not actually cause the importing to occur, since the analyzer still needs to know from where to get the data. Pressing the Open key in this menu brings up the Open dialog and Open menu that provides you with the options from where to recall the data. Once a filename has been selected or entered in the Open menu, the recall occurs as soon as the Open button is pressed.

Key Path	Recall
Mode	All
Notes	The menu is built from whatever data types are available for the mode. Some keys will be missing completely, so the key locations in the sub-menu will vary. No SCPI command directly controls the Data Type that this key controls. The Data Type is included in the MMEM:LOAD commands.
Dependencies	If a file type is not used by a certain measurement, it is grayed out for that measurement. The key for a file type will not show at all if there are no measurements in the Mode that support it.
Preset	Is not affected by Preset or shutdown, but is reset during Restore Mode Defaults
Readback	The data type that is currently selected
Initial S/W Revision	Prior to A.02.00



## Amplitude Correction

This key selects the Amplitude Corrections as the data type to be imported. When pressed a second time, it brings up the Select Menu, which lets you select the Correction into which the data will be imported.

Amplitude Corrections are fully discussed in the documentation of the Input/Output key, under the Corrections key.

A set of preloaded Corrections files can be found in the directory

/My Documents/ EMC Limits and Ampcor.

When the Amplitude Correction is an Antenna correction and the Antenna Unit in the file is not None, the Y Axis Unit setting will change to match the Antenna Unit in the file.

Key Path	Recall
Mode	SA EDGE GSM PN
Remote Command	:MMEMory:LOAD:CORRection 1 2 3 4 5 6 7 8, <filename>
Example	:MMEM:LOAD:CORR 2, "myAmpcor.csv" recalls the Amplitude Correction data from the file myAmpcor.csv in the current directory to the 2nd Amplitude Correction table, and turns on Correction 2. The default path is D:\User_My_Documents\Instrument\My Documents\amplitudeCorrections\
Dependencies	<p>Only the first correction array (Correction 1) supports antenna units. This means that a correction file with an Antenna Unit can only be loaded into the Corrections 1 register. Consequently only for Correction 1 does the dropdown in the Recall dialog include.ant, and if an attempt is made to load a correction file into any other Correction register which DOES contain an antenna unit, a Mass Storage error is generated.</p> <p>Corrections are not supported by all Measurements. If in a Mode in which some Measurements support it, this key will be grayed out in measurements that do not. The key will not show at all if no measurements in the Mode support it.</p> <p>Errors are reported if the file is empty or missing, or if the file type does not match, or if there is a mismatch between the file type and the destination data type. If any of these occur during manual operation, the analyzer returns to the Import Data menu and the File Open dialog goes away.</p> <p>This key does not appear unless you have the proper option installed in your instrument.</p> <p>This command will generate an "Option not available" error unless you have the proper option installed in your instrument.</p>
Couplings	When a correction file is loaded from mass storage, it is automatically turned on ( <b>Correction ON</b> ) and <b>ApplyCorrections</b> is set to On. This allows you to see its effect, thus confirming the load.
Readback	selected Correction
Backwards Compatibility SCPI	:MMEMory:LOAD:CORRection ANTenna   CABLe   OTHer   USER, <filename> For backwards compatibility, ANTenna maps to 1, CABLe maps to 2, OTHer maps to 3 and USER maps to 4
Initial S/W Revision	A.02.00

## Amplitude Correction

These keys let you select which Correction to import the data into. Once selected, the key returns back to the Import Data menu and the selected Correction number is annotated on the key. The next step is to select the Open key in the Import Data menu.

Antenna corrections are a particular kind of Amplitude Corrections – they are distinguished in the corrections file by having the Antenna Unit set to a value other than None. Only Correction 1 supports Antenna Units.

Key Path	Recall, Data, Amplitude Correction
Notes	auto return
Dependencies	Only Correction 1 may be used to load a Correction that contains an Antenna Unit other than None
Preset	Not part of Preset, but is reset to Correction 1 by Restore Input/Output Defaults; survives shutdown.
State Saved	The current Correction number is saved in instrument state
Initial S/W Revision	A.02.00

## Chan Table

Imports the channel table from a channel plan file. This function enables you to use your own defined channel tables by importing a modified channel table file.

Instead of creating a brand new channel plan file, you can generate a channel plan file to fit your needs using a saved channel plan file or the default channel plan file ChannelPlan.txt in the directory “My Documents\Digital Video\data\”. The saved channel plan file is obtained by pressing Save, Data, Channel Table, and then Save As...

Note that while editing the channel plan file, you cannot change the channel plan name, such as NTSC\_B.VHF, NTSC\_B.UHF, otherwise your modifications on the corresponding channel plan will not work. You can add, remove, or modify the channel numbers and center frequencies in each channel plan. The value of Start Channel and Channel Count may also need to be changed.

File Location and Extension

**File location:** “My Documents\Digital Video\data”

**File type:** text file

**File extension:** .txt

**Example:**

File Location: My Documents\Digital Video\data

File Name: ChannelPlan\_0001.txt

Key Path	Recall, Data
Mode	DVB-T/H
Remote Command	MMEMoRY:LOAD:CHTable <string>
Example	MMEM:LOAD:CHT “ChannelPlan_0001.txt”
Initial S/W Revision	A.07.00

## Capture Buffer

Capture buffer functionality is available only in Mod Accuracy measurement. The captured data is raw data which is not processed.

Key Path	Recall, Data
Mode	DVB-T/H
Example	MMEM:LOAD:CAPT "MyCaptureData.bin" This loads the file of capture data (on the default file directory path) into the instrument.
Dependencies	Capture buffer data is only available for Mod Accuracy measurement. In other measurements, this key is grayed out.
Initial S/W Revision	Prior to A.01.70

## DVB-T2 Config

Imports DVB-T2 configuration from setting files (single PLP or multiple PLPs). This key is available only in DVB-T2 Mod Accuracy measurement and will be grayed out in other measurements.

If the configuration file to be recalled is created with previous instrument S/W revision A.10.52 or before (To check the instrument S/W revision, press System, Show, System on the instrument), it doesn't have Transmission Mode and Version parameters. Then you need to set up the DVB-T2 version and transmission mode manually by pressing Mode Setup, Radio Std, DVB-T2, Version 1.1.1, and toggling Transmission Mode to SISO to select the standard version and transmission mode of the signal under test.

All the modulation parameters can be set from the setting file. These parameters include Version, Transmission Mode, Guard Interval, FFT size, Carrier Mode, Pilot Pattern, L1 Modulation Format, Data Symbols, PAPR Type, PLP Number, SubSlices Number, SubSlices Interval, PLP Modulation Format, PLP Constellation Rotation, FEC Type, Time IL Length, FEC Block Num, PLP ID, PLP Start, PLP Type and PLP Code Rate.

File Location and Extension

**File location:** "My Documents\DVB\data\EVMT2\data"

**File type:** text file

**File extension:** .csv

**Example:**

File Location: My Documents\DVB\data\EVMT2\data

File Name: DVBT2Config\_0001.csv

Key Path	Recall, Data
Mode	DVB-T/H
<b>Remote Command</b>	MMEMory:LOAD:T2Config <string>

<b>Example</b>	MMEM:LOAD:T2C "DVBT2Config_0001.csv"
<b>Dependencies</b>	This key is grayed out in all other measurements except DVB-T2 Mod Accuracy measurement.
<b>Couplings</b>	Auto Detect (Meas, DVB-T2 ModAccuracy, Meas Setup) will be changed to OFF automatically when the DVB-T2 config file is loaded.
<b>Initial S/W Revision</b>	A.07.00

### Open...

When you press "Open", the analyzer brings up a Windows dialog and a menu entitled "File Open." This menu allows you to navigate to the various fields in the Windows dialog without using a keyboard or mouse. The Tab and Arrow keys can also be used for dialog navigation.

See "[From File...](#)" on page 2201 in Recall, State, for a full description of this dialog and menu.

<b>Key Path</b>	Recall, Data
<b>Notes</b>	The key location is mode-dependent and will vary. Brings up Open dialog for recalling a <mode specific> Save Type
<b>Initial S/W Revision</b>	Prior to A.02.00

## Restart

The Restart function restarts the current sweep, or measurement, or set of averaged/held sweeps or measurements. If you are Paused, pressing Restart does a Resume.

The Restart function is accessed in several ways:

- Pressing the Restart key
- Sending the remote command INIT:IMMEDIATE
- Sending the remote command INIT:RESTART

See "[More Information](#)" on page 2013

Key Path	Front-panel key
Remote Command	:INITiate[:IMMEDIATE] :INITiate:RESTART
Example	:INIT:IMM :INIT:REST
Notes	:INITiate:RESTART and :INITiate:IMMEDIATE perform exactly the same function.
Couplings	Resets average/hold count k. For the first sweep overwrites all active (update=on) traces with new current data. For application modes, it resets other parameters as required by the measurement.
Status Bits/OPC dependencies	This is an Overlapped command. The STATUS:OPERation register bits 0 through 8 are cleared. The STATUS:QUESTIONable register bit 9 (INTEgrity sum) is cleared. The SWEEPING bit is set. The MEASURING bit is set.
Backwards Compatibility Notes	For Spectrum Analysis mode in ESA and PSA, the Restart hardkey and the INITiate:RESTART command restart trace averages (displayed average count reset to 1) for a trace in Clear Write, but did not restart Max Hold and Min Hold. In the X-Series, the Restart hardkey and the INITiate:RESTART command restart not only Trace Average, but MaxHold and MinHold traces as well. For wireless comms modes in ESA and PSA, the Restart hardkey and the INITiate:RESTART command restart every measurement, which includes all traces and numeric results. There is no change to this operation.
Initial S/W Revision	Prior to A.02.00

### More Information

The **Restart** function first aborts the current sweep/measurement as quickly as possible. It then resets the sweep and trigger systems, sets up the measurement and initiates a new data measurement sequence with a new data acquisition (sweep) taken once the trigger condition is met.

If the analyzer is in the process of aligning when **Restart** is executed, the alignment finishes before the restart function is performed.

Even when set for Single operation, multiple sweeps may be taken when Restart is pressed (for example, when averaging/holding is on). Thus when we say that **Restart** "restarts a measurement," we may mean:

- It restarts the current sweep
- It restarts the current measurement
- It restarts the current set of sweeps if any trace is in Trace Average, Max Hold or Min Hold
- It restarts the current set of measurements if Averaging, or Max Hold, or Min Hold is on for the measurement
- depending on the current settings.

With **Average/Hold Number** (in **Meas Setup** menu) set to 1, or Averaging off, or no trace in Trace Average or Hold, a single sweep is equivalent to a single measurement. A single sweep is taken after the trigger condition is met; and the analyzer stops sweeping once that sweep has completed. However, with **Average/Hold Number** >1 and at least one trace set to **Trace Average, Max Hold, or Min Hold (SA Measurement)** or **Averaging on (most other measurements)**, multiple sweeps/data acquisitions are taken for a single measurement. The trigger condition must be met prior to each sweep. The sweep is stopped when the average count  $k$  equals the number  $N$  set for **Average/Hold Number**. A measurement average usually applies to all traces, marker results, and numeric results; but sometimes it only applies to the numeric results.

Once the full set of sweeps has been taken, the analyzer will go to idle state. To take one more sweep without resetting the average count, increment the average count by 1, by pressing the step up key while **Average/Hold Number** is the active function, or sending the remote command `CALC:AVER:TCON UP`.

## Save

The Save menu lets you choose what you want to save and where you want to save it. Among the types of files you can save are **States**, **Traces**, and **Screen Images**. In addition, an Export (Data) option lets you save a number of data types as CSV files for easy import into Excel and other spreadsheet programs.

Key Path	Front-panel key
Mode	All
Notes	No remote command for this key specifically, but the :MMEM:STORe command is available for specific file types. An example is :MMEM:STOR:STATe <filename>.
Initial S/W Revision	Prior to A.02.00

## State

The Save State menu lets you choose a register or file for saving the state.

The content of a state file includes all of the settings and data required to return the analyzer as closely as possible to the Mode it was in, with the exact settings which were in place, when the save occurred. The Mode settings in each state file include the settings that are affected by Mode Preset, as well as the additional settings affected by Restore Mode Defaults; all of the Mode's settings. In addition, all of the settings of the Input/Output system are included, even though they are outside of the Mode's state, because they are needed to restore the complete setup. Persistent System settings (for example, Verbose SCPI) are not affected by either Mode Preset or Restore Mode Defaults, nor are they included in a saved State file.

After the save completes, the message "File <filename> saved" or "State Register <register number> saved" is displayed.

For rapid saving, the State menu lists 16 registers to save to. Pressing a Register key initiates the save. You can also select a file to save to.

The default path for all State Files is:

My Documents\<>mode name>\state

where <mode name> is the parameter used to select the mode with the INST:SEL command (for example, SA for the Spectrum Analyzer).

Key Path	Save
Mode	All
Remote Command	:MMEMory:STORe:STATe <filename>
Example	MMEM:STOR:STATe "MyStateFile.state" This stores the current instrument state data in the file MyStateFile.state in the default directory.
Notes	Both single and double quotes are supported for any filename parameter over remote. After saving to a register, that register's menu key is updated with the date the time, unless a custom label has been entered for that key. After saving to a register, you remain in the Save State menu, so that you can see the Register key

update. After saving to a file, the analyzer automatically returns to the previous menu and any Save As dialog goes away.

**Backwards Compatibility SCPI** :MMEMory:STORe:STATe 1,<filename>

For backwards compatibility, the above syntax is supported. The "1" is simply ignored. The command is sequential.

Initial S/W Revision Prior to A.02.00

### To File . . .

When you press “To File”, the analyzer brings up a Windows dialog and a menu entitled “Save As.” This menu allows you to navigate to the various fields in the Windows dialog without using a keyboard or mouse. The Tab and Arrow keys can also be used for dialog navigation.

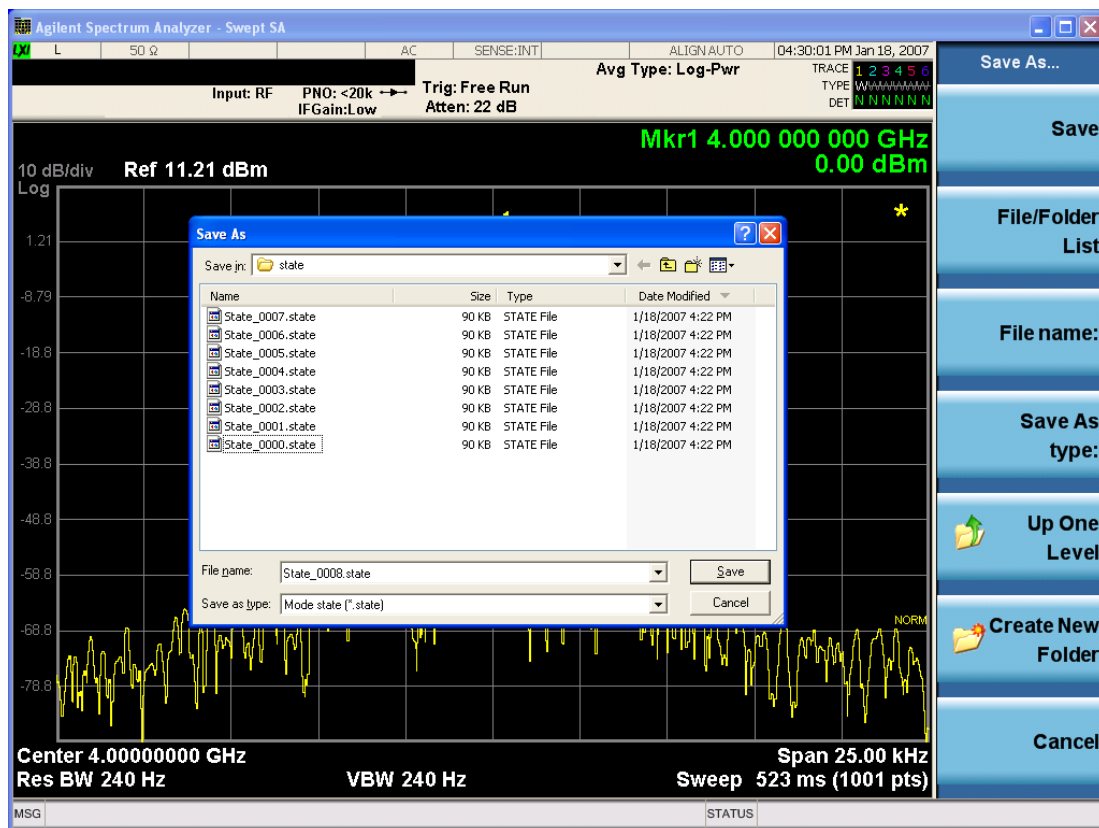

The Listed below

are the functions of the various fields in the dialog, and the corresponding softkeys:

#### Save

Performs the save to the specified file of the selected type. If the file already exists, a dialog will appear that allows you to replace the existing file by selecting OK, or you can Cancel the request. If you select OK, the file will be overwritten. Using the C: drive is strongly discouraged, since it runs the risk of being overwritten during an instrument software upgrade.

While the save is being performed, the floppy icon appears briefly in the Meas bar.



## File/Folder List

Enables you to navigate to the center of the dialog that contains the list of files and folders. Once here you can get information about the file and use the tab keys to navigate to the other fields in the dialog, such as Save In.

## Save In

The Save In field shows the path to which the file will be saved and allows you to change the path using the up and down arrow keys to navigate to other paths; the Enter key to open a directory; and the Backspace key to go back one directory. The **Save In field** defaults to the default path for this type of file and remembers the last path you used to save this type of file. There is no softkey for directly navigating to the Save In field but you can use left tab to get here from the File/Folder List.

User specified paths are remembered when you leave and return to a Mode and are reset back to the default using Restore Mode Defaults.

## File Name

The File Name field is initially loaded with an automatically generated filename specific to the appropriate Save Type. The automatically generated filename is guaranteed not to conflict with any filename currently in the directory. You may replace or modify this filename using the File Name key. See the ["Quick Save " on page 2197](#) documentation for more on the automatic file naming algorithm.

When you press the File Name key the analyzer displays the Alpha Editor. Use the knob to choose the letter to add and the front-panel Enter key to add the letter to the file name. The BK character moves you back and the FW character moves you forward in the filename. The Select key on the front panel generates a space character. When you are done entering the filename press the Done softkey. This returns back to the **File Open** dialog and menu, but does not cause the save to occur.

## Save As Type

This field shows the file suffix for the type of file you have selected to save. For example, if you navigated here while saving State, "Mode state (\*.state)" is in the field. If you navigated here from saving Trace, ""Mode state (\*.trace)" is in the field. If you navigated here while exporting a trace data file, "Trace Data (\*.csv)" is in the field. For some file types, there is more than one choice in the dropdown, which you can select by using the up and down arrow keys and Enter.

## Up One Level

This key corresponds to the icon of a folder with the up arrow that is in the tool bar of the dialog. When pressed, it causes the file and folder list to navigate up one level in the directory structure. The Backspace key does the same thing.

## Create New Folder

This key corresponds to the icon of a folder with the "\*" that is in the tool bar of the dialog. When pressed, a new folder is created in the current directory with the name **New Folder** and you can enter a new folder name using the Alpha Editor.

## Cancel

This key corresponds to the Cancel selection in the dialog. It causes the current **Save As** request to be cancelled. The ESC key does the same thing.

Key Path	Save, State
Mode	All
Notes	Brings up Save As dialog for saving a State Save Type
Initial S/W Revision	Prior to A.02.00

## Edit Register Names

You may enter a custom name on any of the Register keys, to help you remember what you are using that state to save. To do this, press the Edit Register Names key, choose the register whose name you wish to edit, and then enter the desired label using the Alpha Editor or an external PC keyboard.

The maximum number of characters that can be added is 30. In most cases, 30 characters will fit on two lines of the key.

See ["More Information" on page 2018](#)

Key Path	Save, State
Mode	All
<b>Remote Command</b>	:MMEMory:REGister:STATe:LABel <reg number>,"label" :MMEMory:REGister:STATe:LABel? <reg number>
<b>Example</b>	:MMEM:REG:STAT:LAB 1,"my label"
Notes	<reg number> is an integer from 1 to 16. If the SCPI specifies an invalid register number an error message is generated, -222,"Data out of range;Invalid register label number" "label" is a string from 0 to 30 characters in length. If a label exceeds 30 characters, an error message is generated, -150,"String data error;Label clipped to 30 characters" "label" of length 0 erases the custom label and restores the default (time and date) label. E.g.: :MMEM:REG:STAT:LAB 1,""
Dependencies	N9060A-7FP or N9060B-2FP license required to edit the register names. When the feature is not licensed, sending this command generates an error, -221,"Settings conflict;Option not available"
Preset	The names are unaffected by Preset or power cycle but are set to the default label (time and date) on a "Restore System Defaults->Misc"
Initial S/W Revision	A.11.00

## More Information

When you edit one of the register names, the time and date field will be replaced by the custom name.

If you delete all the characters in the custom name, it restores the default (time and date).

The register names are stored within the state files, but they are not part of the instrument state; that is, once you have edited a register name, loading a new state will not change that register name. Another consequence of this is that the names will be persistent through a power cycle. Also, if a named state file is transferred to another analyzer, it will bring its custom name along with it.

If you try to edit the name of an empty register, the analyzer will first save the state to have a file to put the name in. If you load a named state file into an analyzer with older firmware it will ignore the metadata.

The \*SAV and \*RCL commands will not be affected by the custom register names, nor will the MMEM commands.

### Register 1 thru Register 16

Selecting any one of these register menu keys causes the State of the currently active mode to be saved to the specified Register. The registers are provided for rapid saving and recalling, since you do not need to specify a filename or navigate to a file. Each of the register menu keys annotates whether it is empty or at what date and time it was last modified. In addition, you can use the Edit Register Names key to enter custom names for each register.

Although these 16 registers are the only registers available from the front panel, there are 128 state registers available in the instrument. Registers 17–128 are only available from the SCPI interface, using the \*SAV command.

There is one set of 128 state registers in the instrument, not one set for each Mode. When a state is saved, the Mode it was saved from is saved with it; then when it is recalled, the instrument switches to that Mode.

After the save completes, the corresponding register menu key annotation is updated with the date and time and the message "Register <register number> saved" is displayed.

Key Path	Save, State
Mode	All
<b>Example</b>	*SAV 1
Range	1–16 from front panel, 1–128 from SCPI
Readback	Date and time with seconds resolution are displayed on the key OR A custom name of up to 30 characters entered using the Edit Register Names key OR “(empty)” if no prior save operation has been performed to this register.
Initial S/W Revision	Prior to A.02.00
Modified at S/W Revision	A.11.00

### Register 1 thru Register 16

Selecting any one of these register menu keys causes the State of the currently active mode to be saved to the specified Register. The registers are provided for rapid saving and recalling, since you do not need to specify a filename or navigate to a file. Each of the register menu keys annotates whether it is empty or at what date and time it was last modified. In addition, you can use the Edit Register Names key to enter custom names for each register.

Although these 16 registers are the only registers available from the front panel, there are 128 state registers available in the instrument. Registers 17–128 are only available from the SCPI interface, using the \*SAV command.

There is one set of 128 state registers in the instrument, not one set for each Mode. When a state is saved, the Mode it was saved from is saved with it; then when it is recalled, the instrument switches to that Mode.

After the save completes, the corresponding register menu key annotation is updated with the date and time and the message "Register <register number> saved" is displayed.

Key Path	Save, State
Mode	All
Example	*SAV 1
Range	1-16 from front panel, 1-128 from SCPI
Readback	Date and time with seconds resolution are displayed on the key OR A custom name of up to 30 characters entered using the Edit Register Names key OR “(empty)” if no prior save operation has been performed to this register.
Initial S/W Revision	Prior to A.02.00
Modified at S/W Revision	A.11.00

## Data (Export)

Exporting a data file stores data from the current measurement to mass storage files. The Export Menu only contains data types that are supported by the current measurement.

Since the commonly exported data files are in .csv format, the data can be edited by you prior to importing. This allows you to export a data file, manipulate the data in Excel (the most common PC Application for manipulating .csv files) and then import it.

Selecting an Export Data menu key will not actually cause the exporting to occur, since the analyzer still needs to know where you wish to save the data. Pressing the Save As key in this menu brings up the Save As dialog and Save As menu that allows you to specify the destination file and directory. Once a filename has been selected or entered in the Open menu, the export will occur as soon as the Save key is pressed.

Key Path	Save
Mode	All
Notes	The menu is built from whatever data types are available for the mode. So the key locations in the sub menu will vary.  No SCPI command directly controls the Data Type that this key controls. The Data Type is included in the MMEM:STORe commands.
Dependencies	If a file type is not used by a certain measurement, that type is grayed out for that measurement. The key for a file type will not show at all if there are no measurements in the Mode that support it.
Preset	Is not affected by a Preset or shutdown, but is reset during Restore Mode Defaults
Readback	The data type that is currently selected
Initial S/W Revision	Prior to A.02.00

## Amplitude Correction

Pressing this key selects **Amplitude Corrections** as the data type to be exported. Pressing this key again brings up the Select Menu, which allows the user to select which **Amplitude Correction** to save.

Amplitude Corrections are fully discussed in the documentation of the Input/Output key, under the Corrections softkey.

See "[Correction Data File](#)" on page 2021

Key Path	Save
<b>Remote Command</b>	:MMEMory:STORe:CORRection 1 2 3 4 5 6, <filename>
<b>Example</b>	:MMEM:STOR:CORR 2 "myAmpcor.csv" saves Correction 2 to the file myAmpcor.csv on the current path. The default path is My Documents\amplitudeCorrections.
Notes	If the save is initiated via SCPI, and the file already exists, the file will be overwritten. Using the C: drive is strongly discouraged, since it runs the risk of being overwritten during an instrument software upgrade. Both single and double quotes are supported for any filename parameter over SCPI.
Dependencies	Corrections are not supported by all Measurements. If in a Mode in which some Measurements support it, this key will be grayed out in measurements that do not. The key will not show at all if no measurements in the Mode support it. This key will not appear unless you have the proper option installed in your instrument.
Readback	Selected Correction
<b>Backwards Compatibility SCPI</b>	:MMEMory:STORe:CORRection ANTenna   CABLe   OTHer   USER, <filename> For backwards compatibility, ANTenna maps to 1, CABLe maps to 2, OTHer maps to 3 and USER maps to 4
Initial S/W Revision	A.02.00

## Correction Data File

A Corrections Data File contains a copy of one of the analyzer correction tables. Corrections provide a way to adjust the trace display for predetermined gain curves (such as for cable loss).

Corrections files are text files in .csv (comma separated values) form, to make them importable into Excel or other spreadsheet programs. The format for Corrections files is as follows.

Line #	Type of field	Example	Notes
1	File type, must be "Amplitude Correction"	Amplitude Correction	May not be omitted
2	File Description (in quotes)	"Correction Factors for 11966E"	60 characters max; may be empty but may not be omitted. If exceeds 60 characters, error -233 Too much data reported
3	Comment (in quotes)	"Class B Radiated"	60 characters max; may be empty but

Line #	Type of field	Example	Notes
			may not be omitted. . If exceeds 60 characters, error -233 Too much data reported
4	Instrument Version, Model #	A.02.06,N9020A	May be empty but may not be omitted
5	Option List, File Format Version	K03 LFE EXM ,01	May be empty but may not be omitted
6	Freq Unit to be used for all frequency values in the file	Frequency Unit,MHz	assumed to be Hz if omitted
7	Antenna Unit	Antenna Unit,None	If omitted leaves the Antenna unit unchanged. The amplitude unit in the Antenna Unit field is a conversion factor that is used to adjust the Y Axis Units of the current mode, if the mode supports Antenna Units. For more details on antenna correction data, refer to the Input/Output,Corrections key description. Allowable values: dBuV/m, dBuA/m, dBG, dBpT, None
8	Freq Interpolation	Frequency Interpolation,Linear	if omitted leaves the Freq Interpolation unchanged. Allowable values: Linear, Logarithmic
9	Bias value in mA	Bias,0.00	If omitted leaves the Bias value unchanged (added as of A.08.50)
10	Bias State	Bias State,On	If omitted leaves the Bias State unchanged. Allowable values: On, Off (added as of A.08.50)
11	Overlap, two values, Freq1 and Freq2, separated by commas.	Overlap,33500,40000	Uses Freq Unit from line 6. Thus, in this example Freq1=33.5 GHz, Freq2= 40.0 GHz (see note below). If omitted leaves the overlap unchanged (added as of A.08.50)
12	DATA marker	DATA	Corrections data begins in the next line

Lines 2 through 5 can be empty but must appear in the file. Lines 6 through 11 are optional, the lines can be left out of the file altogether.

The Overlap row and the two Bias rows apply only to external mixing. Both are read-only, they are never written by the analyzer. The only way to insert or modify these rows is to edit the file with a text editor or a spreadsheet editor. These rows are intended for use by mixer manufacturers, as they allow the manufacturer to insert data about how the mixer corrections were generated and how they should be applied. The Bias rows allow you to specify whether to turn Bias on or off when the Correction is turned on and to specify a Bias value (turning off the Correction does not change the Bias, but turning it back on again sets it to the value specified in the file). The Overlap row allows you to specify an overlap region in which

two different corrections may be applied. It is expected that in the corrections data itself, there will be TWO corrections values exactly at Max Freq, otherwise Overlap is ignored. The way the overlap is processed is as follows: if at any given time the current analyzer Start Freq is greater than Freq 1 and lower than Freq 2, and the current Stop Freq is greater than Freq 2, extend the first correction point at or above Freq 2 down to Freq 1, rather than using the correction data between Freq1 and Freq2.

The Antenna Unit row can only be used in Correction register 1, because there can only be one setting for Antenna Unit at any given time. If a Correction whose Antenna Unit is set to anything but None is loaded into any Correction register but 1, an error is generated (Mass storage error; Can only load an Antenna Unit into Correction 1). When a correction file is saved from any Correction register but 1, Antenna Unit is always written as None.

Similarly, the Bias rows can only be used in Correction register 1, because there can only be one setting for Bias at any given time. If a Correction file with a Bias or Bias State row is loaded into any Correction register but 1, an error is generated: Mass storage error; Can only load Bias Settings into Correction 1

The data follows the DATA row, as comma separated X, Y pairs; one pair per line.

For example, suppose you have an Antenna to correct for on an N9020A version A.02.06 and the correction data is:

- 0 dB at 200 MHz
- 17 dB at 210 MHz
- 14.8 dB at 225 MHz

Then the file will look like:

- Amplitude Correction
- "Correction Factors for 11966E"
- "Class B Radiated"
- A.02.06,N9020A
- P13 EA3 UK6,01
- Frequency Unit,MHz
- Antenna Unit,dBuV/m
- Frequency Interpolation,Linear
- DATA
- 200.000000,0.00
- 210.000000,17.00
- 225.000000,14.80

The choices for the 1 of N fields in the metadata are as follows:

- Frequency Unit: Hz, kHz, MHz, GHz
- Antenna Unit: dBuv/m, dBuA/m, dBG, dBpT, None

- Frequency Interpolation: Logarithmic, Linear

### Amplitude Correction

These keys let you choose which Correction to save. Once selected, the key returns back to the Export Data menu and the selected Correction number is annotated on the key.

The next step in the Save process is to select the Save As key in the Export Data menu.

Key Path	Save, Data, Amplitude Correction
Preset	Not part of a Preset, but is reset to Correction 1 by Restore Input/Output Defaults. Survives a shutdown.
Readback	1
Initial S/W Revision	A.02.00

### Chan Table

Exports the current channel table to a channel table file.

The exported channel table file can be edited to meet your requirements, and then imported by pressing Recall, Data, Channel Table, and then Open...

Note that while editing the channel plan file, you can't change the channel plan name, such as NTSC\_B.VHF, NTSC\_B.UHF, otherwise your modifications on the corresponding channel plan will not work. You can add, remove, or modify the channel numbers and center frequencies in each channel plan. The value of Start Channel and Channel Count may also need to be changed.

File Location and Extension

**File location:** "My Documents\Digital Video\data"

**File type:** text file

**File extension:** .txt

**Example:**

File Location: My Documents\Digital Video\data

File Name: ChannelPlan\_0001.txt

Key Path	Save, Data
Mode	DVB-T/H
Remote Command	MMEMory:STORe:CHTable <string>
Example	MMEM:STOR:CHT "ChannelPlan_0001.txt"
Initial S/W Revision	A.07.00



## Measurement Results

Different types of results are available for each particular measurement. The results that are available are documented under the individual measurements. These measurement results are the same as the results that are returned when using the MEASure:<measurement> command (usually for sub-opcode 1).

Key Path	Save, Data
Mode	DVB-T/H
Example	MMEM:STOR:RES "MyResultsFile.xml" This stores the measurement results data in the file MyResultsFile.xml in the default directory.
Initial S/W Revision	Prior to A.01.70

## Capture Buffer

Capture buffer functionality is available only in Mod Accuracy measurement. The captured data is raw data which is not processed.

Key Path	Save, Data
Mode	DVB-T/H
Example	MMEM:STOR:CAPT "MyCaptureData.bin" This stores the capture data in the file MyCaptureData.bin in the default directory.
Dependencies	Capture buffer functionality is only available for Mod Accuracy measurement. In other measurements, this key is grayed out.
Initial S/W Revision	Prior to A.01.70

## DVB-T2 Config

Exports the current DVB-T2 configuration to a file (single PLP or multiple PLPs). This key is available only in DVB-T2 Mod Accuracy measurement and will be grayed out in other measurements.

You can view the exported file for the format of the DVB-T2 configuration files and create your own DVB-T2 configuration file by modifying the exported file.

File Location and Extension

**File location:** "My Documents\DVB\data\EVMT2\data"

**File type:** text file

**File extension:** .csv

**Example:**

File Location: My Documents\DVB\data\EVMT2\data

File Name: DVBT2Config\_0001.csv

Key Path	Save, Data
----------	------------

Mode	DVB-T/H
Remote Command	MMEMoRY:STORe:T2Config <string>
Example	MMEM:STOR:T2C "DVBT2Config_0001.csv"
Dependencies	This key is grayed out in all the other measurements except DVB-T2 Mod Accuracy measurement.
Initial S/W Revision	A.07.00

## Save As . . .

When you press "Save As", the analyzer brings up a Windows dialog and a menu entitled "**Save As.**" This menu allows you to navigate to the various fields in the Windows dialog without using a keyboard or mouse. The Tab and Arrow keys can also be used for dialog navigation.

See "[To File . . .](#)" on page 2213 in Save, State for a full description of this dialog and menu.

The default path for saving files is:

For all of the Trace Data Files:

My Documents\<<mode name>\data\traces

For all of the Limit Data Files:

My Documents\<<mode name>\data\limits

For all of the Measurement Results Data Files:

My Documents\<<mode name>\data\<<measurement name>\results

For all of the Capture Buffer Data Files:

My Documents\<<mode name>\data\captureBuffer

Key Path	Save, Data
Mode	All
Notes	The key location is mode-dependent and will vary. Brings up the Save As dialog for saving a <mode specific> Save Type. The save is performed immediately and does not wait until the measurement is complete.
Initial S/W Revision	Prior to A.02.00

## Screen Image

Pressing Screen Image accesses a menu of functions that enable you to specify a format and location for the saved screen image. It brings up a menu that allows you to specify the color scheme of the Screen Image (Themes) or navigate to the Save As dialog to perform the actual save.

Screen Image files contain an exact representation of the analyzer display. They cannot be loaded back onto the analyzer, but they can be loaded into your PC for use in many popular applications.

The image to be saved is actually captured when the Save front panel key is pressed, and kept in temporary storage to be used if you ask for a Screen Image save. When the Screen Image key is pressed, a "thumbnail" of the captured image is displayed, as shown below:

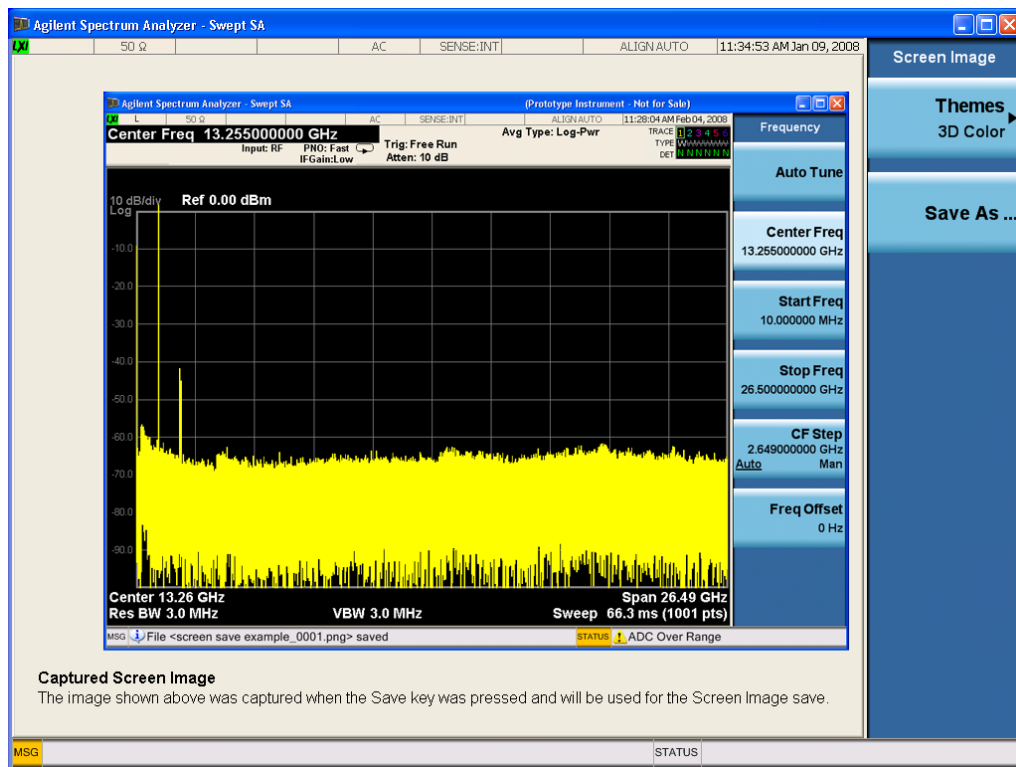

When you continue on into the Save As menu and complete the Screen Image save, the image depicted in the thumbnail is the one that gets saved, showing the menus that were on the screen before going into the Save menu. The save is performed immediately and does not wait until the measurement is complete.

After you have completed the save, the Quick Save front-panel key lets you quickly repeat the last save performed, using an auto-named file, with the current screen data.

**NOTE**

For versions previous to A.01.55, if you initiate a screen image save by navigating through the Save menus, the image that is saved will contain the Save menu softkeys, not the menus and the active function that were on the screen when you first pressed the Save front panel key.

Key Path	Save
Mode	All
Remote Command	:MMEMory:STORe:SCReen <filename>
Example	:MMEM:STOR:SCR "myScreen.png" This stores the current screen image in the file MyScreenFile.png in the default directory.
Initial S/W Revision	Prior to A.02.00

## Themes

Accesses a menu of functions that enable you to choose the theme to be used when saving the screen image.

The **Themes** option is the same as the **Themes** option under the **Display** and **Page Setup** dialogs. It allows you to choose between themes to be used when saving the screen image.

<b>Key Path</b>	Save, Screen Image
<b>Remote Command</b>	:MMEMory:STORe:SCReen:THEMe TDColor   TDMonochrome   FCOLor   FMONochrome  :MMEMory:STORe:SCReen:THEMe?
<b>Example</b>	:MMEM:STOR:SCR:THEM TDM
<b>Preset</b>	3D Color; Is not part of Preset, but is reset by Restore Misc Defaults or Restore System Defaults All and survives subsequent running of the modes.
<b>Readback</b>	3D Color   3D Mono   Flat Color   Flat Mono
<b>Backwards Compatibility Notes</b>	In ESA and PSA we offer the choice of "Reverse Bitmap" or "Reverse Metafile" when saving screen images. This is much like the "Flat Color" theme available in X-Series. Also, if you selected Reverse Bitmap AND a black & white screen image, that would be much like "Flat Monochrome". In other words, each of the X-Series themes has a similar screen image type in ESA/PSA. But they are not identical.
<b>Initial S/W Revision</b>	Prior to A.02.00

### 3D Color

Selects a standard color theme with each object filled, shaded and colored as designed.

<b>Key Path</b>	Save, Screen Image, Themes
<b>Example</b>	MMEM:STOR:SCR:THEM TDC
<b>Readback</b>	3D Color
<b>Initial S/W Revision</b>	Prior to A.02.00

### 3D Monochrome

Selects a format that is like 3D color but shades of gray are used instead of colors.

<b>Key Path</b>	Save, Screen Image, Themes
<b>Example</b>	MMEM:STOR:SCR:THEM TDM
<b>Readback</b>	3D Mono
<b>Initial S/W Revision</b>	Prior to A.02.00

### Flat Color

Selects a format that is best when the screen is to be printed on an ink printer.

Key Path	Save, Screen Image, Themes
<b>Example</b>	MMEM:STOR:SCR:THEM FCOL
Readback	Flat Color
Initial S/W Revision	Prior to A.02.00

### Flat Monochrome

Selects a format that is like Flat Color. But only black is used (no colors, not even gray), and no fill.

Key Path	Save, Screen Image, Themes
<b>Example</b>	MMEM:STOR:SCR:THEM FMON
Readback	Flat Mono
Initial S/W Revision	Prior to A.02.00

### Save As...

When you press "Save As", the analyzer brings up a Windows dialog and a menu entitled "**Save As.**" This menu allows you to navigate to the various fields in the Windows dialog without using a keyboard or mouse. The Tab and Arrow keys can also be used for dialog navigation.

See "[To File . . .](#)" on page 2213 in Save, State for a full description of this dialog and menu.

The default path for Screen Images is

My Documents\`<mode name>`\screen.

where `<mode name>` is the parameter used to select the mode with the INST:SEL command (for example, SA for the Spectrum Analyzer).

Key Path	Save, Screen Image
Notes	Brings up Save As dialog for saving a Screen Image Save Type
Initial S/W Revision	Prior to A.02.00

### Mass Storage Catalog (Remote Command Only)

Key path	SCPI Only
<b>Remote Command</b>	:MMEMory:CATalog? [ <code>&lt;directory_name&gt;</code> ]
Notes	<p>The string must be a valid logical path.</p> <p>Queries disk usage information (drive capacity, free space available) and obtains a list of files and directories in a specified directory in the following format:</p> <p><code>&lt;numeric_value&gt;,&lt;numeric_value&gt;,{&lt;file_entry&gt;}</code></p> <p>It returns two numeric parameters and as many strings as there are files and directories. The first</p>

parameter indicates the total amount of storage currently used in bytes. The second parameter indicates the total amount of storage available, also in bytes. The <file\_entry> is a string. Each <file\_entry> indicates the name, type, and size of one file in the directory list:

<file\_name>,<file\_type>,<file\_size>

As the windows file system has an extension that indicates file type, <file\_type> is always empty. <file\_size> provides the size of the file in bytes. For directories, <file\_entry> is surrounded by square brackets and both <file\_type> and <file\_size> are empty

---

Initial S/W Revision      Prior to A.02.00

---

### Mass Storage Change Directory (Remote Command Only)

---

Key path                      SCPI Only

**Remote Command**        :MMEMory:CDIRectory [<directory\_name>]  
                                 :MMEMory:CDIRectory?

**Notes**                      The string must be a valid logical path.  
  
Changes the default directory for a mass memory file system. The <directory\_name> parameter is a string. If no parameter is specified, the directory is set to the \*RST value.  
  
At \*RST, this value is set to the default user data storage area, that is defined as System.Environment.SpecialFolder.Personal.  
  
Query returns full path of the default directory.

---

Initial S/W Revision      Prior to A.02.00

---

### Mass Storage Copy (Remote Command Only)

---

Key path                      SCPI Only

**Remote Command**        :MMEMory:COPY <string>,<string>[,<string>,<string>]

**Notes**                      The string must be a valid logical path.  
  
Copies an existing file to a new file or an existing directory to a new directory.  
  
Two forms of parameters are allowed. The first form has two parameters. In this form, the first parameter specifies the source, and the second parameter specifies the destination.  
  
The second form has four parameters. In this form, the first and third parameters specify the source. The second and fourth parameters specify the directories. The first pair of parameters specifies the source. The second pair specifies the destination. An error is generated if the source doesn't exist or the destination file already exists.  
  
This command will generate an "access denied" error if the destination is a restricted folder (e.g., C:\Windows) and the current user does not have Power User or Administrator privileges.

### Mass Storage Device Copy (Remote Command Only)

This command transfers data to/from a file and a peripheral device.

Key path	SCPI Only
<b>Remote Command</b>	:MMEMory:COpy:DEvice <source_string>,<dest_string>
Notes	<p>The strings must be a valid logical path or a valid device keyword. If the dest_string is a device keyword, the data is copied from the source file to the device. If the source_string is a device keyword, the data is copied to the source file from the device.</p> <p>Valid device keywords are:            SNS (smart noise source)</p> <p>An error is generated if the file or device is not found.</p>

### Mass Storage Delete (Remote Command Only)

Key path	SCPI Only
<b>Remote Command</b>	:MMEMory:DElete <file_name>[,<directory_name>]
Notes	<p>The string must be a valid logical path.</p> <p>Removes a file from the specified directory. The &lt;file_name&gt; parameter specifies the file name to be removed. This command will generate an “access denied” error if the file is in a restricted folder (e.g., C:\Windows) and the current user does not have Power User or Administrator privileges.</p>
Initial S/W Revision	Prior to A.02.00

### Mass Storage Data (Remote Command Only)

Creates a file containing the specified data OR queries the data from an existing file.

Key path	SCPI Only
<b>Remote Command</b>	:MMEMory:DATA <file_name>, <data> :MMEMory:DATA? <file_name>
Notes	<p>The string must be a valid logical path.</p> <p>The command form is MMEMory:DATA &lt;file_name&gt;,&lt;data&gt;. It loads &lt;data&gt; into the file &lt;file_name&gt;. &lt;data&gt; is in 488.2 block format. &lt;file_name&gt; is string data.</p> <p>The query form is MMEMory:DATA? &lt;file_name&gt; with the response being the associated &lt;data&gt; in block format.</p>
Initial S/W Revision	Prior to A.02.00

### Mass Storage Make Directory (Remote Command Only)

Key path	SCPI Only
<b>Remote Command</b>	:MMEMory:MDIRectory <directory_name>
Notes	<p>The string must be a valid logical path.</p> <p>Creates a new directory. The &lt;directory_name&gt; parameter specifies the name to be created.</p>

---

	This command will generate an “access denied” error if the new directory would be in a restricted folder (e.g., C:\Windows) and the current user does not have Power User or Administrator privileges.
Initial S/W Revision	Prior to A.02.00

---

### Mass Storage Move (Remote Command Only)

---

Key path	SCPI Only
<b>Remote Command</b>	:MMEMory:MOVE <string>,<string>[,<string>,<string>]
Notes	<p>The string must be a valid logical path.</p> <p>Moves an existing file to a new file or an existing directory to a new directory.</p> <p>Two forms of parameters are allowed. The first form has two parameters. In this form, the first parameter specifies the source, and the second parameter specifies the destination.</p> <p>The second form has four parameters. In this form, the first and third parameters specify the source. The second and fourth parameters specify the directories. The first pair of parameters specifies the source. The second pair specifies the destination. An error is generated if the source doesn't exist or the destination file already exists.</p> <p>This command will generate an “access denied” error if the destination is a restricted folder (e.g., C:\Windows) and the current user does not have Power User or Administrator privileges.</p>
Initial S/W Revision	Prior to A.02.00

---

### Mass Storage Remove Directory (Remote Command Only)

---

Key path	SCPI Only
<b>Remote Command</b>	:MMEMory:RDIRECTory <directory_name>
Notes	<p>The string must be a valid logical path.</p> <p>Removes a directory. The &lt;directory_name&gt; parameter specifies the directory name to be removed. All files and directories under the specified directory shall also be removed.</p> <p>This command will generate an “access denied” error if the folder is a restricted folder (e.g., C:\Windows) or is in a restricted folder and the current user does not have Power User or Administrator privileges.</p>
Initial S/W Revision	Prior to A.02.00

---



## Single (Single Measurement/Sweep)

Sets the analyzer for Single measurement operation. The single/continuous state is Meas Global, so the setting will affect all the measurements. If you are Paused, pressing Single does a Resume.

See "[More Information](#)" on page 2033

Key Path	Front-panel key
Example	:INIT:CONT OFF
Notes	See Cont key description.
Backwards Compatibility Notes	<p>For Spectrum Analysis mode in ESA and PSA, the Single hardkey and the INITiate:IMM switched from continuous measurement to single measurement and restarted sweeps and averages (displayed average count reset to 1), but did not restart Max Hold and Min Hold. In the X-Series, the Single hardkey and the INITiate:IMM command initiate a sweep/ measurement/ average sequence/hold sequence including MaxHold and MinHold.</p> <p>For Spectrum Analysis mode in ESA and PSA, the Single hardkey restarted the sweep regardless of whether or not you were in an active sweep or sweep sequence. In the X-Series, Restart does this but Single only restarts the sweep or sweep sequence if you are in the idle state.</p> <p>INIT[:IMM] in ESA &amp; PSA Spectrum Analysis Mode does an implied ABORT. In some other PSA Modes, INIT[:IMM] is ignored if not in the idle state. . The X-Series follows the ESA/PSA SA Mode model, which may cause some Modes to have compatibility problems.</p>
Initial S/W Revision	Prior to A.02.00

### More Information

See "[Restart](#)" on page 2210 for details on the INIT:IMMEDIATE (Restart) function.

If you are already in single sweep, the INIT:CONT OFF command has no effect.

If you are already in Single Sweep, then pressing the Single key in the middle of a sweep does not restart the sweep or sequence. Similarly, pressing the Single key does not restart the sweep or sequence if the sweep is not in the idle state (for example, if you are taking a very slow sweep, or the analyzer is waiting for a trigger). Instead, it results in a message. "Already in Single, press Restart to initiate a new sweep or sequence". Even though pressing the Single key in the middle of a sweep does not restart the sweep, sending INIT:IMMEDIATE does reset it.

To take one more sweep without resetting the average count, increment the average count by 1, by pressing the step up key while **Average/Hold Number** is the active function, or sending the remote command CALC:AVER:TCON UP.

## Source

There is no Source control functionality for this measurement. When this key is pressed, the screen either displays a blank menu, or the previously-selected menu remains unchanged.

---

Key Path	Front-panel key
----------	-----------------

---

## Span X Scale

Accesses a menu of functions that enable you to set the horizontal scale parameters.

Key Path	Front-panel key
Initial S/W Revision	Prior to A.02.00

### Span

Changes the frequency range symmetrically about the center frequency.

For details of WiDEN preset values, see ["IDEN Mode Span Preset for Monitor Spectrum" on page 2036](#).

Key Path	Span X Scale
Mode	All except SA, BASIC
<b>Remote Command</b>	[ :SENSe ] :MONitor:FREQuency:SPAN <freq> [ :SENSe ] :MONitor:FREQuency:SPAN?
<b>Example</b>	MON:FREQ:SPAN 1 MHz MON:FREQ:SPAN?
Couplings	Changing the span causes the resolution bandwidth to change automatically, and affects data acquisition time.
Preset	WCDMA: 10.0 MHz WIMAX OFDMA: 50.0 MHz C2K: 2.5MHz PN: 1.0 MHz GSM/EDGE: 1.0 MHz TD-SCDMA: 3.2 MHz 1xEVDO: 2.0MHz DVB-T/H: 10.0MHz DTMB (CTTB): 10.0MHz ISDB-T: 10.0MHz CMMB: 10.0MHz LTE: 50 MHz LTETDD: 50 MHz IDEN: See the table below Digital Cable TV: 10.0MHz WLAN: If Radio Std is 802.11a/b/g 802.11n(20MHz) 802.11ac(20MHz): 25 MHz If Radio Std is 802.11n(40MHz), 802.11ac (40MHz): 50 MHz If Radio Std is 802.11ac(80MHz): 100MHz If Radio Std is 802.11ac(160MHz): 200MHz

	MSR: 20.0 MHz LTEAFDD, LTEATDD: 20.0MHz
State Saved	Saved in instrument state.
Min	10 Hz
Max	Hardware Dependent: Option 503 = 3.7 GHz Option 507 = 7.1GHz Option 508 = 8.5 GHz Option 513 = 13.8 GHz Option 526 = 27.0 GHz
Initial S/W Revision	Prior to A.02.00
Modified at S/W Revision	A.02.00
Modified at S/W Revision	A.03.00

### IDEN Mode Span Preset for Monitor Spectrum

iDEN Slot Format	WiDEN Slot Format 25kHz	WiDEN Slot Format 50kHz	WiDEN Slot Format 75kHz	WiDEN Slot Format 100kHz	WiDEN Slot Format 50kHz Out
60kHz	60kHz	85kHz	110kHz	135kHz	135kHz

### Full Span

Changes the Span to show the full frequency range of the analyzer.

Key Path	Span X Scale
Mode	All except SA and BASIC
<b>Remote Command</b>	[ :SENSe] :MONitor:FREQuency:SPAN:FULL
<b>Example</b>	MON:FREQ:SPAN:FULL
Couplings	Sets the span to the full frequency range, and adjusts the center frequency accordingly.
Initial S/W Revision	Prior to A.02.00

### Last Span

Changes the measurement span to the span setting of the previous measurement. If there is no existing previous span value, then the span remains unchanged.

Key Path	Span X Scale
----------	--------------

Mode	All except SA and BASIC
<b>Remote Command</b>	<code>[ :SENSe ] :MONitor :FREQuency :SPAN :PREVious</code>
<b>Example</b>	MON:FREQ:SPAN:PREV
Couplings	Selecting last span changes the measurement span value.
Initial S/W Revision	Prior to A.02.00

## Sweep/Control

Access a menu of functions that enable you to set up and control the sweep time for the current measurement

Key Path	Front-panel key
Initial S/W Revision	Prior to A.02.00

### Sweep Time

Selects the length of time in which the spectrum analyzer sweeps the displayed frequency span. Additional overhead time is required by the analyzer. It impacts the sweep rate, but is not calculated as part of the sweep time. Reducing the sweep time increases the rate of sweeps.

Key Path	Sweep/Control
Mode	All except SA and BASIC
<b>Remote Command</b>	[:SENSe]:MONitor:SWEep:TIME <time> [:SENSe]:MONitor:SWEep:TIME? [:SENSe]:MONitor:SWEep:TIME:AUTO OFF ON 0 1 [:SENSe]:MONitor:SWEep:TIME:AUTO?
<b>Example</b>	MON:SWE:TIME 100 ms MON:SWE:TIME? MON:SWE:TIME:AUTO ON MON:SWE:TIME:AUTO?
Preset	Automatically Calculated
State Saved	Saved in instrument state.
Min	1 ms
Max	4000 s
Initial S/W Revision	Prior to A.02.00
MIN/MAX/DEF Support	Yes

### Pause

Pauses a measurement after the current data acquisition is complete.

When Paused, the label on the key changes to Resume. Pressing Resume continues the measurement at the point where it had been paused.

See "[Pause/Resume](#)" on page 2235 under Sweep/Control for more information.

Key Path	Sweep/Control
Initial S/W Revision	Prior to A.02.00

## Gate

Accesses a menu that enables you to control the gating function. The Gate functionality is used to view signals best viewed by qualifying them with other events.

Gate setup parameters are the same for all measurements – they do not change as you change measurements. Settings like these are called “Meas Global” and are unaffected by Meas Preset.

Note that Sweep Time autocoupling rules and annotation are changed by Gate being on.

Key Path	Sweep/Control
Scope	Meas Global
Readback	The state and method of Gate, as [Off, LO] or [On, Video]. Note that for measurements that only support gated LO, the method is nonetheless read back, but always as LO.
Initial S/W Revision	Prior to A.02.00

## Gate On/Off

Turns the gate function on and off.

When the Gate Function is on, the selected Gate Method is used along with the gate settings and the signal at the gate source to control the sweep and video system with the gate signal. Not all measurements allow every type of Gate Methods.

When Gate is on, the annunciation in the measurement bar reflects that it is on and what method is used, as seen in the following "Gate: LO" annunciator graphic.

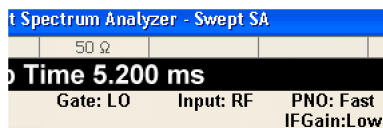

Key Path	Sweep/Control, Gate
Remote Command	[ :SENSe ] :SWEep:EGATe [ :STATe ] OFF ON 0 1 [ :SENSe ] :SWEep:EGATe [ :STATe ] ?
Example	SWE:EGAT ON SWE:EGAT?
Dependencies	The function is unavailable (grayed out) and Off when:

- Gate Method is LO or Video and FFT Sweep Type is manually selected.
- Gate Method is FFT and Swept Sweep Type is manually selected.
- Marker Count is ON.

The following are unavailable whenever Gate is on:

- FFT under Sweep Type when Method=LO or Video or Swept under Sweep Type when Method=FFT
- Marker Count

While Gate is on, the Auto Rules for Sweep Type are modified so that the choice agrees with the Gate Method: i.e., FFT for Method = FFT and Swept for Method = LO or Video.

The Gate softkey and all SCPI under the [:SENSe]:SWEep:EGATe SCPI node are grayed out when Source Mode is Tracking with an external source. This is because the Gate circuitry is used to sync the external source. If the Tracking Source is turned on, the Gate is turned off.

When in the ACP measurement:

- When Meas Method is RBW or FAST, this function is unavailable and the key is grayed out.
- Whenever Gate is on, Meas Method, RBW or FAST is unavailable and keys for those are grayed out.
- When Gate is on, Offset Res BW and Offset Video BW are ignored (if you set these values) and the measurement works as if all Offset Res BW and all Offset Video BW are coupled with the Res BW and the Video BW under the BW menu. When Gate is on, the Offset BW key in the Offset/Limit menu is grayed out.

Preset	Off LTETDD: On
State Saved	Saved in instrument state
Range	On Off
<b>Backwards Compatibility SCPI</b>	[:SENSe]:SWEep:TIME:GATE[:STATe] ESA compatibility
Backwards Compatibility Notes	In ESA, Trig Delay (On) and Gate (On) could not be active at the same time.. This dependency does not exist in PSA or in the X-Series.
Initial S/W Revision	Prior to A.02.00

## Gate View On/Off

Turning on Gate View in the Swept SA measurement provides a single-window gate view display..

Turning on Gate View in other measurements shows the split-screen Gate View. In these measurements, when the Gate View is on, the regular view of the current measurement traces and results are reduced vertically to about 70% of the regular height. The Zero Span window, showing the positions of the Gate, is shown between the Measurement Bar and the reduced measurement window. By reducing the height of the measurement window, some of the annotation on the Data Display may not fit and is not shown.

Key Path	Sweep/Control, Gate
<b>Remote Command</b>	[:SENSe]:SWEep:EGATe:VIEW ON OFF 1 0 [:SENSe]:SWEep:EGATe:VIEW?



<b>Example</b>	SWE:EGAT:VIEW ON turns on the gate view.
Dependencies	<p>In the Swept SA measurement:</p> <p>In Gate View, the regular Sweep Time key is grayed out . When pressed, the grayed out key puts up the informational message "Use Gate View Sweep Time in the Gate menu."</p> <p>In the other measurements:</p> <p>When you turn Gate View on, the lower window takes on the current state of the instrument. Upon leaving Gate View, the instrument takes on the state of the lower window.</p> <p>When you turn Gate View on, the upper window Sweep Time is set to the gate view sweep time.</p>
Couplings	<p>These couplings apply to the Swept SA measurement:</p> <ul style="list-style-type: none"> <li>• When Gate View is turned on, the instrument is set to Zero Span.</li> <li>• Gate View automatically turns off whenever a Span other than Zero is selected.</li> <li>• Gate View automatically turns off if you press the Last Span key while in Gate View, and the instrument returns to the Span it was in before entering Gate View (even if that is Zero Span).</li> <li>• When Gate View is turned on, the sweep time used is the gate view sweep time. This is set according to the rules in section "<a href="#">Gate View Setup</a>" on page 2043</li> <li>• When Gate View is turned off, Sweep Time is set to the normal Swept SA measurement sweep time.</li> <li>• If Gate View is on and Gate is off, then turning on Gate turns off Gate View.</li> </ul>
Preset	OFF
State Saved	Saved in instrument state
Range	On Off
Initial S/W Revision	Prior to A.02.00

A sample of the Gate View screen in the Swept SA measurement is shown in the following graphic :

15 Monitor Spectrum Measurement Sweep/Control

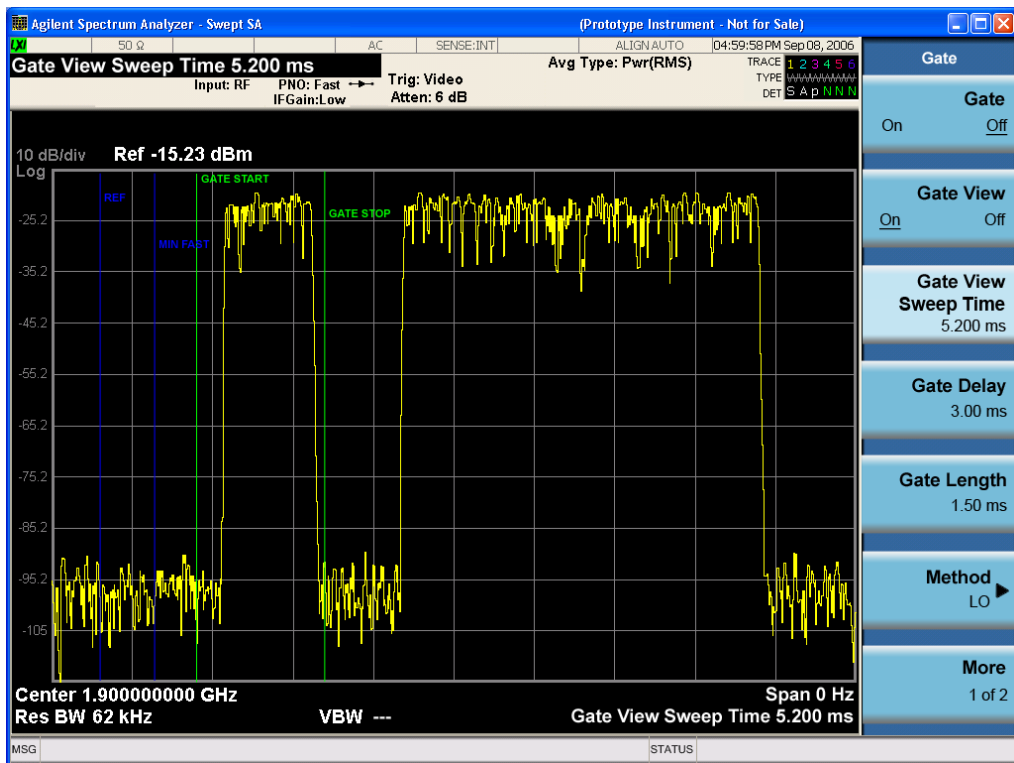

A sample of the Gate View screen in other measurements is shown in the following graphic. This example is for the ACP measurement:

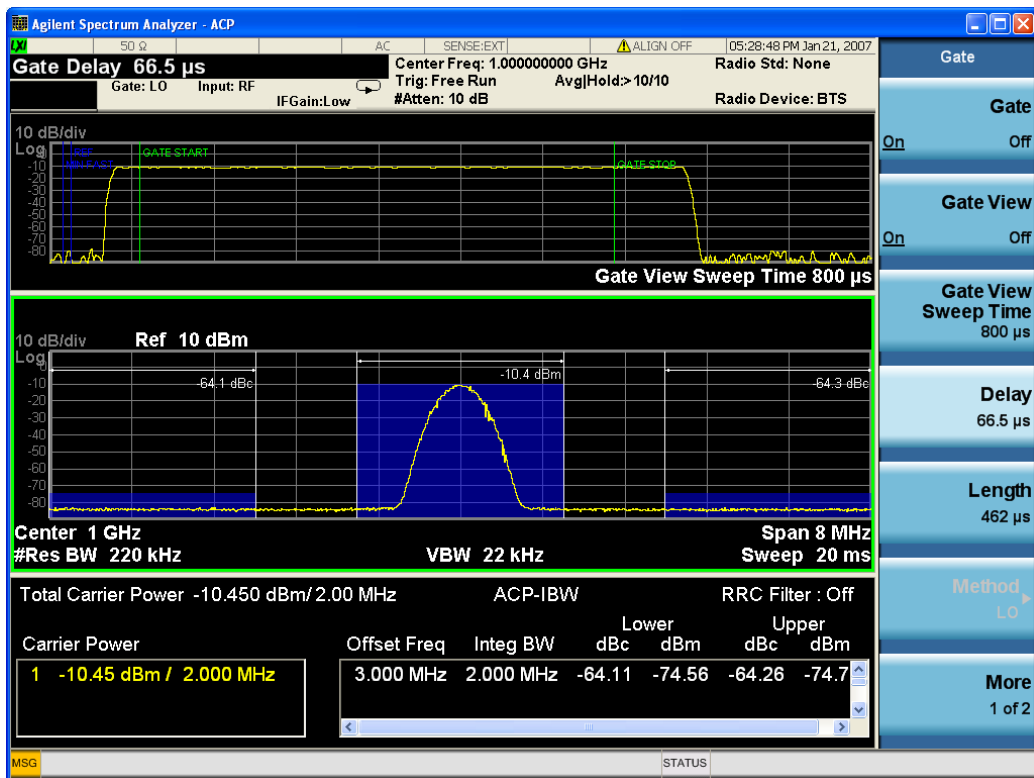

Turning Gate View off returns the analyzer to the Normal measurement view.

In the Swept SA, the normal measurement view is the single-window Swept SA view. When returning to this view, the Swept SA measurement returns to the Span it was in before entering **Gate View** (even if that is Zero Span).

The **Gate View** window is triggered from the Gate Source, with zero trigger delay. Also, when updating the **Gate View** window, the Gate itself must not operate. So it is internally shut off while the gate view window is being updated. For the Swept SA measurement, this means that the Gate is internally shut off whenever the gate view window is displayed. The measurement bar and softkeys continue to show the Trigger source for the main sweep window and give no indication that the Gate is shut off or that the Gate View window is triggered from the Gate Source.

When in **Gate View**, vertical lines are displayed in the Gate View window as follows:

- Green lines are displayed at the gate edges as follows: in Edge Gate, a line is shown for Delay and one for the end of the Gate period, defined by Length. In Level Gate a line is shown only for Delay. You can adjust the position of the green lines by adjusting the gate length and the gate delay. These lines update in the Gate View window as the active function changes, even if the window is not being updated. In Gated LO and Gated Video, these lines are positioned relative to the delay reference line (not relative to 0 time). In Gated FFT, their location is relative to the left edge of the screen.
- A blue line is displayed showing the delay reference, that is, the reference point for the Gate Delay within the Zero Span window. The blue line represents where (in time) the effective location of the gate start would be if the gate were programmed to zero delay.
- 
- The second blue line is labeled "MIN FAST" as shown in the figure above because it represents the minimum Gate Delay for fast Gated LO operation. This line is only displayed in Gated LO. You cannot scroll (knob) or decrement (down key) the Gate Delay to less than that represented by the position of this line, it can only be set below this position manually, although once there it can be moved freely with the knob while below the line.
- A yellow line in the Gated Video case only, is displayed at Blength, where Blength is the display point (bucket) length for the swept trace, which is given by the sweep time for that trace divided by number of Points – 1. So it is referenced to 0 time, not to the delay reference. This line is labeled NEXT PT (it is not shown in the figure above because the figure above is for Gated LO).
- The yellow line represents the edge of a display point (bucket). Normally in Gated Video, the bucket length must be selected so that it exceeds the off time of the burst. There is another way to use the analyzer in Gated Video measurements, and that is to set the bucket width much shorter than the off time of the burst. Then use the Max Hold trace function to fill in "missing" buckets more slowly. This allows you to see some of the patterns of the Gated Video results earlier, though seeing a completely filled-in spectrum later.

## Gate View Setup

Accesses a menu that enables you to setup parameters relevant to the Gate View

Key Path	Sweep/Control, Gate
Scope	Meas Global
Initial S/W Revision	A.10.00

### Gate View Sweep Time

Controls the sweep time in the Gate View window. To provide an optimal view of the gate signal, the analyzer initializes Gate View Sweep Time based on the current settings of Gate Delay and Gate Length.

<b>Key Path</b>	Sweep/Control, Gate, Gate View Setup
<b>Remote Command</b>	[ :SENSe ] :SWEep:EGATe:TIME <time> [ :SENSe ] :SWEep:EGATe:TIME?
<b>Example</b>	SWE:EGAT:TIME 500 ms
<b>Dependencies</b>	Gate View Sweep Time is initialized: <ul style="list-style-type: none"> <li>• On Preset (after initializing delay and length).</li> <li>• Every time the Gate Method is set/changed.</li> </ul> <p>Additionally, in the Swept SA measurement, whenever you do a Preset, or leave Gate View, the analyzer remembers the Gate Delay and Gate Length settings. Then, when returning to Gate View, if the current Gate Delay and/or Gate Length do not match the remembered values Gate View Sweep Time is re-initialized.</p> <ol style="list-style-type: none"> <li>1. Compute the location of the "gate stop" line, which you know is at time <math>t = t_{min} + GateDelay + GateLength</math>.</li> </ol>
<b>Preset</b>	519.3 $\mu$ s WiMAX OFDMA: 5 ms GSM/EDGE: 1 ms
<b>State Saved</b>	Saved in instrument state
<b>Max</b>	6000 s
<b>Initial S/W Revision</b>	Prior to A.02.00

### Gate View Start Time

Controls the time at the left edge of the Gate View.

<b>Key Path</b>	Sweep/Control, Gate, Gate View Setup
<b>Remote Command</b>	[ :SENSe ] :SWEep:EGATe:VIEW:START <time> [ :SENSe ] :SWEep:EGATe:VIEW:START?
<b>Example</b>	SWE:EGAT:VIEW:STAR 10ms
<b>Notes</b>	Units of time are required or no units; otherwise an invalid suffix error message will be generated. See error -131.
<b>Preset</b>	0 ms
<b>State Saved</b>	Saved in instrument state
<b>Min</b>	0
<b>Max</b>	500 ms
<b>Initial S/W Revision</b>	A.10.00

## Gate Delay

Controls the length of time from the time the gate condition goes True until the gate is turned on.

Key Path	Sweep/Control, Gate
Remote Command	[ :SENSe ] :SWEep:EGATe:DELay <time> [ :SENSe ] :SWEep:EGATe:DELay?
Example	SWE:EGAT:DELay 500ms SWE:EGAT:DELay?
Notes	Units of time are required or no units; otherwise an invalid suffix error message will be generated.
Preset	57.7 us WiMAX OFDMA: 71 us GSM/EDGE: 600 us WLAN: 500 us
State Saved	Saved in instrument state
Min	0.0 us
Max	100 s
Backwards Compatibility SCPI	[ :SENSe ] :SWEep:TIME:GATE:DELay ESA compatibility
Initial S/W Revision	Prior to A.02.00

## Gate Length

Controls the length of time that the gate is on after it opens.

Key Path	Sweep/Control, Gate
Remote Command	[ :SENSe ] :SWEep:EGATe:LENGth <time> [ :SENSe ] :SWEep:EGATe:LENGth?
Example	SWE:EGAT:LENG 1 SWE:EGAT:LENG?
Notes	Units of time are required or no units; otherwise an invalid suffix error message will be generated.
Dependencies	<p>Grayed out when Gate Method is set to FFT in which case the label changes to that shown below.</p>  <p>The key is also grayed out if Gate Control = Level.</p>
Preset	461.6 us

	WiMAX OFDMA: 50 us GSM/EDGE: 200 us WLAN: 1.54 ms
State Saved	Saved in instrument state
Min	100 ns
Max	5 s
<b>Backwards Compatibility SCPI</b>	[:SENSe]:SWEep:TIME:GATE:LENGth ESA compatibility
Initial S/W Revision	Prior to A.02.00

### Gate Source

The menus under the Gate Source key are the same as those under the Trigger key, with the exception that neither Free Run nor Video are available as Gate Source selections. However, a different SCPI command is used to select the Gate Source (see table below) because you may independently set the Gate Source and the Trigger Source.

Any changes to the settings in the setup menus under each Gate Source selection key (for example: Trigger Level, Trigger Delay, etc.) also affect the corresponding settings under the Trigger menu keys. The SCPI commands used for these are the same for Trigger and Gate, since there is only one setting which affects both Gate and Trigger. Example: to set the Trigger Level for External 1 you use the command :TRIG:EXT1:LEV regardless of whether you are using External 1 as a Trigger Source or a Gate Source.

Key Path	Sweep/Control, Gate
<b>Remote Command</b>	[:SENSe]:SWEep:EGATE:SOURce EXTernal1   EXTernal2   LINE   FRAME   RFBurst  [:SENSe]:SWEep:EGATE:SOURce?
Dependencies	In some models, there is no second External input. In these models, the External 2 key is blanked and the EXTernal2 parameter will generate a "Hardware missing; Not available for this model number" error.
Preset	EXTernal 1 GSM/EDGE, MSR: FRAME LTETDD: EXTernal 1When Direction is Downlink, FRAME when Direction is Uplink.
Backwards Compatibility Notes	In ESA, there is a single Gate input port. In PSA, the Gate Source may be taken from one of two specified input ports. In the X-Series, any Trigger Source can be a Gate Source.
Initial S/W Revision	Prior to A.02.00
Modified at S/W Revision	A.03.00, A.14.00

## Line

Pressing this key, when it is not selected, selects the line signal as the trigger. A new sweep/measurement will start synchronized with the next cycle of the line voltage. Pressing this key, when it is already selected, access the line trigger setup menu.

Key Path	Trigger
<b>Example</b>	TRIG:SOUR LINE Swept SA measurement TRIG:<meas>:SOUR LINE Measurements other than Swept SA
Dependencies	Line trigger is not available when operating from a "dc power source", for example, when the instrument is powered from batteries.
State Saved	Saved in instrument state
Status Bits/OPC dependencies	The Status Operation Register bit 5 "Waiting for Trigger" is set at the same time as the Sweeping or Measuring bit is set. It is cleared when the trigger actually occurs (that is, after the trigger event occurs and all the applicable trigger criteria have been met). A corresponding pop-up message ("Waiting for trigger") is generated if no trigger signal appears after approximately 2 sec. This message goes away when a trigger signal appears.
Initial S/W Revision	Prior to A.02.00

## Trig Slope

Controls the trigger polarity. It is set positive to trigger on a rising edge and negative to trigger on a falling edge.

Key Path	Trigger, Line
<b>Remote Command</b>	:TRIGger[:SEQuence]:LINE:SLOPe POSitive NEGative :TRIGger[:SEQuence]:LINE:SLOPe?
<b>Example</b>	TRIG:LINE:SLOP NEG
Preset	POSitive
State Saved	Saved in instrument state
Backwards Compatibility Notes	The legacy :TRIGger[:SEQuence]:SLOPe command affects the slopes for the VID, LINE, EXT1, EXT2, and RFB triggers.
Initial S/W Revision	Prior to A.02.00

## External 1

Pressing this key, when it is not selected, selects an external input signal as the trigger. A new sweep/measurement will start when the external trigger condition is met using the external 1 input connector on the rear panel.

Pressing this key, when it is already selected, accesses the external 1 trigger setup menu.

Key Path	Trigger
<b>Example</b>	TRIG:SOUR EXT1 Swept SA measurement TRIG:<meas>:SOUR EXT1 Measurements other than Swept SA
Dependencies	Grayed out if in use by Point Trigger in the Source Setup menu. Forced to Free Run if already selected and Point Trigger is set to External 1.
State Saved	Saved in instrument state
Status Bits/OPC dependencies	The Status Operation Register bit 5 "Waiting for Trigger" is set at the same time as the Sweeping or Measuring bit is set. It is cleared when the trigger actually occurs (that is, after the trigger event occurs and all the applicable trigger criteria have been met). A corresponding pop-up message ("Waiting for trigger") is generated if no trigger signal appears after approximately 2 sec. This message goes away when a trigger signal appears.
Initial S/W Revision	Prior to A.02.00

### Trigger Level

Sets the value where the external 1 trigger input will trigger a new sweep/measurement.

Key Path	Trigger, External 1
<b>Remote Command</b>	:TRIGger[:SEquence]:EXTernal1:LEVel <level> :TRIGger[:SEquence]:EXTernal1:LEVel?
<b>Example</b>	TRIG:EXT1:LEV 0.4 V
Couplings	This same level is used for the Ext1 trigger source in the Trigger menu, for the Ext1 selection in the Periodic Timer sync source (in the Trigger menu and in the Gate Source menu), and also for the Ext1 selection in the Gate Source menu.
Preset	1.2 V
State Saved	Saved in instrument state
Min	-5 V
Max	5 V
Default Unit	V
<b>Backwards Compatibility SCPI</b>	:TRIGger[:SEquence]:EXTernal:LEVel For backward compatibility, the parameter EXTernal is mapped to EXTernal1
<b>Backwards Compatibility SCPI</b>	:TRIGger[:SEquence]:FRAME:EXTernal1:LEVel
Initial S/W Revision	Prior to A.02.00

### Trig Slope

Controls the trigger polarity. It is set positive to trigger on a rising edge and negative to trigger on a falling edge.



Key Path	Trigger, External 1
<b>Remote Command</b>	:TRIGger[:SEQuence]:EXTernal1:SLOPe POSitive NEGative :TRIGger[:SEQuence]:EXTernal1:SLOPe?
<b>Example</b>	TRIG:EXT1:SLOP NEG
Couplings	This same slope is used in the Ext1 selection for the trigger source in the Trigger menu and for the period timer sync source (in the Trigger menu and in the Gate Source menu).
Preset	POSitive
State Saved	Saved in instrument state
<b>Backwards Compatibility SCPI</b>	:TRIGger[:SEQuence]:EXTernal:SLOPe For backward compatibility, the parameter EXTernal is mapped to EXTernal1
<b>Backwards Compatibility SCPI</b>	:TRIGger[:SEQuence]:FRAMe:EXTernal1:SLOPe
Backwards Compatibility Notes	The legacy :TRIGger[:SEQuence]:SLOPe command affects the slopes for the VID, LINE, EXT1, EXT2, and RFB triggers.
Initial S/W Revision	Prior to A.02.00

## External 2

Pressing this key, when it is not selected, selects an external input signal as the trigger. A new sweep/measurement will start when the external trigger condition is met using the external 2 input connector. The external trigger 2 input connector is on the rear panel.

Pressing this key, when it is already selected, accesses the external 2 trigger setup menu.

Key Path	Trigger
<b>Example</b>	TRIG:SOUR EXT2      Swept SA measurement TRIG:<meas>:SOUR EXT2    Measurements other than Swept SA
Dependencies	In some models, there is no second External input. In these models, the External 2 key is blanked and the EXTernal2 parameter will generate a "Hardware missing; Not available for this model number" message.  Grayed out if in use by Point Trigger in the Source Setup menu. Forced to Free Run if already selected and Point Trigger is set to External 2.
State Saved	Saved in instrument state
Status Bits/OPC dependencies	The Status Operation Register bit 5 "Waiting for Trigger" is set at the same time as the Sweeping or Measuring bit is set. It is cleared when the trigger actually occurs (that is, after the trigger event occurs and all the applicable trigger criteria have been met). A corresponding pop-up message ("Waiting for trigger") is generated if no trigger signal appears after approximately 2 sec. This message goes away when a trigger signal appears.
Initial S/W Revision	Prior to A.02.00
Modified at S/W Revision	A.03.00

### Trigger Level

Sets the value where the external 2 trigger input will trigger a new sweep/measurement.

Key Path	Trigger, External 2
<b>Remote Command</b>	:TRIGger[:SEquence]:EXTernal2:LEVel :TRIGger[:SEquence]:EXTernal2:LEVel?
<b>Example</b>	TRIG:EXT2:LEV 1.1 V
Couplings	This same level is used for the Ext2 trigger source in the Trigger menu, for the Ext2 selection in the Periodic Timer sync source (in the Trigger menu and in the Gate Source menu), and also for the Ext2 selection in the Gate Source menu.
Preset	1.2 V
State Saved	Saved in instrument state
Min	-5 V
Max	5 V
Default Unit	V
<b>Backwards Compatibility SCPI</b>	:TRIGger[:SEquence]:FRAMe:EXTernal2:LEVel
Initial S/W Revision	Prior to A.02.00

### Trig Slope

Controls the trigger polarity. It is set positive to trigger on a rising edge and negative to trigger on a falling edge.

Key Path	Trigger, External 2
<b>Remote Command</b>	:TRIGger[:SEquence]:EXTernal2:SLOPe POSitive NEGative :TRIGger[:SEquence]:EXTernal2:SLOPe?
<b>Example</b>	TRIG:EXT2:SLOP NEG
Couplings	This same slope is used in the Ext2 selection for the trigger source in the Trigger menu and for the period timer sync source (in the Trigger menu and in the Gate Source menu).
Preset	POSitive
State Saved	Saved in instrument state
<b>Backwards Compatibility SCPI</b>	:TRIGger[:SEquence]:FRAMe:EXTernal2:SLOPe
Backwards Compatibility Notes	The legacy :TRIGger[:SEquence]:SLOPe command affects the slopes for the VID, LINE, EXT1, EXT2, and RFB triggers.
Initial S/W Revision	Prior to A.02.00

## RF Burst

Pressing this key, when it is not selected, selects the RF Burst as the trigger. A new sweep/measurement will start when an RF burst envelope signal is identified from the signal at the RF Input connector. Pressing this key, when it is already selected, accesses the RF Burst trigger setup menu.

In some models, a variety of burst trigger circuitry is available, resulting in various available burst trigger bandwidths. The analyzer automatically chooses the appropriate trigger path based on the hardware configuration and other settings of the analyzer.

Key Path	Trigger
<b>Example</b>	TRIG:SOUR RFB Swept SA measurement TRIG:<meas>:SOUR RFB Measurements other than Swept SA
State Saved	Saved in instrument state
Status Bits/OPC dependencies	The Status Operation Register bit 5 "Waiting for Trigger" is set at the same time as the Sweeping or Measuring bit is set. It is cleared when the trigger actually occurs (that is, after the trigger event occurs and all the applicable trigger criteria have been met). A corresponding pop-up message ("Waiting for trigger") is generated if no trigger signal appears after approximately 2 sec. This message goes away when a trigger signal appears.
Backwards Compatibility Notes	The legacy command: :TRIGger[:SEquence]:RFBurst:FSElectivity[:STATe] OFF ON 0 1 is not supported in the X-Series, as the hardware to do Frequency Selective burst triggers does not exist in X-Series.
Initial S/W Revision	Prior to A.02.00
Modified at S/W Revision	A.04.00

## Absolute Trigger Level

Sets the absolute trigger level for the RF burst envelope.

When using the External Mixing path, the Absolute Trigger Level is uncalibrated because the factory default was set to accommodate the expected IF levels for the RF path.

Key Path	Trigger, RF Burst
Scope	Meas Global
<b>Remote Command</b>	:TRIGger[:SEquence]:RFBurst:LEVel:ABSolute <ampl> :TRIGger[:SEquence]:RFBurst:LEVel:ABSolute?
<b>Example</b>	TRIG:RFB:LEV:ABS 10 dBm sets the trigger level of the RF burst envelope signal to the absolute level of 10 dBm
Notes	Sending this command does not switch the setting from relative to absolute; to switch it you need to send the :TRIGger[:SEquence]:RFBurst:LEVel:TYPE command, below.  Amplitude Corrections are not taken into account by the Absolute Trigger Level. For example, if you have given yourself effective gain with an amplitude correction factor, the Absolute Trigger will not fire until you have set the trigger level that far below the displayed signal level, rather than simply to

	the displayed signal level. This is only true for Amplitude Corrections, not External Gain or Ref Level Offset functions. If mode is Bluetooth, the default value is -50 dBm.
Couplings	This same level is used for the RF Burst trigger source in the Trigger menu, for the RF Burst selection in the Periodic Timer sync source (in the Trigger menu and in the Gate Source menu), and also for the RF Burst selection in the Gate Source menu
Preset	-20 dBm
State Saved	Saved in instrument state
Min	-200 dBm
Max	100 dBm
Default Unit	depends on the current selected Y-Axis unit
<b>Backwards Compatibility SCPI</b>	:TRIGger[:SEquence]:FRAME:RFBurst:LEVel:ABSolute
Initial S/W Revision	Prior to A.02.00
Modified at S/W Revision	A.04.00

Key Path	Trigger, RF Burst
<b>Remote Command</b>	:TRIGger[:SEquence]:RFBurst:LEVel:TYPE ABSolute RELative :TRIGger[:SEquence]:RFBurst:LEVel:TYPE?
<b>Example</b>	TRIG:RFB:LEV:TYPE REL sets the trigger level type of the RF burst trigger to Relative.
Preset	ABSolute
State Saved	Saved in instrument state
Initial S/W Revision	Prior to A.02.00
Modified at S/W Revision	A.04.00

### Relative Trigger Level

Sets the relative trigger level for the RF burst envelope.

In some models, the relative burst trigger function is implemented in hardware. In other models, without the advanced triggering hardware required, the relative burst trigger function is implemented in software in some measurements, and is unavailable in other measurements.

When implemented in software, the relative RF Burst trigger function is implemented as follows:

1. The measurement starts with the absolute RF Burst trigger setting. If it cannot get a trigger with that level, auto trigger fires and the acquisition starts anyway. After the acquisition, the measurement searches for the peak in the acquired waveform and saves it.

2. Now, in the next cycle of the measurement, the measurement determines a new absolute RF Burst level based on the peak value from the first measurement and the Relative RF Burst Trigger Level (always 0 or negative dB) set by the user. The following formula is used:
  3. absolute RF Burst level = peak level of the previous acquisition + relative RF Burst level
  4. If the new absolute RF Burst level differs from the previous by more than 0.5 dB, the new level is sent to the hardware; otherwise it is not updated (to avoid slowing down the acquisition)
- Steps 2 and 3 repeat for subsequent measurements.

Key Path	Trigger, RF Burst
Scope	Meas Global
<b>Remote Command</b>	:TRIGger[:SEquence]:RFBurst:LEVel:RELative <rel_ampl> :TRIGger[:SEquence]:RFBurst:LEVel:RELative?
<b>Example</b>	TRIG:RFB:LEV:REL -10 dB sets the trigger level of the RF burst envelope signal to the relative level of -10 dB
Notes	Sending this command does not switch the setting from absolute to relative; to switch it you need to send the :TRIGger[:SEquence]:RFBurst:LEVel:TYPE command, above. The relative trigger level is not available in some measurements. In those measurements the RELative parameter, and the :TRIGger[:SEquence]:RFBurst:LEVel:TYPE command (above), will generate an error if sent.
Dependencies	This key is grayed out and Absolute Trigger Level selected if the required hardware is not present in your analyzer and the current measurement does not support Relative triggering.
Preset	-6 dB GSM: -25 dB
State Saved	Saved in instrument state
Min	-45 dB
Max	0 dB
Default Unit	dB or dBc
<b>Backwards Compatibility SCPI</b>	:TRIGger[:SEquence]:RFBurst:LEVel This legacy command is aliased to :TRIGger[:SEquence]:RFBurst:LEVel:RELative because the PSA had ONLY relative burst triggering
Initial S/W Revision	Prior to A.02.00
Modified at S/W Revision	A.04.00

### Trigger Slope

It is set positive to trigger on a rising edge and negative to trigger on a falling edge.

Key Path	Trigger, RF Burst
<b>Remote Command</b>	:TRIGger[:SEquence]:RFBurst:SLOPe Positive NEGative :TRIGger[:SEquence]:RFBurst:SLOPe?

<b>Example</b>	TRIG:RFB:SLOP NEG
Couplings	This same slope is used in the RF Burst selection for the trigger source in the Trigger menu and for the period timer sync source (in the Trigger menu and in the Gate Source menu).
Preset	POSitive
State Saved	Saved in instrument state
<b>Backwards Compatibility SCPI</b>	:TRIGger[:SEQuence]:FRAMe:RFBurst:SLOPe
Backwards Compatibility Notes	The legacy :TRIGger[:SEQuence]:SLOPe command affects the slopes for the VID, LINE, EXT1, EXT2, and RFB triggers.
Initial S/W Revision	Prior to A.02.00

### Periodic Timer (Frame Trigger)

Pressing this key, when it is not selected, selects the internal periodic timer signal as the trigger. Triggering occurrences are set by the **Period** parameter, which is modified by the **Sync Source** and **Offset**. Pressing this key, when it is already selected, accesses the periodic timer trigger setup functions.

If you do not have a sync source selected (it is Off), then the internal timer will not be synchronized with any external timing events.

<b>Key Path</b>	Trigger
<b>Example</b>	TRIG:SOUR FRAM Swept SA measurement TRIG:<meas>:SOUR FRAM Measurements other than Swept SA
State Saved	Saved in instrument state
Readback	[Sync: <value of Sync Source>], for example, [Sync: External 1]
Status Bits/OPC dependencies	The Status Operation Register bit 5 "Waiting for Trigger" is set at the same time as the Sweeping or Measuring bit is set. It is cleared when the trigger actually occurs (that is, after the trigger event occurs and all the applicable trigger criteria have been met). A corresponding pop-up message ("Waiting for trigger") is generated if no trigger signal appears after approximately 2 sec. This message goes away when a trigger signal appears.
Initial S/W Revision	Prior to A.02.00

### Periodic Timer Triggering:

This feature selects the internal periodic timer signal as the trigger. Trigger occurrences are set by the **Periodic Timer** parameter, which is modified by the **Sync Source** and **Offset**.

The figure below shows the action of the periodic timer trigger. Before reviewing the figure, we'll explain some uses for the periodic trigger.

A common application is measuring periodic burst RF signals for which a trigger signal is not easily available. For example, we might be measuring a TDMA radio which bursts every 20 ms. Let's assume that the 20 ms period is very consistent. Let's also assume that we do not have an external trigger source

available that is synchronized with the period, and that the signal-to-noise ratio of the signal is not high enough to provide a clean RF burst trigger at all of the analysis frequencies. For example, we might want to measure spurious transmissions at an offset from the carrier that is larger than the bandwidth of the RF burst trigger. In this application, we can set the Periodic Timer to a 20.00 ms period and adjust the offset from that timer to position our trigger just where we want it. If we find that the 20.00 ms is not exactly right, we can adjust the period slightly to minimize the drift between the period timer and the signal to be measured.

A second way to use this feature would be to use **Sync Source** temporarily, instead of **Offset**. In this case, we might tune to the signal in a narrow span and use the RF Burst trigger to synchronize the periodic timer. Then we would turn the sync source off so that it would not miss-trigger. Miss-triggering can occur when we are tuned so far away from the RF burst trigger that it is no longer reliable.

A third example would be to synchronize to a signal that has a reference time element of much longer period than the period of interest. In some CDMA applications, it is useful to look at signals with a short periodicity, by synchronizing that periodicity to the "even-second clock" edge that happens every two seconds. Thus, we could connect the even-second clock trigger to Ext1 and use then Ext1 as the sync source for the periodic timer.

The figure below illustrates this third example. The top trace represents the even-second clock. It causes the periodic timer to synchronize with the leading edge shown. The analyzer trigger occurs at a time delayed by the accumulated offset from the period trigger event. The periodic timer continues to run, and triggers continue to occur, with a periodicity determined by the analyzer time base. The timer output (labeled "late event") will drift away from its ideal time due to imperfect matching between the time base of the signal being measured and the time base of the analyzer, and also because of imperfect setting of the period parameter. But the synchronization is restored on the next even-second clock event. ("Accumulated offset" is described in the in the **Offset** function section.)

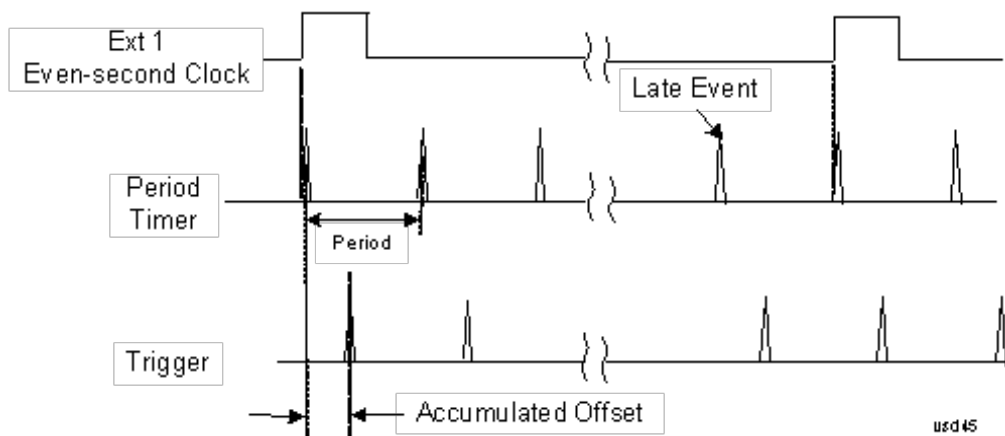

### Period

Sets the period of the internal periodic timer clock. For digital communications signals, this is usually set to the frame period of your current input signal. In the case that sync source is not set to OFF, and the external sync source rate is changed for some reason, the periodic timer is synchronized at the every external synchronization pulse by resetting the internal state of the timer circuit.

Key Path	Trigger, Periodic Timer
Remote Command	:TRIGger[:SEquence]:FRAMe:PERIOD <time>

	:TRIGger[:SEquence]:FRAMe:PERiod?
<b>Example</b>	TRIG:FRAM:PER 100 ms
<b>Dependencies</b>	The invalid data indicator turns on when the period is changed, until the next sweep/measurement completes.
<b>Couplings</b>	The same period is used in the Gate Source selection of the period timer.
<b>Preset</b>	20 ms GSM: 4.615383
<b>State Saved</b>	Saved in instrument state
<b>Min</b>	100.000 ns
<b>Max</b>	559.0000 ms
<b>Default Unit</b>	S
<b>Initial S/W Revision</b>	Prior to A.02.00

### Offset

Adjusts the accumulated offset between the periodic timer events and the trigger event. Adjusting the accumulated offset is different than setting an offset, and requires explanation.

The periodic timer is usually not synchronized with any external events, so the timing of its output events has no absolute meaning. Since the timing relative to external events (RF signals) is important, you need to be able to adjust (offset) it. However, you have no direct way to see when the periodic timer events occur. All that you can see is the trigger timing. When you want to adjust the trigger timing, you will be changing the internal offset between the periodic timer events and the trigger event. Because the absolute value of that internal offset is unknown, we will just call that the accumulated offset. Whenever the Offset parameter is changed, you are changing that accumulated offset. You can reset the displayed offset using Reset Offset Display. Changing the display does not change the value of the accumulated offset, and you can still make additional changes to accumulated offset.

To avoid ambiguity, we define that an increase in the "offset" parameter, either from the knob or the SCPI adjust command, serves to delay the timing of the trigger event.

<b>Key Path</b>	Trigger, Periodic Timer
<b>Remote Command</b>	:TRIGger[:SEquence]:FRAMe:OFFSet <time> :TRIGger[:SEquence]:FRAMe:OFFSet?
<b>Example</b>	TRIG:FRAM:OFFS 1.2 ms
<b>Notes</b>	The front panel interface (for example, the knob), and this command, adjust the accumulated offset, which is shown on the active function display. However, the actual amount sent to the hardware each time the offset is updated is the delta value, that is, the current accumulated offset value minus the previous accumulated offset value. Note that the accumulated offset value is essentially arbitrary; it represents the accumulated offset from the last time the offset was zeroed (with the Reset Offset Display key).  Note that this command does not change the period of the trigger waveform. Note also that Offset is used only when the sync source is set to OFF, otherwise delay is used, see section "Trig Delay" on page 443.



	An increase in the "offset" parameter, either from the knob or the SCPI adjust command, serves to delay the timing of the trigger event.
Notes	When the SCPI command is sent the value shown on the key (and the Active Function, if this happens to be the active function) is updated with the new value. However, the actual amount sent to the hardware is the delta value, that is, the current accumulated offset value minus the previous accumulated offset value.  The SCPI query simply returns the value currently showing on the key.
Dependencies	The invalid data indicator turns on when the offset is changed, until the next sweep/measurement completes.
Couplings	The same offset is used in the Gate Source selection of the period timer.
Preset	0 s
State Saved	Saved in instrument state
Min	-10.000 s
Max	10.000 s
Default Unit	S
Initial S/W Revision	Prior to A.02.00

#### Offset Adjust (Remote Command Only)

This remote command does not work at all like the related front panel keys. This command lets you advance the phase of the frame trigger by the amount you specify.

It does not change the period of the trigger waveform. If the command is sent multiple times, it advances the phase of the frame trigger an additional amount each time it is sent. Negative numbers are permitted.

<b>Remote Command</b>	:TRIGger[:SEquence]:FRAMe:ADJust <time>
<b>Example</b>	TRIG:FRAM:ADJ 1.2 ms
Notes	Note also that Offset is used only when the sync source is set to OFF, otherwise delay is used, see section " <a href="#">Trig Delay</a> " on page 443  An increase in the "offset" parameter, either from the knob or the SCPI adjust command, serves to delay the timing of the trigger event.
Notes	The front panel interface (for example, the knob) and the :TRIG:FRAM:OFFS command adjust the accumulated offset, which is shown on the active function display. However, the actual amount sent to the hardware is the delta value, that is, the current offset value minus the previous offset value.  When the SCPI command is sent the value shown on the key (and the Active Function, if this happens to be the active function) is updated by increasing it (or decreasing it if the value sent is negative) by the amount specified in the SCPI command.  This is a "command only" SCPI command, with no query.
Dependencies	The invalid data indicator turns on when the offset is changed, until the next sweep/measurement completes.
Couplings	The same offset is used in the Gate Source selection of the period timer.
Preset	0 s

State Saved	Saved in instrument state
Min	-10.000 s
Max	10.000 s
Default Unit	S
Initial S/W Revision	Prior to A.02.00

### Reset Offset Display

Resets the value of the periodic trigger offset display setting to 0.0 seconds. The current displayed trigger location may include an offset value defined with the Offset key. Pressing this key redefines the currently displayed trigger location as the new trigger point that is 0.0 s offset. The Offset key can then be used to add offset relative to this new timing.

Key Path	Trigger, Periodic Timer
Remote Command	:TRIGger[:SEquence]:FRAMe:OFFSet:DISPlay:RESet
Example	TRIG:FRAM:OFFS:DISP:RES
Initial S/W Revision	Prior to A.02.00

### Sync Source

Selects a signal source for you to synchronize your periodic timer trigger to, otherwise you are triggering at some arbitrary location in the frame. Synchronization reduces the precision requirements on the setting of the period.

For convenience you may adjust the level and slope of the selected sync source in a conditional branch setup menu accessed from the Sync Source menu. Note that these settings match those in the **Trigger** and **Gate Source** menus; that is, each trigger source has only one value of level and slope, regardless of which menu it is accessed from.

Key Path	Trigger, Periodic Timer
Remote Command	:TRIGger[:SEquence]:FRAMe:SYNC EXTernal1   EXTernal2   RFBurst   OFF :TRIGger[:SEquence]:FRAMe:SYNC?
Example	TRIG:FRAM:SYNC EXT2
Dependencies	In some models, there is no second External input. In these models, the External 2 key is blanked and the EXTernal2 parameter will generate a "Hardware missing; Not available for this model number" message.
Preset	Off GSM/EDGE, MSR,LTE,LTETDD: RFBurst
State Saved	Saved in instrument state
Readback	The current setting is read back to this key and it is also Readback to the previous Periodic Timer trigger key.

<b>Backwards Compatibility SCPI</b>	:TRIGger[:SEquence]:FRAMe:SYNC EXTernal
Initial S/W Revision	Prior to A.02.00
Modified at S/W Revision	A.03.00, A.14.00

### Off

Turns off the sync source for your periodic trigger. With the sync source off, the timing will drift unless the signal source frequency is locked to the analyzer frequency reference.

<b>Key Path</b>	Trigger, Periodic Timer, Sync Source
<b>Example</b>	TRIG:FRAM:SYNC OFF
<b>Readback</b>	Off
<b>Initial S/W Revision</b>	Prior to A.02.00

### External 1

Pressing this key, when it is not selected, selects an external input signal as the trigger. A new sweep/measurement will start when the external trigger condition is met using the external 1 input connector on the rear panel.

Pressing this key, when it is already selected, accesses the external 1 trigger setup menu.

<b>Key Path</b>	Trigger
<b>Example</b>	TRIG:SOUR EXT1 Swept SA measurement TRIG:<meas>:SOUR EXT1 Measurements other than Swept SA
<b>Dependencies</b>	Grayed out if in use by Point Trigger in the Source Setup menu. Forced to Free Run if already selected and Point Trigger is set to External 1.
<b>State Saved</b>	Saved in instrument state
<b>Status Bits/OPC dependencies</b>	The Status Operation Register bit 5 "Waiting for Trigger" is set at the same time as the Sweeping or Measuring bit is set. It is cleared when the trigger actually occurs (that is, after the trigger event occurs and all the applicable trigger criteria have been met). A corresponding pop-up message ("Waiting for trigger") is generated if no trigger signal appears after approximately 2 sec. This message goes away when a trigger signal appears.
<b>Initial S/W Revision</b>	Prior to A.02.00

### Trigger Level

Sets the value where the external 1 trigger input will trigger a new sweep/measurement.

Key Path	Trigger, External 1
Remote Command	:TRIGger[:SEquence]:EXTErnal1:LEVel <level> :TRIGger[:SEquence]:EXTErnal1:LEVel?
Example	TRIG:EXT1:LEV 0.4 V
Couplings	This same level is used for the Ext1 trigger source in the Trigger menu, for the Ext1 selection in the Periodic Timer sync source (in the Trigger menu and in the Gate Source menu), and also for the Ext1 selection in the Gate Source menu.
Preset	1.2 V
State Saved	Saved in instrument state
Min	-5 V
Max	5 V
Default Unit	V
Backwards Compatibility SCPI	:TRIGger[:SEquence]:EXTErnal:LEVel For backward compatibility, the parameter EXTErnal is mapped to EXTErnal1
Backwards Compatibility SCPI	:TRIGger[:SEquence]:FRAME:EXTErnal1:LEVel
Initial S/W Revision	Prior to A.02.00

### Trig Slope

Controls the trigger polarity. It is set positive to trigger on a rising edge and negative to trigger on a falling edge.

Key Path	Trigger, External 1
Remote Command	:TRIGger[:SEquence]:EXTErnal1:SLOPe POSitive NEGative :TRIGger[:SEquence]:EXTErnal1:SLOPe?
Example	TRIG:EXT1:SLOP NEG
Couplings	This same slope is used in the Ext1 selection for the trigger source in the Trigger menu and for the period timer sync source (in the Trigger menu and in the Gate Source menu).
Preset	POSitive
State Saved	Saved in instrument state
Backwards Compatibility SCPI	:TRIGger[:SEquence]:EXTErnal:SLOPe For backward compatibility, the parameter EXTErnal is mapped to EXTErnal1
Backwards Compatibility SCPI	:TRIGger[:SEquence]:FRAME:EXTErnal1:SLOPe
Backwards Compatibility Notes	The legacy :TRIGger[:SEquence]:SLOPe command affects the slopes for the VID, LINE, EXT1, EXT2, and RFB triggers.
Initial S/W Revision	Prior to A.02.00

## External 2

Pressing this key, when it is not selected, selects an external input signal as the trigger. A new sweep/measurement will start when the external trigger condition is met using the external 2 input connector. The external trigger 2 input connector is on the rear panel.

Pressing this key, when it is already selected, accesses the external 2 trigger setup menu.

Key Path	Trigger
<b>Example</b>	TRIG:SOUR EXT2 Swept SA measurement TRIG:<meas>:SOUR EXT2 Measurements other than Swept SA
Dependencies	In some models, there is no second External input. In these models, the External 2 key is blanked and the EXTernal2 parameter will generate a "Hardware missing; Not available for this model number" message. Grayed out if in use by Point Trigger in the Source Setup menu. Forced to Free Run if already selected and Point Trigger is set to External 2.
State Saved	Saved in instrument state
Status Bits/OPC dependencies	The Status Operation Register bit 5 "Waiting for Trigger" is set at the same time as the Sweeping or Measuring bit is set. It is cleared when the trigger actually occurs (that is, after the trigger event occurs and all the applicable trigger criteria have been met). A corresponding pop-up message ("Waiting for trigger") is generated if no trigger signal appears after approximately 2 sec. This message goes away when a trigger signal appears.
Initial S/W Revision	Prior to A.02.00
Modified at S/W Revision	A.03.00

## Trigger Level

Sets the value where the external 2 trigger input will trigger a new sweep/measurement.

Key Path	Trigger, External 2
<b>Remote Command</b>	:TRIGger[:SEquence]:EXTernal2:LEVel :TRIGger[:SEquence]:EXTernal2:LEVel?
<b>Example</b>	TRIG:EXT2:LEV 1.1 V
Couplings	This same level is used for the Ext2 trigger source in the Trigger menu, for the Ext2 selection in the Periodic Timer sync source (in the Trigger menu and in the Gate Source menu), and also for the Ext2 selection in the Gate Source menu.
Preset	1.2 V
State Saved	Saved in instrument state
Min	-5 V
Max	5 V
Default Unit	V
<b>Backwards Compatibility SCPI</b>	:TRIGger[:SEquence]:FRAMe:EXTernal2:LEVel
Initial S/W Revision	Prior to A.02.00

### Trig Slope

Controls the trigger polarity. It is set positive to trigger on a rising edge and negative to trigger on a falling edge.

<b>Key Path</b>	Trigger, External 2
<b>Remote Command</b>	:TRIGger[:SEQuence]:EXTernal2:SLOPe POSitive NEGative :TRIGger[:SEQuence]:EXTernal2:SLOPe?
<b>Example</b>	TRIG:EXT2:SLOP NEG
<b>Couplings</b>	This same slope is used in the Ext2 selection for the trigger source in the Trigger menu and for the period timer sync source (in the Trigger menu and in the Gate Source menu).
<b>Preset</b>	POSitive
<b>State Saved</b>	Saved in instrument state
<b>Backwards Compatibility SCPI</b>	:TRIGger[:SEQuence]:FRAMe:EXTernal2:SLOPe
<b>Backwards Compatibility Notes</b>	The legacy :TRIGger[:SEQuence]:SLOPe command affects the slopes for the VID, LINE, EXT1, EXT2, and RFB triggers.
<b>Initial S/W Revision</b>	Prior to A.02.00

### RF Burst

Pressing this key, when it is not selected, selects the RF Burst as the trigger. A new sweep/measurement will start when an RF burst envelope signal is identified from the signal at the RF Input connector. Pressing this key, when it is already selected, accesses the RF Burst trigger setup menu.

In some models, a variety of burst trigger circuitry is available, resulting in various available burst trigger bandwidths. The analyzer automatically chooses the appropriate trigger path based on the hardware configuration and other settings of the analyzer.

<b>Key Path</b>	Trigger
<b>Example</b>	TRIG:SOUR RFB Swept SA measurement TRIG:< meas>:SOUR RFB Measurements other than Swept SA
<b>State Saved</b>	Saved in instrument state
<b>Status Bits/OPC dependencies</b>	The Status Operation Register bit 5 "Waiting for Trigger" is set at the same time as the Sweeping or Measuring bit is set. It is cleared when the trigger actually occurs (that is, after the trigger event occurs and all the applicable trigger criteria have been met). A corresponding pop-up message ("Waiting for trigger") is generated if no trigger signal appears after approximately 2 sec. This message goes away when a trigger signal appears.
<b>Backwards Compatibility Notes</b>	The legacy command: :TRIGger[:SEQuence]:RFBurst:FSElectivity[:STATe] OFF ON 0 1 is not supported in the X-Series, as the hardware to do Frequency Selective burst triggers does not exist in X-Series.

Initial S/W Revision	Prior to A.02.00
Modified at S/W Revision	A.04.00

### Absolute Trigger Level

Sets the absolute trigger level for the RF burst envelope.

When using the External Mixing path, the Absolute Trigger Level is uncalibrated because the factory default was set to accommodate the expected IF levels for the RF path.

Key Path	Trigger, RF Burst
Scope	Meas Global
<b>Remote Command</b>	:TRIGger[:SEquence]:RFBurst:LEVel:ABSolute <ampl> :TRIGger[:SEquence]:RFBurst:LEVel:ABSolute?
<b>Example</b>	TRIG:RFB:LEV:ABS 10 dBm sets the trigger level of the RF burst envelope signal to the absolute level of 10 dBm
Notes	Sending this command does not switch the setting from relative to absolute; to switch it you need to send the :TRIGger[:SEquence]:RFBurst:LEVel:TYPE command, below.  Amplitude Corrections are not taken into account by the Absolute Trigger Level. For example, if you have given yourself effective gain with an amplitude correction factor, the Absolute Trigger will not fire until you have set the trigger level that far below the displayed signal level, rather than simply to the displayed signal level. This is only true for Amplitude Corrections, not External Gain or Ref Level Offset functions.  If mode is Bluetooth, the default value is -50 dBm.
Couplings	This same level is used for the RF Burst trigger source in the Trigger menu, for the RF Burst selection in the Periodic Timer sync source (in the Trigger menu and in the Gate Source menu), and also for the RF Burst selection in the Gate Source menu
Preset	-20 dBm
State Saved	Saved in instrument state
Min	-200 dBm
Max	100 dBm
Default Unit	depends on the current selected Y-Axis unit
<b>Backwards Compatibility SCPI</b>	:TRIGger[:SEquence]:FRAME:RFBurst:LEVel:ABSolute
Initial S/W Revision	Prior to A.02.00
Modified at S/W Revision	A.04.00

Key Path	Trigger, RF Burst
<b>Remote Command</b>	:TRIGger[:SEquence]:RFBurst:LEVel:TYPE ABSolute RELative :TRIGger[:SEquence]:RFBurst:LEVel:TYPE?

<b>Example</b>	TRIG:RFB:LEV:TYPE REL sets the trigger level type of the RF burst trigger to Relative.
Preset	ABSolute
State Saved	Saved in instrument state
Initial S/W Revision	Prior to A.02.00
Modified at S/W Revision	A.04.00

### Trigger Slope

It is set positive to trigger on a rising edge and negative to trigger on a falling edge.

Key Path	Trigger, RF Burst
<b>Remote Command</b>	:TRIGger[:SEquence]:RFBurst:SLOPe POSitive NEGative :TRIGger[:SEquence]:RFBurst:SLOPe?
<b>Example</b>	TRIG:RFB:SLOP NEG
Couplings	This same slope is used in the RF Burst selection for the trigger source in the Trigger menu and for the period timer sync source (in the Trigger menu and in the Gate Source menu).
Preset	POSitive
State Saved	Saved in instrument state
<b>Backwards Compatibility SCPI</b>	:TRIGger[:SEquence]:FRAME:RFBurst:SLOPe
Backwards Compatibility Notes	The legacy :TRIGger[:SEquence]:SLOPe command affects the slopes for the VID, LINE, EXT1, EXT2, and RFB triggers.
Initial S/W Revision	Prior to A.02.00

### Sync Holdoff

Sync Holdoff specifies the duration that the sync source signal must be kept false before the transition to true to be recognized as the sync timing. The periodic timer phase is aligned when the sync source signal becomes true, after the Holdoff time is satisfied.

A holdoff of 2 ms will work with most WiMAX signals, but there may be cases where the burst off duration is less than 1 ms and this value will need to be changed.

Key Path	Trigger, Periodic Timer
<b>Remote Command</b>	:TRIGger[:SEquence]:FRAME:SYNC:HOLDoff <time> :TRIGger[:SEquence]:FRAME:SYNC:HOLDoff? :TRIGger[:SEquence]:FRAME:SYNC:HOLDoff:STATE OFF ON 0 1 :TRIGger[:SEquence]:FRAME:SYNC:HOLDoff:STATE?
Preset	On, 1.000 ms



State Saved	Saved in instrument state
Min	0 ms
Max	+500 ms
Default Unit	s
Initial S/W Revision	Prior to A.02.00

## Control Edge/Level

Sets the method of controlling the gating function from the gating signal.

### Edge

In Edge triggering, the gate opens (after the Delay) on the selected edge (for example, positive) of the gate signal and closes on the alternate edge (for example, negative).

### Level

In Level triggering, the gate opens (after the Delay) when the gate signal has achieved a certain level and stays open as long as that level is maintained.

Key Path	Sweep/Control, Gate
Remote Command	[ :SENSe ] :SWEep:EGATe:CONTRol EDGE LEVe1 [ :SENSe ] :SWEep:EGATe:CONTRol?
Example	SWE:EGAT:CONT EDGE
Dependencies	If the Gate Method is FFT the Control key is grayed out and Edge is selected. If the Gate Source is TV, Frame or Line, the Control key is grayed out and Edge is selected.
Preset	EDGE
State Saved	Saved in instrument state
Backwards Compatibility SCPI	[ :SENSe ] :SWEep:TIME:GATE:TYPE ESA Compatibility
Initial S/W Revision	Prior to A.02.00

## Gate Holdoff

Lets you increase or decrease the wait time after a gate event ends before the analyzer will respond to the next gate signal.

After any Gate event finishes, the analyzer must wait for the sweep system to settle before it can respond to another Gate signal. The analyzer calculates a "wait time," taking into account a number of factors, including RBW and Phase Noise Optimization settings. The goal is to achieve the same accuracy when gated as in ungated operation. The figure below illustrates this concept:

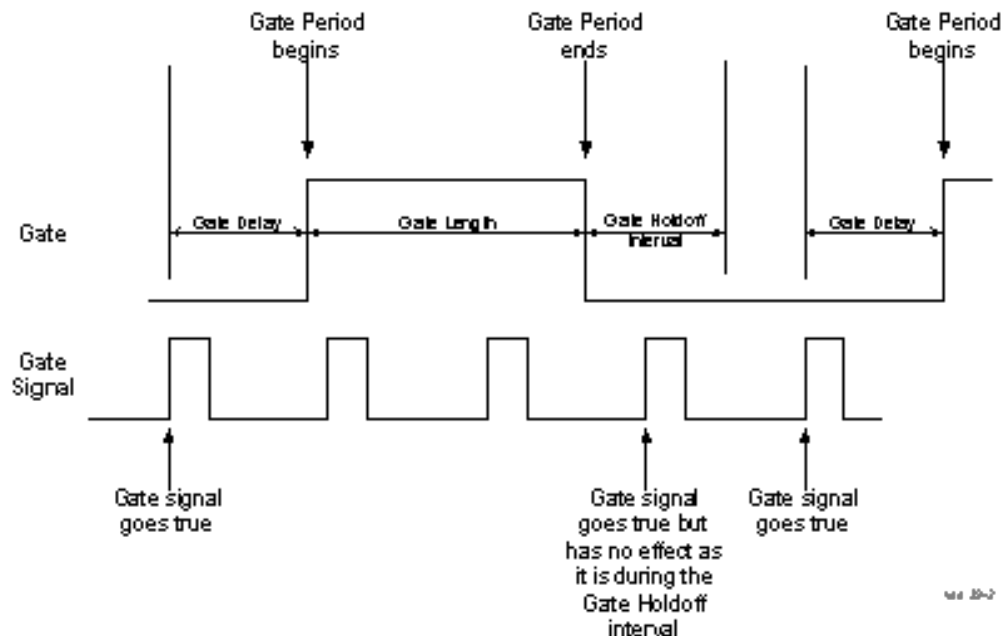

When Gate Holdoff is in Auto, the wait time calculated by the analyzer is used. When Gate Time is in Manual, the user may adjust the wait time, usually decreasing it in order to achieve greater speed, but at the risk of decreasing accuracy.

When the Method key is set to Video or FFT, the Gate Holdoff function has no effect.

In measurements that do not support Auto, the value shown when Auto is selected is “---” and the manually set holdoff is returned to a query.

Key Path	Sweep/Control, Gate
<b>Remote Command</b>	<pre>[ :SENSe ] :SWEep:EGATe:HOLDoff &lt;time&gt; [ :SENSe ] :SWEep:EGATe:HOLDoff? [ :SENSe ] :SWEep:EGATe:HOLDoff:AUTO OFF ON 0 1 [ :SENSe ] :SWEep:EGATe:HOLDoff:AUTO?</pre>
<b>Example</b>	<pre>SWE:EGAT:HOLD 0.0002 SWE:EGAT:HOLD? SWE:EGAT:HOLD:AUTO ON SWE:EGAT:HOLD:AUTO?</pre>
<b>Couplings</b>	<p>When Gate Holdoff is Auto, the Gate Holdoff key shows the value calculated by the analyzer for the wait time.</p> <p>Pressing the Gate Holdoff key while it is in Auto and not selected, causes the key to become selected and allows the user to adjust the value. If the value is adjusted, the setting changes to Man.</p> <p>Pressing the Gate Holdoff key, while it is in Auto and selected, does not change the value of Gate Holdoff, but causes the setting to change to Man. Now the user can adjust the value.</p> <p>Pressing the key while it is in Man and selected, cause the value to change back to Auto.</p> <p>Pressing the key while it is in Man and not selected, causes the key to become selected and allows the user to adjust the value.</p>

	When Method is set to Video or FFT, the Gate Holdoff function has no effect.
Preset	Auto Auto/On
State Saved	Saved in instrument state
Min	1 $\mu$ sec
Max	1 sec
Initial S/W Revision	Prior to A.02.00

## Gate Delay Compensation

This function allows you to select an RBW-dependent value by which to adjust the gate delay, to compensate for changes in the delay caused by RBW effects.

You can select between uncompensated operation and two types of compensation, Delay Until RBW Settled and Compensate for RBW Group Delay.

See ["More Information" on page 2068](#)

Key Path	Sweep/Control, Gate
Scope	Meas Global
Remote Command	[ :SENSe ] :SWEep:EGATe:DELaY:COMPensation:TYPE OFF   SETTled   GDELaY [ :SENSe ] :SWEep:EGATe:DELaY:COMPensation:TYPE?
Example	SWE:EGAT:DEL:COMP:TYPE SETT SWE:EGAT:DEL:COMP:TYPE?
Notes	Although this function is Meas Global, there are some measurements that do not support this function. In those measurements the operation will be Uncompensated. Going into one of those measurements will not change the Meas Global selection; it will simply display the grayed-out menu key with "Uncompensated" showing as the selection. This is a non-forceful grayout, so the SCPI command is still accepted.  If Gate Delay Compensation is not supported at all within a particular mode, the key is not displayed, and if the SCPI command is sent while in a measurement within that mode, an "Undefined Header" message is generated.  Measurements that do not support this function include: Swept SA
Preset	TD-SCDMA mode: Compensate for RBW Group Delay All other modes: Delay Until RBW Settled
State Saved	Saved in instrument state
Range	Uncompensated Delay Until RBW Settled Compensate for RBW Group Delay
Readback text	Uncompensated Settled Group Delay
Initial S/W Revision	Prior to A.02.00
Modified at S/W Revision	A.11.0

## More Information

Selecting Uncompensated means that the actual gate delay is as you sets it.

Selecting Delay Until RBW Settled causes the gate delay to be increased above the user setting by an amount equal to  $3.06/\text{RBW}$ . This compensated delay causes the GATE START and GATE STOP lines on the display to move by the compensation amount, and the actual hardware gate delay to be increased by the same amount. All the other gate lines (for example, MIN FAST) are unaffected. If the RBW subsequently changes, the compensation is readjusted for the new RBW. The value shown on the Gate Delay key does NOT change.

Delay Until RBW Settled allows excellent measurements of gated signals, by allowing the IF to settle following any transient that affects the burst. Excellent measurements also require that the analysis region not extend into the region affected by the falling edge of the burst. Thus, excellent measurements can only be made over a width that declines with narrowing RBWs, which is achieved by decreasing the gate length below the user setting by an amount equal to  $2.53/\text{RBW}$ . Therefore, for general purpose compensation, you will still want to change the gate length with changes in RBW even if the gate delay is compensated. The compensated Gate Length is limited by the analyzer so that it will never go below 10% of the value shown on the Gate Length key, as otherwise the sweep times could get very long. Anytime the Gate Length and RBW values combine in such a way that this limiting takes place, a warning is displayed. For measurements which contain multiple sweeps with different RBW like SEM and SPUR, the smallest RBW is used for this limiting.

Selecting Compensate for RBW Group Delay causes the gate delay to be increased above the user setting by an amount equal to  $1.81/\text{RBW}$ . This compensated delay causes the GATE START, GATE STOP lines on the display to move by the compensation amount, and the actual hardware gate delay to be increased by the same amount. All the other gate lines (for example, MIN FAST) are unaffected. If the RBW subsequently changes, the compensation is readjusted for the new RBW. The value shown on the Gate Delay key does NOT change. Compensate for RBW Group Delay also includes gate length compensation; the gate length itself is adjusted as necessary to attempt to compensate for delay effects imposed by the RBW.

Compensate for RBW Group Delay is similar to Delay Until RBW Settled, but compensates for the group delay of the RBW filter, rather than the filter settling time. As the RBW gets narrow, this can allow the settling tail of the RBW to affect the beginning part of the gated measurement, and allow the beginning of the RBW settling transient to affect the end of the gated measurement. These two effects are symmetric because the RBW response is symmetric. Because the gate length is not automatically compensated, some users might find this compensation to be more intuitive than compensation for RBW settling.

## Min Fast Position Query (Remote Command Only)

This command queries the position of the MIN FAST line, relative to the delay reference (REF) line. See section ["Gate View On/Off" on page 2040](#). If this query is sent while not in gate view, the MinFast calculation is performed based on the current values of the appropriate parameters and the result is returned. Knowing this value lets you set an optimal gate delay value for the current measurement setup.

<b>Remote Command</b>	<code>[ :SENSe ] :SWEep:EGATe:MINFast?</code>
<b>Example</b>	<code>SWE:EGAT:MIN?</code>
<b>Initial S/W Revision</b>	Prior to A.02.00

### Gate Preset (Remote Command Only)

Presets the time-gated spectrum analysis capability.

This command sets gate parameter values to the ESA preset values, as follows:

Gate trigger type = edge

Gate polarity = positive

Gate delay = 1 us

Gate length = 1 us

<b>Remote Command</b>	<code>[[:SENSe]:SWEep:TIME:GATE:PRESet</code> ESA Compatibility
Initial S/W Revision	Prior to A.02.00

### Gate Level (Remote Command Only)

Sets the gate input transition point level for the external TRIGGER inputs on the front and rear panel. This is a legacy command for PSA compatibility. It is simply an alias to the equivalent trigger level command.

<b>Remote Command</b>	<code>[[:SENSe]:SWEep:EGATE:EXTernal[1] 2:LEVel &lt;voltage&gt;</code> <code>[[:SENSe]:SWEep:EGATE:EXTernal[1] 2:LEVel?</code>
Notes	This command is simply an alias to <code>:TRIGger[:SEQUence]:EXTernal[1] 2:LEVel</code> For details refer
Initial S/W Revision	Prior to A.02.00

### Gate Polarity (Remote Command Only)

Sets the polarity for the gate signal. This setup is now done using the gate trigger's slope setting.

When Positive (Pos) is selected, a positive-going edge (Edge) or a high voltage (Level) will satisfy the gate condition, after the delay set with the Gate Delay key. When Negative (Neg) is selected, a negative-going edge (Edge) or a low voltage (Level) will satisfy the gate condition after the delay.

<b>Remote Command</b>	<code>[[:SENSe]:SWEep:EGATE:POLarity</code> NEGative POSitive <code>[[:SENSe]:SWEep:EGATE:POLarity?</code>
<b>Example</b>	<code>SWE:EGAT:POL NEG</code> <code>SWE:EGAT:POL?</code>
Preset	POSitive
State Saved	Saved in instrument state
<b>Backwards Compatibility SCPI</b>	<code>[[:SENSe]:SWEep:TIME:GATE:POLarity</code> ESA compatibility
Initial S/W Revision	Prior to A.02.00

<b>Remote Command</b>	<code>[ :SENSe ] :SWEep:TIME:GATE:LEVel HIGH LOW</code> <code>[ :SENSe ] :SWEep:TIME:GATE:LEVel?</code> ESA compatibility
Preset	HIGH
Initial S/W Revision	Prior to A.02.00

## Points

Sets the number of points per sweep. The resolution of setting the sweep time depends on the number of points selected. If Preset is selected, the number of points per sweep defaults to 1001. The current value of points is displayed parenthetically, next to the sweep time in the lower right corner of the display.

Key Path	Sweep/Control
Mode	All except SA and BASIC
<b>Remote Command</b>	<code>[ :SENSe ] :MONitor:SWEep:POINts &lt;integer&gt;</code> <code>[ :SENSe ] :MONitor:SWEep:POINts?</code>
<b>Example</b>	<code>:MON:SWE:POIN 1000</code> <code>:MON:SWE:POIN?</code>
Couplings	Whenever the number of sweep points changes, the sweep time is re-quantized.
Preset	1001
State Saved	Saved in instrument state.
Range	1 to 20001
Min	1
Max	20001
Initial S/W Revision	Prior to A.02.00

## System

See "System" on page 342

## Trace/Detector

Accesses a menu that enables you to control the display, storage, detection and manipulation of trace data. Each trace is comprised of a series of data points in which X and Y axis information is stored. The analyzer updates the information for the active trace with each sweep of the current measurement.

Key Path	Front-panel key
Initial S/W Revision	Prior to A.02.00

### Select Trace

Allows you to select which trace you want to use for the current measurement. You can select one of three traces. Monitor Spectrum supports 3 traces, numbered 1 through 3.

Key Path	Trace/Detector
Mode	All except SA and BASIC
Preset	Trace 1
State Saved	The number of the selected trace is saved in Instrument State
Initial S/W Revision	Prior to A.02.00

### Trace Type

Allows you to select the type of trace you want to use for the current measurement. You can assign a trace type to one of the three available traces.

The first page of this menu contains a 1-of-N selection of the trace type for the selected trace:

WRITe	Clear Write
AVERAge	Average
MAXHold	Max Hold
MINHold	Min Hold

Key Path	Trace/Detector
Mode	All except SA and BASIC
<b>Remote Command</b>	:TRACe[1] 2 3:MONitor:TYPE WRITe AVERAge MAXHold MINHold :TRACe[1] 2 3:MONitor:TYPE?
<b>Example</b>	TRAC:MON:TYPE WRIT TRAC:MON:TYPE?
Preset	WRITe
State Saved	Saved in instrument state.



Range	WRITe AVERAge MAXHold MINHold for traces 1 through 3
<b>Backwards Compatibility SCPI</b>	:DISPlay:MONitor:VIEW:WINDow:TRACe [1]   2   3 :TYPE
Initial S/W Revision	Prior to A.02.00

## Update

Toggles a trace state between Update and Off. The Off selection makes the trace inactive (or a *stored trace*). This does not affect whether the trace is visible or not. To change the trace visibility, see "[Display](#)" on page 2073.

Key Path	Trace/Detector
Mode	All except SA and BASIC
<b>Remote Command</b>	:TRACe [1]   2   3 :MONitor:UPDate[:STATe] ON OFF 0 1 :TRACe [1]   2   3 :MONitor:UPDate[:STATe]?
<b>Example</b>	TRAC3:MON:UPD OFF TRAC3:MON:UPD?
Preset	ON
State Saved	Saved in instrument state.
Range	On Off(View)
Initial S/W Revision	Prior to A.02.00

## Display

Controls the visibility of a trace. When set to Blank, traces do not display nor appear on printouts but are otherwise unaffected. They may be queried and markers may be placed on them.

Key Path	Trace/Detector
Mode	All except SA and BASIC
<b>Remote Command</b>	:TRACe [1]   2   3 :MONitor:DISPlay[:STATe] ON OFF 0 1 :TRACe [1]   2   3 :MONitor:DISPlay[:STATe]?
<b>Example</b>	TRAC:MON:DISP ON TRAC:MON:DISP?
Preset	ON OFF OFF
State Saved	Saved in instrument state.
Range	Show Blank
Initial S/W Revision	Prior to A.02.00

## Detector

Accesses a menu of functions that enable you to control the detectors for the current measurement. The following choices are available:

- **Auto** – the detector selected depends on marker functions, trace functions, average type, and the trace averaging function. See "[Auto](#)" on page 2075.
- **Normal** – the detector determines the peak of the CW-like signals, and it yields alternating maximums and minimums of noise-like signals. This is also referred to as Rosenfell detection.
- **Average** – the detector determines the average of the signal within the sweep points. The averaging method depends upon the Average Type selection (voltage, power or log scales).
- **Peak** – the detector determines the maximum of the signal within the sweep points.
- **Sample** – the detector indicates the instantaneous level of the signal at the center of the sweep points represented by each display point.
- **Negative Peak** – the detector determines the minimum of the signal within the sweep points.

In swept analysis, the time interval of the data collection for the display sweep points also represents a frequency interval. In FFT analysis, the sweep points represent just a frequency interval. The detector determines the relationship between the spectrum computed by the FFT and the single data point displayed for the sweep points.

Key Path	Trace/Detector
Mode	All except SA and BASIC
Remote Command	<code>[ :SENSe ] :MONitor :DETector :TRACe AVERage   NEGative   NORMal   POSitive   SAMPle  [ :SENSe ] :MONitor :DETector :TRACe?</code>
Example	<code>MON:DET:TRAC NORM MON:DET:TRAC?</code>
Notes	The query returns a name that corresponds to the detector type as shown below. String Returned - Definition <ul style="list-style-type: none"> <li>• NORM - Normal</li> <li>• AVER - Average</li> <li>• POS - Peak</li> <li>• SAMP - Sample</li> <li>• NEG - Negative Peak</li> </ul>
Couplings	When the Detector choice is Auto, the detector selected depends on average type.
Preset	NORMal
State Saved	Saved in instrument state.
Range	Normal Average(RMS) Peak Sample Negative Peak
Backwards Compatibility SCPI	<code>[ :SENSe ] :MONitor :DETector [ :FUNction ]</code>
Initial S/W Revision	Prior to A.02.00

## Auto

Sets the detector for the currently selected trace to Auto. When the detector choice is Auto, the analyzer selects the detector. The selected detector depends on marker functions, trace functions, and trace averaging functions for the current measurement.

Key Path	Trace/DetectorTrace/Detector, Detector
Mode	All except SA and BASIC
<b>Remote Command</b>	<code>[ :SENSe ] :MONitor :DETECTOR :AUTO ON   OFF   1   0</code> <code>[ :SENSe ] :MONitor :DETECTOR :AUTO ?</code>
<b>Example</b>	<code>MON:DET:AUTO OFF</code> <code>MON:DET:AUTO ?</code>
Couplings	When the Detector choice is Auto, the detector selected depends on average state and trace type.
Preset	ON
State Saved	Saved in instrument state.
Range	Auto Man
Initial S/W Revision	Prior to A.02.00

## Clear Trace

Clears the selected trace from the display.

Key Path	Trace/Detector
Mode	All except SA and BASIC
<b>Remote Command</b>	<code>:TRACe :MONitor :CLEAr [TRACE1]   TRACE2   TRACE3</code>
<b>Example</b>	<code>TRAC:MON:CLE</code>
Initial S/W Revision	Prior to A.02.00

Mode	All except SA and BASIC
<b>Remote Command</b>	<code>:DISPlay :MONitor :VIEW :WINDow :TRACe [1]   2   3 :CLEAr</code>
<b>Example</b>	<code>DISP:MON:VIEW:WIND:TRAC:CLE</code>
Initial S/W Revision	Prior to A.02.00

## Clear All Traces

Clears all traces from the display.

Key Path	Trace/Detector
Mode	All except SA and BASIC

---

<b>Remote Command</b>	:TRACe:MONitor:CLEar:ALL
<b>Example</b>	TRAC:MON:CLE:ALL
<b>Backwards Compatibility SCPI</b>	:DISPlay:MONitor:VIEW:WINDow:TRACe:CLEar:ALL
<b>Initial S/W Revision</b>	Prior to A.02.00

---

## Trigger

See ["Trigger" on page 412](#)

### Free Run

See ["Free Run " on page 419](#)

### Video

See ["Video \(IF Envelope\) " on page 420](#)

### Trigger Level

See ["Trigger Level " on page 420](#)

### Trig Slope

See ["Trig Slope " on page 421](#)

### Trig Delay

See ["Trig Delay " on page 422](#)

### Line

See ["Line " on page 2047](#)

### Trig Slope

See ["Trig Slope " on page 2047](#)

### Trig Delay

See ["Trig Delay " on page 424](#)

### External 1

See ["External 1 " on page 2059](#)

### Trigger Level

See ["Trigger Level " on page 2059](#)

### Trig Slope

See ["Trig Slope " on page 2060](#)

### Trig Delay

See ["Trig Delay " on page 427](#)

### External 2

See ["External 2 " on page 2061](#)

### **Trigger Level**

See ["Trigger Level "](#) on page 2061

### **Trig Slope**

See ["Trig Slope "](#) on page 2062

### **Trig Delay**

See ["Trig Delay "](#) on page 429

### **RF Burst**

See ["RF Burst "](#) on page 2062

### **Absolute Trigger**

See ["Absolute Trigger Level"](#) on page 2063

### **Relative Trigger**

See ["Relative Trigger Level"](#) on page 2052

### **Trig Slope**

See ["Trigger Slope "](#) on page 2064

### **Trig Delay**

See ["Trig Delay "](#) on page 433

### **Periodic Timer**

See ["Periodic Timer \(Frame Trigger\) "](#) on page 2054

### **Period**

See ["Period "](#) on page 2055

### **Offset**

See ["Offset "](#) on page 2056

### **Reset Offset Display**

See ["Reset Offset Display "](#) on page 2058

### **Sync Source**

See ["Sync Source "](#) on page 2058

### **Off**

See ["Off "](#) on page 2059

### External 1

See "External 1 " on page 2059

#### Trigger Level

See "Trigger Level " on page 2059

#### Trig Slope

See "Trig Slope " on page 2060

### External 2

See "External 2 " on page 2061

#### Trigger Level

See "Trigger Level " on page 2061

#### Trig Slope

See "Trig Slope " on page 2062

### RF Burst

See "RF Burst " on page 2062

### Absolute Trigger

See "Absolute Trigger Level" on page 2063

#### Trig Slope

See "Trigger Slope " on page 2064

### Trig Delay

See "Trig Delay" on page 443

### Auto/Holdoff

See "Auto/Holdoff " on page 444

### Auto Trig

See "Auto Trig " on page 444

### Trig Holdoff

See "Trig Holdoff " on page 445

## User Preset

Accesses a menu that gives you the following three choices:

- User Preset – recalls a state previously saved using the Save User Preset function.
- User Preset All Modes – presets all of the modes in the analyzer
- Save User Preset– saves the current state for the current mode

Key Path	Front-panel key
Backwards Compatibility Notes	<p>User Preset is actually loading a state, and in legacy analyzers, it was possible to load a state without affecting the trace data, limit lines or correction data. Similarly it was possible to do a User Preset without affecting the trace data, limit lines or correction data.</p> <p>In the X-Series, “state” always includes all of this data; so whenever state is loaded, or User Preset is executed, all of the traces, limit lines and corrections are affected. Although this differs from previous behavior, it is desirable behavior, and should not cause adverse issues for users.</p> <p>On ESA and PSA, User Preset affected the entire instrument’s state. In the X-Series, User Preset only recalls the state for the active mode. There is a User Preset file for each mode. User Preset can never cause a mode switch as it can in legacy analyzers. If you want to recall all modes to their user preset file state, you will need to do a User Preset after mode switching into each mode.</p> <p>User Preset recalls mode state which can now include data like traces; whereas on ESA and PSA, User Preset did not affect data.</p>
Initial S/W Revision	Prior to A.02.00

## User Preset

User Preset sets the state of the currently active mode back to the state that was previously saved for this mode using the Save User Preset menu key or the SCPI command, SYST:PRES:USER:SAV. It not only recalls the Mode Preset settings, but it also recalls all of the mode persistent settings, and the Input/Output system setting that existed at the time Save User Preset was executed.

If a Save User Preset has not been done at any time, User Preset recalls the default user preset file for the currently active mode. The default user preset files are created if, at power-on, a mode detects there is no user preset file. There will never be a scenario when there is no user preset file to restore. For each mode, the default user preset state is the same state that would be saved if a Save User Preset is performed in each mode right after doing a Restore Mode Default and after a Restore Input/Output Defaults.

The User Preset function does the following:

- Aborts the currently running measurement.
- Sets the mode State to the values defined by Save User Preset.
- Makes the saved measurement for the currently running mode the active measurement.
- Brings up the saved menu for the power-on mode.
- Clears the input and output buffers.
- Sets the Status Byte to 0.



Key Path	User Preset
<b>Remote Command</b>	:SYSTem:PRESet:USER
<b>Example</b>	:SYST:PRES:USER:SAVE:SYST:PRES:USER
Notes	:SYST:PRES:USER:SAVE is used to save the current state as the user preset state. Clears all pending OPC bits. The Status Byte is set to 0. Pressing the User Preset front-panel key while already in the User Preset menu will cause the User Preset to get executed
Couplings	A user preset will cause the currently running measurement to be aborted and cause the saved measurement to be active. Recalling a User Preset file has the same issues that recalling a Save State file has. Some settings may need to be limited and therefore re-coupled, since the capabilities of the mode may have changes when the User Preset file was last saved.
Initial S/W Revision	Prior to A.02.00

## User Preset All Modes

Recalls all of the User Preset files for each mode, switches to the power-on mode, and activates the saved measurement from the power-on mode User Preset file.

**NOTE**

When the instrument is secured, all of the user preset files are converted back to their default user preset files.

The User Preset function does the following:

- Aborts the currently running measurement.
- Switches the Mode to the power-on mode.
- Restores the User Preset files for each mode.
- Makes the saved measurement for the power-on mode the active measurement.
- Brings up the saved menu for the power-on mode.
- Clears the input and output buffers.
- Sets the Status Byte to 0.

Key Path	User Preset
<b>Remote Command</b>	:SYSTem:PRESet:USER:ALL
<b>Example</b>	:SYST:PRES:USER:SAVE:SYST:PRES:USER:ALL
Notes	Clears all pending OPC bits. The Status Byte is set to 0. :SYST:PRES:USER:SAVE is used to save the current state as the user preset state.
Couplings	A user preset will cause the currently running measurement to be aborted, cause a mode switch to the power-on mode, and cause the saved measurement to be active in the power-on mode. Recalling a User Preset file has the same issues that recalling a Save State file has. Some settings may need to be limited and therefore re-coupled, since the capabilities of the mode may have changes when the User Preset file was last saved.
Initial S/W Revision	Prior to A.02.00

## Save User Preset

Saves the currently active mode and its State. You can recall this User Preset file by pressing the User Preset menu key or sending the SYST:PRES:USER remote command. This same state is also saved by the Save State function.

Key Path	User Preset
Remote Command	:SYSTem:PRESet:USER:SAVE
Example	:SYST:PRES:USER:SAVE
Notes	:SYST:PRES:SAVE creates the same file as if the user requested a *SAV or a MMEM:STOR:STAT, except User Preset Save does not allow the user to specify the filename or the location of the file.
Initial S/W Revision	Prior to A.02.00

## View/Display

Accesses a menu of functions that enable you to control certain functions related to the display of the analyzer.

The available views and related commands depend on the currently-selected mode. This section includes the following topics:

- "View for all modes except MSR, 1xEV-DO, LTE-Advanced FDD/TDD" on page 2083, LTE-Advanced FDD/TDD
- "1xEV-DO Mode View" on page 2084
- "MSR and LTE-Advanced FDD/TDD Mode Views" on page 2084
- "View Selection by Name (MSR and LTE-Advanced FDD/TDD mode only)" on page 2085
- "View Selection by Number (MSR and LTE-Advanced FDD/TDD mode only)" on page 2085

### View for all modes except MSR, 1xEV-DO, LTE-Advanced FDD/TDD

When the current mode is **not** MSR, LTE-Advanced FDD/TDD or 1xEV-DO, there is a single trace view for this measurement, as shown below:

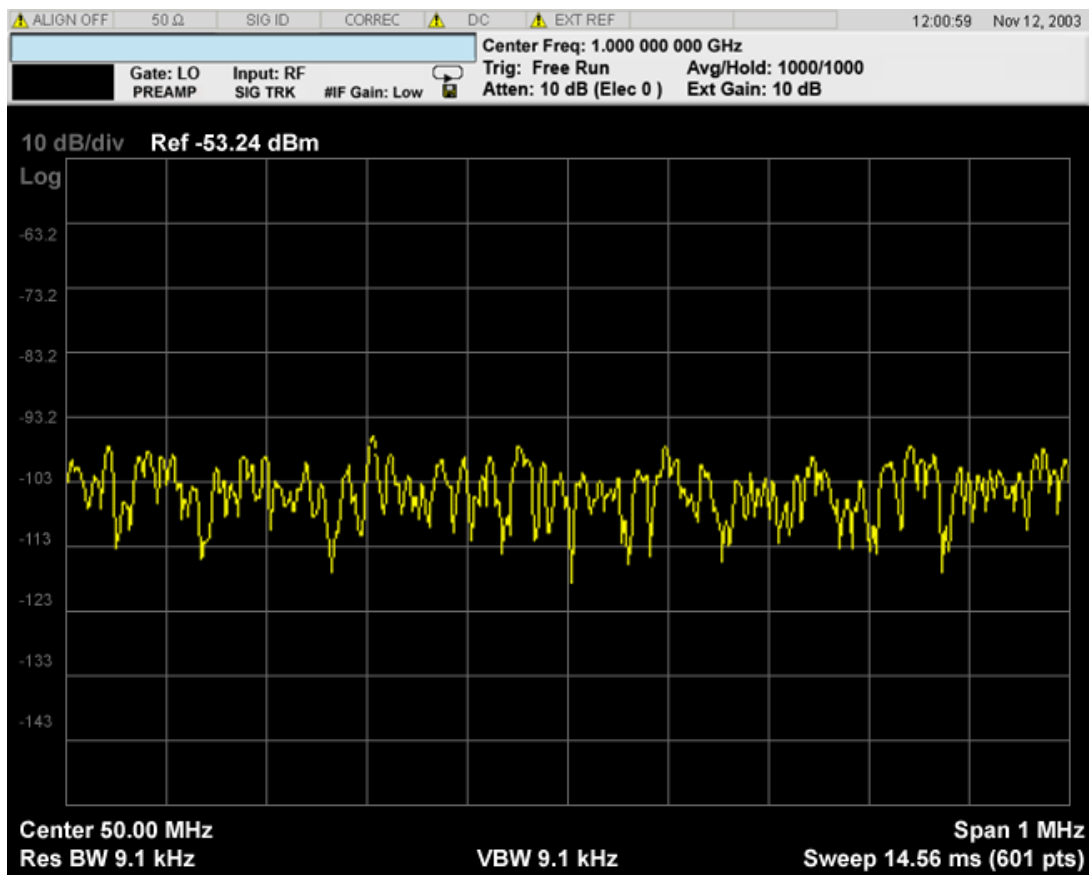

### 1xEV-DO Mode View

When the current mode is 1xEV-DO, a single view is available, as shown in the example below:

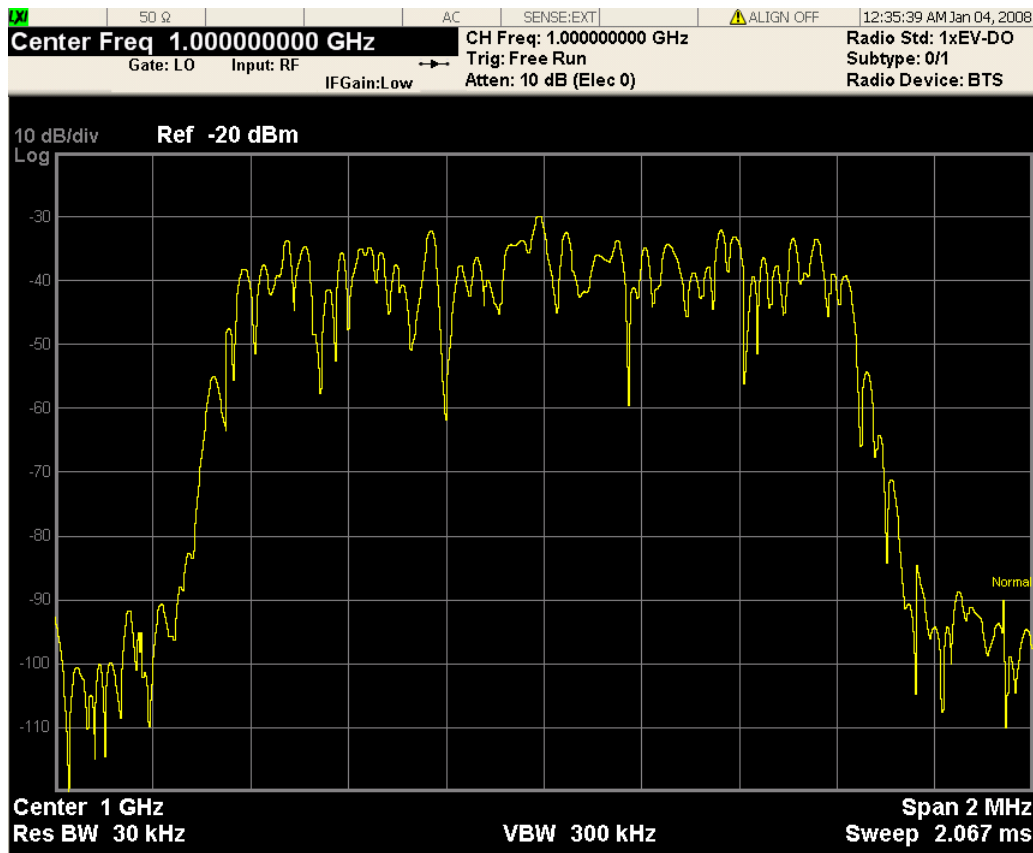

The measurement has no results, but has a number of features that make it flexible and simple to use.

### MSR and LTE-Advanced FDD/TDD Mode Views

When the current mode is MSR and LTE-Advanced FDD/TDD, there are two views, Result Trace and Carrier Info, as described in the table below. The Result Trace view is the same as the common Monitor Spectrum view in other modes. Carrier Info is available on the spectrum trace.

<b>Result Trace</b>	<p>The spectrum trace and power bars are displayed in the upper window. Carrier and offset powers are summarized in the lower window.</p> <p>For more details, see <a href="#">Result Trace (MSR and LTE-Advanced FDD/TDD mode only)</a>.</p>
<b>Carrier Info</b>	<p>Carrier center frequency can be displayed in either offset or absolute frequency depending on Carrier Freq. The table can be scrolled by Select Carrier in the Config Carriers menu. The highlighted row changes as Select Carrier is changed. The highlighted row and Select Carrier are not coupled.</p> <p>For more details, see <a href="#">Carrier Info (MSR and LTE-Advanced FDD/TDD mode only)</a>.</p>

## View Selection by Name (MSR and LTE-Advanced FDD/TDD mode only)

Key Path	Display
Mode	MSR, LTEAFDD, LTEATDD
<b>Remote Command</b>	:DISPlay:MONitor:VIEW[:SElect] RTRace CINformation :DISPlay:MONitor:VIEW[:SElect]?
<b>Example</b>	DISP:MON:VIEW RTR DISP:MON:VIEW?
Preset	RTRace
State Saved	Saved in instrument state
Range	Power Results Carrier Info
Initial S/W Revision	A.10.00

## View Selection by Number (MSR and LTE-Advanced FDD/TDD mode only)

Key Path	DISP:MON:VIEW
Mode	MSR, LTEAFDD, LTEATDD
<b>Remote Command</b>	:DISPlay:MONitor:VIEW:NSElect <integer> :DISPlay:MONitor:VIEW:NSElect?
<b>Example</b>	DISP:MON:VIEW:NSEL 1 DISP:MON:VIEW:NSEL?
Preset	1
State Saved	Saved in instrument state
Min	1
Max	2
Initial S/W Revision	A.10.00

Key Path	Front-panel key
Initial S/W Revision	Prior to A.02.00

## Display

The Display menu is common to most measurements, and is used for configuring items on the display. Some Display menu settings apply to all the measurements in a mode, and some only to the current measurement. Those under the System Display Settings key apply to all measurements in all modes.

Key Path	Display
Key Path	View/Display
Initial S/W Revision	Prior to A.02.00

### Annotation

Turns on and off various parts of the display annotation. The annotation is divided up into four categories:

1. Meas Bar: This is the measurement bar at the top of the screen. It does not include the settings panel or the Active Function. Turning off the Meas Bar turns off the settings panel and the Active Function. When the Meas Bar is off, the graticule area expands to fill the area formerly occupied by the Meas Bar.
2. Screen Annotation: this is the annotation and annunciation around the graticule, including any annotation on lines (such as the display line, the threshold line, etc.) This does NOT include the marker number or the N dB result. When off, the graticule expands to fill the entire graticule area.
3. Trace annotation: these are the labels on the traces, showing their detector (or their math mode).
4. Active Function annotation: this is the active function display in the meas bar, and all of the active function values displayed on softkeys.

See the figure below. Each type of annotation can be turned on and off individually.

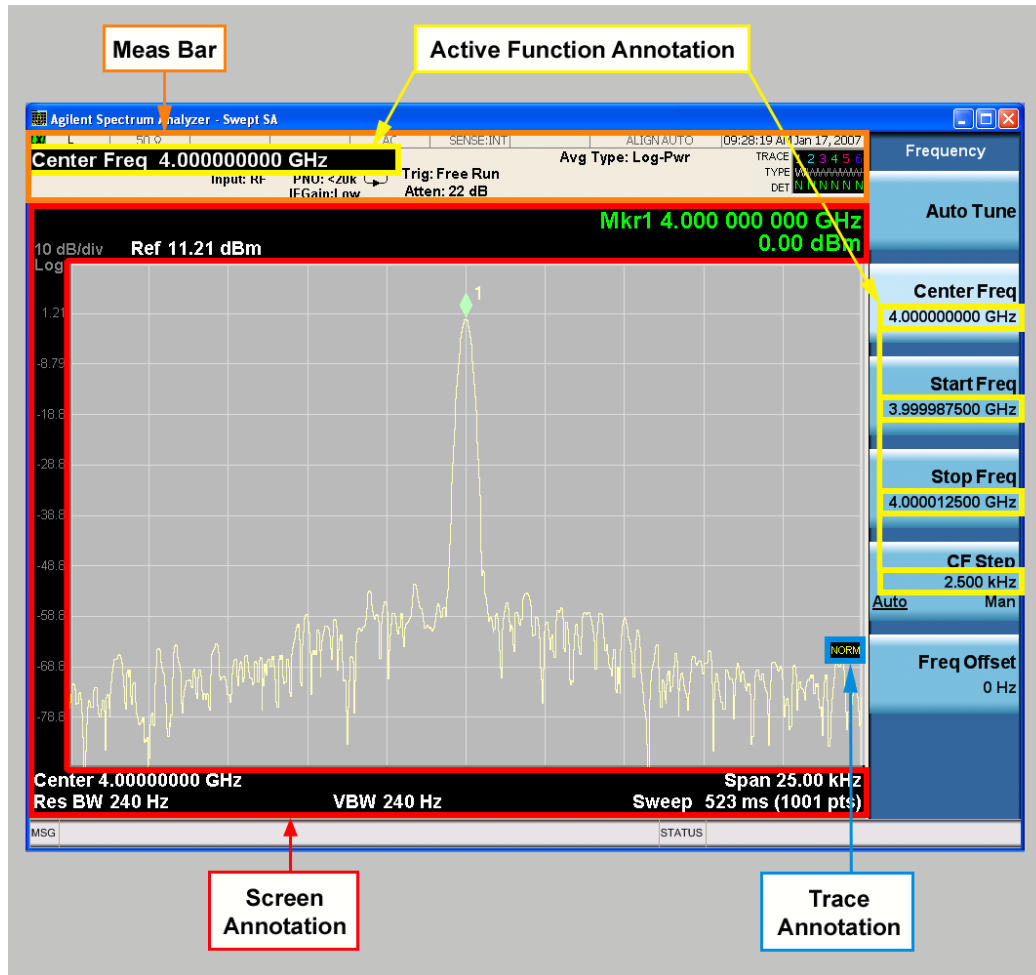

Key Path	View/Display, Display
Initial S/W Revision	Prior to A.02.00

## Meas Bar On/Off

This function turns the Measurement Bar on and off, including the settings panel. When off, the graticule area expands to fill the area formerly occupied by the Measurement Bar.

Key Path	View/Display, Display, Annotation
Remote Command	:DISPlay:ANNotation:MBAR[:STATe] OFF ON 0 1 :DISPlay:ANNotation:MBAR[:STATe]?
Example	DISP:ANN:MBAR OFF
Dependencies	Grayed out and forced to OFF when System Display Settings, Annotation is set to Off.
Preset	On This should remain Off through a Preset when System DisplaySettings, Annotation is set to Off.
State Saved	Saved in instrument state.
Initial S/W Revision	Prior to A.02.00

## Screen

This controls the display of the annunciation and annotation around the graticule, including any annotation on lines (such as the display line, the threshold line, etc.) and the y-axis annotation. This does NOT include marker annotation (or the N dB result). When off, the graticule expands to fill the entire graticule area, leaving only the 1.5% gap above the graticule as described in the Trace/Detector chapter.

Key Path	View/Display, Display, Annotation
Remote Command	:DISPlay:ANNotation:SCReen[:STATe] OFF ON 0 1 :DISPlay:ANNotation:SCReen[:STATe]?
Example	DISP:ANN:SCR OFF
Dependencies	Grayed-out and forced to OFF when System Display Settings, Annotation is set to Off.
Preset	On This should remain Off through a Preset when System DisplaySettings, Annotation is set to Off
State Saved	Saved in instrument state.
Initial S/W Revision	Prior to A.02.00

## Active Function Values On/Off

Turns on and off the active function display in the Meas Bar, and all of the active function values displayed on the softkeys.

Note that all of the softkeys that have active functions have these numeric values blanked when this function is on. This is a security feature..

15 Monitor Spectrum Measurement  
View/Display

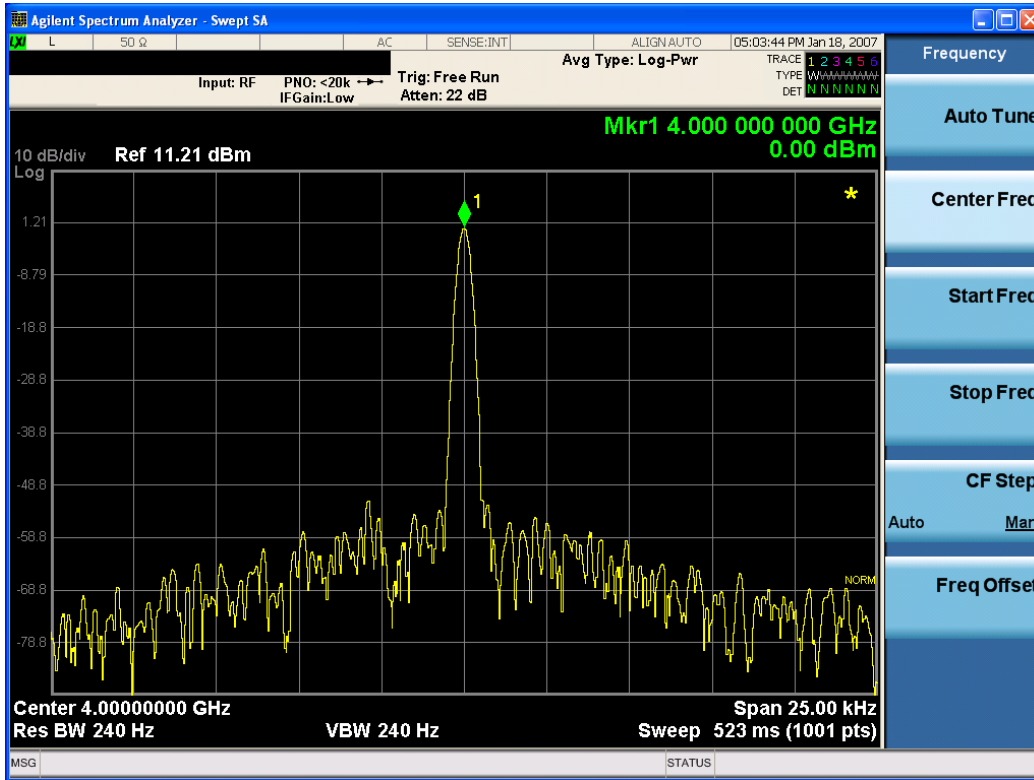

Key Path	View/Display, Display, Annotation
Remote Command	:DISPlay:ACTivefunc[:STATE] ON OFF 1 0 :DISPlay:ACTivefunc[:STATE]?
Example	DISP:ACT OFF
Dependencies	Grayed out and forced to OFF when System Display Settings, Annotation is set to Off.
Preset	On This should remain Off through a Preset when System DisplaySettings, Annotation is set to Off
State Saved	Saved in instrument state.
Initial S/W Revision	Prior to A.02.00

Title

Displays menu keys that enable you to change or clear a title on your display.

Key Path	View/Display, Display
Initial S/W Revision	Prior to A.02.00

Change Title

Writes a title into the "measurement name" field in the banner, for example, "Swept SA".



Press Change Title to enter a new title through the alpha editor. Press Enter or Return to complete the entry. Press ESC to cancel the entry and preserve your existing title.

The display title will replace the measurement name. It remains for this measurement until you press Change Title again, or you recall a state, or a Preset is performed. A title can also be cleared by pressing Title, Clear Title.

**NOTE**

Notice the inclusion of the <measurement> parameter in the command below. Because each measurement remembers the Display Title, the command must be qualified with the measurement name. For the Swept SA measurement this is not the case; no <measurement> parameter is used when changing the Display Title for the Swept SA measurement.

Key Path	View/Display, Display, Title
Mode	All
<b>Remote Command</b>	:DISPlay:<measurement>:ANNotation:TITLe:DATA <string> :DISPlay:<measurement>:ANNotation:TITLe:DATA?
<b>Example</b>	DISP:ANN:TITL:DATA "This Is My Title" This example is for the Swept SA measurement in the Spectrum Analyzer mode. The SANalyzer <measurement> name is not used. DISP:ACP:ANN:TITL:DATA "This Is My Title" This example is for Measurements other than Swept SA. Both set the title to: This Is My Title
Notes	Pressing this key cancels any active function. When a title is edited the previous title remains intact (it is not cleared) and the cursor goes at the end so that characters can be added or BKSP can be used to go back over previous characters.
Preset	No title (measurement name instead)
State Saved	Saved in instrument state.
Initial S/W Revision	Prior to A.02.00

### Clear Title

Clears a title from the front-panel display. Once cleared, the title cannot be retrieved. After the title is cleared, the current Measurement Name replaces it in the title bar.

Key Path	View/Display, Display, Title
<b>Example</b>	The following commands clear the title and restore the measurement's original title: DISP:ANN:TITL:DATA "" This example is for the Swept SA measurement in the Spectrum Analyzer mode. The SANalyzer <measurement> name is not used. DISP:ACP:ANN:TITL:DATA "" This example is for ACP; in measurements other than Swept SA the measurement name is required.
Notes	Uses the :DISPlay:<measurement>:ANNotation:TITLe:DATA <string> command with an empty string (in the Swept SA, the <measurement> is omitted).
Preset	Performed on Preset.
Initial S/W Revision	Prior to A.02.00

## Graticule

Pressing Graticule turns the display graticule On or Off. It also turns the graticule y-axis annotation on and off.

Key Path	View/Display, Display
Remote Command	:DISPlay:WINDow[1]:TRACe:GRATicule:GRID[:STATe] OFF ON 0 1 :DISPlay:WINDow[1]:TRACe:GRATicule:GRID[:STATe]?
Example	DISP:WIND:TRAC:GRAT:GRID OFF
Notes	The graticule is the set of horizontal and vertical lines that make up the grid/divisions for the x-axis and y-axis.
Preset	On
State Saved	Saved in instrument state
Initial S/W Revision	Prior to A.02.00

## System Display Settings

These settings are "Mode Global" – they affect all modes and measurements and are reset only by Restore Misc Defaults or Restore System Defaults under System.

Key Path	View/Display, Display
Initial S/W Revision	Prior to A.02.00

## Annotation Local Settings

This is a Mode Global override of the meas local annotation settings. When it is All Off, it forces ScreenAnnotation, Meas Bar, Trace, and Active Function Values settings to be OFF for all measurements in all modes. This provides the security based "annotation off" function of previous analyzers; hence it uses the legacy SCPI command.

When it is All Off, the Screen, Meas Bar, Trace, and Active Function Values keys under the Display, Annotation menu are grayed out and forced to Off. When Local Settings is selected, you are able to set the local annotation settings on a measurement by measurement basis.

Key Path	View/Display, Display, System Display Settings
Remote Command	:DISPlay:WINDow[1]:ANNotation[:ALL] OFF ON 0 1 :DISPlay:WINDow[1]:ANNotation[:ALL]?
Example	:DISP:WIND:ANN OFF
Preset	On (Set by Restore Misc Defaults)
State Saved	Not saved in instrument state.
Backwards Compatibility Notes	The WINDow parameter and optional subopcode is included for backwards compatibility but ignored – all windows are equally affected.
Initial S/W Revision	Prior to A.02.00

## Themes

Accesses a menu of functions that enable you to choose the theme to be used when saving the screen image.

The **Themes** option is the same as the **Themes** option under the **Display** and **Page Setup** dialogs. It allows you to choose between themes to be used when saving the screen image.

<b>Key Path</b>	Save, Screen Image
<b>Remote Command</b>	:MMEMory:STORe:SCReen:THEMe TDColor   TDMonochrome   FCOLor   FMONochrome  :MMEMory:STORe:SCReen:THEMe?
<b>Example</b>	:MMEM:STOR:SCR:THEM TDM
<b>Preset</b>	3D Color; Is not part of Preset, but is reset by Restore Misc Defaults or Restore System Defaults All and survives subsequent running of the modes.
<b>Readback</b>	3D Color   3D Mono   Flat Color   Flat Mono
<b>Backwards Compatibility Notes</b>	In ESA and PSA we offer the choice of "Reverse Bitmap" or "Reverse Metafile" when saving screen images. This is much like the "Flat Color" theme available in X-Series. Also, if you selected Reverse Bitmap AND a black & white screen image, that would be much like "Flat Monochrome". In other words, each of the X-Series themes has a similar screen image type in ESA/PSA. But they are not identical.
<b>Initial S/W Revision</b>	Prior to A.02.00

### 3D Color

Selects a standard color theme with each object filled, shaded and colored as designed.

<b>Key Path</b>	Save, Screen Image, Themes
<b>Example</b>	MMEM:STOR:SCR:THEM TDC
<b>Readback</b>	3D Color
<b>Initial S/W Revision</b>	Prior to A.02.00

### 3D Monochrome

Selects a format that is like 3D color but shades of gray are used instead of colors.

<b>Key Path</b>	Save, Screen Image, Themes
<b>Example</b>	MMEM:STOR:SCR:THEM TDM
<b>Readback</b>	3D Mono
<b>Initial S/W Revision</b>	Prior to A.02.00

### Flat Color

Selects a format that is best when the screen is to be printed on an ink printer.

Key Path	Save, Screen Image, Themes
<b>Example</b>	MMEM:STOR:SCR:THEM FCOL
Readback	Flat Color
Initial S/W Revision	Prior to A.02.00

### Flat Monochrome

Selects a format that is like Flat Color. But only black is used (no colors, not even gray), and no fill.

Key Path	Save, Screen Image, Themes
<b>Example</b>	MMEM:STOR:SCR:THEM FMON
Readback	Flat Mono
Initial S/W Revision	Prior to A.02.00

### Backlight

Accesses the display backlight on/off keys. This setting may interact with settings under the Windows "Power" menu.

When the backlight is off, pressing ESC, TAB, SPACE, ENTER, UP, DOWN, LEFT, RIGHT, DEL, BKSP, CTRL, or ALT turns the backlight on without affecting the application. Pressing any other key will turn backlight on and could potentially perform the action as well.

Key Path	View/Display, Display, System Display Settings
<b>Remote Command</b>	:DISPlay:BACKlight ON OFF :DISPlay:BACKlight?
Preset	ON (Set by Restore Misc Defaults)
Initial S/W Revision	Prior to A.02.00

### Backlight Intensity

An active function used to set the backlight intensity. It goes from 0 to 100 where 100 is full on and 0 is off. This value is independent of the values set under the Backlight on/off key.

Key Path	View/Display, Display, System Display Settings
<b>Remote Command</b>	:DISPlay:BACKlight:INTensity <integer> :DISPlay:BACKlight:INTensity?
<b>Example</b>	DISP:BACK:INT 50

Preset	100 (Set by Restore Misc Defaults)
Min	0
Max	100
Initial S/W Revision	Prior to A.02.00



## 16 Waveform Measurement

The waveform measurement is a generic measurement for viewing the input signal waveforms in the time domain. This measurement represents how the instrument performs the zero span functionality found in traditional spectrum analyzers. For more details, see ["Waveform Measurement Description" on page 2098](#) below.

This topic contains the following sections:

["Measurement Commands for Waveform" on page 2096](#)

["Remote Command Results for the Waveform Measurement" on page 2097](#)

## Measurement Commands for Waveform

The general functionality of CONFigure, INITiate, FETCh, MEASure, and READ are described at this section.

:CONFigure:WAVeform

:CONFigure:WAVeform:NDEFault

:INITiate:WAVeform

:FETCh:WAVeform[n]?

:MEASure:WAVeform[n]?

:READ:WAVeform[n]?

For more measurement related commands, see the SENSE subsystem, and the section "[Remote Measurement Functions](#)" on page 2165.



## Remote Command Results for the Waveform Measurement

The following table denotes the returned results from the FETCh|MEASure|READ commands:

n	Results Returned
0	Returns unprocessed I/Q trace data, as a series of trace point values, in volts. The I values are listed first in each pair, using the 0 through even-indexed values. The Q values are the odd-indexed values.
1	<p>Returns the following scalar results:</p> <ol style="list-style-type: none"> <li>1. <b>Sample Time</b> is a floating point number representing the time between samples when using the trace queries (n=0, 2, and so forth).</li> <li>2. <b>Mean Power</b> is the mean power (in dBm). This is the power across the entire trace. If averaging is on, the power is for the latest acquisition.</li> <li>3. <b>Mean Power Averaged</b> is the power (in dBm) for N averages, if averaging is on. This is the power across the entire trace. If averaging is on, the power is for the latest acquisition. If averaging is off, the value of the mean power averaged is the same as the value of the mean power.</li> <li>4. <b>Number of samples</b> is the number of data points in the captured signal. This number is useful when performing a query on the signal (i.e. when n=0, 2, etc.).</li> <li>5. <b>Peak-to-mean ratio</b> has units of dB. This is the ratio of the maximum signal level to the mean power. Valid values are only obtained with averaging turned off. If averaging is on, the peak-to-mean ratio is calculated using the highest peak value, rather than the displayed average peak value.</li> <li>6. <b>Maximum value</b> is the maximum of the most recently acquired data (in dBm).</li> <li>7. <b>Minimum value</b> is the minimum of the most recently acquired data (in dBm).</li> </ol>
2	Returns trace point values of the entire captured signal envelope trace data. These data points are floating point numbers representing the power of the signal (in dBm). There are N data points, where N is the number of samples. The period between the samples is defined by the sample time.

## Waveform Measurement Description

Also available under the basic Waveform measurement is an I/Q window, which shows the I and Q signal waveforms in parameters of voltage versus time to disclose the voltages that comprise the complex modulated waveform of a digital signal.

The waveform measurement can also be used to perform general purpose power measurements to a high degree of accuracy.

Key Path	Front-panel key
Initial S/W Revision	Prior to A.02.00

## AMPTD Y Scale

Accesses a menu of functions that enable you to set the vertical scale parameters.

Key Path	Front-panel key
Initial S/W Revision	Prior to A.02.00

### Ref Value

Sets the absolute power reference value. However, since Auto Scaling is defaulted to On, this value is automatically determined by the measurement result. When you set a value manually, Auto Scaling automatically changes to Off.

This functionality depends on the selected view:

- ["Ref Value \(RF Envelope View\)" on page 2099](#)
- ["Ref Value \(I/Q Waveform View\)" on page 2100](#)

### Ref Value (RF Envelope View)

Sets the Y Scale reference value (in dBm) when the RF Envelope View is active. By default, the measurement determines the reference value with Auto Scaling. Entering a reference value manually turns Auto Scaling off.

Key Path	AMPTD Y Scale
Mode	BASIC, PNOISE, WCDMA, C2K, GSM, WIMAXOFDMA, TDSCDMA, 1XEVD0, DVB, DTMB, ISDBT, CMMB, LTE, LTETDD, DCATV, WLAN,LTEATDD, LTEAFDD
Remote Command	:DISPlay:WAVeform:VIEW[1]:WINDow[1]:TRACe:Y[:SCALE]:RLEVel <ampl> :DISPlay:WAVeform:VIEW[1]:WINDow[1]:TRACe:Y[:SCALE]:RLEVel?
Example	DISP:WAV:VIEW:WIND:TRAC:Y:RLEV -50 dBm DISP:WAV:VIEW:WIND:TRAC:Y:RLEV?
Notes	You must be in the mode that includes Waveform measurement to use this command. Use INSTRument:SElect to set the mode.
Couplings	When Auto Scaling is On, this value is automatically determined by the measurement result. When you set a value manually, Auto Scaling automatically changes to Off.
Preset	10.00 dBm
State Saved	Saved in instrument state.
Range	-250.00 dBm to 250.00 dBm
Min	-250.00 dBm
Max	250.00 dBm
Initial S/W Revision	Prior to A.02.00
Modified at S/W Revision	A.03.00

### Ref Value (I/Q Waveform View)

Sets the Y Scale reference value (in volts) when the I/Q Waveform View is active. By default, the measurement determines the reference value with Auto Scaling. Entering a reference value manually turns Auto Scaling off.

Key Path	AMPTD Y Scale
Mode	BASIC, PNOISE, WCDMA, C2K, GSM, WIMAXOFDMA, TDSCDMA, 1XEVD0, DVB, DTMB, ISDB-T, CMMB, LTE, LTETDD, DCATV, WLAN, LTEATDD, LTEAFDD
Remote Command	:DISPlay:WAVeform:VIEW2:WINDow[1]:TRACe:Y[:SCALe]:RLEVel <voltage> :DISPlay:WAVeform:VIEW2:WINDow[1]:TRACe:Y[:SCALe]:RLEVel?
Example	DISP:WAV:VIEW2:WIND:TRAC:Y:RLEV 25 V DISP:WAV:VIEW2:WIND:TRAC:Y:RLEV?
Notes	You must be in a mode that includes the Waveform measurement to use this command. Use INSTRument:SElect to set the mode.
Couplings	When Auto Scaling is On, this value is automatically determined by the measurement result. When you set a value manually, Auto Scaling automatically changes to Off.
Preset	0 V
State Saved	Saved in instrument state.
Min	-250 V
Max	250 V
Initial S/W Revision	Prior to A.02.00
Modified at S/W Revision	A.03.00

### Attenuation

This menu controls the attenuator functions and interactions between the attenuation system components.

There are two attenuator configurations in the X-Series. One is a dual attenuator configuration consisting of a mechanical attenuator and an optional electronic attenuator. The other configuration uses a single attenuator with combined mechanical and electronic sections that controls all the attenuation functions. Different models in the X-Series come with different configurations.

See ["Dual Attenuator Configurations:" on page 2101](#)

See ["Single Attenuator Configuration:" on page 2101](#)

Most Attenuation settings are the same for all measurements – they do not change as you change measurements. Settings like these are called “Meas Global” and are unaffected by Meas Preset.

Key Path	AMPTD Y Scale
Scope	Meas Global
Dependencies	In measurements that support the I/Q inputs, this key is unavailable when I/Q is the selected input, and is replaced by the Range key in that case.

Readback Line	Contains a summary in [ ] brackets of the current total attenuation. See the descriptions of the , " (Mech) Atten " on page 2102, and "Enable Elec Atten" on page 2104 keys for more detail on the contributors to the total attenuation.  Note that when "Pre-Adjust for Min Clip" is on, this value can change at the start of every measurement.
Initial S/W Revision	Prior to A.02.00
Modified at S/W Revision	A.03.00

### Dual Attenuator Configurations:

Configuration 1: Mechanical attenuator + optional electronic attenuator

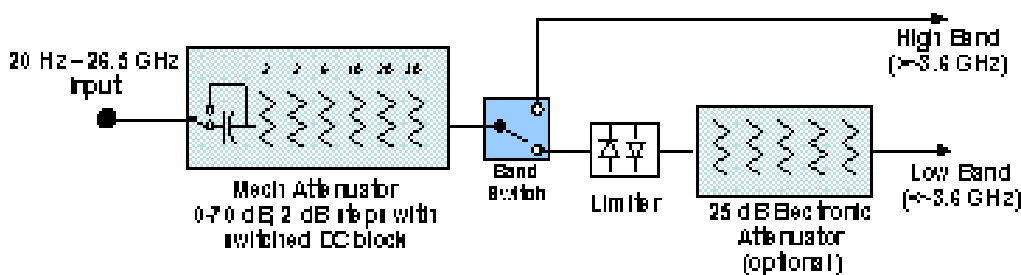

Configuration 2: Mechanical attenuator, no optional electronic attenuator

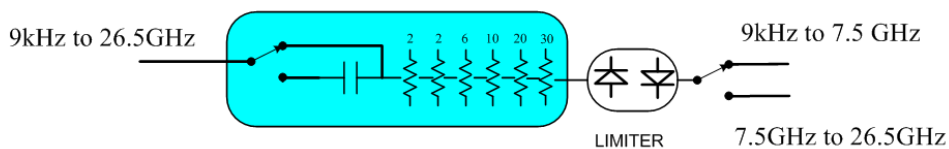

(note that Configuration 2 is not strictly speaking a dual-section attenuator, since there is no electronic section available. However, it behaves exactly like Configuration 1 without the Electronic Attenuator option EA3, therefore for the sake of this document it is grouped into the "Dual Attenuator" configuration)

### Single Attenuator Configuration:

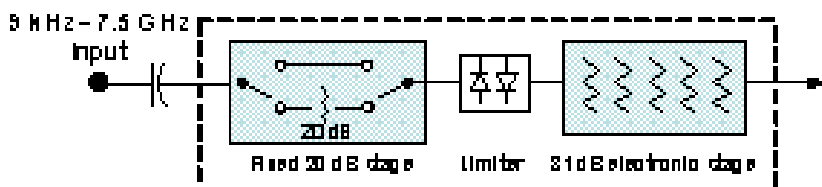

You can tell which attenuator configuration you have by pressing the Attenuation key, which (in most Modes) opens the Attenuation menu. If the first key in the Attenuation menu says Mech Atten you have the dual attenuator configuration. If the first key says Atten you have the single attenuator configuration.

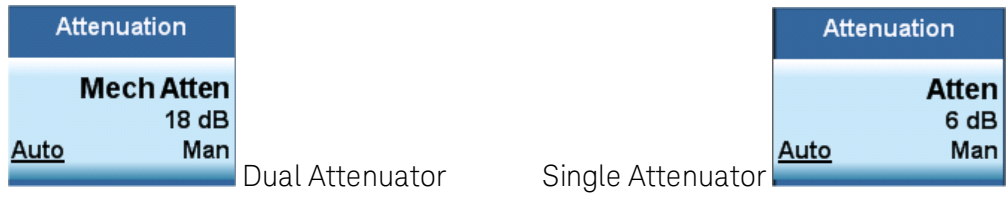

In the single attenuator configuration, you control the attenuation with a single control, as the fixed stage has only two states. In the dual attenuator configuration, both stages have significant range so you are given separate control of the mechanical and electronic attenuator stages.

When you have the dual attenuator configuration, you may still have only a single attenuator, because unless option EA3 (the Electronic Attenuator option) is available, and you purchase it, you will have only the mechanical attenuator.

**(Mech) Atten**

This key is labeled Mech Atten in dual attenuator models and Atten in single attenuator models. In the dual attenuator configuration, this key only affects the mechanical attenuator.

This key lets you modify the attenuation applied to the RF input signal path. This value is normally auto coupled to the Ref Level, the Internal Preamp Gain, any External Gain that is entered, and the Max Mixer Level, as described in the table below.

See ["Attenuator Configurations and Auto/Man" on page 2103](#)

<b>Key Path</b>	AMPTD Y Scale, Attenuation
<b>Remote Command</b>	<pre>[ :SENSe]:POWer[:RF]:ATTenuation &lt;rel_ampl&gt; [:SENSe]:POWer[:RF]:ATTenuation? [:SENSe]:POWer[:RF]:ATTenuation:AUTO OFF ON 0 1 [:SENSe]:POWer[:RF]:ATTenuation:AUTO?</pre>
<b>Example</b>	<p>POW:ATT 20</p> <p>Dual attenuator configuration: sets the mechanical attenuator to 20 dB</p> <p>Single attenuator mode: sets the main attenuation to 20 dB (see below for definition of “main” attenuation).</p> <p>If the attenuator was in Auto, it sets it to Manual.</p>
<b>Dependencies</b>	<p>Some measurements do not support the Auto setting of (Mech) Atten. In these measurements, the Auto/Man selection is not available, and the Auto/Man line on the key disappears.</p> <p>In dual attenuator configurations, when the electronic attenuator is enabled, the mechanical attenuator has no auto setting and the Auto/Man line on the key disappears. The state of Auto/Man is remembered and restored when the electronic attenuator is once again disabled. This is described in more detail in the <a href="#">"Enable Elec Atten" on page 2104</a> key description.</p> <p>See <a href="#">"Attenuator Configurations and Auto/Man" on page 2103</a> for more information on the Auto/Man functionality of Attenuation.</p>
<b>Couplings</b>	<p>When (Mech) Atten is in Auto, it uses the following algorithm to determine a value:</p> <p>If the USB Preamp is connected to USB, use 0 dB.</p> <p>Otherwise, Atten = ReferenceLevel + PreAmpGain + ExternalGain – RefLevelOffset - MaxMixerLevel</p>

	<p>+ IF Gain.</p> <p>Limit this value to be between 6 dB and the Max value. No value below 6 dB can ever be chosen by Auto.</p> <p>The resulting value is rounded up to the largest value possible given the attenuation step setting. That is, 50.01 dB would change to 60 dB (for a 10 dB attenuation step).</p> <p>The “IF Gain” term in the equation above is either 0 dB or +10 dB, depending on the settings of FFT IF Gain, Swept IF Gain, max Ref Level and the Auto/Man setting of Mech Atten.</p> <p>In External Mixing and BBIQ, where the Attenuator is not in the signal path, the Attenuator setting changes as described above when (Mech) Atten is in Auto, but no changes are made to the actual attenuator hardware setting until the input is changed back to the RF Input.</p>
Preset	<p>The preset for Mech Attenuation is “Auto.”</p> <p>The Auto value of attenuation is: CXA, EXA, MXA and PXA: 10 dB</p>
State Saved	Saved in instrument state
Min	<p>0 dB</p> <p>The attenuation set by this key cannot be decreased below 6 dB with the knob or step keys. To get to a value below 6 dB it has to be directly entered from the keypad or via SCPI. This protects from adjusting the attenuation to a dangerously small value which can put the instrument at risk of damage to input circuitry. However, if the current mechanical attenuation is below 6 dB it can be increased with the knob and step keys, but not decreased.</p>
Max	<p>CXA N9000A–503/507: 50 dB CXA N9000A–513/526: 70dB EXA: 60 dB MXA and PXA: 70 dB</p> <p>In the single attenuator configuration, the total of ATT and EATT cannot exceed 50 dB, so if the EATT is set to 24 dB first, the main attenuation cannot be greater than 26 dB and will be reduced accordingly; if the main attenuator is set to 40 dB first, EATT cannot be greater than 10 dB.</p>
Initial S/W Revision	Prior to A.02.00
Modified at S/W Revision	A.03.00

### Attenuator Configurations and Auto/Man

As described in the Attenuation key description, there are two distinct attenuator configurations available in the X-Series, the single attenuator and dual attenuator configurations. In dual attenuator configurations, we have the mechanical attenuation and the electronic attenuation, and the current total attenuation is the sum of the electronic + mechanical attenuation. In single attenuator configurations, we refer to the attenuation set using the (Mech) Atten key (or POW:ATT SCPI) as the “main” attenuation; and the attenuation that is set by the SCPI command POW:EATT as the “soft” attenuation (the POW:EATT command is honored even in the single attenuator configuration, for compatibility purposes). Then the current total attenuation is the sum of the main + soft attenuation. See the Elec Atten key description for more on “soft” attenuation.

In the dual attenuator configuration, when the electronic attenuator is enabled, there is no Auto/Man functionality for the mechanical attenuator, and the third line of the key label (the Auto/Man line) disappears:

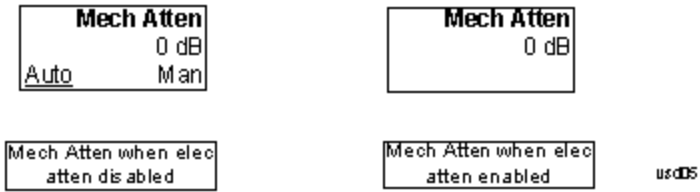

### Enable Elec Atten

Enables the Electronic Attenuator.

The electronic attenuator offers finer steps than the mechanical attenuator, has no acoustical noise, is faster, and is less subject to wear. These advantages primarily aid in remote operation and are negligible for front panel use. See ["Using the Electronic Attenuator: Pros and Cons" on page 2106](#) for a detailed discussion of the pros and cons of using the electronic attenuator.

For the single attenuator configuration, for SCPI backwards compatibility, the “soft” attenuation feature replaces the dual attenuator configuration’s electronic attenuator. All the same couplings and limitations apply. See ["Attenuator Configurations and Auto/Man" on page 2103](#)

See ["More Information" on page 2105](#)

<b>Key Path</b>	AMPTD Y Scale, Attenuation
<b>Remote Command</b>	[ :SENSE ] :POWER [ :RF ] :EATTenuation :STATE OFF   ON   0   1 [ :SENSE ] :POWER [ :RF ] :EATTenuation :STATE ?
<b>Example</b>	POW:EATT:STAT ON
<b>Dependencies</b>	<p>This key only appears in Dual Attenuator models with an Electronic Attenuator installed. It does not appear in models with the Single Attenuator configuration, as in the single attenuator configuration there is no “electronic attenuator” there is only a single integrated attenuator (which has both a mechanical and electronic stage). However, in the single attenuator configuration, EATT SCPI commands are accepted for compatibility with other X-series instruments and set a “soft” attenuation as described in <a href="#">"Attenuator Configurations and Auto/Man" on page 2103</a>.</p> <p>The electronic attenuator (and the “soft” attenuation function provided in single attenuator configurations) is unavailable above 3.6 GHz. Therefore, if the Stop Frequency of the analyzer is &gt; 3.6 GHz then the Enable Elec Atten key will be OFF and grayed out.</p> <p>If the Internal Preamp is on, meaning it is set to Low Band or Full, the electronic attenuator (and the “soft” attenuation function provided in single attenuator configurations) is unavailable. In this case the Enable Elec Atten key will be OFF and grayed out.</p> <p>If either of the above is true, if the SCPI command is sent, an error indicating that the electronic attenuator is unavailable will be sent.</p> <p>If the electronic/soft Attenuator is enabled, then the Stop Freq of the analyzer is limited to 3.6 GHz and the Internal Preamp is unavailable.</p> <p>The SCPI-only “soft” electronic attenuation for the single-attenuator configuration is not available in all measurements; in particular, it is not available in the Swept SA measurement.</p>
<b>Couplings</b>	Enabling and disabling the Electronic Attenuator affects the setting of the Mechanical Attenuator (in



	dual attenuator configurations). This is described in more detail below this table.
Preset	OFF for Swept SA measurement; ON for all other measurements that support the electronic attenuator
State Saved	Saved in instrument state
Initial S/W Revision	Prior to A.02.00
Modified at S/W Revision	A.03.00

## More Information

### Mechanical Attenuator Transition Rules

When the Electronic Attenuator is enabled, the Mechanical Attenuator transitions to a state that has no Auto function. Below are the rules for transitioning the Mechanical Attenuator. NOTE that the information below ONLY applies to the dual attenuator configurations, and ONLY when the Electronic Attenuator is installed:

#### When the Electronic Attenuation is enabled from a disabled state:

- The Mechanical Attenuator is initialized to 10 dB (this is its optimal performance setting). You can then set it as desired with SCPI, numeric keypad, step keys, or knob, and it behaves as it normally would in manual mode
- The Auto/Man state of (Mech) Atten is saved
- The Auto/Man line on the (Mech) Atten key disappears and the auto rules are disabled
- The Electronic Attenuator is set to 10 dB less than the previous value of the Mechanical Attenuator, within the limitation that it must stay within the range of 0 to 24 dB of attenuation.

#### Examples in the dual attenuator configuration:

- Mech Atten at 20 dB. Elec Atten enabled, Mech Atten set to 10 dB, and Elec Atten set to 10 dB. New total attenuation equals the value before Elec Atten enabled.
- Mech Atten at 0 dB. Elec Atten enabled, Mech Atten set to 10 dB, and Elec Atten set to 0 dB. New total attenuation does not equal the value before Elec Atten enabled.
- Mech Atten at 40 dB. Elec Atten enabled, Mech Atten set to 10 dB, and Elec Atten set to 24 dB. New total attenuation does not equal the value before Elec Atten enabled.

#### When the Electronic Attenuation is disabled from an enabled state:

- The Elec Atten key is grayed out
- The Auto/Man state of (Mech) Atten is restored
- If now in Auto, (Mech) Atten recouples
- If now in Man, (Mech) Atten is set to the value of total attenuation that existed before the Elec Atten was disabled. The resulting value is rounded up to the smallest value possible given the (Mech) Atten Step setting - (That is, 57 dB changes to 58 dB when (Mech) Atten Step is 2 dB.)

### Using the Electronic Attenuator: Pros and Cons

The electronic attenuator offers finer steps than the mechanical attenuator, has no acoustical noise, is faster, and is less subject to wear.

The “finer steps” advantage of the electronic attenuator is beneficial in optimizing the alignment of the analyzer dynamic range to the signal power in the front panel as well as remote use. Thus, you can achieve improved relative signal measurement accuracy. Compared to a mechanical attenuator with 2 dB steps, the 1 dB resolution of the electronic attenuator only gives better resolution when the odd-decibel steps are used. Those odd-decibel steps are less accurately calibrated than the even-decibel steps, so one tradeoff for this superior relative accuracy is reduced absolute amplitude accuracy.

Another disadvantage of the electronic attenuator is that the spectrum analyzer loses its “Auto” setting, making operation less convenient.

Also, the relationship between the dynamic range specifications (TOI, SHI, compression and noise) and instrument performance are less well-known with the electrical attenuator. With the mechanical attenuator, TOI, SHI and compression threshold levels increase dB-for-dB with increasing attenuation, and the noise floor does as well. With the electronic attenuator, there is an excess attenuation of about 1 to 3 dB between 0 and 3.6 GHz, making the effective TOI, SHI, and so forth, less well known. Excess attenuation is the actual attenuation relative to stated attenuation. Excess attenuation is accounted for in the analyzer calibration

### Elec Atten

Controls the Electronic Attenuator in dual attenuator configurations. This key does not appear in single attenuator configurations, as the control of both the mechanical and electronic stages of the single attenuator is integrated into the single Atten key.

Key Path	AMPTD Y Scale, Attenuation
Remote Command	<code>[ :SENSe ] :POWer [ :RF ] :EATTenuation &lt;rel_amp1&gt;</code> <code>[ :SENSe ] :POWer [ :RF ] :EATTenuation?</code>
Notes	Electronic Attenuation’s specification is defined only when Mechanical Attenuation is 6 dB.
Dependencies	This key only appears in Dual Attenuator models with an Electronic Attenuator installed. It does not appear in models with the Single Attenuator configuration, as in the single attenuator configuration there is no “electronic attenuator” there is only a single integrated attenuator (which has both a mechanical and electronic stage). However, in the single attenuator configuration, EATT SCPI commands are accepted for compatibility with other X-series instruments and set a “soft” attenuation as described in <a href="#">"Attenuator Configurations and Auto/Man" on page 2103</a> . The “soft” attenuation is treated as an addition to the “main” attenuation value set by the Atten softkey or the POW:ATT SCPI command and affects the total attenuation displayed on the Attenuation key and the Meas Bar.  When Enable Elec Atten is off or grayed out, the Elec Atten key is grayed out.
Preset	0 dB
State Saved	Saved in instrument state
Min	0 dB
Max	Dual attenuator configuration: 24 dB  Single attenuator configuration: the total of ATT and EATT cannot exceed 50 dB, so if the EATT is set to 24 dB first, the main attenuation cannot be greater than 26 dB and will be reduced accordingly; if

	the main attenuator is set to 40 dB first, EATT cannot be greater than 10 dB
Initial S/W Revision	Prior to A.02.00
Modified at S/W Revision	A.03.00

## Adjust Atten for Min Clip

Sets the combination of mechanical and electronic attenuation and gain based on the current measured signal level so that clipping will be at a minimum.

This is an "immediate action" function, that is, it executes once, when the key is pressed.

This key is grayed out in measurements that do not support this functionality. The spectrum analyzer measurement, Swept SA, does not support this functionality.

Key Path	AMPTD Y Scale, Attenuation
Remote Command	<code>[ :SENSe ] :POWer [ :RF ] :RANGe :OPTimize IMMEDIATE</code>
Initial S/W Revision	Prior to A.02.00
Modified at S/W Revision	A.03.00

## Pre-Adjust for Min Clip

If this function is on, it does the adjustment described under "[Adjust Atten for Min Clip](#)" on page 2107 each time a measurement restarts. Therefore, in Continuous measurement mode, it only executes before the first measurement.

In dual attenuator models, you can set Elec+Mech Atten, in which case both attenuators participate in the autoranging, or Elec Atten Only, in which case the mechanical attenuator does not participate in the autoranging. This latter case results in less wear on the mechanical attenuator and is usually faster.

This key is grayed out in measurements that do not support this functionality. The spectrum analyzer measurement, Swept SA, does not support this functionality.

Key Path	AMPTD Y Scale, Attenuation
Remote Command	<code>[ :SENSe ] :POWer [ :RF ] :RANGe :OPTimize :ATTenuation OFF   ELECTRical   COMBined</code> <code>[ :SENSe ] :POWer [ :RF ] :RANGe :OPTimize :ATTenuation?</code>
Notes	The SCPI parameter ELECTRical sets this function to On in single attenuator models. The SCPI parameter COMBined is mapped to ELECTRical in single attenuator models; if you send COMBined, it sets the function to On and returns ELEC to a query.
Dependencies	This key only appears in Dual Attenuator models with an Electronic Attenuator installed. In instruments with Dual Attenuator model, when Enable Elec Atten is off or grayed out, the Pre-Adjust for Min Clip key is grayed out.
Preset	OFF for Swept SA measurement; ON for all other measurements that support Pre-Adjust for Min Clip

State Saved	Saved in instrument state
Range	Dual attenuator models: Off   Elec Atten Only   Mech + Elec Atten Single attenuator models: Off   On
Initial S/W Revision	Prior to A.02.00
Modified at S/W Revision	A.03.00

<b>Remote Command</b>	<code>[ :SENSe ] :POWer [ :RF ] :RANGe :AUTO ON OFF 1 0</code> <code>[ :SENSe ] :POWer [ :RF ] :RANGe :AUTO?</code>
Notes	ON aliases to "Elec Atten Only" (:POW:RANG:OPT:ATT ELEC) OFF aliases to "Off" (:POW:RANG:OPT:ATT OFF) The query :POW:RANG:AUTO? returns true if :POW:RANG:OPT:ATT is not "Off"
Initial S/W Revision	Prior to A.02.00

### Off

Turns Pre-Adjust for Min Clip off. This is the default setting.

This key is grayed out in measurements that do not support this functionality. The spectrum analyzer measurement, Swept SA, does not support this functionality.

Key Path	AMPTD Y Scale, Attenuation, Pre-Adjust for Min Clip
Example	:POW:RANG:OPT:ATT OFF
Initial S/W Revision	Prior to A.02.00

### Elec Atten Only

Selects only the electric attenuator to participate in auto ranging. This offers less wear on the mechanical attenuator and is usually faster.

This key is grayed out in measurements that do not support this functionality. The spectrum analyzer measurement, Swept SA, does not support this functionality.

Key Path	AMPTD Y Scale, Attenuation, Pre-Adjust for Min Clip
Example	:POW:RANG:OPT:ATT ELEC
Initial S/W Revision	Prior to A.02.00

### Mech + Elec Atten

In dual attenuator models, this selects both attenuators participate in the autoranging.

This key is grayed out in measurements that do not support this functionality. The spectrum analyzer measurement, Swept SA, does not support this functionality.

Key Path	AMPTD Y Scale, Attenuation, Pre-Adjust for Min Clip
Example	:POW:RANGe:OPT:ATT COMB
Initial S/W Revision	Prior to A.02.00

## (Mech) Atten Step

This controls the step size used when making adjustments to the input attenuation.

This key is labeled Mech Atten Step in dual attenuator models and Atten Step in single attenuator models. In the dual attenuator configuration, this key only affects the step size of the mechanical attenuator.

Key Path	AMPTD Y Scale, Attenuation
<b>Remote Command</b>	[ :SENSe ] :POWer [ :RF ] :ATTenuation :STEP [ :INCRement ] 10 dB   2 dB [ :SENSe ] :POWer [ :RF ] :ATTenuation :STEP [ :INCRement ] ?
<b>Example</b>	POW:ATT:STEP 2
Notes	Note this feature works like a 1-N choice from the front panel, but it takes a specific value (in dB) when used remotely. The only valid values are 2 and 10.
Dependencies	Blanked in CXA and EXA if option FSA (2 dB steps) is not present. If blanked, attempts to set it via SCPI will yield an error.
Couplings	When the attenuation step size changes, the current mechanical attenuation value is adjusted (if necessary) to be quantized to the new step size. That is, if step is set to 10 dB, mech atten is increased if necessary so it is a multiple of 10 dB
Preset	PXA and MXA: 2 dB EXA and CXA: 10 dB (2 dB with option FSA)
State Saved	Saved in instrument state
Initial S/W Revision	Prior to A.02.00
Modified at S/W Revision	A.03.00

## Scale/Div

Sets the units per division of vertical scale in the logarithmic display. However, since Auto Scaling is defaulted to On, this value is automatically determined by the measurement result. When you set a value manually, Auto Scaling automatically changes to Off.

This functionality depends on the selected view:

- ["Scale/Div \(RF Envelope View\)" on page 2110](#)
- ["Scale/Div \(I/Q Waveform View\)" on page 2110](#)

## Scale/Div (RF Envelope View)

Sets the scale per division for the RF Envelope result waveform (time domain) measurements in the graph window.

<b>Key Path</b>	AMPTD Y Scale
<b>Mode</b>	BASIC, PNOISE, WCDMA, C2K, GSM, WIMAXOFDMA, TDSCDMA, 1XEVD0, DVB, DTMB, ISDBT, CMMPB, LTE, LTETDD, DCATV, WLAN,LTEATDD, LTEAFDD
<b>Remote Command</b>	:DISPlay:WAVeform:VIEW[1]:WINDow[1]:TRACe:Y[:SCALe]:PDIVision <rel_ ampl> :DISPlay:WAVeform:VIEW[1]:WINDow[1]:TRACe:Y[:SCALe]:PDIVision?
<b>Example</b>	DISP:WAV:VIEW:WIND:TRAC:Y:PDIV 5 DISP:WAV:VIEW:WIND:TRAC:Y:PDIV?
<b>Notes</b>	You must be in a mode that includes the Waveform measurement to use this command. Use INSTRument:SElect to set the mode.
<b>Couplings</b>	When Auto Scaling is On, this value is automatically determined by the measurement result. When you set a value manually, Auto Scaling automatically changes to Off.
<b>Preset</b>	10.00 dB
<b>State Saved</b>	Saved in instrument state.
<b>Range</b>	0.10 dB to 20.00 dB
<b>Min</b>	0.10 dB
<b>Max</b>	20.00 dB
<b>Initial S/W Revision</b>	Prior to A.02.00
<b>Modified at S/W Revision</b>	A.03.00

## Scale/Div (I/Q Waveform View)

Sets the scale per division for the I/Q signal waveform graph.

<b>Key Path</b>	AMPTD Y Scale
<b>Mode</b>	BASIC, PNOISE, WCDMA, C2K, GSM, WIMAXOFDMA, TDSCDMA, 1XEVD0, DVB, DTMB, ISDBT, CMMPB, LTE, LTETDD, DCATV, WLAN,LTEATDD, LTEAFDD
<b>Remote Command</b>	:DISPlay:WAVeform:VIEW2:WINDow[1]:TRACe:Y[:SCALe]:PDIVision <voltage> :DISPlay:WAVeform:VIEW2:WINDow[1]:TRACe:Y[:SCALe]:PDIVision?
<b>Example</b>	DISP:WAV:VIEW2:WIND:TRAC:Y:PDIV 25mV DISP:WAV:VIEW2:WIND:TRAC:Y:PDIV?
<b>Notes</b>	You must be in a mode that includes the Waveform measurement to use this command. Use INSTRument:SElect to set the mode.
<b>Couplings</b>	When Auto Scaling is On, this value is automatically determined by the measurement result. When you set a value manually, Auto Scaling automatically changes to Off.
<b>Preset</b>	100.0 mV

State Saved	Saved in instrument state.
Min	1.0 nV
Max	20 V
Initial S/W Revision	Prior to A.02.00
Modified at S/W Revision	A.03.00

## Presel Center

When this key is pressed, the centering of the preselector filter is adjusted to optimize the amplitude accuracy at the frequency of the selected marker. If the selected marker is not on when Presel Center is pressed, the analyzer will turn on the selected marker, perform a peak search, and then perform centering on the marker's center frequency. If the selected marker is already on and between the start and stop frequencies of the analyzer, the analyzer performs the preselector calibration on that marker's frequency. If the selected marker is already on, but outside the frequency range between Start Freq and Stop Freq, the analyzer will first perform a peak search, and then perform centering on the marker's center frequency.

The value displayed on the Presel Adjust key will change to reflect the new preselector tuning (see Presel Adjust).

A number of considerations should be observed to ensure proper operation. See ["Proper Preselector Operation" on page 2112](#).

Key Path	AMPTD Y Scale
Remote Command	[ :SENSe ] :POWer [ :RF ] :PCENter
Example	POW:PCEN
Notes	Note that the rules outlined above under the key description apply for the remote command as well as the key. The result of the command is dependent on marker position, and so forth. Any message shown by the key press is also shown in response to the remote command.
Dependencies	<ul style="list-style-type: none"> <li>• Grayed out if the microwave preselector is off. )</li> <li>• If the selected marker's frequency is below Band 1, advisory message 0.5001 is generated and no action is taken.</li> <li>• Grayed out if entirely in Band 0.</li> <li>• Blank in models that do not include a preselector, such as option 503. If the SCPI is sent in these instruments, it is accepted without error, and the query always returns 0.</li> <li>• Grayed out in the Spectrogram View.</li> </ul>
Couplings	The active marker position determines where the centering will be attempted. If the analyzer is in a measurement such as averaging when centering is initiated, the act of centering the preselector will restart averaging but the first average trace will not be taken until the centering is completed.
Status Bits/OPC dependencies	When centering the preselector, *OPC will not return true until the process is complete and a subsequent measurement has completed, nor will results be returned to a READ or MEASure command. The Measuring bit should remain set while this command is operating and should not go false until

---

the subsequent sweep/measurement has completed.

---

Initial S/W Revision	Prior to A.02.00
Modified at S/W Revision	A.03.00

---

### Proper Preselector Operation

A number of considerations should be observed to ensure proper operation:

1. If the selected marker is off, the analyzer will turn on a marker, perform a peak search, and adjust the preselector using the selected marker's frequency. It uses the "highest peak" peak search method unqualified by threshold or excursion, so that there is no chance of a 'no peak found' error. It continues with that peak, even if it is the peak of just noise. Therefore, for this operation to work properly, there should be a signal on screen in a preselected range for the peak search to find.
2. If the selected marker is already on, the analyzer will attempt the centering at that marker's frequency. There is no preselector for signals below about 3.6 GHz, therefore if the marker is on a signal below 3.6 GHz, no centering will be attempted and an advisory message generated
3. In some models, the preselector can be bypassed. If it is bypassed, no centering will be attempted in that range and a message will be generated.

### Preselector Adjust

Allows you to manually adjust the preselector filter frequency to optimize its response to the signal of interest. This function is only available when "Presel Center" on page 2111 is available.

For general purpose signal analysis, using Presel Center is recommended. Centering the filter minimizes the impact of long-term preselector drift. Presel Adjust can be used instead to manually optimize the preselector. One application of manual optimization would be to peak the preselector response, which both optimizes the signal-to-noise ratio and minimizes amplitude variations due to small (short-term) preselector drifting.

Key Path	AMPTD Y Scale
Scope	Meas Global
Remote Command	[ :SENSe ] :POWer [ :RF ] :PADJust <freq> [ :SENSe ] :POWer [ :RF ] :PADJust?
Example	POW:PADJ 100KHz POW:PADJ?
Notes	The value on the key reads out to 0.1 MHz resolution.
Dependencies	<ul style="list-style-type: none"> <li>• Grayed out if microwave preselector is off. )</li> <li>• Grayed out if entirely in Band 0.</li> <li>• Blank in models that do not include a preselector, such as option 503. If the SCPI is sent in these instruments, it is accepted without error, and the query always returns 0.</li> </ul>

---



- Grayed out in the Spectrogram View.

Preset	0 MHz
State Saved	The Presel Adjust value set by Presel Center, or by manually adjusting Presel Adjust, is not saved in instrument state, and does not survive a Preset or power cycle.
Min	-500 MHz
Max	500 MHz
Default Unit	Hz
<b>Backwards Compatibility SCPI</b>	[:SENSe]:POWer[:RF]:MW:PADJust [:SENSe]:POWer[:RF]:MMW:PADJust PSA had multiple preselectors, but the X-Series has only one. These commands simply alias to [:SENSe]:POWer[:RF]:PADJust
Initial S/W Revision	Prior to A.02.00
Modified at S/W Revision	A.03.00

<b>Remote Command</b>	[:SENSe]:POWer[:RF]:PADJust:PRESelector MWAVe   MMWave   EXTernal [:SENSe]:POWer[:RF]:PADJust:PRESelector?
Notes	PSA had multiple preselectors, and you could select which preselector to adjust. Since the X-Series has only one mm/uW preselector, the preselector selection softkey is no longer available. However, to provide backward compatibility, we accept the legacy remote commands. The command form has no effect, the query always returns MWAVE
Initial S/W Revision	Prior to A.02.00

## μW Path Control

The μW Path Control functions include the μW Preselector Bypass (Option MPB) and Low Noise Path (Option LNP) controls in the High Band path circuits.

When the μW Preselector is bypassed, the user has better flatness, but will be subject to spurs from out of band interfering signals. When the Low Noise Path is enabled, the analyzer automatically switches around certain circuitry in the high frequency bands which can contribute to noise, when it is appropriate based on other analyzer settings.

For most applications, the preset state is Standard Path, which gives the best remote-control throughput, minimizes acoustic noise from switching and minimizes the risk of wear out in the hardware switches. For applications that utilize the wideband IF paths, the preset state is the μW Preselector Bypass path, if option MPB is present. This is because, when using a wideband IF such as the 140 MHz IF, the μW Preselector's bandwidth can be narrower than the available IF bandwidth, causing degraded amplitude flatness and phase linearity, so it is desirable to bypass the preselector in the default case.

Users may choose Low Noise Path Enable. It gives a lower noise floor, especially in the 21–26.5 GHz region, though without improving many measures of dynamic range, and without giving the best possible noise floor. The preamp, if purchased and used, gives better noise floor than does the Low Noise Path, however its compression threshold and third-order intercept are much poorer than that of the non-preamp Low Noise Path. There are some applications, typically for signals around –30 dBm, for which the third-order dynamic range of the standard path is good enough, but the noise floor is not low enough even with 0 dB input attenuation. When the third-order dynamic range of the preamp path is too little and the noise floor of the standard path is too high, the Low Noise Path can provide the best dynamic range.

<b>Key Path</b>	AMPTD Y Scale
<b>Mode</b>	SA, BASIC, PNOISE, VSA , LTE, LTETDD
<b>Scope</b>	Meas Global
<b>Remote Command</b>	[ :SENSe ] : POWer [ :RF ] : MW : PATH STD   LNPath   MPBypass   FULL [ :SENSe ] : POWer [ :RF ] : MW : PATH ?
<b>Example</b>	:POW:MW:PATH LNP Enables the Low Noise path
<b>Notes</b>	If a Presel Center is performed, the analyzer will momentarily switch to the Standard Path, regardless of the setting of $\mu$ W Path Control  The DC Block will always be switched in when the low noise path is switched in, to protect succeeding circuitry from DC. Note that this does not mean “when the low noise path is enabled” but when, based on the Low Noise Path rules, the path is actually switched in. This can happen when the selection is Low Noise Path Enable . In the case where the DC Block is switched in the analyzer is now AC coupled. However, if the user has selected DC coupling, the UI will still behave as though it were DC coupled, including all annunciation, warnings, status bits, and responses to SCPI queries. This is because, based on other settings, the analyzer could switch out the low noise path at any time and hence go back to being DC coupled.  Alignment switching ignores the settings in this menu, and restores them when finished.
<b>Dependencies</b>	Unavailable in BBIQ and External Mixing
<b>Preset</b>	All modes other than IQ Analyzer mode and VXA: STD IQ Analyzer, VXA and WLAN mode: MPB option present and licensed: MPB MPB option not present and licensed: STD
<b>State Saved</b>	Save in instrument state
<b>Readback</b>	Value selected in the submenu
<b>Initial S/W Revision</b>	A.04.00
<b>Modified at S/W Revision</b>	A.10.00

## Standard Path

This path gives the best remote-control throughput, minimizes acoustic noise from switching and minimizes the risk of wear in the hardware switches, particularly in remote test scenarios where both low band and high band setups will follow in rapid succession.

In this path, the bypass of the low band/high band switch and microwave preamp is never activated, which can cause some noise degradation but preserves the life of the bypass switch.

Key Path	AMPTD Y Scale, $\mu$ W Path Control
<b>Example</b>	:POW:MW:PATH STD
Readback Text	Standard Path
Initial S/W Revision	A.04.00

## Low Noise Path Enable

You may choose Low Noise Path Enable, which gives a lower noise floor under some circumstances, particularly when operating in the 21–26.5 GHz region. With the Low Noise Path enabled, the low band/high band switch and microwave preamp are bypassed whenever all of the following are true:

- The analyzer is not in the Low Band, meaning:
- the start frequency is above 3.5 GHz and
- the stop frequency is above 3.6 GHz.
- the internal preamp is not installed or (if installed) is set to Off or Low Band

Note that this means that, when any part of a sweep is done in Low Band, the Low Noise Path is not used, whether or not the Low Noise Path Enable is selected in the user interface. Also, if the preamp is turned on, the Low Noise Path is not used, whether or not the Low Noise Path Enable is selected in the user interface. The only time the Low Noise Path is used is when Low Noise Path Enable is selected, the sweep is completely in High Band (> 3.6 GHz) and no preamp is in use.

See "[More Information](#)" on page 2116

Key Path	AMPTD Y Scale, $\mu$ W Path Control
Measurement	Swept SA
<b>Example</b>	:POW:MW:PATH LNP
Notes	<p>For measurements that use IQ acquisition, the low noise path is used when the Center Frequency is in High Band (&gt; 3.6 GHz) and no preamp is in use.</p> <p>In other words, the rules above are modified to use only the center frequency to qualify which path to switch in.</p> <p>This is not the case for FFT's in the Swept SA measurement; they use the same rules as swept measurements.</p>
Dependencies	<p>Key is blanked if current mode does not support it.</p> <p>Key is grayed out if mode supports it but current measurement does not support it.</p> <p>Unless Option LNP is present and licensed, key is blank and if SCPI command sent, error -241, "Hardware missing; Option not installed" is generated.</p>
Readback Text	Low Noise Path Enable
Initial S/W Revision	A.04.00

### More Information

The user should understand that the Low Noise Path, while giving improved DANL, has the disadvantage of decreased TOI performance and decreased gain compression performance relative to the standard path.

The user should also understand that the bypass switch is a mechanical switch and has finite life, so if the Low Noise Path is enabled, it is possible to cause frequent cycling of this switch by frequently changing analyzer settings such that the above conditions hold true only some of the time. A user making tests of this nature should consider opting for the Standard Path, which will never throw the bypass switch, at the expense of some degraded noise performance.

The low noise path is useful for situations where the signal level is so low that the analyzer performance is dominated by noise even with 0 dB attenuation, but still high enough that the preamp option would have excessive third-order intermodulation or compression. The preamp, if purchased and used, gives better noise floor than does the “Low Noise Path.” However, its compression threshold and third-order intercept are much poorer than that of the non-preamp path. There are some applications, typically for signals around -30 dBm, for which the third-order dynamic range of the standard path is good enough, but the noise floor is not low enough even with 0 dB input attenuation. When the third-order dynamic range of the preamp path is too little and the noise floor of the standard path is too high, the Low Noise Path can provide the best dynamic range

The graph below illustrates the concept. It shows, in red, the performance of an analyzer at different attenuation settings, both with the preamp on and off, in a measurement that is affected by both analyzer noise and analyzer TOI. The green shows the best available dynamic range, offset by 0.5 dB for clarity. The blue shows how the best available dynamic range improves for moderate signal levels with the low noise path switched in. In this illustration, the preamp improves the noise floor by 15 dB while degrading the third-order intercept by 30 dB, and the low noise path reduces loss by 8 dB. The attenuator step size is 2 dB.

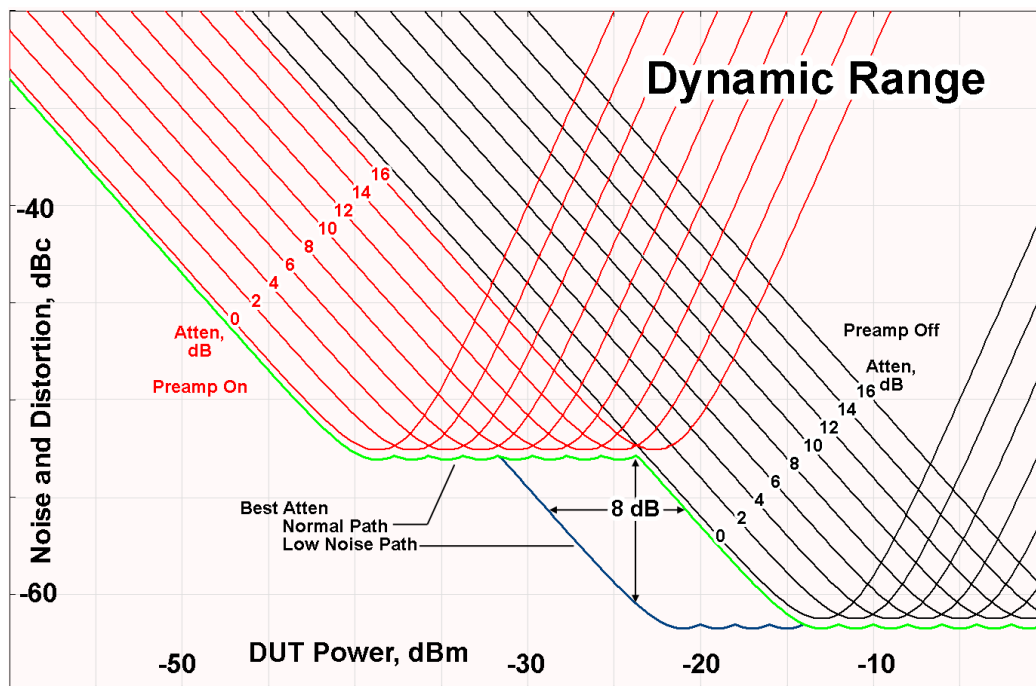

There are other times where selecting the low noise path improves performance, too. Compression-limited measurements such as finding the nulls in a pulsed-RF spectrum can profit from the low noise path in a way similar to the TOI-limited measurement illustrated. Accuracy can be improved when the low noise path allows the optimum attenuation to increase from a small amount like 0, 2 or 4 dB to a larger amount, giving better return loss at the analyzer input. Harmonic measurements, such as second and third harmonic levels, are much improved using the low noise path because of the superiority of that path for harmonic (though not intermodulation) distortion performance.

### μW Preselector Bypass

This key toggles the preselector bypass switch for band 1 and higher. When the microwave preselect is on, the signal path is preselected. When the microwave preselector is off, the signal path is not preselected. The preselected path is the normal path for the analyzer.

The preselector is a tunable bandpass filter which prevents signals away from the frequency of interest from combining in the mixer to generate in-band spurious signals (images). The consequences of using a preselector filter are its limited bandwidth, the amplitude and phase ripple in its passband, and any amplitude and phase instability due to center frequency drift.

Option MPB or pre-selector bypass provides an unpreselected input mixer path for certain X-Series signal analyzers with frequency ranges above 3.6 GHz. This signal path allows a wider bandwidth and less amplitude variability, which is an advantage when doing modulation analysis and broadband signal analysis. The disadvantage is that, without the preselector, image signals will be displayed. Another disadvantage of bypassing the preselector is increased LO emission levels at the front panel input port.

Image responses are separated from the real signal by twice the 1st IF. For IF Paths of 10 MHz and 25 MHz, the 1st IF is 322.5 MHz, so the image response and the real signal will be separated by 645 MHz. The 1st IF will be different for other IF Path settings. When viewing a real signal and its corresponding image response in internal mixing, the image response will be to the left of the real signal.

Also, the image response and the real signal typically have the same amplitude and exhibit the same shape factor.

However, if Option FS1, Fast Sweep Capability, is enabled, the image response in the Swept SA measurement will appear lower in amplitude and have a much wider shape factor compared to the real signal.

Key Path	AMPTD Y Scale, μW Path Control
Example	:POW:MW:PATH MPB
Dependencies	Key is blanked if current mode does not support it. Key is grayed out if mode supports it but current measurement does not support it. Key is blank unless Option MPB is present and licensed. If SCPI command sent when MPB not present, error -241, "Hardware missing; Option not installed" is generated.
Readback Text	μW Preselector Bypass
Initial S/W Revision	A.04.00
Remote Command	[ :SENSe ] :POWer [ :RF ] :MW:PRESelector [ :STATe ] ON OFF 0 1 [ :SENSe ] :POWer [ :RF ] :MW:PRESelector [ :STATe ] ?

<b>Example</b>	:POW:MW:PRES OFF Bypasses the microwave preselector
<b>Notes</b>	The ON parameter sets the STD path (:POW:MW:PATH STD) The OFF parameter sets path MPB (:POW:MW:PATH MPB)
<b>Preset</b>	ON

## Internal Preamp

Accesses a menu of keys that control the internal preamps. Turning on the preamp gives a better noise figure, but a poorer TOI to noise floor dynamic range. You can optimize this setting for your particular measurement.

The instrument takes the preamp gain into account as it sweeps. If you sweep outside of the range of the preamp the instrument will also account for that. The displayed result will always reflect the correct gain.

For some measurements, when the preamp is on and any part of the displayed frequency range is below the lowest frequency for which the preamp has specifications, a warning condition message appears in the status line. For example, for a preamp with a 9 kHz lowest specified frequency: "Preamp: Accy unspec'd below 9 kHz".

<b>Key Path</b>	AMPTD Y Scale
<b>Scope</b>	Meas Global
<b>Remote Command</b>	[ :SENSe ] :POWeR [ :RF ] :GAIN [ :STATe ] OFF   ON   0   1 [ :SENSe ] :POWeR [ :RF ] :GAIN [ :STATe ] ?
<b>Dependencies</b>	Preamp is not available on all hardware platforms. If the preamp is not present or is unlicensed, the key is not shown. The preamp is not available when the electronic/soft attenuator is enabled.
<b>Couplings</b>	The act of connecting the U7227A USB Preamplifier to one of the analyzer's USB ports will cause the Internal Preamp to be switched on. When this happens an informational message will be generated: "Internal Preamp turned on for optimal operation with USB Preamp." Note that if the Internal Preamp was already on, there will be no change to the setting, but if it was Off it will be switched On, to Full Range. Note that this same action occurs when the SA mode is selected while the USB Preamp is connected to one of the analyzer's USB ports, if it is the first time that the SA mode has run since powerup, or if the last time the SA mode was running the USB Preamp was NOT connected. Subsequently disconnecting the USB Preamp from USB does not change the Internal Preamp setting nor restore the previous setting.
<b>Preset</b>	OFF
<b>State Saved</b>	Saved in instrument state
<b>Initial S/W Revision</b>	Prior to A.02.00
<b>Modified at S/W Revision</b>	A.14.00

Key Path	AMPTD Y Scale, Internal Preamp
Scope	Meas Global
<b>Remote Command</b>	[ :SENSe] :POWer [ :RF] :GAIN:BAND LOW FULL [ :SENSe] :POWer [ :RF] :GAIN:BAND?
Dependencies	Preamp is not available on all hardware platforms. If the preamp is not present or is unlicensed, the key is not shown. If a POW:GAIN:BAND FULL command is sent when a low band preamp is available, the preamp band parameter is to LOW instead of FULL, and an "Option not installed" message is generated.
Preset	LOW
State Saved	Saved in instrument state
Initial S/W Revision	Prior to A.02.00

## Off

Turns the internal preamp off

Key Path	AMPTD Y Scale, Internal Preamp
<b>Example</b>	:POW:GAIN OFF
Readback	Off
Initial S/W Revision	Prior to A.02.00

## Low Band

Sets the internal preamp to use only the low band.

The frequency range of the installed (optional) low-band preamp is displayed in square brackets on the Low Band key label.

Key Path	AMPTD Y Scale, Internal Preamp
<b>Example</b>	:POW:GAIN ON :POW:GAIN:BAND LOW
Readback	Low Band
Initial S/W Revision	Prior to A.02.00

## Full Range

Sets the internal preamp to use its full range. The low band (0–3.6 GHz or 0–3GHz, depending on the model) is supplied by the low band preamp and the frequencies above low band are supplied by the high band preamp.

The frequency range of the installed (optional) preamp is displayed in square brackets on the Full Range key label. If the high band option is not installed the Full Range key does not appear.

Key Path	AMPTD Y Scale, Internal Preamp
Example	:POW:GAIN ON :POW:GAIN:BAND FULL
Readback	Full Range
Initial S/W Revision	Prior to A.02.00

### Ref Position

Positions the reference level at the top, center or bottom of the Y Scale display. Changing the reference position does not change the reference level value.

This functionality depends on the selected view:

- "Ref Position (RF Envelope View)" on page 2120
- "Ref Position (I/Q Waveform View)" on page 2121

### Ref Position (RF Envelope View)

Positions the reference level at the top, center or bottom of the Y Scale display. Changing the reference position does not change the reference level value.

Key Path	AMPTD Y Scale
Mode	BASIC, PNOISE, WCDMA, C2K, GSM, WIMAXOFDMA, TDSCDMA, 1XEVD0, DVB, DTMB, ISDBT, CMMB, LTE, LTETDD, DCATV, WLAN,LTEATDD, LTEAFDD
Remote Command	:DISPlay:WAVEform:VIEW[1]:WINDow[1]:TRACe:Y[:SCALE]:RPOSition TOP   CENTER   BOTTom :DISPlay:WAVEform:VIEW[1]:WINDow[1]:TRACe:Y[:SCALE]:RPOSition?
Example	DISP:WAV:VIEW:WIND:TRAC:Y:RPOS CENT DISP:WAV:VIEW:WIND:TRAC:Y:RPOS?
Notes	You must be in a mode that includes the Waveform measurement to use this command. Use INSTRument:SElect to set the mode.
Preset	TOP
State Saved	Saved in instrument state.
Range	Top Ctr Bot
Initial S/W Revision	Prior to A.02.00
Modified at S/W Revision	A.03.00



## Ref Position (I/Q Waveform View)

Positions the reference level at the top, center or bottom of the Y Scale display. Changing the reference position does not change the reference level value.

Key Path	AMPTD Y Scale
Mode	BASIC, PNOISE, WCDMA, C2K, GSM, WIMAXOFDMA, TDSCDMA, 1XEVD0, DVB, DTMB, ISDBT, CMMB, LTE, LTETDD, DCATV, WLAN,LTEATDD, LTEAFDD
Remote Command	:DISPlay:WAVeform:VIEW2:WINDow[1]:TRACe:Y[:SCALe]:RPOSition TOP   CENTER   BOTTom :DISPlay:WAVeform:VIEW2:WINDow[1]:TRACe:Y[:SCALe]:RPOSition?
Example	DISP:WAV:VIEW2:WIND:TRAC:Y:RPOS CENT DISP:WAV:VIEW2:WIND:TRAC:Y:RPOS?
Notes	You must be in a mode that includes the Waveform measurement to use this command. Use INSTRument:SElect to set the mode.
Preset	CENT
State Saved	Saved in instrument state.
Range	Top Ctr Bot
Initial S/W Revision	Prior to A.02.00
Modified at S/W Revision	A.03.00

## Auto Scaling

Toggles the Auto Scaling function between On and Off. When the Restart front-panel key is pressed, this function automatically determines the scale per division and reference values based on the measurement results.

Key Path	AMPTD Y Scale
Mode	BASIC, PNOISE, WCDMA, C2K, GSM, WIMAXOFDMA, TDSCDMA, 1XEVD0, DVB, DTMB, ISDBT, CMMB, LTE, LTETDD, DCATV, WLAN,LTEATDD, LTEAFDD
Remote Command	:DISPlay:WAVeform:VIEW[1] 2:WINDow[1]:TRACe:Y[:SCALe]:COUPlE 0   1   OFF   ON :DISPlay:WAVeform:VIEW[1] 2:WINDow[1]:TRACe:Y[:SCALe]:COUPlE?
Example	DISP:WAV:VIEW:WIND:TRAC:Y:COUP OFF DISP:WAV:VIEW:WIND:TRAC:Y:COUP?
Notes	You must be in a mode that includes the Waveform measurement to use this command. Use INSTRument:SElect to set the mode.
Couplings	When Auto Scaling is On, upon pressing the Restart front-panel key, this function automatically switches the scale per division and reference values into the defaults. When you set a value to either Scale/Div or Ref Value manually, Auto Scaling automatically changes to Off.
Preset	OFF

State Saved	Saved in instrument state.
Range	On Off
Initial S/W Revision	Prior to A.02.00
Modified at S/W Revision	A.03.00

## Range

This key is only available when I/Q is the selected input. It replaces the Attenuation key in that case.

Each input channel (I and Q) has four internal gain ranges. The maximum allowed voltage in each gain range is slightly more than the nominal value, so the break point between ranges is a couple of millivolts higher than the nominal (setting a peak voltage of 0.502 mV will still map to the 0.5 V Peak range).

Gain Setting	Volts RMS	Volts Peak	Volts Peak - Peak	dBm (50Ω)	Break Point
0 dB	0.7071	1.0	2.0	10	n/a
6 dB	0.3536	0.5	1.0	4	0.502 V Peak
12 dB	0.1768	0.25	0.5	-2	0.252 V Peak
18 dB	0.0884	0.125	0.25	-8	0.127 V Peak

Key Path	AMPTD Y Scale
Notes	Visible only when the selected input is I/Q.
State Saved	No
Readback Text	When Range is Auto, "[Auto]" When Range is Man and I & Q are the same, "[<range value>]" When Range is Man and I & Q are different: "[I: <I range value> Q: <Q range value>]" See I Range and Q Range for the <range value> enumeration definition.
Initial S/W Revision	Prior to A.02.00

## Range Auto/Man

The Auto setting for Range causes the range to be set based on the Y Scale settings. When Range is "Auto", the I & Q Range are set based on the top of the Y Scale when the Y scale is in dB units (for example, power), or to the max(abs(top), abs(bottom)) when the Y scale reference is not at the top of the screen.

Not all measurements support Range Auto/Man. If Auto is not supported in the current measurement, this key is grayed out and shows "Man" and MAN is returned to a SCPI query, but this does NOT change the Auto/Man setting for Range. When you go to a measurement that supports Auto, it goes back to Auto if it was previously in Auto mode.

Key Path	AMPTD Y Scale, Range
Scope	Meas Global
<b>Remote Command</b>	[ :SENSe ] :VOLTage:IQ:RANGe:AUTO OFF ON 0 1 [ :SENSe ] :VOLTage:IQ:RANGe:AUTO?
<b>Example</b>	Put the I Range and Q Range in manual. VOLT:IQ:RANG:AUTO OFF
Dependencies	If Auto is not supported, sending the SCPI command will generate an error.
Couplings	When in Auto, both I Range and Q Range are set to the same value, computed as follows: Maximum absolute value is computed for the Y Scale. The top and bottom of the graph are computed based on Ref Value, Scale/Div, and Ref Position. Formula: YMax = max(abs(top), abs(bottom)). The I Range and Q Range are then set to YMax.
Preset	ON
State Saved	Saved in instrument state
Range	Auto   Man
Initial S/W Revision	Prior to A.02.00

<b>Remote Command</b>	[ :SENSe ] :POWer:IQ:RANGe:AUTO OFF ON 0 1 [ :SENSe ] :POWer:IQ:RANGe:AUTO?
<b>Example</b>	Put the I Range and Q Range in manual. POW:IQ:RANG:AUTO OFF
Notes	The POW:IQ:RANG:AUTO is an alternate form of the VOLT:IQ:RANG:AUTO command. This is to maintain consistency with I Range and Q Range, which support both the POWER and VOLTage forms of the command.
Preset	ON
Range	Auto   Man
Initial S/W Revision	Prior to A.02.00

## I Range

This is the internal gain range for the I channel when Input Path is I Only or I and I/Q, and it is used for both the I and Q channels when the Input Path is I+jQ. See "[I/Q Gain Ranges](#)" on page 2127.

Key Path	AMPTD Y Scale, Range
<b>Remote Command</b>	[ :SENSe ] :VOLTage:IQ[:I]:RANGe[:UPPer] <voltage> [ :SENSe ] :VOLTage:IQ[:I]:RANGe[:UPPer]?
<b>Example</b>	Set the I Range to 0.5 V Peak VOLT:IQ:RANG 0.5 V
Notes	The numeric entries are mapped to the smallest gain range whose break point is greater than or equal to the value, or 1 V Peak if the value is greater than 1 V.

Couplings	When Q Same as I is On, the I Range value will be copied to the Q Range. Changing the value will also set Range = Man.
Preset	1 V Peak
State Saved	Saved in instrument state
Range	1 V Peak   0.5 V Peak   0.25 V Peak   0.125 V Peak
Min	0.125 V
Max	1 V
Initial S/W Revision	Prior to A.02.00

<b>Remote Command</b>	<code>[ :SENSE ] :POWER:IQ [ :I ] :RANGe [ :UPPer ] &lt;ampl&gt;</code> <code>[ :SENSE ] :POWER:IQ [ :I ] :RANGe [ :UPPer ] ?</code>
-----------------------	---

<b>Example</b>	Set the I Range to 0.5 V Peak when Reference Z is 50Ω, and to 1.0 V Peak when Reference Z is 75Ω. POW:IQ:RANG 4 dBm
----------------	--

Notes	The POWER form of the command is provided for convenience. It maps to the same underlying gain range parameter as the VOLTage form of the command. The Reference Z (not the I channel Input Z) is used to convert the power to peak voltage, which is then used to set the I Range as with the VOLTage form of the command. The power values of the 4 range states (1V Peak, 0.5V Peak, 0.25V Peak, and 0.125V Peak) will vary with Reference Z. Here are some examples: 50Ω: 10, 4, -2, -8 75Ω: 8.2, 2.2, -3.8, -9.8 600Ω: -0.8, -6.8, -12.8, -18.9
-------	--

Preset	10.0 dBm
Range	-20 dBm to 10 dBm
Min	-20 dBm
Max	10 dBm
Initial S/W Revision	Prior to A.02.00

### 1 V Peak

Set the channel gain state to 1 Volt Peak.

Key Path	AMPTD Y Scale, I Range   Q Range
Initial S/W Revision	Prior to A.02.00

### 0.5 V Peak

Set the channel gain state to 0.5 Volt Peak.

Key Path	AMPTD Y Scale, I Range   Q Range
Initial S/W Revision	Prior to A.02.00

### 0.25 V Peak

Set the channel gain state to 0.25 Volt Peak.

Key Path	AMPTD Y Scale, I Range   Q Range
Initial S/W Revision	Prior to A.02.00

### 0.125 V Peak

Set the channel gain state to 0.125 Volt Peak.

Key Path	AMPTD Y Scale, I Range   Q Range
Initial S/W Revision	Prior to A.02.00

### Q Range Value

This is the internal gain range for the Q channel. See "[I/Q Gain Ranges](#)" on page 2127. The Q Range only applies to Input Path Q Only and Ind I/Q. For input I+jQ the I Range determines both I and Q channel range settings.

Key Path	AMPTD Y Scale, Range
<b>Remote Command</b>	<code>[ :SENSe ] :VOLTage:IQ:Q:RANGe [ :UPPer ] &lt;voltage&gt;</code> <code>[ :SENSe ] :VOLTage:IQ:Q:RANGe [ :UPPer ] ?</code>
<b>Example</b>	Set the Q Range to 0.5 V Peak <code>VOLT:IQ:Q:RANG 0.5 V</code>
Notes	The numeric entries are mapped to the smallest gain range whose break point is greater than or equal to the value, or 1 V Peak if the value is greater than 1 V. The Q Range is only used for Input Path Q Only and Ind I/Q. For input I+jQ the I Range determines both I and Q channel range settings.
Couplings	When Q Same as I is On, the I Range value will be copied to the Q Range and the range value keys are disabled. Changing the value will also set Range = Man.
Preset	1 V Peak
State Saved	Saved in instrument state
Range	1 V Peak   0.5 V Peak   0.25 V Peak   0.125 V Peak
Min	0.125 V
Max	1 V
Initial S/W Revision	Prior to A.02.00

<b>Remote Command</b>	<code>[ :SENSe ] :POWer:IQ:Q:RANGe[:UPPer] &lt;ampl&gt;</code> <code>[ :SENSe ] :POWer:IQ:Q:RANGe[:UPPer] ?</code>
<b>Example</b>	Will set the Q Range to 0.5 V Peak when Reference Z is 50Ω, and to 1.0 V Peak when Reference Z is 75Ω. <code>POW:IQ:Q:RANG 4 dBm</code>
<b>Notes</b>	The POWer form of the command is provided for convenience. It maps to the same underlying gain range parameter as the VOLTage form of the command. The Reference Z (not the Q channel Input Z) is used to convert the power to peak voltage, which is then used to set the Q Range as with the VOLTage form of the command. The power values of the 4 range states (1V Peak, 0.5V Peak, 0.25V Peak, and 0.125V Peak) will vary with Reference Z. Here are some examples: 50Ω: 10, 4, -2, -8 75Ω: 8.2, 2.2, -3.8, -9.8 600Ω: -0.8, -6.8, -12.8, -18.9
<b>Preset</b>	10.0 dBm
<b>Range</b>	-20 dBm to 10 dBm
<b>Min</b>	-20 dBm
<b>Max</b>	10 dBm
<b>Initial S/W Revision</b>	Prior to A.02.00

### Q Same as I

Many, but not all, usages require the I and Q channels to have an identical setup. To simplify channel setup, the Q Same as I will cause the Q channel range to be mirrored from the I channel. That way you only need to set up one channel (the I channel). The I channel values are copied to the Q channel, so at the time Q Same as I is Off, the I and Q channel setups will be identical.

<b>Key Path</b>	AMPTD Y Scale, Range, Q Range
<b>Remote Command</b>	<code>[ :SENSe ] :VOLTage POWer:IQ:MIRRored OFF ON 0 1</code> <code>[ :SENSe ] :VOLTage POWer:IQ:MIRRored?</code>
<b>Example</b>	Turn off the mirroring of I Range to Q Range. <code>VOLT:IQ:MIRR OFF</code> <code>POW:IQ:MIRR OFF</code>
<b>Couplings</b>	When On, the I Range value is mirrored (copied) to the Q Range.
<b>Preset</b>	On
<b>State Saved</b>	Saved in instrument state.
<b>Range</b>	On   Off
<b>Readback Text</b>	"Q Same as I" when On, otherwise none.
<b>Initial S/W Revision</b>	Prior to A.02.00

### 1 V Peak

Set the channel gain state to 1 Volt Peak.

---

Key Path	AMPTD Y Scale, I Range   Q Range
Initial S/W Revision	Prior to A.02.00

---

### 0.5 V Peak

Set the channel gain state to 0.5 Volt Peak.

---

Key Path	AMPTD Y Scale, I Range   Q Range
Initial S/W Revision	Prior to A.02.00

---

### 0.25 V Peak

Set the channel gain state to 0.25 Volt Peak.

---

Key Path	AMPTD Y Scale, I Range   Q Range
Initial S/W Revision	Prior to A.02.00

---

### 0.125 V Peak

Set the channel gain state to 0.125 Volt Peak.

---

Key Path	AMPTD Y Scale, I Range   Q Range
Initial S/W Revision	Prior to A.02.00

---

### I/Q Gain Ranges

See the following sections:

["1 V Peak" on page 2127](#)

["0.5 V Peak" on page 2128](#)

["0.25 V Peak" on page 2128](#)

["0.125 V Peak" on page 2128](#)

### 1 V Peak

Set the channel gain state to 1 Volt Peak.

---

Key Path	AMPTD Y Scale, I Range   Q Range
Initial S/W Revision	Prior to A.02.00

---

### 0.5 V Peak

Set the channel gain state to 0.5 Volt Peak.

Key Path	AMPTD Y Scale, I Range   Q Range
Initial S/W Revision	Prior to A.02.00

### 0.25 V Peak

Set the channel gain state to 0.25 Volt Peak.

Key Path	AMPTD Y Scale, I Range   Q Range
Initial S/W Revision	Prior to A.02.00

### 0.125 V Peak

Set the channel gain state to 0.125 Volt Peak.

Key Path	AMPTD Y Scale, I Range   Q Range
Initial S/W Revision	Prior to A.02.00



## Auto Couple

The Auto Couple feature provides a quick and convenient way to automatically couple multiple instrument settings. This helps ensure accurate measurements and optimum dynamic range. When the Auto Couple feature is activated, either from the front panel or remotely, all parameters of the current measurement that have an Auto/Manual mode are set to Auto mode and all measurement settings dependent on (or coupled to) the Auto/Man parameters are automatically adjusted for optimal performance.

However, the Auto Couple key actions are confined to the current measurement only. It does not affect other measurements in the mode, and it does not affect markers, marker functions, or trace or display attributes.

See ["More Information" on page 2129](#)

Key Path	Front-panel key
Remote Command	:COUPle ALL NONE
Example	:COUP ALL
Notes	:COUPle ALL puts all Auto/Man parameters in Auto mode (equivalent to pressing the Auto Couple key). :COUPLE NONE puts all Auto/Man parameters in manual mode. It decouples all the coupled instrument parameters and is not recommended for making measurements.
Initial S/W Revision	Prior to A.02.00

### More Information

There are two types of functions that have Auto/Manual modes.

#### Auto/Man Active Function keys

An Auto/Man toggle key controls the binary state associated with an instrument parameter by toggling between Auto (where the parameter is automatically coupled to the other parameters it is dependent upon) and Man (where the parameter is controlled independent of the other parameters), as well as making the parameter the active function. The current mode is indicated on the softkey with either Auto or Man underlined as illustrated below.



#### Auto/Man 1-of-N keys

An Auto/Man 1-of-N key allows you to manually pick from a list of parameter values, or place the function in Auto, in which case the value is automatically selected (and indicated) as shown below. If in Auto, Auto is underlined on the calling key. If in manual operation, manual is indicated on the calling key. But the calling key does not actually toggle the function, it simply opens the menu.

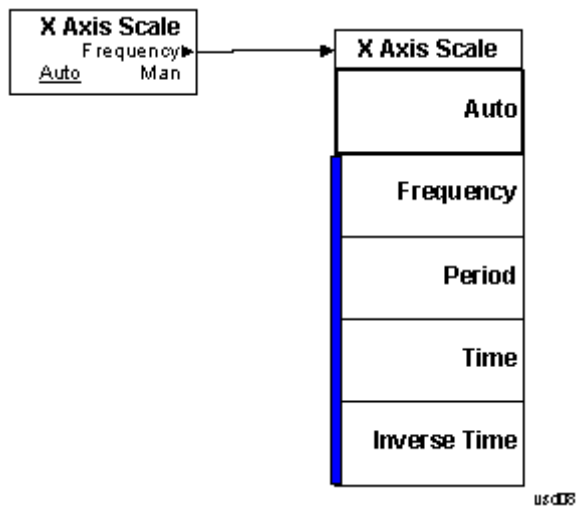

## BW

Accesses a menu that enables you to control the information bandwidth functions of the instrument. You can also select the filter type for the measurement.

Key Path	Front-panel key
Initial S/W Revision	Prior to A.02.00

## Digital IF BW

Enables you to set the Digital IF (formerly Info BW) bandwidth of the instrument.

Key Path	BW
Mode	BASIC, PNOISE, WCDMA, C2K, GSM, WIMAXOFDMA, TD-SCDMA, 1XEVD0, DVB, DTMB, ISDBT, CMMB, LTE, LTETDD, DCATV, WLAN, MSR,LTEATDD, LTEAFDD
Remote Command	<code>[ :SENSe ] :WAVeform :DIF :BANDwidth &lt;freq&gt;</code> <code>[ :SENSe ] :WAVeform :DIF :BANDwidth?</code>
Example	WAV:DIF:BAND 1kHz WAV:DIF:BAND?
Notes	Max value depends on the IF Path Selection
Remote Command Notes	You must be in a mode that includes the Waveform measurements to use this command. Use INSTRument:SElect to set the mode.
Dependencies	For applications that have the IF Path Selection menu such as the BASIC mode, if IF Path Auto is OFF, the maximum value depends on which IF Path is currently selected. If 10 MHz, 25 MHz, 40 MHz, 85 MHz, 125 MHz, 140 MHz or 160 MHz paths are selected, the maximum value of this parameter will be 10, 25, 40, 85, 125, 140 or 160 MHz, respectively. If IF Path Auto is ON, the maximum value will be the maximum Digital IF BW available in the instrument regardless of the current IF Path Selection. For example, if the instrument has the options B25, B40, and B1X installed, the maximum available Digital IF BW of the instrument is 140 MHz. Thus, if IF Path Auto is ON and IF Path Selection is 25 MHz, the maximum Digital IF BW is not limited to 25 MHz but is 140 MHz.
Preset	All except the following list: 100 kHz GSM/EDGE: 510 kHz TDSCDMA: 1.3 MHz 1xEVD0: 1.3 MHz DVB-T/H: 8.0 MHz DTMB (CTTB): 8.0 MHz ISDB-T: 6.0 MHz CMMB: 8.0 MHz Digital Cable TV: 8 MHz LTEAFDD, LTEATDD: 6 MHz LTETDD: 6 MHz

	WLAN: Hardware Dependent No option = 10 MHz Option B25 = 25 MHz Option B40: if Radio Std is 802.11a/b/g/n(20MHz) = 25 MHz if Radio Std is 802.11n(40MHz) = 40 MHz if Radio Std is 802.11ac(20MHz) = 25 MHz if Radio Std is 802.11ac(40MHz) = 40 MHz Option B1X: if Radio Std is 802.11ac(80MHz) = 80 MHz Option B1Y: if Radio Std is 802.11ac(160MHz) = 160 MHz
State Saved	Saved in instrument state.
Min	10 Hz
Max	Hardware Dependent: RF Input: No Option = 10 MHz Option B25 = 25 MHz Option B40 = 40 MHz Option B85 = 85.0 MHz Option B1A = 125.0 MHz Option B1X = 140 MHz Option B1Y = 160 MHz I/Q Input: No Option = 10 MHz per channel (20 MHz for I+jQ) Option B25 = 25 MHz per channel (50 MHz for I+jQ) Option S40 = 40 MHz per channel (80 MHz for I+jQ)
<b>Backwards Compatibility SCPI</b>	[:SENSe]:WAVEform:BWIDth[:RESolution]
Initial S/W Revision	Prior to A.02.00
Modified at S/W Revision	A.03.00, A.13.00

## Filter Type

Selects the type of bandwidth filter that is used.

Besides the Gaussian filter shape, a variety of other filter types are available with variable alpha settings for maximum control over the filter shape..

Key Path	BW
Mode	BASIC, PNOISE, WCDMA, C2K, GSM, WIMAXOFDMA, TDSCDMA, 1XEVD0, DVB, DTMB, ISDBT,

	CMMB, LTE, LTE40, DCATV, WLAN, MSR,,LTE40, LTEAFDD
<b>Remote Command</b>	[:SENSe]:WAVeform:DIF:FILTer:TYPE GAUSSian FLATtop [:SENSe]:WAVeform:DIF:FILTer:TYPE?  (With DIF40 and/or WBDIF) [:SENSe]:WAVeform:DIF:FILTer:TYPE GAUSSian   FLATtop   SNYQuist   RSNYquist   RCOSine   RRCosine [:SENSe]:WAVeform:DIF:FILTer:TYPE?
<b>Example</b>	WAV:DIF:FILT:TYPE GAUS WAV:DIF:FILT:TYPE?
Remote Command Notes	You must be in a mode that includes the Waveform measurements to use this command. Use INSTRument:SElect to set the mode.
Dependencies	Gaussian and Flattop are available in all DIF configurations. For the other filter types, the filters are only available when Option DP2, B40, or wider IF Bandwidth option is installed.
Preset	BASIC with DP2, B40, or wider IF Bandwidth option: FLATtop All other apps: GAUSSian
State Saved	Saved in instrument state.
Range	Gaussian FlatTop When Option DP2, B40, or wider IF Bandwidth option is installed, the range is as follows. Gaussian Flattop Short nyquist Root Short Nquist Raised Cosine Root RaisedCosine
<b>Backwards Compatibility SCPI</b>	[:SENSe]:WAVeform:BANDwidth:SHApe [:SENSe]:WAVeform:BWIDth:SHApe [:SENSe]:WAVeform:BANDwidth BWIDth[:RESolution]:TYPE
Initial S/W Revision	Prior to A.02.00
Modified at S/W Revision	A.03.00, A.13.00

## Filter BW

This feature is only available when Option DP2, B40, or wider IF Bandwidth option is installed.

<b>Key Path</b>	BW
<b>Mode</b>	BASIC
<b>Remote Command</b>	[:SENSe]:WAVeform:DIF:FILTer:BANDwidth <freq> [:SENSe]:WAVeform:DIF:FILTer:BANDwidth? [:SENSe]:WAVeform:DIF:FILTer:BANDwidth:AUTO ON OFF 1 0 [:SENSe]:WAVeform:DIF:FILTer:BANDwidth:AUTO?
<b>Example</b>	WAV:DIF:FILT:BAND 1MHz WAV:DIF:FILT:BAND? WAV:DIF:FILT:BAND:AUTO 0

	<b>WAV:DIF:FILT:BAND:AUTO?</b>
Notes	You must be in the IQ Analyzer (Basic) mode to use this command. Use INSTRUMENT:SElect to set the mode.
Dependencies	This feature is only available when Option DP2, B40, or wider IF Bandwidth option is installed.
Couplings	Sets the same value as the current Digital IF BW value upon a preset or when Channel Filter Bandwidth Auto is ON.
Preset	Same value as Digital IF BW ON
State Saved	Saved in instrument state.
Min	10 Hz
Max	Clipped to the current Digital IF BW value.
Initial S/W Revision	A.04.00, A.13.00

### Filter Alpha

Sets the filter alpha for the DIF filter. This feature is only available when Option DP2, B40, or wider IF Bandwidth option is installed.

Key Path	BW
Mode	BASIC
<b>Remote Command</b>	[ :SENSE ] :WAVeform:DIF:FILTer:ALPHa <real> [ :SENSE ] :WAVeform:DIF:FILTer:ALPHa?
<b>Example</b>	WAV:DIF:FILT:ALPH 0.5 WAV:DIF:FILT:ALPH?
Notes	You must be in the IQ Analyzer (Basic) mode to use this command. Use INSTRUMENT:SElect to set the mode.
Dependencies	This feature is only available when Option DP2, B40, or wider IF Bandwidth option is installed.
Preset	0.2
State Saved	Saved in instrument state.
Min	0.01
Max	1.00
<b>Backwards Compatibility SCPI</b>	[ :SENSE ] :WAVeform:WBIF:FILTer:ALPHa
Modified at S/W Revision	A.13.00

### Filter Type Bwcc

This parameter is strictly for Bwcc purposes.

<b>Remote Command</b>	<code>[ :SENSe ] :WAVeform:WBIF:FILTer[:TYPE] GAUSSian   NONE   NYQuist   RNYQuist   RCOSine   RRCosine</code>  <code>[ :SENSe ] :WAVeform:WBIF:FILTer[:TYPE] ?</code>
<b>Preset</b>	BASIC with Option DP2, B40, or wider IF Bandwidth option: FLATtop All other apps: GAUSSian

## Gaussian

When Option DP2, B40, or wider IF Bandwidth option is installed, the capability for arbitrary Digital IF bandwidths is available. However, for instruments without DP2, B40, or wider IF Bandwidth option, the selectable Gaussian filter bandwidths are predetermined as shown in the following list. There are 160 Info BWs (RBWs) arranged in a 24-per-decade sequence from 1 Hz through 3 MHz, plus the 4, 5, 6 and 8 MHz settings.

The following table list all 160 Gaussian filter types

### Gaussian filters

<b>Normal (-3 dB)</b>	<b>-6 dB</b>	<b>Noise</b>	<b>Impulse</b>
1.0 Hz	1.41 Hz	1.06 Hz	1.49 Hz
1.1 Hz	1.55 Hz	1.16 Hz	1.63 Hz
1.2 Hz	1.69 Hz	1.27 Hz	1.77 Hz
1.3 Hz	1.83 Hz	1.37 Hz	1.92 Hz
1.5 Hz	2.11 Hz	1.59 Hz	2.22 Hz
1.6 Hz	2.25 Hz	1.69 Hz	2.37 Hz
1.8 Hz	2.53 Hz	1.90 Hz	2.66 Hz
2.0 Hz	2.81 Hz	2.12 Hz	2.96 Hz
2.2 Hz	3.09 Hz	2.33 Hz	3.25 Hz
2.4 Hz	3.38 Hz	2.54 Hz	3.55 Hz
2.7 Hz	3.80 Hz	2.86 Hz	3.99 Hz
3.0 Hz	4.22 Hz	3.17 Hz	4.44 Hz
3.3 Hz	4.64 Hz	3.49 Hz	4.88 Hz
3.6 Hz	5.06 Hz	3.81 Hz	5.32 Hz
3.9 Hz	5.49 Hz	4.12 Hz	5.77 Hz
4.3 Hz	6.05 Hz	4.55 Hz	6.36 Hz
4.7 Hz	6.61 Hz	4.97 Hz	6.95 Hz
5.1 Hz	7.17 Hz	5.39 Hz	7.54 Hz
5.6 Hz	7.87 Hz	5.92 Hz	8.27 Hz
6.2 Hz	8.72 Hz	6.56 Hz	9.17 Hz

6.8 Hz	9.55 Hz	7.18 Hz	10.0 Hz
7.5 Hz	10.5 Hz	7.93 Hz	11.1 Hz
8.2 Hz	11.5 Hz	8.66 Hz	12.1 Hz
9.1 Hz	12.8 Hz	9.64 Hz	13.5 Hz
10 Hz	14.0 Hz	10.6 Hz	14.8 Hz
11 Hz	15.4 Hz	11.6 Hz	16.2 Hz
12 Hz	16.9 Hz	12.7 Hz	17.7 Hz
13 Hz	18.3 Hz	13.7 Hz	19.2 Hz
15 Hz	21.1 Hz	15.9 Hz	22.2 Hz
16 Hz	22.5 Hz	16.9 Hz	23.7 Hz
18 Hz	25.3 Hz	19.1 Hz	26.6 Hz
20 Hz	28.1 Hz	21.1 Hz	29.5 Hz
22 Hz	30.9 Hz	23.2 Hz	32.5 Hz
24 Hz	33.8 Hz	25.4 Hz	35.5 Hz
27 Hz	38.0 Hz	28.6 Hz	40.0 Hz
30 Hz	42.3 Hz	31.8 Hz	44.5 Hz
33 Hz	46.3 Hz	34.8 Hz	48.7 Hz
36 Hz	50.7 Hz	38.1 Hz	53.3 Hz
39 Hz	54.9 Hz	41.3 Hz	57.7 Hz
43 Hz	60.5 Hz	45.5 Hz	63.6 Hz
47 Hz	66.1 Hz	49.7 Hz	69.5 Hz
51 Hz	71.7 Hz	53.9 Hz	75.3 Hz
56 Hz	78.9 Hz	59.3 Hz	83.0 Hz
62 Hz	87.3 Hz	65.6 Hz	91.7 Hz
68 Hz	95.5 Hz	71.8 Hz	100 Hz
75 Hz	106 Hz	79.4 Hz	111 Hz
82 Hz	115 Hz	86.8 Hz	121 Hz
91 Hz	128 Hz	96.4 Hz	135 Hz
100 Hz	141 Hz	106 Hz	148 Hz
110 Hz	154 Hz	116 Hz	162 Hz
120 Hz	169 Hz	127 Hz	178 Hz
130 Hz	183 Hz	137 Hz	192 Hz
150 Hz	211 Hz	159 Hz	222 Hz
160 Hz	225 Hz	169 Hz	237 Hz
180 Hz	253 Hz	190 Hz	266 Hz
200 Hz	281 Hz	211 Hz	295 Hz
220 Hz	309 Hz	232 Hz	325 Hz



240 Hz	337 Hz	254 Hz	355 Hz
270 Hz	380 Hz	286 Hz	400 Hz
300 Hz	422 Hz	317 Hz	444 Hz
330 Hz	463 Hz	348 Hz	487 Hz
360 Hz	507 Hz	381 Hz	533 Hz
390 Hz	550 Hz	413 Hz	578 Hz
430 Hz	605 Hz	455 Hz	636 Hz
470 Hz	662 Hz	498 Hz	696 Hz
510 Hz	718 Hz	540 Hz	755 Hz
560 Hz	789 Hz	593 Hz	829 Hz
620 Hz	872 Hz	655 Hz	916 Hz
680 Hz	958 Hz	720 Hz	1.01 kHz
750 Hz	1.06 kHz	794 Hz	1.11 kHz
820 Hz	1.15 kHz	866 Hz	1.21 kHz
910 Hz	1.28 kHz	964 Hz	1.35 kHz
1.0 kHz	1.41 kHz	1.06 kHz	1.48 kHz
1.1 kHz	1.55 kHz	1.17 kHz	1.63 kHz
1.2 kHz	1.69 kHz	1.27 kHz	1.78 kHz
1.3 kHz	1.83 kHz	1.38 kHz	1.93 kHz
1.5 kHz	2.11 kHz	1.59 kHz	2.22 kHz
1.6 kHz	2.26 kHz	1.70 kHz	2.37 kHz
1.8 kHz	2.54 kHz	1.91 kHz	2.67 kHz
2.0 kHz	2.82 kHz	2.12 kHz	2.96 kHz
2.2 kHz	3.10 kHz	2.33 kHz	3.26 kHz
2.4 kHz	3.38 kHz	2.54 kHz	3.56 kHz
2.7 kHz	3.80 kHz	2.86 kHz	4.00 kHz
3.0 kHz	4.23 kHz	3.18 kHz	4.44 kHz
3.3 kHz	4.65 kHz	3.49 kHz	4.89 kHz
3.6 kHz	5.06 kHz	3.81 kHz	5.32 kHz
3.9 kHz	5.48 kHz	4.12 kHz	5.76 kHz
4.3 kHz	6.07 kHz	4.56 kHz	6.38 kHz
4.7 kHz	6.62 kHz	4.98 kHz	6.96 kHz
5.1 kHz	7.16 kHz	5.38 kHz	7.53 kHz
5.6 kHz	7.87 kHz	5.92 kHz	8.27 kHz
6.2 kHz	8.74 kHz	6.57 kHz	9.18 kHz
6.8 kHz	9.58 kHz	7.20 kHz	10.1 kHz
7.5 kHz	10.5 kHz	7.92 kHz	11.1 kHz

8.2 kHz	11.5 kHz	8.66 kHz	12.1 kHz
9.1 kHz	12.8 kHz	9.64 kHz	13.5 kHz
10 kHz	14.1 kHz	10.6 kHz	14.8 kHz
11 kHz	15.4 kHz	11.6 kHz	16.2 kHz
12 kHz	16.9 kHz	12.7 kHz	17.8 kHz
13 kHz	18.3 kHz	13.7 kHz	19.2 kHz
15 kHz	21.2 kHz	15.9 kHz	22.3 kHz
16 kHz	22.4 kHz	16.8 kHz	23.5 kHz
18 kHz	25.2 kHz	19.0 kHz	26.5 kHz
20 kHz	28.4 kHz	21.3 kHz	29.8 kHz
22 kHz	31.2 kHz	23.4 kHz	32.8 kHz
24 kHz	33.8 kHz	25.4 kHz	35.6 kHz
27 kHz	38.1 kHz	28.7 kHz	40.1 kHz
30 kHz	42.1 kHz	31.7 kHz	44.3 kHz
33 kHz	46.8 kHz	35.2 kHz	49.2 kHz
36 kHz	50.1 kHz	37.7 kHz	52.7 kHz
39 kHz	54.8 kHz	41.2 kHz	57.6 kHz
43 kHz	61.1 kHz	46.0 kHz	64.3 kHz
47 kHz	66.2 kHz	49.8 kHz	69.6 kHz
51 kHz	72.3 kHz	54.3 kHz	76.0 kHz
56 kHz	79.5 kHz	59.8 kHz	83.6 kHz
62 kHz	86.3 kHz	64.9 kHz	90.8 kHz
68 kHz	96.5 kHz	72.6 kHz	101 kHz
75 kHz	106 kHz	79.7 kHz	111 kHz
82 kHz	114 kHz	86.0 kHz	120 kHz
91 kHz	129 kHz	97.3 kHz	136 kHz
100 kHz	140 kHz	105 kHz	147 kHz
110 kHz	154 kHz	116 kHz	162 kHz
120 kHz	169 kHz	127 kHz	178 kHz
130 kHz	182 kHz	137 kHz	192 kHz
150 kHz	210 kHz	158 kHz	221 kHz
160 kHz	223 kHz	168 kHz	235 kHz
180 kHz	253 kHz	190 kHz	266 kHz
200 kHz	280 kHz	211 kHz	295 kHz
220 kHz	308 kHz	232 kHz	324 kHz
240 kHz	336 kHz	253 kHz	353 kHz
270 kHz	380 kHz	286 kHz	400 kHz

300 kHz	420 kHz	316 kHz	441 kHz
330 kHz	467 kHz	352 kHz	491 kHz
360 kHz	506 kHz	380 kHz	532 kHz
390 kHz	550 kHz	414 kHz	578 kHz
430 kHz	599 kHz	451 kHz	629 kHz
470 kHz	660 kHz	497 kHz	693 kHz
510 kHz	715 kHz	538 kHz	750 kHz
560 kHz	786 kHz	592 kHz	826 kHz
620 kHz	867 kHz	653 kHz	912 kHz
680 kHz	952 kHz	717 kHz	1.00 MHz
750 kHz	1.05 MHz	791 kHz	1.10 MHz
820 kHz	1.14 MHz	859 kHz	1.19 MHz
910 kHz	1.27 MHz	960 kHz	1.34 MHz
1.0 MHz	1.40 MHz	1.06 MHz	1.47 MHz
1.1 MHz	1.53 MHz	1.15 MHz	1.61 MHz
1.2 MHz	1.66 MHz	1.26 MHz	1.75 MHz
1.3 MHz	1.80 MHz	1.36 MHz	1.89 MHz
1.5 MHz	2.06 MHz	1.56 MHz	2.17 MHz
1.6 MHz	2.19 MHz	1.66 MHz	2.29 MHz
1.8 MHz	2.51 MHz	1.91 MHz	2.63 MHz
2.0 MHz	2.75 MHz	2.10 MHz	2.88 MHz
2.2 MHz	3.00 MHz	2.30 MHz	3.14 MHz
2.4 MHz	3.30 MHz	2.54 MHz	3.45 MHz
2.7 MHz	3.63 MHz	2.81 MHz	3.78 MHz
3.0 MHz	4.09 MHz	3.18 MHz	4.22 MHz
4 MHz	5.30 MHz	4.23 MHz	5.30 MHz
5 MHz	5.78 MHz	4.81 MHz	5.41 MHz
6 MHz	6.31 MHz	5.50 MHz	5.82 MHz
8 MHz	8.07 MHz	7.21 MHz	6.90 MHz

## Flattop

When Option DP2, B40, or wider IF Bandwidth option is installed, the capability for arbitrary Digital IF bandwidths is available. However, for instruments without Option DP2, B40 or wider IF Bandwidth option, the selectable Flattop filter bandwidths are predefined as shown in the following table. There are 134 Digital IF BWs (RBWs).

The table in the section "[Flattop Filters](#)" on page 2140 lists all 134 Flattop filter types.

### Flattop Filters

3.0 Hz	3.3 Hz	3.6 Hz	3.9 Hz
4.3 Hz	4.7 Hz	5.1 Hz	5.6 Hz
6.2 Hz	6.8 Hz	7.5 Hz	8.2 Hz
9.1 Hz	10 Hz	11 Hz	12 Hz
13 Hz	15 Hz	16 Hz	18 Hz
20 Hz	22 Hz	24 Hz	27 Hz
30 Hz	33 Hz	36 Hz	39 Hz
43 Hz	47 Hz	51 Hz	56 Hz
62 Hz	68 Hz	75 Hz	82 Hz
91 Hz	100 Hz	110 Hz	120 Hz
130 Hz	150 Hz	160 Hz	180 Hz
200 Hz	220 Hz	240 Hz	270 Hz
300 Hz	330 Hz	360 Hz	390 Hz
430 Hz	470 Hz	510 Hz	560 Hz
620 Hz	680 Hz	750 Hz	820 Hz
910 Hz	1.0 kHz	1.1 kHz	1.2 kHz
1.3 kHz	1.5 kHz	1.6 kHz	1.8 kHz
2.0 kHz	2.2 kHz	2.4 kHz	2.7 kHz
3.0 kHz	3.3 kHz	3.6 kHz	3.9 kHz
4.3 kHz	4.7 kHz	5.1 kHz	5.6 kHz
6.2 kHz	6.8 kHz	7.5 kHz	8.2 kHz
9.1 kHz	10 kHz	11 kHz	12 kHz
13 kHz	15 kHz	16 kHz	18 kHz
20 kHz	22 kHz	24 kHz	27 kHz
30 kHz	33 kHz	36 kHz	39 kHz
43 kHz	47 kHz	51 kHz	56 kHz
62 kHz	68 kHz	75 kHz	82 kHz
91 kHz	100 kHz	110 kHz	120 kHz
130 kHz	150 kHz	160 kHz	180 kHz
200 kHz	220 kHz	240 kHz	270 kHz
300 kHz	330 kHz	390 kHz	430 kHz
510 kHz	620 kHz	750 kHz	1.0 MHz
1.5 MHz	3.0 MHz	4 MHz	5 MHz
6 MHz	8 MHz		

## Channel Filter Bandwidth Bwcc (Remote Command Only)

This is the backward compatibility command for Channel Filter Bandwidth.

Mode	BASIC
<b>Remote Command</b>	[ :SENSe ] :WAVeform:WBIF:FILTer:BA NDwidth <real> [ :SENSe ] :WAVeform:WBIF:FILTer:BA NDwidth?
<b>Example</b>	WAV:WBIF:FILT:BA ND 0.3 WAV:WBIF:FILT:BA ND?
Notes	You must be in the IQ Analyzer (Basic) mode to use this command. Use INSTRument:SElect to set the mode.
Dependencies	This feature is only available when Option DP2, B40, or wider IF Bandwidth option is installed.
Couplings	The value is determined by the following equation. $\text{ChannelFilterBwBwcc} = (\text{ChannelFilterBw} / (\text{DigitalIFBw} * \text{OverSampleRatio}))$
Preset	0.8
State Saved	Saved in instrument state.
Min	0.01
Max	1.0
Initial S/W Revision	A.04.00
Modified at S/W Revision	A.13.00

## Cont (Continuous Measurement/Sweep)

Sets the analyzer for Continuous measurement operation. The single/continuous state is Meas Global so the setting will affect all measurements. If you are Paused, pressing Cont does a Resume.

<b>Key Path</b>	Front-panel key
<b>Remote Command</b>	:INITiate:CONTinuous OFF ON 0 1 :INITiate:CONTinuous?
<b>Example</b>	:INIT:CONT 0 puts analyzer in Single measurement operation. :INIT:CONT 1 puts analyzer in Continuous measurement operation
<b>Preset</b>	ON (Note that SYST:PRESet sets INIT:CONT to ON but *RST sets INIT:CONT to OFF)
<b>State Saved</b>	Saved in instrument state
<b>Backwards Compatibility Notes</b>	For Spectrum Analysis mode in ESA and PSA, there is no Cont hardkey, instead there is a Sweep Single/Cont key. In these analyzers, switching the Sweep Single/Cont key from Single to Cont restarts averages (displayed average count reset to 1), but does not restart Max Hold and Min Hold. The X-Series has Single and Cont keys in place of the SweepSingleCont key. In the X-Series, if in single measurement, the Cont key (and INIT:CONT ON ) switches to continuous measurement, but never restarts a measurement and never resets a sweep.
<b>Initial S/W Revision</b>	Prior to A.02.00

In Swept SA Measurement (Spectrum Analysis Mode):

The analyzer takes repetitive sweeps, averages, measurements, etc., when in Continuous mode. When the average count reaches the Average/Hold Number the count stops incrementing, but the analyzer keeps sweeping. See the Trace/Detector section for the averaging formula used both before and after the Average/Hold Number is reached. The trigger condition must be met prior to each sweep. The type of trace processing for multiple sweeps, is set under the Trace/Detector key, with choices of Trace Average, Max Hold, or Min Hold.

In Other Measurements/Modes:

With Avg/Hold Num (in the Meas Setup menu) set to Off or set to On with a value of 1, a sweep is taken after the trigger condition is met; and the analyzer continues to take new sweeps after the current sweep has completed and the trigger condition is again met. However, with Avg/Hold Num set to On with a value >1, multiple sweeps (data acquisitions) are taken for the measurement. The trigger condition must be met prior to each sweep. The sweep is not stopped when the average count k equals the number N set for Avg/Hold Num is reached, but the number k stops incrementing. A measurement average usually applies to all traces, marker results, and numeric results. But sometimes it only applies to the numeric results.

If the analyzer is in Single measurement, pressing the Cont key does not change k and does not cause the sweep to be reset; the only action is to put the analyzer into Continuous measurement operation.

If it is already in continuous sweep:

the INIT:CONT 1 command has no effect

the INIT:CONT 0 command will place the analyzer in Single Sweep but will have no effect on the current sequence until  $k = N$ , at which point the current sequence will stop and the instrument will go to the idle state.

16 Waveform Measurement  
File

File

See "File" on page 336



## FREQ Channel

The key accesses a menu allowing you to set Frequency parameters for the current measurement. All measurements in DVB-T/H mode have the same menu structure under FREQ/Channel menu.

Key Path	Front-panel key
Initial S/W Revision	A.02.00

### Channel

Sets the analyzer to a frequency that corresponds to the Channel Number. If the Center Freq value entered does not exactly correlate with the Channel, the displayed value will be “---”.

Key Path	FREQ Channel
Mode	DVB-T/H
<b>Remote Command</b>	<code>[ :SENSe ] :FREQuency:CHANnel:NUMBer &lt;integer&gt;</code> <code>[ :SENSe ] :FREQuency:CHANnel:NUMBer?</code>
<b>Example</b>	FREQ:CHAN:NUMB 21 FREQ:CHAN:NUMB?
Dependencies	If your analyzer has multiple inputs and the selected input is BBIQ, this key will be grayed out and the displaying value will be “---”.
Couplings	Channel is coupled with Center Freq. A certain Channel corresponds to a certain value of Center Freq. If the Center Freq value entered does not exactly correlate with a Channel, the displaying value will be “---”, and the returned value of the SCPI command “FREQ:CHAN:NUMB?” is “-999”.
Preset	21
State Saved	Saved in instrument state.
Min	Depends on the selected channel table
Max	Depends on the selected channel table
Initial S/W Revision	A.02.00

### Center Freq

Sets the center frequency. If your analyzer has multiple inputs (RF and IQ), the displayed value will be updated according to the selected input. SCPI commands are available to directly set the center frequency for a specific input. This key is coupled with Channel when the selected input is RF.

See also:

["RF Center Freq" on page 2147](#)

["IQ Center Freq" on page 2147](#)

Key Path	FREQ Channel
Mode	DVB-T/H
<b>Remote Command</b>	[ :SENSe ] :FREQuency:CENTer <freq> [ :SENSe ] :FREQuency:CENTer?
<b>Example</b>	FREQ:CENT 1.0MHZ FREQ:CENT?
Couplings	Center Freq is coupled with Channel. A certain value of center frequency corresponds to a certain Channel. If the Channel changes, the Center Frequency will be changed to the frequency which is the center of the channel.
Preset	474.00MHz
State Saved	Saved in instrument state.
Min	-79.999995 MHz
Max	Hardware Dependent, for details, see <a href="#">"Maximum Frequency in X - Series Signal Analyzers" on page 2146.</a>
Initial S/W Revision	A.02.00

### Maximum Frequency in X - Series Signal Analyzers

The following table lists the maximum frequency in different X – Series signal analyzers.

Model numbers: N9020A, N9030A

Freq Option	Stop Freq after Mode Preset	Max Freq (can't tune above)
503	3.6 GHz	3.7 GHz
508	8.4 GHz	8.5 GHz
513	13.6 GHz	13.8 GHz
526	26.5 GHz	27.0 GHz
543 (N9030A only)	43 GHz	
544 (N9030A only)	44 GHz	44.5 GHz
550 (N9030A only)	50 GHz	51 GHz

Model number: N9010A

Freq Option	Stop Freq after Mode Preset	Max Freq (can't tune above)
503	3.6 GHz	3.7 GHz
507	7.0 GHz	7.1 GHz

513	13.6 GHz	13.8 GHz
526	26.5 GHz	27.0 GHz
532	32.0 GHz	32.5 GHz
544	44.0 GHz	44.5 GHz

Model number: N9000A

Freq Option	Stop Freq after Mode Preset	Max Freq (can't tune above)
503	3.0 GHz	3.08 GHz
507	7.5 GHz	7.58 GHz

## RF Center Freq

SCPI command to specify the RF Center Frequency. This will always access the RF value, even when the selected input is not RF.

Key Path	FREQ Channel
Mode	DVB-T/H
Remote Command	<code>[ :SENSe ] :FREQuency:RF:CENTer &lt;freq&gt;</code> <code>[ :SENSe ] :FREQuency:RF:CENTer?</code>
Example	FREQ:RF:CENT 1.0MHZ FREQ:RF:CENT?
Couplings	Center Freq is coupled with Channel. A certain value of center frequency corresponds to a certain Channel. If the Channel changes, the Center Frequency will be changed to the frequency which is the center of the channel.
Preset	474.00MHz
State Saved	Saved in instrument state.
Min	-79.999995 MHz
Max	Hardware Dependent, for details, see <a href="#">"Maximum Frequency in X - Series Signal Analyzers" on page 2146.</a>
Initial S/W Revision	A.02.00

## IQ Center Freq

SCPI command to specify the I/Q Center Frequency. This will always access the I/Q value, even when the selected input is not I/Q.

Key Path	FREQ Channel
Mode	DVB-T/H
<b>Remote Command</b>	<code>[ :SENSe ] :FREQuency:IQ:CENTer &lt;freq&gt;</code> <code>[ :SENSe ] :FREQuency:IQ:CENTer?</code>
<b>Example</b>	FREQ:IQ:CENt 1.0MHZ FREQ:IQ:CENt?
Preset	0 Hz
State Saved	Saved in instrument state.
Min	-39.999995 MHz
Max	39.999995 MHz
Initial S/W Revision	A.02.00

### Chan Step

Chan Step changes the step size for the Channel Number.

Key Path	FREQ Channel
Mode	DVB-T/H
<b>Remote Command</b>	<code>[ :SENSe ] :FREQuency:CHANnel:STEP &lt;integer&gt;</code> <code>[ :SENSe ] :FREQuency:CHANnel:STEP?</code>
<b>Example</b>	FREQ:CHAN:STEP 1 FREQ:CHAN:STEP?
Dependencies	If your analyzer has multiple inputs and the selected input is BBIQ, this key will be grayed out.
Preset	1
State Saved	Saved in instrument state.
Min	1
Max	Depends on the selected channel table
Initial S/W Revision	A.02.00

### CF Step

CF Step sets the step size for center frequency. If CF Step State is manual, you can set this value manually. Once CF Step State is changed to auto, CF Step changes to the value of Channel BW automatically.

Key Path	FREQ Channel
Mode	DVB-T/H
<b>Remote Command</b>	<code>[ :SENSe ] :FREQuency:CENter:STEP [ :INCRement ] &lt;freq&gt;</code> <code>[ :SENSe ] :FREQuency:CENter:STEP [ :INCRement ] ?</code>

	<code>[ :SENSe ] :FREQuency:CENTer:STEP:AUTO ON OFF 1 0</code>
	<code>[ :SENSe ] :FREQuency:CENTer:STEP:AUTO?</code>
<b>Example</b>	<code>FREQ:CENT:STEP 100KHZ</code> <code>FREQ:CENT:STEP?</code> <code>FREQ:CENT:STEP:AUTO OFF</code> <code>FREQ:CENT:STEP:AUTO?</code>
<b>Couplings</b>	CF Step is coupled to Channel BW (Mode Setup) when CF Step State is 'Auto'.
<b>Preset</b>	8.00MHz ON
<b>State Saved</b>	Saved in instrument state.
<b>Min</b>	1.0 kHz
<b>Max</b>	1 GHz
<b>Initial S/W Revision</b>	A.02.00

## Chan Table

Allows you to choose the appropriate TV standard: NTSC-M, NTSC-J, NTSC-Brazil, PAL-M, PAL-B/G, PAL-D/K, or PAL-I.

<b>Key Path</b>	FREQ Channel
<b>Mode</b>	DVB-T/H
<b>Remote Command</b>	<code>[ :SENSe ] :FREQuency:CHANnel:TABLE[:SElect] MNTSc   JNTSc   BNTSc   MPAL</code> <code>  IPAL   BPAL   DPAL</code> <code>[ :SENSe ] :FREQuency:CHANnel:TABLE[:SElect]?</code>
<b>Example</b>	<code>FREQ:CHAN:TABL BPAL</code> <code>FREQ:CHAN:TABL?</code>
<b>Dependencies</b>	If your analyzer has multiple inputs and the selected input is BBIQ, this key will be grayed out.
<b>Couplings</b>	Couple with Channel. Setting Chan Table sets the range of Channel to the value corresponding to that Chan Table.
<b>Preset</b>	BPAL
<b>State Saved</b>	Saved in instrument state.
<b>Range</b>	NTSC-M   NTSC-J   NTSC-Brazil   PAL-M   PAL-I   PAL-B/G   PAL-D/K
<b>Initial S/W Revision</b>	A.02.00

## NTSC-M

If the current TV standard is NTSC-M, you can choose the appropriate channel plans in NTSC-M standard: Standard Cable (STD), Broadcast Channel (AIR), HRC Cable (HRC) or IRC Cable (IRC).

Key Path	FREQ Channel, Chan Table
Mode	DVB-T/H
<b>Remote Command</b>	[ :SENSE ] :FREQuency:CHANnel:TABLE:MNTSc [ :SElect ] STD   AIR   HRC   IRC [ :SENSe ] :FREQuency:CHANnel:TABLE:MNTSc [ :SElect ] ?
<b>Example</b>	FREQ:CHAN:TABL:MNTS STD FREQ:CHAN:TABL:MNTS?
Preset	STD
State Saved	Saved in instrument state.
Range	STD   AIR   HRC   IRC
Initial S/W Revision	A.02.00

### NTSC-J

If the current TV standard is NTSC-J, you can choose the appropriate channel plans in NTSC-J standard: Japan Standard Cable (Cable), apan Broadcast channels (AIR), or Japan Digital Cable (Cable Digital).

Key Path	FREQ Channel, Chan Table
Mode	DVB-T/H
<b>Remote Command</b>	[ :SENSE ] :FREQuency:CHANnel:TABLE:JNTSc [ :SElect ] CBL   AIR   DCBL [ :SENSe ] :FREQuency:CHANnel:TABLE:JNTSc [ :SElect ] ?
<b>Example</b>	FREQ:CHAN:TABL:JNTS AIR FREQ:CHAN:TABL:JNTS?
Preset	AIR
State Saved	Saved in instrument state.
Range	Cable AIR Cable Digital
Initial S/W Revision	A.02.00
Modified at S/W Revision	A.08.00

### NTSC-Brazil

If the current TV standard is NTSC-Brazil, you can choose the appropriate channel plans in NTSC-Brazil standard: NTSC-Brazil VHF or NTSC-Brazil UHF. Please refer to Appendix A for more detailed information.

Key Path	FREQ Channel, Chan Table
Mode	DVB-T/H
<b>Remote Command</b>	[ :SENSE ] :FREQuency:CHANnel:TABLE:BNTSc [ :SElect ] VHF   UHF [ :SENSe ] :FREQuency:CHANnel:TABLE:BNTSc [ :SElect ] ?
<b>Example</b>	FREQ:CHAN:TABL:BNTS VHF FREQ:CHAN:TABL:BNTS?

Preset	UHF
State Saved	Saved in instrument state.
Range	VHF UHF
Initial S/W Revision	A.06.00

## PAL-M

If the current TV standard is PAL-M, you can choose the appropriate channel plans in PAL-M standard: Standard Cable (STD), Broadcast Channel (AIR), HRC Cable (HRC) or IRC Cable (IRC).

Key Path	FREQ Channel, Chan Table
Mode	DVB-T/H
<b>Remote Command</b>	[ :SENSe ] :FREQuency:CHANnel:TABLE:MPAL[ :SElect ] STD   AIR   HRC   IRC [ :SENSe ] :FREQuency:CHANnel:TABLE:MPAL[ :SElect ] ?
<b>Example</b>	FREQ:CHAN:TABL:MPAL STD FREQ:CHAN:TABL:MPAL?
Preset	STD
State Saved	Saved in instrument state.
Range	STD   AIR   HRC   IRC
Initial S/W Revision	A.02.00

## PAL-I

If the current TV standard is PAL-I, you can choose the appropriate channel plans in PAL-I standard: HRC Cable (HRC), VHF channels (VHF) or UHF channels (UHF).

Key Path	FREQ Channel, Chan Table
Mode	DVB-T/H
<b>Remote Command</b>	[ :SENSe ] :FREQuency:CHANnel:TABLE:IPAL[ :SElect ] VHF UHF HRC [ :SENSe ] :FREQuency:CHANnel:TABLE:IPAL[ :SElect ] ?
<b>Example</b>	FREQ:CHAN:TABL:IPAL HRC FREQ:CHAN:TABL:IPAL?
Preset	HRC
State Saved	Saved in instrument state.
Range	VHF   UHF   HRC
Initial S/W Revision	A.02.00

## PAL-B/G

If the current TV standard is PAL-B/G, you can choose the appropriate channel plans in PAL-B/G standard: HRC Cable (HRC), VHF channels (VHF), UHF channels (UHF), S channels PAL-B/G Standard (S), S channels PAL-B/G Cable (S-Cable) or CENELEC channels (CENELEC).

<b>Key Path</b>	FREQ Channel, Chan Table
<b>Mode</b>	DVB-T/H
<b>Remote Command</b>	[ :SENSE ] :FREQuency:CHANnel:TABLE:BPAL [ :SElect ] VHF   UHF   HRC   S   SCBL   CEN  [ :SENSe ] :FREQuency:CHANnel:TABLE:BPAL [ :SElect ] ?
<b>Example</b>	FREQ:CHAN:TABL:BPAL HRC FREQ:CHAN:TABL:BPAL?
<b>Preset</b>	UHF
<b>State Saved</b>	Saved in instrument state.
<b>Range</b>	VHF   UHF   HRC   S   S-Cable   CENELEC
<b>Initial S/W Revision</b>	A.02.00

## PAL-D/K

If the current TV standard is PAL-D/K, you can choose the appropriate channel plans in PAL-D/K standard: China Broadcast Channels (DS) or China Standard Cable (Z).

<b>Key Path</b>	FREQ Channel, Chan Table
<b>Mode</b>	DVB-T/H
<b>Remote Command</b>	[ :SENSE ] :FREQuency:CHANnel:TABLE:DPAL [ :SElect ] DS   Z  [ :SENSe ] :FREQuency:CHANnel:TABLE:DPAL [ :SElect ] ?
<b>Example</b>	FREQ:CHAN:TABL:DPAL DS FREQ:CHAN:TABL:DPAL?
<b>Preset</b>	DS
<b>State Saved</b>	Saved in instrument state.
<b>Range</b>	DS   Z
<b>Initial S/W Revision</b>	A.02.00



## Input/Output

See "Input/Output" on page 204

## Marker

Accesses a menu that enables you to select, set up and control the markers for the current measurement.

Key Path	Front-panel key
Initial S/W Revision	Prior to A.02.00

### Select Marker

Displays 12 markers available for selection.

Key Path	Marker
Initial S/W Revision	Prior to A.02.00

### Marker Type

Sets the marker control mode to Normal, Delta, Fixed or Off. All interactions and dependencies detailed under the key description are enforced when the remote command is sent. If the selected marker is Off, pressing Marker sets it to Normal and places it at the center of the screen on the trace determined by the Marker Trace rules. At the same time, the Marker X Axis Value appears on the Active Function area.

The default active function is the active function for the currently selected marker control mode. If the current control mode is Off, there is no active function and the active function is turned off.

Key Path	Marker
Mode	BASIC, PNOISE, WCDMA, C2K, GSM, WIMAXOFDMA, TDSCDMA, 1XEVD0, DVB, DTMB, ISDBT, CMMB, LTE, LTETDD, DCATV, WLAN,,LTEATDD, LTEAFDD
Remote Command	:CALCulate:WAVeform:MARKer[1] 2 ... 12:MODE POSition   DELTa   OFF :CALCulate:WAVeform:MARKer[1] 2 ... 12:MODE?
Example	CALC:WAV:MARK:MODE OFF CALC:WAV:MARK:MODE?
Notes	If the selected marker is Off, pressing Marker sets it to Normal and places it at the center of the screen on the trace determined by the Marker Trace rules. At the same time, Marker X Axis Value appears on the Active Function area.  Default Active Function: the active function for the selected marker's current control mode. If the current control mode is Off, there is no active function and the active function is turned off.  Active Function Display: the marker X axis value entered in the active function area displays the marker value to its full entered precision.  You must be in a mode that includes the Waveform measurement to use this command. Use INSTRument:SElect to set the mode.
Preset	OFF
State Saved	Saved in instrument state.

Range	Normal Delta Off
Initial S/W Revision	Prior to A.02.00
Modified at S/W Revision	A.03.00

## Properties

Accesses the marker properties menu.

Key Path	Marker
Initial S/W Revision	Prior to A.02.00

## Select Marker

Displays 12 markers available for selection.

Key Path	Marker
Initial S/W Revision	Prior to A.02.00

## Relative To

Selects the marker that the selected marker is relative to (*its reference marker*).

Key Path	Marker, Properties
Mode	BASIC, PNOISE, WCDMA, C2K, GSM, WIMAXOFDMA, TDSCDMA, 1XEVD0, DVB, DTMB, ISDBT, CMMB, LTE, LTEADD, DCATV, WLAN,,LTEATDD, LTEAFDD
<b>Remote Command</b>	:CALCulate:WAVEform:MARKer[1] 2 ... 12:REFerence <integer> :CALCulate:WAVEform:MARKer[1] 2 ... 12:REFerence?
<b>Example</b>	CALC:WAV:MARK:REF 8 CALC:WAV:MARK:REF?
Notes	A marker cannot be relative to itself so that choice is grayed out, and if sent from SCPI generates error -221: "Settings conflict; marker cannot be relative to itself." When queried a single value is returned (the specified marker numbers relative marker). You must be in a mode that includes the Waveform measurement to use this command. Use INSTRument:SElect to set the mode.
Preset	2 3 4 5 6 7 8 9 10 11 12 1
State Saved	Saved in instrument state.
Min	1
Max	12
Initial S/W Revision	Prior to A.02.00
Modified at S/W Revision	A.03.00

## Marker Trace

Assigns the specified marker to the designated trace.

<b>Key Path</b>	Marker
<b>Mode</b>	BASIC, PNOISE, WCDMA, C2K, GSM, WIMAXOFDMA, TDSCDMA, 1XEVD0, DVB, DTMB, ISDBT, CMMB, LTE, LTETDD, DCATV, WLAN,,LTEATDD, LTEAFDD
<b>Remote Command</b>	:CALCulate:WAVeform:MARKer[1] 2 ... 12:TRACe RFENvelope   I   Q   IQ :CALCulate:WAVeform:MARKer[1] 2 ... 12:TRACe?
<b>Example</b>	CALC:WAV:MARK:TRAC RFEN CALC:WAV:MARK:TRAC?
<b>Notes</b>	Assigns the specified marker to the designated trace. The IQ selection is for backward compatibility purposes. It is recommended that the users use the I and/or Q selection instead. You must be in a mode that includes the Waveform measurement to use this command. Use INSTRument:SElect to set the mode.
<b>Preset</b>	RFEN
<b>State Saved</b>	Saved in instrument state.
<b>Range</b>	RF Envelope   I   Q   IQ
<b>Initial S/W Revision</b>	Prior to A.02.00
<b>Modified at S/W Revision</b>	A.03.00

## Couple Markers

Toggles the state of the markers to be coupled On or Off. When this function is true (On), moving any marker causes an equal X-axis movement of every other marker which is not Off. "Equal X-axis movement" refers to the difference between each marker's X-Axis value (in the fundamental x-axis units of the trace that marker is on) and the X-Axis value of the marker being moved (in the same fundamental x-axis units) are preserved.

<b>Key Path</b>	Marker
<b>Mode</b>	BASIC, PNOISE, WCDMA, C2K, GSM, WIMAXOFDMA, TDSCDMA, 1XEVD0, DVB, DTMB, ISDBT, CMMB, LTE, LTETDD, DCATV, WLAN,,LTEATDD, LTEAFDD
<b>Remote Command</b>	:CALCulate:WAVeform:MARKer:COUPle[:STATe] ON OFF 1 0 :CALCulate:WAVeform:MARKer:COUPle[:STATe]?
<b>Example</b>	CALC:WAV:MARK:COUP ON CALC:WAV:MARK:COUP ON
<b>Notes</b>	You must be in a mode that includes the Waveform measurement to use this command. Use INSTRument:SElect to set the mode.
<b>Preset</b>	OFF

State Saved	Saved in instrument state.
Range	On Off
Initial S/W Revision	Prior to A.02.00
Modified at S/W Revision	A.03.00

## All Markers Off

Turns off all markers.

Key Path	Marker
Mode	BASIC, PNOISE, WCDMA, C2K, GSM, WIMAXOFDMA, TDSCDMA, 1XEVD0, DVB, DTMB, ISDBT, CMMB, LTE, LTETDD, DCATV, WLAN,LTEATDD, LTEAFDD
<b>Remote Command</b>	:CALCulate:WAVeform:MARKer:AOFF
<b>Example</b>	CALC:WAV:MARK:AOFF
Notes	You must be in a mode that includes the Waveform measurement to use this command. Use INSTRument:SElect to set the mode.
Initial S/W Revision	Prior to A.02.00
Modified at S/W Revision	A.03.00

## Marker X Axis Value (Remote Command Only)

Sets the marker X Axis value in the current marker X Axis Scale unit. It has no effect if the control mode is Off, but is the SCPI equivalent of entering an X value if the control mode is Normal or Delta.

Mode	BASIC, PNOISE, WCDMA, C2K, GSM, WIMAXOFDMA, TDSCDMA, 1XEVD0, DVB, DTMB, ISDBT, CMMB, LTE, LTETDD, DCATV, WLAN,,LTEATDD, LTEAFDD
<b>Remote Command</b>	:CALCulate:WAVeform:MARKer[1] 2 ... 12:X <time> :CALCulate:WAVeform:MARKer[1] 2 ... 12:X?
<b>Example</b>	CALC:WAV:MARK:X 50 ms CALC:WAV:MARK:X?
Notes	If no suffix is sent, uses the fundamental units for the current marker X Axis Scale. If a suffix is sent that does not match the current marker X Axis Scale unit, an error "Invalid suffix" is generated. If the specified marker is Fixed and a Marker Function is on, error -221 "Settings conflict; cannot adjust Fixed marker while Marker Function is on" is generated.  The query returns the marker's absolute X Axis value if the control mode is Normal, or the offset from the marker's reference marker if the control mode is Delta. The query is returned in the fundamental units for the current marker X Axis scale: Hz for Frequency and Inverse Time, seconds for Period and Time. If the marker is Off the response is not a number.  You must be in a mode that includes the Waveform measurement to use this command. Use INSTRument:SElect to set the mode.
Preset	0

Preset	After a preset, all markers are turned OFF, so Marker X Axis Value query returns a not a number (NAN).
State Saved	No
Min	(9.9E+37
Max	9.9E+37
Initial S/W Revision	Prior to A.02.00
Modified at S/W Revision	A.03.00

### Marker X Axis Position (Remote Command Only)

Sets the marker X position in trace points. It has no effect if the control mode is Off, but is the SCPI equivalent of entering a value if the control mode is Normal or Delta. The entered value is immediately translated into the current X Axis Scale units for setting the value of the marker.

Mode	BASIC, PNOISE, WCDMA, C2K, GSM, WIMAXOFDMA, TDSCDMA, 1XEVD0, DVB, DTMB, ISDBT, CMMB, LTE, LTETDD, DCATV, WLAN,,LTEATDD, LTEAFDD
<b>Remote Command</b>	:CALCulate:WAVeform:MARKer[1] 2 ... 12:X:POSition <real> :CALCulate:WAVeform:MARKer[1] 2 ... 12:X:POSition?
<b>Example</b>	CALC:WAV:MARK:X:POS 500 CALC:WAV:MARK:X:POS?
Notes	The query returns the marker's absolute X Axis value in trace points if the control mode is Normal or the offset from the marker's reference marker in trace points if the control mode is Delta. The value is returned as a real number, not an integer, corresponding to the translation from X Axis Scale units to trace points.  You must be in a mode that includes the Waveform measurement to use this command. Use INSTRument:SElect to set the mode.
Preset	0
Preset	After a preset, all markers are turned OFF, so Marker X Axis Value query returns a not a number (NAN).
State Saved	No
Min	(9.9E+37
Max	9.9E+37
Initial S/W Revision	Prior to A.02.00
Modified at S/W Revision	A.03.00

### Marker Y Axis Value (Remote Command Only)

Queries the marker Y Axis value in the current marker Y Axis unit.

Mode	BASIC, PNOISE, WCDMA, C2K, GSM, WIMAXOFDMA, TDSCDMA, 1XEVD0, DVB, DTMB, ISDBT, CMMB, LTE, LTETDD, DCATV, WLAN,,LTEATDD, LTEAFDD
------	---

<b>Remote Command</b>	:CALCulate:WAVeform:MARKer[1] 2 ... 12:Y?
<b>Example</b>	CALC:WAV:MARK11:Y?
<b>Notes</b>	<p>When the marker is on, IQ waveform returns I and Q values.</p> <p>Case #1 - Trace RF, I or Q: returns a single double value.</p> <p>&gt;:CALC:WAV:MARK1:Y? -2.402406506109E+001</p> <p>Case #2 - Trace IQ: returns a double array of two values, the first is I, and the second is Q.</p> <p>&gt;:CALC:WAV:MARK1:Y? -3.006944493834E-003,+9.9870666467354E-004</p> <p>The IQ selection is for backward compatibility purposes. It is recommended that the users use the I and/or Q selection instead.</p> <p>You must be in a mode that includes the Waveform measurement to use this command. Use INSTRument:SElect to set the mode.</p>
<b>Preset</b>	Result dependent on the marker setup and signal source.
<b>State Saved</b>	No
<b>Backwards Compatibility SCPI</b>	:CALCulate:WAVeform:MARKer[1] 2 ... 12:FUNCTion:RESult?
<b>Initial S/W Revision</b>	Prior to A.02.00
<b>Modified at S/W Revision</b>	A.03.00

## Backward Compatibility SCPI Commands

Sets or queries the state of a marker. Setting a marker that is OFF to state ON or 1 puts it in Normal mode and places it at the center of the screen.

<b>Mode</b>	BASIC, PNOISE, WCDMA, CDMA2K, EDGE GSM, WIMAX OFDMA, TDSCDMA, CDMA1XEV, DVB, DTMB, ISDBT, CMMB, LTE, LTETDD, DCATV, WLAN
<b>Remote Command</b>	:CALCulate:WAVeform:MARKer[1] 2 ... 12:STATe OFF ON 0 1 :CALCulate:WAVeform:MARKer[1] 2 ... 12:STATe?
<b>Example</b>	CALC:WAV:MARK:STAT ON CALC:WAV:MARK:STAT?
<b>Notes</b>	You must be in a mode that includes the Waveform measurement to use this command. Use INSTRument:SElect to set the mode.
<b>Preset</b>	OFF
<b>State Saved</b>	Saved in instrument state.
<b>Range</b>	On Off
<b>Initial S/W Revision</b>	Prior to A.02.00
<b>Modified at S/W Revision</b>	A.03.00

## Marker ->

There is no 'Marker ->' functionality supported in Waveform measurements. The front-panel key displays a blank menu when pressed.

---

Key Path	Front-panel key
Initial S/W Revision	Prior to A.02.00

---



## Marker Function

Accesses a menu of marker functions that perform post-processing operations on markers based on the measurement specifications. Marker functions are distinct from measurement functions, which automatically perform complex sequences of setup, data acquisition, and display operations in order to measure specified signal characteristics. Marker Functions are specified for each individual marker and may be turned on individually for each marker.

The Marker Function menu controls which marker functions are turned on and allows you to adjust the setup parameters for each function. These parameters include the following, but only one parameter can be assigned to a given marker:

- Marker Noise
- BandInterval Power
- Band/Interval Density
- Marker Function Off

Key Path	Front-panel key
Initial S/W Revision	Prior to A.02.00

## Select Marker

Displays 12 markers available for selection.

Key Path	Marker
Initial S/W Revision	Prior to A.02.00

## Marker Function Type

Sets the marker control function type to, Marker Noise, Band/Interval Power, Band Interval Density, or Marker Function Off

Key Path	Marker Function
Mode	BASIC, PNOISE, WCDMA, C2K, GSM, WIMAXOFDMA, TDSCDMA, 1XEVD0, DVB, DTMB, ISDBT, CMMB, LTE, LTETDD, DCATV, WLAN,,LTEATDD, LTEAFDD
Remote Command	:CALCulate:WAVEform:MARKer[1] 2 ... 12:FUNCTION BPOwer   BDENsity   OFF :CALCulate:WAVEform:MARKer[1] 2 ... 12:FUNCTION?
Example	CALC:WAV:MARK:FUNC BPOW CALC:WAV:MARK:FUNC?
Notes	You must be in a mode that includes the Waveform measurement to use this command. Use INSTRument:SElect to set the mode.
Preset	OFF

State Saved	Saved in instrument state.
Range	Band/Interval Power Band Interval Density Marker Function Off
Initial S/W Revision	Prior to A.02.00
Modified at S/W Revision	A.03.00

## Band Adjust

Accesses a menu that enables you to set the frequency span width and the left and right edge, or time values, for the band or interval of the selected marker.

Key Path	Marker Function
Initial S/W Revision	Prior to A.02.00

## Band/Interval Span for Time Domain

Sets the width of the frequency span for the selected marker.

Key Path	Marker Function
Mode	BASIC, PNOISE, WCDMA, C2K, GSM, WIMAXOFDMA, TDSCDMA, 1XEVD0, DVB, DTMB, ISDBT, CMMB, LTE, LTETDD, DCATV, WLAN,LTEATDD, LTEAFDD
<b>Remote Command</b>	:CALCulate:WAVEform:MARKer[1] 2 ... 12:FUNCtion:BAND:SPAN <time> :CALCulate:WAVEform:MARKer[1] 2 ... 12:FUNCtion:BAND:SPAN?
<b>Example</b>	CALC:WAV:MARK:FUNC:BAND:SPAN 20 ms CALC:WAV:MARK:FUNC:BAND:SPAN?
Notes	You must be in a mode that includes the Waveform measurement to use this command. Use INSTRument:SElect to set the mode.
Couplings	Changing the Band/Interval Span necessarily changes the Band/Interval Left and Band/Interval Right values
Preset	0
Preset	10% of Meas Time
State Saved	Saved in instrument state.
Min	0
Max	100 s
<b>Backwards Compatibility SCPI</b>	:CALCulate:WAVEform:MARKer[1] 2 ... 4:X:SPAN
Initial S/W Revision	Prior to A.02.00
Modified at S/W Revision	A.03.00

## Band/Interval Left for Time Domain

Sets the left edge frequency or time value for the band of the selected marker.

Key Path	Marker Function
Mode	BASIC, PNOISE, WCDMA, C2K, GSM, WIMAXOFDMA, TDSCDMA, 1XEVD0, DVB, DTMB, ISDBT, CMMB, LTE, LTETDD, DCATV, WLAN,,LTEATDD, LTEAFDD
<b>Remote Command</b>	:CALCulate:WAVeform:MARKer[1] 2 ... 12:FUNction:BAND:LEFT <time> :CALCulate:WAVeform:MARKer[1] 2 ... 12:FUNction:BAND:LEFT?
<b>Example</b>	CALC:WAV:MARK12:FUNC:BAND:LEFT 1 s CALC:WAV:MARK12:FUNC:BAND:LEFT?
Notes	You must be in a mode that includes the Waveform measurement to use this command. Use INSTRument:SElect to set the mode.
Couplings	Changing the Band/Interval Left necessarily changes the Band/Interval Span and Band/Interval Right values
Preset	0
Preset	5% of Meas Time
State Saved	Saved in instrument state.
Min	0
Max	100 s
Initial S/W Revision	Prior to A.02.00
Modified at S/W Revision	A.03.00

## Band/Interval Right for Time Domain

Sets the right edge frequency or time value for the band of the selected marker.

Key Path	Marker Function
Mode	BASIC, PNOISE, WCDMA, C2K, GSM, WIMAXOFDMA, TDSCDMA, 1XEVD0, DVB, DTMB, ISDBT, CMMB, LTE, LTETDD, DCATV, WLAN,,LTEATDD, LTEAFDD
<b>Remote Command</b>	:CALCulate:WAVeform:MARKer[1] 2 ... 12:FUNction:BAND:RIGHT <time> :CALCulate:WAVeform:MARKer[1] 2 ... 12:FUNction:BAND:RIGHT?
<b>Example</b>	CALC:WAV:MARK12:FUNC:BAND:RIGH 1 s CALC:WAV:MARK12:FUNC:BAND:RIGH?
Notes	You must be in a mode that includes the Waveform measurement to use this command. Use INSTRument:SElect to set the mode.
Couplings	Changing the Band/Interval Left necessarily changes the Band/Interval Span and Band/Interval Right values
Preset	0
Preset	5% of Meas Time
State Saved	Saved in instrument state.

16 Waveform Measurement  
Marker Function

Min	0
Max	100 s
Initial S/W Revision	Prior to A.02.00
Modified at S/W Revision	A.03.00

## Meas

The information in this section is common to all measurements. For key and remote command information for a specific measurement, refer to the section that describes the measurement of interest.

Measurements available under the Meas key are specific to the current Mode.

When viewing Help for measurements, note the following:

**NOTE**

Operation for some keys differs between measurements. The information displayed in Help pertains to the current measurement. To see how a key operates in a different measurement, exit Help (press the Cancel Esc key), select the measurement, then reenter Help (press the Help key) and press that key.

---

Key Path	Front-panel key
Initial S/W Revision	Prior to A.02.00

---

### Remote Measurement Functions

This section contains the following topics:

"Measurement Group of Commands" on page 2166

"Current Measurement Query (Remote Command Only)" on page 2168

"Limit Test Current Results (Remote Command Only)" on page 2168

"Data Query (Remote Command Only)" on page 2168

"Calculate/Compress Trace Data Query (Remote Command Only)" on page 2169

"Calculate Peaks of Trace Data (Remote Command Only)" on page 2174

Hardware-Accelerated Fast Power Measurement (Remote Command Only)

"Format Data: Numeric Data (Remote Command Only)" on page 2175

"Format Data: Byte Order (Remote Command Only)" on page 2176

---

Initial S/W Revision	Prior to A.02.00
----------------------	------------------

---

## Measurement Group of Commands

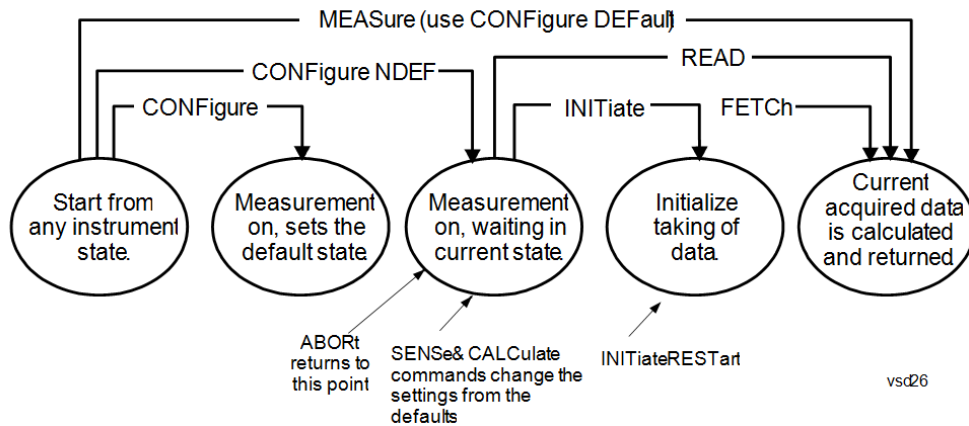

---

### Measure Commands:

:MEASure:<measurement>[n]?

This is a fast single-command way to make a measurement using the factory default instrument settings. These are the settings and units that conform to the Mode Setup settings (e.g. radio standard) that you have currently selected.

- Stops the current measurement (if any) and sets up the instrument for the specified measurement using the factory defaults
- Initiates the data acquisition for the measurement
- Blocks other SCPI communication, waiting until the measurement is complete before returning results.
- If the function does averaging, it is turned on and the number of averages is set to 10.
- After the data is valid it returns the scalar results, or the trace data, for the specified measurement. The type of data returned may be defined by an [n] value that is sent with the command.
- The scalar measurement results will be returned if the optional [n] value is not included, or is set to 1. If the [n] value is set to a value other than 1, the selected trace data results will be returned. See each command for details of what types of scalar results or trace data results are available.
- ASCII is the default format for the data output. (Older versions of Spectrum Analysis and Phase Noise mode measurements only use ASCII.) The binary data formats should be used for handling large blocks of data since they are smaller and faster than the ASCII format. Refer to the FORMat:DATA command for more information.

If you need to change some of the measurement parameters from the factory default settings you can set up the measurement with the CONFIgure command. Use the commands in the SENSe:<measurement> and CALCulate:<measurement> subsystems to change the settings. Then you can use the READ? command to initiate the measurement and query the results.

If you need to repeatedly make a given measurement with settings other than the factory defaults, you can use the commands in the SENSe:<measurement> and CALCulate:<measurement> subsystems to set up the measurement. Then use the READ? command to initiate the measurement and query results.

Measurement settings persist if you initiate a different measurement and then return to a previous one. Use READ:<measurement>? if you want to use those persistent settings. If you want to go back to the default settings, use MEASure:<measurement>?.

---

### Configure Commands:

:CONFIgure:<measurement>

This command stops the current measurement (if any) and sets up the instrument for the specified measurement using

---

---

the factory default instrument settings. It does not initiate the taking of measurement data unless INIT:CONTInuous is ON. If you change any measurement settings after using the CONFigure command, the READ command can be used to initiate a measurement without changing the settings back to their defaults.

In the Swept SA measurement in Spectrum Analyzer mode the CONFigure command also turns the averaging function on and sets the number of averages to 10 for all measurements.

:CONFigure: <measurement>: NDEFault stops the current measurement and changes to the specified measurement. It does not change the settings to the defaults. It does not initiate the taking of measurement data unless INIT:CONTInuous is ON.

The CONFigure? query returns the current measurement name.

The CONFigure:CATalog? query returns a quoted string of all licensed measurement names in the current mode. For example, "SAN, CHP, OBW, ACP, PST, TXP, SPUR, SEM, LIST".

---

#### Fetch Commands:

---

:FETCh:<measurement>[n]?

This command puts selected data from the most recent measurement into the output buffer. Use FETCh if you have already made a good measurement and you want to return several types of data (different [n] values, for example, both scalars and trace data) from a single measurement. FETCh saves you the time of re-making the measurement. You can only FETCh results from the measurement that is currently active, it will not change to a different measurement. An error message is reported if a measurement other than the current one is specified.

If you need to get new measurement data, use the READ command, which is equivalent to an INITiate followed by a FETCh.

The scalar measurement results will be returned if the optional [n] value is not included, or is set to 1. If the [n] value is set to a value other than 1, the selected trace data results will be returned. See each command for details of what types of scalar results or trace data results are available. The binary data formats should be used for handling large blocks of data since they are smaller and transfer faster than the ASCII format. (FORMat:DATA)

FETCh may be used to return results other than those specified with the original READ or MEASure command that you sent.

---

#### INITiate Commands:

---

:INITiate:<measurement>

This command is not available for measurements in all the instrument modes:

- Initiates a trigger cycle for the specified measurement, but does not output any data. You must then use the FETCh<meas> command to return data. If a measurement other than the current one is specified, the instrument will switch to that measurement and then initiate it.
  - For example, suppose you have previously initiated the ACP measurement, but now you are running the channel power measurement. If you send INIT:ACP? it will change from channel power to ACP and will initiate an ACP measurement.
  - Does not change any of the measurement settings. For example, if you have previously started the ACP measurement and you send INIT:ACP? it will initiate a new ACP measurement using the same instrument settings as the last time ACP was run.
  - If your selected measurement is currently active (in the idle state) it triggers the measurement, assuming the trigger conditions are met. Then it completes one trigger cycle. Depending upon the measurement and the number of averages, there may be multiple data acquisitions, with multiple trigger events, for one full trigger cycle. It also holds off additional commands on GPIB until the acquisition is complete.
- 

#### READ Commands:

---

:READ:<measurement>[n]?

- Does not preset the measurement to the factory default settings. For example, if you have previously initiated the ACP
-

---

measurement and you send READ:ACP? it will initiate a new measurement using the same instrument settings.

- Initiates the measurement and puts valid data into the output buffer. If a measurement other than the current one is specified, the instrument will switch to that measurement before it initiates the measurement and returns results.
  - For example, suppose you have previously initiated the ACP measurement, but now you are running the channel power measurement. Then you send READ:ACP? It will change from channel power back to ACP and, using the previous ACP settings, will initiate the measurement and return results.
  - Blocks other SCPI communication, waiting until the measurement is complete before returning the results
  - If the optional [n] value is not included, or is set to 1, the scalar measurement results will be returned. If the [n] value is set to a value other than 1, the selected trace data results will be returned. See each command for details of what types of scalar results or trace data results are available. The binary data formats should be used when handling large blocks of data since they are smaller and faster than the ASCII format. (FORMat:DATA)
- 

---

Initial S/W Revision	Prior to A.02.00
----------------------	------------------

---

### Current Measurement Query (Remote Command Only)

This command returns the name of the measurement that is currently running.

---

<b>Remote Command</b>	:CONFigure?
-----------------------	-------------

<b>Example</b>	CONF?
----------------	-------

Initial S/W Revision	Prior to A.02.00
----------------------	------------------

---

### Limit Test Current Results (Remote Command Only)

Queries the status of the current measurement limit testing. It returns a 0 if the measured results pass when compared with the current limits. It returns a 1 if the measured results fail any limit tests.

---

<b>Remote Command</b>	:CALCulate:CLIMits:FAIL?
-----------------------	--------------------------

<b>Example</b>	CALC:CLIM:FAIL? queries the current measurement to see if it fails the defined limits. Returns a 0 or 1: 0 it passes, 1 it fails.
----------------	--

Initial S/W Revision	Prior to A.02.00
----------------------	------------------

---

### Data Query (Remote Command Only)

Returns the designated measurement data for the currently selected measurement and subopcode.

n = any valid subopcode for the current measurement. See the measurement command results table for your current measurement, for information about what data is returned for the subopcodes.

This command uses the data setting specified by the FORMat:BORDER and FORMat:DATA commands and can return real or ASCII data. (See the format command descriptions under Input/Output in the Analyzer Setup section.)



<b>Remote Command</b>	:CALCulate:DATA[n]?
<b>Notes</b>	The return trace depends on the measurement. In CALCulate:<meas>:DATA[n], n is any valid subopcode for the current measurement. It returns the same data as the FETCH:<measurement>? query where <measurement> is the current measurement.
<b>Initial S/W Revision</b>	Prior to A.02.00

## Calculate/Compress Trace Data Query (Remote Command Only)

Returns compressed data for the currently selected measurement and sub-opcode [n].

n = any valid sub-opcode for that measurement. See the MEASure:<measurement>? command description of your specific measurement for information on the data that can be returned.

The data is returned in the current Y Axis Unit of the analyzer. The command is used with a sub-opcode <n> (default=1) to specify the trace. With trace queries, it is best if the analyzer is not sweeping during the query. Therefore, it is generally advisable to be in Single Sweep, or Update=Off.

This command is used to compress or decimate a long trace to extract and return only the desired data. A typical example would be to acquire N frames of GSM data and return the mean power of the first burst in each frame. The command can also be used to identify the best curve fit for the data.

<b>Remote Command</b>	:CALCulate:DATA<n>:COMPRESS? BLOCK   CFIT   MAXimum   MINimum   MEAN   DMEan   RMS   RMSCubed   SAMPLE   SDEVIation   PPHase [,<soffset> [,<length>[,<roffset>[,<rlimit>]]]]
<b>Example</b>	To query the mean power of a set of GSM bursts: Supply a signal that is a set of GSM bursts. Select the IQ Waveform measurement (in IQ Analyzer Mode). Set the sweep time to acquire at least one burst. Set the triggers such that acquisition happens at a known position relative to a burst. Then query the mean burst levels using, CALC:DATA2:COMP? MEAN, 24e-6, 526e-6 (These parameter values correspond to GSM signals, where 526e-6 is the length of the burst in the slot and you just want 1 burst.)
<b>Notes</b>	The command supports 5 parameters. Note that the last 4 (<soffset>, <length>, <roffset>, <rlimit>) are optional. But these optional parameters must be entered in the specified order. For example, if you want to specify <length>, then you must also specify <soffset>. See details below for a definition of each of these parameters.  This command uses the data in the format specified by FORMat:DATA, returning either binary or ASCII data.
<b>Initial S/W Revision</b>	Prior to A.02.00

- BLOCK or block data - returns all the data points from the region of the trace data that you specify. For example, it could be used to return the data points of an input signal over several timeslots, excluding the portions of the trace data that you do not want. (This is x,y pairs for trace data and I,Q pairs for complex data.)

- CFIT or curve fit - applies curve fitting routines to the data. <soffset> and <length> are required to define the data that you want. <roffset> is an optional parameter for the desired order of the curve equation. The query will return the following values: the x-offset (in seconds) and the curve coefficients ((order + 1) values).

MIN, MAX, MEAN, DME, RMS, RMSC, SAMP, SDEV and PPH return one data value for each specified region (or <length>) of trace data, for as many regions as possible until you run out of trace data (using <roffset> to specify regions). Or they return the number of regions you specify (using <rlimit>) ignoring any data beyond that.

- MINimum - returns the minimum data point (y value) for the specified region(s) of trace data. For I/Q trace data, the minimum magnitude of the I/Q pairs is returned.
- MAXimum - returns the maximum data point (y value) for the specified region(s) of trace data. For I/Q trace data, the maximum magnitude of the I/Q pairs is returned.
- MEAN - returns a single value that is the arithmetic mean of the data point values (in dB/ dBm) for the specified region(s) of trace data. For I/Q trace data, the mean of the magnitudes of the I/Q pairs is returned. See the following equations.

•

**NOTE**

If the original trace data is in dB, this function returns the arithmetic mean of those log values, not log of the mean power which is a more useful value. The mean of the log is the better measurement technique when measuring CW signals in the presence of noise. The mean of the power, expressed in dB, is useful in power measurements such as Channel Power. To achieve the mean of the power, use the RMS option.

Equation 1

Mean Value of Data Points for Specified Region(s)

$$MEAN = \frac{1}{n} \sum_{X_i \in \text{region}(s)} X_i$$

where  $X_i$  is a data point value, and  $n$  is the number of data points in the specified region(s).

Equation 2

Mean Value of I/Q Data Pairs for Specified Region(s)

$$MEAN = \frac{1}{n} \sum_{X_i \in \text{region}(s)} |X_i|$$

where  $|X_i|$  is the magnitude of an I/Q pair, and  $n$  is the number of I/Q pairs in the specified region(s).

- DMEan - returns a single value that is the mean power (in dB/ dBm) of the data point values for the specified region(s) of trace data. See the following equation:

Equation 3

DMEan Value of Data Points for Specified Region(s)

$$\text{DME} = 10 \times \log_{10} \left( \frac{1}{n} \sum_{X_i \in \text{region}(s)} 10^{\frac{X_i}{10}} \right)$$

- RMS - returns a single value that is the average power on a root-mean-squared voltage scale (arithmetic rms) of the data point values for the specified region(s) of trace data. See the following equation.

**NOTE**

For I/Q trace data, the rms of the magnitudes of the I/Q pairs is returned. See the following equation. This function is very useful for I/Q trace data. However, if the original trace data is in dB, this function returns the rms of the log values which is not usually needed.

Equation 4

RMS Value of Data Points for Specified Region(s)

$$\text{RMS} = \sqrt{\frac{1}{n} \sum_{X_i \in \text{region}(s)} X_i^2}$$

where  $X_i$  is a data point value, and  $n$  is the number of data points in the specified region(s).

Equation 5

RMS Value of I/Q Data Pairs for Specified Region(s)

$$\text{RMS} = \sqrt{\frac{1}{n} \sum_{X_i \in \text{region}(s)} X_i X_i^*}$$

where  $X_i$  is the complex value representation of an I/Q pair,  $X_i^*$  its conjugate complex number, and  $n$  is the number of I/Q pairs in the specified region(s).

Once you have the rms value for a region of trace data (linear or I/Q), you may want to calculate the mean power. You must convert this rms value (peak volts) to power in dBm:

$$10 \times \log[10 \times (\text{rms value})^2]$$

- SAMPLe - returns the first data value (x,y pair) for the specified region(s) of trace data. For I/Q trace data, the first I/Q pair is returned.
- SDEViation - returns a single value that is the arithmetic standard deviation for the data point values for the specified region(s) of trace data. See the following equation.
- For I/Q trace data, the standard deviation of the magnitudes of the I/Q pairs is returned. See the following equation.

Equation 6

Standard Deviation of Data Point Values for Specified Region(s)

$$\text{SDEV} = \sqrt{\frac{1}{n} \sum_{X_i \in \text{region}(s)} (X_i - \bar{X})^2}$$

where  $X_i$  is a data point value,  $\bar{X}$  is the arithmetic mean of the data point values for the specified region (s), and  $n$  is the number of data points in the specified region(s).

$$\text{SDEV} = \sqrt{\frac{1}{n} \sum_{X_i \in \text{region}(s)} (|X_i| - \bar{X})^2}$$

where  $|X_i|$  is the magnitude of an I/Q pair,  $\bar{X}$  is the mean of the magnitudes for the specified region(s), and  $n$  is the number of data points in the specified region(s).

- PPHase - returns the x,y pairs of both rms power (dBm) and arithmetic mean phase (radian) for every specified region and frequency offset (Hz). The number of pairs is defined by the specified number of regions. This parameter can be used for I/Q vector ( $n=0$ ) in Waveform (time domain) measurement and all parameters are specified by data point in PPHase.

The rms power of the specified region may be expressed as:

$$\text{Power} = 10 \times \log [10 \times (\text{RMS I/Q value})] + 10.$$

The RMS I/Q value (peak volts) is:

$$\sqrt{\frac{1}{n} \sum_{X_i \in \text{region}} X_i X_i^*}$$

where  $X_i$  is the complex value representation of an I/Q pair,  $X_i^*$  its conjugate complex number, and  $n$  is the number of I/Q pairs in the specified region.

The arithmetic mean phase of the specified region may be expressed as:

$$\frac{1}{n} \sum_{Y_i \in \text{region}} Y_i$$

where  $Y_i$  is the unwrapped phase of I/Q pair with applying frequency correction and  $n$  is the number of I/Q pairs in the specified region.

The frequency correction is made by the frequency offset calculated by the arithmetic mean of every specified region's frequency offset. Each frequency offset is calculated by the least square method against the unwrapped phase of I/Q pair.

Sample Trace Data - Constant Envelope

(See below for explanation of variables.)

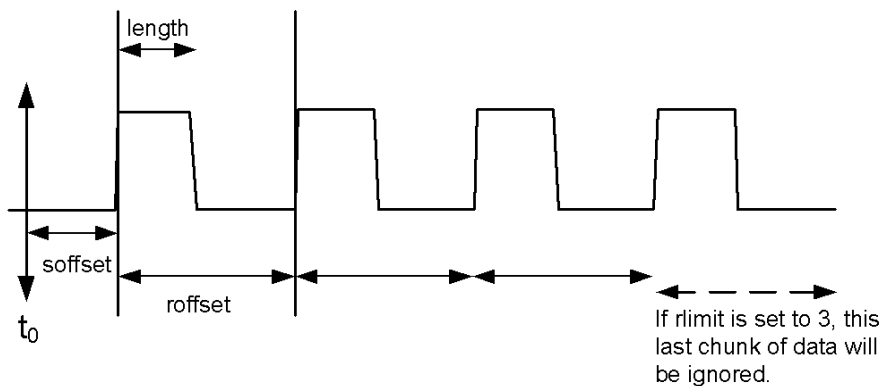

### Sample Trace Data - Not Constant Envelope

(See below for explanation of variables.)

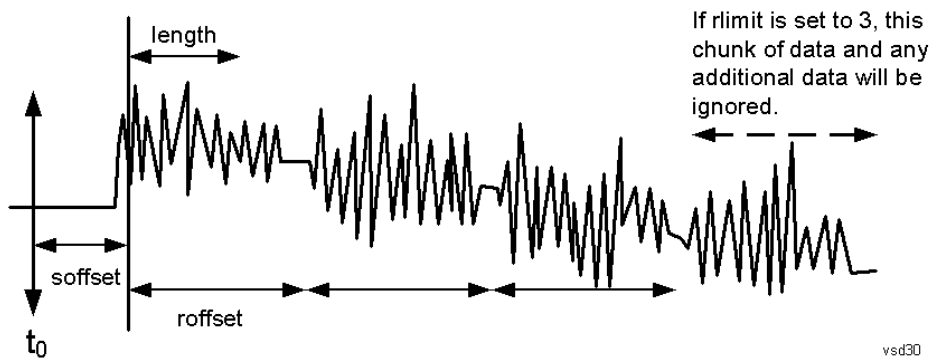

<soffset> - start offset is an optional real number. (It is in seconds for time-domain traces, and is a dimensionless index 0 to Npoints - 1, for frequency-domain traces). It specifies the amount of data at the beginning of the trace that will be ignored before the decimation process starts. It is the time or frequency change from the start of the trace to the point where you want to start using the data. The default value is zero.

<length> - is an optional real number. (It is in seconds for time-domain traces, and is a dimensionless index 0 to Npoints - 1, for frequency-domain traces). It defines how much data will be compressed into one value. This parameter has a default value equal to the current trace length.

<roffset> - repeat offset is an optional real number. (It is in seconds for time-domain traces, and is a dimensionless index 0 to Npoints - 1, for frequency-domain traces). It defines the beginning of the next field of trace elements to be compressed. This is relative to the beginning of the previous field. This parameter has a default value equal to the <length> variable. Note that this parameter is used for a completely different purpose when curve fitting (see CFIT above).

<rlimit> - repeat limit is an optional integer. It specifies the number of data items that you want returned. It will ignore any additional items beyond that number. You can use the Start offset and the Repeat limit to pick out exactly what part of the data you want to use. The default value is all the data.

## Calculate Peaks of Trace Data (Remote Command Only)

Returns a list of all the peaks for the currently selected measurement and sub-opcode [n]. The peaks must meet the requirements of the peak threshold and excursion values.

n = any valid sub-opcode for the current measurement. See the MEASure:<measurement> command description of your specific measurement for information on the data that can be returned.

The command can only be used with specific sub-opcodes with measurement results that are trace data. Both real and complex traces can be searched, but complex traces are converted to magnitude in dBm. In many measurements the sub-opcode n=0, is the raw trace data which cannot be searched for peaks. And Sub-opcode n=1, is often calculated results values which also cannot be searched for peaks.

This command uses the data setting specified by the FORMat:BORDER and FORMat:DATA commands and can return real or ASCII data. If the format is set to INT,32, it returns REAL,32 data.

The command has four types of parameters:

- Threshold (in dBm)
- Excursion (in dB)
- Sorting order (amplitude, frequency, time)
- Optional in some measurements: Display line use (all, > display line, < display line)

---

<b>Remote Command</b>	<p>For Swept SA measurement:</p> <pre>:CALCulate:DATA[1] 2 ... 6:PEAKs? &lt;threshold&gt;,&lt;excursion&gt;[,AMPLitude   FREQuency   TIME[,ALL   GTDLine   LTDLine]]</pre> <p>For most other measurements:</p> <pre>:CALCulate:DATA[1] 2 ... 6:PEAKs? &lt;threshold&gt;,&lt;excursion&gt;[,AMPLitude   FREQuency   TIME]</pre>
-----------------------	--

---

<b>Example</b>	<p>Example for Swept SA measurement in Spectrum Analyzer Mode:</p> <p>CALC:DATA4:PEAK? -40, 10, FREQ, GTDL This will identify the peaks of trace 4 that are above -40 dBm, with excursions of at least 10 dB. The peaks are returned in order of increasing frequency, starting with the lowest frequency. Only the peaks that are above the display line are returned.</p> <p>Query Results 1:</p> <p>With FORMat:DATA REAL, 32 selected, it returns a list of floating-point numbers. The first value in the list is the number of peak points that are in the following list. A peak point consists of two values: a peak amplitude followed by its corresponding frequency (or time).</p> <p>If no peaks are found the peak list will consist of only the number of peaks, (0).</p>
----------------	---

---

<b>Notes</b>	<p>&lt;n&gt; - is the trace that will be used</p> <p>&lt;threshold&gt; - is the level below which trace data peaks are ignored. Note that the threshold value is required and is always used as a peak criterion. To effectively disable the threshold criterion for this command, provide a substantially low threshold value such as -200 dBm. Also note that the threshold value used in this command is independent of and has no effect on the threshold value stored under the Peak Criteria menu.</p> <p>&lt;excursion&gt; - is the minimum amplitude variation (rise and fall) required for a signal to be identified as peak. Note that the excursion value is required and is always used as a peak criterion. To effectively disable the excursion criterion for this command, provide the minimum value of 0.0 dB. Also note that the excursion value used in this command is independent of and has no effect on the</p>
--------------	---

---

excursion value stored under the Peak Criteria menu.

Values must be provided for threshold and excursion. The sorting and display line parameters are optional (defaults are AMPLitude and ALL).

Note that there is always a Y-axis value for the display line, regardless of whether the display line state is on or off. It is the current Y-axis value of the display line which is used by this command to determine whether a peak should be reported

Sorting order:

AMPLitude - lists the peaks in order of descending amplitude, with the highest peak first (default if optional parameter not sent)

FREQUency - lists the peaks in order of occurrence, left to right across the x-axis.

TIME - lists the peaks in order of occurrence, left to right across the x-axis.

Peaks vs. Display Line:

ALL - lists all of the peaks found (default if optional parameter not sent).

GTDLine (greater than display line) - lists all of the peaks found above the display line.

LTDLine (less than display line) - lists all of the peaks found below the display line.

---

Initial S/W Revision      Prior to A.02.00

---

### Format Data: Numeric Data (Remote Command Only)

This command specifies the format of the trace data input and output. It specifies the formats used for trace data during data transfer across any remote port. It affects only the data format for setting and querying trace data for the :TRACe[:DATA], TRACe[:DATA]?, :CALCulate:DATA[n]? and FETCh:SANalyzer [n]? commands and queries.

---

**Remote Command**      :FORMat[:TRACe][:DATA] ASCii|INTeger,32|REAL,32 |REAL,64  
:FORMat[:TRACe][:DATA]?

---

**Notes**      The query response is:  
ASCii: ASC,8  
REAL,32: REAL,32  
REAL,64: REAL,64  
INTeger,32: INT,32

When the numeric data format is REAL or ASCii, data is output in the current Y Axis unit. When the data format is INTeger, data is output in units of m dBm (.001 dBm).

The INT,32 format returns binary 32-bit integer values in internal units (m dBm), in a definite length block.

---

**Dependencies**      Sending a data format spec with an invalid number (for example, INT,48) generates no error. The analyzer simply uses the default (8 for ASCii, 32 for INTeger, 32 for REAL).

Sending data to the analyzer which does not conform to the current FORMat specified, results in an error. Sending ASCII data when a definite block is expected generates message -161 "Invalid Block Data" and sending a definite block when ASCII data is expected generates message -121 "Invalid Character in Number".

---

**Preset**      ASCii

---

**Backwards Compatibility Notes**      Note that the INT,32 format is only applicable to the command, TRACe:DATA. This preserves backwards compatibility for the Swept SA measurement. For all other commands/queries which honor FORMat:DATA, if INT,32 is sent the analyzer will behave as though it were set to REAL,32.

---

Initial S/W Revision      Prior to A.02.00

---

The specs for each output type follow:

AScii - Amplitude values are in ASCII, in the current Y Axis Unit, one ASCII character per digit, values separated by commas, each value in the form:

SX.YYYYYEsZZ

Where:

S = sign (+ or -)

X = one digit to left of decimal point

Y = 5 digits to right of decimal point

E = E, exponent header

s = sign of exponent (+ or -)

ZZ = two digit exponent

REAL,32 - Binary 32-bit real values in the current Y Axis Unit, in a definite length block.

REAL,64 - Binary 64-bit real values in the current Y Axis Unit, in a definite length block.

### Format Data: Byte Order (Remote Command Only)

This command selects the binary data byte order for data transfer and other queries. It controls whether binary data is transferred in normal or swapped mode. This command affects only the byte order for setting and querying trace data for the :TRACe[:DATA], TRACe[:DATA]? , :CALCulate:DATA[n]? and FETCh:SANalyzer[n]? commands and queries.

By definition any command that says it uses FORMat:DATA uses any format supported by FORMat:DATA.

The NORMal order is a byte sequence that begins with the most significant byte (MSB) first, and ends with the least significant byte (LSB) last in the sequence: 1|2|3|4. SWAPped order is when the byte sequence begins with the LSB first, and ends with the MSB last in the sequence: 4|3|2|1.

---

<b>Remote Command</b>	:FORMat:BORDER NORMal   SWAPped :FORMat:BORDER?
-----------------------	--

---

<b>Preset</b>	NORMal
---------------	--------

---

<b>Initial S/W Revision</b>	Prior to A.02.00
-----------------------------	------------------

---



## Meas Setup

Displays the setup menu keys that enable you to control the parameters for the current measurement.

Key Path	Front-panel key
Initial S/W Revision	Prior to A.02.00

### Average/Hold Num

Sets the number of sweeps (average counts) that are averaged. After the specified number of sweeps, the averaging mode (terminal control) setting determines the averaging action.

Key Path	Meas Setup
Mode	BASIC, PNOISE, WCDMA, C2K, GSM, WIMAXOFDMA, TDSCDMA, 1XEVD0, DVB, DTMB, ISDBT, CMMB, LTE, LTETDD, DCATV, WLAN, MSR, LTEATDD, LTEAFDD
<b>Remote Command</b>	[:SENSe]:WAVeform:AVERAge:COUNT <integer> [:SENSe]:WAVeform:AVERAge:COUNT? [:SENSe]:WAVeform:AVERAge[:STATe] OFF ON 0 1 [:SENSe]:WAVeform:AVERAge[:STATe]?
<b>Example</b>	WAV:AVER:COUN 1001 WAV:AVER:COUN? WAV:AVER ON WAV:AVER?
Notes	You must be in a mode that includes the Waveform measurement to use this command. Use INSTRument:SElect to set the mode.
Preset	10 OFF
State Saved	Saved in instrument state.
Min	1
Max	20001
Initial S/W Revision	Prior to A.02.00
Modified at S/W Revision	A.03.00

### Avg Mode

Enables you to set the averaging mode.

- When set to Exponential (Exp) the measurement averaging continues using the specified number of averages to compute each averaged value. The average is displayed at the end of each sweep.
- When set to Repeat, the measurement resets the average counter each time the specified number of averages is reached.

Key Path	Meas Setup
Mode	BASIC, PNOISE, WCDMA, C2K, GSM, WIMAXOFDMA, TDSCDMA, 1XEVD0, DVB, DTMB, ISDBT, CMMB, LTE, LTETDD, DCATV, WLAN, MSR,LTEATDD, LTEAFDD
<b>Remote Command</b>	<code>[ :SENSe ] :WAVeform:AVERage:TCONtrol EXPonential REPeat</code> <code>[ :SENSe ] :WAVeform:AVERage:TCONtrol?</code>
<b>Example</b>	WAV:AVER:TCON REP WAV:AVER:TCON?
Notes	You must be in a mode that includes the Waveform measurement to use this command. Use INSTRUMENT:SElect to set the mode.
Preset	EXPonential
State Saved	Saved in instrument state.
Range	Exp Repeat
Initial S/W Revision	Prior to A.02.00
Modified at S/W Revision	A.03.00

## Avg Type

Selects the type of averaging.

Key Path	Meas Setup
Mode	BASIC, PNOISE, WCDMA, C2K, GSM, WIMAXOFDMA, TDSCDMA, 1XEVD0, DVB, DTMB, ISDBT, CMMB, LTE, LTETDD, DCATV, WLAN, MSR,LTEATDD, LTEAFDD
<b>Remote Command</b>	<code>[ :SENSe ] :WAVeform:AVERage:TYPE LOG   MAXimum   MINimum   RMS   SCALar</code> <code>[ :SENSe ] :WAVeform:AVERage:TYPE?</code>
<b>Example</b>	WAV:AVER:TYPE RMS WAV:AVER:TYPE?
Notes	The SCPI selection of MAX and MIN are kept for BWCC, but they are removed from the front panel access because they are not an Average function. You must be in a mode that includes the Waveform measurement to use this command. Use INSTRUMENT:SElect to set the mode.
Preset	RMS
State Saved	Saved in instrument state.
Range	Pwr Avg(RMS) Log-Pwr Avg(Video) Voltage Avg
Initial S/W Revision	Prior to A.02.00
Modified at S/W Revision	A.03.00

## Avg Type Auto

When Auto is selected, the analyzer chooses the type of averaging. When one of the average types is selected manually, the analyzer uses that type regardless of other analyzer settings, and shows Man on the Average Type softkey.

Key Path	Meas Setup, Avg Type
<b>Remote Command</b>	[ :SENSe ] :WAVeform:AVERage:TYPE:AUTO [ :STATe ] ON OFF 1 0 [ :SENSe ] :WAVeform:AVERage:TYPE:AUTO [ :STATe ] ?
<b>Example</b>	WAV:AVER:TYPE:AUTO 0 WAV:AVER:TYPE:AUTO?
Couplings	Auto selects Power (RMS) averaging if a Marker Function (Marker Noise, Band/Intvl Power) is on.
Preset	ON
State Saved	Saved in instrument state.
Range	Auto Man
Modified at S/W Revision	A.14.00

## Time Avg Num

Sets the number of HW averages to be executed per each data acquisition.

Key Path	Meas Setup
Mode	BASIC
<b>Remote Command</b>	[ :SENSe ] :WAVeform:AVERage:TACount <integer> [ :SENSe ] :WAVeform:AVERage:TACount?
<b>Example</b>	WAV:AVER:TAC 10WAV:AVER:TAC?
Notes	This feature is only available when Option DP2, B40, or wider IF Bandwidth option is installed.
Preset	1
State Saved	Saved in instrument state
Min	1
Max	65535
Default Unit	Enter

## Meas Time

Sets how long the measurement is performed. X Scale only changes the representation of the display.

Key Path	Meas Setup
Mode	BASIC, PNOISE, WCDMA, C2K, GSM, WIMAXOFDMA, TDSCDMA, 1XEVD0, DVB, DTMB, ISDBT, CMMB, LTE, LTETDD, DCATV, WLAN, MSR,LTEATDD, LTEAFDD

<b>Remote Command</b>	<code>[ :SENSe ] :WAVeform:SWEep:TIME &lt;time&gt;</code> <code>[ :SENSe ] :WAVeform:SWEep:TIME?</code>
<b>Example</b>	<code>WAV:SWE:TIME 50 ms</code> <code>WAV:SWE:TIME?</code>
<b>Notes</b>	Specifies and returns how long the measurement is performed. It is the time record length of the measurement waveform. The Max time may be reduced when the sample frequency is high due to the memory limitation. You must be in a mode that includes the Waveform measurement to use this command. Use <code>INSTrument:SElect</code> to set the mode.
<b>Preset</b>	All except the following list: 2.000000 ms LTEAFDD, LTEATDD: 10 ms LTETDD: 10 ms
<b>State Saved</b>	Saved in instrument state.
<b>Range</b>	1.000 (s to 100.00 s)
<b>Min</b>	1.000 us
<b>Max</b>	3200 s
<b>Initial S/W Revision</b>	Prior to A.02.00
<b>Modified at S/W Revision</b>	A.03.00, A.14.00

## Sample Rate

Enables you to set an arbitrary sample rate for the acquired data to be processed.

<b>Key Path</b>	Meas Setup
<b>Mode</b>	BASIC
<b>Remote Command</b>	<code>[ :SENSe ] :WAVeform:SRATe &lt;freq&gt;</code> <code>[ :SENSe ] :WAVeform:SRATe?</code>
<b>Example</b>	<code>WAV:SRAT 1.3636 MHz</code>
<b>Notes</b>	Command and query available when Option DP2, B40, or wider IF Bandwidth option is installed. For other configuration, only query is available.
<b>Couplings</b>	The coupling between Sample Rate and IF BW depends on Physics implementation.
<b>Preset</b>	125.0 kHz
<b>Min</b>	12.5 Hz
<b>Max</b>	<ul style="list-style-type: none"> <li>• (For Option DP2, B40 or wider IF Bandwidth option )</li> <li>• Digital IF 10 MHz path: 12.5 MHz</li> <li>• Digital IF 25 MHz path: 31.25 MHz</li> <li>• Digital IF 40 MHz path: 50 MHz</li> <li>• Option B85 85 MHz path: 106.25 MHz</li> <li>• Option B1A 125 MHz path: 156.25 MHz</li> </ul>

- Option B1X 140 MHz path: 175 MHz
- Option B1Y 160 MHz path: 200 MHz
- (For all other configuration)
- 10 MHz path: 15 MHz
- Option B25 25 MHz path: 45 MHz

Modified at S/W Revision 13.00

## PhNoise Opt

Selects the LO (local oscillator) phase noise behavior for various desired operating conditions.

Key Path	Meas Setup
<b>Remote Command</b>	[ :SENSe ] :WAVeform:FREQuency:SYNThesis [ :STATe ] 1   2   3 [ :SENSe ] :WAVeform:FREQuency:SYNThesis [ :STATe ] ?
<b>Example</b>	WAV:FREQ:SYNT 2 Selects optimization for best wide offset phase noise
Notes	Parameter: 1 optimizes phase noise for small frequency offsets from the carrier. 2 optimizes phase noise for wide frequency offsets from the carrier. 3 optimizes LO for tuning speed (In PXA, the local oscillator hardware provides for extra-low phase noise at the expense of some speed.)
Dependencies	Does not appear in all models. The key is blank in those models, but the SCPI command is accepted for compatibility (although no action is taken).
Preset	Because this function is in Auto after preset, and because Digital IF BW after preset < 150 kHz for MXA/EXA and > 400 kHz for PXA the state of this function after Preset will be 1 for MXA/EXA and 2 for PXA.
State Saved	Saved in instrument state.
Min	1
Min	1
Max	3
Initial S/W Revision	Prior to A.07.00
Modified at S/W Revision	A.07.00

## Auto

Selects the LO (local oscillator) phase noise behavior to optimize dynamic range and speed for various instrument operating conditions.

The X-Series has two grades of LO; a high performance LO that gives the best phase noise performance; and a medium-performance LO that gives excellent performance.

In models with the high performance LO, Auto will choose:

	Best Close in Phase Noise	Best Wide-offset Phase Noise
Filter BW	≤ 400 kHz	> 400 kHz

In models with the medium-performance LO, Auto will choose:

	Best Close in Phase Noise	Best Wide-offset Phase Noise
Filter BW	≤ 150 kHz	>150 kHz

Note that Fast Tuning will not be selected when in Auto.

Key Path	Meas Setup, PhNoise Opt
Remote Command	[ :SENSe ] :WAVeform:FREQuency:SYNThesis:AUTO[ :STATe ] OFF   ON   0   1 [ :SENSe ] :WAVeform:FREQuency:SYNThesis:AUTO[ :STATe ] ?
Example	WAV:FREQ:SYNT:AUTO ON
Preset	ON
State Saved	Saved in instrument state.
Initial S/W Revision	Prior to A.07.00

### Best Close-in P Noise

The LO phase noise is optimized for smaller offsets from the carrier, at the expense of phase noise farther out.

Key Path	Meas Setup, PhNoise Opt
Example	WAV:FREQ:SYNT 1
Couplings	The frequency below which the phase noise is optimized is model dependent: <ul style="list-style-type: none"> <li>• <b>CXA:</b> n/a</li> <li>• <b>EXA:</b> [offset ≤150 kHz]</li> <li>• <b>MXA:</b> [offset ≤150 kHz]</li> <li>• <b>PXA:</b> [offset ≤400 kHz]</li> </ul>
Readback	Close-in. If manually selected, “Man” will be underlined. The actual frequency offset within which noise is optimized is shown with in square brackets, as this can vary depending on the hardware set in use. For example, in some analyzers this annotation appears as [offset <150 kHz]
Initial S/W Revision	Prior to A.07.00

## Best Wide-offset P Noise

The LO phase noise is optimized for wider offsets from the carrier. Closer offsets are compromised and the throughput of measurements (especially remote measurements where the center frequency is changing rapidly), is reduced.

Key Path	Meas Setup, PhNoise Opt
<b>Example</b>	WAV:FREQ:SYNT 2
Couplings	<p>The frequency below which the phase noise is optimized is model dependent:</p> <p>CXA: n/a</p> <p>EXA: [offset &gt;150 kHz]</p> <p>MXA: [offset &gt;150 kHz]</p> <p>PXA: [offset &gt;400 kHz]</p>
Readback	<p>Wide-offset.</p> <p>If manually selected, “Man” will be underlined. The actual frequency offset beyond which noise is optimized is shown with in square brackets, as this can vary depending on the hardware set in use. For example, in some analyzers this annotation appears as [offset &gt;150 kHz]</p>
Initial S/W Revision	Prior to A.07.00

## Fast Tuning

In this mode, the LO behavior compromises phase noise at many offsets from the carrier in order to allow rapid measurement throughput when changing the center frequency. The term “fast tuning” refers to the time it takes to move the local oscillator to the start frequency and begin a capture; this setting does not impact the actual measurement time in any way.

Key Path	Meas Setup, PhNoise Opt
<b>Example</b>	WAV:FREQ:SYNT 3
State Saved	Saved in instrument state.
Readback	<p>Fast Tuning.</p> <p>If manually selected the “Man” will be underlined.</p>
Initial S/W Revision	Prior to A.07.00

## Advanced

Accesses a menu of advanced functions that are used for specific applications. These settings should not be changed for most measurements.

Key Path	Meas Setup
Initial S/W Revision	Prior to A.02.00

## ADC Dither

Accesses the ADC Dither control menu.

Key Path	Meas Setup, Advanced
Initial S/W Revision	Prior to A.02.00

## ADC Dither Auto

Sets ADC dithering to automatically select whether dithering is needed.

Key Path	Meas Setup, Advanced, ADC Dither
Mode	BASIC, PNOISE, WCDMA, C2K, GSM, WIMAXOFDMA, TDSCDMA, 1XEVD0, DVB, DTMB, ISDBT, CMMB, LTE, LTETDD, DCATV, WLAN, MSR,LTEATDD, LTEAFDD
Remote Command	[ :SENSe ] :WAVeform:ADC:DITHer:AUTO [ :STATe ] OFF ON 0 1 [ :SENSe ] :WAVeform:ADC:DITHer:AUTO [ :STATe ] ?
Example	WAV:ADC:DITH:AUTO ON WAV:ADC:DITH:AUTO?
Notes	The dither function improves linearity for low level signals, at the expense of a higher noise floor. You must be in a mode that includes the Waveform measurement to use this command. Use INSTRument:SElect to set the mode.
Preset	OFF
State Saved	Saved in instrument state.
Range	On Off
Initial S/W Revision	Prior to A.02.00
Modified at S/W Revision	A.03.00

## ADC Dither

Toggles the dither function On and Off. The dither function improves linearity for low level signals, at the expense of a higher noise floor.

The reduced clipping-to-noise ratio results in higher noise, because the clipping level of the ADC relative to the front terminals remains unchanged with the introduction of dither. The enhanced linearity is mostly improved scale fidelity.

With dither on, the third-order distortions are usually invisible for mixer levels below  $-35$  dBm. With dither off, these distortions can be visible, with typical power levels of  $-110$  dBm referred to the mixer. Detection nonlinearity can reach 1 dB for dither off at mixer levels around  $-70$  dBm and lower, while the specified nonlinearity is many times smaller with dither on.



Key Path	Meas Setup, Advanced, ADC Dither
Mode	BASIC, PNOISE, WCDMA, C2K, GSM, WIMAXOFDMA, TDSCDMA, 1XEVD0, DVB, DTMB, ISDBT, CMMB, LTE, LETDD, DCATV, WLAN, MSR,LTEATDD, LTEAFDD
<b>Remote Command</b>	[ :SENSe] :WAVeform:ADC:DITHer[:STATe] OFF ON 0 1 [ :SENSe] :WAVeform:ADC:DITHer[:STATe]?
<b>Example</b>	WAV:ADC:DITH ON WAV:ADC:DITH?
Notes	The dither function improves linearity for low level signals, at the expense of a higher noise floor. . You must be in a mode that includes the Waveform measurement to use this command. Use INSTRument:SElect to set the mode.
Preset	OFF
State Saved	Saved in instrument state.
Range	Auto Man
<b>Backwards Compatibility SCPI</b>	[ :SENSe] :WAVeform:WBIF:ADC:DITHer [ :SENSe] :WAVeform:PDITHer
Initial S/W Revision	Prior to A.02.00
Modified at S/W Revision	A.03.00

## IF Gain

Accesses the keys to select the IF Gain settings.

When in Autorange mode, the IF checks its range once for data acquisition, to provide the best signal to noise ratio. You can specify the range for the best speed, and optimize for noise or for large signals.

When the IF Gain is set to Autorange, the IF Gain is set to High initially for each chunk of data. The data is then acquired. If the IF overloads, then the IF Gain is set to Low and the data is re-acquired. Because of this operation, the Autorange setting uses more measurement time as the instrument checks/resets its range. You can get faster measurement speed by forcing the range to either the high or low gain setting. But you must know that your measurement conditions will not overload the IF (in the high gain range) and that your signals are well above the noise floor (for the low gain range), and that the signals are not changing.

When Digital Bus Out (under the Input/Output menu) is ON, the IF Gain State Autorange selection is not allowed. Thus, in this case, IF Gain State will be set to Low.

This only applies to the RF input. It does not apply to baseband I/Q input.

Key Path	Meas Setup, Advanced
Initial S/W Revision	Prior to A.02.00

## IF Gain Auto

Activates the auto rules for IF Gain

Key Path	Meas Setup, Advanced, IF Gain
Mode	BASIC, PNOISE, WCDMA, C2K, GSM, WIMAXOFDMA, TDSCDMA, 1XEVD0, DVB, DTMB, ISDBT, CMMB, LTE, LTETDD, DCATV, WLAN, MSR,LTEATDD, LTEAFDD
Remote Command	[ :SENSe ] :WAVeform:IF:GAIN:AUTO [ :STATe ] ON OFF 1 0 [ :SENSe ] :WAVeform:IF:GAIN:AUTO [ :STATe ] ?
Example	WAV:IF:GAIN:AUTO ON WAV:IF:GAIN:AUTO?
Notes	This only applies to the RF input. It does not apply to baseband I/Q input. You must be in a mode that includes the Waveform measurement to use this command. Use INSTRument:SElect to set the mode.
Preset	ON
State Saved	Saved in instrument state.
Range	On Off
Initial S/W Revision	Prior to A.02.00
Modified at S/W Revision	A.03.00

### IF Gain State

Selects the range of IF gain.

Key Path	Meas Setup, Advanced, IF Gain
Mode	BASIC, PNOISE, WCDMA, C2K, GSM, WIMAXOFDMA, TDSCDMA, 1XEVD0, DVB, DTMB, ISDBT, CMMB, LTE, LTETDD, DCATV, WLAN, MSR,LTEATDD, LTEAFDD
Remote Command	[ :SENSe ] :WAVeform:IF:GAIN [ :STATe ] AUTOrange LOW HIGH [ :SENSe ] :WAVeform:IF:GAIN [ :STATe ] ?
Example	WAV:IF:GAIN HIGH WAV:IF:GAIN?
Notes	This only applies to the RF input and does not apply to baseband I/Q input. You must be in a mode that includes the Waveform measurement to use this command. Use INSTRument:SElect to set the mode. If the user tries to select Autorange while Digital Bus Out is ON, an error message -221 "Settings conflict; "IF Gain Autorange not allowed when Digital Bus Out is ON" is displayed.
Couplings	If the user tries to select Autorange via SCPI while Digital Bus Out is ON, an error message - 224,"Illegal parameter value; "IF Gain Autorange not allowed when Digital Bus Out is on" is displayed. If the user tries to select Autorange via front panel while Digital Bus Out is ON, an advisory message "IF Gain Autorange not allowed when Digital Bus Out is on" is displayed.
Preset	LOW
State Saved	Saved in instrument state.
Range	Autorange (Slower Follows Signals) Low (Best for Large Signals) High (Best Noise Level)
Readback Text	Autorange Low High

Initial S/W Revision	Prior to A.02.00
Modified at S/W Revision	A.03.00

## IF Gain Offset

Sets the IF Gain offset in 2 dB step from –6 dB to +6 dB. Increasing the gain can increase the amplitude of small signals as long as you do not overdrive the hardware. Wideband gain should usually be adjusted after setting the input attenuation.

Internally, the IF Gain value will change based on the current configuration of the hardware. If you choose to offset this value, you may do so with this parameter. The value specified is not an absolute value but relative to the current internal IF Gain setting.

For example:

IF Gain Low + IF Gain Offset +4 dB = Total IF Gain of +4 dB (0 + 4 = 4)

IF Gain High + IF Gain Offset +4 dB = Total IF Gain of +14 dB (10 + 4 = 14)

IF Gain Low + IF Gain Offset –6 dB = Total IF Gain of –6 dB (0 – 6 = –6)

IF Gain High + IF Gain Offset –6 dB = Total IF Gain of +6 dB (10 – 6 = 4)

The total IF Gain range when IF Gain Offset is available is a minimum of 0 – 6 = –6 dB and a maximum of 10 + 6 = 16 dB. The available IF Gain depends on the IF Path and center frequency. The maximum IF Gain may not be achievable at all times depending on the configuration.

Key Path	Meas Setup, Advanced
Remote Command	[ :SENSe ] :WAVeform:IF:GAIN:OFFSet <rel_amp1 > [ :SENSe ] :WAVeform:IF:GAIN:OFFSet?
Example	WAV:IF:GAIN:OFFS 2 Sets the IF Gain offset to 2
Preset	0
State Saved	Saved in instrument state.
Min	–6
Max	+6
Default Unit	dB

## Meas Preset

Restores all the measurement parameters to their default values.

Key Path	Meas Setup
Mode	BASIC, PNOISE, WCDMA, C2K, GSM, WIMAXOFDMA, TDSCDMA, 1XEVD0, DVB, DTMB, ISDBT, CMMB, LTE, LTETDD, DCATV, WLAN, MSR,LTEATDD, LTEAFDD

<b>Remote Command</b>	:CONFigure:WAVeform
<b>Example</b>	CONF:WAV
<b>Notes</b>	Restore default values of all parameters. You must be in a mode that includes the Waveform measurement to use this command. Use INSTRument:SElect to set the mode.
<b>Initial S/W Revision</b>	Prior to A.02.00
<b>Modified at S/W Revision</b>	A.03.00

## HW Averaging

Changes the number of time averages is to be made using hardware. This averaging is much faster than the standard averaging done in software. The hardware averaging is done on the complex voltage time trace data before any measurement application averaging is done. Both types of averaging (HW and SW) can be done on the same measurement data.

When time averaging is being done in HW, each trace update represents N fresh data acquisitions averaged together, where N is the number of averages. You cannot access the individual time data. Note that in the spectrum measurement this averaging is done prior to the standard averaging done within the application. Thus the yellow trace in this measurement shows the result of the time averaging. Subsequent averaging is orthogonal to this hardware based time averaging and its result is seen as the blue trace in this and other applications.

So it is possible to turn off the averaging within the application but still have the HW averaging set to a certain number. In other words, turning averaging off within the measurement will not affect HW averaging. If HW averaging needs to be turned off, simply set the HW Averaging parameter to 1.

Since it is time averaging, a trigger source something other than Free Run should be used to avoid cancelling out the signal to be measured. It is most useful for a periodic signal with known periods.

## Sample Period (Aperture) Setting (Remote Command Only)

Returns the time between samples (sample period or aperture).

<b>Mode</b>	BASIC
<b>Remote Command</b>	[ :SENSe ] :WAVeform:APERture?
<b>Example</b>	WAV:APER?
<b>Notes</b>	Query only.
<b>Couplings</b>	Coupled to Sample Rate by the following equation. Sample Period = 1/(Sample Rate)
<b>Preset</b>	1/(Sample Rate Default)
<b>Min</b>	1/(Max Sample Rate)
<b>Max</b>	1/(Min Sample Rate)

## Mode

See "Mode" on page 298

## Mode Preset

Returns the active mode to a known state.

Mode Preset does the following for the currently active mode:

- Aborts the currently running measurement.
- Brings up the default menu for the mode, with no active function.
- Sets measurement Global settings to their preset values for the active mode only.
- Activates the default measurement.
- Brings up the default menu for the mode.
- Clears the input and output buffers.
- Sets Status Byte to 0.

Mode Preset does not:

- Cause a mode switch
- Affect mode persistent settings
- Affect system settings

See "[How-To Preset](#)" on page 2191 for more information.

<b>Key Path</b>	Front-panel key
<b>Remote Command</b>	:SYSTem:PRESet
<b>Example</b>	:SYST:PRES
<b>Notes</b>	*RST is preferred over :SYST:PRES for remote operation. *RST does a Mode Preset, as done by the :SYST:PRES command, and it sets the measurement mode to Single measurement rather than Continuous for optimal remote control throughput. Clears all pending OPC bits. The Status Byte is set to 0.
<b>Couplings</b>	A Mode Preset aborts the currently running measurement, activates the default measurement, and gets the mode to a consistent state with all of the default couplings set.
<b>Backwards Compatibility Notes</b>	In the X-Series, the legacy "Factory Preset" has been replaced with Mode Preset, which only presets the currently active mode, not the entire instrument. In the X-Series, the way to preset the entire instrument is by using System, Restore System Defaults All, which behaves essentially the same way as restore System Defaults does on ESA and PSA. There is also no "Preset Type" as there is on the PSA. There is a green Mode Preset front-panel key that does a Mode Preset and a white-with-green-letters User Preset front-panel key that does a User Preset. The old PRESet:TYPE command is ignored (without generating an error), and SYST:PRES without a parameter does a Mode Preset, which should cover most backward code compatibility issues. The settings and correction data under the Input/Output front-panel key (examples: Input Z Corr, Ext Amp Gain, etc.) are no longer part of any Mode, so they will not be preset by a Mode Preset. They are preset using Restore Input/Output Defaults, Restore System Defaults All. Note that because User Preset does a Recall State, and all of these settings are saved in State, they ARE recalled when using

	User Preset.
Initial S/W Revision	Prior to A.02.00

## How-To Preset

The table below shows all possible presets, their corresponding SCPI commands and front-panel access (key paths). Instrument settings depend on the current measurement context. Some settings are local to the current measurement, some are global (common) across all the measurements in the current mode, and some are global to all the available modes. In a similar way, restoring the settings to their preset state can be done within the different contexts.

Auto Couple - is a measurement local key. It sets all Auto/Man parameter couplings in the measurement to Auto. Any Auto/Man selection that is local to other measurements in the mode will not be affected.

Meas Preset - is a measurement local key. Meas Preset resets all the variables local to the current measurement except the persistent ones.

Mode Preset - resets all the current mode's measurement local and measurement global variables except the persistent ones.

Restore Mode Defaults - resets ALL the Mode variables (and all the Meas global and Meas local variables), including the persistent ones.

Type Of Preset	SCPI Command	Front Panel Access
Auto Couple	:COUPlE ALL	Auto Couple front-panel key
Meas Preset	:CONFIgure:<Measurement>	Meas Setup Menu
Mode Preset	:SYSTem:PRESet	Mode Preset (green key)
Restore Mode Defaults	:INSTrument:DEFault	Mode Setup Menu
Restore All Mode Defaults	:SYSTem:DEFault MODEs	System Menu; Restore System Default Menu
*RST	*RST	not possible (Mode Preset with Single)
Restore Input/Output Defaults	:SYSTem:DEFault INPut	System Menu; Restore System Default Menu
Restore Power On Defaults	:SYSTem:DEFault PON	System Menu; Restore System Default Menu
Restore Alignment Defaults	:SYSTem:DEFault ALIGn	System Menu; Restore System Default Menu
Restore Miscellaneous Defaults	:SYSTem:DEFault MISC	System Menu; Restore System Default Menu
Restore All System Defaults	:SYSTem:DEFault [ALL] :SYSTem:PRESet:PERSistent	System Menu; Restore System Default Menu
User Preset	:SYSTem:PRESet:USER	User Preset Menu
User Preset All Modes	:SYSTem:PRESet:USER:ALL	User Preset Menu

Power On Mode Preset	:SYSTem:PON:TYPE MODE	System Menu
Power On User Preset	:SYSTem:PON:TYPE USER	System Menu
Power On Last State	:SYSTem:PON:TYPE LAST	System Menu

### Preset Type (Remote Command Only)

As stated in the Backward Compatibility section, to be compatible with ESA/PSA the PRESet:TYPE command will be implemented as a no-op.

<b>Mode</b>	All
<b>Remote Command</b>	:SYSTem:PRESet:TYPE FACTory MODE USER :SYSTem:PRESet:TYPE?
<b>Example</b>	:SYST:PRESet:TYPE FACT
<b>Notes</b>	This command is supported for backward compatibility only. It is a no-op which does not change the behavior of any preset operation.
<b>Preset</b>	This is unaffected by Preset but is set to Mode on a "Restore System Defaults->All"
<b>State Saved</b>	No
<b>Initial S/W Revision</b>	Prior to A.02.00



## Mode Setup

See ["Mode Setup" on page 328](#)

## Peak Search

Places the selected marker on the trace point with the maximum y-axis value for that marker's trace and accesses a menu that enables you to select to do a next peak or minimum peak search.

<b>Key Path</b>	Front-panel key
<b>Mode</b>	BASIC, PNOISE, WCDMA, C2K, GSM, WIMAXOFDMA, TDSCDMA, 1XEVD0, DVB, DTMB, ISDBT, CM MB, LTE, LTETDD, DCATV, WLAN, MSR,LTEATDD, LTEAFDD
<b>Remote Command</b>	:CALCulate:WAVEform:MARKer[1]   2   . . .   12:MAXimum
<b>Example</b>	CALC:WAV:MARK2:MAX
<b>Notes</b>	You must be in a mode that includes the Waveform measurement to use this command. Use INSTRument:SElect to set the mode.
<b>Initial S/W Revision</b>	Prior to A.02.00
<b>Modified at S/W Revision</b>	A.03.00

## Next Peak

Moves the selected marker to the next highest local maximum with a value less than that of the current marker.

<b>Key Path</b>	Peak Search
<b>Mode</b>	BASIC, PNOISE, WCDMA, C2K, GSM, WIMAXOFDMA, TDSCDMA, 1XEVD0, DVB, DTMB, ISDBT, CM MB, LTE, LTETDD, DCATV, WLAN, MSR,LTEATDD, LTEAFDD
<b>Remote Command</b>	:CALCulate:WAVEform:MARKer[1]   2   . . .   12:MAXimum:NEXT
<b>Example</b>	CALC:WAV:MARK:MAX:NEXT
<b>Notes</b>	You must be in a mode that includes the Waveform measurement to use this command. Use INSTRument:SElect to set the mode.
<b>Initial S/W Revision</b>	Prior to A.02.00
<b>Modified at S/W Revision</b>	A.03.00

## Min Search

Moves the selected marker to the minimum y-axis value on the current trace.

<b>Key Path</b>	Peak Search
<b>Mode</b>	BASIC, PNOISE, WCDMA, C2K, GSM, WIMAXOFDMA, TDSCDMA, 1XEVD0, DVB, DTMB, ISDBT, CM MB, LTE, LTETDD, DCATV, WLAN, MSR,LTEATDD, LTEAFDD
<b>Remote Command</b>	:CALCulate:WAVEform:MARKer[1]   2   . . .   12:MINimum
<b>Example</b>	CALC:WAV:MARK:MIN
<b>Notes</b>	You must be in a mode that includes the Waveform measurement to use this command. Use INSTRument:SElect to set the mode.

---

Initial S/W Revision	Prior to A.02.00
Modified at S/W Revision	A.03.00

---

16 Waveform Measurement  
Print

Print

See "Print" on page 341

## Quick Save

The Quick Save front-panel key repeats the most recent save that was performed from the Save menu, with the following exceptions:

- Register saves are not remembered as Saves for the purpose of the Quick Save function
- If the current measurement does not support the last non-register save that was performed, an informational message is generated, “File type not supported for this measurement”

Quick Save repeats the last type of qualified save (that is, a save qualified by the above criteria) in the last save directory by creating a unique filename using the Auto File Naming algorithm described below.

If Quick Save is pressed after startup and before any qualified Save has been performed, the Quick Save function performs a Screen Image save using the current settings for Screen Image saves (current theme, current directory), which then becomes the “last save” for the purpose of subsequent Quick Saves.

The Auto File Naming feature automatically generates a file name for use when saving a file. The filename consists of a prefix and suffix separated by a dot, as is standard for the Windows® file system. A default prefix exists for each of the available file types:

Type	Default Prefix	Menu
State	State_	(Save/Recall)
Trace + State	State_	(Save/Recall)
Screen	Screen_	(Save/Recall)
Amplitude Corrections	Ampcor_	(Import/Export)
Traces	Trace_	(Import/Export)
Limit Lines	LLine_	(Import/Export)
Measurement Result	MeasR_	(Import/Export)
Capture Buffer	CapBuf_	(Import/Export)

A four digit number is appended to the prefix to create a unique file name. The numbering sequence starts at 0000 within each Mode for each file type and updates incrementally to 9999, then wraps to 0000 again. It remembers where it was through a Mode Preset and when leaving and returning to the Mode. It is reset by Restore Misc Defaults and Restore System Defaults and subsequent running of the instrument application. So, for example, the first auto file name generated for State files is State\_0000.state. The next is State\_0001, and so forth.

One of the key features of Auto File Name is that we guarantee that the Auto File Name will never conflict with an existing file. The algorithm looks for the next available number. If it gets to 9999, then it looks for holes. If it find no holes, that is no more numbers are available, it gives an error.

For example, if when we get to State\_0010.state there is already a State\_0010.state file in the current directory, it advances the counter to State\_0011.state to ensure that no conflict will exist (and then it verifies that State\_0011.state also does not exist in the current directory and advances again if it does, and so forth).

If you enter a file name for a given file type, then the prefix becomes the filename you entered instead of the default prefix, followed by an underscore. The last four letters (the suffix) are the 4-digit number.

For example, if you save a measurement results file as “fred.csv”, then the next auto file name chosen for a measurement results save will be fred\_0000.csv.

---

**NOTE** Although 0000 is used in the example above, the number that is used is actually the current number in the Meas Results sequence, that is, the number that would have been used if you had not entered your own file name.

---

**NOTE** If the filename you entered ends with \_dddd, where d=any number, making it look just like an auto file name, then the next auto file name picks up where you left off with the suffix being dddd + 1.

---

---

Key Path	Front-panel key
Notes	No remote command for this key specifically.
Initial S/W Revision	Prior to A.02.00

---

## Recall

The Recall menu lets you choose what you want to recall, and where you want to recall it from. Among the types of files you can recall are **States and Traces**. In addition, an Import (Data) option lets you recall a number of data types stored in CSV files (as used by Excel and other spreadsheet programs).

The default paths for Recall are data type dependent and are the same as for the Save key.

Key Path	Front-panel key
Notes	<p>No remote command for this key specifically, but the :MMEM:LOAD command is available for specific file types. An example is :MMEM:LOAD:STATE &lt;filename&gt;.</p> <p>If you try to recall a State file for a mode that is not licensed or not available in the instrument, an error message will occur and the state will not change.</p>
Backwards Compatibility Notes	<p>In legacy analyzers, it was possible to load a state without affecting the trace data, limit lines or correction data. Similarly (since User Preset is actually loading a state), it was possible to do a User Preset without affecting the trace data, limit lines or correction data.</p> <p>In the X-Series, “state” always includes all of this data; so whenever state is loaded, all of the traces, limit lines and corrections are affected. Although this differs from previous behavior, it is desirable behavior, and should not cause adverse issues for users.</p>
Backwards Compatibility Notes	<p>Recall for the X-Series supports backward compatibility in the sense that you can recall a state file from any X-Series model number and any version of X-Series software. This is only possible if part of the recalling process goes through a limiting step after recalling the mode settings, at least for settings that may vary with version number, model number, option and license differences. If you try to recall a state file onto an instrument with less capability than what was available on the instrument during the save, the recall will ignore the state it doesn't support and it will limit the recalled setting to what it allows.</p> <p>Example: if the saved state includes preamp ON, but the recalling instrument does not have a preamp; the preamp is limited to OFF. Conversely, if you save a state without a preamp, the preamp is OFF in the state file. When this saved file is recalled on an instrument with a licensed preamp, the preamp is changed to OFF. Another example is if the saved state has center frequency set to 20 GHz, but the instrument recalling the saved state is a different model and only supports 13.5 GHz. In this case, the center frequency is limited along with any other frequency based settings. Since the center frequency can't be preserved in this case, the recall limiting tries to at least preserve span to keep the measurement setup as intact as possible.</p> <p>It may be appropriate to issue a warning if the state is limited on the recall; warnings do not go out to SCPI so this would only affect the manual user.</p> <p>Note that there is no state file compatibility outside of the X-Series. For example, you cannot recall a state file from ESA or PSA.</p>
Initial S/W Revision	Prior to A.02.00

## State

The Recall State menu lets you choose a register or file from which to recall the state.

The content of a state file includes all of the settings and data required to return the analyzer as closely as possible to the Mode it was in, with the exact settings that were in place, when the save occurred. The Mode settings in each state file include the settings that are affected by Mode Preset, as well as the

additional settings affected by Restore Mode Defaults; all of the Mode's settings. In addition, all of the settings of the Input/Output system are included, even though they are outside of the Mode's state, because they are needed to restore the complete setup. Persistent System settings (for example, GPIB address) are not affected by either a Mode Preset or Restore Mode Defaults, nor are they included in a saved State file.

Since each state file is only for one Mode, the settings for other Modes are unaffected when it is loaded. Recall State will cause a mode switch if the state being recalled is not from the current active mode.

After the recall completes, the message "File <filename> recalled" or "Recalled State Register <register number>" is displayed.

For rapid recalls, the State menu lists 16 registers that you can choose from to recall. Pressing a Register key initiates the recall. You can also select a file from which to recall.

The default path for all State Files is:

My Documents\<<mode name>\state

where <mode name> is the parameter used to select the mode with the INST:SEL command (for example, SA for the Spectrum Analyzer).

See ["More Information" on page 2201](#).

<b>Key Path</b>	Recall
<b>Mode</b>	All
<b>Remote Command</b>	:MMEMory:LOAD:STATe <filename>
<b>Example</b>	:MMEM:LOAD:STAT "myState.state" This recalls the file myState.state on the default path
<b>Example</b>	MMEM:LOAD:STAT "MyStateFile.state" This loads the state file data (on the default file directory path) into the instrument state.
<b>Notes</b>	<p>When you pick a file to recall, the analyzer first verifies that the file is recallable in the current instrument by checking the software version and model number of the instrument. If everything matches, a full recall proceeds by aborting the currently running measurement, clearing any pending operations, and then loading the State from the saved state file. You can open state files from any mode, so recalling a State file switches to the mode that was active when the save occurred. After switching to the mode of the saved state file, mode settings and data (if any for the mode) are loaded with values from the saved file. The saved measurement of the mode becomes the newly active measurement and the data relevant to the measurement (if there is any) is recalled.</p> <p>If there is a mismatch between file version or model number or instrument version or model number, the recall function tries to recall as much as possible and returns a warning message. It may limit settings that differ based on model number, licensing or version number.</p> <p>After recalling the state, the Recall State function does the following:</p> <ul style="list-style-type: none"> <li>• Makes the saved measurement for the mode the active measurement.</li> <li>• Clears the input and output buffers.</li> <li>• Status Byte is set to 0.</li> <li>• Executes a *CLS</li> </ul> <p>If the file specified is empty an error is generated. If the specified file does not exist, another error is generated. If there is a mismatch between the file and the proper file type, an error is generated. If</p>



	there is a mismatch between file version or model number or instrument version or model number, a warning is displayed. Then it returns to the State menu and File Open dialog goes away. After the Recall, the analyzer exits the Recall menu and returns to the previous menu.
<b>Backwards Compatibility SCPI</b>	:MMEMory:LOAD:STATe 1,<filename> For backwards compatibility, the above syntax is supported. The "1" is simply ignored.
Initial S/W Revision	Prior to A.02.00

## More Information

In measurements that support saving Traces, for example, Swept SA, the Trace data is saved along with the State in the State file. When recalling the State, the Trace data is recalled as well. Traces are recalled exactly as they were stored, including the writing mode and update and display modes. If a Trace was updating and visible when the State was saved, it will come back updating and visible, and its data will be rewritten right away. When you use State to save and recall traces, any trace whose data must be preserved should be placed in View or Blank mode before saving.

The following table describes the Trace Save and Recall possibilities:

You want to recall state and one trace's data, leaving other traces unaffected.	Save Trace+State from 1 trace. Make sure that no other traces are updating (they should all be in View or Blank mode) when the save is performed.	On Recall, specify the trace you want to load the one trace's data into. This trace will load in View. All other traces' data will be unaffected, although their trace mode will be as it was when the state save was performed.
You want to recall all traces	Save Trace+State from ALL traces.	On Recall, all traces will come back in View (or Blank if they were in Blank or Background when saved)
You want all traces to load exactly as they were when saved.	Save State	On recall, all traces' mode and data will be exactly as they were when saved. Any traces that were updating will have their data immediately overwritten.

## From File...

When you press "From File", the analyzer brings up a Windows dialog and a menu entitled "File Open." This menu allows you to navigate to the various fields in the Windows dialog without using a keyboard or mouse. The Tab and Arrow keys can also be used for dialog navigation.

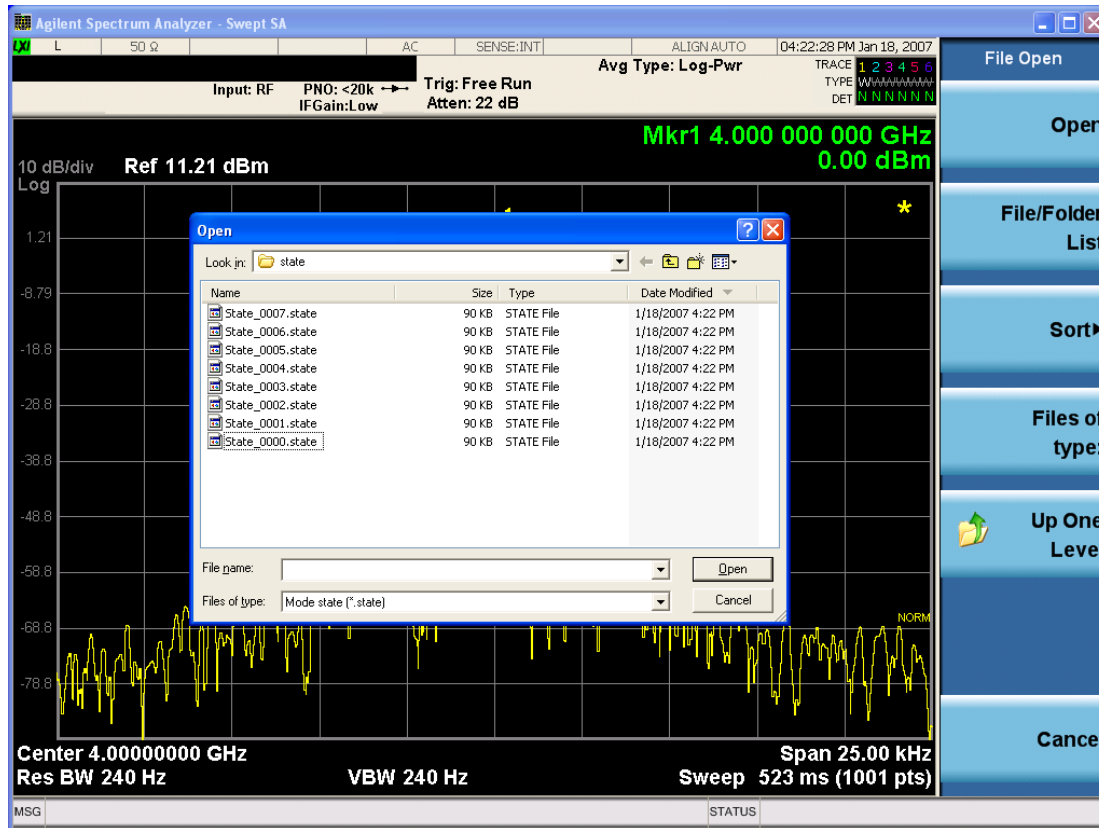

Listed below are the functions of the various fields in the dialog, and the corresponding softkeys:

### Open

Performs the recall of the specified file. While the recall is being performed, the floppy icon appears briefly in the Meas bar.

### File/Folder List

Enables you to navigate to the center of the dialog that contains the list of files and folders. Once here you can get information about the file and use the tab keys to navigate to the other fields in the dialog, such as Look In.

### Look In

The Look In field shows the path from which the file will be recalled and allows you to change the path using the up and down arrow keys to navigate to other paths; the Enter key to open a directory; and the Backspace key to go back one directory. The **Look In field** first uses the last path from the Save As dialog **Save In:** path for that same file type. There is no softkey for directly navigating to the Look In field, but you can use the left tab to get here from the File/Folder List.

User specified paths are remembered when you leave and return to a Mode and are reset back to the default using Restore Mode Defaults.

### Sort

Accesses a menu that enables you to sort the files within the File Open dialog. Only one sorting type can be selected at a time and the sorting happens immediately. The sorting types are By Date, By Name, By extension, and By Size.

#### Files of Type

This field shows the file suffix for the type of file you have selected to recall. For example, if you navigated here while recalling State, "Mode state (\*.state)" is in the field. If you navigated here while recalling Trace, ""Mode state (\*.trace)" is in the field. If you navigated here while importing a trace data file, "Trace Data (\*.csv)" is in the field. For some file types, there is more than one choice in the dropdown menu, which you can select by using the up and down arrow keys and Enter.

#### Up One Level

This key corresponds to the icon of a folder with the up arrow that is in the tool bar of the dialog. When pressed, it causes the file and folder list to navigate up one level in the directory structure. The Backspace key does the same thing.

#### Cancel

This key corresponds to the Cancel selection in the dialog. It causes the current **Open** request to be cancelled. The ESC key does the same thing.

Key Path	Recall, State
Notes	Brings up the Open dialog for recalling a State Save Type
Initial S/W Revision	Prior to A.02.00

### Edit Register Names

You may enter a custom name on any of the Register keys, to help you remember what you are using that state to save. To do this, press the Edit Register Names key, choose the register whose name you wish to edit, and then enter the desired label using the Alpha Editor or an external PC keyboard.

The maximum number of characters that can be added is 30. In most cases, 30 characters will fit on two lines of the key.

For more information and the SCPI command, see Edit Register Names under the Save, State function.

Key Path	Recall, State
Mode	All
Dependencies	N9060A-7FP or N9060B-2FP license required to edit the register names. When the feature is not licensed, sending the SCPI command generates an error, -221, "Settings conflict;Option not available"
Initial S/W Revision	A.11.00

### Register 1 thru Register 16

Selecting any one of these register keys causes the State of the mode from the specified Register to be recalled. Each of the register keys annotates whether it is empty or at what date and time it was last

modified. In addition, you can use the Edit Register Names key under Save, State to enter custom names for each register.

Registers are shared by all modes, so recalling from any one of the registers will cause a mode switch to the mode that was active when the save to the Register occurred.

Although these 16 registers are the only registers available from the front panel, there are 128 state registers available in the instrument. Registers 17–128 are only available from the SCPI interface, using the \*RCL command.

After the recall completes, the message "Register <register number> recalled" appears in the message bar. If you are in the Spectrum Analyzer Mode, and you are recalling a register that was saved in the Spectrum Analyzer Mode, then after the recall, you will still be in the Recall Register menu. If the Recall causes you to switch modes, then after the Recall, you will be in the Frequency menu.

If a requested register is empty an error is generated.

Key Path	Recall, State
<b>Example</b>	*RCL 1
Range	1–16 from front panel, 1–128 from SCPI
Readback	Date and time with seconds resolution are displayed on the key OR A custom name of up to 30 characters entered using the Save, State, Edit Register Names key OR “(empty)” if no prior save operation has been performed to this register.
Initial S/W Revision	Prior to A.02.00
Modified at S/W Revision	Prior to A.11.00

## Register 1 thru Register 16

Selecting any one of these register keys causes the State of the mode from the specified Register to be recalled. Each of the register keys annotates whether it is empty or at what date and time it was last modified. In addition, you can use the Edit Register Names key under Save, State to enter custom names for each register.

Registers are shared by all modes, so recalling from any one of the registers will cause a mode switch to the mode that was active when the save to the Register occurred.

Although these 16 registers are the only registers available from the front panel, there are 128 state registers available in the instrument. Registers 17–128 are only available from the SCPI interface, using the \*RCL command.

After the recall completes, the message "Register <register number> recalled" appears in the message bar. If you are in the Spectrum Analyzer Mode, and you are recalling a register that was saved in the Spectrum Analyzer Mode, then after the recall, you will still be in the Recall Register menu. If the Recall causes you to switch modes, then after the Recall, you will be in the Frequency menu.

If a requested register is empty an error is generated.

Key Path	Recall, State
<b>Example</b>	*RCL 1
Range	1-16 from front panel, 1-128 from SCPI
Readback	Date and time with seconds resolution are displayed on the key OR A custom name of up to 30 characters entered using the Save, State,Edit Register Names key OR “(empty)” if no prior save operation has been performed to this register.
Initial S/W Revision	Prior to A.02.00
Modified at S/W Revision	Prior to A.11.00

## Data (Import)

Importing a data file loads data that was previously saved from the current measurement or from other measurements and/or modes that produce compatible data files. The Import Menu only contains Data Types that are supported by the current measurement.

Since the commonly exported data files are in .csv format, the data can be edited by the user prior to importing. This allows you to export a data file, manipulate the data in Excel (the most common PC Application for manipulating .csv files) and then import it.

Importing Data loads measurement data from the specified file into the specified or default destination, depending on the data type selected. Selecting an Import Data menu key will not actually cause the importing to occur, since the analyzer still needs to know from where to get the data. Pressing the Open key in this menu brings up the Open dialog and Open menu that provides you with the options from where to recall the data. Once a filename has been selected or entered in the Open menu, the recall occurs as soon as the Open button is pressed.

Key Path	Recall
Mode	All
Notes	The menu is built from whatever data types are available for the mode. Some keys will be missing completely, so the key locations in the sub-menu will vary.  No SCPI command directly controls the Data Type that this key controls. The Data Type is included in the MMEM:LOAD commands.
Dependencies	If a file type is not used by a certain measurement, it is grayed out for that measurement. The key for a file type will not show at all if there are no measurements in the Mode that support it.
Preset	Is not affected by Preset or shutdown, but is reset during Restore Mode Defaults
Readback	The data type that is currently selected
Initial S/W Revision	Prior to A.02.00

## Amplitude Correction

This key selects the Amplitude Corrections as the data type to be imported. When pressed a second time, it brings up the Select Menu, which lets you select the Correction into which the data will be imported.

Amplitude Corrections are fully discussed in the documentation of the Input/Output key, under the Corrections key.

A set of preloaded Corrections files can be found in the directory

/My Documents/ EMC Limits and Ampcor.

When the Amplitude Correction is an Antenna correction and the Antenna Unit in the file is not None, the Y Axis Unit setting will change to match the Antenna Unit in the file.

Key Path	Recall
Mode	SA EDGE GSM PN
Remote Command	:MMEMory:LOAD:CORRection 1 2 3 4 5 6 7 8, <filename>
Example	:MMEM:LOAD:CORR 2, "myAmpcor.csv" recalls the Amplitude Correction data from the file myAmpcor.csv in the current directory to the 2nd Amplitude Correction table, and turns on Correction 2. The default path is D:\User_My_Documents\Instrument\My Documents\amplitudeCorrections\
Dependencies	<p>Only the first correction array (Correction 1) supports antenna units. This means that a correction file with an Antenna Unit can only be loaded into the Corrections 1 register. Consequently only for Correction 1 does the dropdown in the Recall dialog include.ant, and if an attempt is made to load a correction file into any other Correction register which DOES contain an antenna unit, a Mass Storage error is generated.</p> <p>Corrections are not supported by all Measurements. If in a Mode in which some Measurements support it, this key will be grayed out in measurements that do not. The key will not show at all if no measurements in the Mode support it.</p> <p>Errors are reported if the file is empty or missing, or if the file type does not match, or if there is a mismatch between the file type and the destination data type. If any of these occur during manual operation, the analyzer returns to the Import Data menu and the File Open dialog goes away.</p> <p>This key does not appear unless you have the proper option installed in your instrument.</p> <p>This command will generate an "Option not available" error unless you have the proper option installed in your instrument.</p>
Couplings	When a correction file is loaded from mass storage, it is automatically turned on ( <b>Correction ON</b> ) and <b>ApplyCorrections</b> is set to On. This allows you to see its effect, thus confirming the load.
Readback	selected Correction
Backwards Compatibility SCPI	:MMEMory:LOAD:CORRection ANTenna   CABLE   OTHer   USER, <filename> For backwards compatibility, ANTenna maps to 1, CABLE maps to 2, OTHer maps to 3 and USER maps to 4
Initial S/W Revision	A.02.00

## Amplitude Correction

These keys let you select which Correction to import the data into. Once selected, the key returns back to the Import Data menu and the selected Correction number is annotated on the key. The next step is to select the Open key in the Import Data menu.

Antenna corrections are a particular kind of Amplitude Corrections – they are distinguished in the corrections file by having the Antenna Unit set to a value other than None. Only Correction 1 supports Antenna Units.

Key Path	Recall, Data, Amplitude Correction
Notes	auto return
Dependencies	Only Correction 1 may be used to load a Correction that contains an Antenna Unit other than None
Preset	Not part of Preset, but is reset to Correction 1 by Restore Input/Output Defaults; survives shutdown.
State Saved	The current Correction number is saved in instrument state
Initial S/W Revision	A.02.00

## Chan Table

Imports the channel table from a channel plan file. This function enables you to use your own defined channel tables by importing a modified channel table file.

Instead of creating a brand new channel plan file, you can generate a channel plan file to fit your needs using a saved channel plan file or the default channel plan file ChannelPlan.txt in the directory “My Documents\Digital Video\data\”. The saved channel plan file is obtained by pressing Save, Data, Channel Table, and then Save As...

Note that while editing the channel plan file, you cannot change the channel plan name, such as NTSC\_B.VHF, NTSC\_B.UHF, otherwise your modifications on the corresponding channel plan will not work. You can add, remove, or modify the channel numbers and center frequencies in each channel plan. The value of Start Channel and Channel Count may also need to be changed.

File Location and Extension

**File location:** “My Documents\Digital Video\data”

**File type:** text file

**File extension:** .txt

**Example:**

File Location: My Documents\Digital Video\data

File Name: ChannelPlan\_0001.txt

Key Path	Recall, Data
Mode	DVB-T/H
<b>Remote Command</b>	MMEemory:LOAD:CHTable <string>
<b>Example</b>	MMEemory:LOAD:CHT “ChannelPlan_0001.txt”
Initial S/W Revision	A.07.00

## Capture Buffer

Capture buffer functionality is available only in Mod Accuracy measurement. The captured data is raw data which is not processed.

Key Path	Recall, Data
Mode	DVB-T/H
Example	MMEM:LOAD:CAPT "MyCaptureData.bin" This loads the file of capture data (on the default file directory path) into the instrument.
Dependencies	Capture buffer data is only available for Mod Accuracy measurement. In other measurements, this key is grayed out.
Initial S/W Revision	Prior to A.01.70

## DVB-T2 Config

Imports DVB-T2 configuration from setting files (single PLP or multiple PLPs). This key is available only in DVB-T2 Mod Accuracy measurement and will be grayed out in other measurements.

If the configuration file to be recalled is created with previous instrument S/W revision A.10.52 or before (To check the instrument S/W revision, press System, Show, System on the instrument), it doesn't have Transmission Mode and Version parameters. Then you need to set up the DVB-T2 version and transmission mode manually by pressing Mode Setup, Radio Std, DVB-T2, Version 1.1.1, and toggling Transmission Mode to SISO to select the standard version and transmission mode of the signal under test.

All the modulation parameters can be set from the setting file. These parameters include Version, Transmission Mode, Guard Interval, FFT size, Carrier Mode, Pilot Pattern, L1 Modulation Format, Data Symbols, PAPR Type, PLP Number, SubSlices Number, SubSlices Interval, PLP Modulation Format, PLP Constellation Rotation, FEC Type, Time IL Length, FEC Block Num, PLP ID, PLP Start, PLP Type and PLP Code Rate.

File Location and Extension

**File location:** "My Documents\DVB\data\EVMT2\data"

**File type:** text file

**File extension:** .csv

**Example:**

File Location: My Documents\DVB\data\EVMT2\data

File Name: DVBT2Config\_0001.csv

Key Path	Recall, Data
Mode	DVB-T/H
Remote Command	MMEMory:LOAD:T2Config <string>



<b>Example</b>	MMEM:LOAD:T2C "DVBT2Config_0001.csv"
Dependencies	This key is grayed out in all other measurements except DVB-T2 Mod Accuracy measurement.
Couplings	Auto Detect (Meas, DVB-T2 ModAccuracy, Meas Setup) will be changed to OFF automatically when the DVB-T2 config file is loaded.
Initial S/W Revision	A.07.00

## Open...

When you press "Open", the analyzer brings up a Windows dialog and a menu entitled "**File Open.**" This menu allows you to navigate to the various fields in the Windows dialog without using a keyboard or mouse. The Tab and Arrow keys can also be used for dialog navigation.

See "[From File...](#)" on page 2201 in Recall, State, for a full description of this dialog and menu.

Key Path	Recall, Data
Notes	The key location is mode-dependent and will vary. Brings up Open dialog for recalling a <mode specific> Save Type
Initial S/W Revision	Prior to A.02.00

## Restart

The Restart function restarts the current sweep, or measurement, or set of averaged/held sweeps or measurements. If you are Paused, pressing Restart does a Resume.

The Restart function is accessed in several ways:

- Pressing the Restart key
- Sending the remote command INIT:IMMEDIATE
- Sending the remote command INIT:RESTART

See "[More Information](#)" on page 2210

Key Path	Front-panel key
Remote Command	:INITiate[:IMMEDIATE] :INITiate:RESTART
Example	:INIT:IMM :INIT:REST
Notes	:INITiate:RESTART and :INITiate:IMMEDIATE perform exactly the same function.
Couplings	Resets average/hold count k. For the first sweep overwrites all active (update=on) traces with new current data. For application modes, it resets other parameters as required by the measurement.
Status Bits/OPC dependencies	This is an Overlapped command. The STATUS:OPERation register bits 0 through 8 are cleared. The STATUS:QUESTionable register bit 9 (INTEGRITY sum) is cleared. The SWEEPING bit is set. The MEASURING bit is set.
Backwards Compatibility Notes	For Spectrum Analysis mode in ESA and PSA, the Restart hardkey and the INITiate:RESTART command restart trace averages (displayed average count reset to 1) for a trace in Clear Write, but did not restart Max Hold and Min Hold.  In the X-Series, the Restart hardkey and the INITiate:RESTART command restart not only Trace Average, but MaxHold and MinHold traces as well.  For wireless comms modes in ESA and PSA, the Restart hardkey and the INITiate:RESTART command restart every measurement, which includes all traces and numeric results. There is no change to this operation.
Initial S/W Revision	Prior to A.02.00

### More Information

The **Restart** function first aborts the current sweep/measurement as quickly as possible. It then resets the sweep and trigger systems, sets up the measurement and initiates a new data measurement sequence with a new data acquisition (sweep) taken once the trigger condition is met.

If the analyzer is in the process of aligning when **Restart** is executed, the alignment finishes before the restart function is performed.

Even when set for Single operation, multiple sweeps may be taken when Restart is pressed (for example, when averaging/holding is on). Thus when we say that **Restart** "restarts a measurement," we may mean:

- It restarts the current sweep
- It restarts the current measurement
- It restarts the current set of sweeps if any trace is in Trace Average, Max Hold or Min Hold
- It restarts the current set of measurements if Averaging, or Max Hold, or Min Hold is on for the measurement
- depending on the current settings.

With **Average/Hold Number** (in **Meas Setup** menu) set to 1, or Averaging off, or no trace in Trace Average or Hold, a single sweep is equivalent to a single measurement. A single sweep is taken after the trigger condition is met; and the analyzer stops sweeping once that sweep has completed. However, with **Average/Hold Number** >1 and at least one trace set to **Trace Average, Max Hold, or Min Hold (SA Measurement)** or **Averaging on (most other measurements)**, multiple sweeps/data acquisitions are taken for a single measurement. The trigger condition must be met prior to each sweep. The sweep is stopped when the average count  $k$  equals the number  $N$  set for **Average/Hold Number**. A measurement average usually applies to all traces, marker results, and numeric results; but sometimes it only applies to the numeric results.

Once the full set of sweeps has been taken, the analyzer will go to idle state. To take one more sweep without resetting the average count, increment the average count by 1, by pressing the step up key while **Average/Hold Number** is the active function, or sending the remote command `CALC:AVER:TCON UP`.

## Save

The Save menu lets you choose what you want to save and where you want to save it. Among the types of files you can save are **States**, **Traces**, and **Screen Images**. In addition, an Export (Data) option lets you save a number of data types as CSV files for easy import into Excel and other spreadsheet programs.

Key Path	Front-panel key
Mode	All
Notes	No remote command for this key specifically, but the :MMEM:STORe command is available for specific file types. An example is :MMEM:STOR:STATe <filename>.
Initial S/W Revision	Prior to A.02.00

## State

The Save State menu lets you choose a register or file for saving the state.

The content of a state file includes all of the settings and data required to return the analyzer as closely as possible to the Mode it was in, with the exact settings which were in place, when the save occurred. The Mode settings in each state file include the settings that are affected by Mode Preset, as well as the additional settings affected by Restore Mode Defaults; all of the Mode's settings. In addition, all of the settings of the Input/Output system are included, even though they are outside of the Mode's state, because they are needed to restore the complete setup. Persistent System settings (for example, Verbose SCPI) are not affected by either Mode Preset or Restore Mode Defaults, nor are they included in a saved State file.

After the save completes, the message "File <filename> saved" or "State Register <register number> saved" is displayed.

For rapid saving, the State menu lists 16 registers to save to. Pressing a Register key initiates the save. You can also select a file to save to.

The default path for all State Files is:

My Documents\<<mode name>\state

where <mode name> is the parameter used to select the mode with the INST:SEL command (for example, SA for the Spectrum Analyzer).

Key Path	Save
Mode	All
Remote Command	:MMEMory:STORe:STATe <filename>
Example	MMEM:STOR:STATe "MyStateFile.state" This stores the current instrument state data in the file MyStateFile.state in the default directory.
Notes	Both single and double quotes are supported for any filename parameter over remote. After saving to a register, that register's menu key is updated with the date the time, unless a custom label has been entered for that key. After saving to a register, you remain in the Save State menu, so that you can see the Register key

update. After saving to a file, the analyzer automatically returns to the previous menu and any Save As dialog goes away.

<b>Backwards Compatibility SCPI</b>	:MMEMoRY:STORe:STATe 1,<filename>
Initial S/W Revision	Prior to A.02.00

### To File . . .

When you press “To File”, the analyzer brings up a Windows dialog and a menu entitled “**Save As.**” This menu allows you to navigate to the various fields in the Windows dialog without using a keyboard or mouse. The Tab and Arrow keys can also be used for dialog navigation.

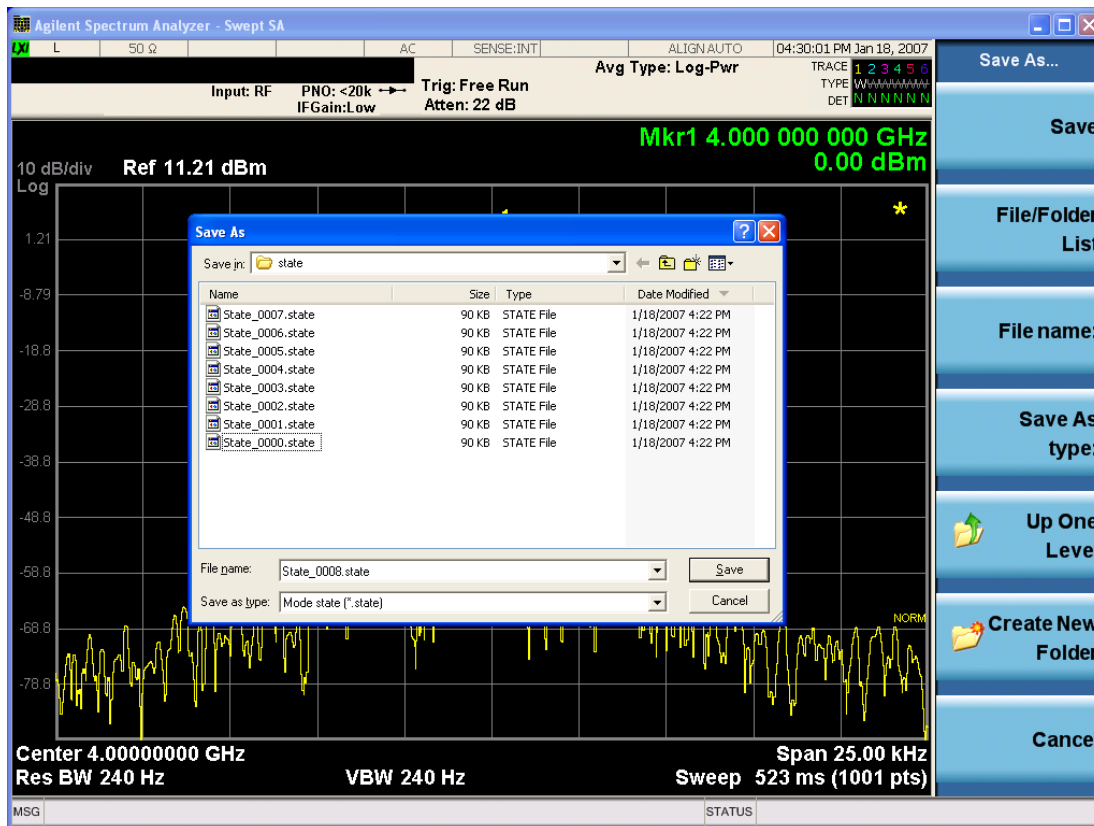

The Listed below

are the functions of the various fields in the dialog, and the corresponding softkeys:

#### Save

Performs the save to the specified file of the selected type. If the file already exists, a dialog will appear that allows you to replace the existing file by selecting OK, or you can Cancel the request. If you select OK, the file will be overwritten. Using the C: drive is strongly discouraged, since it runs the risk of being overwritten during an instrument software upgrade.

While the save is being performed, the floppy icon appears briefly in the Meas bar.

### File/Folder List

Enables you to navigate to the center of the dialog that contains the list of files and folders. Once here you can get information about the file and use the tab keys to navigate to the other fields in the dialog, such as Save In.

### Save In

The Save In field shows the path to which the file will be saved and allows you to change the path using the up and down arrow keys to navigate to other paths; the Enter key to open a directory; and the Backspace key to go back one directory. The **Save In field** defaults to the default path for this type of file and remembers the last path you used to save this type of file. There is no softkey for directly navigating to the Save In field but you can use left tab to get here from the File/Folder List.

User specified paths are remembered when you leave and return to a Mode and are reset back to the default using Restore Mode Defaults.

### File Name

The File Name field is initially loaded with an automatically generated filename specific to the appropriate Save Type. The automatically generated filename is guaranteed not to conflict with any filename currently in the directory. You may replace or modify this filename using the File Name key. See the ["Quick Save " on page 2197](#) documentation for more on the automatic file naming algorithm.

When you press the File Name key the analyzer displays the Alpha Editor. Use the knob to choose the letter to add and the front-panel Enter key to add the letter to the file name. The BK character moves you back and the FW character moves you forward in the filename. The Select key on the front panel generates a space character. When you are done entering the filename press the Done softkey. This returns back to the **File Open** dialog and menu, but does not cause the save to occur.

### Save As Type

This field shows the file suffix for the type of file you have selected to save. For example, if you navigated here while saving State, "Mode state (\*.state)" is in the field. If you navigated here from saving Trace, ""Mode state (\*.trace)" is in the field. If you navigated here while exporting a trace data file, "Trace Data (\*.csv)" is in the field. For some file types, there is more than one choice in the dropdown, which you can select by using the up and down arrow keys and Enter.

### Up One Level

This key corresponds to the icon of a folder with the up arrow that is in the tool bar of the dialog. When pressed, it causes the file and folder list to navigate up one level in the directory structure. The Backspace key does the same thing.

### Create New Folder

This key corresponds to the icon of a folder with the "\*" that is in the tool bar of the dialog. When pressed, a new folder is created in the current directory with the name **New Folder** and you can enter a new folder name using the Alpha Editor.

### Cancel

This key corresponds to the Cancel selection in the dialog. It causes the current **Save As** request to be cancelled. The ESC key does the same thing.

Key Path	Save, State
Mode	All
Notes	Brings up Save As dialog for saving a State Save Type
Initial S/W Revision	Prior to A.02.00

## Edit Register Names

You may enter a custom name on any of the Register keys, to help you remember what you are using that state to save. To do this, press the Edit Register Names key, choose the register whose name you wish to edit, and then enter the desired label using the Alpha Editor or an external PC keyboard.

The maximum number of characters that can be added is 30. In most cases, 30 characters will fit on two lines of the key.

See ["More Information" on page 2215](#)

Key Path	Save, State
Mode	All
<b>Remote Command</b>	:MMEMory:REGister:STATe:LABel <reg number>,"label" :MMEMory:REGister:STATe:LABel? <reg number>
<b>Example</b>	:MMEM:REG:STAT:LAB 1,"my label"
Notes	<reg number> is an integer from 1 to 16. If the SCPI specifies an invalid register number an error message is generated, -222,"Data out of range;Invalid register label number" "label" is a string from 0 to 30 characters in length. If a label exceeds 30 characters, an error message is generated, -150,"String data error;Label clipped to 30 characters" "label" of length 0 erases the custom label and restores the default (time and date) label. E.g.: :MMEM:REG:STAT:LAB 1,""
Dependencies	N9060A-7FP or N9060B-2FP license required to edit the register names. When the feature is not licensed, sending this command generates an error, -221,"Settings conflict;Option not available"
Preset	The names are unaffected by Preset or power cycle but are set to the default label (time and date) on a "Restore System Defaults->Misc"
Initial S/W Revision	A.11.00

## More Information

When you edit one of the register names, the time and date field will be replaced by the custom name.

If you delete all the characters in the custom name, it restores the default (time and date).

The register names are stored within the state files, but they are not part of the instrument state; that is, once you have edited a register name, loading a new state will not change that register name. Another consequence of this is that the names will be persistent through a power cycle. Also, if a named state file is transferred to another analyzer, it will bring its custom name along with it.

If you try to edit the name of an empty register, the analyzer will first save the state to have a file to put the name in. If you load a named state file into an analyzer with older firmware it will ignore the metadata.

The \*SAV and \*RCL commands will not be affected by the custom register names, nor will the MMEM commands.

### Register 1 thru Register 16

Selecting any one of these register menu keys causes the State of the currently active mode to be saved to the specified Register. The registers are provided for rapid saving and recalling, since you do not need to specify a filename or navigate to a file. Each of the register menu keys annotates whether it is empty or at what date and time it was last modified. In addition, you can use the Edit Register Names key to enter custom names for each register.

Although these 16 registers are the only registers available from the front panel, there are 128 state registers available in the instrument. Registers 17–128 are only available from the SCPI interface, using the \*SAV command.

There is one set of 128 state registers in the instrument, not one set for each Mode. When a state is saved, the Mode it was saved from is saved with it; then when it is recalled, the instrument switches to that Mode.

After the save completes, the corresponding register menu key annotation is updated with the date and time and the message "Register <register number> saved" is displayed.

Key Path	Save, State
Mode	All
Example	*SAV 1
Range	1–16 from front panel, 1–128 from SCPI
Readback	Date and time with seconds resolution are displayed on the key OR A custom name of up to 30 characters entered using the Edit Register Names key OR “(empty)” if no prior save operation has been performed to this register.
Initial S/W Revision	Prior to A.02.00
Modified at S/W Revision	A.11.00

### Register 1 thru Register 16

Selecting any one of these register menu keys causes the State of the currently active mode to be saved to the specified Register. The registers are provided for rapid saving and recalling, since you do not need to specify a filename or navigate to a file. Each of the register menu keys annotates whether it is empty or at what date and time it was last modified. In addition, you can use the Edit Register Names key to enter custom names for each register.

Although these 16 registers are the only registers available from the front panel, there are 128 state registers available in the instrument. Registers 17–128 are only available from the SCPI interface, using the \*SAV command.



There is one set of 128 state registers in the instrument, not one set for each Mode. When a state is saved, the Mode it was saved from is saved with it; then when it is recalled, the instrument switches to that Mode.

After the save completes, the corresponding register menu key annotation is updated with the date and time and the message "Register <register number> saved" is displayed.

Key Path	Save, State
Mode	All
Example	*SAV 1
Range	1–16 from front panel, 1–128 from SCPI
Readback	Date and time with seconds resolution are displayed on the key OR A custom name of up to 30 characters entered using the Edit Register Names key OR “(empty)” if no prior save operation has been performed to this register.
Initial S/W Revision	Prior to A.02.00
Modified at S/W Revision	A.11.00

## Data (Export)

Exporting a data file stores data from the current measurement to mass storage files. The Export Menu only contains data types that are supported by the current measurement.

Since the commonly exported data files are in .csv format, the data can be edited by you prior to importing. This allows you to export a data file, manipulate the data in Excel (the most common PC Application for manipulating .csv files) and then import it.

Selecting an Export Data menu key will not actually cause the exporting to occur, since the analyzer still needs to know where you wish to save the data. Pressing the Save As key in this menu brings up the Save As dialog and Save As menu that allows you to specify the destination file and directory. Once a filename has been selected or entered in the Open menu, the export will occur as soon as the Save key is pressed.

Key Path	Save
Mode	All
Notes	The menu is built from whatever data types are available for the mode. So the key locations in the sub menu will vary.  No SCPI command directly controls the Data Type that this key controls. The Data Type is included in the MMEM:STORe commands.
Dependencies	If a file type is not used by a certain measurement, that type is grayed out for that measurement. The key for a file type will not show at all if there are no measurements in the Mode that support it.
Preset	Is not affected by a Preset or shutdown, but is reset during Restore Mode Defaults
Readback	The data type that is currently selected
Initial S/W Revision	Prior to A.02.00

## Amplitude Correction

Pressing this key selects **Amplitude Corrections** as the data type to be exported. Pressing this key again brings up the Select Menu, which allows the user to select which **Amplitude Correction** to save.

Amplitude Corrections are fully discussed in the documentation of the Input/Output key, under the Corrections softkey.

See "[Correction Data File](#)" on page 2218

Key Path	Save
<b>Remote Command</b>	:MMEMory:STORe:CORRection 1 2 3 4 5 6, <filename>
<b>Example</b>	:MMEM:STOR:CORR 2 "myAmpcor.csv" saves Correction 2 to the file myAmpcor.csv on the current path. The default path is My Documents\amplitudeCorrections.
Notes	If the save is initiated via SCPI, and the file already exists, the file will be overwritten. Using the C: drive is strongly discouraged, since it runs the risk of being overwritten during an instrument software upgrade. Both single and double quotes are supported for any filename parameter over SCPI.
Dependencies	Corrections are not supported by all Measurements. If in a Mode in which some Measurements support it, this key will be grayed out in measurements that do not. The key will not show at all if no measurements in the Mode support it. This key will not appear unless you have the proper option installed in your instrument.
Readback	Selected Correction
<b>Backwards Compatibility SCPI</b>	:MMEMory:STORe:CORRection ANTenna   CABLe   OTHer   USER, <filename> For backwards compatibility, ANTenna maps to 1, CABLe maps to 2, OTHer maps to 3 and USER maps to 4
Initial S/W Revision	A.02.00

## Correction Data File

A Corrections Data File contains a copy of one of the analyzer correction tables. Corrections provide a way to adjust the trace display for predetermined gain curves (such as for cable loss).

Corrections files are text files in .csv (comma separated values) form, to make them importable into Excel or other spreadsheet programs. The format for Corrections files is as follows.

Line #	Type of field	Example	Notes
1	File type, must be "Amplitude Correction"	Amplitude Correction	May not be omitted
2	File Description (in quotes)	"Correction Factors for 11966E"	60 characters max; may be empty but may not be omitted. If exceeds 60 characters, error -233 Too much data reported
3	Comment (in quotes)	"Class B Radiated"	60 characters max; may be empty but

Line #	Type of field	Example	Notes
			may not be omitted. . If exceeds 60 characters, error -233 Too much data reported
4	Instrument Version, Model #	A.02.06,N9020A	May be empty but may not be omitted
5	Option List, File Format Version	K03 LFE EXM ,01	May be empty but may not be omitted
6	Freq Unit to be used for all frequency values in the file	Frequency Unit,MHz	assumed to be Hz if omitted
7	Antenna Unit	Antenna Unit,None	If omitted leaves the Antenna unit unchanged. The amplitude unit in the Antenna Unit field is a conversion factor that is used to adjust the Y Axis Units of the current mode, if the mode supports Antenna Units. For more details on antenna correction data, refer to the Input/Output,Corrections key description. Allowable values: dBuv/m, dBuA/m, dBG, dBpT, None
8	Freq Interpolation	Frequency Interpolation,Linear	if omitted leaves the Freq Interpolation unchanged. Allowable values: Linear, Logarithmic
9	Bias value in mA	Bias,0.00	If omitted leaves the Bias value unchanged (added as of A.08.50)
10	Bias State	Bias State,On	If omitted leaves the Bias State unchanged. Allowable values: On, Off (added as of A.08.50)
11	Overlap, two values, Freq1 and Freq2, separated by commas.	Overlap,33500,40000	Uses Freq Unit from line 6. Thus, in this example Freq1=33.5 GHz, Freq2= 40.0 GHz (see note below). If omitted leaves the overlap unchanged (added as of A.08.50)
12	DATA marker	DATA	Corrections data begins in the next line

Lines 2 through 5 can be empty but must appear in the file. Lines 6 through 11 are optional, the lines can be left out of the file altogether.

The Overlap row and the two Bias rows apply only to external mixing. Both are read-only, they are never written by the analyzer. The only way to insert or modify these rows is to edit the file with a text editor or a spreadsheet editor. These rows are intended for use by mixer manufacturers, as they allow the manufacturer to insert data about how the mixer corrections were generated and how they should be applied. The Bias rows allow you to specify whether to turn Bias on or off when the Correction is turned on and to specify a Bias value (turning off the Correction does not change the Bias, but turning it back on again sets it to the value specified in the file). The Overlap row allows you to specify an overlap region in which

two different corrections may be applied. It is expected that in the corrections data itself, there will be TWO corrections values exactly at Max Freq, otherwise Overlap is ignored. The way the overlap is processed is as follows: if at any given time the current analyzer Start Freq is greater than Freq 1 and lower than Freq 2, and the current Stop Freq is greater than Freq 2, extend the first correction point at or above Freq 2 down to Freq 1, rather than using the correction data between Freq1 and Freq2.

The Antenna Unit row can only be used in Correction register 1, because there can only be one setting for Antenna Unit at any given time. If a Correction whose Antenna Unit is set to anything but None is loaded into any Correction register but 1, an error is generated (Mass storage error; Can only load an Antenna Unit into Correction 1). When a correction file is saved from any Correction register but 1, Antenna Unit is always written as None.

Similarly, the Bias rows can only be used in Correction register 1, because there can only be one setting for Bias at any given time. If a Correction file with a Bias or Bias State row is loaded into any Correction register but 1, an error is generated: Mass storage error; Can only load Bias Settings into Correction 1

The data follows the DATA row, as comma separated X, Y pairs; one pair per line.

For example, suppose you have an Antenna to correct for on an N9020A version A.02.06 and the correction data is:

- 0 dB at 200 MHz
- 17 dB at 210 MHz
- 14.8 dB at 225 MHz

Then the file will look like:

- Amplitude Correction
- "Correction Factors for 11966E"
- "Class B Radiated"
- A.02.06,N9020A
- P13 EA3 UK6,01
- Frequency Unit,MHz
- Antenna Unit,dBuV/m
- Frequency Interpolation,Linear
- DATA
- 200.000000,0.00
- 210.000000,17.00
- 225.000000,14.80

The choices for the 1 of N fields in the metadata are as follows:

- Frequency Unit: Hz, kHz, MHz, GHz
- Antenna Unit: dBuV/m, dBuA/m, dBG, dBpT, None

- Frequency Interpolation: Logarithmic, Linear

### Amplitude Correction

These keys let you choose which Correction to save. Once selected, the key returns back to the Export Data menu and the selected Correction number is annotated on the key.

The next step in the Save process is to select the Save As key in the Export Data menu.

Key Path	Save, Data, Amplitude Correction
Preset	Not part of a Preset, but is reset to Correction 1 by Restore Input/Output Defaults. Survives a shutdown.
Readback	1
Initial S/W Revision	A.02.00

### Chan Table

Exports the current channel table to a channel table file.

The exported channel table file can be edited to meet your requirements, and then imported by pressing Recall, Data, Channel Table, and then Open...

Note that while editing the channel plan file, you can't change the channel plan name, such as NTSC\_B.VHF, NTSC\_B.UHF, otherwise your modifications on the corresponding channel plan will not work. You can add, remove, or modify the channel numbers and center frequencies in each channel plan. The value of Start Channel and Channel Count may also need to be changed.

File Location and Extension

**File location:** "My Documents\Digital Video\data"

**File type:** text file

**File extension:** .txt

**Example:**

File Location: My Documents\Digital Video\data

File Name: ChannelPlan\_0001.txt

Key Path	Save, Data
Mode	DVB-T/H
<b>Remote Command</b>	MMEMory:STORe:CHTable <string>
<b>Example</b>	MMEM:STOR:CHT "ChannelPlan_0001.txt"
Initial S/W Revision	A.07.00

## Measurement Results

Different types of results are available for each particular measurement. The results that are available are documented under the individual measurements. These measurement results are the same as the results that are returned when using the MEASure:<measurement> command (usually for sub-opcode 1).

Key Path	Save, Data
Mode	DVB-T/H
Example	MMEM:STOR:RES "MyResultsFile.xml" This stores the measurement results data in the file MyResultsFile.xml in the default directory.
Initial S/W Revision	Prior to A.01.70

## Capture Buffer

Capture buffer functionality is available only in Mod Accuracy measurement. The captured data is raw data which is not processed.

Key Path	Save, Data
Mode	DVB-T/H
Example	MMEM:STOR:CAPT "MyCaptureData.bin" This stores the capture data in the file MyCaptureData.bin in the default directory.
Dependencies	Capture buffer functionality is only available for Mod Accuracy measurement. In other measurements, this key is grayed out.
Initial S/W Revision	Prior to A.01.70

## DVB-T2 Config

Exports the current DVB-T2 configuration to a file (single PLP or multiple PLPs). This key is available only in DVB-T2 Mod Accuracy measurement and will be grayed out in other measurements.

You can view the exported file for the format of the DVB-T2 configuration files and create your own DVB-T2 configuration file by modifying the exported file.

File Location and Extension

**File location:** "My Documents\DVB\data\EVMT2\data"

**File type:** text file

**File extension:** .csv

**Example:**

File Location: My Documents\DVB\data\EVMT2\data

File Name: DVBT2Config\_0001.csv

Key Path	Save, Data
----------	------------

Mode	DVB-T/H
<b>Remote Command</b>	MMEemory:STORe:T2Config <string>
<b>Example</b>	MMEM:STOR:T2C "DVBT2Config_0001.csv"
Dependencies	This key is grayed out in all the other measurements except DVB-T2 Mod Accuracy measurement.
Initial S/W Revision	A.07.00

## Save As . . .

When you press "Save As", the analyzer brings up a Windows dialog and a menu entitled "**Save As.**" This menu allows you to navigate to the various fields in the Windows dialog without using a keyboard or mouse. The Tab and Arrow keys can also be used for dialog navigation.

See "[To File . . .](#)" on page 2213 in Save, State for a full description of this dialog and menu.

The default path for saving files is:

For all of the Trace Data Files:

My Documents\<<mode name>\data\traces

For all of the Limit Data Files:

My Documents\<<mode name>\data\limits

For all of the Measurement Results Data Files:

My Documents\<<mode name>\data\<<measurement name>\results

For all of the Capture Buffer Data Files:

My Documents\<<mode name>\data\captureBuffer

Key Path	Save, Data
Mode	All
Notes	The key location is mode-dependent and will vary. Brings up the Save As dialog for saving a <mode specific> Save Type. The save is performed immediately and does not wait until the measurement is complete.
Initial S/W Revision	Prior to A.02.00

## Screen Image

Pressing Screen Image accesses a menu of functions that enable you to specify a format and location for the saved screen image. It brings up a menu that allows you to specify the color scheme of the Screen Image (Themes) or navigate to the Save As dialog to perform the actual save.

Screen Image files contain an exact representation of the analyzer display. They cannot be loaded back onto the analyzer, but they can be loaded into your PC for use in many popular applications.

16 Waveform Measurement  
Save

The image to be saved is actually captured when the Save front panel key is pressed, and kept in temporary storage to be used if you ask for a Screen Image save. When the Screen Image key is pressed, a "thumbnail" of the captured image is displayed, as shown below:

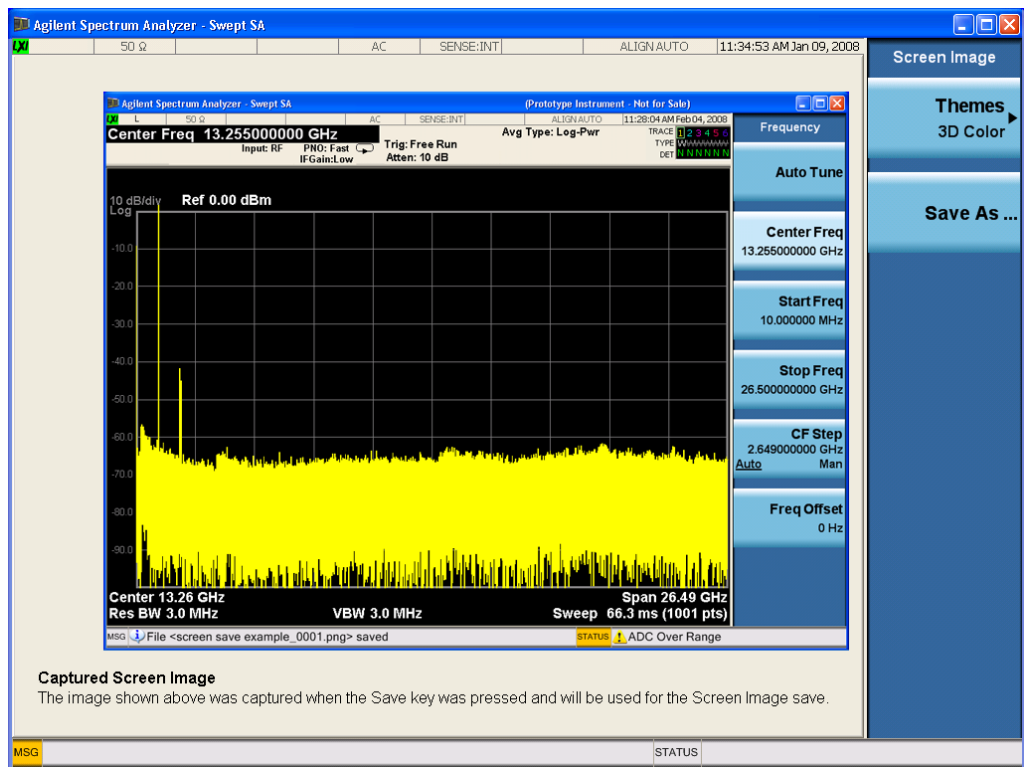

When you continue on into the Save As menu and complete the Screen Image save, the image depicted in the thumbnail is the one that gets saved, showing the menus that were on the screen before going into the Save menus. The save is performed immediately and does not wait until the measurement is complete.

After you have completed the save, the Quick Save front-panel key lets you quickly repeat the last save performed, using an auto-named file, with the current screen data.

**NOTE**

For versions previous to A.01.55, if you initiate a screen image save by navigating through the Save menus, the image that is saved will contain the Save menu softkeys, not the menus and the active function that were on the screen when you first pressed the Save front panel key.

Key Path	Save
Mode	All
Remote Command	:MMEMory:STORe:SCReen <filename>
Example	:MMEM:STOR:SCR "myScreen.png" This stores the current screen image in the file MyScreenFile.png in the default directory.
Initial S/W Revision	Prior to A.02.00



## Themes

Accesses a menu of functions that enable you to choose the theme to be used when saving the screen image.

The **Themes** option is the same as the **Themes** option under the **Display** and **Page Setup** dialogs. It allows you to choose between themes to be used when saving the screen image.

<b>Key Path</b>	Save, Screen Image
<b>Remote Command</b>	:MMEMory:STORe:SCReen:THEMe TDColor   TDMonochrome   FCOLor   FMONochrome  :MMEMory:STORe:SCReen:THEMe?
<b>Example</b>	:MMEM:STOR:SCR:THEM TDM
<b>Preset</b>	3D Color; Is not part of Preset, but is reset by Restore Misc Defaults or Restore System Defaults All and survives subsequent running of the modes.
<b>Readback</b>	3D Color   3D Mono   Flat Color   Flat Mono
<b>Backwards Compatibility Notes</b>	In ESA and PSA we offer the choice of "Reverse Bitmap" or "Reverse Metafile" when saving screen images. This is much like the "Flat Color" theme available in X-Series. Also, if you selected Reverse Bitmap AND a black & white screen image, that would be much like "Flat Monochrome". In other words, each of the X-Series themes has a similar screen image type in ESA/PSA. But they are not identical.
<b>Initial S/W Revision</b>	Prior to A.02.00

### 3D Color

Selects a standard color theme with each object filled, shaded and colored as designed.

<b>Key Path</b>	Save, Screen Image, Themes
<b>Example</b>	MMEM:STOR:SCR:THEM TDC
<b>Readback</b>	3D Color
<b>Initial S/W Revision</b>	Prior to A.02.00

### 3D Monochrome

Selects a format that is like 3D color but shades of gray are used instead of colors.

<b>Key Path</b>	Save, Screen Image, Themes
<b>Example</b>	MMEM:STOR:SCR:THEM TDM
<b>Readback</b>	3D Mono
<b>Initial S/W Revision</b>	Prior to A.02.00

### Flat Color

Selects a format that is best when the screen is to be printed on an ink printer.

Key Path	Save, Screen Image, Themes
<b>Example</b>	MMEM:STOR:SCR:THEM FCOL
Readback	Flat Color
Initial S/W Revision	Prior to A.02.00

### Flat Monochrome

Selects a format that is like Flat Color. But only black is used (no colors, not even gray), and no fill.

Key Path	Save, Screen Image, Themes
<b>Example</b>	MMEM:STOR:SCR:THEM FMON
Readback	Flat Mono
Initial S/W Revision	Prior to A.02.00

### Save As...

When you press “Save As”, the analyzer brings up a Windows dialog and a menu entitled “**Save As.**” This menu allows you to navigate to the various fields in the Windows dialog without using a keyboard or mouse. The Tab and Arrow keys can also be used for dialog navigation.

See "[To File . . .](#)" on page 2213 in Save, State for a full description of this dialog and menu.

The default path for Screen Images is

My Documents\`<mode name>`\screen.

where `<mode name>` is the parameter used to select the mode with the INST:SEL command (for example, SA for the Spectrum Analyzer).

Key Path	Save, Screen Image
Notes	Brings up Save As dialog for saving a Screen Image Save Type
Initial S/W Revision	Prior to A.02.00

### Mass Storage Catalog (Remote Command Only)

Key path	SCPI Only
<b>Remote Command</b>	:MMEMory:CATalog? [ <code>&lt;directory_name&gt;</code> ]
Notes	The string must be a valid logical path. Queries disk usage information (drive capacity, free space available) and obtains a list of files and directories in a specified directory in the following format: <code>&lt;numeric_value&gt;,&lt;numeric_value&gt;,{&lt;file_entry&gt;}</code> It returns two numeric parameters and as many strings as there are files and directories. The first

---

parameter indicates the total amount of storage currently used in bytes. The second parameter indicates the total amount of storage available, also in bytes. The <file\_entry> is a string. Each <file\_entry> indicates the name, type, and size of one file in the directory list:

<file\_name>,<file\_type>,<file\_size>

As the windows file system has an extension that indicates file type, <file\_type> is always empty. <file\_size> provides the size of the file in bytes. For directories, <file\_entry> is surrounded by square brackets and both <file\_type> and <file\_size> are empty

---

Initial S/W Revision      Prior to A.02.00

---

## Mass Storage Change Directory (Remote Command Only)

---

Key path                      SCPI Only

**Remote Command**        :MMEMory:CDIRectory [<directory\_name>]  
                                  :MMEMory:CDIRectory?

**Notes**                      The string must be a valid logical path.  
  
Changes the default directory for a mass memory file system. The <directory\_name> parameter is a string. If no parameter is specified, the directory is set to the \*RST value.  
At \*RST, this value is set to the default user data storage area, that is defined as System.Environment.SpecialFolder.Personal.  
Query returns full path of the default directory.

---

Initial S/W Revision      Prior to A.02.00

---

## Mass Storage Copy (Remote Command Only)

---

Key path                      SCPI Only

**Remote Command**        :MMEMory:COPY <string>,<string> [,<string>,<string>]

**Notes**                      The string must be a valid logical path.  
  
Copies an existing file to a new file or an existing directory to a new directory.  
Two forms of parameters are allowed. The first form has two parameters. In this form, the first parameter specifies the source, and the second parameter specifies the destination.  
The second form has four parameters. In this form, the first and third parameters specify the source. The second and fourth parameters specify the directories. The first pair of parameters specifies the source. The second pair specifies the destination. An error is generated if the source doesn't exist or the destination file already exists.  
  
This command will generate an "access denied" error if the destination is a restricted folder (e.g., C:\Windows) and the current user does not have Power User or Administrator privileges.

---

## Mass Storage Device Copy (Remote Command Only)

This command transfers data to/from a file and a peripheral device.

Key path	SCPI Only
<b>Remote Command</b>	:MMEMory:COpy:DEvice <source_string>,<dest_string>
Notes	The strings must be a valid logical path or a valid device keyword. If the dest_string is a device keyword, the data is copied from the source file to the device. If the source_string is a device keyword, the data is copied to the source file from the device.  Valid device keywords are: SNS (smart noise source)  An error is generated if the file or device is not found.

### Mass Storage Delete (Remote Command Only)

Key path	SCPI Only
<b>Remote Command</b>	:MMEMory:DELeTe <file_name>[,<directory_name>]
Notes	The string must be a valid logical path.  Removes a file from the specified directory. The <file_name> parameter specifies the file name to be removed. This command will generate an "access denied" error if the file is in a restricted folder (e.g., C:\Windows) and the current user does not have Power User or Administrator privileges.
Initial S/W Revision	Prior to A.02.00

### Mass Storage Data (Remote Command Only)

Creates a file containing the specified data OR queries the data from an existing file.

Key path	SCPI Only
<b>Remote Command</b>	:MMEMory:DATA <file_name>, <data>  :MMEMory:DATA? <file_name>
Notes	The string must be a valid logical path.  The command form is MMEMory:DATA <file_name>,<data>. It loads <data> into the file <file_name>. <data> is in 488.2 block format. <file_name> is string data.  The query form is MMEMory:DATA? <file_name> with the response being the associated <data> in block format.
Initial S/W Revision	Prior to A.02.00

### Mass Storage Make Directory (Remote Command Only)

Key path	SCPI Only
<b>Remote Command</b>	:MMEMory:MDIRectory <directory_name>
Notes	The string must be a valid logical path.  Creates a new directory. The <directory_name> parameter specifies the name to be created.

	This command will generate an “access denied” error if the new directory would be in a restricted folder (e.g., C:\Windows) and the current user does not have Power User or Administrator privileges.
Initial S/W Revision	Prior to A.02.00

### Mass Storage Move (Remote Command Only)

Key path	SCPI Only
<b>Remote Command</b>	:MMEMory:MOVE <string>,<string>[,<string>,<string>]
Notes	<p>The string must be a valid logical path.</p> <p>Moves an existing file to a new file or an existing directory to a new directory.</p> <p>Two forms of parameters are allowed. The first form has two parameters. In this form, the first parameter specifies the source, and the second parameter specifies the destination.</p> <p>The second form has four parameters. In this form, the first and third parameters specify the source. The second and fourth parameters specify the directories. The first pair of parameters specifies the source. The second pair specifies the destination. An error is generated if the source doesn't exist or the destination file already exists.</p> <p>This command will generate an “access denied” error if the destination is a restricted folder (e.g., C:\Windows) and the current user does not have Power User or Administrator privileges.</p>
Initial S/W Revision	Prior to A.02.00

### Mass Storage Remove Directory (Remote Command Only)

Key path	SCPI Only
<b>Remote Command</b>	:MMEMory:RDIRECTory <directory_name>
Notes	<p>The string must be a valid logical path.</p> <p>Removes a directory. The &lt;directory_name&gt; parameter specifies the directory name to be removed. All files and directories under the specified directory shall also be removed.</p> <p>This command will generate an “access denied” error if the folder is a restricted folder (e.g., C:\Windows) or is in a restricted folder and the current user does not have Power User or Administrator privileges.</p>
Initial S/W Revision	Prior to A.02.00

## Single (Single Measurement/Sweep)

Sets the analyzer for Single measurement operation. The single/continuous state is Meas Global, so the setting will affect all the measurements. If you are Paused, pressing Single does a Resume.

See ["More Information" on page 2230](#)

Key Path	Front-panel key
Example	:INIT:CONT OFF
Notes	See Cont key description.
Backwards Compatibility Notes	<p>For Spectrum Analysis mode in ESA and PSA, the Single hardkey and the INITiate:IMM switched from continuous measurement to single measurement and restarted sweeps and averages (displayed average count reset to 1), but did not restart Max Hold and Min Hold. In the X-Series, the Single hardkey and the INITiate:IMM command initiate a sweep/ measurement/ average sequence/hold sequence including MaxHold and MinHold.</p> <p>For Spectrum Analysis mode in ESA and PSA, the Single hardkey restarted the sweep regardless of whether or not you were in an active sweep or sweep sequence. In the X-Series, Restart does this but Single only restarts the sweep or sweep sequence if you are in the idle state.</p> <p>INIT[:IMM] in ESA &amp; PSA Spectrum Analysis Mode does an implied ABORT. In some other PSA Modes, INIT[:IMM] is ignored if not in the idle state. . The X-Series follows the ESA/PSA SA Mode model, which may cause some Modes to have compatibility problems.</p>
Initial S/W Revision	Prior to A.02.00

### More Information

See ["Restart" on page 2210](#) for details on the INIT:IMMEDIATE (Restart) function.

If you are already in single sweep, the INIT:CONT OFF command has no effect.

If you are already in Single Sweep, then pressing the Single key in the middle of a sweep does not restart the sweep or sequence. Similarly, pressing the Single key does not restart the sweep or sequence if the sweep is not in the idle state (for example, if you are taking a very slow sweep, or the analyzer is waiting for a trigger). Instead, it results in a message. "Already in Single, press Restart to initiate a new sweep or sequence". Even though pressing the Single key in the middle of a sweep does not restart the sweep, sending INIT:IMMEDIATE does reset it.

To take one more sweep without resetting the average count, increment the average count by 1, by pressing the step up key while **Average/Hold Number** is the active function, or sending the remote command CALC:AVER:TCON UP.

## Source

There is no Source control functionality for this measurement. When this key is pressed, the screen either displays a blank menu, or the previously-selected menu remains unchanged.

---

Key Path	Front-panel key
----------	-----------------

---

## Span X Scale

Accesses a menu of functions that enable you to set the horizontal scale parameters.

Key Path	Front-panel key
Initial S/W Revision	Prior to A.02.00

### Ref Value

Sets the reference value for time on the horizontal axis. When Auto Scaling is set to On, the displayed plots use a Scale/Div value determined by the analyzer, based on the measurement result.

Key Path	SPAN X Scale
Mode	BASIC, PNOISE, WCDMA, C2K, GSM, WIMAXOFDMA, TDSCDMA, 1XEVD0, DVB, DTMB, ISDBT, CMMB, LTE, LTETDD, DCATV, WLAN, MSR,LTEATDD, LTEAFDD
Remote Command	:DISPlay:WAVeform:VIEW[1] 2:WINDow[1]:TRACe:X[:SCALE]:RLEVel <time> :DISPlay:WAVeform:VIEW[1] 2:WINDow[1]:TRACe:X[:SCALE]:RLEVel?
Example	DISP:WAV:VIEW:WIND:TRAC:X:RLEV 10 ms DISP:WAV:VIEW:WIND:TRAC:X:RLEV?
Notes	You must be in a mode that includes the Waveform measurement to use this command. Use INSTRument:SElect to set the mode.
Couplings	If Auto Scaling is set to On, this value is automatically determined by the measurement result. When you set this value manually, Auto Scaling automatically changes to Off.
Preset	0.00 s
State Saved	Saved in instrument state.
Min	-1.000 s
Max	10.00 s
Initial S/W Revision	Prior to A.02.00
Modified at S/W Revision	A.03.00

### Scale/Div

Sets the horizontal scale by changing a time value per division.

Key Path	SPAN X Scale
Mode	BASIC, PNOISE, WCDMA, C2K, GSM, WIMAXOFDMA, TDSCDMA, 1XEVD0, DVB, DTMB, ISDBT, CMMB, LTE, LTETDD, DCATV, WLAN, MSR,LTEATDD, LTEAFDD
Remote Command	:DISPlay:WAVeform:VIEW[1] 2:WINDow[1]:TRACe:X[:SCALE]:PDIVision <time> :DISPlay:WAVeform:VIEW[1] 2:WINDow[1]:TRACe:X[:SCALE]:PDIVision?
Example	DISP:WAV:VIEW:WIND:TRAC:X:PDIV 500 us DISP:WAV:VIEW:WIND:TRAC:X:PDIV?



Notes	You must be in a mode that includes the Waveform measurement to use this command. Use INSTRUMENT:SElect to set the mode.
Couplings	If Auto Scaling is set to On, this value is automatically determined by the measurement result. When you set this value manually, Auto Scaling automatically changes to Off.
Preset	All except the following list: 200.0 us LTEAFDD, LTEATDD: 1.000 ms LTETDD: 1.000 ms
State Saved	Saved in instrument state.
Min	1.000 ns
Max	320 s
Initial S/W Revision	Prior to A.02.00
Modified at S/W Revision	A.03.00, A.14.00

## Ref Position

Sets the reference position for the X axis to Left, Center or Right.

Key Path	SPAN X Scale
Mode	BASIC, PNOISE, WCDMA, C2K, GSM, WIMAXOFDMA, TDSCDMA, 1XEVD0, DVB, DTMB, ISDBT, CMMB, LTE, LTETDD, DCATV, WLAN, MSR,LTEATDD, LTEAFDD
Remote Command	:DISPlay:WAVeform:VIEW[1] 2:WINDow[1]:TRACe:X[:SCALe]:RPOSition LEFT   CENTER   RIGHT :DISPlay:WAVeform:VIEW[1] 2:WINDow[1]:TRACe:X[:SCALe]:RPOSition?
Example	DISP:WAV:VIEW:WIND:TRAC:X:RPOS LEFT DISP:WAV:VIEW:WIND:TRAC:X:RPOS?
Notes	Allows you to set the reference position to Left, Ctr (center) or Right. You must be in a mode that includes the Waveform measurement to use this command. Use INSTRUMENT:SElect to set the mode.
Preset	LEFT
State Saved	Saved in instrument state.
Range	Left Ctr Right
Initial S/W Revision	Prior to A.02.00
Modified at S/W Revision	A.03.00

## Auto Scaling

Toggles the scale coupling function between On and Off.

<b>Key Path</b>	SPAN X Scale
<b>Mode</b>	BASIC, PNOISE, WCDMA, C2K, GSM, WIMAXOFDMA, TDSCDMA, 1XEVD0, DVB, DTMB, ISDBT, CM MB, LTE, LTETDD, DCATV, WLAN, MSR,LTEATDD, LTEAFDD
<b>Remote Command</b>	:DISPlay:WAVeform:VIEW[1] 2:WINDow[1]:TRACe:X[:SCALE]:COUPle 0   1   OFF   ON  :DISPlay:WAVeform:VIEW[1] 2:WINDow[1]:TRACe:X[:SCALE]:COUPle?
<b>Example</b>	DISP:WAV:VIEW:WIND:TRAC:X:COUP ON DISP:WAV:VIEW:WIND:TRAC:X:COUP?
<b>Notes</b>	You must be in a mode that includes the Waveform measurement to use this command. Use INSTRument:SElect to set the mode.
<b>Couplings</b>	When Auto Scaling is On and the Restart front-panel key is pressed, this function automatically determines the scale per division and reference values based on the measurement results. When you set a value to either Scale/Div or Ref Value manually, Auto Scaling automatically changes to Off.
<b>Preset</b>	1
<b>State Saved</b>	Saved in instrument state.
<b>Range</b>	On Off
<b>Initial S/W Revision</b>	Prior to A.02.00
<b>Modified at S/W Revision</b>	A.03.00

## Sweep/Control

Accesses a menu that enables you to configure the Sweep and Control functions of the analyzer, such as Sweep Time and Gating.

Key Path	Front-panel key
Initial S/W Revision	Prior to A.02.00

### Pause/Resume

Pauses a measurement after the current data acquisition is complete.

When Paused, the label on the key changes to Resume. Pressing Resume un-pauses the measurement. When you are Paused, pressing Restart, Single or Cont does a Resume.

Key Path	Sweep/Control
<b>Remote Command</b>	:INITiate:PAUSE
Dependencies	Grayed out in Measurements that do not support Pausing. Blanked in Modes that do not support Pausing.
Initial S/W Revision	Prior to A.02.00

Key Path	Sweep/Control
<b>Remote Command</b>	:INITiate:RESume
Dependencies	Grayed out in Measurements that do not support Pausing. Blanked in Modes that do not support Pausing.
Initial S/W Revision	Prior to A.02.00

### Abort (Remote Command Only)

This command is used to stop the current measurement. It aborts the current measurement as quickly as possible, resets the sweep and trigger systems, and puts the measurement into an "idle" state. If the analyzer is in the process of aligning when ABORT is sent, the alignment finishes before the abort function is performed. So ABORT does not abort an alignment.

If the analyzer is set for Continuous measurement, it sets up the measurement and initiates a new data measurement sequence with a new data acquisition (sweep) taken once the trigger condition is met.

If the analyzer is set for Single measurement, it remains in the "idle" state until an :INIT:IMM command is received.

<b>Remote Command</b>	:ABORt
<b>Example</b>	:ABOR

---

Notes	<p>If :INITiate:CONTInuous is ON, then a new continuous measurement will start immediately, with sweep (data acquisition) occurring once the trigger condition has been met.</p> <p>If :INITiate:CONTInuous is OFF, then :INITiate:IMMEDIATE is used to start a single measurement; with sweep (data acquisition) occurring once the trigger condition has been met.</p>
Dependencies	<p>For continuous measurement, ABORt is equivalent to the Restart key.</p> <p>Not all measurements support the abort command.</p>
Status Bits/OPC dependencies	<p>The STATus:OPERation register bits 0 through 8 are cleared.</p> <p>The STATus:QUEStionable register bit 9 (INTegrity sum) is cleared.</p> <p>Since all the bits that feed into OPC are cleared by the ABORt, the ABORt will cause the *OPC query to return true.</p>
Initial S/W Revision	Prior to A.02.00

---

## System

See "System" on page 342

## Trace/Detector

There is no Trace/Detector functionality supported in the Waveform measurement. The front-panel key displays a blank menu when pressed.

---

Key Path	Front-panel key
Initial S/W Revision	Prior to A.02.00

---

## Trigger

See ["Trigger" on page 412](#)

### Free Run

See ["Free Run " on page 419](#)

### Video

See ["Video \(IF Envelope\) " on page 420](#)

### Trigger Level

See ["Trigger Level " on page 420](#)

### Trig Slope

See ["Trig Slope " on page 421](#)

### Trig Delay

See ["Trig Delay " on page 422](#)

### Line

See ["Line " on page 2047](#)

### Trig Slope

See ["Trig Slope " on page 2047](#)

### Trig Delay

See ["Trig Delay " on page 424](#)

### External 1

See ["External 1 " on page 2059](#)

### Trigger Level

See ["Trigger Level " on page 2059](#)

### Trig Slope

See ["Trig Slope " on page 2060](#)

### Trig Delay

See ["Trig Delay " on page 427](#)

### External 2

See ["External 2 " on page 2061](#)

### **Trigger Level**

See ["Trigger Level "](#) on page 2061

### **Trig Slope**

See ["Trig Slope "](#) on page 2062

### **Trig Delay**

See ["Trig Delay "](#) on page 429

### **RF Burst**

See ["RF Burst "](#) on page 2062

### **Absolute Trigger**

See ["Absolute Trigger Level"](#) on page 2063

### **Relative Trigger**

See ["Relative Trigger Level"](#) on page 2052

### **Trig Slope**

See ["Trigger Slope "](#) on page 2064

### **Trig Delay**

See ["Trig Delay "](#) on page 433

### **Periodic Timer**

See ["Periodic Timer \(Frame Trigger\) "](#) on page 2054

### **Period**

See ["Period "](#) on page 2055

### **Offset**

See ["Offset "](#) on page 2056

### **Offset Adjust (Remote Command Only)**

See ["Offset Adjust \(Remote Command Only\)"](#) on page 2057

### **Reset Offset Display**

See ["Reset Offset Display "](#) on page 2058

### **Sync Source**

See ["Sync Source "](#) on page 2058



## Off

See ["Off "](#) on page 2059

## External 1

See ["External 1 "](#) on page 2059

## Trigger Level

See ["Trigger Level "](#) on page 2059

## Trig Slope

See ["Trig Slope "](#) on page 2060

## External 2

See ["External 2 "](#) on page 2061

## Trigger Level

See ["Trigger Level "](#) on page 2061

## Trig Slope

See ["Trig Slope "](#) on page 2062

## RF Burst

See ["RF Burst "](#) on page 2062

## Absolute Trigger

See ["Absolute Trigger Level"](#) on page 2063

## Trig Slope

See ["Trigger Slope "](#) on page 2064

## Trig Delay

See ["Trig Delay"](#) on page 443

## Auto/Holdoff

See ["Auto/Holdoff "](#) on page 444

## Auto Trig

See ["Auto Trig "](#) on page 444

## Trig Holdoff

See ["Trig Holdoff "](#) on page 445

## Baseband I/Q

See [\\_\\_](#) on page X

### I/Q Mag

See \_\_\_ on page X

### Trigger Level

See \_\_\_ on page X

### Trig Slope

See \_\_\_ on page X

### Trig Delay

See \_\_\_ on page X

### I

See \_\_\_ on page X

### Trigger Level

See \_\_\_ on page X

### Trig Slope

See \_\_\_ on page X

### Trig Delay

See \_\_\_ on page X

### Q

See \_\_\_ on page X

### Trigger Level

See \_\_\_ on page X

### Trig Slope

See \_\_\_ on page X

### Trig Delay

See \_\_\_ on page X

### Input I

See \_\_\_ on page X

### Trigger Level

See \_\_\_ on page X

**Trig Slope**

See \_\_\_ on page X

**Trig Delay**

See \_\_\_ on page X

**Input Q**

See \_\_\_ on page X

**Trigger Level**

See \_\_\_ on page X

**Trig Slope**

See \_\_\_ on page X

**Trig Delay**

See \_\_\_ on page X

**Aux Channel Center Freq**

See \_\_\_ on page X

**Trigger Level**

See \_\_\_ on page X

**Trig Slope**

See \_\_\_ on page X

**Trig Delay**

See \_\_\_ on page X

**Trigger Center Freq**

See \_\_\_ on page X

**Trigger BW**

See \_\_\_ on page X

## User Preset

Accesses a menu that gives you the following three choices:

- User Preset – recalls a state previously saved using the Save User Preset function.
- User Preset All Modes – presets all of the modes in the analyzer
- Save User Preset– saves the current state for the current mode

Key Path	Front-panel key
Backwards Compatibility Notes	<p>User Preset is actually loading a state, and in legacy analyzers, it was possible to load a state without affecting the trace data, limit lines or correction data. Similarly it was possible to do a User Preset without affecting the trace data, limit lines or correction data.</p> <p>In the X-Series, “state” always includes all of this data; so whenever state is loaded, or User Preset is executed, all of the traces, limit lines and corrections are affected. Although this differs from previous behavior, it is desirable behavior, and should not cause adverse issues for users.</p> <p>On ESA and PSA, User Preset affected the entire instrument’s state. In the X-Series, User Preset only recalls the state for the active mode. There is a User Preset file for each mode. User Preset can never cause a mode switch as it can in legacy analyzers. If you want to recall all modes to their user preset file state, you will need to do a User Preset after mode switching into each mode.</p> <p>User Preset recalls mode state which can now include data like traces; whereas on ESA and PSA, User Preset did not affect data.</p>
Initial S/W Revision	Prior to A.02.00

## User Preset

User Preset sets the state of the currently active mode back to the state that was previously saved for this mode using the Save User Preset menu key or the SCPI command, SYST:PRES:USER:SAV. It not only recalls the Mode Preset settings, but it also recalls all of the mode persistent settings, and the Input/Output system setting that existed at the time Save User Preset was executed.

If a Save User Preset has not been done at any time, User Preset recalls the default user preset file for the currently active mode. The default user preset files are created if, at power-on, a mode detects there is no user preset file. There will never be a scenario when there is no user preset file to restore. For each mode, the default user preset state is the same state that would be saved if a Save User Preset is performed in each mode right after doing a Restore Mode Default and after a Restore Input/Output Defaults.

The User Preset function does the following:

- Aborts the currently running measurement.
- Sets the mode State to the values defined by Save User Preset.
- Makes the saved measurement for the currently running mode the active measurement.
- Brings up the saved menu for the power-on mode.
- Clears the input and output buffers.
- Sets the Status Byte to 0.

Key Path	User Preset
<b>Remote Command</b>	:SYSTem:PRESet:USER
<b>Example</b>	:SYST:PRES:USER:SAVE:SYST:PRES:USER
Notes	:SYST:PRES:USER:SAVE is used to save the current state as the user preset state. Clears all pending OPC bits. The Status Byte is set to 0. Pressing the User Preset front-panel key while already in the User Preset menu will cause the User Preset to get executed
Couplings	A user preset will cause the currently running measurement to be aborted and cause the saved measurement to be active. Recalling a User Preset file has the same issues that recalling a Save State file has. Some settings may need to be limited and therefore re-coupled, since the capabilities of the mode may have changes when the User Preset file was last saved.
Initial S/W Revision	Prior to A.02.00

## User Preset All Modes

Recalls all of the User Preset files for each mode, switches to the power-on mode, and activates the saved measurement from the power-on mode User Preset file.

**NOTE**

When the instrument is secured, all of the user preset files are converted back to their default user preset files.

The User Preset function does the following:

- Aborts the currently running measurement.
- Switches the Mode to the power-on mode.
- Restores the User Preset files for each mode.
- Makes the saved measurement for the power-on mode the active measurement.
- Brings up the saved menu for the power-on mode.
- Clears the input and output buffers.
- Sets the Status Byte to 0.

Key Path	User Preset
<b>Remote Command</b>	:SYSTem:PRESet:USER:ALL
<b>Example</b>	:SYST:PRES:USER:SAVE:SYST:PRES:USER:ALL
Notes	Clears all pending OPC bits. The Status Byte is set to 0. :SYST:PRES:USER:SAVE is used to save the current state as the user preset state.
Couplings	A user preset will cause the currently running measurement to be aborted, cause a mode switch to the power-on mode, and cause the saved measurement to be active in the power-on mode. Recalling a User Preset file has the same issues that recalling a Save State file has. Some settings may need to be limited and therefore re-coupled, since the capabilities of the mode may have changes when the User Preset file was last saved.
Initial S/W Revision	Prior to A.02.00

## Save User Preset

Saves the currently active mode and its State. You can recall this User Preset file by pressing the User Preset menu key or sending the SYST:PRES:USER remote command. This same state is also saved by the Save State function.

Key Path	User Preset
Remote Command	:SYSTem:PRESet:USER:SAVE
Example	:SYST:PRES:USER:SAVE
Notes	:SYST:PRES:SAVE creates the same file as if the user requested a *SAV or a MMEM:STOR:STAT, except User Preset Save does not allow the user to specify the filename or the location of the file.
Initial S/W Revision	Prior to A.02.00

## View/Display

Accesses a menu of functions that enable you to set up and control the display parameters for the current measurement.

This topic contains the following sections:

["View Selection by name \(Remote Command Only\)" on page 2247](#)

["View Selection by number \(Remote Command Only\)" on page 2247](#)

### View Selection by name (Remote Command Only)

Selects the results view.

Key Path	View/Display
Mode	BASIC, PNOISE, WCDMA, C2K, GSM, WIMAXOFDMA, TDSCDMA, 1XEVDO, DVB, DTMB, ISDBT, CMMB, LTE, LTETDD, DCATV, WLAN, MSR,LTEATDD, LTEAFDD
<b>Remote Command</b>	:DISPlay:WAVeform:VIEW[:SElect] RFENvelope IQ :DISPlay:WAVeform:VIEW[:SElect]?
<b>Example</b>	DISP:WAV:VIEW RFEN DISP:WAV:VIEW?
Notes	You must be in a mode that includes the Waveform measurement to use this command. Use INSTRument:SElect to set the mode.
Preset	RFENveloper
State Saved	Saved in instrument state.
Range	RF Envelope IQ Waveform
Initial S/W Revision	Prior to A.02.00
Modified at S/W Revision	A.03.00

### View Selection by number (Remote Command Only)

Displays the numeric values of the measurement results.

Mode	BASIC, PNOISE, WCDMA, C2K, GSM, WIMAXOFDMA, TDSCDMA, 1XEVDO, DVB, DTMB, ISDBT, CMMB, LTE, LTETDD, DCATV, WLAN, MSR,LTEATDD, LTEAFDD
<b>Remote Command</b>	:DISPlay:WAVeform:VIEW:NSElect <integer> :DISPlay:WAVeform:VIEW:NSElect?
<b>Example</b>	DISP:WAV:VIEW:NSEL 1 DISP:WAV:VIEW:NSEL?
Notes	You must be in a mode that includes the Waveform measurement to use this command. Use INSTRument:SElect to set the mode.
Preset	1
State Saved	Saved in instrument state.

Min	1
Max	2
Initial S/W Revision	Prior to A.02.00
Modified at S/W Revision	A.03.00

Key Path	Front-panel key
Initial S/W Revision	Prior to A.02.00

## Display

The Display menu is common to most measurements, and is used for configuring items on the display. Some Display menu settings apply to all the measurements in a mode, and some only to the current measurement. Those under the System Display Settings key apply to all measurements in all modes.

Key Path	Display
Key Path	View/Display
Initial S/W Revision	Prior to A.02.00

## Annotation

Turns on and off various parts of the display annotation. The annotation is divided up into four categories:

1. Meas Bar: This is the measurement bar at the top of the screen. It does not include the settings panel or the Active Function. Turning off the Meas Bar turns off the settings panel and the Active Function. When the Meas Bar is off, the graticule area expands to fill the area formerly occupied by the Meas Bar.
2. Screen Annotation: this is the annotation and annunciation around the graticule, including any annotation on lines (such as the display line, the threshold line, etc.) This does NOT include the marker number or the N dB result. When off, the graticule expands to fill the entire graticule area.
3. Trace annotation: these are the labels on the traces, showing their detector (or their math mode).
4. Active Function annotation: this is the active function display in the meas bar, and all of the active function values displayed on softkeys.

See the figure below. Each type of annotation can be turned on and off individually.



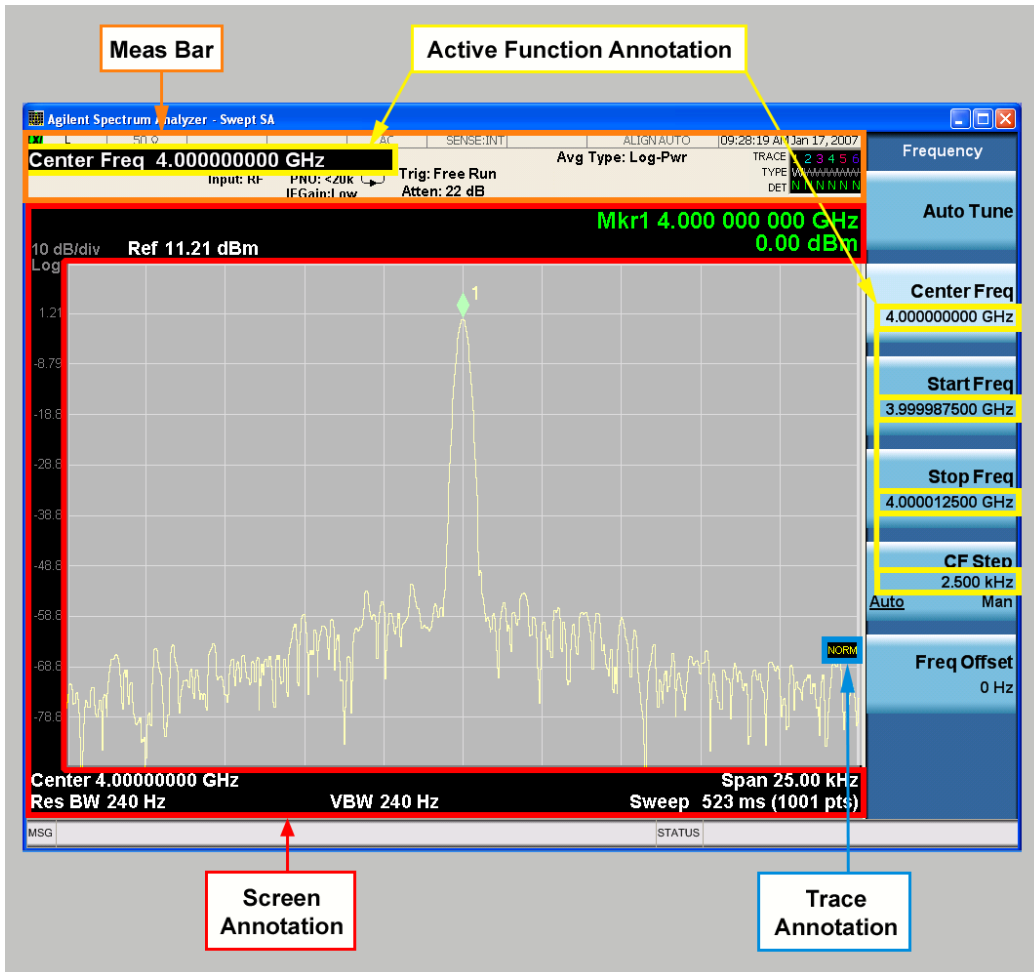

Key Path	View/Display, Display
Initial S/W Revision	Prior to A.02.00

### Meas Bar On/Off

This function turns the Measurement Bar on and off, including the settings panel. When off, the graticule area expands to fill the area formerly occupied by the Measurement Bar.

Key Path	View/Display, Display, Annotation
Remote Command	:DISPlay:ANNotation:MBAR[:STATE] OFF ON 0 1 :DISPlay:ANNotation:MBAR[:STATE]?
Example	DISP:ANN:MBAR OFF
Dependencies	Grayed out and forced to OFF when System Display Settings, Annotation is set to Off.
Preset	On This should remain Off through a Preset when System DisplaySettings, Annotation is set to Off.
State Saved	Saved in instrument state.
Initial S/W Revision	Prior to A.02.00

### Screen

This controls the display of the annunciation and annotation around the graticule, including any annotation on lines (such as the display line, the threshold line, etc.) and the y-axis annotation. This does NOT include marker annotation (or the N dB result). When off, the graticule expands to fill the entire graticule area, leaving only the 1.5% gap above the graticule as described in the Trace/Detector chapter.

<b>Key Path</b>	View/Display, Display, Annotation
<b>Remote Command</b>	:DISPlay:ANNotation:SCReen[:STATe] OFF ON 0 1 :DISPlay:ANNotation:SCReen[:STATe]?
<b>Example</b>	DISP:ANN:SCR OFF
<b>Dependencies</b>	Grayed-out and forced to OFF when System Display Settings, Annotation is set to Off.
<b>Preset</b>	On This should remain Off through a Preset when System DisplaySettings, Annotation is set to Off
<b>State Saved</b>	Saved in instrument state.
<b>Initial S/W Revision</b>	Prior to A.02.00

### Active Function Values On/Off

Turns on and off the active function display in the Meas Bar, and all of the active function values displayed on the softkeys.

Note that all of the softkeys that have active functions have these numeric values blanked when this function is on. This is a security feature..

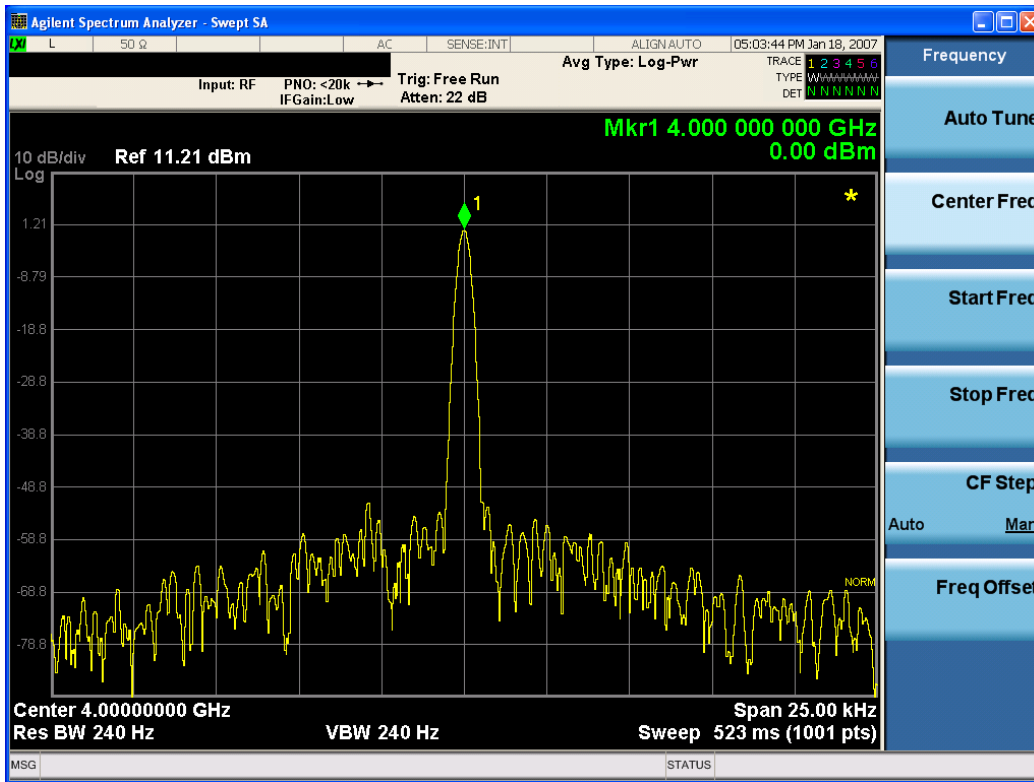

Key Path	View/Display, Display, Annotation
Remote Command	:DISPlay:ACTivefunc[:STATE] ON OFF 1 0 :DISPlay:ACTivefunc[:STATE]?
Example	DISP:ACT OFF
Dependencies	Grayed out and forced to OFF when System Display Settings, Annotation is set to Off.
Preset	On This should remain Off through a Preset when System DisplaySettings, Annotation is set to Off
State Saved	Saved in instrument state.
Initial S/W Revision	Prior to A.02.00

### Title

Displays menu keys that enable you to change or clear a title on your display.

Key Path	View/Display, Display
Initial S/W Revision	Prior to A.02.00

### Change Title

Writes a title into the "measurement name" field in the banner, for example, "Swept SA".

Press Change Title to enter a new title through the alpha editor. Press Enter or Return to complete the entry. Press ESC to cancel the entry and preserve your existing title.

The display title will replace the measurement name. It remains for this measurement until you press Change Title again, or you recall a state, or a Preset is performed. A title can also be cleared by pressing Title, Clear Title.

**NOTE**

Notice the inclusion of the <measurement> parameter in the command below. Because each measurement remembers the Display Title, the command must be qualified with the measurement name. For the Swept SA measurement this is not the case; no <measurement> parameter is used when changing the Display Title for the Swept SA measurement.

Key Path	View/Display, Display, Title
Mode	All
Remote Command	:DISPlay:<measurement>:ANNotation:TITLe:DATA <string> :DISPlay:<measurement>:ANNotation:TITLe:DATA?
Example	DISP:ANN:TITL:DATA "This Is My Title" This example is for the Swept SA measurement in the Spectrum Analyzer mode. The SANalyzer <measurement> name is not used. DISP:ACP:ANN:TITL:DATA "This Is My Title" This example is for Measurements other than Swept SA. Both set the title to: This Is My Title
Notes	Pressing this key cancels any active function. When a title is edited the previous title remains intact (it is not cleared) and the cursor goes at the end so that characters can be added or BKSP can be used to go back over previous characters.
Preset	No title (measurement name instead)
State Saved	Saved in instrument state.
Initial S/W Revision	Prior to A.02.00

**Clear Title**

Clears a title from the front-panel display. Once cleared, the title cannot be retrieved. After the title is cleared, the current Measurement Name replaces it in the title bar.

Key Path	View/Display, Display, Title
Example	The following commands clear the title and restore the measurement's original title: DISP:ANN:TITL:DATA "" This example is for the Swept SA measurement in the Spectrum Analyzer mode. The SANalyzer <measurement> name is not used. DISP:ACP:ANN:TITL:DATA "" This example is for ACP; in measurements other than Swept SA the measurement name is required.
Notes	Uses the :DISPlay:<measurement>:ANNotation:TITLe:DATA <string> command with an empty string (in the Swept SA, the <measurement> is omitted).
Preset	Performed on Preset.
Initial S/W Revision	Prior to A.02.00

## Graticule

Pressing Graticule turns the display graticule On or Off. It also turns the graticule y-axis annotation on and off.

Key Path	View/Display, Display
Remote Command	:DISPlay:WINDow[1]:TRACe:GRATicule:GRID[:STATe] OFF ON 0 1 :DISPlay:WINDow[1]:TRACe:GRATicule:GRID[:STATe]?
Example	DISP:WIND:TRAC:GRAT:GRID OFF
Notes	The graticule is the set of horizontal and vertical lines that make up the grid/divisions for the x-axis and y-axis.
Preset	On
State Saved	Saved in instrument state
Initial S/W Revision	Prior to A.02.00

## System Display Settings

These settings are "Mode Global" – they affect all modes and measurements and are reset only by Restore Misc Defaults or Restore System Defaults under System.

Key Path	View/Display, Display
Initial S/W Revision	Prior to A.02.00

## Annotation Local Settings

This is a Mode Global override of the meas local annotation settings. When it is All Off, it forces ScreenAnnotation, Meas Bar, Trace, and Active Function Values settings to be OFF for all measurements in all modes. This provides the security based "annotation off" function of previous analyzers; hence it uses the legacy SCPI command.

When it is All Off, the Screen, Meas Bar, Trace, and Active Function Values keys under the Display, Annotation menu are grayed out and forced to Off. When Local Settings is selected, you are able to set the local annotation settings on a measurement by measurement basis.

Key Path	View/Display, Display, System Display Settings
Remote Command	:DISPlay:WINDow[1]:ANNOtation[:ALL] OFF ON 0 1 :DISPlay:WINDow[1]:ANNOtation[:ALL]?
Example	:DISP:WIND:ANN OFF
Preset	On (Set by Restore Misc Defaults)
State Saved	Not saved in instrument state.
Backwards Compatibility Notes	The WINDow parameter and optional subopcode is included for backwards compatibility but ignored – all windows are equally affected.
Initial S/W Revision	Prior to A.02.00

## Themes

Accesses a menu of functions that enable you to choose the theme to be used when saving the screen image.

The **Themes** option is the same as the **Themes** option under the **Display** and **Page Setup** dialogs. It allows you to choose between themes to be used when saving the screen image.

<b>Key Path</b>	Save, Screen Image
<b>Remote Command</b>	:MMEMory:STORe:SCReen:THEMe TDColor   TDMonochrome   FCOLor   FMONochrome  :MMEMory:STORe:SCReen:THEMe?
<b>Example</b>	:MMEM:STOR:SCR:THEM TDM
<b>Preset</b>	3D Color; Is not part of Preset, but is reset by Restore Misc Defaults or Restore System Defaults All and survives subsequent running of the modes.
<b>Readback</b>	3D Color   3D Mono   Flat Color   Flat Mono
<b>Backwards Compatibility Notes</b>	In ESA and PSA we offer the choice of "Reverse Bitmap" or "Reverse Metafile" when saving screen images. This is much like the "Flat Color" theme available in X-Series. Also, if you selected Reverse Bitmap AND a black & white screen image, that would be much like "Flat Monochrome". In other words, each of the X-Series themes has a similar screen image type in ESA/PSA. But they are not identical.
<b>Initial S/W Revision</b>	Prior to A.02.00

### 3D Color

Selects a standard color theme with each object filled, shaded and colored as designed.

<b>Key Path</b>	Save, Screen Image, Themes
<b>Example</b>	MMEM:STOR:SCR:THEM TDC
<b>Readback</b>	3D Color
<b>Initial S/W Revision</b>	Prior to A.02.00

### 3D Monochrome

Selects a format that is like 3D color but shades of gray are used instead of colors.

<b>Key Path</b>	Save, Screen Image, Themes
<b>Example</b>	MMEM:STOR:SCR:THEM TDM
<b>Readback</b>	3D Mono
<b>Initial S/W Revision</b>	Prior to A.02.00

### Flat Color

Selects a format that is best when the screen is to be printed on an ink printer.

Key Path	Save, Screen Image, Themes
<b>Example</b>	MMEM:STOR:SCR:THEM FCOL
Readback	Flat Color
Initial S/W Revision	Prior to A.02.00

### Flat Monochrome

Selects a format that is like Flat Color. But only black is used (no colors, not even gray), and no fill.

Key Path	Save, Screen Image, Themes
<b>Example</b>	MMEM:STOR:SCR:THEM FMON
Readback	Flat Mono
Initial S/W Revision	Prior to A.02.00

### Backlight

Accesses the display backlight on/off keys. This setting may interact with settings under the Windows "Power" menu.

When the backlight is off, pressing ESC, TAB, SPACE, ENTER, UP, DOWN, LEFT, RIGHT, DEL, BKSP, CTRL, or ALT turns the backlight on without affecting the application. Pressing any other key will turn backlight on and could potentially perform the action as well.

Key Path	View/Display, Display, System Display Settings
<b>Remote Command</b>	:DISPlay:BACKlight ON OFF :DISPlay:BACKlight?
Preset	ON (Set by Restore Misc Defaults)
Initial S/W Revision	Prior to A.02.00

### Backlight Intensity

An active function used to set the backlight intensity. It goes from 0 to 100 where 100 is full on and 0 is off. This value is independent of the values set under the Backlight on/off key.

Key Path	View/Display, Display, System Display Settings
<b>Remote Command</b>	:DISPlay:BACKlight:INTensity <integer> :DISPlay:BACKlight:INTensity?
<b>Example</b>	DISP:BACK:INT 50

Preset	100 (Set by Restore Misc Defaults)
Min	0
Max	100
Initial S/W Revision	Prior to A.02.00

### RF Envelope

This view shows an example of the RF Envelope result for the waveform (time domain) measurements in the graph window. The measured values for the mean power and peak-to-mean power are shown in the text window.

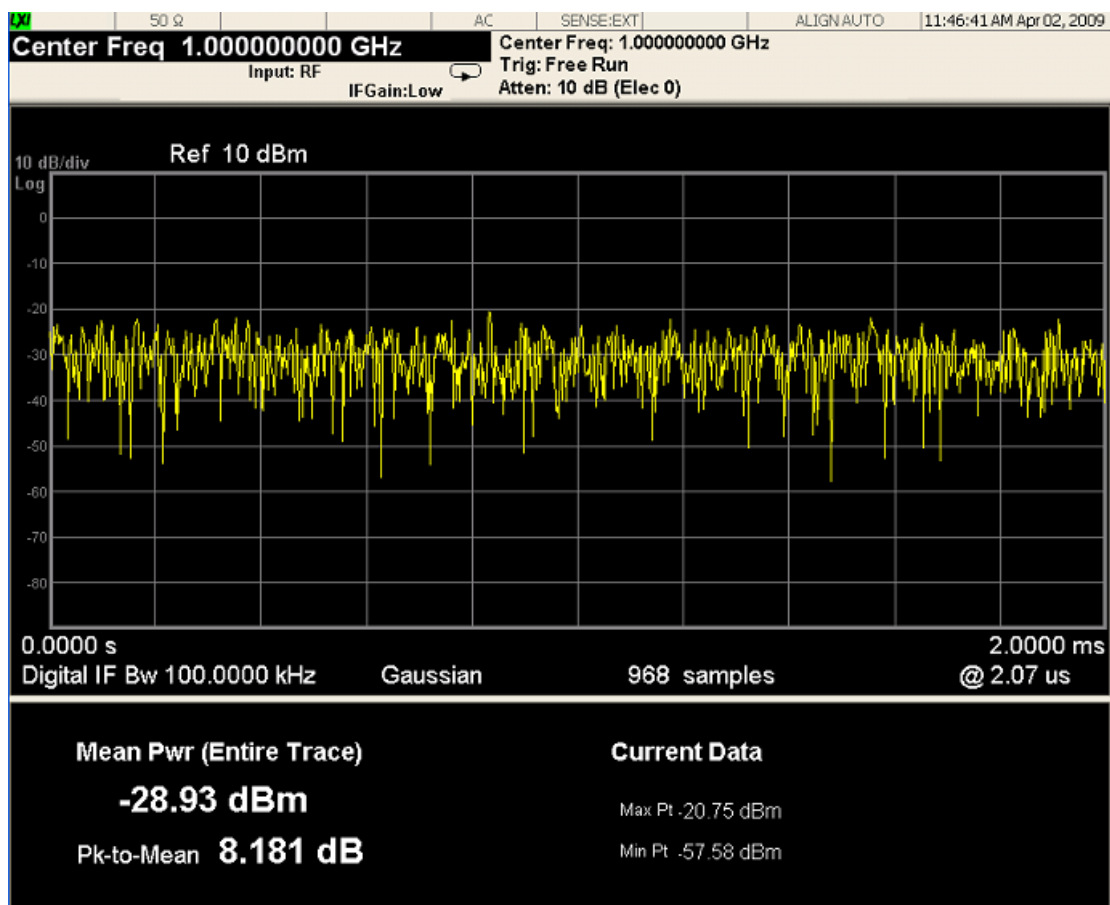

### Numeric Results

Name	Type	Description	Unit	Format
Mean Pwr	Float64	The mean power (dBm). This is either the power across the entire trace, or the power between markers if the markers are enabled.	dBm	XX.XX dBm



Name	Type	Description	Unit	Format
Pk-to-Mean	Float64	This is the ratio of the maximum signal level to the mean power.	dB	XX.XX dB
Max Pt	Float64	The maximum of the most recently acquired data.	dBm	XX.XX dBm
Min Pt	Float64	The minimum of the most recently acquired data.	dBm	XX.XX dBm

Key Path	View/Display
Initial S/W Revision	Prior to A.02.00

### I/Q Waveform

This view shows the I and Q signal waveforms in parameters of voltage versus time.

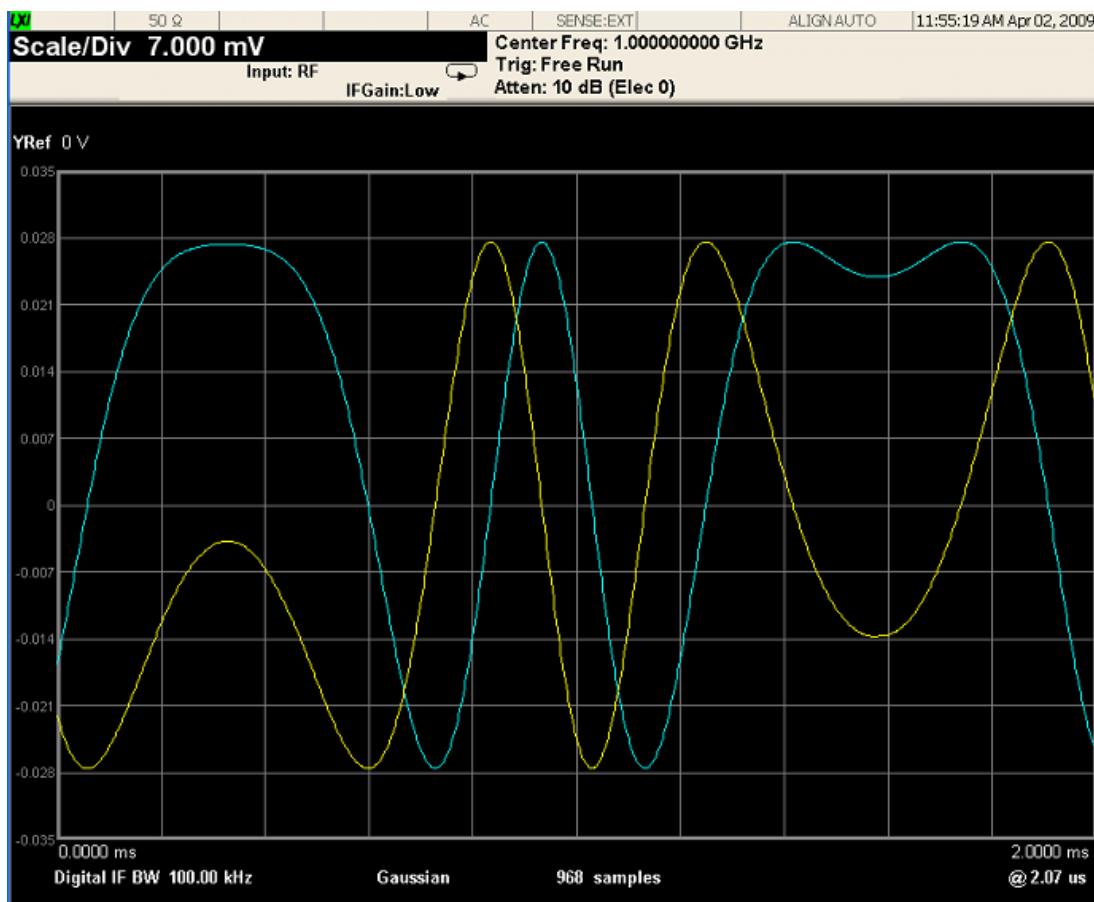

Key Path	View/Display
Initial S/W Revision	Prior to A.02.00



## 17 Appendix A: Channel Identification Plans

This appendix contains channel and frequency information for the following TV standards:

- NTSC
- PAL

## NTSC channels

NTSC, short for National Television System Committee, is the analog television system used in the United States, Canada, Japan, Mexico, the Philippines, South Korea, Taiwan, and some other countries.

NTSC-M and PAL-M shares the same frequency bands.

### NTSC-M

The channel tables for NTSC-M, including NTSC-M STD, AIR, HRC, and IRC.

#### NTSC-M AIR and PAL-M AIR

Channel Number	Frequency Band (MHz)
2	54~60
3	60~66
4	66~72
5	76~82
6	82~88
7	174~180
8	180~186
9	186~192
10	192~198
11	198~204
12	204~210
13	210~216
14	470~476
15	476~482
16	482~488
17	488~494
18	494~500
19	500~506
20	506~512
21	512~518
22	518~524
23	524~530
24	530~536
25	536~542
26	542~548
27	548~554
28	554~560

Channel Number	Frequency Band (MHz)
29	560~566
30	566~572
31	572~578
32	578~584
33	584~590
34	590~596
35	596~602
36	602~608
37	608~614
38	614~620
39	620~626
40	626~632
41	632~638
42	638~644
43	644~650
44	650~656
45	656~662
46	662~668
47	668~674
48	674~680
49	680~686
50	686~692
51	692~698
52	698~704
53	704~710
54	710~716
55	716~722
56	722~728
57	728~734
58	734~740
59	740~746
60	746~752
61	752~758
62	758~764
63	764~770
64	770~776

Channel Number	Frequency Band (MHz)
65	776~782
66	782~788
67	788~794
68	794~800
69	800~806

### NTSC-M STD/HRC/IRC and PAL-M STD/HRC/IRC

Channel	Picture Carrier Frequency (MHz)	Historical		
	STD	HRC	IRC	
1	N/A	72.0036	73.2625	4+,
2	55.25	54.0027	55.2625	
3	61.25	60.0030	61.2625	
4	67.25	66.0033	67.2625	
5	77.25	78.0039	79.2625	A-7(HRC,IRC)
6	83.25	84.0042	85.2625	A-6(HRC,IRC)
7	175.25	174.0087	175.2625	
8	181.25	180.0090	181.2625	
9	187.25	186.0093	187.2625	
10	193.25	192.0096	193.2625	
11	199.25	198.0099	199.2625	
12	205.25	204.0102	205.2625	
13	211.25	210.0105	211.2625	
14	121.2625	120.0060	121.2625	A
15	127.2625	126.0063	127.2625	B
16	133.2625	132.0066	133.2625	C
17	139.25	138.0069	139.2625	D
18	145.25	144.0072	145.2625	E
19	151.25	150.0075	151.2625	F
20	157.25	156.0078	157.2625	G
21	163.25	162.0081	163.2625	H
22	169.25	168.0084	169.2625	I
23	217.25	216.0108	217.2625	J
24	223.25	222.0111	223.2625	K

Channel	Picture Carrier Frequency (MHz)	Historical		
25	229.2625	228.0114	229.2625	L
26	235.2625	234.0117	235.2625	M
27	241.2625	240.0120	241.2625	N
28	247.2625	246.0123	247.2625	O
29	253.2625	252.0126	253.2625	P
30	259.2625	258.0129	259.2625	Q
31	265.2625	264.0132	265.2625	R
32	271.2625	270.0135	271.2625	S
33	277.2625	276.0138	277.2625	T
34	283.2625	282.0141	283.2625	U
35	289.2625	288.0144	289.2625	V
36	295.2625	294.0147	295.2625	W
37	301.2625	300.0150	301.2625	X
38	307.2625	306.0153	307.2625	Y
39	313.2625	312.0156	313.2625	Z
40	319.2625	318.0159	319.2625	DD
41	325.2625	324.0162	325.2625	EE
42	331.2750a	330.0165	331.2750a	FF
43	337.2625	336.0168	337.2625	GG
44	343.2625	342.0171	343.2625	HH
45	349.2625	348.0174	349.2625	II
46	355.2625	354.0177	355.2625	JJ
47	361.2625	360.0180	361.2625	KK
48	367.2625	366.0183	367.2625	LL
49	373.2625	372.0186	373.2625	MM
50	379.2625	378.0189	379.2625	NN
51	385.2625	384.0192	385.2625	OO
52	391.2625	390.0195	391.2625	PP
53	397.2625	396.0198	397.2625	QQ
54	403.25	402.0201	403.2625	RR
55	409.25	408.0204	409.2625	SS
56	415.25	414.0207	415.2625	TT
57	421.25	420.0210	421.2625	UU

17 Appendix A: Channel Identification Plans  
 NTSC channels

<b>Channel</b>	<b>Picture Carrier Frequency (MHz)</b>	<b>Historical</b>		
58	427.25	426.0213	427.2625	VV
59	433.25	432.0216	433.2625	WW
60	439.25	438.0219	439.2625	XX
61	445.25	444.0222	445.2625	YY
62	451.25	450.0225	451.2625	ZZ
63	457.25	456.0228	457.2625	
64	463.25	462.0231	463.2625	
65	469.25	468.0234	469.2625	
66	475.25	474.0237	475.2625	
67	481.25	480.0240	481.2625	
68	487.25	486.0243	487.2625	
69	493.25	492.0246	493.2625	
70	499.25	498.0249	499.2625	
71	505.25	504.0252	505.2625	
72	511.25	510.0255	511.2625	
73	517.25	516.0258	517.2625	
74	523.25	522.0261	523.2625	
75	529.25	528.0264	529.2625	
76	535.25	534.0267	535.2625	
77	541.25	540.0270	541.2625	
78	547.25	546.0273	547.2625	
79	553.25	552.0276	553.2625	
80	559.25	558.0279	559.2625	
81	565.25	564.0282	565.2625	
82	571.25	570.0285	571.2625	
83	577.25	576.0288	577.2625	
84	583.25	582.0291	583.2625	
85	589.25	588.0294	589.2625	
86	595.25	594.0297	595.2625	
87	601.25	600.0300	601.2625	
88	607.25	606.0303	607.2625	
89	613.25	612.0306	613.2625	
90	619.25	618.0309	619.2625	



Channel	Picture Carrier Frequency (MHz)	Historical		
91	625.25	624.0312	625.2625	
92	631.25	630.0315	631.2625	
93	637.25	636.0318	637.2625	
94	643.25	642.0321	643.2625	
95	91.25	90.0045	91.2625	A-5
96	97.25	96.0048	97.2625	A-4
97	103.25	102.0051	103.2625	A-3
98	109.2750a	108.0250	109.2750a	A-2
99	115.2750a	114.0250	115.2750a	A-1
100	649.2500	648.0324	649.2625	
101	655.2500	654.0327	655.2625	
102	661.2500	660.0330	661.2625	
103	667.2500	666.0333	667.2625	
104	673.2500	672.0336	673.2625	
105	679.2500	678.0339	679.2625	
106	685.2500	684.0342	685.2625	
107	691.2500	690.0345	691.2625	
108	697.2500	696.0348	697.2625	
109	703.2500	702.0351	703.2625	109
110	709.2500	708.0354	709.2625	110
111	715.2500	714.0357	715.2625	111
112	721.2500	720.0360	721.2625	112
113	727.2500	726.0363	727.2625	113
114	733.2500	732.0366	733.2625	114
115	739.2500	738.0369	739.2625	115
116	745.2500	744.0372	745.2625	116
117	751.2500	750.0375	751.2625	117
118	757.2500	756.0378	757.2625	118
119	763.2500	762.0381	763.2625	119
120	769.2500	768.0384	769.2625	120
121	775.2500	774.0387	775.2625	121
122	781.2500	780.0390	781.2625	122
123	787.2500	786.0393	787.2625	123

<b>Channel</b>	<b>Picture Carrier Frequency (MHz)</b>	<b>Historical</b>		
124	793.2500	792.0396	793.2625	124
125	799.2500	798.0399	799.2625	125
126	805.2500	804.0402	805.2625	126
127	811.2500	810.0405	811.2625	127
128	817.2500	816.0408	817.2625	128
129	823.2500	822.0411	823.2625	129
130	829.2500	828.0414	829.2625	130
131	835.2500	834.0417	835.2625	131
132	841.2500	840.0420	841.2625	132
133	847.2500	846.0423	847.2625	133
134	853.2500	852.0426	853.2625	134
135	859.2500	858.0429	859.2625	135
136	865.2500	864.0432	856.2625	136
137	871.2500	870.0435	871.2625	137
138	877.2500	876.0438	877.2625	138
139	883.2500	882.0441	883.2625	139
140	889.2500	888.0444	889.2625	140
141	895.2500	894.0447	895.2625	141
142	901.2500	900.0450	901.2625	142
143	907.2500	906.0453	907.2625	143
144	913.2500	912.0456	913.2625	144
145	919.2500	918.0459	919.2625	145
146	925.2500	924.0462	925.2625	146
147	931.2500	930.0465	931.2625	147
148	937.2500	936.0468	937.2625	148
149	943.2500	942.0471	943.2625	149
150	949.2500	948.0474	949.2625	150
151	955.2500	954.0477	955.2625	151
152	961.2500	960.0480	961.2625	152
153	967.2500	966.0483	967.2625	153
154	973.2500	972.0486	973.2625	154
155	979.2500	978.0489	979.2625	155
156	985.2500	984.0492	985.2625	156
157	991.2500	990.0495	991.2625	157
158	997.2500	996.0498	997.2625	158

a. This frequency deviates from the pattern.

### NTSC-J

The channel tables for NTSC-J, including NTSC-J Cable, AIR, and Digital Cable.

#### NTSC-J Cable

Band	Channel	Frequency Band	Picture Carrier	Audio Carrier
Mid Band	13	108-114	109.25	113.75
	14	114-120	115.25	119.75
	15	120-126	121.25	125.75
	16	126-132	127.25	131.75
	17	132-138	133.25	137.75
	18	138-144	139.25	143.75
	19	144-150	145.25	149.75
	20	150-156	151.25	155.75
	21	156-162	157.25	161.75
	22	164-170	165.25	169.75

17 Appendix A: Channel Identification Plans  
NTSC channels

<b>Band</b>	<b>Channel</b>	<b>Frequency Band</b>	<b>Picture Carrier</b>	<b>Audio Carrier</b>
Super High Band	23	222-228	223.25	227.75

<b>Band</b>	<b>Channel</b>	<b>Frequency Band</b>	<b>Picture Carrier</b>	<b>Audio Carrier</b>
	24	230-236	231.25	235.75

17 Appendix A: Channel Identification Plans  
NTSC channels

<b>Band</b>	<b>Channel</b>	<b>Frequency Band</b>	<b>Picture Carrier</b>	<b>Audio Carrier</b>
	25	236-242	237.25	241.75

<b>Band</b>	<b>Channel</b>	<b>Frequency Band</b>	<b>Picture Carrier</b>	<b>Audio Carrier</b>
	26	242-248	243.25	247.75

Band	Channel	Frequency Band	Picture Carrier	Audio Carrier
	27	248-254	249.25	253.75
	28	252-258	253.25	257.75
	29	258-264	259.25	263.75
	30	264-270	265.25	269.75
	31	270-276	271.25	275.75
	32	276-282	277.25	281.75
	33	282-288	283.25	287.75
	34	288-294	289.25	293.75
	35	294-300	295.25	299.75
	36	300-306	301.25	305.75
	37	306-313	307.25	311.75
	38	312-318	313.25	317.75
	39	318-324	319.25	323.75
	40	324-330	325.25	329.75
	41	330-336	331.25	335.75
	42	336-342	337.25	341.75
	43	342-348	343.25	347.75
	44	348-354	349.25	353.75
	45	354-360	355.25	359.75
	46	360-366	361.25	365.75
	47	366-372	367.25	371.75
	48	372-378	373.25	377.75
	49	378-384	379.25	383.75
	50	384-390	385.25	389.75
	51	390-396	391.25	395.75
	52	396-402	397.25	401.75
	53	402-408	403.25	407.75
	54	408-414	409.25	413.75
	55	414-420	415.25	419.75
	56	420-426	421.25	425.75
	57	426-432	427.25	431.75
	58	432-438	433.25	437.75
	59	438-444	439.25	443.75
	60	444-450	445.25	449.75
	61	450-456	451.25	455.75
	62	456-462	457.25	461.75
	63	462-468	463.25	467.75



## NTSC-J AIR

Channel	Frequency Band	Picture Carrier	Audio Carrier
1	90~96	91.25	95.75
2	96~102	97.25	101.75
3	102~108	103.25	107.75
4	170~176	171.25	175.75
5	176~182	177.25	181.75
6	182~188	183.25	187.75
7	188~194	189.25	193.75
8	192~198a	193.25	197.75
9	198~204	199.25	203.75
10	204~210	205.25	209.75
11	210~216	211.25	215.75
12	216~222	217.25	221.75
13	470.142857 ~476.142857	471.25	475.75
14	476.142857 ~482.142857	477.25	481.75
15	482.142857 ~488.142857	483.25	487.75
16	488.142857 ~494.142857	489.25	493.75
17	494.142857 ~500.142857	495.25	499.75
18	500.142857 ~506.142857	501.25	505.75
19	506.142857 ~512.142857	507.25	511.75
20	512.142857 ~518.142857	513.25	517.75
21	518.142857 ~524.142857	519.25	523.75
22	524.142857 ~530.142857	515.25	529.75
23	530.142857 ~536.142857	531.25	535.75
24	536.142857 ~542.142857	537.25	541.75
25	542.142857	543.25	547.75

17 Appendix A: Channel Identification Plans  
 NTSC channels

Channel	Frequency Band	Picture Carrier	Audio Carrier
	~548.142857		
26	548.142857 ~554.142857	549.25	553.75
27	554.142857 ~560.142857	555.25	559.75
28	560.142857 ~566.142857	561.25	565.75
29	566.142857 ~572.142857	567.25	571.75
30	572.142857 ~578.142857	573.25	577.75
31	578.142857 ~584.142857	579.25	583.75
32	584.142857 ~590.142857	585.25	589.75
33	590.142857 ~596.142857	591.25	595.75
34	596.142857 ~602.142857	597.25	601.75
35	602.142857 ~608.142857	603.25	607.75
36	608.142857 ~614.142857	609.25	613.75
37	614.142857 ~620.142857	615.25	619.75
38	620.142857 ~626.142857	621.25	625.75
39	626.142857 ~632.142857	627.25	631.75
40	632.142857 ~638.142857	633.25	637.75
41	638.142857 ~644.142857	639.25	643.75
42	644.142857 ~650.142857	645.25	649.75
43	650.142857 ~656.142857	651.25	655.75
44	656.142857 ~662.142857	657.25	661.75
45	662.142857 ~668.142857	663.25	667.75

Channel	Frequency Band	Picture Carrier	Audio Carrier
46	668.142857 ~674.142857	669.25	673.75
47	674.142857 ~680.142857	675.25	679.75
48	680.142857 ~686.142857	681.25	685.75
49	686.142857 ~692.142857	687.25	691.75
50	692.142857 ~698.142857	693.25	697.75
51	698.142857 ~704.142857	699.25	703.75
52	704.142857 ~710.142857	705.25	709.75
53	710.142857 ~716.142857	711.25	715.75
54	716.142857 ~722.142857	717.25	721.75
55	722.142857 ~728.142857	723.25	728.75
56	728.142857 ~734.142857	729.25	733.75
57	734.142857 ~740.142857	735.25	739.75
58	740.142857 ~746.142857	741.25	745.75
59	746.142857 ~752.142857	747.25	751.75
60	752.142857 ~758.142857	753.25	757.75
61	758.142857 ~764.142857	759.25	763.75
62	764.142857 ~770.142857	765.25	769.75

a. This frequency deviates from the pattern.

### NTSC-J Digital Cable

<b>Band</b>	<b>Channel</b>	<b>Start</b>	<b>Stop</b>	<b>Center</b>
<b>Number</b>	<b>(MHz)</b>	<b>Frequency</b>	<b>Frequency</b>	<b>Carrier</b>
		<b>(MHz)</b>	<b>(MHz)</b>	
	13	108.142857	114.142857	111.142857
Mid Band	14	114.142857	120.142857	117.142857
	15	120.142857	126.142857	123.142857
	16	126.142857	132.142857	129.142857
	17	132.142857	138.142857	135.142857
	18	138.142857	144.142857	141.142857
	19	144.142857	150.142857	147.142857
	20	150.142857	156.142857	153.142857
	21	156.142857	162.142857	159.142857
	22	164.142857	170.142857	167.142857
	23	222.142857	228.142857	225.142857
Super High Band	24	228.142857	234.142857	231.142857
	25	234.142857	240.142857	237.142857
	26	240.142857	246.142857	243.142857
	27	246.142857	252.142857	249.142857
	28	252.142857	258.142857	255.142857
	29	258.142857	264.142857	261.142857
	30	264.142857	270.142857	267.142857
	31	270.142857	276.142857	273.142857
	32	276.142857	282.142857	279.142857
	33	282.142857	288.142857	285.142857
	34	288.142857	294.142857	291.142857
	35	294.142857	300.142857	297.142857
	36	300.142857	306.142857	303.142857
	37	306.142857	312.142857	309.142857
	38	312.142857	318.142857	315.142857
	39	318.142857	324.142857	321.142857
	40	324.142857	330.142857	327.142857
	41	330.142857	336.142857	333.142857
	42	336.142857	342.142857	339.142857
	43	342.142857	348.142857	345.142857

<b>Band Number</b>	<b>Channel (MHz)</b>	<b>Start Frequency (MHz)</b>	<b>Stop Frequency (MHz)</b>	<b>Center Carrier</b>
	44	348.142857	354.142857	351.142857
	45	354.142857	360.142857	357.142857
	46	360.142857	366.142857	363.142857
	47	366.142857	372.142857	369.142857
	48	372.142857	378.142857	375.142857
	49	378.142857	384.142857	381.142857
	50	384.142857	390.142857	387.142857
	51	390.142857	396.142857	393.142857
	52	396.142857	402.142857	399.142857
	53	402.142857	408.142857	405.142857
	54	408.142857	414.142857	411.142857
	55	414.142857	420.142857	417.142857
	56	420.142857	426.142857	423.142857
	57	426.142857	432.142857	429.142857
	58	432.142857	438.142857	435.142857
	59	438.142857	444.142857	441.142857
	60	444.142857	450.142857	447.142857
	61	450.142857	456.142857	453.142857
	62	456.142857	462.142857	459.142857
	63	462.142857	468.142857	465.142857

### NTSC-Brazil

The channel tables for NTSC-Brazil, including NTSC-Brazil VHF and UHF.

#### NTSC-Brazil VHF

<b>Channel</b>	<b>Initial frequency</b>	<b>Final frequency</b>	<b>Central frequency</b>
07	174	180	177+ 1/7
08	180	186	183+ 1/7
09	186	192	189+ 1/7
10	192	198	195+ 1/7
11	198	204	201+ 1/7
12	204	210	207+ 1/7
13	210	216	213+ 1/7

### NTSC-Brazil UHF

Channel	Initial frequency	Final frequency	Central frequency
14	470	476	473+ 1/7
15	476	482	479+ 1/7
16	482	488	485+ 1/7
17	488	494	491+ 1/7
18	494	500	497+ 1/7
19	500	506	503+ 1/7
20	506	512	509+ 1/7
21	512	518	515+ 1/7
22	518	524	521+ 1/7
23	524	530	527+ 1/7
24	530	536	533+ 1/7
25	536	542	539+ 1/7
26	542	548	545+ 1/7
27	548	554	551+ 1/7
28	554	560	557+ 1/7
29	560	566	563+ 1/7
30	566	572	569+ 1/7
31	572	578	575+ 1/7
32	578	584	581+ 1/7
33	584	590	587+ 1/7
34	590	596	593+ 1/7
35	596	602	599+ 1/7
36	602	608	605+ 1/7
37	Not used for television	Not used for television	Not used for television
38	614	620	617+ 1/7
39	620	626	623+ 1/7
40	626	632	629+ 1/7
41	632	638	635+ 1/7
42	638	644	641+ 1/7
43	644	650	647+ 1/7
44	650	656	653+ 1/7
45	656	662	659+ 1/7
46	662	668	665+ 1/7
47	668	674	671+ 1/7
48	674	680	677+ 1/7

<b>Channel</b>	<b>Initial frequency</b>	<b>Final frequency</b>	<b>Central frequency</b>
49	680	686	683+ 1/7
50	686	692	689+ 1/7
51	692	698	695+ 1/7
52	698	704	701+ 1/7
53	704	710	707+ 1/7
54	710	716	713+ 1/7
55	716	722	719+ 1/7
56	722	728	725+ 1/7
57	728	734	731+ 1/7
58	734	740	737+ 1/7
59	740	746	743+ 1/7
60	746	752	749+ 1/7
61	752	758	755+ 1/7
62	758	764	761+ 1/7
63	764	770	767+ 1/7
64	770	776	773+ 1/7
65	776	782	779+ 1/7
66	782	788	785+ 1/7
67	788	794	791+ 1/7
68	794	800	797+ 1/7
69	800	806	803+ 1/7

## PAL Channels

PAL, short for Phase Alternating Line, is a color-encoding system used in broadcast television systems in large parts of the world.

### PAL-M

Refer to "NTSC-M AIR and PAL-M AIR" on page 17-2 and "NTSC-M STD/HRC/IRC and PAL-M STD/HRC/IRC" on page 17-4.

### PAL-I

The channel tables for PAL-I, including PAL-I VHF, UHF, and HRC.

#### PAL-I VHF

Channel	Channel Limits	Vision Carrier	Sound Carrier
1	44.5~52.5	45.75	51.75
2	52.5~60.5	53.75	59.75
3	60.5~68.5	61.75	67.75
4	174~182	175.25	181.25
5	182~190	183.25	183.25
6	190~198	191.25	197.25
7	198~206	199.25	205.25
8	206~214	207.25	213.25
9	214~222	215.25	221.25
10	222~230	223.25	229.25
11	230~238	231.25	237.25
12	238~246	239.25	245.25
13	246~254	247.43	253.43

#### PAL-I UHF

Refer to "PAL-B/G UHF and PAL-I UHF" on page 17-23.

#### PAL-I HRC

Refer to "PAL B/G HRC and PAL-I HRC" on page 17-25.

#### PAL-B/G

The channel tables for PAL-B/G, including PAL-B/G VHF, UHF, HRC, S, S-Cable, CENELEC.



PAL-B/G VHF

Band	Channel	Channel Limits	Vision Carrier	Sound Carrier
IF		33.15~40.15	38.9	33.4
I	E2	47~54	48.25	53.75
	E3	54~61	55.25	60.75
	E4	61~68	62.25	67.75
III	E5	174~181	175.25	180.75
	E6	181~188	182.25	187.75
	E7	188~195	189.25	194.75
	E8	195~202	196.25	210.75
	E9	202~209	203.25	208.75
	E10	209~216	210.25	215.75
	E11	216~223	217.25	222.75
	E12	223~230	224.25	229.75

PAL-B/G UHF and PAL-I UHF

Band	Channel	Channel Limits	Vision Carrier	Sound Carrier		
				G, H	I	K, L
IF	same as VHF for corresponding country					
IV	21	470~478	471.25	476.75	477.25	477.75
	22	478~486	479.25	484.75	485.25	485.75
	23	486~494	487.25	492.75	493.25	493.75
	24	494~502	495.25	500.75	501.25	501.75
	25	502~510	503.25	508.75	509.25	509.75
	26	510~518	511.25	516.75	517.25	517.75
	27	518~526	519.25	524.75	525.25	525.75
	28	526~534	527.25	532.75	533.25	533.75
	29	534~542	535.25	540.75	541.25	541.75
	30	542~550	543.25	548.75	549.25	549.75
	31	550~558	551.25	556.75	557.25	557.75
	32	558~566	559.25	564.75	565.25	565.75
	33	566~574	567.25	572.75	573.25	573.75
	34	574~582	575.25	580.75	581.25	581.75
	35	582~590	583.25	588.75	589.25	589.75
	36	590~598	591.25	596.75	597.25	597.75

<b>Band</b>	<b>Channel</b>	<b>Channel Limits</b>	<b>Vision Carrier</b>	<b>Sound Carrier</b>		
V	37	598~606	599.25	604.75	605.25	605.75
	38	606~614	607.25	612.75	613.25	613.75
	39	614~622	615.25	620.75	621.25	621.75
	40	622~630	623.25	628.75	629.25	629.75
	41	630~638	631.25	636.75	637.25	637.75
	42	638~646	639.25	644.75	645.25	645.75
	43	646~654	647.25	652.75	653.25	653.75
	44	654~662	655.25	660.75	661.25	661.75
	45	662~670	663.25	668.75	669.25	669.75
	46	670~678	671.25	676.75	677.25	677.75
	47	678~686	679.25	684.755	685.25	685.75
	48	686~694	687.25	692.75	693.25	693.75
	49	694~702	695.25	700.75	701.25	701.75
	50	702~710	703.25	708.75	709.25	709.75
	51	710~718	711.25	716.75	717.25	717.75
	52	718~726	719.25	719.25	709.25	709.75
	53	726~734	727.25	732.75	733.25	733.75
	54	734~742	735.25	740.75	741.25	741.75
	55	742~750	743.25	748.75	749.25	749.75
	56	750~758	751.25	756.75	757.25	757.75
	57	758~766	759.25	764.75	765.25	765.75
	58	766~774	767.25	772.75	773.25	773.75
	59	774~782	775.25	780.75	781.25	781.75
	60	782~790	783.25	788.75	789.25	789.75
	61	790~798	791.25	796.75	797.25	797.75
	62	798~806	799.25	804.75	805.25	805.75
	63	806~814	807.25	812.75	813.25	813.75
	64	814~822	815.25	820.75	821.25	821.75
	65	822~830	823.25	828.75	829.25	829.75
	66	830~838	831.25	836.75	837.25	837.75
	67	838~846	839.25	844.75	845.25	845.75
	68	846~854	847.25	852.75	853.25	853.75
	69	854~862	855.25	860.75	861.25	861.75

## PAL B/G HRC and PAL-I HRC

Channel	Channel Limits		Vision Carrier	Sound Carrier	
	Lower	Upper		B/G	I
2	54.75	62.75	56	61.5	62
3	62.75	70.75	64	69.5	70
4	70.75	78.75	72	77.5	78
5	78.75	86.75	80	85.5	86
6	86.75	94.75	88	93.5	94
7	94.75	102.75	96	101.5	102
8	102.75	110.75	104	109.5	110
9	110.75	118.75	112	117.5	118
10	118.75	126.75	120	125.5	126
11	126.75	134.75	128	133.5	134
12	134.75	142.75	136	141.5	142
13	142.75	150.75	144	149.5	150
14	150.75	158.75	152	157.5	158
15	158.75	166.75	160	165.5	166
16	166.75	174.75	168	173.5	174
17	174.75	182.75	176	181.5	182
18	182.75	190.75	184	189.5	190
19	190.75	198.75	192	197.5	198
20	198.75	206.75	200	205.5	206
21	206.75	214.75	208	213.5	214
22	214.75	222.75	216	221.5	222
23	222.75	230.75	224	229.5	230
24	230.75	238.75	232	237.5	238
25	238.75	246.75	240	245.5	246
26	246.75	254.75	248	253.5	254
27	254.75	262.75	256	261.5	262
28	262.75	270.75	264	269.5	270
29	270.75	278.75	272	277.5	278
30	278.75	286.75	280	285.5	286
31	286.75	294.75	288	293.5	294
32	294.75	302.75	296	301.5	302
33	302.75	310.75	304	309.5	310
34	310.75	318.75	312	317.5	318

Channel	Channel Limits	VisionCarrier	Sound Carrier		
35	318.75	326.75	320	325.5	326
36	326.75	334.75	328	333.5	334
37	334.75	342.75	336	341.5	342
38	342.75	350.75	344	349.5	350
39	350.75	358.75	352	357.5	358
40	358.75	366.75	360	365.5	366
41	366.75	374.75	368	373.5	374
42	374.75	382.75	376	381.5	382
43	382.75	390.75	384	389.5	390
44	390.75	398.75	392	397.5	398
45	398.75	406.75	400	405.5	406
46	406.75	414.75	408	413.5	414
47	414.75	422.75	416	421.5	422
48	422.75	430.75	424	429.5	430
49	430.75	438.75	432	437.5	438
50	438.75	446.75	440	445.5	446
51	446.75	454.75	448	453.5	454
52	454.75	462.75	456	461.5	462
53	462.75	470.75	464	469.5	470
54	470.75	478.75	472	477.5	478
55	478.75	486.75	480	485.5	486
56	486.75	494.75	488	493.5	494
57	494.75	502.75	496	501.5	502
58	502.75	510.75	504	509.5	510
59	510.75	518.75	512	517.5	518
60	518.75	526.75	520	525.5	526
61	526.75	534.75	528	533.5	534
62	534.75	542.75	536	541.5	542
63	542.75	550.75	544	549.5	550
64	550.75	558.75	552	557.5	558
65	558.75	566.75	560	565.5	566
66	566.75	574.75	568	573.5	574
67	574.75	582.75	576	581.5	582
68	582.75	590.75	584	589.5	590
69	590.75	598.75	592	597.5	598

Channel	Channel Limits	VisionCarrier	Sound Carrier		
70	598.75	606.75	600	605.5	606
71	606.75	614.75	608	613.5	614
72	614.75	622.75	616	621.5	622
73	622.75	630.75	624	629.5	630
74	630.75	638.75	632	637.5	638
75	638.75	646.75	640	645.5	646
76	646.75	654.75	648	653.5	654
77	654.75	662.75	656	661.5	662
78	662.75	630.75	664	669.5	670
79	670.75	678.75	672	677.5	678
80	678.75	686.75	680	685.5	686
81	686.75	694.75	688	693.5	694
82	694.75	702.75	696	701.5	702
83	702.75	710.75	704	709.5	710
84	710.75	718.75	712	717.5	718
85	718.75	726.75	720	725.5	726
86	726.75	734.75	728	733.5	734
87	734.75	742.75	736	741.5	742
88	742.75	750.75	744	749.5	750
89	750.75	758.75	752	757.5	758
90	758.75	766.75	760	765.5	766
91	766.75	774.75	768	773.5	774
92	774.75	782.75	776	781.5	782
93	782.75	790.75	784	789.5	790
94	790.75	798.75	792	797.5	798
95	798.75	806.75	800	805.5	806
96	806.75	814.75	808	813.5	814
97	814.75	822.75	816	821.5	822
98	822.75	830.75	824	829.5	830
99	830.75	838.75	832	837.5	838
100	838.75	846.75	840	845.5	846
101	846.75	854.75	848	853.5	854
102	854.75	862.75	856	861.5	862
103	862.75	870.75	864	869.5	870
104	870.75	878.75	872	877.5	878

<b>Channel</b>	<b>Channel Limits</b>	<b>VisionCarrier</b>	<b>Sound Carrier</b>		
105	878.75	886.75	880	885.5	886
106	886.75	894.75	888	893.5	894
107	894.75	902.75	896	901.5	902
108	902.75	910.75	904	909.5	910
109	910.75	918.75	912	917.5	918
110	918.75	926.75	920	925.5	926
111	926.75	934.75	928	933.5	934
112	934.75	942.75	936	941.5	942
113	942.75	950.75	944	949.5	950
114	950.75	958.75	952	957.5	958
115	958.75	966.75	960	965.5	966
116	966.75	974.75	968	973.5	974
117	974.75	982.75	976	981.5	982
118	982.75	990.75	984	989.5	990
119	990.75	998.75	992	997.5	998
120	998.75	1006.75	1000	1005.5	1006
121	1006.75	1014.75	1008	1013.5	1014
122	1014.75	1022.75	1016	1021.5	1022
123	1022.75	1030.75	1024	1029.5	1030
124	1030.75	1038.75	1032	1037.5	1038
125	1038.75	1046.75	1040	1045.5	1046
126	1046.75	1054.75	1048	1053.5	1054
127	1054.75	1062.75	1052	1061.5	1062
128	1062.75	1070.75	1064	1069.5	1070
129	1070.75	1078.75	1072	1077.5	1078
130	1078.75	1086.75	1080	1085.5	1086
131	1086.75	1094.75	1088	1093.5	1094
132	1094.75	1102.75	1096	1101.5	1102
133	1102.75	1110.75	1104	1109.5	1110
134	1110.75	1118.75	1112	1117.5	1118
135	1118.75	1126.75	1120	1125.5	1126
136	1126.75	1134.75	1128	1133.5	1134
137	1134.75	1142.75	1136	1141.5	1142
138	1142.75	1150.75	1144	1149.5	1150
139	1150.75	1158.75	1152	1157.5	1158

Channel	Channel Limits	VisionCarrier	Sound Carrier		
140	1158.75	1166.75	1160	1165.5	1166
141	1166.75	1174.75	1168	1173.5	1174
142	1174.75	1182.75	1176	1181.5	1182
143	1182.75	1190.75	1184	1189.5	1190
144	1190.75	1198.75	1192	1197.5	1198
145	1198.75	1206.75	1200	1205.5	1206
146	1206.75	1214.75	1208	1213.5	1214
147	1214.75	1222.75	1216	1221.5	1222
148	1222.75	1230.75	1224	1229.5	1230
149	1230.75	1238.75	1232	1237.5	1238
150	1238.75	1246.75	1240	1245.5	1246
151	1246.75	1254.75	1248	1253.5	1254
152	1254.75	1262.75	1256	1261.5	1262
153	1262.75	1270.75	1264	1269.5	1270
154	1270.75	1278.75	1272	1277.5	1278
155	1278.75	1286.75	1280	1285.5	1286
156	1286.75	1294.75	1288	1293.5	1294
157	1294.75	1302.75	1296	1301.5	1302
158	1302.75	1310.75	1304	1309.5	1310
159	1310.75	1318.75	1312	1317.5	1318
160	1318.75	1326.75	1320	1325.5	1326
161	1326.75	1334.75	1328	1333.5	1334
162	1334.75	1342.75	1336	1341.5	1342
163	1342.75	1350.75	1344	1349.5	1350
164	1350.75	1358.75	1352	1357.5	1358
165	1358.75	1366.75	1360	1365.5	1366
166	1366.75	1374.75	1368	1373.5	1374
167	1374.75	1382.75	1376	1381.5	1382
168	1382.75	1390.75	1384	1389.5	1390
169	1390.75	1398.75	1392	1397.5	1398
170	1398.75	1406.75	1400	1405.5	1406
171	1406.75	1414.75	1408	1413.5	1414
172	1414.75	1422.75	1416	1421.5	1422
173	1422.75	1430.75	1424	1429.5	1430
174	1430.75	1438.75	1432	1437.5	1438

Channel	Channel Limits	VisionCarrier	Sound Carrier		
175	1438.75	1446.75	1440	1445.5	1446
176	1446.75	1454.75	1448	1453.5	1454
177	1454.75	1462.75	1456	1461.5	1462
178	1462.75	1470.75	1464	1469.5	1470
179	1470.75	1478.75	1472	1477.5	1478
180	1478.75	1486.75	1480	1485.5	1486
181	1486.75	1494.75	1488	1493.5	1494
182	1494.75	1502.75	1496	1501.5	1502
183	1502.75	1510.75	1504	1509.5	1510
184	1510.75	1518.75	1512	1517.5	1518
185	1518.75	1526.75	1520	1525.5	1526
186	1526.75	1534.75	1528	1533.5	1534
187	1534.75	1542.75	1536	1541.5	1542
188	1542.75	1550.75	1544	1549.5	1550
189	1550.75	1558.75	1552	1557.5	1558
190	1558.75	1566.75	1560	1565.5	1566
191	1566.75	1574.75	1568	1573.5	1574
192	1574.75	1582.75	1576	1581.5	1582
193	1582.75	1590.75	1584	1589.5	1590
194	1590.75	1598.75	1592	1597.5	1598
195	1598.75	1606.75	1600	1605.5	1606
196	1606.75	1614.75	1608	1613.5	1614
197	1614.75	1622.75	1616	1621.5	1622
198	1622.75	1630.75	1624	1629.5	1630
199	1630.75	1638.75	1632	1637.5	1638

**PAL-B/G S**

Band	Channel	Channel Limits	Vision Carrier	Sound Carrier
IF		33.15~40.15	38.9	33.4
L21	S1	104~111	105.25	110.75
	S2	111~118	112.25	117.75
	S3	118~125	119.25	124.75
	S4	125~132	126.25	131.75
	S5	132~139	133.25	138.75



Band	Channel	Channel Limits	Vision Carrier	Sound Carrier
	S6	139~146	140.25	145.75
	S7	146~153	147.25	152.75
	S8	153~160	154.25	159.75
	S9	160~167	161.25	166.75
	S10	167~174	168.25	173.75
U21	S11	230~237	231.25	236.75
	S12	237~244	238.25	243.75
	S13	244~251	245.25	250.75
	S14	251~258	252.25	257.75
	S15	258~265	259.25	264.75
	S16	265~272	266.25	271.75
	S17	272~279	273.25	278.75
	S18	279~286	280.25	285.75
	S19	286~293	287.25	292.75
	S20	293~300	294.25	299.75
	S21	302~310	303.25	308.75
	S22	310~318	311.25	316.75
	S23	318~326	319.25	324.75
	S24	326~334	327.25	332.75
	S25	334~342	335.25	340.75
	S26	342~350	343.25	348.75
	S27	350~358	351.25	356.75
	S28	358~366	359.25	364.75
	S29	366~374	367.25	372.75
	S30	374~382	375.25	380.75
	S31	382~390	383.25	388.75
	S32	390~398	391.25	396.75
	S33	398~406	399.25	404.75
	S34	406~414	407.25	412.75
	S35	414~422	415.25	420.75
	S36	422~430	423.25	428.75
	S37	430~438	431.25	436.75
	S38	438~446	439.25	444.75
	S39	446~454	447.25	452.75
	S40	454~462	455.25	460.75
	S41	462~470	463.25	468.75

### PAL-B/G Cable

Band	Channel	Channel Limits	Vision Carrier	Sound Carrier
IF		33.15~40.15	38.9	33.4
II	S1	104~111	105.25	110.75
	S2	111~118	112.25	117.75
	S3	118~125	119.25	124.75
	S4	125~132	126.25	131.75
	S5	132~139	133.25	138.75
	S6	139~146	140.25	145.75
	S7	146~153	147.25	152.75
	S8	153~160	154.25	159.75
	S9	160~167	161.25	166.75
	S10	167~174	168.25	173.75
U21	S11	230~237	231.25	236.75
	S12	237~244	238.25	243.75
	S13	244~251	245.25	250.75
	S14	251~258	252.25	257.75
	S15	258~265	259.25	264.75
	S16	265~272	266.25	271.75
	S17	272~279	273.25	278.75
	S18	279~286	280.25	285.75
	S19	286~293	287.25	292.75
	S20	293~300	294.25	299.75
	S21	300~307	301.25	306.75
	S22	307~314	311.25	316.75
	S23	314~321	315.25	320.75
	S24	321~328	322.25	327.75
	S25	328~335	329.25	334.75
	S26	335~342	336.25	341.75
	S27	342~349	343.25	348.75
	S28	349~356	350.25	355.75
	S29	356~363	357.25	362.75
	S30	363~370	364.25	369.75
	S31	370~377	371.25	376.75
	S32	377~384	378.25	383.75

Band	Channel	Channel Limits	Vision Carrier	Sound Carrier
	S33	384~391	385.25	390.75
	S34	391~398	392.25	397.75
	S35	398~405	399.25	404.75
	S36	405~412	406.25	411.75
	S37	412~419	413.25	418.75
	S38	419~426	420.25	425.75
	S39	426~433	427.25	432.75
	S40	433~440	434.25	439.75
	S41	440~447	441.25	446.75
	S42	447~454	448.25	453.75
	S43	454~461	455.25	460.75
	S44	461~468	462.25	467.75

#### PAL-B/G CENELEC

	Lower	Upper		
1	47	54	48.25	53.75
2	118	125	119.25	124.75
3	174	181	175.25	180.75
4	190	197	191.25	196.75
5	206	213	207.25	212.75
6	222	229	223.25	228.75
7	230	237	231.25	236.75
8	246	253	247.25	252.75
9	262	269	263.25	268.75
10	286	293	287.25	292.75
11	310	318	311.25	316.75
12	326	334	327.25	332.75
13	342	350	343.25	348.75
14	358	366	359.25	364.75
15	374	382	375.25	380.75
16	390	398	391.25	396.75
17	406	414	407.25	412.75
18	422	430	423.25	428.75
19	438	436	439.25	444.75

20	446	454	447.25	452.75
21	462	470	463.25	468.75
22	478	486	479.25	484.75
23	494	502	495.25	500.75
24	510	518	511.25	516.75
25	526	534	527.25	532.75
26	542	550	543.25	548.75
27	566	574	567.25	572.75
28	582	590	583.25	588.75
29	598	606	599.25	604.75
30	662	670	663.25	668.75
31	678	686	679.25	684.75
32	694	702	695.25	700.75
33	710	718	711.25	716.75
34	726	734	727.25	732.75
35	742	750	743.25	748.75
36	758	766	759.25	764.75
37	774	782	775.25	780.75
38	790	798	791.25	796.75
39	806	814	807.25	812.75
40	822	830	823.25	828.75
41	838	846	839.25	844.75
42	854	862	855.25	860.75

PAL-D/K (8 MHz)

Channel	Channel Limits	Vision Carrier	Sound Carrier
DS-1	48.5~56.5	49.75	56.25
DS-2	56.5~64.5	57.75	64.25
DS-3	64.5~72.5	65.75	72.25
DS-4	76~84	77.25	83.75
DS-5	84~92	85.25	91.75
Z-1	111~119	112.25	118.75
Z-2	119~127	120.25	126.75
Z-3	127~135	128.25	234.75
Z-4	135~143	136.25	142.75

<b>Channel</b>	<b>Channel Limits</b>	<b>Vision Carrier</b>	<b>Sound Carrier</b>
Z-5	143~151	144.25	150.75
Z-6	151~159	152.25	158.75
Z-7	159~167	160.25	166.75
DS-6	167~175	168.25	174.25
DS-7	175~183	176.25	182.75
DS-8	183~191	184.25	190.75
DS-9	191~199	192.25	198.75
DS-10	199~207	200.25	206.75
DS-11	207~215	208.25	214.75
DS-12	215~223	216.25	222.75
Z-8	223~231	224.25	230.75
Z-9	231~239	232.25	238.75
Z-10	239~247	240.25	246.75
Z-11	247~255	248.25	254.75
Z-12	255~263	256.25	262.75
Z-13	263~271	264.25	270.75
Z-14	271~279	272.25	278.75
Z-15	279~287	280.25	286.75
Z-16	287~295	288.25	294.75
Z-17	295~303	296.25	302.75
Z-18	303~311	304.25	310.75
Z-19	311~319	312.25	318.75
Z-20	319~327	320.25	326.75
Z-21	327~335	328.25	334.75
Z-22	335~343	336.25	342.75
Z-23	343~351	344.25	350.75
Z-24	351~359	352.25	358.75
Z-25	359~367	360.25	366.75
Z-26	367~375	368.25	374.75
Z-27	375~383	376.25	382.75
Z-28	383~391	384.25	390.75
Z-29	391~399	392.25	398.75
Z-30	399~407	400.25	406.75
Z-31	407~415	408.25	414.75
Z-32	415~423	416.25	422.75
Z-33	423~431	424.25	430.75

<b>Channel</b>	<b>Channel Limits</b>	<b>Vision Carrier</b>	<b>Sound Carrier</b>
Z-34	431~439	432.25	438.75
Z-35	439~447	440.25	446.75
Z-36	447~455	448.25	454.75
Z-37	455~463	456.25	462.75
Z-38	566~574	567.25	573.75
Z-39	574~582	575.25	581.75
Z-40	582~590	583.25	589.75
Z-41	590~598	591.25	597.75
Z-42	598~606	599.25	605.75
DS-13	470~478	471.25	477.75
DS-14	478~486	479.25	485.75
DS-15	486~494	487.25	493.75
DS-16	494~502	495.25	501.75
DS-17	502~510	503.25	509.75
DS-18	510~518	511.25	517.75
DS-19	518~526	519.25	525.75
DS-20	526~534	527.25	533.75
DS-21	534~542	535.25	541.75
DS-22	542~550	543.25	549.75
DS-23	550~558	551.25	557.75
DS-24	558~566	559.25	565.75
DS-25	606~614	607.25	613.75
DS-26	614~622	615.25	621.75
DS-27	622~630	623.25	629.75
DS-28	630~638	631.25	637.75
DS-29	638~646	638.25	645.75
DS-30	646~654	647.25	653.75
DS-31	654~662	655.25	661.75
DS-32	662~670	663.25	669.75
DS-33	670~678	671.25	677.75
DS--34	678~686	679.25	685.75
DS-35	686~694	687.25	693.75
DS-36	694~702	695.25	701.75
DS-37	702~710	703.25	709.75
DS-38	710~718	711.25	717.75
DS-39	718~726	719.25	725.75

<b>Channel</b>	<b>Channel Limits</b>	<b>Vision Carrier</b>	<b>Sound Carrier</b>
DS-40	726~734	727.25	733.75
DS-41	734~742	735.25	741.75
DS-42	742~750	743.25	749.75
DS-43	750~758	751.25	757.75
DS-44	758~766	759.25	765.75
DS-45	766~774	767.25	773.75
DS-46	774~782	775.25	781.75
DS-47	782~790	783.25	789.75
DS-48	790~798	791.25	797.75
DS-49	798~806	799.25	805.75
DS-50	806~814	807.25	813.75
DS-51	814~822	815.25	821.75
DS-52	822~830	823.25	829.75
DS-53	830~838	831.25	837.75
DS-54	838~846	839.25	845.75
DS-55	846~854	847.25	853.75
DS-56	854~862	855.25	861.75
DS-57	862~870	863.25	869.75
DS-58	870~878	871.25	877.75
DS-59	878~886	879.25	885.75
DS-60	886~894	887.25	893.75
DS-61	894~902	895.25	901.75
DS-62	902~910	903.25	909.75
DS-63	910~918	911.25	917.75
DS-64	918~926	919.25	925.75
DS-65	926~934	927.25	933.75
DS-66	934~942	935.25	941.75
DS-67	942~950	943.25	949.75
DS-68	950~958	951.25	957.75

