

Operating and Service Manual Special Supplement

Agilent Technologies N8975A Option K67 Blockdown Converter

This manual provides documentation for the following instrument:

N8975A Option K67



Manufacturing Part Number: N8975-90012

**Printed in USA
December 2012
Revision A**

Notice

The information contained in this document is subject to change without notice.

Agilent Technologies makes no warranty of any kind with regard to this material, including but not limited to, the implied warranties of merchantability and fitness for a particular purpose. Agilent Technologies shall not be liable for errors contained herein or for incidental or consequential damages in connection with the furnishing, performance, or use of this material.

Safety Information

The following safety notes are used throughout this manual. Familiarize yourself with each of the notes and its meaning before operating this instrument.

WARNING

Warning denotes a hazard. It calls attention to a procedure which, if not correctly performed or adhered to, could result in injury or loss of life. Do not proceed beyond a warning note until the indicated conditions are fully understood and met.

CAUTION

Caution denotes a hazard. It calls attention to a procedure that, if not correctly performed or adhered to, could result in damage to or destruction of the instrument. Do not proceed beyond a caution sign until the indicated conditions are fully understood and met.

WARNING

This is a Safety Class 1 Product (provided with a protective earthing ground incorporated in the power cord). The mains plug shall only be inserted in a socket outlet provided with a protected earth contact. Any interruption of the protective conductor inside or outside of the product is likely to make the product dangerous. Intentional interruption is prohibited.

WARNING **The power cord is connected to internal capacitors that may remain live for 5 seconds after disconnecting the plug from it's power supply.**

WARNING **The detachable power cord is the instrument disconnecting device. It disconnects the mains circuits from the mains supply before other parts of the instrument. The front panel switch is only a standby switch and is not a LINE switch (disconnecting device).**

WARNING **The opening of covers or removal of parts is likely to expose dangerous voltages. Disconnect the product from all voltage sources before starting to open.**

WARNING **These servicing instructions are for use by qualified personnel only. To avoid electrical shock, do not perform any servicing unless you are qualified to do so.**

Warranty

This Agilent Technologies instrument product is warranted against defects in material and workmanship for a period of one year from date of shipment. During the warranty period, Agilent Technologies Company will, at its option, either repair or replace products which prove to be defective.

For warranty service or repair, this product must be returned to a service facility designated by Agilent Technologies. Buyer shall prepay shipping charges to Agilent Technologies and Agilent Technologies shall pay shipping charges to return the product to Buyer. However, Buyer shall pay all shipping charges, duties, and taxes for products returned to Agilent Technologies from another country.

Agilent Technologies warrants that its software and firmware designated by Agilent Technologies for use with an instrument will execute its programming instructions when properly installed on that instrument. Agilent Technologies does not warrant that the operation of the instrument, or software, or firmware will be uninterrupted or error-free.

LIMITATION OF WARRANTY

The foregoing warranty shall not apply to defects resulting from improper or inadequate maintenance by Buyer, Buyer-supplied software or interfacing, unauthorized modification or misuse, operation outside of the environmental specifications for the product, or improper site preparation or maintenance.

NO OTHER WARRANTY IS EXPRESSED OR IMPLIED. AGILENT TECHNOLOGIES SPECIFICALLY DISCLAIMS THE IMPLIED WARRANTIES OF MERCHANTABILITY AND FITNESS FOR A PARTICULAR PURPOSE.

EXCLUSIVE REMEDIES

THE REMEDIES PROVIDED HEREIN ARE BUYER'S SOLE AND EXCLUSIVE REMEDIES. AGILENT TECHNOLOGIES SHALL NOT BE LIABLE FOR ANY DIRECT, INDIRECT, SPECIAL, INCIDENTAL, OR CONSEQUENTIAL DAMAGES, WHETHER BASED ON CONTRACT, TORT, OR ANY OTHER LEGAL THEORY.

Content

CONTENT	1-0
CHAPTER 1. GENERAL INFORMATION	1-1
SECTION 1.01 INTRODUCTION	1-1
SECTION 1.02 SPECIFICATIONS	1-2
SECTION 1.03 SAFETY CONSIDERATION	1-3
SECTION 1.04 DESCRIPTION	1-3
SECTION 1.05 OPTIONS	1-3
SECTION 1.06 ACCESSORIES SUPPLIED	1-3
SECTION 1.07 EQUIPMENT REQUIRED BUT NOT SUPPLIED	1-4
SECTION 1.08 CHASSIS SLIDE MOUNT KIT	1-4
SECTION 1.09 RECOMMENDED TEST EQUIPMENT	1-5
SECTION 1.10 SYMBOLS AND LABELS	1-6
CHAPTER 2. INSTALLATION	2-1
SECTION 2.01 INTRODUCTION	2-1
SECTION 2.02 INITIAL INSPECTION	2-1
SECTION 2.03 POWER REQUIREMENTS	2-2
SECTION 2.04 LINE VOLTAGE AND FUSE SELECTION	2-2
SECTION 2.05 POWER CABLES	2-2
SECTION 2.06 MATING CONNECTORS	2-3
SECTION 2.07 OPERATING ENVIRONMENT	2-4
SECTION 2.08 BENCH OPERATION	2-4
SECTION 2.09 RACK MOUNTING	2-4
SECTION 2.10 STORAGE AND SHIPMENT ENVIRONMENT	2-4
SECTION 2.11 PACKAGING	2-5
CHAPTER 3. OPERATION	3-1
SECTION 3.01 INTRODUCTION	3-1
SECTION 3.02 PANEL FEATURES	3-1
SECTION 3.03 FRONT PANEL FEATURES	3-1
(a) RF Input (J1)	3-1
(b) RF Output (J2)	3-1
(c) Power (S1)	3-1
SECTION 3.04 REAR PANEL FEATURES	3-2
(a) Power (MPI)	3-2
(b) Fuse	3-2
SECTION 3.05 OPERATING CHARACTERISTICS	3-2
SECTION 3.06 OPERATOR'S MAINTENANCE	3-2
SECTION 3.07 GENERAL OPERATING INSTRUCTIONS	3-4
SECTION 3.08 TURN-ON PROCEDURE	3-4
SECTION 3.09 DOWN CONVERTER OPERATION	3-5
SECTION 3.10 SETUP AND CALIBRATION PROCEDURE	3-5

SECTION 3.11	SALES AND SERVICE OFFICES	3-6
CHAPTER 4.	PERFORMANCE TESTS	4-1
SECTION 4.01	INTRODUCTION	4-1
SECTION 4.02	EQUIPMENT REQUIRED	4-1
SECTION 4.03	PERFORMANCE TEST RECORD	4-1
SECTION 4.04	CALIBRATION CYCLE	4-1
SECTION 4.05	PERFORMANCE TEST PROCEDURES	4-2
SECTION 4.06	FREQUENCY RANGE AND NOISE FIGURE	4-2
(a)	<i>Specification</i>	4-2
(b)	<i>Equipment</i>	4-2
SECTION 4.07	LO FREQUENCY ACCURACY	4-7
(a)	<i>Specification 53.5 GHz. ± 50 MHz</i>	4-7
CHAPTER 5.	ADJUSTMENTS	5-1
CHAPTER 6.	SERVICE	6-1
SECTION 6.01	INTRODUCTION	6-1
SECTION 6.02	SERVICE SHEETS	6-1
SECTION 6.03	SAFETY CONSIDERATIONS	6-1
(a)	<i>Before Applying Power</i>	6-1
SECTION 6.04	SERVICING THE INSTRUMENT	6-3
SECTION 6.05	POZI-DRIVE SCREWDRIVERS	6-3
SECTION 6.06	HARDWARE	6-3
SECTION 6.07	ASSEMBLY LOCATIONS	6-3
SECTION 6.08	PARTS AND CABLE LOCATIONS	6-3
SECTION 6.09	TEST POINT LOCATIONS	6-4
SECTION 6.10	COVER REMOVAL	6-4
SECTION 6.11	CLEANING INTERVALS	6-4
SECTION 6.12	SIX MONTH CLEANING	6-4
SECTION 6.13	TWELVE MONTH CLEANING	6-5
SECTION 6.14	OVERALL TROUBLESHOOTING	6-6
SECTION 6.15	PRINCIPLES OF OPERATION	6-6
SECTION 6.16	TROUBLESHOOTING	6-6
SECTION 6.17	CHECK LIST	6-7
CHAPTER 7.	OPERATING THE DOWN CONVERTER WITH THE 8970B/8971C NF SYSTEM	7-1
CHAPTER 8.	SERVICE REPLACEABLE PARTS	8-1
SECTION 8.01	INTRODUCTION	8-1
SECTION 8.02	SERVICE REPLACEABLE PARTS LIST	8-1

Chapter 1. General Information

Section 1.01 Introduction

This Operating and Service Manual contains information required to install, operate, test and service the Model N8975A Option K67 Block Down Converter. Throughout this manual the Model N8975A Option K67 will also be referred to as the Down Converter.

The Down Converter Operating and Service Manual has eight sections consisting of:

- **Section 1 General Information**
- **Section 2 Installation**
- **Section 3 Operation**
- **Section 4 Performance Tests**
- **Section 5 Adjustments**
- **Section 6 Service**
- **Section 7 Operating with 8970B/8971C**
- **Section 8 Replaceable Parts**

Section 1.02 Specifications

Instrument specifications for the Down Converter are listed in Table 1-1. These specifications are the performance standards against which the instrument may be tested. Supplemental characteristics are listed in Table 1-2. Supplemental characteristics are not warranted specifications, but are typical characteristics included as additional information for the user.

Table 1 - 1 Specifications

Characteristics	Performance Limits	Conditions
Input Frequency	58 – 67GHz	
Output Frequency	13.5 - 4.5GHz	
LO Frequency	53.5GHz ± 50MHz	
Noise Figure	10dB Maximum <18dB Typical	
Temperature Range		
Specification Range	15° to 35 °C	
Operating Range	0 to 50 °C	
Storage	-40° to +70°C	

Table 1 - 2 Supplemental Characteristics

Characteristics	Performance Limits	Conditions
Conversion Gain	18dB Nominal (min > 10dB)	@62.5GHz
Humidity	20 - 80% R.H.	@40°C
Altitude	2000 Meters MAX (6562ft)	
Power Consumption	70VA Max.	50 - 60Hz 100-240V
Dimensions	88.5mm H x 212.6mm W x 348.3mm D	Excluding front and rear panel protrusions
Weight	Net 4.5Kg (9.9lbs) Shipping 8.4Kg (18.5lbs)	

CAUTION This instrument is designed for use in Installation Category II and Pollution degree 2 per IEC 61326 and 61010 respectively.

Section 1.03 Safety Consideration

This instrument has been designed and tested in accordance with IEC publication 61326 and 61010-1 2nd Edition, Safety Requirements for Electrical Equipment for Measurement, Control, and Laboratory Use, and has been supplied in a safe condition. The instruction documentation contains information and warnings that must be followed by the user to ensure safe operation and to maintain the instrument in a safe condition.

WARNING This is a safety Class 1 product (provided with a protective earthing ground incorporated in the power cord). The mains plug shall only be inserted in a socket outlet provided with a protective earth contact. Any interruption of the protective conductor inside or outside the instrument is likely to make the instrument dangerous. Intentional interruption is prohibited.

Section 1.04 Description

The N8975A Option K67 Block Down Converter is designed to be used with the N8975A Noise Figure Analyzer. The option K67 extends the frequency range of the N8975A by down converting the 58GHz to 67GHz frequency band. In addition to the N8975A a suitable Noise Source is required for a complete Noise Figure measurement system.

The Down Converter uses an internal 53.5GHz LO for down conversion of the 58GHz to 67GHz input. The resulting 13.5GHz to 4.5GHz signal is processed by the N8975A Noise Figure Analyzer to give information about the noise figure and gain of a Device Under Test(DUT).

Section 1.05 Options

There are no electrical or mechanical options to the N8975A option K67 Down Converter.

Section 1.06 Accessories Supplied

The N8975A option K67 Down Converter is supplied with a three wire power cable. Different cables are available for different power mains configurations. Check with you local Agilent Technologies office for descriptions and part numbers for these cables.

A rack mount kit is supplied for mounting the N8975A option K67 in a standard 19inch EIA rack. The part number for the rack mount kit is 5063-9240.

A RF cable, part number 08971-60127 is supplied. This cable is used to connect the Down Converter RF OUTPUT to the N8975A INPUT.

Section 1.07 Equipment Required but not Supplied

To form a noise figure measurement system for measurements in the 58 to 67GHz band the additional equipment required:

- N8975A Noise Figure Analyzer
- Suitable Noise Source

Section 1.08 Chassis Slide Mount Kit

This kit is used to install one or more instruments in a sliding support shelf, Order shelf part number 5063-9255, and slide kit 1494-0015(for a single instrument, also order filler panel 5002-3999).

Section 1.09 Recommended Test Equipment

Table 1-3 lists the test equipment recommended for use in testing, adjusting and servicing the Down Converter. The Critical Specification column describes the essential requirement for each piece of test equipment. Other equipment may be substituted if it meets or exceeds the critical specifications.

The recommended model column may suggest more than one model. The first model shown is usually the least expensive, single-purpose model. Alternate models are suggested, with additional features that would be a better choice in some applications.

Table 1 - 3 Recommended Test Equipment

Instrument	Critical Specification	Recommended Model
Noise Figure Analyzer	Noise Figure Measurements 4.5-18GHz	N8975A
Synthesizer	11 – 20GHz	83623A
Millimeter Source (Frequency Multiplier)	50 – 75 GHz 0dBm	83557A
Noise Source (1 - 50 GHz)		346C Option K01
Noise Source (50 – 75 GHz)	ENR> 9dB 50 - 75GHz	NC5115 OPT5 (Noise Com) or other equivalent
Spectrum Analyzer	Signal Analysis 2-18GHz	E4407B, 8566A/B
WR15 Waveguide Adapter (supplied)	WR15	WR15 2” Straight Waveguide

Section 1.10 Symbols and Labels



The Caution, risk of danger symbol. The product is marked with this symbol when it is necessary for the user to refer to the instruction in the supplied documentation



The out position of a bi-stable push control switch



The in position of a bi-stable push control switch



The Stand-by symbol



The ON symbol



Indicates a Protective Conductor Terminal that must be connected to earth ground before operating the equipment – protects against electrical shock in case of a fault.

Warning Warning denotes a hazard. It calls attention to a procedure which, if not correctly performed or adhered to, could result in injury or loss of life. Do not proceed beyond a warning note until indicated conditions are fully understood and met.

Caution Caution denotes a hazard. It calls attention to a procedure which, if not correctly performed or adhered to, could result in damage to or destruction of the instrument. Do not proceed beyond a caution note until the indicated conditions are fully understood and met.

ICES/NMB-001 This ISM device complies with Canadian ICES-001.
Cet appareil ISM est conforme à la norme NMB-001 du Canada.



The CE mark shows that the product complies with all applicable European Directives.



The CSA mark is a registered trademark of the Canadian Standards Association.



The C-Tick mark is a registered trademark of the Australian Communications Authority. This signifies compliance with the Australian EMC Framework Regulations under the terms of the Radio Communications Act of 1992.



This is the symbol for an Industrial, Scientific and Medical, Group 1 Class A product.



This symbol indicates separate collection for electrical and electronic equipment, mandated under EU law as of August 13, 2005. All electric and electronic equipment are required to be separated from normal waste for disposal (Reference WEEE Directive, 2002/96/EC)



This symbol not only indicates the presence of hazardous or toxic substances above the MCV, but also specifies that the material/product is recyclable and should not be "thrown away casually", as well as the length of the environmental protection use period EPUP (Environmental Protection Use Period) is stated in the number of years, starting with the date of manufacture, located in the center of the symbol.



South Korean Class A EMC Declaration

A 급 기기 (업무용 방송통신기자재)

이 기기는 업무용 (A 급) 전자파적합기기로서 판매자 또는 사용자는 이 점을 주의하시기 바라 며 , 가정외의 지역에서 사용하는 것을 목적으로 합니다 .

This equipment is Class A suitable for professional use and is for use in electromagnetic environments outside of the home.

Chapter 2. Installation

Section 2.01 Introduction

This section provides the information needed to install the N8975A option K67 Down Converter. Included is information pertinent to initial inspection, power requirements, line voltage selection, power cables, interconnection, environment, storage and shipment.

WARNING If this instrument is not used as specified, the protection provided by the equipment could be impaired. This instrument must be used in a normal condition (in which all means for protections are intact) only.

WARNING: Appliance Coupler (mains input powercord) is the power disconnect device. Do not position the instrument such that access to the coupler is impaired.

Section 2.02 Initial Inspection

WARNING To avoid hazardous electrical shock, do not perform electrical tests when there are signs of shipping damage to any portion of the outer enclosure (covers, panels, connectors).

Inspect the shipping container for damage. If the shipping container or cushioning material is damaged, it should be kept until the contents of the shipment have been checked for completeness and the instrument has been checked mechanically and electrically. The contents of the shipment should include the accessories specified in section 1-6. Procedures for checking electrical performance are given in Section 4. If the contents are incomplete or if there is mechanical damage or defects notify the nearest Agilent Technologies office. If the shipping container is damaged, or the cushioning material shows signs of stress, notify the carrier as well as the Agilent Technologies office. Keep the shipping material for carrier's inspection.

Section 2.03 Power Requirements

The N8975A Option K67 Down Converter requires a power source of between 100VAC to 240 VAC single phase. Line frequency is 50-60Hz. The rated power consumption is 100VAC 45VA and 240VAC 70VA maximum.

WARNING This is a safety class 1 product (that is, provided with a protective earth terminal). An un-interruptible safety earth ground must be provided from the main power source to the product input wiring terminals, power cord or supplied power cord set.

Whenever it is likely that the protection has been impaired, the product must be made inoperative and be secured against any unintended operation.

Section 2.04 Line Voltage and Fuse Selection

CAUTION This instrument has an auto ranging line voltage input, be sure the supply voltage is within the specified range.

The Down Converter will operate with voltages between 100VAC and 240VAC and so requires no switching or change of fuse.

Section 2.05 Power Cables

Warning Before connecting this instrument, the protective earth terminals of this instrument must be connected to the protective conductor of the line (Mains) power cable. The line plug shall only be inserted in a socket outlet provided with a protective earth contact. The protective action must not be negated by the use of an extension cord (power cable) without a protective conductor (grounding). Grounding one conductor of a two conductor outlet is not sufficient protection.

This instrument is equipped with a three-wire power cable. When connected to an appropriate AC power receptacle, this cable grounds the instrument cabinet. The type of power cable plug shipped with each instrument depends on the country of destination. See Figure 2-2 Power Cable and Line (Mains) Plug part numbers, for the part numbers of available power cables. Cables are available in different lengths or with right angle plugs to the instrument. Check with your nearest Agilent Technologies service center for descriptions and part numbers of these cables.



External Protective Earth Terminal.

While this is a Class I product, provided with a protective earthing conductor in a power cord, an external protective earthing terminal has also been provided. This terminal is for use where the earthing cannot be assured. At least an 18AWG earthing conductor should be used in such an instance, to ground the instrument to an assured earth terminal.

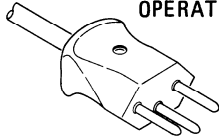
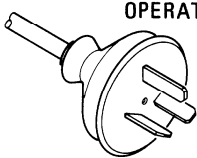
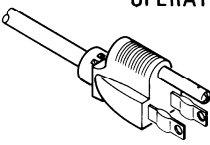
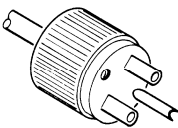
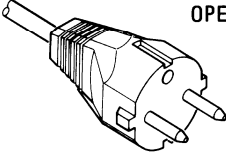
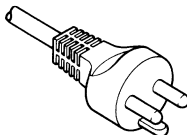
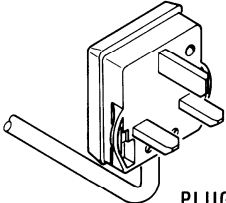
 <p>220/240V OPERATION</p> <p>PLUG*: SEV 1011.1959-24507 TYPE 12 CABLE*: 8120-2104</p>	 <p>220/240V OPERATION</p> <p>PLUG*: NZSS 198/AS C112 CABLE*: 8120-1369</p>	 <p>100/120V OPERATION</p> <p>PLUG*: NEMA 5-15P CABLE*: 8120-1378</p>	 <p>220/240V OPERATION</p> <p>PLUG*: NEMA 6-15P CABLE*: 8120-0698</p>
 <p>220/240V OPERATION</p> <p>PLUG*: CEE7-VII CABLE*: 8120-1689</p>	 <p>220/240V OPERATION</p> <p>PLUG*: DHCK 107 CABLE*: 8120-2956</p>	 <p>220/240V OPERATION</p> <p>PLUG*: BS 1363A CABLE: 8120-1351</p>	
<p>*The number shown for the plug is the industry identifier for the plug only. The number shown for the cable is a part number for a complete cable including the plug.</p>			

(i) Figure 2 - 2. Power Cable and Mains Plug Part Numbers

Section 2.06 Mating Connectors

Mating connectors used with the Down Converter are WR15 waveguide RF INPUT connector and a 50Ω, 3.5mm APC male RF OUTPUT connector located on the front panel. Mating connectors used with the Down Converter should be of the same type and US MIL-C-39012 compatible.

Section 2.07 Operating Environment

The operating environment for the Down Converter should be maintained within the following limitations:

- Specified Temperature Range.....15 °C to 35 °C
- Operating temperature range.....0 °C to 50 °C
- Humidity.....20% to 80% RH @40°C
- Altitude.....<2000 meters (6562 feet)

For indoor use only.

CAUTION VENTILATION REQUIREMENTS

When installing the instrument in a cabinet, the convection into and out of the instrument must not be restricted. The ambient temperature (outside the cabinet) must be less than the maximum operating temperature of the instrument by 4°C for every 100 Watts dissipated in the cabinet. If the total power dissipated in the cabinet is greater than 800 Watts, then forced convection must be used.

Section 2.08 Bench Operation

The instrument has rubber feet for convenience in bench operation.

Section 2.09 Rack Mounting

Rack mounting information is provided with the rack mount kit that is supplied with the instrument.

Section 2.10 Storage and Shipment Environment

The instrument should be stored in a clean, dry environment. The following environment limitations apply to both storage and shipment:

- Temperature.....-40 °C to +70 °C
- Humidity.....<95% relative
- Altitude.....<15,300 Meters (50,000 feet)

Section 2.11 Packaging

Tagging for Service

If the instrument is being returned to Agilent Technologies for service, please complete one of the blue repair tags located at the end of any Service manual, and attach to the instrument.

Original Packaging:

Containers and materials identical to those used in factory packaging are available through Agilent Technologies offices. Mark the container "FRAGILE" to assure careful handling. In any correspondence refer to the instrument by model number and full serial number.

Other Packing:

The following general instructions should be used for re-packaging with commercially available materials:

Wrap the instrument in heavy paper or plastic. If shipping to a Agilent Technologies office or service center, attach a tag indicating the type of service required, return address, model number, and full serial number (use blue repair tag).

Use a strong shipping container. A double wall carton made of 2.4MPa (350 psi) test material is adequate.

Use enough shock absorbing material 75 to 100mm (3 to 4 inches) thick around all sides of the instrument to provide a firm cushion and prevent movement in the container. Protect the front panel with an appropriate type of cushioning material to prevent damage during shipment.

Seal the container.

Mark the container "FRAGILE" to assure careful handling.

In any correspondence, refer to the instrument by model number and full serial number.

Chapter 3. Operation

Section 3.01 Introduction

This section provides complete operating information for the Down Converter. Included in this section are descriptions of the front and rear panel connectors and indicators, maintenance, and operating instructions.

When using the Down Converter with a N8975A Noise Figure Analyzer, refer to the N8975A Operating and Service Manual for additional operating information.

When using the Down Converter with the 8970B/8971C noise figure system a 20dB attenuator connected to the output of the Down Converter is required so that the nominal gain of the Down Converter plus attenuator is approximately 0dB.

Section 3.02 Panel Features

The front and rear panel features are shown in Figure 3-1. Any explanation of all connectors and indicators is given in section 3-3 and 3-4.

Section 3.03 Front Panel Features

(a) RF Input (J1)

A WR15 waveguide connector provides the input to the Down Converter. The maximum input to avoid damage, when used with an N8975A Noise Figure Meter, is -10 dBm. The impedance is 50Ω. Generally, the noise source is attached to this connector for calibration, and the device under test is attached to this connector for noise figure measurement.

(b) RF Output (J2)

A 3.5mm male connector provides the down converted output to the N8975A. Signals of 58GHz to 67GHz at the RF INPUT are mixed with a fixed 53.5GHz LO in the N8975A option K67 to produce the down converted 13.5GHz to 4.5GHz output.

(c) Power (S1)

This switch turns the instrument power supply between stand-by and on. When it is in the ON (1) position the instrument is operational.

Section 3.04 Rear Panel Features

(a) Power (MP1)

Line power module connects the power cord to the Down Converter and contains the line over current protection fuse. Center conductor is a chassis connection for safety earth ground.

(b) Fuse

An F3.15AH fuse is installed for all voltage supplies.

Section 3.05 Operating Characteristics

The Down Converter, when used with N8975A Noise Figure Analyzer, extends the frequency up into the 58-67GHz band.

Down Converter Performance Specifications and Supplemental Characteristics are contained in Tables 1-1 and 1-2.

Section 3.06 Operator's Maintenance

WARNING For continued protection against fire hazard, replace the line fuse only with the same type and rating (F3.15AH, 250V). The use of other fuses or materials is prohibited.

Replacing a defective primary fuse, Agilent Part Number 2110-0957. This fuse is located in the line module assembly.

Clean the cabinet, Using a damp cloth only.

WARNING: No Operator serviceable parts inside. Refer servicing to qualified personnel. To prevent electric shock do not remove covers.

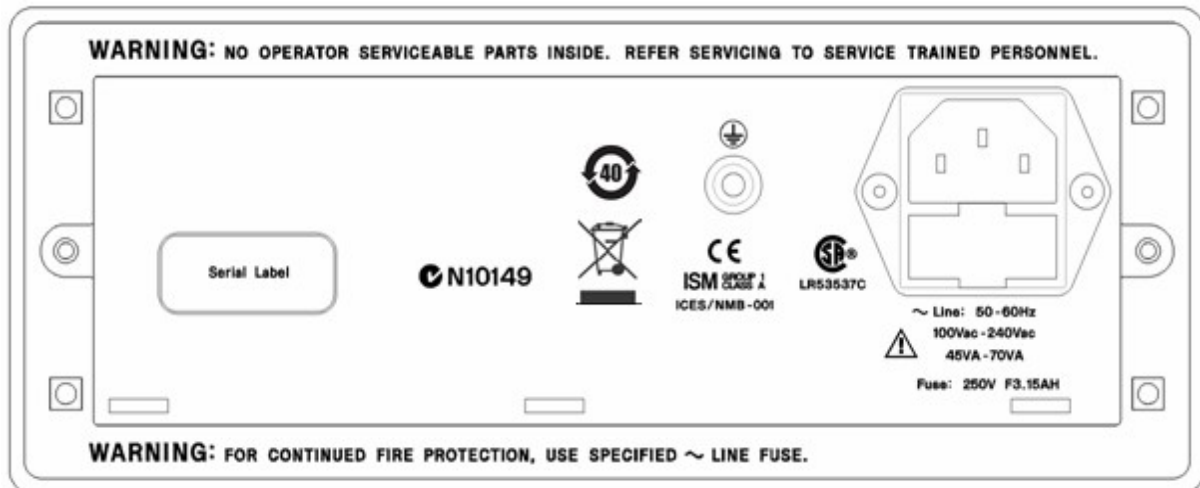
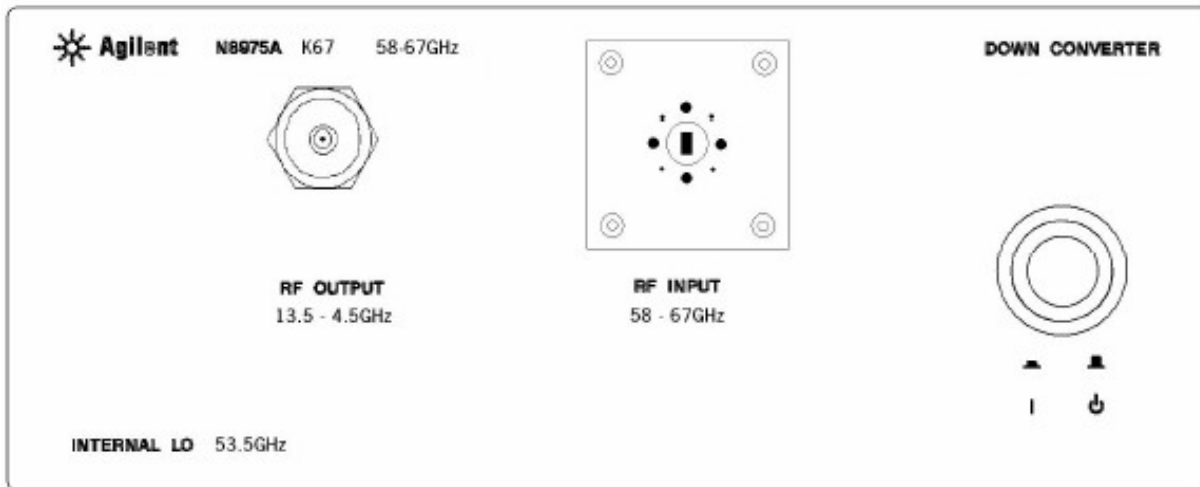

Figure 3-1 Front and Rear Panel

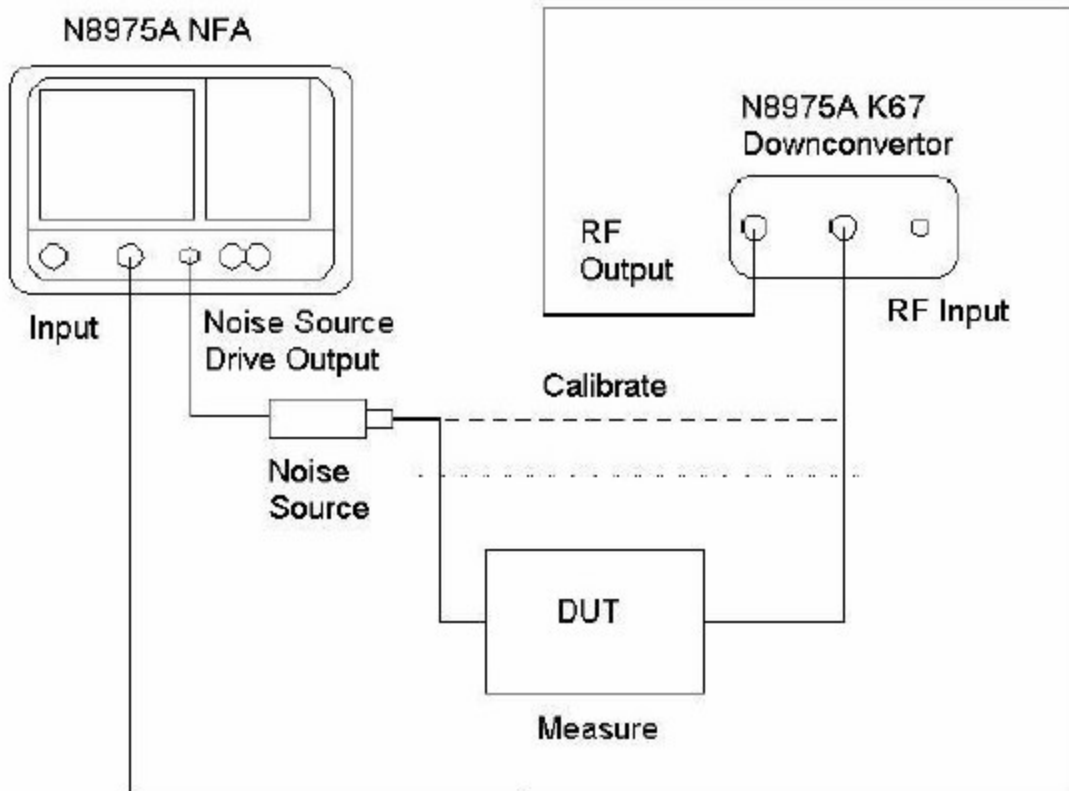

Figure 3-2 Test Set-up for Calibration and Measurement of Noise Figure

Section 3.07 General Operating Instructions

WARNING

Before the instrument is switched on, all protective earth terminals, extension cords, auto transformers, and devices connected to the instrument should be connected to a protective earth grounded socket. Any interruption of the protective earth grounding will cause a potential shock hazard that could result in personal injury.

Section 3.08 Turn-On Procedure

If the Down Converter is not plugged in, follow these instructions:

1. Check the line voltage is correct to operate the Down Converter.
2. Plug in the power cable.
3. Press the line switch on the front panel to ON.

Section 3.09 Down Converter Operation

The Down Converter require to be operated with a N8975A Noise Figure Analyzer for a complete 58GHz to 67GHz noise figure measurement system.

As an example, the following procedure would be used to calibrate and measure the noise figure and gain of an amplifier from 58GHz to 67GHz every 500 MHz.

(i) ENR Data

Before noise figure and gain measurements can be made, the ENR of the Noise Source must be entered into the N8975A. Information on how to enter the data is found in the ENR Table Entry procedure in Chapter 2 in the section on "Entering Excess Noise Ratio Data" of the N8975A Users Guide (N8972-90080). It is not necessary to input all ENR data points, but the data must cover the measurement frequency.

(ii) Connections - Calibration

To calibrate the N8975A and the K67 Down Converter as a system make the following connections as shown in Figure 3-2:

Connect Suitable Noise Source to the K67 RF INPUT

Connect the K67 RF OUTPUT to the N8975A INPUT using cable 08971-60127.

Connect the N8975A Noise Source Drive Output to the Noise Source Drive INPUT.

Section 3.10 Setup and Calibration Procedure

1. Switch on the N8975A and the K67 Down Converter allow half an hour to warm up.
2. Press [System] then softkey {External LO} then {Max Freq} and enter [7] [0] {GHz}.
3. Press key [Meas Mode] then softkey {Amplifier} then key [Tab→].
4. Press Sys Downconv softkey {On}. Note LO Mode should be "Fixed".
5. Press key [Mode Setup]. Note LO Frequency should be highlighted, if not press [Tab→] key until it is.
6. Enter using numeric keys [5] [3] [.] [5] then softkey {GHz}. Note IF Frequency is blank, Sideband should be USB, LO Control should be Off. If not use the [Tab→] key to highlight the parameter to change and then press the appropriate softkey.
7. Press key [Frequency/Points] then softkey {Start Freq} and enter [5] [8] {GHz} then softkey {Stop Freq} and enter [6] [7] {GHz}.
8. Press softkey {More 1 of 2} then softkey {Points} and enter [1] [9] [Enter].
9. Press [System] then softkey {Alignment} then softkey {Alignmnt Mode} to Point. Note Alignment should be ON.
10. Press key [Averaging/Bandwidth] then softkey {Averages} and enter [3] [2] [Enter]. Press softkey {Averaging} to On.
11. Press [Calibrate] twice and wait for calibration to complete.

(i) Measurement Procedure

After calibration disconnect the noise source from the RF INPUT of the K67 Down Converter. Connect the noise source output to the input of the device under test (DUT) and the output of the DUT to the K67 Down Converter RF INPUT. Press [Restart] and wait for the measurement sweep to complete. Record the results.

NOTE	For the Noise Figure Measurement System specifications to be valid, the measurement must use the same START FREQ, STOP FREQ and STEP SIZE that was used for calibration. None of the calibrated points can be skipped. Also, the measurement must be done in the same direction as the calibration, for example, from start frequency to stop frequency.
-------------	---

(ii) Measurement Accuracy

The noise figure of the N8975A/K67 test system is in the order of 8dB. So the noise figure plus Gain of the DUT must be much higher than 8dB for accurate measurement uncertainty. If the DUT has low gain and low noise figure then a pre-amplifier will be required as part of the system and included in the calibration so that the measurement uncertainty is reduced.

Section 3.11 Sales and Service Offices

An up-to-date list of Agilent Offices is available through the Agilent Website at URL: <http://www.agilent.com>.

Chapter 4. Performance Tests

Section 4.01 Introduction

The procedures in this section test the Down Converter's electrical performance using the specifications of Table 1-1 as performance standards. These tests are suitable for incoming inspection, troubleshooting, and preventative maintenance. All tests can be performed without access to the interior of the Down Converter.

Section 4.02 Equipment Required

Equipment required for the performance tests is listed in Table 1-3, **Recommended Test Equipment**. Any equipment that satisfies the critical specifications given in the table may be substituted for the recommended models.

Section 4.03 Performance Test Record

Results of performance tests may be recorded in Table 4-1, **Performance Test Record**. This lists all test specifications and the acceptable limits for each specification. Results recorded at incoming inspection can be used for comparison in periodic maintenance and troubleshooting, and after repairs.

Section 4.04 Calibration Cycle

This instrument requires periodic verification of performance. Depending of the use and environmental conditions, the instrument should be checked, using the performance tests, at least once a year.

Section 4.05 Performance Test Procedures

It is assumed that the person performing the following test understands how to operate the test equipment. Equipment settings are stated in general terms. It is also assumed that the technician will select the cables and adapters required to complete the test set-ups illustrated in this section.

NOTE To consider the performance test valid, the following conditions must be met:

- 1. The Down Converter and all test equipment must have a minimum of 30 minutes warm up time.**
 - 2. The line voltage must be 100 to 240 VAC.**
 - 3. The Ambient temperature must be +15°C to +35°C, from start of the warm up period to the completion of all tests.**
-

Section 4.06 Frequency Range and Noise Figure

(a) Specification

Frequency Range 58GHz to 67GHz
Noise Figure 10 dB Maximum

Description: The Noise Figure Analyzer uses Measurement Mode DUT is Down Converter in fixed LO mode to measure the noise figure of the N8975A option K67.

(b) Equipment

Noise Figure Analyzer N8975A
Noise Source NC5115 OPT5
(Noise Com)
WR15 Waveguide Adapter WR15 2" Straight
(if required) Waveguide Adapter

(i) Performance Calibration and Measurement Procedure

1. Connect the test equipment as shown in Figure 4-1(a) for calibration.
2. Switch on the N8975A and the K67 Down Converter allow half an hour to warm up.
3. Preset all instruments, then enter the ENR data for the Noise Sources into the N8975A. See chapter 3 ENR Data for details. Only data from 4 to 14GHz (from the 346C K01) and 58 to 67GHz (from the high frequency noise source) is needed for the performance test.
4. Press [System] then softkey {External LO} then {Max Freq} and enter [7] [0] {GHz}.
5. Press key [Meas Mode] then softkey {Downconv}. Note LO Mode should be "Fixed".
6. Press key [Mode Setup]. Note LO Frequency should be highlighted, if not press [Tab→] key until it is.
7. Enter using numeric keys [5] [3] [.] [5] then softkey {GHz}. Note IF Frequency is blank, Sideband should be USB, LO Control should be Off. If not use the [Tab→] key to highlight the parameter to change and then press the appropriate softkey.
8. Press key [Frequency/Points] then softkey {Start Freq} and enter [4] [.] [5] {GHz} then softkey {Stop Freq} and enter [1] [3] [.] [5] {GHz}.
9. Press softkey {More 1 of 2} then softkey {Points} and enter [1] [9] [Enter].
10. Press [System] then softkey {Alignment} then softkey {Alignmnt Mode} to Point. Note Alignment should be ON.
11. Press key [Averaging/Bandwidth] then softkey {Averages} and enter [3] [2] [Enter]. Press softkey {Averaging} to On.
12. Press [Calibrate] twice and wait for calibration to complete.

Connect the Down Converter as shown in Figure 4-1(b) for measurement then press [Restart] and wait for the sweep to complete before reading off the results. Use the table format for the results and single sweep so the results can be easily read. For table format press [Format] then softkey {Format} then softkey {Table}.

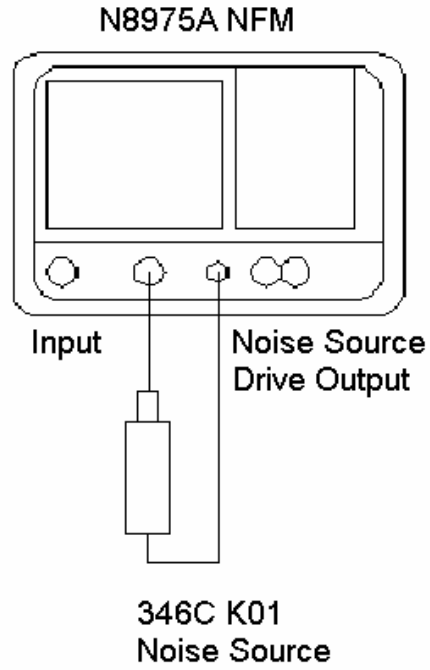

Figure 4 – 1(a). Test Set-up for Calibration

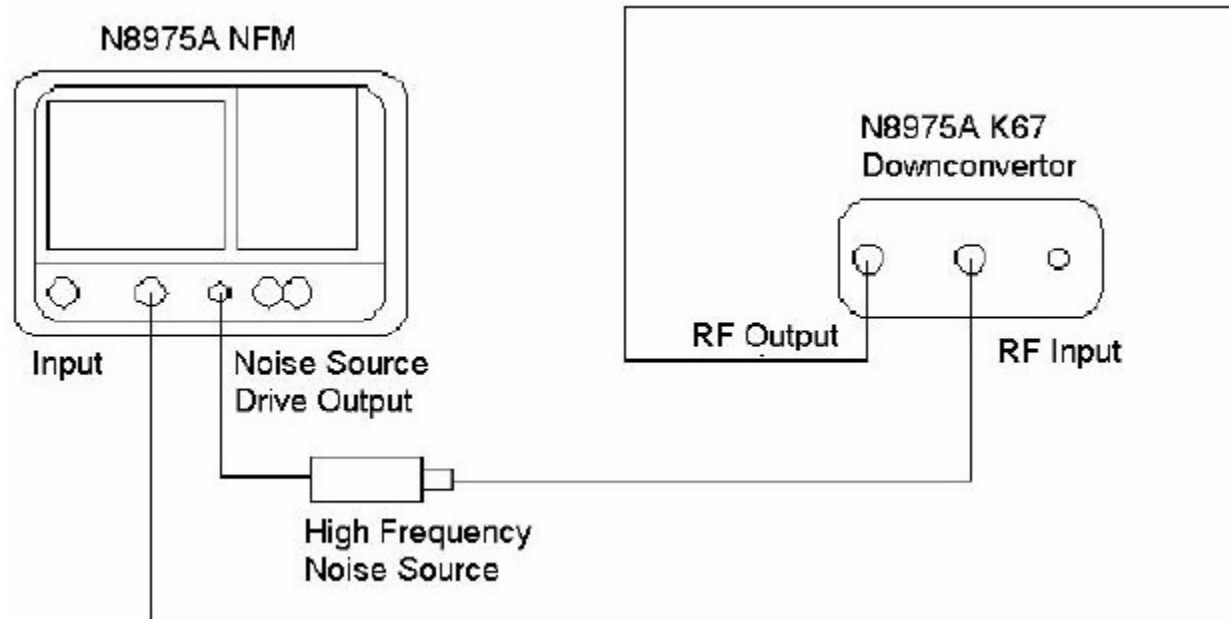
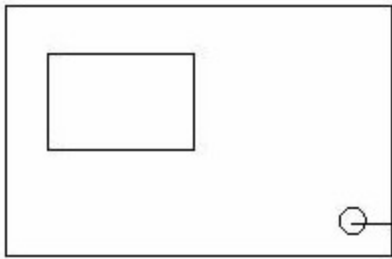
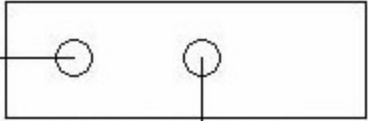

Figure 4 – 1(b). Test Set-up for Measurement

E4407A Spectrum Analyser



N8975A K67 Downconvertor



RF Output RF Input

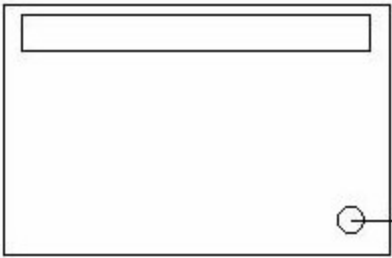

83623A/83557A Combined
Millimeter Wave Source

Figure 4 - 2. Test Set-up for LO Accuracy and Troubleshooting

Section 4.07 LO Frequency Accuracy

(a) Specification 53.5 GHz \pm 50 MHz

(i) Description:

This test measures the Local Oscillator frequency by observing the output frequency at the RF OUTPUT when a highly stable and accurate 67000 MHz is input.

(ii) Equipment

Frequency Synthesiser.....	83623A
Millimeter Source (Frequency Multiplier).....	83557A
Spectrum Analyzer.....	E4407B

(iii) LO Frequency Measurement Procedure

1. Set the 83623A/83557A combination for a CW signal of 67000.00 MHz at -30dBm
2. Connect the equipment as shown in Figure 4-2. Connect the RF output of the 83557A to the N8975A option K67 RF INPUT and connect the E4407B input to the N8975A option K67 RF OUTPUT.
3. Press [PRESET] on the Spectrum Analyser then press [CENTER FREQ] [1] [8] [GHz], [FREQ SPAN] [1] [0] [0] [MHz]. An 13.5 GHz signal at about -10 dBm should be observed near the center of the display.
4. Press Spectrum Analyser [Marker NORMAL] and [PEAK SEARCH]. Read the frequency in the upper right hand corner of the display. The indicated frequency should be 13500 MHz \pm 50. Record the frequency to the Test Record Card.

Test		Results		
4-4 Noise Figure Vs. Frequency Frequency (GHz)		Gain (dB)	Actual NF (dB)	Max NF (dB)
IF	RF			
13.50	67.00			10.00
13.00	66.50			10.00
12.50	66.00			10.00
12.00	65.50			10.00
11.50	65.00			10.00
11.00	64.50			10.00
10.50	64.00			10.00
10.00	63.50			10.00
9.50	63.00			10.00
9.00	62.50			10.00
8.50	62.00			10.00
8.00	61.50			10.00
7.50	61.00			10.00
7.00	60.50			10.00
6.50	60.00			10.00
6.00	59.50			10.00
5.50	59.00			10.00
5.00	58.50			10.00
4.50	58.00			10.00
4-5 LO Frequency Accuracy		Min (MHz) 13450	Actual	Max (MHz) 13550

Table 4-1. Performance Test Record

Chapter 5. Adjustments

The N8975A Option K67 has no internal adjustments

Chapter 6. Service

Section 6.01 Introduction

This section contains information for troubleshooting and repairing the Down Converter. Included are block diagrams, schematic diagrams, principles of operation, and procedures for troubleshooting, repair, disassembly, and re-assembly.

Section 6.02 Service Sheets

The pages following the service introduction are the service sheets comprising of block diagrams, schematics, supplemental diagrams, theory, and troubleshooting information.

Section 6.03 Safety Considerations

(a) Before Applying Power

Verify that the instrument is set to match the available line voltage and that the correct fuse is installed. An uninterrupted safety earth ground must be provided from the main power source to the instrument input wiring terminals, power cable, or supplied power cable set.

(i) Warnings and Cautions

Pay attention to WARNINGS and CAUTIONS they must be followed for your protection and to avoid damage to the equipment.

WARNING Maintenance described herein is performed with power supplied to the instrument and with protective covers removed. Such maintenance should be performed only by service-trained personnel who are aware of the hazards involved (for example, fire and electrical shock). Where maintenance can be performed without power supplied, the power should be removed.

Any interruption of the protective (grounding) conductor (inside of outside the instrument) or disconnecting the protective earth terminal will cause a potential shock hazard that could result in personal injury. (Grounding one conductor of a two conductor outlet is not sufficient protection). In addition, verify that a common ground exists between the unit under test and this instrument prior to energising either unit.

Whenever it is likely that the protection has been impaired, the instrument must be made inoperative and be secured against any unintended operation.

If this instrument is to be powered via an auto-transformer (for voltage reduction) make sure that the common terminal is connected to neutral (that is, the grounded side of the mains supply).

Servicing instructions are for use by service trained personnel only. To avoid dangerous electric shock, do not perform any servicing unless qualified to do so.

Adjustments described in the manual are performed with power supplied to the instrument while protective covers are removed. Energy available at many points may, if contacted, result in personal injury.

Capacitors inside the instrument may still be charged even if the instrument has been disconnected from its source of supply.

For continued protection against fire hazard, replace the line fuse(s) only with 250V fuse(s) of the same current rating and type (F3.15AH, 250V). Do not use repaired fuses or short circuited fuse holders.

CAUTION Do not disconnect or remove any carriers or boards in the instrument unless the instrument is unplugged. Some boards contain devices that can be damaged if the board is removed when the power is on.

Section 6.04 Servicing the Instrument

Once an error has been detected, and the fault is known to be within the instrument, it is necessary to place the instrument in a serviceable position. Refer to Top and Bottom Covers removal procedure near the end of this section.

Section 6.05 Pozi-drive Screwdrivers

Many screws in the Down Converter appear to be Phillips type, but are not. To avoid damage to the screw headshots, Pozi-drive screwdrivers should be used. 8710-0899 is the number 1 Pozi-drive. 8710-0900 is number 2 Pozidrive.

Section 6.06 Hardware

The Down Converter has a mixture of unified national (inch) and metric screws. The metric screws are defined in Industrial Fasteners Publication (IFI 500) and are identified in the list as metric. The unified national screws are identified in the list as non-metric. To prevent thread damage, ensure that the same type of screw and nut is used in each application.

Section 6.07 Assembly Locations

Assemblies in the Down Converter are numbered in groups, both by function and by location. Refer to the service sheets for identification of assemblies.

Section 6.08 Parts and Cable Locations

The location of individual components mounted on the assemblies are shown near the schematic diagram. The part reference designator is the assembly designator plus the parts designator. For example, A2R9 is R9 on the A2 assembly. For specific component descriptions and ordering information, refer to Table 8-1, in Section 8-2

Section 6.09 Test Point Locations

There are no test point locations identified.

Section 6.10 Cover Removal

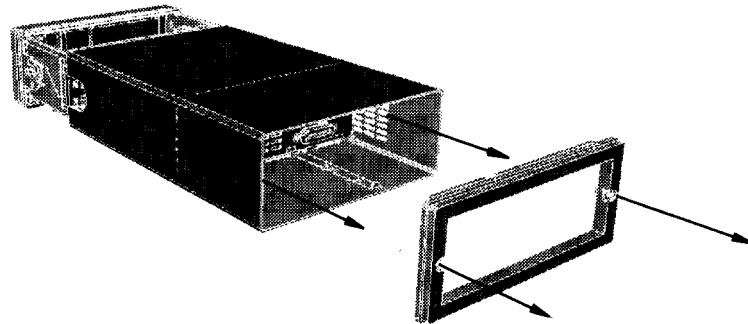

To remove the cover, remove the two screws that hold the rear bezel, as shown in the above picture.

When replacing the cover retighten the captive screws in the rear bezel using a 9 in-lbs T15 screwdriver.

Section 6.11 Cleaning Intervals

Agilent Technologies recommends a 12 month interval between cleaning for some parts of the Down Converter. Front panel connectors should be cleaned every 6 months. Cleaning intervals, are dependent upon where the Down Converter is used. It should be cleaned more frequently if the environment used in a dusty or very humid area.

Section 6.12 Six Month Cleaning

Clean the cabinet of the instrument with a damp cloth only.

Careful cleaning of front panel connectors is essential to assure long, reliable connector life, to prevent accidental damage to connectors, and to obtain maximum measurement accuracy and repeatability.

Dirt and stubborn contaminants should be removed with a cotton swab or lint-free cleaning cloth moistened with a solvent.

NOTE **Use the least amount of solvent possible, and avoid wetting any plastic parts in the connectors with the solvent.**

Use liquid solvents rather than spray. If a spray must be used, always spray the solvent onto a cloth or swab, never directly into a connector.

Very dirty connectors can be cleaned with 91% isopropyl alcohol, Part Number 8500-0559.

WARNING Do not use aromatic or chlorinated hydrocarbons, esters, trepans, higher alcohol's, keytones of ether-alcohols such as benzene toluene, turpentine, dioxin, gasoline, cellosolve acetate, or carbon tetrachloride.

Whichever solvent is used, carefully avoid wetting the plastic support bead inside the connector and blow the connector dry immediately with a gently stream of compressed air. Support beads are easily damaged by solvents.

Interior surfaces, especially on precision 3.5mm connectors, are very difficult to reach, and it is easy to damage connectors in trying to clean them. One suitable method is to cut off the sharp tip of a round wooden toothpick and then to wrap it with a single layer of lint-free cleaning cloth. (A round wooden toothpick or a very small diameter wooden rod is required: metal must never be used because it will scratch the plated surface; diameter must not exceed 0.070 in. or 1.7mm. Moisten the cloth with a small amount of cleaning solvent and carefully insert it into the connector to clean the interior surfaces. Use an illuminated magnifying glass or microscope to see clearly the areas you wish to clean.

When you have cleaned a connector, always be sure that it is completely dry before using it. Blow the connector dry with a gently stream of clean compressed air and inspect it again under a magnifying glass to be sure that no particles or solvent residues remain.

Section 6.13 Twelve Month Cleaning

WARNING Before cleaning, make sure the Down Converter is dis-connected from the power source. This is to eliminate the possibility of electrical shock.

1. Remove the top and bottom covers to gain access to the interior of the instrument.
2. Using a brush, remove dirt from the fan guard and fan blades.
3. Using compressed air, remove dust and dirt from the area behind the fan. Blow air out through the fan and remove loose dirt.
4. Using air and/or a soft bristle brush, clean all other accessible areas of the instrument, starting from the top, including the A1, A2 and A3 assemblies.
5. Replace the instrument covers.

Section 6.14 Overall Troubleshooting

The Overall Troubleshooting section consists of Principles of Operation and Troubleshooting information for the Down Converter.

Section 6.15 Principles of Operation

Input frequencies from 58 to 67GHz are coupled into the A2 Down Converter by WR15 waveguide. A2FL1 prevents frequencies above and below the 58GHz to 67GHz band from entering the mixer A2U1. Frequencies below 58GHz, in the image band (40-49GHz), could mix with the 53.5GHz LO and cause spurious outputs. Frequencies from 58 to 67GHz will mix with this LO and create an Intermediate Frequency of 13.5 to 4.5GHz which is amplified by A2AR1 and routed to the RF OUTPUT. Further IF filtering is performed with the input YIG filter in the N8975A. Note that the N8975A Option K67 uses a LO below the incoming RF so that increasing RF frequency results in increasing IF frequencies e.g. 67GHz input corresponds to 13.5GHz output.

Section 6.16 Troubleshooting

This information is in the form of suggestions to allow the technician troubleshooting the Down Converter to isolate the problem area as rapidly as possible.

The information contained in the Block and Schematic Diagrams, should be used to isolate a malfunction.

Failures generally fall into two categories: catastrophic failures or performance degradation. In both cases it is important to first verify that the failure is in the Down Converter, and not the test equipment.

Section 6.17 Check List

Make a visual inspection of the Down Converter and the connectors of any test instruments. Look for damage to the coax connectors and check that the internal fan is operating.

If the failure is catastrophic, check the +15 volt power supply.

If the LO frequency is incorrect A2A1 is faulty, replace A2 assembly.

If the problem is high noise figure, or low conversion gain, (but the LO frequency is correct), the problem is most likely a failed A2AR1 IF amplifier, or A2U1 mixer, or the input isolator, replace A2 assembly.

The IF amp has a gain of about 25dB, and a noise figure of about 6dB. The mixer has a conversion loss and noise figure of about 7dB. If these components are OK, check that the LO is driving the L port of the mixer with about +12 dBm.

After completing any repairs to the Up/Down Converter, the tests in Section 4 should be performed to ensure that the instrument is operating within the specified limits.

NOTE **The complete A2 assembly should be returned to Agilent Technologies, if faulty. It will be repaired and re-aligned before returning to the customer.**

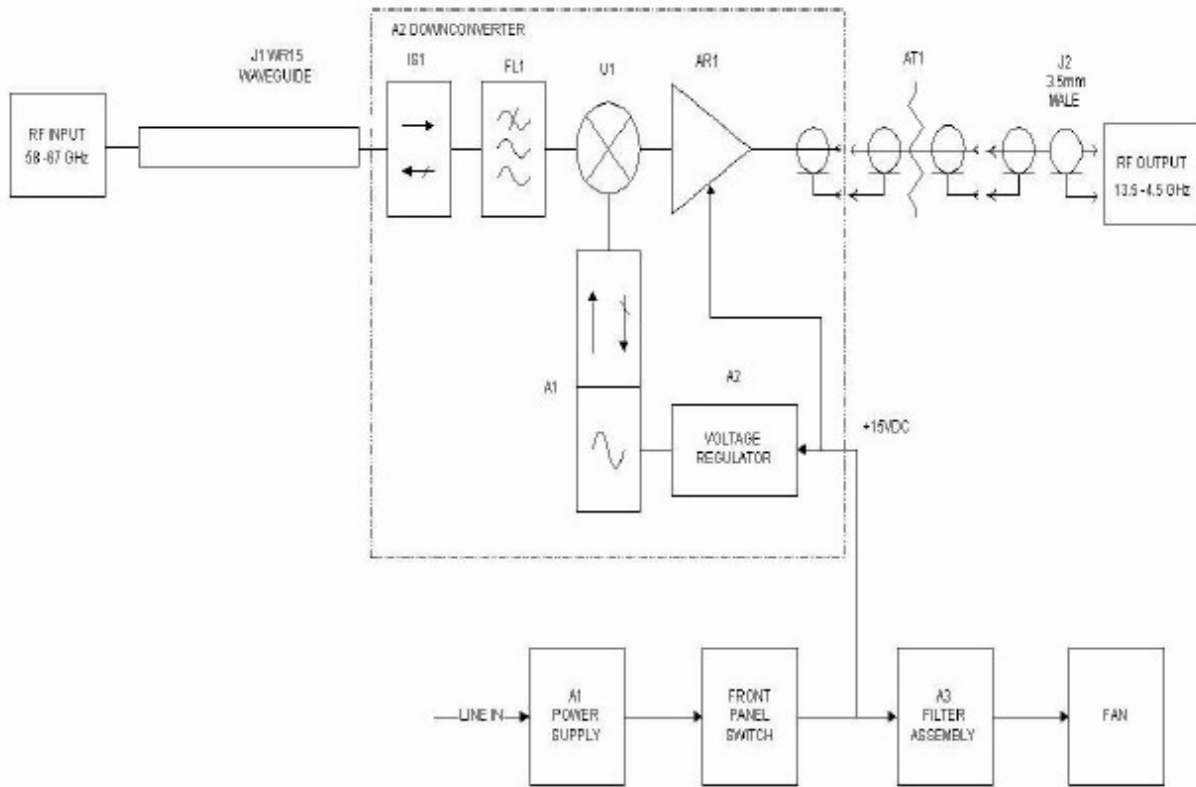

N8975A OPTION K67 BLOCK DOWNCONVERTER BLOCK DIAGRAM

Figure 6-1 Blockdown Converter

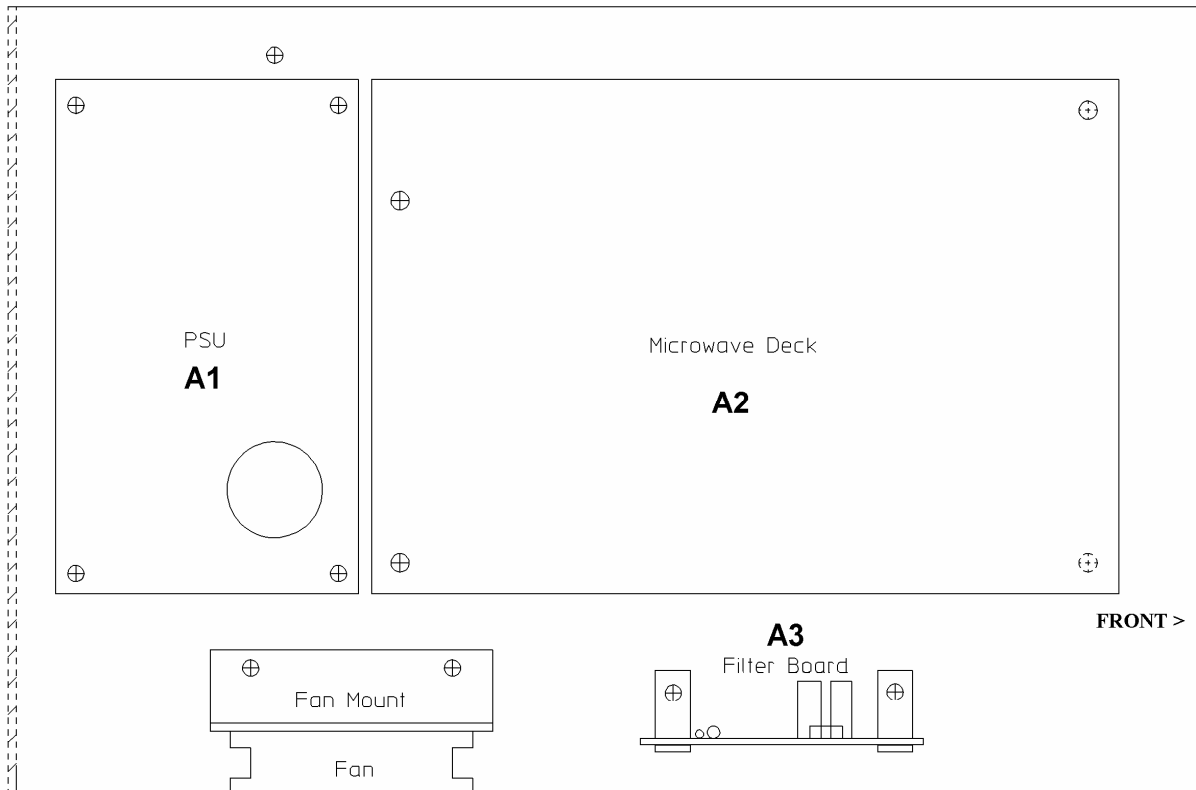

Figure 6-2 Internal Assemblies Layout

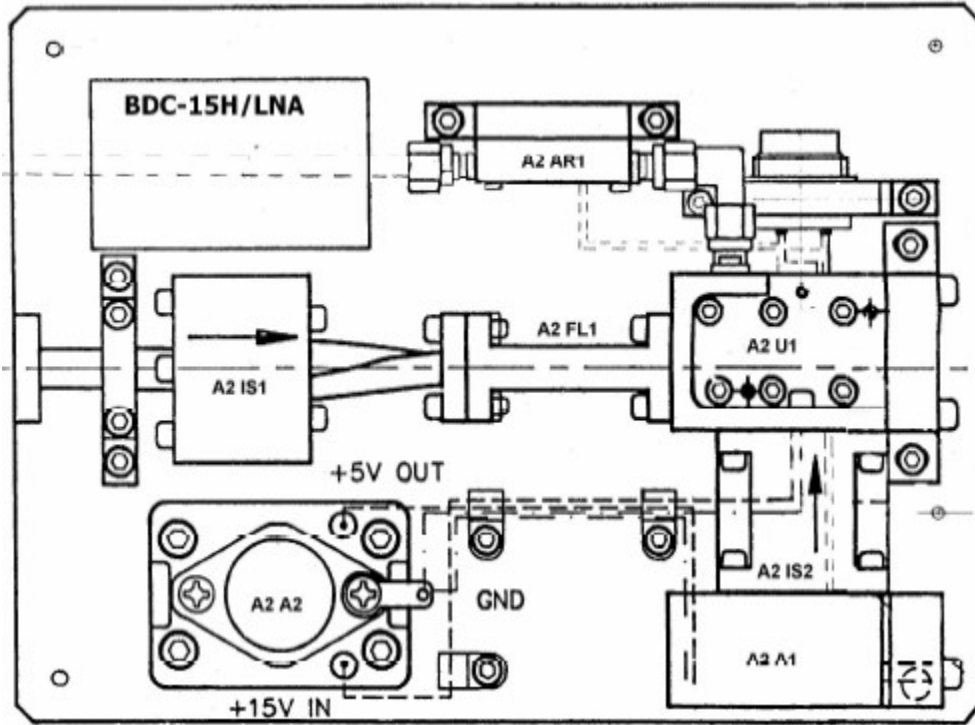
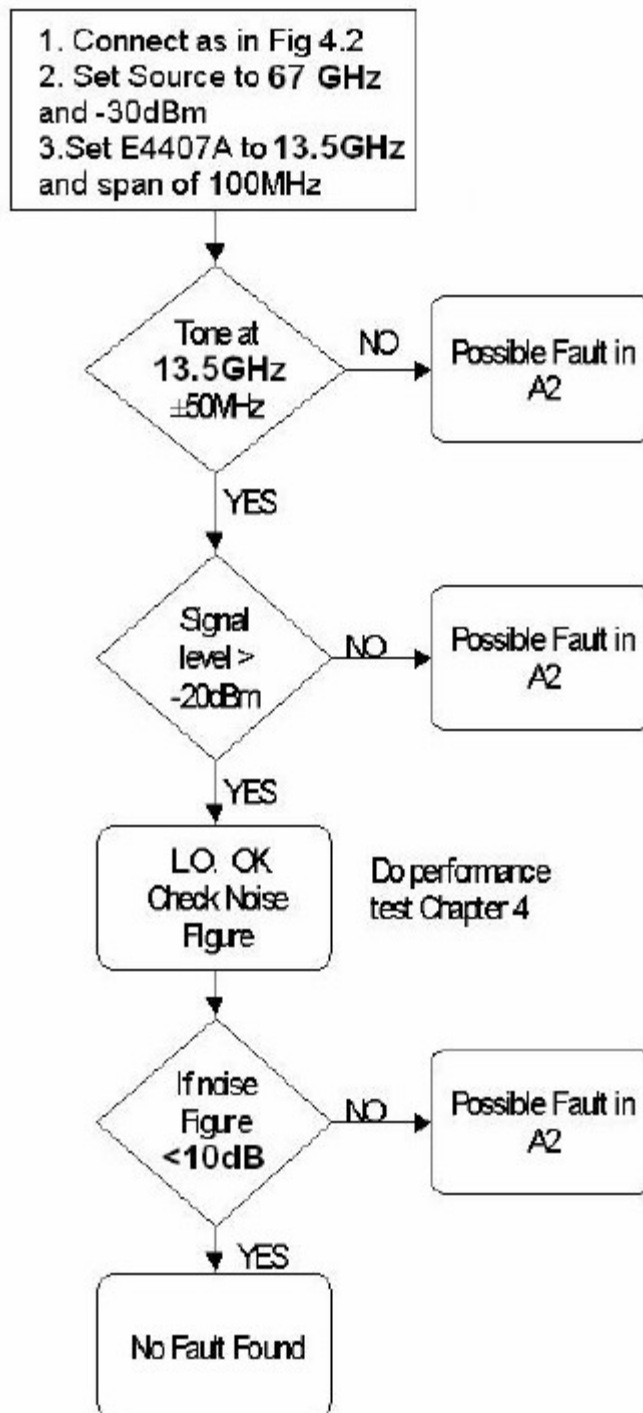

Figure 6-3 Layout of A2 Block Down Converter

Fig 6-4 Troubleshooting Flow Diagram



Chapter 7. Operating the Down Converter with the 8970B/8971C NF System

To operate the Down Converter with the 8970S/V Noise Figure Measurement System set-up the 8970S/V as indicated in section 3-13 of the 8970B Operating and Service Manual. Connect the N8975A option K67 as shown in figure 7-1.

Note: A 20dB pad should be inserted between downconverter output and 8971C input to prevent overloading.

Load the ENR data to cover the frequency range to be measured.

(i) Calibration and Measurement Procedure

As an example, the following procedure would be used to calibrate and measure the noise figure and gain of an amplifier from 58 to 67GHz every 500 MHz.

1. Set up the measurement parameters with the following key strokes;
 - a). Press [0] [.] [9] [SPECIAL FUNCTION]. Press [0] [.] [9] [SPECIAL FUNCTION] (This initialises the special functions)
 - b) Press [1] [.] [7] [SPECIAL FUNCTION] (Sets up fixed LO variable IF operation).
 - c) Press [4] [1] [.] [n] [SPECIAL FUNCTION] (Where n selects the correct system local oscillator program for the millimeter source solution chosen).
 - d) Press [2] [.] [1] [SPECIAL FUNCTION] (Sets up lower sideband operation).
 - e) Press [START FREQ] [5] [8] [0] [0] [0] [ENTER] (Start frequency 58GHz). (Ignore error E28, since the system is not yet calibrated).
 - f) Press [STOP FREQ] [6] [7] [0] [0] [0] [ENTER] (Stop frequency 67 GHz).
 - g) Press [STEP SIZE] [5] [0] [0] [ENTER] (Frequency step 500 MHz).
 - h) Press [3] [.] [1] [SPECIAL FUNCTION] [5] [3] [5] [0] [0] [ENTER] (N8975A option K67 internal LO is 53.5 GHz).
2. Calibrate the system by attaching the Noise Source to the N8975A option K67RF INPUT. When the Calibrate indicator goes out, and all bus activity has ceased, the system is calibrated.
3. Connect the device under test between the Noise Source and the N8975A Option K67RF INPUT. Press [CORRECTED NOISE FIGURE AND GAIN]. The 8970B will display the measurement frequency, the gain and the noise figure of the amplifier at each selected frequency.

NOTE For the Noise Figure Measurement System specifications to be valid, the measurement must use the same START FREQ, STOP FREQ and STEP SIZE that was used for calibration. None of the calibrated points can be skipped. Also, the measurement must be done in the same direction as the calibration, for example, from start frequency to stop frequency.

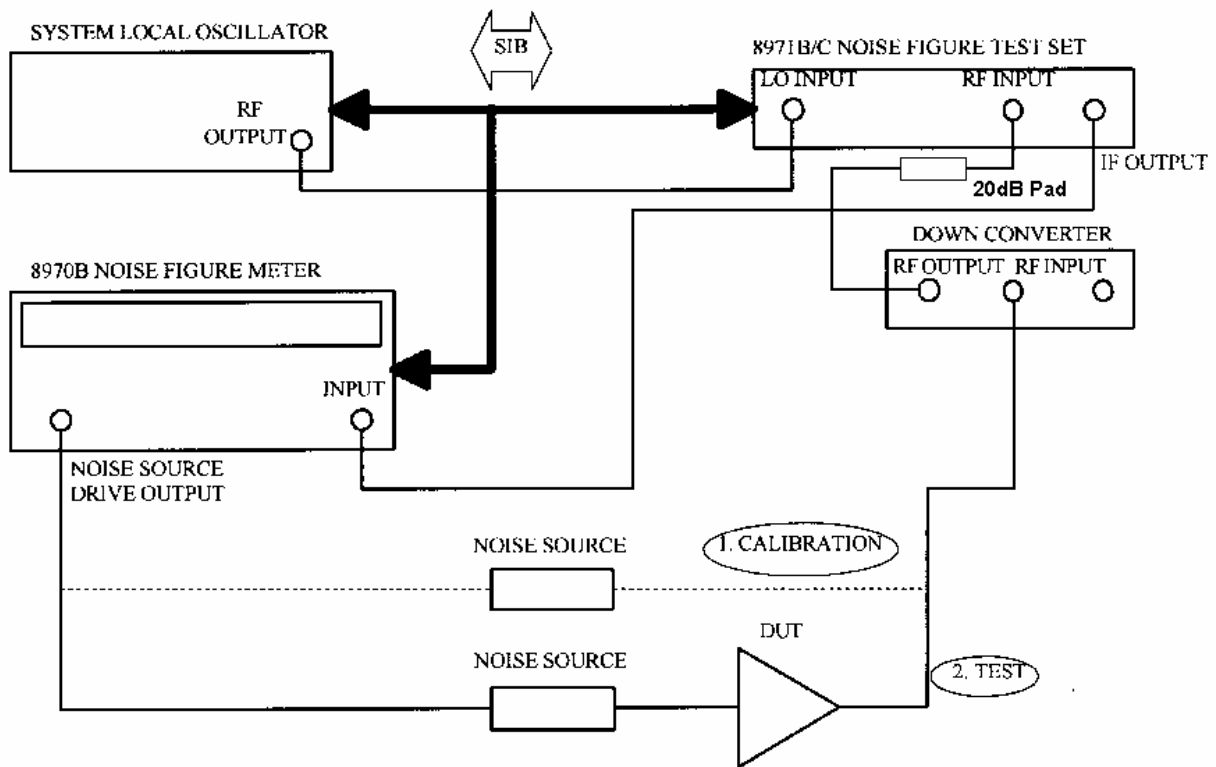

Figure 7-1 Test Setup for Calibration and Measurement with 8970B/71C

Chapter 8. Service Replaceable Parts

Section 8.01 Introduction

This section contains information for ordering parts. Table 8-1 lists all in reference designator order.

Section 8.02 Service Replaceable Parts List

Table 8-1 Replaceable Parts

ITEM	PART NUMBER	QTY	DESCRIPTION	SUPPLIER
1	E4418-61025	1	CHASSIS	Agilent Technologies
2	N8975-40001	1	FRONT SUB PANEL	Agilent Technologies
3	N8975-00001	1	BASE PLATE	Agilent Technologies
4	N8975-00002	2	FILTER MOUNTING	Agilent Technologies
5	N8975-00019	1	FRONT PANEL K67	Agilent Technologies
6	N8975-80001	1	REAR LABEL	Agilent Technologies
7	N8975-00003	1	FAN MOUNTING PLATE	Agilent Technologies
8	3160-4186	1	FAN 12VDC	Agilent Technologies
9	0380-4210	4	PSU/FILTER STANDOFFS	Agilent Technologies
10	N8975-61006	1	PSU	Agilent Technologies
11	N8975-61001	1	WAVEGUIDE WR15 RF INPUT	Agilent Technologies
12	0515-2134	4	SCREWS M3x10mm	Agilent Technologies
13	5062-1247	1	CONN 3.5 IF OUTPUT	Agilent Technologies
14	2950-0132	1	NUT for above	Agilent Technologies
15	2190-0965	2	WASHER for above connectors	Agilent Technologies
16	N8975-00016	1	EMI SCRN	Agilent Technologies
17	3101-2359	1	PANEL PUSH SWITCH	Agilent Technologies
18	08970-60104	1	PCA FILTER ASSEMBLY	Agilent Technologies
19	0515-0886	10	SCREW M3x6mm PAN	Agilent Technologies
20	0535-0025	4	NUT M3	Agilent Technologies
21	0515-1111	4	SCREW M3x16mm PAN	Agilent Technologies
22	0515-1232	2	SCREWS M3.5x8mm	Agilent Technologies
23	0535-0007	2	NUTS M3.5	Agilent Technologies

24	1251-0670	4	CRIMPS CONT-CONN F	Agilent Technologies
25	1251-2993	1	CONN SHELL POST .156	Agilent Technologies
26	0535-0023	6	NUT M4	Agilent Technologies
27	2190-0640	7	LOCK WASHERS M4	Agilent Technologies
28	1400-1552	4	ADHESIVE CABLE TIES	Agilent Technologies
29	E4418-61027	1	COVER	Agilent Technologies
30	34401-45011	1	HANDLE	Agilent Technologies
31	E4418-20008	1	REAR BEZEL	Agilent Technologies
32	34401-86011	1	RUBBER BUMPER (FRONT)	Agilent Technologies
33	34401-86012	1	RUBBER BUMPER (REAR)	Agilent Technologies
34	8150-0449	1.5m	RED WIRE	Agilent Technologies
35	N8975-20002	1	SEMI-RIGID CABLE O/P	Agilent Technologies
36	0360-0016	1	TERMINAL SOLDER	Agilent Technologies
37	8150-0005	1.5m	BLACK WIRE	Agilent Technologies
38	N8975-60015	1	BLOCK DOWN CONVERTER	Agilent Technologies
39	0515-0433	4	SCREW M4x8mm PAN	Agilent Technologies
40	0515-2134	4	SCREW M3x10mm PAN	Agilent Technologies
41	1390-0671	4	FASTENER CAPTIVE SCREW 4-40 THD- 0.312 IN	Agilent Technologies

Accessories

ITEM	PART NUMBER	QTY	DESCRIPTION	SUPPLIER
42	5063-9240	1	RACK ADAPTER KIT	Agilent Technologies
43	1250-2188	1	ADAPTER-COAX STR F-2.4mm	Agilent Technologies
44	08971-60127	1	RF CABLE	Agilent Technologies